

High Fidelity

JULY-AUG.

MILLION

SLEEPER, PUBLISHER

PRICE \$1.00



the Magazine for Music Listeners



gives you highest overall sound recording quality
...at no extra cost

audiotape has been designed, formulated and perfected to meet the most exacting requirements for modern, professional sound recording. Its mechanical and magnetic properties are carefully balanced to assure optimum overall performance in *your* recording machines.

Output, frequency response, noise level and distortion are correctly proportioned for the most satisfactory end result — with no compromise on quality anywhere along the line.

Perfected manufacturing techniques and high production volume enable this premium-quality tape to be offered to you at *no increase in price*.

Here are some of Audiotape's extra-value features:

More Uniform Frequency Response — Audiotape's output does not tend to fall off at the higher frequencies. Response remains excellent throughout the complete range of audible sound, requiring no special equalization.

Low Noise Level — Extremely uniform dispersion of magnetic particles results in exceptionally low noise level — completely free from troublesome ticks and pops. Overall signal-to-noise ratio is entirely comparable to that obtainable with average production of any premium price tape on the market.

Low Distortion — Highest quality magnetic oxide, in a coating of precisely controlled uniform thickness, results in exceptionally low distortion over a wide range of bias settings.

Maximum Uniformity — All 7" and 10" reels of plastic base Audiotape are guaranteed to have an output uniformity within the reel of $\pm \frac{1}{4}$ db or better — and a reel-to-reel variation of less than $\pm \frac{1}{2}$ db. What's more, there's an actual output curve in every 5-reel package to prove it.

Complete Interchangeability — Since Audiotape requires no special equalization adjustments, Audiotape recordings can be interchanged freely between radio stations and studios — played back perfectly on any machine.

Highest Coating Adhesion — keeps the magnetic oxide coating from rubbing or flaking off. No danger of fouling heads and guides.

Guaranteed Splice-Free — Plastic base Audiotape, in both 1200 and 2500 ft reels, is positively guaranteed to be free from splices.

Low-Tension Reel Design — with $2\frac{3}{4}$ " hub now standard for all 1200 foot, 7" reels. By eliminating the high tension zone encountered at smaller hub diameters, this reel assures more accurate timing, more constant pitch, slower maximum reel speeds and reduced wear on heads and tape.

COMPARE AUDIOTAPE in an end-to-end run with any other sound recording tape available. Compare the *prices*, too. You'll find that Audiotape speaks for itself — in *performance* and in *cost*!

AUDIO DEVICES, Inc.

444 Madison Avenue, New York 22, N.Y.

Export Dept.: 13 East 40th St., New York 16, N.Y., Cables "ARLAB"



audiotape
 audiodiscs
 audiopoints
 audiofilm

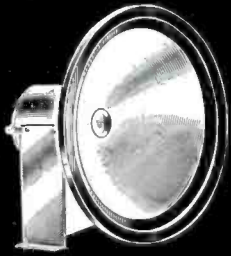

1928 Model DA-4
First high efficiency auditorium speaker

Jensen

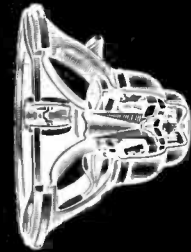

1950 Model G-610
First 3-way integral speaker

Precedents are a habit with Jensen

1st

Since 1927, world's foremost manufacturer of fine loudspeakers

The Jensen organization came into being a quarter-century ago, based on a new concept in loudspeakers. Since then Jensen has made history by consistent contributions to better sound reproduction through improved speaker performance.

This record of achievements means that the Jensen speaker you buy today is a product of distinguished experience . . . your assurance that Jensen speaker performance is *always* way ahead.

Jensen Manufacturing Company—6601 South Laramie Avenue, Chicago 38, Illinois
Division of the Muter Company—In Canada: Copper Wire Products, Ltd., Licensee



1931 Model PM-1
First PM speaker in USA

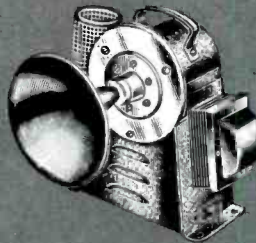

1933 Model Q
First H-F unit "tweeter"



1935 Model L-18
First 18" speaker



1937 Model KM-15
First "bass reflex" cabinet

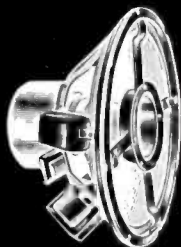

1940 Model JHP-51
First commercially available coaxial speaker

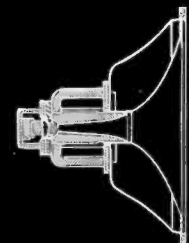

1946 Model HNP-51
First articulated compression driver coaxial

Burton Browne Advertising

Incomparable...

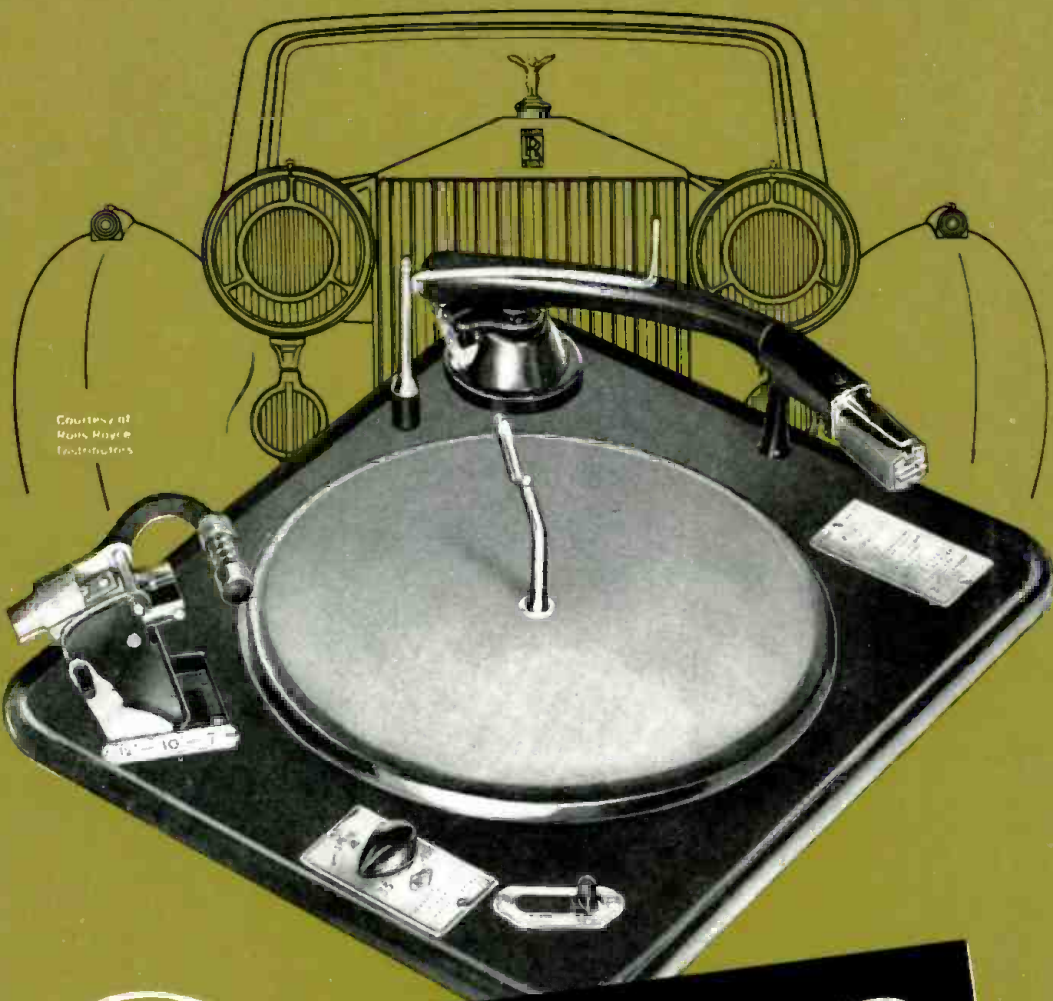

Courtesy of
RCA Victor
Electronics

**CHECK CRAFTSMANSHIP, FEATURES,
PRICE AND SERVICE ...**
and you will understand clearly why this is
the world's No. 1 high-fidelity record changer.



GARRARD
"Triumph"

-  **PUSHER TYPE PLATFORM:**
Always works . . . gently.
No complicated overarm
to dislodge records.
-  **2 INTERCHANGEABLE
SPINDLES:**
Plays records as
Manufacturer intended.
-  **HEAVY DRIVE SHAFT:**
No wows, no wavers.
-  **4 POLE MOTOR:**
No rumble . . . no
induced hum.
-  **WEIGHTED TURNTABLE:**
Flywheel action,
constant speed.
-  **MUTING SWITCH:**
Silence between
records . . .
-  **SILENT AUTOMATIC
STOP:**
Shuts off after last
record. No disturbing
"plop".
-  **EASY STYLUS WEIGHT
ADJUSTMENT:**
Protects long-playing
records.
-  **BALANCED-MOUNTED
TONE ARM:**
True tangent tracking.
-  **UNIVERSAL SHELL:**
Fits all popular
high-fidelity cartridges.

World's Finest Record Changer

Mail coupon today
for
Garrard Fact Sheet
and addresses
of dealers.

GARRARD SALES CORP., Dept. HF-6
164 Duane Street
New York 13, N. Y.

Please send literature to:

Name _____
Address _____
City _____ Zone _____ State _____

High Fidelity

THE MAGAZINE FOR MUSIC LISTENERS

Volume 3 Number 3

July - August 1953

The Cover represents a midsummer night's dream, depicted quite obviously by art-director Roy Lindstrom (who forgot to sign it) and familiar to audio-enthusiasts who live in areas favored by summer music festivals. It wouldn't have to be a mere dream, complains Mr. Lindstrom (who lives near Tanglewood) if only someone had had the forethought to wire the woods for A.C. Into each life some rain must fall.

This Issue. After the appearance in May of H. S. Rummell's *Operation Yagi*, a tale of tribulation and triumph over the FM antenna problem, so many people wrote Mr. Rummell and HIGH FIDELITY offering money for custom antennae that publisher Milron Sleeper, veteran FM crusader, decided a factual article on available FM sky-hooks was needed. No one else volunteered to write it, so he did. It begins on page 83.

When the cultural climate has ripened an idea, it's likely to appear in more places than one. Note the thematic kinship between the remarks of D. T. N. Williamson, reported by Ed Wallace in the first of the series *Adventurers in Sound* (page 32) and the ideas of John Campbell in *Hearing Is Believing?* (page 27). Are we in for a period of emphasis on psycho-acoustics?

Next Issue. The September-October magazine, according to current plans, will be HIGH FIDELITY's biggest and most gala issue, timed to appear during Audio Fair months in the East. As to the contents, there is an embarrassment of riches, which cannot be sorted nor reported effectively until the number of pages has been settled. 140? 150? Wait and see.

CHARLES FOWLER, *Editor*

JOHN M. CONLY, *Associate Editor*

ROY H. HOOPES, JR., *Assistant Editor*

ROY LINDSTROM, *Art Director*

WARREN B. SYER, *Promotion Manager*

MILTON B. SLEEPER, *Publisher*

BRANCH OFFICES (ADVERTISING ONLY). NEW YORK: ROOM 1209, 6 EAST 37TH STREET. TELEPHONE: MURRAY HILL 5-4332. FRED C. MICHALOWE, EASTERN MANAGER. - CHICAGO: 426 NORTH PINE AVENUE. TELEPHONE COLUMBUS 1-1729. CHARLES KLINE, WESTERN MANAGER. - LOS ANGELES: 1052 WEST 4TH STREET. TELEPHONE MICHIGAN 1732. EDWARD BRAND, WEST COAST MANAGER.

Authoritatively Speaking.....	5
Noted With Interest.....	7
Readers' Forum.....	13
New Books.....	19
As the Editor Sees It.....	23
More Music Than Anywhere, by Deborah Ishlon.....	24
<i>With an audiophile mayor and a Rockefeller grant, Louisville is out to show how musical a municipality can get</i>	
Listening Is Believing? by John W. Campbell, Jr.....	27
<i>The question is: is hi fi possible?</i>	
Talking Books, by Frederic Ramsey, Jr.....	29
<i>Now literature may speak for itself — at 16 revolutions per minute</i>	
Adventurers in Sound, by Edward T. Wallace.....	32
<i>Uncle Harry in the Corner</i>	
Inspiration for Custom Installations: Pictures.....	34
In One Ear, by James Hinton, Jr.....	36
KPFA, Berkeley, by Alfred V. Frankenstein.....	38
<i>California's Listener-Sponsored FM Station</i>	
MUSIC AND RECORDS SECTION.....	41-80
News of SME, by Lisbeth Weigle.....	81
The Right Antenna, by Milton B. Sleeper.....	83
<i>Your FM tuner will respond if you feed it properly</i>	
Sound Poll, by Charles Fowler.....	86
<i>With this gadget, you needn't guess at sound or noise levels — and you may be surprised</i>	
Tested in the Home.....	88
Brook Amplifier System	
Karlson Enclosure	
Two Altec Speakers	
Permoflux Headphones	
Gately Super Horn	
Professional Directory.....	95
Music Listener's Bookshelf.....	97
Traders' Marketplace.....	123
Advertisers' Index.....	127

HIGH FIDELITY MAGAZINE IS PUBLISHED BI-MONTHLY BY AUDIOCOM, INC., AT GREAT BARRINGTON, MASS. TELEPHONE, GREAT BARRINGTON 1300. EDITORIAL, PUBLICATION, AND CIRCULATION OFFICES AT THE PUBLISHING HOUSE, GREAT BARRINGTON, MASS. SUBSCRIPTIONS: \$5.00 PER YEAR IN THE UNITED STATES, CANADA, AND COUNTRIES OF THE PAN-AMERICAN POSTAL UNION. SINGLE COPIES: \$1.00 EACH. EDITORIAL CONTRIBUTIONS WILL BE WELCOMED BY THE EDITOR. PAYMENT FOR ARTICLES ACCEPTED WILL BE ARRANGED PRIOR TO PUBLICATION. UNSOLICITED MANUSCRIPTS SHOULD BE ACCOMPANIED BY RETURN POSTAGE. ENTERED AS SECOND-CLASS MATTER APRIL 27, 1951 AT THE POST OFFICE AT GREAT BARRINGTON, MASS., UNDER THE ACT OF MARCH 3, 1879. ADDITIONAL ENTRY AT THE POST OFFICE, PITTSFIELD, MASS. PRINTED IN THE U. S. A. BY THE BEN FRANKLIN PRESS, PITTSFIELD, MASS. COPYRIGHT 1953 BY AUDIOCOM, INC. THE COVER DESIGN AND CONTENTS OF HIGH FIDELITY MAGAZINE ARE FULLY PROTECTED BY COPYRIGHTS AND MUST NOT BE REPRODUCED IN ANY MANNER OR IN ANY FORM.

FROM THE ORIGINATOR OF **Lp**
 AN INSTRUMENT CREATED FOR **Lp** SOUND!

THE NEW COLUMBIA 360

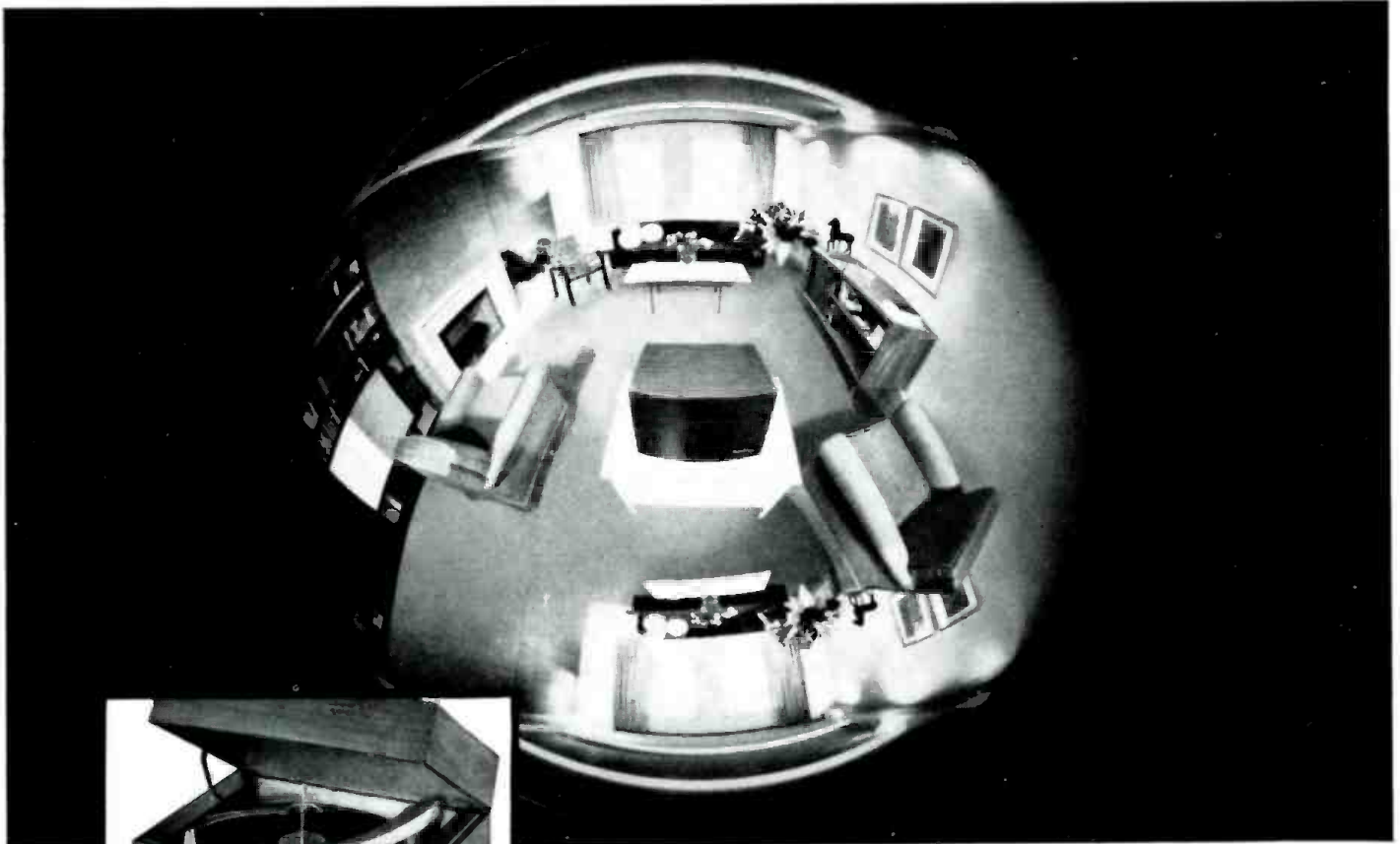

SWITCH IT ON AND THE WHOLE ROOM PLAYS

The smallest, lowest priced high fidelity instrument ever developed. Plays *all* records, *all* speeds, automatically. Engineered and built by CBS Laboratories and Columbia Records. Available in limited quantity. \$139.50 in mahogany (other finishes slightly higher).

THE PERFECT MATCH!

Hear these *new* high fidelity Columbia "Lp" Records on the instrument designed specifically to reproduce their full realism, clarity and extended range of sound! ▶

EXCLUSIVE DEVELOPMENT OF

COLUMBIA RECORDS

"Columbia," "Masterworks," "Lp" Reg. U. S. Pat. Off. Marcas Registradas. "360" Trade-Mark.

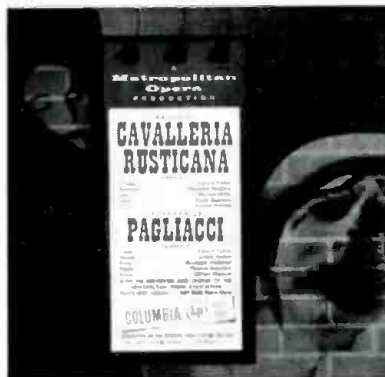

NEW MET PRODUCTION CAVALLERIA RUSTICANA

A high fidelity recording with the *complete* performance of the Met's new Cavalleria. Available as a set with the *complete* Pagliacci or sold separately.



DON JUAN — DEATH AND TRANSFIGURATION

Both Strauss works on one new extended range "Lp" record. Bruno Walter conducts The Philharmonic-Symphony Orchestra of New York.

HIGH FIDELITY MAGAZINE

AUTHORitatively Speaking

Deborah Ishlon, who wrote *More Music Than Anywhere* (see page 24), is press director for Columbia Records and, beyond dispute, one of the best publicity operatives on Manhattan Island, a fact which surprises no one more than herself. She came first to Columbia, a shrinking scholar, in search of a job to pay her way to a Master's degree (sociology) at Columbia University. Now she shrinks, she says, at nothing—even taking Jimmy ("I saw Mommy kissing Santa Claus") Boyd to lunch at Toots Shor's, or dining out with Johnny Ray. However, her interests still outspan the uses of publicity, and when she saw the Louisville music-phenomena, she had the urge to write—even though she had to promise to keep mention of Columbia Records to an irreducible minimum.

When John W. Campbell, Jr., author of *Hearing Is Believing?*, graduated from MIT some years ago, he found he was ahead of the times. His degree was in nuclear physics, and atomic energy was still in the future. So he joined it there—by becoming editor of Street & Smith's magazine *Astounding Science Fiction*. Campbell is generally regarded now as "father" of highbrow science fiction (at one time, ASF had six Nobel prizewinners as regular readers.) He is also author of a non-fiction work on nuclear energy, *The Atomic Story* (Henry Holt, New York, 1947) and pleads guilty to having written the short story from which Hollywood contrived *The Thing*. He has been, he says proudly, a hi fi tinkerer for years, and thinks there is an affinity between the two interests—hi fi, that is, and science-fiction.

Frederic Ramsey, Jr., whose coverage of Audio Books begins on page 29, has just been awarded a Guggenheim fellowship to study pre-jazz Afro-American music, now that he has finished his 11-LP anthology of jazz (for Folkways) and almost finished another LP of the fabulous Leadbelly's last session, soon to be published. His other recording ventures include the American Museum of Natural History's *Tropical Rain Forest* and *Men of the Montanas*. In his idle (!) moments he has written about recordings and books for *Charm*, *Record Retailing* and *Saturday Review*.

Alfred V. Frankenstein, who describes the operation of KPFA, the listener-supported FM station in Berkeley, Calif., (page 38) really needs no introduction to HIGH FIDELITY readers, since he has been reviewing records (mostly modern music) for HF nearly a year. However, it may not be amiss to remind them that he is one of the half-dozen true notables among American music critics. He has fulfilled this function chiefly at the *San Francisco Chronicle* since 1934, but also has taught or lectured at the University of Chicago, University of California, Stanford, Middlebury, Harvard, Mills, University of Minnesota and other institutions of higher learning. He is an authority not only on music, but on art; he discovered the set of paintings which were the subject of Moussorgsky's *Pictures at an Exhibition*. Wical, he is still an A-1 reporter.

REALISM WITHOUT NOISE

WEATHERS

FREQUENCY MODULATION
PHONOGRAPH PICKUP SYSTEM

NEW! Weathers Reproducer Arm
for the W-2 FM Capacitance Pickup
(For Standard W-2 Cartridge Only)
W-216 Arm and W-202 Cartridge.
Set for any 16" transcription turntable

DB

20 50 100 200 300 1K 2K 5K 10K 15K

CYCLES PER SECOND

Typical frequency response curve produced with Cook Series 10 Test Record. (Response over 500 cycles compensated to obtain constant velocity characteristic.) Terminals provide compensation based on AES Standard Playback Curve or constant-amplitude response, as preferred.

Soon . . .
You'll own a Weathers!

If you've heard the super-smooth, precision-engineered, realism-without-noise performance of the Weathers, you'll soon join the thousands of happy people who own this finest of all performers.

First whispered about—then shouted about, the news is all over the country—from coast to coast, that the ultimate in performance can now be yours, with a Weathers.

Our fine new plant (doubled in size within the year) is enabling us to speed up our output daily. If we have not caught up with your order yet, please be patient. Write for our dealer list and then drop in to hear for yourself the reason why the full-range, noise-free Weathers is in such demand.

Send for technical information

WEATHERS INDUSTRIES

BOX 531, 66 EAST GLOUCESTER PIKE
BARRINGTON, N. J.

W-2 FM
Capacitance
Pickup
Cartridge

Weathers
Oscillator

Weathers
Power
Supply

McIntosh

LABORATORY, INC.

brings you 99 $\frac{96}{100}$ %*

perfect amplification

Featuring the Patented McIntosh Circuit

30_{WATT} AMPLIFIER

The power you need with the distortion free performance you can always expect with a McIntosh. Companion model to the McIntosh 50, this new Model A-116 was designed expressly for those who demand professional performance in home sound reproduction systems. It features the same patented McIntosh output transformer circuit as in the widely acclaimed 50 watt model. Step up your listening pleasure . . . step up to a 30 watt McIntosh high fidelity amplifier.



LOST INSTRUMENTS

Do you have your copy of the booklet "Lost Instruments"? It's a free 32 page explanation of the why's and wherefore's of high fidelity sound. Write for yours today!

** All but 0.0004 of power output is a perfect reproduction of input signals at 30 watts.*



McIntosh

LABORATORY, INC.
320 Water Street • Binghamton, New York
Export Division, 25 Warren St., New York 7, N. Y.



Audio Show

Every year in mid-May, electronic equipment manufacturers gather in Chicago to exhibit their latest wares — the items which the public will begin to see in the early Fall. The Parts Show is intended primarily for parts jobbers, audio equipment dealers and custom installation organizations, so they can prepare well in advance for the Fall season. Here's a quick run-down of some of the new audio items which you will see at the September Sight and Sound Exposition in Chicago and at the New York Audio Fair in mid-October:

Item of biggest interest is the entry into the custom equipment field of some of the big names in the television receiver and what we have called "commercial" radio-phonograph business: RCA and General Electric. Stromberg-Carlson led the way last year with its Custom 400 lines, which, by the way, has been revamped and improved. Components available include TV tuners, FM-AM tuners, amplifiers, speakers, and cabinets. The record changer is a Garrard with a GE cartridge.

General Electric has had one or two items in the hi-fi field for many years, notably its pickup and 12-inch speaker. A pair of simple preamplifiers have also been available, along with a record equalizer which was exhibited last Fall in New York. Now the line has been made much more complete with the addition of two tone arms, one for records up to 12 inches in diameter, the other a transcription arm for use with 16-inch records.

Also in the General Electric "Custom Music Ensemble" is a preamplifier control unit which incorporates a loudness control, bass and treble tone controls, and the record equalization control mentioned above. Matching this unit is a 10-watt power amplifier. Specifications on both units are excellent.

Finally, the General Electric group is completed by a new 12-inch coaxial speaker. Prices on the GE line are all in the middle bracket: the power amplifier will be under \$50, the preamplifier under \$60, and the speaker under \$40.

The RCA group of equipment requires a 12-page catalog for a complete description. Leafing through, we find that they offer a record changer (Garrard-made), two FM-AM tuners, a preamplifier, three power amplifiers, three speakers, an equipment cabinet and a speaker cabinet. The price range of a complete system is from around \$125 to \$800 or so.

Wandering the Booths: Regency is introducing a hi-fi line of equipment — tuner, power supply, and power amplifier. Very

Continued on page 9

JULY-AUGUST, 1953



the Moderne
Model UR-312 Available in Cherry Mahogany, Blond Mahogany, or Lined Oak.
User Net: \$ 64.50
Blond and Lined Oak—10% extra

LOOK at the styling . . .
LISTEN to the reproduction . . .

the new *Musicorner*

by **UNIVERSITY**



the Traditional
Model UR-311.
In Cherry or
Cordovan Mahogany.
User Net: \$ 64.50

the Provincial
Model UR-310.
In Maple
or Fruitwood.
User Net: \$ 64.50

Now you can have good "looking" with good listening! Each University MUSICORNER design is authentic in every detail, and reflects the traditions of the old masters of fine furniture. All genuine woods—hand rubbed! Designed to flatter the decor with stylings that smartly blend with any existing interior.

University Musicorner gives you wide angle coverage, clarity and brilliance with its full front radiation. High power handling ability and distortion control, with an internal and extended horn. And, boosted low frequency response with high efficiency, from its unique integral bass reflex system.

THE HEART OF THE *Musicorner*

Model 6201, 12" coaxial speaker system. A TRUE coaxial dual range system, with woofer, and driver type tweeter, built-in crossover network, and "balance" control. Finest to be had! User Net: \$ 45.00



The exclusive University Diffusicone-12 speaker is acclaimed by experts everywhere! Here, in the economy of one speaker you get dual-horn loading, radial projection, and diffraction—to give unsurpassed fidelity, range, and uniform sound distribution. User Net: \$ 27.00



Model 6200, 12" extended range speaker. Gives highly efficient full-bodied response throughout the operating spectrum. User Net: \$ 21.00



FREE BOOKLET!
describing these
wonderful enclosures in
greater detail.

University LOUDSPEAKERS, INC.

80 SOUTH KENSICO AVENUE • WHITE PLAINS, N. Y.

How High can High Fidelity be?

IF YOU could sit in with the select few on the staff of a major record company, you might hear the playback of a master tape of a great symphonic recording. You would be listening to the highest order of fidelity achieved in musical reproduction — something in a distinct class above even the best recorded music *ordinarily* heard elsewhere.

These master tapes are so near to perfect that their deviations from the original sound are beyond the perception of the human ear. The master tapes must not only satisfy the best record making techniques today — but they must anticipate the requirements of the finest reproduction methods of ten, twenty, or fifty years from today.



Ampex tape recorders in a studio of Capitol Records — typical of the demanding professional uses of this high fidelity machine.

It is an open secret how the extraordinary fidelity of these master recordings is achieved. The instrument is the Ampex Magnetic Tape Recorder which is now installed in practically all of the commercial recording studios in America. Although Ampex machines are thoroughly professional equipment — the finest tape recorders built — they are being installed in an increasing number of private homes where the ultimate in musical enjoyment is desired.

People in the music and entertainment fields were among the first to recognize that Ampex Recorders had a place in the home. Some of the great musicians of our time are among



An Ampex installed in a custom home music system. In this installation, sliding panels conceal the recorder and speaker when not in use.

the distinguished owners of Ampex Recorders. For them it provides recorded music and personal performances with a perfection that fully satisfies their highly developed tastes.

In your home an Ampex Recorder can serve both as a recorder and a superlative playback instrument. Pre-recorded tapes are becoming available in an increasingly wide selection of symphonic and incidental music. Also, live F-M broadcasts bring to you a wealth of music of flawless quality and brilliance. While listening to a broadcast, you can make your own "master tapes" which can be replayed countless times. Their extraordinary fidelity is completely permanent, giving you a personal library that will be a lifelong source of tremendous satisfaction.

The answer to "How high can high fidelity be?" may also be your answer to how great can listening pleasure be. If you enjoy owning things that are undisputably the best in their field, an Ampex Recorder and a custom music system belong in your home.



for further details write today.

934 CHARTER ST. • REDWOOD CITY, CALIF.

NOTED WITH INTEREST

Continued from page 7

gorgeous, very high-priced . . . Garrard has redesigned its single-play turntable and is adding a gear-driven changer . . . To its famous Patrician-line, Electro-Voice has added another four-way speaker system, the Georgian. It's \$495 . . . Much interest, and justifiably, in the new Crestwood tape recorders. As we predicted a year ago, ways and means would be found to get wide-range recording and reproduction from a tape speed of 7½ ips and at a reasonable cost. The new Crestwood operates at both 7½ and 3¾ ips; brief listening indicates good sound . . . Radio Craftsmen displayed their new Model 900 FM-only tuner; it is a stripped model having only tuning and volume controls, plus an AFC on-off switch. Specifications indicate advanced design and high sensitivity. . . . An organization by the name of Cousino, Inc., of Toledo, caused a good many people to appear slightly demented. Cousino makes continuous-playing mechanisms which attach to most tape recorders for repetitive sales messages, teaching, and so forth. However, when the same piece of tape is run through a machine a few hundred or thousand times, as a continuous strip, the pull is severe and normal tape tends to stretch. To overcome this difficulty, Cousino developed a tough tape . . . at the Parts Show, they gave out pieces of it, telling people to try to break it. Thus many a visitor could be seen standing quietly in a corner, tugging vigorously. We couldn't break ours!

Good Music — in Atlanta

A HIGH FIDELITY reader wrote us recently that "high fidelity has come to Atlanta at last. Radio Station WBGE has started using their FM transmitter to broadcast a program of classical music." We wrote the station for more information and promptly received this reply: "On December 14, 1952, we started a three-hour concert of fine music. The support and written response to this program was so overwhelming that on March 1st we expanded our programming to encompass a six-hour period. From 4 to 10 p.m., the finest in recorded music is available to lovers of good music in the Atlanta area.

"When we decided to go on the air with fine music, our chief engineer and his staff designed and constructed the studio layout, amplifiers, and so on to feed the General Electric FM transmitter. We faithfully transmit the full frequency range of the finest recordings. We have by no means completed our task of broadcasting the utmost in high fidelity, but constant improvements are being made to all parts of our equipment."

Congratulations to the General Broadcasting Company for its courage, and thanks to Rod Davidson, Program Director of WBGE-FM for his informative letter.

Record Storage

The old problem of how to store phonograph records is still with us, but readers

Continued on page 11



MODEL 50-R

**IT'S
HERE!
IT'S THE
BEST!**

FISHER

FM-AM TUNER

■ We haven't the space here to give you *all* the details on the new FISHER 50-R. However, we *can* tell you *there is no other like it*, anywhere, and at any price! **FEATURES IN BRIEF:** Armstrong system, dual limiters, two IF stages, cascode RF stage, full limiting even on only 1 microvolt signal. Sensitivity, 1.5 microvolts for 20 db of quieting. AFC on switch and adjustable for locality. *Adjustable selectivity on AM.* Separate AM and FM front ends, fully shock-mounted. Response uniform, 20 to 20,000 cycles. Distortion less than 0.04% for 1 volt output. Hum level more than 100 db below two volts output. Cathode follower output. Fully shielded; bottom cover. Aluminum chassis. 12 tubes plus tuning eye and rectifier. Self-powered. **\$159.50**

"Of the very best!" —HIGH FIDELITY
MAGAZINE

FISHER

PREAMPLIFIER EQUALIZER

■ "Either of these two units is of the very best," says *High Fidelity Magazine* of the FISHER 50-C Master Audio Control and 50-A Amplifier. The 50-C can be used with *any* amplifier. Intermodulation distortion is virtually unmeasurable. Complete phono equalization, loudness control, 5 inputs, 5 input level controls, cathode follower outputs. Self-powered.

Chassis, \$89.50
With cabinet, \$97.50



FISHER

50-WATT AMPLIFIER

■ THE FISHER Laboratory Standard Amplifier Model 50-A is, beyond a shadow of a doubt, *the world's finest all-triode amplifier*—and yet moderately priced. **FEATURES:** High output—less than 1% harmonic distortion at 50 watts (.08% at 10 watts.) Intermodulation distortion below 2% at 50 watts. Uniform response within .1 db, 20-20,000 cycles; 1 db, 5 to 100,000 cycles. Hum and noise more than 96 db below full output. Quality components and beautiful workmanship throughout. **\$159.50**

Write for illustrated brochure

FISHER RADIO CORPORATION
45 EAST 47th STREET • NEW YORK

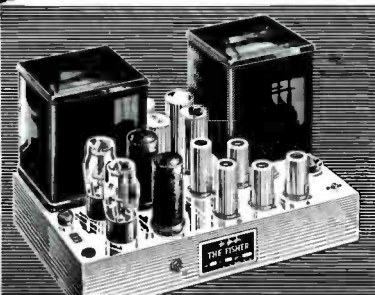



MODEL 2199

BELL'S NEWEST ADDITION TO ITS FAMOUS LINE OF HIGH FIDELITY AMPLIFIERS



FEATURES



Here is an amplifier that gives a new high in performance! Designed in Bell's laboratories, Model 2199 incorporates all those features of fidelity and flexibility you would expect to find only in a much more costly unit. In addition, a removable etched dial plate and four 1 $\frac{3}{4}$ " extension shafts are furnished to simplify mounting in any cabinet or custom installation. A socket is provided for Bell's Model 2201 pilot light assembly, and three 117 volt convenience outlets on the chassis permit control of your entire audio system by the master power switch on the amplifier.

WRITE FOR CATALOG NO. 101

Power output of 12 watts or more
 Amplifier more than 99% distortion-free
 Record equalization for AES, LP/NAB
 and foreign records
 Printed circuit compensated volume
 control
 Separate bass and treble controls with
 boost and cut
 Switch for switching compensation in
 or out
 Switch for motor rumble suppression
 Output jack for direct connection to
 recorders
 Switch for input selection
 Extremely low hum level



BELL SOUND SYSTEMS, Inc.

555-57 MARION ROAD, COLUMBUS 7, OHIO

Export Office: 401 Broadway, N. Y. 13, N. Y. • Cable Address: UNIONTEX

NOTED WITH INTEREST

Continued from page 9

have brought two solutions to our attention. One is a record and music storage chest manufactured by the H. L. Hubbell Manufacturing Company in Zeeland, Michigan. The overall size is 30 inches high, 19 1/4 inches wide, and 22 1/2 inches deep. There are two drawers, both of which operate like regular office filing cabinet drawers, with follower blocks to keep the contents upright. The lower drawer is 12 1/4 inches high by 15 inches wide, and so will hold 12-inch LP's or 78's. The upper drawer is 10 3/4 inches high by 15 inches wide—which is large enough for 10-inch records or for sheet or book music. The music chests come in a variety of styles and wood finishes; price is \$44.95 FOB Zeeland. They are available only direct from the factory, since Hubbell does not sell through dealers.

Roughly, you ought to be able to store about 125 records in each drawer, more if you take the records out of their jackets and use thin separators.

A totally different solution is offered by the Yield House at North Conway, N. H. Their motto seems to be, "Use your walls!" and that's where they suggest you put your records. They have a wall-hanging pine rack with four partitions which will hold up to 100 or so 10-inch records. The overall size is 22 inches wide by 27 inches high by 5 3/4 inches deep. While this rack is designed for 10-inchers only, rumor has it that if there were sufficient demand, they could make a slightly wider rack which would hold 12-inch disks. Price of the available rack is \$18.95, express charges collect.

Yield House, it might be mentioned, is another interesting organization. The only things they sell are those which hang on walls—and they have managed to attach the most unusual objects to plaster and lath. Gun racks, pipe racks—of course. And a silverware rack! All lined, just like a silver chest, with slots for knives, forks, spoons, etc., plus a couple of drawers for larger objects.

While you're sending for catalogs, you might as well send for this one, too—ask for their No. 42, and see what original ideas you'll get for Aunt Martha's birthday.

Good News: Prices Reduced!

Hi-fi enthusiasts may consider themselves doubly blessed and a rare species besides. Not only can they enjoy good music at its best but—and this is where the rare species business comes in—the cost of their hobby is going *down!* We've read the announcement from Fairchild three times over to be sure we're not making a mistake, but it's right there in black and white. Fairchild has reduced the cost of their series 215 cartridges from \$47.50 and \$42.50 to \$37.50! My smelling salts, please!

More power to Fairchild. Others in the hi-fi equipment field are finding that zooming interest in good reproduction of home music is raising production, and prices are beginning to creep down in several lines.

BEST VALUE IN TAPE RECORDING HISTORY!



HiFi Crestwood 400's

Crestwood engineering makes tape recorder history! Matches the finest professional equipment in hi-fi performance—frequency response of 40 to 12,000 cycles at 7 1/2" per second tape-speed. Yet costs only \$199.50 to \$299.50 (taxes not included). All Crestwoods exceed NARTB standards.

NEW Crestwood 303



Nothing like it at the price—little like it at many times the price! Unusual high-fidelity performance—50 to 10,000 cycles frequency response at 7 1/2" per second tape-speed—for only \$199.50 (taxes not included). Smart styling, too.

Crestwood
BY DAYSTROM

TAPE RECORDERS

Open a Brand New World of Recorded Sound

----- SEND IN COUPON TODAY -----

Crestwood Division of Daystrom Electric Corp., Dept. HF-6, Poughkeepsie, N. Y.

Please send me complete information about the new Crestwood models.

My name _____
 City _____ Zone _____ State _____
 Address _____
 My dealer's name _____
 Address _____
 City _____ Zone _____ State _____



Approach listening perfection...

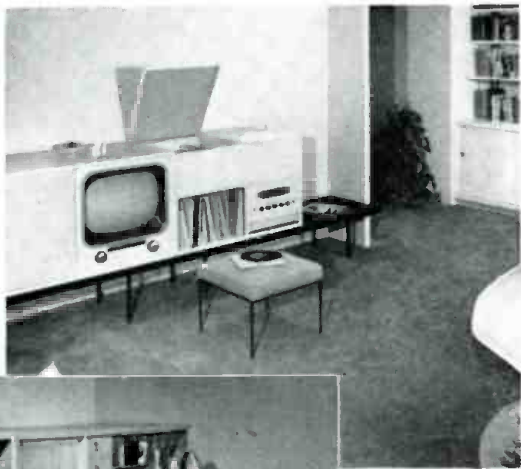

put a Webcor "HF" Diskchanger
in your high-fidelity installation



from \$4950
(available with G. E. triple
play cartridge or equipped
to accommodate your own
special cartridge)

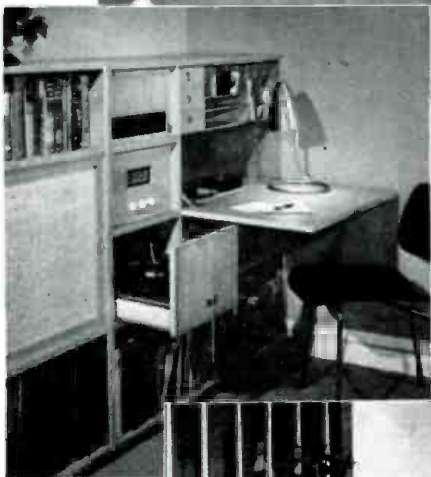

The Webcor 3-speed high-fidelity diskchanger provides super-accurate tracking with absolute minimum "rumble," "wow" and "hum." Changes precious records quickly, gently. Gives up to four hours of supreme listening pleasure. Easily installed in *any* custom installation . . . with or without a base pan.

See and hear a Webcor diskchanger at your music dealer today!

A Webcor Diskchanger is the heart of every High-Fidelity Installation



Webcor®

by Webster-Chicago — Chicago 39, Illinois



© w/c 1953 4271

designed and installed by Voice and Vision



SIR:

I have just been lent some copies of HIGH FIDELITY by a friend. The wealth of information in the magazine has been a revelation to me.

I hope this year to be able to get one or two items brought over from the U. S. A. by friends. Any form of intelligent choice was quite impossible before reading your magazine. Having read some of the issues my head goes round and round!

In France few people seem to have interest in music sufficient to wish for adequate reproduction of the music either broadcast or recorded. There seems to be practically no apparatus of high fidelity standard available. The only available sound equipment is excessively priced. Records are very expensive — a twelve-inch LP sells for the equivalent of *nine dollars*, and it is only with difficulty (and unofficially) that one can get ten percent off. I had some hopes of the situation being improved with importations from England or the U. S. A., but there is very little of that and on the way something queer happens to the prices of the apparatus. I have for, example, a list of the prices of Webcor products here; the model 210 tape recorder sells for the equivalent of \$670 (six hundred and seventy in case you think it is a typing error!)

G. H. Norie
Paris, France

SIR:

The disturbing element of predilection is beginning to creep into Mr. Burke's reviews, but particularly infuriating are his uncommonly graceless and gratuitous asides on the Maestro who Mr. Burke characteristically chooses to call Mr. Toscanini. If I am impressed with Mr. Burke's absence of that awe that a Toscanini performance invariably inspires in me, I am more than a little outraged at his calling the Maestro's reading of the Beethoven Fifth "perhaps, a little absurd," as one who fires a harmless pasquinade at the back of a retreating hero in perverse retaliation for having to salute mortality. When one is not in the mood for the great C minor symphony, Beethoven is perhaps a little absurd. And then again, perhaps Mr. Burke belongs, unhappily, to a minority who have a tendency to "mirth in funeral and dirge in marriage" which certainly does not become a reviewer whose opinions must, in the main, be wholesome and free of neuroticisms.

The bitter preamble to Toscanini's great service to Beethoven affords Mr. Burke with more opportunities for devotion to his own

Continued on page 15

EVERYBODY'S TALKING ABOUT NEWCOMB'S "AUDI-BALANCE"

PATENT APPLIED FOR

"The greatest amplifier improvement in recent years" . . . A godsend to both owner and service man." . . . "It used to take me hours to do what Audi-balance does in seconds." . . . "Does even better than I've been able to do with meters, this balances tubes dynamically." . . . "The problem has plagued us for years, it is now possible to keep perfect balance in output tubes consistently for lowest distortion." . . . "Audi-balance is the perfect solution."

Just one of the features that make the brand new Classic amplifiers by Newcomb so exciting. Write for catalog of 8 completely new home music amplifiers priced from \$39.50 to \$269.50 audiophile net.

The Classic 25

For the sound thrill of a lifetime this superb new 25 watt custom amplifier has every practical operational feature electronic engineering can offer you. Even more important is the incomparable listening pleasure it provides.



The Classic 15

This outstanding 15 watt amplifier is unique in luxury features and technical perfection of a surprisingly moderate cost. Its smoothly designed remote control unit is a superlative piece of engineering, beautifully finished in brushed brass.

Substantial Installation Savings

Savings of as much as, or more than, the entire cost of these fine amplifiers are being reported by enthusiastic purchasers. This is due to their unique design which removes the usual necessity of a remote control being near the amplifier, tuner and changer. These items can now be installed in a hall closet or any similar out of the way location leaving only the beautiful remote control and

the speaker, with no messy confusion of wires, in the living room. No accessories connect directly to the remote control. All inputs connect only to the main amplifier. The savings in cabinetry and of installation labor are obvious and very real to those who take advantage of this new complete remote control design.

NEWCOMB

DEPT. W 6824 LEXINGTON AVENUE, HOLLYWOOD 38, CALIF.

15 years of quality leadership

Write for Catalog



ALL NEW, ALL IMPROVED

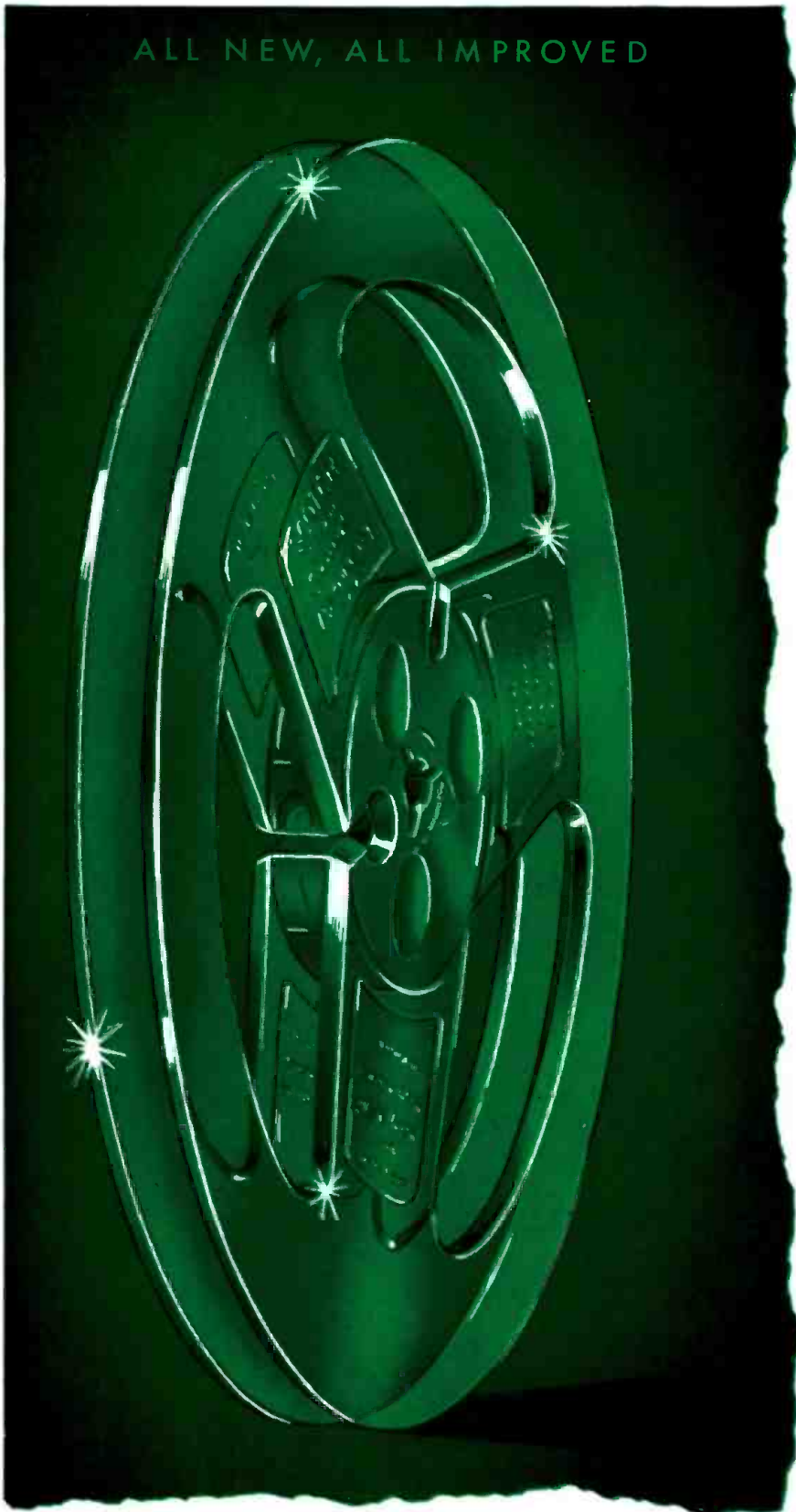

It's the exclusive

REG. U.S. PAT. OFF.
SCOTCH
BRAND

"V" SLOT 7" PLASTIC REEL

Now—enjoy the ultimate in easy handling, in smooth performance on all machines with the all new, all improved "Scotch" Brand "V" slot 7" reel. It's the first truly *functional* plastic reel. 1200 ft. lengths of 111A and the sensational new 120 "High-Output" "Scotch" Brand Magnetic Tape are wound on this new "V" slot 7" reel—splice free.

Check these exclusive features:

- ⊕ "V" SLOT. Say goodbye to threading problems with the easiest, quickest threading device yet perfected.
- ⊕ LARGE 2 1/4" HUB. The only reel that accommodates standard lengths of all magnetic tapes and minimizes timing errors. Eliminates tape spillage in rewind.
- ⊕ WIDE SPOKES. 45% more plastic has been added for extra rigidity. Runs true, balanced to a whisper.
- ⊕ TAPERED FLANGES eliminate frayed tape edges. Get a smoother wind with this precision feature.
- ⊕ EASIER LABELING. Extra large unobstructed writing and labeling surface for added convenience.

Your electronic parts distributor has it!
Order today!

● 111-AP Magnetic Tape also available on the "SCOTCH" Brand professional reel.

Costs no more than ordinary reels

REG. U.S. PAT. OFF.
SCOTCH Magnetic Tape
BRAND



High Output and  TM 3M Co. The term "SCOTCH" and the plaid design are registered trademarks for Sound Recording Tape made in U.S.A. by MINNESOTA MINING & MFG. CO., St. Paul 6, Minn.—also makers of "Scotch" Brand Pressure-Sensitive Tapes, "Underseal" Rubberized Coating, "Scotchlite" Reflective Sheeting, "Safety-Walk" Non-slip Surfacing, "3M" Abrasives, "3M" Adhesives. General Export: 122 E. 42nd St., New York 17, N.Y. In Canada: London, Ont., Can.



READERS' FORUM

Continued from page 13

rather synthetic eloquence and less to Beethoven's more meaningful utterance (the choral symphony). If Toscanini has not spared the baton in his incandescent interpretation Mr. Burke has not spared the rod, either. He adduces the remarkable and astonishing fact that Beethoven is a master and Toscanini something considerably less; he philosophizes on the apocryphal law of compensation. Mr. Burke should be reminded that there is the law of self preservation, and that it has a subtle corollary. We confer greatness with zeal on our predecessors but we are reluctant to confer it upon our contemporaries, lest we envy them. If it is not good that we admire and exalt the servant and not the master, perhaps, then, we embarrass Mr. Bach, by thinking of the B minor Mass in terms of the servant and not his Master. Perhaps we embarrass, confuse, and make one another appear slightly ridiculous by giving our children our names, by passionately revering one another's creations when it appears that we, all of us, are freely expressive interpreters of one supreme genius manifested in His only symphony.

More matter, Mr. Burke, and less art.
Anthony F. Fazio
Newark, New Jersey

In commenting, we may point out that Maestro Toscanini, re the servant-master relationship, agrees with Mr. Burke, not with Mr. Fazio. It is also of interest that at least one clergyman has suggested making use of Mr. Burke's writing on this subject as text for a sermon: "... And his comments anent the Toscanini recording of the Beethoven Ninth: 'it is not good that the cover of a recorded Ninth should carry 20 images of the servant and none of the master' — the man tempts one to use him as a source for sermon texts!"

SIR:

So your stencil is quivering. Hmmmmm! You should see me quivering with anger and disgust every time I receive another issue. First it was Indcox with his beloved "Pal Joey" after praising the works of my beloved Bach, Beethoven, and Borodin. Then you added that "Music Between" stuff. I don't know the author's name. I tolerated, but never read, that junk in your magazine.

And now, *now*, after gaining a good reputation with some excellent articles such as the one on speakers by the highly respected Mr. Briggs, what have you decided to do? ... you larel going to include reviews of, if you will pardon the expression, *stinking jazz!*

Jazz is the cancer of music. Like a filthy disease it slowly eats its way into the brain leaving an empty hollow to echo and re-echo the cacophony of sound trapped within.

Aw, what's the use!

I have enclosed a money order of ten hard-earned dollars for approximately seventeen issues of your magazine. Why seventeen? A few pages of that thing in each issue placed end to bad end will add up to

Continued on page 17

JULY-AUGUST, 1953

HERE'S THE **NEWEST** Browning FM/AM Tuner

The ideal mate to the modern, full-control amplifier.



Model RJ-42

Only two controls are used with the RJ-42 FM/AM Tuner — one for tuning, the other for switching. The latter has four positions: OFF — AM — FM with AFC — FM without AFC. Duplicating none of the controls of the audio amplifier, this new tuner is particularly suited to use in custom installations. A feature of convenience for such installations is a pre-settable output-level control, at the rear of the chassis, to adjust tuner output to amplifier input requirements.

The FM section of the RJ-42 gives you

- New, all-triode RF section, for extremely low noise level.
- Higher sensitivity—3 microvolts for 20 db. quieting—desirable in fringe areas and noisy urban locations.

... and, of course, the standard Browning features: true Armstrong circuit, selectable AFC, compensation for drift-free operation, and sensitive tuning eye for fast, precise tuning. Audio response, flat $\pm 1/2$ db. from 20 to 20,000 cycles, satisfies the most critical high-fidelity listener.

In the AM section, covering 540 to 1650 kilocycles

- Superhet circuit with triple-tuned IF's and separate AVC detector to minimize distortion.
- Sensitivity—1 to 2 microvolts with audio output flat within 3 db. from 20 to 5500 cycles, down 6 db. at 6800 cycles.
- Effective 10-kilocycle whistle filter that does not affect AM fidelity.

For remote installations, a cathode-follower output stage is provided to feed any high-fidelity amplifier, at low impedance, from either the FM or the AM section. This minimizes hum difficulty and high-frequency loss through cable capacitance.

With all these advantages, the RJ-42 Tuner is only 14 $1/2$ x 11 $1/2$ x 7 inches.

For detailed specifications, write us for Bulletin HF-4.

For FM reception only—the Browning Model RV-31 Tuner ... with the same exceptional FM circuitry as the Model RJ-42. Brochure on request.

ENGINEERED
FOR
ENGINEERS



BROWNING
Laboratories, Inc.
Winchester, Mass.

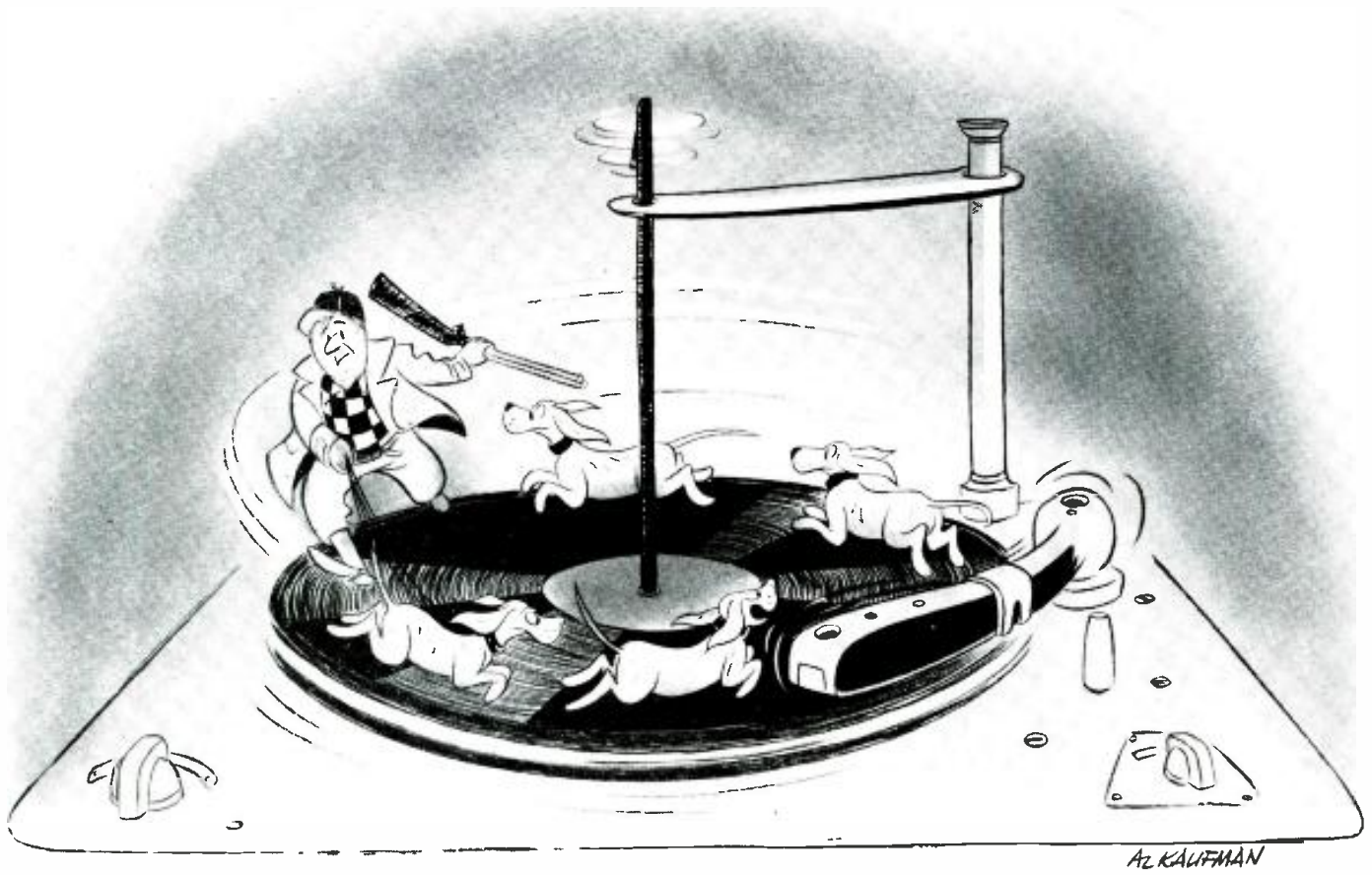

on the hunt for T-A*?

Are you disgusted with wows and bumps . . . groans and throbs in your turntable? Are you on the hunt for T-A*?

PRESTO . . . pioneer in professional recording equipment . . . offers the solution to Hi-Fidelity turntable problems . . . the PRESTO 15-G. Built like an expensive broadcast-type turntable, the 15-G is priced at a nominal \$53.50.

The PRESTO 15-G is miles ahead of the average phonograph equipment in every way. Instant selection of 3 speeds . . . quiet, rumble-free performance and solid, long-lasting construction make this PRESTO turntable the preference of Hi-Fi enthusiasts across the country.

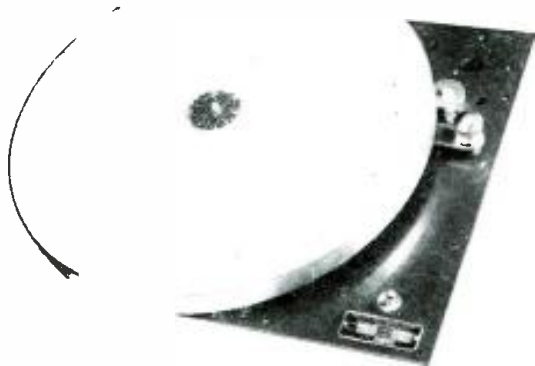

America's finest Hi-Fi turntable . . .
the PRESTO 15-G

Mail this coupon today!

**Turntable Accuracy*



Export Division: 25 Warren Street, New York 7, N. Y.
Canadian Division: Walter P. Downs, Ltd.,
Dominion Square Bldg., Montreal

**WORLD'S LARGEST MANUFACTURER OF
PRECISION RECORDING EQUIPMENT AND DISCS**

**Presto Recording Corporation
High Fidelity Sales Division
Paramus, New Jersey**
Please send full information and prices on your Presto 15-G turntable.

Name
Address
City
Zone State

READERS' FORUM

Continued from page 15

an equivalent issue in number of pages. Which means that others as well as this *music lover* will be paying for eighteen issues and only getting, in effect, approximately seventeen.

Why did you do it? Up to the present, I had nothing but praise for your magazine, but now I honestly cannot recommend the magazine to the music groups with which I come in contact.

Morris Brownstein
Brooklyn, New York

SIR:

Some time ago I wrote to you about the problem which one encounters when one wishes to build a bi-amplifier filter and does not have access to a stock of mica condensers from which condensers of the proper accuracy may be selected. I have since solved the problem in a way which might interest you, if only because inquirers may be given the information.

The Heath Company, of Benton Harbor, Michigan, of whose kit-vending activities you are of course aware, uses 1 percent silver micas in their decade condenser kit, and will sell these condensers separately. They are manufactured in England. Only the following values are available:

Value	Price
.0001, .0002, .0003, .0004, .001	.15
.002	.20
.003	.30
.004	.35
.01	.70
.02	1.75
.03	2.65
.04	3.55

I think you will agree that for precision condensers these are remarkably good prices.

William H. Burke
Kalamazoo, Michigan

SIR:

In the March and April issue of your magazine, R. E. in reviewing the Westminster record WL 5169 of Chopin's four Ballades as played by Ginette Doyen remarks the following:

"A memory slip in the G Minor Ballade in Miss Doyen's version results in the loss of a couple of measures, and it is surprising the recording was approved".

Upon careful rechecking of the piece in question, I must come to the conclusion that your reviewer is mistaken in the statement since nothing is left out in the recording.

Since his remarks deal with an objective fact and, being incorrect, are damaging to both the artist involved and to the musical staff of Westminster Recording Co., Inc., I would appreciate it if you were to print a correction in your next issue.

Kurt List, Musical Director
Westminster Recording Co., Inc.

R. E., otherwise known as Ray Ericson, says Mr. List is perfectly right. The copy of the record he reviewed had a rare blemish — a noiseless gouge which caused his stylus to skip a groove (repeatedly) and make Mlle. Doyen sound forgetful. The correct diagnosis dawned on him too late for a correction. In penance, he says, he aims to BUY a copy of WL 5169.

Incomparable!

these 2 magnificent new enclosures by Jim Lansing



REAR LOADED
CORNER-CONSOLE
ENCLOSURE

Available in Mahogany,
Primavera Wood and
Utility gray.

Exquisitely Designed

and finished all over, this versatile enclosure can be used against a flat wall or as a corner enclosure.

A 6' true exponential horn and large mouth opening give full, uniform reproduction of the low frequencies. When used with the Jim Lansing two-way speaker system, the smooth, more even highs produced by the Koustical Lens, make this a truly outstanding unit.

A single D130 speaker may also be used, since the cone speaker operates as a direct radiator above the acoustic crossover.

See and hear these truly incomparable speakers at your audio dealers today.

Jim Lansing

JAMES B. LANSING SOUND, INC.
2439 FLETCHER DRIVE, LOS ANGELES 39, CALIFORNIA



FULL FRONT-LOADED
CORNER ENCLOSURE

The two basic methods of loading loud speakers on the low end have been incorporated in this magnificent horn enclosure in a unique way. Both low frequency units are fully and uniformly loaded to well below 35 cycles. The uniform full-base response is blended smoothly into the higher frequencies with the revolutionary Jim Lansing Koustical Lens.

How Come?

PILOT

*runs an ad for Hi-Fidelity
Pilotuners and Amplifiers
without listing features!*



PILOTUNER AF-824
\$119.50



PILOTUNER AF-723
\$79.95



PILOTONE AMPLIFIER AA-901
\$99.50

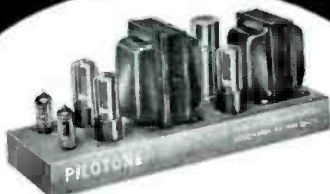

PILOTONE AMPLIFIER AA-902
\$46.95

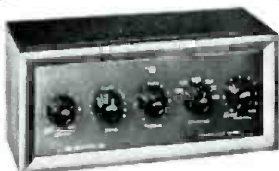

PRE-AMPLIFIER PA-912
\$49.95

Yes, — listing of features on hi-fi equipment is important. But — it would take a good four pages of fine type to list all the outstanding features of these superb PILOT instruments.

So may we suggest, — send in the coupon below for our beautifully illustrated, completely descriptive color folder. Read it in comfort, at your leisure. Compare PILOTUNERS and AMPLIFIERS, feature for feature, with any others on the market. See PILOT's superiority for yourself. You'll be glad you did!

Write in today
PILOT RADIO CORP.
 Dept. AF6-3, 37-06 36th St., Long Island City, N. Y.
 Please send me your free folder describing
 PILOTUNERS and Amplifiers.

NAME

ADDRESS

CITY STATE

FAMOUS PILOT "FIRST!"

1927...
First home
short-wave receiver



FAMOUS PILOT "FIRST!"

1937...
First truly portable
battery receiver



FAMOUS PILOT "FIRST!"

1928... First
Government licensed
TV station, WRNY



PILOT RADIO CORP., "The Standard of Excellence." LONG ISLAND CITY, N. Y.



NEW BOOKS

The Language of Music, by Klaus Liepmann. 376 pages, 6 x 9. Illustrations and index. Cloth. Ronald Press Co., New York. 1953. \$5.

There are two humiliating hazards always lying in wait for the home-music amateur when he opens a book on the subject he loves. Sooner or later, the author will lapse from English into either 1) a technical formula, or 2) a bar of musical notes. Probably the reader is easily intelligent enough to understand the content — if he could but understand the language.

No one yet has written a good interpretative guide to audio-electronics (and someone *should*) but it is a pleasure to report that someone *has* come to the rescue of the musical illiterati. He is Dr. Klaus Liepmann, who teaches music at MIT. He has realized that some people would like to learn to read and understand music *without* learning, at the same time, to sing, or to play the piano, or to write orchestrations. Liepmann's *The Language of Music* is written for the listener. The equipment needed for the latter to make the most of the book consists of a persevering brain, a set off fingers to beat time with, a phonograph and a representative record-collection. A piano is a help, too; it is easiest to imagine an octave-interval when it can be heard.

Liepmann begins with the time-factors in music — note-duration, rhythm, meter, etc. — and works through melody, harmony, tonality and instrumentation. Moreover, he does not stop with the alphabet and grammar of music, so to speak. He carries over to the rhetoric, showing how a composer uses various devices for his effects.

The book is extraordinarily thorough and, although it is lucidly and even eloquently written, it takes real concentration and patience to get through it. When you have, however, you'll be able to follow a concert performance with a score — but you won't! People who can *really* read scores don't need them at concerts. points out Liepmann, any more than a playgoer needs a script of *Macbeth* with him in the theater. J. M. C.

Maurice Ravel by Victor I. Seroff. 310 pages; 5½ x 8½. Cloth. Henry Holt & Co.; New York. 1953. \$3.75.

Although not "the only study of the French master available in English," as it is incorrectly described on the dust jacket (there are at least three others), Victor Seroff's biography of Ravel is probably the best one. Seroff is a competent biographer and writer (his previous books include biographies of Shostakovich and Rach-

Continued on page 21

NEW..... TRU SONIC 15" COAXIAL SPEAKER



**206AX 15"
COAXIAL SPEAKER**

List Price:
\$166.00 16 ohms
\$179.00 500 ohms

It's the Finest . . .

For those who treasure the art of listening, the new Tru-Sonic 206AX offers superb reproduction of true to life tones across the entire audio spectrum . . . plus the space-saving compactness available only with a coaxial system. This single compact assembly combines a 15" low resonant cone reproducer with a separate lightweight metal diaphragm and voice coil assembly, which is coupled to an 8 cell horn having 40° x 80° dispersion. The new 206AX has a 1200 cycle high pass filter. Impedance 16 ohms or 500 ohms. Power rating 20 watts. Frequency response 40 to 20,000 C.P.S. Diameter—15¼". This incomparable coaxial speaker is recommended for broadcast monitoring, motion picture sound, FM, and record reproduction. Hear it at your audio dealers today . . . learn first hand why Stephens Tru-Sonic speakers and components are accepted internationally as first and finest in audio engineering.

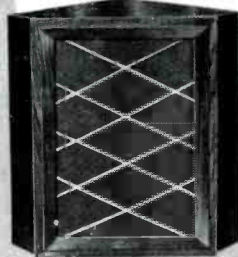

Model 626 Corner Cabinet

The beautiful Model 626 Corner Cabinet available in blonde or mahogany finish. Designed to handle either a Coaxial speaker or a 15" Full Range speaker system, this fine cabinet employs a new principle of horn loading and provides lower fundamental bass response. The rear of the cabinet is completely enclosed. Sound radiates from within the cabinet and is independent of room location. List price: \$160.00



**LIST PRICE
\$184.00**

500 D DIRECT DRIVE AMPLIFIER

Finest Amplifier Built—No Output Transformer. Designed for use with speakers having 500 ohm voice coils. Never before has such fidelity been possible. Stephens Tru Sonic matching speakers with 500 ohm voice coil used in conjunction with the 500 D amplifier provide the finest sound reproduction yet achieved. At full 20 watts, distortion is less than ¼ of one per cent. Phase shift is less than 15° at 20 c.p.s. This is proof again of Tru Sonic engineering leadership.

Write for complete literature on Stephens Tru-Sonic Speakers and components.

STEPHENS MANUFACTURING CORPORATION

8538 Warner Drive • Culver City, California

LAURITZ MELCHIOR

Chooses Revere Recorder

"The Revere Tape Recorder is an indispensable helper in my current search for young American talent. Because Revere records with such amazing fidelity, their recordings will reflect all the realism of the original performance. With the help of the Revere Tape Recorder, I believe we will find a wealth of American talent."

Lauritz Melchior

Lauritz Melchior, great Wagnerian tenor and motion picture star, is currently making a unique concert tour in 100 American cities. Appearing with Mr. Melchior is a group of eight solo artists—and locally-selected talent from each tour city. The voices of the local talent will be Revere tape-recorded and entered in the National Federation of Music Clubs competition. Winners will receive awards ranging from cash to possible Hollywood screen tests and record contracts. This "Lauritz Melchior Show" will include piano classics, Hit Parade songs, operetta and opera—the latter including many of the Wagnerian excerpts in which Lauritz Melchior excels.



Great musical artists rely on the Revere Tape Recorder for rehearsing their performances—knowing it records with maximum fidelity... with the clean highs and clear lows of life itself. They hear their performances *exactly* as their audience will hear them! Why not follow their example and use the Revere Tape Recorder for *your own* musical advancement.

The New REVERE

"Balanced-Tone" TAPE RECORDER

A proud achievement of recording brilliance! To hear the new Revere "BALANCED-TONE" Tape Recorder is an unforgettable experience. Each delicate sound, every musical note, is reproduced with amazing depth of tone, breadth of range, and height of realism heretofore obtainable only with professional

broadcast equipment. Yet, it is extremely simple to operate. Note these outstanding features incorporated in the new Revere:

"Balanced-Tone" Control provides professional, high fidelity tonal quality.

Exclusive Index Counter permits instant location of any part of a recorded reel.

Automatic Key-Controls record, play, or stop recorder instantly.

High Speed Forward and Rewind Lever—no backlash or tearing of tape.

Add to these such important advantages as two full hours of recording on each reel, lightweight portability, magnificent styling, glamorous beauty, low price—and you'll agree the new Revere "BALANCED-TONE" Tape Recorder is in a class by itself. See it at your dealer now!



- Model T-700—Complete with microphone, radio attachment cord, 2 reels (one with tape) and carrying case..... \$225.00
- Model TR-800—Same as above with built-in radio..... \$277.50
- Model T-10—Studio Model, Speed 7.50. \$235.00
- Model TR-20—Same with built-in Radio. \$287.50
- Model T-100—Standard, 1-hour play... \$169.50
- Model T-500—DeLuxe, 2-hour play.... \$179.50



FAITHFUL REPRODUCTION OF SOUND

REVERE CAMERA COMPANY • CHICAGO 16, ILLINOIS

HIGH FIDELITY MAGAZINE

BOOKS

Continued from page 19

maninoff) as well as a pianist and teacher of music. However, as a good biographer should, he approaches Ravel not as a critic of his music but as a chronicler of his life.

Ravel's was a life rich in material for any biographer. Born in 1875 in the Basque village of Cibroure, near the Spanish border, he grew up in the uninhibited Paris of the *fin de siècle*. It was an age of feverish restlessness in the arts, of heated all-night debates in the cafés of Montmartre. Ravel and his friends, a group of contemporary artists, writers and musicians who came to be known as *Les Apaches*, could be found almost any night perched on the high chairs of a Paris bar discussing Debussy, Chopin, Chinese Art, Valéry and other subjects on which they shared like opinions (as one of Ravel's friends said, you can not discuss a subject except with those who agree with you).

Ravel was a complex personality; a man who would go to considerable lengths to be misunderstood. He had set for himself an image of the "artist" which he nourished all his life. Probably his outstanding behavior-trait was a childish naivete which was, unfortunately, accented by his small stature. Ravel never grew to be taller than five feet.

However, his size didn't keep him from causing considerable commotion in the intellectual world of pre-World War I France. He was the center of three of those periodic intellectual storms which are so characteristic of the French. The first *affaire Ravel* grew out of his four unsuccessful efforts to win the annual *Prix de Rome* and the resulting public protests at academic intolerance. (In his first attempt, Ravel angered the judges by inserting a light waltz in a religious cantata; he was annoyed by the insipid nature of the poem he was supposed to set to music.) The second *affaire* began with the controversial first performance of Ravel's *Histoires naturelles* and developed into a journalistic debate on Debussy vs. Ravel. Ravel's refusal to accept the French *Legion d'Honneur* for his services in World War I touched off the third *affaire*. He said he refused out of principle and that he would never wear a decoration because he didn't need one. However, Ravel later accepted a Belgium decoration and a British honorary degree and it is generally assumed that his refusal was due to a lingering resentment at the French Government for not supporting him in the first *affaire Ravel*. R. H. H., Jr.

The Second Audio Anthology edited by C. G. McProud. 124 pages; 9 x 12; illustrated. Paper Bound. Radio Magazines Inc., Mineola, New York. 1953. \$2.75.

Within the bounds of the 124 pages of this book are reprints of articles covering many a subject dear to the heart of the hi-fi hobbyist and constructor. Most of the material requires a fair degree of technical knowledge for adequate comprehension, but several of the articles are of general interest and will be useful even though the

Continued on page 120

For the audio-perfectionist...

High Fidelity magazine reports on the new Regency booster

"At our own location, with a directional antenna aimed at Boston (about 120 miles distant, airline), we were barely able to distinguish a voice through the background noise when tuned to station WGBH, 89.7 mc. With the booster, the voice came out of the noise so that, except during periods of complete fading out, it was strong and clear as a local emission!"

—from an article in High Fidelity Magazine, May, 1953

Engineered for you—this compact booster brings in the full glory of FM sound even when you live miles from the transmitter. Just plug it in—then settle back and enjoy luxury listening such as you've never before experienced.

Made by the makers of the famous Regency TV booster and UHF converter. 88-108 MC. Push-pull amplifier. Smart plastic cabinet. MODEL DB-98A \$29.95 LIST

I.D.E.A., INC., REGENCY DIVISION, 7900 PENDLETON PIKE • INDIANAPOLIS 26



Regency
FM BOOSTER

Blairton browne advertising

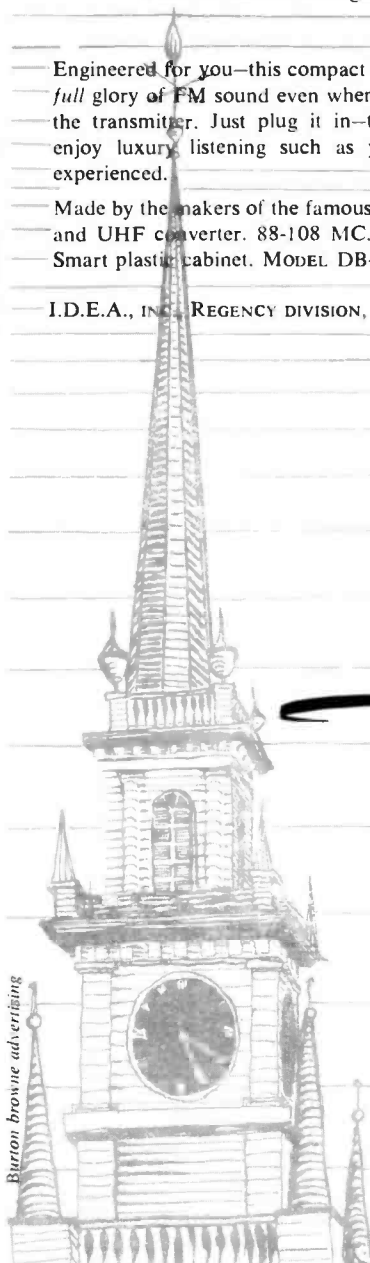

PICKERING

PROFESSIONAL AUDIO EQUIPMENT

BALANCED COMPONENTS / MAXIMIZE PLAYBACK PERFORMANCE

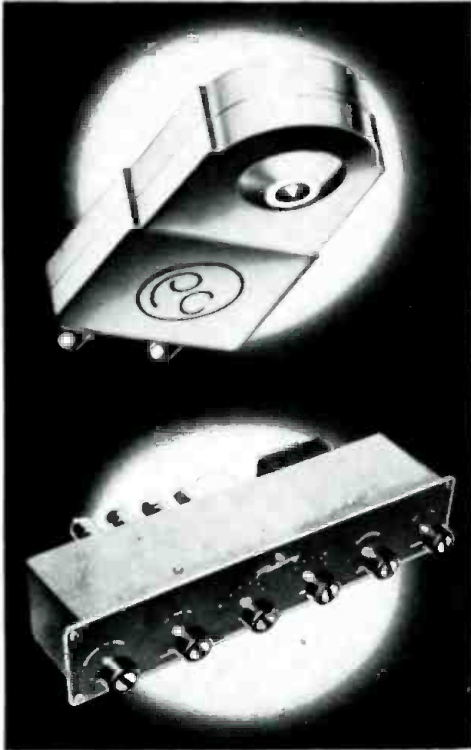

PICKERING CARTRIDGES . . .

are the choice of audio engineers throughout the world. They are universally acclaimed because of their high output, wide range performance and low distortion. They are used wherever a fine cartridge is required in radio stations, recording studios and for purposes of quality control by leading record manufacturers.

MODEL 410 AUDIO INPUT SYSTEM . . .

is designed to provide a complete audio control center. Model 410 may be used in any high quality playback system. Three input channels are provided—one for magnetic cartridges and 2 "flat" channels for other audio circuits. A 3-position equalizer network is built into the magnetic cartridge channel and provides accurate equalization for LP, AES and 78 rpm recording characteristics. Separate bass and treble controls are also provided. These are of the step-type and permit bass and treble adjustments in 2 db increments. The tone control circuits are intended to compensate for record characteristics and for listener-environment acoustical conditions. They are not intended to compensate for amplifier and/or loudspeaker deficiencies. Model 410 is intended for use with the highest quality professional type playback equipment. The output of the Model 410 is fed from a cathode-follower circuit and will work into any high quality audio or line amplifier having a high impedance input. It may also be used with a transformer for the purpose of feeding a 500 ohm line. Because of its flexibility, low noise and low distortion level, it is ideally suited for bridging and monitoring purposes and for critical listening applications.



THE MODEL 190 ARM . . .

is designed primarily for use with microgroove records. Its design has been recognized by leading audio engineers as that which incorporates all of the desirable tracking characteristics. Analysis has shown that for maximum performance with LP records the vertical mass of the moving arm element must be held to a minimum and further, that the arm must be counterbalanced about the vertical axis. This permits minimum stylus or tracking force and provides maximum record life. The Model 190 Arm embodies these all important features necessary for proper microgroove record playback.



MODEL 230H EQUALIZER-PREAMPLIFIER . . .

is unique in its accuracy of equalization and frequency response. The intermodulation distortion is .2 per cent at normal output level. It is intended for use with high quality amplifiers having gain and tone controls. When used with the Pickering Model 132E Record Compensator the 230H is ideal for radio station and recording studio use and for applications requiring accurate low noise and distortion free playback.



MODEL 132E RECORD COMPENSATOR . . .

is designed to be used in conjunction with a magnetic cartridge preamplifier such as the Pickering 230H or any preamplifier which provides 6 db per octave bass boost. Six playback positions are incorporated:

- 1—European 78 rpm Records
- 2—Victor 45 rpm and Decca 78 rpm Records
- 3—No high frequency roll-off, 500 cycle turnover
- 4—All Capitol Records, new Victor 33 $\frac{1}{3}$, Audio Engineering Society Curve
- 5—Columbia, London and most LP Records
- 6—To remove the hiss from old noisy records

Precision elements are used in its construction to give accurate compensation. The 132E is inherently a low distortion R-C device.

PICKERING PROFESSIONAL AUDIO EQUIPMENT

"For those who can hear the difference"

... Demonstrated and sold by Leading Radio Parts Distributors everywhere.
For the one nearest you and for detailed literature, write Dept. II-2



PICKERING and company incorporated • Oceanside, L. I., New York

AS THE EDITOR SEES IT

AT ABOUT the time this editorial appears in print, newspapers will announce the formation of a National Record Awards committee, which will, next Spring, present awards for the best phonograph records issued in 1953. There will be awards in several categories. At the time of this writing, the committee had not revealed the exact number or nature of the categories, but all will fall within the general description of *records of lasting interest*. One of the recordings will be honored as The Record of the Year. The others will be dubbed best-of-type. Both musical and sonic values will be considered.

The Awards are to be made each year. The executive panel of the 1953 committee consists of C. G. Burke, chairman; Irving Kolodin, music editor of the *Saturday Review*; and R. D. Darrell, noted critic and editor of the original *Gramophone Shop Encyclopedia*. These three will select and appoint a jury-panel of several leading record critics and music enthusiasts. The jurors' names will not be divulged, to anyone, until the actual presentation of the awards.

The record industry produces several thousand micro-groove disks annually. No single juror could be expected to have heard all of these. Therefore the Awards committee will have recourse to a large nominating panel, composed of record reviewers throughout the Nation. Each of these will be asked to submit recommendations. From among the disks suggested, the jurors will choose the winners. The nominations will not be a vote in any sense; a recording which receives only one recommendation will be listened to as carefully as one which is nominated by 80 reviewers.

The actual award ceremonies will be held in early Spring, probably in New York, and record companies have hinted at plans to entertain visiting reviewers and music-editors in high style.

The National Record Awards committee will operate as an entirely free agent — as the names of its executive panel members should serve to certify. However, it may utilize volunteer services from record company staffs, and its expenses are to be paid by HIGH FIDELITY Magazine. The Magazine was prevailed upon by Mr. Burke to undertake this service. The value to it, and to the record companies, of the Awards should need no belaboring. The Awards cannot be a publicity or promotion stunt. They must be without partisan commercial taint. If they are kept so, their cultural importance can be enormous.

Paradoxically, if they attain this cultural importance, their practical institutional value grows accordingly, and

makes them worth sponsoring. HIGH FIDELITY, like many a present day record company, is founded on a dual purpose: to promote, and to benefit by, the greater enjoyment of music in American homes. It is an article of faith at HIGH FIDELITY that there are several millions of Americans ready, even hungry, for the exalting adventure offered by today's magnificent recordings and record-playing equipment. All they need is a nudge, which the Awards might furnish. And the results might include not only some local prosperity, but a nobler America. The temptation — to a small publication, with its heart in the right place — proved irresistible. The editors told Mr. Burke to send the bills to Great Barrington.

READERS should *now* put a few circles on their calendars. Fall is not far off, and Fall is the season of audio shows. The first one is scheduled for September 1, 2, and 3 in Chicago: the International Sight and Sound Exposition.

The second event in the show calendar is the Audio Fair in New York, to be held a little earlier than usual this year: October 14, 15, 16 and 17. The place is the Hotel New Yorker, 34th Street and Eighth Avenue, as before. Also, as before, huge crowds are expected.

TO LEAVE our noisome facetiousness for a moment . . . we must turn our thoughts from sound and fury to peaceful contemplation: this issue of HIGH FIDELITY marks the beginning of our third year of publication. Two years and ten issues have passed with alarming rapidity. We have been part of a growing industry and part of a growing social phenomenon whose significance may not be fully assessed for many years to come.

The signposts of growth are familiar: production of long playing records has expanded until one wonders what directions are left for growth. The May 1953 issue of the Schwann catalog contained three times the number of records listed in the May 1951 issue. Whereas there were, two years ago, five versions of the Beethoven Fifth Symphony (and two of the Sixth) there are now thirteen of the Fifth (and twelve of the Sixth) . . . and so forth, without end.

The significance, in terms of increased interest in high fidelity reproduction, of the entry into the field of some of the "big names" among commercial set manufacturers can only be guessed. If, in May 1951, we thought we were on the threshold, what are we on now? Sometimes it seems as if we had not yet so much as opened the door!

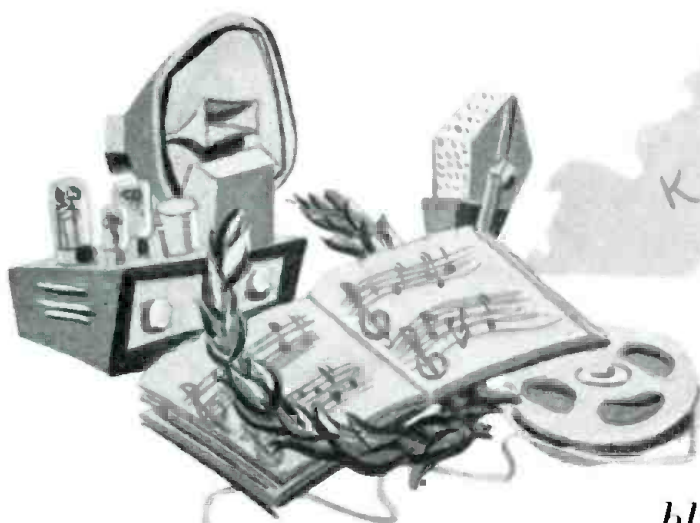

blue grass, beautiful women, and . . .

MORE MUSIC THAN ANYWHERE

by DEBORAH ISHLON



Charles Rowland Peaslee Farnsley is Mayor of Louisville, Kentucky. He is also a patron of the arts and the Ampex tape recorder.

The Mayor believes in clean city government, more music — especially more contemporary music — and higher fidelity for everyone.

Farnsley, in fact, likes nothing better than to take leave of city budgets, blueprints and politics, perch a battered brown felt hat on the mayoral head and hop the mayoral car over to the Louisville Public Library. There he makes for the Audio Visual Center in the basement right wing. A tall, loose-limbed figure in Confederate-style jacket and black string tie, he ambles down the corridor, stopping for a look into the cubicle that houses a record library and a burgeoning collection of tapes (17,000 volumes already).

Then he moves on to the recording studio, glass-walled and almost surgically neat. Six Magnecord tape players, six Ampex recorders, (eventually there will be 49 Ampexes: 10 recorders, 39 playback machines) and four record turntables are ranged along the sides of the room and in center banks. The Mayor taps on the studio window, gets a nod from the teen-age engineers and shouts through the glass to them:

"Play me some Stravinsky and Villa Lobos and some Edgar Varèse, boys."

He then makes his way into the Auditorium, where

he sits back comfortably and grins as the sounds swirl out of an Altec 820A corner speaker at high gain. "This sure spoils you for concerts," he says blandly.

The Mayor's predilection for contemporary composition is legendary in Louisville.

"Beethoven's monopoly isn't goin' to last very long with high fidelity," he was heard to say while listening to a particularly clangorous tape recording. "Young people are startin' to go for modern music an' sounds like this!"

One associate who doesn't share the Mayor's enthusiasm for dissonance and atonality, says mournfully: "Charlie has a blind spot. He doesn't like any music that was written before 1920."

The Mayor bids good-bye to the engineers. "Beautiful machines," he says fondly, as he pats an Ampex on the head and returns to the civic wars.

Since taking office in 1948, Mayor Farnsley has brought the half million citizens of Louisville not only better schools and streets, more playgrounds and policemen, but lots of new music, commissioned from leading contemporary composers; the Audio Visual Center; an FM station for the Public Library — and the Altec, which he regards as a particularly significant municipal acquisition.

"We get one of those in every classroom in Louisville an' then we'll really be gettin' somewhere," he says.

The city's cultural institutions, from the 50-piece Orchestra to a Junior Art Gallery, owe their present state of sound financial health to a Community Fund for the arts, also organized by Mayor Farnsley.

Louisville's municipal Lorenzo di Medici is the son of one of the city's oldest families. He attended the University of Louisville, where he became an expert campus politician, the proprietor of an elderly Rolls Royce and an intensive student of Thomas Jefferson's theories of government and mass education. His progress from collegiate politics to the State Legislature was as smooth as bonded Kentucky bourbon. In 1948, when the Mayor of Louisville died in office, Farnsley was suggested to fill out the term. The city's aldermen elected him by a one-vote majority. Next year he was reelected by popular vote.

Once in office, Charlie Farnsley began a thoroughly unconventional administration. For instance, there was the Louisville street problem. The budget couldn't provide a complete resurfacing program. Farnsley's solution: repaving only the driving lanes in the middle of the streets, leaving parking spaces as they were. He also instituted a weekly Beef Session, to which all Louisvillians were invited to come and voice their complaints in person. City officials had to be present to hear any and all gripes — and to act on them promptly.

Farnsley further decided that Louisville needed some cultural and educational improvement. He started with the city's Public Library. Five years ago H. E. Salley was hired to set up the Audio Visual Center. Now in its third year of large scale operation, the Center operates WFPL, the country's only public library-owned radio station. The 3000-watt transmitter cost them nothing. A local commercial station gave it to them when it decided to abandon its FM operation. WFPL, however, has been so successful that the Center has applied for a license to start another FM station.

From 7 a.m. to 11 p.m. daily, thousands of Louisville school children and adults listen to WFPL programs. Wires go out from the station's basement headquarters

to almost all Louisville classrooms and to the ten branches of the Public Library.

For the first six grades, the Board of Education works out a recorded program, coordinated with the elementary curriculum. Poetry and arithmetic, science and history are taught with the aid of recorded plays, documentaries and readings from the Center's collection. Junior and senior high school teachers are provided with an 600-page catalog of the Center's material so that they can request specific recordings for broadcast to classes at any time.

WFPL can play 20 different programs simultaneously over its city-wide network. An average school day brings more requests than the station can handle. Only 47 means a quiet day. On holidays, the count may go to 80. Branch libraries have listening rooms and earphone equipment so that individuals or groups can request special program material at any time.

In addition to collecting music and programs on records or tape, WFPL is building up a permanent archive of Louisville's musical history. Every concert given by the Orchestra is taped. So is every concert by the Louisville School of Music faculty members and guest artists.

WFPL has a staff of four full-time and two part-time technicians. Most of these are still in their teens and in one or another of Louisville's public high schools. The boys all have operators' licenses. WFPL's sole professional operative is Allen Hankins, a graduate history student at the University of Louisville. He is assigned the station's most demanding engineering chore, recording the Orchestra concerts — and refereeing debates between the one-mike-suspended-low-over-the-stage school and the advocates of more room tone.

No staff announcer is employed at WFPL. One of the local school-teachers drops by the Library basement once a week and records all the announcements that will

Musical Mayor Charles Farnsley (right) felicitates Louisville Orchestra's conductor Robert Whitney during a recording session.



Tenor Farrald Stevens, composer Lukas Foss, narrator Vera Zorina chat with Farnsley before rehearsal of Foss' Parable of Death.





Louisville's lucky orchestra: Beginning in 1954, its members will have guaranteed year-round musical employment, six-week vacations.

be needed to introduce the scheduled programs. Staff technicians simply switch the reels of tape according to schedule, and read or do homework in between.

Charlie Farnsley's Louisville Fund for the arts has provided a degree of financial security for the city's cultural organizations that communities twice as big might envy. The Mayor argued with Louisville business and industrial leaders that the Kentucky Derby was a rather limited form of entertainment for the city. He talked them into making a single contribution apiece to the Fund for music, art and theatre every year. For an economical \$147,000 (the 1952 budget), Louisville supports an Art Center, a Children's Theatre, a Philharmonic Orchestra. Average citizens contribute to the Fund, as well as business institutions.

Biggest item in the Louisville Fund budget is earmarked for the Orchestra, which in the past five years had developed a program for the propagation of modern music that is unequalled by any other symphonic ensemble, anywhere, of any size.

As might be expected, it was Farnsley who sold the idea that the Orchestra should encourage the understanding as well as composition

of contemporary music by commissioning five new works a year. Musical Director Robert Whitney has conducted the Orchestra in twenty-four world premieres of commissioned works. Many of the composers have journeyed to Louisville to be present at first performances. The mayoral car meets them on arrival and there is a police escort waiting to drive them to City Hall. Of course, they receive a miniature flag of Louisville (blue, with fleur-de-lis of gold) and a key to the city.

The commissioned works have ranged in scope from symphonies (Norman Dello Joio's *Triumph of St. Joan*, and *Symphony No. 4* by Carlos Chavez) to Darius Milhaud's seven-minute *Kentuckiana*, subtitled *Divertissement sur Vingt Airs du Kentucky*.

Along with Bach, Beethoven and Brahms, Louisvil-

lians have taken to Hindemith, Roy Harris and Arthur Honegger. The Orchestra's subscription concerts are sell-outs and the commissioned works are also played at its "Pops" concerts. Farnsley's notion of commissioning music has become so popular in Louisville that even the University's brass band has asked composers for special works.

For one of this season's Pops concerts, *Continued on page 94*

Columbia engineer Adjutor Theroux checks reel-speed as tape-happy Mayor kibitzes.



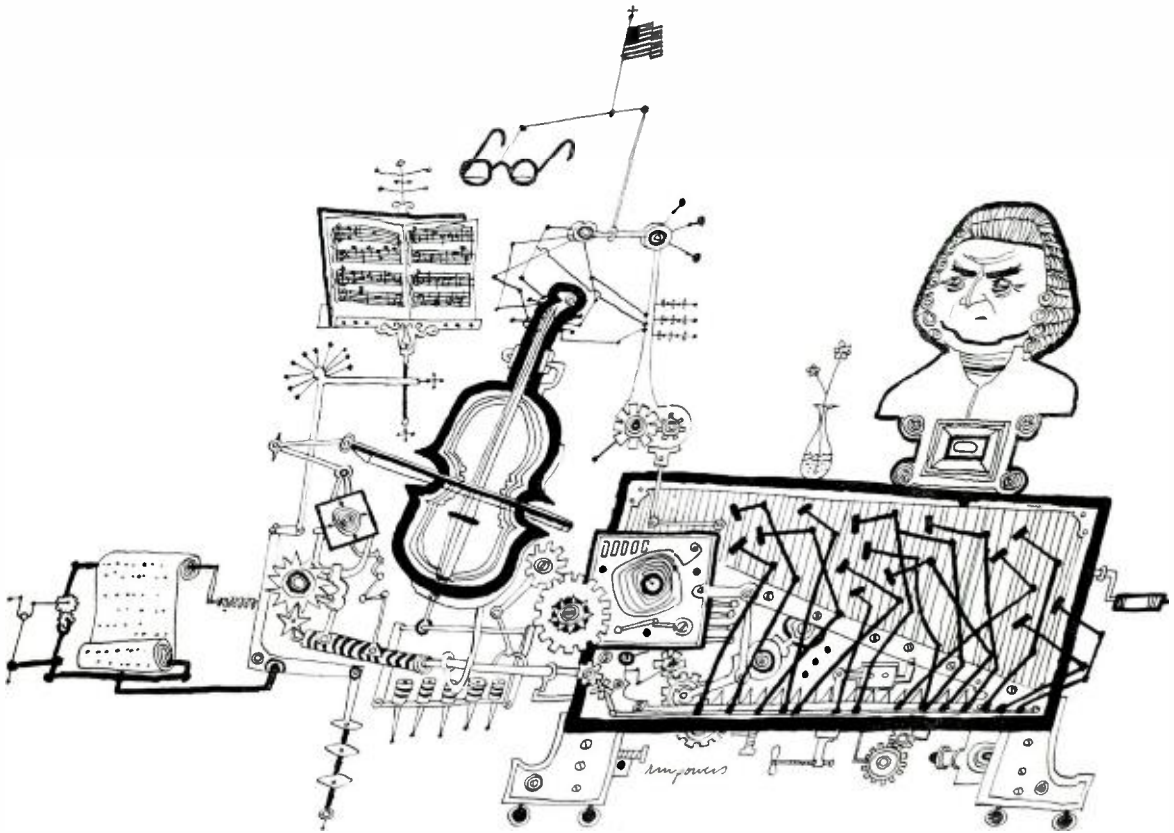

Hearing is Believing? by JOHN W. CAMPBELL, JR.

YOU CAN learn to operate a piece of machinery on the "You push this gimmick, then you pull this thingamabob, then you twist this whatchamacallit" basis. Or, you can learn the basic nature of the equipment, how it operates, and what its limitations are. The latter method usually produces a far better result, more satisfaction and less burned out equipment and tempers.

What's the difference between a high-fidelity sound system and an old fashioned player piano?

They're basically the same article; each represents a sincere effort of its builder to supply a system that could reproduce high-quality music in the home. Back in the 19th century, there was a lot of interest in mechanical reproduction — or, more accurately, technical reproduction. They made player-violins, too: motor-driven wheels replaced the bow, and machine-controlled mechanical fingers pressed the strings. There were "juke box" contrivances which incorporated a mechanical violin and a mechanical piano, busily playing a duet. Fascinating things — even more fun to watch than one of the modern hundred-record super-jukeboxes.

The 19th Century went in also for "artificial silk" and

a lot of similar things — imitations of the natural product. There's a different approach today; nylon is a synthetic fiber, designed to meet a specific requirement. It was never thought of as "artificial silk".

The high-fidelity music systems we have today can't be operated on the "push this gimmick" basis. For full enjoyment, we need to go a bit deeper than electronics to get to what the electronics system is there for. The player-piano, and the player-violin weren't electronic — but they, too, were efforts on the road to high-fidelity music.

The thing we're seeking is a method of packaging a human experience in such fashion that we can unpackage it anywhere, anytime, and enjoy it. Canned peas are not as good as fresh spring peas. Unfortunately, fresh spring peas simply don't exist everywhere, all times, so it behooves us to find means of packaging them, making the pleasure of eating them universally available. "High-fidelity" packaging is improving; modern frozen peas are getting hard to distinguish from the garden-fresh article.

The player-piano tried to package music so that fine playing would be available universally. It's a dead line

Drawings by Richard Powers

of development now, because the inventors took the wrong course—but we can learn something from it. Any human experience involves a human being, some medium of communication, and a source of experience. In the case of music, we have a listener, a sound-medium and the sound-source. The player-piano tried to reproduce music by regenerating the sound-source—by duplicating the performance. The player-violin—and a number of other mechanically played instruments which were developed—tried the same thing.

Edison's first phonograph represented a totally different approach; instead of duplicating the instrument, it attempted to duplicate the sensation-of-hearing.

The whole line of development since that time has been directed toward better and better methods of duplicating the sensation instead of the instrument. Where once efforts were made at automata that would act like people on a stage, the effort is now toward color television and three-dimensional color sound movies. Basically, the problem attacked is the same; only the approach is different.

Even the new approach, however, runs into a slight difficulty: human beings spent two billion years evolving the closest possible approach to an absolutely deception-proof sensory system. Animals, since the dawn of life on Earth, have tried to camouflage themselves so that attackers couldn't find them, and so that their prey couldn't see them coming. Efforts to confuse, befuddle, paralyze, or otherwise render inoperative the sensing systems of the other animals has been standard procedure for the last billion years.

Man happens to be the animal on top of the heap now. We can safely assume that one reason he's there is that he's got the most nearly unfoolable sensing system ever developed.

And this is what the high-fidelity sound experts are trying to fool!

It's fairly evident that they can't do it in reality; only by the willing cooperation of the human mind itself can any deception be achieved. And that isn't going to be true deception, but more on the order of imaginative play.

In the first place, a human experience such as attending a symphony concert at Carnegie Hall, consists of a highly complex, highly integrated and cross-correlated system of perceptions. For the moment, we'll leave the main sound business out, and consider the correlated experiences.

There's the visual impression of the stage, and of the instrumentalists in the string section bowing in rhythm, and of the tympanist standing with arms raised, alert,

starting the downward movement so that the beat comes at precisely the instant required. There's the feeling of hundreds of other individuals, all joining in enjoyment of the performance, the faint odors of perfumes and cigar smoke clinging to clothes, and the odor of wool and human beings. The tactile sensation of the auditorium chairs. And most of all, the *knowing* of how this came about—the trip from home to this precise point in space and time, the sense of orientation with respect to the whole system of the world and life.

When you can contrive an electronic system that can induce a duplication of *that* system of sensations, we can reproduce a human experience. Three-dimensional sound-color movies are the best we've done so far. But the only way you could produce the full experience effect would, necessarily, produce insanity in the audience! You'd have to blank out their memories of where they were, how they got there, what they were doing, and where they were going.

Man himself is the ultimate high-fidelity instrument; it took billions of years of engineering field-trials to develop the magnificent sensory and correlative system we have—and we can stop trying to fool that system right now and save a lot of effort. Instead, let's work with it.

The modern recorded music approach works with it, instead of trying to fool it. The player-piano approach would have called for 120 instruments to reproduce a 120-piece symphony orchestra; the ultimate on

the modern recording approach necessarily will require only two units for full binaural reproduction of the recording. There are only two ears, no matter how many things they're listening to.

But in working with it, it's necessary to understand what the sensory system is, and how it does work; efforts to skimp on that are going to lead to dissatisfaction.

The ears are incredibly fine acoustic mechanisms; experiments in "dead rooms" indicate that human ears are sensitive to such minute impulses as random movements of molecules of the air. It should, incidentally, dispose of the myth that other animals have keener hearing. Man can hear the air molecules moving. How sensitive can you get?

The dog's wonderful hearing, famous in myth, simply represents the fact that if you haven't anything else to do, you can hear a lot of noises. Incidentally, my neighbor, seeking to demonstrate his new "silent dog whistle" to his small daughter, was somewhat mortified by the fact that his 6-year-old police dog couldn't hear the whistle, while the little girl complained that it hurt her ears. It was tuned to about 19,000 cycles. *Continued on page 96*



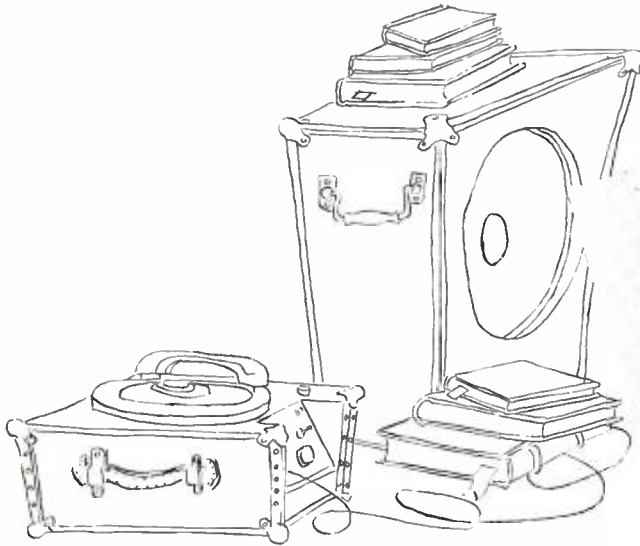

TALKING BOOKS

by Frederic Ramsey, Jr.

"Call me Ishmael. Some years ago — never mind how long precisely — having little or no money in my purse, and nothing particular to interest me on shore, I thought I would sail about a little and see the watery part of the world . . ."

IT COMES FROM the loudspeaker like the voice of a sailor tipping another grog before he settles to a long yarn. It could be Ishmael, the hardened narrator of Herman Melville's tale of *Moby Dick, or The White Whale*. Or it could be Melville himself, down from New Bedford for a session before the microphones. But the yarn and the turntable spin on, and soon the personality of the voice is forgotten, and only the words and their compelling story move forward in the listener's ears.

In reality — perhaps "before reality" would be better, for the real-thing takes shape only as it finally emerges from the sound system — the voice is that of a narrator named Rye Billsbury, and the literary work whose text unfolds without a page turning is known as an Audio Book, published (or produced, take your choice) by the Audio Book Company, Los Angeles.

The first Audio Book, an "Audible Edition of the New Testament" is already available. In addition, 26 hours of experimental recorded literature have been made from the writings of Herman Melville, Dostoevski, John Donne, William Blake, Pepys, William Faulkner and others. A complete reading of *The Postman Always Rings Twice*, by James M. Cain, has also been recorded (listening time — 3 hours) in which the makers of Audio Books experimented with more than one voice.

It isn't hard to find good reasons for putting books on records. One of the best came to light recently during a regular meeting of the James Joyce Society. For the latter part of his life, Joyce was severely limited by failing eyesight. Padraic Colum, who knew the author of *Portrait of the Artist, Ulysses*, and *Finnegan's Wake*, told of Joyce's struggle. "He was so very interested in that writing. Well, I had to set to work and digest it for him. That was the best I could do. It went along all right, but there were nineteen volumes, you know. I'm afraid sometimes

Top to Bottom: Melville, Donne, Blake and Spillane.



Talking New Testament. Twenty-three hours of gospel.

we felt all he was getting out of it was that there were a lot of Spanish kings, all named Alfonse, and a number of Persian ones, all with their same Persian names, too."

We are so used to thinking of ourselves as living in an age of complete scientific achievement that it comes as a shock to hear that a distinguished literary citizen of this age should have been deprived of so simple and wonderful a faculty — the ability to enjoy freely many works of literature. This sort of darkness seems fitting to the dead past; we are reminded of blind John Milton badgering his daughters with dictations of *Paradise Lost*, and that takes us back to the seventeenth century. But it is hard to think of Joyce, who died only twelve years ago, cut off from the pleasure and inspiration of reading.

There can be no doubt that all persons with either limited vision or complete blindness will benefit from this new way of making books available. But what of those who can read for themselves? That is the question that was put to Raymond Tierstein of Audio Books.

"In much the same way persons are visual minded," he replied, "we believe that just as many are audio minded. To carry the point further, we'd say there are people who can make out better, hearing a book, than if they had to read it." Tierstein was speaking from a semi-technical point of view; but many persons who never dreamt that such a thing as audio books could exist have said just about the same thing.

Ever since the time of Greek tragedy, when part of the narration was carried forward by a chorus, the immediate, vital effect of recitation has been recognized. It is still the only way to get at both the meaning and the music of words. Without the spoken word, the printed facsimile would be almost meaningless. There is nothing that can bring the glow of reality to a story, a poem, or a play, better than a "live" performance of the human voice. Every school curriculum features it as a staple of its repertoire; and the staleness or stimulus of most courses depends on the degree of skill brought to its execution.

To name only one contemporary exploitation of recitation, readings at the Y.M.H.A. Poetry Center in New

York City have been exceptionally well attended during the last three seasons. Audiences there have heard prose writers Eudora Welty and Truman Capote, and a number of distinguished poets have read their works. On record, the Columbia LP *Pleasure Dome*, with readings by T. S. Eliot, Marianne Moore, Ogden Nash, e.e. cummings, and W. H. Auden, has aroused wide interest. Caedmon Records have flourished with but one string, the human vocal cord, to their bow; Thomas Mann, Archibald MacLeish, Dylan Thomas, and Laurence Olivier have all read before their microphones. This is by way of saying that the catalog of voice recordings is already, on 33 1/3 microgrooves alone, a bulky affair.

To this scene, charging like knights errant across a not-so-arid desert, come C. C. McDonald and J. I. D. Morrison, the engineers of Audio Books. However, they are hardly newcomers to the recording industry. McDonald has worked with the World Broadcasting System, the Mutual Network, KHJ in Los Angeles, and Decca Records. Back in 1928, when the words "record" and "transcription" were anathemas to the broadcasting industry, McDonald was in charge of the first "delayed broadcast," i.e., transcribed program. J. L. D. Morrison has designed, among other good things in audio, both recording lathes and playback turntables. One of his recent productions is a turntable manufactured by the V-M Company.

About two years ago, they first heard some of the "talking books" prepared for the blind by the Library of Congress. They investigated, and found that although the project brought comfort and aid to the blind, its records were bulky, weighty and, if produced commercially, much more costly than most people could afford.

Their solution is like that of the efficiency expert who was reputedly called in to salvage the tottering budget of the United States Treasury's printing office. It was costing too much to print dollar bills and the government's money-makers were trying to figure ways to cut costs. "Just cut the size of the dollar bill," the expert told them. "It's too big." And he has always claimed that he was paid for the suggestion.

Morrison and McDonald approached audio books with the same zest for diminution. Getting out their slide rules and reducing lenses, they went after the standard microgroove record and lopped off an appreciable amount of dead weight from what had previously been considered the smallest unit of the family of 12, 10, and 7. The outside diameter of seven stayed the same, but they got their reduction from the inside, by cutting out a larger hole — three inches across. They also went back to Edison and Berliner records, engraving

James M. Cain. The Postman has more than one voice.



label copy in the matrices, where it can be clearly seen — and felt. It is cut into the narrow inside margin between the final groove and the center hole.

This left them with an effective working area, or groovable part of a record, of only 1-5/16 inches. Into this, they proposed to cut half an hour of reading time. Some more work with the slide rules, and they had the answer speed would have to come down to half that of the 33 1/3 rpm disk, and grooves would have to be sliced in at the rate of between 400 and 440 per inch. Using a hot stylus cutting technique, they managed to do it. The end-result: a seven-inch, vinyl disk weighing less than half an ounce and performing at 16 revolutions per minute, with one



16 rpm Adapter for your 33 1/3 turntable.

hour of playing time. When they had that, engineers McDonald and Morrison knew they could get books to talk.

There are many advantages to this system and perhaps they should be enumerated before we go into some of its shortcomings. First and foremost, although no one is going to like adding another speed to his already bruised and bleeding turntable, there is the advantage of economy. The seven-inch disk described above takes considerably less vinyl than even the fairly economical 45 disk. And for the amount of playing time stashed away in its 1-5/16 inches of grooving, it can be shipped anywhere for less money than any other kind of recorded sound.

This is especially significant when the intended sound-content is a book. It makes it possible for persons who might not otherwise be able to afford "talking books" to hear them on a "lending library" basis; it is conceivable that if large enough quantities can be pressed at one time, the price of an audio book will compete with that of a printed one. Going from here, it is even possible to speculate on a time when authors will "speak" their books, or narrate them as they evolve, and the final, "printed" version will be one pressed directly by matrices processed from the author's original homespoken tape.

Possibly because of this and other economic factors,

the publishing business is split right down the middle in its reaction to Audio Books. Some want to climb on the audio wagon, and bring out talking editions of everything, or nearly everything. There is talk of a talking Mickey Spillane, and there doesn't seem to be any reason why he shouldn't talk if everyone else is going to. Mike Hammer may some day rival Vaughan Monroe as the Voice with the most muscles. But some publishers are scared, and see their century-old businesses slipping away. They are already behaving as if they heard it whispered behind their backs, "he's an old-timer, you know. Publishes only silent books."

Possibly that time will come, but before it does, audio books will experience a growing pang or two. Among pangs likely to be experienced, at least in the minds of potential buyers of Audio Books, is that of having to adapt for still another speed. It's all very well to say that the answer is a universal speed turntable, and point to Rek-O-Kut, Zenith and V-M models of same, as do engineers McDonald and Morrison, but that still leaves a lusty majority of good sets in operation without universal tables. For them, an adaptor has been made.

Two things can be said in favor of the adaptor for sale by Audio Books: It's cheap (\$2.95 retail) and it works. All resemblance to a satisfactory mechanism stops at this point. Like the "microverter" introduced to convert the 78 turntable to 33 1/3 rpm, it is hardly a precision instrument. In fact, the sample provided this reviewer was so un-precise that its center hole would not fit onto the standard spindle of a professional, high-quality turntable. When I finally got the contraption working, it turned with a rise-and-fall of over 3/32 inch (close to a full 1/8 inch) of the outer edge of the thin disk. This resulted in stylus and cartridge riding the grooves like a lifeboat from Captain Ahab's *Pequod* bobbing from crest to trough of a pretty active sea.

Symptomatic of yet another of audio books' growing pangs is the restriction, because of low speed and close grooving, of recording range. Because the compact 16 rpm system simply cannot, at this stage in its development anyway, handle wide-range speech or music, the producers of Audio Books have had to stick to the middle range of the audio spectrum, perhaps peaking here and there to increase the factor they call "intelligibility."

This is certainly a controversial business. One representative of Audio Books has stated that he doesn't like the "musical" quality inherent in wide-range, modern voice recordings; he thinks it's because sibilants come through with too much insistence. Be that as it may, there is a quality that comes with the wide-range LP's, and it can't be preserved in a system where "intelligibility" alone is the prime factor. That is the quality of "immediacy," or "presence," and it has a lot to do with making the human voice sound more real, more rich, and more live.

The first Audio Book, the "Audible Edition of The New Testament" was issued in May and calls for listening time of 23 hours, 11 minutes. It retails for around \$20.00, and is complete in 24 records. They are kept in a gilt-stamped, spiral-bound black leather cover, measuring 7 1/2 by 8 3/8 inches, with a 1 1/8-inch *Continued on page 110*



D. T. N. Williamson

ADVENTURERS IN *Sound*

Uncle Harry in the Corner

DAVID Theodore Nelson Williamson said he would meet me in a midtown New York restaurant at five o'clock — and just as my wristwatch was ticking off the zero moment, in walked Williamson.

The designer of the Williamson amplifier circuit, one of the first long steps toward quality music-reproduction in the home, turned out to be a pleasant surprise all around. I had expected a rather furious looking man, a busy-type with much audible hum, for I had seen and heard the name Williamson so often it had taken on a personality of its own.

Williamson in the flesh, I must say, looks nothing like the schematic Williamson at all. He is a lanky youth with a soft, quiet voice, and on this occasion his clothing seemed to have been chosen for the purpose of carrying him unnoticed through even the smallest crowds.

We spoke, shook hands, and he introduced a friend who had come along, Richard Davies, general manager of Ferranti Electric, Ltd., in the United States. In fact, I had first thought Davies might be Williamson, for he is a tall, athletic, alert man who appears able to design an amplifier if he wanted to.

But Davies said no, not in his line, the confusion was cleared up and we found a table. I called a waiter and suggested a drink. To get things moving I asked for a Scotch and soda and so did Davies.

But just here, let me explain why I am giving these trivial details. What Davies and I had to drink would be of utter inconsequence — except that it brings our subject into quick focus.

Davies and I may have chosen Scotch out of snap judgment, but not D. T. N. Williamson.

For a full minute he meditated. Then he spoke.

"What to have," he said. "This really calls for some thought. I had a Scotch yesterday, so I don't think I shall repeat today. I had a whiskey sour the day before, and that takes care of that."

Williamson pressed his chin, a strong well-formed chin, in a hand which is muscular and artistic in form. The brow furrowed. The dark eyes lengthened their meditative gaze.

"Do they still make much illegal whiskey in the southern mountains?" he asked.

"Moonshine," I corrected. "Yes, the mountaineers still make their mountain dew and white mule, but the biggest moonshiners are in Brooklyn and New Jersey."

I cannot recall now just how the conversation got from mountain dew to Prohibition's bathtub gin, the lethal effects of improper distilling and the proportion of fusel oil in bootleg whiskey, but Williamson seemed to have a fund of knowledge on the subject and was discussing it when I implored him to settle for a martini, a mint julep, anything, and release our stranded waiter. He settled on a Martini.

My admiration of Williamson had started to mount when he began to talk and I took this moment to fetch the conversation back to him. Digging at his background, I exposed this solid masonry of facts.

He was born in Scotland of Irish parents, and was educated in engineering at the University of Edinburgh. During World War II he was assigned to Ferranti Electric of England, sent to London and put to work on military electronics. Since the war he has been a development and research engineer with Ferranti, devoting most of his time to work on devices for the electronic control of machine tools, and on electronic computing machines.

Sound reproduction has been a hobby with him since high school days in Edinburgh, and just now he doubts that it will ever be anything more.

"But it has been a serious hobby and I intend to keep at it, as a diversion," he explained. "From time to time ideas turn up and get worked on. At the moment I am less interested in amplifiers than in the pickup and the loudspeaker, the two extreme ends in the chain of sound reproduction. I feel they have lagged behind and must now catch up with the performance and quality we now have in our amplifiers. In fact, I'd like to hear a lot less talk about improving the amplifier, and more about the speaker."

Williamson said there is no longer any doubt about the qualities of an amplifier, that it can be scientifically measured, and can be made as nearly perfect as the maker's budget will permit. Williamson himself sees little sense in spending money for merits the ear cannot hear.

The amplifier which Williamson likes best, and understandably, is an attractive two-chassis affair bearing

his signature and made in England exclusively for British Radio Electronics of Washington, D. C. This amplifier, called the Hallmark, is pure Williamson, approved by Williamson and made from components of his own choosing and to his own physical design.

"I have been told that it has attractive lines, and I agree," he said. "Like a bridge or a locomotive, if a mechanical shape reflects good engineering it will be pleasing to the eye. It is one of the laws of nature."

Williamson said American designers of electronic equipment might take a long reflective look at their own products with questions of their aesthetic appeal in mind. In most cases, he thinks, British designs have a more pleasing flow of lines, giving the appearance of being composed as an overall design, not a helter-skelter of tubes and transformers placed to match holes in a chassis.

Making but slight progress on his martini, Williamson then took off on less personal matters of music reproduction in the home.

"Both here and in England I hear endless talk of having the home sound like a concert hall, and I think it's all a little silly. Why should your living room sound like a symphony hall, and how could it?"

"The thing we must all do is decide what kind of an illusion we want to listen to.

"The object in reproducing sound in the home is to create the illusion that we are hearing the original sound. Discovering that this is unattainable — except on rare occasions where favorable conditions occur — we adopt a compromise and try to create an illusion which, although distinguishable from the original, differs only by modifications which could occur in nature under the prevailing circumstances, and which, therefore, are not incongruous."

The component in the high fidelity chain which most often stands in the way of the illusion is the loudspeaker, Williamson said.

"The weakness of the speaker is due largely to the compromises we have had to adopt in order to achieve

a practical size, and to the fact that there is no clearly defined aim as to what we are trying to achieve, as there is with the other components of the system.

"One might be pardoned for thinking that the loudspeaker has progressed only in detail since the 1920's, and before it can be improved substantially we must reach a greater degree of agreement on what we are trying to do, and on how the loudspeaker must fit into the existing acoustical structure."

Williamson pushed his glass away, as if the bartender, too, had been confused as to where the vermouth fits into the martini structure.

At that moment Dr. Peter Goldmark arrived, was introduced to Williamson and Davies, and sat down at the table. The inventor of the microgroove and the modern long playing record called for tomato juice without the slightest hesitation.

When Williamson took up the subject of loudspeakers again he gave thousands of high fidelity extremists an entirely new and perfectly intriguing thing to worry about. Wow, rumble and hum are now old hat. Here was something fresh and novel.

"Many loudspeakers today give us three alternatives in our search for the illusion of reality," he began. "Let us suppose we are to reproduce a talk. Do we wish the talker to sound as if he were actually in the room talking to us? Or do we wish him to sound as if he were standing on the other side of the wall, speaking through a hole in it? Or, do we wish the illusion of being transferred from our room into the studio?"

"A great many loudspeakers today produce the second illusion, that the speaker is talking through a hole in the wall, the hole being, of course, the loudspeaker diaphragm set in its cabinet against the wall or actually mounted in a hole in the wall.

"Now this surely is not natural," Williamson said. "When we have friends visiting us we don't put them in the next room and ask them to speak to us through the service hatch — not unless they are scarlet fever contacts. We have them sit down, *Continued on page 104*

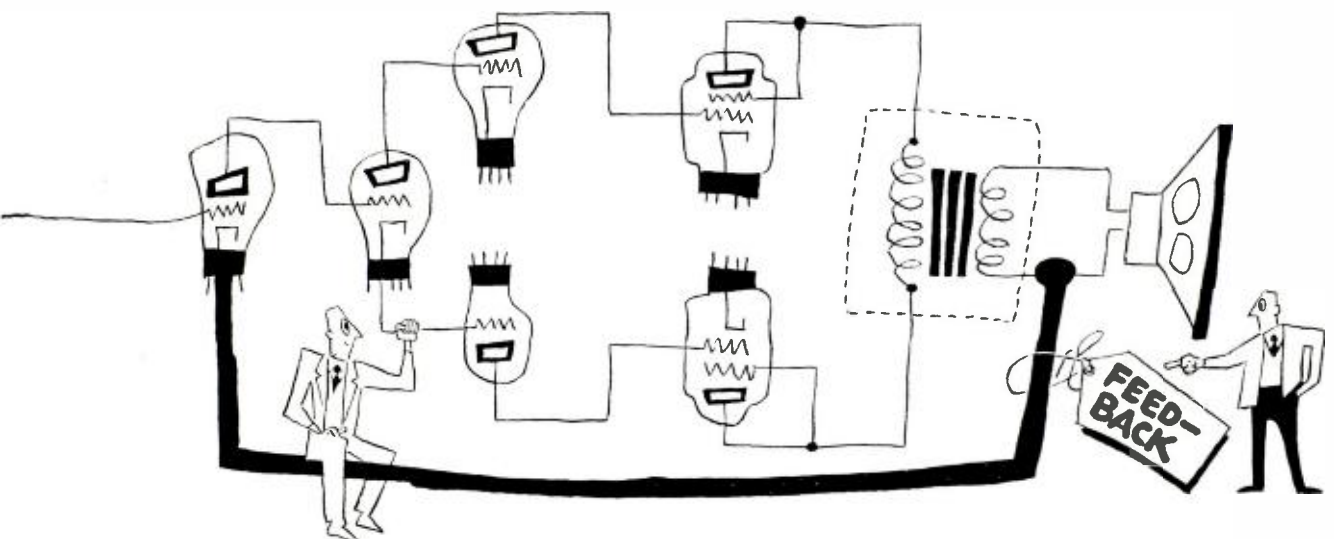

INSPIRATION



FOR

Custom

One of the most important features of a custom installation is that it can — and should — be made to blend with the decorative style of the house, be it modern or traditional, early American or late Victorian.



In the installation above, radio, television, and phonograph equipment occupy half of one wall of the living room. Components include Radio Craftsmen TV and FM tuners with an amplifier of the same make; the loudspeaker is an Altec Lansing, the record changer, a Garrard. Wood is oak with contrasting natural and black finishes. Designed and installed by Lowe Associates, Boston.

Above and right are illustrations of something new in custom installation cabinets: the Angle-Genesee Company of Rochester, N. Y., offers a wide range of standard cabinet exteriors or shells and then equips them with panels, drawers, and shelves tailored to fit the purchaser's equipment and requirements. They also make cabinets completely to customer's designs.



INSTALLATIONS . . .



At the left is another Angle-Genesee cabinet. Above is a completely built-in installation designed by Kierulff of Los Angeles. When the doors of the cabinets are closed, they present an unbroken front with no indication whatsoever that radio and phonograph equipment lurk behind. There is plenty of storage space below the tuner and to the right of the slide-out record changer drawer.

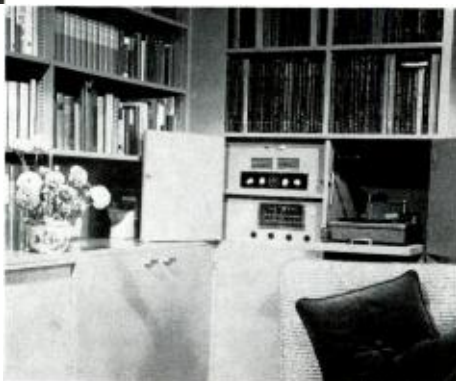

This might be called the ultimate in simplicity — simply a changer, an amplifier, and a tuner mounted neatly and compactly. Attractive, yet simple — giving enjoyable hi fi listening. Designed by Kierulff, of Los Angeles.



In one ear

By JAMES HINTON, JR.



The Pack-Rat Who Backslid

BOSTONIANS, everybody knows, are supposed to be very proper people, little given to lively eccentricities, and probably they are. Fortunately, however, in every generation a few genes defy the statisticians and produce Bostonians whose peculiarities are not only discernible but engaging. Arthur Fiedler, conductor of the Boston Pops, fire-engine chaser, and collector of fire-fighting regalia, is one of these.

Perhaps the initial fixation on fire engines developed somewhere deep in Mr. Fiedler's youthful *id* as an off-season outlet. After all, for thirty-eight years, man and boy, he has either played in or conducted the Boston Pops, a strictly warm-weather enterprise until this year. Winters are cold and long in Boston, and who could blame a high-spirited young fiddler for seeking relief from tedium in such good clean fun as watching buildings burn and hoses squirt? Now he has risen in life, and royalty checks from RCA Victor permit him to follow the red engines in a green Cadillac equipped with short-wave radio and a siren. Now he is honorary fire chief of his native city (he was born, local sources say, on the Charles River Esplanade). Now he can even speed in pursuit of the engines, for he is also honorary police commissioner. It just goes to show what hard work and constant application can do.

This year, though, a new and possibly sinister side of Mr. Fiedler's enthusiasm manifested itself. It all started when the Boston Pops went on tour for the first time in its 68-year history. He who had contented himself with fire-chief honors in his own city and in a couple of carefully selected places like Chicago and San Francisco, suddenly went in quest of honorary firechieftainships and free fire-fighting regalia all over the country. And worse, he allowed himself to be so carried away by it all that he even compromised his original enthusiasm by allowing himself to be made honorary *other things* — things that have nothing to do with fires.

We must face facts bravely: lots of people collect lots of things — stamps, bits of twine, shoes, cigarette butts, bones, dead mice, phonograph records, even money. There is nothing wrong with collecting *per se*. But let a pack-rat complex get out of hand, and trouble is sure to follow.

I call the acquisitive lust a *pack-rat* complex because it seems to have been left out when Latin and German names were being assigned to lusts and complexes. We could call it a *magpie complex* just as well, but since we are in musical territory the term might be misunderstood. Come to think of it, *pack-rat* doesn't seem exactly complimentary, either, but I have had an affection for those Rocky Mountain fanciers of bright and shiny objects ever since being introduced to them in the pages of a book by Ernest Thompson Seton. The dictionary describes the pack-rat as a "large, bushytailed species," anyway, and when last observed Mr. Fiedler's hinder appendage was in no wise bushy, being, rather, bifurcate and impeccably tailored.

In any case, the Boston Pops tour allowed Mr. Fiedler to develop a full-blown pack-rat complex and indulge it to extraordinary lengths. To my mind, his lust for acquisition led him to violate a fundamental rule of the pack-rat ploy. For shame, say I. (I must admit, I too am a pack-rat, and jealous of the tradition.)

Things started innocently enough. In Scranton, Pa., on Jan. 23, Mr. Fiedler was met outside the city by Fire Chief Martin Fitzpatrick, escorted to the city hall, and invested as honorary fire chief of both Scranton and the outlying town of Dunmore. Two days later, in Washington, D. C. pretty much the same thing happened, except that Acting Fire Chief Fred Litteral had to officiate, because *his* chief, M. H. Sutton, had been injured during a fire.

The very next day, Jan. 26, Harrisburg, Pa., fell before the Fiedler attack, and Mayor Claude Robins made

the first breach in our hero's pack-rat integrity by persuading him to accept additional trinkets — the keys to the city. Altoona followed with its fire-fighting badge. And then Mr. Fiedler was cajoled into accepting another key — to Pittsburgh.

Proceedings were on the up-and-up in Lima, Ohio; Lexington, Ky.; Huntington, W. Va.; Roanoke, Va.; Daytona Beach, Fla.; and Miami. Then, in Tallahassee, came an experience so traumatic that it almost excuses subsequent and horrifying developments.

While busily conducting away at Dohnányi's *Variations on a Nursery Song*, keen-eyed Mr. Fiedler observed that the curtain of the high-school auditorium was on fire. Consider his dilemma: as a conductor raised in the fine old show-must-go-on tradition, he should play on; as a fire buff and a pack-rat of fire-chief badges, he should spring into action and extinguish the flames. Alas, he compromised. He called (method of communication unspecified) the attention of the stage manager to the flames, and kept on conducting while mere amateurs dealt with the conflagration. In short, he betrayed his trust and disgraced the badges of no fewer than 15 (by my count) fire departments. Boston hung its head in shame. Tallahassee withheld — rightly, I believe, in view of such unfiremanlike conduct — its badge of honor, and Mr. Fiedler never seemed to quite recover his sense of proper pack-rat proportion. From then on he seemed ready to take anything that was offered.

He pulled himself together well enough to accept honorary fire-chieftainships in Shreveport, La., and Beaumont, Tex., but in New Orleans he wobbled from the straight-and-narrow and accepted the key to the city. Then, in Vicksburg, Miss., he fell completely. Lured by the promise of yet another addition to his collection of fire-chief badges, he supinely allowed himself to be commissioned a Colonel in — of all things — the Confederate Air Force. But worse was to follow, and swiftly.

In Stillwater, Okla., on March 12, Arthur Fiedler, fire buff of national reputation, chief (honorary) of fire departments all over the nation, allowed himself to be made an honorary *Indian* chief. Perhaps his reason had been unseated by the Tallahassee episode; perhaps duress was used. But there is no record that he resisted when Chief Shunatono of the Otoe tribe named him Chief Petuh Toorah-hi — meaning "a great man in more ways than one" (enigmatic, that) — and prayed over him in this wise:

*May the Great Spirit send his choicest blessings on you.
May the Sun Father and the Moon Mother shed their
softest beams on you, and may the Four Winds of Heaven
blow gently on you — on all with whom you share your
heart — and your wigwam.*

A fine thing for a man who started out from Boston as an honest collector of fire-chief badges! If Stillwater doesn't have a fire department the least they could have done was give Mr. Fiedler an old oil well that he could set on fire. Chicago and Ann Arbor, Mich., came through with fire-chief badges, and Detroit and Cleveland added further to the corruption of the once pure by slipping him keys to the city.

Indeed, it is possible, if saddening, to imagine Mr. Fiedler, tainted by non-fire-fighting honors, spoiled by irrelevant adulation, stamping his foot in vexation as the tour ended with Syracuse, N. Y., tendering him nothing more exciting than another mere commission as honorary fire chief.

It is easy to imagine him back in Boston, pretending to polish his badges but casting fond glances at his Confederate wings and Otoe war-bonnet and jingling his collection of city keys, only occasionally letting his thoughts drift back to the debacle in Tallahassee. Thus it is that honest pack-rats lose their singleness of purpose. Schizophrenia is just around the corner.

We can only hope that our hero, back behind the wheel of his green Cadillac once again, will forget all about the Four Winds of Heaven blowing on his wigwam and, badges clanking and siren yowling, take off after the fire engines that gave him his start in pack-rat life. Boston may exert a sobering influence. It usually does.

Charivariety

Edison-proud Americans might note that among the 40,000 disks in the library of the University of Paris are such oddities as an 1885 (sic) recording of *Il Trovatore*, the voice of Captain Dreyfus defending himself against the charge of treason, several different Sarah Bernhardt pressings, not to mention examples by Lenin and Andre Gide. The university has a number of duplicates and is willing to swap — preferably with other institutions.

The surprise recital of the New York season just past was Walter Giesecking's Carnegie Hall return. He had tried before, in 1949, but the Immigration Department took last minute cognizance of violent anti-German sentiment in influential quarters and forced a cancellation. Since "totalitarian" equals "Communist" in McCarran Act application, it was all right this time. As far as anybody knew, Mr. Giesecking had not set foot in America in the interim; but when he was asked whether he had kept up his butterfly-collecting he answered that indeed he had, and had added a number of new specimens during a summer sojourn with his daughter — who lives in the Midwest.

Lt. Col. G. Preston Grant, of White Sands Proving Ground, Las Cruces, N. M., sends the following query: "Back in 1947 I purchased some of the original LP records. Among them was a cutting of *Scheherazade* by the Philadelphia Orchestra . . . a rehash of some old 78's. Recently some people called my attention to the fact that there are distinct dog barks impressed on a silent passage near the end. Can you shed any light?" Happens I can't. They sure sound like dog barks, but nobody seems able to account for them. There are dog barks in the Wolf's Glen scene of *Der Freischutz*, but that is a different pup. Can anybody add to or illuminate?

Early risers in San Mateo, California, called the sheriff to investigate the snores that emerged from their radios when they tuned in on the local Rise and Shine disk-jockey.

KPFA BERKELEY

California's listener-sponsored station

ALFRED V. FRANKENSTEIN

KPFA IS A RADIO STATION of many distinctions and peculiarities, but none more markedly peculiar than this: if you should telephone its directors to express dissent or indignation at one of its programs on public affairs, you will be immediately invited to take the microphone and express your own views of the problem you have heard discussed. Such invitations are a matter of fixed policy at KPFA, and that is one reason why this station has been placed by its admirers and its detractors in every conceivable political category from anarchist to black Republican.



Lore is where you find it; KPFA's roving reporter, Robert Schutz, interviews aged architect Bernard Maybeck, for a taped program.

Actually, politics plays practically no role at all in the thinking behind KPFA. It is an experiment in esthetics and sociology, unusual in practically all respects and altogether unique in one. It is unique in that it is sponsored very largely by its listeners and will in time be sponsored entirely by them. It is unusual in that its programs are based upon the theory that "if a sound is worth passing through the magnificent apparatus of a microphone, a transmitter, and your receiving set, it ought to convey some meaningful intelligence."

The remark just quoted was made by Lewis Hill, founder and executive director of KPFA, who emerged from long experience as a news analyst on commercial stations

in Washington and San Francisco with two convictions: "First, that radio can and should be used for significant communication and art; and second, that since broadcasting is an act of communication, it ought to be subject to the same esthetic and ethical principles as we apply to any communicative act, including the most personal." One implication of that last statement is that the final responsibility for everything done at KPFA rests with the person who is doing it in the light of his best ability; it does not rest with a program department ruled by fear of its audience and its commercial sponsors.

The station's policy of listener-sponsorship has aroused immense interest in the San Francisco area, which it serves, and in the country as a whole. It is partly a matter of dollars and cents, since KPFA's time is completely free of commercial entanglement, and partly a method for securing what Hill calls the "creative tension between broadcaster and audience that constantly reaffirms their mutual relevance." To date its success has not been overwhelming, but Hill, his associates, and the Fund for Adult Education are willing to gamble on the likelihood of its making the grade.

KPFA is an FM-only station operating on 94.1 megacycles. (There was no AM band available when it applied for its license.) This restricts its audience. In Northern California FM has had more difficulty gaining acceptance than it has in the East, probably because the region is hilly and good reception requires good antennas. The general radio audience is inclined to ignore the medium. It is estimated, however, that approximately 25 percent of the radio sets within the radius of KPFA's signal are equipped to receive FM, and KPFA needs subscriptions from 3 percent of the owners of these sets in order to be self-sustaining. At present it has subscriptions, at \$10 a year, from 1.3 percent. The deficit is made up by contributions from individuals and by a grant from the Fund for Adult Education. This grant has been made for three



Boarders away! Chuck Levy reads Treasure Island for youngsters.



Cellist Helen Stross, pictured during a KPFA Artists' Concert.

years, in decreasing amounts each year. The theory is that the subscription list will grow, and that eventually the station will be able to depend entirely on its listeners for its financial support.

The key to adequate and lasting listener-support is psychological. The area is rather rich in well-educated residents, interested in the arts, and most of them are reasonably affluent. The money is there. The problem is, in effect, to make the listeners pay for something they want and *can afford*. A tantalizing clue to the psychological key cropped up recently, by accident. The station's transmitting antenna was damaged. Broadcasting stopped while repairs were made. Listeners began telephoning, anxiously. Even when reassured that the station had not stopped functioning for lack of funds, a substantial number of people insisted on subscribing at once, expressing remorse at not having done so earlier. The diagnosis was easy to make. So long as the programs were on the air, listeners thought of subscribing as an act of altruism — paying for someone else's pleasure. But when the programs went *off* the air, the listeners' thinking changed. Now their problem was to get the programs back *for themselves*. For this, they were willing to pay. Hill would like to arouse and maintain the same sense of urgency without going off the air.

KPFA is on the air nine hours each day. Three hours each morning are devoted to rebroadcasting programs originally presented on the previous night. The main schedule is broadcast between 5 and 11 p.m. and is divided into four categories — music, public affairs, literature and drama, and children's programs. Music occupies approximately 40 percent of the entire time and the other categories 20 percent each.

KPFA broadcasts more live music than any other station in California, perhaps more than any other station west of New York. As an educational venture it has been able to secure a preferred rate from Local 6 of the American Federation of Musicians, and it has run transmission lines into the principal concert halls of Berkeley, where its studios are located, including the concert halls of the University of California. Incidentally, KPFA uses transmission lines capable of carrying 15,000 cycles. (The average transmission line cuts off at 8,000 cycles.) The live musical program stresses the performers and the composers of the region and has embarked upon some unique experiments, like broadcasting rehearsals of the Griller Quartet, which is now connected with the University.

The public affairs program emphasizes commentators — not professional commentators, but individuals of the community who have direct experience of community problems and ideas about national and world issues. There are "round tables" on every conceivable subject, and — a theme rarely stressed elsewhere — views of America and American policy as seen by foreigners. The director of KPFA's department of public affairs recently returned from New York with a series of tapes containing interviews with world leaders assembled at the UN; he also recently put on a round-table about garbage and what to do with it.

The literature program involves readings by innumerable poets and a standing invitation to writers to air



"What is an atheist?" Round-table participants are Dean James L. Haggerty, St. Mary's College; Unitarian layman Gordon L. Robinson; KPFA public affairs director, Wallace Hamilton.

their work. It is hoped that in time writers will come to regard radio in the same light as the printed page, as a natural and logical outlet. Because of difficulties in obtaining adequate local casts, the drama program has been restricted largely to broadcasts of plays recorded by the BBC.

One of the most interesting aspects of KPFA is its

work with children. During the six years of its existence the station has directed its youth programs largely at pre-school levels, and now, as Hill puts it, one of its major problems is that of growing up with its child audience. Story telling (not story reading), folk songs, dramatizations of literary classics and scientific discussions are provided for the children, and children themselves are invited to participate in "kitchen orchestras" and the telling of "pyramid stories," wherein one narrator begins and another takes over, all using their unrehearsed imaginations.

Many of KPFA's programs are circulated on the tape network of the National Association of Educational Broadcasters. But of all the stations involved in that network, it is the only one which deliberately strives for a direct, immediate and functional relationship with its listeners in financing and programming. It is also the only radio station with which the writer has ever had contact whose director states that he believes in the unusual, not simply because it is unusual but because it is important, has influence, and should be heard. KPFA, in other words, is perhaps the West Coast's foremost expression of the idea that adulthood and critical intelligence need not forever be omitted from the radio broadcasters' scheme of things.

The technical side of the KPFA operation is more interesting than most—here are the details given by Bruce Harris, KPFA's chief engineer:

"The main control room equipment consists of an



Pianist Bernhard Abramowitsch, playing at KPFA Artists Concert.

RCA-76B4 consolette, two RCA 70-C2 turntables and two Ampex 403C tape recorders. We use an Altec M11 microphone for live music and round tables where a non-directional microphone is needed, and RCA 44BX's for other uses.

"For remote pickups, we have a Magnecord PT6-AH tape recorder and an RCA BN-ZA remote amplifier.

"Because of the large number of live music broadcasts on KPFA, and the way the station has been supported

by the local hi-fi people, we feel a great responsibility to keep the station operating at its best. This has been something of a problem, as we are a small station, and our engineering department is not overstaffed, to say the least.



Children's Concert: not only for but by youngsters themselves.

We have been given quite a boost by volunteer operators recently. At the present time, volunteers operate the transmitter four days a week, and contribute about 28 hours a week announcing and running the control room. One more volunteer is training as a control room operator about four hours per week.

"One of the problems of particular interest concerns our level of modulation. We decided not to use a limiting amplifier in the interests of better quality. At first we tried to use the VU meter on the consolette to control level, but we could never make it agree with the percentage modulation meter on the transmitter monitor because of the pre-emphasis characteristic of the transmitter and the sluggish nature of the VU meter compared to the ballistically compensated percentage modulation meter. We finally installed a Hewlett-Packard 335B FM monitor at the studio, and put an extension percentage modulation meter on top of the consolette. We installed a Yagi antenna and two TV boosters tuned to our frequency in order to get enough signal to operate the monitor. We try to adjust the gain so that each program peaks near 100 several times, and then leave the gain alone. This results in a very wide dynamic range and low distortion on the high frequencies (which frequently go over 100% when using only a VU meter) but gives a lower average percentage of modulation, so that KPFA sounds weaker than stations using limiting amplifiers. Also, the lower average makes the noise level more apparent, so that we are careful to see that it stays down where it belongs. The FM noise level is 63 db below 100% modulation, with the main studio microphone replaced with a terminating resistor and all gain controls set normally."

Records in Review



TABLE OF CONTENTS:

Classical Music.....	41
Miscellany	54
The Best of Jazz.....	56
The Spoken Word.....	58
The Music Between.....	58
Supplement (Reviews displaced from last issue)	60
Dialing Your Disks.....	63
Building Your Record Library	64
Mozart on Microgroove, Part II.....	65
Beethoven Up-to-Date, Part III.....	73

Reviewed by PAUL AFFELDER • C. G. BURKE • JOHN M. CONLY
 RAY ERICSON • ALFRED FRANKENSTEIN • JAMES HINTON, JR.
 J. F. INDCOX • EDWARD L. MERRITT, JR. • DAVID RANDOLPH
 EMMA DICKSON SHEEHY • JOHN S. WILSON.

CLASSICAL

BACH *Violin Concerto in E Major* — See Prokofieff

BARTOK *Sonata for Two Pianos and Percussion*
 Roger Goeb: *Symphony No. 3*

Gerson Yessin and Raymond Viola, pianos; Elayne Jones and Alfred Howard, percussion. Leopold Stokowski and his symphony orchestra.

RCA VICTOR LM 1727. 22, 20 min. \$5.72.

Bartok's *Sonata for Two Pianos and Percussion* is simply to be described as one of his most prodigiously inventive works, colossal in its ingenuities and its dramatic effect, and without parallel in Western music for its exploitation of the color of drums, gongs, triangle and other instruments of percussion. Its performance on this record is altogether splendid, and so likewise is the recording.

The symphony by Roger Goeb on the reverse side introduces an American composer whose idiom runs to vigorous rhythms, pungent orchestral effects, and a highly complex harmonic tissue, all of which makes very good sense and creates a distinctive creative profile. More of considerable interest may be expected from Mr. Goeb. A. F.

BARTOK *Three Rondos, Sonatina, and Eight Pieces for Children*
 Kodaly: *Seven Piano Pieces*

Ilona Kabos, piano.

BARTOK RECORDS BRS 917. 14, 15 min. \$5.95.

Here, Bartok has transcribed folk materials of his own collection. In the *Rondos* and the *Sonatina* the material is handled in highly

creative and ingenious fashion, while in the children's pieces it is arranged with the utmost simplicity, clarity and point. The Kodaly suite on the other hand, is only partly beholden to folk sources; its seven movements are difficult, brilliant, and powerful and require a first-rate virtuoso for their interpretation. The whole set is a little like a Hungarian *Pictures at an Exhibition*, although it is much shorter than Moussorgsky's work and much wiser in the ways of the keyboard. The performance leaves nothing to be desired, and the recording is fabulously good. A. F.

BARTOK *Divertimento for String Orchestra*
 Kodaly: *Suite from Hary Janos*

Minneapolis Symphony Orchestra, Antal Dorati, cond.
 RCA VICTOR LM 1750. 12-in. 22, 19 min. \$5.72.

One of Bartok's most profound and moving slow movements surrounded by fast movements notable for their rhythmic vivacity and their exploration of the coloristic possibilities of strings, an aspect of his art in which Bartok's imagination was inexhaustible. The Kodaly suite, from a comic opera written early in his career, scarcely needs discussion, since it is as firmly a part of the standard repertoire as *Till Eulenspiegel*, which it resembles in spirit although not at all in substance. Dorati, who is a pupil of Kodaly, plays this work and the Bartok with special perception and authority. A. F.

BEETHOVEN *Concerto for Piano No. 5, in E Flat, "Emperor", Op. 73*

Denis Matthews; Philharmonia Orchestra, London, Walter Süsskind, cond.

COLUMBIA-Entré(e) RL 3037. 12-in. 37 min. \$3.08.

Among the dozen recorded "Emperors" this inexpensive one has a place near the middle. It decisively rejects fuss, and so gives a first movement of imposing majesty with the tenderness of the second subject slighted; an adagio without magic and a rondo acceptable although somewhat angular and over forthright. Better than

satisfactory engineering: good piano, strong bass, boomy bass, deficiency of bright detail. C. G. B.

BEETHOVEN *Quartet for Piano and Strings in E Flat, Op. 16*

New York Quartet (Mieczyslaw Horszowski, Alexander Schneider, Milton Katims, Frank Miller).

COLUMBIA ML 4627. 12-in. 25 min. \$5.45.

†Mozart: *Piano Quartet No. 1*

This is Beethoven's arrangement of his Quintet for Piano and Wind Instruments with the same opus number, well done by VOX (PL 6040). The New York Quartet is made of musicians musicianly averse to virtuosity, who separately have produced for different companies a staggering number of records. When four like this foregather, the situation becomes political; and the political boss, Columbia, has distributed prominence with the deftest and fairest hand. The record is immediately notable for the balanced clarity of the four instruments, almost as if they had been separately recorded and the results superimposed on a disk to the satisfaction of every participant. C. G. B.

BEETHOVEN *Septet in E Flat, Op. 20 — See Cherubini*

BEETHOVEN *Sonata for Piano No. 2, in A, Op. 2, No. 2*
Sonata for Piano No. 23, in F Minor, "Appassionata", Op. 57

Robert Casadesus.

COLUMBIA ML 4622. 12-in. 20, 20 min. \$5.45.

Brilliant playing of careful concepts favoring contrast, dissatisfying after the work of Wilhelm Kempff has been heard. Between the outer movements with their violent passion Mr. Casadesus has sought to establish relief in the "Appassionata" by underplaying the andante. The result seems too casual to be right. The *Second Sonata* shows a beautifully poised pianism, but its fun is as if measured. The feature of the record is the striking verisimilitude of the piano, untroubled and full all along the keyboard, one of the best reproductions of the instrument to have appeared. C. G. B.

BEETHOVEN *Sonata for Piano and Violin No. 10, in G, Op. 96*

BEETHOVEN *Symphony No. 7, in A, Op. 92*

Philharmonia Orchestra, London, Alceo Galliera, cond.

COLUMBIA-Entré(e) RL 3035. 12-in. 35 min. \$3.08.

One of the better discal performances, barring haste in the trio and some in the finale, this would be a gratifying bargain if the full-bodied sound did not have a tiring hardness throughout. C. G. B.

BEETHOVEN *Wellington's Victory, or The Battle of Vittoria, Op. 91*
King Stephen Overture, Op. 117
Eleven Viennese Dances

Paris Radio Orchestra, René Leibowitz, cond.

OCEANIC 34. 12-in. 16, 7, 16 min. \$5.95.

The first two are new to LP. *King Stephen* is esteemed least of the 11 Beethoven overtures, now finally all on microgrooves. The performance is hard and lively, no subtler than need be, the sound hard but very well detailed.

The *Battle Symphony* is Beethoven's unworthy revenge on Bonaparte. It is one of those vaudevilles in which national tunes (*Rule, Britannia; God Save the King*) conquer an enemy tune (*Malbrouk s'en va-t-en guerre*) after a musketry of drums and triumph of trumpets. It was originally written for a mechanical orchestra invented by the composer's friend Maelzel, who also made the first metronome. It is rather ingenious and is not a bore. Mr. Leibowitz handles it well and retains enough after the battle to give the paean of victory some glory. The recording, percussive and brazen, is just right.

A similar sound is not right for the inventive Viennese Dances, which are agile and reflective both. String tone is coarse, and the brilliantly defined woodwinds are blended to suggest a musette. This may be the conductor's doing and not the recordists', but whosever, it tires in its quaintness. C. G. B.

BERLIOZ

Three Excerpts from The Damnation of Faust; Funeral March for the Last Scene of Hamlet, Op. 18, No. 3

†Franck: *Symphonic Interlude from Redemption*

Paris Conservatory Orchestra; George Sebastian, cond.

URANIA URLP 7061. 12-in. \$5.95.

The chief attribute of this disk is the first appearance on long-playing records of the seldom-heard *Funeral March for the Last Scene of Hamlet* and the lovely *Symphonic Interlude*, which is actually the Prelude to Part Two of Franck's oratorio *Redemption*. The familiar *Damnation of Faust* excerpts are here recorded in the order in which they appear in the complete work, which means that they are in reverse order for concert purposes. George Sebastian's interpretations are adequate but rather ponderous. They are blessed, however, with some wonderfully faithful reproduction. P. A.

BERLIOZ

Romeo and Juliet — Dramatic Symphony, Op. 17 — Complete Orchestral Movements

Philharmonic-Symphony Orchestra of New York; Dimitri Mitropoulos, cond.

COLUMBIA ML 4632. 12-in. \$5.45.

Always one to do things in a big way, Berlioz put down his musical impressions of the two immortal Shakespearean lovers, Romeo and Juliet, in a gigantic dramatic symphony for soloists, chorus and orchestra. Most of the work is purely orchestral, and it is this portion of it which is presented here in its entirety for the first time on long-playing records. As long as Columbia went this far, however, why didn't they go a little farther and record the whole composition, vocal parts and all? Then they would have been performing a real service, for this work is seldom heard in the concert hall.

What has been included on this disk has been done in excellent fashion. It comprises the *Introduction; Romeo Alone — Ball and Pête at the Capulets; Love Scene; Queen Mab Scherzo, and Romeo's Death*. Here is to be found some of Berlioz' warmest, most beautiful music — music which comes truly from the heart. Here, too, he can be brilliantly dramatic. Mitropoulos conducts a highly-charged, intense performance. The orchestral playing is first-rate, the recorded sound magnificent, with especially faithful highs. P. A.

BIZET

Symphony in D Major — See Schubert.

BOITO

Mefistofele

Rosetta Noli, (s); Simona dall'Argina, (s); Ebe Ticozzi, (ms); Gianni Poggi, (t); Gino del Signore, (t); Giulio Neri, (bs). Orchestra and chorus of the "Opera di Milano"; Franco Capuana, cond. URANIA URLP 230. Three 12-in. \$17.85.

Arrigo Boito was a man of many parts and some peculiar contradictions. Born into a family of means and cultivation, the son of a painter, he became an aesthetic theorist and a man of the theatre, a litterateur and a musician, a librettist and a composer.

As a librettist he lives to find himself the most praised practitioner of that despised craft in the history of opera. Nothing but good has ever been spoken of the texts that Verdi set as *Otello* and *Falstaff*, and some have gone so far as to picture Boito as a sort of beneficent Svengali to the master's Trilby. As a composer he lived to find himself ranked as a first-rate writer of operas on the strength of a single score — *Mefistofele* — though he wrote another. *Mefistofele* was a failure when it was first presented in 1868; it has since gained reputation, if not much currency. It needs money for settings and a dominating bass or bass-baritone for the title role. Plancon and Chaliapin, Ruffo and Amato, Pinza, Nicolo and Ros-si-Lemeni have sung it here.

Boito spent his life in search of fusion of music and drama that would not be conventionally operatic yet would be vocally Italianate. Small wonder that he was impressed with the possibilities inherent in Goethe's *Faust*, but in view of his later success as a librettist for Verdi it is strange that his own opera should suffer from the commonest of operatic ailments — libretto trouble.

In fashioning a book for *Mefistofele*, the young composer-librettist drew upon both parts of Goethe's play — sacrificing plot to profundity. *Mefistofele* emerged episodic. Nevertheless, it is a work of great interest and power. Boito breathed into his opera a conviction and strength of utterance that are even now fresh and compelling. It is the work of an intellectual, but of an intellectual inspired.

The great prologue in which Mefistofele addresses God and offers to bet with him that he, the Devil, can corrupt the soul of any

man—even of the godly Faust; the crowded, turbulent scene at the fair; the wild chorus of witches at their Sabbath; the archaic poesy of the scene with Helen of Troy; the tragic scene in Marguerite's prison, with its culmination in Salvation—these are all magnificent in their several ways. And the great creation of Mefistofele towers over all, commanding, exulting, and finally failing.

The Urania recording has no competitors. The reproduction is good, but without having quite the range of dynamics to make the really big scenes pay off a full value; and the performance is adequate, if sometimes lacking in bigness of scale. Franco Capuana's conducting has plenty of impetus when that is the order of the moment, but it is not hard to imagine, say, a wilder Walpurgisnacht.

Gianni Poggi is consistently above average as Faust, and Rosetta Noli is sweetly affecting as Marguerite. Simona dall'Argina (Helen of Troy) sings with a good deal of sweep, and the secondary roles are capably treated. Giulio Neri is a little disappointing. At best, his voice is big, virile, and solid. But, in attempting, it would seem, to give color to his rather phlegmatic temperament, he often distorts tones and twists the line out of shape, thus losing the vocal advantage he started with and failing to achieve the other-worldly, Satanic effect he intended. But these exceptions are relatively picayune. The performance is worth hearing, and the music certainly is.

J. H., Jr.

BORODIN

Quartet No. 2 in D Major
†Tchaikowsky: *Quartet No. 1 in D Major, Op. 11*

Hollywood String Quartet.

CAPITOL P 8187. 12-in. 26:24 and 24:56 min. \$4.98.

The principal popularity of these two quartets lies in their slow movements—the *Notturmo* of the Borodin and the *Andante cantabile* of the Tchaikowsky. Both works have a great deal more to commend them, however; they have great lyric beauty and not a little dramatic power. The highly accomplished Hollywood Quartet performs the Borodin and most of the Tchaikowsky with great care, understanding and tonal warmth. Reproduction is good, but for occasional edginess.

P. A.

BRAHMS

Piano Concerto No. 2, in B flat Major, Op. 83

Artur Rubinstein, piano. Boston Symphony Orchestra, Charles Munch, cond.

RCA VICTOR LM 1728. 12-in. 42 min. \$5.72.

Oddly enough, this mammoth and difficult concerto is now available in six recordings. This version can be recommended, for Mr. Rubinstein, playing with a mature artist's easy command of the musical and pianistic problems, offers a thoughtful, well-integrated performance. The tempo he has chosen for the opening of the rondo—not too fast—is a small indication of his soundly musical approach. Mr. Munch and the Boston Symphony work hand-in-glove with the pianist. The recording is praiseworthy and the balance between orchestra and piano just right. I know of no other version with a clear superiority, though I am partial to a superb 78-rpm recording made by Artur Schnabel, who missed many of the notes but extracted more profoundly moving sentiments from the score than his successors have.

R. E.

BRAHMS

Symphony No. 2 in D Major, Op. 73

NBC Symphony Orchestra; Arturo Toscanini, cond.

RCA VICTOR LM 1731. 12-in. 22:51 and 14:05 min. \$5.72.

This is the eleventh long-playing version of the Brahms Second Symphony, and by all odds the best. Toscanini gives a tingling interpretation of the score; his treatment is appropriately bright, and is characterized by his customary long-lined phrasing. The finale may be a trifle hard-driven for some, but this listener was tempted to cheer loudly as the record ended. Those who prefer a more relaxed approach might investigate the Monteux (RCA Victor) and Weingartner (Columbia) versions, though the present disk outshines them all for excellence of orchestral performance and brilliantly lifelike recorded sound.

P. A.

BRAHMS

Variations on a Theme by Haydn, Op. 56a
†Elgar: *Variations for Orchestra on an Original Theme, Op. 36* ("Enigma")

NBS Symphony Orchestra; Arturo Toscanini, cond.

RCA VICTOR LM 1725. 12-in. \$5.72.

The Maestro has always done a noteworthy job with the *Haydn Variations*, one which he repeats here. His earlier reading with the New York Philharmonic-Symphony may be firmer in interpretation, but it cannot compare in the quality of reproduction. What makes the current disk truly outstanding is his pellucid performance of the Elgar *Enigma Variations*. Unhurried and wonderfully plastic, it reveals every striking detail of this imaginative composition, and is thus easily superior to the recently released Concert Hall disk conducted by Walter Goehr. In getting the entire work on one 12-inch side, the engineers have had to reduce the volume in the finale, so as to avoid distortion in the heavier passages; otherwise, the reproduction is all that one could ask.

P. A.

BUXTEHUDE

Three Solo Cantatas for Bass

Bruno Müller, bass. Pro Musica Orchestra, Stuttgart. Eva Holderlin, organ; Hans Grischkat, cond.

Cantata for Two Sopranos

Margot Guillaume, Barbara Groth, sopranos. Instrumental Ensemble of the Bach Anniversary, Hamburg. Marie-Luise Bechert, director and organist.

VOX PL 7620. 12-in. I 19:55, II 22:45. \$5.95.

Vox seems to be making a specialty of recording the cantatas of Buxtehude, a welcome addition to the literature. In his own day, Buxtehude enjoyed much more fame than his contemporary, J. S. Bach. On one occasion, when he refused a musical post, the Town Council offered it to Bach, explaining that, since the first rate musician was unavailable, they had to choose one of lesser stature!

From the music on this recording, it is easy to see why he should have been regarded so highly. Although it contains less "meat" than Bach, it has immediate appeal.

The performances are all done with obvious devotion, and the recording captures the open acoustics of a church. The major share of the burden falls on the bass, Bruno Müller, whose three cantatas occupy about three-quarters of the disc. His voice is somewhat on the heavy side, but he handles it well, and shows an understanding of the style. The two sopranos acquit themselves well.

D.R.

CHAPI

La Revoltosa

Ana Maria Iriarte, Manuel Ausenci, Inés Rivadeneira, Patrocio Rico, Enrique Povedando, Lopez Roldan, Julio Nadal, Antonio Pérez, Joaquin Roda, Mari Carmen del Rio. Orquesta de Camera de Madrid and Cantores de Madrid; Ataulfo Argenta, cond.

MONTILLA FM-LP-3. 12-in. \$5.95.

CHERUBINI

Symphony in D

†Beethoven: *Septet (Violin, Viola, Violoncello, Bass, Clarinet, Bassoon and Horn) in E Flat, Op. 20*

NBC Orchestra, Arturo Toscanini, cond.

RCA VICTOR LM 1745. 12-in. 26, 35 min. \$5.72.

The Symphony is one commissioned by the Royal Philharmonic Society in 1815. It is not one of the best productions of the extra-



Horszowski and Chopin with zest and "blessed normality".

ordinary cosmopolitan whose 82 years began before *Bastien und Bastienne* and ended after *The Flying Dutchman*, but amidst its stiff melodies, facile counterpoint and broad orchestration are passages of tasty interest (the trio; the rhythmic figure dominating the finale).

There is no one like Mr. Toscanini for drawing a precision of florion out of this kind of coldframe.

It is justifiable to object to the multiplication of participants in chamber music, a predilection of Mr. Toscanini, but it ought to be admitted that the conductor's orchestral *Septet* is a pleasant excursion, if lighter than the original. The added violins aerate the score, playing with silky unison, exposed by glossy recording, on what is the longest 33 rpm side this writer has found. C. G. B.

CHOPIN

Piano Concerto No. 1, in E Minor, Op. 11; Four Impromptus

Mieczyslaw Horszowski, piano. Vienna State Philharmonia, Hans Swarowsky, cond.
VOX PL 7870. 12-in. 34, 3, 5, 5, 4 min. \$5.95.

Mr. Horszowski gives a lyrical, somewhat lightweight account performance of Chopin's E minor concerto. For all that the playing seems to skim along on the surface, it is very lovely and sensitive, and the tone always glistens. The orchestra is fair enough, although it has the normal difficulty of accompanying precisely the wayward piano part. There is a dividend in the inclusion of four Chopin impromptus — the "fourth" is the so-called *Fantasy-Impromptu*. But the dividend is a dubious one because there is such a bad echo in the recording hall that the piano cannot be heard with clarity. In the concerto, the recording is technically superior. R. E.

CHOPIN

Scherzo No. 3, in C sharp Minor, Op. 39; Berceuse in D flat Major, Op. 57; Waltz No. 6, in D flat Major, Op. 64, No. 1 (Minute); Impromptu No. 2, in F sharp Major, Op. 36; Etude in E Major, Op. 10, No. 3; Nocturne No. 5; in F sharp Major, Op. 15; Fantasie in F Minor, Op. 49

Guiomar Novaes, piano.
VOX PL 7810. 12-in. 7, 4, 1, 6, 5, 3, 11 min. \$5.95.

CHOPIN

Ballade No. 3, in A flat Major, Op. 47; Ballade No. 4, in F Minor, Op. 52; Etude in E Major, Op. 10, No. 3; Impromptu No. 1, in A flat Major, Op. 29; Nocturne No. 15, in F Minor, Op. 55, No. 1; Scherzo No. 1, in B Minor, Op. 20

Vladimir Horowitz, piano.
RCA VICTOR LM 1707. 12-in. 7, 10, 3, 2, 7, 7 min. \$5.72.

More than most music, Chopin's piano works can be subjected to a variety of valid treatments, and it is difficult to state categorically that one is better than the rest. Most pianists usually find them all interesting, preferring, of course, those that suit their own special tastes. For non-specialists perhaps the ideal interpreter is Guiomar Novaes — with Artur Rubinstein as an alternate. In support of this statement is her playing of the Chopin "recital" listed above. Her Chopin has plenty of romantic sentiment, and it has in equal combination strength and poetry; but its distinction is a kind of blessed normality (which may be another name for complete musicality). She does not provide the brilliance and dash of Rubinstein; the neurotic tension, with its often stunning special effects, of Vladimir Horowitz, or the rather fascinating artificiality of Maryla Jonas. Miss Novaes' virtues are particularly valuable in the *Fantasie*, probably the special glory of this record.

In this his second disk devoted to a Chopin miscellany, Horowitz again offers his special brand of pianism. Always the little exaggerations lend a nervous tension to the music; it does not seem to flow quite naturally. The hammer-like strokes, the spurts of breathtaking speed, exciting for themselves, frequently make the music meaningless. Still, no one but Horowitz could supply quite the beauty of tone he does in the *Nocturne*, the swift grace of the opening of the *Impromptu*, the exciting savagery of the *Scherzo*. The recording of the piano in both cases is exceptionally clear and distinct — too much so in Miss Novaes' case: I missed the kind of sustained legato she can achieve in the concert hall, where the piano ceases to be a percussive instrument and the tone wells up as if sung. R. E.

CHUECA

Agua, Azucarillos y Aguardiente

Ana Maria Iriarte, Tony Rosado, Juan Encabo, Maria Angeles Carchena, Manuel Ortega, Maria Teresa Berganza, Antonio Pérez, Maria Teresa Berganza. Orquesta de Camera de Madrid; Ataulfo Argenta, cond.
MONTILLA FM-LP-7. 10 in. \$4.95.

These seem to be the first examples of the Spanish *zarzuela* to become available on records in this country, as far as I know. The *zarzuela* is a form of musical theatre that dates back to the seventeenth century, when it became established in Spain. It bears some resemblances to comic opera and French vaudeville, but these are said to be coincidental; in any case, they are slight.

The name comes from the Royal Site of the Zarzuela (the word means "bramble"), a country house, near the El Pardo Palace, where the Cardinal-Infante Don Fernando of the Austrian Royal House was entertained by theatrical pieces written by Lope de Vega and Calderon. It is not sure whether these entertainments included *zarzuelas* as they are known today, but, in any case, the name was subsequently applied to this form of musical play, which arose out of the still earlier *tonadilla*.

Recent years have seen a revival of interest in the *zarzuela*, and with the sponsorship of Conrado del Campo, director of the Orquesta Sinfonica de Radio Nacional de Espana, many *zarzuelas* have been presented in concert form, beginning with Gaztambide's *Un Vieja*. Apparently the literature is extensive. Considerable interest has been aroused by these efforts, and the Marquis of Balarque has sponsored stage productions (these works among them), which have also proved successful. The hope is that the *zarzuela* will give birth to an indiginous Spanish form of opera.

Federico Chueca lived in the last half of the nineteenth century, and, although there is no mention of Chapi's dates (album notes are non-existent) his music sounds as if it were of about the same period — this as a warning to those who, lured by the talk about the sixteenth century, might hope for archaeological curiosities. Both works are in the one-act *genero chico* form.

Since librettos in translation are not supplied and since my Spanish is on the *si, si* level, no estimate can be given of their dramatic qualities. The music, decently reproduced, is by turns cheerful and sentimental, seldom very forceful, always pleasant and, well, Spanish. J. H., Jr.

DEBUSSY

Estampes (Pagodes, Soiree dans Grenade, Jardins sous la pluie); Reverie; Two Arabesques; La plus que lente.

Menahem Pressler, piano.
M-G-M E 178. 10-in. 27 min. \$3.00.

Winner of a \$1,000 Debussy prize in an international San Francisco contest in 1946, Mr. Pressler gives a good account of these pieces. Technically, the playing is all it should be; it is also colorful, rhythmically sensitive, gratifyingly full-bodied when necessary. For such early works as *Reverie*, the two *arabesques*, and *La plus que lente*, this may be a first recording. The reproduction of the piano sound is satisfactory. R. E.

DELIUS

Eventyr ("Once upon a time") North Country Sketches

Royal Philharmonic Orchestra; Sir Thomas Beecham, cond.
COLUMBIA ML 4637. 12-in. 40 min. \$5.45.

This is the first recording of the *North Country Sketches* (1914), a typical misty-toned Delius score, describing the bleakness of the Yorkshire countryside in Autumn and Winter. The colors turn a little warmer, with the introduction of a sturdy, rhythmic folk melody in the last sketch typifying the coming of Spring.

Eventyr (1917) is a larger-scaled work, rhapsodic in form, inspired by Norwegian folk tales. Though there are hints of Grieg in the score, it seems more English in derivation than Norse. Beecham achieves the magic that we have come to expect from him in this composer's music. His meticulous attention to orchestral balance, subtlety of phrasing, and marvelous control of tonal values results in a tapestry of gorgeous sound, all brilliantly captured by Columbia's engineers. The record sleeve is marked Volume One, so it is apparent that more Beecham Delius is in prospect. J. F. I.

DOHNANYI

Variations on a Nursery Theme, for Piano and Orchestra, Op. 25 †Strauss: *Burleske for Piano and Orchestra*

Fabienne Jacquinet, piano. Philharmonia Orchestra of London, Anatole Fistoulari, cond.
M-G-M B 3004. 12-in. 24, 20 min. \$4.85.

The Strauss and Dohnanyi works have two things in common: they are musical jokes, and harmonically they stem from Brahms. Today the Strauss joke seems very gentle, and it loses its point in some dull stretches of academic development. The humor in the Dohnanyi variations is sharper, broader, and consequently more obvious. The fun never maintains the level set by the wonderfully bombastic opening, but the music bubbles along very gayly with its satirical musical references, and the variations are thoroughly ingenious. The piano is effectively used; the scoring is richly brilliant — thanks to Strauss's influence. The recorded sound is bright, but with a slight echo and some surface noise, not ideally clear. R. E.

DVORAK *Quartet No. 6 in F Major, Op. 96*
("American")
†Smetana: *Quartet in E Minor* ("From My Life")

Curtis String Quartet.
WESTMINSTER WL 5199. 12-in. 28, 24 min. \$5.95.

(The Same)

Stradivari Records String Quartet.
STRADIVARI STR 613. 12-in. 26, 22 min. \$5.95.

DVORAK *Quartet in F Major, Op. 96* ("American")

Hungarian Quartet.
Suite for Orchestra in D Major, Op. 39, ("Czech").
Winterthur Symphony Orchestra; Henry Swoboda, cond.
CONCERT HALL SOCIETY CHS 1157. 12-in. 23, 24 min. \$5.95.

And now — three Dvorak "American" quartets at once!

First, let it be said for the record, that all three can be recommended without serious reservation. These are satisfying readings of two of the "warmest" works in the quartet repertoire. Incidentally, both these quartets would make an interesting and appealing introduction for anybody who is "on the fringe" where chamber music is concerned. Both works have a variety of pace within themselves. Each contains a dance movement. The Smetana has some intensely dramatic moments. And above all, both are melodious.

As the timings reveal, the Stradivari Quartet tends toward fast tempi, the Hungarian Quartet is slightly slower (in the Dvorak) and the Curtis Quartet slower yet. It should be stressed, though, that the differences are not very great.

The choice actually hinges on how close you like to be to a string quartet. Here the difference is quite marked, at least when the extremes are compared. The Concert Hall recording sounds furthest away, the musicians seeming to be in a large hall, at quite a distance from the listener. The Stradivari group is slightly closer; (about the same distance as the Koeckert Quartet in Decca's recent recording of these two works.) In the Westminster version, the listener seems to be seated among the players. All the recordings have a nice degree of room resonance. In the Concert Hall recording, the Dvorak quartet is not coupled with the Smetana, but with another work by Dvorak. The "Czech" Suite is appealing, easy-to-take music, sympathetically performed and well recorded. D. R.

DVORAK *Symphony No. 2 in D Minor, Op. 70*

Philharmonia Orchestra of London; Rafael Kubelik, cond.
RCA VICTOR LHMV 1029. 12-in. 20:23 and 15:40 min. \$5.95.

This symphony, one of Dvorak's finest, is fairly somber, but is brightened by the presence of Czech folk elements. Considering that he himself is a Czech, it is surprising that Kubelik gives such an unexciting account of this symphony. Not until the third movement does he come to life, then again he lapses into spiritlessness. The HMV engineers have provided adequate reproduction. Because of its greater spirit, more appropriate tempi, dramatic power and superior recording, the Urania disk of this work by Ernst Schrader and the Berlin Philharmonic is decidedly preferable. P. A.

ELGAR *Symphony No. 1, A Flat Major, Op. 55*

London Philharmonic, Sir Adrian Boult, cond.
RCA VICTOR LHMV 1036. 12-in. 49 mins. \$5.95.

In the first year after its premiere in 1908 Elgar's *First Symphony* had more than 100 performances. Today, it is rarely played outside

of England. Since it is still a work of many virtues and sustained power, its appearance on microgroove is welcome. The symphony is the first major composition of Elgar's so-called mature period, and the sure hand of a skilled craftsman is everywhere apparent. The music moves unflinchingly in its cyclic scheme; and the orchestration is richly beautiful and detailed. More important is the real inspiration in much (not quite all) of the material and the way it is handled, particularly in the motto theme, which opens the symphony hauntingly and closes it in a grandiose operation after being subjected to all sorts of treatment. Harmonically, the work is very much of its period, with the influence of Brahms, Wagner, and Strauss in evidence, but where this factor is not a hindrance to admiration the symphony should be well liked. The performance is full-bodied, warm, energetic, yet not devoid of serenity and genuine poetry. The recording, heard in a test pressing, is brilliantly clean and lifelike. R. E.

ELGAR *Variations for Orchestra on an Original Theme, Op. 36* ("Enigma") — See Brahms.

FRANCK *Prelude, Chorale and Fugue*
Prelude, Aria and Finale

Joerg Demus, piano.
WESTMINSTER WL 5163. 12-in. 19, 19 min. \$5.95.

In at least two recent issues, this and the doubling of Schumann's *Fantasia* and *Fantasiestücke*, Joerg Demus and Westminster have combined to produce records of exceptional value. The Franck works are companion pieces, as they were meant to be, stylistically alike but different in content and treatment, and those who like the relatively popular *Prelude, Chorale and Fugue* should enjoy the more rarely played *Prelude, Aria and Finale*. It is also the first time the latter has been recorded as a piano work. (Oddly enough, there is a recording of an orchestral transcription.)

Mr. Demus' performances seem above reproach, and Westminster, more or less as usual, has recorded them with unexceptionable fidelity. R. E.

FRANCK *Symphonic Interlude from Redemption* — See Berlioz

FRANCK *Sonata for 'Cello and Piano in A Major*
†Grieg: *Sonata for 'Cello and Piano in A Minor, Op. 36*

Leonard Rose, 'cello; Leonid Hambro, piano.
COLUMBIA ML 4652. 12-in. 27:14 and 26:15 min. \$5.45.

Though Franck wrote his only Sonata for violin and piano, it is readily adaptable as a vehicle for the 'cello, and is occasionally played in that form. Leonard Rose, one of the finest 'cellists of our day, brings interesting new tone color to the work in this lower register. The eloquence and unflinching assurance of his execution and self-effacing artistry also work wonders with the Grieg Sonata which, in lesser hands, can sound trivial. Leonid Hambro proves to be a perfect collaborator, and Columbia has provided extremely faithful reproduction. Altogether, this is a most worthwhile addition to the recorded 'cello repertoire. P. A.

GLINKA *A Life for the Tsar*

Tanya Shpieler (s), Elena Antonova (a), Georg Nelepp (t), Maxim Mikhailov (bs), Serge Svedlanov (bs); Chorus and Orchestra of the Bolshoi Theatre, Moscow, Alexander Melik-Pashaiev, cond.
VANGUARD 6010-6012. Three 12-in. 2 hr. 45 min. \$18.50.

It is a little uncanny to realize, hearing these disks, that we are acoustically present in the Bolshoi Theatre while a company of Bolsheviks limns devotion to the first Romanoff. (There was a canard some years ago to the effect that the title had been changed by ukase to *A Life for the Soviet*, or *A Life for Stalin*; but truth is not served by heeding what Americans and Russians say about each other.)

In 1613 Russia was enjoying an interregnum — which one would think the happiest political condition for that country — as a result of an excess, even there, of murders and dethronements. Poland and Sweden had candidates in a contest for the succession wherein we find False Dimitri II and III; a contest eventually won by the nineteen-year-old head of the German house of Romanoff. The story of Glinka's opera is this: Ivan Sussanin, a noble muzhik, leads astray a Polish force which would enthrone the candidate of

Poland. These unfortunate troops, not unnaturally resenting the imminence of the starvation to which Sussanin has led them, dispatch him.

If the story is not much, the music is pretty stimulating. This First of Russian Operas is an Italian opera employing Russian folk tunes, and Glinka's countrymen, who had not been trained to admire the native culture, jingled with admiration once Glinka's Tsar had given his approval. Much of this music differentiates character by opposing a mazurka to the buck-and-wing; and although naive it is highly entertaining.

Russian recordings have hardly challenged American techniques, or English, Danish, French, Italian and German techniques, for that matter, but this is one of the best. C. G. B.

GLUCK *Iphigenia in Tauris*

Patricia Neway (s); Pierre Mollet (b); Leopold Simoneau (t); Robert Massard (bs). Paris Conservatory Orchestra; Carlo Maria Giulini, cond.

VOX PL 7822. Two 12-in. 1 hr., 41 min. \$11.90.

In view of both the historic importance of this opera and the dramatic quality of the music, Vox is to be thanked for giving us an opportunity to hear it.

By and large, each of the participants leaves no doubt that he or she is aware of the dramatic import of what is being sung. This is no dry re-creation of "old" music. Those who think that the era of Wagner and Verdi had a corner on emotionalism will be surprised when they hear the dramatic intensity of this music. The singers themselves are obviously mindful of this, and are fully equal to the dramatic demands of the music. Musically, the palm should go, perhaps, to the tenor Leopold Simoneau, whose singing is most consistently beautiful. Very close to him is Patricia Neway, in the taxing role of Iphigenia. At first her voice seems to have almost too much of the opulence ordinarily associated with opera of a much later period. As the opera progresses, however, the incongruity vanishes, her singing becomes exquisite and moving. The

Columbia and the Contemporaries

Like *The Beggar's Opera*, the notes for Columbia's Modern American Music Series open with a dialogue, not, to be sure, between a Beggar and a Player, but between a Composer and a Business Man.

The Composer told the Business Man, "American music gets published and performed all over the world, nowadays, but the recording companies pretend it doesn't exist. And every year the backlog of unrecorded American music gets vaster."

The Business Man replied, "I'll change all that if you will show me how to do it."

So a committee was appointed consisting of Virgil Thomson, Aaron Copland, William Schuman, and Henry Cowell, who are Composers, and Goddard Lieberson, who is Executive Vice President of Columbia Records, Inc., and therefore, presumably, a Business Man. Each year the Composers on this committee will select enough modern American music to fill at least twelve LP sides, and the works will be recorded by Columbia "by artists of the composer's choice working under his immediate direction or supervision. The performances will therefore be authentic as well as first-class. And the works will represent, in the judgment of the Composers' committee, American music at its most distinguished and beautiful."

Of course it is not completely true that the recording companies pretend that modern American music does not exist, but an organized series, carefully selected, authoritatively performed, and recorded in Columbia's magnificent style, is nevertheless a thing of great importance, and the first six records of the series admirably fulfill the expectations aroused by the names of the committee's members.

The first 12 MAMS sides contain 13 pieces of chamber music by 11 composers. The older generation is represented by Charles Ives, Aaron Copland, Walter Piston, Virgil Thomson, William Schuman, Douglas Moore, and Wallingford Riegger, and the younger generation by Ellis Kohs, Lou Harrison, John Cage and Ingolf Dahl. The works selected range in date from 1902 to 1950, with heavy emphasis on productions of the 1940's. The idiom ranges from polished traditionalism to extreme experiment, although the latest type of experiment — that involving the manipulation of sounds recorded on tape and other techniques of partial control — is not represented here, or, for that matter, on any other records in general circulation.

The first record of the series, ML 4490, is devoted to the first piano sonata of Ives, the oldest work in the collection and the only one that fills both sides of its disk. It is typical Ives in that the composer describes it as "a kind of impression," remembrance and reflection of the country life in some of the Connecticut villages in the 1880's and 1890's." There are recollections of old New England hymnody, of barn dances, band music, and ragtime, and a tonal picture of "the fun a father has when his son hits a home run which wins the school baseball game." None of this, of course, is literally transcribed; as Ives reminds us in the same notes, the "oldtimers

often liked to think things out for themselves and to do them in their own way," and Ives' way is frequently capricious, bitingly dissonant, and fantastically complex in rhythm. Many pages of the sonata, however, are as romantic in melody, harmony, and rhythm as so much Schumann, and the work as a whole is rather less taxing to the listener than Ives' later and more celebrated *Concord Sonata*. The performance, by William Masselos, is splendid both in musicianship and virtuosity. (From here on it may be assumed that the interpreters, like Columbia's recording engineers, really know their business.)

ML 4491 contains, on one side, Virgil Thomson's *Stabat Mater* and *Capital, Capitals*, and, on the other, Lou Harrison's *Suite for 'Cello and Harp* and *Second Suite for String Quartet*. The *Stabat Mater* (Jennie Tourel; New Music String Quartet) does not employ the traditional hymn text but a short, simple, beautiful poem by Max Jacob on the same theme, and its setting is one of Thomson's most tender, delicate, reserved, and moving works. *Capital, Capitals*, "for four men and a piano" (Joseph Crawford and Clyde Turner, tenors; Joseph James, baritone, and William C. Smith, bass; the composer at the keyboard) is a kind of preliminary sketch for *Four Saints in Three Acts*. It is based upon a passage of Gertrude Stein which describes Provence in a dialogue of its four capitals — Aix, Arles, Avignon and Les Baux. Thomson says his music "is concentrated almost wholly on verbal articulation. It offers no Provencal landscape of its own to compete with the poet's rendering. It merely provides cadence and scansion for the text and the barest scaffolding of an instrumental support." And that is exactly how it sounds.

Harrison, one of the two young composers chosen to represent the United States in the competition for prizes to be held in connection with the international congress on modern music scheduled to take place in Rome next spring, assembled his *Suite for 'Cello and Harp* (Seymour Barab, 'cello; Lucille Lawrence, harp) from a motley series of pre-existing works, but one would never gather this if one had not been told. It is a very tuneful, spirited, exuberant piece, with a light-hearted touch-and-go in the widely spread network of its texture. The *Suite for String Quartet* (New Music) is a study in polyphony and classic forms, with a most unclassical-sounding canon at the ninth to add variety to its generally serene pages.

ML 4492 is given over to Aaron Copland's *Sextet for String Quartet, Clarinet, and Piano* (Juilliard Quartet; David Oppenheim, clarinet; Leonid Hambro, piano) and Ellis Kohs' *Chamber Concerto for Viola and String Nonet* (Ferenc Molnar, soloist). Both of these are chamber works almost orchestral in size and weight; the Copland, in fact, is a transcription of the same composer's *Short Symphony* of 1933. It is Copland of the era before the folk tunes — grindingly energetic, exuberant, hard, percussive, and exciting, but with frequent touches of the reserved nostalgia which leads directly to the night-on-the-prairie scenes of *Billy the Kid* and *Rodeo*. Kohs, a young Californian making his debut on records, is revealed as a

clean-cut and supremely logical thinker; the concerto makes much use of the sharp planes, clear lines and easily-ridden rhythms of the neo-classic tradition, but also develops the fantastic and rhapsodic implications of its instrumental setting, especially in the handling of its solo part.

William Schuman's fourth string quartet (Juilliard) fills the first side of ML 4493. This is a big, serious, robust work, rather involved in form, rich in harmonic color, but especially rich in the variety and originality of its rhythms. On the other side is the *Concerto a Tre* for clarinet, violin and 'cello by Ingolf Dahl. (Mitchell Lurie, clarinet; Eudice Shapiro, violin; Vicror Gottlieb, 'cello.) Although born aboard, Dahl has lived in Los Angeles for many years and is a colleague of Kohs at the University of Southern California. His *Concerto* is based upon a kind of three-tone row, and the challenge of building a large work on this motif obviously delighted the composer; the ingenuities of the score are presented in a continuous bubble and effervescence that are completely disarming and delightful even when Dahl unconsciously reminds us that at one time he studied with Stravinsky.

Douglas Moore, whose *Quintet for Clarinet and Strings* (Oppenheim; New Music) fills the first side of ML 4494, is the least "modern" of the composers represented in this series, but this negative statement does not do much justice to his great gifts as a melodist, to the refinement and beauty of his harmonic palette, and to his exacting sense of form. Moore, in other words, proves that the "traditional" means of music need not be regarded as exhausted if the composer is not exhausted. The creative mind selects its premise and reasons through to a conclusion. Moore's premises lie in traditional regions and his reasoning powers are immense. Far too often those who proceed from a similar basis cannot reason at all, but merely reminisce.

Wallingford Riegger's *Second String Quartet* (New Music), which backs up the Moore, is the most eloquent, lofty, and grandly scaled ensemble piece in the series. It moves, or seems to the naked ear to move from tonal to atonal and back again with the same kind of freedom and the same kind of lyric urgency that distinguishes the music of Alban Berg. This is, if I am not mistaken, the first



David Oppenheim, clarinet, Leonid Hambro, piano, and Juilliard String Quartet recording the Aaron Copland Sextet for Columbia.

major work of Riegger's to be recorded, and it should be followed by many more, for this composer has been at it for a long time and has not been justly dealt with by performers, to say nothing of recording companies.

The last record in the set, ML 4495, contains Walter Piston's *Sonatina for Violin and Harpsichord* (Alexander Schneider, violin; Ralph Kirkpatrick, harpsichord), and John Cage's *String Quartet* (New Music). The Piston is a flying, gracious, quicksilver kind of piece, beautifully exploiting the clarity and brilliance of its combination and its implications of classical logic. The Cage quartet is exactly the opposite. It is played completely without vibrato, which gives it an austere, monotonous color; its forms seem completely arbitrary, and its long slow movement, marked "Nearly Stationary," invites the observation that music which is by definition "nearly stationary" cannot be expected to go anywhere in particular. But this music nevertheless does not invite rejection; one leaves it wanting to go back, knowing that one has not understood, and with the suspicion that that which first seems most forbidding may in time turn out to be the most rewarding. It has happened before.

ALFRED FRANKENSTEIN

bass, Pierre Mollet, is generally satisfying; the tenor, Robert Massard, less so. The most serious criticism, however, must be levelled against the engineers, who recorded the opera. The sound of the orchestra is clear, without much tonal warmth, but acceptable. However, the recording of the voices leaves me truly mystified. At times there is the feeling that the voices are *permitted* to come through. The singers seem to have been placed in the "driest" part of the studio; it is necessary to listen "through" the orchestra in order to hear them — as if they were not even given a microphone, but were picked up only incidentally! D. R.

- ROGER GOEB *Symphony No. 3 — See Bartok*
 GOULD *Fall River Legend — See Gottschalk-Kay*
 GOUNOD *Faust: Ballad of the King of Thule and Jewel Song. — See Verdi*
 GRIEG *Sonata for 'Cello and Piano in A Minor — See Franck*
 HANDEL *Giulio Cesare*

Elisabeth Roon (s); Mira Kalin (ms); Herbert Handt (t); Otto Wiener (bn); Phil Cutzon (bs). Pro Musica Chamber Orchestra and Vienna Akademiechor; Hans Swarowsky, cond.
 VOX PL 8021. Two 12-in. 1 hr., 40 min. \$11.90.

In view of the fact that Handel wrote 46 operas during his long life, it seems odd and supererogatory that the only two major recordings of his efforts in this field should be of the same work. It is also unfortunate that neither is really satisfactory. Evidently neither Concert Hall nor Vox thought *Julius Caesar*, a magnificent and moving work, worth recording without drastic cuts (amounting, in fact, to about half the score). Vox elected to sacrifice all intelligibility of plot — and the full libretto is not at all bad — by eliminating all recitatives and many arias. The arias they kept, however, they kept in entirety. Concert Hall preserved enough of

the recitatives to make clear the major action, but truncated more arias. Hence, it offers less straight singing, but a better idea of the dramatic context of the set-pieces.

It seems to me that Walter Goehr, who prepared and conducted the Concert Hall performance, deserves a good deal of credit. He has adhered to the score where he could (after all, the original *Cesare* was a castrato) and his conducting, if not very inspiring, is well paced. Hans Swarowsky, on the other hand, tends to lush things up in what seems an unbecomingly romantic manner, and to vacillate between tempos that drag and those that rush the singers.

Both versions are well recorded, the Vox sound being the richer, the Concert Hall a shade brighter and more crisply defined. As for the principal singers (Vox eliminates all secondary characters), those in the Vox set have slightly better voices; those in the Concert Hall seem to have given more thought to stylistic matters. The sad fact is that neither group is able to cope with the technical difficulties of bravura singing when the going gets rough.

Giulio Cesare is no mere period curiosity; it is as worth owning as any of the great Handel oratorios. Of the two truncated versions available, my choice would be the Concert Hall issue, on the ground — mainly — that an opera, however cut, should still sound like an opera. J. H., Jr.

- HANDEL *Six Sonatas for Violin and Harpsichord (Op. 1)*

Campoli, violin; George Malcolm, harpsichord.
 LONDON LL 652. 12-in. I 28:05, II 29:15 mins. \$5.95.

These are thoroughly satisfying performances by a violinist whose name should be better known in this country. The playing is technically adroit, tonally warm and well recorded, with a lot of space around the performers. D. R.

- HAYDN *Symphony No. 88, in G
 Symphony No. 93, in D*

Vienna National Opera Orchestra, Hermann Scherchen, cond.
 WESTMINSTER WL 5178. 12-in. 22, 26 min. \$5.95.

Less than thirty months ago Westminster introduced Hermann Scherchen to LP with recordings of two Haydn symphonies, the second of which, No. 100 ("Military"), made a great noise in phonographic precincts and is still one of the preeminent orchestral records. This disk (with Symphony No. 95 on the obverse) proclaimed the serious intentions of the young company in a more competitive field than she yet had entered, and displayed Dr. Scherchen as a Haydn conductor of pertinent, courageous and unfrivolous imagination. No. 93, now issued with No. 88, makes sixteen the total of Haydn symphonies that he has given us; and one is startled realizing that this D Major work — Haydn's twentieth symphony in the key — effects for Dr. Scherchen in his recording the consummation of a labor Olympian in perception and care, and never before undertaken by anyone, anywhere. He is the first conductor to have entrusted to records all the London Symphonies, the last twelve, the two sets of six that Haydn wrote for the impresario Salomon of Bonn; the culmination and fulfillment of the symphonic life of the composer who had already written more good symphonies than anyone else had written or would write. Herewith 93:

Nowhere else in Scherchen's Haydn is there such evidence of insistent preparation. The orchestra is spun fine, with unexpected suggestions of the quivering nicety contrived by Beecham, Toscanini, Reiner, Rodzinski and Szell. There are long violin lines, *pp*, of precarious and stunning tenuity, within a lingering and heady progression of the kind we call romantic, with episodic license to the dramatic instruments — here trumpets — to dominate, and full value given to polyphonic motion and harmonic substance. This is carried in a sound of brilliantly detailed clarity, as well realized as any in the Scherchen series and thus unsurpassed in Haydn.

There are two other versions, and it may well be imagined that

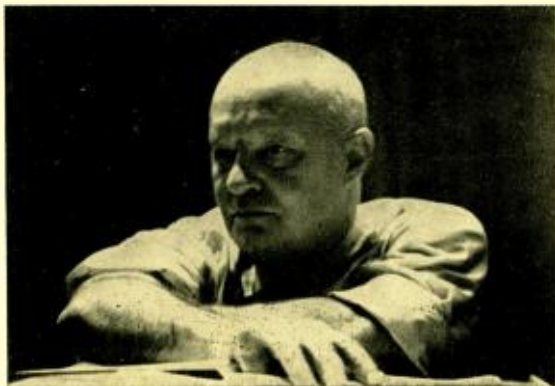

Paul Hindemith: an authoritative reading of *Kammermusik* No. 1, modern music — "moving, eloquent and unforgettable".

Sir Thomas Beecham's, of a Symphony he has always favored, does not undergo eclipse as a challenge. The Englishman's essay is lighter, defter: it has more humor, and the humor has a bright edge (Columbia ML 4374). The difference may be conveyed by recourse to the impression made by the words dance and prance uttered quickly and quickly expunged from memory. One way has of course no more "authority" than another, but Sir Thomas's is the more classic way. Sonics would decide for the remarkable new Westminster over the merely excellent Columbia.

The fragrant No. 88, so often abused in recording, is favored with a beautiful performance that in its studied glow seems more desirable even than the Furtwangler record of a few months ago. By retarding the pace of the second movement to contrast abruptly with a minuet quicker than usual, but slower than the foaming finale, Dr. Scherchen accumulates interest in drama while maintaining interest in form; and a daring length of phrase makes the largo exceptionally memorable. Unfortunately the sound, otherwise splendid, has a glassy shimmer supervened to the violins, in-eradicable and irritable; dire on certain magnetic pickups, tolerable on others, a pity on any.

C. G. B.

HINDEMITH *Kammermusik* No. 1 and No. 3

Philharmonic Chamber Ensemble, the composer conducting.
CONTEMPORARY RECORDS AP 101. 12-in. 24 min. \$4.85.

A quarter of a century ago, the writer of these lines, attending a festival of modern music in the Coolidge Auditorium at the Library of Congress, heard a piece by Hindemith in which there was a slow movement scored for solo clarinet, flute and bassoon plus a single, fatefully repeated bell. At that time it seemed about as moving, eloquent, and unforgettable a piece as he had met with in his entire experience of music, and it has remained in his memory as a symbol of a youthful enthusiasm which could only be blunted if not altogether dissipated by the subsequent 25 years of professional listening in which he has engaged. That slow movement belongs to the *Kammermusik* No. 1 which was accordingly approached with considerable nervousness not unmixed with fear. And then the music came forth from the disk as fresh, superbly expressive and communicative as it had been on that frabjous day in Washington; it actually was not youthful inexperience but the genius of Paul Hindemith that had produced this result. The rest of the work is also equally important, however, and this I had not recalled.

Kammermusik No. 3 is a 'cello concerto, its solo part here performed by Laszlo Varga. It is a rather conventional piece, of considerably less interest than the other.

A. F.

HONEGGER *Jeanne d'Arc au Bucher*

Vera Zorina; Raymond Gerome; Anne Carrere; Charles Mathieu; Jean Juillard (spoken roles); Frances Yeend (s); Carolyn Long (s); Martha Lipton (c); David Lloyd (t); Kenneth Smith (bs); John H. Brown (boy sopr.); Temple University Choirs; St. Peter's Boys' Choir; The Philadelphia Orchestra, Eugene Ormandy, cond.

COLUMBIA SL 178. Two 12-in. \$11.

The word oratorio inadequately describes Honegger's *Joan at the Stake*. As well as conventional arias and choruses, it has spoken dramatic dialogue and narration, chants, shrieks, shouts and sound-effects, some weird and all wonderful. The intent is to create fantasy, and through fantasy convey something profound and important. Author of the text is Charles Claudel, impressionist poet, Catholic mystic and one-time French ambassador to the United States. He has used elements of ancient morality dramas and old French fairy-tales to give a nightmare quality to the youthful Joan's last hours before execution. Honegger, once self-described as a "biblical composer" and known also as a man fascinated with orchestral sounds, has made the most of the obvious possibilities. In the performance there is nothing to cavil at; the cast is the only current troupe experienced at presenting *Joan*, and they do an impressive job — particularly Vera Zorina in the title role and Raymond Gerome as her priest-confidant. The microphoning was done with "presence effect" in mind, and the so-called sonic well of the Philadelphia Academy of Music has lent its usual acoustic enrichment.

J. M. C.

MAHLER *Symphony No. 1 in D Major*

Symphony Orchestra of Radio Berlin; Ernest Borsamsky, cond.
URANIA URLP 7080. 12-in. \$5.95.
VANGUARD VRS 436. 12-in. \$5.95.

Here we have the unusual situation of the same recording issued simultaneously by two different companies. Comparison shows that these were made from identical tapes; though, in the process of transferring them to disks, Vanguard re-recorded its version at a slightly higher volume level. The performance of this, one of Mahler's most songful and best-integrated scores, is admirably proportioned, carefully controlled and very well played. Discriminating Mahlerites may want to compare this reading with the older but more dramatic one by Mitropoulos and the Minneapolis Symphony (Columbia); for the average listener, however, the present version, on either label, is preferable because of the better reproduction.

P. A.

MASCAGNI *Cavalleria Rusticana*

Margaret Harshaw (ms), Mildred Miller (s), Richard Tucker (t), Frank Guarrera (bn), Thelma Votipka (ms). Orchestra and Chorus of the Metropolitan Opera Company; Fausto Cleva, cond. Kurt Adler, Chorus Master.
COLUMBIA SL 123. Two 12-in. (Fourth side, Metropolitan Orchestra, Cleva cond. Overture to *La Forza del Destino*; Preludes to Acts 1 and 3 of *La Traviata*; Overture to *I Vesprio Siciliani*.)

Old chestnuts never *could* die; if they all sounded like this. Reminiscent of a Beecham *Faust* or a Toscanini *Bobeme* in fresh concepts, this stirring rebirth is a blood-and-thunder must for the now or nascent opera fan. Tucker is gutty and crude of personality (as he should be as Turiddu) and there is manly enthusiasm in his every note. Frank Guarrera is properly robust and rich-voiced as the cuckolded Alfio. Thelma Votipka and Mildred Miller make the most of their limited appearances as Lucia (beg pardon, Mama Lucia) and Lola. In fact, Miller vocally outdoes many a Carmen, in pure oomph, with her Scene VI entrance. As for Margaret Harshaw (who can't quite seem to make up her mind whether she is going to sing mezzo or soprano roles) she *is* Santuzza. She recalls vividly the dark-voiced drama of Rose Bampton, some of the dramatic strength of Muzio and much of the "wide open" quality of Milanov at her best. The chorus and orchestra are right in the spirit of the thing, and Clea directs a well ordered and spirited show. The sound is full-blown.

After the emotional uplift of the first three sides, about all the fourth side proves is that the Metropolitan Opera Orchestra could move into almost any of our concert halls without disadvantage to the listeners. W. B. S.

MENDELSSOHN *Symphony No. 3 in A Minor, Op. 56* ("Scotch")

London Symphony Orchestra; Georg Solti, cond.
LONDON LL 708. 12-in. 15:51 and 17:06 min. \$5.95.
Pittsburgh Symphony Orchestra; William Steinberg, cond.
CAPITOL S 8192. 12-in. 16 and 17:10 min. \$5.72.

These first really new long-playing versions of the *Scotch* Symphony are both highly commendable. Solti's treatment is light-textured, delicate and transparent, with reproduction of matching transparency; Steinberg's is somewhat broader and tonally warmer, but, though recorded with equal fidelity, is marred by excessive hall resonance. As the relative timings indicate, there is little difference between the tempi adopted by the two conductors, both of whom take the symphony at a fairly crisp pace. P. A.

MIASKOVSKY *Violin Concerto* — See Prokofieff

MILHAUD CONDUCTING HIS OWN MUSIC

CONTEMPORARY RECORDS. AP 102,103. Two 12-in. \$4.85 each.

These two disks represent very different aspects of Milhaud's production. The first is the Milhaud of charm, whimsicality and delicate sentiment, as represented in a cycle of four songs for vocal quartet and small orchestra entitled *Les Amours de Ronsard* and the *Concertino d'Esté* for violin. The songs are sung by excellent artists — Anne Bollinger, Herta Glaz, Leslie Chabay, and Mack Harrell — but the omission of the text seriously impairs the value of the recording. The violin concerto is admirably played by Robert Courte; the orchestra for both is the Philharmonic Chamber Ensemble.

On the second record is the Milhaud of power, dynamism, grand proportions and dense, polytonal textures. The performers are the Stanley Quartet of the University of Michigan with Brooks Smith, pianist, and Clyde Thompson, bass. Incidentally, the notes inform us that Milhaud turned to the quintet because in 1950 he had fulfilled a vow he took 30 years earlier to write just 18 string quartets and no more. A. F.

MONTEVERDI *L'Incoronazione di Poppea*

Sylvia Gahwiller (s); Heidi Juon (s); Annalies Gamper (s); Lydia Herbst (s); Maria Helbling (ms); Mabella Ott-Penetto (c); Margarete Witte-Waldbauer (c); Friederich Brückner-Rüggeberg (t); Rolf Sander (t); Fred Reburg (t). Paul Grümmer, gamba; Hermann Leeb, flute; Heinz Wehrle, organ; recorder quintet; Zürich Tonhalle Orchestra and Chorus; Walter Goehr, cond.
CONCERT HALL CHS 1184. Three 12-in. \$17.85.

If ever a composer has been worthy of the appellation "great", Claudio Monteverdi was, and anyone who is more than casually interested in music as a continuing manifestation (or, particularly, in the art of combining words with music) should hear *L'Incoronazione di Poppea*. Opera was a very young art when it was composed in 1642, yet it remains one of the great pinnacles of operatic achievement. Nor is this a hollow puff for a rarity qua rarity.

Opera was born late in the sixteenth century; its forbears were madrigal dramas and religious plays with music. When Peri com-

posed the first opera, *Orfeo*, he was motivated by the highest classical ideals. He was creating a work that, at least to him, recaptured the spirit of Greek drama, a work in which the arts of song and poetry and movement would be combined in perfect harmony. Caccini followed in his steps, and then Monteverdi created in his *Orfeo* something that surpassed anything that had gone before. *L'Incoronazione di Poppea* is his last work, his final testament to *dramma per musica*. Then opera became popular and before 1700 A.D., 16 opera houses had been opened in Venice alone. The day of the virtuoso singer dawned; opera became a formalized series of *da capo* areas designed for vocal display interlarded with scenic spectacles, and it was not until Gluck that any composer really attempted to return to the earliest ideals of music drama. Thus *L'Incoronazione di Poppea* is a great pivotal work. Its style will sound strange to the ears of listeners who expect merely an earlier form of Handelian opera. There are long sung speeches, but nothing that can properly be called an aria at all. The whole emphasis is directed toward truthful characterization, toward intensifying the impact of the drama. Words are repeated for emphasis, but the whole point is that the music supports the words without distracting them. It is, in truth, drama and music combined, striking and exciting.

The libretto, couched in the florid poetic Italian of the time, tells of the Emperor Nero's renunciation of his wife Octavia and marriage to Poppea. There are plots of assassination, passionate love scenes and interventions by the gods — for Love is on the side of Nero and Poppea against all moral considerations. It is not at all a bad play, and it makes a great opera.

Two difficulties vex the would-be producer of *L'Incoronazione di Poppea*: first, if played uncut it would last probably more than five hours; second, the original instrumentation is not known, so any orchestral solution is bound to bring down damnation from those who disagree.

Concert Hall has solved the first problem by cutting and cutting. Some of the cuts are unfortunate, but six LP sides of Poppea are better than none. Walter Goehr, who prepared and conducted the performance, solved the second problem by basing his scoring on that of Monteverdi's *Orfeo*, which *is* known. Since *Orfeo* calls for unobtainable forces like two gravicembalists, ten players of the viol da braccia, and so on, Goehr doubtless had to compromise at a good many points, but his orchestra sounds in keeping. And he seems to have refrained from modernizing cadences and touching up textures in an anachronistic way.

It would be pointless to pretend that all or even most of the singers seem thoroughly at home in this music, for singers today simply are not trained in the techniques — or what we imagine to have been the techniques — of seventeenth-century vocal style. But they are well prepared musically; serious, intelligent, and generally accurate, and deserve great credit for the really considerable things they achieve.

The recording is good technically — clear and round in tone and quite free of extraneous noise. There are a few abrupt shifts in volume level, but not enough to be seriously disturbing. All in all, the great values of this set far outweigh any disvalues, and it should prove to be both a stimulating first experience and a source of lasting and increasing pleasure to anyone seriously interested in music and theatre. J. H., Jr.

MOZART

Concerto for Violin No. 4, in D, KV 218
Three Overtures: Don Giovanni; Die Entführung aus dem Serail; La Clemenza di Tito

Gerard Poulet; "Austrian" Symphony Orchestra, Gaston Poulet, cond. (Concerto) and same orchestra, Gustav Koslik, cond. (Overtures).
REMINGTON 199-125. 12-in. 26, 6, 6, 5 min. \$2.49.

The Concerto is one of the clearest gems from Remington's vaults. Gaston Poulet has long been known as a conductor in Paris and elsewhere, but the emergence of his son as a violinist of the first water had no prefatory announcement of his true excellence. We note at once address, ease and sensitivity, particularly the ease that makes the considered intonation seem inevitably natural. Coordination between *père* and *filis* is a laudable demonstration of family solidarity, and the sound is realistic, without problems of adjustment. There is formidable competition from Heifetz-Beecham (Victor) and Goldberg-Süsskind (Decca), and others; but as a whole this is as good as any. — The three overtures have neither the best nor the worst performances in the businesslike efforts overside, with their outright and unpolished sound, their diligent playing under a leadership emphasizing the fundamentals. C. G. B.

PROKOFIEFF *Violin Concerto No. 1*
Miaskovsky: Violin Concerto

David Oistrakh and Symphony Orchestra, A. Gauk cond.
PERIOD SPLP 539. 23, 23 min. 12-in. \$5.95.

To judge from the records and the publicity associated with them, Oistrakh is the foremost violinist in Soviet Russia, and this recording does nothing to controvert that view. His playing as captured here is peaches, cream and candy pie, yet its lushness of tone and romantic style do not run away with the musical issues of these important works. The tuneful, zestful Prokofieff needs no criticism at this late date; the Miaskovsky, on the other hand, is little known. It is in a "conservative" somewhat Tchaikowskian vein, but exceedingly well written; it stands on its own sound feet and to mention its reminiscence is only to place it in the tradition to which it belongs. A. F.

PROKOFIEFF *Violin Concerto No. 2*

Zino Francescatti and New York Philharmonic Orchestra, Dimitri Mitropoulos cond.

Bach: Violin Concerto in E major

Zino Francescatti and Columbia Symphony Orchestra, George Szell, cond.
COLUMBIA ML 4648. 20, 16 min. 12-in. \$5.45.

A magnificent performance of the big, lyrical, soft-edged concerto by Prokofieff, which is well worth hearing immediately after the first as an index of the growth of Prokofieff's style. The writer of this review has been engaged by HIGH FIDELITY as a specialist in modern music, and as such has no business expressing an opinion about the work of one Johann Sebastian Bach on the other side, but it seems like a rather good piece. (Nicely played, too, Ed.) A. F.

PROKOFIEFF *Symphony No. 5*

Danis State Radio Symphony Orchestra, Eric Tuxen, cond.
LONDON LL 672. 36 min. 12-in. \$5.95.

The growth of Prokofieff's style is further indicated here; now his expression takes on an epic character, and if the harmonic fabric, in keeping with Soviet dictates, is more conventional than that of the violin concertos, Prokofieff was still sufficiently great a creator to cope with this disciplinary regulation and still say something without vulgarity. Neither performance nor reproduction, however, can compare with the famous RCA Victor recording of the same work by Koussevitzky and the Boston Symphony. A. F.

PUCCHINI *Tosca: Recondita armonia and E lucevan le stelle*
La Fanciulla del West: Ch'ella mi creda libero e lontano
Manon Lescaut: No! pazzo son!
Turandot: Non piangere, Liu—See Verdi

RACHMANINOFF *Rhapsody on a Theme of Paganini, Op. 43;*
Piano Concerto No. 1, in F sharp Minor, Op. 1

Sergei Rachmaninoff, piano. Philadelphia Orchestra; Leopold Stokowski, cond. in Rhapsody; Eugene Ormandy, cond. in Concerto.
RCA VICTOR LCT 1118. 12-in. 22, 24 min. \$5.72.

RCA Victor's reissue of Rachmaninoff's own performance of his Paganini rhapsody, in the Treasury of Immortal Performance series, is valuable and welcome. One of his best works, the rhapsody has been well described as "musical champagne," and its effervescence should last for some time. The playing is actually not as brilliant or note perfect as in many of today's concert performances of the work, and the composer could treat rather cavalierly his own dynamic markings in the printed score. Still, this is a definitive performance, in that Rachmaninoff wrote piano music to suit his style and technical specialties. Delicacy and complete lack of sentimentality mark the total performance, with its finely tapered phrases, glittering filigree, bell-like tones, and exact rhythms.

The *First Concerto*, recorded later than the rhapsody, emerges much clearer in transference to LP than its companion piece, and

it is the only recording available. Written when Rachmaninoff was 18 and still a student, it was later revised in structure and instrumentation. Somewhat dull in musical content, it is a characteristic work, characteristically played, and as such should appeal to Rachmaninoff's idolaters. R. E.

RACHMANINOFF *Symphonic Dances, Op. 45*

Rochester Philharmonic Orchestra; Erich Leinsdorf, cond.
COLUMBIA ML 4621. 12-in. \$5.45.

This is the first recording of Rachmaninoff's last composition. Written in his inimitable style, it is really a three-movement suite, conceived along broad symphonic lines, with dance-like overtones. Since the work was dedicated to Eugene Ormandy and the Phila-

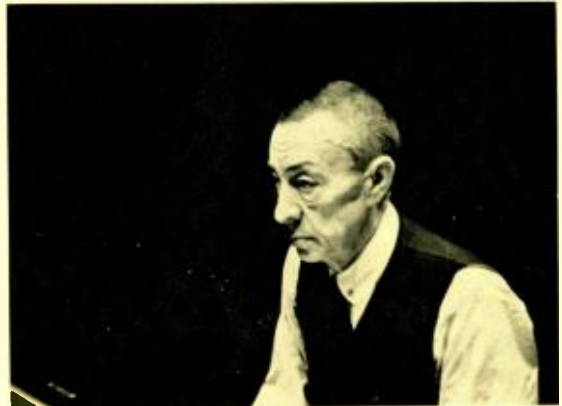

Sergei Rachmaninoff: after years, the champagne still effervesced.

delphia Orchestra, it is surprising that they were not selected to record it. One cannot quarrel, however, with this brilliantly played and very faithfully recorded interpretation by Leinsdorf and the Rochester Philharmonic. A welcome addition to the recorded repertoire. P. A.

RAVEL *Daphnis et Chloe—Complete Ballet*

L'Orchestre de la Suisse Romande and Motet Choir of Geneva; Ernest Ansermet, cond.
LONDON LL 693. 12-in. 26:37 and 25:17 min. \$5.95.

The second suite of "orchestral fragments" from Maurice Ravel's ballet, *Daphnis et Chloe*, is as familiar to the average concertgoer as his own name; occasionally, the first suite will also make an appearance. Otherwise, the imaginative, often fairy-like, music for this enchanting ballet is completely unknown on this side of the Atlantic. The Sadler's Wells Ballet may very well remedy that deficiency during its forthcoming American tour. In the meantime, here is the first recording of the complete ballet score, and it serves to show that though we have been allowed to hear the best portions of the music all these years, we have also missed a great deal of charming and wonderful writing. Always an expert ballet conductor, Ansermet directs a delicate and crystal clear performance, complete with all the wordless choral passages. Ravel's music will take on new meaning with this revealing and well-recorded presentation. P. A.

RAVEL *L'Heure Espagnole*

Janine Linda, (s) (Concepcion); André Dran, (t) (Gonzalve); Jean Mollien, (t) (Torquemada); Jean Hoffman, (bn) (Ramiro); Lucien Mans, (bs) (Don Inigo Gomez). L'Orchestre Radio-Symphonique de Paris de la Radiodiffusion Francaise; René Leibowitz, cond.
VOX PL 7880. 12-in. \$5.95.

It is a little shocking to realize that this is the first recording of one of the few authentic musical masterpieces written in the 20th Century. It is gratifying to be able to report that it is very good, although not quite definitive.

L'Heure Espagnole is a work that benefits singularly from the

development of high-fidelity recording and reproducing techniques, for it is music that needs above all to be heard in intimate detail. Ravel loved his language with a true French passion, and every syllable of his libretto is set with the utmost regard for flavor and nuance. The music grows out of the text; both are delicate, fine-spun, full of subtleties. It could not be heard to advantage in a big opera house; it needs closeness. Neither can it be submitted to workshop conditions; it needs the skill of devoted professionals. Nor can it make its point in translation. Like delicate wines that do not travel well are *L'Heure Espagnole* and its companion masterpiece, *L'Enfant et les Sortilèges*. But the vineyard itself need be no more distant than the nearest record shop.

The story, somewhat complicated, concerns Concepcion, young bride of old Torquemada, a clockmaker. Every afternoon Torquemada goes out to regulate the city clocks — and Concepcion entertains. This particular afternoon is a busy one; one would-be lover after another is hustled into the case of a grandfather clock and carted upstairs and down on the broad shoulders of Ramiro, a mule-reer. If you want to know who gets Concepcion, buy the recording. And if your French isn't good, buy a libretto; they don't give you one.

Janine Linda preserves an engaging kind of bland innocence as the clocks tick away and her admirers pop in and out of them; the men are satisfying, and Rene Leibowitz conducts with faultless verve. J. H., Jr.

RIMSKY-KORSAKOFF *May Night*

Irina Maslennikova (s); Valentina Birisenko, (ms); Elena Verbitskaya (ms); Natasha Klyagina, (ms); Elena Gribova (ms); Olga Insarova (ms); Serge Lemeshev (t); Viacheslav Shevtsov (t); Peter Volovov (bn); Serge Krasovskiy (bs); Vladimir Tyutyunnik (bs). Orchestra and Chorus of the Bolshoi Opera; Vassily Nebolsin, cond.

VANGUARD VRS-6006. Three 12-in. \$17.85.

May Night (otherwise known in English, when it is known at all, as *A Night in May*) was completed in time for a premiere in St. Petersburg in 1880. It was soon withdrawn and did not reappear in Russia until 18 years later, in Moscow. That locates it in time. Presumably it is still — or, at least, occasionally — in the repertoire of the Bolshoi Theatre.

What is it about? After reading the libretto, I, for one, am not quite sure. Levko, the tenor and hero, is the son of the Golova, or village big-shot. He is, by a strange aberration, in love with a mezzo-soprano — Ganna. Main complication: papa admires Ganna, too. There is a serenade and a love duet. Then we hear about the local spooks — Roussalkas, or fresh-water mermaids, standard equipment in Russian operas. There are more complications, lots of peasant festivities, an attempted hopak by the village lush, estrangements, high-jinks of the Keystone Cops variety, multiple arrests, mistaken identities, choruses of villagers, bandura playing, dancing, and lots of Roussalkas.

The music is like that of most works in which a composer of sound conservatory background goes about using local folk materials. It is jolly. It is Slavic. It is often pretty. It has harmony. It has counterpoint. It is also pretty dull after a couple of sides, at least to a non-Slav.

Presumably the performance is a good one. At least it is safe to assume that if the Bolshoi people can't give a good performance of *May Night* nobody else is likely to. The recording sounds like an air-check tape. J. H., Jr.

RIMSKY-KORSAKOFF *Mozart et Salieri*

Jean Mollien, (t); Jacques Linsolas, (bne). L'Orchestre Radio-Symphonique de Paris de la Radiodiffusion Française and chamber chorus; Rene Leibowitz, cond.

OCEANIC OCS 32. 12-in. \$5.95.

In addition to his indefatigable tinkering with other people's music, Rimsky-Korsakoff composed no fewer than 15 operas of his own. None has survived in the repertoire, so it is hard to be sure, but I would lay odds that *Mozart et Salieri* is the stupidest of the lot. It is the kind of work habitually referred to by music historians (and hence program annotators) as "charming." Don't be fooled. It isn't anything of the sort.

The libretto, written by Pushkin in what must have been the most vapid hour-and-a-half of his life, is a set of monologues and conversations involving the two title characters. (Antonio Salieri, in case the name is unfamiliar, was the kingpin composer around Vienna for many years.) As the opera opens, Salieri is foaming at the mouth. He gives a history of his own career and ends by

saying that he now knows jealousy for the first time, because Mozart is a Greater Composer than he. Then Mozart drops in. The two of them chat about this and that, including an old blind fiddler who plays *Voi che sapete* out of tune. Then Mozart plays the piano. Salieri butters him up and invites him to go out to dinner. Mozart trots off to tell his wife that he won't be home till late, and the scene ends with Salieri deciding that he must poison Mozart so that he can have the Great Composer pitch all to himself. Next act, after more such twaddle, he does. Mozart foggily heads homeward for his death bed and the curtain falls with a soggy thud.

The music is broad-lined, rich in texture, and uncompromisingly dull. As for the performance, Jean Mollien (Mozart) sings neatly, and Paul Jacobs plays the piano solos well enough, but Jacques Linsolas (Solieri) has trouble with sagging pitch. Rene Leibowitz conducts well, but it doesn't seem to matter very much. Anyway, Mozart died of uremia. J. H., Jr.

RIMSKY-KORSAKOFF *Scheherazade, Op. 35*

Philharmonia Orchestra; Leopold Stokowski, cond.
RCA VICTOR LM 1730. 12-in. 46 min. \$5.72.

This score has always been a prime favorite with Stokowski, who has recorded it more times than I would care to guess since his early Philadelphia days. This follows the pattern of his previous efforts, with some highly personalized ideas about rhythms and accents, though I don't find these particularly disturbing. The orchestral work is on a high level, but I am surprised there is no more immediacy in the sound per se. The record sleeve says "Recorded in England," but not in what hall. There seems to have been improper mike placement, resulting in a strange distant quality. My review copy also had a slight echo in spots. The Dorati Mercury recording still makes the strongest appeal. J. F. I.

SCHOENBERG *Piano Concerto* *Piano Pieces, Op. 11 and Suite for Piano, Op. 25*

Claude Helffer and Orchestra Radio-Symphonique de Paris, Rene Leibowitz, cond.
Michael Field, piano.
PERIOD SPL 568. 17, 24 min. 12-in. \$5.95.

The piano concerto, one of Schoenberg's last works, is also one of his most logical monumental and austere. In this case, however, "austere" is not to be read as a polite synonym for "unpleasant"; the austerity of logic has a rarefied beauty all its own, and the concerto is quite readily comprehensible even on a first hearing. The famous three pieces, Opus 11, with their rather enigmatic phraseology and sonorous color, are very well performed by Field, and he does something almost unprecedented with Opus 25; he makes its wide leaps and skips, its inexorable dissonances and its capricious rhythms sound actually charming. People have been telling us for years that Schoenberg is the Beethoven of the future; Field, it would seem, is also convinced that he is something like the Chopin of the present. A. F.

SCHUBERT *Symphony No. 1 in D Major* †Bizet: *Symphony in C Major*

L'Orchestra Radio-Symphonique de Paris; Rene Leibowitz, cond.
OCEANIC OCS 33. 12-in. 23:35 and 28:37 min. \$5.95.

Symphony No. 4 in C Minor ("Tragic")

Mozarteum Orchestra of Salzburg; Wolfgang Freilassing, cond.
ORFEO LP 10. 12-in. 17:15 and 10:27 min. \$5.45.

Here are three charming symphonies, only one of which has achieved the popularity it deserves. Both composers died much too young — Schubert at 31, Bizet at 37 — and both manifested their talents at an early age. Schubert composed his First Symphony when he was only 16, his Fourth when he was 19; Bizet's lone Symphony was the product of his 17th year. Yet all three works represent a blend of youthful vigor with amazing craftsmanship and inventiveness.

Least familiar of the three is the Schubert First, a work which ought to be heard more frequently. Both it and the Bizet Symphony — the latter now much used as ballet music — are accorded spirited readings by the versatile Leibowitz. Since the Scherzo of the Bizet is dragged a bit, however, and since the orchestral playing, though fine, is not up to that of the New York Philharmonic-Symphony, the older Columbia disk of this work is still slightly preferable.

But if you are interested in having both symphonies, the present brilliantly recorded disk more than fills the bill.

Other extant recorded versions of the *Tragic Symphony* are not at hand for purposes of comparison, but it would seem that there must be something better than this satisfactory, though not very subtle performance by Freilassing. The reproduction is harsh and often distorted, and the symphony needlessly runs to two sides of a 12-inch disk when it easily could have been placed on one. P. A.

SCHUBERT *Symphony No. 9 in C*

Vienna Philharmonic Orchestra, Herbert von Karajan, cond.
COLUMBIA ML 4631. 12-in. 48 min. \$5.45.

Certainly one of the best performances of this huge poem, without inflation (Furtwangler, Mengelberg) or compression (Toscanini) of its romanticism. Not that the congruent individualism of Furtwangler and Walter is a hurt — in fact the Furtwangler version for Decca is still the preference here — but Prof. von Karajan's leadership, in its reasonable tempos and accents, establishes a touchstone of patent utility. The fault with this newer Columbia version — not very new except on LP — is its thickly massive sound, which without being bad denies to us the chiseled detail that we expect nowadays. C. G. B.

SCHUBERT *Die Winterreise, Op. 89*

Karl Schmitt-Walter, baritone; Hubert Giesen, piano.
LONDON LL 702 & 703. Two 12-in. 1 hr. 15 min. \$11.90.

The fourth LP of these 24 songs in defeat of hope is scanned to the last quaver and the last syllable, under the supposition, held by most to be correct, that the significance of word and sound is identical, and that the interaction of the two must forbid a delivery static for even a bar, a prohibition applicable equally to singer and pianist. This London record is the most analytical fulfillment we have, not a measure permitted to coast, not a word without a chosen intonation, a rise and fall of sound coolly charted to an emotionalism of a hundred intensities. Moving and remarkable, especially from a voice like this of ordinary quality; and especially too in its resistance to vocal excesses and dramatic exaggeration. The pianist is true partner here, and Mr. Giesen's portentous soft staccato is something to note. The sound is immaculate: voice and piano, without phonographic modifications. German and English text is furnished. C. G. B.

SCHUBERT *Octet in F Major, Op. 166*

Chamber Music Ensemble of the Berlin Philharmonic Orchestra.
DECCA DL 9669. 12-in. 26:28 and 25:34 min. \$5.85.

Trio No. 1 in B flat Major, Op. 99

Jean Fournier, violin; Antonio Janigro, cello; Paul Badura-Skoda, piano.
WESTMINSTER WL 5188. 12-in. 19:46 and 14:40 min. \$5.95.

Trio No. 2 in E flat Major, Op. 100

Adolf Busch, violin; Herman Busch, cello; Rudolf Serkin, piano.
COLUMBIA ML 4654. 12-in. 21:41 and 18:53 min. \$5.45.

Three of Schubert's greatest chamber music masterpieces — in fact, three pillars of the entire chamber music repertoire — are here offered in new recordings, two of which are definitive.

A proper presentation of the Octet requires a certain solidity, combined with sensitivity of phrasing and warmth of tone. These qualities are attributes of the earlier Vox and Westminster recordings of this work, and make them preferable to the present one by members of the Berlin Philharmonic which, though sensibly performed, is rather thin-textured and overly delicate, seeming almost Gallic at times. The recorded sound is only fair.

Fournier, Janigro and Badura-Skoda are developing into a splendid threesome, giving us the best example to date of their ensemble work and the most desirable modern recording of this gloriously songful trio. Of course, those who own the memorable Heifetz-Feuermann-Rubinstein version, reissued by RCA Victor, will not ever want to part with it, but this magnificently reproduced new disk won't be out of place as an up-to-date counterpart.

Victor also once had a recording on 78 rpm. disks of the Trio No. 2 in E flat Major in a never-to-be-forgotten reading by the Busch-Serkin Trio. Now Columbia has put us in its debt by releasing this fine new recording by the same artists. It is a tightly knit, yet free-flowing interpretation that is full of vitality, and serves as a fitting tribute to the memory of the late Adolf Busch. The reproduc-

tion is first-rate, though it sounds as if the recording had been made in a fairly small studio. Unquestionably, the last word as far as recorded performances of this composition are concerned. P. A.

SCHUMANN *Liederkreis*

Suzanne Danco, soprano. Guido Agosti, piano.
LONDON LS 590. 10-in. 30 min. \$4.95.

This record comes close to perfection. Miss Danco brings to these superb lieder a fine-spun voice, secure vocalism and exquisite musicianship. Meaning and mood are sensitively mirrored in the color of a tone or the shaping of a phrase. The ecstatic performance of the familiar *Mondnacht* alone is worth the price of the record. Since the singer is served by an excellent accompanist and impeccable sound reproduction, a word to the wise should be sufficient. R. E.

SMETANA *Quartet in E Minor ("From My Life") — See Dvorak*

STRAVINSKY *Histoire du Soldat*

Instrumental ensemble; Fernand Oubradous, cond.
VOX PL 7960. 44 min. \$5.95.

Oubradous collaborated as bassoonist in the famous Columbia recording of the suite from *Histoire du Soldat*, which was one of the great highlights of the Stravinsky discography. Now he conducts the entire score, with Jean Marchat reading the text and with Michel Auclair and Marcel Herrand in the roles of the Soldier and the Devil, and the results are equally important. The recording is magnificent and the interpretation highly authoritative. At last it is possible to hear on records the full text of this masterpiece of satire and disciplined musical jugglery. A. F.

STRAVINSKY *Oedipus Rex*

Jean Cocteau, narrator; Peter Pears (t); Martha Modl (m-s); Heinz Rehfuss (bnc); Otto von Rohr (bs); Cologne Radio Symphony Orchestra and Chorus, Stravinsky, cond.
COLUMBIA ML 4644. 45 min. \$5.45.

Stravinsky's towering, flinty version of the Sophocles tragedy has been in existence for nearly 20 years, but this is the first recording of it to appear. It is described as an "opera-oratorio", whatever that may mean; the style is one of monumental dignity, not unlike that of the *Symphony of the Psalms*, but some of the arias, it seems to me, are strained in their effort at baroque floridity, and some of the choruses are on the dry side. The effect of the whole is by no means enhanced by Columbia's failure to provide written text. It is sung in Latin, but Cocteau's narration is in French. The sound is a little cavernous, rather effective. A. F.

STRAUSS *Burleske for Piano and Orchestra — See Dohnanyi*

STRAUSS, R. *Ein Heldenleben, Op. 40*

Minneapolis Symphony Orchestra; Antal Dorati, cond.
MERCURY MG 50012. 12-in. \$5.95.

One would think that Strauss' grandiose tone poem would provide a field day for Dorati and for Mercury's "Living Presence" recording technique. The conductor's reading, however, is very tame, lacking much of the necessary fire and imagination. Though the reproduction is clear, it, too, is somewhat on the cautious side. With the exception of some occasional technical slips, the orchestra plays quite well. For better *Heldenleben* recordings, try either the Clemens Krauss-Vienna Philharmonic (London) or Fritz Reiner-Pittsburgh Symphony (Columbia) disks. P. A.

STRAUSS, RICHARD *Songs*

Hat Gesagt — bleibst nicht vorbei, Op. 36, No. 3; *Ach Lieb, Ich mus, nun scheiden*, Op. 21, No. 3; *Heimkehr*, Op. 15, No. 5; *Die Nacht* Op. 10, No. 3; *Schlagende Herzen*, Op. 29, No. 2; *Schlechtes Wetter*, Op. 69, No. 5; *Einerlei*, Op. 69, No. 3; *Morgen*, Op. 27, No. 4. Anny Felbermayer, s; Viktor Graef, piano.

Winterliebe, Op. 48, No. 5; *Ruhe, meine Seele*, Op. 27, No. 1; *Walseligkeit*, Op. 49, No. 1; *Das Rosenband*, Op. 36, No. 1; *Im Spatboot*, Op. 56, No. 3; *Nichts*, Op. 10, No. 2; *Traum durch die Dämmerung*, Op. 29, No. 1; *Mein Herz ist Stumm*, Op. 19, No. 6. Alfred Poell, (bn); Viktor Graef, piano.

VANGUARD VRS 431. 12-in. \$5.95.

This latest in Vanguard's series utilizing the talents of Anny Felbermayer and Alfred Poell maintains the high standards set earlier. Richard Strauss, the last — or at least the latest, with no real successor in view — of the great line of *lieder* composers, produced far more songs than the relatively few that are common recital fare in this country. Both singers avoid the most obvious choices in favor of relatively unfamiliar, but no less valuable, coin from the treasury, and both render the composer his due. For the benefit of those who have not heard her yet, Miss Felbermayer possesses a gleaming lyric voice and a sure technique. Mr. Poell (or Dr., since he is a physician as well as a member of the Vienna Staatsoper) cannot offer the same immediately engaging youthfulness of sound and spirit, but he has the complementary virtues — taste, broad cultivation, and manliness — in full measure. Viktor Graef is sensitive to both singers' needs, the reproduction is clean and intimate. J. H., Jr.

STRAUSS, R. *Suite for Wind Group in B flat Major, Op. 4*
Serenade for Wind Group in E flat Major, Op. 7

Vienna Philharmonic Wind Group.
WESTMINSTER WL 5185. 12-in. 23:25 and 9:05 min. \$5.95.

Very early, rather uncharacteristic Strauss, these two works for pairs of flutes, oboes, clarinets and bassoons, a contra-bassoon and four horns are neither very inspired nor very interesting. Besides, the playing here lacks subtlety and tonal polish, though the recording has excellent fidelity. P. A.

TARTINI *Sonata in G Minor; Violin and Harpsichord*
("The Devil's Trill")
†Geminiani: *Sonata in B flat Major; Violin alone*
†Vitali: *Chaconne for Violin and Figured Bass*

Ricardo Odnoposoff, violin; Heinz Wehrle, harpsichord and organ.
CONCERT HALL SOCIETY CHS 1170. 12-in. 14:9; 12 min. \$5.95.

Some violin playing of a very high order may be heard on this fine disk. The playing is secure and tonally rich. If one could find anything to criticize, it might be Mr. Odnoposoff's sliding. In view of the technical mastery which he displays throughout, this is patently a matter of stylistic conviction, rather than the result of any inadequacy. The playing has a fine sense of line and of dynamic contrast, and the violinist is ably, if somewhat unobtrusively, assisted by his associate. In the Vitali *Chaconne*, the figured bass is realized on the organ. The recording presents the violin with a lot of "air" around it, yet without any suggestion of its being lost in a large hall. D. R.

TCHAIKOWSKY *Mozartiana (Suite No. 4 in G Major), Op. 61*
Suite from the Opera, The Slippers

Philharmonia Orchestra of London; Anatole Fistoulari, cond.
MGM E 3026. 12-in. 17:10 and 17:53 min. \$4.85.

Two pieces of rather rare Tchaikowskyana are offered here. *Mozartiana* is little more than four works by Mozart arranged and orchestrated by Tchaikowsky, but it makes pleasant listening. It would be even more pleasant if some of the variations in the final movement had not been cut; such cuts on uncrowded long-playing disks are inexcusable. The older Rodzinski recording for Columbia also suffers from the same defect, but the orchestral playing in the latter version is somewhat more refined. It is coupled, however, with the *Nutcracker Suite*, whereas the present disk contains some rather attractive orchestral excerpts from a nearly-forgotten Tchaikowsky opera. Fistoulari's direction and the recorded sound are both adequate, though the latter has some thickness to it. P. A.

TCHAIKOWSKY *Quartet No. 1 in D Major. Op. 11* —
See Borodin

VERDI *Luisa Miller: Quando le sere al placido*
La Traviata: De miei bollenti spiriti
Macbeth: Ah! La paterno mano
†Puccini: *Tosca: Recondita armonia and E lucevan le stelle*
†Puccini: *La Fanciulla del West: Ch'ella mi creda libero e lontano*
†Puccini: *Manon Lescaut: No! pazzo son!*
†Puccini: *Turandot: Non piangere, Liu*

Mario del Monaco (t). Orchestra of the Accademia di Santa Cecilia; Alberto Erede, cond.
LONDON LS 670. 10-in. \$4.95.

Used to the full in music of dramatic character, Mr. Del Monaco's voice, especially at the top, is electrifying. It is difficult to imagine a more propulsively commanding effect than he achieves in *No! pazzo son!*, a more dramatically affecting performance of *Ah! La paterna mano*, a more compelling climax to *Recondita armonia*, and so on. In more lyric passages, particularly those lying in the middle and lower registers, he is far less satisfying, even distressing. Since he is reputedly self-taught as a singer, he may yet discover means of extending his technical command to include the lighter shadings of emotion. He could become another Martinelli; it is worth hoping for. J. H., Jr.

VINCENT, JOHN *Quartet No. 1*

American Art Quartet.
CONTEMPORARY RECORDS C 2002. 17 min. \$3.85.

A fascinating, original and important work, Mr. Vincent, professor of music in the University of California at Los Angeles, is an authority on the medieval modes, and the entire harmonic and



In John Vincent's quartet, medieval modes are joined to the main stream of modern music.

melodic scheme of his quartet is based upon them. The result is, unexpectedly enough, melodious, fluent, swiftly paced and altogether winning. Vincent, it would appear, does not believe in using the modes as a medium of the picturesque, but as a medium of contribution to the main stream of music. Beautiful, lifelike engineering. A. F.

VITALI *Chaconne for Violin and Figured Bass* —
See Tartini

WAGNER *Siegfried's Rhine Journey and Funeral Music from Gotterdammerung*

Pittsburgh Symphony Orchestra; William Steinberg, cond.
CAPITOL S 8185. 12-in. \$5.72.

Since he recently took command of the Pittsburgh Symphony, William Steinberg has raised the orchestra to new heights in both the concert and recording fields. His interpretation of the *Tristan* music is one of glowing intensity, no whit of which is lost in Capitol's realistic reproduction. The *Gotterdammerung* excerpts are also very well done; but here, for some unknown reason, the recording engineers allowed considerable hall resonance to creep in, causing the music to lose much of its incisiveness. This disk is certainly worth owning, however, if only for the *Tristan* readings. P. A.

WAGNER *Lobengrin: Bridal-chamber scene from Act II.*
Parsifal: Kundry-Parsifal duet from Act II.

Kirsten Flagstad (s), Lauritz Melchior (t), Gordon Dilworth (bne). RCA Victor Symphony; Edwin McArthur, cond.
RCA VICTOR LCT 1105. 12-in. \$5.72.

These Collector's Issue performances should be known already to most of those interested. Recorded on successive days in the fall of 1940, they have survived transfer to LP without serious hurt. Kirsten Flagstad is in magnificent form in both excerpts, but only on the *Parsifal* side has Lauritz Melchior left an adequate reminder of how superb he used to sound. The serious flaw here is the Milquetoast-like conducting. For those interested mainly in the *Lohegrin* duet, a check of the Traubel-Baum issue on Columbia will be revealing.

J. H., Jr.

MISCELLANY

CATHEDRAL VOLUNTARIES AND PROCESSIONALS

E. Power Biggs, organ.

COLUMBIA ML 4603. 12-in. 43 min. \$5.45.

Includes Purcell's *A Trumpet Voluntary* and *Voluntary in C (Fanfare)*; Vaughan Williams' *Chorale Prelude on Rhosymedre*; William Walond's *Introduction and Toccata, from a Set of Six Voluntaries*; Parry's *Chorale Prelude on Melcombe*; Herbert Murrill's *Postlude on a Ground*; Marcello's *Psalm 19*; Buxtehude's *Chorale Prelude on Nun bitten wir den Heiligen Geist*; Bach's *Komm susser Tod*; a sixteenth-century anonymous work, *Verses from the Te Deum*; Mattheson's *Aria in E Minor*; Schubert's *Litany for the Feast of All Souls*; and Strauss's *Processional for Festival Occasions*.

The estimable Mr. Biggs here calls attention to a body of music not heard by people who do not go to church and not usually listened to by those who do. The selection, covering three centuries, is tasteful, if sometimes dull, and the same can be said of the playing. The Mattheson, Buxtehude, Bach, and Vaughan Williams works are worth recording, and the Parry is quite lovely in its Victorian way. The Purcell makes a striking effect in Mr. Briggs' astringent registration, and the Strauss curiosity gives him a chance to build up a fascinating crescendo. The organ is the one installed not too long ago in Symphony Hall in Boston. Some of the lowest pedal notes speak slowly, and Mr. Biggs makes a few abrupt and odd shifts in registration. Otherwise the instrument sounds admirable, with clearly defined textures. A judicious amount of echo gives a churchly illusion.

R. E.

'CELLO RECITAL BY PIERRE FOURNIER

Bach: *Chorale "Herzlich tut mich verlangen," Sonata for 'Cello and Piano No. 1 in G Major*; Bloch: *Nigun*; Kreisler: *Chanson Louis XIII et Pavane*; Debussy-Heifetz: *Beau Soir*; Fauré: *Fileuse, Op. 80, No. 2*; Gershwin: *Prelude No. 2*; Nin: *Granadina*.

Pierre Fournier, 'cello; Ernest Lush, piano.

LONDON LL 700. 12-in. \$5.95.

Fournier is one of the finest 'cellists before the public today. He is a master stylist, as he demonstrates vividly here, adapting to such varied fare as a Bach sonata, a Bloch improvisation, a Debussy song, and even a blues-like Gershwin prelude. Ernest Lush's accompaniment is well-nigh ideal, and the reproduction is excellent.

P. A.

ELIZABETHAN LOVE SONGS & HARPSICHORD PIECES

Hugues Cuenod, tenor; Claude Jean Chaisson, harpsichord.

LYRICHORD LL 37. 12-in. 42 min. \$5.95.

An early tendency to have his picture taken looking like Jean Gabin with a cigarette drooping from his mouth, has made it hard for us to think of Hugues Cuenod as exactly Elizabethan in character. Yet a French gallant at Elizabeth's court, singing *Drink to me only* and other songs on this disk, probably would have sounded thus. Cuenod's style is irreproachable and, beyond that, he injects a touching sincerity into these ditties. Be it added that his English is excellently intelligible, and the recording so clear that he might really be in the room. The interspersing of harpsichord pieces dissipates the curse usual to LP collections of period-pieces — there is no monotony. This is a very charming record.

J. M. C.

FRENCH ART SONGS

Debussy: *Trois Ballades de Francois Villon (Ballade de Villon a s'amy; Ballade que fait Villon a la requeste de sa mere pour prier Notre-Dame; Ballade des femmes de Paris)*; *Le Promenoir des Deux Amants (Après de cette grotte sombre; Crois mon conseil,*

chere climene; Je tremble en voyant ton visage); *Fantoches*. Chabrier: *Les Cigales; Ballade des Gros Dindons; Villanelle des petits Canards; L'île Heureuse*. Ravel: *Chansons Madecasses (Nahandove; Aoua; Il est doux)*.

Jacques Jansen, (bne), Jacqueline Bonneau, piano; and, in the Ravel, Maurice Gendron, cello, and Jean Pierre Rampal, flute.

LONDON LL 644. 12-in. \$5.95.

This is a highly intelligent ordering of some of the most attractive short cycles and individual items in modern French song literature. The London engineers have achieved striking presence and excellent balance in the reproduction, and Jacques Jansen's singing can hardly be faulted on stylistic grounds. His diction is a constant joy, his vocalism smooth and generally agreeable in sound, and his interpretations those of a serious and educated musician to whom respect for *le bon gout* is second nature. If his voice lacks the color to make the most of the *Chansons Madecasses*, who is to complain?

J. H., Jr.

FRENCH ORCHESTRAL MUSIC

Saint-Saens: *Danse Macabre; Le Rouet D'Omphale*. Chabrier: *Marche Joyeuse; Espana*. Ravel: *Pavane pour une infante defunte*.

Orchestre de la Suisse Romande; Ernest Ansermet, cond.

LONDON LL 696. 12-in. 34 min. \$5.95.

One of the finest records London has released in some time, not only for the vivid and spacious quality of its sound, but also for the splendidly assured Ansermet readings.

The two Saint-Saens show pieces, strangely enough, are less effective than the Chabrier and Ravel. Ansermet's *Danse Macabre* is good, but no match for London's own 78 disk by Munch and the Concertgebouw Orchestra of Amsterdam, released four years ago. The Ravel score is most affectingly played, with some beautiful solo horn playing — the best performance I ever heard of this stately piece of music. Both Chabrier compositions are pure delights, turned and discharged with such buoyancy as to make them definitive versions.

J. F. I.

FRENCH RENAISSANCE VOCAL MUSIC

Vocal and Instrumental Ensemble under direction of Nadia Boulanger.

DECCA DL 9627. 12-in. 15:40, 21:20 min. \$5.85.

MONTEVERDI *Vocal and Instrumental Works*

Vocal and Instrumental Ensemble under direction of Nadia Boulanger.

DECCA DL 9629. 12-in. 20:37, 22:00 min. \$5.85.

For the sake of the record (pun intended) it should be noted at the outset that the writer of this review is himself a conductor of madrigals, and has recorded several disks of French, English and Italian madrigals, including some by Monteverdi. It therefore behooves the writer (if he is to avoid any accusation of bias), to bend over backwards in his criticism of these records.

Assuming that one were not to cavil over Mlle. Boulanger's custom of doubling some of the voice parts in the Monteverdi works, which, according to some viewpoints, is contrary to the authentic manner of performing madrigals, — and assuming, also, that one did not argue with the inclusion of the harp among the accompanying instruments, there are still a number of points which one must question. Chief among them is the "French" manner in which the Monteverdi madrigals are performed. Its applicability to the French works is of course, in place. But, when it is applied to the more emotional and dramatic madrigals of Monteverdi, the effect is one of ultra refinement, as if the singers were unmoved by the music they performed. It is only in the Monteverdi works involving solos or duets that the singers seem aware of the fact that they are expressing emotions. Particularly fine is the singing of Flore Wend in the charming scherzo *Quel sguardo sdegnosetto*, and that of the two tenors Paul Derenne and Hugues Cuenod in their duet *O, come vaghi . . .*

It is in the French works that the group really reaches the heights. Here the light, French tone is perfectly apt, and it is gratifying to be able to report the ultimate subtlety — Mlle. Boulanger's use of a different quality of vocal tone for each of the works, depending upon the period and the subject matter.

Thus, the group sings the earliest works with a dry tone almost innocent of vibrato, while, for the raucous *Quand mon mary* of Lassus, Mlle. Boulanger is not afraid to draw from her singers

a rough, intentionally-ugly sound. Although one might question the excessively hammerlike rhythms in *Francon vint l'autre jour*, her reading of Jannequin's *Le Chant des Oiseaux* is a model of its kind.

Unfortunately, the dry quality of both recordings makes one wonder whether modern high fidelity techniques were used, especially in the case of the French record.

A curious situation prevails with regard to the annotations accompanying both records. For the French music, Mlle. Boulanger has written excellent notes, informative and scholarly. In the case of the Monteverdi disk, however, one must content oneself with merely listings of the singers' names and descriptions like the following, quoted in full: "Another expression of Monteverdi's sovereign skill in writing for the voice". With neither record is one given the original Italian or French text. The French set contains English translations; the Monteverdi record gives only the meagrest of clues as to the meaning of the words.

D. R.

MUZIO SONG RECITAL

Pergolesi: *Se tu m'ami*. Donaudy: *Spirate pur, spirate; O del mio amato bene*. Refice: *Umbra di nube; Ave Maria*. Reger: *La ninna nanna della Vergine*. Debussy: *Beau soir*. Delibes: *Bon jour Suzon; Les Filles de Cadix*. Bainbridge Crist: *C'est mon ami*.

Claudia Muzio, soprano, with unidentified orchestra; Cav. Lorenzo Molajoli and Licinio Refice, cond.
COLUMBIA ML 4634. 12-in. \$5.45.

These songs, recorded a year before Claudia Muzio's death in 1936, make available to the rising LP generation further evidence (if any more is needed) of how great an artist she was. The fatal ma-



Claudia Muzio: not even death and time can prevail against true beauty.

lignancy had begun to take its toll of her resources, and the intervening 18 years have seen recording techniques advanced by giant steps; but, for all that, the vocal sound is strikingly fluid and lifelike, the interpretative genius undimmed in the glow with which it shines forth from even the least ponderable of these musics.

J. H., Jr.

OLD ITALIAN AIRS

Alessandro Scarlatti: *L'Autore e i Pensieri; Sento nel core*. Lotti: *Pur dicesti, o bocca bella*. Durante: *Vergine, tutto amor*. Bassani: *Ah se tu dormi an cora*. Caldara: *S'ebben, crudele*. Cesti: *Intorno all' idol mio spirate*. Giordani: *Caro mio ben*. Gluck: *O del mio dolce ardor*. Gasparini: *Lasciar d'amarti*. Legranzi: *Che fiero costume*. Pergolesi: *Tre giorni son che Nina*. Carissimi: *Vittoria, mio core!*

Giacinto Prandelli (t), Dick Marzollo, piano.
VOX PL 7930. 12-in. 39 min. \$5.95.

These 13 items are as good a cross-section as is available on one disk of seventeenth- and early-eighteenth-century Italian song, and the performances are representative of the music as it is performed in reputable circles today. For those primarily in search of notable vocalism, it should perhaps be noted that Giacinto Prandelli earns the patent of good style more by avoiding improprieties than by accomplishing anything very positive in the way of suave tone or brilliant execution. The reproduction is superb.

J. H., Jr.

SEVEN CENTURIES OF SACRED MUSIC

Composers: Léonin, Pérotin, DuFay, Benet, Attey, Gombert, Torre, Franco, Franck, Albert, Schütz, J. S. Bach, Couperin, Pergolesi, Handel, Paumann, Hammerschmidt, Mozart.

Yves Tinayre with Instrumental and Choral Ensemble.
DECCA DX-120. Two 12-in. 1 hour, 14 min. \$11.70.

A collection such as this hardly requires a "review" as such. In view of the rarity of this music, and of its historic value as well as its beauty, one need only list the composers represented—and then be grateful for the fact that an album such as this exists.

Yves Tinayre's name, of course, has long been associated with old music. His performances are not merely dry-as-dust museum pieces. He brings to them a certain warmth and conviction that makes even some of the very oldest pieces quite listenable, while never making the mistake of using a nineteenth-century, over-opulent tone quality.

Since these are all dubs of records previously issued well over a decade ago, it is to be expected that the recorded sound is not the last word in high fidelity reproduction. A certain amount of surface noise could not be removed from some of the original 78 rpm masters and has therefore been preserved in a few of these selections. For the most part, however, the reproduction is quite satisfactory—in fact, surprisingly so, in view of the age of the originals.

D. R.

SPANISH AND TURKISH FOLK SONGS

Cynthia Gooding, contralto, with guitar.
ELEKTRA EKLP 6. 10-in. 28 min. \$4.45.

Miss Gooding ventures on dangerous ground in these Spanish Folk Songs, which call for a voice of vibrant earthiness and that odd timbre that is peculiar to Spanish singers. Her voice lacks both these primary requisites, and the result is a genteel and refined performance by a singer who knows her medium, but is unable to do it full justice. She may be more successful with her Turkish songs, though I am hardly qualified to offer an opinion there. The Elektra recording is most faithful to the sound of the guitar, and balance is good.

J. F. I.

THE TRIUMPHES OF ORIANA

The Randolph Singers (Anna Louise Kautz, s; Harriet Hill, s; Mildred Greenberg, c; Arthur Squires, t; Gordon Myers, bn; Bert Spero, bs.); David Randolph, cond.
WESTMINSTER WAL 212. Two 12-in. \$11.90.

In 1600, it occurred to Master Thomas Morley that his Queen, Elizabeth I of England, was deserving of some sort of concerted honor from her musician-subjects. So he determined upon a bouquet of madrigals, to be composed by the kingdom's leading madrigalists. Each madrigal was to close with the line: "Long live fair Oriana!" The use of a classic pseudonym was common in such tributes; besides, Oriana is easier to find rhymes for than Elizabeth. The 24 madrigalists were to turn in 32 madrigals. True to tradition, seven missed the deadline, but the *Triumphes* was still a success. In 1953, coronation year of Elizabeth II, it occurred to David Randolph that the time was ripe to revive and record the collection. By dint of some arduous digging ("exciting," he says) he located the seven late left-outs, so this version of the *Triumphes* is complete. It is also entrancing. The Randolph Singers are probably a little "cooler" in style than Elizabeth's court singers, but it's a safe five-to-one that they sing better. Westminster's intimate, crystalline recording also insures that everyone who buys this bouquet will hear the songs at least as well as Elizabeth R. did. Even so, madrigals are hard to understand, so a text comes with the album.

J. M. C.

RECORDS FOR CHILDREN

Golden Records (Big and Little) have come up with a crop of interesting disks recently. Among their good 10-in. ones are *Mother Goose* for the very young and *The Golden Treasury of Folk Songs*. The latter includes *Turkey in the Straw*, *Camptown Races*, *Dixie*, *Bluetail Fly* and others. On Little Records, Mitch Miller has explored and produced such gay tunes of past generations as *Alexander's Ragtime Band*, *The Man on the Flying Trapeze*, and *Glow Worm*. In some cases new lyrics have been provided that appeal to children but the music is the same. The singers are Anne Lloyd, Bob Miller, Dick Byron, Ralph Nyland and Michael Stewart.

THE BEST OF JAZZ

Pete Seeger accompanies himself on a five string banjo as he sings with ease and informality on a Folkways 10-in. LP, *American Folk Songs for Children*. He has selected 11 songs from the excellent collection with the same title published by Doubleday and edited by Ruth Crawford Seeger. Among them are *Jim Along Josie*, *This Old Man*, *Bought Me a Cat*, *Train is a Coming* and *All Around the Kitchin*. A good record. Also on the folksy side, Folkways has come up with *One, Two, Three and a Zing Zing Zing*, 10-in. LP of street games and songs of New York City children. This is of special interest to teachers and students who are interested in knowing more about children's out-of-school play.

And still more folklore — this time on two 10-in. LP's of old Irish tales told by Josephine Gardiner (Thomas Tenney Records, 2984 College Avenue, Berkeley 5, Cal.) *The Wee Red Man*; *The Twelve Magic Windows and Next Time I'll Know*; *Titty Mouse and Tatty Mouse*; *The Old Woman and the Pig*. This could be better recorded but even so it has a great deal of charm. It is straight story telling without any decorations and its unpretentious and homey tone should delight children from six and up.

If you like the idea of history told through song you may be interested in the following *Records of Knowledge* — *Sing a Song of Presidents: Dwight Eisenhower* featuring dramatic incidents in President Eisenhower's childhood up to the present and sung and told by Lawrence Weber and Leonard Fabian. Daniel Boone, Sam Houston, Davy Crockett, Magellan, Columbus and others are represented in Album I with two 10-in. records — *Sing a Song of Pioneers and Explorers*.

There is plenty of present-day pioneering in two new *Sergeant Preston of the Yukon* records (Decca) in which the sergeant captures the man who murdered his father and the story about how he got his dog. Still more excitement comes off the turntable in Columbia's *Shipwrecked on Planet X* with Rocky Jones, the Space Ranger. For youngsters from about 6 and up.

A Midsummer's Night Dream with Mendelssohn's music has been adapted by Leo Paris for children and produced by CRG. Richard Mohaupt arranged the music and conducted. This is another of CRG's excellent permanent contributions to a child's record library. The complete story is printed on the envelope so the child can read as he listens to these two fine records.

Dance and Whistle (Columbia) offers the delightful entertainment of Josef Marais and Miranda in good singing, dancing and whistling tunes which are easy to sing along with.

Cradle Song by Brahms (Bornand Music Co., 333 5th Ave., Pelham 65, N. Y.) is a charming old music box recording which is a good antidote for the too strenuous life. When things get too quiet Columbia's *Rap-A-Tat-Tat*, *The Dancing Cat* is guaranteed to start everyone dancing as well as marching to the *Mosquitoes' Parade* on the reverse side under the direction of Percy Faith and his orchestra.

For the youngest, Mercury-Childcraft has a jolly little record, *Choo Choo Train to the Farm*. It's full of animal sound effects and is held together by familiar and appropriate songs along with the narration of tripping back and forth to a farm via a choo-choo train. Recommended.

Incredible Christopher (Mercury-Childcraft) is a record you must not miss. The youngsters think it is hilarious because Christopher always goes in reverse! I agree. On the other side is a jolly pirate story about Captain Snorter. Both stories are told in nonsense rhyme by Alice Gray and set to music and directed by Curtis Biever very much in the Gilbert and Sullivan style. Children from about five up (and some younger) will enjoy this really delightful production.

Campfire Songs and Cowboy Songs (Mercury Childcraft) are recommended for their excellent musical arrangements. *Home on the Range*, *Red River Valley*, *Oh, How Lovely is the Evening*, *Blow the Man Down* and *Taps* are on the first record and Jack Russell does a fine job in singing popular cowboy songs on the second — *Strawberry Roan*, *Cool Water*, *Tumbling Tumbleweeds* and *Last Roundup*. Curtis Biever gets credit for arrangements and direction.

EMMA DICKSON SHEEHY

BENNY GOODMAN AND HIS ORCHESTRA Eddie Sauter Arrangements

COLUMBIA GL 523. 12-in. \$4.85.

Moonlight on the Ganges; *More Than You Know*; *Intermezzo*; *La Rosita*; *Soft As Spring*; *That's the Way It Goes*; *'Tis Autumn*; *Not a Care in the World*; *Tangerine*; *Ramona*; *Love Walked In*.

Fletcher Henderson Arrangements

COLUMBIA GL 524. 12-in. \$4.85.

Stealin' Apples; *Night and Day*; *Honeysuckle Rose*; *Can't You Tell?*; *Crazy Rhythm*; *Henderson Stomp*; *Frenesi*; *Somebody Soled My Gal*; *Just You, Just Me*; *I'll Never Say "Never Again" Again*; *What a Little Moonlight Can Do*; *You're a Heavenly Thing*.

During the active career of Benny Goodman's band, key roles in its development were played by two arrangers: Fletcher Henderson, whose arranging style formed the basis for the band's first success, and Eddie Sauter, whose writing reoriented and reanimated the band after it had wormed its way into a stylistic rut. These two LPs provide reasonably representative summaries of what each of Goodman's top arrangers had to offer.

In essence, Henderson wrote in a straight line while Sauter took bypaths. Typically Henderson's is the tight section writing that comes smiling through as Goodman's smoothly drilled reeds tackle *Honeysuckle Rose* and as Trummy Young leads the trombones into *Just You, Just Me*. Unfortunately, the Goodman band had a heavy quality which sometimes defeated an essential element of Henderson's writing — a gentle, insistent swing. The best Goodman versions of Henderson catch this — the two numbers mentioned above as well as *Can't You Tell* and *What a Little Moonlight Can Do* — but just as often what Henderson is trying to do is strangled by the band's leaden qualities (*Somebody Soled My Gal* and *Frenesi* are instances on this LP).

Three of the numbers on the Henderson LP were recorded this year by a band largely made up of Goodman alumni (not the band he started to tour with before his collapse) plus Helen Ward vocals. Instrumentally, they sound much like the old Goodman band with the advantage of more realistic recording. Miss Ward, one of the most provocative objects ever displayed on a bandstand, always had a fine feeling for a swinging beat even though she had little to offer as a voice. She doesn't seem to have changed with the passage of years.

Sauter brought a writing style to the Goodman band which broke up the loginess it had fallen into while retaining the lightly swinging elements. His arrangements are much more sophisticated than Henderson's and, in general, the band does them more justice. Strangely enough, seven of the twelve numbers on the Sauter LP are being issued for the first time now although they were all out between 1940 and 1945. One of the debutantes is a fine version of *Love Walked In* which boasts a remarkably smooth but gutty alto chorus by Bill Shine, a saxophonist who deserves more attention than he has received. Another previously unreleased delight is *Not a Care in the World*, a charming but practically never heard song written by John Latouche and Vernon Duke for *Banjo Eyes*, sung in this instance by Peggy Lee in a rather uncomprehending manner but played by the band with pleasure. Both sides of this disk are loaded with Sauterian inventiveness, played with expressiveness and the sharp discipline that Goodman always worked for.

DIXIELAND AT JAZZ, LTD., VOL. 1

ATLANTIC ALS 139. 10-in. \$3.85.

Doc Evans, trumpet; Miff Mole, trombone; Bill Reinhardt, clarinet; Ralph Blank, piano; Sy Nelson, bass; Doc Cenardo, drums;

Jazz Me Blues; *The Charleston*; *Tin Roof Blues*; *High Society*.

DIXIELAND AT JAZZ, LTD., VOL. 2

ATLANTIC ALS 140. 10-in. \$3.85.

Muggsy Spanier, trumpet; Munn Ware, trombone; Bill Reinhardt, clarinet; Don Ewell, piano; Sid Thall, bass; Wally Gordon, drums;

Washington and Lee Swing; *A Good Man is Hard to Find*.

Sidney Bechet, soprano saxophone, in place of Spanier:
Careless Love; Egyptian Fantasy; Maryland, My Maryland.

Doc Evans, trumpet, in place of Bechet:
Wolverine Blues; It's a Long Way to Tipperary.

Don Ewell, piano:
Maple Leaf Rag.

The first volume, which is far the better of the two, provides an impressively alert reading of the four old two-beat war horses. Particularly on *Jazz Me Blues* and *Charleston*, the vitality in these eldering gentlemen is amazing. They play cleanly, they play with guts, they swing and they mix curves with their fast balls. The upside is not quite as full of life and, on *Tin Roof Blues*, Mole gives in to the trombonist's urge to eject blurbis simply for blurbis' sake, but otherwise the blood is kept pleasantly pulsing. The recording is live, rounded and well balanced.

Volume Two is an entirely different proposition, both in personnel and results. Only when Doc Evans is at the helm does cohesion set in and the resultant *Wolverine Blues* and *Tipperary* are notable largely in relation to the rest of the record. Spanier is caught in one of his moods when he stirs up a lot of noise without generating any heat while Bechet, who seems to be one of the most insensitive of upper echelon of jazz musicians, manages to mar an otherwise moving version of *Careless Love* by injecting a few grossly inappropriate laughing bars of *Humoresque*.

DON EWELL'S PIANO JAZZ

GOOD TIME JAZZ EP 1004. 7-in. \$3.00.

Don Ewell, piano:
Muskrat Ramble; Rumpus Rag; Parlor Social; Wild Man Blues.

Good Time Jazz has started transferring some of its catalogue to EPs and among the first ten extended 45's released are four numbers by Don Ewell which have never appeared before in any speed. They were cut in Baltimore in 1947 and, despite a slightly tubby tone, they reveal Ewell as a sure-fingered follower of both Jelly Roll Morton and James P. Johnson — a pianist who is disciplined and exciting. *Muskrat Ramble* is solidly Morton and Ewell takes to the style with such fine, striding strength that you might think he had created the approach himself. *Parlor Social*, a Ewell original, is in the Johnson manner and again Ewell is completely at home in this vigorous, ragging vein. Altogether, this is a pleasantly provocative showcasing of this still relatively unheralded pianist.

EARL HINES—Piano Solos

ATLANTIC ALS 120. 10-in. \$3.85.

Earl Hines, piano:
Chicago High Life; Just Too Soon; A Monday Date; Off Time Blues; Pantber Rag; Chimes in Blues; Stowaway; Blues in Thirds.

These piano solos originally appeared on the very shortlived QRS record label in 1928 and, a decade later, were reissued by the Hot Record Society to a limited audience. All eight numbers are Hines originals and, except for *A Monday Date* and *Blues in Thirds*, these are the only recordings made of them. In general, they are excellent instances of Hines as both a composer and performer. They are full of the sharp, staccato ecstasy which is his hallmark. He is at his exuberant best in *Chicago High Life*, a hard-riding, rocking number, and in the more slowly swinging *Stowaway* which boasts a fantastically involved and lengthy break. Because this LP was cut directly from the old QRS records, there is considerable surface noise but Hines' style is calculated to cut through any such minor interference.

ERROLL GARNER—Overture to Dawn

BLUE NOTE BLP 5007, BLP 5008. 10-in. \$4.00 each.

Erroll Garner, piano:
Volume 1: *I Hear a Rhapsody; You Were Born to Be Kissed; Overture to Dawn.*

Volume 2: *Autumn Mood; Erroll's Concerto; Floating on a Cloud; I Surrender, Dear.*

Passport to Fame

ATLANTIC ALR 128. 10-in. \$3.85.

Erroll Garner, piano.
Perdido; Everything Happens to Me; Soft and Warm; Blues I Can't

Forget; I Get a Kick Out of You; I'm in the Mood for Love; Boogie Woogie Boogie; All the Things You Are.

Both of these records are claimed, by the men who recorded them in 1944, to be Garner's first. The Blue Note sides, recorded by Timme Rosenkrantz, were not intended to be commercial releases. They show Garner relaxing after hours with whatever comes to his mind. The numbers on the Atlantic LP, on the other hand, were cut by Roger Kay with commercial malice aforethought.

These early Garners leave two strong impressions: (1) His highly individual style was well developed nine years ago, as is evidenced by the Atlantic numbers; (2) Garner's talent is as a performer with a definite theme at hand, not as a composer nor as an ad lib performer. The latter point is made painfully clear on the Blue Note sides: *Overture to Dawn, Autumn Mood, Erroll's Concerto* and *Floating on a Cloud* are largely trite and empty with themes, when they turn up, that are palely imitative. He fares better on the pop tunes but it is still rather tentative Garner.

He is much more certain, much more disciplined and much more realistically recorded on the Atlantic LP. Granted most of these numbers are the things he has done over and over again in the intervening years, still there is a freshness and vigor about his 1944 approach.

FATS WALLER—Rediscovered Fats Waller Solos

RIVERSIDE RLP 1010. 10-in. \$3.85.

Fats Waller, piano:
Squeeze Me; You Can't Do What My Last Man Did; Mama's Got the Blues; 'Tain't Nobody's Biz-ness if I Do; 18th Street Strut; Your Time Now; Papa Better Watch Your Step; Snake Hips.

"Rediscovered" appears in the title of this LP because these Waller solos were made on piano rolls in 1923 and, presumably, forgotten. Now, exhumed, they have been transposed to record with commendable skill, achieving a tone which is several cuts above player piano expectancy. Individually, each of these numbers is a clean, straightforward bit of jazz piano work but, because of the similarity of material, approach and tempo on all of them, they get a shade monotonous when taken all at once.

FLETCHER HENDERSON AND HIS ORCHESTRA—Fletcher Henderson Memorial Album

DECCA DL 6025. 10-in. \$3.35.

Wild Party; Rug Cutter's Swing; Wrappin' It Up; Happy As the Day is Long; Down South Camp Meetin'; Big John's Special; Hotter Than 'Ell; It's the Talk of the Town.

The Henderson band of 1934, which plays seven of these numbers, was studded with outstanding soloists. In this case the prominent members were Buster Bailey, Ben Webster and Red Allen and it is largely their work that brightens these selections. This Henderson band demonstrates the gently riding swing that Goodman's band frequently lacked when it tackled Fletcher's arrangements, but Henderson's sections rarely come up with the integration and polish that Goodman achieved. The Henderson style represented on this LP was the style that got the Goodman band going and the versions given here of what have become swing classics may be considered definitive. As a bonus, *Talk of the Town* (made in 1933) offers Coleman Hawkins in a relatively light demonstration of the lyric style he later developed in heavier tones.

JIMMY MC PARTLAND DIZZY GILLESPIE Hot vs. Cool

MGM E 194. 10-in. \$3.00.

Jimmy McPartland, cornet; Edmond Hall, clarinet; Vic Dickenson, trombone; Dick Carey, piano; Jack Lesberg, bass; George Wettling, drums.

Dizzy Gillespie, trumpeter; Buddy De Franco, clarinet; Ray Abrams, tenor saxophone; Don Elliott, trumpet and mellophone; Ronnie Ball, piano; Al McKibbin, bass; Max Roach, drums.

How High the Moon; Indiana; Muskrat Ramble; Battle of Blues.

The ideas of pitting a group of hot musicians against exponents of the cool idiom, with both playing the same tunes, sounds gimmicky on the surface but, as carried out on this disk, it has resulted in some fine performances in both styles with a little good, clean fun on the side. Gillespie is in fine fettle throughout. His work on *How High the Moon* and *Muskrat Ramble* pleads the cool cause

with great eloquence. For the hot team, Ed Hall's warm, wriggling, itchy clarinet creates most of the excitement. His personal duel with Buddy De Franco on *Indiana* is as rousing a challenge affair as has been put on disks. The recording was made at Birdland, the New York cool spot, and contains a minimum of audience interference. For a location job, the resultant sound is good, although not up to the best studio quality. JOHN S. WILSON

THE SPOKEN WORD

ADLAI STEVENSON SPEAKS

RCA VICTOR LM 1769. \$5.72.
Selections from the Campaign Speeches of Adlai Stevenson, edited and narrated by James Fleming.

Although the gifted oratory of Presidential nominee Adlai Stevenson was not enough to save the Democratic Party from defeat, it did, in a few short months, establish him as a national figure of consequence. He had said in Chicago that he was going to "talk sense to the American people . . . [to] . . . tell them the truth," and he probably came as near to it as any politician in American history.

This record is a composite of selections from Stevenson's campaign speeches edited and narrated by NBC News Commentator James Fleming. From the first words ("A wise man does not try to rush history") to the last (" . . . rational man, animated by the destiny of greatness can think and act and do greatly,") the listener is aware that the voice he is hearing, regardless of the politi-



Adlai Stevenson, adept at an art seldom met today: true oratory.

ASSOCIATED PRESS

cal future of its owner, is the voice of a great political orator with a priceless gift for expressing himself ("patriotism is not the fear of something, it is the love of something"); the voice of a philosopher ("Nature is neutral. Man has wrested from nature the power to make the world a desert — or to make the desert bloom. There is no evil in the atom — only in men's souls"); the voice of a humorist ("Man does not live by words alone — despite the fact that he sometimes has to eat them"); the voice of man with the courage to speak his mind, even in a political campaign ("Whose fault is it . . . that we shall get what we deserve in government . . . ? It is not the lower order of the genus pol, but it is the fault of you the people").

Adlai Stevenson said, "I am persuaded that congenitally and as a candidate I talk too much." This egghead would like to suggest that, if anything, he doesn't talk enough. R. H. H., Jr.

SCOTS BORDER BALLADS

Read by George S. Emmerson.
TENNEY TG-1001. 12-in.

All persons desirous of having their blood run cold will be well advised to consider these nine Scottish ballads read by George S. Emmerson as reminder that life is nothing but a murky night, with no starlight, and none of us will get out of it alive.

The ballads chosen for this vinyl disk, utterly silent except for the speaker's voice, are the sort of ancient tale which carries its horror right into the bone marrow.

Like most Scotsmen Mr. Emmerson is at least fifty percent dialect and will require several hearings before the ballads achieve their intended impact.

The ballads are: Sir Patrick Spens; Thomas the Rhymer; The Battle of Otterbourne; The Wife of Usher's Well; Edward; The Twa Corbies; Clerk Saunders; Fair Annie and Kinmont Willie, any one which, catching you in the proper mood, should gas ye greet a meikle of spait. But, then, in order to hear Mr. Emerson that's a sair pain ye maun bide.

"Last night I dreamed a dreary dream,

"Beyond the Isle of Skye.

"I saw a dead man win a fight;

"And I think that man was I."

That's just one little tid bit from The Battle of the Otterbourne. But that is no climax. It takes off from there. Ed Wallace

SHAKESPEARE *Hamlet*

John Gielgud; Pamela Brown; Dorothy McGuire; supporting players. Directed by Homer Fickert.

RCA VICTOR LM 6007. Two 12-in. \$11.44.

In the recording business there is an adage, seldom discredited by the facts, to the effect that a transcription of a broadcast performance seldom stands up well as a recording. Unfortunately, it applies here. This presentation of *Hamlet* was prepared for a Theatre Guild on the Air broadcast more than a year ago, and as a broadcast it was extremely effective. A record, for some reason, is listened to more critically (especially after the first time). And the radio production, on disks, sounds choppy and a little hammy. John Gielgud's never-varied hollow vibrato becomes especially wearing. However, there are some very clever editing devices, such as making Horatio an interim narrator, and the pacing is good. Shakespeare-devotees, it can be promised, won't like the set. High school English teachers, however, will crave it for classroom use. J. M. C.

THE MUSIC BETWEEN

CURTAIN TIME SERIES: Music by Strauss and Gungl

WESTMINSTER WL 4004. 12-in. \$4.95.

Leslie Bridgewater and The Westminster Light Orchestra. *Artist's Life Waltz; Czardas from "Ritter Pazmann"; Pizzicato Polka; Fledermaus Waltz; Soldatenlieder Waltz; Amoretten Dance; Hydropatben Waltz; Casino Dance.*

CURTAIN TIME SERIES: Folksongs from The British Isles

WESTMINSTER WL 4003. 12-in. \$4.95.

Leslie Bridgewater and The Westminster Light Orchestra. *I Am the Boy for Bewitching; Over Here; Planxty Kelly; The Ballad of Yarrow; Get Up Early; Have You Seen but a White Lillie Grow; Gentle Maiden; Sentry Box; Hares on the Mountain; Lord Rendal; Green Broom; Drink to me Only; When Dull Care; Waly, Waly; Oyster Girl.*

MARCHES: Deutschmeister Band cond. by Julius Herrmann

WESTMINSTER WL 3003. 10-in. \$3.95.

Radetzký March; "Die Bosniaken Kommen"; Philippovits March; Schoenfeld March; Auersberg March; 84th Regiment March; Vindobona March; Andreas Hofer March; Castaldo March.

GYPSY SONGS: Antal Kocze, King of the Gypsies, and Band

WESTMINSTER WL 3001. 10-in. \$3.95.

Hora; Sad Sunday; Romance Le Luc and Blaskovicz Waltz; Hungarian Song; Magyar Melody.

CHANSONS DE PARIS: Mira Jozelle with Ben Ludlow Orch.

WESTMINSTER WL 3006. 10-in. \$3.95.

Je Suis Belle, Cheri; Ciel de Paris; La Fiancee du Prestidigitateur; Humne a L'Amour; Sur la Route; France Dimanche; L'Amour est Parti; Le Loup, la Biche et la Chevalier.

The five records listed above mark the entry of Westminster Records to the field of music which Westminster chooses to call "light." Regardless of nomenclature, we are glad to welcome these new recordings to "The Music Between". The venture turns out to be a much more than satisfactory debut.

It would be possible to argue about the choice of material, artists and types of music, but the records at hand are uniformly of excellent quality both as regards recording and surface. The European style of perspective is admirably served in all five of these disks, and serves particularly to enhance the solo instruments in the folksong collection.

One of the most attractive features of this release is the presence of five relatively unknown items on the Strauss-Gungl record. In these days, when the various companies seem to be engaged in competition to rack up the largest score for recording old familiar chestnuts, such pioneering deserves mention. Equally praiseworthy are the tasteful arrangements of old English folk-songs by Armstrong Gibbs. Admitting the limitations of the cult of vocal folk singing, one can foresee a much wider appreciation of these songs in their present guise.

Herr Hermann and his fine band offer one of the finest march time disks in recent months (coming on the heels of a rash of John Sousa disks). If gypsy music is attractive the Antal Kocze recording deserves special attention.

In the world of Continental popular vocalists there seems to be an unwritten rule that all female singers must closely approximate the sounds of an asthmatic basso bullfrog. To holders of this dogma, Mlle Mira Jozelle must necessarily come as a stunning shock. The young lady sings affectively with a rather clear light soprano, nicely supported by Ben Ludlow's orchestra and special arrangements. As in the other four records in Westminster's "light" music releases, the room tone captured on the disk enhances the details of the orchestrations, and the plaintive quality of Miss Jozelle's voice.

LOVER'S RHAPSODY

CAPITOL H 366. 10-in. \$2.98.

Jackie Gleason and his orchestra, with Bobby Hackett.

Lover's Rhapsody: *Desire, Flirtation, Temptation, Enchantment, When Your Lover Has Gone, Tenderly, I'm Thru With Love, Dark Is the Night.*

This disk comes on the heels of the original Gleason release and follows up the success therein. If one could have had one's own choice, perhaps the side devoted to the *Lover's Rhapsody* would have been filled instead with more delicious standards. However, the sounds on both sides are notable. In fact, if the ear is true, this present recording is more impressive than the original.

MELACHRINO STRINGS

RCA VICTOR LPM 3077. 10-in. \$3.15.

The Melachrino Orchestra.

Masquerade: Violins in the Night; Waltz of Pavee; Out of My Dreams; Kiss Me Again; Padam . . . Padam . . . ; Pink Lady Waltz; A Waltz Dream.

Following the original release of three twelve-inch Melachrino records, Victor has followed up with this ten-inch sample for the less daring buyers. If orchestral music between is your fare, you can't go wrong with this offering.

The Melachrino arrangements, as we have noted before, are something special, deceptively simple. They have a way of getting everything out of a melody without having to try. As a result they provide the best examples of this type of music now available.

Victor's English affiliates have lavished their magnificent recording techniques on these tunes and the result has been put onto fine surfaces.

PRAISE YE THE LORD: Songs of Faith and Exultation

CAPITOL L 382. 10-in. \$3.98.

The Voices of Walter Schumann.

The Lord's Prayer (Malotte); Ave Maria (Bach-Gounod); Alleluja (Mozart); Onward, Christian Soldiers (Sullivan-Morton); The Palms (Faure); Christ the Lord Is Risen Today (Wesley-Scott); The Apostle's Creed (Schumann); Psalm 150 (Morton).

Over the past few years this group has been turning out a series of well-considered arrangements of popular songs. With this release it turns its talents to music of a more serious nature. The singing is most enjoyable and pleasantly free from the mannerisms and affectations which defeat certain other popular singing groups. Of particular interest is the Walter Schumann setting of *The Apostle's*

Creed which was first heard from an acetate recording during the pre-Broadway tour of *John Brown's Body*, from which score the theme is taken. The transition of this music from the closing scene of a dramatic work to the great affirmation of faith may well give it years of added life.

SIGMUND ROMBERG FAVORITES

DECCA DL 9665. 12-in. \$5.95.

Hollywood Bowl Pops Orchestra, Johnny Green, cond.

The Student Prince Selections; Viennese Nights Waltzes; American Humoresque; Tyrolean Woodchopper's March; Blossom Time Selections; Faithfully Yours; My Maryland Selections.

One of the first modern recordings of several of the late Sigmund Romberg's melodies, this disc offers a chance to hear the West Coast division of Decca at work. Some of the tricks, both in performance, scoring and recording, so familiar to other labels are missing in this recording but the net result is quite satisfactory.

By comparison with some of the other entries in this month's sweepstakes this may not be ultra-hi-fi, but it is very good.

SONGS OF REVERENCE

DECCA DL 7535. 10-in. \$3.85.

Richard Tauber with Orchestra.

Panis Angelicus; Ave Maria; O Sanctissima; Bless This House; Ave Maria; A Perfect Day; Largo; Agnus Dei.

With the release of this album, the Decca collection of re-recordings by the late Richard Tauber now numbers seven. Very possibly more will be forth-coming, since the British Parlophone catalogue, from which these items are selected by Decca, contains some 250 or more separate Tauber selections.

Looking over, and listening to, the present release one cannot but regret the choice as measured against the possibilities. Generally speaking, the entire selection is without much to recommend it, being both indifferently recorded and of limited interest. If memory of Tauber motion picture serves, several of these songs may have been taken from motion picture sound tracks, a fact which might account for the lack of definition in the recording.

VICTOR HERBERT SUITE

LONDON LL 746. 12-in. \$5.95.

Mantovani and his Orchestra.

Ab! Sweet Mystery of Life; When You're Away; Neapolitan Love Song; March of the Toys; Gypsy Love Song; Kiss me Again; Indian Summer; To the Land of my Own Romance; Italian Street Song; A Kiss in the Dark; Habanera; Sweethearts; The Irish Have a Great Day Tonight.

The amazing Mantovani, a consistent best seller in this day of vocal rampancy, provides a wonderful showcasing for the music of Victor Herbert. Actually, this English orchestra with its rich string and echo style seems beautifully right for this familiar music. Checking back through the many previous releases by this same orchestra, one is forced to the conclusion that this is their best effort. To the fine playing of the orchestra, London's engineers have added one of their characteristically high quality jobs and the whole is pressed on fine surfaces.

WOODLAND SKETCHES

DECCA DL 4059. 10-in. \$2.50.

Camarata and his orchestra.

To a Wild Rose; Will O' the Wisp; At an Old Trysting Place; In Autumn; From an Indian Lodge; To a Water Lily; From Uncle Remus; A Deserted Farm; By a Meadow Brook; Told at Sunset.

Edward MacDowell's *Woodland Sketches* hold the memory of a couple of generations of piano students. During all this time, only a few of the sketches have been transcribed for orchestra. So it is that Decca is able to present the first recording of the complete *Woodland Sketches* in orchestral form. The Camarata orchestra traverses these arrangements by their conductor in highly acceptable form. For a change, light music has been written for orchestra without violence to the original idea.

EDWARD L. MERRITT, JR.

SUPPLEMENT

(Reviews displaced from
the May-June issue.)

ARNELL *Punch and the Child* — See Berners

BARTOK *Dance Suite*
Kodaly: *Dances From Galanta*

London Philharmonic Orchestra, Georg Solti, cond.
LONDON LL 709. 16, 16 min. \$5.95.

The *Dance Suite* is really not a suite at all but a continuous work in six sections held together by recurrent ritornello. It was composed to commemorate the 50th anniversary of the merger of Buda with Pest — and it has a festive, joyous, lighthearted character. Bartok's dances are all original, though they employ rhythms and modes suggestive of Central European and Arab folk music. Kodaly's are transcribed directly from a Hungarian Gypsy collection published in Vienna in 1800. Kodaly's version is, of course, distinguished for the refinement of its orchestral and harmonic tissue, and for its general air of gayety. Excellent performances, good recordings. A. F.

BELLINI *La Sonnambula*

Lina Pagliughi (s); Wanda Ruggieri (s); Annamaria Anelli (ms); Ferruccio Tagliavini (t); Armando Benzi (t); Cesare Siepi (bs); Piero Poldi (bs). Orchestra of Radio Italiana, Turin, and Cetra Chorus; Franco Capuana, cond.
CETRA-SORIA XTV 18175-80. Three 12-in. \$17.85.

For lovers of pure *bel canto*, this recording should certainly rank as one of the richest treasures made possible by LP. Who would ever have dared hope for a full-length *La Sonnambula*? Yet here it is, and in a performance that does its beauties credit.

La Sonnambula was finished in 1831, a year before *Norma*, when Vincenzo Bellini was in the thirtieth year of his life. He died before he was quite 34.

The present upsurge of interest in Bellini may come to nothing, as far as the world's opera houses are concerned. Perhaps there really are not enough qualified singers anywhere to give his operas real repertoire status. Fortunately, we do not need to find out — at least as long as record companies keep coming up with albums like this one. For what it aspires to, *La Sonnambula* is a perfect thing. All one needs to hear it is a sense of melody and a joy in vocal accomplishment.

The simple story concerns a simple Alpine maiden who gets (1) into trouble with her betrothed and (2) out of it again, through her habit of walking — and singing — in her sleep. A transient nobleman and a lady innkeeper complicate the plot, but not much.

This tale is set forth in the kind of music where beautiful (*really* beautiful) melody is presupposed and coloratura figurations arise as the most natural of expressive accentuations. Not the least contribution to this performance is that of Franco Capuana, who allows the music to flow and sparkle as freshly and naturally as if it were just being thought of for the first time.

In the central role, Lina Pagliughi hints at the honorable length of her career only by the exquisite style and sweetness of phrasing that she brings to her music, for her voice is pure and true; her treatment of *fioreatura* supple and natural. Cesare Siepi sings with rich manliness and sounds every bit a nobleman. Ferruccio Tagliavini is less consistently satisfying. At his best — actually, most of the time — he sings with blandishing tone and a gentlemanly regard for musical proprieties. At worst, he coarsens his performance by self-display. In between, he has to push his voice pretty hard to keep up with the inordinately high tessitura. However, the accomplishment as a whole is so fine, in view of the world's present-day Bellini resources, and the music so lovely that it would be most ungrateful to quibble. J. H., Jr.

BORODIN *Prince Igor — Orchestral Suite*

Philharmonia Orchestra; Walter Süsskind, cond.
M-G-M E 3008. 12-in. \$4.85.

This so-called "orchestral suite" consists of the three principal symphonic excerpts from *Prince Igor* — the *Overture*, *Polovtsi March* and *Polovtsian Dances*, the latter in the version without chorus. Most of the fiery music is Borodin's, but most of the orchestration was the work of Glazounoff, Rimsky-Korsakoff and Liadoff, the composer's colleagues, who put the opera together after his death. Süsskind's interpretations of these excerpts are completely in the vein, and he has the Philharmonia Orchestra playing in fine style. M-G-M, too, has done itself proud with some of the most faithful recording and quietest surfaces it has thus far provided. P. A.

BERNERS *The Triumph of Neptune*
†Arnell: *Punch and the Child*

Philadelphia Orchestra; Sir Thomas Beecham, cond. in *The Triumph of Neptune*. Royal Philharmonic Orchestra; Sir Thomas Beecham, cond. in *Punch and the Child*.
COLUMBIA ML 4593. 12-in. 20, 18 min. \$5.45.

Two British ballet suites, one — the Berners — a kind of classic, overflowing with wit, tunefulness, and ingenuity, the other exceedingly well written, but without much of interest in its essential substance. A. F.

BIZET *Les Pêcheurs de Perles: Au fond du temple saint* — See Verdi

DONIZETTI *Lucia di Lammermoor* (excerpts)

Patrice Munsel (s), Thelma Voripka (s), Jan Peerce (t), Paul Franke (t), Luigi Vellucci (t), Robert Merrill (bne), Ezio Pinza (bs).
RCA VICTOR Orchestra and Chorus; Renato Cellini, cond.
RCA VICTOR LM 1710. 12-in. \$5.72.

A good guess would be that these "highlights" are what RCA Victor regards as salvageable residue from a projected full-length recording, since Ezio Pinza would hardly have been called in to deliver the few remaining lines here left to Raimondo. A further guess would place the sessions a couple of years ago, since Robert Merrill's voice sounds brighter and freer than it has since before his temporary suspension from the Metropolitan. Whatever their history, though, it would have been better for almost everybody involved if the whole thing had been given up as a bad job and the tapes scrapped.

Far and away the best contribution is made by Jan Peerce, an Edgardo of style and experience. Patrice Munsel's coloratura is frequently no more than a sketchy approximation as she slips and slides from pitch to pitch. Ashton is not one of Mr. Merrill's opera-house roles, and with the best will in the world it is nearly impossible to find more than scattered evidences that he knows what he is singing about. Mr. Pinza discharges his few duties with authority, if in hollow tones, and Thelma Votipka is, as always, secure as Gibraltar in Alisa's lines. The reproduction, if anyone is still interested, is up to RCA Victor's rather high operatic standard. J. H., Jr.

FAURE *Elegie* — See Lalo

GLAZOUNOV *Raymonda Ballet Suite*
†Gliere: *The Red Poppy*

Orchestra of the National Theatre. Yuri Fayer, cond.
VANGUARD VRS 432. 12-in. 28, 15 min. \$5.95.

The very titles of the sections of the Glazounov score — *Grande Valse*, *Grand Pas D'Action* — are sufficient indication that this is a ballet in the great 19th Century Russian tradition. Glazounov seldom strayed from the conventional, and it is thus a little strange to find his work coupled with the Glière ballet suite, a very forward looking score, by a composer who was only nine years his junior.

I presume this to have been recorded in Moscow, the National Theatre Orchestra remaining anonymous as to its home base. Fayer

makes rather heavy going of the Glazounov. More sympathetic treatment is accorded the Gliere . . . but the recording is lustreless in sound, obscure in outline, well below current American recording standards. Vanguard's surfaces are extremely quiet. J. F. I.

GLIERE *The Red Poppy. (Suite No. 2)*
— See Glazounov

GOTTSCHALK-KAY *Cakewalk*
†Gould: *Fall River Legend*

Philadelphia Orchestra; Eugene Ormandy, cond., in *Cakewalk*; New York Philharmonic-Symphony Orchestra; Dimitri Mitropoulos, cond., in the *Legend*.
COLUMBIA ML 4616. 12-in. 21 min., each. \$5.45.

Suites from two recent American ballets on American themes. *Cakewalk* was created by Ruthanna Boris for the New York City Ballet. Its subject is the 19th century minstrel show, and its source is taken largely from piano pieces by Louis Moreau Gottschalk, plus three authentic minstrel tunes. Hershey Kay's arrangement of this material is brilliant, imaginative and adroit.

Agnes de Mille's *Fall River Legend*, a ballet on the Lizzie Borden murder case, is one of the great tragic creations of the modern American theater. I have always felt that Morton Gould's score for it was not up to the power of the choreography, but Mitropoulos makes a gallant try at giving it some weight and depth. A. F.

GOULD *Fall River Legend* — See Gottschalk-Kay

GOUNOD *Faust arias* — See Verdi

REYNALDO HAHN Songs

Chansons Grises (Chanson d'automne; L'allée est sans fin; En sourdine; L'Heure exquise; Tous deux); Quand je fus pris au pavillon; L'Incredule; Paysage; Phyllis; Si mes vers avaient des ailes; Mai.

Jacques Jansen, (bne.); Jacqueline Bonneau, piano.
LONDON LS 645. 10-in. \$4.95.

In the Paris of the 1890's and early 1900's the young Reynaldo Hahn was already an anachronism. Born in 1874, he was one of a generation that was already bringing impressionism to music, yet he chose to compose as melodically as his teacher Massenet. His reward was to be passed off as a salon composer, yet in their sensitive purity his songs are exquisite. In this recording, Jacques Jansen sings them with the grace and simplicity they require, and London's close-to, clear-etched technique has seldom graced music more congenial to it. J. H., Jr.

KODALY *Dances from Galanta* — See Bartok

LALO *'Cello Concerto in D Minor*
†Fauré: *Elégie for 'Cello and Orchestra, Op. 24*

Bernard Michelin, 'cello. Haarlem Symphony Orchestra; Toon Verheij, cond., in the *Concerto*; Utrecht Symphony Orchestra; Paul Hupperts, cond., in the *Elégie*.

CONCERT HALL CHS 1162. 12-in. 25:07 and 6:12 min. \$5.95.

Melodically, the Lalo Concerto is one of the more appealing works in the all-too-limited repertoire; orchestrally, it is one of the poorest, with its many annoying, punctuating chords, styled like a recitative. It is the kind of concerto that has to be "sold" by the solo performer. Michelin, a well-schooled 'cellist, gives a good, clean, firm account of the music, but greater subtlety of phrasing and a less harsh orchestral background would have helped.

There is far more delicacy, subtlety and refinement in Michelin's projection of the quiet little Fauré *Elégie*, which appears here, as a filler, for the first time on LP. P. A.

LISZT *Todtentanz, for Piano and Orchestra*
†Rimsky-Korsakoff: *Piano Concerto in C sharp Minor*

Fabienne Facquinot, piano. Philharmonia Orchestra of London, Anatole Fistoulari, cond.

MGM E 182. 10-in. 14, 12 min. \$3.00.

Although theatrical, the *Todtentanz* remains a striking work. In seeking for demonic effects, Liszt created some powerful, highly charged, and original music, and the intricate uses to which he put the *Dies Irae* theme are worth studying. Miss Jacquinet and the Philharmonia Orchestra compliment the music with a literally stunning performance. Rimsky-Korsakoff's Piano Concerto, which he said was distantly inspired by the *Todtentanz*, owes most of its effectiveness to pianistic fireworks borrowed from Liszt. It is not very interesting, but happily it is brief. The presentation is all it should be. A slight surface noise afflicts an otherwise satisfactory recording. R. E.

MENDELSSOHN *Midsummer Night's Dream*
— See Schubert

OFFENBACH *La Belle Hélène (excerpts)*
Orpheus en Enfer (excerpts)

Janine Linda, Claudine Collart, Jean Mollien, André Dran, Bernard Demigny, Jacques Linsolas, Jean Hoffman, and others. Paris Philharmonic Orchestra and Chorus; René Leibowitz, cond. RENAISSANCE X 51. 12-in. \$5.95.

Each side of this record holds an abridgement of the complete Renaissance recording of one of these sparkling Offenbach comic operas. The cuts are tastefully made, and since there is lots of spoken dialogue, to be pruned, it is possible to get a good percentage of the bounciest music on a 12-inch disk. The conducting of René Leibowitz is as bright and right as can be, and the singing, if not of unalloyed beauty, is always spirited and in the vein. This makes a wonderful party record. J. H., Jr.

PONCHIELLI *La Gioconda*

Maria Callas (s), Fedora Barbieri (ms), Maria Amadini (c), Gianni Poggi (t), Armando Benzi (t), Paolo Silveri (bne), Giulio Neri (bs), Piero Poldi (bs). Orchestra of Radio Italiana, Turin, and Cetra Chorus; Antonio Votto, cond. CETRA-SORIA XTV 18726-31. Three 12-in. \$17.85.

All told, this is one of the most exciting opera recordings to come out of the dies of Cetra-Soria or any other company, for it is well conducted and excellently reproduced, and its central role is sung with fabulous virtuosity by Maria Callas, making her recording debut in the United States.

La Gioconda, the grandparent of all the blood-and-guts veristic operas that were to follow it a quarter of a century later, is the sole successful work of its composer. Artistically, it is a real anomaly. It was worked over and patched up and tinkered with in complete unconfidence; yet it turned out to be a masterpiece. Its libretto was thought to be so bad that Boito would sign his name to it only as an anagram, and the finished work has sections that by all rights should fall flat; yet it goes over in performance, for everything in it reaches the audience and makes its effect.

The title role is a real soprano-killer, for the music is continually tending downward into a Santuzza-like register and then shooting up to pay off on the high notes of a Leonora. This kind of thing can only go on for just so long without damage to the vocal mechanism, and the opera is very, very long; yet all sopranos want to sing it.

Miss Callas, a transplanted Brooklyn girl who is now firmly established as the ranking soprano in Italy for such diverse roles as Norma, Violetta, and Lucia, proves to be all that advance reports told, although her vocalism is more striking and individual than seamlessly conventional. Her low tones are firm and in the chest, but without distortion; the middle tones, usually heavily covered, are full and rich most of the time; the upper tones (from about A on up for her, in most contexts) are big and extremely brilliant, and although *Gioconda* does not call for such altitude it is easy to believe that she has a secure E above. She is really a wonder. The rest of the cast is not on this plane, although generally effective. But the real show is Miss Callas, and she is a bargain at any price. J. H., Jr.

PROKOFIEFF *Romeo and Juliet*
— See Shostakovich

Supplement (continued)

PUCCINI

La Bohème (excerpts)

Licia Albanese (s), Patrice Munsel (s), Giuseppe di Stefano (t), Leonard Warren (bnc.), George Cehanovsky (bnc.), Nicola Moscona (bs), RCA Victor Orchestra; Renato Cellini and Victor Trucco, cond.
RCA VICTOR LM 1709. 12-in. \$5.72.

Of all the operas in the standard repertoire, *La Bohème* is one of the most difficult to kill by a mediocre performance. It may be debatable whether or not Puccini was a great composer, but that he was great theatrical craftsman there can be no doubt. When the time comes for a real sure-fire climax, Puccini is right there behind the singers — encouraging, protecting, supporting their voices with the orchestra, and making sure that the margin for error is as slight as possible.

For the listener whose purse does not permit the greater outlay or whose aspirations do not extend beyond the so-called "highlights", this new RCA Victor recording is about as satisfactory a solution as there is. The reproduction is excellent; the excerpts, in general, are well chosen; and the cast is far above average. J. H., Jr.

PUCCINI

O Mimi, tu piu — See Verdi

RIMSKY-KORSAKOFF *Piano Concerto* — See Liszt

RUBBRA

String Quartet No. 2, in E flat

Griller Quartet.
LONDON LS 657. 10-in. 22 min. \$4.95.

A few of Edmund Rubbra's compositions have appeared on records, but this modern English composer is still largely unknown to the American audience. His second quartet is a work of great refinement, ingenuity, skill and expressiveness; the whole thing has a stamp of maturity and independence which is not too common in the contemporary British string quartet. The performance is quite as masterly as the score, the reproduction up to London's average. A. F.

SCHMIDT

Quintet for Piano and Strings in G Major

Joerg Demus, piano. Barylli Quartet.
WESTMINSTER WL 5158. 12-in. \$5.95.

Until this interesting disk came along, I had never heard of Franz Schmidt (1874-1939), a Hungarian-born composer who spent most of his life in Vienna. His Quintet turns out to be a most attractive, if not outstanding, post-romantic work. It is likely to appeal to those who like the music of Dohnanyi who, incidentally, was born three years after Schmidt in the same town — Pressburg. The performance here is quite sensitive, and it has been brightly reproduced. P. A.

SCHUBERT

Rosamunde: Incidental Music. (Overture: Entr'acte in B Flat Major; Ballet music in G Major
†Mendelssohn: *A Midsummer Night's Dream. Overture (Op. 21); Nocturne (Op. 61, No. 7); Scherzo (Op. 61, No. 1).*

Concertgebouw Orchestra of Amsterdam; Edward Van Beinum, cond.
LONDON LL 622. 12-in. 45 min. \$5.95.

Better versions of these two scores are available elsewhere: the Mendelssohn by Toscanini on Victor LM 1221, the Schubert on Westminster WL 5182. (Both carry more excerpts than are presented here.) Van Beinum's approach does not strike me as being very sympathetic to either composer. There is no indication that these were dubbed from 78's, but the rather papery strong tone and some occasional stringency in the overall orchestral sound suggests that might be the case. J. F. I.

SCHUTZ

Passion According to Saint Matthew Symphonicae Sacrae IX, X

Max Meili (t). Soloists and Combined Berlin Chamber Choirs; Helmut Koch, cond.

BACH GUILD BG 519/20. Two 12-in. 69 min.; 6:40, 7:18 min.
\$11.90.

There is in existence a portrait of Heinrich Schütz, in which that venerable old master's eyes seem to me to have a very knowing, philosophical expression. However comprehending he may have been, though, I doubt that he could have foreseen the fact that more than two-and-a-half centuries after his death (which occurred in 1672) a new impetus would be given to his fame, as the result of the invention of the LP recording. With the appearance of this album, we now have *two* recorded versions of this tremendous work, the other being the set previously issued by Renaissance Records, in the performance by the Stuttgart Choral Society under Hans Grischkat.

The Bach Guild recording is slightly richer, from the tonal standpoint. Both its chorus and soloists were recorded closer to the microphone. The Stuttgart group has the advantage of capturing, to a remarking degree, the acoustics of a large church. Each is a fine recording in its way. D. R.

SHOSTAKOVITCH *Ballet Suite No. 1*

†Prokofieff: *Romeo and Juliet, Suite No. 2*

State Orchestra of the USSR; Alexander Gauk, cond., in the *Ballet Suite*. Leningrad Philharmonic Orchestra; Eugene Mravinsky, cond., in the *Romeo and Juliet Suite*.
VANGUARD VRS 6004. 12-in. 20, 28 mins. \$5.95.

The Shostakovitch, which dates from 1950, is straight-out Russian ballet music, vintage of 1880, such as might have been written by Ludwig Minkus, Julius Gerber, or some other composer of the era of champagne in the slipper. The Prokofieff, however, is a work of considerable grandeur, originality, and dramatic edge. The ballet for which it was written, produced in 1935, is said to have been one of the major choreographic achievements of the Soviet regime, and one can readily believe that to be true. A. F.

STRAVINSKY

Concerto for Piano and Wind Orchestra
Scherzo a la Russe
Pater Noster; Ave Maria

RCA Victor Symphony Orchestra, the composer conducting.
RCA VICTOR LM 7010. 10-in. 12, 5, 7 min. \$4.67.

Stravinsky's piano concerto, here recorded with the composer's son as soloist, is one of those brisk, brittle, nervous, toccata-like compositions which were much in vogue in the new-classic era of the 1920's. Stravinsky was a past master of that idiom, and, indeed, historians of the future may decide that it all sprang from this vital and impressive work of his. The other side of the record is filled out with minor Stravinskiana of no great importance, the two choral pieces having been recorded by a nameless aggregation of men and boys. The reproduction? Adequate. A. F.

TCHAIKOWSKY *Symphony No. 5 in E minor. Opus 64*

Hamburg Radio Symphony Orchestra. Hans Schmidt-Isserstedt, cond.
LONDON LL 691. 12-in. 46 min. \$5.95.

With eleven competitive versions already in the catalog, this stodgy, unexciting performance is going to find the going pretty rough. As a matter of fact, London already has a more convincing version, in the Celibidache reading on LL 163, even if it is somewhat frenzied and erratic. Schmidt-Isserstedt conceives the work in a very heavy Germanic vein, devoid of passion, an odd idea for a Tchaikovsky symphony. J. F. I.

VERDI

Aida: Ritorna vincitor!
†Gounod: *Faust: Ballad of the King of Thule and Jewel Song*

Renata Tebaldi (s), Orchestre de la Suisse Romande; Alberto Erede, cond.
LONDON LD 9017. 10-in. \$2.95.

Prospective buyers should note that this *Ritorna vincitor!* is not from the complete London *Aida* but was recorded separately in Victoria Hall, Geneva. Both voice and orchestra are very immediate and even more clearly defined than in the complete set. The volume level is higher. The *Faust* scena is sung in Italian with a high degree of Italianate competence. Perhaps this is not just what the music needs, but the singing is first-class despite an unpleasantly harsh climactic B. J. H., Jr.

VERDI

La Forza del Destino: Solenne in quest' ora Don Carlo: Io l'ho perduta
Otello: Si, pel ciel
 †Puccini: *La Bohème: O Mimi, tu piu.*
 †Bizet: *Les Pêcheurs de Perles: Au fond du temple saint.*

Jussi Bjoerling (t), Robert Merrill (bne.), Emil Markow (bs).
 RCA Victor Orchestra; Renato Cellini, cond.
 RCA VICTOR LM 7007. 10-in. \$4.67.

This is an interesting miscellany and, at least on the face of it, a good value for collectors of excerpts who get tired of hearing nothing but arias all the time. The performances are vigorous and extremely well reproduced, but no one should assume that the artists are on very intimate terms with much of the material they sing here. Neither Jussi Bjoerling nor Robert Merrill is usually associated with *Otello*, *Forza*, or *Pearl Fishers*, although both have sung (and together!) in *Don Carlo* and Mr. Bjoerling is a Rodolfo of some note, if infrequent Metropolitan appearances. Both are in what will pass for good voice most of the time. J. H., Jr.

VERDI

Quattro Pezzi Sacri

Aachen Cathedral Choir and Orchestra of the City of Aachen; Theodore B. Rehmann, cond.
 DECCA DL 9661. 12-in. \$5.85.

The four sections of this last of Verdi's works to be performed are *Ave Maria*, *Stabat Mater*, *Laudi all Vergine Maria*, and *Te Deum*. Although all were composed during the period of *Otello* and *Falstaff*, they are oddly different in character. The first and third are four-voice a capella settings; the second and fourth call for full orchestral forces and relate to the *Manzoni Requiem* much as the later operas relate to the operas of the middle period. In short, this is very great music, deeply and personally devotional in feeling and expression. The performance here is not first-class, but it does more than grammatical justice to the music. I have not heard the competitive version, made in Vienna and available on Concert Hall. J. H., Jr.

WOLF-FERRARI *I Quattro Rusteghi*

Gianna Perea Labia (s), Alda Noni (s), Esther Orell (s), Agnes Dubbini (ms), Gilda Capozzi (ms), Mario Carlin (t), Manfredi Ponz de Leon (t), Carlo Ulivi (bne), Fernando Corena (bs), Pasquale Lombardo (bs), Cristiano Dalamangas (bs). Orchestra of the Radio Italiana, Milan; Alfredo Simonetto, cond.
 CETRA-SORIA XTV 16774-9. Three 12-in. \$17.85.

Aside from his one excursion into *verismo* blood and violence with *The Jewels of the Madonna*, Ermanno Wolf-Ferrari went through life as a composer of light and good hearted operas in *buffa* vein; *I Quattro Rusteghi* is one of the best of them. It is intriguing to find a spiritual descendent of Pergolesi and Cimarosa operating around the turn of the century (this work was first given in 1906) and even more intriguing to note that it was in Germany, not in Italy, that music so Italianate found its most faithful public. If one were to say all of the nice things possible about the score without qualifying them, a description of *I Quattro Rusteghi* would sound like a description of another *Falstaff*; it is not that, for its composer lacked the spark of genius to be really recreative about *opera buffa*. But the music is tuneful and witty, the setting and underscoring of the text apt and expert, and the instrumental writing filled with moments of charm.

The performance here is basically good in shape, and Alda Noni and Fernando Corena sing with real style and intelligence; but too many of the voices are unattractive to make the opera seem better than what it is — a sunny, undemanding companion when no better is available. J. H., Jr.

OPERATIC EXCERPTS

Donizetti: *Udite, udite, o rustici (L'Elisir d'Amore)*; *Ab! un foco insolito (Don Pasquale)*. Rossini: *Il mio piano e preparato (La Gazza Laddra)*.

Fernando Corena (bs), L'Orchestra de la Suisse Romande; Alberto Erede, cond.

Verdi: *Il balen (Il Trovatore)*. Rossini: *Largo al factotum (Il Barbiere di Siviglia)*. Leoncavallo: Prologue to *Pagliacci*.

Aldo Protti (bar). L'Orchestra de la Suisse Romande; Alberto Erede, cond.

LONDON LS 701. 10-in. \$4.95.

This is Vol. II in London's series of Famous Operatic Excerpts.

The prospective buyer's decision should rest largely on whether or not he requires the six arias included, all of which, except the one from *La Gazza Laddra*, are standard, and all except its first-class examples of their genres. The performances are all acceptable, but none save Fernando Corena's *Udite, udite* has distinction. The engineering is superb — if you like the extremely close-to-London orchestral miking. J. H., Jr.

SCHLUSNUS SINGS

Mendelssohn: *Venetianisches Gondelied; Auf Flugeln des Gesanges*. Liszt: *O komm im Traum*. Loewe: *Der Nock; Das Erkennen*. Schumann: *Talisman; Die Beiden Grenadiere; Romanze*. Schubert: *Standchen; An Die Musik; Der Blumenbrief*.

Henrich Schlusnus, baritone. Franz Rupp, Sebastian Peschko, Otto Braun, piano.

DECCA DL 9624. 12-in. 36 min. \$5.85.

Additional examples of Schlusnus' art as a singer of lieder. Volumes III and IV were reviewed in the last issue, and generally speaking, this release maintains the same high artistic level. I was disappointed in the singer's unemotional performance of *Die Beiden Grenadiere*, and there is more in Schubert's marvelous *An Die Musik* than Schlusnus manages to discover. The recordings, made in the mid 1930's, are quite acceptable. J. F. I.

Dialing Your Disks

This column lists latest available data on the recorded frequency characteristics used by record manufacturers. The Bass column refers to low-frequency turnover, the TREBLE column to high-frequency preemphasis.

The NAB curve has a turnover point of 500 cycles and a treble boost of 16 db. The AES turnover is at 400 cycles, its treble boost is at 12 db at 10,000 cycles. In imprecise terms (for people with imprecise amplifier controls), NAB records need more treble cut and more bass boost than AES disks; LON and COL need less bass boost than NAB; COL and NAB are the same at the high end but LON and AES need less treble cut than COL. Asterisk means manufacturer lists data on record jackets.

LABEL	BASS	TREBLE
Atlantic ¹	NAB	NAB
Bartok	629 ²	16 db ³
Blue Note Jazz	AES	AES
Caedmon	629 ²	11 db ⁴
Canyon	AES	AES
Capitol	AES	AES
Capital-Cetra	AES	AES
Cetra-Soria	COL	NAB
Columbia	COL	NAB
Cook Laboratories ¹	NAB	AES
Decca	COL	NAB
EMS*	AES	AES
Elektra	629 ²	16 db ³
Esoteric	NAB	AES
Haydn Society	COL	NAB
London	COL	LON
Lyrichord*, new ⁵	629 ²	16 db ³
Mercury*	AES	AES
M-G-M	NAB	AES
Oceanic	COL	NAB
Philharmonia	AES	AES
Polymusic ¹	NAB	NAB
RCA Victor	Ortho ⁶	Ortho ⁷
Remington	NAB	NAB
Tempo	NAB	Ortho ⁷
Urania*, most	COL	NAB
Urania*, some	AES	AES
Vanguard — Bach Guild*	COL	NAB
Vox	COL	NAB
Westminster*	NAB ⁸	NAB ⁸

¹Binaural records produced by this label are recorded to NAB standards, on the outside band. On the inside band, NAB is used for low frequencies, but the treble is recorded flat, without pre-emphasis.

²NAB position on equalizer is close match.

³NAB position on equalizer is close match.

⁴Use LON position on equalizer, or AES with slight treble cut.

⁵Some older records of this label were recorded to COL curve, others to AES.

⁶Very close to NAB on lows.

⁷Very close to AES on high; cut treble slightly.

⁸Unless jacket indicates AES.

building your record library

number two



JOHN INDCOX MIXES A SUMMERTIME COCKTAIL

A jigger of Rossini
— a dash of Kodaly
— a sprig of Respighi



The mischievous gentleman disporting himself at the top of the page — I mean, of course, the one with the pipes — should be sufficient warning that music of a lighter calibre is up for discussion, in this second article in the *Building Your Record Library* series. If the transition from Bach to such light musical fare seems sudden and surprising . . . blame it on the weather. It is well known that summer's enervating heat strongly affects the average record buyer's listening habits. In July and August, the profundities of Beethoven and Mozart are likely to be passed over in favor of the airy fancies of the Strauss-Offenbach school.

In the following list of suggestions, I have tried to find items appropriate for summer listening, music that falls gratefully on the ear without making great demands on the mind. Also, I have striven to avoid disks likely to be in everyone's collections already, and all selections are ideal high fidelity demonstration recordings. The delightful, and often impish melodies of Rossini that constitute the basis for Respighi's confection, *La Boutique Fantasque* (*The Magic Toyshop*) make an ideal starter. This infectiously gay and vivacious work is performed to utter perfection under the admirable Ansermet direction, and London, rising to the occasion, has decked it with super ffr sound (London LL 274).

Anyone afflicted with what I like to call sedentary wanderlust may take a Mediterranean voyage, without moving from his chair, by way of the impressionistic tone pictures Ibert paints in his *Escales*. The sights and sounds, but fortunately not the smells, of Palermo, Tunis and Valencia are vividly recreated in these delightful pastiches. The new version by Stokowski on Victor LM 1706 is heartily recommended, both for its lush orchestral sound and for the conductor's insidious way with scores of this kind.

Janos Starker's remarkable performance of Kodaly's *Sonata for Unaccompanied Cello* on Period SPLP 510 will quickly transport you to the wide, wild plains of Hungary. It is alive with dashing Hungarian rhythms, intermingled with lovely folk tunes and spiced with the curious and surprising sounds of the shepherd's pipe and horn, produced with odd conviction on the cello. The fire and brilliance of the performance is matched by the fidelity of the recording.

I prefer to pass over the music of Johann Strauss, because of its familiarity, and suggest instead a lively collection of waltzes, polkas and marches by the little known Danish composer, Lumbye, who writes in much the same strain. His melodies are pretty, if less sophisticated than Strauss', his polkas have dash and the marches are all properly full-blooded and lively. They have been excellently recorded by Mercury on MG 10130, named *Tivoli Dances* (after a famous Danish place of entertainment) and are dazzlingly played by a Copenhagen orchestra.

There is nothing like the sound of a piano, in the summer dusk. I came across the ideal thing in the recital of Liszt, Chopin, Rach-

maninoff and Debussy compositions Constance Keene plays so felicitously on *Piano Music*, Mercury MG 10113. These romantic piano favorites provide a peaceful interlude in this series of predominantly orchestral recordings.

Is there any such thing as a summery symphony? I would unhesitatingly suggest the engaging little *Symphony in C* of Bizet, written when he was only 17. It is such an exuberant work, with its sprightly melodies and its spirit of youthful *joie de vivre*, that it is difficult to imagine anybody remaining indifferent to its appeal. There is an aging version by Rodzinski, better in style than a newer one by Stokowski on Victor LM 1706, but the latter has the benefit of richer, fuller sound, and is the one to buy.

Since light opera is a flower that flourishes most vigorously in the summer, it is almost mandatory for me to include one example of the form here. And there's the rub, for the stock items — *Blossom Time*, *The Student Prince*, et al — have all been done to death. In their place, I go far afield to a French operetta by Messager, called *Véronique*. Neither the story nor the language need bother you, but listen to the elegant charm of the delightful melodies Messager has provided, the air of sophistication that informs them. A highly competent French cast gives an excellent performance of this little known work (I believe it was once produced in New York early in the 1900's) and — the recording on Vox 21100 is perfection in balance and sound.

Something more modern to your taste? Then I suggest the *Stravinsky Suite for Little Orchestra No. 1*, a work he wrote for a Paris music hall sketch, with its wry little tunes, satirical overtones and masterly orchestration. This is music to make you chuckle. Hindemith's *Kammermusik No. 1* a jazzy score, makes an ideal coupling. This little disk (Decca DL 7529) is one of my very special favorites, equally for the music and for the cleanly delineated sound in the recording. The two remaining records are suggested as super-high-fidelity offerings, which should impress and convert skeptical summer acquaintances as to the value of our new art.

On London LL 598, London sound and Ansermet *savoir-faire* have combined to produce one of the definitive recordings of the day, in a stunning version of De Falla's *Three Cornered Hat*. This exotic, intoxicating score, with its passionate Iberian rhythms and brilliant orchestral coloring is an endless delight, from the opening trumpet fanfare to the final click of the castanets.

Though the musical content of Morton Gould's *Latin American Symphonette* is less interesting, being a working over of typical South American rhythms — rumba, tango, guaracha, conga and so forth — the Mercury recording (MG 40002) surely represents some of the highest fidelity to appear on records. The clarity of the odd percussion instruments is almost visually apparent and the whole work has a sparkle and verve not previously matched on this label, except in their Olympian series.

Mozart on microgroove

By C. G. BURKE



Part II: Concertos; Overtures

CONCERTOS FOR PIANO AND ORCHESTRA

(Mozart composed 25 concertos for solo piano and orchestra. Ludwig von Köchel included in his Chronological Catalogue the Concerto for Three Pianos, KV 242, as Concerto No. 7; and the Concerto for Two Pianos, KV 365, as Concerto No. 10. That method does not please our modern concept of systemization, and KV 365 and 242 will follow the solo concertos in this survey. But since suppression of the numbers "7" and "10" would disarrange the numeration of twenty subsequent concertos whose numbers time has made intrinsic to them, "7" and "10" have been retained as guideposts. There is also a Concert-Rondo in D, KV 382, composed as a new finale to Concerto No. 5, KV 175, but generally played as a separate work.)

NO. 1, IN F, KV 37 (1 Edition)

Everyone has heard the story that Mozart composed a harpsichord concerto at four, and the story may even be true, since we know that it was told in good faith, although subject to the vagaries of reminiscence 32 years after the event. Concerto No. 1 is not that vanished Concerto of 1760: the concertos numbered through four date from Mozart's eleventh year. They are small, elegant and sophisticated works of art, seductive and glistening. They ought to be: they are the product of an unplanned collaboration between the young Mozart and some of the finest talents of the age: Philip Bach, Christian Bach, Johann Schobert (a terribly tragic martyr to mycology, whose entire household perished with him after feasting on deadly amanitas) and others whose themes were appropriated and woven into concertos of a physical compass fitted to the small fingers that were to play them, and a compass of musical understanding creditable to anyone named Bach and to Mozart at any age. They are pastiches in marvelous and invisible consolidation. — No. 1, in its fluent and rippling temper and

tasteful orchestration, is not the least of the four, and the small-scaled address of Balsam-Goehr, crisply aloof, is pleasantly apt to the gallant surface which needs no depth. Easy sound, without problems in reproduction.

—Artur Balsam; Winterthur Sym. Orch., Walter Goehr, cond. Concert Hall CHS 1119. 12-in. (with *Conc.* 2). 15 min. \$5.95.

NO. 2, IN B FLAT, KV 39 (1 Edition)

Captivates immediately, and seems durable, two sparkling epigrams with a gentle Italian romance between. This is probably the best of the four early concertos, although some of the credit for making it seem so is definitely Mr. Balsam's, bubbling in symmetrical exactitude along a course of imperturbable good manners and incidentally giving a lesson on the obliteration of personalism to pianists essaying rococo. The orchestra is adjusted to the Balsam poise, and the whole has been engineered to respectable standards. Recommended warmly.

—Artur Balsam; Winterthur Sym. Orch., Walter Goehr, cond. Concert Hall CHS 1119. 12-in. (with *Conc.* 1). 14 min. \$5.95.

NO. 3, IN D, KV 40 (1 Edition)

The consistent showiness here is mitigated by a comfortable warmth of harmonization, but the Concerto is less valuable than its predecessors. The recording too has altered: Mr. Ackermann uses a larger orchestra than Mr. Goehr, and more reverberation is permitted its sound, wherein the choirs coalesce in a telling way. Opposed by a stronger force, Mr. Balsam is stronger and a little less convincing, and the piano is intermittently brittle at the top.

—Artur Balsam; Winterthur Sym. Orch., Otto Ackermann, cond. Concert Hall CHS 1163. 12-in. (with *Conc.* 4). 13 min. \$5.95.

NO. 4, IN G, KV 41 (1 Edition)

Near No. 3 in its forward display, but more

interesting thematically, and a recording of not appreciably dissimilar qualities.

—Artur Balsam; Winterthur Sym. Orch., Otto Ackermann, cond. Concert Hall CHS 1163. 12-in. (with *Conc.* 3). 14 min. \$5.95.

NO. 6, IN B FLAT, KV 238 (1 Edition)

The voice of Mozart sounds without ambiguity for the first time in a concerto for piano, and everyone can recognize it; but for most of KV 238 it is the glib voice of the perfect composer avoiding serious involvements. Except for some novel comedy given to the horns in the rondo, this is not a concerto of the class of No. 2, written when Mozart was nine years younger, but with distinguished if absent help. A brightly embossed declaration of Naught, neither unattractive nor dull anywhere, and given a reading by Messrs. Balsam and Goehr of happy and garlanded reciprocal understanding and adjustment to its perfumed problems of a Trianon. Pleasant, facile sound, often excellent for both piano and orchestra.

—Artur Balsam; Winterthur Sym. Orch., Walter Goehr, cond. Concert Hall CHS 1120. 12-in. (with *Conc.* 8). 22 min. \$5.95.

NO. 7, IN F, KV 243

(See below, *Concerto for Three Pianos.*)

NO. 8, IN C, KV 246 (1 Edition)

The first two movements are insinuated into the hearer's acceptance and woo his admiration by a self-assurance of effortless urbanity, a musical counterpart to the best *vers de société*, wherein the form must charm and the matter may sting but never stir. The minuet-in-rondo interjects a couple of misshapen episodes as if to say that Mozart knows well that refinement can cloy, and that tougher stuff will come with ensuing concertos. The record gives that tripping intimacy of homogeneous, lightweight flexibility in which the Balsam-Goehr association has shown to happy advantage, flicking out a scent of peppermint. There are no tonal surprises, and no disappointments, in a tractable and facile recording.

Records listed in parentheses and not discussed were not received for review.

—Artur Balsam; Winterthur Sym. Orch., Walter Goehr, cond. Concert Hall CHS 1120. 12-in. (with *Conc. 6*). 23 min. \$5.95.

NO. 9. IN E FLAT, KV 271 (3 Editions)
Here is a new voice — muttering disconsolation, impatient of restriction, impetuous to escape a decorous confinement — albeit a voice of familiar timbre and as yet nowise raucous. It is one of the great concertos, but a KV number under 350 discourages frequent performance except on the phonograph, not without justification, our modern halls being too cavernous for an orchestra of twenty or thirty strings and four winds.

The records are hardly definitive. A certain discomfiting flippancy from Miss Kraus injures a beautiful orchestral delineation by the Philharmonia, and the piano sound is neither impressive nor true. Dame Myra Hess is spiritually nearer the core of the music, and much nearer her conductor; but we have heard her defter, and perhaps she should have objected to the very slow tempos of Pau Casals. Opinion here is cautious in that respect, because those tempos seemed more appropriate at a third hearing than at the first, and indubitably they dignify the moroseness of the slow movement. The old Gieseking 78's recur persistently to mind as a criterion, and neither of these sounds much like that achievement. — However, both piano and orchestra sound well as such in the Hess-Casals version.

—Myra Hess; Perpignan Fest. Orch., Pablo Casals, cond. Columbia ML 4568. 12-in. 35 min. \$5.45.

—Lili Kraus; Philharmonia Orch., Walter Süßkind, cond. Decca DL 9525. 12-in. (with *Fantasy*, KV 475). 29 min. \$5.85.

NO. 10. IN E FLAT, KV 365
(See below, *Concerto for Two Pianos*.)

NO. 12. IN A, KV 414 (2 Editions)
This is a long and really rather barren Concerto whose occasional excursions into novelty are not particularly interesting and seem wayward rather than important. It is a transitional work less appealing than several predecessors because longer and more diffuse. A creditable performance on the Mercury disk is unlucky in the belled tone of the piano, the orchestra being fair. The much newer Haydn Society record reflects smartly the analytic precision of Mr. Wöldike, who has certainly convinced Folmer Jensen of its propriety here. All neat and very clean; inconsistent, demure even, with an analogous sound, agreeable and unexciting, hard at times in the piano's treble.

—Folmer Jensen; Ch. Orch. of the Danish Nat. Radio, Mogens Wöldike, cond. Haydn Society 1054. 12-in. (with *Conc. 21*). 27 min. \$5.95.

—Margaret Knittel; Bavarian Radio Orch., Rudolf Albert, cond. Mercury 10007. 12-in. (with *Conc. for 2 Pianos*). 25 min. \$4.85.

NO. 13. IN C, KV 415 (1 Edition)
Trumpets and drums insert a new orchestral brilliance into a Concerto which needs help to maintain interest. Carefully cut to a traditional fashion, and otherwise careful, this represents Mozart in compromise with what he was about to do, and what he was

expected to do, in piano concertos. (In no other form was he so tentative so late.) The only recording has Dr. Swoboda full of energy and Mr. Balsam inadequate in force to oppose the orchestral opposition. The sound is acceptable but will draw no encomiums.

—Artur Balsam; Sym. Orch., Henry Swoboda, cond. Concert Hall CHS 1116. 12-in. (with *P Sonata 10*). 25 min. \$5.95.

NO. 14. IN E FLAT, KV 449 (2 Editions)
Nothing of Mozart's for piano and orchestra has warned of this astonishing apparition in its fascinating ambiguity of humors. A threat is mingled with the kiss, and a cudgel hidden behind the handclasp. This kind of mystification is to become increasingly a Mozart specialty: it makes the works that display it practically inexhaustible. The Istomin-Casals record is one of the treasures of the Mozart repertory, and in the reflection of its light the rival version is cruelly outclassed. The Columbia piano sound is in its small way one of the company's best, and the orchestra is clearly delineated. The



Artur Balsam: In the early concertos, bubbling zest and firm exactitude.

great credit, however, is the players', in an endless mobility of expression obtained by nearly imperceptible mutations of force, accent and speed, all with a finality of mature refinement and varied tone. The subtle coloration of the unsettled mockery in the finale can hardly be excelled. Reinforced by its overside gleam, the appeal of the disk is compulsive.

—Eugene Istomin; Perpignan Fest. Orch., Pablo Casals, cond. Columbia ML 4567. 12-in. (with *Fl. Conc. 1*). 24 min. \$5.45.

—Paul Badura-Skoda; Vienna Sym. Orch., Jonathan Sternberg, cond. Oceanic 22. 12-in. (with *Conc. 22*). 22 min. \$5.95.

NO. 15. IN B FLAT, KV 450 (1 Edition)
A superb Concerto, whose qualities of performance are forever indiscernible in the remarkable concealment realized in the recording of the only version. We have here one of the very worst of LP's, with a trifling cyclic range, general obscurity of voices and loss of timbre, in addition to a special fault

that gives the disk a quaint curio value. In transference from 78's the original hiatuses between sides have been reverently preserved, with a refinement added: each change of side has been colorfully illustrated by a corresponding change of pitch and volume.

—Andor Foldes; Lamoureux Orch., Paris. Eugène Bigot, cond. Vox VLP 6580. 12-in. 26 min. \$5.95.

NO. 16. IN D, KV 451 (2 Editions)
From No. 14 on, the piano concertos have decided and unmistakable temper. The contours are as sharp as the earlier concertos', but the contents become peremptory: they dictate the manner of their interpretation. They have no program, but they have an inviolable abstract mood. The three movements of KV 451 are in order assertion, reflection and celebration, it matters not of what; but pianists and conductors are obligated to stipulate in those senses. The participants in two recorded versions agree in this, but Mr. Balsam has a defter manual mechanism to convey the thought and is more in accord with his orchestra. He also benefits from a better recorded sound of the piano. But Mr. Bales has the larger orchestral (and in this Concerto the orchestra should be as large as the pianist can withstand) which is more clearly stated by WCFM than Concert Hall effects for Mr. Desarzens, particularly since the Concert Hall record abruptly attenuates its force after the second movement. Neither conductor is here a master of pertinent subtlety, but Mr. Bales tries harder. Imperfect records not bad, with the preference of this study for Concert Hall, meaning Mr. Balsam.

—Artur Balsam; Winterthur Sym. Orch., Victor Desarzens, cond. Concert Hall CHS 1405. 12-in. (with *Variations*, KV 354). 22 min. \$5.95.

—Jeannette Haien; National Gallery Orch., Richard Bales, cond. WCFM 101. 10-in. 26 min. \$4.75.

NO. 17. IN G, KV 453 (3 Editions)
It may be a pity, though it probably is not, that two manufacturers declined combat for their representatives. The only version examined has peculiarities quite capable of disappalling to people unprepared for them. Mr. Kirkpatrick plays a piano built to imitate the small sound of late-Eighteenth Century instruments: the pace is pertinaciously slow; the orchestra comprises only twenty men. Any of the ten thousand infinitesimal variations of good taste (bad taste is absolute and immutable) may balk to some degree at the special aspects of this record, and (good) taste in any of its gradations ought not to be blamed for loyalty to its delicate prejudices. But if this piano, this speed, this chamber group, do not in themselves offend preconception, the disk will be welcomed as an exemplary and beautiful statement outstanding among the Mozart concertos.

For the piano, with its fragile treble and chubby bass, entices if we let it; the slow pace puts into relief the ambiguity of a high comedy flirting with profundity; and the little orchestra, engraved with telling transparency, has as much weight as the narrative needs, and much more clarity than we usually get. Flute, oboes and horns are particularly to be remarked. In this opinion the

uncustomary presentation is better than the customary, and the disk has a freshness quite its own.

—Ralph Kirkpatrick; Dumbarton Oaks Ch. Orch., Alexander Schneider, cond. Haydn Society 1040. 12-in. (with *V Conc.* 4). 33 min. \$5.95.

—(Leonid Hambro; Oklahoma City Sym. Orch., Victor Alessandro, cond. Allegro ALG 3004. 12-in. (with *Conc.* 19). \$5.95.)

—(Gaby Casadesus; Pro Musica Orch., Eugène Bigot, cond. Vox PL 6720. 12-in. (with 12 *Minuets*, KV 176). \$5.95.)

NO. 18, IN B FLAT, KV 456 (1 Edition)

The orchestral performance of this beckoning mischief is a credit to Mr. Goehr, and Miss Kraus seems in order too; but the piano tone is percussive high and woolly low in the ancient recording. A wonderful concerto which Decca should remake to her modern standard.

—Lili Kraus; London Philh. Orch., Walter Goehr, cond. Decca DL 8505. 12-in. (with *P & V Sonata*, KV 404; and *Schubert: Ländler*). 28 min. \$4.85.

NO. 19, IN F, KV 459 (3 Editions)

Certain works of art embellish an environment or embellish life without affecting the shape of the one or the current of the other: the comedies of Congreve, the verses of Herrick, the paintings of Watteau, KV 459. This is perfect music, of which it cannot be said that it lacks character; but its character lacks shape. We are unable to identify it, to categorize it, by a word or a phrase. Its brilliant ideas are developed with an entire consequentiality of irresistible logic, but they are as if written in air, lost after stimulating a fresh pleasure, itself lost until recalled by a subsequent hearing. So what at first seems a deficiency actually provides a curious durability. The only recording heard is notable in the quality of its sound—limpid, explicit, easy; exact in the timbre of the winds even when the timbres are pleached, gracious in the strings, and the piano pat. The performance is not of such decisive illumination, but it is able, musicianly and genially responsive.

—Clara Haskil; Winterthur Sym. Orch., Henry Swoboda, cond. Westminster WL 5054. 12-in. (with *Conc.* 20). 29 min. \$5.95.

—(Lili Kraus; Vienna Sym. Orch., Rudolf Moralt, cond. Vox PL 6890. 12-in. (with *Conc.* 23). \$5.95.)

—(Leonid Hambro; Oklahoma City Sym. Orch., Victor Alessandro, cond. Allegro ALG 3011. 12-in. (with *Conc.* 17). \$5.95.)

NO. 20, IN D MINOR, KV 466 (7 Editions)

The only Mozart concerto persistent in American repertory of the last thirty years is a brooding, malignant masterpiece at vicious odds with that conception of epicene daintiness that teachers of music and writers were in a fatigued way concurrently trying to impose on a public too little habituated to Mozart to discern the libel. The quarrelsome D Minor growl of KV 466—relieved by a litany called a romance—was favored in performance by a great pianist named Beethoven, who imitated its structure in his own concertos, by an instinctive acquiescence in its fever of insurrection.

A number of large talents have participated in the recordings, but few of the

records are of a quality to bear close scrutiny. The Weidlich disk has a cutting treble. The sound of the Kempff is musty. Serkin-Ormandy are rather cavalier and peremptory, although perhaps not to the extent they seem in the obdurate sound of their recording. Many readers will remember a promising Mozart pianist of the thirties, José Iturbi: he returns to us in the D Minor Concerto as pianist and conductor both, with a new assurance and refinement acquired in the vicinity of Beverly Hills. Not a man to rebuke the limelight, Iturbi the pianist disputes it with Iturbi the conductor in violent struggle, both being lacerated in the contest whose inconclusiveness many will regret; Mozart suffering multiple contusions and temporary disfigurement. The horror of this has been skillfully engraved with the piano right in the ear and the orchestra tearing the firmament: high fidelity devoted to low treachery.

After this showy junk, the disk of Artur Schnabel, who is no longer with us, and that of Clara Haskil, seem like Luke and John in antidote to Mr. Mickey Spillane. The analytic poetry of Schnabel, and the natural poetry of Mme. Haskil—particularly the former, which seems more natural—have the finality of an art chary of mere



Casadesus: notable refinement and gusto in a good, old No. 21.

effect, and that of Schnabel one dictated by an unchallengeable compulsion of sentiment and reason. The authority attains this extreme, that after Schnabel has been heard any other way of playing seems preposterous, and it seems equally absurd to recommend any other disk. Nevertheless, the Haskil record is a good one, superior in accuracy of sound to the others and with an orchestral delineation by far the best, whereas the Schnabel-Süsskind is tonally no more than fair. By the often-satisfactory method of computing comparative desitability through averaging—comparing the mean of the respective values, the Westminster, first in sound, second in performance, would equivaile the HMV, second in sound, first in performance; but the method is deceptive in a case like this where the HMV performance has a supremacy of value transcending the possibilities of computation.

—Artur Schnabel; Philharmonia Orch., Walter Süsskind, cond. Victor LHMV 1012. 12-in. (with *Conc.* 24). 30 min. \$5.95.

—Clara Haskil; Winterthur Sym. Orch., Henry Swoboda, cond. Westminster WL

5054. 12-in. (with *Conc.* 19). 31 min. \$5.95.

—Rudolf Serkin; Philadelphia Orch., Eugene Ormandy, cond. Columbia ML 4424. 12-in. 29 min. \$5.45.

—Wilhelm Kempff; Dresden Philh. Orch., Paul van Kempen, cond. Decca DL 7515. 10-in. 29 min. \$3.85.

—Fritz Weidlich; Salzburg Fest. Orch., Fritz Weidlich, cond. Remington 199-33. 12-in. 30 min. \$2.49.

—José Iturbi; RCA Orch., José Iturbi, cond. Victor LM 1717. 12-in. (with *Conc. for 2 Pos.*, KV 365). 30 min. \$5.72.

—(Lili Kraus; Pro Musica Orch., Enrique Jorda, cond. Vox PL 6290. 12-in. (with *Minuet*, KV 355, & *Rondo* KV 485). \$5.95.)

NO. 21, IN C, KV 467 (2 Editions)

Concedes precedence in confident, aristocratic address to nothing in Mozart or elsewhere. A prodigality of brilliant invention is dissimulated by absorption into a design of imperturbable symmetry, as a gentleman, before that condition became archaic, would reject unnecessary manifestations of the wealth which facilitated the condition. KV 467 has no meaning and it inspires no feeling but ebullience. There is no glossary for its magic.

The recorded performances differ so baldly that choice must be choice of a type. The type of play exploited by Messrs. Jensen and Wöldike is not in the current of American experience. It is deliberate, exact, undivagating and icy, intolerant of a single slur. It is also, in its orchestral adjustments, a revelation of harmonic finesse and union of stroke. It enjoys a tingling clarity of reproduced sound (after the compensator has been put to hard repressive work on the treble) denied by the difference in recording dates to its rival. Nevertheless this rival is one of those astonishing early Columbians which after four years can still extort genuine approbation, and it is played by Mr. Casadesus and the New York Philharmonic with notable refinement and with gusto absent from the Danish version. Conductor and pianist are continuously responsive to the little implications which make music glow but cannot be printed and must not be exaggerated: the trifling increment of force here, the incipient acceleration there; a arpeggio doted on in one place and an arpeggio slighted in another. More people will find the Casadesus-Munch way just, but the other way, startling in its very reticence, is not the work of fools impervious to implications. It has a durable charm once it has ceased surprising.

—Robert Casadesus; N. Y. Philh-Sym. Orch., Charles Munch, cond. Columbia ML 2067. 10-in. 28 min. \$4.00.

—Folmer Jensen; Ch. Orch. of the Danish Nat. Radio, Mogens Wöldike, cond. Haydn Society 1054. 12-in. (with *Conc.* 12). 29 min. \$5.95.

NO. 22, IN E FLAT, KV 482 (3 Editions)

The four concertos 19, 20, 21 and 22 are concatenated in alternate sublimations, the odds of manners, the evens of mood. There is not their equipoised like in music. No. 22 is eccentric, contradictory and unstable, embracing while it stabs, with an unprecedented rondo of evil impulses chastened without finality by an urgency for peace. Two recordings—the third being unheard—present the enigma faithfully, but with

decided advantage to Columbia in the first two movements, from the kindling influence of Casals, whose decisive stroke seems instinctive, and with no advantage in the finale where Mr. Sternberg matches his understanding and experience. Both pianists are reticent, Mr. Serkin perhaps too much so, and both reproductions are good in different ways. Columbia is more solid, and her emphases, mainly of wind, are more significant: Oceanic is brighter, with a wider range but more restricted dynamics. The Oceanic sound is infinitely superior to that of the disk's companion-piece, Concerto No. 14. But this is a Casals triumph.

—Rudolf Serkin; Perpignan Fest. Orch., Pablo Casals, cond. Columbia ML 4569. 12-in. 38 min. \$5.45.

—Paul Badura-Skoda; Vienna Sym. Orch., Jonathan Sternberg, cond. Oceanic 22. 12-in. (with *Conc. 14*). 34 min. \$5.95.

—(Lili Kraus; Vienna Sym. Orch., Rudolf Moralt, cond. Vox PL 7290. 12-in. (with *Rondo*, KV 382). \$5.95.)

NO. 23, IN A, KV 488 (4 Editions)

In acknowledging the highly expert piano-play of Mr. Rubinstein and Mr. Kilenyi, we do it with condensation after hearing Gieseking-Karajan. KV 588 is a Concerto of innocent aspect, latent with subtle grimaces of foreboding and trial. These are exposed in the Columbia version by a demonstration of elegant interpretive art featuring the unique Gieseking talent for the most delicate articulation in alliance with the charged phrase. A fascinating complication is the conveyance of portent by a piano tone of singular ingratiation, soft as the plumage of a striking falcon. Mr. von Karajan's imaginative and plastic leadership is simply not challenged by the other conductors. With a little more velvet in the orchestral sound this would have been one of the great Mozart records: it is patently one of the great Mozart performances. Not that the sound is bad: it is better than fair, and the best here of three records all satisfactory for the piano and variously flawed for the orchestra.

—Walter Gieseking; Philharmonia Orch., Herbert von Karajan, cond. Columbia ML 4536. 12-in. (with *Francé: Variations Symphoniques*). 25 min. \$5.45.

—Artur Schnabel; St. Louis Sym. Orch., Vladimir Golschmann, cond. Victor LM 1091. 12-in. (with *Falla: Nights in the Gardens of Spain*). 25 min. \$5.72.

—Edward Kilenyi; Mozarteum Orch., Salzburg, Paul Walter, cond. Remington 199-61. 12-in. (with *Liszt: Hungarian Fantasy*). 26 min. \$2.49.

—(Lili Kraus; Vienna Sym. Orch., Rudolf Moralt, cond. Vox PL 6890. 12-in. (with *Conc. 19*). \$5.95.)

NO. 24, IN C MINOR, KV 491 (3 Editions)

Unquestionably there is a greatest of Mozart's concertos, but wanting a meter to measure art we shall never know which it is. KV 491 is the grimmest. It is bleak with menace, regret and anxiety. Most musicians who undertake it know its tenor, and performances are seldom poor in understanding. This prevails on the records, where there are no large conceptual disagreements, but where strong differences in execution are obvious. Mme. Biro plays well although

without telling force, and her conductor is on the right track although his orchestra falters. The Remington sound here is vivid and the projection as a whole satisfactory. HMV offers a pianist, Schnabel, eloquent in statement and inuendo, the best; but in a sound whose substance disturbs: artificial, phonographic, not ill-defined or exaggerated, but consistently a little wrong and not pleasant. Mr. Badura-Skoda, with an admirable manipulation, manages to imply a neutrality of sentiment more apt to a commentator than a participant. (This is not without a sting of its own.) At any rate, the whiplash crackling effectiveness of the Vienna Symphony Orchestra in Westminster's recording of Mr. Prohaska's impressive sensibility in this dire music, primarily orchestral, carries the day.

—Paul Badura-Skoda; Vienna Sym. Orch., Felix Prohaska, cond. Westminster WL 5097. 12-in. (with *Conc. 27*). 29 min. \$5.95

—Sari Biro; Sym. Orch., Wilhelm Loibner, cond. Remington 199-70. 12-in. (with *Figaro Ovt.*). 32 min. \$2.49.

—Artur Schnabel; Philharmonia Orch., Walter Süsskind, cond. Victor LHMV 1012. 12-in. (with *Conc. 20*). 31 min. \$5.95.

NO. 25, IN C, KV 503 (2 Editions)

Brilliantly theatrical, ceremonial and puckish, pompous and mocking, a queen and



Gieseking: a unique talent for the charged phrase.

a hoyden, the grand No. 25 (which is seldom played) has something to offer to everyone. The two recordings are valuable in performance and sound, the HMV of Fischer-Krips exceptional in its lucidity of comprehension and statement: one of the five or six true fulfillments of a Mozart concerto.

—Edwin Fischer; Philharmonia Orch., Josef Krips, cond. Victor LHMV 1004. 12-in. (with *Bach: Conc. for 3 Pianos*). 31 min. \$5.95.

—Carl Seemann; Munich Philh. Orch., Fritz Lehmann, cond. Decca DL 9568. 12-in. (with *Variations*, KV 455). 31 min. \$5.85.

NO. 26, IN D, KV 537 (4 Editions)

Badly nicknamed "Coronation", with No. 19. Both were composed well before the coronation of Leopold II in 1790, and neither had official recognition at the festivities celebrating the accession of the unlucky,

half-enlightened Holy Roman Emperor whose most memorable responsibility was the Declaration of Pillnitz, the first catastrophe of a series which expunged the Empire in fifteen years. The Concerto is the most magnificent of its kind ever written by anyone, and because this is so patently so, it has undergone a martyrdom of contempt and defamation for generations. It is denounced bitterly for being so triumphantly what it exactly is, for being what Mozart intended it to be. It is vituperated for not being a duplication of No. 20 or No. 24, as if we should denounce Miss Katherine Cornell for not being a wrestler, or Marivaux for not being Montaigne. KV 537 is a courtier's festival, not necessarily less attractive than a hobo's or a strangler's; and if the gorgeous glitter of its artful rhetoric has no meaning it has an iron durability and is exceptionally beautiful.

The records are not much. Only one sounds out in full panoply, Bachauer-Sherman, and we should prefer more grace, more distinction of phrasing here. It is not bad, but this Concerto demands more. We find the grace in Mme. Landowska, who has made something of a career of the work; but the measly band employed for her record libels the musical intention and corrupts the musical result. One look at the score shows that the orchestral force should be limited only by the pianists' ability to hold head with it. The old recording is lamentably restricted in range, color and detail. The other versions are morosely played or inadequately engineered or both. Gieseking? Fischer? Kempff? Or Landowska again, with Dr. Reiner and eighty healthy men?

—Gina Bachauer; New London Orch., Alec Sherman, cond. Victor LM 9000. 12-in. (with *Liszt: Rapsodie Espagnole*). 30 min. \$5.72.

—Wanda Landowska; Ch. Orch., Walter Goehr, cond. Victor LCT 1029. 12-in. (with *Haydn: Concerto in D*). 31 min. \$5.72.

—Lili Kraus; Vienna Sym. Orch., Rudolf Moralt, cond. Vox PL 7300. 12-in. (with *Adagio*, KV 540). 34 min. \$5.95.

—Conrad Hansen; Berlin Nat. Op. Orch., Arthur Rother, cond. Capitol P 8109. 12-in. 30 min. \$4.98.

NO. 27, IN B FLAT, KB 595 (4 Editions)

The last of Mozart's concertos was written in his death-year, 1791. It is a great Concerto, but not one of his greatest. The moribund did not, like Schubert, grow in dying. — The emotion is petulance corrected by experience; disciplined by the finest taste of any musician who has been.

Unless we insist on standards forever unrealizable, we shall find the recorded performances good, all four. The nicest pianistic niceties are from Messrs. Casadesus, Horszowski, Foldes and Badura-Skoda, and they come in that order. But there is incomplete accord between Casadesus and his conductor, and the old recording does not please. Westminster has vitrified the sound of the Badura-Skoda piano, and that will not please. Foldes-Goldschmidt-Vox is agreeable from all directions, and Horszowski-Casals-Columbia is more agreeable still.

—Mieczyslaw Horszowski; Perpignan Fest. Orch., Pablo Casals, cond. Columbia ML 4570. 12-in. 32 min. \$5.45.

—Andor Foldes; Pro Musica Orch., Arthur

Goldschmidt, cond. Vox PL 6810. 12-in. (with *Variations*, KV 455). 32 min. \$5.95. —Paul Badura-Skoda; Vienna Sym. Orch., Felix Prohaska, cond. Westminster WL 5097. 12-in. (with *Conc.* 24). 29 min. \$5.95. —Robert Casadesus; N. Y. Philh.-Sym. Orch., (Sir) John Barbirolli, cond. Columbia ML 2186. 10-in. 29 min. \$4.00.

CONCERTO FOR TWO PIANOS AND ORCHESTRA, IN E FLAT, KV 365 (4 Editions)

Display is not invidious if it is becoming or tasteful. The beautiful ideas so profuse in KV 365 withstand the glaring light of brilliant display without loss of status, while the élan of the cavorting outer movements has its own worth besides making the touching andante seem more touching.

The Mercury edition is a poor recording scheduled for withdrawal. Columbia is an old record with the deficiencies of its date: too much bass, hard pianos which progressively become harder. Victor's sound is lucent and would have been the best without a fault in emphasis that hurts interpretation. Westminster's sound is pretty good but not good Westminster.

Vronsky-Babin-Mitropoulos is the most poetically perceptive combination, subtler, more alertly responsive than the others and remarkably more moving in the andante. The Iturbis have a hard attack, and the prominence permitted to their keyboards by the recording director has further caloused the glitter mistaken for the texture. (But the orchestral reproduction is the best here.) Dr. Scherchen, surprisingly cautious, leads his band and his soloists in an honorable performance second to Columbia's but much more appealing than the Iturbis'. The orchestral sound is solid and satisfactory, but the pianos lack decision at the top. Multiplication of factors makes this the preference except where sonic considerations are slighted in favor of the superior exposition of V-B-M.

—Paul Badura-Skoda, Reine Gianoli; Vienna Nat. Op. Orch., Hermann Scherchen, cond. Westminster WL 5095. 12-in. (with *Conc. for 2 Pianos*, KV 242). 24 min. \$5.95.

—Vitya Vronsky, Victor Babin; Robin Hood Dell Orch., Philadelphia, Dimitri Mitropoulos, cond. Columbia ML 4098. 12-in. (with *Conc. for 3 Pianos*, KV 242). 23 min. \$5.45.

—Amparo Iturbi, José Iturbi; RCA Orch., José Iturbi, cond. Victor LM 1717. 12-in. (with *Piano Conc.* 20). 24 min. \$5.72.

—Heinz Schröter, Hans Altmann; Bavarian Radio Orch., Hans Altmann, cond. Mercury 10007. 12-in. (with *Piano Conc.* 12). 25 min. \$4.85.

CONCERTO FOR THREE PIANOS AND ORCHESTRA, IN F, KV 242 (2 Editions)

The two versions are not entirely in competition, Columbia presenting Mozart's original score and Westminster Mozart's later reduction to two pianos. But it is the same music, easy and diverting in a small way, the third piano no indispensable participant. In spite of a solemn minuet-in-rondo and a vague reluctance to sparkle on the part of Dr. Scherchen and his pianists, the Westminster disk is the choice imposed by its much greater clarity of sound. The Columbia is old but not bad for two movements. Thereafter reproduction deteriorates rapidly, and the more appropriately light performance is nullified by pianos in in-

creasing clatter. Not that the Westminster is one of her grand achievements: the piano treble is not keen and the tuttis do not satisfy. These are not large faults — maybe we have learned to expect near-impeccability from certain labels.

—Paul Badura-Skoda, Reine Gianoli; Vienna Nat. Op. Orch., Hermann Scherchen, cond. Westminster WL 5095. 12-in. (with *Conc. for 2 Pianos*, KV 365). 23 min. \$5.95. —Rosina Lhevinne, Vitya Vronsky, Victor Babin; Little Orch. Society, Thomas Scherman, cond. Columbia ML 4098. 12-in. (with *Conc. for 2 Pianos*, KV 365). 23 min. \$5.45.

CONCERTOS (3) FOR PIANO AND STRINGS, AFTER J. C. BACH, KV 107 (1 Edition)

Sebastian Bach utilized in simple transpositions some concertos of Vivaldi. In time the transposer's fame eclipsed the composer's and the former was generally credited with writing the music he had appropriated. A retarded revenge at the expense of Sebastian's most brilliant son is threatened in the title prefixed to the present record. These Concertos were sonatas by Christian Bach, and remain Christian Bach after the boy Mozart and his father had embellished them with facile string accompaniments. Mozart's contribution here is less important than the instrumental reinforcement he brought to *Messiah*, a work we still call Handel's. Thus the record of these Concertos is really an interloper in a Mozart discography: these comments are to obviate erroneous impressions. — The disk is a pleasant addition to the slim repertory of Johann Christian Bach, at thirty a consummate worldling and gracefully able composer, the Concertos boldly played and competently enregistered.

—Artur Balsam; Winterthur Sym. Orch., Otto Ackermann, cond. Concert Hall CHS 1164. 12-in. 14, 10, 10 min. \$5.95.

CONCERTOS—MISCELLANEOUS

CONCERTO FOR BASSOON AND ORCHESTRA, NO. 1, IN B FLAT, KV 191 (1 Edition)

There is a tendency to take this gorgeous light music too lightly because a clown is protagonist. The tendency is illustrated in the one recording, ruthlessly bustled along a severe route. Mr. Sharrow's romantic throb would have fared better at an easier pace. Excellent orchestral playing, and a sound fit for yesterday's phonograph: pleasing and easy, lacking the upper and suppressing the nether frequencies.

—Leonard Sharrow; NBC Orch., Arturo Toscanini, cond. Victor LM 1030. 12-in. (with *Sym.* 41). 16 min. \$5.72.

CONCERTO FOR CLARINET AND ORCHESTRA, IN A, KV 622 (2 Editions)

Examining all the facets of this work, rolling its successive flavors on the tongue, one must accept a conclusion that it is impeccable, unimprovable. It implies as much as it says, and implications and statements alike are shaped with a kind of glowing formalism. It is a show-piece without showiness, its solo virtuosity obedient to a higher order of music.

In a Mozart repertory of prevalent recorded mediocrity, there is cause for satisfaction and exasperation both, at the

presence of two excellent versions of the Clarinet Concerto. One is bound to feel that the intelligent effort expended on one would better have been devoted to one of the symphonies without a satisfactory recording. It is not easy to be downright in preference between this pair, which are, however, easily distinguishable. Both clarinets are thoroughly endowed, both orchestras expert. The basic and persisting difference is one of scope, Kell-Zimmler expressing an intimacy of chamber music, Cahuzac-Wöldike asserting a positive concertoism. The acoustic results accord well with the respective concepts, the one emphasizing proximity and detail, the other more spacious and enveloping, and both very good. Kell is the spryer but the less exuberant soloist: in the chamber-music setting he restricts the volume of his instrument as Cahuzac does not, and strict classicists will prefer the Kell manner to the bigger sound and bigger variety of tone produced by the Frenchman. In contrast, the Zimmler orchestra is warmer in phrase than the Danish, and the classicists will prefer the latter. So does the writer.

—Louis Cahuzac; Ch. Orch. of the Danish Nat. Radio, Mogens Wöldike, cond. Haydn Society 1047. 12-in. (with *Haydn: Sym.* 61). 31 min. \$5.95.

—Reginald Kell; Zimmler Sinfonietta. Decca DL 7500. 10-in. 28 min. \$3.85.

CONCERTO FOR FLUTE AND ORCHESTRA, NO. 1, IN G, KV 313 (2 Editions)

The two Flute Concertos provide redundant confirmation of the professional objectivity which was instinct with Mozart. Written on order, and for an instrument he disliked in a solo capacity, they have the glossy perfection of works composed to please his own infallible taste. A generalized description of one fits the other, and the airy semblance of their easy melodies joined in a sequence apparently ordained by nature, trifling fluff, hides a resistance to repeated exposure indicative of something tougher underneath. — Mr. Wummer's virtuosity in No. 1 is what we should expect from the fine first flute of the New York Philharmonic, and the fellowship of Mr. Casals' enthusiastic orchestra, especially in the slow movement, is sensitive to the values that lie below the surface. The flute recording is very good; the orchestral sound is fair. This is as convenient a place as any to warn that the Perpignan records — three albums of them — are not to be judged as a unit. Their qualities are not equal in performance or in sound, and music-lovers would be losers to assume that because a few are disappointing the majority are not good and some even outstanding.

—John Wummer; Perpignan Fest. Orch., Pablo Casals, cond. Columbia ML 4567. 12-in. (with *P Conc.* 14). 28 min. \$5.45.

—(Bavarian Radio Orch. Mercury 10056. 12-in. (with *Haydn: V Conc.* 1). \$4.85.)

NO. 2, IN D, KV 314 (1 Edition)

More familiar than its companion, primarily because of tunes easy to remember. Mr. Nicollet is a flutist of the first order, a musician and a tonalist whose playing here permits no cavil, and Dr. Swoboda is competent, as usual. Again the sound is good for the flute and fair in the orchestra, with horns difficult in the finale.

"I had no idea of the real service that could be rendered the record purchaser until I discovered the Music Box"

writes a reader of High-Fidelity . . . one of the many satisfied customers, who know they can depend on receiving from us:

- Brand new, unplayed LP records.
- Carefully inspected for imperfections, before shipment.
- Carefully cleaned against damage in transit.
- Carefully packed, and mailed, post free anywhere in the U. S. A.
- Any record listed in the Schwann LP catalog.
- A copy of the Schwann LP catalog . . . Free every month.
- Information on any records, American or European . . . on all speeds.
- Prompt . . . honest . . . and personal service on any matter pertaining to records.
- Special attention to collectors' wants.

The Music Box
279 Main Street
Great Barrington, Mass.

—Aurèle Nicolet; Winterthur Sym. Orch., Henry Swoboda, cond. Concert Hall CHS 1073. 10-in. (with *Andante for Flute*, KV 315). 18 min. \$4.67.

CONCERTO FOR FLUTE, HARP AND ORCHESTRA, IN C, KV 299 (1 Edition)

As tasty a meringue as ever confectioned on short order, and an unflinching appetizer for more of it. Its incorruptible savor emanates even from a recorded re-serving implacably routine and unimaginative. The chef's (d'orchestre) torpor is cruelly illumined by a sound of close, bright realism.

—Karl Mess, Dora Wagner; Ton-Studio Orch., Stuttgart, Gustav Lund, cond. Period 544. 12-in. (with *Horn Conc. 1*). 28 min. \$5.95.

CONCERTO FOR HORN AND ORCHESTRA, NO. 1, IN D, KV 412 (1 Edition)

The least of the four horn concertos, but beguiling nevertheless, competently played if cautiously by the soloist, and with spirited enjoyment by the little orchestra, whose tone would have improved with the addition of a few more violins. Vital sound, with a sharpness of treble easily governed.

—Gerhard Görmer; Ton-Studio Orch., Stuttgart, Gustav Lund, cond. Period 544. 12-in. (with *Flute and Harp Conc.*). 9 min. \$5.95.

CONCERTO FOR HORN AND ORCHESTRA, NO. 2, IN E FLAT, KV 417 (1 Edition)

The Concerto has no more meaning than a little mountain cascade, but it imparts a fresh, healthy stimulation to the listener however wan its cascading may leave the solo horn. The recording, still estimable in spite of its age, gives a rarely mellow and controlled demonstration of horn-playing by one of the best in the best of form, and the Philharmonia Orchestra spatkles.

—Dennis Brain; Philharmonia Orch., Walter Süsskind, cond. Columbia ML 2088. 10-in. (with *Horn Conc. 4*). 13 min. \$4.00.

CONCERTO FOR HORN AND ORCHESTRA, NO. 3, IN E FLAT, KV 447 (1 Edition)

No. 3 is particularly remarkable in the limpid spontaneity of its effect, which in turn depends upon torturing soloists whose instrument is never easy. It is the finest and the hardest of the four horn concertos, and Mr. Jones holds his own beautifully most of the time. The conducting is sinuous and sensitive—the best Mr. Bales has done on records—and the orchestra is confronted with no problems like those which bedevil the solo horn. The sound is weak, because the horn strong is dangerous to record, and the others have been proportioned to the soloist; but the discretion seems a little too discreet: the tadiane is slightly clouded.

—Mason Jones; National Gallery Orch., Richard Bales, cond. WCFM 8. 12-in. (with *the Motet*, KV 165; and *an aria from Zaidé*). 15 min. \$5.95.

CONCERTO FOR HORN AND ORCHESTRA, NO. 4, IN E FLAT, KV 495 (1 Edition)

Second in musical appeal to No. 3, and well played in a dull and thick old recording which must surely soon have a replacement.

—Dennis Brain; Hallé Orch., anon. cond.

Columbia ML 2088. 10-in. (with *Horn Conc. 2*). 17 min. \$4.00.

CONCERTED WORKS, NOT CALLED CONCERTOS

ADAGIO FOR VIOLIN AND ORCHESTRA, IN E, KV 261 (2 Editions)

No more convincing than a lying love-letter read by the wrong eyes, written by Mozart at the behest of a Salzburg virtuoso who wished a substitute for the slow movement of the fifth violin concerto. Not much, although both fiddlers try to make something of it, Mr. Milstein with the greater success. The orchestras are relegated to the background in both cases, especially Mr. Steinberg's larger one.

—Nathan Milstein; RCA Orch., William Steinberg, cond. Fictor LM 1064. 12-in. (with *Rondo*, KV 373; and *Glazounof: V Concerto*). 7 min. \$5.72.

—Gustav Swärdström; Ton-Studio Orch., Stuttgart, Gustav Lund, cond. Period 548. 12-in. (with *V Conc. 7*, and *2 Rondos*). 7 min. \$5.95.

ANDANTE FOR FLUTE AND ORCHESTRA, IN C, KV 315 (1 Edition)

Written to replace the original slow movement of the first flute concerto, too hard for the average performer, this fragment permits the soloist to describe facile patterns over a persistent bass. Good playing on a disk of rather muddy sound.

—Aurèle Nicolet; Winterthur Sym. Orch., Henry Swoboda, cond. Concert Hall CHS 1073. 10-in. (with *Fl. Conc. 2*). 5 min. \$4.67.

CONCERTONE FOR TWO VIOLINS, OBOE, VIOLONCELLO AND ORCHESTRA, IN C, KV 190 (1 Edition)

Not impossibly this is the illustration in excelsis of the common and careless adjective "Mozartean". This Concertone, dug out of limbo by the Westminster pioneers, has a serene perfection of eurhythmic construction in tender Italianate design, decorated by melody of a beguiling simplicity, expressive of no sentiment and aspiring to none. There is no flaw in the logical flow of its facile current of lulling and persistent loveliness. It is "unimportant", because there is no frown in its pleasure.

In all his exuberance of recording, when LP was still a novelty, Dr. Swoboda managed nothing better than the Concertone. His anonymous solo violins are pleasant and the solo oboe is excellent, and everyone plays as if the occasion were an enjoyment. The sound, with bass up and treble down more than usual, is appealing and accurate. A gracious holiday, and indispensable.

—Vienna Sym. Orch., Henry Swoboda, cond. Westminster WL 5013. 12-in. (with *Sym. 23*). 27 min. \$5.95.

CONCERT RONDO FOR PIANO AND ORCHESTRA, IN D, KV 382 (1 Edition)

Neat and apparently naive, not really, these variations were used by Mozart as a new finale for the fifth concerto, KV 175, years after the original was written. The record exhibits a splendid performance, fair reproduction of the orchestra, and disintegrating piano-sound.

—Wilhelm Kempff; Dresden Philh. Orch., Paul van Kempen, cond. Decca DL 9535. 12-in. (with *Sym.* 38). 8 min. \$5.85.

RONDO FOR VIOLIN AND ORCHESTRA, IN B FLAT, KV 269 (1 Edition)

Another substitute movement, this one of an animated emptiness and moribund interest, well bowed on the record by a violinist too close to the microphone.

—Gustav Swärdström; Ton-Studio Orch., Stuttgart, Gustav Lund, cond. Period 548. 12-in. (with *V Conc.* 7; *Adagio*, KV 261; & *Rondo*, KV 373). 5 min. \$5.95.

RONDO FOR VIOLIN AND ORCHESTRA, IN C, KV 373 (2 Editions)

Better than the other occasional pieces for violin and orchestra, although slight Mozart. Mt. Milstein bounces along in a polished whine while the orchestra allows him too-generous precedence; Mr. Swärdström is less polished and more serious. The conductors agree that their place is in the background, thus attenuating the value of both records.

—Nathan Milstein; RCA Orch., William Steinberg, cond. Victor LM 1064. 12-in. (with *Adagio*, KV 261; & *Glazounof: V Conc.*). 5 min. \$5.72.

—Gustav Swärdström; Ton-Studio Orch., Stuttgart, Gustav Lund, cond. Period 548. 12-in. (with *V Conc.* 7; *Adagio*, KV 261; & *Rondo*, KV 269). 7 min. \$5.95.

SINFONIA CONCERTANTE FOR OBOE, CLARINET, HORN, BASSOON AND ORCHESTRA, IN E FLAT, KA 9 (3 Editions)

Epithets more elastic than the language affords are needed to give an exact impression of this masterly amalgam of several schools of musical thought, almost perversely unfixed in mood: morose here, naïve there, courtly somewhere else. Dr. Swoboda's flexible direction—the only one that is flexible—wins the honors for performance from Mr. Wöss, whose neatness is too much of a piece. The Stuttgart interpretation cannot recover from a solo horn in the distress of suffocation. Remington and Westminster also enjoy an easier sound, the former with a superiority in clearness, the latter more incisive in the bass.

—Wind Quarter from the Vienna Philh. Orch.; Ch. Orch of the Vienna Nat. Opera Henry Swoboda, cond. Westminster WL 5020. 12-in. (with *Divert.* KA 229, No. 2). 32 min. \$5.95.

—Soloists & Sym. Orch., Kurt Wöss, cond. Remington 199-54. 12-in. (with *Thomas: 2 Entr'actes*). 31 min. \$2.49.

—Soloists & Pro Musica Orch., Stuttgart, Rolf Reinhardt, cond. Vox PL 7320. 12-in. (with *Sinf. Conc.*, KV 364). 31 min. \$5.95.

SINFONIA CONCERTANTE FOR VIOLIN, VIOLA AND ORCHESTRA, IN E FLAT, KV 364 (4 Editions)

Words have to be diffident, utilitarian, explanatory and hasty, in reference to an unprecedented masterpiece like this Double Concerto, which establishes its own standard, utters its own explicit language and provides its own illumination. Say that the composer was twenty-three; that he wrote after having studied the fine Mannheim orchestra and assimilated the taste of Paris; that his band was no more than the conven-

tional pairs of oboes and horns coloring the strings; that the Sinfonia Concertante after its production had an obscure history during Mozart's lifetime. Angels would fear to analyze the snarls—and none ever more musical—the high-hearted rebellion and dictatorial turmoil of the first movement, the philosophical elegy of the second, the plaintiveness seasoning the sport of the third with mystery: alone players of a superior class can translate the staves successfully, by playing.

When played, KV 364 is usually played well. This is reflected in the records, any one of which would serve. Some have special advantages: Vox gives both *Sinfonia* on a single disk; Westminster's players are immaculate in style; the Decca accomplishment is admirable. And all are insufficient when the Columbia has been heard.

The Perpignan Festival record, with Messrs. Stern and Primrose in form, the extraordinary Casals touched with enlightenment and an orchestra of superb poetic responsiveness, is one of the sparse marvels in the Mozart discography. At Perpignan the incense of devotion sometimes obfuscates the musical celebration: not this time. The patriarchal celebrant guides with true love. The many tiny mutations of tempo and stress which give this performance its distinction are stated with a unanimity implying implacable direction, yet the phrasing is fluid, the lyricism tender. The revolt then seems sterner, the drama more tense. The soloists are a part of it, in such a natural coalescence that we hear them as indispensable symphonic elements even when their arabesques are spectacular. —The sound has been beautifully engineered into a mellow and seductive orchestral likeness, without any straining for effect or any other strain. There are no brilliant alarms to worry about in the orchestration, and the recording director has been able to concentrate on natural tone and harmonious balance. A compulsive triumph.

—Isaac Stern; William Primrose; Perpignan Fest. Orch., Pablo Casals, cond. Columbia ML 4564. 12-in. 34 min. \$5.45.

—Walter Barylli, Paul Doktor; Vienna Nat. Op. Orch., Felix Prohaska, cond. Westminster WL 5107. 12-in. 31 min. \$5.95.

—Joseph Fuchs, Lillian Fuchs; Zimblet Sinfonietta. Decca DL 9596. 12-in. 31 min. \$5.85.

—Reinhold Barchet, Heinz Kirchner; Pro Musica Orch., Stuttgart, Wilhelm Seegelen, cond. Vox PL 7320. 12-in. (with *Sinfonia Concertante*, KA 9). 30 min. \$5.95.

SONATAS FOR ORGAN AND STRINGS

Mozart wrote nearly a score of these little concertos over a period of nearly fifteen years, at Salzburg, where they served as unchurchly interludes in the cathedral. They are refreshing diversions easy to play and to hear. The six recorded on the disk below are satisfactory in performance, and will be satisfactory in reproduction only on apparatus weak in treble or equipped with an equalizer resourceful in repression. —A Mercury record which could not be found has an unspecified number of these sonatas on one of its sides.

—Nos. 1, 2, 3, 6, 8 & 14. P. Messner; Mozarteum Orch., Salzburg, Paul Walter, cond. Period 534. 12-in. (with "*Haffner*" *March*, KV 249). 24 min. \$5.95.

OVERTURES

(Since many of the Mozart overtures are popular in the concert hall, it has been thought proper to include them all in a separate category rather than as mere preludes to the complete works they do in fact precede. The stage works are as a matter of course recorded with their overtures, but many discophiles may wish to have the overtures alone, or may not have the means to buy entire operas. Mozart's overtures are to musical texts, or have titles, in four languages, to which Americans refer in some cases always by the original (*Così fan tutte*) and in others always by a translation (*The Marriage of Figaro*). For uniformity they are entered here by the original.

(Not one of the recorded overtures has exclusive occupancy of an LP, and that has forced for this category a method of listing different from that employed elsewhere in the discography. Rather than catalogue some disks six or seven times, every record containing one or more Mozart overtures has been listed once, at the foot of the text. A number has been ascribed to each record, and reference has been made to the appropriate number in the discussion of every work. The numerical sequence is not to be regarded as indicative of relative quality.)

IN B FLAT, "PARIS", KV 311a (1 Edition)
The "Paris" Overture deserves the title of Symphony as much as several of the early works in a tripartite construction—fast, slow, fast: the traditional Italian overture—which Mozart did call symphonies, although the brilliant and alluring little work in B Flat has a slow start in the French manner. Mr. Swarowsky's direction is deficient in neither verve nor nuance; and the orchestral reproduction, with bass up and treble down, volume large, is effective. (Record No. 1, below.)

APOLLO ET HYACINTHUS, KV 38 (1 Edition)
Less than three minutes long, the proficient and spry melodrama preceded Mozart's first stage-work, a Latin comedy composed when he was eleven. It is well played by Mr. Bales's orchestra, and if one has patience and a good compensator the quality of sound suffices. (Record No. 2.)

BASTIEN UND BASTIENNE, KV 50 (1 Edition)

The only recording of the sweet overture to a sweet pastoral unaccountably written by a giant of twelve is contained in the disk bearing the complete *Bastien und Bastienne*, q. v. Its musical theme is interval-by-interval identical with the first subject of the *Eroica* Symphony, which has never been called sweet. Beethoven did not commit a plagiarism: it is unlikely that he ever heard the little Mozart *singspiel*; and in any event his rocky tune is fashioned from the notes of the *Eroica*'s tonic chord of E Flat, Mozart's key being G. The same recording has been transferred to Record No. 3, below: its one-and-three-quarters-of-a-minute are delectable in a gentle performance and a sound without problems.

(LA) CLEMENZA DI TITO, KV 621 (THE CLEMENCY OF TITUS) (2 Editions)
Satisfactory versions with nothing memorable in either. The bigger sound of Mr.

Lehmann's considerably bigger orchestra (Record No. 4) is not so pleasant in reproduction as the sound of the Period disk (Record No. 3), which has an attractive blending of winds. This Period version is extracted from a complete recording of the opera, no longer available, but which may reappear under another label.

COSÌ FAN TUTTE, KV 588 (The Way of All Women) (5 Editions)

Dr. Stiedry's version in the Columbia album of the complete opera has most sting in its performance and most suavity in its sound. The Lehmann edition is a commendable second (Record No. 4). Dr. Krips (Record No. 5) seems tired, and Mr. Dünnwald (No. 3) tied to a metronome. The last is in transference from the recording of the opera (q. v.) formerly under the Period, now under the Remington, label.

DON GIOVANNI, KV 527 (5 Editions)

Mr. Swarowsky in the Haydn Society's edition of the opera is most effective with the dramatic antitheses, aided by a sound more pointed in detail than any of the others, but a sound requiring sharp reduction at its extremes. The old Glyndebourne recording is too restricted to do more than hint the merit of the Busch performance. The two records of Dr. Krips are of the same performance, but the more recent transfer, to the ten-inch disk, is clearer and stronger than its forerunner, No. 6 preferable to No. 5. The Krips menace is imposing, the mockery unconvincing. The Decca of Fritz Lehmann and the Berlin Philharmonic presents a good standard show, and is the best of the versions not tied to the opera (Record No. 4).

(Die) **ENTFÜHRUNG AUS DEM SERAIL, KV 384** (The Abduction from the Seraglio) (3 Editions)

The relative sobriety of Dr. Krips with the London Symphony Orchestra (Record No. 5) is disappointing after the warm gaiety of Dr. Krips with the Vienna Philharmonic Orchestra in the performance on the first side of London's complete *Entführung*. Decca's excellent recording of the Berlin Philharmonic's dash is easily the preferred concert version (Record No. 7).

(La) **FINTA GIARDINIERA, KV 196** (The Pretended Flower-Girl) (3 Editions)

One performance is available in two places — on the Period recording of the whole opera, and sonically a little improved in transfer to Record No. 3. It is a proficient projection in the fair sound of a small orchestra, and has a morphic advantage over the Bales record (No. 2) in repeating the fast opening subject as coda. — The two disks, with seven items apiece, duplicate only two, and are hardly in competition.

(La) **FINTA SEMPLICE, KV 51** (The Sham Innocent) (1 Edition)

A minor masterpiece of vivid thought and compact construction, by a composer aged 12, one of the most successful features of Record No. 2.

IDOMENEU, RE DI CRETA, KV 367 (Idomeneus, King of Crete) (4 Editions)

The only version not connected to other parts of the opera is that of the Berlin Phil-

harmonic under Fritz Lehmann for Decca. This is the most downright performance and it has the most outspoken sound. (Record No. 7.) The others in order of general merit are those of Fritz Busch in the Victor record of excerpts from the Glyndebourne performance, Zallinger in the Haydn Society's complete opera, and Altmann in Wolf-Ferrari's abbreviation for Mercury.

LUCIO SILLA, KV 135 (Lucius Sulla) (1 Edition)

At any age, Mozart was a stage composer *hors concours*. The miniature symphony which introduces his opera on Sulla is mature, neat and dramatically unwavering. The only recording in existence (Record No. 2) exploits a good performance in a fair sound.

MITRIDATE, RE DI PONTU, KV 87 (Mithridates, King of Pontus) (1 Edition)

The slightest of Mozart's overtures is of course worth hearing. The recording serves. (Record 2.)

(Le) **NOZZE DI FIGARO, KV 492** (The Marriage of Figaro) (8 Editions)

The giddiest froth is whipped up by Busch, Karajan and the Anon. for Parade who is really too fast. Busch and Karajan are the conductors for the Victor and Columbia versions of the opera. Prof. Heger and Mr. Previtali lead a slower pace, not harmful. The latter directs the Cetra edition of the opera, and has the richest orchestral sound after that of the Berlin Philharmonic for Decca on Record No. 7. Parade's Anon. is the first band of a rather curious record of excerpts from the opera. The Heger performance is appended to the Remington version of Piano Concerto No. 24. The Krips (No. 5) and Munch (No. 8) records are a little turgid.

(Il) **RE PASTORE, KV 208** (The Shepherd King) (3 Editions)

There are two satisfactory performances, of which Mr. Lund's for Period (No. 3) is more convincing and has a more agreeable tone than Mr. Bales's (No. 2). The Lund is abstracted from Period's presentation of the pastoral cantata complete.

(Der) **SCHAUSPIELDIREKTOR, KV 486** (The Impresario) (5 Editions)

The sound accorded by Decca (Record No. 7) to Mr. Lehmann is so much more living and detailed than that of the other disks that the Decca is indispensable. Mr. Leinsdorf — in a recording originally made for Sears, Roebuck — makes the wit of a wonderful little Overture most apparent, but his performance is prefixed to a recording of the rest of the *Schauspieldirektor's* music under other direction (Mercury). Mr. Reinhardt is pretty limp in the extract (Record No. 3) that Period has made from their complete recording of the *singspiel*. Dr. Krips (No. 5) is doleful, weeping into the champagne.

(Lo) **SPOSO DELUSO, KV 430** (The Gulled Bridegroom) (1 Edition)

The title of Mozart's abandoned opera implies an aromatic involvement with cuckoldry, as in *Figaro* and *Così*, but a portentous undercurrent in the hearty Overture implies something deeper. The only recorded performance is bald, its sound coarse but serviceable. (No. 2).

(Die) **ZAUBERFLOETE, KV 620** (The Magic Flute) (5 Editions)

The irreconcilable elements of *The Magic Flute* — Masonic ritual solemnly intended, and an improvised fairy-tale — are displayed at equal length in the Overture, thus posing a problem to conductors. Shall one be stressed at the expense of the other (and which?) or shall they be peers? Conductors are not in agreement. Sir Thomas Beecham, in the Victor version of the opera, underlines both the majestic chordal annunciations of the trombone symbolism and the fun of the *fughetta*, making the most violent contrast. Mr. Fritz Lehmann (Record No. 4) deprecates solemnity in a burst of speed for the whole, in a record with the best distinction of timbre. Dr. Krips, in his two records of the same performance (Nos. 5 and 6) blunts both fun and majesty in a lyrical interpretation not without a special soft beauty. Prof. von Karajan's direction, found in the Columbia album of the opera, is not unlike Sir Thomas's, but is more crisply vigorous and gains from the sharper detail of the orchestra in the much later engineering. It is comfortably the preference of this writer.

—1. "PARIS" OVERTURE, KV 311a; Haydn: *Syms. 54 & 70.*

Ch. Orch. of the Vienna Nat. Acad. of Music, Hans Swarowsky, cond. LYRIC CHORD L 32. 12-in. 8 min. \$5.95.

—2. SEVEN OVERTURES: *Apollo et Hyacinthus, La finta Semplice, Mitridate, Lucio Silla, La finta Giardiniera, Il Rè pastore, Lo Sposo deluso.*

National Gallery Orch., Washington, Richard Bales, cond. WCFM 3. 12-in. 3, 6, 6, 9, 5, 3, 6 min. \$5.95.

—3. BALLET, LES PETITS RIENS; Six Overtures: *Così fan tutte, La Clemenza di Tito, La finta Giardiniera, Il Rè pastore, Der Schauspieldirektor, Bastien und Bastienne.* Ton-Studio Orch., Stuttgart, Gustav Lund, Joseph Dünnwald & Rolf Reinhardt, cond. PERIOD 559. 12-in. 5, 5, 6, 4, 4, 2 min. \$5.95.

—4. FOUR OVERTURES: *Così fan tutte, Don Giovanni, Die Zauberflöte, La Clemenza di Tito.*

Berlin Philh. Orch., Fritz Lehmann, cond. DECCA DL 4035. 10-in. 4, 6, 6, 5 min. \$2.50.

—5. SIX OVERTURES: *Die Entführung aus dem Serail, Der Schauspieldirektor, La Nozze di Figaro, Don Giovanni, Die Zauberflöte, Così fan tutte.*

London Sym. Orch., Josef Krips, cond. LONDON LL 356. 12-in. 6, 5, 4, 6, 8, 5 min. \$5.95.

—6. TWO OVERTURES: *Die Zauberflöte, Don Giovanni.*

London Sym. Orch., Josef Krips, cond. LONDON LD 9001. 10-in. 8, 6 min. \$2.95.

—7. FOUR OVERTURES: *Entführung, Figaro, Idomeneu, Schauspieldirektor.*

Berlin Philh. Orch., Fritz Lehmann, cond. DECCA DL 4036. 10-in. 5, 4, 4, 4 min. \$2.50.

—8. OVERTURE: FIGARO; Handel-Harty: *Water Music*; Schumann: OVERTURE: GENOVEVA.

Boston Sym. Orch., Charles Munch, cond. VICTOR LM 7009. 10-in. 4 min. \$4.67.

Part III of the Mozart Discography will include Operas and Vocal Music.

IT SOUNDS DIFFERENT ON FFRR

Of course it does . . . it must . . . because FFRR is the *only* recording system by which every audible musical frequency is not only recorded in the studio, but put on to the record which you buy. Without FFRR, long-playing is only a mere matter of how long a record plays; with FFRR you have quality that has been accepted the world over as the standard by which others are judged.

LATEST RELEASES

ACADEMIC FESTIVAL OVERTURE
(Johannes Brahms) (Op. 80)
TRAGIC OVERTURE (Johannes Brahms) (Op. 81)
VARIATIONS ON A THEME OF HAYDN
(Johannes Brahms) (Op. 56a)
Eduard van Beinum — Concertgebouw Orchestra
of Amsterdam
LL-735 \$5.95

SYMPHONY No. 4 IN C MINOR (Tragic)
(Franz Schubert)
Eduard van Beinum — Concertgebouw Orchestra
of Amsterdam
LL-736 \$5.95

EN SAGA — Symphonic Poem (Jean Sibelius) (Op. 9)
TAPIOLA — Symphonic Poem (Jean Sibelius) (Op. 112)
Eduard van Beinum — Concertgebouw Orchestra
of Amsterdam
LL-737 \$5.95

SONATA No. 13 IN E FLAT MAJOR
(Beethoven) (Opus 27, No. 1)
SONATA No. 14 IN C SHARP MINOR (Moonlight)
(Beethoven) (Opus 27, No. 2)
SONATA No. 19 IN G MINOR
(Beethoven) (Opus 49, No. 1)
SONATA No. 20 IN G MAJOR
(Beethoven) (Opus 49, No. 2)
Wilhelm Backhaus — Piano
LL-705 \$5.95

DER FREISCHUTZ — Vocal Highlights
(Carl Maria von Weber)
Hans Hopt (tenor) — Maud Cunitz (soprano)
Emmy Laese (soprano) — Alfred Poell (baritone)
The Vienna State Opera Chorus and
The Vienna Philharmonic Orchestra
Conductor: Otta Ackermann
LL-646 \$5.95

LA BOHEME — Vocal Highlights (Giacomo Puccini)
Renata Tebaldi (soprano) — Giacinto
Prandelli (tenor)
Hilde Gueden (soprano) — Raphael Arie (bass)
Fernanda Carena (bass) — Giovanni
Inghilleri (baritone)
Chorus and Orchestra of the Accademia di Santa
Cecilia
Conductor: Alberto Erede
LL-649 \$5.95

MADAMA BUTTERFLY — Vocal Highlights
(Giacomo Puccini)
Renata Tebaldi (soprano) — Guisepppe
Campora (tenor)
Chorus and Orchestra of the Accademia di
Santa Cecilia
Conductor: Alberto Erede
LL-650 \$5.95

CONCERTO FOR VIOLIN AND ORCHESTRA
(Federico Elizalde)
Christian Ferras (violin) with
The London Symphony Orchestra
Conductor: Gaston Poulet
LS-564 \$4.95

SONATA FOR UNACCOMPANIED VIOLIN
(Bela Bartók)
Wandy Tworak (violin)
LS-711 \$4.95

LUCIA DI LAMMERMOOR — Complete Mad Scene
(Gaetano Donizetti)
HAMLET — Complete Mad Scene (Ambroise Thomas)
Mado Robin (soprano) with
L'Orchestre de la Société des Concerts du
Conservatoire de Paris
Conductor: Richard Blareau
LS-676 \$4.95

CLASSICAL ARIAS — Volume Two
Mentre fi lascio, o figlia (Mozart) (K. 513)
Il Sedecia - Caldo sangue
(A. Scarlatti-Dörumsgaard)
Alceste - Il faut passer (Lully)
Cadmus et Hermione - Air de Cadmus (Lully)
Les Pèlerins de la Mecque - C'est un torrent impétueux
(Gluck)
Castor et Pollux - Nature, amour (Rameau)
Gerard Souzay (baritone) with
L'Orchestre de la Société des Concerts du
Conservatoire de Paris
Conductor: Robert Cotman
LS-730 \$4.95

CANZONE SCORDATE (Arne Dörumsgaard)
Four Sacred Songs (1620-1700)
Three C.P.E. Bach Songs (1714-1788)
Seven Italian Monodies (1609-1634)
Five A. Scarlatti Songs (1659-1725)
Gerard Souzay (baritone) and Jacqueline
Bonneau (piano)
LL-731 \$5.95

FFRR FREQUENCY TEST RECORD

(This record gives the correct equalization utilized in the recording and playback of all London FFRR long-playing records. The recording is from outside to inside in bands of constant frequency and covers from 15,000 cps. to 40 cps. Levels are accurate to within + or - 5dB.)
LL-738 \$5.95

LONG-PLAYING *plus* FULL FREQUENCY RANGE RECORDING

LONDON

THE WORLD'S FINEST QUALITY RECORD

Beethoven Up-to-date

By C. G. BURKE

Part III: Quartets, Variations, Addenda

STRING QUARTETS

(Having subjected the sixty-four recorded versions of the sixteen inexhaustible masterpieces which form an emotional epic without precedent, beyond compare and invulnerable to imitation, to a detailed and prostrating examination, the writer of this would like to express sincere respect for the manufacturers who sponsored them. These people sell to live, and live to sell. But the lure of the ubiquitous buck must have faded in the Olympian light of the Sixteen Quartets, realized by the disk-mongers in re-creations of reverential probity. The assignment to record, to transmit to the future, seems in every case to have been given by the manufacturer to the musicians nearest the level of their task of those available to him. There is no incompetent playing in these Quartets. There is a very high average of intelligent and sensitive musicianship. When we disagree with a concept or with the execution of it, we can in most cases discern a reason for what we regard as a deviation. Very rarely can we find a flagrant contumacy. Let them have a bow of recognition.)

NO. 1, IN F, OP. 18, NO. 1 (3 Editions)

Two of these performances are by groups named The Budapest Quartet. First violinist and cellist are the same in both, and were with the organization at its inception, although the violin was then second, and Mr. Mischa Schneider is not the only cellist to have served with the quartet. At least four sets of four men have comprised the quartet, with Mr. Roisman, the present first violin, supplying continuity. It is the immediately contemporary Budapest Quartet who have recorded in the Library of Congress, on four Stradivari instruments, all the Quartets and the big Fugue for Columbia. Their records are credited here to "Budapest Quartet". Records by one of their predecessors are credited to "Budapest Quartet—old", without regard to the particular incarnation.

The two Budapest versions are remarkably similar in interpretation, a little terser in the earlier, whose recording shows the ills of the age—overbassed, thin at the top and dryish over the range. The new Budapest apparently was not made in best adjustment to room-acoustics: the sound is a little dry and the violins tend to acidity. This gives leadership to the Pascal record with its warm

and friendly sound, although the Pascal playing has not the élan of the Budapesters', nor the immaculate adjustment of their attack.

—Pascal Quartet. Concert Hall CHS 1201. 12-in. (with *Quartet after P Sonata No. 3*). 28 min. \$5.95.

—Budapest Quartet. Columbia ML 4576. 12-in. (with *Quartet No. 2*). 27 min. \$5.45.

NO. 2, IN G, OP. 18, NO. 2 (3 Editions)

Three excellent performances without major differences, but with a number of secondary points favoring Budapest, particularly in the rare nicety of their mechanism. Their sport here is the gayest, their exultation the freest. Sound is excellent too, with particularly satisfying articulation. Pascal, bowing a commendable second, and engineered with less technical prowess, is then second definitely, the sum of its advantages somewhat superior to Kroll's.

A paradox appears in the Budapest-Pascal rivalry here that will appear again. That is, one group—in this case Budapest—has been accorded engineering of closer finesse than the other, but this other gives forth a more agreeable sound. The tone from Pascal in the Second Quartet is sweeter than that from Budapest: it is more ingratiating. It is not the pure Pascal tone: there is no such thing. It is their tone as affected by the circumstances of the recording: the environment, the temperature, the humidity, the attendance, the dispositions taken by the engineers. It does not necessarily imply merit in the recording as such or the playing as such when one string tone is more gracious than another, for the credit may really appertain to a tapestry. Tone may be superior on a record to what it was in the playing, and it may be inferior. The appeal of tone ought to be mentioned here as an important consideration in the complexity of appeals that determines preference; but if the reader discovers inconsistencies of judgment here he will be kind to remember that the inconsistency could have been of musicians, or the weather, or something else.

—Budapest Quartet. Columbia ML 4576. 12-in. (with *Quartet No. 1*). 22 min. \$5.45.

—Pascal Quartet. Concert Hall CHS 1202. 12-in. (with *Quartet No. 3*). 22 min. \$5.95.

NO. 3, IN D, OP. 18, NO. 3 (3 Editions)

There is no convincing basis for preference among the three polished performances of

Beethoven's slightest Quartet. The writer is inclined to favor Kroll in a smaller, primmer projection. Beautiful registration of the Budapest violins, and of the Pascal viola and cello, and no serious faults anywhere.

—*Kroll Quartet. Allegro AL 78. 12-in. (with *Quartet No. 2*). 20 min. \$5.45.

—Budapest Quartet. Columbia ML 4577. 12-in. (with *Quartet No. 4*). 21 min. \$5.45.

—Pascal Quartet. Concert Hall CHS 1202. 12-in. (with *Quartet No. 2*). 21 min. \$5.95.

NO. 4, IN C MINOR, OP. 18, NO. 4

(4 Editions)

The assertive individuality of this Quartet seems particularly well served by the free flight and emphasized harmonies of the Pascals, aided in the recording by a reverberation that gives an effect of airiness. The jeweled nicety of Budapest is something admirable in itself. —Older versions by an older Budapest and the Paganini Quartet are both good, although coarser in quarter-sound than the new records, and replacement of either is certainly not imperative.

—Pascal Quartet. Concert Hall CHS 1203. 12-in. (with *Quartet No. 5*). 25 min. \$5.95.

—Budapest Quartet. Columbia ML 4577. 12-in. (with *Quartet No. 3*). 21 min. \$5.45.

NO. 5, IN A, OP. 18, NO. 5 (4 Editions)

The tone—players' plus hall's plus engineers'—of the Barylli caresses more than the others' (after treble reduction) and theirs is a genial, unaffected performance. Paganini, which of the four groups probably have the best tone before the engineers get busy, are in an older and the least commendable sound, but offer a performance distinguished by courtly grace and sophistication. Pascal, at ease in their forthrightness, offer no trait of individualism but that, which does not mean that theirs may not be the best performance. Budapest have the greatest intensity, the widest dynamics, the least static expression. On the whole they seem to give the greatest satisfaction.

—Budapest Quartet. Columbia ML 4578. 12-in. (with *Quartet No. 6*). 27 min. \$5.45.

—Pascal Quartet. Concert Hall CHS 1203. 12-in. (with *Quartet No. 4*). 28 min. \$5.95.

—Barylli Quartet. Westminster WL 5140. 12-in. (with *Quartet No. 11*). 28 min. \$5.95.

NO. 6, IN B FLAT, OP. 18, NO. 6 (3 Editions)

Except in *la malinonia*, where an added allocation of bass lends a richer gravity to Pascal, this is to Budapest. The quick movements are distinguished by a happy airiness, and the adagio by a reflective delicacy, that make the Budapest interpretation rare and memorable; and the sound in itself is particularly beautiful throughout much of this wonderful music.

—Budapest Quartet. Columbia ML 4578. 12-in. (with *Quartet No. 5*). 24 min. \$5.45.

—Pascal Quartet. Concert Hall CHS 1204. 12-in. (with *Quartet No. 11*). 25 min. \$5.95.

NO. 7, IN F, "FIRST RASOUMOWSKY", OP. 59, NO. 1 (5 Editions)

Three are patently inferior to the other two. The sound of the Busch record betrays its good age. Konzerthaus play with a deliberation hard to accept save in the adagio, and the engineers, giving them a huge sound heated in the bass, have made the violins whistle when high and loud. London, displaying a pleasant, soft tone markedly

Asterisks indicate records reviewed in original Beethoven Discography (No. 3; May 1952). Records listed in parentheses and not discussed were not submitted for review.



RCA VICTOR

“NEW ORTHOPHONIC SOUND”

HERE'S WHAT IT MEANS TO YOU

1. Complete frequency range
2. Constant fidelity from outside to inside of record
3. Ideal dynamic range suitable for home listening
4. Improved quiet surfaces

These “New Orthophonic Sound” recordings will demonstrate the high quality of your equipment.

Rodgers Slaughter on Tenth Avenue and other Ballet Selections. Boston Pops Orchestra. Arthur Fiedler, cond. WDM-1726 \$5.14; LM-1726 \$5.72

Beethoven Concerto No. 5, in E-Flat (“Emperor”). Vladimir Horowitz with Fritz Reiner conducting the RCA Victor Symphony Orchestra. WDM-1718 \$5.14; LM-1718 \$5.72

Chopin Sonata No. 3, in B Minor and Mazurkas. William Kapell. WDM-1715 \$5.14; LM-1715 \$5.72

Brahms Concerto No. 2, in B-Flat. Artur Schnabel with the Boston Symphony Orchestra. Charles Munch, conductor. WDM-1728 \$5.14; LM-1728 \$5.72

Ballet and Bizet. Leopold Stokowski and his Symphony Orchestra. WDM-1706 \$5.14; LM-1706 \$5.72

Early Italian Music. Leopold Stokowski and his Symphony Orch. WDM-1721 \$5.14; LM-1721 \$5.72

Goeb Symphony No. 3 and Bartók Sonata for Two Pianos and Percussion. Leopold Stokowski and his Symphony Orchestra (with soloists). WDM-1727 \$5.14; LM-1727 \$5.72

Wagner Excerpts from Parsifal and Schubert Rosamunde Ballet Suite. Leopold Stokowski and his Symphony Orchestra. WDM-1730 \$5.14; LM-1730 \$5.72

Beethoven Symphony No. 9, in D Minor (“Choral”) and **Symphony No. 1, in C.** Arturo Toscanini and the NBC Symphony Orchestra (with soloists). WDM-6009 \$8.60; LM-6009 \$11.44

Brahms Symphony No. 4, in E Minor. Arturo Toscanini and the NBC Symphony Orchestra. WDM-1713 \$5.14; LM-1713 \$5.72

Elgar Enigma Variations and Brahms Variations on a Theme by Haydn. Arturo Toscanini and the NBC Symphony Orchestra. WDM-1725 \$5.14; LM-1725 \$5.72

HI-FI AWARD WINNERS!

Verdi Il Trovatore. Zinka Milanov, Fedora Barbieri, Jussi Bjoerling, Leonard Warren. WDM and LM-6008 \$11.44.

Don't Let The Stars Get In Your Eyes. Perry Como. 20-5064, 47-5064 89¢.

First Annual Audio Engineering Awards for Musical and Technical Excellence in Classical Recording (Operatic Division) and Popular Recording (Vocal Division).

Prices suggested list, including Federal Excise Tax. Add local tax.



For the first time...

**A
complete listing
of classical
long play
recordings
by
artist
and
orchestra**

Schwann Long Playing Record Catalog, after a year's preparation, has devoted its entire June issue to a comprehensive artist, conductor and orchestra listing.

For example: Brahms' Piano Concerto No. 2 in B Flat Major, Op. 83, on London Records is listed once under Wilhelm Backhaus, the pianist, another time under the Vienna Philharmonic Orchestra, and is cross referenced under Karl Schuricht, the conductor.

Our June issue is a mammoth compilation containing 128 pages of editorial content.

This is the first in a series of semi-annual artist-orchestra catalogs.

Available
at your
record dealer
now.

*Pick up your
copy today.*

schwann
long
playing
record
catalog

131 Clarendon St., Boston 16, Mass.

superior to much of her quartet recording, trots out the wondrous New Italian Quartet aglow in its ethereal, peerless manner, feminine and whispering, to give us the First Rasoumowsky, stalwart and virile, in epicene dress and flavor: Beethoven in lace drawers.

The duelists becoming familiar remain, Pascal and Budapest. Advantages of nuance, dynamics and intra-adjustment cannot be denied to the latter, nor the honesty of their phrasing. Pascal, sturdy and refined both, but less painstaking in detail, less admirable as technicians, seem to give the grand but simple essence more completely, perhaps because the essence in their version is not divisible into exemplary aspects.

—*Pascal Quartet. Concert Hall CHS 1205. 12-in. 37 min. \$5.95.

—Budapest Quartet. Columbia ML 4579. 12-in. 38 min. \$5.45.

—Vienna Konzerthaus Quartet. Westminster WL 5127. 12-in. 41 min. \$5.95.

—New Italian Quartet. London LL 673. 12-in. 40 min. \$5.95.

NO. 8, IN E MINOR, "SECOND RASOUMOWSKY", OP. 59, NO. 2 (3 Editions)

The brevity of this notice is inverse to the length of the Konzerthaus superiority. Last year this record subdued an excellent Pascal: now it stays one of the most heartfelt Beethoven realizations recorded; and the best recording of a most heartfelt realization.

—*Vienna Konzerthaus Quartet. Westminster WL 5098. 12-in. 42 min. \$5.95.

—*Pascal Quartet. Concert Hall CHS 1206. 12-in. 34 min. \$5.95.

—Budapest Quartet. Columbia ML 4580. 12-in. 31 min. \$5.45.

NO. 9, IN C, "THIRD RASOUMOWSKY", OP. 59, NO. 3 (5 Editions)

We do not know in what sequence Budapest chose to record the Sixteen Quartets, but they have been studied here in undeviating numerical ordination, and No. 9 is the first in which the Columbia engineers have entirely accustomed themselves to the features of the Coolidge Auditorium in the Library of Congress. In the eight preceding Quartets we are always a little conscious of the dryness of the cello, and the violins frequently venture close to intractability. Here everything is limpid and refreshing, soaring uncontaminated and uncramped, comparable to the best of the recording Columbia did of the Schneider Quartet for the Haydn Society. In deference to the splendor of the engineering, Budapest have responded with a performance of extraordinary musical delicacy, in the andante of a sustained communal tenacity probably unsurpassable. Admirable; but the broader, tougher, less imaginative work of the Pascals is preferred in one of their candid, panoramic scrutinies that accept the parts as tributary to an inviolable entity. Although without the Columbia transparency, their disk is sonically excellent.

—*Pascal Quartet. Concert Hall CHS 1207. 12-in. 31 min. \$5.95.

—Budapest Quartet. Columbia ML 4581. 12-in. (with Quartet No. 11). 29 min. \$5.45.

—Vienna Konzerthaus Quartet. Westminster WL 5134. 37 min. \$5.95.

NO. 10, IN E FLAT, "HARP", OP. 74 (3 Editions)

Last year the only entry was a sad one from Concert Hall. They have withdrawn it in

*... to those who are
especially particular
about their LP records*

FOR THE FINEST

VIRGIN

UN-TOUCHED

UN-HANDLED

UN-MAULED

MINT-CONDITION

BRAND-NEW

**CAREFULLY-
INSPECTED**

**WONDERFUL
QUALITY**

LP's

you ever put a needle to,

**Securely packed and
promptly shipped**

**ANYWHERE
the mail can go . . .**

write or wire

**RHAPSODY
RECORD SHOP**

**1723 North Highland Ave.
Hollywood 28, Calif.**



**HI-FIDELITY RECORD
HEADQUARTERS**

HIGH FIDELITY MAGAZINE

favor of the best team in their stable. The result is a performance of spirited wholeheartedness and real gusto — qualities not apparent in the exacting finesse of Budapest, who appear not fond of the music. Their record is a succession of glittering patterns, to which the engineers have added a squeal in the violins. The sound given to Pascal is better, but coarse when volume is large. Konzerthaus play with the tenderness characteristic of them, not maudlin here; and despite a trick or two of tempo which will not please, have produced such a sweetness of tone in their long phrases that the record must be accepted as the best of the three.

—Vienna Konzerthaus Quartet. Westminster WL 5149. 12-in. 35 min. \$5.95.
 —Pascal Quartet. Concert Hall CHS 1208. 12-in. 32 min. \$5.95.
 —Budapest Quartet. Columbia ML 4582. 12-in. 29 min. \$5.45.

NO. 11, IN F MINOR, "SERIOUS", OP. 95 (5 Editions)

Old Budapest, having shown their mettle over a course of honorable years, sound too much of metal now for retention in a more expertly recorded batch of challenging performances. — The big contrasts of Barylli suggest that a competent group is trying to make itself a significant group; and there is too much first violin. — Grillier have been recorded to an odd characteristic, one that multiplies bass much more than usual and treble much less, with a tendency in either playing or recording for violins to disappear. This spoils the record, a pity, since the interpretation seems both imaginative and beautiful. — To these ears the Budapest illustration of the difference between brusquerie and surrender is overdrawn in spite of the fineness of the line, and the cello barrels. — The Pascals have it, in one of their disarming and arousing readings, all musical and dramatic honesty, and one of their best recordings.

—Pascal Quartet. Concert Hall CHS 1204. 12-in. (with *Quartet No. 6*). 21 min. \$5.95.
 —Budapest Quartet. Columbia ML 4581. 12-in. (with *Quartet No. 9*). 22 min. \$5.45.
 —Barylli Quartet. Westminster WL 5140. 12-in. (with *Quartet No. 5*). 21 min. \$5.95.
 —Grillier Quartet. London LS 107. 10-in. 22 min. \$4.95

NO. 12, IN E FLAT, OP. 127 (3 Editions)

A Budapest performance of exceptional eloquence has been traduced by the engineers into an unreal and unlovely waste of everyone's time. We seem to hear primitive wind-instruments here. Concert Hall are not to be felicitated on the tone that they have given to the Pascal violins, but this record, older than most in the Pascal series, is nevertheless unmistakably of a string quartet in a robust and understanding performance. Konzerthaus have a beautifully tender exposition of the adagio, but spasmodically elsewhere the violins hurt, and the reinforced bass repeatedly suggests the presence of a string orchestra.

—*Pascal Quartet. Concert Hall CHS 1209. 12-in. 36 min. \$5.95.
 —Vienna Konzerthaus Quartet. Westminster WL 5120. 12-in. 39 min. \$5.95.
 —Budapest Quartet. Columbia ML 4583. 12-in. 36 min. \$5.45.



URANIA

presents two new

50 ~ — 15,000 ~

releases

ALBÉNIZ-ARBÓS "IBERIA SUITE"

L'Orchestre de l'Association des Concerts Colonne
 George Sebastian, conductor.

URLP 7085 1-12" \$5.95

BEETHOVEN-WEINGARTNER "HAMMERKLAVIER SONATA"

Op. 106 (Orchestral Arrangement)

Bavarian Symphony Orchestra—Kurt Graunke, conductor.

URLP 7089 1-12" \$5.95

Recorded with Telefunken microphones on a Magnetophon T9. New Orthaphanic curve.

Our special high fidelity demonstration record is now available. Ask for it at your record dealer.

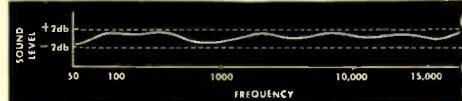

Mercury DISTINGUISHED NEW RELEASES

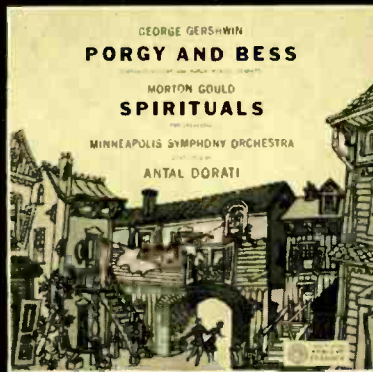

GEORGE GERSHWIN
PORGY AND BESS

MORTON GOULD
SPIRITUALS

MINNEAPOLIS SYMPHONY ORCHESTRA

ANTAL DORATI



SIBELIUS

SYMPHONY NO. 1

MINOR OP. 9

JEAN SIBELIUS

ANTAL DORATI

SIBELIUS — Symphonies 1 through 7 (complete). SIXTEN EHRLING conducting the Stockholm Radio Symphony Orchestra. MG10125, MG10129, MG10141, MG10142, MG10143

GERSHWIN-BENNETT — *Porgy and Bess*, Symphonic Picture; **GOULD** — *Spirituals for Orchestra*. **ANTAL DORATI** conducting the Minneapolis Symphony Orchestra. MG50016

STRAUSS — *Ein Heldenleben*. **ANTAL DORATI** conducting the Minneapolis Symphony Orchestra. MG50012

GOULD — *Latin-American Symphonette*; **BARBER** — *"School for Scandal" Overture*, *Adagio for Strings*, *Essay No. 1*. **HOWARD HANSON** conducting the Eastman-Rochester Symphony Orchestra. MG40002

SMETANA — *Ma Vlast ("My Fatherland")*. **RAFEL KUBELIK** conducting the Chicago Symphony Orchestra. OL-2-100

RESPIGHI — *The Pines of Rome; The Fountains of Rome*. **ANTAL DORATI** conducting the Minneapolis Symphony Orchestra. MG50011

Please send me the complete listing of MERCURY CLASSICS LIVING PRESENCE recordings.



Mail to: Mercury Record Corp.
 1733 Broadway New York 19, N. Y.

Name

Address

City

NO. 13, IN B FLAT, OP. 130 (3 Editions)
 There are musical performances on rare occasions which auditors cannot forget, although the fallible brain cannot remember what made them unforgettable beyond a suffusive excellence unique to their experience with the players performing or the singers in grand form. Such occasions come without warning and are not repeated—such a performance of the *Appassionata* by Rachmaninoff, of *Figaro* by a cast never notable before, of the *Winterreise* by a young baritone not himself able to tell how that time he did it so well. We need recordings of such things to make them truly imperishable except as adjectives, but the unceremonial nature of recording sessions does not often capture the single exalted performance, which usually requires an unprepared and relaxed audience. Nevertheless the Pascal playing of the Thirteenth Quartet does seem like such a performance, figuratively unforgettable, and literally, as long as the record lasts. Relaxation and confidence seem to be at the bottom of their unaffected warm delivery of the complex simplicities of this Quartet. (This is a victorious carry-over from last year, and as such, in the interests of paper and ink, was not entitled to further comment; but it seems even better than last year, and paper and ink will be saved at the expense of the competitors.)

—*Pascal Quartet. Concert Hall CHS 1210. 12-in. 37 min. \$5.95.
 —Budapest Quartet. Columbia ML 4584. 12-in. 36 min. \$5.45.
 —Barylli Quartet. Westminster WL 5129. 34 min. \$5.95.

NO. 14, IN C SHARP MINOR, OP. 131 (4 Editions)

Superlatives are fairly applied to the Budapest interpretation of the greatest Quartet. In a different and perhaps harder way this is as masterly as the Pascal Thirteenth. Where Pascal have made their beautiful effect by a union of the burgher virtues of application and honesty with unanimous insight and extraordinary health, the Budapest triumph is obviously the result of a studied analysis and practice for a perfection equally complete in musical understanding and mechanical mastery. Their feat is to have maintained intact the enormous emotional potency of the music while weaving a texture of the first fineness. The fabric is built with a delicate vertical equality remarkable enough anywhere, and astonishing in this grievous part of Beethoven's autobiography. Subdued passages, especially when slow, heighten poignancy and spiritualize melancholy when whispered close to the vanishing point with a unified clarity that does not vanish. One is not likely ever to hear the slow movements—and there are three—played with more telling command; and the other three records of the work, honorable as they are, together offer a smaller aggregate of recognizable superiority. The sound that Columbia has given to Budapest is adequate if not admirable: it is at its best at fairly low volume.

—Budapest Quartet. Columbia ML 4585. 12-in. 38 min. \$5.45.
 —*Pascal Quartet. Concert Hall CHS 1211. 12-in. 38 min. \$5.95.
 —Barylli Quartet. Westminster WL 5144. 12-in. 39 min. \$5.95.

NO. 15, IN A MINOR, OP. 132 (6 Editions)
 Impressive testimony to Beethoven's serene equipoise in matters of form is visible in the minute number of his works where popular affection is concentrated on one movement—the adagio of the "Moonlight" Sonata, minuet of the Septet, possibly the scherzando of the Eighth Symphony. The Fifteenth Quartet is not a popular work, but its "Thanksgiving" adagio dominates the repute of this work, and the commentary on it, to a degree not found in any movement of any other work. In performance this results in a mobilization of powers on the one movement to make it perfect, with a consequent and probably unconscious slight to the requirements of the others. In the records this is illustrated in every case except one: a beautiful adagio is enclosed by rather wry playing.

Now the critic must eat half a crow. He must apologize for the damage that his notice of the Griller Quartet a year ago may have done to the Messrs. Griller, the Messrs. London, and to those who may read him. The Griller interpretation is quite easily the best and so too their recording. The fault in the criticism resulted from critical impatience with surfaces whose own sound competed heartily with the music engraved therein. A new copy of the disk with respectable surfaces reveals an emphatic superiority of concept and recording throughout: in a devout "Thanksgiving" as well as intelligently-aimed surrounding movements, their rorment clear, their statement bold.

—*Griller Quartet. London LL 318. 12-in. 45 min. \$5.95.
 —*Budapest Quartet (old). Columbia ML 4006. 12-in. 40 min. \$5.45.
 —Budapest Quartet. Columbia ML 4586. 12-in. 44 min. \$5.45.
 —Pascal Quartet. Concert Hall CHS 1213. 12-in. 46 min. \$5.95.

NO. 16, IN F. OP. 135 (4 Editions)

Barylli give a pleasant performance until one hears the others, when one begins to object to the Barylli devotion to what Turguenieff called "the opposite commonplace", the routine inversion of the ordinary to make an immediate effect. Relaxed when others are tense, and tense when others are relaxed, the Barylli effect is not only immediate but temporary. Agreeable sound. Budapest have a few moments of preciosity in the first movement and then overcome their self-consciousness to make a beautiful continuation aided by the best recording of the work, the best that Columbia has given us in the series, and one that makes the record as a whole preferable to Pascal.

—Budapest Quartet. Columbia ML 4587. 12-in. (with *Great Fugue*). 24 min. \$5.45.
 —*Pascal Quartet. Concert Hall CHS 1212. 12-in. (with *Great Fugue*). 22 min. \$5.95.
 —Barylli Quartet. Westminster WL 5151. 12-in. (with *Great Fugue*). 24 min. \$5.95.
 —(*Scherzo and lento only.*) NBC Orch., Arturo Toscanini, cond. Victor LCT 1041. 12-in. (with *Sym. No. 5; Leonora No. 1 and Prometheus Ovs.*). 11 min. \$5.72.

GRAND FUGUE IN B FLAT, OP. 133 (5 Editions)

Multiplying the quartet does not harm this staunch work—in this opinion a hundred strings would be right—and two of the records are by string orchestra. Mr. Mün-

VOX

new...
UHF
(ULTRA HIGH FIDELITY)
RECORDINGS

<i>Brabms:</i>	PIANO CONCERTO NO. 1, D MINOR, OP. 15 <i>Friedrich Wuehrer, piano — Vienna State Philharmonia — Hans Swarowsky, conductor</i>	PL 8000
<i>Chopin:</i>	MAZURKAS <i>Guionar Novaes, piano</i>	PL 7920
<i>Handel:</i>	4 SONATAS FOR RECORDER & CONTINUO <i>Alfred Mann, recorder—Helmut Reimann, cello—Helma Elsner, harpsichord</i>	PL 7910
<i>Mahler:</i>	SYMPHONY NO. 1, D MAJOR <i>Pro Musica Symphony, Vienna—Jascha Horenstein, conductor</i>	PL 8005
<i>Monteverdi:</i>	VESPRO DELLA BEATA VERGINE (1610) <i>Soloists — The Swabian Choral Singers — The Stuttgart Bach Orchestra—Hans Grischkat, conductor</i>	PL 7902
<i>Offenbach:</i>	LA BELLE HELENE (Abridged) <i>Soloists—Raymond Saint-Paul Chorus—Lamoureux Orchestra—Jules Gressier, conductor</i>	PL 20.500
<i>Shostakovich:</i>	SYMPHONY NO. 5, OP. 47 <i>Vienna Symphony Orchestra—Jascha Horenstein, conductor</i>	PL 7610
<i>Stravinsky:</i>	HISTOIRE DU SOLDAT <i>Soloists—Instrumental Ensemble under Fernand Oubradous</i>	PL 7960

Ask your dealer for the New Complete 1953 Catalog

VOX PRODUCTIONS, INC. 236 W. 55th St., New York, N. Y.

chinger's band suffers from old engineering pains: a bad rumble and incorrigible violins. The Litschauer performance seems as good as it did last year, with its sound still vivid, difficult to reproduce but not exceptionally for a good amplifier. Any of the four-man versions will serve, but Barylli have an advantage in the clarification of the parts provided by themselves or the engineers, a clarification particularly important in fugue and especially in this fugue where we want to have the right element dominant to preserve sense. In addition, the best tone is provided on the Westminster record.

—Barylli Quartet. Westminster WL 5151. 12-in. (with *Quartet No. 16*). 17 min. \$5.95.

—*Vienna Chamber Orch., Franz Litschauer, cond. Vanguard 419. 12-in. (with *Purcell: Chaconne; 3 Fantasias*). 15 min. \$5.95.

—Budapest Quartet. Columbia ML 4587. 12-in. (with *Quartet No. 16*). 16 min. \$5.45.

—Stuttgart Chamber Orch., Karl Münchinger, cond. London LL 526. 12-in. (with *Bach: Ricercare; 2 Fugues*). 17 min. \$5.95.

QUARTETS AFTER PIANO SONATAS SONATA NO. 3 (1 Edition)

The arrangement was not made by Beethoven: it is careful and conscientious, and gives opportunity to the Pascal Quartet to have a holiday pleasant for them and for us. The sound is real in a reverberant way after reduction of the treble.

—Pascal Quartet. Concert Hall CHS 1201. 12-in. (with *Quartet No. 1*). 22 min. \$5.95.

SONATA NO. 9 (1 Edition)

Beethoven made this setting.

—*New Music Quartet. Bartok 909. 12-in. (with *Quartet No. 9*). 14 min. \$5.95.

VARIATIONS

FOR PIANO (32) IN C MINOR, G 191 (1 Edition)

—*Orazio Frugoni. Vox PL 6040. 12-in. (with *Quintet. Op. 16*). 10 min. \$5.95.

FOR PIANO (6) IN D, "TURKISH MARCH", OP. 76 (1 Edition)

The theme was later appropriated for the well-known fragment in *The Ruins of Athens*. The Variations are curiously restful and naïve, giving an uncomplicated kind of pleasure that we are often reluctant to admit. Mr. Steurer is above everything else neat, and his demure style here, probably touched by a sense of humor, catches the sport without strain. This assures a record destined for longevity, since a piano's tone has not been seized with a realism like this on more than four or five disks.

—Hugo Steurer. Urania 7033. 12-in. (with *Sonatas No. 13 and 20; and Rondos, Opp. 51 and 129*). 6 min. \$5.95.

FOR PIANO (15 AND FUGUE) IN E FLAT, "EROICA", OP. 35 (1 Edition)

The theme was later more elaborately varied in the finale of the "Heroic" Symphony. It had previously served as a contra-dance and in the finale of the *Prometheus* Ballet. It remains in recognizable evidence throughout the transformations that Beethoven gives to it in a set of variations that here provide Mr. Gulda with an opportunity for brilliant and impressive piano-playing. The sound is large, unusually easy in the treble, the bass pleasant.

WESTMINSTER NEWS

ANOTHER GREAT HIGH FIDELITY PIANO CONCERTO RECORD

MacDowell

PIANO CONCERTO NO. 1

in A minor, Op. 15

PIANO CONCERTO NO. 2

in D minor, Op. 23

Vivian Rivkin—Piano. Orchestra of the Vienna State Opera, conducted by Dean Dixon WL 5190

\$10,000 HI-FIDELITY CONTEST CLOSES

May 31 marked the deadline for entries in Westminster's New High Fidelity recording technique contest. Thousands of names were suggested. A panel of leading musicologists and audio engineers will study the results and make their decision. The winners will be announced in this publication's September issue.

Westminster Wins GRAND PRIX DU DISQUE AWARD

Prokofieff

LT. KIJE

SUITE, Op. 60

Vienna Symphony Orchestra, conducted by Hermann Scherchen WL 5091



Spectacular Recordings

Each "Sounds of Our Times" pressing is a masterpiece of the recording art. Each is produced as a mint copy, to become a collector's item. Each is worthy of being played on the finest high-fidelity equipment.

If you love fine music, you will find unending pleasure in owning a complete set of the records listed below.

If you are a hi-fi enthusiast, you will be delighted to hear how magnificently these wide-range records show off the performance of your audio system.

Order these latest additions to "Sounds of Our Times" series, produced under the supervision of Emory Cook:

COOK LABORATORIES, Manhattan-Pacific Bldg., Pacific St., Stamford, Conn.

Please send following 10" unbreakable 33-1/3 wide-range records at price indicated, plus 50c postage, per shipment:

() 1027: FIESTA FLAMENCA *Carlos Montoya*, guitar, transients, castanets, dancing \$4.00.

() 1052: PERCUSSION & PEDAL *Reginald Foort* (Cheshire) In the Mosque, Console Calisthenics, a new type of organ record, with organ booklet \$4.00

() 1053: REGINALD FOORT IN THE

MOSQUE Light Cavalry Overture, Anvil Chorus, Scherzo, Prelude 3rd Act, Monastery Garden \$4.00

() 2064: MASTERPIECES FROM THE THEATRE \$4.80

() 2065: MOZART G MINOR SYMPHONY \$4.80

() 2066: MASTERPIECES OF THE DANCE "Some of the finest sound to be heard on records," *Time Magazine* \$4.80

Name

Address

—Friedrich Gulda. London LLP 322. 12-in. (with *Sonata No. 26*). 22 min. \$5.95.

FOR PIANO (6) IN F, OP. 34 (1 Edition)
The composer had a strong liking for these ingenious excursions which are worth a truer piano-tone than the one recording vouchsafes.

—Leonard Shure. Vox PL 6360. 12-in. (with *Diabelli Variations*). \$5.95.

FOR PIANO (33) IN C, ON A WALTZ BY DIABELLI, OP. 120 (2 Editions)

The artificial sound of Mr. Shure's piano is less tolerable than a year ago; regrettable, since Mr. Horowitz's much superior engineering does not communicate as much enlightenment.

—Mieczyslaw Horowitz. Vox PL 7730. 12-in. 48 min. \$5.95.

—Leonard Shure. Vox PL 6360. Two 12-in. (with *Variations, Op. 34*). 53 min. \$11.90.

FOR PIANO AND VIOLONCELLO (7) IN E FLAT, ON "BEI MAENNERN", G 158 (4 Editions)

Serkin-Casals is practically a trio, a continual sturdy thudding, as from the agitation of an unstable microphone, inserting a rhythmic punctuation. Mr. Casals contributes cellism of utmost sensitivity, Mr. Serkin little. Messrs. Zecchi and Janigro play a pleasant equality and receive an admirable clarity of sound. Theirs is the best version, but the Graudan disk is good enough to retain.

—Carlo Zecchi, Antonio Janigro. Westminster WL 5173. 12-in. (with *P & Vo Sonata No. 3*). 11 min. \$5.95.

—*Joanna Graudan, Nikolai Graudan. Vox VL 6150. 12-in. (with 2 other sets of *Variations*). 9 min. \$5.95.

—Rudolf Serkin, Pablo Casals. Columbia ML 4572. 12-in. (with *P & Vo Sonata No. 2* and *Variations, Op. 66*). 11 min. \$5.45.

—(Adolph Baller, Gabor Rejto. Allegro AL 75. 12-in. (with *P & Vo Sonata No. 5* and 2 other sets of *Variations*). \$5.45.)

FOR PIANO AND VIOLONCELLO (12) IN F, ON "EIN MAEDCHEN ODER WEIBCHEN", OP. 66 (3 Editions)

Mr. Serkin's subjection harms a record notable for beautiful playing by Pablo Casals. The Graudans are a team.

—*Joanna Graudan, Nikolai Graudan. Vox VL 6150. 12-in. (with 2 other sets of *Variations*). 10 min. \$5.95.

—Rudolf Serkin, Pablo Casals. Columbia ML 4572. 12-in. (with *P & Vo Sonata No. 2* and *Variations, G 158*). 11 min. \$5.45.

—(Adolph Baller, Gabor Rejto. Allegro AL 75. 12-in. (with *P & Vo Sonata No. 5* and 2 other sets of *Variations*). \$5.45.)

FOR PIANO AND VIOLONCELLO (12) IN G, ON "SEE THE CONQUERING HERO", G 157 (2 Editions)

—*Joanna Graudan, Nikolai Graudan. Vox VL 6150. 12-in. (with 2 other sets of *Variations*). 12 min. \$5.95.

—(Adolph Baller, Gabor Rejto. Allegro AL 75. 12-in. (with *P & Vo Sonata No. 5* and 2 other sets of *Variations*). \$5.45.)

FOR PIANO, VIOLIN AND VIOLONCELLO (10) IN G, ON "ICH BIN DER SCHNEIDER KAKADU". (ADAGIO, VARIATIONS AND RONDO) OP. 121a (1 Edition)

—*Alma Trio. Allegro AL 40. 12-in. (with *Trio No. 3*). 17 min. \$5.45.

ADDENDA

SONATA FOR PIANO AND VIOLIN NO. 1, IN D, OP. 12, NO. 1

SONATA FOR PIANO AND VIOLIN NO. 10, IN G, OP. 96

—Ginette Doyen, Jean Fournier. Westminster WL 5176. 12-in. 18, 23 min. \$5.95.

Poetic instinct here is laudable and tone is precarious. Miss Doyen, properly with the bigger part, seems not at ease, and Mr. Fournier, intoning eloquently, draws an uneven line. The hazards of recording are vivid in this pair of sonatas which give an unwanted fifth string to No. 1 and no sign of it in No. 10, the piano-sound being good in both. The outstanding virtue is that the piano commands according to the composer's intentions and as few records permit when a fiddler is present.

AN DIE FERNE GELIEBTE, OP. 98

GELLERT LIEDER, OP. 48

—Elena Nikolaidi, contralto; Jan Behr, piano. Columbia ML 4628. 12-in. (with *Schubert: 6 Songs*). 13, 12 min. \$5.45.

Miss Nikolaidi's sensuous dark tones are the first of a woman to record Beethoven's cycle *To the Faraway Beloved*, whose appealing romanticism is obtaining a recognition on the phonograph denied to it in recital. Her natural tonal voluptuousness is a peculiarly suitable conveyance for the composer's pantheism in the Gellert songs; and in fact this record has a pretty rich statement of all its contents, some passages of vocal insecurity being redeemed by emotional understanding and very clear reproduction of voice and piano.

SONATA FOR PIANO AND CELLO NO. 4, IN C, OP. 102, NO. 1

SONATA FOR PIANO AND CELLO, NO. 5, IN D, OP. 102, NO. 2

—Carlo Zecchi, Antonio Janigro. Westminster WL 5180. 12-in. 16, 21 min. \$5.95.

The record proclaims immediately and maintains throughout both its sides two considerable virtues. The equality of the players is exactly just, and the quality of sound in reproduction has a whipping accuracy ahead of any other recording of the combination. These virtues are just right for delineation of fugue, and impose the choice of this version in Sonata No. 5. In No. 4, however, Messrs. Bogin and Starker for Period, spry and imaginative and supported by good if not outstanding sonics, earn a favorable decision and leave discophiles dangling between the contrary lures. — Both these duos have now recorded all five sonatas.

CONCERTO FOR PIANO NO. 5, IN E FLAT, "EMPEROR", OP. 73

—Walter Gieseking; Philharmonia Orch., London, Herbert von Karajan, cond. Columbia ML 4623. 12-in. 39 min. \$5.45.

It is heartening that successive "Emperors" tend to displace their predecessors. It indicates a fundamental good sense on the part of the manufacturers and progression in the abatement of technical problems. The Horowitz-Reiner performance, which rather surprisingly (because Mr. Horowitz's best-known style is antipathetic to this kind of music) was considered the best in the Beethoven discography, had its weakest aspect in the distribution of the orchestral forces for the recording. Technically there is no salient weakness in the Gieseking-Karajan record: technically it is the best record. Nothing sensational in it, but amidst the general excellence we can hear an especially rare and commendable peculiarity: the strings have a truer and more incisive value than the winds. Gieseking here is more manly than the Gieseking of the 78's made with the Vienna Philharmonic under Bruno Walter; and while his aloofness here makes us sigh for Schnabel's marriage of majesty with humanity — in the modern engineering which we cannot have — and admittedly there is something portly in his nobility, the record on its aggregate of good things seems to prevail. The piano is really a piano in reproduction; the Philharmonia is broadly convincing; and the accord between conductor and pianist is by now a musical tradition.

VARIATIONS (33) ON A WALTZ BY DIABELLI, OP. 120

VARIATIONS (15) AND FUGUE ON A THEME FROM "PROMETHEUS", OP. 35

—Claudio Arrau, piano. Decca DX 122. Two 12-in. 54, 26 min. \$11.70.

Here some good piano-playing is wasted on a reproduction which has artificial metal in it. The tone is consistently just a little wrong whenever it is loud, and the hearer will find this a strain. For the Diabelli Variations Mr. Horowitz's record for Vox is preferable, and for the *Prometheus* or *Eroica* set the London disk of Mr. Gulda withstands the challenge.

SONATA FOR PIANO, NO. 29, IN B FLAT, "HAMMERKLAVIER", OP. 106

—Wilhelm Backhaus. London LL 602. 12-in. 41 min. \$5.95.

The great "Hammerklavier" seems to be a London affinity. Although young Friedrich Gulda's record (LL 422) still seems to be the best, the internal movements by Wilhelm Backhaus (who is no longer young) on the present disk are beautiful examples of relaxed romanticism not bettered on disks; and if the enclosing movements have a labored grandeur, they have also long passages of grand clarification. Good piano-sound.

SONATA FOR PIANO NO. 21, IN C, "WALDSTEIN", OP. 53

SONATA FOR PIANO NO. 30, IN E, OP. 109
—Rudolf Serkin. Columbia ML 4620. 12-in. 26, 22 min. \$5.45.

Good recording cannot redeem Mr. Serkin's embarrassing fussing with tempos in a display of unwanted individuality. Everyone is warned against this flashy *Waldstein*; and Mr. Serkin is begged to behave as a musician and not as a pianist.

— FINIS —

News of the SME



EDITOR'S FOREWORD: *For the past several issues, there has been a dearth of information in HIGH FIDELITY about the Society of Music Enthusiasts. The reason is simple: early discussion of the Society in the Magazine produced so much correspondence and work that available staff, working entirely on a volunteer basis, was thoroughly swamped. We therefore felt it wiser, and fairer to everyone, to withhold further publicity until the SME could receive proper attention. That time has now arrived — and therefore the report, below, of the present status of the Society.*

For those of our readers who have not seen past references to the Society of Music Enthusiasts, it should be pointed out that, after the founders of the Society had formulated their ideas and plans, they faced the problem of translating these ideas into a working organization. About six months ago, HIGH FIDELITY Magazine agreed to support the Society by making available mechanical facilities (i.e., handling membership applications, mailings, bookkeeping, etc.) and publishing facilities. The latter referred specifically to printing and distributing the Society's bulletin.*

In March 1953, the Society was officially activated. In May, HIGH FIDELITY decided that only just so much work could be accomplished in spare time. In May, a full time worker was taken on to handle SME affairs. Lisbeth Weigle was a most fortunate find — and the immediate result was that the first SME bulletin was mailed to members in the latter part of May. The second immediate result is her report, below. — C. F.

IF ANY of you think you've got problems fixing your temperamental amplifier or eliminating a new hum in your speaker, you should be secretary to the Society of Music Enthusiasts! It's not that I don't know *how* to write, the editors of HIGH FIDELITY tell me gently — it's just that I don't know when to stop! The SME has me so fascinated that I typed 243 lines instead of the 121 allowed. So . . . by gritting my enthusiasm between my typewriter platen, I'll give you the Society's news minus all unnecessary verbiage!

In the month of May the SME moved into high gear. Individual memberships increased. The official SME bi-

*In HIGH FIDELITY, Nos. 6 and 7.

monthly Bulletin was published and mailed to all Society members. New local Chapters were activated.

The Toronto SME Chapter, under the leadership of Mr. Avie Rotenberg, set a terrific pace, easily qualifying as the "Busiest Chapter of the Month". Outstanding authorities in the world of hi fi and music acted as guest speakers for the monthly meetings of the Chapter. Mr. H. Goldin, Chief Engineer for the J. Arthur Rank Organization, spoke in January on the installation of the sound system used in connection with the Metropolitan Opera Company's appearance at the Maple Leaf Gardens. At another meeting, Mr. J. B. Smyth, Canadian representative of the English Wharfedale Wireless Works, discussed the installation of high fidelity equipment in the home — the problems encountered and suggestions on how they can be overcome. He explained that the size of the room and the furnishings were the major problems. To demonstrate the effect of speaker-location in a room, Mr. Smyth used a sand-loaded corner enclosure fitted with a 15-inch Wharfedale bass speaker; a small separate enclosure held a Wharfedale 5-inch Tweeter and a 10-inch mid-range speaker. Both speakers were directed upwards and toward the rear wall which gave a much better dispersion of sound. Mr. Smyth used the Wharfedale three-way cross-over of 800 and 5,000 cycles.

Mr. Rotenberg's write-up of the Toronto Chapter's March meeting stated proudly: "We were fortunate in having Mr. David Yeddeau, Stage Manager of the Winnipeg Ballet, as our speaker. He got a big hand for a well-delivered and humorous talk, and his interpretation of several passages from the *Sleeping Beauty* score and other ballets. No, he did *not* dance!". In April Mr. Harold D. Weiler, author of *High Fidelity Simplified*, spoke to the collected members of Toronto's SME Chapter.

Three new Chapters of the Society were organized in the late Spring. Mr. Arthur D. Gordon, Chairman of the Detroit Chapter, is described by a friend as "an avid listener who has very good equipment and is conversant with the problems of a good music reproducing system. He is a member of the Engineering Society, as well as being acquainted with many of the musicians in the Detroit Symphony Orchestra". SME's Chapter in Pensacola, Fla., has Dr. Nathan S. Rubin as Chairman; and Mr. Austin K. Gutman fills the chairmanship of Philadelphia's brand-new Chapter.

For the benefit of readers of HIGH FIDELITY who didn't

happen to see previous issues of the Magazine in which SME was described, I feel I should give you some explanation of what the Society stands for, the qualifications for membership and last, but-oh-so-far-from-least — how much it costs.

Mr. Lawrence Epstein, Managing Director of the Society, describes SME eloquently: "Without the impetus of carnival publicity the SME has been born. It has attracted persons of every station and interest. From the amoebic tissue of the Society shall grow a living, active, and ambitious organization stemming from the enthusiasm of hundreds of confident members. The SME is not a commercial effort. It sells nothing, it offers no special or material incentive. It is what its members can and will make of it — an opportunity to discover new comrades in music, to share the talents and enthusiasms of fellow members, and to participate in the local and national efforts of the Society. The SME is *your* Society — lock, stock, and barrel. *You* will write its score and wield the baton!"

I'll let SME's National Chairman, Mr. Ronald Lowdermilk, (of the Radio and Television Section of the U. S. Office of Education) explain the qualifications needed for membership in the Society of Music Enthusiasts. "The only qualification needed is that a person have a sincere love of music. It doesn't matter if your preference runs to the classics, Lower Basin Street, or Rosemary Clooney's latest recording. You need no technical knowledge of high fidelity nor must you have a hi fi installation in your home. Certainly you don't have to be a trained musician, and if you haven't the faintest idea of the difference between a coda and a quarter-rest, who cares?"

I've whipped up my own metaphor to answer a question

some readers may have in mind: "Why belong to a local SME Chapter?" Think of the Society itself as an avenue — a sort of musical boulevard on which you, as an individual member, can walk. Here you'll bump into many other individual members who feel as you do about hi fi or music, but on a street you can't stop to talk too long, no matter how enthusiastic or pleasant your conversation. And so if you want to take your newly-found friend home with you, the local SME Chapter in your community can be more than just a quick meeting spot — it can be your musical "home". No longer do you have to be an isolated enthusiast; in your local Chapter of the Society you can become part of an exciting family whose members have all sorts of different talents, knowledge, or equipment.

The membership dues are painlessly low. You pay \$3.00 a year if you do *not* subscribe to HIGH FIDELITY, and a mere \$2.00 if you are a subscriber. The difference in rate is caused by the Magazine's plan to bind the SME Bulletin (to which you are entitled) into copies of HIGH FIDELITY going to member subscribers, thus effecting a substantial saving in production and mailing costs. Family members are "for free" for those under 16, and \$1.50 a year for 16-year-olds and older.

If you decide to join SME but don't want to mar this copy of HIGH FIDELITY by cutting out the application form on this page, drop me a note and I'll send you one.

All right, so I'll close down my typewriter and totter home. In fact, I'm not even going to wait to see if my final writing attempt passes the inspection of the editors.

Lisbeth Weigle, Executive Secretary
The Society of Music Enthusiasts
Great Barrington, Mass.

<p>MEMBERSHIP APPLICATION: SOCIETY OF MUSIC ENTHUSIASTS</p> <p>Please fill in separate form for each member and check below type of membership for which application is being made.</p> <p><input type="checkbox"/> Full Member (Dues \$3.00 a year; if subscriber to High Fidelity Magazine, \$2.00)</p> <p><input type="checkbox"/> Family member age 16 and over (Dues: \$1.50 a year)</p> <p><input type="checkbox"/> Family member under age 16 (No dues). Please give date of birth: Month _____ year _____</p> <p>..... NAME PLEASE PRINT CLEARLY</p> <p>..... ADDRESS</p> <p>..... CITY ZONE STATE</p> <p>I hereby apply for membership in the Society of Music Enthusiasts and agree to abide by its By-Laws</p> <p>..... SIGNATURE</p> <p>CHECK () CASH () M. O. () FOR \$..... ENCLOSED</p>						<p>To help in planning programs and in preparing material, please give us as much of the following information as possible:</p> <p>What is your business or profession?.....</p> <p>To what other societies, organizations, or clubs devoted to interests similar to the SME, do you now belong?.....</p> <p>What musical instruments, if any, do you play?.....</p> <p>Do you participate in musical activities: frequently () occasionally () seldom ()</p> <p>If, so, please specify type of activity.....</p> <p>How many concerts or musical events have you attended in the past 12 months?.....</p> <p>Please number the following types of music in order of preference:</p> <p>symphony () chamber () opera () popular () jazz () show music () instrumental () choral () vocal () other.....</p> <p>Have you a high fidelity phonograph or radio system?.....</p> <p>If so, did you install and connect it yourself?..... Have you built any audio equipment yourself?.....</p> <p>In which of two basic types of SME programs and material would you be most interested: on music () on sound reproduction ()</p> <p>Would you like to be advised of the formation of an SME Chapter in your vicinity?.....</p>					
NO.	DATE	ENTD	HF	CL	CHAP						

Your FM tuner deserves

The Right Antenna

By MILTON B. SLEEPER

If your FM reception is poor, don't blame your location or your receiver. Chances are that you have an inadequate antenna, and there is a lot you can do to improve your reception. Here's sound advice on selecting and installing the right antenna to give you best results.

IF ONLY we could get the New York Philharmonic programs on Sunday over FM! Of course, we listen to it on AM, but there's so much noise that it spoils the music." I had stopped at South Norwalk, en route from Boston to New York, to call on some old friends who, before they moved out from the city, seldom missed a Sunday concert at Carnegie Hall.

At that time, the spring of 1940, Major Edwin H. Armstrong, inventor of FM, was carrying the CBS broadcasts of the Philharmonic Concerts over his FM station W2XMN.¹ I had been staging a series of FM demonstrations in Boston for Pilot Radio. They were among the very first companies to get into production on FM sets, and I had one of the new table models in my car. It was an excellent receiver, with a cabinet large enough to contain an 8-in. loudspeaker.

To me, that remark about not being able to get FM from New York was a challenge. Without stopping to think that the airline distance to W2XMN was nearly 55 miles, I said: "Of course you can get the Philharmonic Concerts on FM. Just give me a hand to carry the set I have in my car, and I'll show you how easy it is!"

My host went along to help me, but he explained in an indulgent tone: "You'll see that I was right. We had an FM set here for a week, but we couldn't get a thing. Oh, we did hear something, but it was drowned out in the noise."

A Good Antenna Makes the Difference

We put the set down in the house, and then I went out again to get a simple dipole antenna that I used for demonstration purposes. I took it up to the second floor, leaned out a window directly above the location of the set, propped

the antenna mount on the roof, and dropped a two-wire lead-in down to the ground. Finally, I fished the lead-in through a window near the set, and connected it to the proper terminals.

"What's all that for?" my host asked.

"That's a simple FM antenna. It isn't very good, but I think it will do. What did you use for an antenna on the other set you had here?"

"I didn't have an antenna. Well, at least, I think the set had a built-in antenna."

Meanwhile, I had plugged in the power cord and switched on the set with the volume turned down while the tubes warmed up. When I tuned in W2XMN by watching the eye, I knew that I had a good, strong signal. By way of being a little dramatic, I said: "Now you are going to enjoy the most perfect reproduction of the New York Philharmonic you have ever heard!"

With that, I turned up the volume, and there indeed was the music they had wanted but hadn't been able to get before. Despite the considerable distance from the transmitter, the reception was just as perfect as I had said it would be. Needless to say, my friends were delighted.

And their little daughter, aged four, paid FM one of the most sincere compliments I have ever heard. After she had listened intently for a few minutes to a piano solo, she turned to her mother and said: "It sounds as if he's playing right inside that box!"

Special Antennas Needed for FM

The moral of this story is that it is just as necessary to have an antenna for FM as it is for TV. The characteristics of the lower frequencies used for AM broadcasting are entirely different from those of the VHF frequencies on which FM and TV_s signals are transmitted. People take it for granted that a TV set must have an antenna, but they do not realize that the FM broadcast band is directly above TV channel 6. This is illustrated in the accompanying chart which shows the locations of the

¹Major Armstrong's station is actually located at Alpine, N. J. The call letters are now KE2XCC, but the call was W2XMN in 1940. This station has been on the air since April 10, 1938.

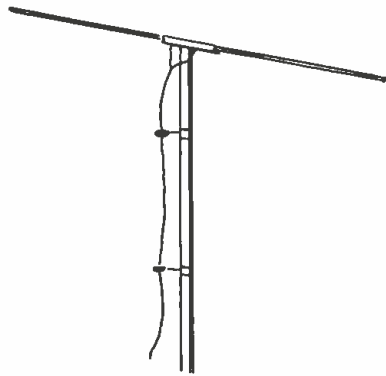

STRAIGHT DIPOLE: *This is the basic high frequency antenna. Seldom used now because of difficulty in matching to receiver. Directional: front and back.*

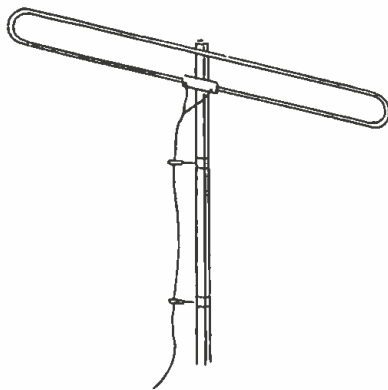

FOLDED DIPOLE: *Very common. Directional: best reception from front and back. Low gain. Even efficiency over entire FM band. Mfrs.: Ward, JFD.*

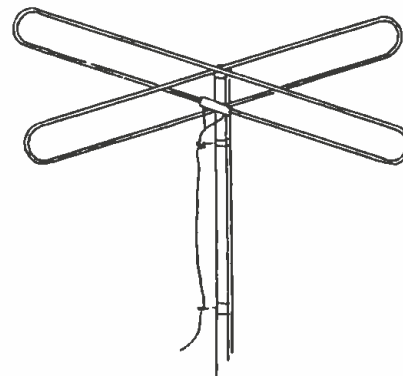

OMNIDIRECTIONAL FOLDED DIPOLE: *Receives from all directions with approximately equal but very low efficiency. Mfrs.: Ward, JFD, Clearbeam, Amphenol.*

AM, FM, and TV bands in the radio frequency spectrum.

Perfect, noise-free reception can be obtained on FM with a much weaker signal than is required for clear, sharp TV pictures. Thus, FM does not require as elaborate or expensive an antenna as is necessary for TV reception over the same distance, but — in all but a few rare cases — it does need something more than a built-in antenna.

Unfortunately, in the beginning of FM, dealers were reluctant to suggest to people that they should spend a few dollars extra for an antenna. In those days, even Major Armstrong discounted the importance of this adjunct. I remember asking him about the best kind of an antenna to use for FM. He said, "Oh, you can get good reception with just a few inches of wire."

That was true then, and still is — *if* a set is operated under sufficiently favorable conditions, within a few miles of an FM station. It is possible to get television reception, too, in some locations, with a makeshift antenna. However, in most cases it is reasonable to assume that an antenna will be required.

Many Factors Influence Antenna Selection

What kind of an antenna is necessary? Well, that depends on a number of factors. One of them is the sensitivity of the FM receiver. Some manufacturers have always made high-sensitivity receivers. There are others whose current models have been improved greatly in that respect over their earlier designs. Some built sets in large quantities after the war that were so insensitive on FM that it almost seemed as if they were intended to show up FM at a disadvantage in comparison with AM.

Related to sensitivity is limiting action, by which noise and inter-station interference are reduced or com-

pletely quieted. These factors² are generally specified in manufacturers' literature as, for example: "5 microvolts required for 30 db quieting." Sensitivity is, as the word implies, the ability of the tuner to respond to weak signals.

The importance of high sensitivity depends upon the distance over which reception is required, and the type of antenna to be used. A good antenna installation increases the strength of the signal at the receiver antenna terminals. How elaborate an antenna installation is required depends on individual circumstances, including sensitivity of the FM tuner. In metropolitan areas, where FM stations are nearby, a moderately sensitive set and a simple antenna may be adequate. A simple antenna with a high-sensitivity set (or a good antenna with a moderately sensitive tuner) will probably give good results well out into the suburbs. Greater distances call for combining the best in receiver design and antenna installation.

Noisy locations also call for high sensitivity and a good antenna, for the stronger the signal, the more effective the noise limiting action of the tuner. If the theoretical receiver mentioned above will provide 30 db of quieting with a 5 microvolt signal, it will quiet a great deal more background noise (such as ignition interference) with a 10 microvolt signal.

Factors Influencing Signal Strength

The strength of a signal from a given FM transmitter at the antenna terminals of a particular receiver depends on many factors, including the following:

²For a complete discussion of factors to be considered in selecting an FM tuner, see the article "How to Select an FM Tuner" in *HIGH FIDELITY* No. 5 (Summer 1952).

This chart shows how widely the AM channels are spaced from those assigned to FM and TV. Receiving characteristics in the medium

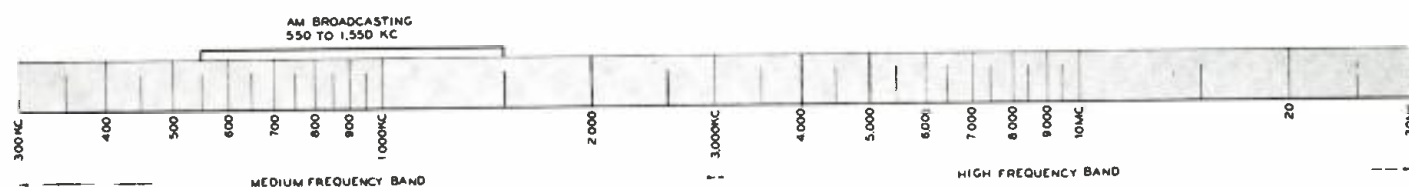

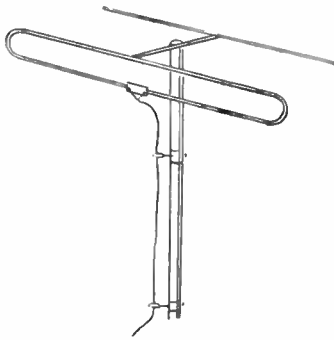

DIPOLE WITH REFLECTOR: *More efficient and directional than dipole without reflector. Best efficiency from front. Mfrs.: Ward, Taco, RMS, Ampheno.*

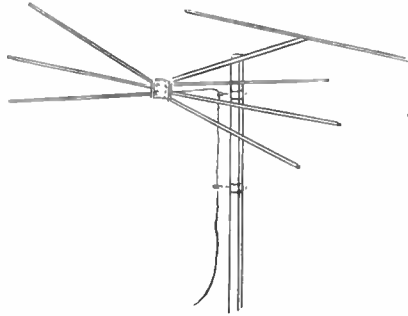

CONICAL WITH REFLECTOR: *Similar in characteristics to dipole with reflector but generally more evenly efficient throughout FM band. Mfrs.: JGD, RMS.*

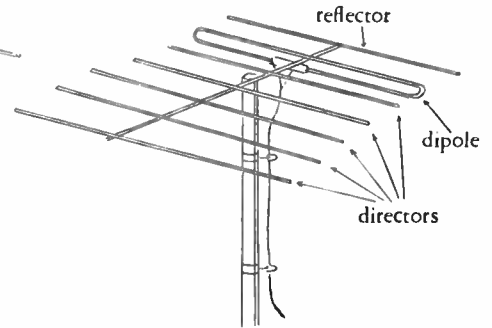

YAGI: *Best efficiency, best directivity, but poorest bandwidth coverage of any type. May be stacked. Mfrs.: Vee-D-X, RMS.*

1. Power of the FM transmitter.
2. Height of the transmitting antenna.
3. Distance from transmitter in receiving area.
4. Intervening topography (mountains, buildings, etc.).
5. Topography surrounding receiving area (because of reflection of signals).
6. Prevailing atmospheric conditions.
7. Height of receiving antenna.
8. Location of receiving antenna (one chimney may give better results than another!).
9. Type of transmission line (lead-in) used from receiving antenna to receiver.
10. Design of receiving antenna.

There is nothing much which can be done about the first six factors. The last four, however, are subject to careful consideration, and the last — design of receiving antenna — is the most important.

Antenna Height

As far as height of the receiving antenna is concerned, the general rule holds that the higher the antenna, the stronger the signal which will be picked up. This advantage is counterbalanced by another rule: There is a certain loss of signal strength due to lead-in, increasing with its length. It is generally agreed that, if care is used in selecting the type of lead-in, the gain due to increased antenna height will offset the loss caused by the increased length of the lead-in. However, in most cases, practical considerations limit antenna height — perhaps 10 to 40 ft. above roof level is average — and therefore loss from lead-in need not be considered.

Factor 8, in the list, should be mentioned here: at a given distance from the transmitter, the signal is likely to

be stronger in one spot than in another — and the distance between spots may be a matter of 10 or 20 ft. The reasons are complex; suffice it to say that for optimum results, it is wise to test the antenna in different locations and at different heights until the precise area of maximum signal strength is found. Most often, there is just one chimney to which an antenna can be attached — which settles that problem!

Lead-in Wires from Antenna

In most installations, 300-ohm twin-lead is used. Most FM tuners are designed for use with this type of wire. And most antennas — TV as well as FM — are designed to match 300-ohm line. Only in special cases is it necessary or advisable to use anything else. Those special cases nearly always involve noise from local sources such as passing cars, trucks, or diathermy machines. If standard 300-ohm twin-lead, twisted 180° per foot as it comes down from the antenna, and all other methods such as increased antenna height, fail to cure the trouble, a different type of lead-in may be indicated.

One type is *shielded* 300-ohm twin-lead. This is simply standard twin-lead around which a braided shield has been wrapped. Its disadvantage is that the loss per foot is considerably greater than that of the unshielded variety. Thus antenna height should be kept low when shielded twin-lead is used.

A second type is coaxial cable. This is an inner conductor with a shield around it, very precisely spaced to maintain a 72-ohm impedance. (There are other types of coaxial cable which have different impedances; forget them!) Like shielded twin-lead, coaxial cable has a higher loss per foot than ordinary twin-lead. *Continued on page 112*

frequency band are totally different from those in the VHF and UHF bands. Therefore totally different antenna systems are required.

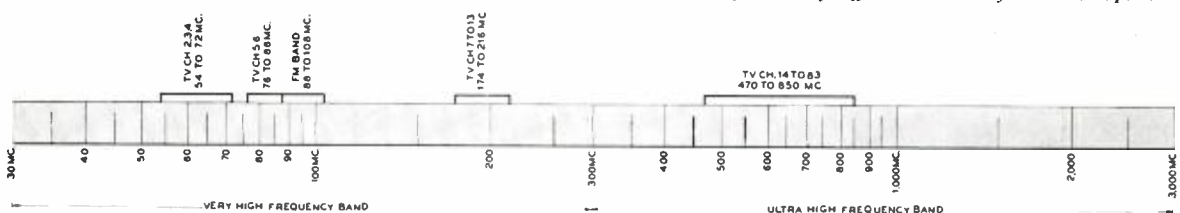

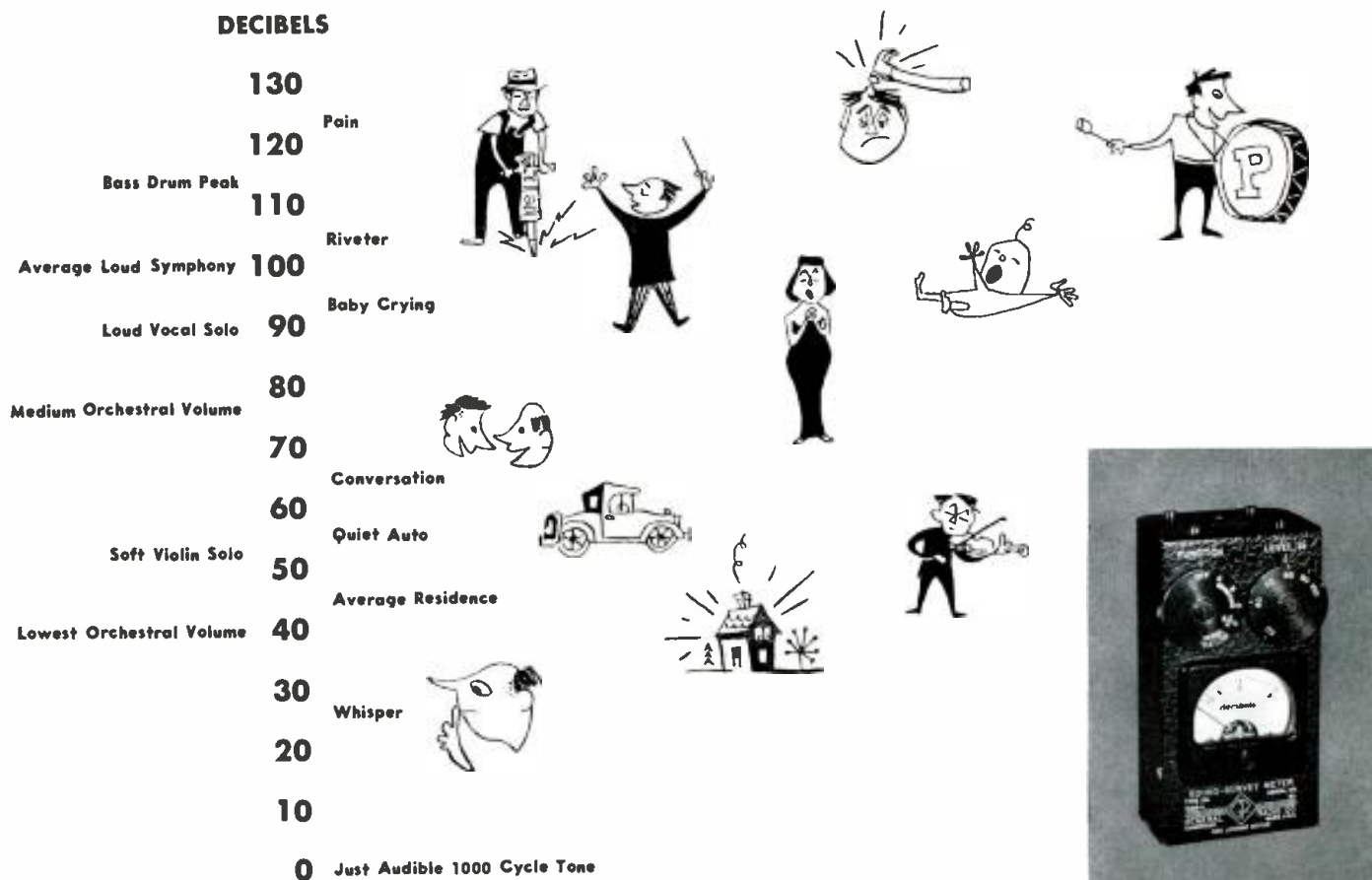

SOUND POLL *by Charles Fowler*

YOU MAY be making a grievous mistake if you get involved with the gadget shown above. If you read further, you, your family, and your friends may live to regret it. And HIGH FIDELITY Magazine cannot assume any responsibility.

Nor can the General Radio Company, who will not, by the way, appreciate having their highly scientific Sound-Survey Meter type 1555-A called a "gadget". Perhaps if I could keep this whole affair on the gadget level, it would be all right. But it is just about impossible to have an S-S meter around the house for more than fifteen minutes without going scientific. And then in no time you'll wind up at the local movie house, annoying those around you with the discovery that audience nose-blowing during the big sob scene is worth 5 db. Your secretary will borrow the meter and prove that the typewriter which she's been using happily all these years actually creates a sound intensity of 90 db or so at her eardrums, and this is dangerously close to what the S-S meter instruction manual says is "probably unsafe for every day exposures". That will cost you a new typewriter.

You will also discover that the gleaming Kingfisher Special which you ride around in is about the noisiest contraption on four wheels. This fact will so fascinate you that you'll forget to watch where you're going; that will be the end of the Kingfisher Special, the S-S meter which you were holding in your right hand, and you.

As you can see, the S-S meter is something to stay away

from. Nevertheless, having it around has been not only fascinating but instructive and useful. I've learned a lot about sound; I've discovered what's wrong with a speaker cabinet, and cured a resonance in a pickup system. I showed a neighbor why he should move his favorite listening chair 3½ feet to the right, where everything sounds a lot better and the hum from a fluorescent desk lamp, across the room, doesn't bother him any more.

What is this gadget? Essentially, it's a sensitive microphone, several stages of amplification, and a meter which indicates the sound level at the microphone. It's extremely compact: 6 by 3 by 2½ inches. It is a precision instrument, capable of metering a wide range of sound levels, from a soft whisper to more noise than is made by a sledge hammer crashing on a steel plate: from about 40 to 135 db.

Sound levels are generally measured in terms of decibels referred to a standard level: zero db is the intensity of a 1,000-cycle note which is just barely audible to a human with very good hearing. This scale in the sketch above will give you an idea of how decibel measurements relate to noises and sounds with which you are familiar.

The range of sound intensity which the human ear can tolerate is phenomenal. If the intensity of that just-audible 1,000-cycle note is increased a thousand times, the result is the level of a quiet home: 30 db. If the quiet-home sound intensity is increased tenfold, it will reach that of lowest orchestral volume — 40 db on the chart.

And, if we measure the orchestra at its loudest, full *fortissimo*, the sound intensity will have increased 1,000,000,000 times!

It might be well to mention here that acousticians recognize a difference between intensity and loudness. Intensity is objective: it is the true strength of a sound measured by instruments. Loudness is subjective: it is the apparent strength as we hear it. For example, the ear is most sensitive to sounds with a frequency of about 3,000 cycles. To produce a just-audible sound at 50 cycles would require a million times as much power as would be required at 3,000 cycles. As has been pointed out in previous articles in HIGH FIDELITY, the difference in sensitivity of the ear varies not only with frequency but with intensity. Kinsler and Frey¹ show that a sound which has an intensity level of 20 db at 1,000 cycles would have to be increased to 50 db at 100 cycles to appear equally loud, but if the 1,000-cycle intensity level were instead 60 db, at 100 cycles the intensity level would have to be only 70 db for apparent equal loudness.

It is because of this characteristic of hearing that many manufacturers incorporate loudness controls (as opposed to volume controls) in their amplifiers and pre-amplifiers. And it is for the same reason that readings of the S-S meter can be weighted below 1,000 cycles so that they can be interpreted in terms of loudness rather than intensity.

Specifically, the left-hand dial of the instrument has seven positions. The first is OFF; the next three are the weighting positions, with A being used for intensities below 55 db, B between 55 and 85 db, and C above 85 db. A fourth position extends the range of the instrument by 30 db, and the last two positions are used to check the filament and plate voltages (the S-S meter is powered by a small flashlight battery and a tiny B battery such as would be used in a hearing aid). The C position is normally used for measuring frequency response of audio equipment, although it is possible to make a rough check on the efficiency of a loudness control by using the weighting positions. For example: you should be able to feed a 1,000-cycle tone through your audio system at a level of 90 db, measured on the C setting of the S-S meter, and switch to a 100-cycle tone without having the meter change appreciably. Then, if your loudness control functions properly, you should be able to drop the level of the 1,000-cycle tone to 50 db, switch to the A scale on the S-S meter, drop to 100 cycles, and still read about 50 db.

The chances of your achieving this goal are rather slim. There are about seventy-two different reasons why — some of them quite fascinating. In fact, I spent hours in one field of experimentation alone: room acoustics. That was what demonstrated the need to move my neighbor's

favorite listening chair. G. A. Briggs wrote a feature article in an earlier issue of HIGH FIDELITY on this subject, so there is no need for us to go into it in any detail. It can all be summarized by saying that sounds bounce all over a room. The bounce pattern is different for every frequency. At any given spot, the intensity varies for each frequency, ranging from almost no sound for one frequency to full loudness for another.

At high frequencies the bounce is terrific. It becomes less severe as the frequency is lowered. In one experiment, I put the S-S meter on the edge of a desk, and ran an audio oscillator from 10,000 cycles down to 50. Down to about 800 cycles, the most miniscule shift of frequency caused the meter to fluctuate wildly. By the time the frequency had been lowered to 100 cycles, the meter needle was moving back and forth slowly. Yet changing the position of the meter by a few inches made a very considerable difference in the reading. To give you a specific example: with the meter set up on a table about 7 feet from the loudspeaker, I got a reading of 72 db. Moving the meter 3 feet further away put it into a zone of no sound or null; the reading was 52 db. Then I moved it back until it read 62 db and measured the distance: exactly 7¼ inches!

Even though the meter was positioned *between* me and the speaker, my slightest move changed the reading in the middle-frequency range. Turning my head made the reading drop by several db. Reaching for a pencil caused a fluctuation of about 4 db. Mind you, these readings were not the result of the noise of turning my head (my neck doesn't creak that much!) but rather stemmed from the difference created in the bounce pattern — in this case, by changing the reflection of sound back to the meter.

I really shouldn't use that word "bounce". Three major factors are involved: reflection, refraction, and absorption. Each frequency is affected to a different degree by each factor. The combination is the confusion which I have been loosely calling bounce.

You can see, from the foregoing, why it is so difficult to make accurate measurements on a loudspeaker in anything other than a free field or an anechoic chamber. However, improved accuracy can be achieved if the S-S meter is moved closer to the loudspeaker. I set one up on a typewriter case, about 8 inches in front of the cone of a rather poorly housed 12-inch speaker. Starting with 70 db at

1,000 cycles, I moved the oscillator down the frequency range. At 800 cycles, the reading was 72 db. It stayed relatively steady down to 80 cycles, where the reading was 69 db. Then it started going down. At 60 cycles, it was 65 db — at 30 cycles, it wasn't! There was a little bump, of a few db, at 48 cycles — cone or cabinet resonance, no doubt.

The reason I suggested moving the *Continued on page 118*

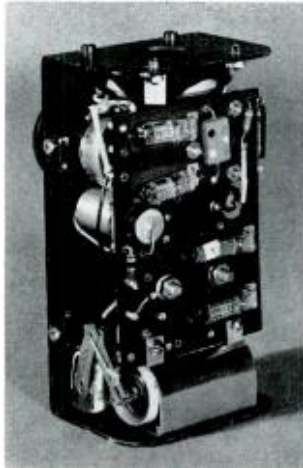

Rear view with cover removed shows extremely compact arrangement.

¹Fundamentals of Acoustics. John Wiley & Sons, 1950.

TESTED IN THE HOME



These reports may not be quoted or reproduced, in part or in whole, in any form whatsoever, without written permission from the publisher.

Brook Amplifier System

SPECIFICATIONS (furnished by manufacturer): 30-watt power amplifier and preamplifier. Model 4 preamplifier can be used with either 10-watt model 12A or 30-watt model 10C power amplifier. **Accessories:** power supply for preamplifier, needed when preamp is not used with power amplifier. Also a remote control "de-commercializer" switch which drastically cuts volume. **Inputs:** 4 low-gain inputs for tuners, etc., and one high gain input for variable reluctance cartridges. **Controls:** seven: on-off, volume, loudness in-out, treble, bass, record equalization, input selection. **Output impedances:** 2, 4, 8, and 16 ohms grounded, and 500 ohms ungrounded. **Gain** (including power amplifier) 95 db from low gain inputs, 110 db at 1,000 cycles from high gain input. **Intermodulation distortion,** 30-watt model: 0.97% at 2 watts, 1.24% at 10 watts, 1.69% at 30 watts. **Tubes:** preamp — one 6J7 (or 1620), two 6SJ7, two 6C4; power amplifier — two 2A3 (or 300B), one 6SN7, six 6J5, one 5U4G. **Prices:** model 10C 30-watt power amplifier, \$228.00; model 12A 10-watt power amplifier, \$118.50. Preamplifier and power amplifier, combined, 30-watt, \$331.50; 10-watt, \$222.00. **Address:** Brook Electronics, Inc., 34 DeHart Place, Elizabeth 2, N. J.

Brook amplifiers have set a standard of fidelity almost since the beginning of hi-fi. Two features have characterized these units: high quality and their designer's insistence that the best way to achieve optimum fidelity is by the use of triode tubes throughout. The triode vs. pentode argument has not been (and maybe never will be) settled. Certainly, Brook achieves superlative amplification and we need not, therefore, pay too much attention to how it is achieved. Very few changes have been made during recent years in the characteristics of the power amplifier; the preamplifier was modernized last Fall to increase its flexibility. Overall result is very fine, clean, sound output. Hum is inaudible — a feature much stressed by Brook engineers. Gain is more than ample for direct connection of a Fairchild cartridge.

Tone controls are of the step type (as opposed to continuous). The bass control has 10 steps, the range being

Fig. 1. Complete system. Snap switch controls decommercializer.



from minus 18 to plus 27 db at 50 cycles when the loudness control is at about 3 o'clock. Because of the loudness feature, bass boost is considerably higher at low volume levels. Step 4 is flat. The treble control also has 10 steps, providing a range of from 36 db cut to 10 db boost at 10,000 cycles. Position 8 is flat.

The loudness control boosts the bass only. All five input channels have level controls.

The record equalization control has 9 positions, giving the following combinations:

Boost at 50 cycles	Turnover Frequency	De-emphasis at 10,000 cycles
23.0 db	600 cycles	12.5 db
23.0	600	16.0
13.3	500	16.0
12.2	500	10.5
18.0	400	6.0
18.0	400	12.5
16.0	400	12.5
17.0	400	14.5
14.0	250	6.0

The foregoing specifications are those furnished by the manufacturer. A spot check with frequency test records



Fig. 2. Rear of preamplifier. Large socket is for power cable.

indicated that in actual performance the specifications were met within close tolerances.

A tenth position on the record equalization control provides 110 db of flat amplification so that the phono input channel may be used for a microphone. If both phono pickup and microphone are to be used interchangeably (as in tape recording), an external switch could be added so that it would not be necessary to disconnect the phono input lead.

Output from the preamplifier to power amplifier is through a multi-wire cable, to the left in Fig. 2. This cable also carries power for the preamp.

A second output connection is provided on the rear of the chassis, just to the right of the cable connection socket in Fig. 2. This is normally connected by a long wire to the de-commercializer switch. Throwing the switch on reduces volume at the speakers almost to inaudibility. This extra output jack may also be used as an input-to-tape connection. Note, however, that the output level at this jack is affected by the position of the loudness control on the preamp.

On the back of the preamp chassis are three AC outlets, controlled by the main on-off switch.

The preamplifier phono input is loaded to match 47,000 ohms, which will be satisfactory with G-E and Audak cartridges. For optimum results, the resistance should be changed to 27,000 ohms when the preamp is used with Pickering cartridges. Alternatively, a resistance of ap-

proximately 62,000 ohms can be wired across the pickup.

Incidentally — or perhaps it is not so incidental, at that — the instructions which accompany the Brook units are exceptionally complete and helpful.

Certainly, the 30-watt Brook system is a very fine combination. Good sound, careful design and engineering, a sufficiently large number of record equalization positions to meet most variations, and an exceptional degree of control over bass and treble response: these features add up to thoroughly enjoyable listening.

P.S.: After completing this report, Brook advised us that they are introducing a self-powered preamplifier, to be known as the Model 7. It is identical with the Model 4 discussed above, except that a power supply has been added. Overall frequency response is stated to be within 1 db from 15 to 30,000 cycles. Price is \$119.70. — C. F.

Gately Super Horn

SPECIFICATIONS (furnished by manufacturer): two models of corner enclosures, one for 12 and one for 15-inch speakers, each available in mahogany or blond wood finish (simulated). **Size:** 12-inch model — 34 ins. high, 15 ins. from corner, 20 ins. along wall; 15-in. model — 37 ins. high, 17 ins. from corner, 21½ ins. along wall. **Prices:** \$75 to \$85, depending on size and finish. **Address:** The Gately Development Laboratory, Glouster Pike, Barrington, N. J.

Although there are myriad designs of loudspeaker enclosures, three general types predominate: infinite baffles, reflexes, and horns. There are additional basic types; there are many cross-breeds, utilizing characteristics of two or more types; there are mutations within types. The infinite baffle is typified by mounting a speaker in a wall between two rooms, or using a very large, totally enclosed cabinet. The aim is to utilize only the radiation from the front of the cone. Bass reflexes employ the



Cut - away view shows interior construction of 15-in. enclosure. Note large opening at bottom and sloping panels which form part of horn mouth.

principle of resonance to 1) reduce the response peak at cone resonance and 2) add an enclosure resonance to improve extreme low-frequency response. Good results

can be achieved provided speaker and cabinet characteristics are precisely matched.

An extreme example of the horn principle is a theatre speaker: a relatively small cone is placed at one end of a long horn whose throat expands to a mouth which is at least several feet wide. In the musical sphere, tubas utilize the same principle. In home audio systems, horn-type enclosures apply the horn principle to sound radiation either from the front or from the back of the speaker, or sometimes from a combination of both. The Gately Super Horn, as shown by the sketch, utilizes the horn

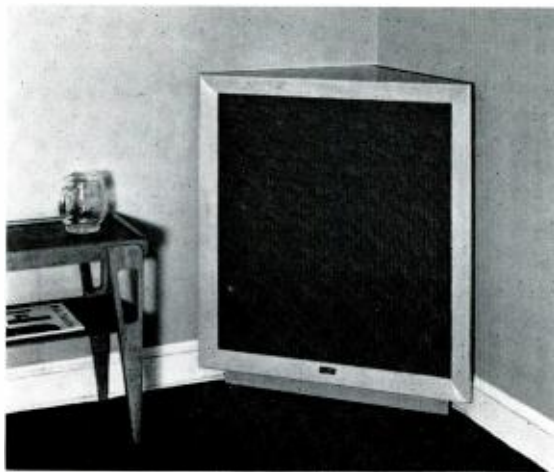

Compact corner enclosure uses walls and floor as part of horn.

principle for the radiation from the back of the speaker cone, thus reinforcing sound produced from the front of the cone.

Horns require long throats and large mouths. To keep the size of the enclosure to a minimum, Gately uses the corner walls and the floor of the room as part of the horn throat and mouth, designing the interior so that the throat expands at an optimum rate.

The effect of the Gately is to improve response below 100 cycles or so and to lower the frequency, and the

strength, of the sound peak caused by speaker cone resonance. Data published by Gately shows, for instance, that a typical 12-in. speaker resonated at 52 cycles in an infinite baffle, at 61 cycles in 4 cu. ft. box, and at 38 cycles in the Gately. Thus the range of clean reproduction was extended by almost an octave.

Listening tests for this report confirmed these data. The model designed for 15-in. speakers was used; response was clean and smooth down to below the expected resonance of the speaker itself. Bass was reinforced slightly. The cabinet did not "color" the basic sound characteristics

of the speaker. A mellow-sounding speaker will sound mellow in the Gately; a brilliant speaker will lose none of its brilliance or crispness.

It is important that a 12-in. speaker be used in the cabinet designed for that size unit, and that the Gately model for 15-in. speakers be used only with 15-in. units. The 15-in. cabinet should not be used with 12-in. speakers; the effectiveness of the horn will be somewhat lost. Otherwise, speaker match to cabinet is not critical and the Gately will give excellent results in relatively little space. Since rear horn loading

Continued on page 123

Two Altec Speakers

SPECIFICATIONS (furnished by manufacturer): Model 601-A is a 12-in. coaxial speaker having a 1.8-pound magnet, aluminum ribbon voice coil with an impedance at 400 cycles of approximately 8 ohms. Model 602-A is a 15-in. unit with a 2.4-pound magnet, same impedance characteristic. Both use a coaxially-mounted tweeter with a 1-in. diaphragm at the throat of a small horn which has a cut-off at approximately 2,000 cycles. Tweeters in both units are identical. Both speakers utilize a series-type, 6-db-per-octave, dividing network (capacitor and inductance) which is tapped so that volume level of tweeter, in comparison to woofer, can be dropped as much as 4 db. High-frequency horn is mounted slightly off-center to avoid cancellation effects. **Power rating:** 20 watts. **Prices:** 601-A, \$89.00; 602-A, \$114.00 net. **Address:** Altec-Lansing Corp., 9356 Santa Monica Blvd., Beverly Hills, Calif.

Both speakers give very clean, brilliant sound. Best comparison we can think of is that with either unit, we felt that the sound was similar to that produced by use of close-mike technique in recording: crisp and distinct. Frequency response is exceptionally flat — influenced, as usual, by cabinet design. Use of the Altec 606 cabinet (price \$118.00) helped low-frequency reproduction. High-frequency dispersion is good.

As may be expected, low-frequency reproduction is better with the 15-in. unit. Cone resonance is estimated (by us) to be in the low forties for the larger speaker, in the low fifties for the 12-in. unit.

Cone resonant frequency varies with a number of factors, including such unusual ones as atmospheric conditions and age, but the lower it is, the better will be reproduction down to that point in the frequency spectrum.



Both 12 and 15-inch speakers are identical in appearance. Small tweeter horn is mounted slightly off-center, is powered by separate voice coil.

Below cone resonance, there is likelihood of frequency doubling and other undesirable distortions. That's one reason why the larger cone gives better bass response.

Incidentally, the Altec 606 cabinet is of bass reflex design, shaped to fit a corner, and is one of the heaviest and most sturdily built we have seen. Rigid, well-braced and well-padded construction of this type helps noticeably to keep speaker response clean and free from resonant peaks. This contributed no doubt to our opinion that both these speakers possess a marked degree of brilliance combined with cleanness; the 15-in. unit adds a bit of bass and so sounds slightly fuller. — C. F.

Permoflux Headphones

SPECIFICATIONS (furnished by manufacturer): Two basic models of headphones: standard and high-fidelity, both of dynamic (moving coil) type of construction. Each model available with either 12 or 300 ohms impedance, and each available either with both phones wired together, monaural model, or wired separately for binaural listening. **Response:** both standard and high fidelity series are, according to chart, almost perfectly flat from 100 to 3,000 cycles. The standard series show a slight (3 db) rise to about 4,200 cycles, then drop off so that the useful range ends at 5,500 cycles. The high-fidelity series show a droop of around 4 db from 3,000 to 5,000 cycles, then peak up 4 db at 6,500, and drop off at 7,500 cycles. **Accessories:** ear cushions are normally supplied. **Address:** Permoflux Corp., 4900 West Grand Ave., Chicago 39, Ill.

Headphones are never going to replace hi-fi loudspeaker systems, but there are many occasions when they are not only useful but essential. Monitoring during a tape recording session almost always requires headphones. If loudspeakers are used for monitoring purposes, the sound may be picked up by the microphone — and then bedlam breaks loose. And there are those who insist that the only way to listen to binaural reproduction is with headphones; speaker systems cannot give a true binaural effect (this seems to be theoretically true, though binaural even over speakers is dramatic).

Continued on page 92



**Of course he's using Soundcraft Recording Tape
...it's **micro-polished*****

Perfect reproduction — that's the reason why more and more engineers today demand Soundcraft Professional Recording Tape.

Soundcraft is the only professional tape that is Micro-Polished. The only tape that is polished, buffed and re-polished by a special process to produce a surface that is mirror-smooth, completely free of even the most minute irregularity. The results of Micro-Polishing are apparent to any sound engineer:

- Lower distortion**
- Uniformity of output**
- Improved high frequency response**
- Better head contact**
- Less friction, longer head life**

Soundcraft Professional Recording Tape incorporates all the features developed by Soundcraft research engineers during the last two years: **pre-coating** to insure better adhesion, prevent curling and cupping — **dry lubrication** to eliminate squeals. The 7" reel has the 2 $\frac{3}{4}$ " hub, eliminating torque problems and resulting in better timing. All this, plus a splice-free guarantee on all 1200' and 2500' reels.

Why settle for less than the best? Next time, insist on Soundcraft Professional Recording Tape. It's Micro-Polished!



REEVES

SOUNDCRAFT CORP.

* PATENT APPLIED FOR

WRITE FOR FREE INFORMATION — DEPT. F-7

10 East 52nd Street, N. Y. 22, N. Y.

The problem of even approaching loudspeaker reproduction with relatively tiny headphones is a serious one, and Permoflux has done a surprisingly good job. The amount of bass reproduction is unexpected; we feel that realism in the low frequencies is helped by the ear cushions which, in addition to keeping external sounds out, provide a sort of air chamber in which the sound has a chance to generate. This seems to help give the illusion of listening to sound generated in a room by means of loudspeakers. Older earphones, which clamped tightly and directly to the ear, seemed particularly lacking in low-frequency response. The illustration shows the cushion arrangement and also makes apparent the large size of the diaphragm area, another difference that old timers, accustomed to something like a 3/8ths-inch hole in the earpiece, will note with interest.

The peak in the high frequencies is noticeable. Cutting down on high-frequency response by means of the treble tone control will help, or it would be possible to design a corrective network if phones were used extensively.

It may be heresy, but we enjoyed listening with earphones! We could play the records as loud as we wanted



Large pads make these earphones comfortable and improve sound.

without bothering anyone. We could listen to whatever we wanted. And the sound had a new "flavor" — old wine in new bottles. Try it, sometime. — C. F.

The Karlson Enclosure

SPECIFICATIONS (furnished by manufacturer): a rectangular loudspeaker enclosure for 15-in. speakers, adapter available for 12-in. units. **Dimensions:** 34½ ins. high, 22¼ ins. wide, 18 ins. deep. **Shipping weight:** 120 lbs. in shipping carton. **Finish:** Formica, simulated blonde or mahogany. Also available unfinished on special order. **Prices:** \$117.60 finished, \$75.00 unfinished. Add \$2.00 for adapter for 12-in. speakers. **Address:** Karlson Associates, 1379 East 15th Street, Brooklyn 30, N. Y.

Design of the Karlson is decidedly unusual, as can be seen from the sketch. Note that the speaker does not attach directly to the front panel but is, so to speak, aimed at it. The front panel opening has the exponentially tapered shape shown in the photograph, and this is an

important part of the secret of the smooth response achieved by the Karlson. The theory is that the cabinet forms an air column; by making a tapered opening, the harmonics created by a normal air column are smoothed out to provide improved low-frequency response.

Radiation of sound from the front of the speaker passes through the front panel; radiation from the back follows a devious course to blend with, and reinforce, that from the front.

Response of the cabinet-with-speaker is not especially affected by speaker characteristics, so any good speaker can be used. A coaxial-type speaker can be used, or a tweeter can be added and mounted inside the cabinet.

Because the entire output of the speaker feeds *through* the cabinet, sound output of the speaker will be "colored"

perceptibly by the cabinet. It is decidedly difficult to describe just what the Karlson does to the sound from the speaker; it is not a matter of resonances (the Karlson produces surprisingly few spurious resonances). Using the same make and size of speaker in an infinite baffle and in the Karlson, the sound from the Karlson will be fuller — as if heard from fairly far back in the concert hall as compared with row A. A violin will sound a bit as if its mute had been applied. Whether or not this effect is liked by the listener is a matter of personal taste — and much depends on the speaker. A subdued-sounding speaker will sound more subdued, but the Karlson cabinet may well take the edge off a hard-sounding speaker. — C. F.

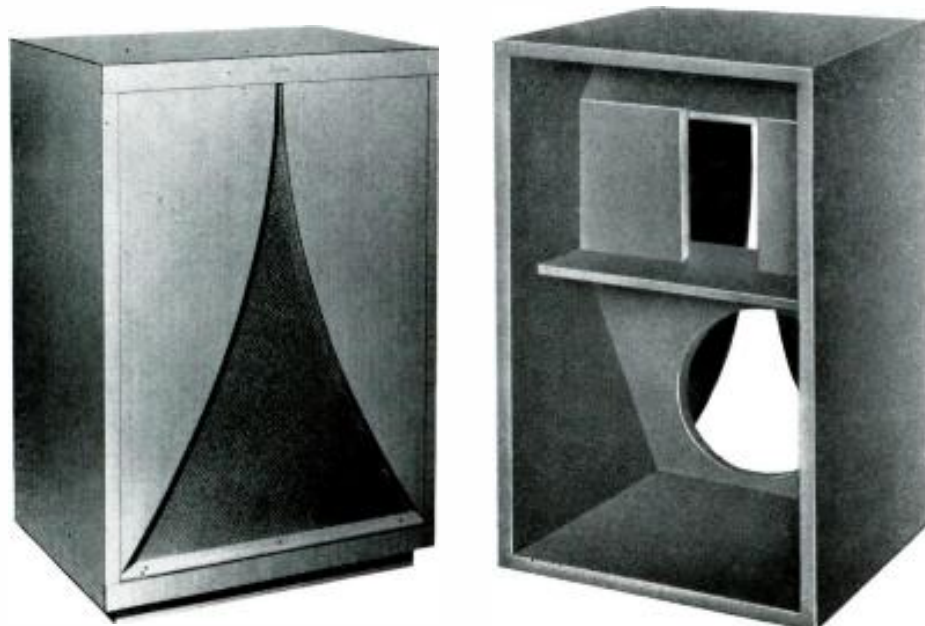

Two views show construction of cabinet. Note tapered front and complex internal design.

**Here is the first basic advance
in tone arm design in
many decades!**



The GRAY "Viscous-Damped" 108-B Tone Arm

Gives you perfect contact and tracking on all records at lowest stylus pressure—virtually eliminates tone arm resonances—cannot damage record if accidentally dropped.

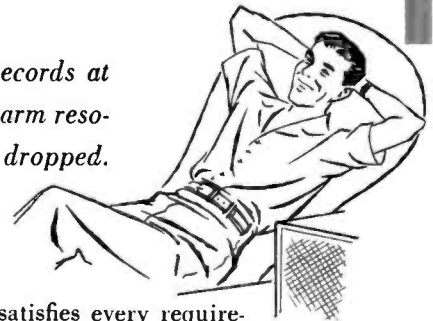

If your record collection includes old favorites, with grooves so worn that the stylus jumps or skids—or if your equipment is subject to floor vibrations that can cause groove-jumping—you'll welcome the new Gray 108-B. Its "viscous-damped" design provides perfect tracking, as well as eliminating any possibility of record damage if the arm is accidentally dropped.

The 108-B satisfies every requirement of high fidelity reproduction.

A plug-in feature permits instant change from 78-rpm to 33 $\frac{1}{3}$ -rpm or 45-rpm, with automatic adjustment to the correct stylus pressure. See and try this "viscous-damped" arm soon—treat your valuable records to the kind of tone arm they deserve!

GRAY

RESEARCH
AND DEVELOPMENT CO., INC., 598 HILLIARD STREET, MANCHESTER, CONN.
Division of The GRAY MANUFACTURING COMPANY—Originators of the
Gray Telephone Pay Station and the Gray Audograph and PhonAudograph

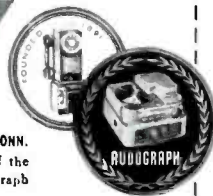

Gray Research & Development Co., Inc.
598 Hilliard Street, Manchester, Conn.

Please send me your Bulletin RE-7 on the new Gray
"Viscous-Damped" 108-B Tone Arm.

NAME _____

ADDRESS _____

CITY _____

STATE _____

THERE IS A

Difference

type 210-B

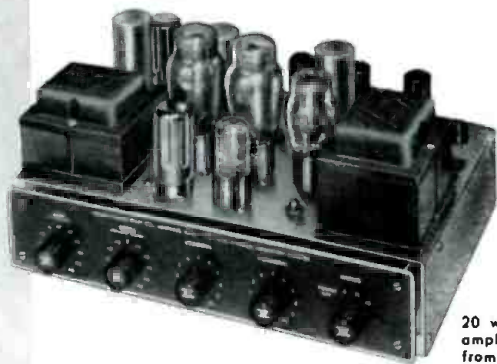

H. H. SCOTT

amplifiers

AGAIN rated BEST

The author of HIGH FIDELITY SIMPLIFIED, expert HAROLD WEILER says "The finest amplifier on the market today in my opinion, is the H. H. Scott 214-A".

20 watt amplifiers from \$117.50



For the SATURDAY REVIEW HOME BOOK OF RECORDED MUSIC AND SOUND REPRODUCTION, critic C. G. BURKE tested the leading equipment and rated the H. H. SCOTT 214-A amplifier FIRST CHOICE of all amplifiers, the H. H. SCOTT 210-B FIRST CHOICE, single-chassis amplifiers.

220-A

120-A

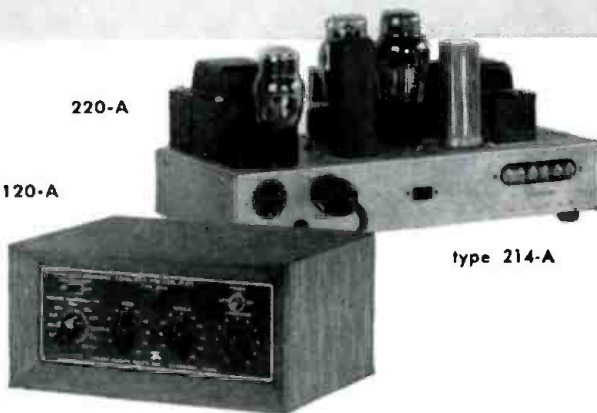

type 214-A

FM radio station WXHR, Boston's leading music station, uses the H. H. Scott 120-A Equalizer-Preamplifier as professional broadcast equipment. General Manager John Thornton says, "The flexibility of equalization possible with the H. H. Scott 120-A gives WXHR exactly what it needs in the perplexing problem of correct record equalization." Just why are the 210-B and 214-A amplifiers recognized as standards for comparison in the field? Simply because H. H. SCOTT amplifiers give you the best music under all conditions, not just ideal ones.

Write us today for FREE booklet HF 153, complete specifications, and the name of your nearest distributor.

MORE MUSIC

Continued from page 26

chestra manager Dick Wangerin signed as guest artist one Julius La Rosa, teen-age singing idol and Arthur Godfrey television protege. The program included, besides Mr. La Rosa's ballads, music by Srauss (Johann), Franz Lehar and Darius Milhaud—the latter's *Kentuckiana*. Milhaud got almost as much applause as young Mr. La Rosa.

The hard-working Orchestra, all the members of which are employed in the city public schools or the University, gives forty concerts a year. Besides the subscription series there are the "Making Music" concerts, for 8,000 school children, and the "Introduction to Music" recitals at the ten Public Library branches.

Mayor Farnsley also saw to it that his city's Orchestra was heard on records. In 1951 the Orchestra recorded William Schuman's *Judith* and *Undertow* for Mercury. Now the Louisville Philharmonic is under contract to Columbia to record at least one LP of selected commissioned works every year.

But Charlie Farnsley's greatest feat as an art-and-audio patron was achieved last month when he got the Rockefeller Foundation to grant \$400,000 to the Louisville Philharmonic Society for an unprecedented project: for the next four years, entirely apart from its regular program, the Society will commission 46 new orchestral and operatic compositions, to be performed in weekly Saturday matinee concerts at popular prices. Beginning in January, thus, the orchestra will be on a year-round schedule, but for a six-week summer vacation.

Each month Columbia will record for the Society an LP comprising four commissioned works, to be distributed by the Orchestra on a subscription basis. The recordings will also be made available to the State Department's Voice of America, which already broadcasts the Orchestra's concerts, and to educational radio stations throughout this country and the rest of the world.

Farnsley's theory is that if the annual output of disks is sold on a record-a-month-club plan, the Orchestra in four years should be getting enough money to maintain the new program on a self-supporting basis. He has calculated a sliding-scale deficit of \$192,399 the first year, \$11,459 the fourth, and says hopefully that an American symphony orchestra can be self-sustaining on the basis of record sales and local support of the Louisville Fund variety.

Farnsley will direct the project. He expects to have more time for such activities after next November, when he leaves Louisville's City Hall for private law practice. The Audio Center, the Orchestra and the recording crews will see even more of citizen Farnsley than they did of the Mayor. And then—if not earlier—he plans to do some more lobbying in New York. He'd like to have the Orchestra's Saturday matinee programs of new music broadcast on a nation-wide radio hookup.

Perhaps the best view of Farnsley in action can be seen at a recording session, like the Orchestra's most recent stint.

The session was already underway when

Continued on page 96

HERMON HOSMER **SCOTT, INC.**

"PACKAGED ENGINEERING"

385 PUTNAM AVE. • CAMBRIDGE 39, MASS.

PROFESSIONAL DIRECTORY

IN THE WEST

... for higher fidelity ...

BERKELEY CUSTOM ELECTRONICS
2302 Roosevelt Corner Bancroft
BERKELEY, CAL. Hornwall 3-4180

Everything in High Fidelity—Audiophile net prices—units, complete installations. Pushbutton selector for comparative listening—BCE scratch filters, record equalizers—Cabinetry—Hi Fi servicing.

Klipschorn on demonstration



WEINGARTEN ELECTRONIC LABORATORIES INC.
7556 Melrose Avenue, Los Angeles 46, California
WALnut 5405 YORk 3872

The ultimate in High Fidelity at net prices.

RECORDINGS TO YOUR ORDER

Have your rare records copied on high-quality discs, either 78 or 33 RPM. Our services also include monitoring off-the-air, copying tape to tape, tape to disc, etc. Satisfaction guaranteed. Reasonable rates. Write for prices.

The DUBBINGS Co.
41-10 45th St., Long Island City 4, N. Y.
Dept. HF-43 ST-4-7370

"WE HAVE IT"

Hi-Fi Components Exclusively



HOLLYWOOD ELECTRONICS

7460 MELROSE AVENUE
LOS ANGELES 46, CALIFORNIA

WEbster 3-8208

WESTPORT, CONN.

Hi-fi sales and installations at lowest prices. All popular brands. Cook wide range recordings.

Visit our Audio Room or write

Music Systems of Westport, Inc.
Post Road 2-9695 Westport

SERVICE

FOR YOUR HI-FI EQUIPMENT

Specializing in Custom Equipment and Installations since 1947. Calls made in N. Y. C., Westchester, Long Island.

VECTOR LABORATORIES

217 3rd Ave., N.Y.C. GR-3-7686

"EVERYTHING"

in high fidelity

From Primary Components to Completed Custom Installations
VISIT OUR NEW "AUDIO-PHILE HAVEN"
or write to

KIERULFF

Sound Corp.

820 West Olympic Blvd. Los Angeles 15, Calif.
Richmond 7-0271 Zenith 0271

MUSIC LOVERS' VACATION EXTRA

Summer Stoppers near the "Hub" needn't miss Boston's wealth of quality FM Broadcasting. Enhance your vacation by renting complete, compact Hi-Fi FM equipment from Hastings of Boston. Call or write NOW; specially reserved equipment may be delivered or picked up at our Soundroom.

HASTINGS PRODUCTS, INC.
171 Newbury St., Boston: COpley 7-1568

HIGH QUALITY

- Cabinets
- Speaker Enclosures
- Custom Work

For Hi-Fi Units

YORK FURNITURE CORP.
208 East 47 St. N. Y. 17, N. Y.
Plaza 5-2684

ALL MAKES TAPE RECORDERS

Largest stock tape splicers, splicing tape, microphones.

The West's largest distributors

Magnetic Recorders Co.

7120 MELROSE AVE. • LOS ANGELES 46, CALIF.

CUSTOM INSTALLATIONS

Radio - Phonograph - Television

The best in fine cabinetry and electronic engineering

LOWE ASSOCIATES

167 Bay State Road
Boston, Massachusetts
COpley 7-6644

Philadelphians: ELECTRONICS' audio and music specialists can improve your facilities by 1. Home Consultation Service; 2. Trading Post and "Swap or Sell" List; 3. Reengineering and custom conversion Service. Hear the Bozak BINAURAL-MONAUROUS Speaker, BROCIENER Home Music systems, FAIRCHILD cartridges, THORENS platters, etc., under ideal conditions. We feature Quality, not quantity, at "net".

ELECTRONICS R116 City Line Center
GR. 3-7474 Philadelphia, Penna.

FOLLOW THE LEADER IN HIGH FIDELITY

Visit Our Ultra-New Sound Studio for All Your Hi-Fi Requirements

OLYMPIC ELECTRONICS

7636 Santa Monica Blvd.
Los Angeles 46, Calif. Hollywood 4-9144

ARCHITECTURAL SERVICE

Individual designs, tailored to give your high-fidelity system the ultimate in appearance and performance. Complete working drawings that you or your cabinetmaker can follow.

For full details, without obligation, write

RAM COMPANY

P. O. Box 221, Great Barrington, Mass.
Marsh B. Giddings, Jr., Architectural Designer
Alan C. Macy, Technical Advisor

For the Connoisseur . . .

Factory-Fresh, Selected LONG PLAYING RECORDS, Tested on the Finest High-Fidelity Equipment.

SOUTHWEST RECORD SALES
4710 Caroline Houston 4, Texas

For leisurely listening and comparison of all the Stars in Sound, visit

Sound Unlimited

Figart's Sound Un-Ltd.

Southern California's finest Audio Hdqtrs.
Opposite Carthay Circle Theater
6320 Commodore Sloat Drive
Los Angeles 48, California YO-6218

CUSTOM SOUND

featuring

- Selected British & American units
- Special demonstration facilities
- Cabinets to your specifications

CRAIG AUDIO LABORATORY

12 Vine Street Rochester, N.Y.
BAker 1345

"a stylus to a Klipschorn"

IN CANADA—

There's one place where you can find — and hear — all your high-fidelity equipment needs. We carry a complete stock . . . come in, or write in, for a chat, a look, and a listen.

ELECTRO-VOICE SOUND SYSTEMS

141 Dundas St., West. TORONTO

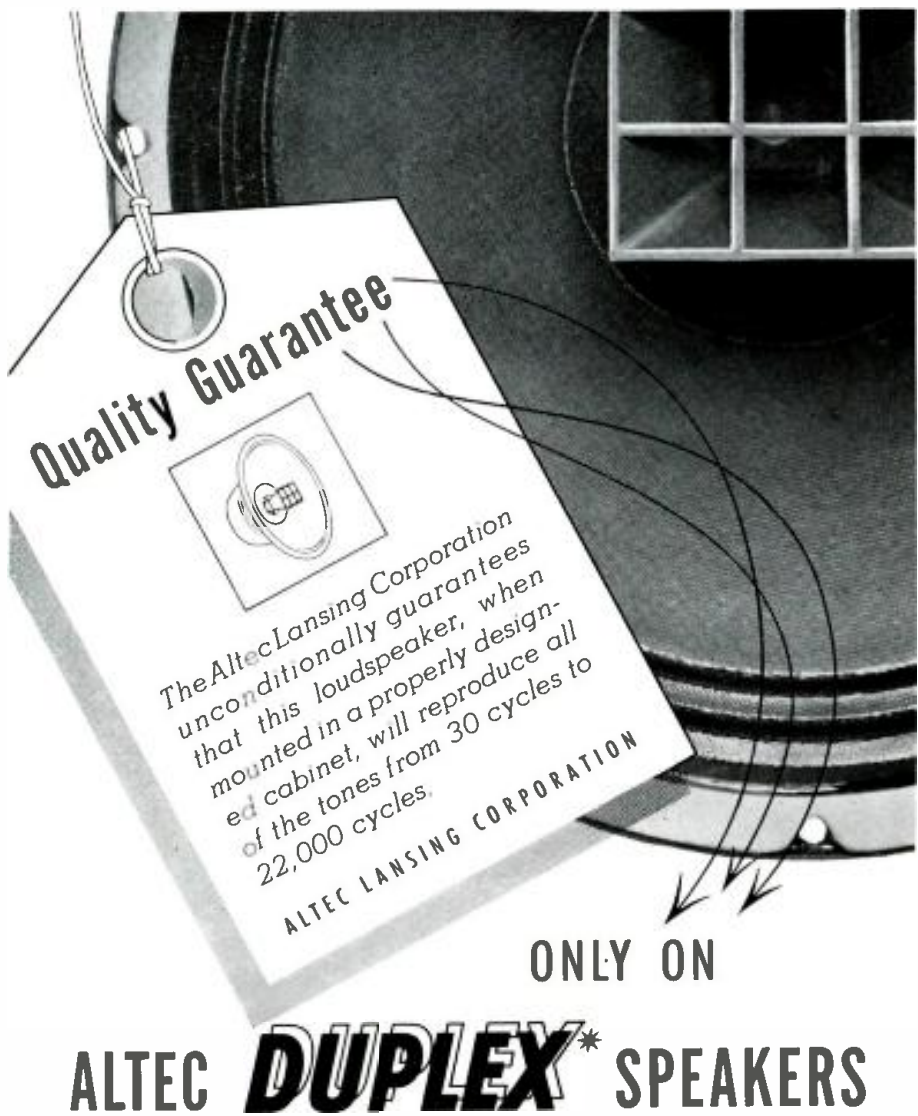

Quality Guarantee

The Altec Lansing Corporation unconditionally guarantees that this loudspeaker, when mounted in a properly designed cabinet, will reproduce all of the tones from 30 cycles to 22,000 cycles.

ALTEC LANSING CORPORATION

ONLY ON

ALTEC DUPLEX* SPEAKERS

Altec Lansing Corporation is the only manufacturer that tests every loudspeaker in an acoustical laboratory to insure that the frequency response of each DUPLEX* is held within 2½ db of the production standard throughout its entire range from 30 to 22,000 cycles.

This stringent quality control permits Altec alone to guarantee unconditionally the frequency range of every speaker.

<p>601A—12" 20 watts \$89.00 with network</p>	<p>602A—15" 20 watts \$114.00 with network</p>	<p>604C—15" 35 watts \$156.00 with network</p>
--	---	---

These DUPLEX* speakers are the finest in the world. Hear them at your nearest Altec dealer's today.

*Duplex: Mechanically and electrically independent high and low frequency loudspeakers mounted within the physical size of single frame.



9356 Santa Monica Blvd., Beverly Hills, Calif. • 161 Sixth Ave., New York 13, N.Y.

MORE MUSIC

Continued from page 94

the Mayor arrived, wearing a slightly wilted carnation in his lapel and suffering from what he described casually as "a very bloody afternoon at the office." He slumped into a chair at the back of the Auditorium and munched hot dogs while Lukas Foss' *Parable of Death* played on.

At the first signal from the control room for a playback, Farnsley started for the site of the Ampex tape recorders. An Orchestra member spotted him from the stage and called out:

"Hello, Mr. Mayor . . . how does it sound?"

"Just fine," said the Mayor, and proceeded to the control room, located next to the building boiler plant. He listened sympathetically as the engineers complained alternately about the heat and the acoustics.

"Boys, we'll get this place straightened out before you come back again . . . I'll get a good man to redesign the whole set-up," he promised apologetically. He put on his mangled brown hat and added:

"I'll go right out an' raise the money for it tomorrow."

HEARING IS BELEIVING?

Continued from page 28

Go ahead! Just try to fool human sensory systems!

But the extreme sensitivity of Man's ears wouldn't last long if it weren't protected by an automatic volume-control system. There's a tiny muscle that can tighten or loosen the coupling between the parts of the aural acoustic system. It's extremely efficient, and extremely fast-acting. Hollywood found that out when a movie sound-effects department tried running a pistol-shot backwards through the sound machine to see what kind of a sound effect it would produce. The sound resembled that of somebody stopping a leaky gas jet; a more completely uninteresting, unsuccessful sound effect could hardly be arranged. Run backwards, the pistol shot consisted of a rapidly increasing loudness, the ear desensitized itself so rapidly that, when the shot arrived, there was practically no sensitivity; the whole thing sounded extremely weak.

This protective system causes high-fidelity engineers no end of trouble; not only does it desensitize the ear, it also changes the ear's frequency response.

Now if the human sensory system were satisfied with one method of sound detection, we could overcome this change of frequency response with volume quite simply. The volume compensation systems that increase the bass and treble boost with decreasing volume would then work fine.

And Man would long since have become extinct, too, if he had only one sound-detecting system. How do you distinguish between a distant, loud sound and a near-by weaker sound?

Sound, in travelling long distances in air, tends to slide down the scale of pitch.

Continued on page 98

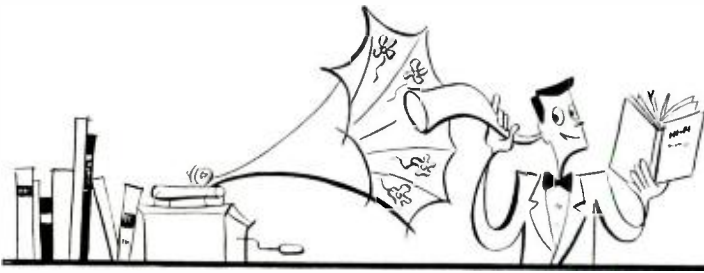

MUSIC LISTENER'S BOOKSHELF

HIGH FIDELITY MAGAZINE'S Most Popular BOOK OF THE MONTH

HOME MUSIC SYSTEMS: Edward Tattall Canby. 300 pages, illustrated. How to assemble and enjoy high-fidelity equipment at tremendous savings. Explains the operation of a radio-phonograph, where to buy and how to house the separate parts. Can help you avoid making expensive mistakes.

No. 109 \$3.95

LATEST RELEASE

SOUND REPRODUCTION: Third Edition of G. A. Briggs' famous book. Many new chapters and 175 new and original illustrations. Mr. Briggs, aided by hundreds of photographs and drawings, brings his usual flair for lucid, readable explanation to all the essential elements of high-fidelity reproduction.

No. 110 \$3.50

HIGH FIDELITY SIMPLIFIED: Harold Weiler, 209 pages, 104 illustrations. The latest and most understandable discussion of the fundamental theories of high-fidelity sound reproduction. Working designs for speaker enclosure.

No. 101 \$2.50

WILLIAMSON AMPLIFIER BOOKLET: D. T. N. Williamson, 36 pages, 31 illustrations. Contains complete design data for constructing this famous high-fidelity amplifier.

No. 94 \$1.00

MAKE MUSIC LIVE: Green, Radcliffe and Scharff, 256 pages, illustrated, cloth. A practical guide for planning, assembling and installing high-fidelity home music systems. Also methods of concealing elements in furniture.

No. 70 \$4.50

WORLD ENCYCLOPEDIA OF RECORDED MUSIC: F. F. Clough and G. J. Cuming, 890 pages. A very valuable compendium of recorded music. The most all-inclusive reference work ever published for collectors and libraries. Every recorded work — 78, 45, or 33 1/3, U. S. or foreign — is listed in its versions. Truly encyclopedic.

No. 57 \$17.50

BINDERS FOR HIGH FIDELITY Magazine: Red leatherette, gold-stamped on front and backbone. Volume 3 to hold the six issues a year HIGH FIDELITY is now publishing. Volume 1 and Volume 2, in limited quantity, still available (to hold four issues each). Specify Volume Number.

Binder 1, 2, 3 \$2.75 each

FIFTY BEST DESIGNS: This brochure has been planned to answer three questions that more and more people are asking: How do you start finding out about high-fidelity? What do high-fidelity installations look like? How should you go about selecting equipment that will provide the greatest enjoyment at the lowest cost?

No. 115 \$.50

THE RECORDING AND REPRODUCTION OF SOUND: Oliver Read, Second Edition, 805 pages, over 700 illustrations, cloth. A complete and authoritative treatment of the entire subject of sound. Covers all aspects of recording.

No. 46 \$7.95

LOUDSPEAKERS: G. A. Briggs. Intended for those who are interested in the Loudspeaker and how it works and how results may be improved. Non-technical terms throughout.

No. 56 \$1.60

MICROPHONES by Engineering Staff, BBC, 114 pages, cloth. Covers the theory, design and characteristics of all standard microphone types.

No. 73 \$3.25

AMPLIFIERS: Briggs and Garner, 216 pages, 174 illustrations, cloth. This book covers, in characteristic non-technical language, the myriad considerations involved in amplifier design and construction. Details are given for the construction of a recommended amplifier. Essential reading.

No. 100 \$2.95

SAT. REV. HOME BOOK OF MUSIC, etc.; Canby, Burke, and Kolodin. 308 pages, 25 illustrations, cloth. Three top experts tell the story of music, its recording and its reproduction in the home. Specific suggestions are given for selection of high-fidelity components.

No. 98 \$4.50

THE CONCERT COMPANION: Bagar and Biancolli, program annotators for the N. Y. Philharmonic Symphony Society. Preface by Deems Taylor — 750 pages, illustrated. Informative collection of concert compositions, the work of 150 composers from Bach, Beethoven, and Brahms to the leading contemporary American and European men of music.

No. 77 \$4.95

THE LANGUAGE OF MUSIC: Klaus Liepmann, 376 pages. A practical guide to the understanding of music, this new work is an outgrowth of the author's wide experience as a music educator, musician, and conductor. Detailed analyses of selected pieces of great music and a wealth of suggestions for intelligent listening.

No. 118 \$5.00

MAURICE RAVEL: Victor I. Seroff, a biography, 310 pages, illustrated. The result of several years' penetrating research, not only on the influences and meanings of Ravel's particular genius, but on the carefully guarded, personal life of the great French musician.

No. 117 \$3.75

AUDIO ANTHOLOGY: Second edition, C. G. McProud. Mostly reprints of articles originally appearing in "Audio Engineering" about amplifiers, loudspeakers, enclosures, and phonograph equipment.

No. 112 \$2.75

LISTENING TO MUSIC CREATIVELY: Edwin J. Stringham, 479 pages, illustrated, cloth. An absorbing and ingenious presentation of not only the history of music but a method by which the untrained listener can find pleasure and meaning in music. An excellent guide for building a well-integrated record collection.

No. 89 \$6.00

BURKE-BEETHOVEN DISCOGRAPHY: a Reprint, in the form of a 16-page excerpt from the Spring, 1952 issue of HIGH FIDELITY.

No. 122 \$.50

The following back issues of HIGH FIDELITY Magazine are still available, though supplies are getting low. To complete your file, order immediately. \$1.00 per copy. Box BD, HIGH FIDELITY Magazine, Great Barrington, Mass.

Summer 1951	Sept.-Oct. 1952
Fall 1951	Nov.-Dec. 1952
Winter 1951	March-April 1953
May-June 1953	

Book Department
HIGH FIDELITY Magazine
Great Barrington, Mass.

I enclose \$..... for which please send me the books indicated by the circled numbers below. (No C.O.D.'s please.)

*Send 25c for foreign postage registration.

46 56 57 70 73 77 89 94 98 100 101 109

110 112 115 117 118 122 Binders-1-2-3

NAME

ADDRESS

Not Out of this World . . .
at
NEWARK
but here for your enjoyment now!
hallicrafters
High Fidelity Equipment



MODEL A-84 AMPLIFIER

Response: ± 1 db, 10-100,000 cps. at 10 watts. Total harmonic distortion less than 0.25%; intermodulation distortion, less than 0.1%. All-triode, inverse feedback circuit. Hum and noise level, -90 db. Sensitivity, 1.5 volts across 470,000 ohm input for 10 watts. Output impedances, 8 or 16 ohms. Accessory output socket -6.3 volts at 1.5 amps, 150 volts at 25 ma, for powering preamp or tuner without power supply. With 12AU7, 2-KT66, 5U4C; rectifier. Size, 13½"W, 8½"D, 7¾"H. Wt., 26 lbs.
98F021. NET. 99.50



MODEL ST-83 AM-FM TUNER

Meets FCC specifications on oscillator radiation. Excellent temperature compensation with no drift. FM sensitivity, 5 microvolts for 30 db quieting. Phono inputs for built-in preamp, compensation for magnetic pickups and provision for crystal pickups. Accessory inputs for TV and tape recorder. Independent dual audio outputs, medium and low impedance through cathode follower. Separate bass and treble tone controls. 10 tubes including rectifier. Chrome-plated chassis. Size: 14x7½x9½". Wt., 18 lbs.
98F020. NET. 129.95

Tuner Closeout!
 While They Last!
44.50

ST-74 FM-AM TUNER
 Originally 59.50! Save \$15.00 on this final closeout of the famous Hallicrafters ST-74 high-fidelity tuner. Balanced ratio detector circuit. Response, ± 3 db, 60 to 12,000 cps. Sensitivity, 50 microvolts. Size, 13¼x5½x7¾". Wt., 13 lbs.
98F016. Special Price 44.50

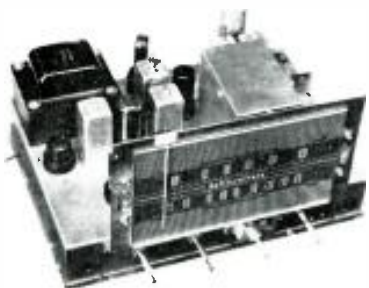

S-78A FM-AM CHASSIS

Response, ± 3 db, 50-14,000 cps. Full range tone control for treble and bass. Two push-pull audio tubes provide eight watts output with minimum distortion. Phono input jack on rear of chassis. Uses 10 miniature tubes, plus rectifier. Impedances, 3.2 and 500 ohms. Sizes, 12½ x 7¾ x 11". With tubes, escutcheon and knobs, 22 lbs.
98F015. NET. 89.50

Full of the Latest Releases in High Fidelity



Order from Department H-7
Send for Newark's Catalog No. 55



223 W. Madison Street • Chicago 6, Illinois

HEARING IS BELIEVING?

Continued from page 96

A nearby lightning flash makes a sharp crack; a distant flash produces low-toned thunder. If we measure both frequency and sound-energy, and cross-correlate the readings, we'll get some indication of what caused the sound. It's important to distinguish between a pig in a nearby bush and a rhinoceros pushing trees around a little further off.

The skin "hears" too; the skin extends human hearing right on down from the usual bass range all the way down to zero cycles a second — a steady push. But the skin measures sound energy rather than sound frequency.

This is easier to understand in another context: If you look at a fluorescent lamp, the tube appears to have exactly the same color and shade as a bar of solid tungsten at a temperature of 2,800 degrees Centigrade. So far as your eyes are concerned, the two appear the same. But your skin also measures radiant energy; the skin reports very little energy, so you're not fooled.

Your skin also reports that a piece of iron is radiating so much heat you'd better stay away from it, even when your eyes say it's black.

If you listen to the Philharmonic at Carnegie Hall, your skin not only reports the tactile sensations of your clothes and the chair — it also reports on the powerful sound-energy of the orchestra. Skin, muscles and viscera combine to report on crescendo passages. The little muscle in the ears is also reporting that it has slacked off and desensitized the ear, indicating that the sounds are of high energy.

So when you play a Philharmonic recording at a nice, gentle volume, and turn up bass and treble boost to compensate for the change in the ear's sensitivity — skin, muscles, viscera and the little ear-muscles all combine to report, scornfully: "TILT!" The total sensory system recognizes that distortion is present.

So, since we cannot fool the total sensory-integrative system of the human organism, let's see what we can do about working with it. Let's enlist imagination.

Man, alone among animals, has a real imagination. He can understand a situation, and imagine from it a different situation.

In the case of sound reproduction, we have to recognize what we are actually doing; we are not at the symphony concert, and the limitations imposed are real. We can, on the matter of volume, for instance, recognize that it's impolitic to play the New York Philharmonic at full power level in a New York apartment, and settle willingly for the intentional distortion of frequencies needed to compensate for the ear's mechanism. Or we can, like a friend of mine, construct a house with 18-inch adobe walls, well insulated from the neighbors, build the speakers solidly into the frame of the house, and use a 50-watt amplifier, all-out.

But even with a home-music system like my fortunate friend's, technical electronics can go only so far. The rest of the job must be done by the imaginative mind of the listener. That's not a platitude; it's a technical specification. The approach of

Continued on page 102

the
unique

Regency



**KLIPSCH LICENSED FOLDED HORN ENCLOSURE
with complementary speaker systems**

**Provides "built-in" corner; can be
used in corner or against flat wall**

**Designed for 15" coaxial speakers,
or separate 2-way and 3-way systems
... without need for modification**

**One full octave of added bass
guaranteed over any commercially
available bass reflex enclosure**

**10 to 15 db more efficient than
conventional enclosures; laboratory
flatness ± 5 db to 30 cps**



Dimensions:
29 $\frac{3}{8}$ " high
33 $\frac{1}{2}$ " wide
19" deep

REGENCY ENCLOSURE ONLY

Mahogany. List \$200.00; Audiophile Net, \$120.00
Blonde. List \$215.00; Audiophile Net, \$129.00

COMPLETE REPRODUCER SYSTEMS

REGENCY II. Includes E-V Model 114-A
2-way system in Regency enclosure.

Mahogany. List \$517.00; Audiophile Net, \$310.20
Blonde. List \$532.00; Audiophile Net, \$319.20

REGENCY III. Includes E-V Model 114-B
3-way system in Regency enclosure

Mahogany. List \$592.00; Audiophile Net, \$355.20
Blonde. List \$607.00; Audiophile Net, \$364.20



Superlatively styled in low-boy motif, gracefully accented by a solid antique brushed brass grille, the Regency is appealing as a design of excellence and enduring beauty. Adaptable to the living room, study or den, the exquisite veneers are hand-rubbed to a mirror finish on every exposed surface. The Regency is available in rich mahogany or smart lustrous Korina blonde.

A Klipsch-licensed folded corner horn with integrally built-in "corner," the Regency can be employed in the corner for augmented bass response or against the wall of the room away from the corner for flat response (± 5 db to 30 cps). In the Regency, the vital cavity behind the cone baffle exploits the unique, patented Klipsch feature of resonating the back-load with the frontal air load to increase bass efficiency through a broad 4-octave pass-band acoustic circuit.

Send for Bulletin 185

Electro-Voice

ELECTRO VOICE, INC., BUCHANAN MICHIGAN • Export: 13 East 40th St., New York 16, U.S.A. Cables: Arlab

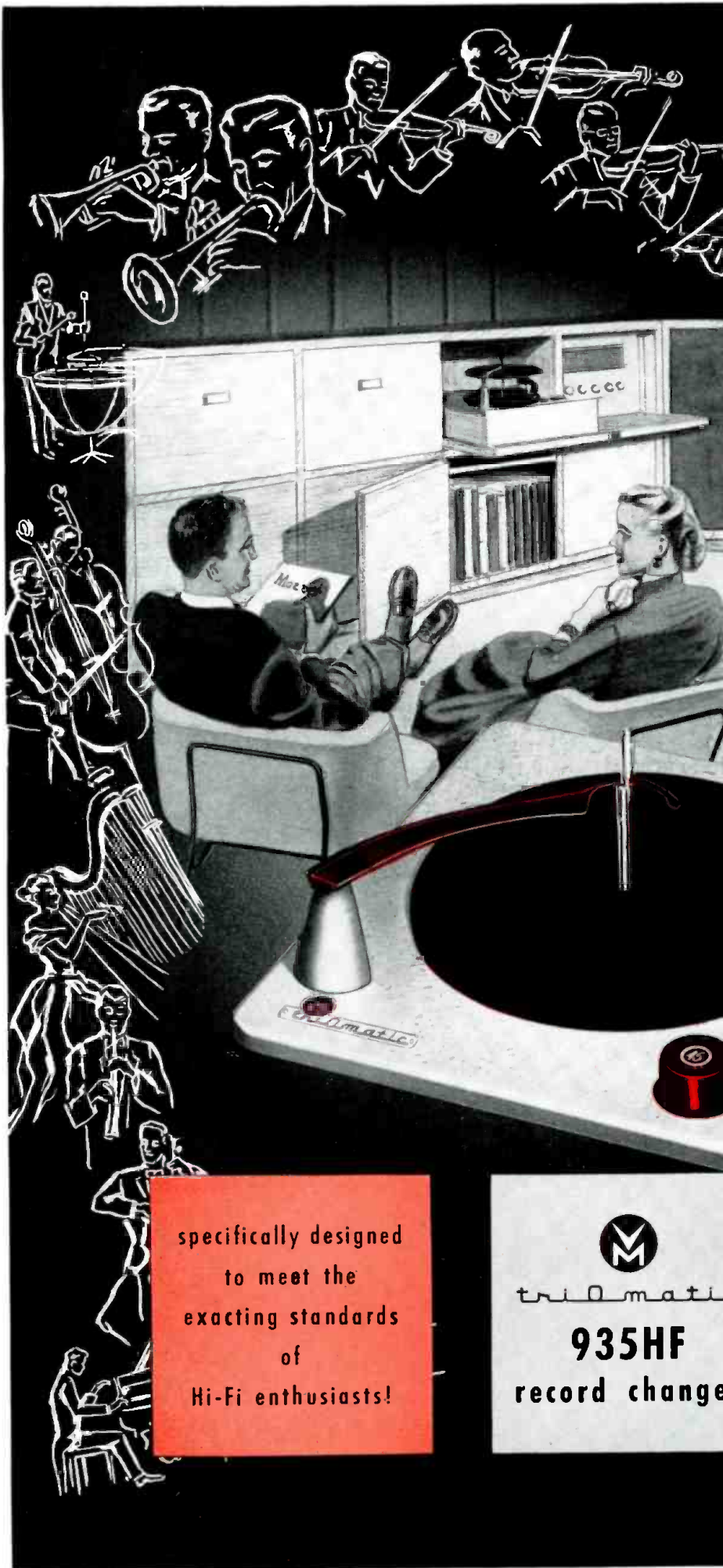

Presents

the World's FIRST
Completely NEW
High Fidelity
Record Changer!



specifically designed
to meet the
exacting standards
of
Hi-Fi enthusiasts!

triomatic®
935HF
record changer

OFFERS
more Exclusive
Hi-Fi Features...
more Record
Protecting Features...
more Convenient Record
Handling Features...
THAN ANY COMPETITIVE CHANGER!



All New

triomatic® 935HF record changer

"Custom-Precision" quality for the discriminating buyer

The V-M 935HF is a top quality high fidelity record changer throughout! Its many exclusive features will have tremendous appeal to ALL of your customers interested in life-like reproduction of recorded music.

MANUAL OPERATION—Allow changer to shut off automatically, place record on turntable and set speed, turn Control Knob to "ON" and place needle in lead-in groove.

- 1 LAMINATED TURNTABLE WITH PRECISION-FORMED CONCENTRICITY**, (exclusive in this price range) is weighted and balanced to assure constant-speed operation. New motor mount and close-tolerance drive completely eliminate wow. Extra heavy flocking silences and cushions record drop. Turntable is mounted on a selected three-ball thrust bearing, with mirror-finished surfaces, for silent rumble-free performance.
- 2 GENTLE TRI-O-MATIC SPINDLE** protects records, eliminates record holders that grip the grooves. Records are moved at the center (point of perfect control) . . . are lowered, NOT dropped, to spindle shelf and flat, air-cushion dropped to turntable.
- 3 DIE CAST TONE ARM** of aluminum, is rigid and resonance-free! Is balanced for easy, exact adjustment to needle pressures specified by needle or cartridge manufacturers.
- 4 TWO PLUG-IN TONE ARM HEADS** (1 gold, 1 red, less cartridges) are included. Precision-fitted cast aluminum construction. Adaptable to: GE "turn-about" RPX050, GE RPX040, GE RPX041, Pickering single-play and turnover, and Clarkstan cartridges.*
- 5 A MINIMUM OF LATERAL PRESSURE** is required to track and trip the friction-free V-M 935HF changer. Cartridges requiring down to 5 grams needle pressure can be used with excellent results.
- 6 MUTING SWITCH** for absolute quiet during change cycle.
- 7 V-M 45 SPINDLE** is included. Permits automatic play of up to fourteen large center-hole records.
- 8 EXCLUSIVE FOUR-POLE, FOUR-COIL MOTOR** with surplus power for silent, constant-speed service, eliminates the source of electronic hum and rumble.

*Pre-amplification stage required.

ADDITIONAL FEATURES:

Gold base plate, burgundy accessories; complete, automatic shut-off; plays all speed, size records automatically; completely jamproof mechanism.

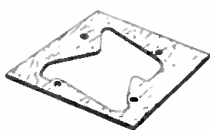

V-M 935 Mounting Board Pre-Cut.
Measures 3/4" x 16 1/4" x 17 1/4"

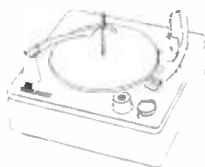

V-M 936HF Changer Attachment on metal pan has 6' AC cord, 4' phono cord with plugs. Underwriters' Approved.



CORPORATION

BENTON HARBOR, MICHIGAN

WORLD'S LARGEST MANUFACTURER OF PHONOGRAPHS
AND RECORD CHANGERS EXCLUSIVELY

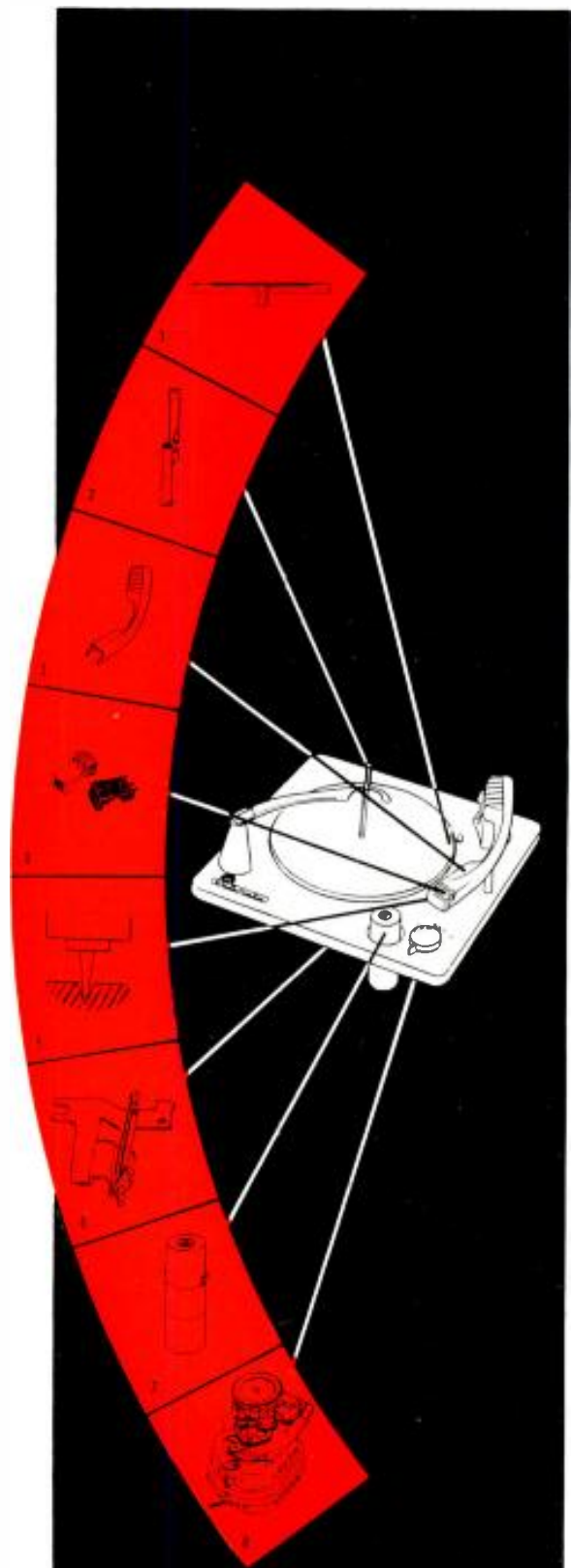

V-M Corporation, Benton Harbor 1, Michigan

Gentlemen: Please send illustrated literature telling ALL about the new V-M 935HF high fidelity changer.

Name _____

Address _____

City _____ State _____

These G-E units give you...

HIGH-FIDELITY PERFORMANCE

...at low cost!



CONVERSION KIT



Replace your present Crystal Pickup with a...

G-E "Golden Treasure" CARTRIDGE

Acclaimed by music critics everywhere, this famous variable reluctance cartridge delivers incomparable performance. Select the model you prefer for smooth response up to 15,000 cycles. Then, simply mount the cartridge in the record player* and plug the tone arm lead into a...

G-E RECORD COMPENSATOR

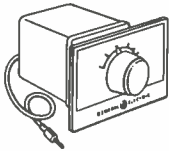

Model A1-900. This outstanding, new G-E product has met with instant success. No wonder when the entire recorded range of all your records...current favorites or collector's items...is reproduced in proper balance! Features *five selective settings!* Now plug its shielded lead into the...

G-E SELF-POWERED PREAMPLIFIER

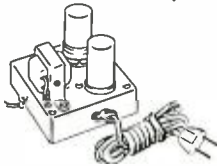

Model UPX-003A. A completely self-contained unit designed for new, improved performance. Plug the preamplifier output lead into the phono-amplifier connection of your present radio phonograph and experience new listening pleasure.

WRITE TODAY!

General Electric Co., Section 5473
Electronics Park, Syracuse, N. Y.

*Please send me your new brochure "Variable Reluctance Application Data" containing information on compatible record players. 15¢ is enclosed.

NAME.....
ADDRESS.....
CITY.....STATE.....

GENERAL  ELECTRIC



HEARING IS BELIEVING?

Continued from page 98

modern music reproduction is psycho-physiological, not mechanical as was the player-violin and player-piano. For true high-fidelity enjoyment, the total psychological aspect of the listener is an integral part of a psycho-physiological approach to music reproduction.

One simple and common result of this has annoyed many a high-fidelity addict: many and many a time the addict's wife insists that Bill Jones' sound system is better than her husband's. This frustration imposed on hubby does *not* stem from inherent cussedness of women, but from the fact that the music system embodies a psycho-physiological approach. There is, inherent here, a darned good reason why the Jones' system sounds better to her.

Part of the enjoyment of the Philharmonic at Carnegie Hall is knowing that you're at Carnegie Hall, with hundreds of others who enjoy with you the experience you're enjoying.

The woman of the house, when listening to music at home, knows she is at home; she'd have to have total amnesia to escape that knowledge. But home is, to her, her place of business, her place of responsibility and work. She listens to the music — and notices the dust she missed under the couch — and listens to the music — and remembers the shopping list for tomorrow — and listens . . .

Try gathering last year's Christmas bills, and this year's income tax forms, and the latest growl from the Boss, and hanging them in front of you while you listen to your favorite recording. You'll suddenly discover that the recording isn't as good as you thought. And that needle-hiss is getting bad. And the turntable rumble is a nuisance and you can't afford a new one, and . . .

At this point, leave the bills and tax forms hanging, and go listen to Jones' sound system. See — it sounds better, doesn't it?

When you use psycho-physiological techniques, your own psychology is directly coupled into the system. You can't uncouple it, either. So — you'll get better results from the system by knowing what you want, and seeing to it that you have it.

Just as the distractions of Christmas bills and income tax forms can decrease your enjoyment, so the reverse is true. A man with Equipment System A, who feels that he has the best practicable system possible to him will enjoy his music greatly. Given the same equipment exactly, but the conviction that he was a fool not to have bought System B instead — he won't enjoy the music as much. Wherefore, for him, System B is in fact better.

Music has a meaning that's primarily emotional; clearly, then, in enjoying it fully, there must be emotional satisfaction as a background. A man with a speaker system he knows within himself is *good*, an amplifier he convincingly believes to be top-notch — for him, the music is deeper, richer and more rewarding.

The effort of selecting the components, of judging and weighing their values, of

Continued on page 104

Everything in High-Fidelity

ALWAYS IN STOCK AT

ALLIED



immediate delivery
on these new
Hi-Fi releases

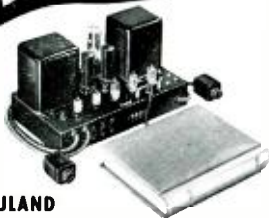

NEW RAULAND 1826 AMPLIFIER & REMOTE CONTROL

New, uniquely styled 20-watt remote-control high-fidelity amplifier. Self-powered remote-control unit is covered in rich, brown leatherette with gold trim—looks just like a beautifully bound book. Controls are accessible under hinged backbone. Remarkable authentic music reproduction, versatility and neat installation. Remote unit controls: Bass, Treble, Volume, 6-position Crossover, 6-position High-Frequency Cut-off. Also Input Selector switch and AC switch with separate remote-control cables. For 8 and 16 ohm speakers.

93-805. Net. \$232.26



NEW McINTOSH A-116 BASIC AMPLIFIER

New 30-watt basic amplifier superseding the renowned 20W2—but at a new low price! A brilliant performer. Uses the famous McIntosh-patented output transformer. Exceedingly wide response—± 1 db, 10-100,000 cps at 15 watts; ± 0.1 db, 20-30,000 cps at 30 watts. Only ½ volt for full output. Output Impedance: 4, 8, 16 and 600 ohms.

93-895. Net. \$139.50



NEW BROWNING RJ-42 FM-AM TUNER

For the finest hi-fi systems. Only two panel controls (Tuning and FM-AM) to permit complete control of volume and tone with amplifier or remote preamp. Superb response and sensitivity—Armstrong detection and all-triode FM front-end. Automatic frequency control and drift compensation; AFC can be switched off. Cathode-follower output. AM whistle filter. 13 tubes, tuning eye and rectifier.

97-931. Net. \$166.50

for critical ears...

two "Studio Presence" custom-music systems

CUSTOM PHONOGRAPH SYSTEM. Best buy in a full-fidelity record-reproducing system recommended by *Saturday Review's* E. T. Canby and associates. Complete system includes: Bogen DB-10-1 High-Fidelity Amplifier, Garrard RC-80 3-Speed Changer with two G. E. cartridges and diamond stylii, Electro-Voice SP12B Coaxial Speaker. Complete with cables (no soldering required), hardware and full instructions.

Shpg. wt., 65 lbs.

93-572. Only \$16275

93-911. BOGEN R604 FM-AM TUNER.

High-Fidelity tuner for above system. Only . . . \$97.35



FM-AM-PHONO SYSTEM. The famous Radio Craftsmen system selected by a majority of ALLIED "Auditioner" listeners for musical excellence and value. Notable for distortion-free record reproduction and superb FM-AM radio reception.

The complete system includes: famous Craftsmen C500 Williamson-type Amplifier, Craftsmen C800 Tuner with built-in preamplifier, Garrard RC-80 3-Speed Changer with two Pickering cartridges (D-140S and D-120M), Altec-Lansing Model 604C Coaxial Speaker. The music system is provided complete with cables (no soldering connections required), hardware, and easy-to-follow instructions. Own and enjoy the finest in true-toned, distortion-free reproduction.

Shpg. wt., 125 lbs.

93-589. Net \$51975



Convenient
Terms if
Desired

Other fine music systems from \$108 to \$1250



FREE CATALOG

Write today for our complete 236-Page Buying Guide listing the world's largest selection of High-Fidelity systems, amplifiers, tuners, speakers, changers and accessories. If it's anything in Hi-Fi, it's in stock at ALLIED. Send for our FREE Catalog today.

ASK FOR THE ALLIED "AUDITIONER"

We'll be glad to mail you our quarterly publication "High-Fidelity Auditioner"—written especially for Hi-Fi enthusiasts. It's informative, helpful—keeps you up-to-date on new developments, equipment and techniques. Ask to be placed on our mailing list.



ALLIED RADIO CORP., Dept. 49-G-3
833 W. Jackson Blvd., Chicago 7, Illinois

Send Free Catalog Put me on "Auditioner" mailing list

Name

Address

City Zone State

ALLIED RADIO

IMPROVE YOUR FM TUNER'S SIGNAL!

*REG. \$29.95 LIST, ASTATIC BT-1 BOOSTER FOR FM, TV, 2 METERS

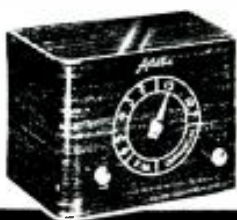

- ★ MALLORY INDUCTUNER!
- ★ CONTINUOUS TUNING!
- ★ 52-216 MC! 6AK5!
- ★ HI GAIN, LOW NOISE!
- ★ AC TRANSF. SUPPLY!

\$9.95

Ship wt. 5 lbs.

Ideal for weak FM signals, the Astatic BT-1 features broad band continuous coverage in 6 turns of the entire 52-216 mc band, including FM broadcast, TV channels 2-13, and the 144-148 mc band! Use as FM and TV booster, or as a 2-meter preselector (similar to R9er) if you're a radio amateur. Handsome 4 3/4 x 6 3/8 x 4 3/4" metal cabinet with mahogany woodgrain finish. On-off switch for cutting in and out of circuit — no need to disconnect booster when not in use. AC only. Provision for 72 ohm or 300 ohm impedance input and output. Full guarantee. Typical Radio Shack savings! **36-001**

RADIO SHACK
CORPORATION
167 Washington St., Boston 8, Mass.

RADIO SHACK BUYS OUT APPROVED HI-FI FM-AM TUNER INVENTORY!

Sale!
\$34.50

Biggest Buy in Hi-Fi History!

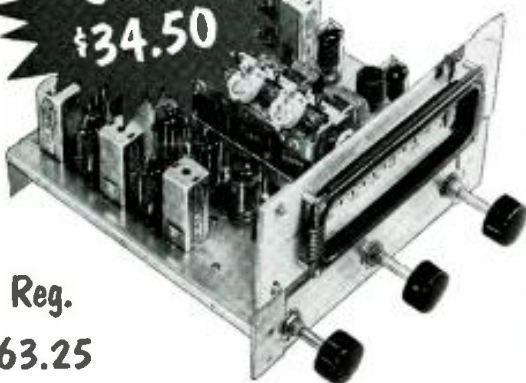

Reg.
\$63.25

12 MIN. TUBES
DOUBLE LIMITER
DISCRIMINATOR
TUNED RF (AM)
TUNED RF (FM)
10 uv @ 92 MC
12 uv @ 106 MC
ORDER BY MAIL

Another exclusive Radio Shack value. The nationally cataloged *Approved Electronics* Model A-710 hi-fi genuine Armstrong circuit FM-AM tuner at a price more than 45% below regular dealer net! With 12 miniature tubes, escutcheon, knobs, schematic and full guarantee. Compact 8 1/4 x 5 3/8 x 8" deep chassis. *Less power supply*: requires 170V DC @ 20 mils and/or 150V DC @ 40 mils, and 6.3V AC @ 4 amps — see A-620 supply below. *Tuner*: Ord. No. 36-206, \$34.50.

MORE APPROVED ELECTRONICS BUYS!

\$37.50

APPROVED PREAMP-EQUALIZER!



\$19.95

Model A-800, almost half off! Preamp for magnetic pickups, 6 pos. equalizer for G-E and Pick. Separate tone controls and all remote features. Take power off Williamson and other amps. Ord. No. 33-246, \$19.95.

APPROVED'S
A-610 SUPPLY
ONLY \$12.05



For A-710 tuner, scores of other uses. 6.3V AC @ 4 amps., 150V DC @ 40 ma, 170V DC @ 20 ma. Ord. No. 36-207, \$12.05.

TECHMASTER
WILLIAMSON
Amplifier KIT



Williamson type kit, complete to the last component, can be wired by anyone. Includes power supply. 9 x 12 x 6 1/2". Ship wt. 27 lbs. Order No. RN33-340 \$49.95

REG. \$8.20
G-E PICKUP
ONLY \$4.44
1952 Model



The most famous make variable reluctance cartridge (requires preamp) and a Radio Shack exclusive. Separate sapphire styli for 78 and 33-45. Same as reg. stock except for packaging which is mfg's bulk. Ord. No. 15-092

EQUALIZER
FOR GE CART.



Also for Audax, and another Radio Shack exclusive. 6 position switch for all domestic and foreign 78 and LP records, including noise eliminator. No wiring: plug tone arm lead into equalizer, plug equalizer lead into preamp; mounts on any panel. Ord. No. 15-568, \$11.95. Special, with above cartridge, \$16.

AUDIOPHILES!
COOK LABS.
10" LP
HI-FI DISCS,
\$4 EACH



#1025 *Kills On Parade* (bag-pipes). #1070 *Rail Dynamics* (RR sounds). #1035 *Great Barrelhouse Piano* (hi-fi on the nickelodeon). #1030 *Harp solo*. #1050 *Pipe Organ Vol. 1*. #1051 *Pipe Organ Vol. 2*. Also Cook test records \$4.80 each: Series 10 (78 rpm); Series 10A (10" LP). Both have 35-20,000 cycle tones accurately calibrated. Add 50c per ship't for packing and mailing.

ACROSOUND T0-300
XFMR. FOR ULTRA-LINEAR
"WILLIAMSON"
AMPLIFIERS

Half the size of competitive units. Freq. response ± 1 db, 10 cps to 100 kc, 24 watts @ 3% intermodulation with only 3/4 volt input. Gray Hammetone case. Order No. R14-343, \$24.75

FREE! 224-PAGE
1953 CATALOG —
WRITE TODAY!



MAIL ORDER
FACTS:
Include estimated postage, we refund any overpayment. Min. 20% deposit on COD's. Write for time-pay form!

RADIO SHACK
CORPORATION
167 Washington St., Boston 8, Mass.

HEARING IS BELIEVING?

Continued from page 102

building the system up component by component, thoughtfully selected component — that, sir, will make your music finer, more satisfying, than it could possibly be if provided by some ready-packaged unit someone else gave you, however fine the unit technically!

"Know thyself!" must be the ultimate ideal, and the basic instruction for enjoying life fully. But if that's too tough a job — "Know thy sound system!" Know why you've picked each component, why it is satisfying — and know that you are, yourself, part of the full system of psycho-physiological music reproduction.

And do the selecting *yourself*. No matter what the experts say, you have your own, personal "impedance"; what you want is a system that matches into that "impedance" — that matches *you*.

Necessarily, the full high-fidelity instrument system must include the load into which it works.

That's where you come in!

ADVENTURERS

Continued from page 33

offer them tea, and we carry on a spirited conversation, sitting perhaps eight feet apart.

"Similarly, if someone comes to play our piano, we should be considered quite rude if we took a seat in the next room, leaving the door open. And yet, most loudspeakers today produce just this result, and we wonder why there is something unnatural."

Having long been a corner cabinet man, happy as a lark with my loudspeaker, never once having suffered any illusion or hallucination as to where all that beautiful music of Verdi, Puccini and Bizet was coming from, I tried to impart my satisfaction to Williamson.

It turned out, according to D. T. N. that I, unerringly had found the worst possible place for my speaker.

"Right where we usually put it," he said. "Screwed tightly in a corner. In this position it excites all the room resonances, fundamentals and harmonics, with the highest possible efficiency, producing a tub-thumping, apartment-shaking result which is usually blamed on the loudspeaker and leads inevitably to the divorce court!"

"Would we invite Uncle Harty along to play his fiddle, then squeeze him tightly into the corner of our living room?" our man Williamson asked. "Certainly not. A corner would cramp his style, make him cross and in peevish spite he might even cut us out of his will. In our search for realism we must always choose a position for the loudspeaker which could reasonably be occupied by a live performance."

It is possible, he said, to reproduce a solo instrument with such fidelity that it cannot be distinguished from the actual performer in the room, and often equally well with the small ensemble, but to bring a full symphony orchestra into the average

Continued on page 106

SPECIALIZATION MAKES THE DIFFERENCE

Specialization may be defined as the concentration of all effort to a special or specific course of action

Even a mechanical device concerned with the function of record reproduction should possess all the advantages of such specialization.

Most units undertake to do much more. They change records, mix records, flip records, reject records, and assume a multitude of other functions. This is 'generalization' as distinguished from 'specialization'.

The REK-O-KUT turntable, on the other hand, is devoted entirely to playing records. And every design feature, every fragment of engineering know-how has been devoted and restricted to the all-important job of playing records . . . to provide the constant, steady, unwavering record motion necessary for the faithful reproduction of records free of mechanical distortion.

Specialization makes that difference. And all of the efforts and facilities of the manufacturer shall continue to be intensively devoted to that one objective . . . that one aim: *To make the finest turntables in the world.*

There is a REK-O-KUT Turntable for your specific discriminating requirement. Seven models are available at prices ranging from \$59.50. At Leading Radio Parts Distributors and at Sound and Music Dealers.

Write for Descriptive Literature



REK-O-KUT TURNTABLES

REK-O-KUT COMPANY, 38-03M Queens Boulevard, Long Island City 1, New York
Export Division: 458 Broadway, New York 13, U. S. A. Cables—Morhanex
In Canada: Atlas Radio Corp., Ltd., 560 King Street, W., Toronto 2B

**NOW... PROFESSIONAL QUALITY SOUND REPRODUCTION
RIGHT IN YOUR OWN HOME!**

**THE AMAZING NEW
FAIRCHILD
SERIES 215
DIAMOND
CARTRIDGE**



Replace any modern pickup with this new cartridge, and enjoy recorded music as never before! High compliance — freedom of stylus to yield to rapid lateral deflections — provides these exciting improvements:

- New shades of tone color from fine recordings!
- New clear timbre in high volume piano chords!
- Rich low-frequency tones never previously heard!
- Arm resonance, "needle talk," rendered inaudible!
- Stylus wear greatly reduced, record quality preserved!
- And above all — **TRACKING DISTORTION ELIMINATED!**

High compliance, low-mass stylus assembly and smooth linearity of extended range are exclusive features of the new Fairchild 215.

First to achieve near-perfect lateral compliance for optimum Hi-Fi performance...

With finest diamond stylus for 33, 45 or 78 rpm records

**NOW ONLY
\$37.50**

ORDER FROM YOUR AUDIO DEALER—or write direct to:

FAIRCHILD RECORDING EQUIPMENT
10th Ave. & 154th St., Whitestone, N.Y.
Manufacturers of the World's Finest Professional Sound Equipment

**WORLD ENCYCLOPEDIA
OF RECORDED MUSIC**

F. F. Clough and G. J. Cuming, 890 pages.

The most all-inclusive reference work for libraries and serious record collectors ever published. Every recorded work — 78, 45, or 33 1/3, U. S. or foreign — is listed in all its versions. A truly encyclopedic compendium of recorded music.

No. 57..... \$17.50

Stocks on this excellent book are low all over. It will not be reprinted. We have exactly 42 copies on hand and can't get any more. Order promptly. Book Department, HIGH FIDELITY Magazine, Great Barrington, Massachusetts.

ADVENTURERS

Continued from page 104

small living room is like trying to seat a hundred men around a dinner table set for two.

"I would like to see more common sense brought to bear on sound reproduction in the home," he said.

It was suggested that with recording engineers searching the audio spectrum for new colors and reality, a person listening to higher and ever higher fidelity will find himself wedged between two cellos one moment, and sitting astride the bassoon the next. What has become accepted as reality is something quite new in the enjoyment of music.

At a symphony concert the audience will be from about 40 to 200 feet from the musicians, while a person sitting near his loudspeaker is right down among the instruments — even closer than the conductor was when the recording tape was made. It is as if a listener had crept upon the stage during the scherzo of Schubert's *Symphony No. 9* and, strangely unobserved, taken a vacant chair in the string section. If this is reality, it is a reality which never existed until the high fidelity music system came along and put the listener right on the clef sign.

"Everyone must decide on the illusion he likes best," Williamson said. "Personally, I like orchestral music to sound as if I were sitting in about Row K — and on the aisle, just in case I don't care too much about what I hear."

Williamson was asked what kind of music he liked, and this very nearly precipitated a deliberative process like that which preceded his martini.

"My ears are catholic, I'd say," he said. "I like concertos and dance music. Then, I can listen to about two Dixielands a night. But may be that's because I have but two."

Williamson pulled a slender tone-arm from the breast pocket of his jacket, then fished deeper to bring out a very small magnetic cartridge which he attached to the arm. These, too, were Williamson all the way. They were pilot models he had brought with him, explaining that production would be taken over by Ferranti in Scotland.

Sight of these items brought Dr. Goldmark quickly alert, clear-headed from his tomato juice, and he and Williamson buzzed with the language of science and mathematics for ten minutes.

Later I asked him what had prompted him to design the now-famous Williamson circuit, and publish it for the free use of anyone who wanted to build it.

"Before the Williamson, nearly all amplifiers, or at least those available to the amateur or hobbyist, had five percent distortion or more. In fact, five was the standard," he said.

"This was too much for quality reproduction, so I set about to make something a bit better than necessary. I took one-tenth of one percent as my arbitrary standard, and I worked toward a circuit that would not be difficult to build. I knew more hobbyists would tackle the job that way."

Continued on page 108

HARVEY the House of Audio



Harvey is proud to announce its appointment as a distributor of

AMPEX

PRECISION MAGNETIC RECORDING EQUIPMENT



All models are on Demonstration at the Harvey AUDIO-torium, and are Available for Immediate Deliveries directly from Stock. Write for Complete Details.



ALTEC DUPLEX

LOUDSPEAKERS and SPEAKER ENCLOSURE

After ten years of research, Altec has perfected three speakers to provide wide frequency range, smoother response, and lower distortion than has been previously attained. These speakers are unconditionally guaranteed by the manufacturer to reproduce all frequencies from 30 to 22,000 cycles when mounted in a suitable enclosure.

These speakers are all effectively self-contained two-way systems and are supplied with dividing networks. The Model 601A and the Model 602A are respectively 12 and 15 inches in diameter. Impedance in both cases is 8 ohms and power rating is 20 watts (30 watts peak). Crossover frequency 3000 cycles.

The Model 604C (illustrated) is designed for high power handling requirements with a rating of 35 watts (50 watts peak). Diameter of speaker is 15 inches; impedance, 16 ohms, and crossover frequency, 1600 cycles.

Model 601A \$89.00
Model 602A 114.00
Model 604C 156.00

The Model 606 Corner Cabinet was designed and engineered specifically for use with the duplex speaker. Available in either mahogany, walnut or blond, its appearance and finish will harmonize with the interior and furnishings of the home.

Dimensions: Height, 36 1/2"; Overall Width, 36"; Depth to Corner, 23 1/2"
Mahogany or Walnut \$118.00
Blond 128.00

Specify for 12 or 15 inch speaker

A New High in High Fidelity Recording

Now Available!

COOK RECORDS

33 1/3 rpm Microgroove

- Full Frequency Range
- Full Dynamic Range
- Each record in Sealed Vinyl Jacket
- Playback Curve Indicated on each Record

Recent 10" Releases. each \$4.80

- #2064 BIZET: Introduction to Act I (Carmen)
- ROSSINI: Overture (La Gazza Ladra)
- MEYERBEER: Overture (Euryanthe)
- vanWEBER: Overture (Euryanthe)
- #2065 MOZART: Symphony #40 in G Minor
- RIMSKY-KORSAKOV: Dance of the Buffons
- #2066 STRAUSS: Emperor Waltz
- SAINT-SAENS: Danse Macabre
- BRAHMS: Hungarian Dance No. 6

Write for FREE literature

Visit the HARVEY AUDIOtorium

If you want to See and Hear the finest... the widest selection of high fidelity equipment... be sure to visit the HARVEY AUDIOtorium. It will thrill you.

NOTE: Prices Net, F.O.B., N.Y.C. Subject to change without notice.

The NEW PICKERING TURN-OVER PICKUP

Model DD-260 with diamond stylus \$60.00

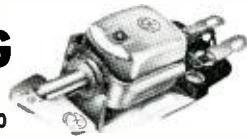

Engineered and constructed with the care and craftsmanship which have gained Pickering Cartridges a position in the top ranks, the new model DD-260 has been designed to play standard as well as micro-groove records at 33 1/2, 45, and 78 rpm. It consists of a cartridge, swivel-mounted, and provided with a lever-knob for convenient turn-over. The model DD-260 is provided with 2 diamond stylus. The entire unit fits easily into standard tone arms.

NEW BOGEN HIGH FIDELITY UNITS

FM-AM TUNER Model R604



An all-superheterodyne AM-FM Tuner with 5 microvolt sensitivity for 30db noise reduction on FM, and rated output on AM. FM frequency response: 50 to 15,000 cps \pm 1db. Has built-in power supply with power receptacle for control of main amplifier and other units with master power knob on tuner. Supplied with indoor loop antenna. Has terminals for external 300 ohm antenna. AFC provides complete stability. External socket permits simple switch installation for optional AFC cut-out. Dimensions: 10" w x 11 1/2" d x 7" h.

Complete with tubes, escutcheon plate, and instructions \$97.35

20 WATT AMPLIFIER Model DB20



A high quality amplifier with features providing complete control of sound reproduction. Exclusive Loudness Contour Selector permits instant selection of desired frequency response to compensate for losses revealed by the Fletcher-Munson curves. Frequency response: 20 to 20,000 cps \pm 0.7db. Ten position selector switch provides inputs for phono, tuner, TV, tape, and other signal sources. Separate Bass and Treble Controls permit continuous boost and attenuations: +17 to -18db at 40 cps and +15 to -21db at 15kc. 7 equalization positions permit matching of preamp section to characteristics of most record types. Has built-in power supply furnishing dc to preamp heaters. Dimensions: 15" w x 9 1/4" d x 8" h.

Complete with tubes \$99.00

THORENS Model E-53PA TURNTABLE



High Quality turntable with direct drive, governor controlled motor for silent, rumble and wow-free operation. Has 12" cast aluminum turntable with rubber mat. Permits instant selection of 33 1/2, 45 or 78 rpm speeds \$60.00

The NEW MAGNECORD VOYAGER

One-Case Portable TAPE RECORDER

Model PT6-VAH

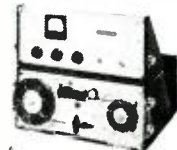

A professional-quality portable unit designed for use wherever top-quality recording and reproduction are required. Operates at either 15"/second or 7 1/2"/second, with a frequency response within 3 db from 50 to 15,000 cycles at 15"/second. Has high as well as low impedance inputs. Output is 600 ohms. Provided with earphone monitor jack which is in the circuit for both record and playback. Dimensions: 7 3/4" x 17 3/4" x 19 1/4" inches. Weight: 42 lbs. Power requirements: 110v., 60 cycles A.C. \$499.50



HARVEY

RADIO COMPANY, INC.

103 W. 43rd Street, New York 36, N. Y. • JUdson 2-1500

A new concept
of recorded music

THE HEATHKIT Dual RECORD PLAYER KIT



- Dual matched speakers for room filled perimeter sound
- Plays all record sizes, all speeds
- Newly developed ceramic cartridge
- Automatic shut off for changer and amplifier

MODEL RP-1

\$59⁵⁰

SHIPPING
WT. 30 LBS.
Shipped
Express
Only

Here is a *new* introduction to quality record reproduction. A simple to operate compact table top model with none of the specialized custom installation problems usually associated with high fidelity systems. Two matched speakers mounted in an acoustically correct enclosure reproduce *all* of the music on the record. Re-

production with the unique sensation of being in a halo of glorious sound.

The world famous VM Tri-O-Matic record changer plays all three record sizes at all three speeds. Automatic shut off for both changer and

amplifier after the last record is played. A wide range ceramic cartridge features an ingenious "turn-under" twin sapphire stylus for LP or 78 records without turning the cartridge. Simplified easy to assemble four tube amplifier featuring compensated volume control and separate tone control. Proxylon impregnated fabric covered cabinet supplied completely assembled. You build only the amplifier from simple step-by-step instructions. No specialized tools or knowledge required.

The Heathkit Dual Kit includes cabinet, VM player, speakers, tubes, and all circuit components required for amplifier construction. If a kit project has ever tempted you, here is the perfect introduction to an interesting and exciting pastime. Build the Heathkit Dual and enjoy unusually realistic room filling reproduction of fine recorded music.

OTHER *Famous*
HEATHKIT AMPLIFIERS

THE HEATHKIT 6 WATT AMPLIFIER KIT

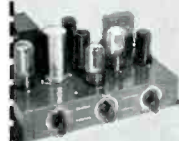

Model A-7B
\$14.50

Ship. Wt. 10 lbs.

The Heathkit Model A-7B Amplifier features separate bass and treble tone controls — two compensated inputs — three output impedances 4, 8, and 16 ohms — frequency response $\pm 1\frac{1}{2}$ db from 20 to 20,000 cycles — push pull beam power output at full 6 watts.

Heathkit Model A-7C with preamplifier stage..... **\$16.50**

HEATHKIT *High Fidelity* AMPLIFIER KIT



\$35.50

Model A-9A
Ship. Wt. 17 lbs.

A 20 watt high fidelity amplifier especially designed for custom installations. Low hum and noise level 9 pin miniature dual triodes in pre-amplifier and tone control circuits. Four switch selected inputs. Frequency response ± 1 db 20 to 20,000 cycles. Output impedances of 4, 8, and 16 ohms.

Write For Free
CATALOG

New 32 page 1953
Catalog lists all kits,
specifications, sche-
matics and latest
price information.

HEATH COMPANY

BENTON HARBOR 8
MICHIGAN

YOU SAVE BY ORDERING DIRECT FROM FACTORY

ADVENTURERS

Continued from page 106

The Williamson circuit, actually, was not invented by Williamson anymore than Beethoven invented the musical notes with which he made his Fifth Symphony. The notes had all been used before, and so had everything Williamson put into the amplifier circuit. What was new, and what made the big difference was the *sequence* in which familiar ideas were put together in the new design, plus careful specifications for building a truly adequate output transformer. The latter was needed to permit use of the distortion-quelling device Williamson wanted to incorporate in his circuit — 20 db of feedback over three stages and the output transformer.

First details of this circuit were published in *Wireless World* in April 1947 and the circuit now called the Williamson was one of three which he outlined in the British periodical. This article discussed various ways to put together a high quality amplifier, together with the components required for construction and concluded by selecting one of the three circuits as the one which would be easiest to construct for the amateur technician and music lover who had but little testing equipment, no extraordinary skill and who might be limited in other ways. The other two circuits were eliminated, not because they were inferior, but because Williamson felt they would cause the novice more trouble in construction.

Williamson considers the output transformer as probably the most critical component of a high fidelity amplifier and success of the many amplifiers, built by amateurs in their home shops after publication in 1947, was due to explicit instructions given for making this component. In the past six years technical description and diagrams of the circuit have been published in all the principal countries of the world. In the United States, it is claimed by Williamson partisans, approximately 70 percent of the high quality amplifiers now being manufactured here are advertised as employing circuits of the Williamson type.

To set apart the amplifier which he, personally, approves, Williamson asked the manufacturers of the two-chassis, 12-watt, 47-pound "Hallmark" to designate each one with an attached metal tag bearing his signature, signed: D. T. N. Williamson.

I had been intrigued by the name David Theodore Nelson Williamson and asked if he ever had any tracking difficulties with such an LP name.

"I use the initials to conserve time and space," he said. "In Scotland, growing up, it was no advantage to be known as Theodore, but I understand the name is considered quite rugged over here. However, having a choice of David and Nelson, I made out very well."

After making notes on this aspect of the Scotsman whose name is perhaps the one most often heard in reference to amplifiers, I looked up to see Williamson glancing at his watch and slowly rising from the table.

Dr. Goldmark took off quickly in some predestined direction. Davies, a tall Welchman, stretched his legs and made ready to

Continued on page 110

Why Wait?

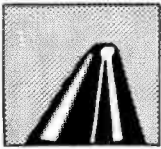

Osmium Stylus after 15 playing hrs.



Sapphire Stylus after 30 playing hrs.



Diamond Stylus after 300 playing hrs.

For Only
\$10
Postpaid

Now—YOUR NEEDLE CAN BE DIAMOND TIPPED

Precision diamond tipping is an ART, and our diamond craftsmen are ARTISTS in this precious stone specialty. Each diamond-tip is custom formed, micro-calibrated, meticulously examined for flaws—highly polished to ride in your fine record grooves smoothly for the cleanest clarity and highest fidelity possible.

Send us your replaceable needle and a check or money order for \$10—LOWEST PRICE FOR THIS QUALITY! You will receive a genuine, unconditionally guaranteed diamond stylus, which retains its tip form nearly 100 times longer than sapphires. If your old needle cannot be forwarded, please add \$1, specify make and number of your phono cartridge. We will furnish the proper stylus shaft.

The
DIATONE CO.
Mfrs. of Custom Crafted Diamond Stylus

DEPT. H-F
31 WEST 47th STREET
NEW YORK 36, N. Y.

What's the meaning of this?

The _____ and Finale, played by _____ on Capitol P 8078, comprise a _____ and justifiable _____ The _____ and seven numbers arbitrarily _____ Mr. van Beinum to _____ of off _____ represent an old _____ of off _____ caretaker cutting. One tableau _____ has as much value as another will not find in the _____ paying the _____ record any _____

The words are recognizable, but the sense is lost—because some of the most important ideas have disappeared. Hardly "good reading!"

Good music, too, needs full reproduction



Stromberg-Carlson

"CUSTOM FOUR HUNDRED"
HIGH FIDELITY

reproduces, in your own home, the full range of musical beauty which an artist created and master craftsmen impressed on your records.

Test this! Ask your Stromberg-Carlson dealer to play any record of your choice on an ordinary reproducer and then on "Custom Four Hundred" equipment. You'll likely agree that you have been only half-hearing your music!

Illustrated brochure and dealer's name on request.



STROMBERG-CARLSON
Sound Division

1222 Clifford Ave., Rochester 3, N. Y.

NEW WILLIAMSON TYPE

Heathkit AMPLIFIER KIT

FEATURES

- Practically distortionless. Harmonic and intermodulation distortion both less than one half of 1% at 5 watts.
- Frequency response +1 db from 10 cycles to 100 kilocycles.
- Altec Lansing PEERLESS or ACRO SOUND transformers available.
- First Williamson type Amplifier supplied with matching preamplifier.

When selecting an amplifier for the heart of a fine high-fidelity audio system, investigate the outstanding advantages offered by the Heathkit Williamson type Amplifier. Here is an amplifier that meets every high-fidelity audio requirement and makes listening to recorded music a thrilling new experience through naturally clear, lifelike reproduction of sound at all tonal levels. Wide acceptance of the Heathkit Williamson type Amplifier by the most critical purchasers clearly demonstrates that high-fidelity can be coupled with low cost. For factual information regarding the Heathkit Williamson type Amplifier, consult "CONSUMERS RESEARCH ANNUAL CUMULATIVE BULLETIN 1952-53."

This outstanding amplifier is offered with the optional choice of either the ACRO SOUND output transformer or the PEERLESS output transformer. ACRO SOUND features ULTRA-LINEAR circuitry, which is the exclusive development of the Acro Products Company and provides a greater margin of reserve power efficiency and increases power output. PEERLESS features additional primary taps to permit the optional choice of either the extended power circuitry, now enjoying current popularity, or all of the advantages of the original Williamson type circuit.

The construction manual has been simplified to the point where even the complete novice can successfully construct the amplifier without difficulty. Write for a free catalogue containing complete specifications and schematics of the Heathkit Williamson type Amplifier.



PRICES OF VARIOUS COMBINATIONS

- W-2 Amplifier Kit (incl. Main Amplifier with Peerless Output Transformer, Power Supply and W-A-1 Preamplifier Kit) Shipping Weight 39 lbs. Shipped express only **\$69.50**
- W-2M Amplifier Kit (incl. Main Amplifier with Peerless Output Transformer and Power Supply) Shipping Weight 29 lbs. Shipped express only **\$49.75**
- W-3 Amplifier Kit (incl. Main Amplifier with Acrosound Output Transformer, Power Supply and W-A-1 Preamplifier Kit) Shipping Weight 39 lbs. Shipped express only **\$69.50**
- W-3M Amplifier Kit (incl. Main Amplifier with Acrosound Output Transformer and Power Supply) Shipping Weight 29 lbs. Shipped express only **\$49.75**
- W-A-1 Preamplifier Kit only. Shipping Weight 7 lbs. Shipped express or parcel post. **\$19.75**

HEATH COMPANY
BENTON HARBOR 8, MICH.

You are
the Maestro
with the NEW

Bogen

**DB20
HI-FI AMPLIFIER**



featuring

**The Most Complete
and Versatile Control
of Sound Reproduction
ever offered!**

NEW LOUDNESS CONTOUR SELECTOR!

An exclusive Bogen control providing compensated frequency response to match any listening level.

ALL-INCLUSIVE RECORD COMPENSATION!

Seven positions for LP, AES, NAB, AM78, EU78, FFRR and Popular records, cover all normal requirements.

NEW WIDE RANGE TONE CORRECTION!

Individual treble and bass controls of remarkable flexibility. Bass control +17 db to -18 db at 40 cps. Treble control +15 to -21 db at 15 kc.

FOUR-POSITION INPUT SELECTOR!

Provides complete selection of matched inputs for Magnetic Phono, Radio, TV and Tape Recorded program sources.

—plus the finest overall
performance ever offered
at a popular price!

The DB20 embodies all the advanced design features that have made BOGEN a by-word for quality. Power output is 20 watts with 5 feedback loops and partial cathode loaded output reducing distortion to a low, low 0.3%. Frequency response is 20 to 20,000 cps \pm 0.7 db. D.C. on preamp filaments reduces hum to -75 db.

WRITE TODAY FOR BULLETIN #7



**DAVID BOGEN
CO., INC.**

29 NINTH AVE., NEW YORK 14, N. Y.

*A Quarter Century of
Electronic Specialization*

ADVENTURERS

Continued from page 108

steer Williamson back into New York's bruising sidewalk traffic.

"Have I given you anything?" Williamson asked pleasantly.

"Yes," I said, putting on a cheerful face to hide my new worries. "You have given me acoustical nightmares."

Williamson peered intently for about the time it takes a 12AX7 to warm up.

"What do you mean?"

"All those people in the corner," I said. "I'd never noticed them before — but now that you've mentioned them, I do. For months I've been so happy with my corner speaker that I went about urging everyone to buy one — but all I can see now is your poor Uncle Harry and his fiddle, jammed in but trying so desperately to play."

I wished the young Scotsman calm sea and prosperous voyage, then hurried home to make a very important test, the outcome of which might well shake me out of high fidelity and back to the Victrola.

I whipped a Mozart quintet from the sleeve, then put it back. No! I would face it, all or nothing. I took Beethoven's Ninth Symphony from the album, put Side 3 on the spindle. This ought to do it, I thought. I listened to the entire side, then turned the amplifier (Williamson-type) off . . .

I don't know — maybe I'm wrong, but it sounded mighty good to me. Even with Toscanini and the NBC Symphony Orchestra, Eileen Farrell, Jan Peerce, Nan Marri-man, Norman Scott, yes! and Robert Shaw and The Robert Shaw Chorale — there seemed to be plenty of room for everybody, right there in my own little corner.

Maybe it was just my imagination, but I don't think so. I believe it was an illusion. That wonderful substitute for reality which Williamson said we should look for.

TALKING BOOKS

Continued from page 31

backbone. As one friend remarked, "it even smells like a leather-bound Bible." Actually, in spite of whatever objections one might have to a limited audio spectrum, the sound is clear and each word, even the long, hard ones, can be understood. The reading, by Marvin Miller, is clean and unpretentious — an important factor, unless we miss our guess, in making Audio Books palatable. Marvin Miller, incidentally, did the very sympathetic, very restrained job of narrating that warmhearted cartoon about a lonely child, *Gerald McBoing Boing*. Recordings of works by classic authors — the names of Homer, Descartes, Marcus Aurelius, Voltaire, and Jean-Jacques Rousseau are usually mentioned in any conversation with the producers of Audio Books — are scheduled to follow.

Only one question remains to be solved — to make room for the ambiguous newcomer, do we have to scrounge around for more space among our records, or do we shove aside the books in our library.

CORRECTION—A line was omitted near the bottom of page 29, an error we discovered too late to correct. So, by way of explanation: "that writing" which interested James Joyce so much was the *Arabian Nights*.

Needles are your protection . .



**and all phonograph records
require the finest needles
for protected performance**

DUOTONE needles save the lives of phonograph records. There is a Duotone diamond for every record player and a Duotone needle in every price range.

Change your needle yourself by writing for free illustrated booklet showing every needle and every cartridge and instructions for replacing needles.



Canadian Representative:
CHARLES W. POINTON, TORONTO, CANADA
Export Division:
AD. AURIEMA, INC., NEW YORK CITY, N. Y.

**Now SWISS CRAFTSMANSHIP BRINGS YOU
SUPERB REPRODUCTION**



**THORENS
CONCERT CD-43
VARIABLE SPEED
RECORD CHANGER**

Two plug-in heads, adaptable for your favorite cartridge.

Automatically intermixes 10" and 12" records, special selector for 7" size with all metal spindle for large hole records sold separately.

Automatic last record shut-off, reject, repeat, and pause controls complete with muting switch and tracking weight adjustment screw.

For the latest in record players see our CBA-83 Automatic Player.

Compare these features:

- **DIRECT DRIVE** governor controlled four pole induction type motor provides completely silent wow-free operation
- **EXACT SPEED** maintained through specially designed centrifugal governor which automatically compensates for variations in line voltage, heat and load.
- **CAREFULLY ENGINEERED** long, low mass tonearm provides excellent tracking and complete freedom from parasitical resonances.
- **PATENTED SPEED CONTROL** for variable speed adjustments around each of the three main positions.

Write for complete catalogue on THORENS record changers and record players.

THORENS CO. BOX 166F NEW HYDE PARK, N. Y.

THE R.T. BOZAK CO.

Quality Loud Speakers

Open up the "Hole in the Wall"!



with the
new
**BOZAK B-201
BINAURAL-
MONAURAL
Speaker System.**

New realism for
even the finest
high-fidelity
outfit.

First Binaural Speaker System to combine single-cabinet convenience with true binaural acoustics and balanced response.

First Monaural Speaker System to provide broad sound-source and eliminate the point-source, or hole-in-wall, effect.

Switches instantly from Binaural to Monaural playback. Adjustable directors control sound placement to enhance the acoustical qualities of any room. Clean, crisp sound—clean, rugged cabinetwork. "Contemporary" and "Georgian" styles. 36½" x 19½" x 33". For details write R. T. Bozak Co., 114 Manhattan St., Stamford, Conn.



**OWN THIS GREAT LIBRARY
for complete authoritative
analyses of all important
AUDIO AMPLIFIERS**

Only data of its kind available on hundreds of important audio amplifiers. Complete, uniform, detailed analysis of each unit, based on actual laboratory study of the equipment. Includes circuit diagrams, chassis photo views, parts data, full technical coverage. Available in four profusely illustrated volumes—absolutely indispensable to audiophiles, engineers and students.

VOL. 4. Covers 75 audio amplifiers and important tuners produced during 1951 and 1952. Never before available in a single compilation. 352 pages, 8½ x 11".

ORDER AA-4. Only \$3.95

VOL. 3. Covers 50 audio amplifiers and 22 FM and AM tuners made during 1950. Detailed data on design and servicing. 352 pages, 8½ x 11".

ORDER AA-3. Only \$3.95

VOL. 2. Covers 104 amplifiers and 12 tuners produced in 1949. 368 pages, 8½ x 11".

ORDER AA-2. Only \$3.95

VOL. 1. Covers 102 post-war amplifiers and tuners produced through 1948. 352p, 8½ x 11".

ORDER AA-1. Only \$3.95

BEST-SELLER ON AUDIO!



**"The Recording and
Reproduction of Sound"**

Only complete reference on AUDIO! New second edition—over 800 pages. Chapters on sound wave behavior; recording methods; the decibel; phono reproducers; cutting styli; microphones; loudspeakers;

dividing networks; attenuators; mixers; amplifiers; tuners; home music systems—hundreds of other subjects. The great Audio book by Oliver Read—largest-selling in its field.

ORDER RR-2. Only \$7.95

HOWARD W. SAMS & CO., INC.

Order from your Parts Jobber today, or write direct to Howard W. Sams & Co., Inc. 2213 East 46th St., Indianapolis 5, Ind.

\$..... enclosed. Send following books:
 AA-1 (\$3.95) AA-3 (\$3.95) RR-2 (\$7.95)
 AA-2 (\$3.95) AA-4 (\$3.95)

Name

Address

City Zone .. State

"The Quality of Music Is Not Strained"

Nor Is It Brilliant, Mellow, Spectacular, or Sensational. Danby Speaker Systems Produce Natural Sound Rather Than Startling Realism



Rear Loaded

Danby Rear-Loaded (bottom-vented) and Corner dual loudspeaker systems faithfully reproduce every nuance of sound free of distortion and without sacrifice of any frequency from below 35 to above 16,000 cps.

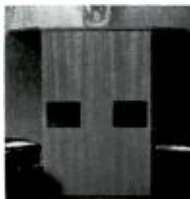

Corner System

Solidly constructed of 3/4" furniture ply-woods, these folded-horn enclosures combine high quality acoustic engineering and fine cabinetry. Originally built on a custom basis for various Philadelphia musicians, teachers, and engineers, they are now available for mail-order purchase.

In Natural Birch or Mahogany. Special Finishes To Order.

Rear-Loaded Horn

Single 12" (15 W.) speaker—\$195.00

Dual 12" (25 W.) speakers—\$255.00

Folded Corner Horn System (25 W.)

Single tweeter—\$295.00

Dual tweeters—\$325.00

DANBY RADIO CORP.

2042 CHESTNUT STREET

PHILADELPHIA 3, PENNA.

THE RIGHT ANTENNA

Continued from page 85

Also, note that 72-ohm impedance. This will match some antennas, but not most; it will match some FM tuners, but not most. And mismatch causes further loss of signal strength. Matching transformers are available, so that handicap can be overcome if it is necessary to use coaxial cable.

A third general type of lead-in is of open wire design: two bare wires held apart by insulators spaced at regular intervals. Its advantage is extremely low loss per foot, but this advantage is seldom needed unless the antenna is on a tower 100 ft. or more in height.

Efficiency and Directivity

There are two basic factors which must be considered in selecting an antenna for a particular installation. One is efficiency, and the other is directivity. The latter is the characteristic of an antenna to accept signals from a particular direction, and to reject signals from other directions. The greater the directional effect, the greater the efficiency. Least efficiency is obtained from an antenna designed to receive signals from all directions.

A further problem is introduced by those factors of efficiency and directivity. As the efficiency is increased, the range of frequencies which the antenna will pick up becomes narrower. Thus it is not possible to have a high-efficiency (*i.e.*, high-gain) antenna which is also evenly efficient over the full FM band. So you must determine whether the stations you want to hear are located relatively nearby and in all directions, or if you want to single out one or two in a specific direction which are sufficiently important so that you want them at a cost of losing other stations. These considerations are explained in the following discussion of the various types of FM antennas which are now available.

The accompanying chart illustrates the FM antenna types most widely used, and presents a summary of their characteristics, as well as the names of companies producing them.³ Following are additional details and notes which should be considered in selecting the type best adapted for particular operating conditions:

STRAIGHT DIPOLE: Because this type has an impedance of 72 ohms, it is seldom used. Most sets are designed for 300 ohms impedance, and 300-ohm lead-in wire is easiest to obtain.

FOLDED DIPOLE: The simplest antenna for FM reception is the folded dipole. In commercial form, it is merely a rod bent at each end in the form of a hairpin, with the ends separated slightly by a mounting insulator. The two wires of ordinary 300-ohm twin-lead are connected to the ends of the rod. Since the length of the dipole determines the frequency to which it responds, this type is usually cut for 98 mc.,

Continued on page 114

³If you want catalogs and literature, a list of the companies and their addresses can be obtained by sending a postcard request to HIGH FIDELITY Magazine, The Publishing House, Great Barrington, Mass.

ESPEY

*proudly announces its
Silver Anniversary Models*

AM-FM Receivers, Tuners and Amplifiers

Your inquiry is invited

ESPEY MANUFACTURING CO., INC.

528 EAST 72nd STREET, NEW YORK 21, N. Y.

Quality manufacturers since 1928

WILLIAMSON "HALLMARK" AMPLIFIER

Available from the
Principal Distributors
Throughout the United States
and

In Canada

J. B. Smyth, 2063 Victoria St.
Montreal 2

In Cuba

California Radio-Television
Infanta y 23, Havana

In Panama

Tropical Electronics
Aptdo. 1812, Panama City

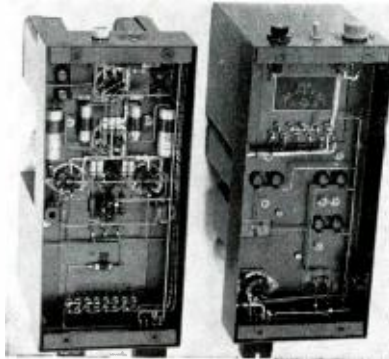

ENGINEERED

for quality and durability

Arrangements are in hand for direct shipment from England
to Guatemala, Hong Kong, Japan, Puerto Rico and Peru.

For further information and
addresses of Distributors,
apply to

British Radio Electronics, Ltd.
1833 Jefferson Place, Washington 6, D. C.

ONLY PENTRON OFFERS Interchangeable Heads

with

REMOVABLE POLE PIECES

Uses separate record-erase
heads . . . standard dual track
or full width (single track pro-
fessional type). Removable pole
pieces save 80% in replace-
ment costs, eliminate need of
buying entire heads.



As Easy to
Change as a
Phono Needle

4 HOURS Recording or Playback with Reel Adapter

Converts Pentron Recorders
and Players for NAB hub 10 1/2"
broadcast reels. Attaches in 2
minutes. Uses all sizes without
detaching.

Model 9T-3C complete \$179.50 list
Adapter \$30.00 list

**MULTI-SPEED
PENTRON
TAPE RECORDER**

THE PENTRON CORP. 664-Hh North Michigan Blvd.,
Chicago 11, Ill.

Send FREE
Literature.

Name _____

Street _____

City _____

State _____

TRUVOX

*The Answer
To Large Scale
Performance
In A Small Size
Enclosure*



TRUVOX MODEL NO. 2 ENCLOSURE

NEVER BEFORE In A High Fi-
delity Cabinet of This Size Has
the Full Breadth of Tonal Real-
ism Been Captured.

The TRUVOX enclosure has
been carefully designed to
greatly enhance the range of
ANY 8" speaker.

Employing new concepts of
acoustic design it is superbly
made of select hardwood.

18" High-15" Wide-12" Deep

Available In Colors To Match
The Following Finishes: Ma-
hogany, Walnut, Bleached
and Black.

PRICE \$26.95

WITH PERMOFLUX 8" SPEAKER \$40.20
(F.O.B., NEW YORK)

SEND CHECK, M.O., OR BANK DRAFT
TO:

**TRUVOX
MANUFACTURING CO.**
208 EAST 47 STREET
NEW YORK 17, N. Y.
Plaza 5-2684

DEALERS NAMES ON REQUEST

FAS Air-Coupler for Bass Reinforcement



WHEREVER IT IS DEMONSTRATED, the most critical audio experts and designers of custom installations choose the Dual Air-Coupler as the most effective type of enclosure for bass response because 1) it delivers musical bass reproduction down to the lowest organ pedal notes, and 2) the bass does not drop out at low volume.

THE G.A. DUAL AIR-COUPLER, illustrated here with the front plate removed, is an exact duplicate of the original FAS design. It can be mounted under the floor, laid on edge to form part of a seat or low table, or spaced out 6 to 8 ins. from the wall. Dimensions are 72 by 16 by 6 ins.

DUAL AIR-COUPLER, KNOCKED DOWN, all parts precision-cut from high-quality 3/4-in. plywood. Can be assembled with only simple tools. Opening cut for a 12-in. speakernow only \$34.50

DUAL AIR-COUPLER, COMPLETELY ASSEMBLED as illustrated, with front plate mounted, but without speaker. Can be stained or painted, as preferred. Opening cut for a 12-in. speaker.....now only \$47.50

NEW, COMPACT AIR-COUPLER, supplied completely assembled. A revised design for limited space, measures 42 by 18 by 7 ins. thick. Power-handling capacity is slightly less than standard design, but cut for mounting a 12-in. speaker.....\$29.75

ASSOCIATED ITEMS: Altec 600-B speaker for Air-Coupler and intermediate speaker, \$46.50 . . . University 4408 tweeter, \$16.50 . . . Peerless C-455A power choke, \$6.90 . . . Peerless R-560A power transformer, \$10.98 . . . Peerless S-230Q output transformer, \$16.98 . . . English KT-66 output tube, \$4.95. For immediate delivery.

Networks for Two or More Loudspeakers

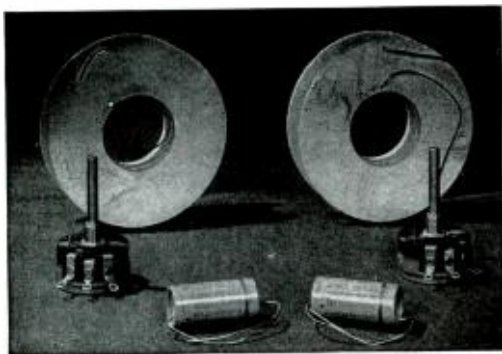

By a judicious selection of associated components, the three coil sizes on which G.A. has standardized enable our customers to secure low-cost crossover networks which will operate at 14 different crossover frequencies! For the experimenter, that means a wide range of choice without having to break the bank to buy dozens of coils. For the man who wants to install his system once and for all, it means money saved, because G.A. saves money by making only three coil sizes (10.2, 5.1, and 1.6 Mh) — and it passes on those savings direct to its customers.

If you want to use three speakers with crossover points at 350 and 1,100 cycles, for example, just order two of the networks listed above (for a system employing an 8-ohm woofer, it would be No. 6 and No. 8).

As most everyone has found out by now, G.A. is headquarters for crossover networks. As far as we know, we're the only organization stocking networks specifically designed for use with Air-Couplers.

If you are in doubt about the selection of a network for your particular speakers, send 10c for the G.A. Network Data Sheet, from which you can determine your requirements exactly.

RAPID ATTENUATION NETWORKS

12 db droop per octave. These networks use two inductance coils.

Impedance of low frequency speaker	Crossover Frequency	Order by Number	Price 2 Coils Only	Price Complete*
16 ohms	2,200	No. 1	\$7.00	\$11.50
	1,100	2	7.00	12.00
	700	3	12.00	16.00
	350	4	12.00	17.50
	175	5	20.00	24.00
8 ohms	1,100	6	7.00	12.00
	550	7	7.00	13.00
	350	8	12.00	17.50
	175	9	20.00	24.00
	85	10	20.00	26.50
4 ohms	550	11	7.00	13.00
	275	12	7.00	15.00
	175	13	12.00	19.00
	85	14	20.00	26.50

* Complete networks include necessary capacitors and level controls. Be sure to indicate whether you want just the coils or the complete network.

Air-Couplers are shipped via Railway Express, FOB Great Barrington, Mass.

Other items shipped FOB unless 75c is included to cover parcel post and insurance charges.

General Apparatus Co.

State Road, Great Barrington, Massachusetts

THE RIGHT ANTENNA

Continued from page 112

the center of the FM band. That gives broad-band response from 88 to 108 mc.

The folded dipole is directional. That is, if the dipole points east and west, best reception is from the north and south. Thus, it is necessary to swing the dipole around until the best position is found for a given location.

In a city area, where signals are strong, there may be very little directional effect, because the signals are reflected in many different directions by the buildings. Out in the country, the directional effect may be quite marked but, if there are nearby hills, best reception may not be obtained with the dipole at right angles to the direction of the FM transmitter, due to reflections caused by the high ground.

This directivity effect may be used to advantage to balance out a strong station to favor a weaker one.

OMNI-DIRECTIONAL ANTENNA: If you want to receive stations located in several different directions from your home, you may get adequate results with an omni-directional (all-direction) antenna. This is a combination of two folded dipoles, mounted at right angles to one another. This is a low-efficiency design. However, it is adequate for moderate distances, particularly if it is installed at a fairly high point.

Frequently, a folded dipole is furnished with one back reflector rod. That is to increase reception to the front, and to reduce the signal pickup at the rear. The decision to use or omit the reflector depends on the directions from which signals are to be received. It may give the extra pickup needed for a distant station, and still not reduce reception appreciably from a nearby station in another direction. Or it may help to eliminate occasional interference between a local and a distant station on the same frequency, but in different directions from the receiver.

CONICAL ANTENNA: The conical antenna was developed originally for TV, but two companies make this design with dimensions correct for FM reception. This type, like the folded dipole and reflector, is directional, receiving more effectively from the end where the conical rods are mounted. It is recommended particularly when stations to be received are at the extreme ends of the FM band. The purpose of the conical construction is to provide broad-band response.

YAGI ANTENNA: For long distance, the Yagi antenna is the most efficient. However, this advantage is achieved at the cost of sharper directional effect, and greater frequency-selectivity. The Yagi type consists of a dipole and reflector, plus directors located ahead of the dipole. The greater the number of directors, the greater the signal pickup and the greater the directivity and the narrower the frequency band.

The RMS Company makes two types of Yagis, each with a number of directors. Greatest pickup is provided by the narrow-band design. It responds to a frequency band only 6 to 8 mc. wide. Therefore, in

Continued on page 116

KARLSON BREAKS THROUGH THE SOUND BARRIER

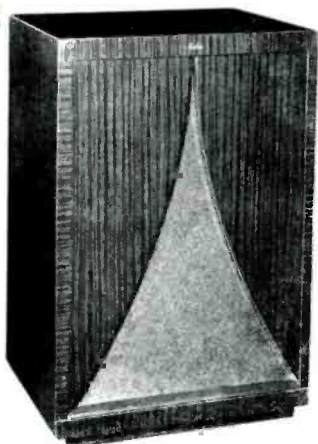

The speaker enclosure too long has been the *weakest link* in the high-fidelity chain.

With the Karlson Enclosure this last barrier to Ultra-Fidelity has been **CRACKED**.

The discovery of a completely new basic acoustical principle — the exponential coupler — now makes possible the thrilling recreation of the original sound picture.

The Karlson Ultra-Fidelity Enclosure
Blond or Mahogany \$117.60
Other models from \$75 to \$150

Write or phone for our descriptive folder telling about this amazing advancement in high-fidelity.

KARLSON ASSOCIATES

1379 E. 15th ST., BOX 11
BROOKLYN 30, NEW YORK
PHONE: DE 9-1691

AT LAST! A CUSTOM-ENGINEERED CABINET AT AN UNUSUALLY LOW PRICE!

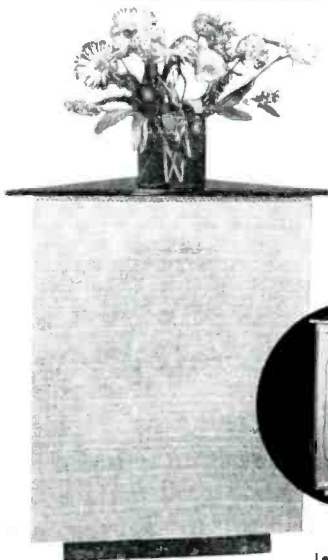

- There's no need to spend several hundred dollars—now that our custom-engineered speaker cabinet is available! Carefully crafted of selected 3/4" plywood, it's truly a piece of fine furniture. Extremely low resonance—excellent low frequency response—freedom from rattle. Comes completely assembled with speaker mounting hardware, terminal strip and acoustical lining.

- Finished in: Black Lacquer, Bleached or Dark Mahogany. Plain or Modern hand-painted fabrics. Height 37"; width 26"; depth 18".

\$49.50

CONSUMER NET
FOB NEW ORLEANS

Above: Cutaway view
(Speaker not included)

Left: Traditional Model #T.1

Write for specification sheet



CUSTOM ELECTRONICS INC.

813 Chartres Street • Canal 4120 • New Orleans

For Listeners in "Fringe" Areas

The two components below bring to music lovers in fringe areas (distances up to 80 miles) consistently clear, brilliant reception . . .

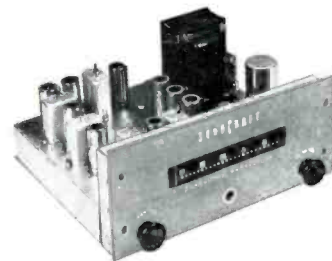

SONACRAFT FM TUNER

Acclaimed for tonal quality and faithful reproduction. New blackout tuning indicator; 3 gang inductive tuning; dual limiter; all coils slug-tuned; 5 microvolt sensitivity for 20db quieting; 200KC bandwidth at 6db down; adjacent channel down 60db; 11 miniature tubes; AFC with disable switch; compact, 10" w., 4" h., 8" d.; easy installation . . . **\$89.95**



REGENCY DB98-FM SIGNAL BOOSTER

Easy to operate; simple to install. Attractive steel hammertone finished case; polished aluminum dial; Internal impedance matching for 300 or 72 ohms. Push-pull triode design. Frequency range 88-108 MC. 20db gain on all FM channels. Automatically compensates for impedance mismatch. Uses one 6J6 tube as RF amplifier. Size 3-5/16" x 4-1/8" x 5-1/4" . . . **\$16.17**



GIFT . . .
from America's most advanced Hi-Fi studios . . . Come in for your copy of "Sound Advice" by Irving Greene, 124 pages of vital Hi-Fi data . . . It's FREE!

ASCO SOUND CORPORATION

115 WEST 45th STREET, 3rd FLOOR
NEW YORK 36, N. Y.

Our sentiments remaining the same, we reprint our "ad" of HIGH FIDELITY Summer issue 1951:



The Authentic KLIPSCHORN

IN THE realm of sound reproduction, laymen have stated they are at the mercy of the advertiser. What can the non-technical man decide, when a certain speaker for \$49.50 is touted as the best, and another is even more flamboyantly advertised at \$1549.50?

For the authentic Klipschorn, let it be said that it was developed to achieve truly full-range performance. We credit Higher Guidance (some might call it luck) with the greater part of our success. To the same Source we credit the opportunities for the application of good engineering and hard work.

As to the degree of success, comparisons between reproduced and live voice, violin, piano and organ have satisfied the most critical of listeners. As for our claims of full range, low distortion — in short, REproduction — we welcome any comparisons or test to which any one wants to put Klipschorn.

From Buffalo, Berkeley, Boston and other points far and near, we have welcomed visitors to our laboratory where they could "see with their own ears" what we mean by REproduction.

Klipsch & Associates

Makers of Klipschorn and
Rebel Reproducers

Phones: 7-6795 7-4538 7-6775
Hope, Arkansas

THE RIGHT ANTENNA

Continued from page 114

ordering this type, the frequency of the station to be received must be specified so that the elements can be cut accordingly.

The second type, at some sacrifice of efficiency, is designed for broad-band response. Cut for 98 mc., the center of the FM band, it covers about 18 mc. each way.

La Pointe makes a broad-band, 4-element Yagi that is intended to cover 88 to 108 mc., as well as four 5-element, narrow-band types of somewhat greater efficiency. The series is designed for 88 to 94, 94 to 98, 98 to 103, and 103 to 108 mc. Of course, any of these antennas can pick up signals somewhat above and below the frequencies specified. If, for example, you want to get a strong station on 93.1 and a weak station on 95.3, the best choice is the antenna intended for 94 to 98 mc. But if the weak one is on 93.1, it will probably be possible to get both with an antenna cut for 88 to 94 mc.

JFD has a 10-element TV antenna, with a band-spread of 6 mc., which can be modified for FM. The elements must be shortened, and the spacing between the elements reduced. To determine the correct dimensions, multiply the length of the original elements and the spacing by 85, and divide by the FM frequency in megacycles that you want to receive.

Because the Yagi is so directional, and so limited in frequency response, this type is ordinarily used for long-distance reception of a particular station. If two or more distant stations are on widely separated frequencies, or are located in different directions, it will be necessary to install individual antennas. They can be mounted on the same mast, but they should be spaced from one another by at least 4 ft., and more if possible.

Antennas can be stacked, one above the other, to increase pickup. Two antennas are better than one — but not twice as good. It is important that they be spaced exactly according to manufacturer's instructions and that precisely cut interconnecting wires (usually furnished by the manufacturer) be used. If the antennas are incorrectly spaced, or incorrectly tied together, total pickup may be less than that of a single antenna.

Some FM sets have connections at the back for using the AC cord as an antenna. If the receiver is sufficiently sensitive, and the signals are strong enough, the line-cord antenna is all right. It is an inefficient antenna, however, and the FM system of broadcasting or the receiver should not be blamed if reception is unsatisfactory when such an arrangement is used.

A very simple antenna can be made or purchased from twin-lead. Cut off a piece of twin-lead 4 ft. 2 ins. long. Bare the wires for 1/2 in. at each end, and twist the adjacent ends together. That will form a closed wire loop. Exactly at the center of this length of twin-lead, cut one wire. Pull the ends of that wire away from the insulation for about 1 in. This makes, in effect, a folded dipole. Then, to the wires you pulled out at the center of your dipole,

Continued on page 118

THE FINE-ARTS QUARTETTE

of the American Broadcasting Co.

PLAYS FLAWLESSLY—



The Quartette Recording During Rehearsal . . .

They record their music faithfully with the

'SONODYNE'

Dynamic Microphone

- Staff artists of the American Broadcasting Company in Chicago, the Fine-Arts Quartette is known for its unsurpassed tone quality and technical perfection. Consistent recording of all rehearsals has helped this renowned quartette achieve the high standards of perfection for which it is known.

High-fidelity enthusiasts, as well as professional recording artists, are using the "Sonodyne" in ever-increasing numbers. Home users of tape-recorders are finding that the "Sonodyne" reproduces voice and music with a remarkable degree of "naturalness." It makes the "Sonodyne" the ideal high-quality, moderately-priced replacement for the conventional microphones supplied with tape recorders.



Model
"51"

Model "51" Sonodyne.
List price, \$45.00.
Available at Shure Distributors everywhere.



SHURE BROTHERS, Inc.
MICROPHONES and ACOUSTIC DEVICES
225 W. Huron St., Chicago 10, Ill. Cable: SHUREMICRO

HIGH FIDELITY MAGAZINE

NOW at Brooklyn HIGH-FIDELITY
SOUND CENTER

THE **New PENTRON TAPE RECORDER**

Use 2 Ways FOR CUSTOM INSTALLATION
OR AS A PORTABLE RECORDER

Available at last... a high fidelity recorder for the audio connoisseur, unbelievably low priced. Ideal as well for home, school, church or commercial use.

1 — FOR CUSTOM INSTALLATION

Model 9T-3M Tape Mechanism. 2 Speeds: 3.75" and 7.5" per second. 2 hours record-playback time. Super rewind-forward speeds—1200" in 40 seconds. Separate record-erase heads—removable pole, single or dual track. Flutter: -0.3% at 7.5"—0.5% at 3.75". **59.75**

Model PRE-7 Pre-Amp. Push-pull supersonic bias-erase. Magic eye record level indicator. 5 Tubes. Exclusive oscillator circuit. Frequency response: ± 3 db. 50 to 11,500 cps at 7.5"; ± 3 db. 50 to 6500 cps at 3.75". Outputs: amplifier and headphones. Inputs: radio, phono and mike. **39.75**

2 — FOR PORTABLE USE

Model PMC. Complete Portable Unit. Consists of tape mechanism and pre-amp above, in handsome carrying case, complete with reel of tape and take-up reel. Less amplifier; for use with your home music system or radio. **114.50**

ALSO AVAILABLE

Model 9T3C. Complete Portable Tape Recorder. With built-in amplifier and speaker.

25% Deposit with orders—Balance C.O.D.

Send for our **FREE CATALOG** on High Fidelity

Visitors Always Welcome to our New Ultra-Modern Sound Center

BROOKLYN HIGH FIDELITY SOUND CENTER
2128 CATON AVENUE (Cor. Flatbush Ave.)
BROOKLYN 26, N. Y. • BUckminster 2-5300

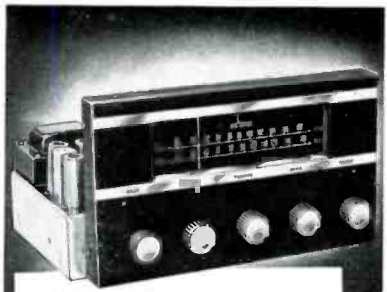
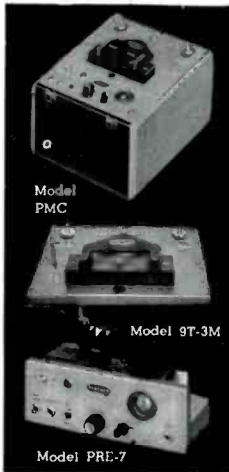

We rest our case
on evidence
you can hear



Words can't prove
the performance
of this superb High
Fidelity Tuner.

Neither can witness-
es. When it's time for

a decision, your judgement of
the CRAFTSMEN 10 is based on one
thing: evidence you hear with your own
ears. Listen—and the conclusive evi-
dence of incomparable sensitivity and
flexibility will turn your trial into a
lifetime of distinctly better listening.

the
craftsmen 10
high fidelity
FM-AM tuner

- Two cathode followers furnish both audio output and detector output for remote installations.
- Built-in pre-amplifier, compensated for variable reluctance pick-ups.
- Automatic Frequency Control entirely eliminates drift, simplifies tuning.
- 5 microvolts sensitivity on both FM and AM.
- 10 kc filter on AM eliminates inter-station squeal.
- Bass and treble tone controls for boost, cut, or 20-20,000 cycle flat response.

JUDGE

THE C-500 TOO!

Williamson all-
triode circuit—
99.99% distor-
tion-free!



high fidelity by craftsmen
means distinctly better listening

For information, write to:
The radio CRAFTSMEN, Inc.
Dept. H-7, 4401 N. Ravenswood Ave.,
Chicago 40, Ill.

The High Fidelity Record Changer for High Fidelity Record Reproduction

Collaro

7, 10, AND 12
INCH RECORDS

Fully Automatic

3-SPEED RECORD CHANGERS

MODEL 3/522*
Intermixes 10 and 12-inch records
LIST PRICE \$65.00
(less base)

MODEL 3/521*
Non-Intermix Model
LIST PRICE \$54.50
(less base)

*Available in
cream, brown or
gray finish.

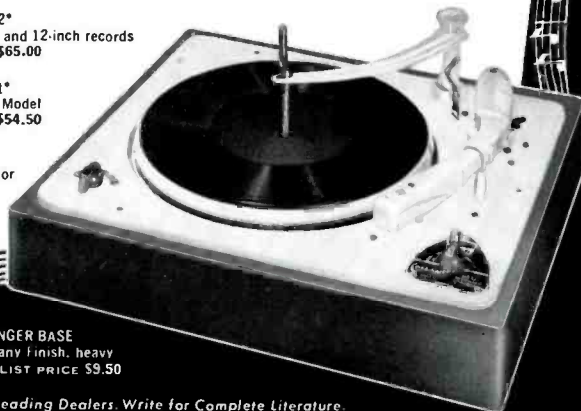

RECORD CHANGER BASE
Wood, Mahogany Finish, heavy
construction. LIST PRICE \$9.50

On Sale at Leading Dealers. Write for Complete Literature.

ROCKBAR CORPORATION • 211 East 37th Street, New York 16, N. Y.

IMPORTANT MESSAGE

from

Brociner

NOW YOU CAN AFFORD THE BEST...
can you afford anything less?

LOWER PRICES and IMPROVED DESIGN made possible by increased production due to wide acceptance!

COMPLETE AUDIO CONTROL CENTER



for \$99†

Where else can you get a precision-built Preamplifier with...

24 RECORD-PLAYBACK CHARACTERISTICS to match every possible record. UNIVERSAL PICK-UP COMPENSATION to accommodate all makes of high quality pick-ups. TREBLE CUT-OFF FILTER... a professional range selector to give you the best possible results from imperfect as well as flawless program material. ADJUSTABLE LOUDNESS CONTROL... a true level compensator easily adjustable for all requirements. SPECIAL LOW-NOISE PREAMPLIFIER TUBES... and other features too numerous to mention here, presented in complete, factual form in our bulletins.

†Without cabinet.

A POWER AMPLIFIER



Worthy of the name!

for \$129

30 WATTS* at 1% intermodulation. ULTRA-LINEAR CIRCUIT using the famous Acro TO-300 output transformer. KT66 OUTPUT TUBES. 20 db feedback over 4 stages. Engineered for easy installation. *Equivalent sine wave power.

Ask your distributor to let you see and hear the Brociner Amplifier. If he hasn't one to show you, use the coupon below to ask for FREE bulletins describing these remarkable units.

BROCINER ELECTRONICS LABORATORY

1546-A Second Avenue, New York 28

Please send me your bulletins.

Name.....

Address.....

City.....Zone.....State.....

THE RIGHT ANTENNA

Continued from page 116

connect the two wires from another piece of twin-lead, to provide connections to your receiving set. This antenna can be tacked up along the molding near the ceiling or strung up in the attic, where the added height will help.

The owner of a TV set will be familiar with the use and function of boosters to improve signal strength. There are one or two makes of boosters designed specifically for the FM band, and in many cases, they are likely to be of help. Their use was described in HIGH FIDELITY No. 10 (May-June 1953), page 85.

SOUND POLL

Continued from page 87

chair was that average bounce was least noticeable in a spot a few feet from its former position. This was determined by putting a gliding tone frequency test record on the turntable and letting it run through its range over and over again while my neighbor and I watched the S-S meter. Of course, it fluctuated violently in all locations, but some spots seemed less violent than others.²

Spotting the trouble with the pickup system, which I mentioned at the beginning, was more or less luck. When I used a gliding tone record, with the meter near the speaker so it would not be affected too much by room resonances, I noticed a sudden peak of sound somewhere down around 70 cycles. It could have been caused by any number of different rattles or resonances, except for the fact that it had not appeared when I used an audio oscillator connected to the speaker voice coil leads. That meant that the 70-cycle resonance was somewhere between test record and speaker. To make a long story short, I tried a different pickup and arm. The peak was absent. Fussing around, looking for trouble, I finally discovered that the cartridge was almost imperceptibly loose in its mount. A little tightening up and the trouble was gone.

These are but a few of the many uses for sound survey meters. They not only serve some very scientific purposes but are wonderful instruments with which to demonstrate — and study — acoustic phenomena. The same experiments can, of course, be run with more complicated equipment such as microphone, preamplifier, amplifier, and meter systems — but somehow one is more tempted to explore when a complete test instrument can be slipped into a trouser pocket.

Now that summer is here, try out an S-S meter on the power mower. It will only take a few seconds to prove that the noise level is far too high to be safe for a pair of sensitive, hi-fi ears!

²For a detailed discussion of loud speaker positioning and adjusting with the help of an S-S meter, see the Journal of the Audio Engineering Society, Vol. 1, No. 1, January 1953, pg. 146 ff. This article also describes a method for testing loudspeaker characteristics inside a room by averaging the results of a number of "frequency runs" such as that described above.

It's the New
STEPHENS 15" Coaxial
and **TERMINAL**
Has it!

THE LATEST
and
FINEST
in



COAXIAL SPEAKERS

The new STEPHENS 206AX 15" coaxial speaker employs a 7½ lb. Alnico V magnet for optimum clarity and freedom from distortion at whisper and power crescendo levels. Improved and extended frequency response is due to the new diaphragm and high frequency throat structure. Aluminum die cast for prevention of warping... plus other outstanding features. A must for those who demand the finest in musical reproduction.

Power Capacity 25 watts
Response 40 to 16000 cycles
Crossover Frequency 1200 cycles
Total Weight 32 lbs.

Price **122⁰⁰** net

Also:

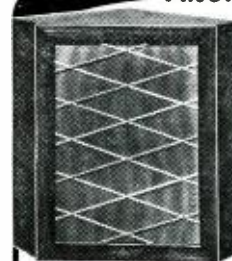

Newly designed STEPHENS Corner Cabinet, Model 626 for 15" loudspeakers. Ideal for the 206AX speaker.

Price **117⁶⁰** net

FREE! Send for new "TERMINAL'S AUDIO CATALOG" a complete guide for true sound reproduction.



Terminal Radio Corp.

OPEN THURSDAY EYES. TILL 8 AM
AMPLE PARKING AFTER 6 P.M.

85 Cortlandt St., New York 7, N. Y.
WORTH 4-3311

Custom Styled for Hi-fidelity

by **Cabinart**



MODEL 28
Equipment
Cabinet

Designed for the audiophile, these handsome cabinets will accommodate any combination of high fidelity components. Panels are replaceable for future changes of equipment. The loudspeaker cabinet is acoustically correct, tuned for the average 12" or 15" loudspeaker, pre-cut as requested. Construction is of select birch, with a fine lacquer finish hand-rubbed to a high gloss. All joints are glued and screwed, and lock-joint miters are used throughout, affording utmost rigidity.

Dimensions:
35½" high, 23½" wide, 18" deep.
Finishes:
Blond Birch
Cordovan Mahogany on Birch.
Baffle Area: 6½ cubic feet.

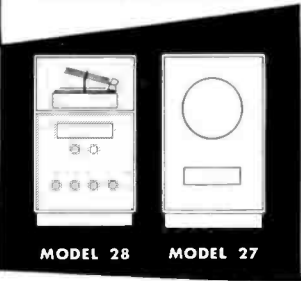

MODEL 27
Loudspeaker
Cabinet

Net Price
MODEL 27 . . . \$48.00
MODEL 28 . . . \$72.00

Sold through leading radio parts distributors.
Write for free catalog and nearest distributor.

G & H WOOD PRODUCTS COMPANY • 75 NORTH 11th STREET • BROOKLYN 11, N. Y.
Pioneers in radio furniture for high fidelity equipment.

A New Development!

WHITE SOUND WITH THE

New Revolutionary Amplifier Circuit

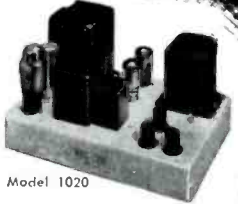

Model 1020

Ultra High Fidelity



Model 3422
15-18,000 cps.

WHITE SOUND AMPLIFIERS
White Sound's new circuit has established a New High in the realistic reproduction of music. The finest electronic components, precision engineering and White's new design combine to give you Ultra High Fidelity.
• Cross-Coupled Amplifier Circuitry
• Balanced Drive • Tapped Screen Output
• Balanced Impedance Phase Inverter
Exclusive! Non-resonant Cross-Over Circuit
• Cross-Over (24db./ Octave) at the Input of Dual Channel Amplifier.
Model 1010, 10 watts. Model 1020, 20 watts
Model 2010, Dual Channel Amplifier with the Model C-101, Cross-Over Network.

WHITE CABINET SPEAKERS
• A True Exponential Horn (within 1%) . . . Coupled to Speaker through a New Unique Phasing Device and Sound Trap • Nine foot Horn compactly Curled into Non-Resonant Cabinet • Response: 15-18,000 cps • White Cabinet Speakers offered in 4 Sizes . . . 3 Finishes . . . 5 Prices.

For Complete Information, see your Distributor
or Write to Department H-3

105 W. MADISON ST. **WHITE SOUND, INC.** CHICAGO 2, ILLINOIS

HOW TO BUY A LOUDSPEAKER

CONTRARY TO popular belief it is possible to apply a large element of objective common sense to the purchase of a loudspeaker as well as other components. The implication made by many Hi-Fi showrooms is that we should listen to a selection of speakers and then purchase the one that "sounds right" to us. The fallacy behind this argument is that our taste in speakers changes with time. Chances are that the man who has eight speakers is not happy with any one of them, in the fullest sense. He simply went through a "treble phase" and then a "bass phase" and bought a speaker for each.

All this is nonsense. There is a method of applying a totally objective test that can to at least some degree remove the element of personal and temporary bias. Frequency test records are NOT the answer . . . music is a dynamic thing, not static as a test record is.

Of course, if you can buy a new speaker with every paycheck, or every whim, read no further. THERE IS NO REASON WHY A SPEAKER THAT SATISFIES CERTAIN FUNDAMENTAL REQUIREMENTS SHOULD NOT REMAIN SATISFACTORY OVER AN INDEFINITE TIME. Most so-called high fidelity speakers do not, however, satisfy these basic requirements.

H. A. Hartley of London, England has developed a speaker that satisfies these requirements. He has also written brilliantly about the process of elimination that led to the Hartley 215. We have combined Mr. Hartley's writings with pertinent information we have gleaned from the standard speaker text books in an effort to shed some light on the subject for the non-technical music lover. We include with these booklets an analysis of a few popular speaker systems. YOU CANNOT AFFORD TO BE WITHOUT THESE BOOKLETS.

We are obliged to make a charge of fifty cents for this unique mailing, copies of which are available now.

c/o Los Angeles Hartley Dealer
McSHANE & CO.
7461½ Melrose Avenue
Hollywood, California

KELTON* *Quality*

MEANS

Each Individual Unit tested to rigid specifications in the Kelton Acoustics Laboratory.

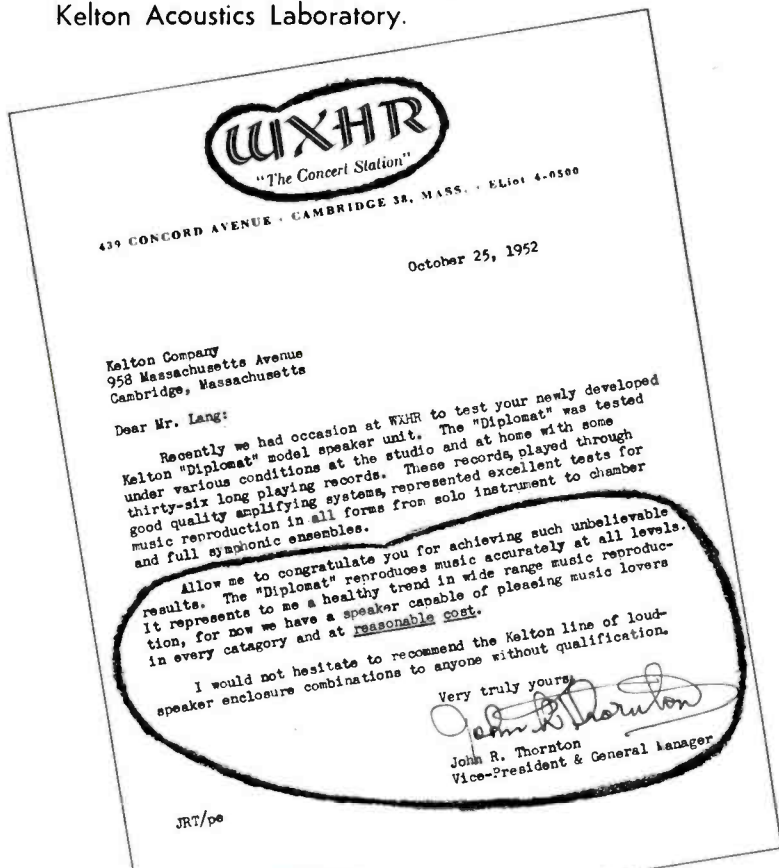

The KELTON "Ambassador"
Blond or Mahogany Net \$69.75

The KELTON "Diplomat"
Blond only Net \$49.50

WRITE FOR technical data and
name of dealer.

THE KELTON* COMPANY
Incorporated
958 MASSACHUSETTS AVENUE
CAMBRIDGE, MASSACHUSETTS

*Trademark

NEW BOOKS

Continued from page 21

reader's engineering experience is but slight. For the hobbyist who is familiar with the problems of building his own equipment, there is a wealth of material here.

The articles originally appeared in *Audio Engineering* from January 1950 to July 1952 and are grouped roughly according to subject matter. There are, for instance, nine articles about amplifiers—mostly of the "ultra-linear" type; six articles about feedback, loudspeaker damping, and related problems; eight articles about preamplifiers and input systems; five articles on recording and phonograph reproduction; nine articles on loudspeakers and speaker enclosures, and another dozen articles on various topics which do not fit the rough classifications we ourselves made for the foregoing analysis.

We do not attempt to judge the technical accuracy of the material presented: this supposedly goes without saying. However, we would feel more confident that the authors could speak with authority if we were told not only their names but enough of their background for us to judge their competency. It is more or less the custom in technical publications to indicate the author's business or other affiliations; this policy has not been followed here, and it weakens an otherwise excellent publication. C. F.

Benjamin Britten, A Commentary on His works From A Group Of Specialists, Edited by Donald Mitchell and Hans Keller. 410 pages; 5½ x 8¾. Cloth. Philosophical Library, New York. 1953. \$7.50.

The first chapter (by the Earl of Harewood) of this book devoted to Benjamin Britten presents his biography in brief. The remaining 25 chapters constitute an exhaustive technical, aesthetic and psychological study of his music and will prove rather hard going for anyone who is not a student of music.

The 24 contributing specialists dissect Britten's compositions almost note by note, with results that will probably send the average reader back to his phonograph and another session with the *Sea Scenes* and *Rejoice in the Lamb* to restore his faith in the music. Take, for instance, A. E. F. Dickinson's heady discussion of the first movement, *Early Morning Bath*, of Britten's *Holiday Diary*:

"The first movement places a clear, swinging tune in mainly 8-bar phrases, in C and later E, in a flow of arpeggio which runs diatonic and clear after a preliminary sally in the salt sprays of pantonality. A dominant pedal, and an equivocal chord of fourth and fifth above it, avoid triteness of texture, and the music returns to the careless (but not formless) sprays at the end. Definitely a salt and fresh water bathe, it may be said." Definitely.

It may also be said that this book is an unusual tribute to Britain's outstanding contemporary composer. When 24 British musical scholars consider a composer, who has still not reached his fortieth birthday, worthy of so much of their time and attention, it would seem to imply that there will always be a Britten. R. H. H., Jr.

SOUND WITHOUT FATIGUE

...with the HARTLEY 215 LOUDSPEAKER

A loudspeaker converts electrical impulses into sound energy. Any sound contributed by the speaker itself appears as distortion. While the ear cannot be relied upon for accurate measurements of distortion, the reaction of the human ear and nervous system to such distortion is unmistakable. This sensation is known as listening fatigue.

When audio enthusiasts say that the ten inch HARTLEY 215 sounds smooth and natural and can be listened to for hours, they mean that it does not produce fatigue. Instrument measurements confirm the 215's remarkable freedom from resonant peaks and other forms of distortion. It reproduces music and speech with life-like realism, and without imposing upon the listener an awareness that a loudspeaker is in operation. The Hartley 215 is priced at only \$57.50.

Hartley Products are now available in America through franchised Hartley dealers.

For complete information regarding the Hartley 215, and the new Baffle Speaker Enclosure, Preamplifier, and Main Amplifier, write to Department HF-7

Prices slightly higher West of the Rockies



H. A. HARTLEY CO., INC.
521 East 162nd Street, Bronx 51, N. Y.

Concertone "Music for the Masters"

A symphony orchestra is built around the string section, which covers the extreme frequency range of 40 to 15,000 c.p.s.

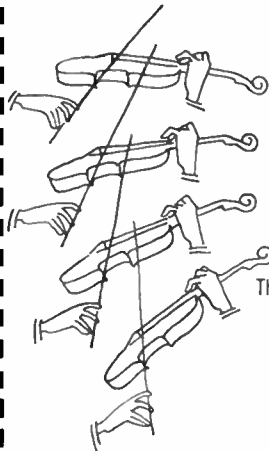

"just like being there"



Model 1501

Only the finest equipment is capable of recording and reproducing the multi-resonant properties of the strings with all their glowing harmonics. The Concertone 1501 is the only tape recorder under \$1000 combining distortion-free full frequency response with all the tape handling facilities of professional equipment.

Write for Bulletin 202



The Answer to High Fidelity's Most Common Problem — Cost



Get your FREE copy

Record fans who want to hear the "Three B's" at their best, but can't afford a super-ultra-hyper-high-fidelity system in a 24-room house, as shown in many a magazine article, will be glad to know that at Federated Purchaser we go out of our way to help apartment-dwelling, suburbanite and rural friends to acquire home music systems thrilling in fidelity of musical reproduction, yet sized to fit anybody's living room and priced down to earth. What's more, we enjoy selling folks such systems!

The attractive little booklet shown above lists a few such systems, hand-picked for you for all-around suitability, high quality reproduction and no costly frills. All ready to plug together and play and be enjoyed for years to come. *Be sure to write for your copy today.* Dept. II, New York.

Federated Purchaser INC.

High Fidelity demonstration rooms in
New York, Newark and Allentown.
New York 7, N. Y. • 66 Dey St. • Dlgb 9-3050
Newark, N. J. • 114 Hudson St. • Market 3-9035
Allentown, Pa. • 1115 Hamilton St. • Hemlock 3-7441
Easton, Pa. • 925 Northampton St. • Easton 4259
Los Angeles, Cal. • 911 S. Grand Ave. • Trinity 1761



**Music
Glistens**

NEW! . . . 12 Watt Control Amplifier



Harmonic dist. less than 1% at 12 watts; less than .5% at 10 watts. IM less than 2% at 10 watts. 20-20,000 cps \pm 1 DB. Feedback 15 DB. 7 tubes. Bass range +17 to -15 DB; Treble +15 to -18 DB. Hum -70 DB. Record Comp. for LP, AES and Foreign. Inputs for all cartridges, radio and aux. 8 and 16 ohms. Model WA-310 \$69.45
12" x 7 1/2" d 6" h.

NEW! . . . 25 Watt Basic Amplifier



Harmonic dist. less than .5% at 25 watts; less than .1% at 20 watts. IM less than 1% at 20 watts. Power response 20-60,000 cps. \pm 1 DB, at 25 watts. Feedback 24 DB. Hum and noise 85 DB below 25 watts. Direct Coupled Triode Split Load Phase Inverter. Damping 30/1. 8 and 16 ohms. \$99.45
14" x 7" d 6" h. Model WA-325

NEW! . . . Pre-amplifier-Equalizer



In Cordovan or Blonde Mahogany cabinet. Record Comp. for LP, AES and Foreign. Inputs for all cartridges, radio and aux. Bass range +17 to -15 DB; Treble +15 to -18 DB. 20-20,000 cps. \pm 1 DB. Distortion .2%. Self contained power supply. 3 AC outlets. 11 1/2" x 1 5/8" d 5 1/8" h \$49.50
Model WA-300

Write for literature

DON MCGOHAN, Inc.
3700 West Roosevelt Rd.
Chicago 24, Illinois

Dept. HF-5



**TIME TO CHANGE
YOUR PHONO NEEDLE**

Replace it today with a...



**NEW
Jensen
NEEDLE**

• Your Favorite Record
and Service Dealer Has
Jensen Needles — Ask
Him About a Replacement
For Your Record Player!

- ★ Makes Your Old Records
Sound Like New—
- ★ Your New Records
Sound Better Than Ever!

Oldest Name in Sound Engineering

Jensen INDUSTRIES, INC., Chicago 12, Illinois



This is the Hi-Fi
SHOW PLACE
... IN CHICAGO

... the place to listen,
compare and choose
your High Fidelity
components, enclosures,
or custom installations.

COMPLETE AUDIO SERVICE

1. All Leading Makes of Components
in Stock - at Audiophile Net Prices.
2. Cabinet-Assembled Matched Units,
Ready for Use.
3. Specially-Designed Custom Installa-
tions.
4. Expert Servicing by Audio Engineers.

Voice and Vision, inc.

53 E. WALTON • CHICAGO 11, ILL. • WH 3-1166

*Be guided by this
firm of experts
who have made
hundreds of re-
nowned custom
high-fidelity in-
stallations.*



Pioneers in Diamond Needle Tipping Make Special Offer . . .

THE TRANSCRIBER COMPANY OF BOSTON, pioneers in diamond retipping of phonograph needles and the first in this highly specialized field, will retip your present needle with a genuine whole diamond (not chips or splints) for \$10.50 plus 25 cents for handling and postage.

Today, diamond needles are accepted as the only way to protect valuable, finely grooved long-playing records and to obtain distortion-free reproduction.

Chances are your record player is equipped with a sapphire or osmium-tipped needle, which has an average life of from 20 to 30 hours of playing time. Beyond that you run the risk of serious damage to your records. A diamond tipped needle can be used safely for approximately 1000 hours. When you retip your needle with a diamond you save, because diamonds cost you less per playing hour and records last longer.

Send us your replacement needle assembly now—today. Let us retip it with the highest quality genuine diamond styli—exactly the same as we make for leading radio stations the country over. You pay only \$10.50 for a genuine diamond from Transcriber because you deal directly with a leading manufacturer of diamond styli for broadcast use.

If you cannot spare your assembly for shipment, tell us the make and number of your needle or cartridge when you order. We will furnish the correct needle assembly, at our exact cost, tipped with diamond.

THE TRANSCRIBER CO.
Diamond Styli Manufacturers

172 Green St. Dept. H Boston 30, Mass.

LOUDSPEAKER

Continued from page 89

effects all speakers in approximately the same way and to the same degree, the better the speaker is to start with, the better will be the final results with the Gately.

It is also important that a good corner be chosen for the cabinet. At least 2 ft. of wall space should be available on either side of the cabinet before furniture and other obstacles are placed in the path of the sound waves. The cabinet probably will work best when pushed right into the corner, but pulling it out an inch or two may help if any tendency toward boominess is noted.

The top comes off to permit mounting the speaker; it should be fastened back down securely so the area back of the speaker will be airtight.

Connections to the speaker are through two sets of Fahnestock clips, one pair inside the cabinet and the other pair outside. In the cabinet which was sent to us, they were located down inside where it was almost impossible to reach them. Any method of running speaker leads can be used so long as the back is kept airtight. — C. F.

TRADER'S MARKETPLACE

Here's the place to buy, swap, or sell audio equipment. Rates are only 20c a word (including address), and your advertisement will reach 30,000 to 50,000 audiophiles. Remittance must accompany copy and insertion instructions.

FM Antennas: Standard and special types for long distance reception. Wholesale Supply Co., Lunenburg, Mass.

TAPE RECORDERS, Tapes, Accessories, unusual values. Dressner, 624K E. 20th St., N. Y. C.

GUARANTEED used equipment, Stephens 106AX Speaker, UTC-Williamson and Altec Peerless 20 watt amplifiers, Maynard Preamp/Equalizer, etc. George Myers, Hagerstown, Indiana.

SP12B coaxial speaker in unfinished bass reflex cabinet; AEI FM-AM tuner, power supply; Newcomb P10-A amplifier; dipole antenna, chimney mount; \$150 complete. W. McCarthy, 28 Church Street, Great Barrington, Mass.

NEW NEVER USED: (Approved's 710A AM-FM tuner and power supply \$43) McIntosh 20W2 with C104 Preamp-equalizer \$180. Browning RV-31 FM tuner \$89. USED 1 MONTH: Altec 601A speaker \$75 and R-J F-12-M enclosure \$38. Wm. Dougherty, 3730 N. Percy Street, Philadelphia 40, Pennsylvania.

TRADE Your Used commercial or high-fidelity components for latest audio equipment. Tremendous values. Literature. CREATIVE AUDIO, 150 South Harrison Street, East Orange, New Jersey, ORange 6-5229.

BROWNING RJ-20A FM-AM tuner, Value \$175. As new, \$115. S. C. Wilcox, 808 Elm, Norman, Oklahoma.

FOR SALE Altec Lansing 800 speaker, Base 803A, Treble 8C2B; H. Hosmer Sco'12'0A amplifier; 2 Livingston Universal Arms; Pickering Cartridges diamond styli, 1 LP, 1 Standard; Rek-O-Kut T-12 table; all mounted; hardly used. Military service transfer forces sale at 92 Cliff Rd., Wellesley Hills, Mass. Telephone WE 52689.

WANTED: Used fifteen-inch woofer. State price and type. L. Kautz, 1831 Quimby Lane, Westfield, New Jersey.

FREE! LATEST EDITION HI-FIDELITY CATALOG



Get
Yours
NOW!

COMPLETE BUYING GUIDE For all your needs in HI-FIDELITY MUSIC SYSTEMS

★ **VALUE PACKED** with all the finest high fidelity and audio equipment. Speakers, tuners, amplifiers, recorders, record changers, complete packaged systems, custom cabinets.

★ **PLANNING GUIDE.** Helpful suggestions on what to buy, easy installation instructions, complete data and specifications on all units.

★ **FAST SERVICE.** All merchandise shown in catalog is in stock for fast delivery. Our expert personal help and low prices have made every customer a satisfied customer.

**SEND COUPON TODAY
FOR YOUR CATALOG!**

**WHOLESALE RADIO
PARTS CO., INC.**

311 W. Baltimore St., Balto. 1, Md.

Wholesale Radio Parts Co., Inc.
Baltimore 1, Maryland

Please rush big new Catalog No. 106.

Name.....

Address.....

City..... Zone..... State.....

PORTABLE

High Fidelity

FOR THOSE
WHO MUST
ASK THE
PRICE

*All the Presence and Realism
of a Custom Installation
in a Compact, Portable Unit*

CUSTOM
IMPERIAL
MODEL 401



\$178.50
Federal Tax
Included

- G.E. variable reluctance cartridge
- 3-speed Webster changer
- Custom Jim Lansing Signature Speaker
- Separate treble and bass equalizing controls
- Richly finished in gray leatherette with chrome trim

WRITE FOR
CATALOGUE HF-1

CALIFONE CORPORATION

1041 North Sycamore Avenue
Hollywood 38, California

A Leonard First!



The Amazing New
BOZAK
2 Way
Speaker System

- BINAURAL
- MONAURAL

Yes . . . for the first time anywhere Leonard and Bozak bring you thrilling new 2 way sound! Not monaural alone . . . not just stereophonic . . . but monaural-stereophonic or the dynamically new binaural . . . ALL IN ONE BEAUTIFULLY DESIGNED CABINET . . . both controlled by a single switch! You've got to see it to believe it . . . hear it to appreciate it!

Send TODAY for complete details and specifications . . . or visit our sound laboratories for demonstration!

Write for FREE Hi-Fi Guide, "Music of the Masters."



LEONARD-RADIO-INC.

69 CORTLANDT ST., NEW YORK 7, N. Y.

Audio Mart

CORTLANDT 7-0315-9

The House Built on Service

Dept. HF-7

Introducing THE Self-Powered HIGH QUALITY AUDIO PRE-AMPLIFIER... MODEL 7

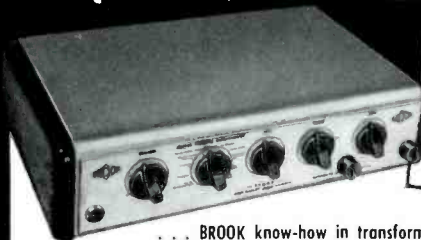

OTHER STANDARD BROOK AMPLIFIERS	
MODEL 1DC4	3D-WATT
	REMOTE CONTROL
MODEL 12A4	10-WATT
	REMOTE CONTROL
MODEL 4	PRE-AMPLIFIER

- ... BROOK know-how in transformer design paved the way to incorporate a power transformer in one chassis; yet, HUM LEVEL IS MINIMIZED TO VANISHING POINT.
- ... Ideally suited to any quality basic amplifier
- ... Famous BROOK 10-position stepped bass and treble controls; plus separate 9-position record playback control, equalized for virtually all records, offer the music and audio connoisseur an exceptionally wide range of flexibility in tone control.
- ... Five input channels for radio, TV or recorders; including one channel to accommodate any type pickup; or microphone.
- ... In performance, the MODEL 7 offers the NATURAL, IMMEASURABLE TONAL QUALITY which built the BROOK reputation.

Write today for technical data on the complete line of Brook High Quality Audio Amplifiers; also name of nearest dealer. Dept. FH.3

BROOK ELECTRONICS, INC.

First in the High-Quality Audio Field Since 1934

34 DeHART PLACE, ELIZABETH 2, N.J.

Discover WHAT INCREASED AIR-LOADING DOES FOR YOUR SPEAKER

Super Horn LOUDSPEAKER ENCLOSURES

A unique principle of acoustical engineering . . . exclusive with Super-Horn . . . gives peak free, smooth bass response. Superbly designed in beautiful dark or natural mahogany, or blond finish, Super-Horn enclosures are available for 12 inch and 15 inch speakers.

WRITE FOR TECHNICAL LITERATURE,
CATALOGS & PRICE LIST

GATELY
DEVELOPMENT LABORATORY
BARRINGTON, NEW JERSEY



And looks to match!

Beautiful cabinets to match the tonal beauty of your equipment

Housing your high-fidelity equipment used to be a problem.

It was necessary to have expensive special cabinets made, or to build the units into the wall where they were hard to get at for servicing, changes, additions.

Now you can get these beautiful high-quality cabinets for all makes and combinations of high-fidelity equipment—at surprisingly low cost.

An ingenious design lets you install any make of equipment in any arrangement you

**ANGLE GENESEE
CORPORATION**

101 Norris Drive, Rochester 10, N. Y.

want . . . with any combination of doors and grilles.

These handsome cabinets are available in modern oak, as shown, or in traditional mahogany. There is no difference in price.

See your dealer *now* or send for illustrated brochure.

ANGLE GENESEE CORPORATION
101 Norris Drive, Rochester 10, N. Y.

Please send me illustrated brochure and complete information on the new High-Fidelity Cabinets.

NAME _____
ADDRESS _____
CITY _____ ZONE _____ STATE _____

Have you Heard
BINAURAL
thru
PERMOFLUX
Binaural Dynamic
Headsets

Enjoy the startling realism and sense of actual presence, that surpasses all other high fidelity systems.

Permoflux Binaural Headsets are manufactured with the same watchmaking precision and of the same superior quality components which have made Permoflux famous the world over.

Designed for those who must have the finest . . . Permoflux phones are preferred by Music Lovers, Orchestra Leaders, Broadcast Engineers and many others.

Binaural headsets are available in two models.
Model BDHS-178—(300 ohms per phone)
Model BDHS-288—(12 ohms per phone)

An adapter is now available which permits either binaural or monaural service.
Permoflux also carries a complete line of conventional monaural headsets

For unrivaled high fidelity in speakers hear the Permoflux Royal Speakers and Enclosures.
See your High Fidelity Distributor or write to

Permoflux
CORPORATION
4916 West Grand Avenue
Chicago 39, Illinois

GROMMES AMPLIFIERS



Model 50 PG

A high fidelity single unit amplifier with unusual performance. Power output, 10 watts, 30 watts peak. Distortion at 10 watts, 1% harmonic and 2% intermodulation. Frequency response ± 3 dB, 30 to 30,000 CPS. (2:1 G, 30 to 30,000 CPS at 10 watt level).

\$5500



Model 100BA

Best basic amplifier for average home high-fidelity system. Distortion at 10 watts: 1% harmonic and 2% intermodulation. Freq. resp. 3 watts, ± 5 dB, 20 to 50,000 CPS.

\$4125

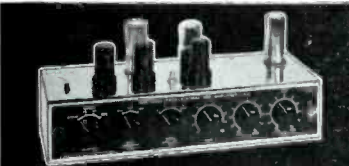

Model 210 PA PRE-AMPLIFIER

Completely variable feedback equalization for reproducing records exactly. Response to 100,000 CPS. IM distortion less than .1%. Calibrated step type controls.

\$9950



**Model 215BA
15 Watt**

ALL TRIODE BASIC AMPLIFIER

Response 10 to 100,000 CPS. Peak power 24 watts. Distortions at 8 watts, .07% H. and 2% I.M. 25 DB feedback from 3 loops, 2 direct coupled stages, cathode follower drivers.

\$9950

WRITE FOR CATALOG



PRECISION ELECTRONICS, Inc.
9101 King Avenue, Franklin Park, Ill.

**Handy,
New**



Pfan-Tone

PICK-UP KIT!

Discover the hidden music in your records—untapped by standard phonograph pickup equipment. Let amazing new Strain-Sensitive Pfan-Tone Pickup bring out the best in your records—old and new.

- ✓ **Exclusive New Principle**
Modulates current from preamplifier—reproduces faithful electrical image.
- ✓ **Free From Hummmm—**
No coils to pick up induced current from turntable motor.
- ✓ **Easy to Install—**Now in handy KIT form. No soldering necessary.

Takes you into a new world of Music!
INSTALL IT YOURSELF
Easily, Inexpensively
on your own record player

If you own a single-play, professional turntable, you'll want the truly functional PFAN-WOOD Tonearm. Made of wood with free moving roller joints, it is adjustable for pressure, tracking angle, height... tracks beautifully in low pressures... free from interfering resonances. Ask for FREE INFORMATION on kit or T...

Pfanstiehl
CHEMICAL COMPANY

110 Lake View Avenue

Waukegan, Illinois

HIGH FIDELITY

"EAR LEVEL" SOUND THROUGHOUT THE ROOM!

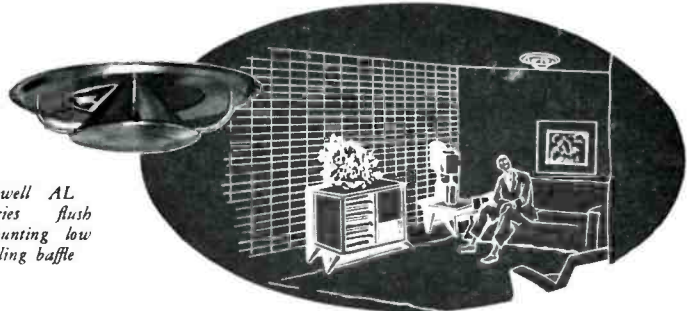

Lowell AL Series flush mounting low ceiling baffle

LOWELL flush mounting ceiling Speaker Baffles "with floating conical action"

Lowell aluminum speaker baffles are designed and engineered to meet the most difficult acoustical requirements. They assure 360° diffusion of controlled, undistorted sound throughout entire tonal range. The conical diffuser is mounted through soft rubber grommets to eliminate metallic resonance. Modern, functional styling and ease of installation, in addition to their high fidelity performance, make Lowell speaker baffles popular. Lowell AL Series baffles available in six models for 6" to 15" speakers.

Ask your Sound Dealer about Lowell speaker baffles, or, write for complete details (enclosing a dimensioned sketch of your music room), to

LOWELL MANUFACTURING CO.

3030 Laclede Station Road, St. Louis 17, Missouri

In Canada: Atlas Radio Corp., Ltd., 560 King St., West, Toronto, Ontario

ADVERTISING INDEX

Allied Radio Corp.	103	Leonard Radio, Inc.	124
Asca Sound Corp.	115	London Records	73
Altec Lansing Corp.	96	Lowe Associates	95
Ampex Electric Corp.	8	Lowell Mfg. Co.	126
Angle Genesee Corp.	125		
Audio Devices, Inc.	Inside Front Cover	Magnetic Recorders Co.	95
Audio Exchange, Inc.	127	McIntosh Laboratory, Inc.	6
		McShane & Co.	119
Bell Sound Systems, Inc.	10	Mercury Record Corp.	77
Berkeley Custom Electronics	95	Minnesota Mining & Mfg. Co.	14
Bogen, David, Co.	110, 128	The Music Box	78
Book Department	97	Music Systems of Westport, Inc.	95
Bozak, R. T., Co.	111		
British Industries, Inc.	2	Newark Electric Co.	98
British Radio Electronics, Ltd.	113	Newcomb Audio Pmts. Co.	13
Brociner Electronic Lab.	118		
Brook Electronics, Inc.	124	Olympic Electronics	95
Brooklyn High-Fidelity Sound Center	117		
Browning Laboratories, Inc.	15	Pentron Corp.	113
		Permoflux Corp.	125
Califone Corp.	124	Pfanstiehl Chemical Co.	126
Capitol Records, Inc.	Back Cover	Pickering & Co., Inc.	22
Callaro	117	Pilot Radio Corp.	18
Columbia Records	4	Precision Electronics, Inc.	126
Concertone Recorders, Berlant Associates	121	Presto Recording Corp.	16
Cook Labs, Inc.	79	Professional Directory	95
Craig Audio Lab.	95		
Crestwood Recorder Division	11	Ram Co.	95
Custom Electronics, Inc.	115	RCA Victor	75
		Radio Craftsmen, Inc.	117
Danby Radio Corp.	112	Radio Shack Corp.	104
Diatone Co.	109	Rauland-Borg Corp.	128
Don McGohan, Inc.	122	Reeves Soundcraft Corp.	91
Dubbings Co.	95	Regency	21
Duotone, Inc.	110	Rek-O-Kut Co.	105
		Revere Camera Co.	20
Electro-Voice, Inc.	99	Rhapsody Record Shop	76
Electro-Voice Sound Systems	95	Rackbar Corp.	117
Espey Mfg. Co., Inc.	112		
		Sams, Howard W., Co., Inc.	111
Fairchild Recording & Eqpt. Co.	106	Schwann, W.	76
Federated Purchaser, Inc.	121	Scott, Hermon Hosmer, Inc.	94
Figart's Sound Un-Ltd.	95	Shure Brothers, Inc.	116
Fisher Radio Corp.	9	Sounds of our Times	79
		Southwest Record Sales	95
Garrard Sales Corp.	2	Stephens Mfg. Corp.	19
Gately Development Laboratory	125	Stramberg-Carlson	109
General Apparatus	114		
General Electric	102	Terminal Radio Corp.	118
G & H Wood Products Co.	119	Thorens Co.	111
Gray Research and Development Co.	93	Traders' Marketplace	123
Grommes	126	Transcriber Co.	123
		Truvox Mfg. Co.	113
H. A. Hartley Co., Inc.	121		
Harvey Radio Co.	107	University Loudspeakers, Inc.	7
Hastings Products, Inc.	95	Urania Records, Inc.	77
The Heath Co.	108, 109	United Transformer	Inside Back Cover
Hollywood Electronics	95		
		Vector Laboratories	95
I. D. E. A., Inc., Regency Division	21	V-M Corp.	100, 101
		Voice & Vision, Inc.	122
James B. Lansing Sound, Inc.	17	Vax Productions, Inc.	78
Jensen Industries, Inc.	122		
Jensen Mfg. Co.	1	Weathers Industries	5
		Webster-Chicago Corp.	12
Karlson Associates	115	Weingarten Electronic Labs	95
Kelton Co.	120	Westminster Records	79
Kierulff Sound Corp.	95	White Sound, Inc.	119
Klipsch & Associates	116	Wholesale Radio Parts Co.	123
Klass Industries	128	World Encyclopedia of Recorded Music	106
Lansing Sound Inc.	126	York Furniture Corp.	95
Lectronics	95		



MODERN - \$365
GOLDEN MAHOGANY

Brociner
**MODEL 4
CORNER HORN**

* Performance of unrivalled purity and smoothness over the entire audible range! Powered by a remarkable twin-cone driver unit designed expressly for horn loading, this dual horn achieves naturalness that simply cannot be put into words or expressed in terms of specifications. Moderate in size as well as price, it lends itself to graceful, attractive, decorative treatment that renders it a complement to the finest decor.

This speaker-system is made for the man who wants to be done with looking for something better.

At **THE AUDIO EXCHANGE** your high fidelity components, which stand improvement, can be traded against the Brociner speaker-system.

Literature upon request.



TRADITIONAL
MAHOGANY \$420

**the audio
exchange inc.**

159-19 HILLSIDE AVENUE
JAMAICA 32, N. Y.
OLYMPIA 8-0445

You have to
HEAR it to believe it!



Full symphonic level
high-fidelity sound from the
amazing BARUCH-LANG corner loudspeaker system.

- The phenomenal BARUCH-LANG high fidelity corner loudspeaker system is the successful result of research at one of the leading university acoustic laboratories to achieve high quality, wide-range response in a compact, low-cost unit.
- Complete, ready for connection to any amplifier, radio, or television set, this amazingly efficient speaker system is ideal not only as the main high-fidelity speaker in your living room, but also as a second or third speaker placed at other points in your home. Designed exclusively for corner installation, this unit is only 13½" high and 19¾" across the front.
- Only from KLOSS INDUSTRIES, the original manufacturer of this famous, nationally advertised speaker, can you buy direct and thus save dealer markup. Kloss industries offers you an unconditional 10 day refund guarantee in order that you may listen to the KLOSS BARUCH-LANG system in your own home without obligation.

\$19.95

Shipped by express only, shipping charges collect. Weight 14 lbs. C.O.D. if you wish. Specify birch or mahogany moulding, 4 or 16 ohms impedance.

KLOSS INDUSTRIES

10 Arrow Street, Cambridge 38, Mass. Dept. 1

-to Gratify Your Wish for Excellence

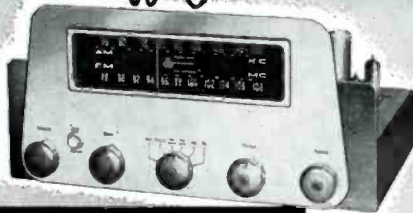

BOGEN R-701 FM-AM TUNER

- SUPERB REPRODUCTION
- TECHNICAL SUPERIORITY
- HANDSOME STYLING
- OUTSTANDING PERFORMANCE
- EVERY OPERATING CONVENIENCE

The Model R-701 is a truly superb FM-AM radio receiver designed expressly for the discriminating listener. It provides a quality of performance so brilliantly real and so vastly superior to standard mass produced receivers that it must be heard to be believed. Handsomely styled for custom installation, it is easily adaptable to any wall or cabinet closure. Six position function selector switch, volume control, and separate bass and treble correctors centralize all operation on one panel . . . permit remote location of the audio amplifier.

MODEL H010 — A superb all triode amplifier providing minimum distortion (less than 0.3% at 10 watts), maximum response (flat 10-50,000 cycles), tremendous dynamic range and overall balance. Ideal for use with the R701 Tuner.

MODEL D010 — New popular priced Hi-Fi custom Amplifier, designed for use with the new R701 Tuner. Can be mounted directly behind the tuner in most installations. Ten watts output at less than 1% distortion. Response flat 20-20,000 cps.

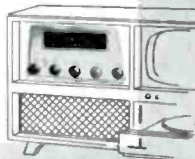

WRITE FOR LITERATURE
DAVID BOGEN CO., INC.
29 NINTH AVE., NEW YORK 14, N. Y.

A Quarter Century of Electronic Equipment Specialization

ultra-fidelity
ultra-utility with ultra-smart

"LIBRETTO"
remote control

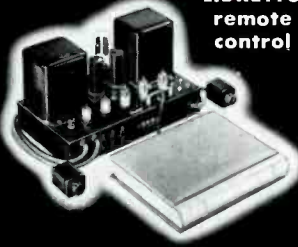

HEAR the difference, SEE the difference
in the *Rauland* model 1826
ultra-fidelity ensemble



The proof of unprecedented superiority of the new RAULAND Ultra-Fidelity Ensemble is in its unmatched performance. That proof awaits you now at your Hi-Fi dealer. The Rauland Amplifier is of matchless quality. The unique self-powered "Libretto" Remote Control-Preamplifier, with its amazing flexibility, is an ingenious innovation. The laboratory tests are a revelation, but the ultimate proof of superiority is in the thrilling listening and operating experience. The specifications summarized below can only hint of the quality of this new dimension in sound.



the master amplifier

A truly superb instrument with frequency response of ± 0.3 db, 20 to 40,000 cps at rated 20 watts output. Harmonic distortion less than 0.5% at rated output, less than 0.3% at 10 watts. Intermodulation distortion less than 0.4% at 1 watt (home level), 0.7% at rated output (measured at 60 and 7,000 cycles 4 to 1 ratio). Output imp., 8 and 16 ohms. 4-position input selector—for magnetic pickup, crystal pickup and 2 auxiliary. Dimensions: 14" x 9" x 8" high.

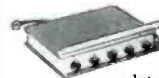

the LIBRETTO remote control

A true remote control, completely self-powered and capable of operation several hundred feet from amplifier. Uniquely fashioned in the form of a luxuriously bound book (only 8¾ x 11 x 2" thick). Backbone lifts to provide easy access to tuning controls. Operates flexibly in either horizontal or vertical positions.

CONTROL FUNCTIONS

1. 6-position crossover control (flat, 150, 300, 450, 700, 1000 cycles).
2. 6-position roll-off control (flat, -5, -8, -12, -16, -24 db at 10,000 cps).
3. Volume Control—instant choice of conventional control or loudness control.
4. Bass Tone, +24 db to -20 db at 20 cps (db calibrated).
5. Treble Tone, +18 db to -30 db at 10,000 cps (db calibrated).

Custom-Engineered, Custom-Styled
For Audio Connoisseurs

See the RAULAND 1826 Ultra-Fidelity ensemble at your Hi-Fi dealer, or write for full details.



RAULAND-BORG CORPORATION
3515 W. Addison St., Dept. Chicago 18, Ill.



ULTRA COMPACT UNITS...OUNCER UNITS

HIGH FIDELITY... SMALL SIZE... FROM STOCK

UTC Ultra compact audio units are small and light in weight, ideally suited to remote amplifier and similar compact equipment. High fidelity is obtainable in all individual units, the frequency response being ± 2 DB from 30 to 20,000 cycles. True hum balancing coil structure combined with a high conductivity die cast outer case, effects good inductive shielding.

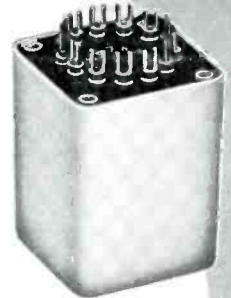

TYPE A CASE
1 1/2" x 1 1/2" x 2" high

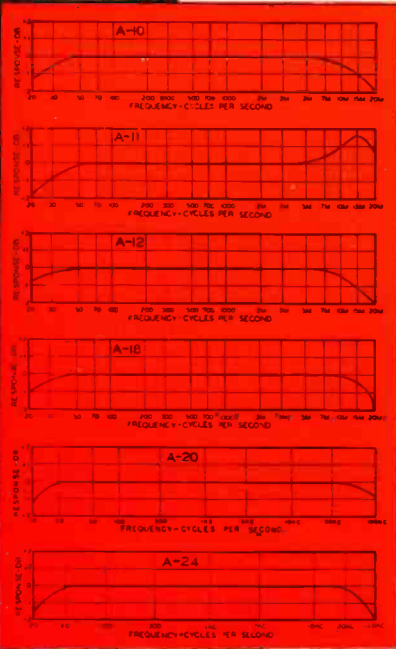

Type No.	Application	Primary Impedance	Secondary Impedance	List Price
A-10	Low impedance mike, pickup, or multiple line to grid	50, 125/150, 200/250, 333, 500/600 ohms	50 ohms	\$16.00
A-11	Low impedance mike, pickup, or line to 1 or 2 grids (multiple alloy shields for low hum pickup)	50, 200, 500	50,000 ohms	18.00
A-12	Low impedance mike, pickup, or multiple line to grids	50, 125/150, 200/250, 333, 500/600 ohms	80,000 ohms overall, in two sections	16.00
A-14	Dynamic microphone to one or two grids	30 ohms	50,000 ohms overall, in two sections	17.00
A-20	Mixing, mike, pickup, or multiple line to line	50, 125/150, 200/250, 333, 500/600 ohms	50, 125/150, 200/250, 333, 500/600 ohms	16.00
A-21	Mixing, low impedance mike, pickup, or line to line (multiple alloy shields for low hum pickup)	50, 200/250, 500/600	50, 200/250, 500/600	18.00
A-16	Single plate to single grid	15,000 ohms	60,000 ohms. 2:1 ratio	15.00
A-17	Single plate to two grids. 8 MA unbalanced D.C.	As above	As above	17.00
A-18	Single plate to two grids. Split primary	15,000 ohms	80,000 ohms overall, 2.3:1 turn ratio	16.00
A-19	Single plate to two grids. 8 MA unbalanced D.C.	15,000 ohms	80,000 ohms overall, 2.3:1 turn ratio	19.00
A-24	Single plate to multiple line	15,000 ohms	50, 125/150, 200/250, 333, 500/600 ohms	16.00
A-25	Single plate to multiple line. 8 MA unbalanced D.C.	15,000 ohms	50, 125/150, 200/250, 333, 500/600 ohms	17.00
A-26	Push pull low level plates to multiple line	30,000 ohms plate to plate	50, 125/150, 200/250, 333, 500/600 ohms	16.00
A-27	Crystal microphone to multiple line	100,000 ohms	50, 125/150, 200/250, 333, 500/600 ohms	16.00
A-30	Audio choke. 250 henrys @ 5 MA 6000 ohms D.C. 65 henrys @ 10 MA 1500 ohms D.C.			12.00
A-32	Filter choke 60 henrys @ 15 MA 2000 ohms D.C. 15 henrys @ 30 MA 500 ohms D.C.			10.00

UTC OUNCER components represent the acme in compact quality transformers. These units, which weigh one ounce are fully impregnated and sealed in a drawn aluminum housing 7/8" diameter...mounting opposite terminal board. High fidelity characteristics are provided, uniform from 40 to 15,000 cycles, except for O-14, O-15, and units carrying DC which are intended for voice frequencies from 150 to 4,000 cycles. Maximum level 0 DB.



OUNCER CASE
7/8" Dia. x 1 1/8" high

Type No.	Application	Pri. Imp.	Sec. Imp.	List Price
O-1	Mike, pickup or line to 1 grid	50, 200/250, 500/600	50,000	\$14.00
O-2	Mike, pickup or line to 2 grids	50, 200/250, 500/600	50,000	14.00
O-3	Dynamic mike to 1 grid	7.5/30	50,000	13.00
O-4	Single plate to 1 grid	15,000	60,000	11.00
O-5	Plate to grid, D.C. in Pri.	15,000	60,000	11.00
O-6	Single plate to 2 grids	15,000	95,000	13.00
O-7	Plate to 2 grids, D.C. in Pri.	15,000	95,000	13.00
O-8	Single plate to line	15,000	50, 200/250, 500/600	14.00
O-9	Plate to line, D.C. in Pri.	15,000	50, 200/250, 500/600	14.00
O-10	Push pull plates to line	30,000 ohms plate to plate	50, 200/250, 500/600	14.00
O-11	Crystal mike to line	50,000	50, 200/250, 500/600	14.00
O-12	Mixing and matching	50, 200/250	50, 200/250, 500/600	13.00
O-13	Reactor, 300 Hys.—no D.C.; 50 Hys.—3 MA. D.C.		6000 ohms	10.00
O-14	50:1 mike or line to grid	200	1/2 megohm	14.00
O-15	10:1 single plate to grid	15,000	1 megohm	14.00

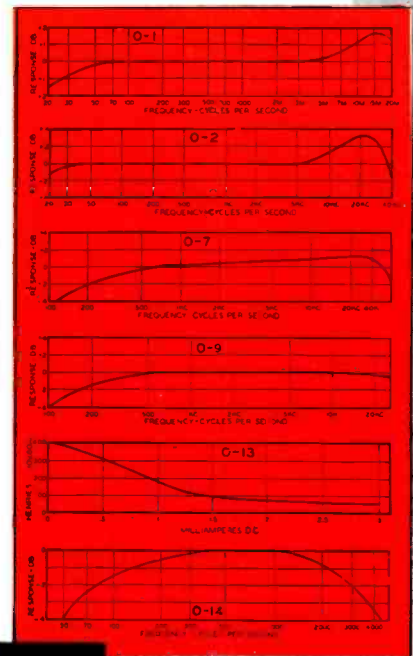

United Transformer Co.
150 VARICK STREET NEW YORK 13, N. Y.

EXPORT DIVISION: 13 EAST 40th STREET, NEW YORK 16, N. Y. CABLES: "ARLAB"

Capitol proudly brings you **FABIEN SEVITZKY**
 and the INDIANAPOLIS SYMPHONY...
 with the concert-hall clarity of

Full Dimensional Sound

ENESCO



First Capitol Release by Mr. Sevitzy

Enesco's beloved "Rumanian Rhapsodies Nos. 1 and 2" and the delightful "Slavonic Dances" by Dvorak, coupled on one 12" Long-Play record. Available separately on 10" Long-Play.

In these outstanding new albums, Capitol again demonstrates how its exclusive Full Dimensional Sound recording technique "breaks the sound barrier" of old style reproduction. Full Dimensional Sound reproduces the full tonal perspective — the depth, balance and range of a live performance. Hear these distinguished releases at your record dealer... add them to your collection.

breaking the sound barrier

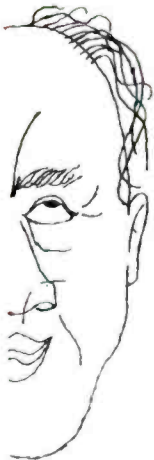

BLOCH

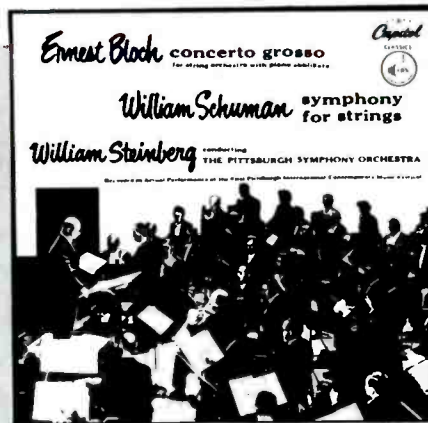

New William Steinberg Release

Bloch's "Concerto Grosso" and William Schuman's "Symphony for Strings" performed by The Pittsburgh Symphony Orchestra and recorded during the Pittsburgh Contemporary Music Festival. Coupled on 12" Long-Play record.



"like opening a window to the live performance"



Consult your record dealer for complete repertoire and latest releases of Capitol FDS Classics.