

TAPE RECORDING & BUYING GUIDE 1983

COMPLETE DIRECTORY OF CASSETTE / OPEN REEL / VIDEO RECORDERS • BLANK TAPES • MICROPHONES • CAR STEREO • SIGNAL PROCESSORS • INCLUDES FULL SPECS • FEATURES • PRICES

SPECIAL FEATURES: Comparative tests of over 30 cassette tapes. Experts explain Dolby C and predict tape's future

9 TEST REPORTS: Aiwa AD 3800U / Akai GX-77 / JVC DD-9 / Nakamichi LX5
Optonica RT 6005 / Pioneer CT-8R / Sony NR-500
Teac X-1000R / Technics SV-P100



High Fidelity for Humans:

**NOW WHEN
IT DOESN'T HAVE**

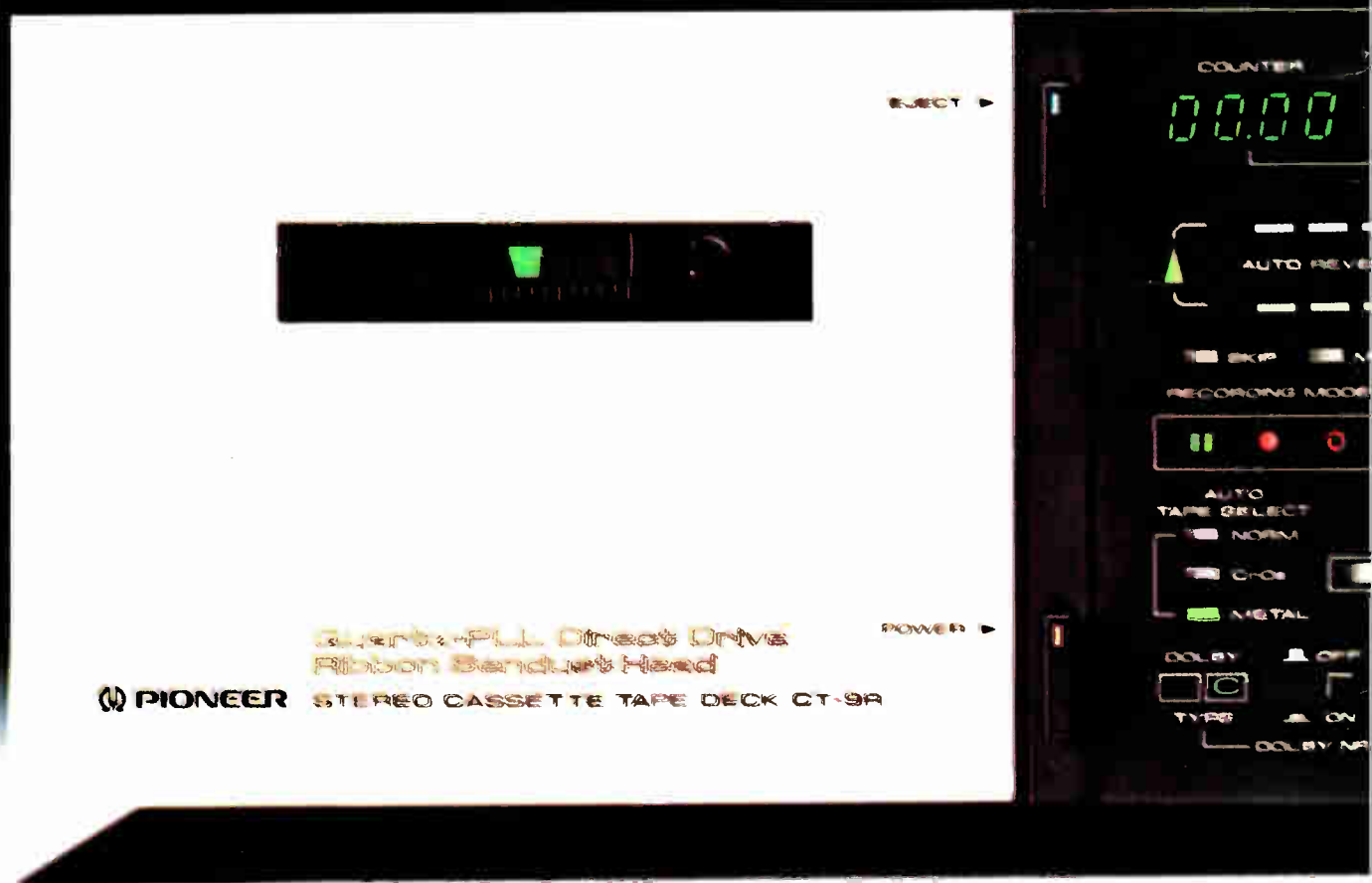

Anyone who records on tape knows what a pain it is to run out of tape before running out of music.

Pioneer has relieved this pain. Along with quite a few others inherent in the designs of practically all components being built today.

We've done it through a concept we call *High Fidelity for Humans*. A design and engineering idea so far reaching, that for the first time components are as pleasant to live with as they are to listen to.

For example, our new CT-9R cassette deck shows you a digital readout of the precise amount of recording time left on a tape.

Touch a button and find your favorite song. Because the CT-9R Index Scan breezes through your tape, automatically stopping to play the first five seconds of each piece of music.

If you want to hear a song over, you don't press REVERSE. STOP. PLAY. REVERSE. STOP. PLAY, until you find the beginning. Instead, you simply press the Music Repeat button. The deck does the rest.

The CT-9R even plays both sides of a cassette, automatically.

But don't get the idea that we've produced a cassette deck that is just a lot of fun to play with. It's also a lot of

YOU RECORD, TO END LIKE THIS

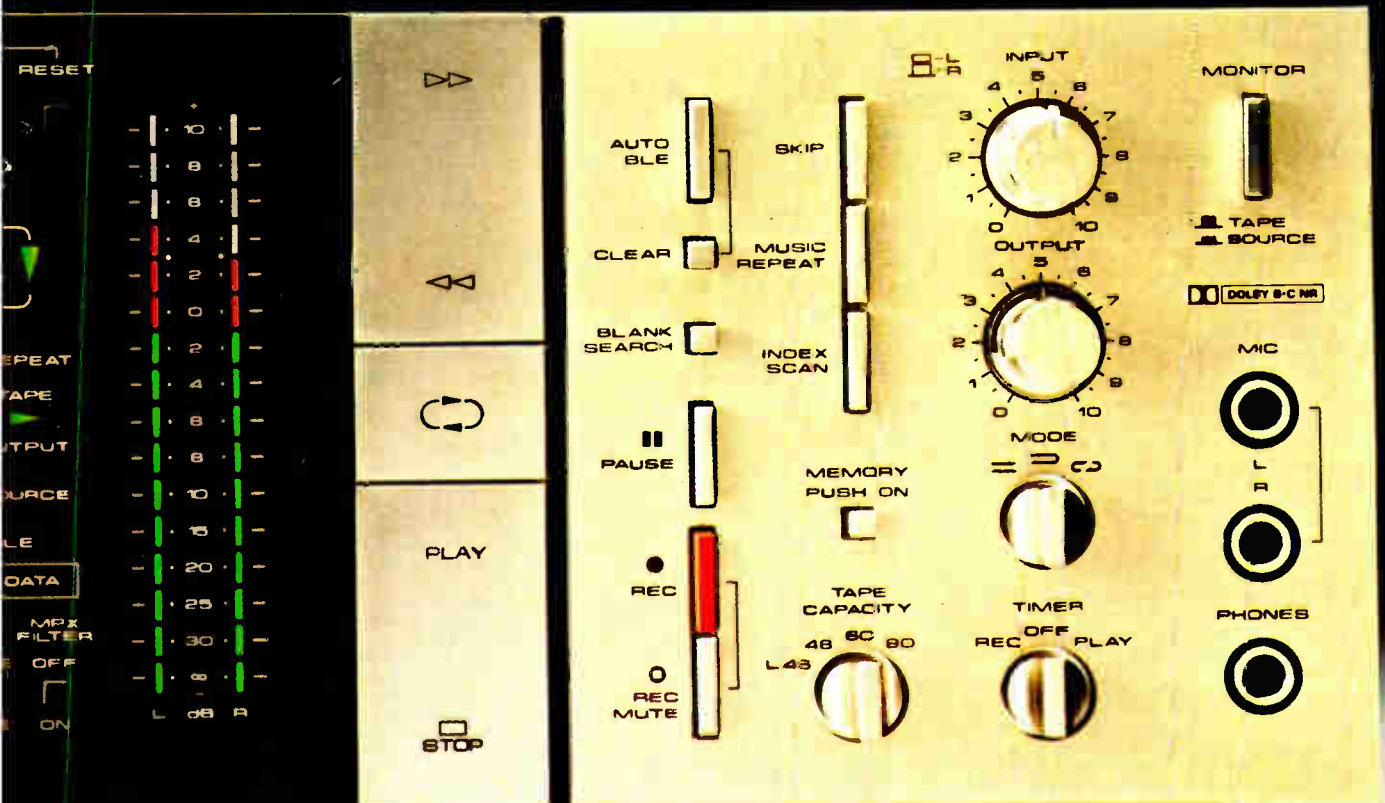

fun to listen to.

Our signal-to-noise ratio and high frequency response set a standard in state of the art electronics due to the creation of totally unique record and play heads. They're called RIBBON SENDUST heads and they're only on Pioneer cassette decks.

We've also attained extraordinary record and playback accuracy. Because we've seen to it that the drive capstan and both the take up and supply spindles are driven directly by their own motors. We call it our 3 Direct Drive motor transport and it, too, is exclusively Pioneer's.

Plus, we have Dolby C. The latest in Dolby engineering,

designed to once and for all rid you and your tape of hiss.

If you're the least bit skeptical that a cassette deck could do so much so well, we suggest you visit your nearest Pioneer dealer.

You can see the CT-9R for yourself, as well as an entire line of new Pioneer cassette decks.

But be forewarned. After seeing these, you'll begin to see cassette decks that just play music for exactly what they are.

Somewhat less than adequate.

PIONEER

We bring it back alive.

CIRCLE NO. 15 ON READER SERVICE CARD

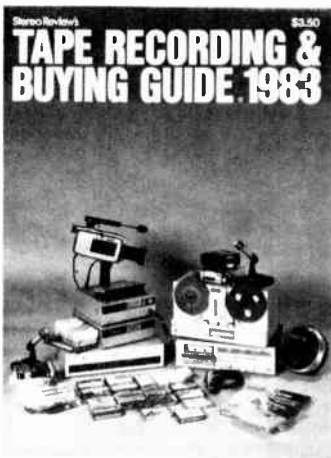

Cover Photo: Justin and Barbara Kerr

Cover Equipment (from left to right, top to bottom): Shure Brothers Model 516EQ-PR Microphones; Toshiba Model 1K-1900 Color Video Camera; JVC Models HR-2650 Portable Videocassette Recorder and TU-26 Tuner/Timer Accessory; Discwasher Videocassette Head Cleaner; Concord Model HPA-41 Car-Stereo Booster Amplifier; Radio Shack Realistic Catalog No. 12-1897 AM/FM-Stereo Radio/Cassette Player; Akai Model GX-77D Open-Reel Tape Deck; Harman/Kardon Model CD401 Cassette Deck; Sennheiser Model HD420 Stereo Headphones. Blank Tape: AMP; BASF; Denon; Fuji; Kenwood; Loran; Maxell; Memorex; Nakamichi; PDMagnetics; Scotch; Sony; TDK; Yamaha.

ZIFF-DAVIS PUBLISHING COMPANY

President: Richard P. Friese
 President, Consumer Magazine Division: Albert S. Traina
 Executive Vice President: Furman Hebb
 Senior Vice Presidents: Phillip T. Heffernan, Sidney Holtz, Edward D. Muhlfeld, Philip Sine
 Vice Presidents: Robert Bavier, Paul Chook, Baird Davis, George Morrissey
 Vice President, Consumer Annuals: Jerry Schneider
 Treasurer: Selwyn Taubman
 Secretary: Bertram A. Abrams

Editorial, Executive, and Circulation Offices

One Park Avenue
 New York, New York 10016
 Associate Publisher, Rober J. Ur, Sr.
 National Advertising Mgr., Richard J. Halpern
 Eastern Advertising Rep., Charles P. Watson

Midwestern Office

The Pattis Group
 4761 West Touhy Avenue
 Lincolnwood, Illinois 60646
 312-679-1100
 Arnold S. Hoffman

Western Office

3460 Wilshire Boulevard
 Beverly Hills, California 90010
 213-387-2100

Japan

Iwai Trading Co., Ltd.
 J.S. Yagi
 603 Ginza Sky Heights Building
 18-13, Ginza 7-Chrome
 Chuo-Ku, Tokyo, Japan 104
 Telephone: (03) 588-0165, 545-3908

1983 TAPE RECORDING & BUYING GUIDE is published annually by the Ziff-Davis Publishing Company, One Park Avenue, New York, N.Y. 10016. Also publishers of Stereo Review, Popular Electronics, Electronic Experimenter's Handbook, Invitation To Electronics and Stereo Buyers Guide.

Stereo Review's

TAPE RECORDING & BUYING GUIDE 1983

FEATURES

Directory of Manufacturers 4
 Status Of Tape In 1982..... Julian D. Hirsch..... 6
 How To Make Live Recordings David Ranada..... 12
 Shhh! Dolby Does It Again Martin Forrest..... 19
 Comparing High-Tech Audio Cassettes Craig Stark..... 23
 Bargain Tapes Craig Stark..... 27
 Tape Futures Ralph Hodges..... 33
 Microtape And Music..... Ivan Berger..... 36
 A Basic Vocabulary Of Tape Recording David Ranada..... 37
 Tape Equipment Test Reports Hirsch-Houck Labs..... 40
Aiwa AD-3800U Cassette Deck; Akai GX-77 Open-Reel Tape Deck; JVC DD-9 Cassette Deck; Nakamichi LX-5 Cassette Deck; Optonica RT-660S Dubbing Cassette Deck; Pioneer CT-8R Cassette Deck; Sony NR-500 Dolby C Noise-Reduction Unit; Teac X1000R Open-Reel Tape Deck; Technics SV-100P Digital Cassette Deck
 Late Arrivals 132

PRODUCT INFORMATION

SECTION 1 Cassette Tape Machines 56
 SECTION 2 Open-Reel Tape Machines 73
 SECTION 3 Blank Tape 76
 SECTION 4 Videocassette Recorders 83
 SECTION 5 Car Stereo Equipment 88
 SECTION 6 Headphones 103
 SECTION 7 Microphones 109
 SECTION 8 Mixers 116
 SECTION 9 Signal Processors 119
 SECTION 10 Accessories 127

SCOTT BRIGGS Publisher • ARTHUR P. SALSBERG Editorial Director
 ALEXANDER W. BURAWA Managing Editor
 EDWARD I. BUXBAUM Art • CARL WEINSCHENK Editorial Assistant
 ROBERT J. UR, SR., Associate Publisher
 RICHARD J. HALPERN, National Advertising Manager

TAPE RECORDING & BUYING GUIDE is published annually by Ziff-Davis Publishing Company at One Park Avenue, New York, New York 10016.

COPYRIGHT© 1982 BY ZIFF-DAVIS PUBLISHING COMPANY. ALL RIGHTS RESERVED.

PERMISSIONS: Material in this publication may not be reproduced in any form without permission. Requests for permission should be directed to John Babcock, Rights & Permissions, Ziff-Davis Publishing Company, One Park Avenue, New York, New York 10016.



You've had your hair blown ...



your glasses shattered ...

Have you ever heard a cassette sound like real music?

DENON'S 70 YEARS OF EXPERIENCE RECORDING LIVE MUSIC.

It shouldn't be surprising that most tape manufacturers describe their products in terms that have little to do with real music. After all, they are basically industrialists and marketers.

Denon, on the other hand, is in the music business and has been for over 70 years. Our vast range of recording experience includes supplying professional equipment to most of Japan's recording studios and radio stations; the recording and distribution of the world famous Denon PCM record library (using the digital process which we developed) and over 14 years specifically devoted to the manufacturing of cassette tape.

Denon DX Series Cassette Tape is not someone else's product that we place our name on to capitalize on Denon's success in other categories. We manufacture every single element of our DX-Tape from the dual coatings (each designed for a specific portion of the bandwidth) and the precision half-shells (which exceed the I.E.C. specifications by 300%) to the non-abrasive, self-cleaning leader provided on each and every DX cassette.

CASSETTE TAPES, LIKE COMPONENTS, CAN MEASURE ALIKE AND STILL SOUND DIFFERENT.

Serious audiophiles know that components with identical specifications can sound noticeably different. Conventional measurement techniques do not explain this phenomenon, so words such as "musical" are often used to describe sound that possesses the "life-like" characteristics of real music.

DYNAMIC DISTORTION: THE FIRST TRUE MEASUREMENT OF TAPE SOUND QUALITY.

The reason conventional tape testing measurements do not tell the whole performance story is that they are based on single test tones rather than complex musical signals. Denon, on the other hand, adopted a means for measuring Dynamic Distortion, the distortion created on the tape by actual music signals. By specifically developing formulations to reduce Dynamic Distortion, Denon was able to significantly improve DX-Tape's ability to accurately recreate the sound of *real music*.

Thus, by satisfying conventional "static" and Dynamic Distortion parameters, every formulation of Denon DX-Tape including normal (DX-1, DX-3), FeCr (DX-5), Chrome (DX-7), and Metal (DXM) delivers the type of satisfying *musical* performance that is making Denon DX-Tape the first true "audiophile's" cassette.



DENON *Imagine what we'll do next.*

Nippon Columbia Co., Ltd., No. 14-14, 4-Chome, Akasaka, Minato-Ku, Tokyo 107, Japan

CIRCLE NO. 2 ON READER SERVICE CARD

DIRECTORY OF MANUFACTURERS

- ADC, A BSR Company**
Route 303, Blauvelt, NY 10913
- ADS, ANALOG & DIGITAL SYSTEMS, INC.**
One Progress Way, Wilmington, MA 01877
- AI ALARON, INC.**
185 Park St., Box 550, Troy, MI 48099
- AIWA AMERICA INC.**
35 Oxford Dr., Moonachie, NJ 07074
- AKAI AMERICA LTD.**
800 W. Artesia Blvd., P.O. Box 6010, Compton, CA 90220
- AKG ACOUSTICS INC.**
77 Selleck St., Stamford, CT 06902
- ALLSOP, INC.**
P.O. Box 23, Bellingham, WA 98227
- ALPINE ELECTRONICS OF AMERICA, INC.**
3102 Kashiwa St., Torrance, CA 90505
- AMP, INC. (Adama Magnetic Products)**
81 Rickman Rd., Closter, NJ 07624
- R.B. ANNIS COMPANY**
1101 N. Delaware St., Indianapolis, IN 46202
- AUDIO CONTROL CORP.**
6520 212 St., S.W., Lynnwood, WA 98036
- AUDIOMAGNETICS**
2602 Michelson Dr., P.O. Box B-G, Irvine, CA 92716
- AUDIONICS OF OREGON**
P.O. Box 969, University Sta., Portland, OR 97207
- AUDIOSOURCE**
1185 Chester Dr., Foster City, CA 94404
- AUDIO-TECHNICA U.S., INC.**
1221 Commerce Dr., Stow, OH 44224
- AUDIOVOX CORPORATION**
150 Marcus Blvd., Hauppauge, NY 11787
- AUTOTEK CORPORATION**
1447 N. Carolan Ave., Burlingame, CA 94010
- AVANTI PRODUCTS, INC.**
1970 N.W. 70 Ave., Miami, FL 33126
- BANG & OLUFSEN OF AMERICA, INC.**
515 Busse Rd., Elk Grove Village, IL 60007
- BASF SYSTEMS CORP.**
10 Crosby Dr., Bedford, MA 01730
- BENJAMIN ELECTROPRODUCTS, INC.**
180 Miller Pl., Hicksville, NY 11801
- BEYER/DYNAMIC INC.**
5-05 Burns Ave., Hicksville, NY 11801
- BIAMP SYSTEMS, INC.**
9600 SW Barnes Rd., Portland, OR 97225
- BIB**
1751 Jay Ell Dr., Richardson, TX 75081
- BLAUPUNKT**
2600 S. 25 Ave., Broadview, IL 60153
- BOSE CORPORATION**
The Mountain Rd., Framingham, MA 01701
- BOZAK, INC.**
Box 1166, Darien, CT 06820
- CERTRON**
1701 S. State College Blvd., Anaheim, CA 92806
- CERWIN-VEGA!**
12250 Montague St., Arleta, CA 91331
- CLARION CORP. OF AMERICA**
5500 Rosencrans Ave., Lawndale, CA 90260
- CONCORD ELECTRONICS**
6025 Yolanda Ave., Tarzana, CA 91356
- CRAIG CORP.**
291 W. Artesia Blvd., Compton, CA 90220
- CROWN INTERNATIONAL, INC.**
1718 W. Mishawaka Rd., Elkhart, IN 46514
- CYBERNET INTERNATIONAL**
7 Powder Horn Dr., Warren, NJ 07060
- DAHLQUIST, INC.**
601 Old Willets Path, Hauppauge, NY 11788
- dbx®, INC.**
71 Chapel St., Newton, MA 02195
- DENON AMERICA, INC.**
P.O. Box 1139, West Caldwell, NJ 07006
- DISCWASHER**
1407 N. Providence Rd., P.O. Box 6021, Columbia, MO 65201
- DUAL, United Audio Products, Inc.**
120 S. Columbus Ave., Mt. Vernon, NY 10553
- DUBIE CORPORATION**
221 Crane St., Dayton, OH 45403
- ELECTRO-VOICE, INC.**
600 Cecil St., Buchanan, MI 49107
- ERCONA CORP.**
2492 Merrick Rd., Bellmore, NY 11710
- EV-GAME, INC.**
186 Buffalo Ave., Freeport, NY 11520
- FISHER CORP.**
21314 Lassen St., Chatsworth, CA 91311
- FUJI PHOTO FILM U.S.A., INC.**
Magnetic Tape Div., 350 Fifth Ave., New York, NY 10118
- FULTRON, Arthur Fulmer**
P.O. Box 177, 122 Gayoso at 2nd., Memphis, TN 38101
- FURMAN SOUND**
616 Canal St., San Rafael, CA 94901
- GENERAL ELECTRIC CO.**
Television Div., Portsmouth, VA 23705
- GLI INTEGRATED SOUND SYSTEMS, INC.**
29050 Northern Blvd., Long Island City, NY 11101
- DAVID HAFLER CO.**
5901 Crescent Blvd., Pennsauken, NJ 08109
- HARMAN/KARDON**
240 Crossways Dr. W., Woodbury, NY 11797
- HEATH COMPANY**
Benton Harbor, MI 49022
- HITACHI SALES CORP. OF AMERICA**
401 W. Artesia Blvd., Compton, CA 90220
- INFINITY SYSTEMS, INC.**
7930 Deering Ave., Canoga Park, CA 91304
- INTEGREX, INC.**
P.O. Box 747, Havertown, PA 19083
- IRISH MAGNETIC RECORDING TAPE**
270-78 Newton Rd., Plainview, NY 11803
- JENSEN SOUND LABORATORIES**
4136 N. United Pkwy., Schiller Park, IL 60176
- J.I.L. CORP. OF AMERICA**
737 W. Artesia Blvd., Compton, CA 90220
- US JVC CORPORATION**
41 Slater Dr., Elmwood Park, NJ 07407
- KENWOOD ELECTRONICS, INC.**
75 Seaview Dr., Secaucus, NJ 07094
- KRACO ENTERPRISES INC.**
505 E. Euclid Ave., Compton, CA 90224
- KOSS CORP.**
4129 N. Port Washington Ave., Milwaukee, WI 53212
- LORANGER ENTERTAINMENT**
10-48 Clark St., Warren, PA 16365
- LT SOUND**
P.O. Box 338, Stone Mountain, GA 30086
- LUX AUDIO OF AMERICA LTD.**
Div. Alpine Electronics of America, 3102 Kashiwa St., Torrance, CA 90505
- MARANTZ, Subsidiary of Superscope, Inc.**
20525 Nordhoff St., Chatsworth, CA 91311
- MARLBORO SOUND WORKS, Div. of M.I.C.A.**
170 Eileen Way, Syosset, NY 11791
- MAXELL CORP. OF AMERICA**
60 Oxford Dr., Moonachie, NJ 07074
- MEMOREX CORP.**
1600 Memorex Dr., Santa Clara, CA 95052
- MITSUBISHI ELECTRIC SALES AMERICA, INC.**
7045 N. Ridgeway Ave., Lincolnwood, IL 60645
- MURA CORPORATION**
177 Catigue Rd., Westbury, NY 11590
- MULTIVOX, Sorkin Music Co., Inc.**
370 Motor Pkwy., Hauppauge, NY 11787
- MXR INNOVATIONS, INC.**
740 Driving Park Ave., Rochester, NY 12613
- NAD (USA), INC.**
675 Canton St., Nonwood, MA 02062
- NAKAMICHI RESEARCH (USA), INC.**
1101 Colorado Ave., Santa Monica, CA 90401
- NEUMANN, Gotham Audio Corp**
741 Washington St., New York, NY 10014
- NIKKO AUDIO**
320 Oser Ave., Hauppauge, NY 11788
- ONKYO U.S.A. CORPORATION**
200 Williams Dr., Ramsey, NJ 07446
- OPTONICA ELECTRONICS CORPORATION**
10 Keystone Pl., Paramus, NJ 07652
- PANASONIC CONSUMER ELECTRONIC GROUP**
One Panasonic Way, Secaucus, NJ 07094
- PD MAGNETICS**
P.O. Box 4499, Wilmington, DE 19807
- J.C. PENNEY COMPANY, INC.**
1301 Ave. of Americas, New York, NY 10019
- PHILCO, NAP Consumer Electronics Corp.**
Interstate 40 & Straw Plains Pike, Box 6950, Knoxville, TN 37914
- PICKERING & CO., INC.**
101 Sunnyside Blvd., Plainview, NY 11803
- PIONEER, U.S. Pioneer Electronics Corp.**
85 Oxford Dr., Moonachie, NJ 07074
- PIONEER ELECTRONICS OF AMERICA**
P.O. Box 1540, Long Beach, CA 90801
- QUASAR COMPANY**
9401 W. Grand Ave., Franklin Park, IL 60131
- RCA**
600 N. Sherman Dr., Indianapolis, IN 46201
- REALISTIC, Div. Tandy Corp.**
1300 One Tandy Center, Fort Worth, TX 76102
- RECORDER CARE DIV., Nortronics Co., Inc.**
8101 Tenth Ave. N., Minneapolis, MN 55427
- RECOTON CORP.**
4623 Crane St., Long Island City, NY 11101
- RG DYNAMICS**
6440 N. Ridgeway Ave., Lincolnwood, IL 60645
- RKO TAPE CORP.**
3 Fairfield Crescent, W. Caldwell, NJ 07006
- ROBINS INDUSTRIES CORP.**
75 Austin Blvd., Commack, NY 11725
- ROTEL OF AMERICA, INC.**
13519 S. Normandie Ave., Gardena, CA 90249
- RUSSOUND/FMP, INC.**
P.O. Box 2369, Woburn, MA 01888
- SAE Scientific Audio Electronics**
701 E. Macy St., Los Angeles, CA 90012
- SANSUI ELECTRONICS CORP.**
1250 Valley Brook Ave., Lyndhurst, NJ 07071
- SANYO ELECTRIC INC.**
1200 W. Artesia Blvd., P.O. Box 5177, Compton, CA 5177
- SCHOEPS by POSTHORN RECORDINGS**
142 W. 26 St., New York, NY 10001
- SCOTCH, 3M Company**
3M Center Bldg., 223-4E-03, St. Paul, MN 55144

(Continued on page 82.)

BASF Chrome.

The world's quietest tape is like no tape at all.

Today, only one high bias tape is able to combine outstanding sensitivity in the critical high frequency range with the lowest background noise of any oxide tape in the world.

That tape is BASF's Professional II.

Professional II is like no other tape because it's made like no other tape. While ordinary high bias tapes are made from modi-

fied particles of ferric oxide, Professional II is made of pure chromium dioxide. These perfectly shaped and uniformly sized particles provide a magnetic medium that not only delivers an absolute minimum of background noise, but outstanding high frequencies as well.

Like all BASF tapes, Professional II comes encased in the new ultra-precision cassette shell for perfect alignment, smooth, even

movement and consistent high fidelity reproduction.

With Professional II, you'll hear all of the music and none of the tape. And isn't that what you want in a tape?

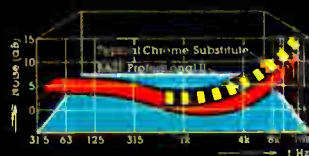

The difference in noise level between PRO II and ordinary high bias tape is greatest where the human ear is most sensitive (2.0 kHz).

GUARANTEE OF A LIFETIME

All BASF tape cassettes come with a lifetime guarantee. Should any BASF cassette ever fail — except for abuse or mishandling — simply return it to BASF for a free replacement.

Mobile Fidelity Sound Lab.

BASF Professional II is so superior it was chosen by Mobile Fidelity Sound Lab for their Original Master Recording™ High Fidelity Cassettes. These state-of-the-art pre-recorded cassettes are duplicated in real time from the original recording studio master tapes of some of the most prominent recording artists of our time.



CHROME



BASF

For the best recordings you'll ever make.

THE STATUS OF TAPE IN 1982

Like all other hi-fi components, tape decks have undergone continuous growth and development. The less viable products have been weeded out by marketplace pressures, and replaced by newer products. Among the losers in this competition were the 8-track format, which once dominated the car-stereo scene and has been replaced by cassette decks, and the Elcaset, a short-lived attempt to bridge the gap between the cassette and open-reel formats.

For many years, the principal recording formats for home-entertainment systems have been the open-reel and cassette (the latter should be called by its full name, "Compact Cassette" to distinguish it from the newer varieties, but we'll use "cassette" to mean the same thing). For a time, it appeared that open reel was becoming obsolete for home use, since few new machines appeared and existing models were gradually dropped from production. It now appears that rumors of its demise were somewhat premature, and new, advanced open-reel decks have been announced by several Japanese manufacturers.

Today's cassette performance is far superior to what was available only a few years ago. This reflects the on-going improvements in recorders themselves and in tape formulations. For many people, the cassette medium is virtually equal to open reel in quality (they aren't truly equal, but for any but the most critical applications, most people would have difficulty distinguishing between the two

formats solely on the basis of sound). Even the smaller variants of the cassette format, such as the "microcassette," are beginning to appear in miniaturized stereo components designed for home use.

At the other end of the quality (and price) scale are digital recorders. At least a couple, based on videocassette technology and transport mechanisms, have already been introduced in this country; no doubt more will follow. Still in the future are digital compact cassette recorders, which have been developed by several Japanese manufacturers and demonstrated to the press as well at the recent Tokyo Audio Show. They're likely to reach the marketplace within a few years.

Tapes themselves have been largely responsible for the emergence of the cassette as a true high-fidelity medium. Improved ferric-oxide formulations continue to appear, as well as high-bias "chrome-equivalent" tapes that have nearly displaced true chromium-dioxide (CrO₂) tapes in the market. Metal tape, following the fanfare of its introduction a few short years ago, is now available from most major tape manufacturers, and its price has dropped somewhat. Most reasonably good cassette decks are now "metal compatible," although sometimes (as in the case of car-stereo players) the claim is redundant, since the only "compatibility" required for playing—as opposed to *recording*—metal tapes is the 70-microsecond equalization used for chrome and high-bias tapes.

Noise reduction has long been a man-

datory feature of cassette tape recorders. For some years, Dolby B was virtually synonymous with noise reduction in home tape decks, and is still universally used. Sensing impending competition between analog and digital tape recording techniques in the consumer market (with respect to noise levels), a number of manufacturers—Dolby Laboratories among them—have been working diligently to surpass the performance of Dolby B in a reasonably economical manner. It has long been recognized that Dolby B (or its equivalent, such as JVC's ANRS) was necessary, and barely sufficient, to make a high-fidelity medium of the cassette, which was originally intended for voice dictation or similar low-fidelity applications.

For a number of years, the dbx® noise-reduction system has actively competed for a share of Dolby's market in both the consumer and professional areas. Although Dolby B used with a cassette recorder couldn't come close to matching the noise level and dynamic range promised by digital recording, dbx could and did achieve comparable noise levels. It's more expensive than the Dolby system; it's also incompatible with Dolby and other decoding playback systems and must be properly decoded in playback to produce acceptable sound quality.

Meanwhile, Dolby Labs developed the Dolby C noise-reduction system, an extension of Dolby B that increased the original 10 dB of noise reduction to 20 dB with only modest increase in cost

by Julian D. Hirsch

...and then came the SE-9.

35 years ago, to satisfy listening preferences, serious music lovers had to redesign their listening rooms. Remove the drapes. Add a rug here. Rearrange the upholstered sofa there. Get rid of that crystal chandelier!

Bass and treble tone controls came later, and they helped — but only a little. When you needed a boost in that lowest bass region, you had to accept boosted upper bass and mid-range tones as well — whether you needed them or not.

By 1958, the first equalizers appeared. They allowed you to alter specific bands of tones to suit the needs of the listening room — and the music program. With special mics, a pink noise generator, and a real-time

analyzer, you could electronically adjust your system to your listening preference. If — that is — you didn't mind spending several thousand dollars and a half hour adjusting and readjusting controls to enjoy a half hour of listening.

Then came Sansui's remarkable SE-9 Comp-Equalizer. It takes the guesswork and the frustration out of equalization. At the touch of a button, the SE-9's built-in pink noise generator feeds its signals first to one speaker, then the other. Sounds picked up by the SE-9's calibrated microphone are then analyzed by its microprocessor. Sit back and watch in amazement, as the SE-9's motorized system moves each of its

16 fader controls (8 per channel) to create the curve that yields precisely flat response at your preferred listening location.

Touch another button, and the curve is memorized for future, instant recall. Move to another location — even another room — and the SE-9 can create and store a new curve — up to four of them.

At last, after 35 years — a perfect equalization system without errors or frustration. And, at a price that makes perfect equalization affordable for all serious music lovers.

See the SE-9 and Sansui's truly complete line of high quality components and systems at your Sansui dealer today. Or write to us for details.



SANSUI ELECTRONICS CORPORATION
Lyndhurst, New Jersey 07071, Gardena, CA 90248
Sansui Electric Co., Ltd., Tokyo, Japan

Sansui

CIRCLE NO. 9 ON READER SERVICE CARD

World Radio History

Status Of Tape. . .

while remaining quasi-compatible with playback through Dolby B-equipped decks. To make its noise-reduction systems even more attractive, Dolby also developed the HX "headroom-extension" system to improve the high-frequency recording headroom of cassette decks, which has traditionally been one of the weaknesses of the cassette medium. Dolby HX isn't a noise-reduction system per se; rather, it operates with control signals derived from the Dolby B circuits. It's inexpensive to add to a tape deck in its design stages. Still another variation of the headroom-extension system is the Bang & Olufsen HX Professional, which is somewhat similar to Dolby HX but isn't linked to the Dolby noise-reduction circuits for its operation.

Comparison Of Tape Formats. Advocates of each tape format claim certain advantages over the others, which may—and should—influence the prospective buyer to seek the system that best meets his or her needs.

A fundamental limitation of any tape-recording system is the fact that, all else being equal, the amount of information that can be stored on or read from a tape is proportional to the area of the magnetic coating that passes the tape head gap in a given amount of time. This is why the faster tape speed of an open-reel deck gives better high-frequency performance than a cassette deck and why the wider recorded tracks on a 1/4" wide open-reel tape produce higher voltages than the narrow tracks of a 1/8" wide cassette tape, and thus a better signal-to-noise (S/N) ratio.

These limitations aren't immutable in practice, since there are other variables under the designer's control. Improved and more efficient tape head designs store and retrieve more energy for a given tape than was possible in the past. Tape formulations themselves are constantly being improved, and today's tapes can carry a much greater information density than was possible with earlier formulations.

While the major effort appears to have gone into improving the cassette medium—perhaps because it was most in need of improvement—things haven't been static in the world of open-reel tape. One of the more recent developments was the announcement of "EE" (Extra Efficiency) tape by two major Japanese competitors, Maxell and TDK, simultaneously with availability of compatible decks from Akai and TEAC. This tape is analogous in its benefits and requirements to cobalt-treated or metal-alloy

high-performance cassette tapes. Like them, it requires a higher bias than did earlier tapes. It also provides greater headroom, especially at high frequencies; requires less recording equalization (high-frequency preemphasis); and should be played back with 35- instead of the usual 90-microsecond equalization time constant at 7½ ips. In general, EE tape is claimed to give open-reel recording at low speeds, particularly 3¾ and 7½ ips, performance hitherto available only at the next faster speed.

Although metal tape was supposed to provide similar benefits in cassette recording, especially in improved high-frequency headroom, its high price (initially about twice that of premium ferric-oxide tapes and still well above their price range) has limited its acceptance, in spite of the widespread availability of recorders able to make use of it.

Cassette Deck Features. Except at the lowest prices, modern cassette decks have at least Dolby B noise-reduction systems and switchable bias and equalization for ferric-oxide (normal) and chromium-dioxide (CrO₂) or chrome-equivalent tapes. Most also offer the high bias required for recording on metal-alloy tapes. Almost all current cassette decks are front-loading types, with a hinged door or panel that opens to receive the cassette. On some decks, the front-panel cassette opening isn't covered by a door, but the basic mode of operation is similar. The earliest cassette decks were top loaders; there's no functional difference between the two, but front-loading decks are more likely to blend in with the styling of other stereo components with which they're used.

Low-to-medium-priced cassette decks employ two heads: a combination record/play head and an erase head. This arrangement doesn't permit monitoring from the tape while recording; to be able to do this, separate record and playback heads and electronics are required. Its chief drawback is the use of a single compromise head gap width for both functions. The usual result of this arrangement is a more limited frequency response when recording. In spite of this, the level of performance available with a well-designed two-head deck is surprisingly high, high enough in fact to satisfy the majority of users.

A second characteristic of inexpensive cassette decks is the number of motors used to drive the tape. Single-motor machines generally use a dc servo-controlled motor to drive the capstan and, through a system of belts and clutches, the two tape hubs. A well-designed and well-constructed machine of this type can give satisfactory results, though usually with somewhat greater flutter than is typical of more advanced transport mechanisms.

A better arrangement employs two motors, one to drive the capstan and the other to handle the tape hubs. Although this doesn't necessarily yield better performance than does a single-motor transport, it frequently does exhibit lower flutter and faster high-speed operation, moving a cassette's tape from end to end in less time in fast forward and rewind. One effective method of reducing wow and flutter, used in a few cassette decks, is a double-capstan drive system. This technique maintains the tape under uniform tension as it moves, greatly reducing the effects on tape motion of mechanical imperfections in the cassette itself.

Operating controls on tape transports are likely to be "piano keys" in lowest-priced machines and light-touch buttons that operate solenoids in more expensive decks. The latter offers no performance advantage but is easier to operate and may be adaptable to remote control with optional accessories available for some decks. Most solenoid-operated tape transports also have some form of internal logic that makes it possible to switch from one transport mode to another (playback, record, fast forward, and rewind) as rapidly as one wishes, without having to wait for tape motion to stop.

At prices in the \$300 to \$600 range, cassette decks are likely to have a number of convenience features that may or may not be important to a particular user. Typical among these features are memory rewind, which stops the tape in the rewind mode at a point where the tape counter indicates 000, and timer operation in which switching on power via an external clock timer automatically puts the deck into record or playback, as one desires, for unattended operation. In this price range, it's also becoming commonplace to find both Dolby B and C noise reduction available. A few decks offer Dolby B and dbx noise-reduction systems. On some decks, user-adjustable recording bias (sometimes with the help of an internal test signal) makes it possible to optimize the deck for any given tape. At the upper end of this price range one begins to find three-head decks with separate heads optimized for the record and playback functions. These heads have their own separate record and playback electronics, including noise-reduction systems. Consequently, one can listen to playback of the tape in its final form *during* recording. This is an excellent way to be sure that operating levels are set correctly and that the tape is moving properly.

The improved high-frequency response and greater headroom of a well-designed three-head deck are its principal strengths. The best examples of this type of deck offer serious competition to many open-reel tape decks. Most three-head cassette decks employ what appears to be



The new Technics cassette decks with dbx.[®] They don't just reduce tape noise. They eliminate it.

There is a new line of Technics cassette decks so technologically advanced they are capable of reproducing music with virtually no audible tape noise. None.

They not only feature Dolby* noise reduction, but also the dbx noise elimination system. With dbx, a Technics cassette deck compresses the signal so the dynamic range is halved. When a tape is played back, the process is reversed. The original dynamic range is then restored and noise is pushed below audibility. Loud passages can be recorded without distortion, and soft ones without tape noise. There is even dbx disc decoding available for playing dbx encoded records.

The Technics RS-M255X goes even further.

Wide range (-40 to +18 db), three-color FL meters handle the dynamic range dbx gives you. An electronic tape counter doubles as a remaining time indicator to show how much time is left on your cassette. Bias and EQ levels are automatically selected for any tape formulation. Microprocessor feather-touch controls give you fast, easy, mode switching. And Technics RS-M255X gives you the stability and accuracy of a two-motor drive system.

Audition all of the sophisticated Technics cassette decks with dbx. Including the very affordable RS-M228X.

Why settle for tape noise reduction when you can have tape noise elimination? From Technics.

*Dolby is a trademark of Dolby Laboratories, Inc. [®] dbx is a registered trademark of dbx, Inc.

Technics
The science of sound.

CIRCLE NO. 34 ON READER SERVICE CARD

Status Of Tape. . .

a single record/playback head. But appearances can be deceiving because, in reality, there are two separate heads in a single housing. In addition to its economic advantages, if the head is assembled with sufficient precision, the two gaps will be inherently and permanently parallel within very tight tolerances. This eliminates the need for costly mechanisms for user adjustment of the recording head azimuth (to align its gap at exact right angles to the direction of tape motion and parallel to the playback-head gap). Playback head azimuth is normally factory aligned to match a standard alignment tape for compatibility with tapes recorded on other decks. However, when physically separate record and playback heads are used, it's vital that their gaps be set parallel to each other every time a tape is inserted into the deck for a recording. This capability is provided on only a few of the most expensive cassette decks.

The usual argument against combining two heads in a single housing is that it's not possible to set their azimuths with sufficient precision. In practice, however, better decks of this type have proven to be excellent performers. To some extent, this may be because the close spacing between record and playback heads eliminates the problem of tape skewing that necessitates user adjustment when the heads are farther apart.

Many of the best cassette decks use three motors: one for the capstan and one for each of the two tape hubs. These are often direct-drive motors, miniature equivalents of the ones used in many phonograph turntables. This eliminates all belts and clutches that are a source of potential trouble in a tape deck and make it possible to have a very low flutter level. Some three-motor machines also feature very fast rewind and fast forward, which can be a convenience when using longer-play C90 cassettes.

A number of top cassette decks from most major manufacturers feature automatic internal adjustments to match them to the requirements of the tape being used. This is made possible by the availability of inexpensive microprocessors, which are used to control a number of complex internal adjustments, including measuring tape performance to establish optimum settings of bias, recording equalization, and level, and storing these settings in an internal computer memory for recall at a later time, if desired.

This automatic adjustment process is essentially what every recorder undergoes in the final stages of its testing at the point of manufacture. It's far too com-

plex for the lay user to perform, since it requires use of laboratory test instruments. If one uses a recorder with the specific tape formulation used for its initial setup, there's no need to repeat the procedure. However, no two tape types are identical, which, in the absence of this self-calibration facility, effectively locks one into using one particular tape (not always identified correctly in the deck's user's manual).

The first cassette decks to have internal self-calibration required about 15 to 30 seconds to complete the setup process, accompanied by flashing lights to inform the user of what was happening. Today, the process is much faster (typically 4 to 8 seconds) as well as less spectacular, but it seems to be equally effective. Although decks with this self-calibration capability are much less expensive than they used to be, they're still costly, generally \$500 and up. However, it's a genuinely useful feature and well worthwhile for any serious user of a cassette recorder.

For many years, cassette decks were limited to a single $1\frac{7}{8}$ -ips speed by the licensing requirements of the inventor of the compact cassette, N.V. Philips of the Netherlands. A few years ago, with expiration of the earliest patents on the cassette, several companies announced availability of two-speed cassette decks. In some cases, the second speed was a faster $3\frac{3}{4}$ ips to improve high-frequency recording headroom. Since metal tapes that were beginning to appear at the time claimed to provide superior high-frequency characteristics, the faster speed was touted as giving the performance of metal tape with ordinary ferric-oxide tapes at only half the price of metal tape. Of course, since a cassette operated at double speed has only half its $1\frac{7}{8}$ -ips capacity, there's no economic advantage to using the faster speed.

The other option has a half-speed mode, moving tape at only $1\frac{5}{16}$ ips. Most cassette manufacturers chose not to take this route, because of the difficulty in achieving the desired performance, even with metal tape (almost a necessity at this very slow speed). As a result, two-speed design hasn't had a major impact on the design of home cassette decks.

During the past year, several manufacturers have announced dual-transport cassette decks. Containing two separate cassette mechanisms, these products are designed to simplify copying, or dubbing, tapes. One transport and its heads is designed for recording only, the other for playback only. Setting of correct signal levels and gain, as well as necessary switching and interconnections, are built into the single unit, which is no larger than an ordinary cassette deck and costs considerably less than two separate single-transport decks of equivalent quality. Potential performance of this type of ma-

chine is high since the record and playback heads are separate and designed specifically to fulfill their own special functions. One of the few drawbacks of this design approach, as compared to conventional three-head deck designs, is the inability to listen to a tape while it's being recorded. In fact, one must physically remove the tape from one transport and load it into the other transport before it can be heard in playback.

Open-Reel Tape Decks. There are few fundamental design differences between open-reel and cassette decks, since their basic requirements are virtually the same. Most current open-reel decks have three heads and three motors and offer either two- or three-speed operation. The preferred speeds are $3\frac{3}{4}$ and $7\frac{1}{2}$ ips; the third is either $1\frac{7}{8}$ or 15 ips.

Although most home recording is done using 7" tape reels, many home machines are capable of accommodating $10\frac{1}{2}$ " reels as well, doubling their uninterrupted record/play time. Logic-controlled solenoid-operated transports are the rule. Most decks designed for home use employ the standard $\frac{1}{4}$ -track stereo format, with two stereo tracks in each direction of tape movement (as is the case with cassettes). However, many open-reel decks can be purchased with two-track stereo heads for improved S/N performance. Professional features, such as low-impedance inputs for balanced microphones, are offered on some of the more expensive models.

Prices for open-reel decks cover a range as wide as for cassette decks. There are a few open-reel decks priced competitively with medium-priced cassette decks, but those with professional performance and features are likely to cost between \$1000 and \$3000.

In general, noise reduction isn't built into open-reel decks, nor is it likely to be needed, except in the most demanding applications. External noise-reduction accessories are available from several manufacturers for this purpose. The wider tape tracks and faster speed of open-reel decks give this medium an inherently greater dynamic range than is possible with cassette decks, especially at high frequencies, where there's much less tendency toward tape saturation at high signal levels.

Barring those cases where the higher inherent quality of an open-reel deck is needed to handle the program content, the chief advantage of this format is the ease with which the tape can be edited. For serious recording, an editing capability is vital. With a cassette deck, editing is nearly impossible, except by dubbing to a second deck, which is at best a difficult and unsatisfactory process, to say nothing of the quality degradation that comes from rerecording on cassettes. ◇

Take the Perfect Path™ Home



Discwasher® Perfect Path™ Cassette Head Cleaner

At home or in your car, nothing cleans cassette heads easier or safer than the Perfect Path Cassette Head Cleaner. In one pass, the non-abrasive fibers gently remove signal reducing magnetic oxides from the tape heads . . . and without messy swabs or damaging fluids. At the same time, they carry away debris from along the entire tape path. The result . . . restored response and improved fidelity from your cassette deck.

Discwasher, the world leader in record care, now offers unparalleled tape care. Take the Perfect Path Cassette Head Cleaner home . . . for sound maintenance you need.



- A. Response with clean heads.
- B. Response after 3 hours play with standard tape.
- C. Restored response, to within 1 dB, after one pass of the Perfect Path Cassette Head Cleaner.

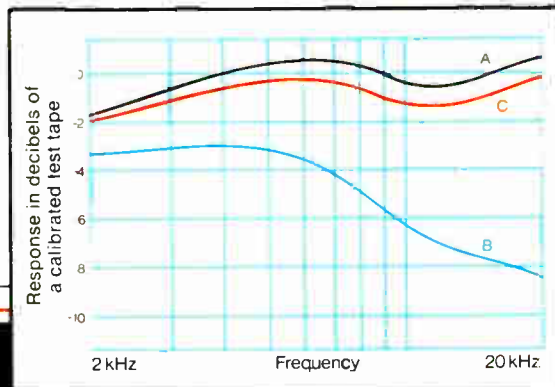

discwasher®

PRODUCTS TO CARE FOR YOUR MUSIC

1407 North Providence Road, P.O. Box 6021
Columbia, MO 65205

A DIVISION OF JENSEN an ESMARK Company

CIRCLE NO. 11 ON READER SERVICE CARD

Anyone can make a recording. Just throw a cheap portable cassette recorder with a self-contained microphone near the performers and let it loose. The results from such an exercise will generally be quite poor, however, especially compared to what can be done with even a minimal investment in microphones and connecting cables.

The utmost challenge for any recordist is a live recording session. You get to choose everything that determines the ultimate sound quality: the recorder, tape, and microphones and their placement. And that ultimate sound quality can be superb—better than nearly everything available on either disc or tape—without the expense of “professional” equipment.

If you are someone who might be asked to tape a school recital, play, or concert; if you are a musician who needs tapes for auditions or as “sonic mirrors;” this article will take you through the basic decisions confronting anyone making a live recording. While this handbook is too short for a complete explanation of modern multi-track and multi-microphone techniques, the principles outlined here can easily be applied to more complex productions.

Tape Recorders. Selecting a tape recorder for live recording is fairly easy, at least at the start. Those who will have to edit the tapes they produce will need an open-reel recorder, period! If compatibility with radio-station and recording-studio tape formats is required (for possible broadcast or duplication of the master tapes), then the 1/2-track (or 2-track) open-reel format is necessary, preferably running at 15 ips. Such open-reel recording consumes great quantities of rather expensive tape, but this is the only way to go with analog equipment if you want the widest frequency response, widest dynamic range, and lowest noise. Many cassette recorders, especially those equipped with advanced noise-reduction systems, can equal or exceed the dynamic range capabilities of some “unaided” open-reel recorders. But don't forget that noise-reduction systems are available for open-reel machines, too. A properly set-up and utilized open-reel recorder equipped with an advanced noise-reduction system can rival the dynamic range of a digital audio recording system.

As of this writing, digital-audio recorders are just being made available at prices the well-heeled audiophile can afford. These machines are usually adaptors for use with a videocassette recorder (VCR). They turn two channels of audio into a digital signal that is, in turn, transformed into a video signal, which is something a VCR can cope with. On playback of the videocassette, the video signal is converted back to a digital audio

HOW TO MAKE LIVE RECORDINGS

signal which is converted into an analog signal that's extraordinarily close to the original signal.

Though expensive, digital-audio adaptors (or VCRs containing them) are not that much more costly than high-end open-reel recorders. Tape costs can be *lower* than for analog open-reel recording, and most critical listeners would agree that the sound is far superior (no wow or flutter, no print-through or modulation noise, and low noise and distortion). The only problem with the digital audio approach is that of compatibility with other tape media. Most recording studios are not equipped to handle a digital-audio videocassette, and certainly few home users will be able to do so. Perhaps the best bet is to rely on a digital recorder to make the master tape (with an analog-recorder “safety”), and to make whatever copies as may be necessary on an analog open-reel or cassette machine.

If for reasons of expense or convenience you must use a cassette recorder, get the best you can afford. Three-head units not only have playback heads optimized for extended high-frequency response, but the third head permits you to monitor the recording a fraction of a second after it has been made. Catching a defective cassette before a recording is ruined is made much easier.

Tape choice is more of a factor in cassette live recording than with open reel, though it is important in both. Live signals can have very wide dynamic ranges and greater high-frequency content than either records or FM broadcasts. Capturing live signals with normal cassette ferric tapes is straining at the boundaries of both theory and technology. Ferric and chrome or chrome-equivalent tapes may be fine to record limited-range material, but to get the most from live music will require metal tape used in conjunction with an advanced noise-reduction system for highest fidelity. The Dolby HX-Professional headroom expansion system can relieve the demand for metal tape in some situations.

Other factors which should be considered in the purchase of a tape recorder for live recording include:

- Ruggedness.
- Repairability.
- Ease of adjustment (bias, equalization, and head alignment).
- Portability (handles? carrying case?).
- Microphone inputs (type of mic jack).
- Noise the machine makes while operating.
- Whether it can be powered by batteries.
- Machine size and weight.

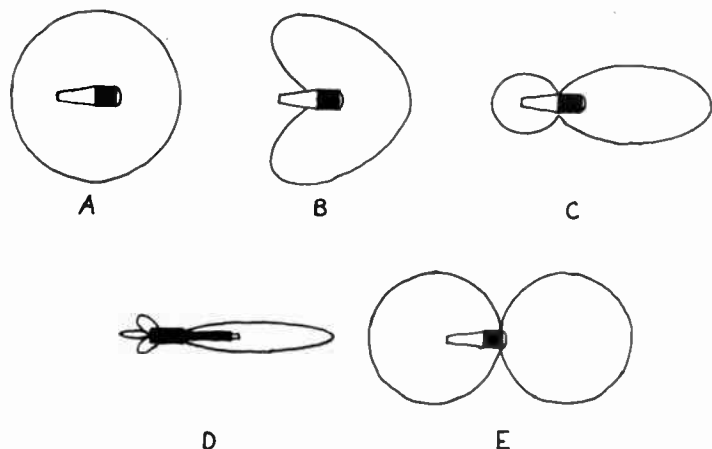

Figure 1. Pickup patterns for omnidirectional (A), cardioid (B), hypercardioid (C), shotgun (D), and Figure-8 (E) microphones.

There's More to Noise Reduction Than Silence.

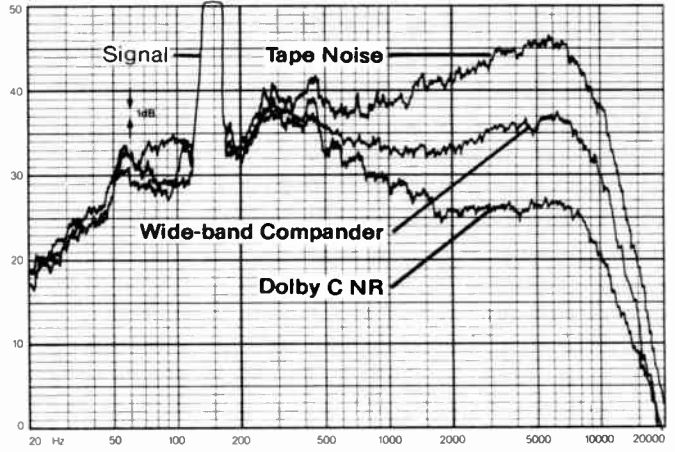
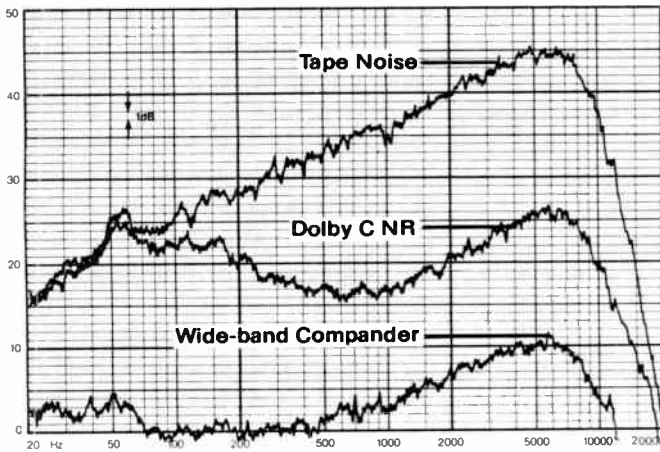

FIGURE 1: NOISE AND NOISE REDUCTION IN THE ABSENCE OF MUSIC. Noise from biased cassette tape without noise reduction, the effects of Dolby C-type noise reduction, and the effects of a wide-band compander are shown in the absence of any signal? Dolby C's noise reduction effect results in an overall perceived noise level below the ambient noise of many listening rooms, even at high playback levels. In the absence of signals, the conventional wide-band compander provides still more electrical noise reduction (but usually no more audible noise reduction).

FIGURE 2: NOISE AND NOISE REDUCTION IN THE PRESENCE OF MUSIC. In the presence of a signal (148 Hz, D below middle C on the piano, recorded at Dolby level), in all cases noise in the region of the signal will be masked by it. However, at higher frequencies, especially between 2 kHz and 10 kHz where tape hiss is clearly audible, Dolby noise reduction provides almost as much noise reduction as if the signal weren't there, while the compander allows the noise to increase to a considerably higher level than with Dolby C.

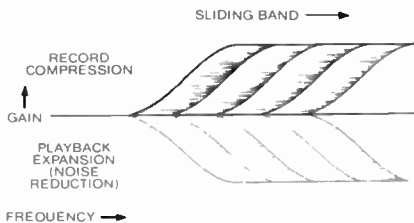

FIGURE 3: THE SLIDING BAND PRINCIPLE. Dolby noise reduction operates over a band of frequencies which slides up out of the way of the music, resulting in noise reduction just where there is no musical signal to hide the noise. Thus the perceived noise level is consistently low at all times.

Providing noise reduction on silence is not all that difficult. For years, conventional wide-band compressors have been available which dramatically reduce noise — between selections on a tape or record.

Yet it is just as important to have noise reduction when there is music playing. While music will mask noise part of the time, there are times when it won't. A bass drum note, for example, cannot hide tape hiss, no matter how loud the drum is: the ear can detect both simultaneously.

Conventional noise reduction systems effect noise reduction at the time of playback by turning down the volume when there is little or no music present. This turns down the noise as well. But they also turn the volume back up again on louder music, and so turn the noise back up at the same time. Thus the bass drum note is accompanied by a burst of tape hiss — hiss which is audible if there is no music at higher frequencies to hide it.

This problem is called noise modulation. It means that with a conventional NR system, the noise level is constantly shifting up and down with changes in the level of the music. But Dolby noise reduction, on the other hand, is free of noise modulation on virtually any type of music (Figures 1 and 2).

Unlike conventional compressors, Dolby noise reduction operates over a constantly changing, or sliding band of frequencies (Figure 3). The band extends low enough to provide very effective noise reduction on silence. But in the presence of music, the band slides up just out of the way of the music, so that noise at frequencies above the music is almost as effectively reduced as if the music weren't there.

Both Dolby B-type and Dolby C-type noise reduction are sliding-band systems. With the standard B-type system, noise reduction begins at 500 Hz and increases to 10 dB at 4 kHz and above, while with the new C-type system, noise reduction begins at 100 Hz and increases to 20 dB at 1 kHz and above. With either system, the presence of music does not prevent noise reduction from occurring where it is still needed.

*70µs equalization, measured with a constant-bandwidth wave analyzer, and weighted (CCIR/ARM) to reflect the ear's sensitivity to noise and noise reduction effects.

Dolby

Dolby Laboratories Licensing Corp.,
731 Sansome St., San Francisco, CA 94111,
Telephone (415) 392-0300. Telex 34409.

"Dolby" and the double-D symbol are the registered trademarks of Dolby Laboratories Licensing Corporation for its A-type, B-type, and C-type noise reduction systems. 581/3307/3403.

...LIVE RECORDINGS

Microphones. The selection and placement of microphones is a major portion of a recording engineer's skill, for a recording can be no better than the original signals, and it is the microphones which provide them. Microphones, like tape recorders, come in several technological "flavors." In this case, however, mic choice is complicated by how each unit responds to the specific acoustical environment it is required to transduce.

There are two basic types of microphone in common use: directional and omnidirectional. Taking the simple case first, an omnidirectional mic is equally sensitive to sounds arriving from all directions. Most omni mics have a slight rolloff of the very highest frequencies for all directions other than "on-axis," however. (Off-axis coloration is a major contributor to the "sound" of a particular microphone—and why some models are preferred for certain applications and not for others.)

Directional microphones, as their name implies, do not pick up sounds as efficiently from some directions as from others. The most common directional microphone is called the "cardioid," presumably because its sensitivity pattern is somewhat heart-shaped (Figure 1). From that Figure—which shows the pattern of equal sensitivity around the microphone, with the farther the curve from the microphone meaning greater sensitivity in that direction—you can see a cardioid mic is most sensitive to sounds coming from straight ahead. This sensitivity is maintained until the sounds come from the side and back of the microphone. Sounds arriving from the sides and rear are transduced, but at a substantially lower level than they would have been had they arrived from the front.

Other directional microphones in common use include hypercardioid, shotgun (named for the shape of the mic), and figure-8 or bidirectional configurations. All of them feature directions in which sounds are preferentially attenuated. Those microphones with rear lobes (hypercardioid and figure-8) invert the phase of the sounds arriving from the rear.

Both omnidirectional and directional microphones are available in two common technologies: dynamic and "condenser" or electrostatic. Like their loudspeaker namesakes dynamic microphones use a coil moving in a magnetic field. Generally, the coil is attached to the microphone diaphragm and the magnet to the body of the mic. As the diaphragm vibrates, the coil moves in the magnetic field, generating a voltage. Condenser microphones are much like electrostatic speakers or headphones in reverse. Both the microphone diaphragm and a fixed nearby metal plate are given high electrostatic charges (in an "electret" microphone these charges have been fixed in place so a source of polarizing voltage is not required). As the diaphragm vibrates in the sound field, its distance from the fixed plate changes. This is sensed by the mic's internal circuitry as a change in capacitance between the plate and the diaphragm. An output voltage is then generated proportional to the vibration of the diaphragm.

Condenser mics are generally preferred by professionals for their extended high-frequency response and low distortion. Dynamic microphones are preferred

It's almost like getting a new VCR for the cost of a tape.

New JVC High Grade VHS Tape

Now from JVC, the originators of the VHS system, comes High Grade VHS video tape. A tape so advanced, so perfected, that alone it can make a significant difference in the quality of your VCR's performance.

JVC High Grade. A video tape that's ultrasmooth, ultrarefined, ultrasensitive. With it, you'll possess all the advanced qualities required for consistent, maximum recording and playback excellence.

What's more, there is no software anywhere that performs better in today's world of punishing "slow-speed" VCR features like six hour recording, slow motion, and freeze frame. Plus, JVC High Grade reduces the possibility of drop-outs to an all time low.

JVC High Grade comes in both 60 and 120 minute lengths. It's the one new video tape no VCR should be without. See it at your JVC Vidstar dealer today.



CIRCLE NO. 7 ON READER SERVICE CARD

where extremely high sound levels are to be recorded, where great ruggedness is required, where extremes of environmental conditions are expected, and where cost is an important consideration.

The best microphones are expensive—a professional engineer can expect to pay several hundred dollars for a high-quality condenser mic. But an amateur can obtain extraordinarily good results with much less expensive equipment. Some electret condenser mics of high sound quality are available at reasonable cost as accessories. What you generally give up with these less-expensive models is flatness of frequency response, low self-noise levels, lowest distortion, and deluxe packaging. What matters most with microphones of reasonable quality (and there are many of those) is not how good they are, but how they are used.

Microphone Placement. This is the core of the recording engineer's art. Even with mediocre equipment, proper microphone placement can result in a stunningly lifelike recording. This, of course, assumes that you want to make a lifelike recording. Many record producers nowadays, especially in pop and jazz, try to create new musical sounds and dazzling sonic effects through innovative mic placement and the use of various signal-processing devices like delay lines and vocoders. These effects, oft times musically effective, are generally out of the range of most amateur home recordists. Duplicating the "sound" of today's top selling pop albums would require substantial numbers of microphones, a multi-channel mixer, and a multi-track tape recorder.

For this article the sonic alternative will be examined: making a high-fidelity recording, one which attempts to recreate accurately the sonic effect of the original performance. This is relatively easy to do with only two or three microphones and a conventional stereo tape recorder. (Note that "high-fidelity" makes no judgment as to how "good" the recording sounds, only as to its ability to give an illusion of the original.)

The first consideration in mic placement is distance from the performers. In general, microphones must be placed much closer to the performers than a "live" listener for the same sonic effect upon playback as the "live" listener received. Also, mic distance should vary with the size of the auditorium (at least for non-amplified instruments); the larger the auditorium the more distant can be the microphones.

If the performing ensemble is deep, with some musicians much farther from the mics than others, the microphones might have to be raised on stands to reduce the differences in distance. Raising the mics has the beneficial effect of reducing sound coloration caused by reflec-

tions from a nearby floor.

If you have no idea where to put the microphones, try a location 6 to 10 feet back from the performers and 6 to 10 feet above them, and "adjust to taste." Too close a placement can sound unnaturally analytical, too distant can sound too "washed out" and reverberant. Too low can overemphasize the nearer instruments, too high can remove all sense of ensemble depth in addition to sounding too echoey.

There are several "canonical," tried-and-true methods of deploying microphones for a stereo recording. They are usually called "minimal-microphone" or "purist" techniques. On playback, each of these positionings is claimed to provide an accurate and stable stereo image of the original performing forces. In truth, each distorts sonic reality a little bit, some techniques altering different aspects of the image than others.

The simplest and perhaps least troublesome minimalist technique was developed by the French broadcasting system and takes its name from the initials of that organization: ORTF (Figure 2). The ORTF system of two cardioid microphones with their diaphragms 17 centimeters apart (around 6¾ inches) and angled apart by 110° has survived listening tests as the best compromise of image placement accuracy, directionality, and sense of hall ambience. An ORTF pair, placed as outlined above is a good starting point for experimentation.

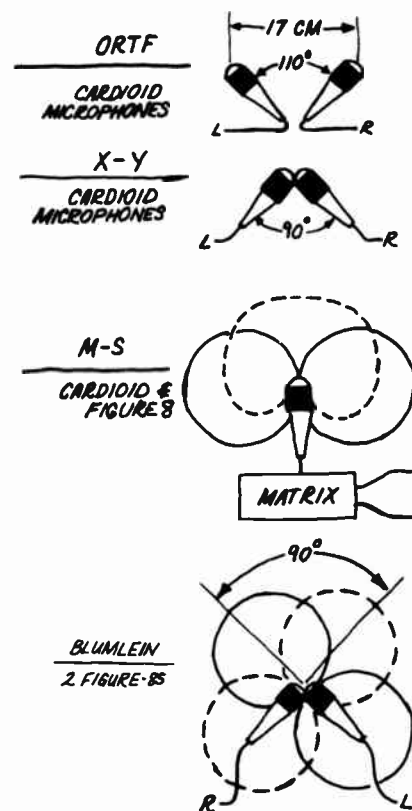

Figure 2. Microphoning techniques.

Some theorists and audiophiles prefer "coincident" microphone techniques. These place two directional microphones (pointing in different directions) with the diaphragms as close together as possible. Among the variations of this technique are "X-Y;" (two cardioid mics, tips together, 90° angle); "M-S" (a figure-8 plus and omni or cardioid feeding a special matrixing circuit), and "Blumlein" (two figure-8 mikes, 90° angle).

Aside from any theoretical advantages, coincident techniques have (they are very amenable to mathematical modeling), their primary real-world advantage is exceptionally good compatibility with monophonic broadcasting and stereo-disc cutting. This is because coincident placement effectively eliminates any phase differences between the two stereo channels, the only differences being those in signal intensity. Beware, however, of claims that coincident techniques, particularly the Blumlein system, are the be-all and end-all of stereo mic techniques. They are just tools, like the ORTF technique, and require equal amounts of experimentation with exact placement for good results.

You can often get stunning results with just two *omnidirectional* microphones placed 6 to 10 feet apart at the distances recommended above. This technique has less good mono compatibility than the systems outlined above, however. Also, a "hole-in-the-middle" effect can occur if the mics are too widely spaced and disturbing phase effects can happen if they are too closely spaced. Adding a third omnidirectional microphone midway between the original spaced pair (and moving the original pair apart a few feet more), mixed equally loud in both stereo channels, and adjusted to slightly lower than the original pair in level solves the hole-in-the-middle problem.

Remember that all these recommendations are just that, and that there are no hard and fast rules. If you are not too concerned with "high fidelity," you can experiment with placing mics over, under, and even inside instruments for new effects. Try to avoid widely spaced directional microphones (though figure-8's can sometimes be used like omnis) and closely spaced omni mics. Otherwise, experimentation is the name of the game.

On Location. If you are taping a live concert, the first order of business, once you unload all the equipment, is to set up the microphones. Stands are the most convenient means of supporting mics, though sturdy, large models can be outrageously expensive. If you use stands, make sure they aren't in anybody's way and aren't blocking sight lines between musicians or to the audience (if any). The floor on which stands are placed should not reso-

The new Harman Kardon CD series of cassette decks.

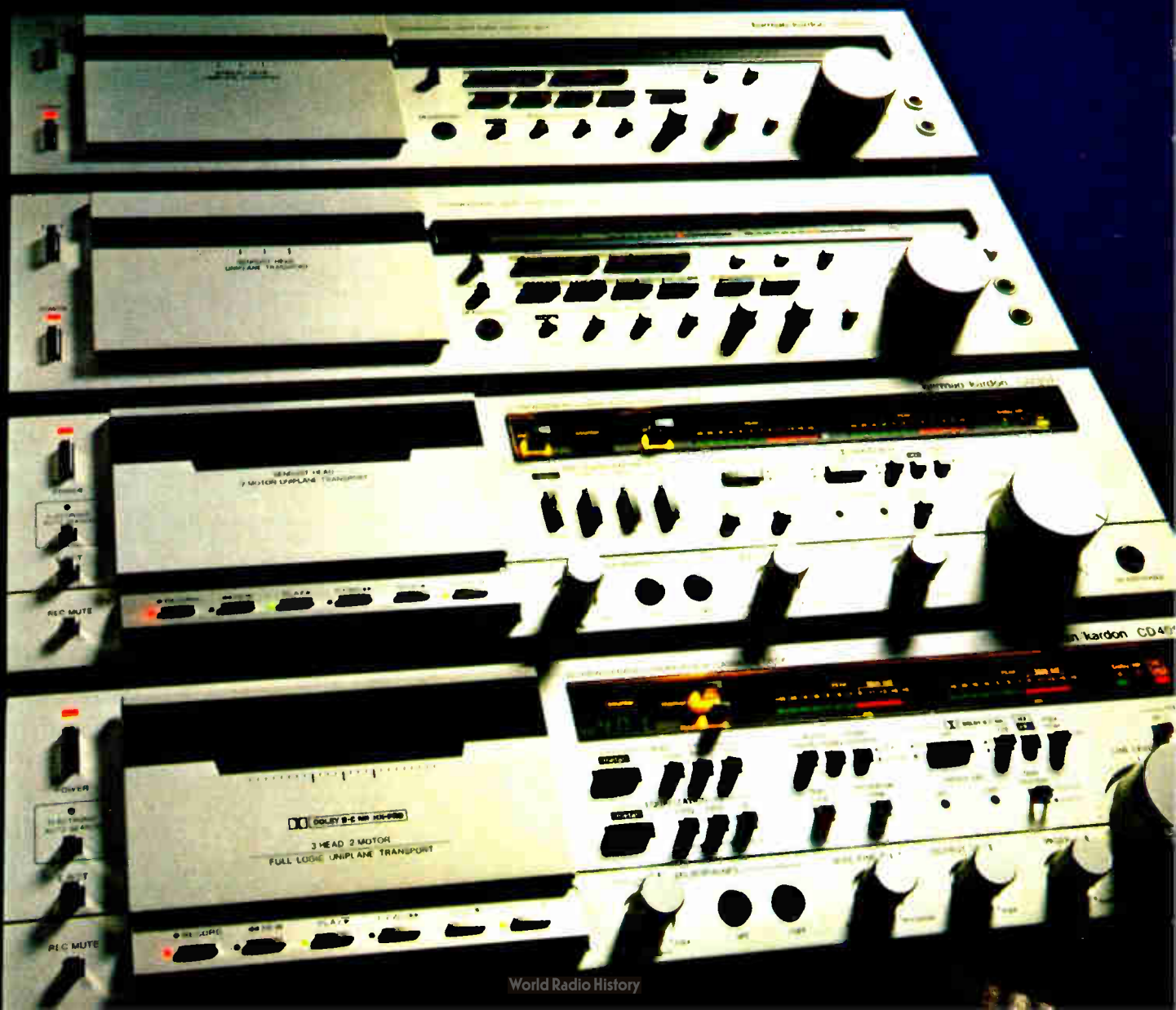

THE FIRST LINE OF DECKS TO EQUAL THE RANGE OF HUMAN HEARING.

It's been known for nearly a century that the range of human hearing extends from 20 to 20,000Hz. And for at least the last 15 years, every stereo component has had to meet that standard in order to be considered high fidelity.

Yet until now, only a handful of the most expensive cassette decks—often costing more than the rest of your system—have been able to accurately reproduce the entire frequency range.

Now Harman Kardon introduces the CD Series of cassette decks.

Every deck in the line matches or exceeds the frequency range of human hearing to an accuracy of ± 3 dB.* From the deepest bass reverberations at 20Hz, to the highest shimmering overtones at 20,000Hz.

And every deck achieves this with *any* tape formulation, not just costly metal tape.

Perhaps most important of all, the entire line is priced like ordinary decks, from \$299 to \$749.**

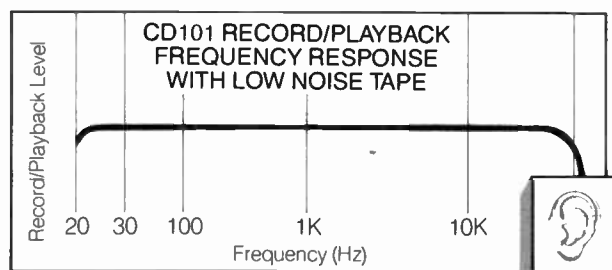

Even our least expensive model covers the entire audible spectrum, from the deepest bass at 20Hz to the highest overtones at 20,000Hz. (Shaded area represents accuracy to ± 3 dB.)

Which means that anyone who is serious about stereo systems can now afford a cassette deck with true high fidelity performance.

Trade up to our least expensive deck.

The CD101 costs only \$299.** Yet its frequency response is so faithful to the original music that many people will undoubtedly trade-up from their present \$400 and \$500 decks. The CD101 also gives you features like solenoid transport, bias fine trim, and auto repeat.

As you go up the line, you can add Dolby C,[†] Dolby HX Professional[†] and three heads for performance that easily rivals tape systems costing thousands more.

harman/kardon
ASK ANY AUDIOPHILE.

We're finishing what we started.

Harman Kardon helped make cassette tapes a serious recording medium when we introduced the first decks with Dolby B[†] in 1970. Then in 1980, we were first with Dolby HX.[†]

Now, with the CD Series, we've made the cassette deck a true high fidelity component.

Of course, there's only one way to appreciate these revolutionary new decks. And that's to go hear them.

Ask your audio specialty dealer for a demonstration today. You'll hear what few people have ever heard before.

Everything.

For your nearest dealer, call toll-free, 1-800-528-6050, ext. 870. Or write Harman Kardon, 240 Crossways Park West, Woodbury, NY 11797-2057. In Canada, Gould Marketing, Montreal H4T 1E5.

*Other manufacturers may quote seemingly similar upper and lower frequency response specifications, but without the ± 3 dB tolerance. Without the tolerance specified, these limits can be greatly

exaggerated and therefore misleading.

**Manufacturer's suggested list prices.

[†]Dolby B, C, HX and HX Professional are registered trademarks of Dolby Laboratories, Inc.

...LIVE RECORDINGS

nate too much nor be pounded or hit during the performance, or you might end up with a tape filled with unexplained bumps and grinds. Inexpensive shock mounts are available for isolating microphones from external vibrations. An alternative approach is to suspend the mics from a cable, either their own cables or attached to a clothesline or a long length of "zip-cord" lamp wire. Make sure the mics, if hung, point in the right directions and don't move during the performance.

Microphone cables should be strung and positioned so as not to interfere with the performers. All cables should be taped down and otherwise secured from flopping around and being safety hazards. Use "gaffer's" or "duct" tape, which is strong and removable. Masking tape will do in a pinch.

When interconnecting cables make sure all connections are firm. If you are not using self-latching XLR-type connectors, it's a good idea to tape together the plunges and jacks of any connections along a cable run. When stringing cables in a theatre, try not to lay them too close to any stage lighting; some light-dimming systems emit high levels of electrical interference that sound like a hum or buzz in the microphone outputs. Keep cable lengths as short as possible. When hanging mics by their cables, make sure that the cables can support both the microphones and their own weight.

Once the mics and cables are set up, see if all of them are working as soon as you can. Changes on or above a stage may not be possible in the last minutes before a concert. After you're sure that all the mics are operating correctly and repositioned properly, set up the tape recorder.

Most of the tape-machine set-up procedure should be done beforehand, when time and space are available. Proper set-up includes checking head alignment (usually not possible on non-professional recorders), cleaning and demagnetizing the heads and all other parts contacting the tape, and making a short test recording of a known signal source (like FM interstation hiss). Some recorders allow home adjustment of bias and equalization controls. These should be set for the specific type of tape to be used.

With the recorder (and any external noise reduction system) and mics connected and operating, the last remaining task is to set recording levels. If your taping experience has been with only discs and broadcasts, the first thing you'll notice is the wide dynamic range of live music, the softs (if there are any) will be very soft, the louds very loud. Fitting that

range on a tape can be a problem for all except digital and open-reel analog recorders with noise-reduction systems.

There are engineers who take the "gain riding" approach to solving the problem, and those who have a "hands off" policy. Gain riders will raise the recording level as a very soft passage is approached and slowly lower it before a loud crash hits. Of course, it helps to be able to follow the printed music, to memorize the score, and/or to record a rehearsal. With very-wide-range music, like a full orchestra, the hands-off method will mean that sometimes the signal will sink dangerously near the noise level of the tape and/or be straining "in the red" for substantial periods during loud passages. With analog tape recorders, the latter course is to be preferred. Analog recording overloads "softly" and is not too audibly objectionable until gross overload is reached. However, running such "hot" levels increases the risk of print-through.

If you have to go into a live recording session "blind" (deaf?), with no idea where to set record levels, you can take a hint from the audience applause that greets the artists as they troop out on stage. With non-amplified instruments and the microphones placed as noted above, a well-filled audience's applause should read between -5 and -10 on the recorder's meters.

Monitoring. Unfortunately, a live recording session usually means you have to monitor on headphones. Sealing headphones are rare (most headphones nowadays are non-isolating), and those that are available sometimes have inferior sonic characteristics. Still, they are usually the only way to judge the effects of mic placement, recording levels, and tape quality before it's too late. A good stereo image, by the way, should sound slightly too wide on headphones; speaker playback will reduce the apparent separation.

If possible, arrange to have a separate room sonically isolated from the main performing area since it is very difficult, even with isolating headphones, to hear all the details going on during a live performance. If you can, bring along a small amplifier and speakers for playback before the performance or during breaks. Even mini-speakers not ideally placed will tell you much about how the stereo image is being picked up.

Behaving Yourself. If you decide to get into what could be a personally and financially rewarding hobby, the making of live recordings places more obligations on you than just those involved in making a master tape. For example, you should be as unobtrusive as possible during a live concert recording, both visually and logistically. Don't make noises when they can be picked up by the mics or

heard by the performers. An open-reel tape should not rub against the reel flanges as the recording is being made. Not only does this damage the tape edge, but is also very noisy.

Plan your equipment hookup to take as little time to set up and take down as possible. You can get into trouble with the backstage crew if you don't. A rehearsal always helps.

If you plan to duplicate and/or sell the tapes you record, get *written* permission to do so from the artists involved. If the music you sell is under copyright, you must also obtain permission from the copyright holders. If you get this far, you might be able to go into business.

Impedance, Unbalanced, Balanced. Microphone impedances and the ins and outs of balanced and unbalanced operation are two subjects that still confuse even professional recording engineers. Many are stymied by the thought that mic impedance and output configurations have something to do with the specific microphone technology (condenser, electret, or dynamic). Others confuse mic impedance and output signals with mic output level, believing there is a necessary connection between them. The fact is that condenser or dynamic mics can have either high or low-impedance outputs, and those outputs can be either balanced or unbalanced.

Let's tackle the less complicated of the two aspects of mic outputs first: impedance. A microphone's impedance is theoretically the *output* impedance (*not* the *input* impedance of the amplifier to which it is connected). A mic's output impedance is what you would encounter if you were to try to force a signal into the microphone. However, according to common usage, a microphone's impedance means the impedance the mic can be assumed to have while designing a circuit to amplify it, not necessarily the actual microphone output impedance. Low-impedance microphones are desired in critical recording work because, while their output levels are generally lower than those of high-impedance microphones, a cable hooked up to a low-impedance mic is far less likely to pick up electrical interference. In addition, long lengths of cable attached to high-impedance microphones roll off high-frequency response. Most microphone inputs in consumer tape decks will accept and amplify the outputs of most common high or low-impedance mics. When in doubt try it out.

Most consumer-type audio connections are "unbalanced," meaning there are only two wires leading to each connection: a "hot" or signal-carrying lead,

(Continued on page 55.)

Shhh!

DOLBY DOES IT AGAIN

A new noise-reduction system that works twice as well as the ubiquitous Dolby B

BY MARTIN FORREST

If you ask any audio authority what development of the last 15 years influenced home high-fidelity recording the most, the answer you are likely to hear is: "Dolby B noise reduction." To be sure, the success—not to say dominance—of the stereo cassette recorder is in large measure due to the incorporation of Dolby B encoding and decoding circuitry in all but the very least expensive models.

The Challenges of Noise Reduction. It is generally agreed that in a high-quality sound system, residual noise (in cassette tapes that means largely tape hiss) should be at least 50 dB lower than the peak levels of the program material. But in the late 1960s and early 1970s the best signal-to-noise ratio that could be had from existing cassette tapes and decks was about 42 to 45 dB. The solution to this problem, as almost everyone knows by now, was Dolby B, a compander system that, when properly used, offered as much as 10 dB of tape hiss reduction. Adding this 10 dB to the 42 to 45 dB S/N available from cassette tape systems in 1970 gave 52 to 55 dB. This was hardly total absence of noise, but it could be fairly easily tolerated by those who sought to make high-fidelity music recordings at home.

Over the years, cassette tapes and recorders have improved in small increments, so that now, using premium-quality hardware, it is possible to achieve signal-to-noise ratios in excess of 60 dB. However minute they may seem, such noise levels are nevertheless still audible. Furthermore, program source material has improved too, so that what is available to the home re-

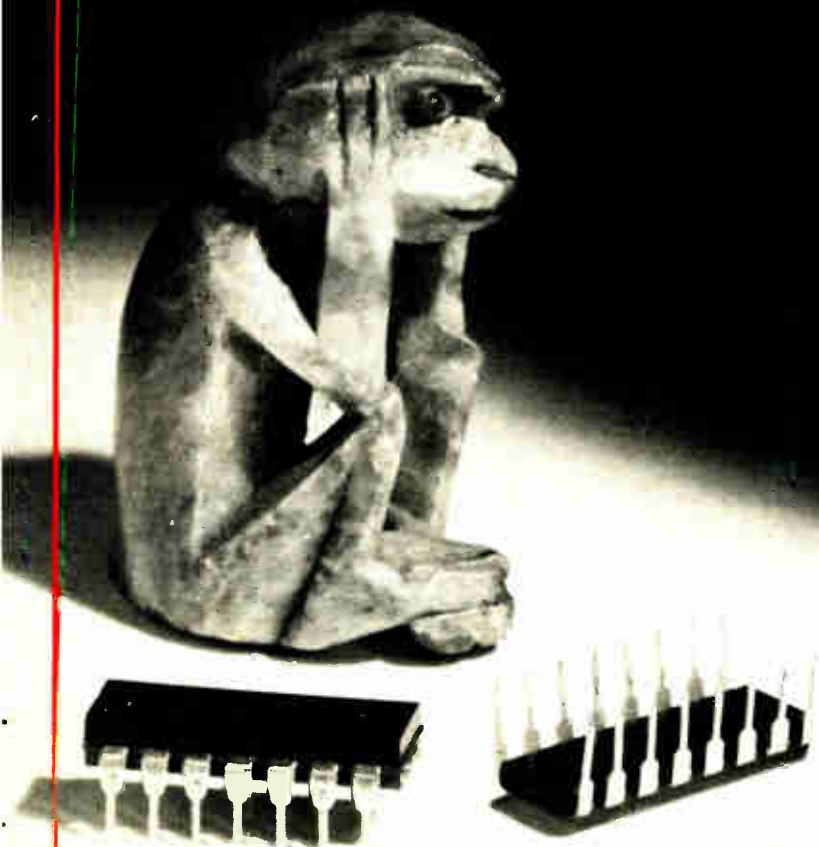

cordist for transcription onto cassettes, (favorite discs, once-in-a-lifetime FM concerts, etc.) is apt to have more dynamic range than when Dolby B was introduced.

Today's direct-to-disc and digitally mastered records can, in some cases, deliver S/N ratios as high as 75 or even 80 dB (measured with an appropriate form of weighting curve). If you tried to transfer such a disc to cassette tape, even with Dolby B, you would either saturate the tape in the loudest passages or "bury" the softest passages below the tape hiss.

Largely for these reasons, several companies other than Dolby have recently developed and marketed compander noise-reduction systems that suppress noise by substantially more than does Dolby B. The dbx linear companding system, for example, can provide up to 30 or 35 dB of noise reduction. Telefunken, of West Germany, developed a noise reduction system, known as High-Com II that is sold in the U.S. in its consumer version by Nakamichi. Sanyo has a system called Super-D (which, like High-Com II provides about 20 dB of noise reduction), while Toshiba markets (in Japan only, thus far) a noise-reduction system known as

ADRES, that is similar in concept to the dbx system.

One obvious common characteristic of these new noise-reduction systems is that all can improve S/N by 20 dB or more, compared with the 10-dB maximum of Dolby B. Despite the widespread acceptance that had been achieved, pressure on Dolby began to mount, even to the point where competing noise reducers were finding their way into consumer cassette decks right beside the familiar B system. It began to seem that the sun was setting on the mountain of which Dolby B had been king for so long.

But the limitation to 10 dB of noise reduction for Dolby B had been neither capricious nor arbitrary. It is generally conceded that the more compression/expansion there is applied to an audio signal, the more likely it is that modulation of the noise accompanying the signal by the compander will become audible. (This is the source of the much dreaded "breathing" or "pumping" heard in some systems at times.) Furthermore, precisely because Dolby B had been so widely accepted, it was necessary that any new Dolby system be at least reasonably compatible with its predecessor. Finally, it would be desirable

that, as is the case with B, a tape encoded in the new system be tolerable to listen to undecoded. At last, early this year, Dolby felt that it had sufficiently met these challenges and introduced a consumer noise-reduction system that offered a 20-dB improvement in S/N for any given recorder or tape. That system, logically enough, was called Dolby C noise reduction.

How Dolby C Works. Dolby C noise reduction lowers the noise inherent in low-speed tape recordings by about 20 dB above 1 kHz. Figure 1 is a multiple plot of noise spectra measured with a constant-bandwidth wave analyzer and weighted using the CCIR/ARM curve to reflect the ear's sensitivity to low-level noise. While Dolby B reaches its greatest effectiveness above approximately 4 kHz and from there upward reduces noise by about 10 dB compared with unprocessed tape recordings, Dolby C reaches full effectiveness at about 1 kHz and offers as much as 20 dB of noise reduction above that frequency. Like the two other Dolby systems (in addition to Dolby B, there is the professional Dolby A system) Dolby C is double-ended. The signal is processed during recording and "deprocessed" in

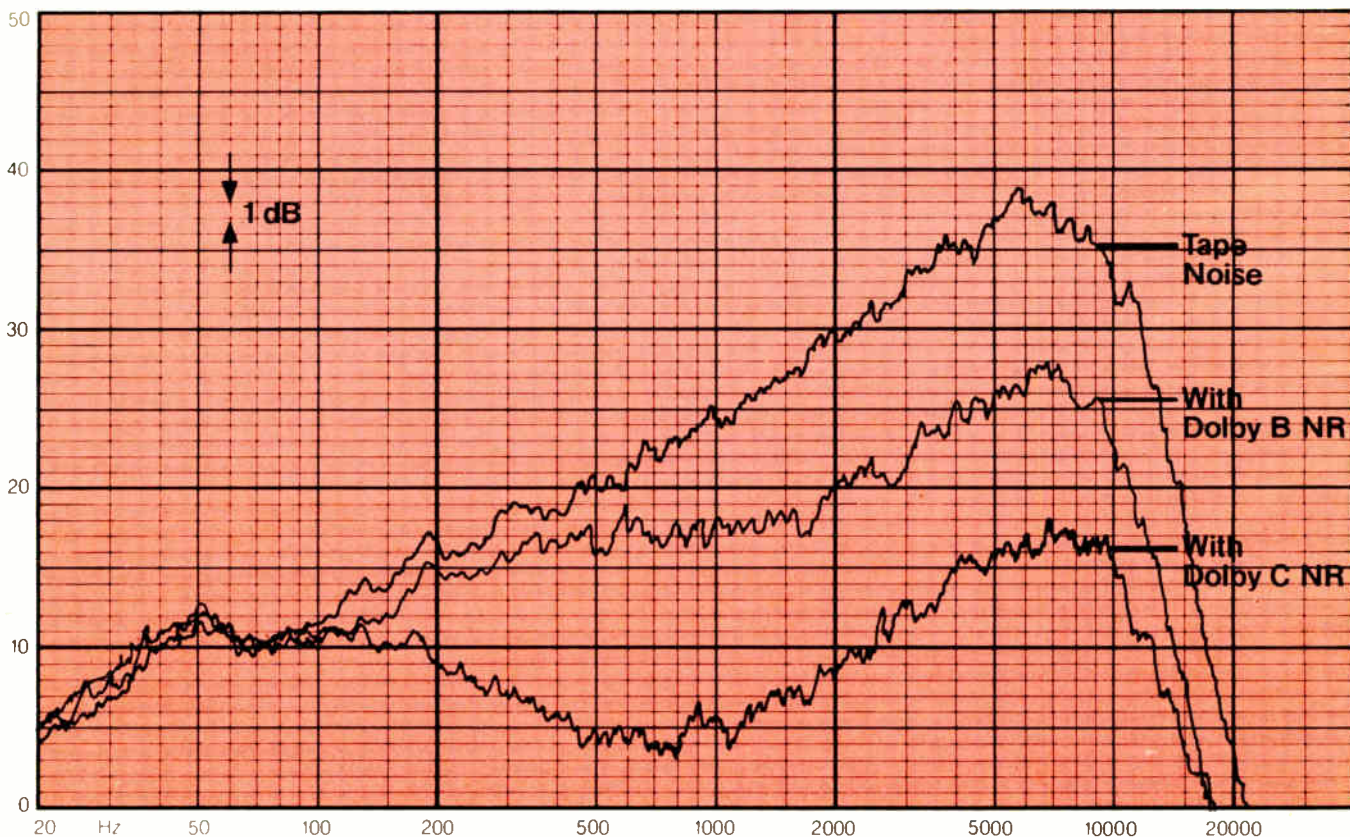

Fig. 1. Comparison of noise (CCIR/ARM weighted) from cassette tapes without noise reduction, with Dolby B, and with Dolby C noise reduction.

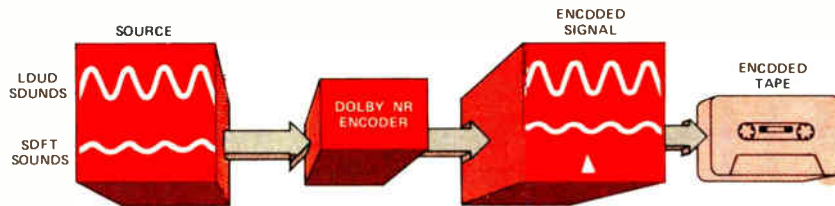

Fig. 2. In encoding, low-level mid- and high-frequency signals are boosted, high-level signals are not altered.

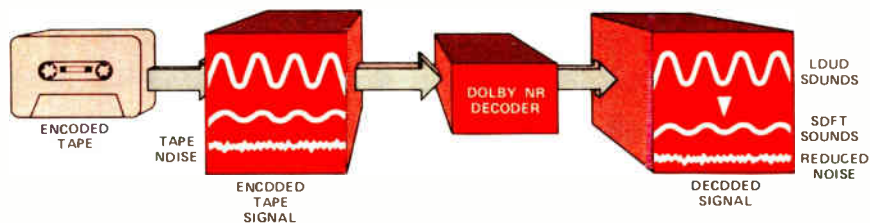

Fig. 3. In Dolby C decoding, low-level signals previously boosted are restored to correct relative amplitudes.

playback. This is illustrated in Figs. 2 and 3. Like Dolby A and B, Dolby C operates only at low program levels, where noise is audible, leaving unaltered high-level sounds that normally can mask tape hiss. Also, like Dolby B, Dolby C is a "sliding band" system. Full noise reduction occurs only in that part of the spectrum where it is most needed.

The chief difference between Dolby C and Dolby B is the *amount* by which signals are boosted during the recording half of the process and attenuated during playback. Dolby C also operates over a greater range of frequencies than did Dolby B, extending noise reduction downward to midrange frequencies, as plotted in Fig. 4. Achieving these new capabilities while satisfying all necessary constraints required several new developments.

A simplified block diagram of the Dolby C encode/decode circuitry is shown in Fig. 5. Each circuit incorporates two sliding-band stages that operate much as does a Dolby B processor. The two operate at different levels, however. Each stage provides 10 dB of compression during recording and the complementary expansion during playback. The high-level stage of Fig. 5 is sensitive to signals at about the same levels as the B-type. Since the two stages operate in tandem, their effect is to successively multiply the signal (or its equivalent, to add or subtract the corresponding number of dB) so that a total of 20 dB of compression/expansion takes place during encode/decode. This, in turn, results in a net reduction in noise of 20 dB. At no time is the program signal subjected to 20 dB of compression or expansion by

a *single circuit*. Figure 6 illustrates the principle involved. According to Dolby, the tandem two-stage configuration is much more accurate than a single compressor circuit would be.

In addition to the tandem processing, Dolby C incorporates two further developments worth mentioning. One of these, called spectral skewing, reduces the likelihood of encode/decode errors by reducing the sensitivity of the processing circuitry to frequency-response errors above 10 kHz. This allows for the usual variations in high-frequency response often encountered in casual use of a cassette recorder (such as by using a tape for which the deck has not been optimally adjusted). In Fig. 4, the plot shows that the maximum amount of compression in the C-type system diminishes above 10 kHz and crosses the B-type curve at around 20 kHz. This reduction in high-frequency compression results from the spectral-skewing and anti-saturation networks in the C system (Fig. 5). The anti-saturation network, as its name implies, operates at high signal levels to prevent tape saturation.

Nakamichi, one of the first manufacturers to introduce Dolby C (albeit as a separate add-on unit), has demonstrated that Dolby C, used with the Model 1000ZXL Cassette Recorder and metal tape, provided a record/play frequency response at 0 dB recording level that was down only 1.0 dB at 20 kHz. Without the anti-saturation networks, record/play response for the same conditions was down some 11 dB at the same frequency.

Recordings made with C-type noise reduction, while not perfectly reproduced, will be listenable when played back on cassette decks equipped with Dolby B decoding. They will even be tolerable with no noise reduction, though purists would say that to call this compatibility is stretching a point.

How Expensive Will It Be? Dolby C-type noise-reduction circuitry is more complex than the B system, and will cost more to incorporate into consumer cassette decks. For the moment, two Dolby-B IC circuits can be configured to carry out C-type noise reduction. Further-

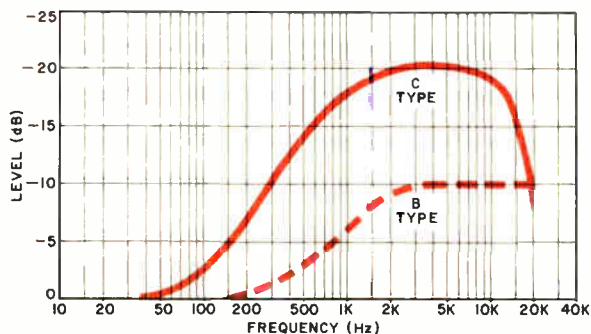

Fig. 4. Comparison of low-level encoding frequency response for Dolby B and Dolby C noise reduction systems.

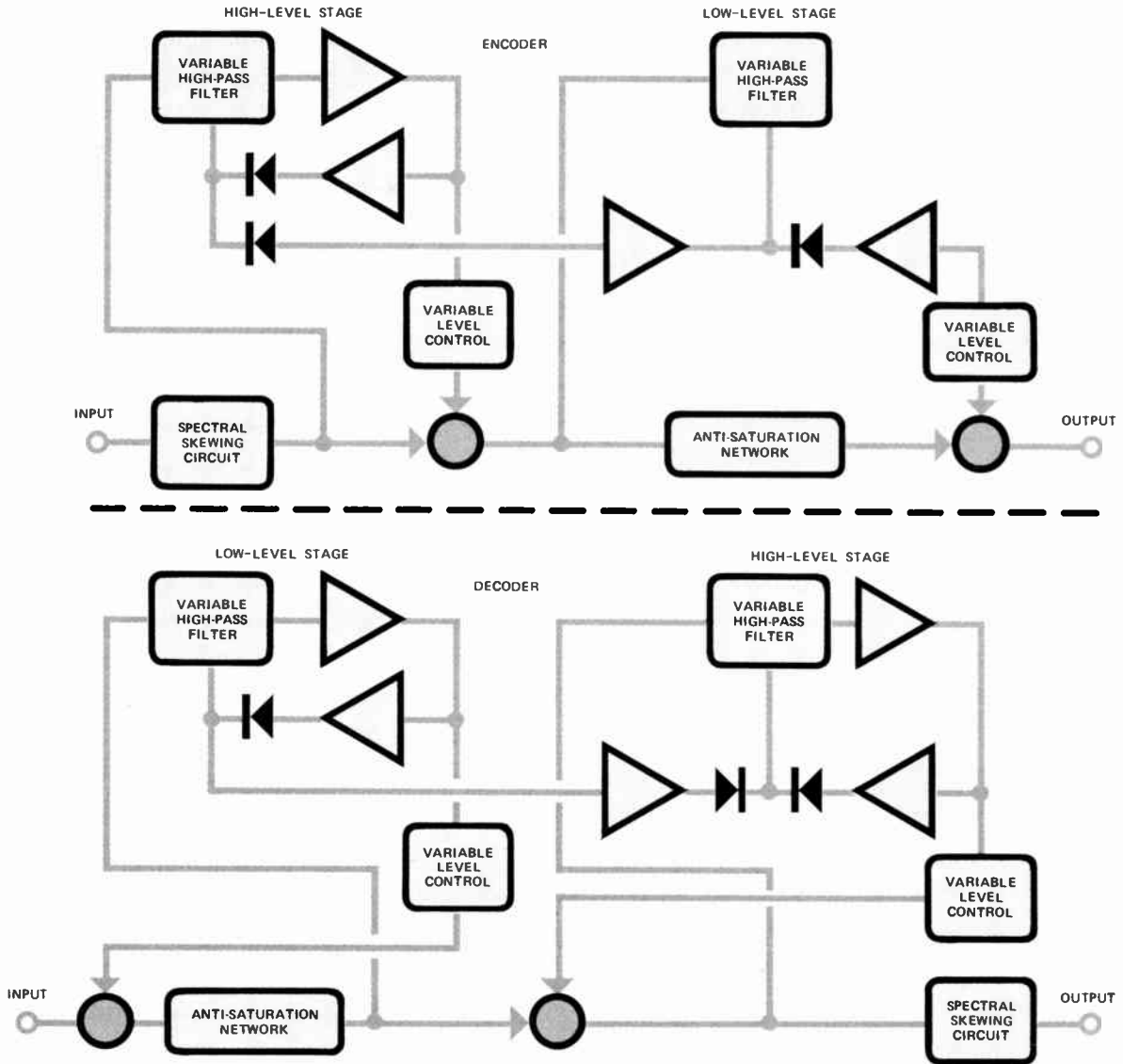

Fig. 5. Simplified block diagram of the encoding and decoding circuitry for a Dolby C noise reduction system.

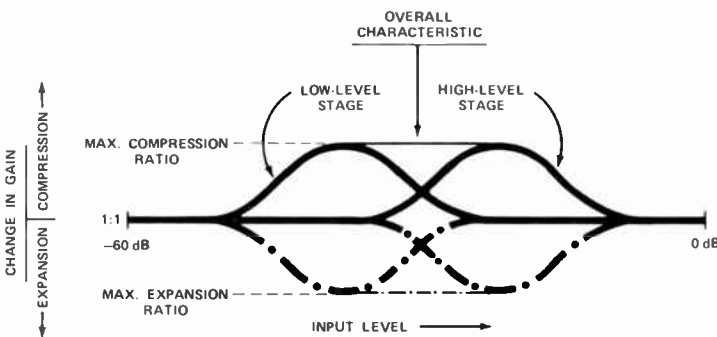

Fig. 6. In the two-level, two-stage Dolby C configuration, effects of the two stages multiply (add in dB) to achieve the full 20 dB of processing required.

more, one of the two stages can be conveniently reconfigured through switching to provide the B-type characteristic as well. It is expected that upcoming development of an IC chip for the C system will reduce costs further yet, but they will always be somewhat higher than those of Dolby B.

On the positive side, Dolby C should not represent a substantially larger fraction of the cost of the cassette decks in which it appears than does Dolby B now. This is because it takes a high-performance recorder to realize the benefits of the new system. Naturally, such machines are expensive to begin with, so it seems reasonable to suppose that the extra cost of Dolby C will not be much more than proportionate, if that. \diamond



COMPARING HIGH-TECH AUDIO CASSETTE TAPES

What makes one cassette tape better than another? Are there any real differences between the technologically best products? To provide an answer to these questions, samples of some of today's "top tapes" were subjected to a number of established tests designed to bring out their strengths and weaknesses.

LET'S begin our comparison with an overview of the tape market. There are four major cassette tape *types* currently available. The most widespread is Type I, ferric oxide (Fe_2O_3), which is produced in all grades of quality, from 3-for-a-dollar unbranded specials to top-notch formulations, some of which are lightly laced with cobalt to improve their magnetic performance. As a type, ferric-oxide tapes use the least record

bias, and are designed to be played back with 120-microsecond equalization (see Fig. 1).

Type II tapes are known generically as chromium dioxide (CrO_2), though most such tapes today are cobalt-enhanced ferric-oxide formulations, usually designated as "chrome equivalent." Chrome-type tapes use roughly 50 percent more bias than ferrics, and are intended for playback with 70-microsec-

ond equalization. The difference between 70-microsecond (chrome) and 120-microsecond (ferric) playback equalization affects the amount of tape hiss you hear. All else being equal (though it rarely is!), you'll get less hiss from 70- than from 120-microsecond playback equalization (see Fig. 1).

Ferrichrome (FeCr) tapes are designated Type III, and use two separately coated layers of magnetic material: a relatively heavy layer of ferric oxide, topped by a thin layer of chromium dioxide. Highly popular in the car stereo market, ferrichromes have not won wide acceptance among home-based audiophiles because of wide variations from brand to brand. Thus, hi-fi cognescenti rarely use these tapes for home systems; and for that reason they were not tested in this study.

The newest entrants on the cassette scene, Type IV, are the metal-particle tapes. Although these can be *played back* on any tape deck with a 70-microsecond ("chrome") equalization position, their extremely high bias requirement—approximately twice that of

CrO₂—demands that they be recorded on a deck whose heads and bias oscillator are designed to handle the high current associated with such high bias.

Theoretically, the "best" tape is that which produces the least inherent noise while providing the greatest undistorted signal storage capacity across the range of desired wavelengths. "Wavelengths" correspond to "frequency response," once you factor in tape speed. One second's worth of a 1000-Hz tone at a tape speed of 15 inches-per-second has a wavelength eight times as long as the same one-second tone at the cassette speed of 1 7/8 ips, and a tape formulation optimized for the former speed will not be equally suitable for the latter.

"Undistorted" is admittedly a weak word, but long-standing tradition, based on successful experience, favors defining it in terms of 3% third-harmonic distortion at a suitable middle frequency for the tape speed involved. For the tests in this report, the 400-Hz frequency used by Dolby-level calibration tapes was chosen.

Practically, of course, the "best" tape is that which most closely approximates the theoretical ideal on your machine. This is an important caveat. Tapes do test (and perform) somewhat differently on different tape decks and under different bias (and record equalization) conditions. I used the top-quality three-head Nakamichi 582, which has a wide record-head gap (3.5 microns) and a narrow-gap playback head (0.9 microns). A typical two-head cassette recorder, on the other hand, might have a record-playback head with a gap of 1.2 to 1.3 microns. The head gap affects both the high- and low-frequency extremes. Too wide a gap limits treble playback response; too narrow a gap may limit penetration of the record signal to the full depth of the magnetic coating.

In practical terms, a deck with a wide record-head gap will favor tapes with a relatively thick magnetic coating when measuring signal-to-noise ratio; the advantage of the thick coating may not be realized on a two-head deck. Similarly, a recorder with a narrow-gap playback head will tend to favor tapes with highly polished surfaces, which facilitate flat response to 20,000 Hz and beyond, though this advantage might not show up at all on a typical two-head deck, whose response may only extend to about 16.5 kHz.

Record bias and equalization are additional considerations when tapes are compared. Most decks provide a 3- or 4-position switch that sets bias and equalization (EQ) for optimum performance from a specific tape within

each basic type. Brand-to-brand differences among tapes of the same type do exist, however, which is the rationale for the "bias optimization" controls included in many decks. Using the adjustments available on my tape deck, I could have optimized the deck for each tape in turn, but this wouldn't show up tape differences under the fixed conditions most

deck owners have to use. I chose instead, therefore, to set up my test deck with the tapes most frequently specified as having been used in factory alignment by the numerous deck manufacturers whose recorders I have tested in recent years. These are: Maxell UD-XLI (ferric); TDK SA (CrO₂-type); and TDK MA (metal).

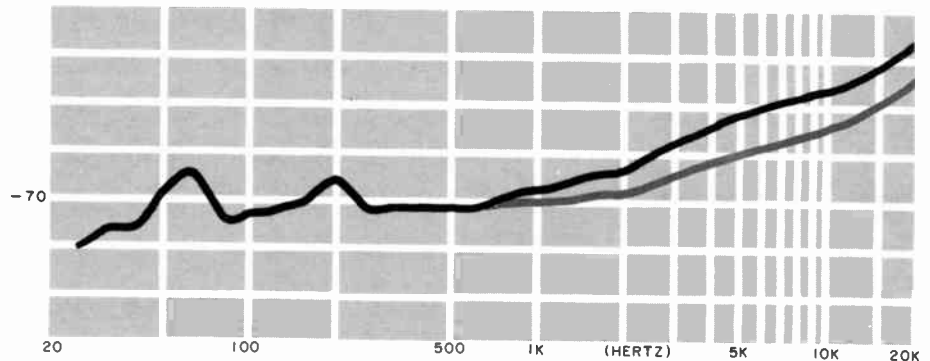

Fig. 1. Comparison of noise-level between 70-microsecond (colored curve) and 120-microsecond (black curve) playback equalization. The 70-dB level is with reference to 200 nanowebers/meter (Dolby level). The 70-microsecond equalization is standard for chromium dioxide tapes and 120-microsecond for ferric. If all other factors are equal, there should be less hiss from the 70-microsecond playback equalization.

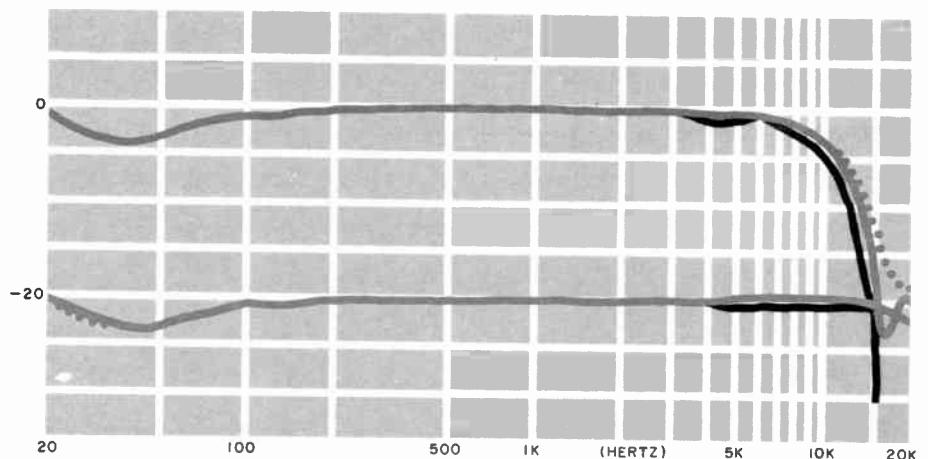

Fig. 2. Response curves for the three reference tapes: Type I, Maxell UD-XLI (ferric), solid black curve; Type II, TDK SA (chrome), solid color curve; Type IV, TDK MA (metal) dotted color curve. (These conventions with regard to the curves and Types apply to all of the response curves on the opposite page.) The tape deck used in the tests was adjusted for the three reference tapes and left that way for the rest of the tests.

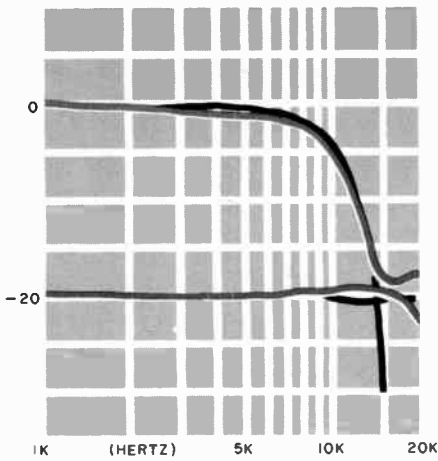

Fig. 3. BASF Professional I (solid black); BASF Professional II (solid color).

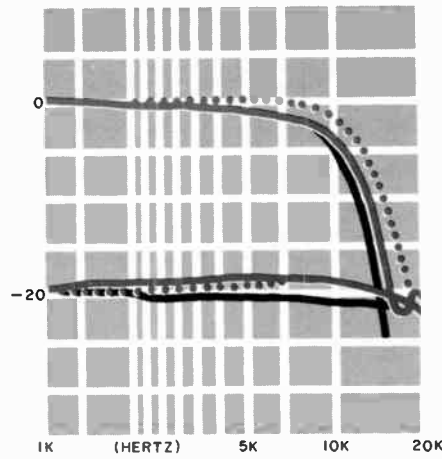

Fig. 4. Fuji FX-I (solid black); Fuji FX-II (solid color); Fuji Metal (dotted color).

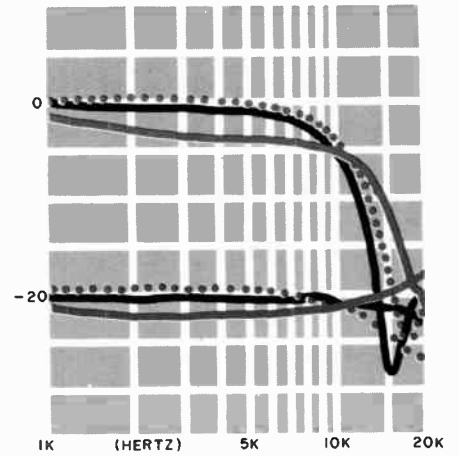

Fig. 5. Loran Normal Bias (solid black); Loran Chrome (solid color); JVC ME-P (dotted color).

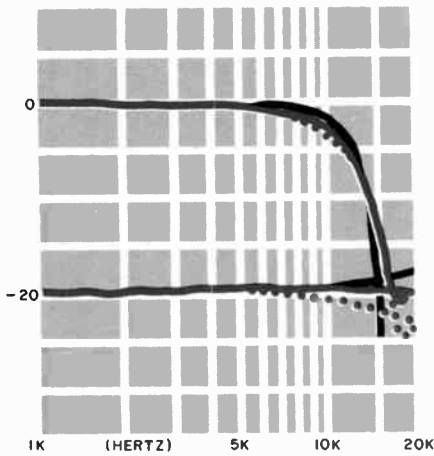

Fig. 6. Maxell XL-IS (solid black); Maxell XL-IIS (solid color); Maxell MX (dotted color).

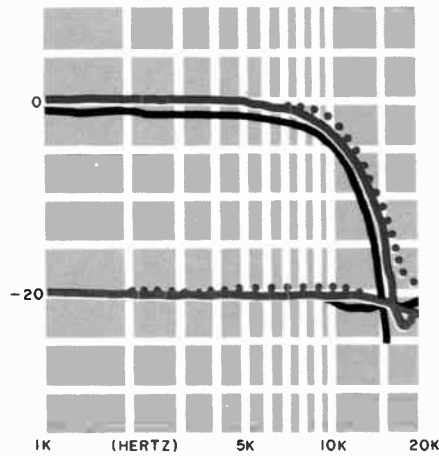

Fig. 7. Memorex MRX-I (solid black); Memorex HBII (solid color); Memorex Metal IV (dotted color).

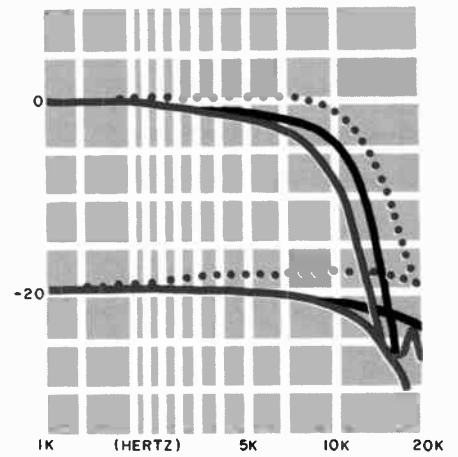

Fig. 8. PD Tri-Oxide Ferro (solid black); PD 500 Crolyn (solid color); PD 1100 Metal (dotted color).

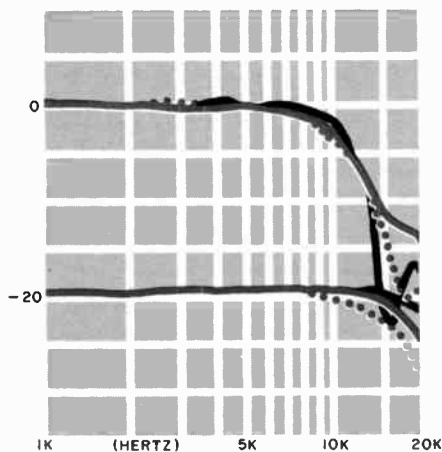

Fig. 9. Scotch Master I (solid black); Scotch Master II (solid color); Scotch Metafine (dotted color).

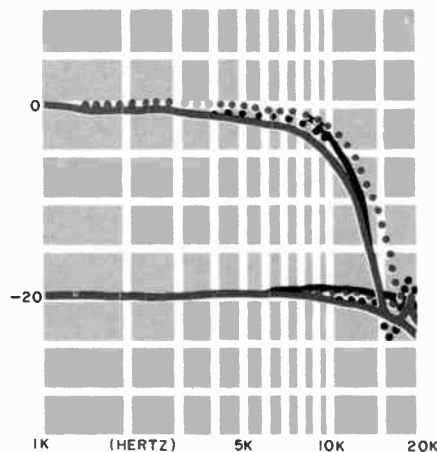

Fig. 10. Sony HFX (solid black); Sony EHF (solid color); Sony Dev. Hi-Bias (dotted black); Sony Metallic (dotted color).

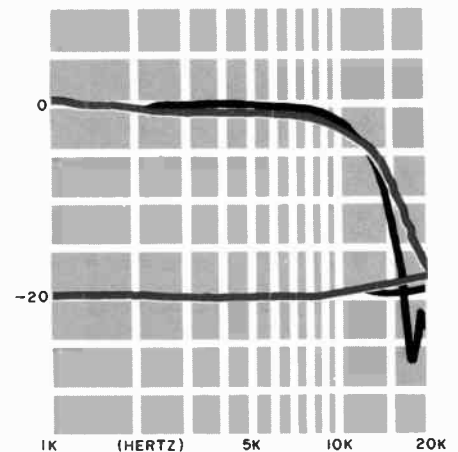

Fig. 11. TDK AD (solid black); TDK SA-X (solid color).

Testing the Tapes. Using these tapes as reference points for each type, the first test was of tape sensitivity at 400 Hz, the Dolby calibration frequency. Each tape was fed a fixed-level tone, and the resulting output was measured. The results are in the first column of the Table. A variation of ± 1 dB is hardly consequential in and of itself. As ± 2 dB is approached, however, it is possible that some frequency-response errors may occur when using the Dolby noise-reduction system if your deck is not set up with this particular tape.

After checking sensitivity, I raised or lowered (as necessary) the 400-Hz level so that the tape played back at a standard 200 nanoWeber/meter (Dolby) level, and measured the third-harmonic distortion, using a General Radio 1900-A wave analyzer. These results are recorded in the second column. The record signal input was then raised to the point where the tape playback produced 3% third-harmonic distortion, the normal reference level for signal-to-

noise measurements. The higher the number in the third column (400 Hz Maximum Output Level) of the Table, the higher is the record level you can use before the onset of serious (audibly noticeable) distortion.

At the 400-Hz 3% maximum, the input signal was short-circuited so that biased tape noise level could be measured under no-signal conditions. The noise level was passed through an IEC "A" weighting network (whose weighting, by frequency, corresponds closely to the sensitivity of the ear to low-level sounds such as tape hiss), and the difference between the MOL and the biased tape noise is reported in the fifth column as the A-weighted signal-to-noise level.

To check the high-frequency capacity of the tape, I used a 10-kHz tone, adjusting the signal-input level to obtain maximum possible output. This is shown in the fourth column of the Table, with reference to the 400-Hz Dolby level of 200 nWb/m. As can be seen, no tape could produce that much output at 10

kHz, so the numbers are all negative. The closer the negative number is to zero, the more 10-kHz storage capacity the tape has, given the bias/machine conditions imposed. A lower bias level would raise the maximum 10-kHz output capacity of all the tapes, but it would also lower the 400-Hz MOL (column 3) and raise distortion at 200 nWb/m (column 2). It would also influence the high-frequency response of all of the tapes. On the other hand, a higher bias level would depress the 10-kHz MOL still further, though it might slightly increase the 400-Hz MOL.

As a final test, each of the tapes was measured for frequency response across the 20-to-20,000-Hz range, both at a 0-dB record level (200 nWb/m) and at the conventional -20-dB level normally used for checking frequency response. These results are presented graphically. Where a tape shows a rising high-frequency response at -20 dB, it is probable that it is slightly under-biased; where there is a treble fall-off at this level, it is almost certainly overbiased, since all of the tapes in this survey are capable of flat response throughout the audio range. The degree of high-frequency roll-off at the 0-dB level is an index of short-wavelength storage capacity.

Conclusions. The differences between tape types and among brands are slight enough to be virtually inaudible. Usually, a 3-dB difference between sounds of like frequency is necessary before a listener can determine which sound is less distorted or "noisy." Looking at each column of the Table, it is clear that the performance of any single tape falls within 3 dB of almost all the others. (The percent of Dolby-level distortion in the second column also reflects differences which would be inaudible to even the listener with above-average sensitivity.) Still, differences can be measured, if not always heard.

As a group, the metal tapes provide a very slight advantage over the CrO₂ types and a more significant advantage over the ferric oxides in terms of signal-to-noise ratio. In terms of 10-kHz storage capacity, metal tapes, overall, are better than ferrics and chromes—hardly surprising since this is metal tape's claim to fame. Keep in mind, though, that the metal tapes cost about 70% more than the other two types. (Ferrics and chromes cost about the same.)

Which should you buy? That's a tough question. If you don't have a high-end cassette deck, it probably doesn't make any difference. If you do, you can check the figures in the Table given here and make a determination based on numbers alone. Or you can trust your ears. Good luck! \diamond

TAPE TEST RESULTS

Tape Type I	400-Hz Sens.(dB)	Dolby-level Distortion (%)	400-Hz MOL (dB)	10 kHz MOL (dB)	S/N A-wtd (dB)
Maxell UD-XLI	0.0	0.38	+6.5	-5.2	58.0
BASF Professional I	-1.0	0.44	+5.5	-5.8	56.8
Fuji FX-I*	-1.3	0.31	+4.8	-6.2	58.5
Loran Normal Bias	0.0	0.34	+7.0	-6.0	59.5
Maxell XL-IS	0.0	0.45	+7.0	-3.0	58.2
Memorex MRX-I	-0.8	0.38	+6.2	-5.5	59.8
PD Tri-Oxide Ferro*	0.0	0.27	+7.0	-6.2	58.5
Scotch Master I	0.0	0.38	+7.2	-4.8	58.2
Sony HFX	-0.8	0.51	+4.8	-5.8	56.1
TDK AD	-1.0	0.50	+4.8	-2.8	58.9

Type II	400-Hz Sens.(dB)	Dolby-level Distortion (%)	400-Hz MOL (dB)	10 kHz MOL (dB)	S/N A-wtd (dB)
TDK SA	0.0	0.64	+5.0	-5.5	59.1
BASF Professional II	-1.4	1.05	+4.1	-6.5	61.2
Fuji FX-II*	0.0	0.86	+4.8	-5.0	60.1
Loran Chrome	-0.3	1.20	+4.1	-6.3	60.9
Maxell XL-IIS	-0.4	0.97	+4.2	-4.5	58.8
Memorex HBII	-0.2	0.80	+4.8	-4.8	59.5
PD 500 Crolyn*	-1.2	1.00	+4.5	-9.8	61.1
Scotch Master II	+0.8	0.49	+6.5	-5.5	60.4
Sony EHF	+0.6	0.77	+5.2	-7.0	59.7
Sony Dev. High-Bias**	+1.3	0.40	+7.0	-4.8	61.1
TDK SA-X	+1.6	0.30	+5.2	-3.0	59.6

Type IV	400-Hz Sens.(dB)	Dolby-level Distortion (%)	400-Hz MOL (dB)	10 kHz MOL (dB)	S/N A-wtd (dB)
TDK MA	0.0	0.54	+6.5	-3.8	59.8
Fuji Metal*	-0.4	0.60	+6.1	-3.5	59.5
JVC ME-P	-1.0	0.54	+6.2	-6.2	60.0
Maxell MX	-0.4	0.58	+6.2	-5.0	60.2
Memorex Metal IV	+0.3	0.31	+7.9	-2.8	61.4
PD1100 Metal*	-0.8	0.94	+5.5	-2.8	59.5
Scotch Metafine***	+0.5	0.48	+6.8	-5.2	62.3
Sony Metallic	0.0	0.54	+6.5	-4.5	60.8

*Single sample only supplied
 **New product, to be released soon
 ***No samples supplied; tapes purchased 4/81 commercially

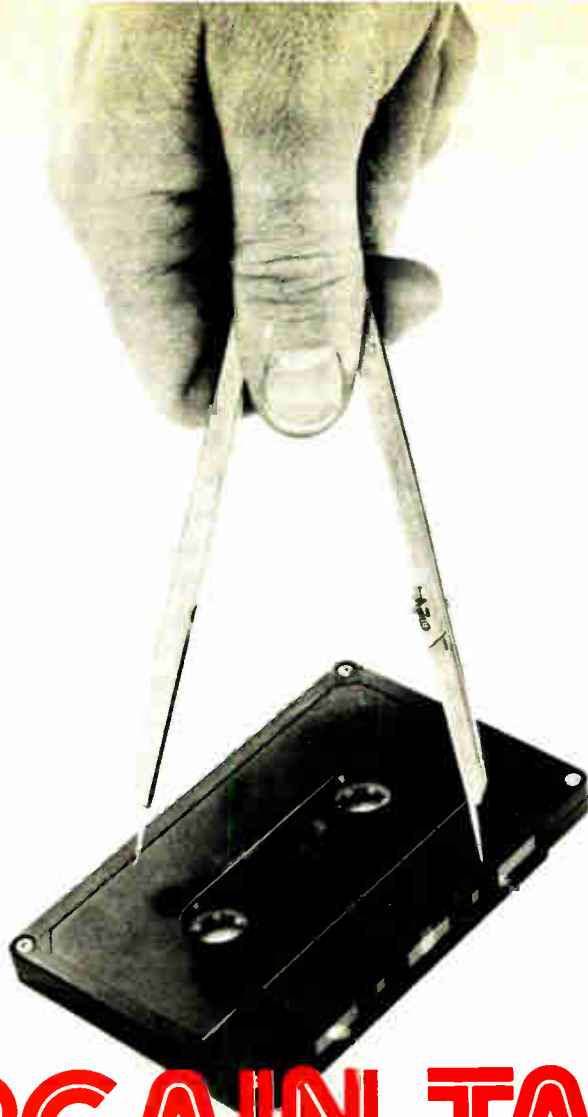

BARGAIN TAPES

Tape expert Craig Stark puts them to the test and finds they are gratifying performers— if they come from a name-brand manufacturer

I DON'T know anyone who doesn't like a bargain, and that probably explains why tape manufacturers make second- and even third-line cassettes designed to sell for significantly less than their premium-price formulations. Are these less expensive cassettes really "almost as good," as salespeople readily assure prospective buyers, or are they fit only for such undemanding applications as speech recording and the like?

To shed a little light on this question I tested a number of samples of modestly priced cassettes using the very same procedures I would use for top-of-the-line products. The tests are standard, and no attempt was made to examine a large number of samples of any one cassette or even to cover more than a rea-

sonable number of the available products. I used a single very high-quality tape deck, Nakamichi LX-5, whose head characteristics and bias/equalization adjustments would probably bring out the best performance of which a given cassette is capable.

In addition to the less expensive lines of reputable tape manufacturers, there are two other kinds of tape "bargains." The first is off-brand products, which are sometimes available at discount stores for less than a dollar each. Years ago, when open-reel was the dominant format, we called such wares "white box" tape. The "Nippon" and "Tempest" tapes whose responses are reported in the graphs and the accompanying table are examples of this sort of thing in the cassette genre, and the

performance speaks for itself.

The second kind of bargain tape is more sinister: out-and-out counterfeits of reputable products from such manufacturers as Maxell, Sony, and TDK. TDK was kind enough to supply unopened samples of some lookalike counterfeits of their products that would certainly pass for genuine visually. In performance, however, they were among the worst I have ever measured. How can a buyer tell they're counterfeit without testing? In this case by looking for the words "TDK FULL LIFE TIME WARRANTY" visible through the cellophane wrapper on the back of the genuine article.

Happily, there are some *genuine* bargains to be had if your recording job doesn't require the very highest level of

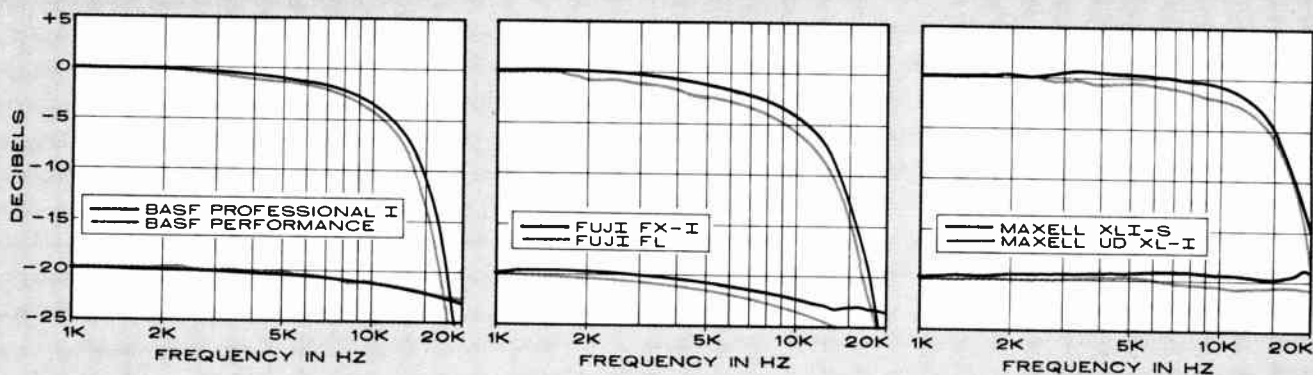

performance. Most brand-to-brand performance variations among premium formulations have narrowed in recent years, and frequently what manufacturers once sold as top-of-the-line products now continue as their second or third line. Conversely, formulations that were originally intended to be "economy" tapes have frequently been upgraded. For the purposes of this limited survey I picked a group of C-90 ferric-oxide cassettes, all of which have list prices under \$5 and most of which actually sell for much less.

How the Tapes Were Tested

The Nakamichi LX-5 recorder used for these tests was checked for playback response (31.5 Hz to 18 kHz) with a new IEC-standard BASF calibrated test tape, and its output was adjusted to produce a 0-dB (0.775-volt) level when playing back a Teac MTT-150A Dolby-level (200 nanowebers/meter) test tape. Record bias and equalization were optimized for Nakamichi EX-II tape, which is similar in its requirements to the premium-price TDK and Maxell formulations. Each cassette was then fed with a fixed-level 315-Hz test

tone that produced a 0-dB record-playback output with the Nakamichi EX-II tape; variations in the other cassettes' sensitivity are noted in the accompanying table. Variations in sensitivity of more than ± 2 dB are important principally because they may affect frequency response when a noise-reduction system is used.

The input level of the 315-Hz signal was then raised or lowered, as appropriate, to produce a 0-dB output (Dolby-level) from each cassette, and frequency-response measurements were made across the entire 20- to 20,000-Hz audio spectrum both at the 0-dB level (where there is invariably some high-frequency loss with cassettes) and at the -20-dB level (where frequency response should ideally be flat). These curves (from 1,000 Hz up) are shown in the graphs with (where possible) a company's higher-price product displayed with its lower-cost formulations.

No less important than frequency response is the signal-to-noise ratio of a tape. This was measured by increasing the 315-Hz input level until the third-harmonic distortion in the output reached 3 per cent (the "signal"), short-circuiting the output of the audio

generator while continuing to record, and then measuring the recorded "noise" through a standard IEC A-weighting filter (which closely approximates the sensitivity of the ear to tape hiss). This was done without using a noise-reduction system.

While almost every tape has some safety margin ("+" reading in the table) between a Dolby-level output at 315 Hz and the onset of severe distortion (the 3 per cent point), no cassettes can handle this level at the highest audio frequencies. The final test, therefore, was of the maximum output level each cassette could produce (with this machine and its factory-adjusted bias/equalization setting) at 10 kHz. While all the numbers in this column of the table are negative, the closer the figure is to 0 dB the better.

What do the numbers in the table and the traces in the graphs really show? Besides sounding a clear warning to avoid unbranded (and counterfeit) products, they demonstrate that most companies' second-line tapes compare extremely well with their premium product, usually suffering only a slight loss in signal-to-noise ratio and in high-frequency overload capability. Further,

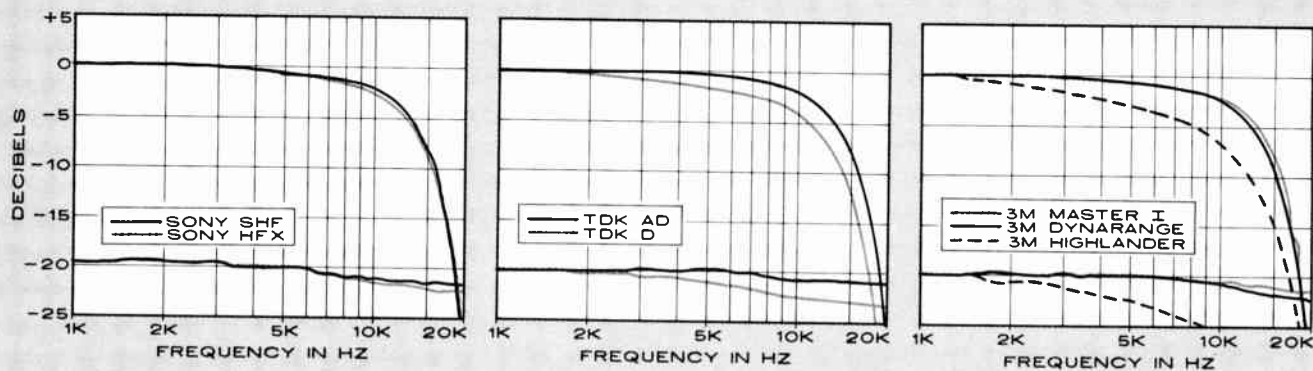



Stereo Review Sweepstakes

OFFICIAL ENTRY FORM

Get *Stereo Review* at HALF PRICE, too!

YES!

Enter my name in the Stereo Review Sweepstakes and start my subscription to *Stereo Review* for the term checked:

- One year for \$4.99—HALF PRICE!
 Two years for \$9.98—HALF PRICE!
 Three years for \$14.97—HALF PRICE!

Savings based on full one-year subscription price of \$9.98.

CHECK ONE: Payment enclosed. Bill me.

NO

I do not wish to subscribe now, but tell me if I've won the Stereo Review Sweepstakes.

Mr./Mrs./Ms. _____ (please print full name) _____ 8H260

Address _____ Apt. _____

City _____ State _____ Zip _____

Offer valid in the U.S., its territories and possessions. Please allow 30 to 60 days for delivery of first issue if you subscribe.

NO PURCHASE NECESSARY—ENTER TODAY!



NO POSTAGE
NECESSARY
IF MAILED
IN THE
UNITED STATES

BUSINESS REPLY MAIL

FIRST CLASS PERMIT NO. 66, BOULDER, COLORADO

POSTAGE WILL BE PAID BY ADDRESSEE

Stereo Review Sweepstakes

P.O. Box 2760

Boulder, Colorado 80321

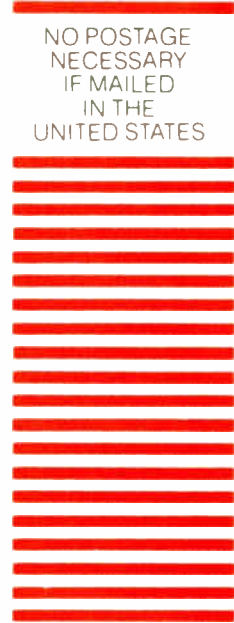

STEREO REVIEW

\$3000 Akai SWEEPSTAKE

Save 50% on *Stereo Review*, too!



The Stereo Review Sweepstakes is open to all our readers. No purchase is necessary—and you'll receive a top-of-the-line Akai recording group worth over \$3000 if you're the lucky winner!

Here's how the Sweepstakes works

Just mail the attached card on the coupon below after filling in your name and address. Be sure to indicate whether you're also subscribing to *Stereo Review* at the special HALF PRICE rates shown.

Then, if you win, we'll send you a magnificent Akai Super Recording Group. Its three components are, first,

the VS-7 Video Stereo Cassette Recorder (\$1495), featuring four heads... wireless remote... stereo sound... 105 channel cable-ready... 14 day/8 event programmability... built-in camera adaptor;

Next comes the GX-77 Open Reel Tape Deck (\$795), for use with either conventional or EE chrome-type tapes; EE capability means that performance previously attainable only at 7½ ips can be achieved at 3¾ ips.

And finally, the microcomputer-controlled GX-F91 Cassette Deck (\$750), a three-head, two-motor full logic system with quartz lock direct drive, double-capstan closed loop and tape transport. In all, a superb Akai

grouping worth a full \$3040!

You're sure to win with *Stereo Review*!

Whether or not you're our Sweepstakes winner, your stereo listening and buying will come out ahead when you subscribe to *Stereo Review*. It's the finest magazine in its field—filled with recommendations on the best buys in audio equipment, and expert commentary on the latest recordings on disc and tape.

Why not enjoy a year or more of *Stereo Review* at our low introductory prices? You'll save 50% if you subscribe at the same time you enter our Sweepstakes!

OFFICIAL RULES

No Purchase Necessary

1. On an official entry form or a 3" x 5" piece of paper, hand-print your name, address and zip code. Enter as often as you wish, but mail each entry separately to Stereo Review Sweepstakes, P.O. Box 2760, Boulder, Colorado 80322. Entries must be received no later than November 30, 1982, and the drawing will be held by December 28, 1982. All entries become the property of Stereo Review, which reserves the right to reprint the name and address of the winner.
2. Winner will be selected in a random drawing from among all entries received under the supervision of the publishers of Stereo Review, whose decision is final. Only one prize will be awarded in this Sweepstakes. Winner will be notified by mail and may be required to execute affidavit of eligibility and release. Odds of winning will depend on the number of entries received. Ziff-Davis will arrange delivery of prize. Taxes are the responsibility of the winner. Any manufacturer's claims and warranties will apply, but Ziff-Davis makes no claims or warranties with regard to any prizes. Prize is not transferable. No substitutions or exchanges for prizes.
3. Sweepstakes open to all residents of the U.S., its territories and possessions, except employees of Ziff-Davis Publishing Company, its affiliates, and its advertising and promotion agencies. Void wherever prohibited or restricted by law.
4. For the winner's name, send a stamped self-addressed envelope to Stereo Review Sweepstakes, Circulation Department, Ziff-Davis Publishing Company, One Park Avenue, New York, N.Y. 10016.

OFFICIAL ENTRY FORM

Mail to: Stereo Review Sweepstakes
P.O. Box 2760, Boulder, Colorado 80322

YES! Enter my name in the Stereo Review Sweepstakes and start my subscription to *Stereo Review* for the term checked:

- One year for \$4.99—HALF PRICE!
- Two years for \$9.98—HALF PRICE!
- Three years for \$14.97—HALF PRICE!

Savings based on full one-year subscription price of \$9.98.

NO I don't wish to subscribe now, but tell me if I've won the Stereo Review Sweepstakes.

Mr./Mrs./Ms. _____ (please print full name)

Address _____ Apt. _____

City _____ State _____ Zip _____

Offer valid only in the U.S., its territories and possessions. Please allow 30 to 60 days for delivery of first issue if you subscribe.



CHECK ONE:
 Payment enclosed.
 Bill me later.

8H260

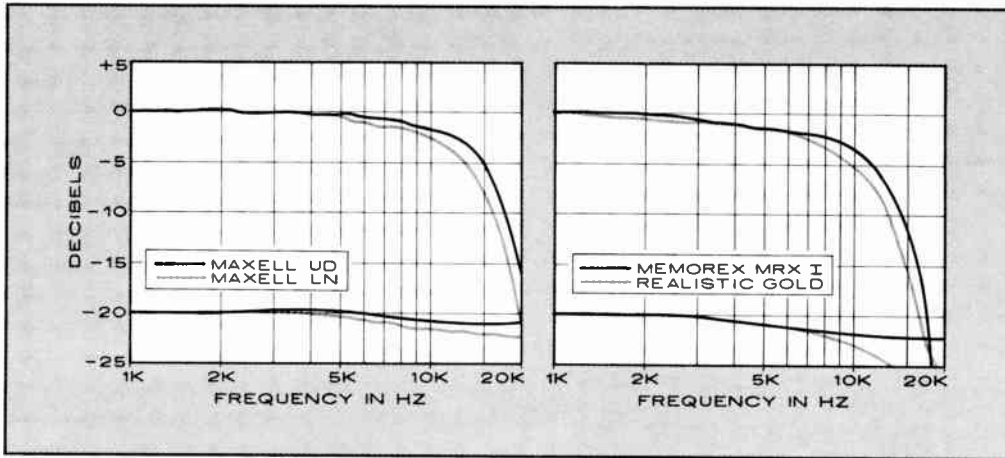

the results tend to illustrate how hard won are the advances in tape technology. In fact, the state of the art is now so far advanced that improvements of more than a decibel or so are accounted "revolutionary" even if their audible effect is minimal at best. In tapes at the very bottom of a company's line, however, the compromises are necessarily greater, sufficiently so in my estimation to suggest that music recorded on them will usually be audibly affected.

In the end, of course, "you pay your money and you take your choice." I find that the sensible solution is to use the premium formulations for very critical music recordings for your home system and the second- and third-line tapes for everything else. If you wonder whether a less-than-premium tape will achieve the level of performance you want on your particular machine, the best advice I can give you is to try it and see. In any case, this brief study demonstrates that there's nothing wrong with an economy product *if it comes from a name-brand manufacturer*. But stay away from the unknowns; there's good reason for their anonymity. □

Brand and Type	315-Hz sensitivity	3 per cent third-harmonic distortion	A-weighted S/N	10-kHz saturation
BASF Professional I	0.0	+4.7	56.8	-4.7
BASF Performance	-0.2	+4.6	56.7	-5.3
Fuji FX-I	-0.6	+4.0	58.3	-5.8
Fuji FL	-1.2	+1.6	53.6	-9.2
Maxell XLI-S	+0.5	+5.7	57.5	-2.1
Maxell UD XL-I	+0.3	+5.1	56.8	-4.5
Maxell UD	-0.6	+3.5	55.1	-4.3
Maxell LN	-2.6	-0.2	52.6	-7.2
Memorex MRX I	-0.3	+4.4	57.3	-5.0
Realistic Supertape Gold	-0.5	+4.1	57.0	-8.0
Sony SHF	+0.35	+5.0	57.0	-4.3
Sony HFX	-0.6	+3.8	55.9	-5.8
TDK AD	-0.8	+3.3	58.2	-3.7
TDK D	-1.0	+3.4	56.1	-5.0
3M Master I	+0.6	+6.0	57.7	-3.9
3M Dynarange	-0.25	+4.6	56.8	-4.8
3M Highlander	-1.0	+1.6	56.1	-10.4
"Nippon" (C-60)	-4.8	-4.7	49.0	-10.3
"Tempest"	-5.0	-5.0	47.8	-26.0
Counterfeit TDK AD	-0.7	+2.5	56.1	-27.0

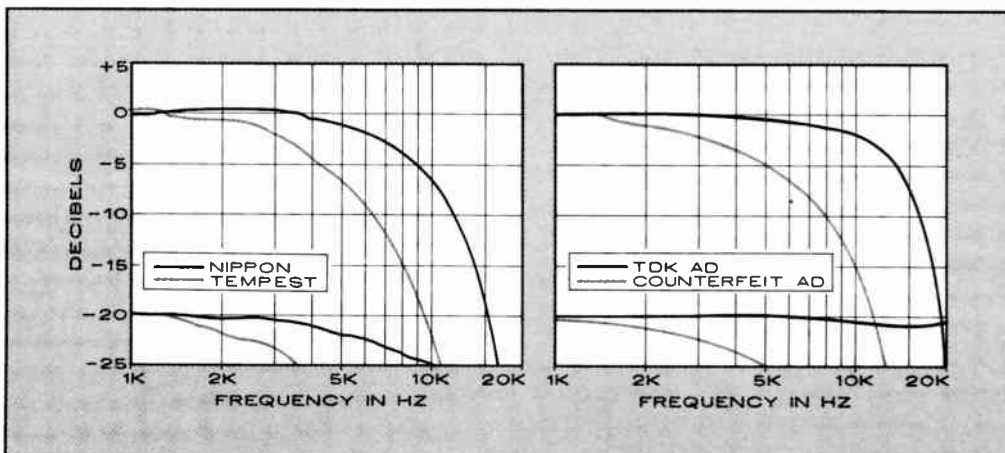

TAPE FUTURES

Ralph Hodges takes a look at some evolutionary and revolutionary advances in tape technology



If they ever stop to think about it at all, tape buffs probably do not sufficiently appreciate the fact that the rapid progress in tape-machine performance over the past couple of decades has been matched, innovation for innovation, by advances in tape manufacturing and formulation. New developments in audio tape have particularly benefited of late from useful discoveries made in the fields of video and computer tape, with the result that we are once again looking at a "new generation" of high-performance audio tapes that will begin to reach the market within the next few months.

The first of this new wave of tapes to appear will lay emphasis on recording objectives that have not previously been paramount in tape designs. The second wave should bring some new magnetic materials, some older ones in new forms, and the advent of multi-application tapes. At least one manufacturer plans to introduce a cassette that will handle analog and digital (PCM) audio with equal aplomb. Another expects to produce a tape that will accommodate analog, digital—and *video* to boot! The common sense of this is quite plain when you realize that all video tapes will likely have two tracks of audio, and sooner or later these will be very high-quality tracks indeed.

Wrenching secrets from tape manufacturers is only a little less difficult than, say, discovering the full nuclear potential of the Soviet Union. The industry is notoriously competitive, and if some advance information should accidentally happen to leak out the door on Friday, it could mean mass executions by Monday. Still, by reading between the lines of press releases and paying as much attention to what manufacturers *won't* talk about as to what they will, it's possible to get some idea of what the future holds.

A tape can be divided into three parts: backing (or base), binder, and magnetic material. (There is also an optional fourth part, a back-coating, that some manufacturers favor, some don't, and some change their minds about from time to time.) All three parts are critical, and all three are candidates for improvement.

Backings

The backing, a clear base film of tensilized polyester, would probably be the least problematic of the three if so many manufacturers didn't have to get it from outside suppliers. Surface irregularities in the backing material cause coating-thickness variations in the finished tape, and such thickness variations are a principal mechanism in the

production of modulation noise, no matter how well controlled the *total* thickness of the backing-plus-coating may be. One manufacturer reports that he was unable to convince his supplier of this problem until he embarked on the production of a very tricky video formulation and the final tape didn't work. Clearly, backings will have to advance to a higher standard of uniformity for the proposed new tapes, but it's unlikely that you will hear much about the heroic efforts that will be required to accomplish this.

On the other hand, there are excellent reasons why a backing should *not* be perfectly smooth and uniform. A texturized backing gives the capstan and pinch-roller a better grip on the tape and combats what is generally referred to as "slippage." According to one company's view, a good backing is not so smooth as to be slippery and not so rough as to prevent a good recording. Back-coatings, which are sometimes applied to the nonmagnetic side of the tape in the final production stages, can provide texturizing without interfering with the properties of the backing itself, and at the same time they create a scratch-resistant surface to prevent polyester debris from fouling the recording system.

Binders

Binders are simply glues, mixed with solvents and other additives. Ideally they should start out by holding the magnetic particles in a perfectly dispersed suspension during the coating process and end up by bonding the particles to the backing in a very permanent way. On the way from liquid to semi-solid to fully cured solid, a binder *system* should be fluid enough to permit free rotation of the magnetic particles as they are oriented in the intended recording direction, then malleable enough to respond well to the calendaring and polishing processes, then soft enough to permit slitting of the tape into its final widths without crumbling at the edges, and, finally, hard enough to resist scratching and flaking when the tape is used. Binder systems are constantly being tested and changed. Some manufacturers stick faithfully to binder systems whose changes of state are timed to the production cycle. Others are willing to interrupt the production process in midstream to let the tape sit and "cure" its way into the next desired state.

Quizzing a tape manufacturer on what's new in binder systems is something like asking a medieval alchemist to describe his technique for transmuting lead into gold: the best you can ex-

pect is to receive no *misinformation*. Chemical analysis of the final tape doesn't help very much because so much of the binder brew goes up in volatile fumes during tape production (it will also go up in flames if the maker is not exceedingly careful). Still, together with the crystal-formation techniques for making the magnetic particles, the chemistry and technology of binder systems have been keys to the fine tapes of today and will be the starting point for the superior tapes of tomorrow.

Magnetic Materials

The crystalline forms that magnetic tape particles assume are not found in nature but are synthesized through the control of temperature, pressure, pH values, catalysts, and the timing of the crystal-growth cycle. From the first, the goals for magnetic particles in recording tape have been the same: a "clean," needle-like shape free of pits or branches ("dendrites"), appropriate size, and uniformity from particle to particle. In recent years, particle size has been getting smaller and smaller, and the premium tapes appearing now are typically endowed with "needles" one-quarter the size of their predecessors. Coercivity, which affects high-frequency performance at slow recording speeds, is enhanced by small particle size, but the general feeling in the industry is that with metal tape we have achieved as much coercivity as we need. The new emphasis is on what smallness, uniformity, and cleanliness can do to improve the packing density of magnetic material in the tape coating, which will lead to increased remanence and better performance at the longer wavelengths (lower frequencies).

The chemical composition of the various tape particles we'll be offered should lead to some interesting competitive skirmishes. Maxell and TDK want to pursue, respectively, their Epitaxial and Super Avilyn materials, both of which are ferric oxides sufficiently refined (by cobalt-adsorption processes) to accomplish "almost anything," in the words of a TDK spokesman. Fuji seems bent on pursuing the technology of pure metal. BASF remains committed to chromium dioxide for its premium products and believes that it has superior characteristics for digital (PCM) recording as well as video. And Sony recently introduced an IEC Type II ("high bias") cassette employing a very small iron-oxide particle with a coating scheme said to afford exceptional remanence and squareness ratio. The company is carefully keeping up its involvement with many other materials, however, even to the point of using them in

dual-coated products such as ferri-chrome. Most major manufacturers promise flexibility and further research in new materials, and mixtures of materials seem a likely possibility in the near future. As for vapor-deposited pure-metal coatings (pioneered in Matsushita's Angrom microcassette), there are some doubts as to the technique's capabilities for longer-wavelength recording as well as some hopes for its potentially superior remanence, especially if appropriate metallic alloys are used.

Cassettes of the Future

A not-unexpected finding that the metal-tape market is somewhat limited by high product cost has persuaded a number of manufacturers to move in the direction of improving more conventional tape coatings; TDK, for example, now feels it can, for all practical purposes, match the performance of metal using variants of Super Avilyn. In its available forms, metal has shown greatest strength in the area of coercivity, and TDK has countered with SA-X, a dual-layer cassette tape that has a thin, high-coercivity layer on top and a thicker, high-remanence layer below—both composed of Super Avilyn material. In the future, the company will be working closely with hardware manufacturers to produce a cassette that is adaptable to PCM recording (digital tapes are expected to be more critical in terms of tape guidance than in magnetic properties). Dupont is working on a two-layer chrome tape.

Maxell has introduced its XL-S line of cassettes to represent refinements in particle-growth and coating techniques. Their processes for both are said to be unique and highly effective in improving packing density and tape-to-head contact. The most interesting development at Maxell, however, is a new type of tape with particles oriented along the tape path but with some pitched into and out of the tape at about a 45-degree angle as well as some parallel to the surface. This enables the tape to take advantage of the fact that flux lines from the recording heads pass through the tape surface in an arc; since more particles will be aligned with the flux, the tape will be capable of greater energy storage. (The particles are reported to be very short, by the way—about 0.1 micrometer.)

In general, the industry is moving toward what it terms a "balanced" cassette tape, adequate in high-frequency performance to match the capabilities of current cassette recorders and augmented at lower frequencies to deal with the noise and dynamic-range limitations of previous machines. Most

manufacturers plan to increase the performance of their cassette tapes so that this year's medium-quality tapes will be just about equal to last year's premium tapes, and the premium tapes will be one step better than before. These improvements will be achieved through developments that are described as incremental rather than revolutionary. More and more, the key ingredients of non-premium cassettes come from outside suppliers who have pulled their standards up to acceptable levels.

The Future of Open Reel

It is the intention of four companies—Maxell and TDK on the tape end, Akai and Teac on the hardware end—to establish a new standard for consumer open-reel recording. BASF is also expected to cooperate in this venture. According to joint statements by these companies, the new EE (“Extra Efficiency”) standard is destined to “take over” the home open-reel tape market.

The impetus behind the EE innovation is a desire to apply technology gained in cassette development to the open-reel format. The motivation comes from market studies, one of which found that production of open-reel tape decks in Japan exceeds 200,000 a year and is holding steady. This is a market large enough to be attractive, yet small enough to be manipulated. The EE innovation is expected to encourage market growth to some degree, but, more important, it might compel open-reel devotees to abandon their current equipment for new and improved models.

New open-reel models are needed to handle the EE tapes, which resemble the high-coercivity, high-remnance cassette formulations more closely than anything that has been seen in open-reel heretofore. They require higher bias and, concurrently, some changes in equalization if they are to perform at their best. That best should yield improvements comparable to what cassettes have demonstrated in recent years: lower noise, higher output levels and sensitivities at all frequencies, and greater consistency of performance. Again, these gains are evolutionary. The benefit most emphasized by the four companies is the potential improvement at lower tape speeds, one that promises the equivalent of the performance offered now by the next speed up. The first EE-optimized decks are now arriving in the U.S., so we'll soon know exactly how good it is.

Other Developments

Dual-layer products are going to con-

tinue to be available in the tape repertoire, even though one manufacturer preceded his comments on them with a few unprintable adjectives. The real problem, as he has experienced it, has to do with the transition point between the coating layers. Making the two layers similar in magnetic properties smooths the transition, but it throws away the advantages of going to two layers in the first place. Making the layers dissimilar (the outer layer strongly favoring highs, the inner one favoring lows) exploits the technology to its fullest but it runs risks in the mid-range that can upset noise-reduction tracking and inter-machine compatibility even if the average listener does not notice obvious impairment of frequency response.

Vapor-deposition metal tape, although attractive as an idea, is not universally attractive in practice. Some companies are pursuing it avidly; others are going to wait and see. The majority view is that vapor deposition is going to be of great benefit for the very short wavelengths employed in data processing and video, even though the resultant coating appears, at the moment, to be too fragile.

The word from Japan is that micro-cassettes are going to sweep the market

for automotive and portable uses. Certainly they will have an impact, reinforced by new recording techniques and new noise-reduction systems such as B&O's HX Professional. And the next generation of microcassettes (as well as the players they will be employed in) promises to be superb.

ALL of which leaves me in something of a quandary about the final justification for multi-application tape formats. They will provide convenience to the consumer (any tape on hand can do the job he needs done) and a certain amount of the same to the manufacturer (any tape he produces can be sold for any application), but will they be the best possible for each *individual* application? Analog audio, requiring excellent performance at both short and long wavelengths, calls for some fairly sophisticated tape design. Whether it will still show up at its best in multi-application tapes remains a question. Perhaps the answer lies in a house joke popular at 3M: one day packing density will have become so great that the tape will be able to record and play without having to move at all! That will surely spell the end of magnetic recording as we know it, inspiring tape manufacturers to move on to the next thing. □

"Digital recording quality? On my own system? In my lifetime?"

Is this too much to hope for?

That one piece of equipment, the dbx Model 224, can deliver recording quality in the home that's the equal of digital recording in the studio.

With more than twice the noise reduction of Dolby C* type systems.

With full dynamic range, preserved.

And that this self-same dbx Model 224 can also play dbx Discs—recognized to be the finest audiophile discs in the world.

You'll know it when you hear it. At any hi-fi store that sells dbx equipment. Ask for it by name.



Dolby C is a registered trademark of Dolby Laboratories Licensing Corporation.

dbx. Music can't live without us.

dbx, Inc., 71 Chapel St., Box 100C, Newton, Mass. 02195 U.S.A. Tel. (617) 964-3210, In Canada: BSR (Canada) Ltd.
CIRCLE NO. 18 ON READER SERVICE CARD

Microtape and Music

By Ivan Berger

FOR MONTHS, now, I've been walking around with a complete stereo system in my pocket: Sony's M-1000 portable stereo microcassette recorder. I haven't been using it for music, though—just speech.

A stereo recorder makes a great dictating machine. That's chiefly due to a side benefit of stereo: directional microphones. And directional microphones can make a major difference in sound clarity when you're recording in noisy surroundings.

There are times when I do take direct advantage of the M-1000's stereo capability, even in recording speech. When I'm taping meetings or conversation under very noisy conditions, it's much easier to tell who's saying what if I listen in stereo through headphones. (Sony supplies a pair with the M-1000.) Even though I didn't buy the M-1000 as a music machine, Sony seems to have that possibility in mind. Besides its headphone and a case, the M-1000 kit includes a patch cord for taping music from a stereo system. The cord has phono plugs at one end, a 3.5-mm stereo miniphone plug at the other (to fit the recorder's MIC input), and an attenuating resistance somewhere in between, so the line-level signal from the stereo system won't overload the mike-level input.

I never put much credence in that cord. I've used the same arrangement with standard-cassette portables, and I've never been entranced by the results. But that's not the only way to tape music onto microcassettes these days. You can tape live or off the air with an FM/AM/micro portable. (Aiwa, Fisher, Panasonic and Sanyo make mono or stereo FM/AM/Microcassette ones.) And you can tape from a stereo system with Fisher's CR-M500 deck. The latter is as state-of-the-art as it could be, considering it was first shown over a year ago. It has Dolby HX and the ability to record on metal tape.

Fisher's deck gave me an idea. If I could make good tapes on it to play back through the Sony, I'd be able to carry my favorite music with me just by slipping a few tiny cassettes and a pair of headphones into my pockets. So I borrowed the Fisher deck to try the idea.

The M500 causes lots of double-takes. It's styled to look like any other cassette deck, so it sometimes takes a moment to realize that it's built on a much smaller scale (2¾" × 8¾" × 9¾"). For all its tiny size, there's not much missing. As

on most full-sized cassette decks, the POWER and TIMER STANDBY switches are on the far left, together with the counter and the headphone jack. Just to the right is the tape compartment and seven feather-touch, solenoid logic control buttons for the tape transport. Further to the right is a 13-LED peak level indicator that covers the range from -20 to +6 dB; below that are the buttons for EJECT, DOLBY ON/OFF, METAL/NORMAL tape select, MIC/LINE select, and the COAXIAL INPUT LEVEL controls.

The only features to strike me offhand as different about the deck were that the MIC inputs were at the rear (which makes the MIC/LINE switch a necessity) and that there was no memory rewind on the counter. Since it's hard to tell from a distance what that tiny tape is doing, I also appreciated the mode indicators next to the recording-level display. They light up green for PLAY, red for REC and PAUSE, and flashing red for REC MUTE (which records blank spots on the tape, for editing or just for silence between tunes).

The deck's performance is like a full-sized tape deck's, too—but a deck from the days before Dolby and CrO₂ tape. Specifically, I compared the CR-M500's recording/playback performance (using TDK "MA" metal microcassette tape and Dolby HX) to the Akai GX-F95's (using a very old Sony normal-bias cassette, and no Dolby), and got nearly the same results—equally low distortion, equally high hiss, equally compressed dynamic range, and almost equal frequency response (the micro had noticeably more high-end response). When I switched to a more modern normal-bias cassette (TDK "D" Dynamic), the Akai gave me less compression and more even frequency response than the micro deck.

If Dolby HX and metal only bring microcassette performance up to the level of normal cassettes without Dolby, then microcassettes don't pose too much of a threat to the manufacturers of regular-cassette tapes and players (especially as the same manufacturers, by and large, make both). That's not the Fisher's fault, but the medium's. When you run tape at half the already-low speed of a standard cassette, getting good sound becomes a major challenge. On the other hand, the cassette probably seemed just as idle a threat to the open-reel market ten years back. I was able to get quite listenable results from the Fisher by switching in my Carver

preamp's Autocorrelator (which got rid of most hiss) and Peak Unlimiter (which got rid of much compression). All it would take to make microcassettes really popular as a mass-music medium, I suspect, would be a hotter grade of tape than today's metal formulations, and a more potent form of noise reduction—Dolby "C", perhaps, or more likely dbx. That would bring microcassette quality to about where most home compact-cassette systems (with Dolby B and non-metal tape) are now.

But who needs it? People who want maximum portability, that's who. So far, the portables are lagging behind the Fisher deck since they lack metal-tape equalization and have no Dolby NR. (Dolby IC's available so far require higher power-supply voltages than microportables provide.) As a result, metal Dolby tapes made on the deck sound over-bright and super-hissy on my little Sony. Non-Dolby tapes made on normal-bias TDK and Olympus tapes with the Fisher deck gave far better results on the M-1000 than the metal HX recordings did, though still too hissy for me. And tapes made on the Sony itself, with its patch cord, fell right in the middle as far as hiss and sound quality were concerned. There was also some apparent loss of dynamic range when recording on the Sony, mainly due to the portable's automatic recording-level control. There was some apparent high-frequency loss, too.

So the only tapes I could enjoy listening to on the Sony portable were those made without Dolby, on standard tape, with the Fisher deck. (I suspect I could have done still better with Panasonic's metal-deposited, normal-bias Angrom tape, but my one Angrom cassette seems to have disappeared.) If it weren't for the hiss problem, I could live happily with this combination as a way of adding music to my travels. And if Dolby isn't available on a suitable low-voltage chip, National Semiconductor's LM1894 DNR noise reducer IC can operate on voltages as low as 4.5 V, about the highest voltage available from a compact battery supply. I expect microcassette portables with DNR will be coming in the next year or two.

Meanwhile, there is some definite news of what's to come in micro music machines. Prerecorded micro tapes are already available in Japan. Cetec Gauss has just announced metal-capable microcassette duplicating equipment here. And Matsushita last year made two micro-music announcements in Japan: first, a tape deck combining both standard and microcassette transports; then a set of three micro components that included a player with FM and AM reception for car dashboards, an underdash player, and a home system with FM, AM and micro recording deck. Fisher is now advertising a portable in Japan that can play and record regular and microcassettes. If microcassettes gain any popularity for musical use here, we'll probably be offered the same products. ◇

A BASIC VOCABULARY OF TAPE RECORDING

By David Ranada

RECORDING tape and the machines that use it have evolved at a rate unmatched by any other component in our audio systems. The resulting expansion of capability, versatility, and features in a profusion of new products (particularly in the cassette area) has created a parallel expansion in the vocabulary used in component advertising, in test reports, and in technical articles.

For the ordinary consumer, this often bewildering thicket of new terms has further complicated the already challenging task of shopping, with the result that he needs buying guidance more than ever. Since knowing the lingo is at least half the battle, we have prepared the definitions in the basic tape-recording vocabulary that follows as much as possible in layman's language.

Alignment—The geometrical relationship between head gap, tape guides, and tape. The most important alignment is azimuth alignment, which requires that the head gap be perfectly perpendicular to the direction of tape travel. Aspects of performance which depend on azimuth alignment include high-frequency response, phase response, and compatibility with tapes recorded on other machines. All heads in a recorder must be aligned, especially the record and play heads in *three-head* machines. Some three-head cassette decks have their record and play heads installed side by side in the same housing, thus reducing the alignment problem.

ANRS—A complementary *noise-reduction system*, developed by JVC, which operates on low-level high-frequency signals as a *Dolby B* circuit does. There is some compatibility between ANRS and *Dolby B*. Super ANRS, in addition to the actions of an ANRS circuit, compresses high-level high-frequency signals during recording and expands them during playback to increase high-frequency *dynamic range* and decrease high-frequency distortion.

Back coated—Some tapes have the back side of the plastic base material (the side opposite the magnetically coated side) covered with a conductive compound. The surface texture of the compound improves the tape's traction through the recorder.

Bias—A large ultrasonic signal of constant frequency and level sent to the record head along with the audio signal. The bias signal is applied to the tape to reduce noise and distortion which would otherwise be generated by the recording process. The correct bias level is crucial to obtain-

ing best performance with a given tape formulation: too high a bias level gives a rolled-off high-frequency response, and too little bias reduces the *signal-to-noise ratio* and increases distortion.

Capstan—The driven spindle or shaft in a recorder which rotates against the tape. In conjunction with the pinch-roller, it pulls the tape through the machine at constant speed. The capstan's rotational speed and diameter determine tape speed. Some advanced professional machines do not use a pinch-roller but instead use only a large-diameter, servo-controlled capstan and reel drive.

Chromium dioxide (chrome, CrO₂, CrOlyn)—A high-coercivity magnetic material, particles of which are used in magnetic tape. The high coercivity of chromium dioxide permits greater high-frequency output at slow tape speeds than that possible with "standard" ferric tapes. Chrome tapes are *not* more abrasive than other types and do *not* wear down heads faster than other tapes.

Closed-loop drive—A *tape-transport system* which drives both incoming and outgoing tape in order to control the portion of the tape contacting the heads and isolate it from the reels or cassette hubs. There are several closed-loop geometries regularly used with open-reel recorders, but *dual-capstan* drive is the most popular for both open-reel and cassette tapes.

Cobalt doped—Tape utilizing a combination of "standard" gamma ferric oxide and cobalt as the magnetically active portion of the coating in order to improve *maximum output level* at low and high frequencies.

Coercivity—The magnetic field, measured in oersteds (Oe), required to reduce the magnetization of a *saturated* material to zero. Coercivity is proportional to the high-frequency capabilities of a tape as well as of the recording, *bias*, and erase levels that it requires.

Compander—A type of *noise-reduction system* that compresses all or part of a signal during recording and expands it in a complementary way during playback. In general, such companders as ANRS, *dbx*, and *Dolby B* must be used during both recording and playback, otherwise the signal may be unlistenable or at least have boosted highs. Anomalies in the record-playback process (involving frequency-response irregularities or level changes) will cause some sort of mistracking between the input and the output halves of the com-

panding process. The effects of this may or may not be audible.

dbx—Refers either to a series of *dynamic-range enhancement devices*, or to a complementary *compander system*, developed by dbx Inc. The *compander system* translates every 2-dB change in the overall input signal level to a 1-dB change fed to the recorder. During playback, the reverse process takes place: every 1-dB change is retranslated to a 2-dB change at the dbx output. The dbx system can provide up to 30-dB of noise reduction over the entire audio band.

Decibel (dB)—A ratio of quantities expressed in logarithmic terms. The number of decibels between voltage A and voltage B is twenty times the logarithm of A divided by B.

DIN (Deutsche Industrie Normenausschuss)—A set of standards and specifications promulgated by German manufacturers and covering such audio-related matters as connectors, frequency weighting, measurement techniques, and specifications. Similar to the ASA (American Standards Association).

Dolby B—A complementary *noise-reduction system* designed to reduce tape (and FM) hiss. A *Dolby B* circuit boosts low-level high-frequency signals during recording and reduces them, along with the tape's added noise, in a complementary fashion during playback. Noise can be reduced up to 10 dB above 5 kHz with the *Dolby B* system. It is now in virtually universal use in cassette decks.

Drop-out—A momentary drop in signal level caused by a loss of the required close tape-to-head contact. Drop-out problems can be minimized by choosing a high-quality tape, cleaning the recorder regularly, and protecting the tape and recorder from mishandling, dust, dirt, and fingerprints.

Dual capstan—A tape-drive system in which the tape is pulled by two capstan/pinch-roller combinations, one on either side of the head assembly. This form of tape drive isolates the movement and tension of the tape over the heads from any motion irregularities at the *feed* or take-up reels.

Dynamic range—In a recording system, the range in decibels (dB) between the maximum undistorted output level and the noise level. Just how distorted the "undistorted output level" is depends on whose spec sheet is being read, and the interpretation of "maximum" output can range from

(Continued on next page.)

maximum operating level to saturation. Dynamic range varies with frequency. The dynamic range of a program is the range through which its volume changes. See *noise, weighting, decibel*.

Equalization (EQ)—The process of selective amplification or attenuation of certain frequencies or frequency bands in a recording system so as to give a flat overall frequency response, minimize noise, or create a special effect. Equalization is performed in tape recorders for the first two reasons. The better cassette recorders provide a choice of equalization in order to obtain the best performance from various tape formulations. Cassette playback equalizations (70-microsecond "chrome" and 120-microsecond "ferric"), along with open-reel playback EQs (NAB, CCIR), have been standardized to assure intermachine compatibility of recordings.

Feed reel—The reel (or cassette hub) from which tape is drawn during recording or playback. Also known as the supply reel.

Ferric—The original tape formulation, available today in many variations, based on magnetic particles of gamma ferric oxide ($\gamma \text{Fe}_2\text{O}_3$). See *cobalt doped*.

Ferrichrome—A tape formulation with a layer of "ferric" particles beneath a thin layer of chromium-dioxide particles. Benefits claimed for this tape include increased low- and high-frequency headroom over standard chromium-dioxide formulations.

Ferrite—A family of nonmetallic, ceramic-like materials usually made from ferric oxide in combination with other oxides. The magnetic properties of ferrites and their exceptional hardness make them suitable for magnetic heads.

Frequency response—An indication of a recorder's ability to reproduce all the audio frequencies supplied to it without altering the original balance among them. A perfect frequency response would extend at least from 20 to 20,000 Hz (the traditional and numerically convenient limits to human hearing) with a ± 0 -dB deviation. The record-playback frequency response of a tape recorder varies with the recording level: as the overall recording level increases, high-frequency response decreases. When comparing record-play specifications, make sure that the recording levels are equal.

Harmonic distortion—Distortion in which spurious harmonics (arithmetic multiples) of the original input frequencies appear at the output. Usually expressed as a percentage of the output signal and abbreviated HD or THD (total harmonic distortion). Harmonic distortion in tape recorders varies with *bias* and overall recording levels.

Head—A generally broken-ring-shaped electromagnet over which the tape is drawn. A head can: (a) erase a previous recording by producing a large, rapidly alternating magnetic field; (b) make a recording by converting an electrical signal to a

varying magnetic field which is picked up and retained by the tape; or (c) play back a recording by sensing the varying magnetic patterns on a tape and converting them to electrical signals. The break in the "ring" of a head is called the gap; the length and width of which help determine the *frequency response* and *noise* of the playback system.

Headroom—The range between a reference recording level and the *maximum output level* available at a specific frequency or band of frequencies. See *noise, weighting, dynamic range, signal-to-noise ratio*.

Flutter—Rapid, periodic variations in tape speed causing rapid changes in pitch and volume. Flutter and wow are sometimes specified in mutually incomparable ways by different manufacturers. Differences in wow and flutter measurement methods (peak versus rms versus average) and frequency weighting should be noted. In its test reports, Hirsch-Houck Labs uses both a weighted-rms method popular in Japan and a *DIN* peak-weighted method.

Hiss—The most noticeable form of tape noise. The human ear is most sensitive to noise in the 2,000- to 8,000-Hz range—which is heard as hiss. In fact, it is this region of frequencies that gives wideband "white" noise (which contains all audible frequencies) its "hissy" quality.

Light-emitting diode (LED)—An electronic device which converts a current directly and instantaneously into light. This property makes the LED suitable for peak-reading or peak-indicating audio displays. At present only red, yellow, and green lights are commercially available.

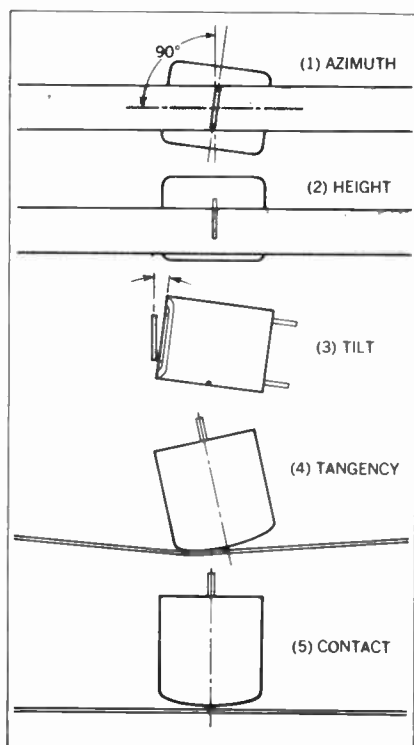

Liquid-crystal display (LCD)—An alphanumeric display that uses liquid crystals which interact with an external source of polarized light. Originally used in watches, they are now found in calculators and various hi-fi readouts. LCDs require very little power, but the earlier types had very slow response and were temperature sensitive.

Logic controlled—A tape transport with its functions switched by digital-logic circuitry activated by front-panel switches or a remote control. Logic control theoretically does not permit an improper or potentially damaging series of commands to be executed by a tape deck, and it is likely to be found only in solenoid-operated machines.

Maximum operating level* or maximum recording level (MRL)—The magnetization level of a tape which results in a specified level of distortion. The MRL varies with applied *bias* level and frequency: as the MRL at 1,000 Hz rises, the MRL at 10,000 Hz falls.

Maximum, output level (MOL)*—The playback level produced by a tape after it has been saturated with a signal (typically 333 Hz). At other frequencies maximum output level is the point at which an increase in the recording level produces a decrease in the playback level (a result of a phenomenon known as self-erasure).

Metal tape—Tape in which the magnetically active portion of the coating is made up of particles of iron as opposed to particles of ferric oxide or chromium dioxide. Metal-particle tape has very high *coercivity* and *retentivity*, leading to improved high-frequency performance. Special circuitry and heads are needed to record on metal tape.

Multiplex (MPX) filter—A filter designed to reduce or remove the 19-kHz stereo pilot tone present in all stereo FM broadcasts. This pilot tone, usually filtered out by tuners and receivers, must be removed when using a *Dolby B* circuit to record a stereo FM broadcast, for the *Dolby* circuit will otherwise mistake the tone for a high-frequency audio signal, leading to improper performance. Most good tuners and receivers have adequate 19-kHz filtering built in. For those that don't, the use of the MPX filter on the cassette deck is necessary for successful taping off the air.

Noise—Unwanted electrical signals of mathematically random nature. There are many types of noise in tape recording, most of which sound like hiss. Noise is added to a tape when it passes through the *bias* and erase fields of the recorder and by the signal itself during the recording process (modulation noise). Tape noise can be minimized by the choice of tape, careful setting of bias and recording levels, regular cleaning and demagnetizing, etc.

*Some authorities use the abbreviation MOL to refer to maximum operating level; others use the same abbreviation to refer to maximum output level.

Noise-reduction system—An electronic circuit that attempts to achieve a reduction of noise level without changes in musical content. There are two basic types of noise-reduction systems: *companders* (complementary record-playback systems) and single-ended (playback only) systems. A compander is used for noise reduction during the record-playback cycle, while a single-ended system is used for removing noise from already recorded material.

Pressure pad—A small, feltlike pad designed to press the tape into intimate contact with a head. Although few modern open-reel machines have them, a pressure pad is built into every tape cassette, where it helps maintain high-frequency response. Pressure pads in open-reel machines should be kept clean and should be replaced when worn.

Print-through—The undesired transfer of recorded signals from one layer of tape to adjacent layers. At worst, print-through will cause distinct pre- and post-echoes. Print-through depends on a tape's thickness and its magnetic properties, on the recording level, and on tape-storage conditions. To minimize print-through, use as thick a tape as possible, be conservative with recording levels, and store the recording in a played, "tails-out" condition under stable temperature and humidity conditions.

Retentivity—The maximum possible magnetization that will remain after *saturation* of a magnetic material. Maximum low-frequency output level is directly proportional to retentivity. Measured in gauss (Gs).

rms (root-mean-square)—A method of mathematically averaging an a.c. signal such as audio. As used in *wow*, *flutter*, *noise*, and amplifier power measurements, rms relates to the energy of the signal. An rms-reading meter will respond to a transient faster than an average-reading meter but slower than a peak-reading meter.

Saturation—Magnetic overload. In effect, a saturated material has been magnetized "as far as it can go," and no increase of magnetizing force will produce an increase in the material's magnetic intensity. In analog audio recording, both heads and tape may saturate when handling high recording levels, with very high distortion resulting.

Scrape flutter—Vibration in a tautly stretched tape caused by the tape's friction against heads, pressure pads, tape guides, and other objects. Scrape flutter has audible characteristics similar to those of modulation *noise*: both impart a harsh quality to the sound. Many recorders have scrape-flutter "filters"; these usually consist of no more than a small roller touching the tape and damping the vibrations.

Sendust—An alloy of iron, aluminum, and silicon. Its great hardness and special magnetic properties make it especially suitable as a material for tape heads.

Servo controlled—A method of regulating *capstan* speed and/or reel tension. As the capstan rotates, it generates a voltage or frequency proportional to its speed. The voltage or frequency is compared with a reference voltage or frequency and the difference is used to shift the motor speed up or down. When the capstan-generated voltage or frequency matches the reference, the difference signal goes to zero and the motor speed is stabilized. The whole comparison-with-a-reference process is called a servo loop.

Signal-to-noise ratio (S/N, SNR)—The ratio, expressed in decibels, between (1) a signal at a specified reference frequency and output level and (2) the output *noise*. The signal-to-noise ratio varies with frequency and is subject to innumerable mutually incompatible methods of measurement. See *noise*, *weighting*, *dynamic range*, *headroom*, *decibel*.

Solenoid—An electromagnet with a movable core. When the coil is energized, the core moves, providing a mechanical action that is used to control a tape *transport*.

Source/tape monitoring—A feature on some tape recorders that permits listening to and switching between the signal being fed to the recorder and the signal just recorded on the tape (as provided by the playback-head amplifiers). Source/tape monitoring is possible only with *three-head* tape machines.

Three head—A recorder with separate erase, record, and play heads, as opposed to a two-head deck in which both the record and play functions are performed by a single record/play head. A properly designed three-head machine can have its record and play heads optimized for their individual duties. (In some cassette decks both heads are in a single housing.) In particular, playback frequency response is improved by the narrower gap possible in a play-only head (a record head requires a wider gap). A three-head recorder also offers the advantage of *source/tape monitoring*. See *head*, *alignment*.

Three-motor transport—A transport similar to a *two-motor transport* but having a separate motor for each reel or hub. This makes for simpler mechanical design and permits better control of tape tension. See *closed-loop*, *dual-capstan*.

Transport—The mechanical portion of a tape recorder responsible for moving the tape across the heads with no variation in speed or alignment. Transport controls such as rewind, play, and fast forward are either mechanical or electronic ("logic controlled," "feather touch"). In general, the savings in cost possible with a mechanically controlled transport are outweighed by the simpler mechanical design and higher reliability of one that is electronically or *solenoid* controlled.

Two-motor transport—A transport in which one motor drives the *capstan(s)* and another drives the *feed* and take-up reels. This arrangement is often used in cassette decks.

VU meter—A meter used to display audio signal levels in decibels relative to a fixed 0-dB reference level. A "true" VU meter, rarely found in consumer audio equipment, has standardized ballistic (mechanical) and electrical characteristics that allow professionals to judge signal levels regardless of the associated equipment. See *decibel*.

Weighting—The assignment of relative importance to certain measurement figures so as to take into account the ears' varying sensitivity with frequency, loudness, and energy distribution. For example, "A-weighting," commonly used in *signal-to-noise* measurements, gives less prominence to low frequencies because of the ears' low sensitivity to low-frequency noise.

Wow—A slow, periodic variation of tape speed resulting in slow changes of playback pitch. Wow can originate in the *transport* or from tape-related causes: uneven tension in the reels or hubs, friction against the reels or cassette shell, and low-quality, poorly manufactured, or damaged tape. Fast wow is called *flutter*. □

Chart shows the dynamic range of a typical cassette recorder without noise reduction. Signal-to-noise ratio is the span between the upper curve and a weighted average of the lower curve at a specified frequency, here 333 Hz.

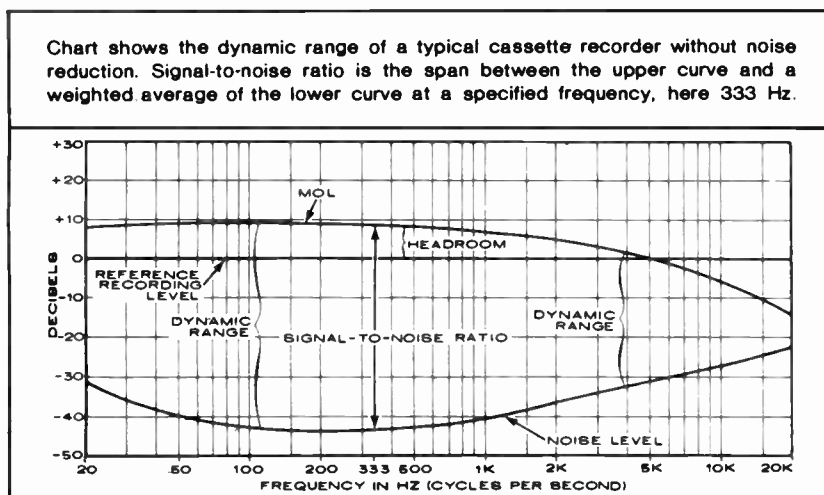

TAPE DECK TEST REPORTS

By Hirsch-Houck Labs

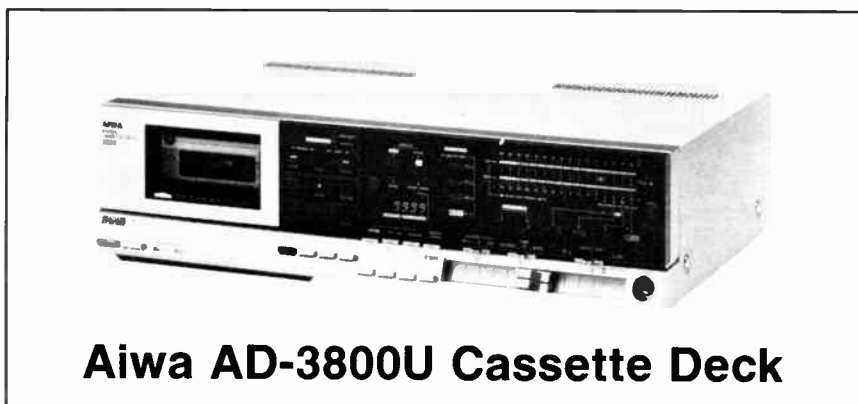

Aiwa AD-3800U Cassette Deck

- **Aiwa AD-3800U Cassette Deck**
- **Size:** 16 $\frac{1}{2}$ x 4 $\frac{3}{4}$ x 10 $\frac{1}{2}$ inches
- **Weight:** 11 $\frac{1}{4}$ pounds
- **Price:** \$595

THE Aiwa AD-3800U is a three-head, dual-capstan deck that incorporates both Dolby-B and Dolby-C noise-reduction systems. Through the use of a microprocessor chip it is also able to make automatic adjustments of record bias, equalization, and sensitivity, thus minimizing performance differences between tape brands. Separate record and playback heads, using laminated sendust and hard permalloy construction, are enclosed in a single housing. The recording head has a 4-micrometer gap to provide full magnetic penetration of the tape, while a 1-micrometer gap is used for the playback section to increase high-frequency resolution. A d.c. servomotor drives the capstans, and a second d.c. motor is used for the cassette hubs.

The transport of the AD-3800U is solenoid operated. Cassettes are inserted, tape openings downward, into slides on the rear of the cassette-well door. A tinted window on the door provides label visibility, rear illumination allows the user to see how much tape is left on a side, and the heads are ac-

cessible for routine cleaning when the door is open. Head demagnetization is accomplished by an automatic circuit that operates when the deck is turned on or when the ADMS button is pressed. The process takes

Aiwa AD-3800U Cassette Deck

- **Comment.** Using the Dolby-C system (or even Dolby-B, for that matter) the Aiwa AD-3800U was able to make impeccable copies of all FM and almost all recorded material. Some slight high-frequency losses could be heard, but only in a direct source/tape recorded comparison of digitally mastered material or interstation FM hiss recorded *above* a -10-dB input level. This is, of course, excellent performance, and the Aiwa AD-3800U can certainly be recommended to anyone searching for a top-performing cassette deck. —Craig Stark

less than 2 seconds, and a LED signals its operation. Record levels are set with a pair of long-throw horizontal slider controls, and a similar (though smaller) slider is used to determine output level. The level indicators are three-color, sixteen-segment peak-reading displays calibrated from -30 to +10 dB. The electronic four-digit counter can be switched to read out minutes and seconds when recording or playing back, but not during fast-winding operations.

Pressing the DATA SYSTEM button initiates the tape-optimization procedure, during which BIAS, CAL, and EQ indicators flash. On completion, after about 16 seconds, a READY indicator comes on and the tape is automatically rewound to its starting point. Pushbuttons with LED indicators are provided for Dolby-B or Dolby-C noise-reduction systems and for tape-type selection. Additional buttons and switches permit muting the recording during commercials, activation by an external timer, and memory rewind and/or play. The rear panel of the AD-3800U contains the usual input/output jacks, a DIN-type connector for a remote-control accessory, and the microphone-input phone jacks. An optional wireless remote control costs \$95.

- **Laboratory Measurements.** The material provided with my sample of the Aiwa AD-3800U indicated that it had been set up for use with TDK MA (metal), TDK SA (CrO₂-equivalent), Sony Duad (ferrichrome), and TDK D (ferric). Because of the ease with which the machine could be adapted to any tape, I tried a variety of additional formulations, including BASF Pro I, 3M Master I, Loran ferric, Sony HFX (Type I), Memorex High Bias, Fuji FX II, Maxell UD-XLII (CrO₂-types), and Sony Metallic, from all of which I obtained essentially equivalent frequency-response curves. My only departure from Aiwa's recommendation was to substitute Maxell XLI-S for the less expensive TDK D in the ferric position, as it gave a better signal-to-noise ratio.

Playback response was measured with the new IEC-standard BASF test tapes, which

cover the range from 31.5 Hz to 18 kHz. The slight bass rise below 100 Hz shown in the graph on page 50 is not a characteristic of the AD-3800U but results from using a full-track test tape on a quarter-track stereo deck. The 3.7- and 4.7-dB 18-kHz roll off is principally the consequence of a small modification in the new IEC standards. Overall record-playback response was extremely uniform among the tape types at the normal -20-dB measurement level. The "knee" in the curves was between 16 and 18 kHz. Predictably, the ferrichrome formulation dropped off in its high-end response with a 0-dB input, but TDK's SA was very close to matching the company's metal-particle tape.

Using a 315-Hz input at the indicated 0-dB record level, I measured only 0.4 per cent third-harmonic distortion with Maxell XLI-S, 0.5 per cent with TDK MA, 1.2 per cent with TDK SA, and 1.8 per cent with Sony FeCr. To reach the 3 per cent distortion reference point required increasing the input signal level by 8.6, 7.4, 3.3, and 3.5 dB, respectively. On an unweighted basis, without noise reduction, the better-than-average signal-to-noise ratios (S/N) of the four tapes measured 56 dB (XLI-S and MA) and 53 dB (SA and FeCr). With CCIR weighting and Dolby-B noise reduction these figures improved to 66.3 dB for the Maxell XLI-S and the metal TDK MA, to 63.7 dB for TDK SA, and to 65 dB for Sony FeCr. Dolby-C reduced the noise still further, producing excellent S/N figures: 74.5 dB (Maxell XLI-S and TDK MA), 74

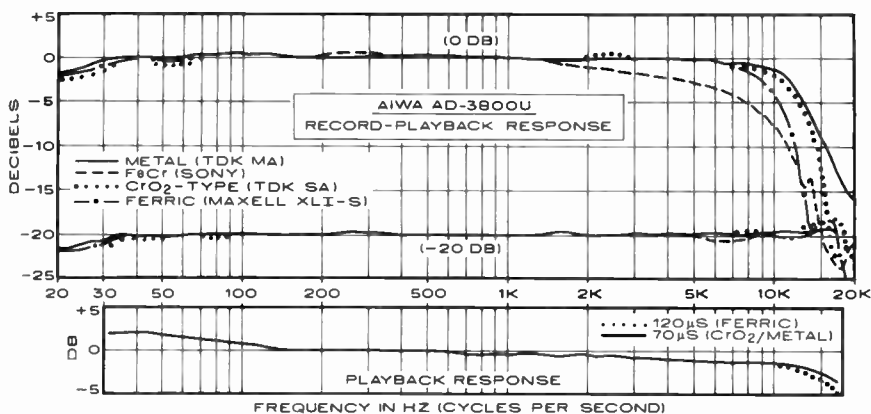

The upper curves indicate overall record-playback response at the manufacturer's indicated 0-dB recording level using the tapes designated on the graph. In the center are the same measurements recorded at -20 dB relative to the upper curves, a level conventionally used for tape-deck frequency-response measurements. Bottom curves show playback response from calibrated test cassettes and indicate the deck's ability to play prerecorded tapes.

dB (Sony FeCr), and 72 dB (TDK SA).

Wow-and-flutter, using a TDK MTT-111 test tape, measured only 0.018 per cent wrms and 0.03 per cent on the DIN peak-weighted basis. The Dolby-level marking was admirably exact, and frequency-response tracking was within ± 1 dB with Dolby-B and ± 2 dB with Dolby-C up to 15 kHz at a -20-dB input level. At a -30-dB level the high-frequency error increased

only slightly to ± 1.5 dB (Dolby-B) and +3 dB (Dolby-C) at 15 kHz.

At 1,000 Hz a signal level of 44 mV (0.044 V) at the line-level inputs and 0.3 mV at the microphone inputs was sufficient to produce a 0-dB indication and 350-mV output level. The microphone inputs accepted up to 640 mV before overloading. Fast-forward and rewind times were just under 80 seconds for a C-60 cassette.



Akai GX-77 Open-Reel Tape Deck

- Akai GX-77 Open-reel Tape Deck
- Size: 17¼ x 9½ x 9 inches
- Weight: 37½ pounds
- Price: \$795

THE Akai GX-77 is an open-reel deck designed to use both conventional and the new EE (Extra Efficiency) chrome-type tapes, and it is the first of these units I have

had an opportunity to test. A two-speed (7½ and 3¾ inches per second), 7-inch-reel machine, the GX-77 is capable of bidirectional recording and playback. The basic advantage of the new EE tapes (currently available from TDK, Maxell, and BASF) is that, when used with recorders designed for them, performance previously attainable only at 7½ ips can be achieved at 3¾ ips.

The formulation thus makes it possible to provide an uninterrupted 90-minute playing time (twice that of a C-90 cassette) with a standard 1,800-foot 7-inch reel and, further, an increase in the potential signal-to-noise ratio. The EE tapes, however, require increased bias and departure from the standard playback equalization. A switch on the GX-77 selects the proper parameters for either conventional or EE formulations, and a control permits a ± 30 per cent bias variation to compensate for brand-to-brand tape differences. No internal audio generator is provided to facilitate bias adjustment, though the owner's manual suggests recommended settings for a number of different tape brands and types.

The dual-capstan transport of the GX-77 uses a servo-controlled d.c. drive motor and two d.c. reel motors. There are six tape heads—erase, record, and playback for each direction. The transport pushbuttons operate logic-controlled solenoids that prevent tape damage from rapid mode switching and permit instantaneous direction change during recording or playback at normal speeds.

Tape threading is a simple, straight-line procedure from supply to take-up reels, and the head cover is hinged to facilitate editing and routine cleaning and demagnetizing. A separate roller that glides up and down in a slot approximately 5 inches long is used both to draw the tape into the head nest and to control a digital counter that reads di-

rectly in minutes and seconds. During the threading operation the two spring-loaded tension arms are automatically retracted.

Separate left- and right-channel recording controls are supplemented by a MASTER record knob that affects both channels simultaneously. Record and playback levels are displayed on a sixteen-segment peak-reading fluorescent indicator that is calibrated from -20 to +8 dB. An OUTPUT control adjusts the level at both the front-panel headphone jack and at the regular rear-panel output jacks. Additional front-panel switches are provided for a CUE/REVIEW function, operation from an external timer, and speed, as well as for selection of either one-direction, auto-reverse for a single cycle, or continuous repeat-play modes. The automatic-reverse functions require the addition of a short length of metal-foil sensing tape to the tape backing at the point(s) where reversal is desired.

The rear panel of the GX-77 has the usual input/output jacks plus provision for a remote-control accessory. A separate Akai MM-77 mixer (or equivalent) is required for recording with microphones.

● **Laboratory Measurements.** The Akai GX-77 unit I received for testing did not include the usual manufacturer's check-out data, nor were specific tapes indicated as having been used in the factory setup. Experimenting with various formulations, I achieved the best performance (by a narrow margin) with TDK SA in the EE position and with 3M Master XS in the regular mode, though essentially the same results could be achieved with a variety of alternative formulations from Maxell, BASF, and Ampex.

Playback response was tested using MRL test tapes for the standard (NAB/IEC) playback equalizations at 7½ and 3¾ ips, as shown in the graph. EE tapes use different time constants for the two speeds (35 and 50 microseconds instead of 50 and 90 μsec), and there are, as yet, no standard playback test tapes available for this format. Using standard test tapes and mathematically calculating the response variations to be expected with the new format indicated that the playback of the GX-77 in its EE position would fall within a few tenths of a decibel of the curves shown. The bass rise in the playback curves is *not* a characteristic of the recorder but results from using a full-track test tape on a quarter-track deck.

On an overall record-playback basis the advantages of EE-type tape are most obvious at the 3¾-ips speed when recording at a relatively high level (0 dB), as the curves in the graph indicate. In a way it is comparable to the difference between a metal-particle cassette and a good ferric or CrO₂-type cassette. The difference between 7½ and 3¾ ips is not entirely wiped out, but for most practical recording purposes it is reduced to insignificance. The curves in the graph are for the forward direction, but those made in the reverse direction did not differ by more than ±0.5 dB.

Third-harmonic distortion from a 1,000-Hz tone at an indicated 0-dB input level measured only 0.2 per cent at the 7½-ips speed with the 3M tape and only 0.15 per

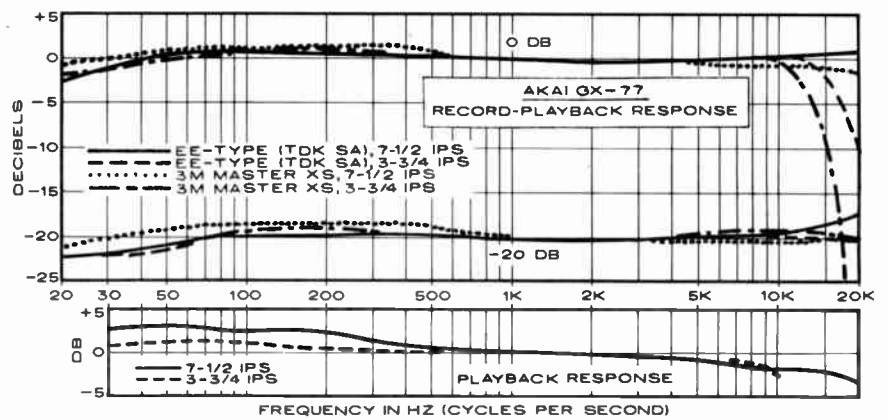

cent with the EE TDK SA. At 3¾ ips the respective figures (averaging the forward- and reverse-direction measurements as before) were 0.3 per cent for both tapes. The overload margin was generous for both the regular ferric and the EE formulations at both speeds, averaging between 7.5 and 10 dB with either tape before producing 3 per cent third-harmonic distortion. At 7½ ips, the signal-to-noise ratio, referred to the 3 per cent distortion point, measured 63 dB with the TDK SA and 62 dB with 3M Master XS unweighted, rising to 68 dB and 66.8 dB with IEC A-weighting. At the 3¾-ips speed the S/N figures were 60.6 and 60.1 dB (unweighted) and 64.7 and 64.1 dB (A-weighted) for the TDK and 3M tapes, respectively.

Averaging both directions, overall record-playback wow and flutter at 7½ ips measured only 0.032 per cent on the conventional wrms basis and 0.048 when employing the stricter DIN peak-weighted standard. At 3¾ ips the comparable figures were 0.04

and 0.07 per cent, respectively. Fast-forward and rewind times for a 1,200-foot reel averaged 72 seconds, and an input signal of 64 mV was required to produce a 0-dB indication. The output at this level was 0.755 volt.

● **Comment.** The Akai GX-77 is certainly easy to operate, though some of its control knobs seem slightly small. It was capable of making truly excellent copies of audiophile discs at the 7½-ips speed, and at 3¾ ips only the most demanding material showed any sign of high-frequency rolloff. The specific virtues of the EE format are still, to some degree, to be determined, for while high-end response and signal-to-noise ratio are definitely improved at 3¾ ips, modulation noise (flutter and program-responsive hiss) could still be detected by very critical listening. Nonetheless, for the home user interested in open-reel capabilities I can recommend serious consideration of the Akai GX-77. —Craig Stark

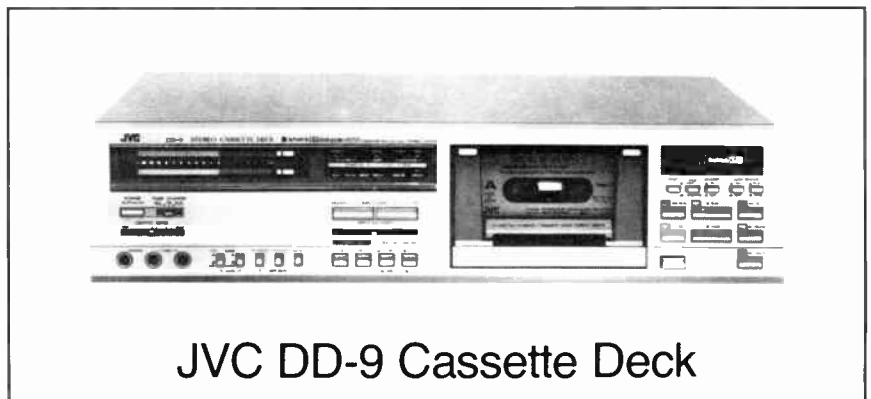

JVC DD-9 Cassette Deck

THE JVC Model DD-9 is a two-motor, three-head cassette deck that includes, among its many advanced features, the new Dolby-C noise-reduction system. Through virtually doubling the amount of noise reduction provided by the normal Dolby-B system (or its JVC equivalent, ANRS), C-type Dolby is designed to meet the needs

of today's wider-dynamic-range recordings without losing compatibility with existing Dolby-B-encoded tapes. The DD-9 thus provides switches for selecting either no noise reduction, ANRS/Dolby-B, or Dolby-C.

The capstan of the DD-9 is direct-driven by a quartz-locked servomotor, and a sepa-

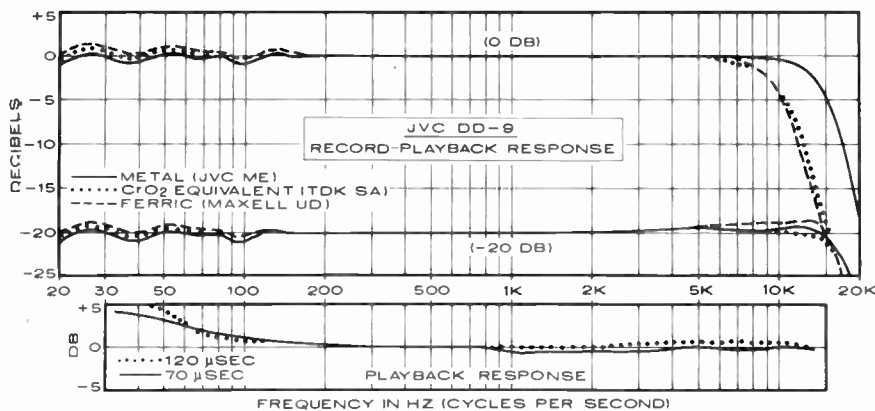

rate d.c. motor is used to turn the reels. The record- and playback-head elements, both housed in a single casing, are made from Sen-Alloy and have tapered ("X-cut") pole pieces to reduce variations in low-frequency response.

Transport functions are electrically operated under IC-logic control with light-touch pushbuttons, and LED indicators are provided to show the current mode of operation. We found these indicators useful more than once, since even during high-speed rewind and fast-forward the DD-9 made so little mechanical noise it was hard to know that it was running. Cassettes are loaded, tape openings downward, into slides behind the cassette well door, whose large, transparent surface provides ample visibility for the cassette inside. The door is also easily removable for routine head cleaning.

Recording level is set by separate UP and DOWN pushbuttons that control internal motor-driven potentiometers. A red indicator needle shows the actual position of the record-level control. Although this motorized level-control system worked smoothly and is unquestionably elegant, we found it slightly less convenient to use than more conventional rotary or slide controls. An additional, center-detented INPUT BALANCE slider is provided to adjust left/right channel balance. A similar horizontal slider (without the detent) controls the deck's output level at the rear-panel jacks and at the front-panel headphone jack.

An eighteen-segment fluorescent display, calibrated from -20 to +9 dB, indicates signal levels. A pushbutton switch allows selection of either VU or peak-reading characteristics, and in the latter mode the segment corresponding to the highest level of a transient remains illuminated for a second or two after the signal has dropped. Indications above 0 dB are shown in red, those below in blue.

Three pushbuttons select the appropriate bias and equalization for ferric, CrO₂, and metal-tape formulations. To use the factory-determined settings a PRESET pushbutton is pressed. Or, alternatively, one can compensate for brand-to-brand variations among tapes of the same type by using JVC's microprocessor-controlled optimization system. Called B.E.S.T. (Bias, Equalization, Sensitivity of Tape), this automated calibration procedure successively tests various bias levels, mid- and high-frequency record-equalization settings, and sensitivity

levels, and selects the optimum settings for the cassette in use. It then rewinds the tape to the starting point. The whole operation is initiated with a START pushbutton and takes only about 30 seconds to complete.

The tape counter uses a four-digit electronic readout and can be switched to indicate either the number of hub revolutions or, if the STOPWATCH button is pressed, the actual running time. Complete memory and auto rewind/replay facilities are provided, as are a momentary-contact RECORD MUTE switch and an external-timer switch. A SOURCE/TAPE monitor pushbutton, with LED indicators, permits instant comparison between the input signal and the recording made of it. Two front-panel microphone jacks override the high-level inputs, so mike/line mixing is impossible without an external mixer.

The rear panel of the DD-9 contains the usual input and output jacks, an FM MPX switch (to eliminate possible interference from the stereo subcarrier signal when recording FM broadcasts), and a DIN-type connector that accepts a remote-control accessory. The overall dimensions of the JVC DD-9 are approximately 17³/₄ x 4¹/₈ x 12⁷/₈. Price: \$900.

● **Laboratory Measurements.** JVC supplied the specific tapes used for the factory setup of our sample of the DD-9 and we used them as the primary reference for our measurements. As the manual indicates, these tapes are JVC-ME (metal), TDK-SA (CrO₂), and Maxell UD (ferric). Other premium tapes from BASF, 3M, Memorex, and Fuji produced substantially identical results with the factory settings, however, and by using the B.E.S.T. system we were able to bring even tapes with a known rising high-end or midrange droop into line.

Playback-only response was checked using Teac MTT-216 and MTT-217 test tapes (120- and 70-microsecond equalization, respectively) and, as the accompanying graph shows, response from the 315-Hz reference to the 14-kHz limit of the tapes was exceptionally flat—within ±0.5 dB. The rising bass response indicated is largely a result of using full-track test tapes with quarter-track heads, as the flatter record-playback curves suggest.

Using the JVC-ME, TDK-SA, and Maxell UD tapes supplied, the overall response at the usual -20-dB measurement level was also extremely flat—within ±1.5 dB

from 20 Hz to about 16 kHz. Bass undulations ("head bumps") were particularly well controlled. Above 16 kHz, response fell rather rapidly, with the -3-dB point at 17 kHz for SA and UD and at 17.5 kHz for the JVC metal. The ferric and CrO₂-type tapes reached -6 dB at about 18 kHz, the metal extending to about 19 kHz. This is clearly the result of a conscious engineering decision by JVC, for their narrow-gap (1-micrometer) playback head could provide "flat-line" response to 20 kHz. The trade-off, however, would be that much more recording equalization would have had to be used at the extreme high frequencies, inviting noise and possible distortion in an area where there is little musical content.

With a 0-dB input, the difference in high-frequency capacity between metal tape and ferric or CrO₂-equivalent formulations is clearly shown in the graph. Response from TDK-SA and Maxell UD fell to -3 dB at approximately 9.5 kHz, while JVC-ME held up all the way to 14 kHz.

Using a 1,000-Hz tone recorded at a 0-dB level, we measured third-harmonic distortion of 0.54, 0.46, and 0.42 per cent for JVC-ME, TDK-SA, and Maxell UD, respectively. All three tapes reached the 3 per cent distortion point at +5 dB. Referred to this level, and on an unweighted basis with no noise reduction, their signal-to-noise ratios were 53.5, 53.8, and 51.6 dB, respectively. Adding ANRS/Dolby-B and CCIR weighting increased these figures to 63.5, 63.8, and 59 dB. With the same weighting and using Dolby-C, the respective signal-to-noise ratios rose to 72.2, 72.4, and 68.5 dB, truly extraordinary figures.

JVC specifies a wow/flutter rating of 0.055 per cent (DIN, peak-weighted) or 0.019 per cent (weighted rms)—the latter of which is the lowest specification we have ever seen for a cassette deck. In the lab the DD-9 more than met its DIN specification, measuring 0.036 per cent, one of the lowest numbers we have encountered. On a wrms basis, our test-equipment limitations prevented us from measuring better than 0.028 per cent. Suffice it to say that the DD-9 was about as free of wow and flutter as any deck we can recall testing.

There was no Dolby-level marking on the level display of the DD-9, but when we checked ANRS/Dolby-B tracking at a -20-dB level we found it to be essentially perfect (within ±0.5 dB) out to the upper limit of the deck's response. Dolby-C tracking, at least in our early test sample, introduced a gradual rise in response between 2 and 15 kHz. The maximum discrepancy was about 3 dB at 15 kHz. However, since it appeared at levels of -20 and below, the audible effect was not significant.

At the line inputs a signal level of 83 millivolts (mV) was required to produce a 0-dB indication, and the output at this point was 400 mV. Microphone sensitivity was 0.2 mV. Fast-forward and rewind times for a C-60 cassette were 78 and 77 seconds.

● **Comment.** The JVC DD-9 gave us one of our first opportunities to use the new Dolby-C noise-reduction system. When Dolby-B was introduced about a decade ago it lowered the audible tape hiss so dramatically

that for many it seemed to do all that needed to be done in this respect. But switching in the C-type Dolby, which not only lowers high-frequency hiss still further but also extends the noise-reduction processing down to the mid-low frequencies, instantly reveals how much remaining noise

we had unconsciously learned to live with over the years.

Recordings from FM and most discs were audibly flawless; only on material with an extremely wide frequency range could a very slight dulling of the highs be perceived, and then only by an instantaneous compari-

son between the source and monitor switch positions.

All controls and features worked perfectly, and mechanical noise was so low as to be, practically speaking, inaudible. In sum, we found the JVC DD-9 to be a truly outstanding performer.

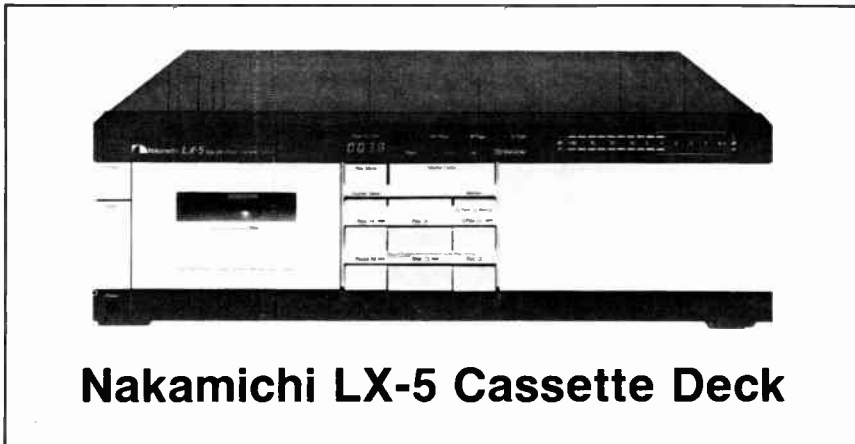

Nakamichi LX-5 Cassette Deck

- Nakamichi LX-5 Cassette Deck
- Size: 17³/₄ x 5⁵/₁₆ x 12¹/₆ inches
- Weight: 18³/₄ pounds
- Price: \$775

THE Nakamichi LX-5 cassette deck adds the Dolby-C noise-reduction system to the discrete three-head, dual-capstan technology used in a number of the company's recent models. The separate Crystalloy playback and record heads of the LX-5 have gap widths (the distance between their pole pieces) of 0.6 and 3.5 micrometers (23.6 and 137.8 millionths of an inch), respectively, and have been so miniaturized that both will fit within the center opening of the cassette shell. Both have etched slots at the points where the top and bottom edges of the tape pass across the heads so that any wear will remain even. Additionally, the playback head is fitted with a special tape guide that also pushes the pressure pad of the cassette out of the way in the interest of lowering scrape flutter.

The dual-capstan transport uses capstans and flywheels of slightly different sizes to regulate the pressure of the tape against the heads and to eliminate the possibility that wow-and-flutter would be magnified by having two comparable masses rotating in unison. While the transport controls of the LX-5 are microprocessor-controlled, the usual solenoid operation of the tape gate and brakes has been replaced with the gentler action of a motor and cam, ensuring that shock will not endanger the head alignment. Cassettes are inserted, tape openings downward, into slides on the back of the cassette-well door. The door is removable for routine head cleaning and demagnetization. While the cassette well is illuminated (to show how much tape remains on a side),

the viewing angle is rather narrow and precludes reading the label.

Most of the controls of the LX-5 are normally hidden behind a push-to-open panel. The usual transport-operating pushbuttons are immediately accessible, of course, as are SOURCE/MONITOR and RECORD MUTE switches, along with a two-speed automatic MASTER FADER, which permits smooth fade-in and fade-out of predetermined record levels. Behind the panel are knobs and pushbuttons for selecting output level, left- and right-channel record level, timer activation in either record or play mode, the memory rewind/replay options, and Dolby-B or Dolby-C noise-reduction systems. Bias

adjustment and equalization controls are also provided to compensate for the requirements of different tape brands, but there are no internal facilities for optimizing the adjustments.

There are LED indicators along the top of the LX-5 to show when Dolby-B, Dolby-C, or the record mute are operating. The tape counter is a four-digit LED display, and sixteen-segment LED indicators calibrated from -40 to +10 dB show the record and playback levels. The rear panel of the LX-5 contains the usual line-level input/output connectors (but no built-in provision for microphone recording) together with a DIN-type jack for a remote-control accessory.

● **Laboratory Measurements.** Nakamichi provided the actual samples of their ZX (metal), SX (CrO₂-equivalent), and EX-II (ferric) tapes used for the factory adjustment of the LX-5 I tested, and these became the "references" for my measurements. However, substantially similar results were obtained with Maxell UD-XLI, TDK AD, and 3M Master I (ferric); TDK SA, BASF Professional II, PD 500 Crolyn, and Maxell XLII-S (high-bias); and Memorex Metal IV, Sony Metallic, and TDK MA-R. My samples of Fuji FX-I and Loran Ferric showed a slight loss at 20 kHz, and Fuji Metal and TDK SA-X (high-bias) showed a slight rise at that frequency, but all were well within the control range of the LX-5's bias-adjustment facility.

The playback-response curves shown in

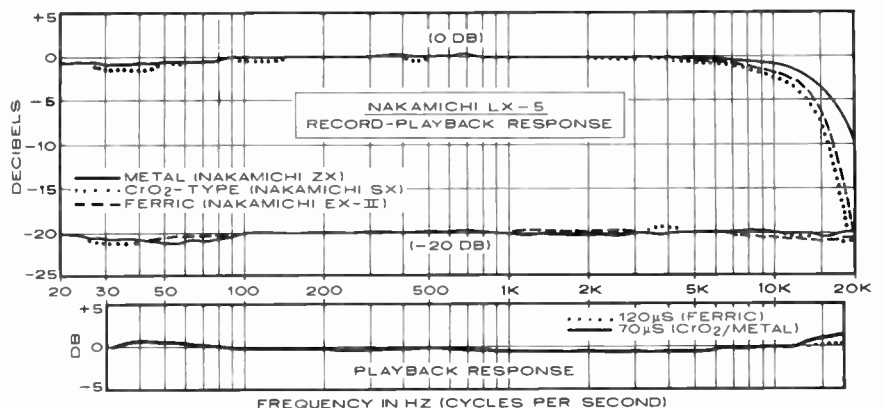

The upper curves indicate overall record-playback response at the manufacturer's indicated 0-dB recording level using the tapes designated on the graph. In the center are the same measurements recorded at -20 dB relative to the upper curves, a level conventionally used for tape-deck frequency-response measurements. Bottom curves show playback response from calibrated cassettes and indicate the deck's ability to play prerecorded tapes.

the accompanying graph for 120- and 70-microsecond tapes are so nearly perfect that they call for no comment beyond noting that they were made using the new BASF standard calibrated test tapes, which extend the measurement range from 31.5 Hz to 18 kHz in accordance with the new IEC measurement standard.

Overall record-playback response, measured at the usual -20-dB level, was so flat across the 20- to 20,000-Hz range that it is almost pointless to put it in the graph. Even at 0 dB (which indicated 1 dB higher than my Dolby-level calibration tape), neither metal, ferric, nor chrome-type cassettes were down by more than 2.5 dB at 10 kHz—truly extraordinary performance. Wow-and-flutter, measured with the TDK AC-342 test tape, was only 0.026 per cent on the customary weighted-rms standard and approximately 0.05 per cent on the

peak-weighted DIN measurement.

Third-harmonic distortion at 0 dB measured 0.32, 0.27, and 0.29 per cent for the Nakamichi ZX, SX, and EX-II formulations, and their respective headroom before reaching 3 per cent third-harmonic distortion was an additional 9, 8, and 7.2 dB. With reference to the 3 per cent distortion point, the unweighted signal-to-noise ratios were 56.5 dB for ZX and SX, 53.4 dB for EX-II. Adding Dolby-B and CCIR/ARM weighting increased these figures to 66.7, 66.8, and 63.8 dB, respectively, for the three tapes. And with Dolby-C added, the signal-to-noise ratios (again CCIR/ARM weighted) measured, respectively, 75 dB for the metal and CrO₂-type tapes, 72.5 dB for the ferric.

Dolby tracking, measured at -20-, -30-, and -40-dB levels, was within ±1 dB with Dolby-B and within ±2 dB with

the more effective Dolby-C throughout the 20- to 20,000-Hz range. The line input had a 50-millivolt sensitivity for a 0-dB indication, at which point the output was 0.96 volt. Fast-forward and rewind times were 55 and 50 seconds for a C-60 cassette.

● **Comment.** The Nakamichi LX-5 is a superb cassette deck, remarkable in performance, simple in operation and styling. Dubbing from various sources—LPs, FM, and even master tapes—produced impeccable copies, and even when using FM hiss as a test signal it was virtually impossible to distinguish between the original and the taped copy (using metal tape). Apart from the demands of a laboratory recorder (variable equalization, bias-monitoring jacks, etc.), this is perhaps the finest deck I have yet tested.
—Craig Stark

The Optonica RT-6605 cassette deck departs from normal practice in that it contains two separate transport systems. One, designed Tape 1, is for playback only, using a single Sendust core head with a 0.8-micrometer gap. A second head is also included, apparently to sense the blank intervals that trigger the APSS system.

The other transport, Tape 2, is basically for recording only, with a 3-micrometer gap in its single head. (Of course, it also has a combination bias/erase head for recording).

The transport's controls are "soft-touch" buttons, most of them not operating solenoids. The bulk of the mechanical work in the transports is done by the drive motors (one per transport) through plastic gears and levers. The control buttons can be operated in any sequence.

Except for the need to transfer the tape from the Tape 2 to Tape 1 mechanism for playback after recording, and the separate controls for setting the BIAS/EQ and Dolby operation for the two decks, the normal operation of the RT-6605 is straightforward. However, the presence of two transports allow for a convenient built-in dubbing facility. Pushing the DUBBING button and setting the RECORD level control to a calibrated point are all that is needed to copy from Tape 1 to Tape 2.

The metal cabinet of the Optonica RT-6605 is finished in black, with simulated leatherette grain. It is 17" W × 12½" D × 4½" H, and weighs 16.5 pounds. Suggested retail price is \$550.

General Description. Each of the two tapes transports has its own motor, with a frequency-generator servo system to control speed. Although separate, the tape drives can be linked to the Tape 2 PAUSE button so that releasing it will start them in synch. Separate heads for recording and playback give the RT-6605 the performance potential of a con-

ventional three-head machine, except for the ability to monitor the tape while recording.

Tape 2 PLAY MONITOR button appears to provide that function, but it can be used to monitor a tape in the Tape 2 transport only *after* recording. *During* recording, the incoming signal is heard via the LINE OUT jacks. After the tape is recorded and rewound, pressing PLAY MONITOR starts the Tape 2 transport and plays the tape through the LINE OUT jacks, using the record head for playback. In this mode, frequency response is not flat, and there is no Dolby decoding. Proper playback frequency response and noise levels can only be obtained via Tape 1.

The "soft touch" transport controls operate smoothly, but with mechanical noises that last a second or so each time a button is pressed. On Tape 2, only the RECORD button need be pressed to make a recording (there being no "play" button as such), and one can change from any tape direction or mode to any other (even from a fast speed into record) with-

out touching STOP. The same flexibility exists for Tape 1, except that it has no recording function (or tape index counter) and the APSS is always available for operation. In either fast-forward or rewind, when a four-second unrecorded tape segment is encountered, the tape stops and goes into play (or remains stopped if the PAUSE button was previously engaged).

Even though it lacks an index counter, Tape 1 can still be used to return a tape to a previously selected reference point. If the four-second silent sections have been inserted into the recording between selections or parts of longer works (by pressing REC MUTE while recording) the APSS will help locate parts of a recorded tape when it is played in Tape 1 transport.

Both transports can be used with timer-controlled operation for unattended recording or playback. The buttons for PLAY and RECORD engage mechanically, so that when power is later applied, the soft-touch mechanism completes its operating cycle.

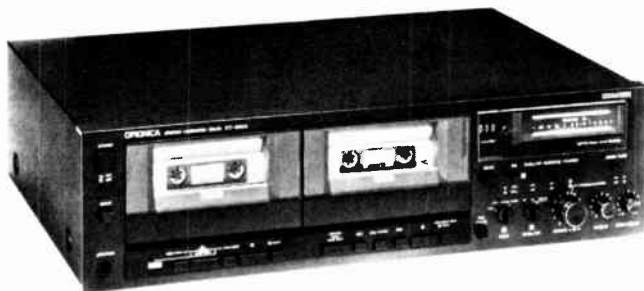

Optonica RT-6605 Cassette Deck

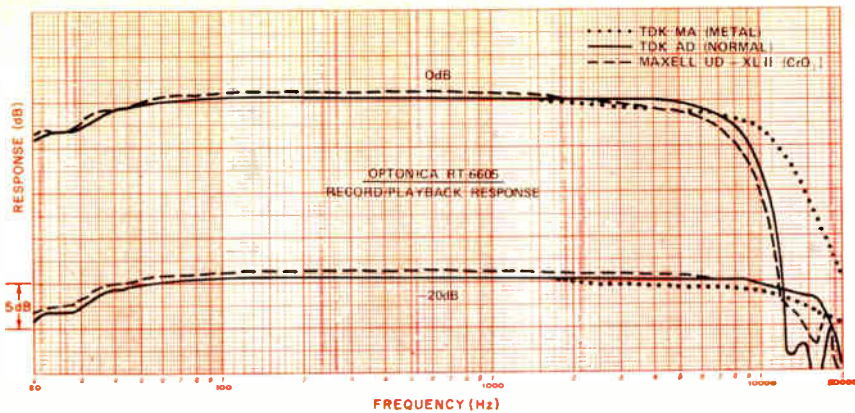

Frequency-response curve for three different tape types.

Levels for dubbing are set by an index mark on the RECORD level knob, but there is provision for transferring between tapes that have very different output levels for the same recording reference level, or in cases where the master tape was recorded at a higher or lower level than usual. The RECORD knob has calibrations over a ± 7 -dB range at 1-dB intervals, and the instruction manual lists recommended settings for various combinations of tape formulations and master levels (as read on the recorder's peak-level indicators).

The peak-level indicators are twin parallel lines of fluorescent marks calibrated from -20 to $+8$ dB (the standard Dolby level of 200 nW/m comes at the 0-dB calibration). The indicators have a very fast attack time and slower decay. As a further aid to setting levels for dubbing, the PEAK HOLD button on the panel causes the maximum peak levels in each channel (higher than 0 db) to be retained on the display while the rest of it continues to show the changing program levels.

Laboratory Measurements. The instruction manual for the Optonica RT-6605 lists a number of currently available tape formulations together with the recommended EQ settings and the suggested range of BIAS ADJUST variation that might be used for flattest response with each. The manual also suggested a few tapes that (we assume) were used to establish the recorder's specifications. We used some of these, plus our own choices, for the measurements on the recorder.

Our NORMAL (low-bias ferric) tape was TDK AD, with Maxell UD-XL II serving as a "chrome equivalent" tape, and TDK MA for metal tape. Although the machine has a switch setting for FeCr tape, none was specifically recommended and we did not use one in our tests.

The BIAS ADJUST was set to its mid-position (lightly detented) for each tape and its record/playback frequency response was measured at recording levels of 0 and -20 dB. The "tracking" of the Dolby circuits was checked by measuring the record/playback response at

-20 and -40 dB, with and without the Dolby switched on, to see how much the frequency-response was affected. Response of the MPX filter was also measured at a -20 -dB level. The range of the BIAS ADJUST control was measured for each tape by plotting its frequency response (at -20 dB) for center and extreme settings of the control. Playback equalization was measured on Tape 1 with both 70 - μ s and 120 - μ s standard tapes, and also in the PLAY MONITOR mode of Tape 2. For all of our combined record/playback response measurements, we recorded in Tape 2 and transferred the cassette to Tape 1 for playback.

A line input of 70 mV at 1 kHz produced a 0-dB recording level indication. The maximum playback output from that signal was in the range of 1 to 1.25 V, depending on the tape used, from the Tape 2 PLAY MONITOR, and about 0.8 to

0.85 V from the Tape 1 output. The third-harmonic distortion in the playback from a 0-dB signal was 0.7% with TDK AD and MA tapes, and 1% with Maxell UD-XL II. To reach the reference distortion level of 3% , we had to record at $+6$ dB with TDK AD, $+4$ dB with Maxell UD-XL II, and $+7$ dB with TDK MA. The unweighted S/N in the output, referred to those signal levels, was about 55 dB with the two ferric tapes and 58 dB with metal tape. With the Dolby system on, and CCIR weighting, the respective S/N readings were 66 to 67 dB, and just over 70 dB.

The level indicators read -1 dB with a standard level Dolby calibration tape on Tape 1, and 0 to $+1$ dB on Tape 2. The level indicators read 100% of their steady-state readings on 0.3 -second tone-burst signals. The two transports operated at identical speeds, which appeared to be exact.

Flutter readings on both were very low— 0.065% weighted peak and 0.04% weighted rms. The fast tape speeds were not particularly fast, with 103 seconds required on either transport to move a C60 tape from one end to the other.

The 120 - μ s playback response (Tape 1) was flat within $+0.5$, -1.5 dB from 40 to $12,500$ Hz, and the 70 - μ s response had about the same variation, but at different frequencies. Response of the PLAY MONITOR output of Tape 2 dropped off below 200 Hz, to -5 dB at 40 Hz with both test tapes. The equalization (fixed in this mode of operation) was fairly good for the 70 - μ s tape, with a 2.5 -dB rise in the 4 -to- 6 -kHz range and a drop-off to -1.2 dB at $10,000$ Hz. The error with 120 - μ s tape was much larger, with the response rolling off above 3 kHz to -11 dB at 12.5 kHz.

OPERATING FEATURES

Front-Panel:

- POWER:** Switch button.
- EJECT:** (Separate for two cassette transports.) Opens cassette door for loading or removing tape.
- REC MUTE:** Removes recording signal from Tape 2 while it is held in, to provide pauses necessary for operation of APSS.
- TAPE:** A four-position bias/eq switch for FeCr, CrO₂, NORMAL, METAL tapes.
- DOLBY NR:** A three-position switch for OFF, ON, MPX (filter that affects only recording input).
- RECORD:** Concentric level adjustments for recording inputs. Calibrated for dubbing mode.
- OUTPUT:** Playback output level adjustments, controlling line and phone levels from either deck.
- BIAS ADJUST:** Provides a $\pm 10\%$ vernier adjustment of bias for each of the tape settings.
- PEAK HOLD:** A button that causes the level of display to retain its highest

reading, while showing variations of program level, in either record or playback operation.

- PHONES:** Jack for stereo headphones.
- Tape 1:** Transport control push buttons: REWIND, FAST FORWARD, PLAY, STOP, PAUSE. Tape 1 also has APSS (Auto Program Search System) feature that stops tape at beginning or end of a recorded segment in fast speed.
- Tape 1:** Electronics pushbuttons: EQ (70 or 120 μ s), DOLBY NR (ON or OFF), DUBBING (internal connection to Tape 2 recording input), MONITOR (connects line and phones outputs to playback from either Tape 1 or Tape 2).
- Tape 2:** Transport control pushbuttons: REWIND, FAST FORWARD, RECORD, PLAY MONITOR (uses record head for playback, with limited frequency response and no Dolby decoding), STOP, PAUSE/ONE TOUCH START (can be used to start both transports for dubbing).

Rear Panel:

Phono Jacks: LINE IN and LINE OUT

The record/playback frequency response of all the tapes at -20 dB was fairly similar. It was notably flat, smooth, and free of low-frequency "head bumps", although the low-frequency output sloped downward below about 50 Hz and was typically about -5 dB at 20 Hz. The response curve was virtually ruler-flat from 100 to about 9,000 Hz with all the tapes, with no high-frequency peak and only a gentle downward slope above 10,000 Hz. The -3 -dB response frequencies for TDK AD tape were 32 and 17,800 Hz; for Maxell UD-XL II, they were 32 and 13,000 Hz; and for TDK MA, they were 32 and 15,000 Hz.

The BIAS ADJUST control had a profound effect on the high-frequency response of all the tapes. Typically, the response was affected above 1 kHz with the maximum change occurring at about 17 kHz (20 kHz with the MA tape). The range of variation was about ± 6 dB, so that it would have been possible to achieve a nearly flat response up to well beyond 15 kHz with any of the tapes. However, there is no built-in means of optimizing the bias, and it is extremely tedious to record noise or other signals on Tape 2 and transfer the tape to Tape 1 to determine the effect of each small bias change on response.

The 0-dB record/playback response with most of the tapes followed the usual pattern, rolling off at high frequencies and intersecting the -20 -dB curve at 12 to 13 kHz. The metal tape, due to its

superior high-frequency saturation properties, had a 0-dB response that remained well above the -20 -dB curve all the way up to our 20-kHz measurement limit.

The Dolby tracking was very close at -40 dB, but at -20 dB there was an error of about 3 dB over most of the upper-middle and high-frequency range. The MPX filter cut off the recorded signal sharply above 17 kHz. Since the recorder's inherent response falls rapidly in that range, the filter can safely be left on whenever the Dolby is engaged.

User Comment. The Optonica RT-6605 is truly a unique cassette deck (or pair of decks). Its electrical performance is first-rate, as evidenced by its very smooth and extended frequency response, low distortion, and a S/N of better than 70 dB with metal tape. Of course, this is, functionally speaking, a machine with separate recording and playback heads and electronics—and even transport mechanisms!—although it lacks the off-the-tape monitoring feature of most three-head machines.

For many people, the internal dubbing connection of the RT-6605 will more than compensate for any such omissions. Even if two good decks are available for dubbing tapes, there is always some awkwardness and the possibility of problems in the interconnection between them. We have also found it clumsy at some times to start two

machines simultaneously. This is done with one button in the Optonica RT-6605 and so effortlessly that one comes to take it for granted.

Less easy to accept, perhaps, is the operation of the RT-6605 as a normal cassette deck. Frankly, it is annoying, after recording a cassette in Tape 2, to have to rewind it to 000 on the single index counter (which only functions on Tape 2), then unload it and load it into Tape 1 before playing it. This problem is aggravated by a rather critical fit between the cassette and the guide rails in the loading door. If the cassette is inserted hurriedly or carelessly, it will not seat properly and the door cannot be closed.

In fairness, we must say that after some use operation becomes less awkward, and we certainly cannot fault the actual performance of the recorder in any way. A careful study of the manual is a "must" if one expects to use this deck at all, however. We also would have appreciated a distinctive marking or color coding for the Tape 1 buttons and other controls, to distinguish them from those affecting only Tape 2.

In summary, the Optonica RT-6605 is a very fine double cassette deck with unparalleled versatility for many types of operation. For all that it does, it is priced very competitively. And when dubbing is required, the RT-6605 is far superior in compactness, versatility, and convenience than two machines would be.—*Julian D. Hirsch*

THE Pioneer CT-8R is a three-head, three-motor machine featuring built-in Dolby B and Dolby C noise-reduction systems and bidirectional playback with auto-reverse operation. Its style matches that of other current Pioneer audio components, finished in satin gold with a dark brown center panel on which are displays of the signal path through the machine and the exact operating mode being used.

The CT-8R has a number of unusual tape transport functions and operating features, controlled through an internal microprocessor system. These include automatic tape bias and equalization optimization, a logic-controlled solenoid operated tape transport, and an elaborate program-search-and-selection system based on sensing unrecorded tape segments.

Overall dimensions of the Pioneer CT-8R are approximately $16\frac{1}{2}$ " W \times $12\frac{5}{8}$ " D \times $5\frac{1}{8}$ " H. It weighs 14 lb 5 oz. Suggested retail price is \$575.

General Description. The front panel of the Pioneer CT-8R is divided into three essentially equal parts. On the left is a bottom-hinged door containing the cassette guides. It opens at the touch of the nearby EJECT button. The right third



Pioneer CT-8R Cassette Deck

of the panel contains almost all the operating controls, consisting of four small knobs and a number of rectangular buttons of different sizes and shapes. The center section (in contrasting dark brown) contains illuminated displays of tape transport mode, signal path, and the internal operating conditions of the machine.

The CT-8R tape transport uses three miniature direct-drive motors to turn the capstan and the two tape hubs. The motors' speeds and torques are controlled by ICs to provide a smooth, even wind on the hubs.

The head movement required for bidirectional play is accomplished by a rotating head turret, whose design al-

lows the playback head azimuth to be adjusted separately for each direction of tape motion. The combination record/playback head (two separate heads in a common housing) is shaped to insure close, stable contact between the tape and the head during operation.

The heads themselves are made of Sendust alloy, formed into a ribbon by a proprietary Pioneer process. According to Pioneer, its Ribbon Sendust head has a very low loss and high permeability, which is largely responsible for the machine's excellent performance characteristics. Data offered by Pioneer to compare the magnetic and physical properties of the Ribbon Sendust head with conventional Sendust, Permalloy, and ferrite core heads shows a modest but definite superiority for Ribbon Sendust in most cases.

Automatic tape optimization systems have been available for a few years, and this feature is now offered in at least some models from almost every cassette recorder manufacturer. They vary somewhat in operating details and their criteria for setting the bias, equalization, and recording level; but all of them are capable of extracting the maximum performance from almost any kind of tape.

Early automatic tape optimizing systems (actually, it is the recorder rather than the tape that is optimized) required as much as 20 to 30 seconds to perform their adjustment cycle, but in the Pioneer CT-8R, this time has been reduced to about 8 seconds! When the AUTO BLE ("bias, level, equalization") button is pressed, the tape is first recorded with a 1-kHz test signal and the output from the playback head is measured. If the output is absent or too low, the sequence stops; otherwise the recording level is set roughly and the bias is stepped through a sequence of levels until the output meets an (unstated) criterion for correctness. If that condition cannot be met, the adjustment is terminated and the recorder is automatically set to its internal reference bias setting for that type of tape.

When the correct bias has been determined, its value is set into the computer memory and the final level setting is made. Again, if the optimum value cannot be reached, the machine reverts to its internal preset value. The third automatic adjustment is of recording equalization, with the same default procedure if the tape cannot be optimized. When all three key parameters have been set for flattest frequency response and correct output level, they are stored in the computer memory, and the AUTO BLE light (which has been blinking during the process) remains on. The tape rewinds to the point at which the process started and the machine stops, ready for use.

Although Dolby B noise reduction has been universally adopted by manufacturers of cassette recorders, the newer Dolby C system is only now beginning to appear in regular production recorders. It is very similar in concept to the B system, but operates at lower signal levels



Frequency responses for three different types of tape.

and extends its noise reduction to lower frequencies. The final result is an overall noise reduction of about 20 dB, compared to the 10 dB of the Dolby B system. A certain degree of compatibility exists between the two systems, so that tapes recorded with Dolby C can be played (if necessary) on any Dolby B machine with about the same degree of success as would occur if a Dolby B tape were played without any Dolby decoding in the playback. The "incompatibility" in either case is a slightly brighter sound. However, a properly decoded Dolby C tape will sound dramatically quieter than a Dolby B tape, as well as having the correct frequency response.

Laboratory Measurements. Although the AUTO BLE system should make the Pioneer CT-8R usable with practically any tape, we measured its frequency response with a number of tapes, including TDK D, OD, SA-X, and MA, as well as Maxell XL-IS and XL-IIS. The AUTO BLE adjustment was used for each tape before making any measurements.

Frequency response differences between all the tapes were exceedingly small, typically 2 to 4 dB of variation from 10,000 to 20,000 Hz at a -20-dB recording level. The only exceptions to this pattern were the Maxell XL-IS (a "normal" ferric tape) and TDK MA (metal), both of which gave an extremely flat response all the way to 20,000 Hz. All the tapes had the same mid- and low-frequency response, with moderate "head bumps" visible between 20 and 40 Hz. The overall response was typically ± 2.5 dB from 20 to 20,000 Hz (± 2 dB with the XL-IS and MA tapes). If the low-frequency variations are averaged out, the overall response with XL-IS or MA was within ± 1.5 dB from 20 to 20,000 Hz, which is superb performance for any cassette deck. For our full tests of the CT-8R, we used Maxell XL-IS (normal), Maxell XL-IIS (CrO₂) and TDK MA (metal).

When the response was measured at a 0-dB recording level, the differences between the tapes were slightly more visible. However, one of the most unusual characteristics of the frequency response was that the 0-dB curve did not

intersect the -20-dB curve, up to 20,000 Hz, with any of the tapes. This indicates the superior quality of the Pioneer recording head, which evidently requires less recording equalization boost at high frequencies than do less efficient heads (and thus produces less tape saturation). The MPX filter, designed to remove any 19-kHz pilot carrier from an FM signal being recorded, was highly effective. It had virtually no effect on the response up to about 16,500 Hz, and cut off rapidly above that frequency.

The playback equalization of the CT-8R was checked using the new standard calibration tapes from BASF, whose recorded frequencies span from 31.5 to 18,000 Hz (previous tapes were limited to 12,500 Hz). The 70- and 120- μ s playback responses were essentially identical, within ± 1.5 dB from 31.5 to 12,000 or 14,000 Hz, and rising 4 or 5 dB at 18,000 Hz. A check with our previous tape (the TDK AC-337) showed a ± 1.5 -dB frequency response from 40 to 12,500 Hz.

At the maximum gain setting, a 0-dB recording level indication required a line input of 63 mV. The microphone sensitivity was 0.27 mV, with overload occurring at 48 mV. Since plugging in one microphone jack replaces only its corresponding line input, it is not possible to make a mono recording from a single microphone unless an external "Y" connection is used.

The playback output from a 0-dB signal was in the range of 0.64 to 0.68 V, depending on the tape used. The third harmonic distortion in the playback from a 0-dB, 1000-Hz recorded reference signal was down 41 to 42 dB for Maxell XL-IIS and TDK MA, and 47 dB for Maxell XL-IS. To reach a reference playback distortion of 3% (third harmonic down 32 dB) we had to record at 5.5 dB above reference with XL-IIS and at 7 dB above reference with the other two tapes.

Referred to the playback from those recording levels, the unweighted S/N in the output was 50.5 dB (XL-IS), 51.5 dB (XL-IIS) and 52.5 dB (MA). With CCIR/ARM weighting and using Dolby B noise reduction, those readings improved to 62.2, 66.2, and 66.4 dB.

Finally, with Dolby C, the S/N readings were impressively high, respectively 73, 74, and 74.5 dB for the three tapes.

The Dolby tracking (the change in overall record/playback frequency response with Dolby on or off, at various recording levels) was excellent. With Dolby B, the response changes were visible only above 10,000 Hz and did not exceed 1 dB up to 15,000 Hz, for recording levels between 0 and -30 dB (TDK MA tape). The results with Dolby C were also good, with smooth variations in output (1.5 to 2 dB) at various frequencies up to 15,000 Hz.

A standard Dolby level-test tape produced a +3-dB reading on the CT-8R's LED display. The LEDs responded very rapidly, giving the same readings on steady signals or on 0.3-second tone bursts. The tape transport, which ran about 0.65% fast, moved a C60 cassette from end to end in 110 seconds (fast forward) or 114 seconds (rewind). The weighted peak flutter (CCIR) was

$\pm 0.05\%$ and the weighted rms flutter (JIS) was 0.03%, both very low readings for a cassette deck.

User Comment. The recording and playback performance of the Pioneer CT-8R are so outstanding that little additional comment is needed. Recording and playing back records, FM programs, and even interstation FM tuner hiss did not reveal any significant difference in sound between the incoming program and the playback. This was the case even at indicated recording levels of 0 dB, which normally result in dulled high-frequency output due to tape saturation. We have never used a cassette deck that could surpass this performance, and very few can even come close to matching it. Even without considering the many special operating features of the CT-8R, its basic performance alone would justify its price.

Not long ago, the better open-reel home-type tape recorders could not

match the flutter readings of the CT-8R, even at 15 inches per second. None of the several automatic tape optimizing systems we have used were any more effective than the AUTO BLE, and all of them were much slower in operation.

We found only one operating flaw in the CT-8R. Cassettes lacking rear notches to identify the tape type cannot be used properly in this machine (they will be automatically assigned the 120- μ s playback equalization). We have a number of early Advent chromium-dioxide tapes that will never sound right on the CT-8R because there is no way to select the 70- μ s equalization manually. There was a similar problem in trying to test the machine with different metal tapes, since few of our early samples had the rear keying holes. A manual tape selection override would have been a most desirable feature on this deck.

The proximity of the EJECT button to the edge of the cassette door requires considerable care when opening the

PIONEER CT-8R CONTROLS AND INDICATORS

Front Panel

Knobs

INPUT	Concentric L and R channel recording level controls.
OUTPUT	Playback program level control.
MODE	Three-position switch for normal stop at end of tape, auto-reverse (playback only), and auto-reverse with four complete plays before stopping.
TIMER	Three-position switch (OFF, REC, PLAY) for unattended operation with external ac power switched by timer.

Operations Switches

Flat plates for fast forward, rewind and reversing tape direction, identified by arrow symbols. PLAY and STOP controlled by pressing opposite ends of a single large plate.

Pushbuttons

EJECT	Opens cassette door.
POWER	Controls ac line power to recorder.
AUTO BLE	Activates automatic system for optimizing tape bias, level, and equalization.
CLEAR	Clears AUTO BLE data, replacing with reference values built into machine.
BLANK SEARCH	Puts tape in fast forward until a nonrecorded segment of at least 8 seconds is encountered. At that point, tape stops and is positioned to play following section.

PAUSE

Alternate pressures stop and start tape without affecting operating mode (not operative in fast speeds).

REC

Single red button initiates recording mode of operation.

REC MUTE

While held in during recording, removes incoming program from recording head to add silent interval to tape.

MS/SKIP

When set to ON, pressing the fast-forward or rewind control moves the tape to beginning of next recorded selection and resumes play from that point. Cancelled by second operation.

INDEX SCAN

Causes tape to scan in fast speed in direction set by operations switch. Stops at each recorded section, plays 7 seconds, and resumes scan until either PLAY or STOP is pressed.

MUSIC REPEAT

Pressing during playback causes selection to be repeated up to 8 times (or until cancelled by pressing one of the operations switches).

MEMORY

Push to ON to engage AUTO STOP at 000 counter reading in fast speeds.

MONITOR

Connects line outputs to TAPE or SOURCE.

DOLBY NR

Three small buttons turn on Dolby system, select B or C system, and engage the MPX filter.

Display Panel Features

COUNTER	Three-digit mechanical index counter with reset button.
LEVEL	Two vertical rows of LEDs reading instantaneous program levels from -20 to +8 dB.
AUTO REVERSE	Green, lighted arrows and bar pattern to show travel/stop status of tape. Rate of light movement shows speed and direction. Arrows show when machine is set for auto-reverse.
RECORDING MODE	Lights show REC, PAUSE, and REC MUTE status. Arrows show whether MONITOR is set to TAPE (playback) or SOURCE.
TAPE AUTO SELECT	Lights show NORM, CrO ₂ , METAL selection of bias and playback EQ according to index holes on the back of the cassette.
AUTO BLE	Green AUTO DATA light flashes while automatic tape optimization is in progress, speeding up as it continues and remaining on when it is complete. Letters B or C illuminate showing the Dolby system in use.

Jacks

MIC (L and R)	These 1/4" jacks automatically replace the rear line inputs when microphone plugs are inserted (mono recording not possible with single microphone). Stereo headphone jack.
---------------	---

PHONES

Rear Panel

LINE IN, LINE OUT	Phono jacks.
-------------------	--------------

door, which can easily be blocked by the tip of the finger that is pressing the button. For most people, left-handed operation of the button would be extremely awkward.

Experience with other recent Pioneer components featuring the same styling as the CT-8R has left us with strong positive feelings about the informative center display panel. The signal flow and function display is both attractive and useful. In view of the many special control features of the CT-8R, a clearly visible display of its operating modes would seem to be a virtual necessity.

We used all of the special features of the CT-8R to verify their operation. Everything worked exactly as described in the instructions. However, this is not a machine that can be used to full advantage without a careful study of the manual, and considerable practice. Until the use of all the buttons becomes automatic on the part of the user, the CT-8R can be a formidable challenge.

Fortunately, it can be used as a perfectly conventional cassette deck, without bothering about its various search and fast-scan modes. We chose to do just that, since it became obvious that

sustained practice would be needed to use any of these modes effectively.

The "bottom line" of our evaluation of the Pioneer CT-8R is that it is one of the finest cassette recorders we have used and is an exceptional value in its price range. Its basic performance—frequency response, distortion, S/N, and flutter—would be very difficult to surpass at any price. And once its special tape-handling features are mastered, it offers another good reason to choose the CT-8R. The unit earns top honors as a superb cassette recorder at a surprisingly low price.—*Julian Hirsch.*

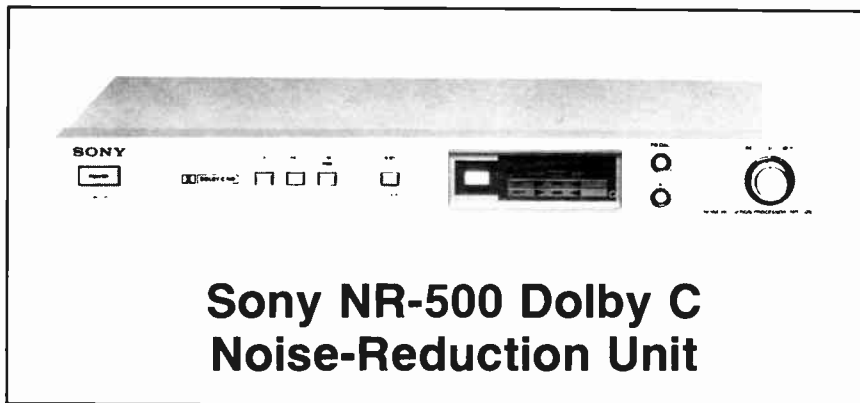

THE Sony NR-500 Noise Reduction Processor makes Dolby C noise reduction available for any tape deck (cassette or open reel). It connects between the tape deck and the system amplifier, and has front-panel bypass switches so that the recorder can be used with or without the NR-500.

A compact unit finished in satin silver, the NR-500 measures 17"W by 11¼"D by 2¼"H. It weighs about seven pounds and has a suggested retail price of \$190.

General Description. The recently developed Dolby C noise-reduction system is an extension of the Dolby B system now incorporated in virtually every component-type cassette deck. In the B system the program is recorded ("encoded") with variable pre-emphasis in the upper middle and high frequencies that is determined by the program's spectral content and level. During playback, variable de-emphasis ("decoding") takes place.

Encoding and decoding are complementary, so that the overall frequency response through a record/playback cycle is flat. However, the playback decoding process also attenuates noise (about 10 dB at 5000 Hz). Successful system operation requires that the signal levels be matched closely during recording and playback.

The Dolby C system can be consid-

ered as the simultaneous operation of a Dolby B processor and a second similar circuit that operates at lower signal levels and extends the noise-reduction action down to 200 Hz. The end result is a noise reduction of 20 dB at 5000 Hz, giving a good cassette deck a total signal-to-noise ratio of around 75 dB. This permits a dynamic range comparable to that of any analog disc, including those cut from digital tape masters.

The successful use of either Dolby B or C requires a flat record/playback frequency response from the recorder. Any departures from flatness are doubled by the Dolby system—or by any of the other popular "companding" noise reducers. Since most of the response variation of a cassette (excluding low-frequency "head bumps") takes place at the highest frequencies, the Dolby-C sensing circuit was modified to make the system less sensitive to response variations above 10 kHz.

Also, an anti-saturation network has been added to the NR-500 to reduce tape saturation at high audio frequencies. The network introduces a fixed 4 dB recording roll-off at 10 kHz, with a complementary boost in the playback system. Although the playback boost reduces the noise reduction above 10 kHz, most audible hiss is below that frequency. Therefore, the anti-saturation network has a negligible effect on the overall signal-to-noise ratio.

Calibration. The Sony NR-500 is supplied with a calibration cassette, recorded with a 400-Hz tone at standard Dolby level (200 nWb/m is the 0-dB reference). For the initial system adjustment, it is played on the cassette deck being updated while the NR-500's CAL and DOLBY C buttons are engaged. The deck's playback level control is set to a convenient point, and must not be moved again.

When the tape is played, a pair of red LED arrows on the NR-500's front panel show whether the playback level is too high or too low. For each channel, set the PB CAL adjustments so that the red arrows are out and only the center green LED is on. (Use a screwdriver or the tool supplied with the NR-500.) This calibrates the NR-500 playback system to the output of the tape deck.

Next, the recording levels are calibrated, using the same kind of tape that will be regularly employed for recording on the deck. The CAL tone from the NR-500 is recorded, and the deck's recording level controls are set to yield a "0 dB" recording level. Then the tape is rewound and played into the NR-500 to check that the playback level is identical to that from the calibration tape (green LED lit). If not, the CAL tone is re-recorded at slightly different record-level control settings. The process is repeated until playback into the NR-500 shows that the recording level has been matched to the calibrated level. A change of tape type may require a recalibration of the recording levels.

From this point on, the record level controls on the tape deck are not touched again. All recording level adjustment is done with the concentric front-panel knobs on the NR-500, using the recorder's meters in the conventional manner.

To record with Dolby C processing, the REC button and the DOLBY C button on the NR-500 are engaged and the recording is made in the usual manner. For playback, it is necessary to press the PB button. The NR-500 has only one set of processing circuits that are switched between encode and decode operation. If no external noise reduction is wanted, the DOLBY C button on the NR-500 is

left in its OUT position, which extinguishes the yellow DOLBY C light on the panel.

When recording with a three-head tape deck, it is necessary to use a pair of NR-500s, one set to REC and the other to PB, to take full advantage of the recorder's tape-monitoring facility.

Laboratory Measurements. Although we made some measurements on the NR-500 alone, we also combined it with a two-head cassette deck to measure its effect on the noise and frequency response of a complete system, and for

CONTROLS AND INDICATORS

Front Panel

Pushbuttons

- POWER: Switches power to NR-500.
- CAL: Must be engaged when calibrating tape deck to NR-500.
- REC: Must be engaged for recording.
- PB: Must be engaged for playback.
- DOLBY C: Must be engaged to use Dolby C circuits.

Screwdriver Adjustments

- PB CAL: Two, for L and R channels. Adjust for PROPER LEVEL indication while playing Dolby level-calibration tape.

Knobs

- REC LEVEL: Concentric knobs for adjusting recording levels after calibration.

Display

- DOLBY C: Yellow indicator when DOLBY C button is on.
- CAL INDICATOR: Red arrows indicate HIGH or LOW signal levels for each channel when calibrating. Green bar indicates PROPER LEVEL.

Rear Connectors

- LINE IN: Connects to amplifier TAPE OUT.
- LINE OUT: Connects to amplifier TAPE IN.
- TAPE: Connects to tape deck LINE OUT.
- REC OUT: Connects to tape deck LINE INPUT.

Other

- MPX FILTER: Slide switch activates 19-kHz filter for recording FM broadcasts.
- AC OUTLET: Unswitched.

subjective listening tests. The recorder was a Nakamichi 500, using Nakamichi EX tape.

The signal-to-noise ratio of the tape deck, referred to standard Dolby level, was 50 dB with no noise reduction, and 68 dB with Dolby C and CCIR/ARM weighting. The noise-reduction measurements were made by playing a blank tape and displaying its noise output on an H-P 3580A spectrum analyzer—first with no noise reduction, then with just the recorder's own Dolby B system, and finally with just the Dolby C system of the NR-500.

The noise reduction of the Dolby B became significant above 2 kHz, and

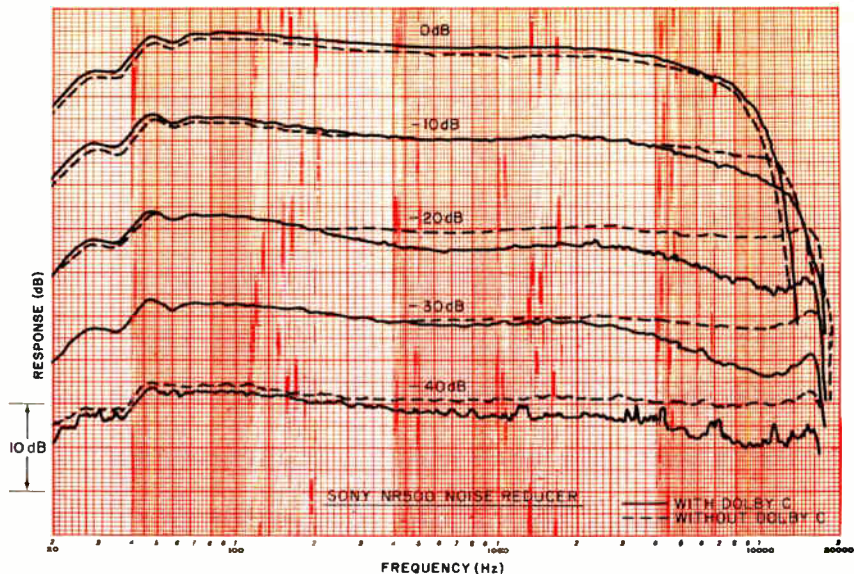

Record/playback responses using Nakamichi 500 recorder and EX tape.

measured 5 to 8 dB over most of the range above that frequency. When we used Dolby C, the noise reduction began at 200 Hz, exceeded 15 dB up to 43 kHz (analyzer's upper limit), and was a full 20 dB from 2 to 10 kHz.

The frequency response of the Sony NR-500 alone was measured at a number of input levels. Encode and decode responses were tested separately. In general, the two sets of curves were complementary, although we made no special effort to match the levels. However, the fixed "cut" (recording) and "boost" (playback) of the anti-saturation network was clearly evident, with a gradual response change up to about 12 kHz and very rapid change from there to 20 kilohertz.

The record/playback response of the cassette deck, with and without the Dolby C, was measured at several indicated

recording levels from 0 to -40 dB. We noted mistracking between the encode and decode processes, as evidenced by a change in frequency response when the Dolby C system was switched in or out. At most signal levels, and over the lower audible frequency range, the difference between the NR-500's on and off curves was less than 3 dB. But differences of 6 dB were noted between 5 and 15 kHz, and at recording levels of -20 dB or lower. However, these test-instrument measurements are really moot since we were unable to make distinctions by ear alone.

While our two-head recorder and single NR-500 processor setup made it impossible to compare incoming and outgoing signals with the flip of a switch, any audible changes that might have been noted were certainly not obvious. We heard no modification of

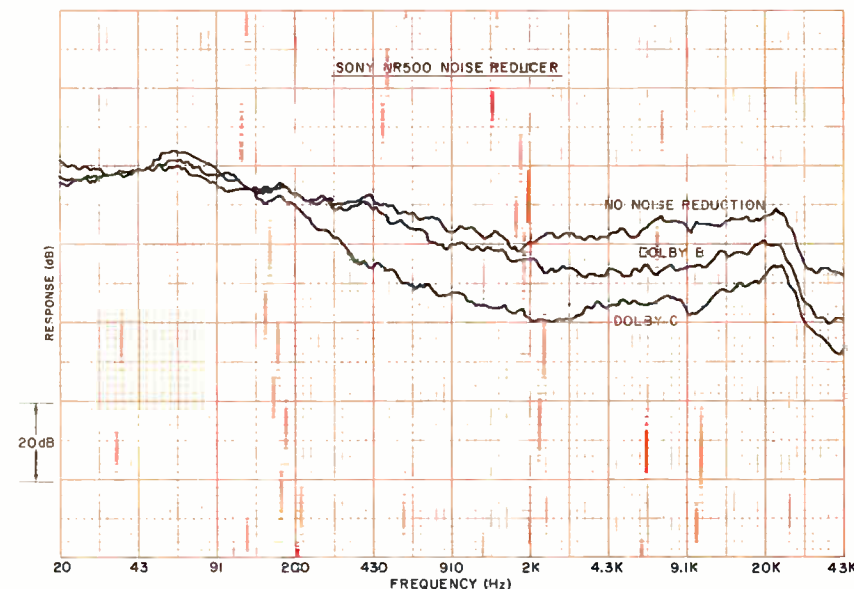

Noise spectrum playing blank tape on Nakamichi 500 recorder with EX tape.

the recorder's response with various musical programs. The noise reduction, however, was *very* obvious, especially when dubbing from good-quality, quiet discs at very low indicated levels on the recorder's meters (-10 to -20 dB). Recordings made at these low levels without noise reduction were intolerably noisy during playback.

The Sony NR-500 requires an encode input level of at least 77 mV (from the amplifier TAPE output) for proper operation, and delivers about 0.25 V of encoded signal to the recording inputs. During playback, the NR-500 should receive at least 77 mV from the recorder line outputs, and it returns approximately 0.44 V to the amplifier TAPE inputs. All of these levels are well within the normal operating range of most stereo system components. The LED system calibration indicators have a rated

level accuracy of ± 0.5 dB.

User Comment. When the original Dolby B noise-reduction system was introduced, more than 14 years ago, there were virtually no cassette (or open-reel) tape recorders equipped with it. During the several years it took for the tape recorder industry to build the Dolby system into their products, a number of companies marketed adapters so that the advantages of Dolby B could be enjoyed with existing tape machines.

Availability of the Sony NR-500 marks a parallel development. Every cassette deck today has Dolby B (or an equivalent), but just a few late models include Dolby C. The NR-500 makes Dolby C available at modest cost for anyone who now has a tape deck.

The Sony NR-500 works very well, as our tests show. However, switching

manually between the record and playback modes is a bit awkward, though with some familiarization the mode switching becomes routine.

Obviously, it would not be worthwhile to spend \$200 for this add-on feature if you own, say, a \$240 deck without Dolby C since you could buy a new machine in this price range with it. But if you own a costly cassette deck and wish to overcome dull highs when recording fine source material or do not want to risk tape saturation by recording at a high level in order to squeeze out that better fidelity, then the Sony NR-500 is a most welcome component. With some two-dozen cassette decks selling without Dolby C for upwards of \$600 only a year ago, not to mention such earlier expensive models, there are likely to be a lot of candidates for upgrading with this new product. —Julian Hirsch

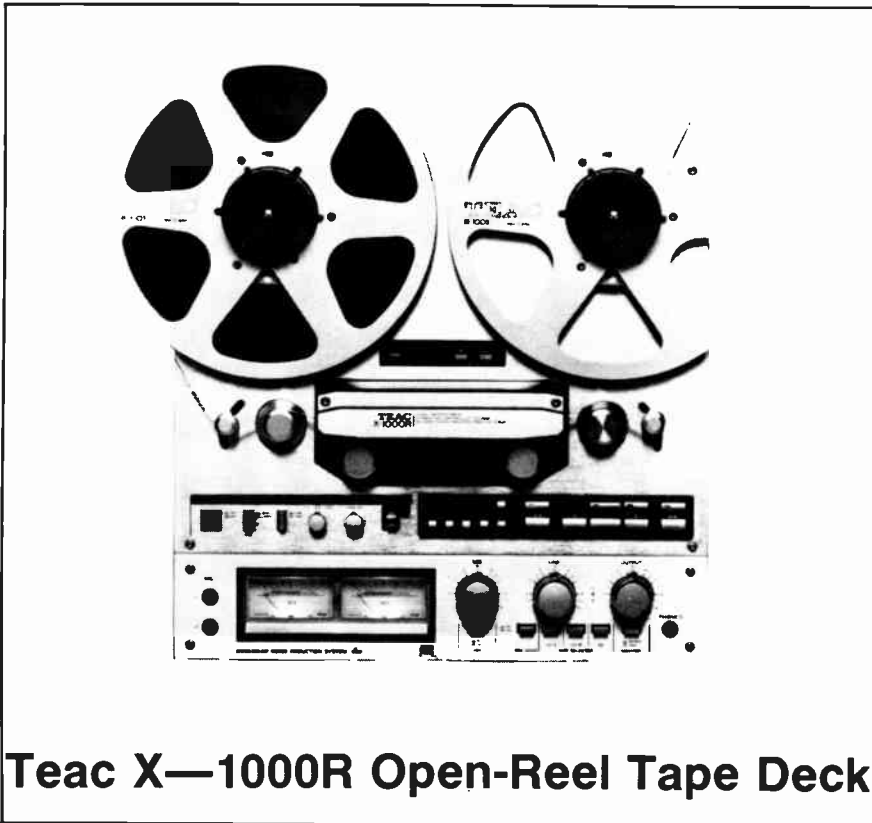

Teac X—1000R Open-Reel Tape Deck

- Teac X-1000R Open-reel Tape Deck
- Size: 17 x 17¼ x 10³/₈ inches
- Weight: 48½ pounds
- Price: \$1,400

THE Teac X-1000R is a fully bidirectional open-reel recorder designed to use both conventional tapes and the newly introduced EE ("Extra Efficiency") type on reel sizes up to 10½ inches. It also incorpo-

rates a dbx Type II noise-reduction system and operates at either 7½ or 3¾ ips in the regular home-stereo quarter-track format. The closed-loop, dual-capstan drive of the X-1000R uses a servo-controlled d.c. motor, and the capstan shafts are magnetically "floated" at the bottom to minimize low-frequency mechanical noise. Separate d.c. motors are used for the reels. A total of six heads (erase, record, and playback for each

direction) are employed, and the light-touch transport controls operate through solenoids under microprocessor control.

Unlike most tape decks, the five-digit electronic tape counter of the X-1000R can be set either to register tape footage or, more conveniently, to read out directly in hours, minutes, and seconds. In conjunction with PROGRAM, REPEAT, and CUE pushbuttons it can also be used to define a specific block of recorded material to be repeated or skipped within the reel. The counter is driven by an inertial roller on the right side of the head nest; a corresponding roller on the left side contains a sensing post to detect the presence of a foil strip to initiate the automatic-reverse sequence. An additional pair of spring-loaded tension arms is provided to smooth tape motion further, minimizing wow-and-flutter at the cost of making the threading of the tape slightly more tricky. Two pushbuttons permit the user to "search to zero" (STZ) or to a selected cue point (STC) at high speed. An electrically assisted braking system slows the tape gently to a stop at the desired points.

Green LEDs indicate the direction of tape travel at the two normal speeds, and red LEDs accompany the PROGRAM, REPEAT, PAUSE, RECORD, and DUPLI-SYNC buttons. This last is used only in conjunction with certain other Teac recorders for dubbing, which can also be done by conventional techniques. The RECORD LED begins flashing when a separate REC MODE switch is pressed to ready the system, and it remains on constantly while the recording is being made.

Separate concentric controls are provided for microphone and line inputs, which are monitored on a pair of VU-type meters calibrated from -20 to +5 VU. Another set of knobs adjusts the output simultaneously at the rear jacks and at the headphone connector. The REC MUTE button is provided with an AUTO SPACER control that varies the silent time between selections from 0 to 8 seconds. Pushbuttons for external timer control in either direction interact with the

setting of the AUTO REV switch, and a pull-out/turn knob (similar to the on-off/volume control on many TV sets) permits varying playback speed by ± 6 per cent to correct an off-pitch recording. Three push-buttons permit selection of typical LH-I, LH-II, and EE tapes, but without the option of fine-tuning bias and equalization. Additional buttons switch between source and monitor, dbx noise reduction in/out, high or low tape speed, and large or small (7- or 10 1/2-inch) reels. A tape-lifter defeat lever is included to hold the tape against the heads to facilitate editing.

The rear panel of the X-1000R contains the usual line-level input and output jacks, plus additional connectors for the Dupli-Sync function and an optional RC-100 remote-control accessory.

● **Laboratory Measurements.** While no test data were supplied with the X-1000R, Teac did provide the actual tapes used for factory adjustment of two of the three bias/

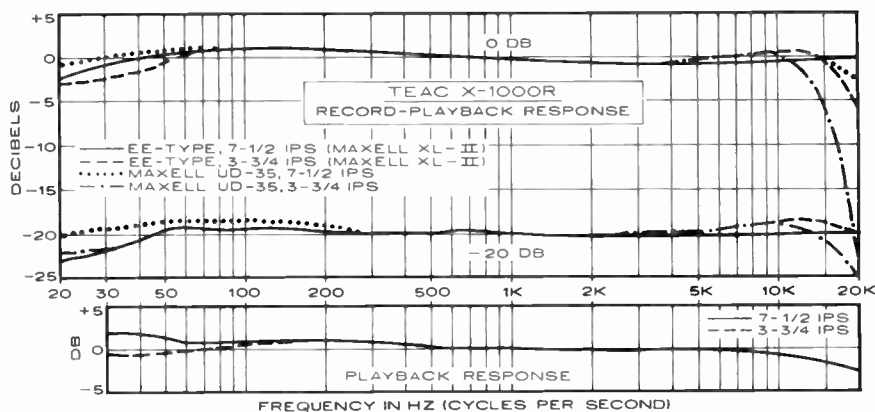

The upper curves indicate overall record-playback response at the manufacturer's indicated 0-dB recording level using the tapes designated on the graph. In the center are the same measurements recorded at -20 dB relative to the upper curves, a level conventionally used for tape-deck frequency-response measurements. Bottom curves show playback response from standard calibrated test tapes and indicate a deck's performance with prerecorded tapes.

Teac X-1000R Open-reel Tape Deck

● **Comment.** The Teac X-1000R is obviously a top-quality machine, and its inclusion of the dbx noise-reduction system gives it a dynamic range nearly equivalent to that of a digital recorder. Copying master tapes and recording pure tones at 3 3/4 ips produced a very slight grainy quality, but the 7 1/2-ips performance was excellent. And FM and disc copies made at either speed were just fine. Obviously, the Teac X-1000R is an excellent machine for the serious home recordist, and I recommend it strongly. —Craig Stark

equalization positions. These were Maxell XL-II (for EE) and Maxell UD35 (for LH-II), and I used them for my measurements. For the LH-I position I achieved the best results with 3M's 207.

Playback-equalization accuracy was measured using Magnetic Reference Laboratory test tapes. As shown in the accompanying graph, the response was exceedingly flat at both 7 1/2 and 3 3/4 ips. The very mild treble rolloff at 20 kHz for 7 1/2 ips undoubtedly reflects a slight azimuth difference between the playback head and test tapes. (The 3 3/4-ips tape stops at 10 kHz.)

Overall record-playback frequency response was impressively flat throughout the 20-Hz to 20-kHz range. At the 0-dB level the EE tape (Maxell XL-II) was superior to traditional formulations at the extreme high end, particularly at the 3 3/4-ips speed, where its response was very close to that of other tapes running at 7 1/2 ips. At the conventional -20-dB test level the advantage was 3 dB at 20 kHz. More impressive was the nearly identical frequency response of all the tapes when shifting speed from 7 1/2 to

3 3/4 ips. Frequency-response error induced by the dbx noise-reduction system was slight: within a ± 2 -dB range except at the lowest frequencies (below 40 Hz).

Distortion at a 0-VU input measured 0.3 per cent at 3 3/4 ips for the two Maxell tapes and 0.5 per cent for 3M 207. The overload margin (3 per cent third-harmonic distortion) was reached at input levels of +6.2

dB (3M 207), +7.6 dB (Maxell UD-35), and 10.5 dB (Maxell XL-II). At 7 1/2 ips the 0-VU figures were 0.2 per cent for Maxell UD-35, 0.3 per cent for 3M 207 and Maxell XL-II; their respective overload margins were +6.2, +10.4, and +5 dB.

Unweighted signal-to-noise ratios at 3 3/4 ips measured 56.3, 56, and 59.2 dB for the 3M 207, UD-35, and XL-II tapes, respec-

WE'LL LURE YOU WITH OUR PRICES...AND WIN YOU WITH OUR SERVICE!

THE J&R MUSIC WORLD AUDIO / VIDEO PRODUCT CATALOGUE

An indispensable **240 PAGE** guide to every major brand of audio, car stereos, tape decks, portables, accessories, video games, TV's, computers, every format blank tapes... **EVERY MAJOR BRAND** worth hearing or watching at **BEST PRICES NATIONWIDE.** All guaranteed factory sealed with original warranty. All ready for immediate shipment via exclusive **Computerized Express Mail Order Service.**

WHAT COULD BE BETTER?
 ●●●●●●●● **OUR CATALOGUE IS FREE!** ●●●●●●●●

FOR IMMEDIATE DELIVERY
CALL NOW (800) 221-8180 **IN NEW YORK (212) 732-8600**
TOLL FREE

J&R MUSIC WORLD
23 PARK ROW, DEPT. TR8, N.Y.C. 10038

WRITE IN NO. 5 ON READER SERVICE CARD

tively. Adding IEC A-weighting and dbx noise reduction, these figures improved to 84.2, 82.2, and 86.3 dB. At the 7½-ips speed the corresponding figures for the three tapes were: 61, 60, and 59.4 dB unweighted and without dbx, 88.2, 82.2, and 88.5 dB with A-weighting and dbx noise reduction. All of these figures are outstanding for a quarter-track analog open-reel recorder/

reproducer.

Wow-and-flutter measured 0.08 per cent and 0.04 per cent (wrms) in the forward and reverse directions at 3¾ ips (0.12 and 0.07 per cent on the more stringent DIN standard). At 7½ ips the forward/reverse measurements were 0.03 and 0.02 per cent (wrms) and 0.08 and 0.04 per cent (DIN), again very impressive performance.

Fast-forward and rewind times averaged 56.5 seconds for a 7-inch reel of 1,200 feet and 172.5 seconds for a 3,600-foot 10½-inch reel. A line-level input signal of 55 millivolts (mV) was necessary to achieve a 0-VU indication with an output of 0.8 volt. The microphone input required 0.19 mV to achieve 0 VU and would accept up to 0.015 volt before overload.



Technics SV-P100 Digital Cassette Recorder

- Technics SV-P100 Digital Cassette Recorder
- Size: 17 x 10¹⁵/₁₆ x 13³/₈ inches
- Weight: 40 pounds
- Price \$3,000

THE Technics SV-P100 is the first integrated home *digital* recorder to be reviewed in these pages and possibly anywhere. Built to the recently adopted EIAJ (Electronic Industries Association of Japan) standard for consumer digital audio, it employs VHS videocassettes and is a self-contained, one-piece unit.

Audiophiles who have followed the progress of the industry have long known that home digital tape machines were coming, but probably few readers are aware of the basic principles by which a deck such as the SV-P100 operates. In a regular *analog* open-reel or cassette recorder the attempt is made to produce tracks of magnetic fields on the tape that correspond, one-to-one, with the audio material being recorded. Even the best professional systems fail in this attempt, specific problem areas being the handling of high-level high frequencies, mechanical imperfections that lead to wow

and flutter, and inadequate signal-to-noise ratio.

A *digital* deck such as the SV-P100 operates on very different principles. Instead of trying to record the audio waveform as analogous magnetic fields, the SV-P100 deliberately *samples* the audio level some 44,056 times each second and records each sample as a fourteen-"bit" digital binary number. This technique provides an available dynamic range of 84.3 dB. No less important, distortion is kept under 0.01%.

In theory, the high-frequency response of a digital recorder is equal to half its sampling rate, though the necessary input and output filters reduce this somewhat. On the other hand, because the digital signals are "clocked"—synchronized with an extremely accurate quartz-crystal reference oscillator—mechanically generated wow-and-flutter (and attendant FM-modulation noise) are essentially eliminated.

The front panel of the SV-P100 is designed to convey a sense of familiarity to the regular cassette user. Pressing the OPEN/CLOSE button swings open a wide-window door into whose rear slides the VHS cassette is inserted. The door is closed auto-

matically. While there is a light within the cassette well, it is not sufficient to illuminate either the cassette's label or tape.

The familiar logic-activated solenoid pushbuttons for RECORD, FAST FORWARD, PLAY, STOP, REWIND, and PAUSE are provided, together with a SEARCH button that is used to locate (digitally) preselected spots on the tape for subsequent playing. There are actually three memory systems built into the SV-P100. The LOCATE buttons operate similarly to the memory-rewind/play functions of a regular cassette deck. One of the two auxiliary tape tracks, which do not in any way interfere with the audio, is used for "search" signals that may be activated at any point but are automatically inserted when a recording begins. These allow one to go forward or backward in the high-speed modes to find a desired selection. A "jump" command may be placed on the other auxiliary track, instructing the deck to skip unwanted selections. Both the jump and search signals may be erased by a CLEAR button during playback.

The record-level indicator of the SV-P100 consists of two thirty-two-element displays calibrated from -40 to +5 dB. It may be switched to show either the audio level or the pre-emphasized signal going to the tape. A third switch activates the indicator when in play mode to examine the frequency and severity of tape dropouts.

The microphone inputs cannot be mixed with the line inputs, but the user may select a direct digital input if he has a second EIAJ-standard deck and wishes to make a maximum-fidelity copy. In addition to the left- and right-channel recording-level controls there is a master fader (it operates on both channels simultaneously in either record or play mode) to facilitate easy fade-in/out operation. Provisions for both external timer and remote control are included.

The rear panel of the SV-P100 contains the customary line-input/output phono jacks plus the pair designed for digital dubbing. Access to a tracking control to use with tapes recorded on another machine is also provided, as are switches for alternate a.c. line voltages and a warmup delay.

● **Laboratory Measurements.** Because of its digital configuration, the Technics SV-P100 precluded many of the tests I normally make on a tape deck. There are no calibrated playback frequency-response tapes available, for example, and trying to measure wow and flutter was an exercise in futility—all I could detect on a record-playback basis was the residual readings of my meter (0.008 per cent weighted rms, 0.01 per cent

DIN peak-weighted). And with digital recording there are no brand-to-brand differences in tape-bias requirements that would affect treble response.

The third-harmonic distortion from a standard 315-Hz tone at an indicated 0-dB level measured only 0.008 per cent—again, about the residual of my wave analyzer. At a +2-dB input, however, distortion was up to 4.8 per cent, and by +4 dB it rose to more than 16 per cent. What this indicates is that digital recording is extraordinarily good within its defined limits, but there is little margin for error. Fortunately, the signal-to-noise ratios available enable you to record well under 0 dB without encountering objectionable hiss (or its digital equivalent, "quantization noise"). The peak-reading display of the SV-P100 was fully adequate to the task of monitoring levels as critically as required.

I used the output at 0 dB as my reference point for measuring signal-to-noise ratios. Unweighted, the S/N of the SV-P100 registered a spectacular 80.3 dB, improving to 82.2 dB and 84.5 dB with CCIR/ARM and IEC A-weighting, respectively. This, by the way, is without the use of a noise-reduction system, which would be superfluous.

A signal level of 150 mV was required to produce a 0-dB indication on the SV-P100's indicators, and the maximum output voltage with that input was a little over 2 volts. Using the microphone inputs, a 3.5 mV sig-

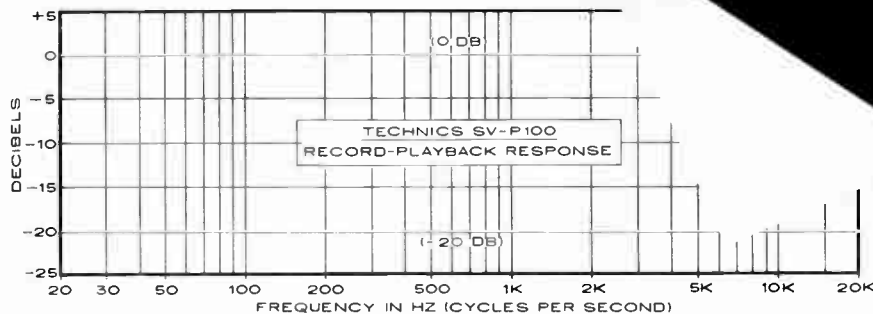

Insofar as flat lines can be called "curves," these are drawn to the normal vertical scale.

nal was required for 0 dB at full gain, and input overload did not occur until 210 mV was applied.

● **Comment.** To evaluate—and appreciate—a digital recorder such as the SV-P100 there is only one really satisfactory "test signal": the live performance of music. It is pointless to ask whether a deck can make satisfactory dubs of FM and discs when the deck is far better than any source could possibly be. Technics was kind enough to lend me some of their digital master tapes made on the SV-P100 and some recorded on a previous prototype; impressive as they were, the only way I could be satisfied was to "roll my own" in a re-

ording session.

Shure lent me a pair of their excellent SM-81 condenser microphones (and a stand), and Technics supplied one of their professional Ramsa WR-130 mixers so I could feed the SV-P100 (electrically) with a signal worthy of it. Flutist Sydney Goldsmith and classical guitarist Lisa Hurlong, both professional musicians, kindly consented to be my "test signals." Subject to commercial vagaries, you'll one day be able to hear the results for yourselves on LP or tape; for now I can only report that it was the cleanest sound I have ever recorded, and I've recorded a lot. To me, that says enough about the SV-P100's capabilities.

—Craig Stark

... LIVE RECORDINGS

(Continued from page 18.)

and a ground or "shield" lead. Most professional-type audio connections are "balanced." In this case there are three conductors: two hot leads carrying *one* audio signal in anti-phase (when one lead's voltage rises, the other's falls by the exact same amount), and a ground lead. The purpose of this arrangement is to reduce the effects of long cable runs. An interfering signal is likely to be picked up *in-phase* by the two signal-carrying leads so that the interfering voltage rises and falls in the same direction, and with the same level in each hot lead. When the noise signals reach the microphone inputs, the signals on the two hot leads are subtracted, the result is the interference gets cancelled. If you want to use professional microphones, you'll have to convert their balanced outputs to unbalanced ones, and you'll also have to use three-conductor cable and 3-pronged XLR-type connectors.

The least expensive way to get the balanced output of a professional mic into the unbalanced mic input of a consumer tape recorder is to use an adapting transformer. They can be purchased with a 3-prong XLR-type jack on one end and a standard 1/4-inch phone jack on the oth-

er. Many of these transformers also convert a low-impedance mic output into a high-impedance one. While this is not essential for many of today's mic inputs, the bonus is that it increases the output voltage of the microphone by a substantial amount and thereby lessens the noise requirements of the microphone amplifiers. Such impedance-matching transformers should be kept as close as possible to the tape recorder. Some electret and most condenser mics require a power supply for proper operation; connect the power supply between the microphone output and the adaptor transformer.

To sum up then, there are three common combinations of mic impedance and output configuration in general use:

1. low-impedance, balanced output (professional equipment)
2. low-impedance, unbalanced output (semi-professional and much consumer equipment).
3. high-impedance, unbalanced output (low grade consumer equipment).

The best bet are low-impedance, balanced-output microphones used in combination with the necessary multi-conductor cables, connectors, and matching transformers. ◇

**STEREO
CORPORATION
OF AMERICA**

**TRY & BEAT
OUR PRICES!**

**CALL TOLL-FREE
800-221-0974**

Mon - Sat 9AM - 5:30PM E.S.T.
or use our "Nite Owl" line
M - F 5:30 - 10PM E.S.T.
in N.Y. Call (212) 253-8888

**LET US BEAT ANY
PRICE YOU CAN FIND!**

Over 80 major lines
of audio-video components.
Write or call for a FREE flyer.

**STEREO CORPORATION
OF AMERICA**

Dept. TR
1629 Flatbush Avenue
Brooklyn, New York 11210
MASTERCARD & VISA ACCEPTED

CIRCLE NO. 12 ON READER SERVICE CARD

1

CASSETTE TAPE MACHINES

AIWA

AD-3800U Stereo Cassette Deck

Stereo cassette deck with D.A.T.A. (Digital Automatic Tape Adaptation) microcomputer system and A.D.M.S. (Automatic De-Magnetizing System). Features exclusive tension-stabilized dual-capstan system; metal tape compatibility; Dolby B and C noise-reduction systems;



AIWA DX-combination 3-head system; dc recording amplifier; multiple-operation digital electronic display; auto repeat memory and LED; IC logic transport controls with cue-and-review operation; 3-color 16-LED peak signal displays with peak-hold. Wow and flutter 0.025% wrms; S/N ratio 68 dB \$595
AD-3700U. Similar to AD-3800U except no D.A.T.A. microcomputer system, dc recording amplifier. Includes automatic record mute. 12-LED displays. Wow and flutter 0.028% wrms \$495

AD-3500U Stereo Cassette Deck

Front-loading stereo cassette deck with 3-head, soft-touch-controlled transport with cue and review, and Dolby B and C noise-reduction circuits. Features A.D.M.S. (Automatic De-Magnetizing System); built-in new-style control panel display of function and mode settings; 3-color, 12-LED signal displays with peak hold; LH-bias fine adjust control. Wow and flutter 0.038% wrms \$395.

AD-3300U Stereo Cassette Deck

Slim-design, automatic front-loading stereo cassette deck with Dolby B and C noise-reduction systems. Features AIWA's unique LED remaining-tape time display; soft-touch IC logic transport controls; new auto-tune convenience (preset) record level for FM recording and 19-kHz MPX filter; LH-bias fine adjust control; 3-color 12-LED peak signal display. Wow and flutter 0.60% wrms; S/N ratio 74 dB with metal tape \$340

SD-L80U Stereo Cassette Deck

Metal-compatible stereo cassette deck with Dolby B and C noise-reduction systems and 12-point multi-color LED peak level displays. Features timer record/playback selector switch; oil-damped eject; front-panel headphone jack; servo-controlled dc motor; click-touch IC-logic transport controls. Wow and flutter 0.032% wrms \$340

SD-L60U Stereo Cassette Deck

Stereo cassette deck with new style automatic front-loading system. Features feather-touch IC-logic transport controls; LED tape time-remaining display; 3-color LED signal-level displays; Dolby B noise-reduction system; metal-tape compatibility. Wow and flutter 0.06% wrms \$340

SD-L50U Stereo Cassette Deck

Metal-tape-compatible stereo cassette deck with Dolby B noise-reduction system. Features timer standby; oil-damped eject; servo-controlled dc motor; 12-LED signal-level display; soft-touch IC-logic transport controls; rec-sync operation; automatic rewind/repeat; front panel microphone and headphone jacks. Wow and flutter 0.04% wrms \$340

AKAI

GX-F95 Stereo Cassette Deck

Stereo cassette deck with concealed cassette well, Dolby B noise-reduction system, 4-digit tape counter, and Super GX combination record/play tape head. Features tape/source monitoring; computerized Bias Equalization and Sensitivity Tuning (B.E.S.T.) system for all tape formulations; built-in memory; full-logic feather-touch transport controls; 24-segment 2-color fluorescent switchable peak/VU meters with peak hold; electronic tape/real-time counter; standby blinker. Wow and flutter 0.025% wrms; frequency response 20-21,000 Hz ± 3 dB with metal tape; S/N ratio > 72 dB A weighted with Dolby on, metal tape; distortion $< 0.6\%$ at 1 kHz, 0 VU with metal tape; 17.3"W \times 14.2"D \times 6.4"H; 28.7 lb \$1195

GX-F91 Stereo Cassette Deck

Deluxe computer-controlled stereo cassette deck with



Dolby B and C noise-reduction systems. Features Super GX record/play heads; 3-head, 2-motor full-logic transport system; quartz-locked direct-drive, double-capstan closed-loop system; Quiet and Quick mechanism; auto tape selector; auto tape tuning with adjustable bias; output and headphone level controls; dc servo amplifier; switchable peak/VU meters; digital real-time tape counter; automatic play; IPLS; Intro Scan; automatic fader; automatic record mute; automatic record cancel. Wow and flutter $< 0.025\%$ wrms; frequency response 15-21,000 Hz ± 3 dB with metal tape; S/N ratio no NR/Dolby B/Dolby C 60/70/80 dB; distortion $< 0.7\%$; \$750

GX-F66RC Stereo Cassette Deck

Computer-controlled auto-reverse stereo cassette deck with Dolby B and C noise-reduction systems. Features automatic reverse in both record and play; quick-reverse mechanism; automatic play; continuous play; random program search; blank search; Intro Scan; automatic tape selector; twin-field Super GX head; automatic record mute; 16-segment bargraph meters; electronic digital tape counter. Wow and flutter 0.035% wrms; frequency response 20-19,000 Hz ± 3 dB with metal tape; S/N ratio no NR/Dolby B/Dolby C 60/70/80 dB with metal tape; distortion $< 0.7\%$ \$575

GX-F71 Stereo Cassette Deck

Computer-controlled stereo cassette deck with Dolby B and C noise-reduction systems. Features Super GX heads; 3-head, 2-motor double-capstan-closed-loop system; quiet and quick mechanism; automatic tape tuning; automatic tape selector; dc amplifier; automatic monitor; direct-drive; time record with auto tape tuning; Intro Scan; IPLS; automatic fader; power eject/direct lead-in system; auto record cancel; 18-segment FLD bargraph meters; electronic digital time/tape counter. Wow and flutter 0.03% wrms; frequency response 20-21,000 Hz ± 3 dB with metal tape; S/N ratio no NR/Dolby B/Dolby C 60/70/80 dB; \$450

CS-F39R Stereo Cassette Deck

Bidirectional record/play stereo cassette deck with Dolby B and C noise-reduction systems. Features quick reverse; 2 motors; full-logic feather-touch transport controls; automatic play; IPLS; 12-segment FL meters; automatic continuous play; 3-position tape selector with metal capability; automatic record mute. Wow and flutter 0.04% wrms; frequency response 26-19,000 Hz ± 3 dB with metal tape; S/N ratio no NR/Dolby B/Dolby C 60/70/80 dB; distortion $< 0.7\%$ \$375

GX-F31 Stereo Cassette Deck

Computer-controlled stereo cassette deck with Dolby B and C noise-reduction systems. Features twin-field Super GX head; automatic tape selector; dc amplifier; direct drive; quiet and quick mechanism; Intro Scan; IPLS; 2 motors; power eject/direct lead-in system; automatic record cancel; maximum input level indicators; electronic digital tape counter. Wow and flutter 0.035% wrms; frequency response 20-19,000 Hz ± 3 dB with metal tape; S/N ratio no NR/Dolby B/Dolby C 60/70/80 dB \$300

CS-F21 Stereo Cassette Deck

Stereo cassette deck with Dolby B and C noise-reduction systems. Features automatic play; HD head; metal-tape capability; feather-touch transport controls; record mute; 12-segment FLD bargraph meters; remote-control jack. Wow and flutter 0.04% wrms; frequency response 30-18,000 Hz ± 3 dB with metal tape; S/N ratio no NR/Dolby B/Dolby C 58/68/78 dB; distortion $< 0.8\%$ \$250

BANG & OLUFSEN

Beocord 9000 Stereo Cassette Deck

Top-loading stereo cassette deck with automatic computer-controlled calibration that automatically adjusts for specific tape formulation used. Features Dolby B and C noise-reduction and Dolby HX (headroom-extension) systems; double Sendust/ferrite tape head with separate gaps for record and playback; manual switching system for normal/CrO₂/metal tape formulations; special low-noise playback amplifier; -20 to $+6$ dB record/playback peak signal-level meters; automatic demagnetization; minutes/seconds tape counter; tape-end indicator; single-motor/capstan drive system. Wow and flutter DIN/wrms $< 0.1\%$ / $< 0.045\%$; frequency response 10-25,000 Hz ± 3 dB referred to 250 nWb/m, -20 dB, 20-20,000 Hz ± 1.5 dB all tape formulations; S/N ratio Dolby B/C



Sony is about to widen your ideas of audio tape.

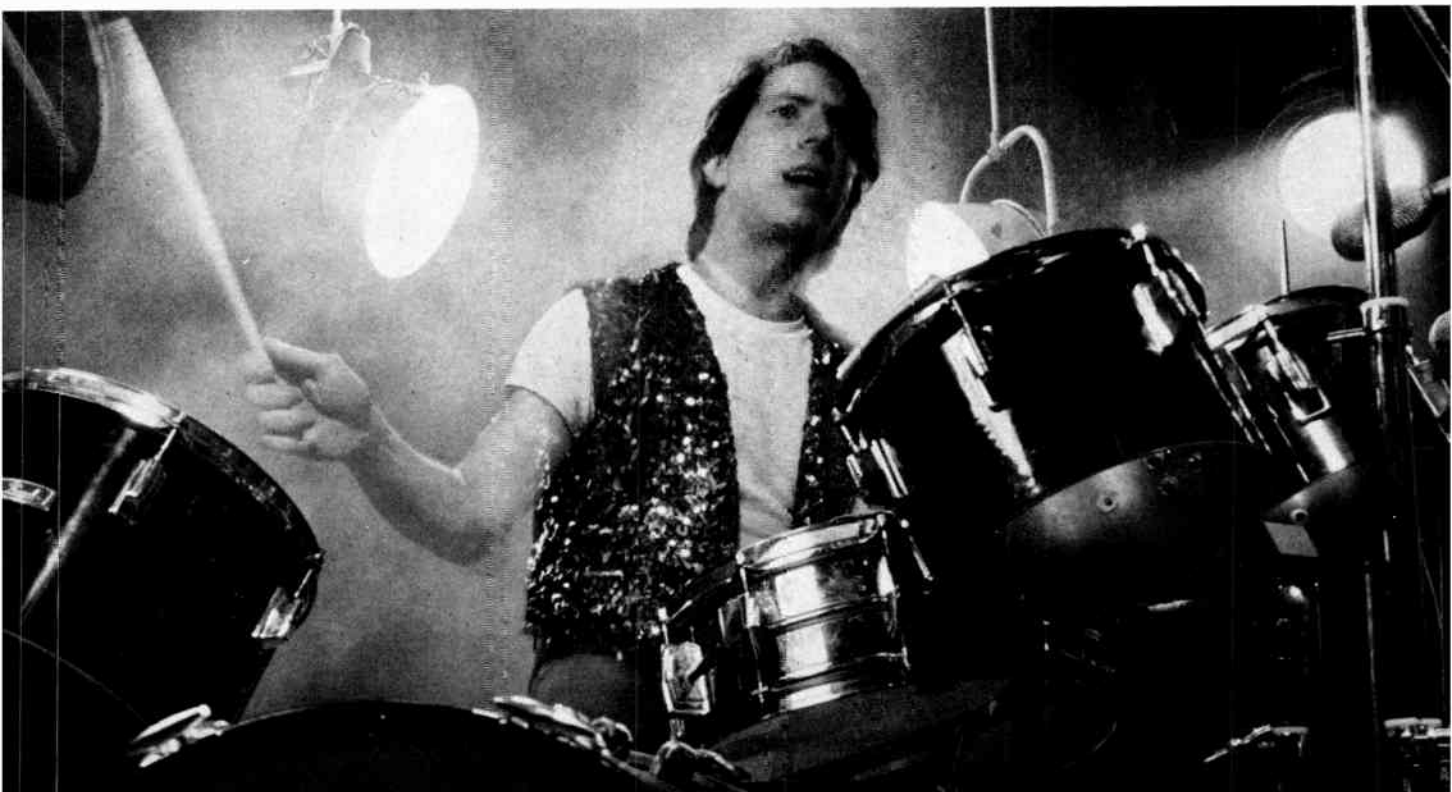

INTRODUCING UCX-S WITH WIDE FIDELITY SOUND.

Sony's revolutionary UCX-S has the widest dynamic range of any high-bias tape; it has expanded recording capacity.

We call it Wide Fidelity Sound.[™]

With UCX-S, you can record at higher volume levels with less distortion than any other high-bias tape.

UCX-S has unsurpassed frequency response in the low and middle ranges. And at the very delicate high frequency



ranges, its enhanced responsiveness gives exceptionally beautiful high notes. The incredible specifications include

Retentivity and Squareness higher by far than any other high-bias tape. Retentivity: 1800 Gauss. Squareness: 93%, an astounding figure.

But the real test comes when you lean back and listen. You'll hear everything with more clarity than you've ever heard before on a high-bias tape. On Sony UCX-S, with Wide Fidelity Sound. **SONY.**

© 1982 Sony Tape Sales Co., a Div of Sony Corp. of America. Sony is a trademark of Sony Corp. Wide Fidelity Sound is a trademark of Sony Corp. of America.

1

CASSETTE TAPE MACHINES

68/79 dB Scotch Metafine and Sony FeCr, 70/80 dB BASF chrom II, 64/74 dB BASF LHI tape; channel separation >40 dB at 1 kHz; input sensitivity/impedance 0.4mV/47k ohms radio, 15 mV/22k ohms line, 0.15 mV/3k ohms mic, 40 mV/22k ohms



Aux; output level/impedance 500-2000 mV/5/6k ohms radio, 10 V maximum/56 ohms headphones; power consumption 50 W maximum; fast-wind time 70 seconds with C60 cassette; 20 $\frac{7}{8}$ "W \times 11 $\frac{1}{4}$ "D \times 5 $\frac{1}{2}$ "H; 17 lb. \$1800

Beocord 8002 Stereo Cassette Deck

Top-loading stereo cassette deck with Dolby B noise-reduction and Dolby HX (headroom-extension) systems. Features automatic normal/CrO₂/metal bias selection; real-time calibration system that gives index to music in minutes and seconds; automatic computer-controlled search; single-gap record/play head; automatic demagnetization; stop function that places 4-second noise-free pause between recordings; timer start/stop function in both record and playback. Wow and flutter <0.045% wrms; frequency response 20-20,000 Hz \pm 3 dB; S/N ratio Dolby on/off >68/>60 dB metal, >66/>58 dB CrO₂, >64/>56 dB normal tape; channel separation >35 dB; power consumption 50 W maximum; fast-wind time 70 seconds with C60 cassette; 20 $\frac{7}{8}$ "W \times 11 $\frac{1}{4}$ "D \times 5 $\frac{1}{2}$ "H; 16.5 lb. \$1100

Beocord 8000 Cassette Recorder

Dual-microcomputer-controlled metal-compatible top-loading cassette recorder with Dolby B noise-reduction system and single Sendust combination head containing Sendust alloy poles and bedding. Features electronic time measurement of tape travel in all operating modes, shown on illuminated digital display—precise measurement accomplished by microcomputer calibration of inserted cassette tape based on varying tape lengths, types, and thicknesses of magnetic coating (calibration data erased upon ejection); electronically-controlled automatic search locates any time-indexed selection through pushbutton operation—user can also instruct recorder to hold tape until otherwise specified and when to turn record or playback function on or off; automatic memory returns tape to beginning of last recorded segment; automatic 4-second pause effected from stop button; electronically-controlled dual 8-LED peak program meters monitor signal strength; built-in electronic timer shows correct time when TIME SET is pressed; automatic demagnetization of tape head. Fast-wind time 70 seconds with C60 cassette; wow and flutter \pm 0.1%; frequency response 30-16,000 Hz \pm 2.5 dB (chrome), 63 dB (ferro); input sensitivity/impedance 1mV/10k ohms (radio), 120 mV/1.2M ohms (aux), 0.1 mV/2.2k ohms (receiver), 9 V/56 ohms (headphones); 20 $\frac{7}{8}$ "W \times 11 $\frac{1}{4}$ "D \times 5 $\frac{1}{4}$ "H. \$995

Beocord 2400 Stereo Cassette Deck

Top-loading stereo cassette deck with Dolby B noise-reduction system and single Sendust record/play

tape head. Features memory; bias touch controls; 2 illuminated peak signal-level VU meters; channel balance control; above-surface-mount tape function keys; 3-digit tape counter with memory. Wow and flutter 0.15% DIN; frequency response 30-16,000 Hz \pm 3 dB; S/N ratio 66 dB with metal tape, Dolby on; channel separation 35 dB; input sensitivity/impedance 50 mV/470k ohms line, 0.3 mV/33k ohms mic (DIN); output level/impedance 700 mV/10k ohms; 15 $\frac{1}{4}$ "W \times 10"D \times 3 $\frac{1}{4}$ "H. \$550

Beocord 1600 Stereo Cassette Deck

Stereo cassette deck with peak-reading record indication after Dolby noise reduction and record boost. Features automatic tape-head demagnetization; Sendust record/play head; balance control for record levels; automatic normal/chrome and chrome-equivalent tape selection. Frequency response 30-16,000 Hz \pm 2.5 dB with built-in MPX filter; S/N ratio 68 dB; channel separation 35 dB. \$550

BENJAMIN ELECTROPRODUCTS

Benjamin RAC 10 Mark II Cassette Changer

Automatic cassette changer plays both sides of up to 10 cassettes in succession without interruption for up

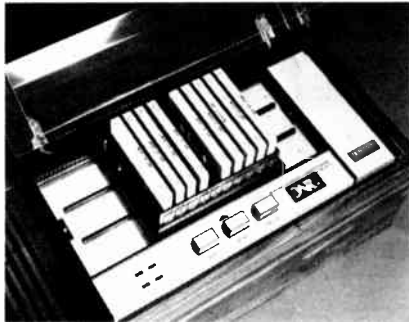

to 15 hrs; adjustable stereo output; monitor speaker/amplifier with level control; frequency range 25-14,000 Hz; S/N ratio >50 dB; 19.5"W \times 8"D \times 7"H; 18.7 lb. \$850
RAC-10 Mark II DNR. Same as Mark II except has dynamic noise-reduction system built in for 60 dB S/N ratio. \$900

DENON

DR-F7 Stereo Cassette Deck

Front-loading, 3-head stereo cassette deck with Dolby C noise-reduction system, Tape Tension Servo II, and Flat Twin direct-drive capstan motor. Features all-dc discrete audio circuitry; Flat Tuning (infinitely variable auto-bias) system or selectable preset bias; tape/source monitor switch; separate input and output lev-



el controls; LED peak indicators and dual VU meters; 3-digit tape counter; timer record and play buttons; provision for wired remote control (RC-57); pause/mute function. Frequency range 25-21,000 Hz metal, 30-20,000 Hz CrO₂; S/N ratio >73 dB Dolby C on; wow and flutter <0.027% wrms; crosstalk -65 dB at 1 kHz; power consumption 36 W at 117 V ac; fast-wind time 90 seconds with C60 cassette; 17.4"W \times 12.8"D \times 4.7"H; 16.5 lb. \$500
DR-F8. Same as DR-F7 but with addition of quartz-lock capstan motor and gold-plated input and output connectors. \$575
DR-F6. Same as DR-F7 but without FTS auto-bias. \$425

DR-240 Stereo Cassette Deck

Moderately priced stereo cassette deck with IC-controlled full-logic transport, separate capstan and reel-drive motors, and automatic cueing system. Features nonslip reel-drive mechanism; Sendust alloy record/

play head; VU-type signal-level meters and 3-LED peak-indicating array; normal/chrome/FeCr/metal tape selector; cue/review; switchable MPX filter; dc-servo-controlled capstan and dc-powered reel motors. Wow and flutter 0.04% wrms; frequency response \pm 3 dB 30-15,000 Hz normal, to 17 kHz CrO₂, to 19 kHz metal tape; S/N ratio >65 dB with Dolby on; fast-wind time 90 seconds with C60 cassette; 17.1"W \times 11.8"D \times 4.6"H; 15.4 lb. \$350

DUAL

C844 Stereo Cassette Deck

Front-loading, metal-compatible stereo cassette deck with Dolby B and C noise-reduction systems and 2-speed (1 $\frac{1}{4}$ and 3 $\frac{3}{4}$ ips), 2-motor, dual-capstan closed-loop drive system. Features Sendust record/play and ferrite erase heads; direct load-and-lock transport with photoelectric stop switches; automatic head shield; electronic fade/edit with playback monitoring; electronic 4-digit tape counter with memory set, stop, play; automatic music finder; auto spacing; auto repeat; 6-position tape selector; equalized VU meters; mic/line mixing; switchable MPX filter; provision for optional extended timer and 12-command remote controller. Specifications at 1 $\frac{1}{4}$ ips: frequency response 20-19,500 Hz with ferrichrome tape, to 20 kHz with metal tape \pm 3 dB; S/N ratio 76 dB with ferrichrome tape, Dolby C on; harmonic distortion 0.04%; wow and flutter 0.03% wrms. Specifications at 3 $\frac{3}{4}$ ips: frequency response 20-20,000 Hz with ferrichrome and metal tapes; S/N ratio 78 dB with ferrichrome and metal tapes, Dolby C on; harmonic distortion 0.3%. \$700

C828 Stereo Cassette Deck

Front-loading, metal-compatible slim-line stereo cassette deck with Dolby B noise-reduction system, automatic reverse in record and playback with friction-resistant 4/4-track M + X head and double-gap ferrite erase head, and 2-motor dual-capstan drive system. Features direct load-and-lock transport with photoelectric stop switches; microcomputer-controlled drive function using solenoids and a logic system; automatic head shield; switchable MPX filter; 4-position tape selector; one-control record-ready system; equalized peak-indicating record-level system; 3-digit tape counter with memory; illuminated cassette well. Frequency response \pm 3 dB 30-19,000 Hz with metal tape; wow and flutter 0.04% wrms. \$500
C822. Similar to C828 except no auto reverse \$375

C814 Stereo Cassette Deck

Front-loading slim-line stereo cassette deck with Dolby noise-reduction system, direct load-and-lock transport, and electronic tape-motion sensor/protector. Features friction-resistant M + X record/playback head with automatic protective head guard; soft-touch drive control with direct-mode switching; switchable MPX filter; automatic tape-type switch-over; automatic input selector; peak-indicating equalized meters with double scales. \$300

FISHER

DD450 Stereo Cassette Deck

Three-head, direct-drive cassette deck with separate tape-hub motor, dual-process Dolby B noise-reduction system, and full-logic IC solenoid transport controls. Features 3 Sendust heads; normal/CrO₂/FeCr/metal tape switching with separate fine bias control; memory/auto-repeat function; fluorescent peak-level auto-hold meters. Wow and flutter 0.04% wrms; frequency response \pm 3 dB 30-14,000 Hz normal, to 16 kHz CrO₂ and FeCr, to 18 kHz metal tape; S/N ratio 62 dB with Dolby on; THD 1.5% at 0 VU; fast-wind time 90 seconds for C60 cassette; 17"W \times 10 $\frac{1}{2}$ "D \times 4"H; 15.5 lb. \$580

DD300 Stereo Cassette Deck

Front-loading metal-compatible stereo cassette deck with Dolby B noise-reduction system, direct-drive dc servo capstan motor, and 2 MX/ferrite heads. Features normal/FeCr/CrO₂/metal tape selector; dual VU meters with 3-LED peak indicators; input level control with line/mic input selector; output level control; auto repeat memory; 3-digit tape counter with reset; record mute; electronic solenoid feather-touch con-

The Kyocera D-801 Cassette Deck with 3 motors and a direct driven dual capstan...

With only 0.02% WRMS wow and flutter.

If you think 3 motors impress you, think of what they can do for tape performance. One drives our dual capstans to insure constant and highly accurate speed with remarkable low wow & flutter of 0.02%. A second motor drives both the take-up and feed reels while the third motor gently positions the record/playback head against the tape surface. An innovative approach resulting in accurate head-to-tape positioning and optimal head azimuth alignment. But motors alone do not insure top

performance. That's where both Dolby* B and C noise reduction circuits come in, along with a Sendust alloy tape head; electromagnetic braking on both take-up and feed reels; selectable bias and equalization for all types of tapes; 30-20,000 Hz response range; full LED function indication; feather-touch controls; APMR for automatic program search; auto stop; auto repeat, memory and a full bank of operational controls concealed behind a flip-down access panel: plus the convenience of a

4-digit LED electronic timer/counter for precise elapsed time, remaining time, stopwatch and memory stop and registering time and/or counter reference of recorded programs... and more.

But our most impressive feature awaits at your local audio retailer... a demonstration of the D-801...it's just one of a very impressive list of distinguished audio components and systems from Kyocera...where the future is now!



Cybernet[®]
A Division of *Kyocera*

*Dolby is a reg. tm. of Dolby Laboratories, Inc.
© 1982 CYBERNET

Seven Powder Horn Drive, Warren, N.J. 07060-0227 U.S.A. Telephone: (201) 560-0060 Telex: 642529 CYBERNET WARE.

1 CASSETTE TAPE MACHINES

trols with LEDs; timer standby with external audio timer. Wow and flutter 0.04%; frequency response 30-18,000 Hz \pm 3 dB with metal tape; S/N ratio 62 dB with Dolby; 17 $\frac{1}{2}$ "W \times 9 $\frac{1}{2}$ "D \times 5 $\frac{1}{4}$ "H \$350
DD280. Similar to DD300 but minus FeCr tape position, auto repeat memory, and output level control; has separate left/right input level controls; metal tape frequency response 30-15,000 Hz \pm 3 dB; optional RC 80 full-function remote control unit available; 17 $\frac{1}{2}$ "W \times 10 $\frac{1}{2}$ "D \times 4"H \$300

CR150 Stereo Cassette Deck

Studio Standard 3-head cassette deck with dual-process Dolby noise-reduction system, power-assisted soft-touch transport controls, and bias fine-adjustment control. Features MPX filter; independent left and right input level controls; output level control; normal/CrO₂/metal tape selectors; dual lighted VU meters plus peak-level LEDs; tape/source monitoring, MPX filter; Wow and flutter 0.06% wrms; frequency response \pm 3 dB 40-14,000 Hz normal, to 16 kHz CrO₂, to 18 kHz metal tape; S/N ratio 62 dB, Dolby on; THD 1.5% at 0 VU; fast-wind time 90 seconds with C60 cassette; 17 $\frac{1}{2}$ "W \times 10 $\frac{1}{2}$ "D \times 4 $\frac{1}{4}$ "H; 13 lb \$350

DD350 Stereo Cassette Deck

Studio Standard direct-drive cassette deck with full-logic transport controls, metal-tape compatibility, Dolby B noise-reduction system, peak indicators, and timer standby. Features separate motor for tape reels; normal/CrO₂/metal bias/EQ switches; MX/ferrite heads; 2 large dual-scale VU meters; 3 peak-level LED indicators; timer standby switch; low-impedance microphone inputs. Wow and flutter 0.04% wrms; frequency response \pm 3 dB 40-14,000 Hz normal, to 15 kHz CrO₂ and metal tapes; S/N ratio 62 dB with Dolby on; THD 1.5% at 0 VU; fast-wind time 90 seconds with C60 cassette; 17 $\frac{1}{2}$ "W \times 10 $\frac{1}{2}$ "D \times 4"H; 13 lb \$300

CR130 Stereo Cassette Deck

Studio Standard cassette deck with power-assisted transport controls, Dolby noise-reduction system, and dc governor-controlled motor. Features Auto Search Function (ASF); normal/CrO₂/metal tape bias/EQ selectors; 2 large VU meters with 3 peak-level LEDs; hard Permalloy record/playback head; separate input level and single output level controls; full automatic stop. Wow and flutter 0.06% wrms; frequency response \pm 3 dB 30-14,000 Hz normal, to 15 kHz CrO₂ and metal tape; S/N ratio 62 dB, Dolby on; THD 1.5% at 0 VU; fast-wind time 90 seconds with C60 cassette; 17 $\frac{1}{2}$ "W \times 10 $\frac{1}{2}$ "D \times 4 $\frac{1}{4}$ "H; 11 lb \$270
CR125. Similar to CR130 but less ASF, peak LEDs, output level control \$250

CR155 Double Stereo Cassette Deck

Stereo cassette deck designed for high-quality tape duplication. Features ASF (Auto Search Function) on playback-only compartment; Dolby B noise-reduction

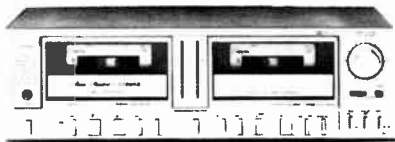

system; dc governor-controlled motors; metal-tape capability; LED bar-graph meters; separate tape selectors for each cassette compartment; timer standby function; hard Permalloy record/playback head; separate drive motors for each compartment; record mute; dual-concentric input level controls; front-panel stereo headphone jack; 3-digit tape counter. Wow and flutter 0.06% wrms; frequency response \pm 3 dB 30-14,000 Hz normal, to 15 kHz CrO₂ and metal tapes;

S/N ratio Dolby off/on 52/60 dB; THD 1.5%; input sensitivity/impedance 70 mV/50k ohms line; output level/impedance 500 mV/5k ohms line at 0 VU; channel separation 40 dB; crosstalk 70 dB; fast-wind time with C60 cassette 100 sec; power consumption 12 W; 15 $\frac{1}{4}$ "W \times 8 $\frac{3}{4}$ "D \times 4 $\frac{1}{4}$ "H; 10 lb.... \$230

CR77 Stereo Cassette Deck

Front-loading, metal-compatible stereo cassette deck with Dolby B and C noise-reduction systems, dual 7-LED level meters, and powered mechanism. Features input level control; metal/CrO₂/normal tape selector; record mute switch; microphone/line input selector; low-impedance microphone inputs; dc governor-controlled motor; hard Permalloy record/playback head; full auto stop; LED function indicators; 3-digit tape counter; stereo headphone jack. Wow and flutter 0.06% wrms; frequency response \pm 3 dB 30-14,000 Hz normal, to 15 kHz CrO₂ and metal tapes; S/N ratio Dolby off/B on/C on 52/60/70 dB; THD 1.5% at 0 VU; input sensitivity/impedance 1 mV/10k ohms mic, 100 mV/50k ohms line; output level/impedance 700 mV/2.2k ohms line; channel separation 40 dB; crosstalk 70 dB; fast-wind time 110 seconds with C60 cassette; power consumption 8 watts; 15 $\frac{1}{4}$ "W \times 8 $\frac{3}{4}$ "D \times 4 $\frac{1}{4}$ "H; 9 lb \$200

CR140 Stereo Cassette Deck

Front-loading, metal-compatible stereo cassette deck with powered mechanism, Dolby B noise-reduction system, and dual 7-LED bar-graph level meters. Features normal/CrO₂/metal tape selector; dc governor-controlled motor; hard Permalloy record/playback head; record mute switch; slide-type input-level and balance controls; full automatic stop; stereo headphone jack; 3-digit tape counter; LED function indicators; soft-eject cassette door. Wow and flutter 0.06% wrms; frequency response \pm 3 dB 30-14,000 Hz normal, to 15 kHz CrO₂ and metal tapes; S/N ratio Dolby off/on 52/62 dB; THD 1.2% at 0 VU; input sensitivity/impedance 0.5 mV/10k ohms microphone, 90 mV/10k ohms line; output level/impedance 450 mV/5k ohms line; separation 40 dB; crosstalk 70 dB; fast-wind time 120 seconds with C60 cassette; power consumption 13 watts; 15 $\frac{1}{4}$ "W \times 11 $\frac{1}{8}$ "D \times 4 $\frac{1}{4}$ "H; 9.9 lb \$160

CR116 Stereo Cassette Deck

Front-loading, metal-compatible stereo cassette deck with soft-touch transport controls, powered mechanism, LED bar-graph displays, and Dolby B noise-reduction system. Features 3-position tape selector; microphone/line input selector; hard Permalloy record/play head; dc governor-controlled motor; timer standby function; dual concentric input level controls; 3-digit tape counter. Wow and flutter 0.06% wrms; frequency response \pm 3 dB 30-14,000 Hz normal, to 15 kHz CrO₂ and metal tapes; S/N ratio Dolby off/on 52/60 dB; THD 1.5% at 0 VU; input sensitivity/impedance 1 mV/10k ohms microphone, 70 mV/50k ohms line; output level/impedance 500 mV/5k ohms line; fast-wind time 100 seconds with C60 cassette; power consumption 8 watts; 15 $\frac{1}{4}$ "W \times 8 $\frac{3}{4}$ "D \times 4 $\frac{1}{4}$ "H; 9 lb \$180

CR113 Stereo Cassette Deck

Front-loading, metal-compatible stereo cassette deck with Dolby B noise-reduction system and 2-color LED bargraph meters. Features 2-position tape selector; hard Permalloy record/playback head; dc governor-controlled motor; full automatic stop; separate input level controls for each channel; stereo headphone jack; 3-digit tape counter. Wow and flutter 0.1% wrms; frequency response \pm 3 dB 40-11,000 Hz normal, to 12 kHz metal tape; S/N ratio Dolby off/on 48/58 dB; THD 1.8% at 0 VU; input sensitivity/impedance 0.2 mV/10k ohms mic, 100 mV/50k ohms line; output level/impedance 1 V/5k ohms; separation 40 dB; crosstalk 68 dB; fast-wind time 100 seconds with C60 cassette; power consumption 11 watts; 15 $\frac{1}{4}$ "W \times 9"D \times 5 $\frac{1}{2}$ "H; 7.9 lb \$120

HARMAN/KARDON

CD401 Stereo Cassette Deck

Front-loading, metal-compatible stereo cassette deck with Dolby HX professional headroom-extension and Dolby B and C noise-reduction systems, switchable

multiplex filter, and 3 heads. Features ultrawideband frequency response with any tape formulation; solenoid-controlled transport; fader; automatic rewind; automatic replay; tape monitor switch; LED digital tape counter; timer; memory stop; record mute; Dolby B and C record calibration tones; mic/line mixing; electronic Auto Search; bias fine trim; output level controls; automatic repeat. Wow and flutter 0.04% wrms (NAB); frequency response 20-24,000 Hz \pm 3 dB, any tape formulation; 17 $\frac{1}{8}$ "W \times 13 $\frac{1}{2}$ "D \times 4 $\frac{1}{8}$ "H \$750

CD301 Stereo Cassette Deck

Front-loading, metal-compatible stereo cassette deck with Dolby HX professional headroom-extension and Dolby B and C noise-reduction systems, switchable multiplex filter, and 2 heads. Features ultrawideband frequency response with any tape formulation; solenoid-controlled transport; memory stop; record mute; Dolby B and C record and bias calibration tones; microphone/line mixing; electronic auto search; Sendust record/play head; dual 12-LED peak-indicating meters; bias and equalization selectors; bias fine trim; output level controls; automatic repeat. Wow and flutter 0.04% wrms (NAB); frequency response 20-22,000 Hz \pm 3 dB, any tape formulation; 17 $\frac{1}{8}$ "W \times 13 $\frac{1}{2}$ "D \times 4 $\frac{1}{8}$ "H \$530

CD201 Stereo Cassette Deck

Front-loading, metal-compatible stereo cassette deck with Dolby B and C noise-reduction systems, switchable multiplex filter, and 2 heads. Features ultrawideband frequency response with any tape formulation; solenoid-controlled transport; Sendust record/play head; memory stop; record mute; 12-LED peak-indicating meters; bias and equalization selectors; bias fine trim; output level controls; automatic repeat. Wow and flutter 0.05% wrms (NAB); frequency response 20-21,000 Hz \pm 3 dB, any tape formulation; 17 $\frac{1}{8}$ "W \times 13 $\frac{1}{2}$ "D \times 4 $\frac{1}{8}$ "H \$400

CD101 Stereo Cassette Deck

Front-loading, metal-compatible stereo cassette deck with Dolby B noise-reduction system, switchable multiplex filter, and 2 heads. Features ultrawideband frequency response with any tape formulation; solenoid-controlled transport; Sendust record/play head; dual 12-LED peak-indicating meters; bias and equalization selectors; bias fine trim control; output level controls; automatic repeat. Wow and flutter 0.05% wrms (NAB); frequency response 20-21,000 Hz \pm 3 dB, any tape formulation; 17 $\frac{1}{8}$ "W \times 13 $\frac{1}{2}$ "D \times 4 $\frac{1}{8}$ "H \$300

CD91 Stereo Cassette Deck

Front-loading, metal-compatible stereo cassette deck with Dolby B noise-reduction system, switchable multiplex filter, and 2 heads. Features ultrawideband frequency response with any tape formulation; solenoid-controlled transport; Sendust record/play head; dual 12-LED peak-indicating meters; bias and equalization selectors. Wow and flutter 0.05% wrms (NAB); frequency response 20-20,000 Hz \pm 3 dB, any tape formulation; 17 $\frac{1}{8}$ "W \times 13 $\frac{1}{2}$ "D \times 4 $\frac{1}{8}$ "H \$250

HITACHI

DE99 Stereo Cassette Deck

Two-motor, dual-capstan stereo cassette deck with ATRS, 3 heads, and Dolby B and C noise-reduction systems. Features IC logic feather-touch transport controls; metal-tape capability; electronic counter



with elapsed time; automatic reset memory rewind; 2-color fluorescent meters with peak hold; automatic record mute; facility for optional remote control. Wow and flutter 0.03%; S/N ratio 75 dB with Dolby C on; 17 $\frac{1}{8}$ "W \times 11 $\frac{1}{8}$ "D \times 4 $\frac{1}{8}$ "H; 13 lb 14 oz. \$570

DE66 Stereo Cassette Deck

Three-head stereo cassette deck with Dolby B and C noise-reduction systems, IC logic feather-touch transport controls, and metal-tape capability. Features electronic digital tape counter with elapsed-time display; automatic reset memory rewind; 2-color 32-LED meter with peak hold; automatic record mute; facility for optional remote control. Wow and flutter 0.038%; S/N ratio 78 dB with Dolby C on; 17 $\frac{1}{8}$ " \times 11 $\frac{1}{8}$ " \times 4 $\frac{3}{16}$ "H; 11 lb 14 oz \$400

DE57 Stereo Cassette Deck

Stereo cassette deck with Dolby B and C noise-reduction systems, Scanplay, and DRPS. Features computer memory; metal-tape capability; 32-LED meters with peak hold; IC logic transport control; electronic digital tape counter; automatic reset memory rewind; automatic record mute; facility for optional remote control. Wow and flutter 0.04%; S/N ratio 73 dB with Dolby C on; 17 $\frac{1}{8}$ " \times 11 $\frac{1}{8}$ " \times 4 $\frac{3}{16}$ "H; 10 lb 2 oz \$350

DE44 Stereo Cassette Deck

Metal-tape-capable stereo cassette deck with Dolby B and C noise-reduction systems. Features feather-touch transport control mechanism; 24-LED meters; automatic record mute; facility for optional remote control. Wow and flutter 0.04% wrms; S/N ratio 72 dB with Dolby C on; 17 $\frac{1}{8}$ " \times 11 $\frac{1}{8}$ " \times 4 $\frac{3}{16}$ "H; 10 lb 3 oz \$260

DE33 Stereo Cassette Deck

Metal-capable stereo cassette deck with Dolby B and C noise-reduction systems. Features soft-touch transport mechanism; LED level meters; record mute. Wow and flutter 0.05% wrms; S/N ratio 72 dB with Dolby C on; 17 $\frac{1}{8}$ " \times 11 $\frac{1}{8}$ " \times 4 $\frac{3}{16}$ "H; 7 lb 8 oz \$200
DE22. Similar to DE33 except no Dolby B/C . \$170

DE11 Stereo Cassette Deck

Front-loading, metal-compatible stereo cassette deck with Dolby B noise-reduction system. Features 3-position bias/EQ switch; air-damped cassette-well door; full automatic stop. S/N ratio 64 dB with Dolby on; 17 $\frac{1}{8}$ " \times 8" \times 4 $\frac{3}{16}$ "H; 7 lb 1 oz \$150

DW700 Double Stereo Cassette Deck

Double stereo cassette deck designed for duplicating programs from one cassette to another. Features Dolby B and C noise-reduction systems; IC logic feather-touch transport controls; random programming; dubbing/playback; repeat play; 2 dc motors; facility for optional remote control; 17 $\frac{1}{8}$ " \times 11 $\frac{1}{8}$ " \times 4 $\frac{3}{16}$ "H; 13 lb \$390

JVC

DD-99 Stereo Cassette Deck

Quartz-lock direct-drive, front-loading stereo cassette deck with computer-set bias/equalization tuning (B.E.S.T.) system. Features 3-head configuration with X-cut SA combination record/play and 2-gap SA erase heads; Dolby B and C (ANRS) noise-reduction systems; electronic digital tape counter with memory 1 and 2 that doubles as elapsed-time counter; quartz-lock, direct-drive pulse servo motor for improved speed accuracy; direct-coupled amplifiers; 2-motor, full-logic transport; tension stabilizing loop for better tape-to-head contact; 2-color fluorescent switchable peak/VU meters with hold in peak mode; music scan; record mute; remote-control option; safety-locked timer standby; gear/oil-damped cassette door; output volume control. Wow and flutter 0.019% wrms; frequency response ± 3 dB 25-18,000 Hz metal and SA/CrO $_2$, to 17 kHz normal tape; S/N ratio Dolby C off/on 70/80 dB with metal tape; THD 1.0% with metal tape at 0 VU, 1 kHz; input sensitivity/impedance 0.2 mV/600-10k ohms mic, 80 mV/80k ohms line; output level/impedance 500 mV/5k ohms line, 0.6 mW/matching impedance 8-1k ohms; power consumption 37 W; fast-wind time 90 seconds with C60 cassette; 17 $\frac{1}{8}$ " \times 12 $\frac{3}{4}$ " \times 4 $\frac{3}{16}$ "H; 16.9 lb \$800

DD-77. Similar to DD-99 except SE record/play head; no B.E.S.T./memory system. Wow and flutter 0.021% wrms; power consumption 30 W; 10 $\frac{3}{8}$ " \times 13.9 lb \$500

DD-66. Similar to DD-77 except no electronic digital

counter; same specifications, except power consumption 28 W; weight 13.4 lb \$450

KD-D55 Stereo Cassette Deck

Metal-capable, front-loading stereo cassette deck with Dolby B and C (ANRS) noise-reduction systems, 3 heads, and electronic digital counter. Features full-logic transport controls; digital multifunction counter that counts tape, shows elapsed/remaining tape time, Music Scan countdown; Multiple Music Scan system that allows up to 20 selections to be skipped; 7-LED multi-peak indicators; record mute; output volume control; timer function; gear/oil-damped cassette door. Wow and flutter 0.05% wrms; frequency response ± 3 dB 30-16,000 Hz metal and CrO $_2$, to 15 kHz normal tape; S/N ratio Dolby C off/on 58/78 dB with metal tape; THD 1.0% with metal tape at 0 VU, 1 kHz; input sensitivity/impedance 0.2 mV/600-10k ohms mic, 80 mV/100k ohms line; output level/impedance 500 mV/5k ohms line, 0.6 mW/matching impedance 8-1k ohms; power consumption 20 W; fast-wind time 110 seconds with C60 cassette; 17 $\frac{1}{8}$ " \times 11" \times 4 $\frac{3}{16}$ "H; 12.1 lb \$380

KD-D50 Stereo Cassette Deck

Metal-capable stereo cassette deck with Dolby B and C (ANRS) noise-reduction systems, soft-touch logic control transport, and electronic digital counter. Features SA combination record/play head; Multiple Music Scan system; digital multi-function counter; 2-color fluorescent Spectro-Peak Indicator signal-level meters. Wow and flutter 0.05% wrms; frequency response ± 3 dB 30-16,000 Hz metal and CrO $_2$, to 15 kHz normal tape; S/N ratio Dolby C off/on 58/78 dB with metal tape; THD 1.0% with metal tape at 0 VU, 1 kHz; input sensitivity/impedance 0.2 mV/600-10k ohms mic, 80 mV/100k ohms line; output level/impedance 300 mV/5k ohms line, 0.3 mV/matching 8-1k ohms; power consumption 20 W; fast-wind time 105 seconds with C60 cassette; 17 $\frac{1}{8}$ " \times 10 $\frac{7}{16}$ " \times 4 $\frac{3}{16}$ "H; 13.2 lb \$340
KD-D40. Similar to KD-D50 except mechanical tape counter instead of electronic digital counter; same specifications, except power consumption 18 W \$280

KD-D30 Stereo Cassette Deck

Economy-priced front-loading stereo cassette deck with Dolby B and C (ANRS) noise-reduction systems. Features metal-tape capability; Metaperm record/play head; soft-logic transport controls; record mute; gear/oil-damped cassette door; Single Music Scan system; 7-LED multi-peak signal-level meters; mechanical tape counter; cue and review. Wow and flutter 0.05% wrms; frequency response ± 3 dB 30-15,000 Hz metal and CrO $_2$, to 14 kHz normal tape; S/N ratio Dolby C off/on 58/78 dB; THD 1.0% with metal tape at 0 VU, 1 kHz; input sensitivity/impedance 0.2 mV/600-10k ohms mic, 80 mV/100k ohms line; output level/impedance 300 mV/5k ohms line, 0.3 mW/matching 8-1k ohms headphones; power consumption 17 W; fast-wind time 102 seconds with C60 cassette; 17 $\frac{1}{8}$ " \times 10 $\frac{7}{16}$ " \times 4 $\frac{3}{16}$ "H; 13.2 lb \$215

KD-D20. Similar to KD-D30 except no Dolby C NR system; S/N ratio Dolby B off/on 58/68 dB; power consumption 13 W \$185

KD-D10. Similar to KD-D20 except with meters instead of fluorescent bargraph displays; piano-key transport controls; no headphone output; wow and flutter 0.075%; power consumption 11 W; 10 $\frac{3}{8}$ " \times 4 $\frac{3}{16}$ "H; 8.6 lb \$175

KD-W7 Dubbing Cassette Deck

Double-transport stereo cassette deck for dubbing, mixing, continuous-play, etc., operation. Features metal-tape compatibility; Dolby B (ANRS) noise-reduction system; SA record/play heads; full-logic transport controls; dub at normal or double-speed capability; tape/mic and line/mic mixing facilities; single Music Scan system; 7-LED multi-peak signal-level displays; record mute; timer standby facility; continuous play between decks; gear/oil-damped cassette door. Wow and flutter 0.05% wrms; frequency response ± 3 dB 40-15,000 Hz metal and CrO $_2$, to 14 kHz normal tape; S/N ratio Dolby off/on 58/68 dB with metal tape; THD 1.0% with metal tape at 0 VU, 1 kHz; input sensitivity/impedance 0.2 mV/600-10k ohms mic, 55 mV/100k ohms line; output level/

impedance 300 mV/5k ohms line, 0.3 mW/matching 8-1k ohms headphones; power consumption 22 W; fast-wind time 110 seconds with C60 cassette; 17 $\frac{1}{8}$ " \times 10 $\frac{3}{4}$ " \times 5 $\frac{1}{8}$ "H; 15.4 lb \$450

Compact Cassette Decks

D-E3 Stereo Cassette Deck

Slim design metal-compatible stereo deck with cassette drawer. Features Dolby B (ANRS) noise-reduction system; Metaperm record/play head; full-logic transport controls; motor-driven cassette drawer; Single Music Scan system; 2-color, 7-LED multi-peak signal-level displays; timer standby (requires optional timer/clock); LED indicators for normal/CrO $_2$ /metal bias/EQ selection and noise-reduction on; record mute; 3-digit mechanical tape counter. Wow and flutter 0.05% wrms with metal tape; frequency response ± 3 dB 30-16,000 Hz metal and CrO $_2$, to 15 kHz normal tape; S/N ratio Dolby off/on 58/68 dB with metal tape; THD 1.0% with metal tape at 0 VU, 1 kHz; input sensitivity/impedance 0.2 mV/600-10k ohms mic, 80 mV/100k ohms line; output level/impedance 300 mV/5k ohms line; power consumption 19 W; fast-wind time 110 seconds with C60 cassette; 13 $\frac{3}{8}$ " \times 10 $\frac{7}{16}$ " \times 2 $\frac{1}{16}$ "H; 9 lb... \$300

D-M3 Stereo Microcassette Deck

Two-speed (2.4 and 1.2 cm/second) stereo microcassette deck with 2-motor, full-logic transport, Dolby B (ANRS) noise-reduction system, and compact cabinet design. Features 7-LED multi-peak signal-level displays; music scan; record mute; timer standby; gear/oil-damped cassette door; headphone jack. Wow and flutter 0.08% wrms; frequency response ± 3 dB at 2.4 cm/sec 40-12,500 Hz metal, to 10 kHz normal tape; S/N ratio Dolby off/on 52/62 dB with metal tape; input sensitivity/impedance 0.2 mV/600-10k ohms mic, 80 mV/100k ohms line; output level/impedance 300 mV/5k ohms line, 0.3 mW/matching 8-1k ohms headphones; power consumption 19 W; fast-wind time 120 seconds with MC60 microcassette; 13 $\frac{3}{8}$ " \times 10 $\frac{7}{16}$ " \times 2 $\frac{1}{16}$ "H; 8.8 lb \$330

KENWOOD

KX-1000D Stereo Cassette Deck

Direct-drive stereo cassette deck with 3 heads and 2 motors. Features Dolby B noise-reduction and Dolby HX (headroom-extension) systems; metal-tape capability; IC logic control; automatic rewind/repeat; automatic lead-in; normal/CrO $_2$ /FeCr/metal tape selector; tape/source monitor switch; record mute; fluorescent



peak-hold metering system; fine-bias control; one-touch recording; timer standby in record and play; pause control; MPX filter; ferrite heads; FG servo capstan and dc reel-drive motors. Wow and flutter 0.035% wrms; frequency response ± 3 dB 20-19,000 Hz metal, to 18,000 Hz all other tape formulations; S/N ratio Dolby on/off 67/57 dB normal, 69/59 dB CrO $_2$ and FeCr, 70/60 dB metal; harmonic distortion <0.3% at 1 kHz, 0 VU with metal tape; input sensitivity/impedance 77.5 mV/50k ohms line, 0.25 mV/10k ohms mic; output level/impedance 390 mV at 0 VU/100k ohms line, 50 mV/8 ohms headphones; power consumption 25 W; 17 $\frac{1}{8}$ " \times 14 $\frac{11}{16}$ " \times 4 $\frac{3}{16}$ "H; 16.7 lb. Supplied with head-cleaning set and audio cable \$500

KX-7XCG Stereo Cassette Deck

Dual-motor drive, full electronic logic control stereo cassette deck with Dolby B and C noise-reduction systems. Features amorphous alloy tape head; Direct Program Search System for up to 15 selections; one-cut indefinite repeat and fill-side repeat; rerecording standby facility; timer standby facility. Wow and flutter 0.04% wrms; frequency response ± 3 dB 20-21,000 Hz metal tape; S/N ratio with metal tape,

1 CASSETTE TAPE MACHINES

Dolby C on/off 74/57 dB, Dolby B on/off 67/57 dB; input sensitivity/impedance 77.5 mV/50k ohms line, 0.3 mV/10k ohms mic; output level/impedance 390 mV at 0 VU/100k ohms line, 50 mV/8 ohms headphones; power consumption 25 W; 17 $\frac{1}{16}$ "W \times 13"D \times 4 $\frac{1}{2}$ "H; 12.8 lb \$425

KX-900 Stereo Cassette Deck

Dual-motor drive stereo cassette deck with logic control transport with memory storage and random access of up to 15 programs, program search by microprocessor, amorphous alloy head, and metal-tape capability. Features Dolby B noise-reduction system; fluorescent peak-hold metering system; normal/CrO₂/FeCr/metal tape selector; fine-bias control; record mute; full automatic shutoff; timer standby in record and play. Wow and flutter 0.04% wrms; frequency response ± 3 dB 25-16,000 Hz normal, to 17 kHz CrO₂ and FeCr, to 18 kHz metal tape; S/N ratio Dolby on/off 67/57 dB normal/CrO₂/FeCr, 68/58 dB metal tape; harmonic distortion <0.08% at 1 kHz, 0 VU with metal tape; input sensitivity/impedance 77.5 mV/50 ohms line, 0.25 mV/10k ohms mic; output level/impedance 390 mV at 0 VU/100k ohms line, 58 mV/8 ohms headphones; fast-wind time 90 seconds with C60 cassette; 17 $\frac{1}{16}$ "W \times 14 $\frac{1}{16}$ "D \times 4 $\frac{1}{16}$ "H; 15.2 lb. Supplied with head-cleaning kit and audio cable \$400

KX-5XC Stereo Cassette Deck

Stereo cassette deck with full logic controls, Dolby B and C noise-reduction systems, and Direct Program Search Systems for up to 15 selections. Features one-cut indefinite repeat and full-side repeat; rerecording standby facility; and timer standby facility. Wow and flutter 0.04% wrms; frequency response ± 3 dB 20-17,000 Hz metal; S/N ratio with metal tape Dolby C on/off 72/57 dB, Dolby B on/off 67/57 dB; input sensitivity/impedance 77.5 mV/50k ohms; output level/impedance 390 mV at 0 VU/100k ohms line, 50 mV/8 ohms headphones; power consumption 18 W; 17 $\frac{1}{16}$ "W \times 12 $\frac{1}{4}$ "D \times 4 $\frac{1}{16}$ "H; 12.1 lb . \$350

KX-77C Stereo Cassette Deck

Full logic control stereo cassette deck with Dolby B and C noise-reduction systems and Direct Program Search System for up to 15 programs. Features one-cut indefinite repeat and full-side repeat; rerecording standby facility; timer standby facility. Wow and flutter 0.04% wrms; frequency response ± 3 dB 20-17,000 Hz with metal tape; S/N ratio with metal tape, Dolby B on/off 67/57 dB; input sensitivity/impedance 77.5 mV/50k ohms line, 0.55 mV/10k ohms mic; output level/impedance 390 mV at 0 VU/100k ohms line, 50 mV/8 ohms headphones; power consumption 15 W; 17 $\frac{1}{16}$ "W \times 10 $\frac{1}{16}$ "D \times 4 $\frac{1}{4}$ "H; 10.4 lb \$330

KX-55C Stereo Cassette Deck

Deck has full logic controls, Dolby B and C noise-reduction systems, and Direct Program Search System for up to 15 selections. Features full-side repeat; rerecording standby facility; timer standby facility. Wow and flutter 0.04% wrms; frequency response ± 3 dB 20-17,000 Hz with metal tape; S/N ratio with metal tape, Dolby C on/off 72/57 dB, Dolby B on/off 67/57 dB; input sensitivity/impedance 77.5 mV/50k ohms line, 0.55 mV/10k ohms mic; output level/impedance 390 mV at 0 VU/100k ohms line, 50 mV/8 ohms headphones; power consumption 15 W; 17 $\frac{1}{16}$ "W \times 9 $\frac{1}{4}$ "D \times 4 $\frac{1}{4}$ "H; 9.3 lb \$285

KX-40 Stereo Cassette Deck

Front-loading stereo cassette deck with Dolby B noise-reduction system and metal-tape capability. Features hard Permalloy record/play and ferrite erase heads; electronically controlled dc motor; full automatic off mechanism in all modes; 7-LED peak level meters (-20 to +6 dB); timer standby mechanism; 3-digit

tape counter. Wow and flutter 0.06% wrms; frequency response ± 3 dB 40-13,000 Hz normal, to 15 kHz metal tape; S/N ratio with Dolby on 60 dB normal, 62 dB metal; fast-wind time 85 seconds with C60 cassette; 17 $\frac{1}{16}$ "W \times 9 $\frac{1}{16}$ "D \times 4 $\frac{1}{16}$ "H; 9.5 lb. Comes with head-cleaning set \$184
KX-50II. Similar to KX-40 except has Permalloy record/play head; CrO₂ capability; -15 to +5 dB LED peak meters; frequency response ± 3 dB 35-15,000 Hz with all tape formulations; wow and flutter 0.05% wrms; S/N ratio 67 dB normal and CrO₂ and 68 dB with metal tape, Dolby on; fast-wind time 105 sec \$225

LUX

KX-102 Stereo Cassette Deck

Computerized ServoFace stereo cassette deck with dbx[®] noise-reduction system. Features 3-head design; double dbx circuitry for both tape and disc playback; Duo Beta circuitry for minimum negative feedback and elimination of transient intermodulation distortion (TIM); 15% bias control; peak level fluorescent meters; Dolby B noise-reduction system; computerized tuning system that selects best bias level for tape used; automatic repeat, rewind, play; facility for using wireless remote controller. Wow and flutter 0.04% wrms; frequency response ± 3 dB 20-22,000 Hz



with metal tape; S/N ratio Dolby B/dbx 68/94 dB; THD 0.7% with LH tape at 400 Hz, 0 dB test level \$1000

KX-101 Stereo Cassette Deck

Full-logic, solenoid-controlled stereo cassette deck with Dolby B and C noise-reduction systems. Features fluorescent indicators; Duo Beta circuitry; 2 Sendust heads; metal-tape capability; ServoFace design. Wow and flutter 0.04% wrms; frequency response 20-20,000 Hz ± 3 dB with metal tape; S/N ratio with Dolby C on, metal tape 73 dB; THD 0.7% with LD tape at 400 Hz, 0 dB test level \$500

K-118 Stereo Cassette Deck

Stereo cassette deck with Duo Beta circuitry, dbx[®] noise-reduction and disc-decoder systems, and Dolby B noise-reduction system. Features fluorescent tape counter; normal/CrO₂/metal tape selector; full-logic solenoid-controlled transport with remote-control capability; fluorescent peak level indicators; automatic rewind/play/repeat; switchable MPX filter. Wow and flutter 0.04% wrms; frequency response ± 3 dB 20-17,000 Hz normal, to 18 kHz CrO₂, to 20 kHz metal tape; S/N ratio with metal tape, no NR/Dolby/dbx 58/67/93 dB; overall distortion 0.6% with LH tape at 1 kHz, 0 dB; input sensitivity 60 mV line, 0.3 mV mic; power consumption 33 W; 18 $\frac{1}{4}$ "W \times 10 $\frac{1}{2}$ "D \times 5 $\frac{1}{4}$ "H; 13.2 lb \$500

K-117 Stereo Cassette Deck

Metal-compatible stereo cassette deck with Dolby B noise-reduction system. Features automatic repeat; bias fine control; full-logic solenoid transport controls with remote-control capability; direct change from play to record mode; fluorescent peak level indicators; record mute; normal/CrO₂/metal tape selector; switchable MPX filter. Wow and flutter 0.04% wrms; frequency response ± 3 dB 20-16,000 Hz normal, to 18 kHz CrO₂, to 20 kHz metal tape; S/N ratio with metal tape Dolby off/on 61/70 dB; overall distortion 0.7% with LH tape at 1 kHz, 0 dB; input sensitivity 100 mV line, 0.3 mV mic; output level 500 mV; power consumption 25 W; 18 $\frac{1}{4}$ "W \times 10 $\frac{1}{2}$ "D \times 5 $\frac{1}{4}$ "H; 13.2 lb \$400

K-113 Stereo Cassette Deck

Metal-capable stereo cassette deck with Dolby B noise-reduction system. Features soft-touch transport

controls; skew adjustment; fluorescent peak level indicators; metal/CrO₂/normal tape selector. Wow and flutter 0.06% wrms; frequency response ± 3 dB 20-16,000 Hz normal, to 18 kHz CrO₂, to 19 kHz metal tape; S/N ratio with metal tape Dolby off/on 57/72 dB; overall distortion 0.7% with LH tape at 1 kHz 0 dB; input sensitivity 80 mV line, 0.3 mV mic; output level 500 mV; power consumption 20 W; 17.5"W \times 11"D \times 4.4"H; 9.24 lb \$300

MARANTZ

SD9000 Stereo Cassette Deck

Two-speed (1 $\frac{1}{2}$ and 3 $\frac{1}{4}$ ips), 3-head Compudeck stereo cassette deck with total programmability. Features Sendust-alloy tape heads; double-Dolby noise-reduction system; metal-tape capability; 24-karat gold plated input and output jacks; LED peak level display meters; soft-touch electronic transport controls. Electronic tape-mode controls; automatic bias and EQ control; fine bias control; digital timer/tape counter/time-of-day display; MPX filter; microprocessor programming and selection circuitry for direct keyboard entry of up to 19 music selections; tape/source monitor switch; separate mic and line controls for each channel; timer-set/counter/program/clock/clock-set switch; repeat/single/off program mode switch; timer rec/off/play switch. Wow and flutter 0.03 wrms at 3 $\frac{1}{4}$ ips; 0.05% at 1 $\frac{1}{2}$ ips; frequency response at 3 $\frac{1}{4}$ ips ± 3 dB 25-23,000 Hz metal, to 22 kHz FeCr, to 20 kHz CrO₂, to 20 kHz normal; frequency response at 1 $\frac{1}{2}$ ips 25-23,000 Hz metal, to 18 kHz FeCr, to 17 kHz CrO₂, to 16 kHz normal; S/N ratio at 3 $\frac{1}{4}$ ips 62 dB Dolby off, 72 dB Dolby on; S/N ratio at 1 $\frac{1}{2}$ ips 59 dB Dolby off, 72 dB Dolby on; 16 $\frac{3}{4}$ "W \times 11 $\frac{1}{4}$ "D \times 5 $\frac{1}{4}$ "H; 22 lb 1 oz \$650

SD5010 Stereo Cassette Deck

Slim-line front-loading cassette deck with motorized linear-skating cassette drawer mechanism. Features metal-tape capability; 24-karat gold plated input and output connectors; LED peak level meters; Dolby B noise-reduction system; soft-touch electronic control transport system; electronic tape mode controls; super-hard metal-alloy heads. Wow and flutter 0.05% wrms; frequency response ± 3 dB 35-18,000 Hz metal to 16 kHz FeCr, to 17 kHz CrO₂, to 15 kHz normal tape; S/N ratio 54 dB Dolby off, 64 dB Dolby on; 16 $\frac{1}{4}$ "W \times 12 $\frac{1}{2}$ "D \times 2 $\frac{1}{4}$ "H; 13 lb 4 oz \$495

SD-420 Stereo Cassette Deck

Stereo cassette deck with Dolby B and C noise-reduction systems. Features soft-touch transport controls;



gold-plated input and output connectors; multiple program Compuskip forward and backward; repeat playback; fine bias control; LED indicators for all transport controls, as well as for tape type and Dolby; timer standby; LED peak signal-level displays; metal/CrO₂/normal tape selector; record mute; tape counter. Wow and flutter 0.05% wrms; frequency response ± 3 dB 40-12,500 Hz normal, to 15 kHz CrO₂, to 16 kHz metal tape; S/N ratio no NR/Dolby B/Dolby C 52/62/72 dB; input sensitivity/impedance -24 dBV/50k ohms line, -70 dBV/10k ohms mic; output level/impedance 600 mV/5k ohms line, 35 mV/240 ohms headphones; 16 $\frac{1}{4}$ "W \times 11 $\frac{1}{4}$ "D \times 3 $\frac{1}{4}$ "H \$340

SD 3510 Stereo Cassette Deck

Stereo cassette deck with Dolby B noise-reduction system and normal/CrO₂/FeCr/metal tape capability. Wow and flutter 0.07% wrms; frequency response ± 3 dB 35-14,000 Hz normal, to 15 kHz FeCr, to 16 kHz CrO₂, to 17 kHz metal tape; S/N ratio Dolby off/on 54/64 dB; input sensitivity/impedance -26 dBV/50k ohms line, -72 dBV/600 ohms mic; output level/impedance 500 mV/6k ohms line, 50 mV/8 ohms headphones; 16 $\frac{1}{4}$ "W \times 12"D \times 2 $\frac{1}{4}$ "H; 13 lb 1 oz \$325

SD-320 Stereo Cassette Deck

Stereo cassette deck with Dolby B and C noise-reduction systems. Features soft-touch transport controls; gold-plated input and output connectors; LED peak signal level displays; normal/CrO₂/metal tape selector; record mute; timer standby; tape counter. Wow and flutter 0.07% wrms; frequency response ±3 dB 40-12,500 Hz normal, to 14 kHz CrO₂, to 15 kHz metal tape; S/N ratio no NR/Dolby B/Dolby C 52/62/72 dB; input sensitivity/impedance -24 dBV/50k ohms line, -70 dBV/10k ohms mic; output level/impedance 600 mV/5k ohms line, 35 mV/100 ohms headphones; 16 $\frac{1}{8}$ "W × 7 $\frac{1}{2}$ "D × 3 $\frac{3}{4}$ "H \$250

SD-225 Stereo Cassette Deck

Stereo cassette deck with Dolby B noise-reduction system. Features soft-touch transport controls; timer standby; LED peak signal level meters; normal/CrO₂/metal tape selector; record mute; tape counter. Wow and flutter 0.08% wrms; frequency response ±3 dB 40-12,500 Hz normal, to 14 kHz CrO₂, to 15 kHz metal tape; S/N ratio Dolby off/on 52/62 dB; input sensitivity/impedance -24 dBV/50k ohms, -70 dBV/10k ohms mic; line output level/impedance 600 mV/5k ohms; 16 $\frac{1}{8}$ "W × 7 $\frac{1}{2}$ "D × 3 $\frac{3}{4}$ "H... \$198

MITSUBISHI

DT-40 Cassette Deck

Front-loading dual-speed (1 $\frac{1}{8}$ and 3 $\frac{3}{4}$ ips) metal-compatible stereo cassette deck with Dolby B noise-reduction system with multiplex filter, dual-speed PLL-controlled dc servo capstan and dc reel motors, and Sendust combination 4-micron record/triple-laminated-core 1-micron playback head and ferrite/Sendust erase heads. Features bias and equalization sector for normal, FeCr, special, and metal tapes with bias fine adjust; dual peak-reading meters with peak hold; fluorescent digital tape counter display with read out/in memory, repeat, and reset; separate line and mic level controls; tape/source monitor switch; output level control; automatic spacing-pause system (ASPS) for equal spacing between selections; record/play timer with external audio timer; feather-touch logic micro-switch controls; LED tape speed, Dolby, and metal tape indicators. Fast forward/rewind time 80 seconds with C60 cassette; wow and flutter 0.05% wrms (1 $\frac{1}{8}$ ips), 0.04% wrms (3 $\frac{3}{4}$ ips); frequency response ±3 dB at 1 $\frac{1}{8}$ ips; 40-15,000 Hz normal, to 17 kHz special, to 18 kHz FeCr, to 20 kHz metal, ±3 dB at 3 $\frac{3}{4}$ ips; 40-20,000 Hz normal, to 22 kHz special and FeCr, to 23 kHz metal; S/N 68 dB with Dolby, metal tape; 6.75"H × 16.75"W × 14.875"D \$650

DT-35 Stereo Cassette Deck

Three-head, metal-tape-compatible stereo cassette deck with Dolby B and C noise-reduction systems. Features FeCr/normal/special/metal tape selector; bias test oscillator; slide-type bias-adjust control with LED bias indicators; fluorescent peak level meters; digital tape counter; feather-touch transport controls with logical interlock; record mute; memory play; read in/read out buttons for special counter memory operations; record/play timer function; output level control; MPX filter; lighted cassette compartment; pneumatically damped cassette eject. Wow and flutter 0.035% wrms; frequency response 30-20,000 Hz ±3 dB with metal tape; S/N ratio Dolby B/C on 66/74 dB; harmonic distortion 0.9%/1.0%/0.8%/0.9% metal/FeCr/special/normal tape; input sensitivity/impedance 0.3 mV/2.2k ohms mic, 70 mV/47k ohms line; 18 $\frac{1}{2}$ "W × 11 $\frac{3}{8}$ "D × 5 $\frac{3}{8}$ "H..... \$490

Microcomponents Series

M-T04 Stereo Cassette Deck

Compact metal-compatible stereo cassette deck with feather-touch transport controls and Dolby B noise-reduction system. Features metal/special/normal/FeCr tape selector; multielement LED peak level meters; 2-motor transport; Automatic Spacing Pause System (ASPS); record/play timer standby function. Wow and flutter 0.05% wrms; frequency response ±3 dB 35-15,000 Hz normal, to 16 kHz all other tapes; S/N ratio Dolby off/on 56/64 dB; crosstalk between channels/tracks 30/60 dB; THD 0.9% normal/metal/FeCr, 1.2% special; input sensitivity/impedance 0.3 mV/2.2k ohms mic, 90 mV/50k

ohms line; output level/impedance 440 mV/22k ohms line, 0.8 mW/8 ohms headphones; power consumption 30 W; 10 $\frac{3}{8}$ "W × 9 $\frac{3}{8}$ "D × 5 $\frac{1}{2}$ "H; 14 lb \$460

NAD (USA)

6150C Cassette Deck

Front-loading, metal-compatible stereo cassette deck with Dolby B and C noise-reduction systems, dc servo capstan motor, Sendust record/play and ferrite erase heads. Features dual LED peak level bargraph display; bias and EQ for normal, CrO₂, metal tapes and user-adjustable fine bias control; record and playback level controls; full-logic feather-touch transport controls; timer-start and remote-control provisions; 3-digit tape counter with memory rewind. Fast wind time 70 seconds with C60 cassette; wow and flutter 0.045% wrms; frequency response ±3 dB 35-16,000 Hz with normal, to 17 kHz with CrO₂, to 19 kHz with metal tape; S/N 72 dB with Dolby C, metal tape (A weighted); input sensitivity/impedance 0.5 mV/10k ohms mic, 35 mV/50k ohms line, 6 mV/25k ohms DIN; 16 $\frac{1}{2}$ "W × 11"D × 4 $\frac{1}{2}$ "H \$398

6050C Stereo Cassette Deck

Front-loading, metal-compatible stereo cassette deck with Dolby B and C noise-reduction systems, dc servo capstan motor, and direct-load cassette mechanism. Features dual LED peak-level bargraph displays; bias, equalization, and fine bias trim for normal, CrO₂, and metal tapes; soft-touch tape transport controls; 3-digit tape counter. Wow and flutter 0.06% weighted peak; frequency response ±3 dB 40-16,000 Hz normal, to 17 kHz CrO₂, to 19 kHz metal tape; S/N ratio 70 dB with Dolby C and metal tape (A weighted); input sensitivity/impedance 0.6 mV/10k ohms mic, 90 mV/50k ohms line; 16.5"W × 9.5"D × 4"H \$298

6040A Cassette Deck

Front-loading, metal-compatible stereo cassette deck with Dolby HX headroom-extension and Dolby B noise-reduction systems, dc servo capstan motor, and Sendust record/play and ferrite erase heads. Features illuminated peak-indicating VU meters; bias and equalization pushbuttons for normal, CrO₂, and metal tapes; 3-digit tape counter with memory rewind. Fast-wind time 100 seconds with C60 cassette; wow and flutter 0.07% wrms; frequency response ±3 dB 40-16,000 Hz normal, to 17 kHz CrO₂, to 18 kHz metal tape; S/N 68 dB with Dolby, metal tape (A weighted); input sensitivity/impedance 0.6 mV/2k ohms mic, 60 mV/50k ohms line 16.5"W × 9.5"D × 4.7"H \$279

NAKAMICHI

1000ZL Computing Cassette Deck

Front-loading computer-controlled discrete stereo cassette deck with Dolby B noise-reduction system, double-capstan transport, and 3 heads. Microcomputer automatically calibrates azimuth, bias, level, and equalization of any quality tape; features 4 tape memories for recording conditions obtained by computer; 15 program RAMM with 30 command memories via high-speed bi-directional search; LED status indicators. Additional features include 70/120μsec equalization selector; under/normal/over bias set selector; 400-Hz test tone oscillator; quartz-controlled bias oscillator; multiplex and subsonic filter switches; dual

fluorescent recording level bargraph displays with peak hold and VU/peak switch; 2-channel mic, line input, and output level vertical slide controls; tape/source-monitoring; LED 4-digit tape counter with memory stop/play; pitch control; timer record/play with external audio timer; C-MOS logic function controls powered by motor-driven cam; direct-coupled recording and playback amplifiers and double NF equalizer circuitry; 3 microphone inputs for tri-mic recording and mic/line mixing; provision for external noise-reduction system. Wow and flutter 0.04% wrms; frequency response 10-25,000 Hz ±3 dB; EIA rack-mounting; 10 $\frac{1}{8}$ "H × 20 $\frac{3}{4}$ "W × 12 $\frac{1}{8}$ "D \$3800

700ZXL Stereo Cassette Deck

Front-loading stereo cassette deck with RAMM (automated playback) system that counts silent sections between programs. Features 3-head, dual-capstan, CMOS-logic-controlled transport; 4-digit LED digital tape counter; LED bargraph signal-level meters (-40 to +10 dB) with peak-hold function; 3 microphone inputs (left, right, center "blend") that can be mixed with line inputs; subsonic filter; 400-Hz, 0-dB test tone to calibrate noise-reduction system; direct-coupled record and playback amplifiers; timer record/play function; high-output headphone jack; Dolby B noise-reduction system plus facilities for switching in and out an external NR system; alarm indicator; 70/120μsec; EQ selector; fine bias adjust control; pitch control; memory stop/play and MPS on/off switches; sealed secondary-control panel. Wow and flutter less than 0.08% wrms; frequency response 20-20,000 Hz ±2 dB with Nakamichi EX, EXII, SX, ZX tapes; S/N ratio better than 66 dB at 3% THD, Dolby on; THD less than 0.8% ZX tape, 1.0% SX, EXII tape; separation >37 dB at 1kHz, 0 dB; crosstalk >60 dB at 1 kHz, 0 dB; power consumption 50 W; 19 $\frac{1}{16}$ "W × 10 $\frac{1}{8}$ "H × 9 $\frac{7}{32}$ "D; 30 lb 4 oz \$3000

682ZX Stereo Cassette Deck

Discrete 3-head stereo cassette deck with Dolby B and C noise-reduction systems, Auto-Azimuth Alignment system for extended frequency response, and 9-program Random Access Music Memory (RAMM) system. Features auto azimuth alignment/automatic record-level calibration; bias calibration controls with 2-tone oscillator; dual-gap ferrite/Sendust erase head; separate tape and equalization switches for ZX, SX, EX cassettes; dc recording amplifiers with double NF circuitry; asymmetrical dual-capstan, diffused-resonance transport with motor-driven cam, dual-slot guides, tape-pad lifter; PLL capstan motor; CMOS logic controls with 2-speed cueing, high-speed shutoff, and slack takeup; peak-responding fluorescent meters; master and separate-channel input level controls; output level control; record mute; high-output headphone jack; tape-start memory with 3-digit counter; timer record/play capability with optional RM-200 controller. Wow and flutter <0.08% weighted peak; frequency response ±3 dB 20-22,000 Hz ZX, to 20 kHz SX and EXII tape; S/N ratio Dolby B/C on >66/72 dB at 400 Hz, 3% THD A weighted with ZX tape; THD 0.8% with ZX, 0.1.0% SX and EXII tape at 400 Hz, 0 dB; separation/crosstalk 37/60 dB at 1 kHz, 0 dB; input sensitivity/impedance 50 mV/50k ohms line; output level/impedance 1 V/2.2k ohms line, 48 mW/8 ohms headphones; power consumption 36 W; 19"W × 13 $\frac{3}{8}$ "D × 5 $\frac{3}{8}$ "H; 19 lb 13 oz \$1550

NOTICE TO READERS

Prices of items described are suggested prices only and are subject to change without notice. Actual selling prices are determined by the dealer.

1 CASSETTE TAPE MACHINES

ZX-7 Stereo Cassette Deck

Microprocessor-controlled discrete 3-head, double-capstan stereo cassette deck with Dolby B and C noise-reduction systems. Features microprocessor-controlled transport; master fader; diffused-resonance transport; asymmetrical dual capstan; LED peak level meters with -40 to +10-dB range; 4-digit LED tape counter; high-quality amplification with special equalizer and double-NF monitor; record mute; defeatable MPX filter; facility for optional RM-200 remote controller; timer record/play capability. Wow and flutter >0.08% weighted peak, >0.04% wrms; frequency response ± 3 dB 20-20,000 Hz SX and EXII, to 21 kHz ZX tape; S/N ratio Dolby B/C on >66/>72 dB; THD <1% with SX and EXII tape, <0.8% with ZX tape; $17\frac{1}{2}'' \times 11\frac{1}{8}'' \times 5\frac{1}{8}''$; H; 21 lb. \$1250

LX-5 Stereo Cassette Deck

Discrete 3-head stereo cassette deck with Dolby B and C noise-reduction systems. Features microprocessor-controlled transport; master fader; diffused-resonance transport; asymmetrical capstans; 50-dB LED peak-indicating meters; 4-digit electronic LED tape counter; bias tune control; defeatable MPX filter; record mute; facility for optional RM-200 remote controller; timer record/play capability. Wow and flutter <0.1% weighted peak, <0.06% wrms; frequency response ± 3 dB 20-20,000 Hz with ZX, SX, EXII tapes; S/N ratio Dolby B/C on >64/>70 dB; THD <0.9% ZX, <0.1% SX and EXII tape; $17\frac{1}{2}'' \times 12\frac{1}{8}'' \times 5\frac{1}{8}''$; H; 18 lb 12 oz. \$850

LX-3 Similar to LX-5 except 2-head design; S/N ratio Dolby B/C on >62/>68 dB; THD <1.0% ZX, <1.2% SX and EXII tape. \$595

480B Stereo Cassette Deck

Two-head stereo cassette deck with Dolby B noise-reduction system. Features new record/play head with metal-tape capability; direct flux erase head; diffused-resonance transport; IC-logic transport controls with high-speed automatic shutoff; wide-range (47-dB) peak-responding meters; automatic takeup of slack tape; defeatable MPX filter; separate tape and equalization selectors; slide-type record level controls; facility for optional remote controller; timer operation; tape start memory; black front panel. Wow and flutter 0.11% weighted peak, 0.06% wrms; frequency response ± 3 dB 20-20,000 Hz; S/N ratio Dolby off/on 52/62 dB; THD <1.0% ZX and EXII, <1.2% SX tape; separation/crosstalk >36/>60 dB; input sensitivity/impedance 50 mV/30k ohms line; output level/impedance 600 mV/2.2k ohms line, 10 mW/8 ohms headphone; power consumption 23 W; $17\frac{3}{4}'' \times 11\frac{1}{8}'' \times 5\frac{1}{8}''$; H; 14 lb 2 oz. \$425

480S. Same as 480B except silver finish front panel. \$425

Remote Controllers

RM-730. Wireless remote controller for 730 cassette deck. \$245

RM-300. Wired remote controller for 1000ZXL, 700ZXL cassette decks. \$190

RM-200. Wired remote controller for LX-3, LX-5, LX-7, 580Z Series, 680, ZX Series, 700ZX cassette decks. \$45

RM-100. Wired remote controller for 480, 480Z Series cassette decks. \$45

NIKKO

ND-1000 Stereo Cassette Deck

Three-head, 2-motor stereo cassette deck with computerized tape-evaluation system. Features source/tape monitoring; full-logic transport controls; facility for optional remote-control unit; normal/CrO₂/metal tape selector; dual 12-section LED peak-level displays; output level control; Dolby B noise-reduction

system; MPX filter; automatic memory stop/play function; timer record/play capability; Compu-Tecs automatic bias and sensitivity adjustment circuit; $17.3'' \times 9.9'' \times 4.7''$; H. \$580

ND-800 Stereo Cassette Deck

Stereo cassette deck with 2-motor, direct-drive transport operated by IC-logic controls. Features facility for optional remote-control unit; dual 12-section LED peak-level displays; output level control; Dolby B noise-reduction system; MPX filter; bias/EQ switch for normal/CrO₂/metal tape; automatic rewind; automatic memory stop/play at preselected points on tape; timer record/play facility; $17.3'' \times 9.9'' \times 4.7''$; H. \$400

ND-700 Stereo Cassette Deck

Stereo cassette deck with dbx* and Dolby B noise-reduction systems. Features memory rewind; dual 9-section LED peak-level signal displays; power-assisted soft-touch tape-function buttons; one-button recording system; output level control; cue and review for fast location of recordings; MPX filter; 2-way dbx NR system that also features expanded dynamic range; removable cassette-compartment door; $17.3'' \times 9.9'' \times 4.7''$; H. \$320

ND-500 Stereo Cassette Deck

Stereo cassette deck with dual 7-section LED peak-level signal displays, output level control, and power-assisted transport controls. Features one-button recording; cue and review for fast location of recordings; Dolby B noise-reduction system; removable cassette-compartment door; $17.3'' \times 9.9'' \times 4.7''$; H. \$240

ONKYO

TA-2070 Stereo Cassette Deck

Three-head, metal-compatible stereo cassette deck with Dolby B and C noise-reduction systems. Features tape/source monitoring; Sendust heads; brushless direct-drive 3-motor tape transport; digital tape counter



that indicates consumed or remaining time; automatic Accubias; feather-touch transport controls; 2-color fluorescent signal meters; automatic space button; memory stop/play; facility for optional remote-control unit. Wow and flutter 0.021% wrms; frequency response ± 3 dB 20-16,000 Hz normal, to 18 kHz CrO₂, to 19 kHz metal tape; S/N ratio no NR/Dolby B/Dolby C 60/70/80 dB with metal tape; input sensitivity/impedance 0.3 mV/400-50k ohms mic, 50 mV/50k ohms line; output level/impedance 775 mV/>50k ohms line; 1 V/8-200 ohms headphones; power consumption 45 W; fast-wind time 90 seconds with C60 cassette; $17\frac{1}{8}'' \times 15\frac{1}{8}'' \times 3\frac{1}{8}''$; H; 20.9 lb. \$700

TA-2060 Cassette Deck

Front-loading metal-compatible stereo cassette deck with Dolby HX and Dolby B noise-reduction systems, 2 direct-drive motors, and sendust alloy record/play and double-gap ferrite erase heads. Features normal, high, and metal tape selectors with LED indicators and Accubias adjust for any tape type; Dolby NR/HX selector with LED HX indicator; peak-high meters; fader control; tape/source monitoring; input and output level controls; record mute; full logic tape function controls; 3-digit tape counter with memory play/stop; timer record/play with external audio timer. Wow and flutter 0.04% wrms, frequency response 20-19,000 Hz ± 3 dB with metal tape; S/N 60 dB without Dolby. \$470

TA-1500 Stereo Cassette Deck

Metal-tape-compatible stereo cassette deck with Dolby B noise-reduction system. Features dc servo-controlled motor; hard Permalloy record/play head; feather-touch transport controls; timer standby; slide-type input balance control; 3 tape-selector switches; large illuminated VU meters; full automatic stop; facil-

ity for optional remote controller. Wow and flutter 0.06% wrms; frequency response ± 3 dB 30-14,000 Hz normal, to 15 kHz CrO₂ and metal tape; S/N ratio Dolby off/on 58/68 dB; input sensitivity/impedance 0.3 mV/5k ohms mic, 50 mV/50k ohms line; output level/impedance 350 mV/>50k ohms line; headphone output impedance 8-200 ohms; power consumption 13 W; fast-wind time 90 seconds with C60 cassette; $16\frac{1}{2}'' \times 10\frac{1}{4}'' \times 4\frac{1}{4}''$; H; 9.7 lb. \$380

TA-2055 Stereo Cassette Deck

Front-loading, metal-compatible stereo cassette deck with 3-motor direct-drive system, C90/C60/C46 tape-length selectors, and digital real-time counter. Features display of remaining or consumed tape time; 5-second automatic space on record; hard Permalloy record/play head; Accubias to fine tune recording bias for any type of tape; Dolby B and C noise-reduction systems; feather-touch transport controls; memory stop/play; 2-color LED peak level meters; timer record/play; facility for optional remote controller. Wow and flutter 0.035% wrms; frequency response ± 3 dB 20-15,000 Hz normal, to 18 kHz CrO₂, to 19 kHz metal tape; S/N ratio no NR/Dolby B/Dolby C 60/70/80 dB; input sensitivity/impedance 0.3 mV/5k ohms mic, 50 mV/50k ohms line; output level/impedance 1100 mV/>50k ohms line; headphone output impedance 8-200 ohms; power consumption 28 W; fast-wind time 90 seconds with C60 cassette; $16\frac{1}{2}'' \times 14\frac{1}{8}'' \times 3\frac{1}{8}''$; H; 14.8 lb. \$360

TA-2035 Stereo Cassette Deck

Microcomputer-controlled 3-motor stereo cassette deck with Dolby B and C noise-reduction systems. Features automatic music search; automatic space on record; automatic tape selection; hard Permalloy record/play head; Accubias fine bias tuning; timer switch; full automatic stop; 2-color LED peak level displays; feather-touch transport controls; facility for optional remote controller. Wow and flutter 0.045% wrms; frequency response ± 3 dB 30-14,000 Hz normal, to 16 kHz CrO₂, to 17 kHz metal tape; S/N ratio no NR/Dolby B/Dolby C 60/70/80 dB; input sensitivity/impedance 0.3 mV/5k ohms mic, 50 mV/50k ohms line; output level/impedance 350 mV/>50k ohms line; headphone output impedance 8-200 ohms; power consumption 20 W; fast-wind time 90 seconds with C60 cassette; $16\frac{1}{2}'' \times 10\frac{1}{8}'' \times 3\frac{1}{8}''$; H; 9.9 lb. \$300

TA-2025 Stereo Cassette Deck

Front-loading stereo cassette deck with metal-tape compatibility and Dolby B noise-reduction system. Features automatic music search system; 5-second auto space on record; microcomputer-controlled 3-motor transport; hard Permalloy record/play head; 2-color LED peak level meters; timer standby; full automatic stop; feather-touch transport controls; 3 tape selectors; facility for optional remote controller. Wow and flutter 0.045% wrms; frequency response ± 3 dB 30-14,000 Hz normal, to 15 kHz CrO₂, to 16 kHz metal tape; S/N ratio Dolby off/on 60/70 dB; input sensitivity/impedance 0.3 mV/5k ohms mic, 50 mV/50k ohms line; output level/impedance 500 mV/>50k ohms line; headphone output impedance 8-200 ohms; power consumption 18 W; fast-wind time 90 seconds with C60 cassette; $16\frac{1}{2}'' \times 10\frac{1}{8}'' \times 3\frac{1}{8}''$; H; 9.9 lb. \$255

TA-2015 Stereo Cassette Deck

Three-motor computer-controlled stereo cassette deck with Dolby B and C noise-reduction systems. Features automatic music search system; automatic space button in record; automatic tape (type) detection system; hard Permalloy record/play head; Accubias fine bias tuning; timer switch; full automatic stop; 2-color LED peak level meters; feather-touch transport controls; facility for optional remote control. Wow and flutter 0.06%; frequency response ± 3 dB 30-14,000 Hz normal, to 15 kHz CrO₂, to 16 kHz metal tape; S/N ratio no NR/Dolby B/Dolby C 58/68/78 dB; input sensitivity/impedance 0.4 mV/5k ohms mic, 50 mV/50k ohms line; output level/impedance 350 mV/>50k ohms line; headphone output impedance 8-200 ohms; power consumption 18 W; fast-wind time 90 seconds with C60

RECOMMENDED FOR MATURE ADULTS ONLY.

You're old enough to know better. So pull out all the stops, end all the compromising and introduce yourself to AKAI quality and performance. You'll find we've engineered all the



intimidation out of high-performance hi-fi. And put a whole lot more human engineering in. While adding 15 superbly crafted new components that give you just a little more for your money.

But if you're an adult, you're not about to settle for less.

In tune with the times.

For example, take the all-new AKAI GX-F71 cassette deck. Just for openers, you get Dolby® B and C noise reduction and AKAI's famous Super GX Combo Heads. Plus the convenience of a built-in microcomputer that automatically calibrates bias, equalization and sensitivity for any tape used, Auto-Fade, Instant Program Locating System and Intro-Scan that plays a 10-second preview of every program selection.

One for the records.

With the AKAI AP-L95 you can always count on a well-rounded performance. And for obvious reasons. A built-in micro-computer makes it fully

programmable. A linear-tracking tone arm virtually eliminates normal tracking error. And a superb quartz lock, direct drive motor keeps wow & flutter to an inaudible minimum.

Efficiency expert.

AKAI's magnificent GX-747 represents that latest breakthrough in open-reel technology. Because it's one of the world's first decks designed to handle the new "EE" (Extra Efficient) tapes.

And that means you get the equiva-



lent of 7½-ips performance at a much more economical speed of just 3¾ ips.

But that's not all. You also get: four Super GX Heads, two erase heads, Auto-Reverse Playback/Record, Auto-Mute and an unheard of frequency response of 25-33,000 Hz ± 3dB at 7½-ips.

So visit your AKAI dealer soon. Or write: AKAI, P.O. Box 5010, Compton, CA 90224.

With AKAI, you've never heard it so good.



AKAI

Hi-Fi & Video

®TM, Dolby Labs, Inc.

CIRCLE World Radio History SERVICE CARD

1

CASSETTE TAPE MACHINES

cassette; 16½"W × 10¾"D × 4½"H; 10.1 lb \$210

TA-W88 Dubbing Stereo Cassette Deck

High-speed dubbing stereo cassette deck with Dolby B noise-reduction system. Features one-touch recording; continuous/simultaneous playback modes; microphone mixer; dc servo-controlled motors; hard Permalloy record/play heads; feather-touch transport controls; record mute; LED level meters; timer standby mode; full automatic stop; facility for remote controller. Wow and flutter 0.06% wrms; frequency response ±3 dB 30-14,000 Hz normal, to 15 kHz CrO₂, to 16 kHz metal tape; S/N ratio 68 dB with Dolby on, metal tape; input sensitivity/impedance 0.3 mV/5k ohms mic, 50 mV/50k ohms line; output level/impedance 350 mV/>50k ohms line; head-phone output impedance 8-200 ohms; power consumption 18 W; fast-wind time 90 seconds with C60 cassette; 16½"W × 10¾"D × 4¾"H; 14.3 lb \$380

OPTONICA

RT-6405 Stereo Cassette Deck

Direct-drive, 2-motor stereo cassette deck with Dolby B noise-reduction system, microprocessor full-logic solenoid transport controls, and peak level displays with peak hold. Features FeCr/CrO₂/normal/metal bias and EQ selector; APSS (Automatic Program Search System); automatic spacing pause control; soft eject cassette holder with detachable cover; timer recording standby system; output level control; LED indicators for record, playback, pause/auto-spacing, Dolby on; MPX filter; Sendust record/play head, double-gap ferrite head. Wow and flutter 0.038% wrms; frequency response ±3 dB 30-15,000 Hz normal, to 17 kHz CrO₂, to 18 kHz FeCr and metal tapes; S/N ratio 67 dB with CrO₂ tape, Dolby on; 17"W × 12¾"D × 3¾"H; 13.2 lb \$280
RT-6207. Similar to RT-6405 except no direct drive. Wow and flutter 0.055% wrms; frequency response to 14 kHz normal, to 16 kHz CrO₂, to 17 kHz FeCr and metal; hard Permalloy head \$330

RT-3400 Stereo Cassette Deck

Front-loading stereo cassette deck with Dolby B and C noise-reduction systems. Features solenoid full-logic feather-touch transport controls; metal-tape capability; APSS; low profile; normal/CrO₂/metal tape selector; 2-color 8-LED peak level meters; soft eject; full automatic stop. Wow and flutter 0.05% wrms; frequency response ±3 dB 30-13,000 Hz normal, to 14 kHz CrO₂, to 16 kHz metal tape; 16½"W × 9¾"D × 4½"H; 10.4 lb \$220

RT-5050 Double Stereo Cassette Deck

Metal-capable dual stereo cassette deck designed for high-speed dubbing. Features Dolby B noise-reduction system; Automatic Program Search System (APSS); dubbing level scales; metal/CrO₂/normal tape selectors; record mute; red and green indicators to inform of mode position of transports; timer record/play standby; mic mixing in dubbing mode; separate frequency generator servo motor in each transport; soft-touch logic transport controls; one-touch dubbing control; VU meters switchable between play and record decks. Wow and flutter 0.04% wrms; frequency response ±3 dB 30-16,000 Hz normal, to 17 kHz CrO₂, to 18 kHz metal tape; S/N ratio Dolby off/on 57/67 dB; input sensitivity/impedance 0.2 mV (-74 dB)/6.8k ohms mic, 50 mV (-26 dB)/50k ohms line; output level/impedance 550 mV/50k ohms line, 46 mV/8 ohms headphones; power consumption 18 W; 17"W × 11¼"D × 4¾"H; 11.9 lb \$380

JC PENNEY

3575 Cassette Deck

Stereo cassette deck with front-loading cassette well, Dolby noise-reduction system, metal-tape capability. Features hard permalloy record/play head with Sendust guard; MPX filter; peak signal level LED indicators (-30 to +6 dB). Wow and flutter 0.04% wrms; frequency response 40-18,000 Hz ±3 dB; THD 1.2% at 200 nWb; fast-wind time 90 seconds with C60 cassette \$300

3588 Stereo Cassette Deck

Auto-reverse stereo cassette deck with Dolby B noise-reduction system. Features continuous automatic-reverse control; quick reverse control; mechanical soft-touch transport controls; timer standby; LED record level meters; record mute; metal tape capability. Wow and flutter 0.08%; S/N ratio Dolby off/on 51/60 dB; separation/adjacent-track crosstalk 57/57 dB; power consumption 11.2 W; 16.5"W × 10.6"D × 4.3"H; 9.5 lb \$300

3549 Stereo Cassette Deck

Front-loading stereo cassette deck with Dolby B and C noise-reduction systems. Features automatic shut-off; soft-touch transport controls; record mute; 14-segment fluorescent record level meters; metal-tape capability; MPX filter; record and pause indicators; normal/CrO₂/metal tape selector. Wow and flutter 0.08% wrms; power consumption 15.1 W; 16¾"W × 8½"D × 4¼"H; \$250

3555 Stereo Cassette Deck

Front-loading stereo cassette with Dolby B noise-reduction system. Features automatic shut-off; 18-segment fluorescent record level meters; LED record indicator; damped cassette door; normal/CrO₂/metal tape selector. Wow and flutter 0.06% wrms; frequency response ±3 dB 50-13,000 Hz normal, to 14 kHz CrO₂, to 15 kHz metal tape; S/N ratio Dolby off/on 50/60 dB; power consumption 11 W; 16¾"W × 8½"D × 4½"H; 9 lb \$220

3554 Stereo Cassette Deck

Front-loading stereo cassette deck with Dolby B noise-reduction system. Features hard Permalloy record/play tape head with Sendust guard; soft-touch transport controls; soft cassette eject; direct function change; large VU meters; metal tape capability. Wow and flutter 0.05% wrms; frequency response ±3 dB 40-14,000 Hz; S/N ratio Dolby off/on 57/63 dB; THD 1.2% at 200 nWb; fast-wind time 95 seconds with C60 cassette \$190

3543 Stereo Cassette Deck

Soft-touch transport stereo cassette deck with Dolby B noise-reduction system. Features automatic shut-off; VU record meters; metal-tape capability; LED record indicator. Wow and flutter 0.06% wrms; frequency response ±3 dB 50-13,000 Hz normal, to 14 kHz CrO₂, to 15 kHz metal tape; S/N ratio Dolby off/on 60/60 dB; input sensitivity 100 mV line, 0.45 mV mic; power consumption 10 W; 16¾"W × 7½"D × 4¾"H \$160

PIONEER

CT-9R Stereo Cassette Deck

Computer-controlled stereo cassette deck with 3-motor direct-drive transport and Dolby B/C/automatic noise-reduction system. Features digital electronic real-time tape counter that indicates minutes and seconds even in fast forward and rewind; automatic bias, level, equalization adjustment; Blank Search/Index Scan system; Music Search/Repeat; Blank Skip. Wow and flutter 0.03% wrms; frequency response ±3 dB 20-22,000 Hz with metal tape; S/N ratio no NR/Dolby B/Dolby C 60/70/80 dB; 16¾"W × 12¾"D × 5¼"H; 14 lb 5 oz \$675
CT-8R. Similar to CT-9R except standard mechanical index counter; wow and flutter 0.035% \$575
CT-7R. Similar to CT-8R except auto-reverse operates in record and playback; no auto Dolby; wow and flutter 0.04%; frequency response to 20 kHz; S/N 79 dB; 3¾"H; 12 lb 2 oz \$450
CT-6R. Similar to CT-7R except auto-reverse in playback only \$350

CT-5 Stereo Cassette Deck

Stereo cassette deck with Dolby B and C noise-reduction systems, IC full-logic transport controls, and dc-servo motor. Wow and flutter 0.05% wrms; frequency response ±3 dB 20-18,000 Hz with metal tape at -20 dB; S/N ratio 78 dB at 5 kHz, Dolby C on; 16¾"W × 9¾"D × 3½"H; 9 lb 11 oz .. \$280
CT-4. Similar to CT-5 except no full-logic control system; frequency response to 17 kHz; 9¾"D × 4¾"H \$200

JT-216 Wired Remote Controller

Wired remote controller for CT-9R, CT-8R, CT-7R, and CT-6R computer-controlled cassette decks .. \$50

REALISTIC

SCT-33 Stereo Cassette Deck

Three-head stereo cassette deck with double Dolby B and C noise-reduction systems and bias fine tune control. Features normal/CrO₂/metal tape selectors; automatic rewind/replay; 2-color, 14-segment fluorescent peak-hold meters; record mute; full-logic solenoid-activated transport controls; automatic-rewind switch for automatic rewind/replay or rewind/shutoff at end of play; output level control; switchable MPX filter \$400

SCT-28 Stereo Dubbing Deck

High-speed dubbing dual stereo cassette deck with Dolby B noise-reduction system. Features automatic music search; soft-touch transport controls; deck 1 optimized for playback and has automatic equalization selection; deck 2 has full record/play facilities with pushbutton selectors for normal/CrO₂/metal tape; record mute; dual concentric level controls; 2-color, 5-segment LED peak level meters; switchable MPX filter; high/normal-speed selector \$340

SCT-27 Stereo Cassette Deck

Solenoid-operated stereo cassette deck with Dolby B and C noise-reduction systems. Features normal/CrO₂/metal tape selectors; adjustable bias control; record mute; dual concentric record level control with memory ring; output level control; record, pause, play, Dolby LED indicators; switchable MPX filter; timer-standby switch \$300

SCT-500 Stereo Cassette Deck

Stereo cassette deck with soft-touch transport controls and Dolby B noise-reduction system. Features Automatic Search Music System (ASMS); normal/CrO₂/metal tape selector; 2-color, 8-segment LED level indicators; record and search mode indicators \$200

SCT-29 Stereo Cassette Deck

Stereo cassette deck with Dolby B noise-reduction system and automatic music search. Features 2-color, 8-LED peak level meters; normal/CrO₂/metal tape selectors; switchable MPX filter; soft-touch transport controls; damped cassette door; output level control. Wow and flutter <0.15% wrms; frequency response ±3 dB 30-14,000 Hz metal, to 12 kHz CrO₂/normal tape; S/N ratio 64 dB Dolby on; THD 1.3%; output level 0.7 V maximum; 15¾"W × 9"D × 4¾"H \$160

SCT-24 Cassette Deck

Front-loading metal-compatible stereo cassette deck with Dolby noise-reduction system and switchable multiplex filter. Features dual LED peak metering; auto stop; tape selector buttons for ferric, CrO₂, metal tapes; tape counter. Wow and flutter 0.15% wrms; frequency response ±3 dB 30-12,000 Hz (ferric and CrO₂), to 14 kHz (metal); S/N ratio 64 dB with metal tape, Dolby on; THD 0.3%, CCIR weighted ... \$130

REVOX

B710 MKII Stereo Cassette Deck

Three-head, 4-motor, front-loading deck with microprocessor-activated controls and counter display. Features dual direct-drive, crystal-controlled capstan and separate servo-controlled reel motors; constant-speed fast forward/rewind with electrical braking; pneumatically damped solenoid-controlled head assembly; 4-digit electronic counter with run-up button and real-time clock with internal timer switching for both B710 and external equipment; automatic bi-

as/equalization sensing for metal, CrO₂, ferrichrome, and ferric-oxide tape formulations; mic/line mixing; separate playback level control; peak-reading LED record/play level displays with 1-dB resolution from -10 to +6 dB and 2-dB intervals from -30 to -10 dB; full plug-in modular construction with optional rack mounting adaptors. Wow and flutter 0.08% DIN, 0.035% wrms; frequency response +2/-3 dB 22-22,000 Hz metal, to 16 kHz ferric; S/N 72 dB at 3% THD, A weighted, 1 kHz, Dolby C on; 17.8"W × 13.85"D × 6"H \$1949 Remote control with all transport functions plus source/tape switch \$200

ROTEL

RD-1010 Stereo Cassette Deck

Three-head stereo cassette deck with metal-tape capability and double Dolby B noise-reduction system. Features electronic governor dc motor; Sendust-core combination dual record/play and Sendust-tip erase



heads; full-logic solenoid feather-touch transport controls; metal/FeCr/CrO₂/normal tape selector; automatic rewind; automatic repeat; timer record/play; memory repeat/rewind; dual 16-point LED signal-level displays; MPX filter switch; output level control; record mute switch; record, pause, play indicators. Wow and flutter 0.1% DIN, 0.045% wrms; frequency response ±3 dB 30-17,000 Hz normal, to 18 kHz CrO₂, to 19 kHz FeCr and metal tapes; S/N ratio Dolby on/off 64/56 dB; 16¹/₁₆"W × 11¹/₁₆"D × 4¹/₃₂"H; 13.6 lb \$425

RD-700 Stereo Cassette Deck

Two-motor, full-logic-control stereo cassette deck. Features Sendust-core record/play head; tape selector for metal/special/normal formulations; full-logic feather-touch transport controls; memory stop/play; LED peak-level signal displays; Dolby B noise-reduction system; direct cassette loading; full automatic shutoff; LED indicators for record, play, pause, and Dolby NR; remote-control jack for RR-700 controller. Wow and flutter 0.13% DIN, 0.037% wrms; frequency response ±3 dB 30-15,000 Hz normal, to 16 kHz CrO₂, to 17 kHz metal tape; S/N ratio Dolby on/off 70/63 dB; 1¹/₁₆"W × 11¹/₂"D × 4⁷/₈"H; 11 lb \$300

RD-560 Stereo Cassette Deck

Soft-touch stereo cassette deck with electronically controlled dc motor and direct cassette loading. Features power-assisted soft-touch transport controls; Sendust record/play head; Dolby B noise-reduction system; full automatic shutoff; FL peak level indicators; MPX filter. Wow and flutter 0.1% DIN, 0.07% wrms; frequency response ±3 dB 30-15,000 Hz normal, to 16 kHz CrO₂, to 17 kHz metal tape; S/N ratio Dolby on/off 64/55 dB; 16¹/₁₆"W × 9¹/₁₆"D × 4¹/₃₂"H; 11 lb \$220

RD-400 Stereo Cassette Deck

Economy stereo cassette deck with Dolby B noise-reduction system. Features electronically controlled dc motor; High B super-hard Permalloy laminated record/play head; large illuminated VU meters; normal/special/metal tape selector; full automatic shutoff. Wow and flutter 0.1% DIN, 0.07% wrms; frequency response ±3 dB 30-14,000 Hz normal, to 15 kHz CrO₂, to 17 kHz metal tape; S/N ratio Dolby on/off 64/55 dB; 16¹/₁₆"W × 10¹/₁₆"D × 4²/₃₂"H; 10.1 lb \$180

Micro System Stereo Cassette Decks

Designed to be part of Rotel's "Micro System" component line but available separately.

RMD-90. Two-motor, full-logic deck with LED peak-level indicators; metal-tape compatibility; Dolby B noise-reduction system; solenoid-controlled transport. Wow and flutter 0.1% DIN, 0.05% wrms; frequency response 30-14,000 Hz normal, to 15 kHz CrO₂, to

16 kHz metal tape; S/N ratio Dolby on/off 63/55 dB; 11"W × 10¹/₁₆"D × 4¹/₃₂"H; 8.5 lb \$300
RMD-82. Soft-touch transport controls; High-B super-hard Permalloy record/play head; metal/special/normal tape selector; full automatic shutoff; 5-LED signal-level indicators. Specifications same as for RMD-90 except 8¹/₁₆"D × 4²/₃₂"H, 7 lb \$240
RMD-70. Metal-tape-capable deck with 5-LED peak level indicators; High-B Permalloy record/play head; Dolby B noise-reduction system; metal/special/normal tape selector. Specifications same as for RMD-90 except 11"W × 8³/₃₂"D × 4²/₃₂"H, 6.8 lb \$180

SAE

SAE Two Line

C4 Cassette Deck

Front-loading metal-compatible stereo cassette deck with Dolby B noise-reduction system and FG servo motor. Features logic solenoid tape function controls; 3-position bias and equalization for normal, FeCr, and high output (includes metal) tapes with variable bias; automatic stop; LED peak level bargraph display; mic, line, and record mute switches; tape counter with reset; timer switch; optional remote control. Wow and flutter 0.06%; frequency response 30-18,000 Hz ±2.5 dB \$599 Remote One. Remote control unit for C4 \$50

SANSUI

D-700R Stereo Cassette Deck

Twin-capstan/3-motor stereo cassette deck with instant (0.6-second) automatic-reverse record/play transport, Dolby B and C noise-reduction systems, and full-logic transport controls. Features 4-channel record/play head with electronic switching that permits computerized access to selections on either side of tape; AMPS (Automatic Music Program Search) that locates desired selections 15 bands ahead or behind on either side of tape; dual memory function that blocks off start and end points of tape for repeat play (points referenced to 4-digit fluorescent counter display that shows conventional or real-time); peak-indicating record level indicators. Wow and flutter 0.04%; frequency response ±3 dB 35-16,000 Hz normal, to 17 kHz CrO₂, to 18 kHz metal tape; S/N ratio no NR/Dolby B/Dolby C 60/70/80 dB; 16¹/₁₆"W × 12¹/₄"D × 4³/₈"H; 14.6 lb \$600

D-570 Stereo Cassette Deck

Three-head, direct-drive, full-logic stereo cassette deck with Dolby B and C noise-reduction systems. Features automatic music program search; tape lead-in facility that automatically bypasses leader; roller-coupled holdback tension that takes up tape slack; Compu-Edit capability; dual memory function; 4-digit fluorescent tape/real-time counter; 12-segment peak-indicating signal meters; timer record/play capability; semiautomatic bias control. Wow and flutter 0.03% wrms; frequency response 30-21,000 Hz ±3 dB with metal tape; S/N ratio no NR/Dolby B/Dolby C 60/70/80 dB; 16¹/₁₆"W × 12¹/₄"D × 4³/₈"H; 14.3 lb \$540

D-370 Stereo Cassette Deck

Direct-drive, full-logic stereo cassette deck with Dolby B and C noise-reduction systems. Features 4-digit dual-mode fluorescent tape/real-time counter; AMPS for rapid access to recorded selections; dual-memory system; Compu-Edit for dubbing selections in any sequence from Sansui P-M7 linear-tracking turntable; record mute; timer record/play capability; roller-coupled holdback tension mechanism that takes up tape slack; one-touch tape lead-in switch; 12-segment LED

peak-signal level displays. Wow and flutter 0.03% wrms; frequency response 30-18,000 Hz ±3 dB with metal tape; S/N ratio no NR/Dolby B/Dolby C 60/70/80 dB; 16¹/₁₆"W × 12¹/₄"D × 4³/₈"H; 14.1 lb \$420

D-300M Cassette Deck

Front-loading cassette deck with Automatic Music Program Search. Features electronically-controlled dc motor and full IC-logic transport controls; 24-segment peak-level LED record/play indicators; separate bias/EQ switches for metal, CrO₂, ferric tapes; external timer or optional remote-control operation; Hi-B Permalloy record/playback head and double-gap ferrite erase head; black or silver finish. Wow and flutter 0.05% wrms; frequency response ±3 dB 30-17,000 Hz metal, to 16 kHz CrO₂, to 14 kHz ferric tape; S/N ratio 68 dB with metal tape, Dolby on; 16¹/₁₆"W × 9³/₈"D × 5¹/₄"H \$320

D-95M Cassette Deck

Metal-compatible, front-loading cassette deck with 18-segment peak-level LED record/play indicators. Features direct-change transport mode controls with single-button record activation; separate bias/EQ switches for metal/CrO₂/ferric tapes; separate channel record-level controls; Hi-B Permalloy record/play and double-gap ferrite erase heads; black or silver finish. Wow and flutter 0.07% wrms; frequency response ±3 dB 30-15,000 Hz with metal, to 14 kHz ferric tape; S/N ratio 68 dB with metal tape, Dolby on; 16¹/₁₆"W × 9³/₈"D × 5¹/₄"H \$200

SANYO

RD S46 Stereo Cassette Deck

Two-head stereo cassette deck with Automatic Music Select System (AMSS) and Dolby B and C noise-reduction systems. Features power-assisted transport controls with logic interlock; metal-tape capability; fluorescent peak signal level meters; one-touch recording; output level control; record mute; full automatic stop; soft cassette eject. Wow and flutter 0.05% wrms; frequency response ±3 dB 30-16,000 Hz CrO₂, to 18 kHz metal tape; S/N ratio Dolby B/C 67/77 dB; 17¹/₈"W × 10³/₈"D × 4⁷/₈"H \$200

RD S35 Stereo Cassette Deck

Two-head, metal-capable stereo cassette deck with Dolby B and C noise-reduction systems. Features Automatic Music Select System (AMSS); logic-interlock, power-assisted transport controls; illuminated VU meters; one-touch recording; superhard Permalloy tape head; function indicators; full automatic stop; soft cassette eject. Wow and flutter 0.05% wrms; frequency response ±3 dB 30-16,000 Hz CrO₂, to 18 kHz metal tape; S/N ratio Dolby B/C 67/77 dB; 16¹/₁₆"W × 9³/₈"D × 4⁷/₈"H \$170
RD S24. Similar to RD S35 except no Dolby C noise-reduction system \$150

RD S21 Stereo Cassette Deck

Two-head, metal-compatible stereo cassette deck with Automatic Music Select System (AMSS) and Dolby B noise-reduction system. Features power-assisted transport controls with logic interlock; single-motor dc servo drive system; illuminated VU meters; air-damped cassette door. Wow and flutter 0.05% wrms; frequency response ±3 dB 30-15,000 Hz CrO₂, to 16 kHz metal tape; S/N ratio 64 dB, Dolby on; 15"W × 9¹/₁₆"D × 5¹/₄"H \$130

RD 10 Stereo Cassette Deck

Two-head metal-compatible stereo cassette deck with Dolby B noise-reduction system. Features dc governor motor; automatic stop; 2-color LED signal meters. Wow and flutter 0.09% wrms; frequency response ±3 dB 30-14,000 Hz normal, to 15 kHz metal tape; S/N ratio 62 dB, Dolby on; 15¹/₁₆"W × 7¹/₂"D × 5³/₈"H \$100
RD 8. Similar to RD 10 except no Dolby noise-reduction system; S/N ratio 50 dB \$80

RD W50 Dubbing Stereo Cassette Deck

Dual-transport dubbing stereo cassette deck with Automatic Music Select System (AMSS) and Dolby B noise-reduction system. Features metal-tape capability; LED peak signal meters; record mute; full automat-

NEED MORE INFORMATION?

Write directly to the manufacturer or distributor. A list of names and addresses starts on page 4.

1

CASSETTE TAPE MACHINES

H.H. SCOTT

ic stop; air-damped cassette doors; LED indicators. Wow and flutter 0.06%; frequency response ± 3 dB 30-15,000 Hz CrO₂, to 16 kHz metal; S/N ratio 60 dB, Dolby on; $1\frac{3}{4}'' \times W \times 7\frac{1}{2}'' \times D \times 4\frac{1}{16}'' \times H$.. \$220

Plus Series

D56 Stereo Cassette Deck

Front-loading stereo cassette deck with metal-tape capability, Automatic Music Select System (AMSS), IC-logic transport controls, and built-in Dolby noise-reduction system. Features 2-color, 12-segment peak level meters; Permalloy record/play and ferrite erase heads; timer operation in both record and playback modes; normal/CrO₂/metal tape selector switches. Wow and flutter 0.05% wrms; frequency response ± 3 dB 30-19,000 Hz metal, to 17 kHz CrO₂, to 14 kHz normal tape; S/N ratio Dolby on/off 67/59 dB metal, 65/57 dB CrO₂, 63/55 dB normal tape; THD metal/CrO₂ tape 0.8%/1.5%; separation 40 dB; crosstalk -70 dB; $1\frac{7}{8}'' \times W \times 10\frac{1}{8}'' \times D \times 4'' \times H$ \$200

Plus Series

D90 Stereo Cassette Deck

Two-head stereo cassette deck with Sanyo Super D tape-hiss reduction system and 15-program Automatic Music Select System (AMSS). Features Dolby B noise-reduction system; metal-tape compatibility; wide-range peak level meters; switchable MPX filter; output level controls; full-logic transport controls; 2-motor transport; record mute; timer record/play standby. Wow and flutter 0.04% wrms; frequency response ± 3 dB 30-14,000 Hz normal, to 17 kHz CrO₂, to 19 kHz metal tape; S/N ratio Dolby off/on 55/65 dB normal, 57/67 dB CrO₂, 59/68 dB metal tape; S/N with Super D, metal tape 100 dB weighted peak; THD 0.06%; separation 40 dB; input sensitivity/impedance 0.3 mV/400-10k ohms mic, 50 mV/50k ohms line; output level/impedance 400 mV/2k line, 40 mV/8 ohms headphones; $1\frac{7}{8}'' \times W \times 10\frac{1}{8}'' \times D \times 4\frac{3}{8}'' \times H$ \$380

D58 Stereo Cassette Deck

Full-logic IC transport control stereo cassette deck with Sanyo Super D tape-hiss reduction system and 15-program Automatic Music Select System (AMSS). Features metal-tape compatibility; Dolby B noise-reduction system; 12-segment LED peak level meters; record mute; timer standby; automatic stop. Wow and flutter 0.05% wrms; frequency response ± 3 dB 30-14,000 Hz normal, to 17 kHz CrO₂, to 19 kHz metal tape; S/N ratio Dolby off/on 55/65 dB normal, 57/67 dB CrO₂, 59/69 dB metal tape; S/N with Super D, metal tape 100 dB weighted peak; THD 0.06%; input sensitivity/impedance 0.3 mV/400-10k ohms mic, 50 mV/50k ohms line; output level/impedance 400 mV/2k ohms line, 40 mV/8 ohms headphones; separation 40 dB; $1\frac{7}{8}'' \times W \times 10\frac{1}{8}'' \times D \times 4'' \times H$ \$300

D57. Similar to D58 except no Super D circuit; THD metal/CrO₂ tape 0.8%/1.5% \$230

D56 Stereo Cassette Deck

Two-head stereo cassette deck with Dolby B noise-reduction system. Features metal-tape capability; Automatic Music Select System (AMSS); 12-segment, 2-color LED peak signal level meters; full-logic feather-touch transport controls; record mute; timer standby; automatic stop. Wow and flutter 0.05% wrms; frequency response ± 3 dB 30-14,000 Hz normal, to 17 kHz CrO₂, to 19 kHz metal tape; S/N ratio Dolby off/on 55/63 dB normal, 57/65 dB CrO₂, 59/67 dB metal tape; THD metal/CrO₂ tape 0.8%/1.5%; input sensitivity/impedance 0.3 mV/400-10k ohms mic, 50 mV/50k ohms line; output level/impedance 400 mV/2k ohms line, 50 mV/8 ohms headphones; separation 40 dB; $1\frac{7}{8}'' \times W \times 10\frac{1}{8}'' \times D \times 4'' \times H$ \$200

658DM Stereo Cassette Deck

Slimline full-logic stereo cassette deck with feather-touch controls. Features separate pushbutton selectors for normal/CrO₂/FeCr/metal tape formulations; tape memory rewind/replay; timer record/play standby; Dolby B and C noise-reduction systems; separate level and record-balance controls; Sendust record/play and dual-gap ferrite erase heads; fluorescent peak-hold signal-level meters; soft-eject front loading. Wow and flutter 0.04% wrms; frequency response ± 3 dB 30-16,000 Hz normal, to 17 kHz CrO₂, to 18 kHz metal tape; S/N ratio 64 dB normal, 66 dB CrO₂ and metal tape, Dolby on; THD normal/CrO₂/metal tape 1.5%/2.5%/1.2%; input sensitivity line/mic 100 mV/0.3 mV; output level 550 mV; fast-wind time 80 seconds with C60 cassette; $17'' \times W \times 8\frac{1}{16}'' \times D \times 3\frac{1}{16}'' \times H$ \$300

638DM Stereo Cassette Deck

Slimline stereo cassette deck with soft-touch transport controls. Features LED function indicators; dual fluorescent peak-hold signal-level displays; record mute; separate level and record balance controls; super B Permalloy record/play and dual-gap ferrite erase heads; Dolby B noise-reduction system; soft-eject mechanism; metal/CrO₂/FeCr/metal tape bias/equalization selector; timer record/play standby. Wow and flutter 0.045% wrms; frequency response ± 3 dB 30-16,000 Hz metal, to 17 kHz CrO₂ and FeCr, to 18 kHz metal tape; S/N ratio Dolby on/off 66/58 dB with normal tape; separation 40 dB; input sensitivity/impedance 100 mV/47k ohms line, 3 mV/15k ohms mic; output level 550 mV maximum; $430 \text{ mm} \times W \times 220 \text{ mm} \times D \times 110 \text{ mm} \times H$ \$250

628DM Stereo Cassette Deck

Slimline stereo cassette deck with Dolby B noise-reduction system. Features normal/CrO₂/FeCr/metal tape bias/equalization selector; wide-range VU meters; soft-touch mechanical transport controls; record mute; separate level and record balance controls; super B Permalloy record/play and dual-gap ferrite erase heads; soft-eject cassette mechanism. Wow and flutter 0.045% wrms; frequency response ± 3 dB 30-16,000 Hz normal, to 17 kHz CrO₂ and FeCr, to 18 kHz metal tape; S/N ratio Dolby on/off 66/58 dB with normal tape; separation 40 dB; input sensitivity/impedance 110 mV/47k ohms line, 3 mV/15k ohms mic; output level 550 mV maximum; $430 \text{ mm} \times W \times 220 \text{ mm} \times D \times 110 \text{ mm} \times H$ \$215

SHARP

RT-300 Stereo Cassette Deck

Solenoid full-logic feather-touch transport stereo cassette deck with Dolby B and C noise-reduction systems. Features slim design; APSS; metal-tape capability; normal/CrO₂/metal tape selector; 2-color 8-LED peak signal level displays; soft eject; full automatic stop; $17'' \times W \times 9\frac{1}{8}'' \times D \times 4'' \times H$ \$220

RT-32 Stereo Cassette Deck

Stereo cassette deck with Dolby B noise-reduction system, soft-touch transport controls, 9-position Auto Program Locate Device (APLD) and indicators. Features normal/CrO₂/metal tape capability; Sharpscan 16-LED, 2-color peak level displays; dual-concentric record-level controls; full automatic stop; dampened eject; hard Permalloy record and triple-gap erase heads; digital tape counter; $16\frac{1}{16}'' \times W \times 8\frac{1}{8}'' \times D \times 4\frac{1}{16}'' \times H$ \$190

RT-31. Similar to RT-32 but with Auto Program Search System instead of APLD \$170

RT-200 Stereo Cassette Deck

Solenoid full-logic feather-touch transport stereo cassette deck with APSS and Dolby B noise-reduction system. Features metal-tape capability; 2-color LED



peak signal level meters; soft eject; normal/CrO₂/metal tape selector; electronically controlled dc motor. Wow and flutter 0.07% wrms; frequency response ± 3 dB 40-14,000 Hz metal, to 13 kHz CrO₂, to 12.5 kHz normal tape; S/N ratio Dolby off/on 52/62 dB; input sensitivity/impedance 0.2 mV (-74 dB)/6.8k ohms mic, 50 mV (-26 dB)/50k ohms line; output level/impedance 550 mV/50k ohms line, 0.2 mW/8 ohms headphones; $15\frac{1}{4}'' \times W \times 9'' \times D \times 4'' \times H$; 6.9 lb \$180

RT-20 Cassette Deck

Front-loading metal-compatible stereo cassette deck with Dolby B noise-reduction system, electronically-controlled dc motor, and hard Permalloy record/play and triple-gap ferrite erase heads. Features computer-controlled multi-display showing Sharpscan peak level meters, time, AM/PM, electronic tape counter; bias and equalization for normal, CrO₂, metal tapes; pushbutton tape time remaining counter for C90, C60, C46 tapes with 3-minute warning; timer alarm; 50/60-Hz ac frequency selector; automatic stop. Wow and flutter 0.09% wrms; frequency response 30-14,000 Hz normal, to 17 kHz metal; S/N ratio 64 dB, Dolby on; $15\frac{1}{8}'' \times W \times 8\frac{1}{4}'' \times D \times 5'' \times H$ \$190

RT-12 Stereo Cassette Deck

Stereo cassette deck with Dolby noise-reduction system, metal-tape capability, and Auto Program Search System (APSS). Features soft-touch transport controls; Sharpscan 10-LED peak level indicator; independent left/right record level controls; full automatic stop; hard Permalloy record and triple-gap ferrite erase heads; dampened eject; tape counter; $15\frac{1}{8}'' \times W \times 8'' \times D \times 4\frac{1}{2}'' \times H$ \$150

RT-10 Cassette Deck

Front-loading metal-compatible stereo cassette deck with Dolby B noise-reduction system, electronic-controlled dc motor, and hard Permalloy record/play and ferrite erase heads. Features LED peak level display; normal/CrO₂/metal tape selector; separate left/right record level controls; soft-eject cassette holder; automatic stop. Wow and flutter 0.09% wrms; frequency response 30-14,000 Hz normal, to 16 kHz metal tape; S/N ratio 62 dB, Dolby on; silver finish; $15\frac{1}{8}'' \times W \times 8\frac{1}{4}'' \times D \times 5'' \times H$ \$130

RT-100 Stereo Cassette Deck

Low-profile stereo cassette deck with metal-tape capability and Dolby B noise-reduction system. Features 10-LED peak signal level displays; electronically controlled dc motor; normal/CrO₂/metal tape selector; soft eject; hard Permalloy record/play head. Wow and flutter 0.1% wrms; frequency response ± 3 dB 40-13,000 Hz metal, to 12 kHz CrO₂, to 11 kHz normal tape; S/N ratio Dolby off/on 52/62 dB; input sensitivity/impedance 0.2 mV (-74 dB)/6.8k ohms mic, 50 mV (-26 dB)/50k ohms line; output level/impedance 550 mV/50k ohms line, 0.2 mW/8 ohms headphones; $15\frac{1}{4}'' \times W \times 8\frac{1}{4}'' \times D \times 4\frac{1}{8}'' \times H$; 5.5 lb \$120

SHERWOOD

S-6000 CP Stereo Cassette Deck

Three-head stereo cassette deck with Dolby B and C noise-reduction systems. Features Sendust tape



heads; normal/CrO₂/metal tape capability; fine bias adjust control; switchable MPX filter; microprocessor-controlled soft-touch transport. Wow and flutter 0.05% wrms; frequency response 30-21,000 Hz ± 3 dB with metal tape; S/N ratio > 77 dB with Dolby C; THD 3%; $1\frac{7}{8}'' \times W \times 15\frac{1}{2}'' \times D \times 4\frac{3}{8}'' \times H$ \$400

S-5000CP Cassette Deck

Microprocessor-controlled front-loading stereo cassette deck with Dolby B noise-reduction system, super-hard alloy Sendust heads, and record/play timer

function. Features soft-touch controls; air-dampened cassette door with backlighting; electronically governed dc motor; LED indicators for play, record and pause; dual-function, 2-color fluorescent displays with peak-hold/average signal level indication; metal/chrome/ferrichrome/normal tape EQ selector with separate bias fine adjust control; MPX filter; separate line output and headphone controls. Wow and flutter 0.05% wrms; frequency response $+1/-3$ dB at -20 -dB record level 25-16,500 Hz normal, to 17.5 kHz chrome, to 19 kHz metal tape, $30-13,000$ Hz ± 3 dB at 0-dB rec level with metal tape; S/N ratio with chrome tape Dolby on/off 63/56 dB; THD 1% at 1 kHz with metal tape \$350

S-250 CP Stereo Cassette Deck

Metal-capable stereo cassette deck with Dolby B and C noise-reduction systems. Features Dynalloy tape heads; normal/CrO₂/metal tape selector; soft-touch transport controls; 12-segment LED level meters. Wow and flutter $<0.06\%$ wrms; frequency response 30-19,000 Hz $+1/-3$ dB; S/N ratio >76 dB with Dolby C; THD 3%; $17\frac{3}{4}''W \times 15\frac{1}{2}''D \times 4\frac{3}{4}''H$ \$230

S-100CP Cassette Deck

Front-loading, metal-compatible stereo cassette deck with Dolby B noise-reduction system, super-hard Dynalloy record/play head, and memory rewind. Features fully automatic tape transport; automatic shut-off; metal/chrome/normal tape selector; record and Dolby LEDs; cassette backlighting; pause control. Wow and flutter 0.06% wrms; frequency response $+1/-3$ dB at -20 -dB rec level 25-15,000 Hz normal, to 15.5 kHz chrome, to 17 kHz metal tapes, 30-10,000 Hz ± 3 dB at 0-dB rec level with metal tape; S/N ratio Dolby on/off 63/54 dB; THD 1% at 1 kHz with metal tape \$200

SONY

TC-K777 Stereo Cassette Deck

Reference Standard 3-head deck with Sendust and ferrite Independent Suspension record and play heads and ferrite erase head. Metal-tape capable; quartz-locked direct-drive closed-loop dual-capstan transport with Magnedisc servo control, 2 Sony BSL motors, and solenoid feather-touch transport controls; 4-position tape selector switch, including metal position; Dolby B noise-reduction system; variable bias, record sensitivity, and Dolby calibration with built-in test-tone generator; total tape information display center that includes 30-element peak program meters with hold capability, linear real-time tape counter, bias/record sensitivity indicators, and record level guides; all-stage dc construction; memory play/stop; automatic-space record mute; facility for optional remote-control accessories. Wow and flutter 0.025% wrms; frequency response ± 3 dB 20-20,000 Hz with Type IV tape; S/N 60 dB A weighted with Dolby off \$950
 RM-50. Wired remote control \$55
 RM-80. Wireless infrared remote control \$120
 RM-44. Full system wireless remote control for use with selected Sony RC-capable products \$150
 RM-65. Recording synchronizer for use with selected Sony turntables \$25

TC-FX1010 Stereo Cassette Deck

Self-monitoring, 3-head, computerized stereo cassette deck with audio signal processor (ASP) IC for feather-touch control of all functions and settings. Features self-monitoring head that adjusts bias and tape sensitivity for each tape used, monitors record level and adjusts for minimum distortion; multi-function memory that allows storage of tape settings and calibration of up to 4 different types of tape; Dolby B and C noise-reduction systems; independent-suspension Sendust and ferrite record and play/monitor head; closed-loop dual-capstan drive system with BSL capstan and dc reel motors; concentrated display that includes electronic peak program meters, linear real-time tape counter, and record level setting guides; automatic tape selection system for all types of tape, including metal; automatic play; memory play/stop; automatic-space record mute; memory backup system; dc amplifier and direct-coupled play head amplifier; facility for optional remote controller.

Wow and flutter 0.04% wrms; frequency response 25-18,000 Hz ± 3 dB; S/N ratio 60 dB A weighted, Dolby off \$650

TC-K555 Stereo Cassette Deck

Three-head, 2-motor stereo cassette deck with independent suspension Sendust and ferrite record and playback heads. Features closed-loop dual-capstan dc servo belt-drive transport system; BSL capstan and dc reel motor with solenoid logic feather-touch transport controls; fine tuning bias control for Type I tape, plus positions for Types II, III, and IV tapes; Dolby B and C noise-reduction systems; automatic-space record mute; automatic play; memory stop/play; concentrated display that includes electronic peak program meter, linear real-time tape counter, and record level setting guides; provision for optional remote control. Wow and flutter 0.04% wrms; frequency response 30-18,000 Hz ± 3 dB with Type IV tape; S/N ratio 60 dB A weighted, Dolby off \$450

TC-FX77 Stereo Cassette Deck

Two-motor stereo cassette deck with Dolby B and C noise-reduction systems. Features dc servo belt-drive system; noncrystalline LaserAmorphous record/play head for greater dynamic range; feather-touch full-logic solenoid transport controls; concentrated display that includes electronic peak program meters, linear real-time tape counter, 9-selection Automatic Music Sensor (AMS)/automatic repeat feature, and record level guides; 4-position tape selector (includes metal); automatic play; memory play/stop; automatic-space record mute; dc amplifier and direct-coupled play head amplifier; facility for optional remote controller. Wow and flutter 0.04% wrms; frequency response 30-17,000 Hz ± 3 dB with Type IV tape; S/N ratio 59 dB A weighted, Dolby off \$400
 TC-FX66. Similar to TC-FX77 except no AMS/repeat feature or record level guides \$320

TC-FX44 Stereo Cassette Deck

Stereo cassette deck with Dolby B and C noise-reduction systems and Sony SD record/play head. Features dc servo belt-drive system; full-logic feather-touch transport controls; automatic tape selection system for all tape formulations, including metal; Automatic Music Sensor (AMS) with automatic-space record mute; automatic play; LED peak meters; facility for optional remote controller. Wow and flutter 0.05% wrms; frequency response 30-16,000 Hz ± 3 dB with Type IV tape; S/N ratio 59 dB A weighted, Dolby off \$210
 TC-FX33. Similar to TC-FX44 except Dolby B only NR system, no automatic play, no remote-control capability \$180

TC-P85 Playback-Only Stereo Cassette Deck

Features Sendust and ferrite head; 2-motor dc servo transport; Dolby B noise-reduction system; solenoid logic feather-touch transport controls; 2-position tape selector switch, including metal; random music sensor; headphone level control; dubbing capability with selected Sony tape decks, using optional RM-65 accessory \$220

TANDBERG

TC-D 3004 Cassette Deck

Microprocessor-controlled metal-compatible vertical front-loading stereo cassette deck with dual Dolby B noise-reduction system, 4 motors, and 3 tape heads. Features PROM-brain logic microprocessor function controls with LED indicators; recording preset; Dyneq[®] record equalization and Actilinear[®] headroom-extension system; 4-position bias/record and

70/120- μ sec playback equalization controls with bias fine adjust; calibration selector for off, azimuth, bias fine adjust, and left and right record level with calibration meter; separate left/right record level and mic level controls with master control; source/tape monitor switch; headphones volume control; LED digital counter display with memory and reset; dual peak-indicating meters; error-detection digital display; wind speed control; azimuth control. Frequency response 20-20,000 Hz ± 3 dB; S/N ratio 70 dB \$2195

TC-D 400A Cassette Deck

Metal-compatible stereo cassette deck with dual Dolby B noise-reduction system, separate record, play, and Tandberg erase heads (80 dB erasure at 1 kHz and 60 dB erasure at 100 Hz), and 3 motors in dual-capstan transport system. Features Dyneq[®] record equalization circuitry designed to automatically adjust record preemphasis of deck to maximize potential treble response while simultaneously minimizing treble distortion; Actilinear[®] recording system; dual peak-indicating meters with second scale reflecting metal-particle signal levels; 10-kHz test oscillator; bias adjust controls for ferric, CrO₂, and metal tapes with set of left/right LEDs; separate left and right slider input and output level controls with LEDs; LED Dolby, tape I and II/metal, source/tape, record preset on/off, and power on/off indicators; optional PCM infrared wireless remote control available. Frequency response 20-20,000 Hz ± 3 dB; S/N 70 dB A weighted; anodized matte black finish; $18\frac{1}{16}''W \times 8\frac{7}{8}''D \times 4''H$ \$995

TC-D 420A Stereo Cassette Deck

Front-loading metal-compatible stereo cassette deck with Dolby B noise-reduction system, 3 motors in dual-capstan transport system, and diamond-cut Senalloy record/play and Tandberg erase (80-dB erasure at 1 kHz, 60-dB at 100 Hz) heads. Features Dyneq[®] dynamic equalization amplifier circuitry; Actilinear[®] recording system; tape and bias selectors for tape I (ferric), II (chrome), and metal with left- and right-channel bias-adjust selectors for each tape; separate left and right input and output level vertical slide levers; equalized peak-indicating VU meters; 3-digit tape counter with reset. Wow and flutter 0.13% wrms; frequency response 30-18,000 Hz ± 3 dB; THD 3.0% metal, 2.0% ferric and chrome; S/N with metal tape 68 dB (IEC A weighted); input sensitivity/impedance 8 mV/47k ohms radio, 40 mV/220k ohms line; microphone input sensitivity 0.15-20 mV (mic input matched to dynamic microphone); $18\frac{1}{16}''W \times 8\frac{7}{8}''D \times 4''H$ \$649

TC-D 3034 Stereo Cassette Deck

Soft-touch, logic-controlled stereo cassette transport. Features cue and record mute; peak-indicating equalized meters; Dyneq[®] and Actilinear[®] headroom-extension system; instant-access loading. Dust cover for cassette compartment optional. Accommodates metal tape. Frequency response 10-20,000 Hz ± 3 dB \$499

TEAC

C-1A/BA Stereo Cassette Deck

Front-loading stereo cassette deck with Dolby B noise-reduction system and 3-motor, 3-head dual-capstan transport system with PLL dc servo capstan and 2 dc coreless reel motors. Features LSI logic tape function operation controls; pitch control to vary tape speed up to 4%; double-action input controls; 2 peak program VU meters; 3-position bias and equalization switch; optional interchangeable bias/equalization card, CX-8; 3-position monitor switch; switchable Dolby/dbx[®] noise reduction system with optional dbx II Interface; input selector switch for mic/mic-with-attenuation/line; memory function for automatic stop/repeat; timer control switch; provision for optional remote control unit. Wow and flutter 0.04% (NAB weighted); frequency response 31.5-18,000 Hz ± 3 dB CrO₂, to 16 kHz ± 3 dB normal tape; S/N ratio Dolby off/on 60/70 dB; fast-wind time 100 seconds with C60 cassette; mic input sensitivity/impedance -72 dB (0.25 mV)/600 ohms; line input sensitivity/impedance 60 mV/50k ohms; available in champagne or brown; $19''W \times 13\frac{1}{4}''D \times 6\frac{1}{2}''H$ \$1350

C-3RX Stereo Cassette Deck

Stereo cassette deck with dbx[®] noise-reduction sys-



1

CASSETTE TAPE MACHINES

tem and 3-head, 2-motor transport. Features double dbx NR; tape/source monitoring; Dolby B noise-reduction system; 3-step independent bias and equalization selectors; timer function; memory play/stop; independent input level controls; output level control; adjustable bias/record calibration; optional rack-mount kit, remote controller, test-tone oscillator. Wow and flutter 0.04% NAB weighted; frequency response ± 3 dB 20-20,000 Hz metal, to 19 kHz CrO₂ and CO, to 16 kHz normal tape; S/N ratio no NR/dbx 60/91 dB; fast-wind time 80 seconds with C60 cassette; 15.7"W \times 15.7"D \times 5.8"H; 20.9 lb \$690

V-95RX Stereo Cassette Deck

Bidirectional record/play stereo cassette deck with 3-head, 2-motor transport and dbx* noise-reduction system. Features quick-reverse transport; Computomatic Program System; block repeat; 4-digit LED tape counter; LED bargraph level meters; electronic-control output level (up/down, 2-step, slow/fast); L/R balanced output level control; remote-control capability (CPS, start/stop memory capability); timer function. Optional accessories include remote controller and timer \$625

V-1RX Stereo Cassette Deck

Electroload motorized head loading stereo cassette deck with 3-motor, 3-head transport and dbx* noise-reduction system. Features dynamic-range-expansion system; direct-drive capstan motor; block repeat; vertical peak level meters; timer record/play; output level control; fine bias adjust control; double Dolby B noise-reduction system; normal/CrO₂(Co)/metal tape selectors; 4-digit electronic tape counter; soft-touch transport controls. Wow and flutter 0.025% wrms; frequency response ± 3 dB 20-18,000 Hz normal, to 19 kHz CrO₂/Co, to 20 kHz metal tape; S/N ratio no NR/Dolby/dbx 63/73/92 dB; input sensitivity/impedance 60 mV/50k ohms line; microphone input 0.25 mV/-72 dB; output level/impedance 0.3 V/50k ohms line; headphone output impedance 8 ohms; power consumption 25 W; fast-wind time 90 seconds with C60 cassette; 17 $\frac{1}{16}$ "W \times 10 $\frac{1}{4}$ "D \times 4 $\frac{7}{16}$ "H; 13 lb 4 oz \$590

V-95RX Stereo Cassette Deck

Bidirectional stereo cassette deck with Positouch transport control, Computomatic Program System, dbx* and Dolby noise-reduction systems, and dbx dynamic-range expansion. Features real-time reverse; block repeat; 3-motor transport; touch fader control system; bipolar power supply; dc circuitry; timer record/play; LED bargraph peak level meters; 4-digit LED tape counter; output level control; recording balance control; all-clear button; normal/CrO₂(Co)/metal tape selectors. Wow and flutter 0.045% wrms; frequency response ± 3 dB 30-16,000 Hz normal, to 18 kHz CrO₂/Co, to 19 kHz metal tape; S/N ratio no NR/Dolby/dbx 59/69/91 dB; input sensitivity/impedance 60 mV/50k ohms line; microphone input 0.25 mV/-72 dB; output level/impedance 0.3 V/50k ohms line; headphone output impedance 8 ohms; power consumption 25 W; fast-wind time 80 seconds with C60 cassette; 17 $\frac{1}{16}$ "W \times 11 $\frac{1}{16}$ "D \times 4 $\frac{7}{16}$ "H; 13 $\frac{3}{8}$ lb \$695

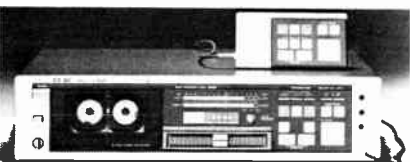

V-90R. Same as V-95RX except no Computomatic Program System; weight 13 $\frac{3}{4}$ lb \$490

M-124 Syncaset Stereo Cassette Deck

Front-loading Simul-Sync stereo cassette deck with Dolby B noise-reduction system, FG dc servo-controlled motor, and record/play and erase heads. Features Simul-Sync that permits monitoring on one track while simultaneously recording on another through the same head; crossfield switch for Simul-Sync for slight blending of left and right channels; independent bias and equalization selectors for normal/CrO₂ tapes; separate left and right record level controls; mic/DIN and line input selector; 3-digit tape counter with memory rewind; 2 VU meters; fast-wind time 90 seconds with C60 cassette. Wow and flutter 0.07% wrms; frequency response ± 3 dB 30-16,000 Hz with CrO₂ tape; S/N ratio Dolby off/on 55/65 dB; input sensitivity/impedance 60 mV/50k ohms line, 0.25 mV/600 ohms mic; 16 $\frac{1}{8}$ "W \times 11 $\frac{1}{2}$ "D \times 6 $\frac{1}{4}$ "H \$450

V-80 Stereo Cassette Deck

Professional Series stereo cassette deck with Positouch controlled 3-head, 2-motor transport and TRT-mode tape counter. Features color-coded fluorescent peak level meters; double Dolby B noise-reduction system; multifunction tape counter with real-time display; memory stop; record mute; timer record/play capability; source/tape monitor switch; separate left and right record level controls and single output level control; normal/CrO₂/metal bias selectors. Wow and flutter 0.035% wrms; frequency response ± 3 dB 20-17,000 Hz normal, to 19 kHz CrO₂ and metal tape; S/N ratio Dolby off/on 59/69 dB; input sensitivity/impedance 60 mV/50k ohms line; mic input 0.25 mV/-70 dB at 200 ohms or more; output level/impedance 0.3 V/50k ohms or more; mic output impedance 8 ohms; power consumption 30 W; fast-wind time 90 seconds with C60 cassette; 17"W \times 10 $\frac{3}{8}$ "D \times 4 $\frac{1}{4}$ "H; 13 lb 3 oz \$420

V-70C Stereo Cassette Deck

Standard Audio Series stereo cassette deck with Dolby B and C noise-reduction systems, multi-function real-time display tape counter, and fluorescent peak program meters. Features IC logic transport controls; 2-head, 2-motor transport; record mute; memory stop; normal/CrO₂/metal tape selectors; timer record/play; facility for optional remote controller. Wow and flutter 0.035% wrms; frequency response ± 3 dB 20-17,000 Hz normal, to 18 kHz CrO₂, to 19 kHz metal tape; S/N no NR/Dolby B/Dolby C 59/69/74 dB; input sensitivity/impedance 60 mV/50k ohms line; mic input sensitivity 0.25 mV/-72 dB at 200 ohms or greater; output level/impedance 0.3 V/50k ohms; headphone output impedance 8 ohms; power consumption 30 W; fast-wind time 90 seconds with C60 cassette; 17"W \times 10 $\frac{3}{8}$ "D \times 4 $\frac{1}{4}$ "H; 13 lb 3 oz \$390

V-50 Stereo Cassette Deck

Stereo cassette deck with Dolby B noise-reduction system, built-in condenser microphone, and metal-tape capability. Features 3-step bias/equalization selector; LED bargraph signal-level meters; output level control; input level controls; line/mic/built-in mic selector; record mute; timer standby record/play. Wow and flutter 0.06% NAB weighted; frequency response ± 3 dB 30-17,000 Hz metal and CrO₂, to 15 kHz normal tape; S/N ratio Dolby off/on 57/67 dB; distortion 1.0% at 400 Hz; fast-wind time 110 seconds with C60 cassette; 17"W \times 10"D \div 4.3"H; 12 lb \$270

V-40. Similar to V-50, including microswitch soft-touch transport controls but less built-in microphone and output level control \$240

V-30 Stereo Cassette Deck

Stereo cassette deck with Dolby B noise-reduction system. Features BRILLIANT switch for improving frequency response; LED bargraph signal level meters; 3-step bias/equalization selectors; timer record/play. Wow and flutter 0.06% wrms; frequency response ± 3 dB 30-17,000 Hz metal and CrO₂, to 15 kHz normal tape; S/N ratio Dolby off/on 57/67 dB; distortion 1.0% at 400 Hz; fast-wind time 110 seconds with C60 cassette; 17"W \times 10"D \times 4.3"H; 12 lb \$210

TECHNICS

RS-M258R Stereo Cassette Deck

Front-loading, automatic-reverse stereo cassette deck with Dolby B noise-reduction system. Features quick-



reverse tape mechanism; mode and direction selectors; fixed SX heads; dual flywheel; soft-touch transport controls; music select to automatically locate beginning of taped selections; record mute; single-touch recording; timer record/play; automatic normal/CrO₂/metal tape selection; dot-pattern FL meters; output level control; automatic input selector. Wow and flutter 0.07% wrms; frequency response ± 3 dB 30-15,000 Hz normal, to 16 kHz CrO₂ and metal tape; S/N ratio Dolby off/on 57/67 dB; input sensitivity/impedance 0.25 mV/400-10k ohms mic, 60 mV/>36k ohms; output level/impedance 700 mV/2.6k ohms line, 125 mV/8-125 ohms headphones; fast-wind time 90 seconds with C60 cassette; power consumption 20 W; 16 $\frac{7}{8}$ "W \times 13 $\frac{3}{8}$ "D \times 4 $\frac{1}{8}$ "H; 12 lb 13 oz \$400

RS-M222 Stereo Cassette Deck

High-speed dubbing double stereo cassette deck with Dolby B noise-reduction system. Features synchro start; microphone mixing; series playback; automatic normal/CrO₂/metal tape select; music selector; dub/mix switch; peak-hold FL meters; playback level control; single-touch recording; record mute; soft-touch transport controls; rewind automatic play; metal-compatible MX heads; cue and review; dual pause controls; automatic input selector. Wow and flutter 0.048% wrms; frequency response ± 3 dB 20-17,000 Hz normal, to 18 kHz CrO₂, to 19 kHz metal tape; S/N ratio Dolby off/on 57/67 dB; input sensitivity/impedance 1.0 mV/400-10k ohms mic, 60 mV/>47k ohms line; output level/impedance 400 mV/2.5k ohms line, 800 mV (at 8 ohms)/8-600 ohms; power consumption 15 W; fast-wind time 90 seconds for C60 cassette; 16 $\frac{7}{8}$ "W \times 10 $\frac{1}{16}$ "D \times 4 $\frac{11}{16}$ "H; 12 lb 7 oz \$300

RS-M250 Stereo Cassette Deck

Microprocessor-controlled stereo cassette deck with digital tape counter, logic-controlled transport, and FL peak-hold meters. Features Dolby B noise-reduction in/out system; MPX filter, normal/CrO₂/FeCr/metal tape selectors; 2 motors; SX (Sendust Xtra) record/play and double-gap ferrite erase heads; full automatic stop; oil-damped soft load and eject; illuminated cassette compartment. Wow and flutter 0.04% wrms; frequency response ± 3 dB 30-17,000 Hz metal, to 16 kHz CrO₂ and FeCr, to 15 kHz normal tape; S/N ratio Dolby off/on 57/67 dB; power consumption 20 W; fast-wind time 80 seconds with C60 cassette; 16 $\frac{7}{8}$ "W \times 11 $\frac{1}{2}$ "D \times 4 $\frac{1}{4}$ "H; 11 lb 3 oz \$300

RS-M226 Stereo Cassette Deck

Stereo cassette deck with Dolby B and C noise-reduction systems and soft-touch transport controls. Features single-touch recording; rewind automatic play; cue and review; timer record/play; peak-hold FL meters; metal-compatible MX head; oil-damped cassette door. Wow and flutter 0.048% wrms; frequency response ± 3 dB 20-27,000 Hz normal, to 18 kHz CrO₂ and metal tape; S/N ratio no NR/Dolby B/Dolby C 57/67/75 dB; input sensitivity/impedance 0.25 mV/400-10k ohms mic, 60 mV/>47k ohms line; output level/impedance 400 mV/<2.3k ohms line, 80 (at 8 ohms)/8-600 ohms headphones; fast-wind time 90 seconds with C60 cassette; power consumption 12 W; 16 $\frac{7}{8}$ "W \times 9 $\frac{3}{8}$ "D \times 4 $\frac{1}{16}$ "H; 8 lb 13 oz \$200

RS-M224. Similar to RS-M226 except illuminated meters instead of FL displays \$180

RS-M218 Stereo Cassette Deck

Stereo cassette deck with Dolby B noise-reduction system, peak-hold metering, and auto tape select. Features soft-touch transport controls; fluorescent level meters; MX record/play and double-gap erase heads; separate left and right input level controls; single-touch recording; timer-assisted record/play; full automatic stop; oil-dampened cassette load/unload; removable cassette-well door. Wow and flutter 0.05% wrms; frequency response ± 3 dB 20-17,000 Hz

metal, to 16 kHz CrO₂, to 15 kHz normal tape; S/N ratio Dolby off/on 56/66 dB; fast-wind time 90 seconds with C60 cassette; power consumption 12 W; 16¹/₈"W × 8¹/₂"D × 4¹³/₁₆"H; 8 lb 13 oz.... \$200

RS-M205 Stereo Cassette Deck

Stereo cassette deck with metal-tape compatibility, soft-touch transport controls, and dual analog VU meters. Features Dolby noise-reduction system; separate left and right input level controls; oil-damped soft loading and eject; removable cassette-well door; MX record/play and double-gap ferrite erase heads. Wow and flutter 0.05% wrms; frequency response ±3 dB 20-17,000 Hz metal, to 16 kHz CrO₂, to 15 kHz normal tape; S/N ratio Dolby off/on 56/66 dB; fast-wind time 90 seconds with C60 cassette; power consumption 10 W; 16¹/₈"W × 8¹/₂"D × 4¹³/₁₆"H.... \$165

Three-Head Cassette Decks

RS-M280 Stereo Cassette Deck

Quartz direct-drive, 3-head stereo cassette deck with dual-capstan and double Dolby B noise-reduction system. Features microprocessor logic control; electronic tape counter; SX tape heads; -20 to +8 dB FL meters; automatic/manual tape selector; bias fine adjust control; high-linearity amplifiers; LED function display; FM MPX filter; record mute; timer record/play; output level control; remote-control capability. Wow and flutter 0.024% wrms; frequency response ±3 dB 25-17,000 Hz normal, to 18 kHz CrO₂, to 19 kHz metal tape; S/N ratio Dolby off/on 60/70 dB; input sensitivity/impedance 0.25 mV/400-10k ohms mic, 60 mV/42k ohms line; output level/impedance 700 mV/2.5k ohms line, 125 mV/8 ohms headphones; power consumption 25 W; fast-wind time 80 seconds with C60 cassette; 16¹/₈"W × 13³/₈"D × 3¹/₄"H; 13 lb 15 oz..... \$800

RS-M273 Stereo Cassette Deck

Two-motor, dual-capstan, 3-head stereo cassette deck. Features dual-capstan closed-loop transport; microprocessor feather-touch transport controls; electronic tape counter with memory; FL meters; automatic tape selector; fine bias adjust control; double Dolby B noise-reduction system; LED function display; timer record/play; record mute; output level control. Wow and flutter 0.037% wrms; frequency response ±3 dB 30-15,000 Hz normal, to 18 kHz CrO₂, to 19 kHz metal tape; S/N ratio Dolby off/on 59/69 dB; input sensitivity/impedance 0.25 mV/400-10k ohms mic, 60 mV/40k ohms line; output level/impedance 700 mV/3.5k ohms line, 125 mV/8 ohms headphones; power consumption 25 W; fast-wind time 80 seconds with C60 cassette; 16¹/₈"W × 13³/₈"D × 4¹/₂"H; 14 lb 5 oz..... \$550

RS-M263 Stereo Cassette Deck

Three-head stereo cassette deck with automatic tape selector and Dolby B noise-reduction system. Features SX heads; bias fine adjust control; soft-touch transport controls; rewind automatic play; FL meters; record mute; output level control; automatic input selector; full automatic stop; illuminated cassette compartment. Wow and flutter 0.048% wrms; frequency response ±3 dB 30-15,000 Hz normal, to 17 kHz CrO₂, to 18 kHz metal tape; S/N ratio Dolby off/on 58/68 dB; input sensitivity/impedance 0.25 mV/400-10k ohms mic, 60 mV/40k ohms line; output level/impedance 700 mV/22k ohms line, 125 mV/8 ohms headphones; power consumption 17 W; fast-wind time 90 seconds with C60 cassette; 16¹/₈"W × 11¹/₄"D × 4³/₄"H; 10 lb 13 oz..... \$350

dbx® Cassette Decks

RS-M275X Stereo Cassette Deck

Direct-drive stereo cassette deck with Dolby B and C and dbx® noise-reduction systems. Features 3-motor direct-drive transport; Intro-Search; AX (amorphous) head; multi-function FL digital counter; wide-scale, 3-color FL meter (-40 to +18 dB) with peak-hold; dbx® disc decoder; automatic normal/CrO₂/metal tape selector; microprocessor feather-touch transport controls; bias fine adjust control. Wow and flutter 0.03% wrms; frequency response ±3 dB 30-16,000 Hz normal, to 17 kHz CrO₂, to 18 kHz metal tape; S/N ratio no NR/Dolby B/Dolby C/dbx 58/68/

76/92 dB; dynamic range 110 dB at 1 kHz with CrO₂ tape; 16¹/₈"W × 12⁷/₈"D × 3¹/₄"H..... \$600

RS-M255X Stereo Cassette Deck

Stereo cassette deck with Dolby B and dbx® noise-reduction systems. Features dbx® disc decoder; multi-function FL display; 4-digit real-time counter; 3-digit tape counter; music select display; wide-range FL meters (-40 to +18 dB) with peak-hold feature; automatic tape selector; microprocessor feather-touch transport controls; 2-motor drive; metal-compatible MX head; output level control; timer record/play; illuminated cassette compartment. Wow and flutter 0.038% wrms; frequency response ±3 dB 30-15,000 Hz normal, to 16 kHz CrO₂, to 18 kHz metal tape; dynamic range 110 dB at 1 kHz with dbx® in; S/N ratio no NR/Dolby/dbx® 58/68/92 dB; input sensitivity/impedance 0.25 mV/400-10k ohms mic, 60 mV/47k ohms line; output level/impedance 700 mV/22k ohms line, 125 mV/8 ohms headphones; power consumption 28 W; fast-wind time 90 seconds with C60 cassette; 16¹/₈"W × 13"D × 4¹/₄"H; 13 lb..... \$380

RS-M228X. Similar to RS-M255X except no multi-function FL display; wow and flutter 0.048% wrms; S/N ratio Dolby off/on 57/67 dB; power consumption 20 W; 11"D × 4¹/₂"H; 11 lb..... \$250

Professional Series

RS-M95 Stereo Cassette Deck

Front-loading quartz-locked metal-compatible stereo cassette deck with Dolby noise-reduction system, quartz-locked direct-drive motor, and hot-pressed ferrite record/play and erase heads in 3-head system. Features dual-color fluorescent VU/instant peak/peak hold bargraph display; 4-position bias and equalization for normal, FeCr, CrO₂, metal tapes with bias fine adjust; microprocessor tape counter with memory play/rewind/stop; optional RP-9690-P or RP-070 remote control unit available; black and metal cabinet..... \$1400

RS-M851I Stereo Cassette Deck

Front-loading metal-compatible stereo cassette deck with Dolby B noise-reduction system; vertical hold, flat component style; quartz-locked-planar-opposed dc brushless, coreless, slotless direct-drive capstan motor with servo-controlled circuit; separate coreless reel motor; full IC-logic control; laminated Sendust head; low-noise equalizer and high linearity amplifier; MPX filter. Features fluorescent electronic bargraph peak displays; dim/bright and VU/peak switches; 4-position tape selector with fine bias-adjust control; electronic full automatic stop; record mute; mic/line mixing; output level control; 3-digit tape counter with memory rewind; timer record with external timer; electronic muting circuit. Wow and flutter 0.035% wrms; frequency response ±3 dB 30-14,000 Hz normal, to 16 kHz CrO₂ and FeCr tape; S/N ratio Dolby off/on 59/69 dB; microphone input sensitivity/impedance 0.25 mV/400-10k ohms; fast-wind time 90 seconds with C60 cassette; 19"W × 15³/₈"D × 3³/₄"H..... \$750

Micro Series

RS-M02 Stereo Cassette Deck

Front-loading metal-compatible stereo cassette deck with Dolby noise-reduction system, FG servo direct-drive dc capstan and dc coreless reel motors, and SX record/play and double-gap Sendust/ferrite erase heads. Features 2-color fluorescent peak-indicating bargraph display; tape selector buttons for normal, FeCr, CrO₂, and metal tapes; IC logic tape function controls; record/record mute button with LED; input level control with rear-panel mic/line switch and front-panel LED mic indicator; timer record/play with external timer; 3-digit tape counter with reset; fast-wind time 80 seconds with C60 cassette. Wow and flutter 0.035% wrms; frequency response ±3 dB 30-17,000 Hz metal, to 16 kHz CrO₂ and FeCr, to 14 kHz normal; S/N ratio 68 dB with Dolby; input sensitivity/impedance 0.25 mV/400-10,000 ohms mic, 60 mV/47k ohms line; 3¹/₄"H × 11¹/₄"W × 9"D \$400

RS-M04 Stereo Cassette Deck

Front-loading metal-compatible stereo cassette deck

with Dolby B noise-reduction system and MX record/play head. Features automatic tape selector buttons for normal, CrO₂, FeCr, and metal tapes; 2-color 18-segment fluorescent bargraph display with automatic-reset peak-hold memory circuit; music selector system; rewind automatic play; automatic stop; input and output level controls; record mute; timer standby; 3-digit tape counter with reset. Wow and flutter 0.05% wrms; frequency response ±3 dB 30-16,000 Hz metal, CrO₂, FeCr, to 14 kHz normal tape; S/N ratio 67 dB with Dolby; 12.2 cmH × 29.7 cmW × 23.2 cmD..... \$330

RS-M04A. Same as RS-M04 except 110, 125, 220, 240 V operation..... \$335

RS-M07 Stereo Cassette Deck

Soft-touch, automatic tape-select stereo cassette deck with Dolby B noise-reduction system and analog-type signal-level meters. Features MX record/play and double-gap ferrite erase heads; automatic mic/line selection; precision-calibrated VU meters; separate left and right input-level controls; single-touch recording; full automatic stop; oil-damped soft loading and eject; removable cassette-well door. Wow and flutter 0.048%; frequency response ±3 dB 20-18,000 Hz metal and CrO₂, to 17 kHz normal tape; S/N ratio Dolby off/on 57/67 dB; fast-wind time 90 seconds with C90 cassette; power consumption 10 W; 11¹/₈"W × 9¹/₈"D × 4¹/₄"H; 7 lb 11 oz... \$250

TEKNIKA

8861 Stereo Cassette Deck

Front-loading, damped-eject stereo cassette deck with hard Permalloy record/play head and dual-gap ferrite erase head. Features solenoid-operated 2-motor, direct-drive transport with FG servo dc capstan motor; soft-touch IC-logic transport controls; Cassette Program Quick Sensor (CPQS) to locate beginnings of



programs; separate input and output level controls; Dolby B noise-reduction system; 24-segment peak-hold fluorescent signal-level meters; 4-position tape selector (includes metal); automatic stop at end of play. Wow and flutter 0.03% wrms; frequency response 30-17,000 Hz ±3 dB with metal tape; S/N ratio 63 dB, Dolby on; THD <1.5% at 0 VU; 17¹/₈"W × 12¹/₈"D × 4¹/₄"H..... \$299

8761 Stereo Cassette Deck

Front-loading, damped-eject stereo cassette deck with hard Permalloy record/play head and dual-gap ferrite erase head. Features dc capstan motor; CPQS; separate input and output level controls; 10-segment LED peak level meters; Dolby B noise-reduction system; normal/CrO₂/metal tape selector; automatic stop. Wow and flutter 0.07% wrms; frequency response 40-14,000 Hz ±3 dB with metal tape; S/N ratio 63 dB, Dolby on; THD <1.5%; 15³/₈"W × 10¹/₄"D × 6¹/₈"H..... \$199

4861 Stereo Cassette Deck

Front-loading, damped-eject stereo cassette deck with hard Dynalloy record/play head and dual-gap ferrite erase head. Features dc capstan motor; soft-touch IC-logic controlled transport; Dolby B noise-reduction system; LED recording-level displays; normal/CrO₂/metal tape selector; automatic stop. Wow and flutter 0.06% wrms; frequency response 40-16,500 Hz ±3 dB; S/N ratio 61 dB, Dolby on; THD <1.5%; 14¹/₈"W × 9¹/₈"D × 5¹/₂"H..... \$199

TOSHIBA

PC-G6R Stereo Cassette Deck

Solenoid-operated, 2-motor stereo cassette deck with automatic reverse and metal-tape capability. Features quick reverse; single-side, one-cycle, and continuous-play modes; Dolby B noise-reduction system; 3-way

1

CASSETTE TAPE MACHINES

tape selector; peak-indicating signal-level meters; timer record/play function; optional remote-control capability. Wow and flutter 0.045% wrms; frequency range 25-18,000 Hz; S/N ratio 57 dB, Dolby off; 16 $\frac{1}{16}$ "W \times 10 $\frac{1}{4}$ "D \times 4 $\frac{1}{8}$ "H \$300

PC-G4C Stereo Cassette Deck

Solenoid-operated, 2-motor stereo cassette deck with Dolby B and C noise-reduction systems and metal-tape capability. Features peak-indicating LED signal-level meters; timer record/play function; 3-way tape selector switches; optional remote-control capability.

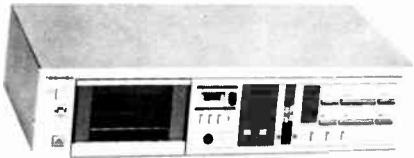

Wow and flutter 0.045% wrms; frequency range 20-19,000 Hz; S/N ratio 59 dB, Dolby off; 16 $\frac{1}{16}$ "W \times 10 $\frac{1}{4}$ "D \times 4 $\frac{1}{8}$ "H \$220

PC-G2 Stereo Cassette Deck

solenoid-operated, 2-motor stereo cassette deck with metal-tape capability. Features Dolby B noise-reduction system; peak-indicating LED signal-level displays; timer record/play function; 3-way tape selector. Wow and flutter 0.045% wrms; frequency range 25-18,000 Hz; S/N ratio 68 dB, Dolby on; 16 $\frac{1}{16}$ "W \times 10 $\frac{1}{4}$ "D \times 4 $\frac{1}{8}$ "H \$220

PC-G1 Stereo Cassette Deck

Front-loading, metal-compatible stereo cassette deck. Features Dolby B noise-reduction system; peak-indicating LED signal-level meters; soft-touch transport controls. Wow and flutter 0.055% wrms; frequency range 35-17,000 Hz; S/N ratio 57 dB, Dolby off; 16 $\frac{1}{16}$ "W \times 10 $\frac{1}{4}$ "D \times 4 $\frac{1}{8}$ "H \$160

UHER by WALTER ODEMER

CR-240 Portable Cassette Deck

Compact front-loading portable cassette deck with Dolby noise-reduction system, low-wear motor with electronic control, 2 contrarotating flywheels, and built-in loudspeaker for mono monitoring. Features automatic start after fast-forward or rewind; automatic end-of-tape shut-off; switchable alc (automatic level control); remote control accessory; clock timer operation; separate or tandem (mechanical coupling) record level controls; twin peak-reading level meters for record and playback with meter illumination and 3 LED function indicators; battery check with quick-action switch; built-in condenser microphone; linear stereo power amplifier; stereo headphone jack socket; joystick control for selection of 3 tape transport functions. Wow and flutter 0.2% (DIN); frequency range 30-16,000 Hz; S/N 58 dB Dolby off with FeCr, 66 dB Dolby on with CrO₂ and FeCr, 65 dB Dolby on with normal tape; crosstalk -70 dB at 1 kHz, reverse track, -45 dB stereo; mic input 0.2 mV at 500 ohms source impedance; power ac line, dry cells, rechargeable, or car battery; 9 $\frac{1}{2}$ " \times 2 $\frac{1}{2}$ " \times 7 $\frac{1}{4}$ " .. \$1389
CR-240AV. Audio-visual version of CR-240 .. \$1427

VECTOR RESEARCH

VCX-800 Stereo Cassette Deck

Front-loading stereo cassette deck with 3 heads, 2 motors, and dual capstans. Features Dolby B and C tape, Dolby FM noise-reduction, and Dolby HX headroom-extension systems; microprocessor-controlled Compu-counter that automatically selects tape length,

displays remaining time in minutes and seconds, and searches for any location on a tape; sweep oscillator that allows adjustment for flattest response; 2 memory circuits; automatic rewind/play; record mute; feather-touch transport controls. Wow and flutter 0.03%; frequency response ± 3 dB 25-19,000 Hz normal, to 20 kHz CrO₂, to 21 kHz metal tape; S/N



ratio no NR/Dolby B/Dolby C 56/66/76 dB; 17 $\frac{3}{8}$ "W \times 14 $\frac{1}{2}$ "D \times 5 $\frac{1}{16}$ "H \$1000

VCX-600 Stereo Cassette Deck

Front-loading metal-compatible stereo cassette deck with Dolby B noise-reduction system containing 4 Dolby processors, FG servo dc capstan and servo reel motors, and separate Sendust record, Sendust playback, and ferrite erase heads. Features computerized programmable music search (8 program buttons with LEDs represent 8 selections on tape side, of which one or several chosen pieces are sought out and played); programmable search that automatically seeks next selection; separate bias and equalization for Fe, Co, and metal tapes with bias adjust; dual LED peak level bargraph meters; separate automatic play and rewind buttons; memory stop IC logic tape function controls with LEDs; record mute; cue and review; input and output level controls; tape/source monitor switch; 3-digit tape counter with reset; optional remote control capability. Fast-wind time 90 seconds with C60 cassette; wow and flutter 0.06% wrms; frequency response ± 3 dB 30-16,000 Hz normal, to 18 kHz Co/CrO₂, to 20 kHz metal tape; S/N ratio (A weighted, 3.0% THD) 65 dB, Dolby on; input sensitivity/impedance 60 mV/50,000 ohms line, 0.25 mV/600 ohms mic; output level/impedance 580 mV/1000 ohms line; headphone impedance 8 ohms; 5 $\frac{1}{8}$ "H \times 17 $\frac{3}{8}$ "W \times 14 $\frac{1}{4}$ "D \$750

VCX-500. Similar to VCX-600 less 8-selection programmable music search, automatic play and rewind, and tape/source monitor switch; has combination Sendust record/play and ferrite erase heads; line output level/impedance 500 mV/1000 ohms. .. \$575
VRC-2. Wired remote control for VCX-500/600 \$75

VCX-510 Stereo Cassette Deck

Stereo cassette deck with Dolby B and C noise-reduction system, IC-logic 2-motor transport, and Music Search*. Features new Duralloy head; 4-position tape selector; automatic rewind/play; repeat play memory function; LED peak level meters; record mute; output level control; MPX filter; provision for optional VRC-22 remote-control unit. Wow and flutter 0.04% wrms; frequency range 25-19,000 Hz metal, to 18 kHz CrO₂, to 16 kHz normal; S/N ratio no NR/Dolby B/Dolby C 56/66/76 dB A weighted, referred to 3% THD; input sensitivity/impedance 60 mV/50k ohms line, 0.25 mV/-72 dB, 600 ohms or more mic; output level/impedance 650 mV/1k ohm line, 120 mV/8 ohms headphones; fast-wind time 100 seconds with C60 cassette; power consumption 35 W; 17 $\frac{3}{8}$ "W \times 14 $\frac{1}{2}$ "D \times 5 $\frac{1}{8}$ "H; 15.7 lb \$500

VCX-400 Stereo Cassette Deck

Stereo cassette deck with Dolby B and C noise-reduction systems, full-logic solenoid-controlled transport, and memory rewind. Features Duralloy head; 4-position tape selector; fine bias adjust control; LED peak-level meters; record mute; MPX filter; provision for

optional VCR-22 remote controller. Wow and flutter 0.05% wrms; frequency range 25-18,000 Hz metal, to 17 kHz CrO₂, to 15 kHz normal tape; S/N ratio no NR/Dolby B/Dolby C 56/66/76 dB A weighted referred to 3% THD; input sensitivity/impedance 60 mV/50k ohms line, 0.25 mV/-72 dB (600 ohms or more) mic; output level/impedance 650 mV/1K ohm line, 120 mV/8 ohms mic; fast-wind time 100 seconds with C60 cassette; power consumption 30 W; 17 $\frac{3}{8}$ "W \times 14 $\frac{1}{2}$ "D \times 5 $\frac{1}{8}$ "H; 14.6 lb \$350

YAMAHA

K-960B Stereo Cassette Deck

High-end deck contains Dolby and dbx* noise-reduction systems (providing up to 30 dB of noise suppression with dbx system). Features Sendust record/play and double-gap ferrite erase heads; 2-motor transport with IC logic control; fluorescent bargraph meters; continuously adjustable bias control; timer recording switch; subsonic and MPX filters; low-noise



equalizer preamp; focus switch to extend high-end frequency response; black front panel. Wow and flutter <0.028% wrms, <0.1% DIN; frequency response ± 3 dB 30-17,000 Hz normal, to 19 kHz CrO₂, to 22 kHz metal tape; S/N ratio no NR/dbx on >60/>100 dB with metal tape; overall distortion <1.0% normal and metal tape, <1.5% CrO₂ tape; input sensitivity/impedance 0.3 mV/5k ohms mic, 50 mV/100k ohms line; output level/impedance 340 mV/1.6k ohms line, 1 mV/8 ohms (5 mV/150 ohms); power consumption 35 W U.S. and Canada; fast-wind time 70 seconds with C60 cassette; 17 $\frac{1}{2}$ "W \times 12"D \times 5 $\frac{1}{8}$ "H; 17 lb 10 oz \$495
K-960S. Same as K-960B but with silver front panel \$495

K-500 Stereo Cassette Deck

Full-logic transport controls stereo cassette deck with 2 motors and Dolby B and C noise-reduction systems. Features Sendust record/play and double-gap ferrite erase heads; 2-color bargraph meters; automatic tape selector; timer record/play function; memory stop with repeat function; dc servo capstan and dc reel motors; facility for optional remote controller. Wow and flutter <0.05% wrms, <0.08% DIN; frequency response ± 3 dB 40-16,000 Hz normal, to 18 kHz CrO₂, to 20 kHz metal tape; S/N ratio no NR/Dolby B/Dolby C 60/68/76 dB EIAJ with CrO₂ tape; overall distortion <1% EIAJ at 315 Hz; input sensitivity/impedance 0.4 mV/3.9k ohms mic, 60 mV/60k ohms line; output level/impedance 350 mV/24k ohms line; 0.6 mV/8 ohms headphones; power consumption 20 W; 17 $\frac{1}{8}$ "W \times 11"D \times 4 $\frac{3}{8}$ "H; 9 lb 14 oz \$340
K-300. Similar to K-500 except no memory stop with repeat or remote-control capability; has hard Permalloy record/play head. Frequency response to 16 kHz normal, to 16 kHz CrO₂, to 17 kHz metal tape \$270

K-200 Stereo Cassette Deck

Two-motor stereo cassette deck with Dolby B noise-reduction system. Features soft-touch transport controls; true meter-type signal-level meters with VU characteristics; timer record function; dc servo capstan, flat-torque dc reel motors; hard Permalloy record/play, double-gap ferrite erase heads. Wow and flutter 0.05% wrms, 0.08% DIN; frequency response 40-15,000 Hz ± 3 dB all tape formulations, including metal; S/N ratio Dolby off/on >50/>60 dB with CrO₂ tape; overall distortion 1.0% at 315 Hz; channel separation >35 dB at 1 kHz; crosstalk >60 dB at 125 Hz; input sensitivity/impedance 0.3 mV/5k ohms mic, 60 mV/80k ohms line; output level/impedance 350 mV/2.2k ohms line; power consumption 14 W; fast-wind time 80 seconds with C60 cassette; 17 $\frac{1}{8}$ "W \times 11"D \times 4 $\frac{1}{32}$ "H; 9 lb \$220

NEED MORE INFORMATION?

Write directly to the manufacturer or distributor. A list of names and addresses starts on page 4.

2

OPEN-REEL TAPE MACHINES

AKAI

GX-747 Open-Reel Deck

Four-track, 2-channel auto-reverse record/play stereo/mono open-reel deck with 10½" reel capacity and EE tape capability. Features 2-color LED peak-hold meters; full-logic feather-touch transport controls; tape/source monitoring; automatic tension-arm lock system; electronic digital real-time counter with

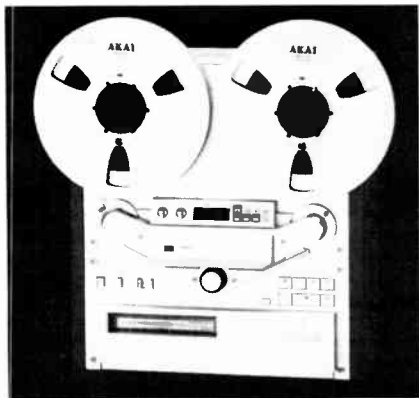

memory function; cue and review; remote-control capability. Wow and flutter <0.03% wrms; frequency response 25-33,000 Hz ±3 dB at 7½ ips; S/N ratio >65 dB at 7½ ips; distortion less than 0.4% at 7½ ips; 19.4"H × 17.3"W × 10.1"D; 51.2 lb. \$1250

GX-625 Stereo Tape Deck

Two-speed (3¼ and 7½ ips) ¼-track 2-channel stereo tape deck with ac servo direct-drive capstan, and 2 eddy-current reel motors. Features 2 GX for record and play and one erase heads; maximum reel capacity 10½"; automatic repeat, play, and stop; illuminated logic solenoid tape function controls with LED standby indicator; LED digital timer/tape counter; 2-deck tape monitoring; mic/line mixing; output level control; variable pitch control; mono/stereo recording; timer record/play with external timer; computerized electronic braking system. Wow and flutter 0.03% rms at 7½ ips; frequency response 30-26,000 Hz ±3 dB at 7½ ips; S/N ratio 62 dB weighted, with low-noise tape and peak recording level at 3% THD; 17.6"H × 17.3"W × 9.5"D \$850

GX-77D Open-Reel Tape Deck

Four-track, 2-channel, automatic-reverse record/play stereo/mono 7" open-reel tape deck with EE tape capability. Features 2-color LED peak-hold meters; tape/source; power loading system; digital electronic real-time counter; fine bias-adjust control; cue and review; timer record/play capability; remote-control capability. Tape speeds 7½, 3¼ ips; wow and flutter less than 0.03% wrms at 7½ ips; S/N ratio better than 63 dB at 7½ ips, DIN 45500 standard; frequency response 25-33,000 Hz ±3 dB at 7½ ips; distortion <0.5% at 7½ ips; 17.2"W × 9.6"H × 8.9"D; 37.5 lb. \$795

GX-400D Compact Tape Deck

Contains GX record and playback and separate erase heads and accommodates up to 7" reels. Features tape/source monitoring; mic/line mixing; sound-on-sound and sound-with-sound; track selector; automatic-stop; output level control; VU meters. Tape speeds 7½ and 3¼ ips; wow and flutter less than 0.08% rms at 7½ ips; frequency response 30-24,000 Hz ±3 dB at 7½ ips; S/N ratio better than 60 dB weighted at wide range tape setting with peak level at 3% THD; distortion <1% at 1 kHz, 0 VU; 17.3"W × 12.4"H × 9.1"D; 29 lb. \$400

DENON

DH-510 2-track Tape Deck

Three-motor, 2-speed tape deck with direct-drive capstan and 10½" reel capacity. Features Direct Tension Servo to maintain tape tension constant at a specified level; 2-track stereo record/play; rationalized transport system with rapid response; all-aluminum diecast frame; hard Permalloy record and play heads and ferrite erase head; wide dynamic range amplifier circuitry; continuously variable bias/EQ; IC logic control transport; record mute/pause mechanism; automatic safety switch; timer record/play; remote-control capability; compatibility with low-to-high-impedance headphones; horizontal or vertical operation. Wow and flutter <0.025% wrms at 38 cm/sec, 0.03% at 19 cm/sec; frequency response 30-30,000 Hz ±3 dB at 38 cm/sec, 20-25,000 Hz at 19 cm/sec; S/N ratio >66 dB referred to maximum recording level (514 nWb/m), >58 dB referred to operating level (200 nWb/m); THD <0.5% at 1 kHz; third-harmonic distortion <0.1% at 1 kHz, using Scotch 250 tape; separation >50 dB at 1 kHz; input impedance/level 50k ohms unbalanced/0.2 mV minimum (-72 dB) mic, 100k ohms unbalanced/62 mV minimum (-22 dB); output impedance/level 100 ohms unbalanced (600 ohms optimum)/775 mV line, >8 ohms headphonest; power consumption 85 W; 475mmH × 255mmW × 210mmD; 22 kg \$1350

PIONEER

RT-909 Stereo Tape Deck

Two-speed (3¼ and 7½ ips), ¼-track, 3-motor, 4-head stereo tape deck; FG dc servo dual-capstan motor and two 6-pole inner rotor reel motors; accepts up to 10½" reels. Features 2-step bias and equalization selector with variable bias; fluoroscan level indicators with peak and average functions; 4-digit electronic counter; reel and speed selector; pitch control; repeat switch; timer start with external timer; automatic reverse; tape/monitor switch; separate mic/line and left/right input level controls; output level control. Wow and flutter 0.04% at 7½ ips, 0.08% at 3¼ ips; frequency response 20-28,000 Hz ±3 dB (7½ ips), 20-18,000 Hz ±3 dB (3¼ ips); S/N ratio 60 dB (7½ ips), 55 dB (3¼ ips); 13¼"H × 18¼"W × 12½"D \$895

RT-707 Stereo Tape Deck

Automatic-reverse open-reel stereo tape deck. Features 2 speeds (3¼ and 7½ ips); speed accuracy ±0.5%; 3 motors; 4 heads; ¼-track, 2-channel de-

sign; handles 7" reels; FG servo ac direct drive motor for capstan drive and two 6-pole inner-rotor induction motors for reel drive; solenoid-operated, direct-switchable function buttons and preset function buttons for timer record and play; automatic/manual reverse play; automatic repeat play; independent L/R recording mode selectors; 2 bias and 2 equalization tape selection; full complement of inputs/outputs. Wow and flutter 0.055 wrms; (7½ ips), 0.08% wrms (3¼ ips); S/N ratio 58 dB; distortion 1% maximum at 7½ ips; fast rewind 100 seconds with 7" reel; frequency response 30-24,000 Hz ±3 dB at 7½, to 16 kHz at 3¼ ips; crosstalk -50 dB; separation 50 dB; pitch control ±6% (playback only); 9¼"H × 18¾"W × 14½"D \$695

SONY

TC-766-2 Open-Reel Deck

Half-track open-reel stereo record/play deck with ¼-track playback option. Features Ferrite-and-Ferrite discrete 4-head design; patented dc head/play FET amplifier; 3-motor ac servo closed-loop, dual-capstan tape drive system; 15 and 7½ ips tape speeds with electronic speed change and tension regulation system; feather-touch IC logic transport controls; punch-in recording; 10½" reel capability; RM-30 remote-control unit. 20¼"H × 17½"W × 9¼"D; 85 lb 7 oz \$1350

TC-765 Open-Reel Deck

Quarter-track stereo record playback deck with Ferrite-and-Ferrite tape heads and 7½- and 3¼-ips speeds. Features discrete 3-motor ac servo closed-loop, dual-capstan tape drive system; electronic speed change and tension regulation system; feather-touch IC logic transport controls; punch-in recording; 10½" reel capacity. RM-30 remote-control unit optional. 20¼"H × 17½"W × 9¼"D; 58 lb 7 oz \$1250

TC-399 Open-Reel Deck

Quarter-track stereo record/play deck with Ferrite-and-Ferrite heads in 3-head design and head/play amplifier. Features ac induction motor drive system; 7½, 3¼, and 1¼ ips tape speeds; servo back-tension device; scrape flutter filter; all-mode automatic stop; 7" reel capacity. 17¼"H × 16¾"W × 7½"D; 27 lb 13 oz \$520

STUDER/REVOX

B77 MKII Stereo Tape Recorder

Two-speed (choice of 3¼ and 7½ ips, and 15 ips, 1½ and 1¼ and 3¼ ips) stereo tape recorder with 3 motors; 10½" reel capacity. Features integrated drive logic computer-type push-point function keys; built-in tape cutter; dual VU meters with peak level indicators; separate left/right record and input level controls; front-panel variable speed control; tape monitor switch; provision for remote control of all functions and electric timer operation; connectors for remote control of tape transport functions, remote control of variable tape speed, and slide projector or crossfade unit. Wow and flutter (DIN 45507/IEEC 193-1971) 0.06% at 15 ips, 0.08% at 7½ ips,

2

OPEN-REEL TAPE MACHINES

0.1% at 3 3/4 ips; frequency response +2/-3 dB 30-22,000 Hz at 15 ips, to 20 kHz at 7 1/2 ips, to 16 kHz at 3 3/4 ips; S/N ratio on 1/4-track 63 dB at 15 and 7 1/2 ips, 60 dB at 3 3/4 ips; on 1/2-track 67 dB at 15 and 7 1/2, 64 dB at 3 3/4 ips; mic input level/impedance 0.15 mV/2.2k ohms (lo position, 50-to-6000-ohm mics), 2.8 mV/110k ohms (hi, 20k-ohm mics); 16.3"H x 17.8"W x 8.14"D \$1799

B77 Self Sync. Same as B77; available in 3 3/4 and 7 1/2 ips or 7 1/2 and 15 ips speeds with playback possibility from record head \$1899

B77 Autostart. Same as B77 except with VOX control \$2049

B77 Slide Sync. Same as B77 except with additional head for slide projector control \$1899

PR99 Stereo Tape Deck

Two-speed (15 and 7 1/2 or 7 1/2 and 3 3/4 ips) half-track stereo recorder with direct-drive, servo-controlled capstan and electrically-controlled reel motors; 10 1/2" reel capacity. Features balanced (XLR) line-in/out and switched cal/uncal level settings; high-or low-impedance microphone input (balanced, XLR option); 2-way Self-Sync with complete tape editing facilities including tape dump; logic-controlled transport; true VU meters with LED peak indicators; tape/source monitoring; safe/ready record switches; 4-digit tape counter; manual/remote-control/fader-start operation. Wow and flutter (DIN) 0.06% at 15 ips, 0.08% at 7 1/2 ips, 0.1% at 3 3/4 ips; frequency response +2/-3 dB 30-22,000 Hz at 15 ips, to 20 kHz at 7 1/2 ips, to 16 kHz at 3 3/4 ips; S/N ratio 66 dB at 15 and 7 1/2 ips, 63 dB at 3 3/4 ips; case or 19" rack mount; 19"W x 15.7"H x 7.9"D \$2095

Console \$330

Carrying case \$225

TANDBERG

TD 20 A "Baron" Open-Reel Deck

Features Actilinear record system; active transconductance circuit for lower intermodulation distortion; built-in Sel Sync; 4-motor solenoidless operation;



phase linearity network; pushbutton operation with LED indicators, including FREE position for easy tape editing and threading; stand-by position with LED when one or both record buttons are engaged; electronically-governed speed; optional wireless infrared remote control or conventional cord remote control; 4 line inputs and master control for fading in/out; 2-step front panel switch for mic attenuation by 25 dB; very wide scale, peak-reading VU meters; front panel accessible bias adjustment. 7 1/2 and 3 3/4 ips; 1/4-track \$1395

TD20A SE. Similar to TD20A except black-on-black styling; new record equalization curves allow 80-dB or better S/N ratio without noise-reduction system (EQ

switchable to NAB standard); Dyneq® and Actilinear® headroom extension systems; phase-corrected circuitry for pinpoint imaging.

1/4-track, 15 and 7 1/2 ips \$1595

1/2-track, 15 and 7 1/2 ips \$1595

1/4-track, 7 1/2 and 3 3/4 ips \$1595

Series 15 Open-Reel Recorder

Three-speed (7 1/2, 3 3/4, 1 1/4 ips) mono record/play open-reel recorder; wow and flutter 0.1% at 7 1/2 ips; frequency response 40-18,000 Hz ±2 dB at 7 1/2 ips; S + N/N 55 dB at maximum record level; 5 W/channel continuous, both channels driven; preamp output 0.75 V; low-impedance mic; high- and low-level inputs; 6 3/4"H x 13 3/4"W x 11 1/4"D.

1521F. 1/4-track or 1/2-track; includes foot control \$885

1521. 1521F without foot control \$715

TASCAM by TEAC

Series 30 Recorder/Reproducers

Feature high-torque slotless dc reel motors; FG dc servo capstan motor; pitch control; logic-operated transport controls; computer-controlled sensing logic; photo-optical end-of-tape detector; 10 1/2" reel capacity; full sync functions; full frequency response in sync reproduce mode; FET switching in function and output select sections; zero return function; optional full dual-process dbx® noise-reduction system; circuit-driven 4-digit FL index counter; flip-up head cover; Sync head shield; cue lever; dump edit logic; facility for optional remote transport control; optional remote punch-in/out foot pedal. Can be used vertically or horizontally or mounted in standard 19" EIA rack with optional hardware.

Model 34. 4-track 1/4" recorder/reproducer operates at 15 and 7 1/2 ips and features illuminated VU meters and 4 phono-jack unbalanced high-impedance line inputs and outputs (nominal level -10 dBV or 0.3 V). Wow and flutter 0.06% peak at 15, 0.09% peak at 7 1/2 ips; frequency response (Sync & reproduce 3 dB at 0 VU) 40-22,000 Hz at 15 ips, to 16 kHz at 7 1/2 ips; THD (at 1 kHz) 0.08% at 0 VU (250 nWb/m), 3% at 13 dB above 0 VU (1116 nWb/m); S/N ratio 68 dB NAB A weighted at 15 ips, 66 dB at 7 1/2 ips; crosstalk > 50 dB down at 1 kHz, 0 VU; 17.5"H x 16"W x 8.43"D; 44 lb \$1700

Model 32. Half-track 1/4" recorder/reproducer operates at 15 and 7 1/2 ips and features dual concentric input and output level controls; stereo headphone jack with independent level control; 2 illuminated VU meters; 2 unbalanced high-impedance phono-type line input jacks; 2 unbalanced high-impedance phone-type mic input jacks. Nominal line/mic input level -10 dBV (0.03 V)/-60 dBV (1 mV); wow and flutter at 15 and 7 1/2 ips 0.06%/0.09% weighted peak; frequency response (sync and repro. 3 dB at 0 VU) 40-22,000 Hz at 15 ips, to 15 kHz at 7 1/2 ips; THD (at 1 kHz) 0.08% at 0 VU (250 nWb/m), 3% at 13 dB above 0 VU (1116 nWb/m); S/N ratio 68 dB NAB A weighted at 15 ips, 66 dB at 7 1/2 ips; crosstalk > 50 dB down at 1 kHz, 0 VU; 17.5"H x 16"W x 8.43"D; 44 lb \$1300

22-4 Recorder/Reproducer

Four-channel system with 7" reel capacity and 15 and 7 1/2 ips record/play capability. Features mixer interface; function and output select; punch-in recording; removable head housing; logic-controlled transport functions; headphone monitor selectors; expanded-scale VU meters; independent level controls; memory stop function; pitch control (±6% range); manual cueing. dbx® Type I interface optional. Tape format



1/4": tape speeds 15 and 7 1/2 ips ±0.5%; frequency response 40-22,000 Hz at 15 ips, to 16 kHz at 7 1/2 ips, both ±3 dB at 0 VU; THD 1.0% at 0 VU, 1 kHz, 185 nWb/m; S/N ratio 67 dB at 15 ips, 60 dB at 7 1/2 ips A weighted (NAB) (increases to 88 dB in both cases with dbx); record/play amplifier headroom 23 dB above 0 VU; 16 3/4"W x 16 1/4"H x 10 1/4"D; 40 lb \$1425

22-2 Half-Track Recorder/Reproducer

Three-motor/three-head 1/4" tape recorder/reproducer that accepts 7 1/2" reels and operates at 15 or 7 1/2 ips. Features expanded-scale -2 to +5 dB VJ meters; independent monitor and record ready controls for each channel; mic/line mixing; detachable head housing; precision molded reel tables and spring-loaded reel holders. Fully independent electronics permit source or tape monitoring and record for reproduce mode to be selected independently for either track. Wow and flutter 0.07% peak DIN/IEC/ANSI weighted at 15 ips, -0.04% rms JIS/NAB weighted at 15 ips (0.09% and 0.05%, respectively, at 7 1/2 ips); frequency response 40-22,000 Hz ±3 dB at 0 VU, 1 kHz, 185 nWb/m; S/N ratio 66 dB NAB A weighted at 15 ips, 64 dB at 7 1/2 ips; headroom > 26 dB above 0 VU at 1 kHz for record, 38 dB for play amplifiers; 16 1/8"W x 12 7/8"H x 9 1/8"D; 30.8 lb \$775

TEAC

X-1000R Bidirectional Stereo Deck

Computer-controlled dual-capstan stereo open-reel deck with bidirectional record/play, dbx® decilinear noise-reduction/dynamic range-expansion system, and EE-tape compatibility. Features 5-digit LED multi-function digital tape counter/timer; dual-capstan closed-loop transport with tension servo control; Magne'loat capstan bearings; STZ (search to zero) and STC (search to cue); automatic spacing in record; block repeat; Dupli-Sync for dubbing to cassette; automatic reverse/repeat; real-time pause; electrically assisted reel braking; 6% pitch control; motion sensing; timer record/play; 3 dc motors; 6 heads (3 each forward and reverse); facility for optional remote controller. Speeds 7 1/2 and 3 3/4 ips; reel size up to 10 1/2"; wow and flutter at 7 1/2 and 3 3/4 ips 0.03%/0.04%; frequency response ±3 dB 40-30,000 Hz at 7 1/2, to 24 kHz at 3 3/4 ips; S/N ratio dbx® off/on 65/100 dB; harmonic distortion 0.8% at 1 kHz, normal operating level; separation 50 dB at 1 kHz; input sensitivity/impedance 60 mV/50k ohms

NOTICE TO READERS

Prices of items described are suggested prices only and are subject to change without notice. Actual selling prices are determined by the dealer.

line, 0.25 mV (-72 dB)/200 ohms or more mic; output level/impedance 0.45 V/10k ohms or more line; headphone output impedance 8 ohms; power consumption 80 W; fast-wind time 100 seconds with 1800-ft tape; 17¹/₁₆"H × 17"W × 10¹/₁₆"D; 48 lb 6 oz \$1400

X-10MKII Stereo Tape Deck

Dual-capstan closed-loop stereo open-reel tape deck with EE tape compatibility. Features IC-logic transport controls; motion sensing; electric braking; real-time pause in record; electrical pause; cue; ±6% pitch control in record and play; record mute; mic/line mixing; VU meters; timer capability; facility for optional dbx® noise-reduction system. Speeds 7¹/₂ and 3³/₄



ips; reel size up to 10¹/₂"; wow and flutter at 7¹/₂ and 3³/₄ ips 0.03%/0.04%; frequency response ±3 dB 40-30,000 Hz at 7¹/₂ ips, to 22 kHz at 3³/₄ ips; S/N ratio 65 dB at 3% THD, no NR; harmonic distortion 0.8% at 1 kHz normal operating level; separation 50 dB at 1 kHz; input sensitivity/impedance 60 mV/50k ohms line, 0.25 mV (-72 dB)/200 ohms or more; output level/impedance 0.45 V/10k ohms line; headphone output impedance 8 ohms; power consumption 75 W; fast-wind time 100 seconds with 1800-ft tape; 17¹/₁₆"H × 17"W × 10¹/₁₆"D; 44 lb 1 oz. \$1090

X-7RMKII Stereo Deck

Bidirectional record/play stereo open-reel deck with EE tape capability. Features IC-logic transport controls; automatic repeat; electrical pause; ±6% pitch control for record and play; record mute; mic/line mixing; facility for remote controller. Speeds 7¹/₂ and 3³/₄ ips; reel size up to 7"; remaining specifications same as for X-10MKII except power consumption 77 W; fast-wind time 150 seconds; 14¹/₁₆"H; 39 lb 11 oz \$890
X-7MKII. Similar to X-7RMKII except no automatic reverse/repeat, no reverse record \$790

X-3R Bidirectional Stereo Deck

Bidirectional-playback stereo open-reel deck with 3-motor/3-head transport, light-touch transport controls, and EE (Extra Efficiency) tape compatibility. Features mic/line mixing; silent transport solenoids; left and right channel VU meters; independent left and right channel output controls; independent left and right channel line and microphone input level controls; tape/source monitor switch; 4-digit tape counter; removable head housing; one-touch reel clamps; EL/LH/LHII tape selectors. Dust cover and EIA rack-mount kit optional. Tape speeds 7¹/₂ and 3³/₄ ips; reel size 7" and 5"; wow and flutter at 7¹/₂ and 3³/₄ ips 0.04%/0.06%; frequency response ±3 dB 40-30,000 Hz at 7¹/₂ ips, to 24 kHz at 3³/₄ ips; S/N ratio 75 dB at 3% THD, weighted; harmonic distortion 0.8% at nominal operating level; separation 50 dB at 1 kHz; input sensitivity/impedance 60 mV/50k ohms line, 0.25 mV (-72 dB)/200 ohms or more; output level/impedance 0.45 V/10k ohms line; headphone output impedance 8 ohms; power consumption 85 W; fast-wind time 140 seconds with 1800-ft tape; 16¹/₁₆"W × 12¹/₁₆"H × 9¹/₁₆"D; 33 lb 2 oz .. \$650
X-3MKII. Same as X-3R except no bidirectional play; weight 30 lb 4 oz \$590

TECHNICS

RS-1520US Open-Reel Deck

Compact professional tape deck; 1/2-track, 2-channel record/play and 1/4-track, 2-channel record/play and 1/4-track, 2-channel play; 4 head system; 3 speeds (15, 7¹/₂, 3³/₄ ips); quartz control phase-locked dc brushless servo direct-drive capstan motor; reel tables; 2-tape tension controlled dc brushless direct drive motors; isolated loop direct-drive transport system. Features full IC-logic tape transport functions; direct switching from mode-to-mode without tape strain; separate left and right bias and equalization controls; left and right VU meters; built-in stroboscope. Wow and flutter 0.018% wrms at 15 ips, 0.3% wrms at 7¹/₂ ips; fast-wind time 150 seconds with 2500-ft tape; frequency response 30-30,000 Hz ±3 dB at 15 ips, to 25 kHz at 7¹/₂ ips; S/N ratio 60 dB; 0.8% distortion; 50 dB separation; mic input sensitivity 0.25 mV (-72 dB); microphone impedance 200-10,000 ohms; 17¹/₂"H × 18"W × 10¹/₂"D \$2100

RS-1500US Open-Reel Deck

Three-speed (15, 7¹/₂, and 3³/₄ ips) 1/2-track 2-channel record, playback, erase, and 1/4-track 2-channel playback stereo tape recorder with quartz-controlled PLL dc brushless servo direct-drive capstan motor with double pinch rollers and 2 tape-tension-controlled dc brushless direct-drive reel motors and 4 heads for recording. 1/2- and 1/4-track playback, and erasure; mixing; reel capacity 10¹/₂". Features IC logic-plus-transistor tape transport controls with LED indicators and mode-to-mode switching with automatic pause between modes; 3-position bias and equalization switches; dual 2-scale VU meters with ±3-dB normal, +6-dB high range meter scale selector; separate mic and line level input controls with mixing; 0/20-dB mic attenuator; output level control; left and right tape/source monitor switches; left/right rec mode switches; 4-digit tape counter showing elapsed time in minutes and seconds; timer start with external audio timer; edit dial; fast-wind time 150 seconds (2500-ft, 1.5-mil tape). Wow and flutter 0.018% wrms at 15 ips, 0.03% at 7¹/₂ ips; frequency response ±3 dB 30-30,000 Hz at 15 ips, 20-25,000 Hz at 7¹/₂ ips, 20-15,000 Hz at 3³/₄ ips; S/N ratio 60



dB NAB weighted at 7¹/₂ ips, 58 dB at 3³/₄ ips; THD at 400 Hz, 0 VU 0.08%; separation 50 dB; input sensitivity/impedance 0.25 mV/4.7k ohms (mic, unbalanced), 60 mV/150k ohms (line, phono jack); rosewood veneer side panels; 19¹/₂"W × 17¹/₂"H × 10¹/₂"D \$1600
RS-1506US. Similar to RS-1500US except 4-track 2-channel play/record and 2-track 2-channel play \$1600
RS-1700. Similar to RS-1506US except automatic reversing 4-track 2-channel record/play, no 2-track 2-channel play \$2100

TELEX

Telex/Magnecord 1400 Series

Three-speed (15, 7¹/₂, 3³/₄, 1¹/₈ ips) open-reel tape recorder. Accepts reel sizes up to 8¹/₂". Available with variety of head configurations for single, 2-, or 4-track operation. Features brushless dc servo ball-bearing drive system. Wow and flutter 0.35% at 3³/₄ ips, 0.24% at 7¹/₂ ips, 0.17% at 15 ips, all DIN weighted, or 0.25% at 3³/₄ ips, 0.17% at 7¹/₂ ips,

0.12% at 15 ips, all unweighted rms; S/N ratio 60 dB NAB weighted; frequency response 30-10,000 Hz ±3 dB at 3³/₄ ips, to 18 kHz at 7¹/₂ ips; 35-22,000 Hz at 15 ips (2-track); crosstalk 50 dB at kHz (2-track head); inputs 150-ohm microphone, balanced bridge, unbalanced bridge, mixing bridge, aux bridge; outputs 150/600 ohms balanced, +4 dBm aux A and B unbalanced. Features VU meters; separate microphone and line-input controls; master gain control; catenary head block design; hyperbolic heads to ensure intimate tape-head contact; 110/130 V ac, 50/60 Hz; power consumption 180 W \$2500

Telex/Magnecord 3000 Series

Professional-style 3-motor 1/4" system that offers option of purchasing transport, electronics package, and accessories separately or as a package and choice of speeds and head formats. Accepts up to 10¹/₂" reels with NAB Type A or B hubs and fits 19" racks. Features transformer-isolated CMOS-logic transport controls; automation capability; Automatic Cue Release (AQR) switch; interchangeable head blocks for variety of head configurations; snap-on head cover with mu-metal shield; heavy-gauge head assembly plate that accommodates up to 4 heads and contains tape guides, head selector switch, and optical infrared sensor. Wow and flutter 0.22% DIN, 0.15% wrms at 3³/₄ ips to 0.15% DIN, 0.1% wrms at 15 ips; speeds 3³/₄ ips and 7¹/₂ ips or 7¹/₂ and 15 ips; record/play frequency response ±3 dB 50-20,000 Hz at 15 ips, 30-18,000 Hz at 7¹/₂ ips, 20-12,000 Hz 3³/₄ ips with adjustments optimized for 3M 176 tape; S/N ratio 60 dB or better NAB weighted with half-track head, 3M 176 tape; record/play THD at 1 kHz 1% or less at 0 dB with 600-ohm line output termination; equalization adjustable for most standard or high-output, low-noise tapes; crosstalk rejection 50 dB or better at 1 kHz; fast-wind times 90 seconds or less for 10¹/₂" 2400-ft tape, 80 seconds for 7" 1200-ft tape. Transport: 19"W × 12¹/₂"H × 10"D; 46 lb. Record/play electronics: 19"W × 5¹/₂"D × 3¹/₂"H; 5.5 lb \$1990-\$2470

UHER by WALTER ODEMER

SG-631 Logic Open-Reel Deck

Three-speed (7¹/₂, 3³/₄, 1¹/₈ ips) 2- or 4-track stereo record/play deck; Omega looping system eliminates pinch roller, drive couplings, springs, and function wheels; 4-motor drive system includes 2 dc hub motors, an electronically regulated capstan drive, and servomotor to form the Omega loop. Wow and flutter 0.05%; frequency response 20-25,000 Hz at 7¹/₂ ips, to 16 kHz at 3³/₄ ips, to 12 kHz at 1¹/₈ ips; S/N ratio 65 dB, 2-track at 7¹/₂ ips. Features built-in strobe disc; speed control; peak-reading meter; Dia-Pilot for recording signal impulses and automatic slide-projector control; switchable peak-level limiter; separate stereo headphone power with volume, bass, and treble controls; A/B monitoring; remote-control facility; 10¹/₂"-in reel, maximum \$1936

SG561 Royal Open-Reel Deck

Four-speed (7¹/₂, 3³/₄, 1¹/₈, 1¹/₁₆ ips) 2- or 4-track mono/stereo record/play deck with interchangeable 2- or 4-track tape head mount with Recovac longlife heads and built-in stereo amplifier with mixing facility; 7" reel capacity. Features Synchro-Play sound-with-sound, Multi-Play sound-on-sound, reverb effect, and echo; Dia-Pilot for record/play of ceuing signals for automatic slide projectors, will also synchronize sound and picture in 8- and 16-mm film-making; separate mic/radio and phone input controls; mic in/out switch; dual peak-indicating meters tape/source monitor switch separate and continuous tandem tone control; 4-digit tape counter with zero reset; tape tension comparator; electronic end-of-tape shutoff. Wow and flutter (DIN 45507) 0.05% at 7¹/₂ ips, 0.1% at 3³/₄ ips, 0.2% at 1¹/₈ ips; frequency response 20-20,000 Hz at 7¹/₂ ips, to 15 kHz at 3³/₄ ips, to 9 kHz at 1¹/₈ ips; S/N ratio (DIN 45500) on 2-track 67 dB at 7¹/₂ ips, 66 dB at 3³/₄ ips, 65 dB at 1¹/₈ ips, on 4-track 65 dB at 7¹/₂ ips, 64 dB at 3³/₄ ips, 61 dB at 1¹/₈ ips; crosstalk -60 dB mono, -45 dB stereo; 18"W × 13.9"H × 7.5"D \$1711

Blank Tape begins next page.

3

BLANK TAPE

AMP, INC

Studio EC Premium Economy Series

Premium low-noise AGFA 619 or 819 ferric-oxide extended-range cassettes designed for normal bias.

EC30. 30 min	\$2.19
EC60. 60 min	\$2.39
EC90. 90 min	\$3.19

Studio-SCF Ferric-Oxide Series

Extremely low-noise/high-output AGFA 611 or 811 ferric-oxide cassettes for superior high-end response and super low distortion; designed for normal bias.

SCF30. 30 min	\$2.49
SFC60. 60 min	\$2.89
SCF90. 90 min	\$3.49

Studio-SCR Superchrom Series

Extremely low-noise/high-output AGFA 613 or 813 cassettes with double coating to yield superior high-end response and dynamic range; designed for chrome (CrO₂) bias.

SCR60. 60 min	\$4.49
SCR90. 90 min	\$5.89

Spoken Word Dictation Cassettes

Premium low-noise AGFA 619 or 819 ferric-oxide leaderless cassettes for instant-start dictation use.

DC30. 30 min	\$2.19
DC60. 60 min	\$2.39
DC90. 90 min	\$3.19

AUDIOMAGNETICS

Tracs® Metal Audio Cassettes

Audio cassettes designed for metal bias/EQ. In Phillips box or Phillips box/blister pack.

90 min	\$9.98
--------	--------

Tracs® TRXII High-Bias Cassettes

Audio cassettes in Phillips box or in Phillips box/blister card.

60 min	\$2.79
90 min	\$3.49

In Phillips box, 2 per polybag.

90 min	\$4.99
--------	--------

Tracs® TRXI Audio Cassettes

Designed for normal bias; in Phillips box or Phillips box/blister pack.

60 min	\$2.49
90 min	\$3.09

In Phillips box, packed 2 per poly bag.

90 min	\$4.99
--------	--------

Tracs® Audio Cassettes.

In poly box or on blister card.

45 min	\$1.29
60 min	\$1.39
90 min	\$1.95
120 min	\$2.39

In Phillips box or Phillips box/blister card.

45 min	\$1.49
60 min	\$1.59
90 min	\$2.19
120 min	\$2.69

Tracs® D Series Audio Cassettes

In Phillips box or Phillips box/blister card.

60 min	\$2.09
90 min	\$2.69

Packed 2 per poly bag.

60 min	\$3.09
90 min	\$3.99

High Performance I Audio Cassettes

Audio cassettes designed for normal bias, in Phillips box or Phillips box/blister card.

60 min	\$2.49
90 min	\$3.09

In Phillips box, packed 2 per poly bag.

60 min	\$3.89
90 min	\$4.99

High Performance II Audio Cassettes

Designed for high bias; in Phillips box or Phillips box/blister card.

60 min	\$2.79
90 min	\$3.49

In Phillips box, packed 2 per poly bag.

60 min	\$4.09
90 min	\$4.99

Tracs® 8-Track Cartridges

Packed in sleeves or on blister cards.

45 min	\$2.19
90 min	\$2.79

Packed 2 per poly bag.

45 min	\$3.29
90 min	\$4.19

Accessories

Empty Phillips cassette boxes, 6 per pack . . . \$0.99
8-track cartridge player head cleaner . . . \$1.59

AVANTI PRODUCTS

Hi Energy Alpha Cassettes

Normal bias, 120- μ sec equalization; 5-screw housing with silicon-coated "bubble-type" liners; stainless-steel axle pins and large windows. Packed in hard Phillips box. Available on blister display card (B designated) and in multiples in polybags.

HE 60. 60 min	\$1.49
HE 90. 90 min	\$1.89
HE 60B. 60 min	\$1.59
HE 90B. 90 min	\$1.99
HE 2/90. Two 90 min	\$3.49
HE 3/60. Three 60-min	\$3.99
HE 3/90. Three 90 min	\$4.99

Ultra Low Noise Cassettes

Ultra-low-noise normal-bias cassettes packed in hard Phillips box. Feature 5-screw shell; precision pins and lubricated rollers; bronze spring and pressure pad; reversible index card. Available on blister card (B designated) and in multiples in polybag.

ULN 40. 40 min	\$0.89
ULN 60. 60 min	\$0.99
ULN 90. 90 min	\$1.19
ULN 120. 120 min	\$1.89
ULN 40B. 40 min	\$0.99
ULN 60B. 60 min	\$1.19

ULN 90B. 90 min	\$1.39
ULN 120B. 120 min	\$1.99
ULN 2/90. Two 90 min	\$1.99
ULN 3/60. Three 60 min	\$1.99
ULN 3/90. Three 90 min	\$2.99

BASF

Metal IV Cassettes

Metal-pigment tape for Type IV/metal settings.

60 min	\$8.65
90 min	\$11.50

Professional I Series Cassettes

Ferric-oxide formulation matched for Type I/normal/ferric positions.

60 min	\$3.99
90 min	\$5.49

Professional I Super Series Cassettes

Uses latest in ferric-oxide technology to produce a Type I tape.

60 min	\$4.69
90 min	\$6.29

Professional II Series Cassettes

Pure chromium-dioxide formulation for Type II/chrome/high-bias position.

60 min	\$4.69
90 min	\$6.29

Professional III Series Cassettes

Double-layer formulation of chromium dioxide and ferric oxide; recommended for car stereos.

60 min	\$4.49
90 min	\$5.99

Performance Series Cassettes

Normal/Type I/ferric position.

60 min	\$2.99
90 min	\$4.19
120 min	\$5.19

Ferro Series Open-Reel Tape

Low-noise/high-output formulation exceeds professional recording studio requirements. Complete with sleeve and dust-proof box.

1800-ft, 7-in. reel	\$12.99
2400-ft, 7-in. reel	\$16.99

Chrome EE Open-Reel Tape

Extra-efficiency chrome tape for recorders with EE bias and EQ position.

1800-ft, 7-in. reel	\$19.99
3600-ft, 10½-in. metal reel	\$49.99

Videocassette Tape

Betamax Format

Chrome formulation.

L-500. 1-2-3 hrs	\$21.95
L-750. 3-4½ hrs	\$29.95

VHS Format

Chrome formulation.

T-120. 2-4-6 hrs	\$29.95
------------------	---------

MAXELL IS PLEASED TO PRESENT AN EVEN HIGHER PERFORMANCE TAPE.



If you're familiar with Maxell UD-XL tapes you probably find it hard to believe that any tape could give you higher performance.

But hearing is believing. And while we can't play our newest tape for you right here on this page, we can replay the comments of Audio Video Magazine.

"Those who thought it was impossible to improve on Maxell's UD-XL II were mistaken. The 1981 tape of the year award goes to Maxell XL II-S."

How does high bias XL II-S and our normal bias equivalent XL I-S give you such high performance? By engineering smaller and more uniformly shaped epitaxial oxide particles we were able to pack more into a given area of tape. Resulting in a higher maximum output level, improved signal-to-noise ratio and better frequency response.

To keep the particles from rubbing off on your recording heads Maxell XL-S also has an improved binder system. And to eliminate tape deformation, XL-S comes with our unique Quin-Lok Clamp/Hub Assembly to hold the leader firmly in place.

Of course, Maxell XL II-S and XL I-S carry a little higher price tag than lesser cassettes.

We think you'll find it a small price to pay for higher performance.



IT'S WORTH IT.

Maxell Corporation of America, 60 Oxford Drive, Monroeville, PA 15146

CIRCLE NO. 8 ON READER SERVICE CARD

3

BLANK TAPE

CERTRON

Ferex I Cassettes

Premium tape.

F-60 FE. 60 min	\$3.00
F-90 FE. 90 min	\$3.99

Ferex II Cassettes

High-bias cassettes

FEII 60 min	\$3.00
FEII 90 min	\$3.99

High Energy Gamma Cassettes

Oxide formulation; durable binder system.

C-60 HE. 60 min	\$1.99
C-90 HE. 90 min	\$2.59
C-120 HE. 120 min	\$2.99

Low Noise Cassettes

C-30 LN. 30 min	\$0.99
C-45 LN. 34 min	\$1.09
C-60 LN. 60 min	\$1.19
C-90 LN. 90 min	\$1.59
C-120 LN. 120 min	\$1.89

High Density Cassettes

C-30 HD. 30 min	\$1.29
C-45 HD. 45 min	\$1.39
C-60 HD. 60 min	\$1.59
C-90 HD. 120 min	\$2.09
C-120 HD. 120 min	\$2.49

Memotape for Minicassette

MT30. 30 min	\$3.99
--------------	--------

Micro Cassette

For Lanier, Olympus, and Panasonic capstan-drive machines.

M60. 60 min	\$3.99
-------------	--------

Dictation Cassettes

D30. 30 min	\$1.79
D45. 45 min	\$1.89
D60. 60 min	\$1.99
D90. 90 min	\$2.59
D120. 120 min	\$2.99

8-Track Cartridges

8T-45. 45 min	\$1.69
8T-90. 90 min	\$2.49

Tape Accessories

CHC. Cassette head cleaner	\$0.99
8T-HC. 8-track head cleaner	\$1.19

DENON

DXM Metal Cassette

Designed exclusively for music; features improved MOL in low and medium frequency range and SOL in high frequency range, wide dynamic range at high-frequency end, and stable and smooth magnetic coating with low drop-out; high-precision cassette shells and matrix sheets; 70- μ sec equalization.

C60. 60 min	\$8.60
C90. 90 min	\$12.00

DX-7 Series Cassettes

Improved chrome-position double-coated cobalt-doped tape for music programs; 70- μ sec equalization; high saturation output level in high frequencies and wide dynamic range; precision shell half.

C60. 60 min	\$5.00
C90. 90 min	\$7.00

DX-5 Series Cassettes

Double-coated FeCr-type music tape; broad bias curve and +8-dB increase in maximum output level/bias setting of 70- μ sec; compatible with variety of

cassette decks and program sources; ferri-chrome position.

FC-60. 60 min	\$5.00
FC-90. 90 min	\$7.00

DX-3 Series Cassettes

Double-coated magnetic FeCr-type tape accommodates all types of cassette decks; normal bias setting; normal position.

NC-60. 60 min	\$3.99
NC-90. 90 min	\$5.60

FUJI

Metal Tape

Metal coating with polyester base and prestressed backing; very high output, ultra-low noise, 7-12 dB higher MOL than chrome; metal bias; 70 μ sec equalization; packaged in hinged plastic box.

C46. 46 min	\$8.30
C60. 60 min	\$9.10
C90. 90 min	\$12.00

FX-I Premium Cassette Series

Pure ferric-oxide coating with polyester base and backing; normal bias; 120 μ sec equalization; packaged in hinged plastic box.

C46FX-I. 46 min	\$4.25
C60FX-I. 60 min	\$4.89
C90FX-I. 90 min	\$6.70

FX-II Premium Cassette Series

Beridox coating with polyester base and backing; high bias; 70 μ sec equalization; packaged in hinged plastic box.

C46FX-II. 46 min	\$4.40
C60FX-II. 60 min	\$5.10
C90FX-II. 90 min	\$6.95

FL Low-Noise Cassettes

Ferric-oxide coating with prestressed polyester backing; packaged in hinged plastic box.

C46FL. 46 min	\$3.00
C60FL. 60 min	\$3.40
C90FL. 90 min	\$4.70
C120FL. 120 min	\$6.50

Videocassette Tape

Super HG VHS Format

Super-fine Beridox. Exclusive Duroback coating; 4 dB higher color and video S/N ratio.

T-120. 2-6 hr	\$37.00
T-100. 1 $\frac{1}{2}$ -5 hr	\$33.35
T-80. 1 $\frac{1}{4}$ -4 hr	\$29.65
T-60. 1-3 hr	\$27.00
T-40. $\frac{3}{4}$ -2 hr	\$24.85
T-30. $\frac{1}{2}$ -1 $\frac{1}{2}$ hr	\$24.10
T-20. $\frac{1}{2}$ -1 hr	\$23.35

VHS Format

Fine-grain Beridox.

T-160. 2 $\frac{1}{2}$ -8hr	\$39.95
T-120. 2-6 hr	\$29.65
T-90. 1 $\frac{1}{2}$ -4 $\frac{1}{2}$ hr	\$26.70
T-60. 1-3 hr	\$21.65
T-30. $\frac{1}{2}$ -1 $\frac{1}{2}$ hr	\$19.45

Beta Format

Fine-grain Beridox; high-impact ABS housing.

L-750. 1 $\frac{1}{2}$ -4 $\frac{1}{2}$ hr	\$26.95
L-500. 1-2 hr	\$21.60
L-370. $\frac{3}{4}$ -1 $\frac{3}{4}$ hr	\$18.10
L-250. $\frac{1}{2}$ -1 hr	\$15.45
L-125. $\frac{1}{4}$ - $\frac{1}{2}$ hr	\$14.00

Video Head-Cleaning Cassettes

Cleans videocassette-recorder heads in 10 seconds.

VCL-10. VHS format	\$34.40
BCL-10. Beta format	\$34.40

HITACHI

ME Cassettes

Metal-tape bias current for metal-tape position.

ME-46. 46 min	\$8.45
ME-60. 60 min	\$9.45
ME-90. 90 min	\$12.45

UD-ER Cassettes

Epitaxial magnetic substance; high output and energy, low distortion; normal bias; includes replaceable self-indicator label and leader tape.

60ER. 60 min	\$4.00
90ER. 90 min	\$5.50

UD-EX Cassettes

Epitaxial magnetic substance for chrome position.

60Ex/ 60 min	\$4.00
90EX. 90 min	\$5.50

IRISH

Professional-Series Cassettes

In polybag.

261-C60-3PA-HK. 60 min, 3/bag	\$3.30
261-C90-3PA-HK. 90 min, 3/bag	\$4.50

In flip-top plastic box.

2000-C30. 30 min	\$1.50
2000-C60. 60 min	\$1.75
2000-C90. 90 min	\$2.15

In flip-top plastic box and polybag.

2000-C60B. 60 min	\$1.90
2000-C90B. 90 min	\$2.30

Low-Noise, Extended-Range Cassettes

Flip-top plastic box.

7000 C-60. 60 min	\$2.10
7000 C-90. 90 min	\$2.70

270 Series Professional Tape

277-151. 1800-ft, 7" reel	\$15.25
---------------------------	---------

200 Series Professional Tape

Standard, 1 $\frac{1}{2}$ -mil, polyester base, $\frac{1}{4}$ ".

231-151. 1200-ft, 7" reel	\$8.95
---------------------------	--------

Extra-length, 1-mil, polyester base, $\frac{1}{4}$ ".

241-151. 1800-ft, 7" reel	\$11.25
---------------------------	---------

Double-length, $\frac{1}{2}$ -mil, polyester tensilized base.

251-151. 2400-ft, 7" reel	\$17.40
---------------------------	---------

Videocassette Tape

VHS Videocassettes

T-60. 1-2 hr	\$17.95
T-120. 2-4 hr	\$24.49

JVC

ME Metal Tape

Metal-particle-formulation cassette designed for the serious amateur recordist requires high bias and 70- μ sec EQ and delivers 4500-gauss flux density.

ME-46. 46 min	\$9.50
ME-60. 60 min	\$11.00

ME-P Metal Cassette

Metal-particle-formulation cassette designed for the advanced audiophile requires high bias and 70- μ sec EQ and delivers 4800-gauss flux density.

ME-P-46. 46 min	\$11.50
ME-P-60. 60 min	\$13.00

Videocassette Tape

VHS Format

T-30. $\frac{1}{2}$ -1 hr	\$15.00
T-60. 1-2 hr	\$17.00
T-120. 2-4-6 hr	\$26.00

KENWOOD

MD Series Cassettes

Designed for metal bias/70- μ sec equalization.

C-90. 90 min	\$11.55
C-60. 60 min	\$9.25

CD Series Cassettes

Cobalt-absorbed gamma ferric oxide formulation designed for high bias/70- μ sec equalization.

C-90. 90 min	\$5.75
C-60. 60 min	\$4.25

ND Series Cassettes

Premium ferric-oxide formulation designed for normal bias/120- μ sec equalization. Particle shape, size, uniformity, and dispersion are controlled to yield maxi-

mum output level and low noise across frequency spectrum. High frequency response is 4 to 7 dB over conventional normal-bias tapes. Recommended for portable and car-stereo tape players.

C-90. 90 min	\$5.00
C-60. 60 min	\$3.45

N Series Cassettes

High-grained ferric-oxide formulation with a high-frequency sensitivity of up to 4 dB over conventional low-noise/high-output tapes; designed for low-noise and low distortion on equipment with or without bias/equalization controls.

C-90. 90 min	\$3.45
C-60. 60 min	\$2.70

Videocassette Tape

High-grade VHS-format videocassette tape designed for high-density recording.

T-120HG. 2-4-6 hr	\$31.50
T-60HG. 1-2-3 hr	\$23.00

LORANGER

Loran Normal-Bias Cassettes

Designed for normal bias, 120- μ sec equalization settings.

C-46. 46 min	\$4.45
C-60. 60 min	\$5.55
C-90. 90 min	\$7.65

Loran High Bias, Type II Cassettes

Ferri-cobalt tape designed for use with CrO₂ settings.

C-60. 60 min	\$5.75
C-90. 90 min	\$7.75

Loran Metal Cassettes

Metal-particle formulation cassettes designed for type IV bias, 70- μ sec equalization.

C-60. 60 min	\$12.70
C-90. 90 min	\$15.75

LUX

XM-IV Metal-Particle Tape

Premium tape for metal bias, 70- μ sec equalization.

C-90. 90 min	\$14.95
--------------	---------

MAXELL

MX Metal Cassettes

Metal bias/equalization.

MX-46. 46 min	\$8.99
MX-60. 60 min	\$9.99
MX-90. 90 min	\$11.99

XL II-S Epitaxial Cassettes

High-level bias; 70- μ sec equalization.

XL II-S 60. 60 min	\$5.29
XL II-S 90. 90 min	\$8.20

XL I-S Epitaxial Cassettes

Normal bias; 120- μ sec equalization.

XL I-S 60. 60 min	\$5.29
XL I-S 90. 90 min	\$7.29

UD-XL-I Epitaxial Cassettes

Normal bias; 120- μ sec equalization.

C-60. 60 min	\$5.29
C-90. 90 min	\$6.39

UD-XL-II Epitaxial Cassettes

Chrome type; high-level bias; 70- μ sec equalization.

C-60. 60 min	\$4.59
C-90. 90 min	\$6.39

Ultra-Dynamic Cassettes

Normal bias.

UD-46. 46 min	\$3.19
UD-60. 60 min	\$3.49
UD-90. 90 min	\$5.19
UD-120. 120 min	\$6.99

Low-Noise Cassettes

Normal bias.

LN-46. 46 min	\$2.19
LN-60. 60 min	\$2.39

LN-90. 90 min	\$3.59
LN-120. 120 min	\$4.69

8-Track Cartridges

Normal bias; low noise.

LN8T-46. 46 min	\$3.39
LN8T-60. 60 min	\$3.79
LN8T-90. 90 min	\$4.29

Microcassettes

MC-46MX (1 per card)	\$8.09
MC-60MX (1 per card)	\$8.99
MC-46UD2PK (2 per card)	\$8.39
MC-60UD2PK (2 per card)	\$9.29

Open-Reel Tapes

XLII Open-Reel Tapes

Designed for use with EE-capable decks.

XLII 35-90. 1800 ft	\$19.99
XLII 35-180. 3600 ft	\$54.59

XLI Back-Coated Open-Reel Tapes

XLI 50-60B. 1200 ft, 7" reel	\$11.29
XLI 50-120B. 2500 ft, 10 1/2" reel	\$30.59
XLI 35-90B. 1800 ft, 7" reel	\$12.69
XLI 35-180B. 3600 ft, 10 1/2" reel	\$34.99

Ultra-Dynamic Open-Reel Tapes

UD50-60. 1200 ft, 7" reel	\$18.99
UD50-120. 2500 ft, 10 1/2" reel	\$25.69
UD35-90. 1800 ft, 7" reel	\$10.39
UD35-180. 3600 ft, 10 1/2" reel	\$28.89

Tape Accessories

7" plastic reel (PR-7)	\$4.09
7" precision metal reel (MR-7M)	\$9.19
10 1/2" precision metal reel (MR-10)	\$14.59
Wand demagnetizer (WMD-110)	\$14.99
Cassette demagnetizer (HE-44)	\$25.99
Tape winder (CW-340)	\$25.99
12-cassette plastic storage box	\$4.99

Videocassette Tapes

VHS Epitaxial Videocassettes

Cobalt-ferric oxide formulation; mirror-finished tape surface and binder system keep head wear to a minimum.

T-60	\$17.50
T-120	\$24.95
T-160	\$36.95

VHS High-Grade Epitaxial Videocassettes

HGX T-30	\$18.95
HGX T-60	\$21.95
HGX T-90.90 min	\$25.95
HGX T-120.120 min	\$29.95

Beta Videocassettes

L-250	\$13.50
L-500	\$17.95
L-750	\$21.95

HGX Beta Videocassettes

High-grade Beta-format videocassettes.

HGX L-250	\$17.45
HGX L-500	\$22.45
HGX L-750	\$27.45

Video Tape Accessories

VHS head-cleaning cassette (T-CL)	\$24.95
Beta head-cleaning cassette (L-CL)	\$21.55

MEMOREX

METAL IV Cassettes

State-of-the-art metal formulation for metal bias (Type IV) and 70- μ sec equalization settings; low and midrange S/N ratio at +6 dB above conventional premium tapes; unique dustproof Memorex album locks open or closed, accepts cassettes in either direction.

METAL IV C-60. 60 min	\$4.59
METAL IV C-90. 90 min	\$6.29

HIGH BIAS II Cassettes

New superfine uniform ferrite crystal oxide formulation for high-bias (CrO₂, Type II) setting and 70- μ sec

equalization; delivers flat frequency response at preferred record levels (0 dB) and 4 to 5 dB lower noise; unique dustproof Memorex album locks open or closed, accepts cassettes in either direction.

HIGH BIAS II C-60. 60 min	\$3.19
HIGH BIAS II C-90. 90 min	\$4.79

MRX I Cassettes

New unique ferric-oxide formulation for normal bias, 120- μ sec equalization settings; improved dynamic range across full sound spectrum; unique dustproof Memorex album locks open or closed, accepts cassettes in either direction.

MRX I C-30. 30 min	\$2.79
MRX I C-45. 45 min	\$2.99
MRX I C-60. 60 min	\$3.19
MRX I C-90. 90 min	\$4.79
MRX IC-120. 120 min	\$6.39

8-Track Cartridges

45 min	\$3.49
60 min	\$3.89
90 min	\$4.09

Accessories

8-track head/capstan cleaner	\$3.29
cassette cleaning kit	\$2.99
8-track head cleaner	\$1.89
Cassette head cleaner	\$1.99

Videocassette Tape

VHS Videocassettes

High Chroma, high r-f output for brilliant life-like color, excellent picture clarity and stability; features dustproof plastic storage case.

T-60. 1-2-3 hrs	\$16.99
T-90. 1 1/2-3 1/2 hrs	\$18.99
T120. 2-4-6 hrs	\$24.99

Betamax Premium Videocassettes

High Chroma, high r-f output for brilliant life-like color, excellent picture quality and stability.

L-250	\$12.45
L-500	\$16.95
L-750	\$20.95

Accessories

VHS cleaning cassette	\$24.99
V-100 VHS storage case	\$1.99

NAKAMICHI

ZX Cassette Tape

Metalloy (metal-particle) formulation for use with metal-compatible decks only; features ultra-high coercivity and retentivity for improved distortion and MOL; 70 μ sec equalization.

ZX-C60. 60 min	\$6.50
ZX-C90. 90 min	\$9.00

SX Cassette Tapes

Single-coated; ionized cobalt and ferric oxide formulation; high coercivity permits use of CrO₂ bias and equalization (70 μ sec) for 4-5 dB better S/N ratio.

SX-C60. 60 min	\$4.00
SX-C90. 90 min	\$5.85

EX II Cassette Tapes

Single-coated; ferricobalt formulation; same bias and equalization (120 μ sec) as EX tape; extra-low noise, high output.

EXII-C60. 60 min	\$3.70
EXII-C90. 90 min	\$5.40

PANASONIC

Videocassette Tape

VHS Videocassettes

NV-T60. 1-2-3 hr	\$14.00
NV-T120. 2-4-6 hr	\$17.00
NV-T160. 8 hr	\$30.00

PD MAGNETICS

1100 Metal Audio Cassettes

Designed to produce flat response over entire 30-

3

BLANK TAPE

20,000-Hz range for critical recording applications; metal bias.

C-60. 60 min	\$8.99
C-90. 90 min	\$11.99

500 Crolyn Audio Cassettes

Chromium-dioxide cassettes in precision housings and with laminated double-layer foil construction for superior winding quality, controlled friction, and no jamming; designed for CrO₂ bias.

C-60. 60 min	\$4.99
C-90. 90 min	\$6.49

Tri-Oxide FERRO Audio Cassettes

Premium-quality ferric-oxide audio cassettes designed for normal bias.

C-60. 60 min	\$3.49
C-90. 90 min	\$4.99

Videocassette Tape

Beta-Format Videocassettes

L-250	\$13.45
L-500	\$17.45
L-750	\$21.95

VHS-Format Videocassettes

T-60	\$17.95
T-90	\$21.95
T-120	\$25.95

QUASAR

MT602 Microcassettes

60-minute microcassette designed for normal bias; twin pack

	\$4.45
--	--------

MT462M Microcassettes

46-minute microcassette designed for metal bias; twin pack

	\$9.95
--	--------

MT90A Microcassettes

Angrom tape microcassette

	\$9.95 ea.
--	------------

Videocassette Tape

VHS-Format

VC-T160. 1-2-3 hrs	\$14.50
VC-T120. 2-4-6 hrs	\$18.95
VC-T160. 2 hr 40 min-5 hr 20 min-8 hr	\$32.95

REALISTIC

Supertape Metal Cassette

44-960. 60 min	\$7.99
44-961. 90 min	\$8.99

Supertape Hi-Bias Cassettes

44-940. 60 min	\$3.99
44-941. 90 min	\$4.99

Supertape Gold Cassettes

44-920. 45 min	\$2.69
44-921. 60 min	\$2.99
44-922. 90 min	\$3.99
44-923. 120 min	\$4.99

RECOTON

Rainbow 5-Packs

Audio cassettes supplied 5/pack in see-through molded plastic boxes. Cassette shells come in 5 different colors for easy identification.

RC5 × 60. 60 min each	\$3.99
RC5 × 90. 90 min each	\$5.79

High-Bias Cassettes

Studio Standard Series high-bias cassettes in rigid Norelco case. Features Teflon-treated tape reels for trouble-free operation.

SH-60. 60 min	\$2.79
SH-60RJ. 60 min, blister packed	\$2.79

60 min	\$4.49
90 min	\$5.79

Deluxe Ultra Flow Cassettes

RU60. 60 min	\$1.19
RU90. 90 min	\$1.49
RU60-2RJ. Pkg of 2 60 min	\$2.49
RU90-2RJ. Pkg of 2 90 min	\$3.29
RU4 × 60. Four 60 min in Magic-Stak module	\$5.39
RU4-90. Four 90 min in Magic-Stak module	\$6.79

Ultra Flow High-Energy Cassettes

Available individually boxed or on blister cards.

HE60. 60 min	\$1.75
HE90. 90 min	\$2.25
HE60-2RJ. Pkg of 2 60 min, blister packed	\$3.49
HE90-2RJ. Pkg of 2 90 min, blister packed	\$3.49

Budget-Priced Cassettes

Available individually wrapped or in poly bags.

RC60. 60 min	\$0.89
RC90. 90 min	\$1.19
RC3 × 60. Pkg of 3 60 min, poly bag	\$1.79
RC2 × 90. Pkg of 2 90 min, poly bag	\$2.49
RC3 × 90. Pkg of 3 90 min, poly bag	\$3.49

8-Track Cartridges

Available in shrink wrap or blister pack.

8T40. 40 min	\$2.49
8T45. 45 min	\$2.59
8T80. 80 min	\$3.19
8T90. 90 min	\$3.69
8T100. 100 min	\$3.99
8T40-4. Pkg of 4 40 min	\$10.95
8T80-4. Pkg of 4 80 min	\$12.95

RKO

Ultrachrome Cassettes

Chromium dioxide formulation; chrome (high) bias; 70-μsec equalization; housed in five-screw polystyrene shell with chrome notch.

C-60. 60 min	\$4.49
C-90. 90 min	\$5.99

Broadcast I Cassettes

Ferric formulation; normal bias; 120 μsec equalization; housed in five-screw polystyrene shell.

C-60. 60 min	\$3.99
C-90. 90 min	\$45.49

Xtra Dynamic Cassettes

Ferric bias; for home recording.

C-45. 45 min	\$2.49
C-60. 60 min	\$2.99
C-90. 90 min	\$3.99

Videocassette Tape

ColorChrome Videocassettes

Beta and VHS formats; packaging features dust-protector sleeve and color-coded filing system for home storage.

L250. ½-1½ hrs	\$12.95
L-500. 1-3 hrs	\$16.95
L-750. 1½-4½ hrs	\$20.95
T-60. 1-2 hrs	\$17.95
T-120. 2-4 hrs	\$24.95

SCOTCH

Metafine Cassettes

Fine metal magnetic particle formulation; delivers maximum output up to 10 dB better than typical oxide tapes and up to 7 dB greater than chrome tapes; low distortion, added high frequency response, and improved S/N ratio.

46 min	\$7.19
60 min	\$7.99
90 min	\$10.29

Master I Cassettes

Features premium grade, low-noise ferric oxide; for use with recorders in the normal or 120 μsec equalization position; album packaging; improved shell for critical mechanical permanence and 3-head equipment.

Master II Cassettes

Features premium grade, low-noise ferric oxide; for use with recorders in the normal or 120 μsec equalization position; album packaging; improved shell for critical mechanical permanence and 3-head equipment.

60 min	\$4.79
90 min	\$5.99

Dynarange Cassettes

High-output, low-noise ferric oxide cassette featuring full dynamic range throughout audible sound spectrum; 5-screw impact polymer shell houses an inner assembly that features specially made low-friction roller guides; album package.

45 min	\$2.99
60 min	\$3.29
90 min	\$4.79
120 min	\$6.59

Highlander Cassettes

Low-noise oxide formulation for all-purpose cassette use; polyester base.

45	\$1.89
60 min	\$2.19
90 min	\$3.29
120 min	\$4.79

Dynarange 8-Track Cartridges

Features low-noise ferric oxide; fidelity uniform throughout audible frequency range; heavy-duty binder; lubricant system; precise tape-to-head alignment.

S-8TR-45. 45 min	\$3.19
S-8-TR-90. 90 min	\$3.99

206-207 Open-Reel Tapes

Polyester base tape with "Posi-Trak" backing, leader, trailer. Designed for critical stereo mastering.

206. 7" reel, 60 min at 7½ ips, 1.5 mil	\$7.99
207. 7" reel, 90 min at 7½ ips, 1.0 mil	\$9.99

Dynarange Open-Reel Tapes

Provides high-fidelity recording even at 3¾ ips; multi-purpose tape providing full dynamic range throughout audible spectrum; S/N is 4 to 6 dB better than standard tapes.

211. Polyester backing, white yellow trailer, 5" reel, 30 min at 7½ ips, 1.5 mil	\$4.09
7" reel, 60 min	\$6.29
212. 5" reel, 45 min at 7½ ips, 1.0 mil	\$4.89
90 min, 7" reel	\$8.39
213. 7" reel, 120 min at 7½ ips, 0.5 mil tensilized	\$12.59
214. 5" reel, 90 min at 7½ ips, 0.5 mil tensilized	\$8.39
180 min, 7" reel	\$16.59

Videocassette Tape

VHS-Format Videocassettes

T-30. ½-1-hr	\$18.45
T-60. 1-2 hrs	\$21.75
T-120. 2-4 hrs	\$27.95

Beta-Format Videocassettes

L-250. ½-1 hr	\$14.95
L-500. 1-2 hrs	\$18.95
L-750. 1½-3 hrs	\$23.95

Videocassette Head Cleaners

Head-cleaning tape with recorded message, "When you can read this message, your heads are clean. Stop the player now."

VHS-format	\$28.95
Beta-format	\$27.95

SONY

Metal Series Cassettes

70-μsec metal equalization.

Metallic 46. 46 min	\$7.00
Metallic 60. 60 min	\$8.45
Metallic 90. 90 min	\$11.50

FeCr Series Cassettes

Normal or FeCr bias; 70- μ sec FeCr equalization.	
FeCr-46. 46 min	\$3.90
FeCr-60. 60 min	\$4.15
FeCr-90. 90 min	\$6.10

UCX-S Series Cassettes

Ferric-oxide magnetic tape; high bias, Type II. 70 μ sec equalization.

UCX-S 60. 60 min	\$5.00
UCX-S 90. 90 min	\$7.00

EHF Series Cassettes

Cobalt-absorbed magnetic tape; high bias; 70 μ sec equalization.

EHF-46. 46 min	\$3.70
EHF-60. 60 min	\$4.15
EHF-90. 90 min	\$5.75

SHF Series Cassettes

Ferric oxide magnetic tape; normal bias; 120- μ sec equalization.

SHF-46. 46 min	\$3.35
SHF-60. 60 min	\$3.80
SHF-90. 90 min	\$5.20

HFX Series Cassettes

Normal bias; normal or 120 μ sec equalization.

HFX-46. 46 min	\$2.75
HFX-60. 60 min	\$3.10
HFX-90. 90 min	\$4.25
HFX-120. 120 min	\$5.45

LNK Series Cassettes

Normal bias; normal or 12 μ sec equalization.

LNK-46. 46 min	\$2.05
LNK-60. 60 min	\$2.25
LNK-90. 90 min	\$3.15
LNK-120. 120 min	\$4.05

Microcassettes

Popular Series; ferric oxide; 3 to a package.

3MC. 60 min	\$11.40
-------------	---------

Popular Series; blister pack.

MC-60. 60/120 min	\$3.80
MC-90. 90/180 min	\$8.00

High Fidelity Series.

MC46 HF. 46/92 min	\$4.10
MC60 HF. 60/120 min	\$4.50

Metallic Series.

MC46 Metallic. 46/92 min	\$5.55
MC60 Metallic. 60/120 min	\$6.10

Elcasetts

Type I: SLH tape.

LC-60. 60 min	\$8.00
LC-90. 90 min	\$10.60

Type II: FeCr Tape.

LC-60. 60 min	\$10.60
LC-90. 90 min	\$12.80

8-Track Cartridges

8T-46HF. 46 min	\$3.30
8T-46HF-C. 46 min	\$3.30
8T-90HF. 90 min	\$4.20
8T-90HF-C. 90 min	\$4.20

Open-Reel Tapes

FeCr Series.

FeCr 7-550BL. 90 min	\$14.00
FeCr 11-1100BL. 180 min	\$39.00

ULH Series.

ULH 72-370BL. 60 min	\$9.00
ULH 7-550BL. 90 min	\$11.50
ULH 11-1100BL. 180 min	\$31.00

Videocassette Tape

Dynamicon Beta Videocassettes

Betamax I, II, and III formats; available in blister pack or standard package.

L-125. 15/30/45 min	\$10.95
L-250. 30/60/90 min	\$12.45
L-500. 60/120/180 min	\$16.95
L-750. 90/180/270 min	\$20.95
L-830. 200/300 min	\$22.95

Dynamicon High Grade Videocassettes

Betamax I, II, and III formats; available in standard

package.

L-125. 15/30/45 min	\$11.90
L-250. 30/60/90 min	\$13.55
L-500. 60/120/180 min	\$18.45
L-750. 90/180/270 min	\$22.80

STUDER/REVOX

631 Magnetic Tape

New Revox tape with improved maximum output level at low frequencies. For 3% distortion, flux on tape reaches 1200 nWb/m, representing an S/N ratio of 78 dB. Bias adjustment compatible with 621 tape.

TAPE 5

Wide-Latitude Cassettes

Small-particle highly-polished gamma ferric oxide mastering cassette tape; normal bias and equalization; wide tolerance for differing bias settings of various cassette decks; S/N ratio 64.4 dB; 5-stainless-steel-screw cassette shell; Norelco-type outer case with overlapping lid.

C-46. 46 min	\$2.99
C-60. 60 min	\$3.49
C-90. 90 min	\$4.49
C-120. 120 min	\$5.99

TDK

Professional Reference Series

MA-R (Metal Allow-Reference) Cassettes

Metal bias; 70- μ sec equalization; housed in reference standard diecast metal shell; excellent high-frequency MOL and high coercivity for improved sensitivity and extra recording headroom.

MA-R 60. 60 min	\$8.99
MA-R 90. 90 min	\$11.99

SA-X (Super Avilyn-Extended) Cassettes

Double-coated Super-Avilyn-particle tape; high bias; 70- μ sec equalization; high output and wide dynamic range; housed in precision shell and laboratory standard mechanism.

SA-X 60. 60 min	\$4.99
SA-X 90. 90 min	\$6.99

AD-X (Acoustic Dynamic-Extended) Cassettes

Avilyn-particle technology in a normal-bias cassette. High output, wide dynamic range, excellent sensitivity. Laboratory standard mechanism. 120- μ sec equalization.

AD-X60. 60 min	\$3.89
AD-X90. 90 min	\$5.49

Reference Standard Series

MA (Metal Alloy) Cassettes

Metal bias; 70- μ sec equalization; housed in precision molded plastic shell housing and laboratory standard mechanism.

MA-60. 60 min	\$6.69
MA-90. 90 min	\$8.99

SA (Super Avilyn) Cassettes

Cobalt-ferric formulation; high bias; 70- μ sec equalization; extended frequency response and low noise; laboratory standard mechanism.

SA-60. 60 min	\$4.39
SA-90. 90 min	\$6.19

AD (Acoustic Dynamic) Cassettes

Linear ferric oxide particle formulation for normal bias; 120- μ sec equalization; superior high-end response and output level; laboratory standard mechanism; for home and car decks.

AD-60. 60 min	\$3.29
AD-90. 90 min	\$4.79

General-Purpose Cassettes

D (Dynamic) Cassettes

Normal bias; 120- μ sec equalization; precision mechanism.

D-30. 30 min	\$2.09
D-46. 46 min	\$2.29

FREE

details... **A DIFFERENT KIND OF RECORD CLUB**

You can now own every record or tape that you may ever want... at tremendous savings and with no continuing purchase obligations. You can get valuable free dividend certificates, you can get quick service and all the 100% iron-clad guarantees you want.

Now you can stop price increases that leave you with less music for your record and tape budget. You can guarantee yourself more music for less money through membership in Discount Music Club.

Look at these benefits:

TREMENDOUS SAVINGS

on every record and tape in print—no "disc-to-purchase" obligations of any kind

DISCOUNTS OF 43% TO 73% off mfg. suggested list... special catalog features hundreds of titles and artists.

ALL LABELS AVAILABLE

including most imports through special custom ordering service. If we don't stock it we'll get it for you.

SCHWANN CATALOG

lists thousands of titles; classical, pop, jazz, ballet, opera, musical shows, folk, rock, vocal, instrumental, country, etc.

DISCOUNT DIVIDEND CERTIFICATES

Dividend Gifts—Every shipment carries a dividend gift or dividend certificate. Certificates redeemable immediately for extra discounts.

NEWSLETTERS

happenings in the world of music; concerts, critiques, new releases... special super-sale listings at discounts of up to 73%.

DISCOUNT ACCESSORY GUIDE

Diamond needles, cloths, tape cleaners, etc. Discount Music Club is your complete one stop music and accessory buying service.

QUICK SERVICE

same day shipping on many orders... rarely later than the next several days. Partial shipments always made in the event of unforeseen delay... all at no extra cost to you.

100% IRON-CLAD GUARANTEES

on all products and services. Everything is guaranteed factory fresh and free of defects or damages of any sort. Your total satisfaction is unconditionally guaranteed.

Discount Music Club is a no-obligation membership club that guarantees tremendous discounts on all stereo records and tapes and lets you buy what you want... when you want... or not at all if you choose.

These are just a few of the money-saving reasons to write for free details. You can't lose so why not fill out and mail the coupon below for immediate information.

DMC DISCOUNT MUSIC CLUB, INC
650 Main Street DEPT. 33-0882
P.O. Box 2000
New Rochelle, N.Y. 10801

NAME

ADDRESS

CITY

STATE

ZIP

CIRCLE NO. 4 ON READER SERVICE CARD

3

BLANK TAPE

D-60. 60 min	\$2.49
D-90. 90 min	\$3.39
D-120. 120 min	\$3.99
D-180. 180 min	\$5.59

Endless Cassettes

EC (Endless) Cassettes

Endless-loop design permits continuous repeating of recorded material; back coated; available with or without foil strip for machines with automatic shutoff sensor.

EC-20S(F). 20 sec.....	\$4.19
EC-30S(F). 30 sec.....	\$4.29
EC-1M(F). 1 min	\$4.39
EC-3M(F). 3 min	\$4.49
EC-6M(F). 6 min	\$4.99
EC-12M(F). 12 min.....	\$5.99

Open-Reel Tapes

SA Open-Reel Tape

Extra-efficiency Super Avilyn open-reel tape for use with new EE tape decks. High coercivity, low noise for full performance at half speed.

SA35-90. 1800-ft, 7" plastic reel	\$15.95
SA35-180M. 3600-ft, 10½" metal reel ..	\$41.95

GX Open-Reel Tape

Extremely high output level, extended range, low noise, low distortion tape for mastering and all critical recording applications. Back treated for smooth running and stable winding. Available in 35- and 50-micron thicknesses.

GX35-90B. 1800 ft, 7" plastic reel	\$12.95
GX35-180BM. 3600 ft, 10½" metal reel ..	\$34.95
GX50-60B. 1200 ft, 7" plastic reel	\$10.95

GX50-120BN. 2500 ft, 10½" metal reel \$29.95

LX Open-Reel Tape

High output level, extended range, low noise, low distortion tape for professional and all critical recording applications. Available in 35- and 50-micron thicknesses. Back treated (except for LX 35-90 and LX35-180M).

LX35-90. 1800 ft, 7" plastic reel	\$9.95
LX35-90B. 1800 ft, 7" plastic reel	\$10.95
LX35-180M. 3600 ft, 10½" metal reel ..	\$27.95
LX35-180BM. 3600 ft, 10½" metal reel ..	\$30.95
LX50-60B. 1200 ft, 7" plastic reel	\$9.95
LX50-120BM. 2500 ft, 10½" metal reel ..	\$27.95

Microcassettes

MA-MC60B Microcassettes

Same metal-alloy tape formulation as standard-size cassettes. High-MOL, high-coercivity tape for critical music recording in metal-compatible microcassette recorders.

MA-MC60. 60 min	\$8.99
-----------------------	--------

AD-MC60B2 Microcassettes

Same acoustical dynamic formulation as standard-size cassettes. High-output, extended-range, low-noise tape for music and speech recording. Packed in twos.

AD-MC60B3. 60 min each	\$9.99
------------------------------	--------

D-MC60B3 Microcassettes

Same dynamic formulation as standard-size cassettes. Has flat response and low noise figure for speech recording. Packed in threes.

D-MC60B3. 60 min each	\$11.99
-----------------------------	---------

Videocassette Tapes

Super Avilyn HG VHS And Beta

High-grade formulation for higher output than standard videocassettes, 3-dB better color S/N ratio level, and improved performance at all speeds, especially in 6-hr mode.

VAT-120HG. 2-4-6 hr	\$31.50
VAT-60HG. 1-2-3-hr	\$23.00
BAL-750HG.	\$28.50

BAL-500HG. \$22.50

Super Avilyn VHS Videocassettes

VAT-160	\$35.00
VAT-120HG. 2-4-6 hr	\$26.00
VAT-90. 1½-3-4½ hr	\$22.00
VAT-60. 1-2-3 hr	\$19.00
VAT-30. ½-1-1½ hr	\$17.00

Super Avilyn Beta Videocassettes

Special formula designed to give crisp picture and brilliant color.

BAL-750. 1½-3-4½ hr	\$24.00
BAL-500. 1-2-3 hr	\$19.00
BAL-250. ½-1-1½ hr	\$13.50

YAMAHA

Metal-Alloy Audio Cassettes

Designed for metal bias, 70-µsec equalization.

MR-60. 60 min	\$8.39
MR-90. 90 min	\$11.29

Super Ferric Oxide Extended Cassettes

Super ferric-oxide extended audio cassettes designed for high bias, 70-µsec equalization.

CRX-60. 60 min	\$6.29
CRX-90. 90 min	\$8.69

Super Ferric Oxide Audio Cassettes

Super ferric-oxide audio cassettes designed for high bias, 70-µsec equalization.

CR-60. 60 min	\$5.49
CR-90. 90 min	\$7.79

Ferric Oxide Audio Cassettes

Standard ferric-oxide audio cassettes designed for normal bias, 120-µsec equalization.

NR-60. 60 min	\$4.29
NR-90. 90 min	\$6.19

ZENITH

Beta-Format Videocassette Tapes

L830. 5 hr Beta III, 3½ hr Beta II	\$16.95
L750. 4½ hr Beta III, 3 hr Beta II	\$14.95
L500. 3 hr Beta III, 2 Hr Beta II	\$12.95

DIRECTORY OF MANUFACTURERS

(Continued from page 4.)

H.H. SCOTT, INC.

20 Commerce Way, Woburn, MA 01801

SEARS, ROEBUCK & CO.

Sears Tower, Chicago, IL 60684

SENNHEISER ELECTRONIC CORP.

10 West 37 St., New York, NY 10018

SHARP ELECTRONICS CORP.

10 Keystone Pl., Paramus, NJ 07652

SHERWOOD, Div. Inkel Corp.

17107 Kingsview Ave., Carson, CA 90746

SHURE BROTHERS, INC.

222 Hartrey Ave., Evanston, IL 60204

SIGNET DIVISION, A.T.U.S., INC.

4701 Hudson Dr., Slow, OH 44224

SONY CORPORATION OF AMERICA

9 W. 57 St., New York, NY 10019

SOUNDAIDS

395 Riverside Dr., New York, NY 10025

SOUND CONCEPTS, INC.

P.O. Box 135, Brookline, MA 02416

SOUNDCRAFTSMEN

2200 S. Rittchey, Santa Ana, CA 92705

SPARKOMATIC CORP.

Millord, PA 18337

STANTON MAGNETICS, INC.

Terminal Dr., Plainview, NY 11803

STUDER/REVOX

1425 Elm Hill Pike, Nashville, TN 37210

SUPEREX ELECTRONICS CORP.

151 Ludlow St., Yonkers, NY 10706

SYLVANIA, NAP Consumer Electronics Corp.

Interstate 40 & Siraw Plains Pike, P.O. Box 6950, Knoxville, TN 37914

TANDBERG OF AMERICA, INC.

Labnola Court, P.O. Box 58, Armonk, NY 10504

TAPE 5 INC.

111 Third Ave., New York, NY 10003

TAPCO, a Gulton Company

3810 148 Ave. N.E., Redmond, WA 98052

TASCAM by TEAC

7733 Telegraph Rd., Montebello, CA 90640

TDK ELECTRONICS CORP.

12 Harbor Dr., Fort Washington, NY 11050

TEAC CORP. OF AMERICA

7733 Telegraph Rd., Montebello, CA 90640

TECHNICS (Panasonic Co.)

One Panasonic Way, Secaucus, NJ 07094

TEKNIKA ELECTRONICS CORP.

1633 Broadway, New York, NY 10019

TELEX COMMUNICATIONS, INC.

9600 Aldrich Ave. S., Minneapolis, MN 55420

TOSHIBA AMERICA, INC.

82 Totowa Rd., Wayne, NJ 07470

UHER OF AMERICA, INC.

c/o Walter Odemer Co., Inc., 1516 W. Magnolia Blvd., Burbank, CA 91506

URSA MAJOR, INC.

Box 18, Belmont, MA 02178

VECTOR RESEARCH, INC.

20600 Nordhoff St., Chatsworth, CA 91311

VIDAIRE ELECTRONICS MFG. CORP.

150 Buffalo Ave., Freeport, NY 11520

WALD SOUND, INC.

1131 Dora St., Sun Valley, CA 91352

YAMAHA INTERNATIONAL CORPORATION USA

6660 Orangethorpe Ave., Buena Park, CA 90620

4

VIDEO CASSETTE RECORDERS

AKAI

VS-7 VHS Videocassette Recorder

VHS-format videocassette recorder with 4 heads; infrared wireless remote controller; stereo sound in Dolby; 105-channel cable-ready capability; instant assemble editing; bidirectional search; noise-free special effects; front-loading mechanism; feather-touch transport controls; tape-end warning monitor; automatic rewind; 14-day/8-event programmability; 2/6-hour record, 2/4/8-hour playback; built-in camera adapter; 2-way memory search; FM input ... \$1595

VC-X2 Color Video Camera

VHS-format videocassette recorder with Saticon tube; automatic focusing; exclusive intervalometer; 300-line resolution; polarity reverse-4 state; 30-LUX low-light capability; automatic iris; automatic white balance; 2-speed telephoto lens; 10-pin connector; universal control; automatic fade; audio and video signal outputs \$1195

FISHER

FVH525 VHS Videocassette Recorder

VHS-format videocassette recorder with 2-head helical-scan system and SP/LP/EP modes for up to 8 hours record/play time. Features 7-day/5-event programmable timer; 14-preset-channel electronic tuner; 12 function remote control; pause/still; fast playback; fast reverse; slow playback; triple-speed playback; frame-by-frame advance; audio dubbing; automatic playback switching; soft-touch transport controls; soft eject; automatic rewind; 4-digit AM/PM clock with day indicator and power-failure alert; electronic tape counter; dew-protection system with dew indicator. Video output level/impedance 1 V p-p/75 ohms; video input level/impedance 0.5-2.0 V p-p/75 ohms; video S/N ratio SP/LP/EP 45/42/40 dB; audio output level -65 dBm; audio input level -6 dBm line; microphone input level/impedance -65 dBm/600 ohms; power consumption 57 W; 19.2"W x 13.6"D x 5.2"H; 22 lb \$900

FVH520 VHS Videocassette Recorder

VHS-format videocassette recorder with 2-head helical-scan system and SP/LP/EP modes for up to 8 hours record/play. Features 14-preset channel electronic tuner; 7-day/1-event programmable timer; remote control; pause/still; cue and review; slow and triple-speed playback; frame-by-frame advance; audio dub; automatic playback switching; separate start and end displays; soft-touch transport controls; soft eject; automatic rewind; 4-digit AM/PM clock with day indicator; electronic tape counter; dew protection and dew indicator. Specifications same as for FVH520 \$850

FVH510 VHS Videocassette Recorder

Two-head helical-scan system VHS-format videocassette recorder with SP/LP/EP modes for up to 8 hours record/play. Features remote pause control; 24-hour/1-event programmable timer; automatic rewind; automatic playback switching; 12-preset channel electronic vhf/uhf tuner; soft-touch transport controls; soft eject; 4-digit AM/PM clock; dew protection

system and dew indicator. Specifications same as for FVH520 except power consumption 45 W ... \$750

GENERAL ELECTRIC

1VCR3018W VHS Videocassette Recorder

VHS-format 8-hour videocassette recorder with 4 video heads, stereo sound capability, and wireless remote control. Features cable channel capability; 3-week/8-event programmable tuner/timer; feather-touch transport controls; pause control; audio dubbing; program search; digital timer display with memory function; variable-speed video scan; electronic tuning with midband and superband capability; tracking control; accessory jacks; stereo input/output capability; digital clock; special effects in SP and EP modes, including variable-speed slow motion, quick motion, freeze frame, frame advance. Comes with accessories for connecting to any TV receiver/antenna system. Power consumption 47 W; 18 1/4"W x 14"D x 5 1/2"H; 23 lb \$1500

1VCR3014W VHS Videocassette Recorder

VHS-format 8-hour videocassette recorder with wireless remote control. Features 7-day/5-event tuner/timer; feather-touch transport controls; recorder time selector; pause control; audio dubbing; program search; digital electronic tape counter with memory function; video scan; electronic tuning with cable-TV capability; digital clock; tracking control; accessory jacks; special video effects in EP mode include variable-speed slow motion, quick motion, freeze frame, frame advance. Comes with all accessories for connecting to any TV receiver/antenna system. Power consumption 47 W; 18 1/4"W x 14"D x 5 1/2"H; 23 lb \$1300

1VCR3010X VHS Videocassette Recorder

VHS-format 8-hour videocassette recorder with electronic tuning and 10-day/3-event programmable timer. Features remote control; recording time selector; automatic playback speed; tracking control; accessory jacks; pause control; audio dubbing; digital tape counter with memory function; remote video scan and freeze frame in EP mode. Power consumption 34 W; 17 1/4"W x 13 1/2"D x 5"H; 21 lb \$895

1CVD3020X Portable VHS Videocassette Recorder

VHS-format videocassette recorder with choice of 5 power sources: internal battery, ac adapter, car or boat battery, optional quick charger/adaptor, or optional tuner. Features recorder time selector; video scan; special EP-mode effects that include variable-speed slow motion, freeze frame, frame advance; remote control; insert editing; fine editing; electronic tape counter with memory function; unique single-point power connector. Power consumption record/play 16/7 W; 9 1/2"D x 9 1/4"W x 3 3/4"H; 12 lb \$1045

1CVT605. Optional tuner/timer for 1CVD3020X VCR. Features wireless remote control; programmable 14-day/4-event timer; electronic 14-channel tuning with midband and superband cable-TV capability; one-touch recording; built-in ac adapter/battery charger for 1CVD3020X. Power consumption 36 W; 9 1/2"D x 9 1/4"W x 3 3/4"H; 8 lb \$445

1CTVT615. Optional tuner/timer for ICVD3020X VCR. Similar to 1CVT604 except 24-hour/1-event programmability; power consumption 34 W .. \$350

Color Video Cameras

1CVC3035E. Color video camera equipped with adjustable electronic viewfinder and built-in character generator for on-tape titling and timing in minutes and seconds of sporting events. Features Newvicon pickup tube; automatic-focus system; negative/positive reversing for copying film and slides to tape; viewfinder displays; fade control; remote control; f/1.4 6:1 power zoom lens; automatic/manual ris; automatic white balance control; tally lamp; telescoping boom microphone; standby switch; adjustable shoulder rest. Power consumption 6.4 W at 12 V dc; 11 1/2"D x 9"H x 8 3/8"W; 5.5 lb \$1350

1CVC3030E. Same as 1CVC3035E except no character generator; power consumption 5.7 W .. \$1040

JVC

HR-7650 VHS Videocassette Recorder

VHS-format table-model videocassette recorder with SP/EP recording and SP/LP/EP playback capabilities. Features 4-head system; motorized front-loading

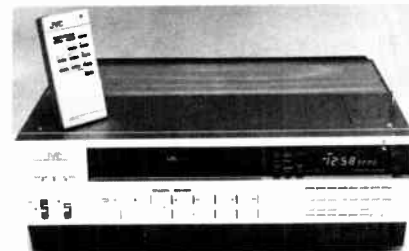

mechanism; full-function infrared remote control; 2 audio channels with Dolby noise reduction; 16-channel presetable tuner with 105-channel cable-ready capacity; simplified insert editing and automatic backspace editing; comprehensive digital fluorescent display; 14-day/8-event programmable timer; variable slow-motion, still-frame, and frame-advance special effects playback; 2-way shuttle search in SP and EP modes; sleep timer; direct front-panel camera connector; 18 1/4"W x 14 1/8"D x 6 1/4"H; 26.5 lb. \$1595

HR-7300 VHS Videocassette Recorder

VHS-format videocassette recorder with SP/EP record and SP/LP/EP playback capabilities. Features 4-head system; 2-way shuttle search in SP and EP modes; feather-touch microprocessor-based full-logic pushbutton transport controls; 14-day/8-event microprocessor-controlled programmable timer; 10-mode full-function remote control; precision-machined direct-drive head drum and 3 other independent motors; 14-channel pretunable electronic tuner; automatic rewind at end of play; counter search; 17 1/8"W x 13"D x 5 1/8"H; 21.6 lb. \$1050

HR-2650 VHS Portable Videocassette Recorder

VHS-format portable videocassette recorder with

4

VIDEO CASSETTE RECORDERS

SP/EP record and SP/LP/EP playback capabilities. Features power supply flexibility (Ni-Cd battery pack, tuner/adaptor, ac power adapter); 4 heads; full-function infrared remote control; 2 audio channels and Dolby noise reduction; simplified insert editing and automatic back-space editing; 2-way shuttle search in SP and EP; flexible audio dubbing; slow motion at half speed and frame advance; fast motion at 3× normal in EP; liquid-crystal display (LCD) tape counter with memory function; automatic quick review with camera's viewfinder; 10 $\frac{1}{16}$ "F × 10 $\frac{1}{16}$ "W × 4 $\frac{1}{16}$ "H; 10.1 lb without battery \$1150

TU-26. Tuner/adaptor for HR-2650 VCR. Features unattended recording with built-in 14-day/8-event programmable timer; 14-channel presettable tuner with 105-channel cable-ready capacity; 90-minute fast recharging of HR-2650's battery pack; remote controllable for power and channel change with HR-2650's remote controller; 12"D × 10 $\frac{3}{16}$ "W × 4 $\frac{1}{16}$ "H; 12.1 lb \$375

AA-P22. Ac power adaptor for HR-2650 VCR. Drives HR-2650 from ac line; recharges 2 Ni-Cd battery packs in series; 12"D × 5 $\frac{1}{16}$ "W × 4 $\frac{1}{16}$ "H; 8.1 lb \$150

Color Video Cameras

GX-S9. Color video camera with Saticon[®] tube. Features clear color picture with reduced lag and burn; ABO (automatic beam optimizing) circuit that reduces "comet-tail" effect; minimum light intensity of 50 LUX; f/1.6 6× 2-speed power zoom lens; automatic iris with EE lock and manual override; 2 audio channels for stereo or mixed mono recording; multi-function fade mechanism (allows both audio and video signals to be faded out); fade to white or black; remote control over VCR; built-in color-conversion filter; R/B dual-axis white-balance control circuit; 3 preset indoor color temperatures; telescoping unidirectional microphone; handgrip that can be positioned at 3 different angles; 1.5" CRT electronic viewfinder with indicators for exposure, VCR mode (standby or record), tape running, battery power alarm, white-balance adjustment, and position of built-in conversion filter; resolution > 300 lines at center; 14 $\frac{1}{16}$ "D × 7 $\frac{1}{2}$ "H × 7 $\frac{1}{2}$ "W; 6 lb \$1100

GX-88. Color video camera with built-in 1.5" electronic viewfinder; f/1.4 lens; built-in filter and vidicon shutter switches; iris control mode and automatic white balance switches; resolution > 270 lines at center; 13 $\frac{3}{4}$ "D × 11"H × 3 $\frac{3}{4}$ "W; 4.3 lb \$1000

GX-68. Video color camera with 6× zoom lens with macro; TTL (through-the-lens) optical viewfinder; 3-position color-compensator switch and manual tint control; automatic iris; automatic fade mechanism; sensitivity select switch; resolution > 250 lines at center; 11 $\frac{1}{16}$ "D × 9"H × 3 $\frac{1}{16}$ "H; 3.3 lb \$850

GX-44. Super-lightweight color video camera with 1.5" electronic viewfinder; f/1.4 4× zoom lens; automatic iris with back-light compensation and manual override; white balance control; switchable filter and vidicon shutter switch; resolution > 270 lines at center; 11 $\frac{1}{4}$ "D × 8 $\frac{1}{16}$ "H × 2 $\frac{1}{4}$ "H; 2.65 lb \$770

Video Camera Accessories

VF-P30. Electronic viewfinder/shoulder-rest assembly for GX-88 camera \$180

MZ-500. Zoom microphone for GX-88 camera \$170

MZ-250. Zoom microphone for video cameras \$90

GA-23. Camera adapter for connecting HR-7300 VCR to GX-68 camera \$112

CA-P25U. Camera adapter for connecting HR-7300 VCR to GX-S9 camera \$80

CV-AC212A. Ac adapter kit for connecting HR-7300 VCR to GX-88/44 camera \$79

KENWOOD

KV-901 Videocassette Recorder

VHS-format videocassette recorder with 2/4/6-hour

record/play format. Features 4-head record/play system; direct-drive, quartz-lock motor; full logic transport controls; direct channel selection; fast VCR Search in all modes; stop-motion frame freeze; 2-week/8-event programmable timer; counter search; automatic rewind; audio dubbing; automatic pause cancel after 5 minutes; and remote-control facility. Vhf output (TV Channel 3 or 4) 75 ohms unbalanced; video input 0.5-2.0 V p-p into 75 ohms unbalanced; video output 1.0 V p-p into 75 ohms unbalanced; video S/N ratio > 45 dB; horizontal resolution > 240 lines; audio input sensitivity/impedance -67 dB/10k ohms mic, -20 dB/50k ohms line; audio output level/impedance -6 dB high impedance/< 1000 ohms unbalanced; audio S/N ratio > 40 dB; audio frequency range 100-10,000 Hz; 17 $\frac{1}{16}$ "W × 12 $\frac{1}{16}$ "D × 5 $\frac{1}{16}$ "H; 22 lb \$1150

MITSUBISHI

HS-320UR VHS Videocassette Recorder

VHS-format 4-head videocassette recorder with SP/LP/EP modes and 8-hour record/play capability. Features 18-function wireless remote control; scan forward/reverse; slow motion; frame-by-frame advance; 14-day/8-event programmable timer; 105-channel cable-ready frequency-synthesized tuner; 5-V dc direct-drive transport motor; Dolby noise-reduction system; digital electronic real-time tape counter; timer backup; fine edit; automatic rewind; speed search 9× normal in EP, 7× normal in SP. Horizontal resolution > 240 lines in SP mode; S/N ratio video/audio > 45/> 46 dB; 16 $\frac{1}{4}$ "W × 14 $\frac{1}{16}$ "D × 5 $\frac{1}{16}$ "H \$1300

HS-303UR VHS Videocassette Recorder

Compact-chassis VHS-format videocassette recorder with SP/LP/EP capability. Features 8-hour record/play capability; 8-function wireless remote control; microcomputer-controlled 5 V dc direct-drive motor transport; 1-day/1-event programmable timer; edit feature; timer backup; automatic rewind. Horizontal resolution > 240 lines in SP mode; S/N ratio video/audio > 45/> 40 dB; 16 $\frac{1}{4}$ "W × 13 $\frac{1}{16}$ "D × 4 $\frac{1}{16}$ "H \$800

PANASONIC

Omnivision Table Models

PV-1770 VHS Videocassette Recorder

VHS-format 6-hour programmable super long play (SLP) VHS color videocassette recorder with full-function wireless infrared remote control and 14-position (105-channel, including cable) electronic tuner. Features Omniseach in all modes (SP, LP, and SLP); 8-program/14-day programmable timer; soft-touch transport controls with total electronic tuning; automatic rewind at end of play; compatibility with other 2/4- and 2/4/6-hr VHS VCRs; 4 video heads; direct-drive video head cylinder and capstan motor; channel lock to prevent accidental channel change during record; 1-hour battery backup for digital clock; memory counter; automatic dubbing; tracking control; dew detector that shuts off deck automatically under damp conditions; special motion features in SP and SLP modes with remote controller (features full rewind, stop, fast forward, play, record, pause, frame advance, ×2 playback speed, Omniseach, various slow-motion and channel-change functions). Supplied with accessories to connect to all types of TV receivers and antennas and one NV-T60 blank videocassette \$1595

PV-1750. Similar to PV-1770 except has only 2 hot-pressed ferrite heads \$1495

PV-1470 VHS Videocassette Recorder

Omnivision 6-hour super long play (SLP) VHS VCR with 105-channel (including CATV band) tuning capability and 9-position remote control. Features Omniseach in LP and SLP modes; 8-program/14-day programmable timer; soft-touch transport controls; electronic tuning; automatic rewind at end of play; switchable to LP 4-hour and standard 2-hour record; 2 hot-pressed ferrite heads; direct-drive video head cylinder and capstan motor; channel lock to prevent accidental channel change during record; automatic backup of tape in pause while recording to eliminate

picture skip; 1-hour battery backup of digital clock; memory counter; audio dubbing; tracking control; dew detector. Remote controller optional. Supplied with complete accessories to connect to all TV receivers and antennas and one NV-T60 blank videocassette \$1295

PV-1370 VHS Videocassette Recorder

Super-long-play (SLP) VCR with Omniseach in LP and SLP modes, still-frame in SLP mode, and 9-position remote control. Features soft-touch transport controls; electronic tuning; automatic rewind at end of play; switchable to LP 4-hour and SP 2-hour recording; 2 hot-pressed ferrite heads; 24-hour/1-program programmable timer; direct-drive video head cylinder and capstan motors; channel lock to prevent accidental channel change during record; memory counter; audio dubbing; tracking control; dew detector. Supplied with complete accessories to connect to any TV receiver and antenna and one blank NV-T60 blank videocassette \$1145

Portable/Home Series

PV-5500 VHS Videocassette Recorder

VHS-format 8-hour programmable portable/home videocassette recorder with wireless infrared remote control. Features 16-function wireless remote control; Omniflex playback features for freeze-action and frame-by-frame advance; 14-day/4-program cable-ready programmable timer with 105-channel programmability; Omniseach for fast-speed search in forward and reverse; SP/LP/SLP modes; r-f output on TV Channel 3 or 4; aluminum diecast chassis; direct-drive motors; tracking controls; video dubbing; electronic LCD memory counter; soft-touch controls; camera remote on/off; tuner input, video in/out, audio in/out through microphone adapter; 3-way operation (ac, car battery, rechargeable battery); adjustable combination shoulder strap/carrying handle; battery-charge indicator; electronic VCR/TV switch; one-touch recording \$1350

PV-5200. Similar to PV-5500 except 12-function wireless remote control; 24-hour programmability; no one-touch recording \$1195

PV-5110. Similar to PV-5200 but minus tuner/timer \$995

Color Video Cameras

PK-972. Features special C-mount 12:1 newwicon pickup tube designed for low-light conditions; built-in character generator for inserting titles that appear on video tape; time generator that displays (on tape) elapsed time up to 59 minutes 100/100 seconds; VCR remote control with play/pause, search forward/reverse, slow and frame-by-frame advance; positive/negative switch for transferring negatives or slides to tape; pistol-grip-mounted variable-speed zoom and pause switch; pause compatibility switch for camera use with non-Panasonic brand VCRs using standard 10-pin connector; front-mounted automatic white balance and color preference controls; 12:1 manual zoom lens with macro capability; automatic/manual iris control; fade-in/fade-out control; electronic viewfinder/monitor; indoor/outdoor color temperature switch; built-in remote control for Panasonic PV-5000 Series portable VCRs; telescoping boom microphone. Power source 12 V dc; power consumption 5.8 W operating/1.0 W standby on 12 V dc, 19 W on 120 V ac; minimum light intensity 60 LUX at f/2.0; video output 1.0 V p-p, 75 ohms balanced; audio output -20 dB, 1000 ohms; S/N ratio > 45 dB; horizontal/vertical resolution > 250/> 350 lines; 14"D × 8.7"H × 8.3"W, including shoulder/hand grip; 5.9 lb with shoulder strap/hand grip, plus 2.6 lb with optional ac adaptor \$1350

PK-956. Automatic-focus color video camera with $\frac{1}{8}$ " newwicon pickup tube for low-light conditions. Features character generator for on-tape titles; time generator for on-tape elapsed time display of sporting events; positive/negative switch for transferring negatives and slides to tape; pistol-grip-mount variable-speed zoom and pause switch; pause compatibility switch for use with non-Panasonic VCRs with standard 10-pin connector; front-mounted automatic white balance and color preference controls; 6:1 f/1.4 variable-speed zoom lens with macro; electronic viewfinder/monitor; automatic/manual iris; fade-in/

fade-out control; indoor/outdoor color temperature switch; built-in remote control for PV-5000 Series portable VCRs; telescoping boom microphone. Power source 12 V dc; power consumption 6.4 W operating/1.4 W standby on 12 V dc, 19 W on 120 V ac; minimum light intensity 30 LUX at f/1.4; video output 1.0 V p-p, 75 ohms unbalanced; audio output -20 dB, 1000 ohms unbalanced; S/N ratio >45 dB; horizontal/vertical resolution >250/>350 lines; 11.6"D x 8.7"H x 8.3"W, including shoulder/hand grip; 5.5 lb with shoulder/hand grip, 2.6 lb extra with optional ac adapter \$1295

PK-805. Auto-focus color video camera with 2/3" pickup tube that resists permanent burning and has low image retention. Features side-mounted adjustable 1.5" diagonal electronic viewfinder/monitor; 6:1 motorized 2-speed f/1.4 zoom lens with macro; fade-in/fade-out control; optional camera remote control (PK-R70) for VCR that gives play/pause, search, frame advance with Panasonic PV-4000 Series VCRs; agc light sensitivity switch for 6-dB gain in low light; color preference control; automatic white balance control; indoor/outdoor color temperature switch; automatic/manual iris control; standby switch to conserve battery power; telescoping boom microphone. Power source 12 V dc; power consumption 8.7 W operating/0.9 W standby on 12 V dc, 19 W on 120 V ac; minimum light intensity 50 LUX at f/1.4; video output 1.0 V p-p, 75 ohms balanced; audio output -20 dB, 1000 ohms; S/N ratio >43 dB; horizontal/vertical resolution >240/>300 lines; 12"D x 8"H x 7"W, including shoulder/hand grip; 7 lb with shoulder/hand grip, 2.4 lb for optional ac adapter \$1200

PK-802. Color video camera with built-in character generator for on-tape titles and built-in time generator for on-tape elapsed time display for sporting events. Features 2/3" special pickup tube that resists permanent burning and has low image retention; positive/negative switch for transferring negatives and slides to film; pistol-grip-mounted variable-speed 6:1 f/1.4 zoom lens with macro and pause switch; pause compatibility switch for use with non-Panasonic VCRs with standard 10-pin connector; front-mounted automatic white balance and color preference controls; electronic viewfinder/monitor; automatic/manual iris; fade-in/fade-out control; indoor/outdoor color temperature switch; built-in VCR remote control for Panasonic PV-5000 Series portable VCRs; telescoping boom microphone. Specifications same as for PK-956 except 11.2"D, including shoulder/hand grip; 5.1 lb shoulder/hand grip \$1095

PK-756. Similar to PK-956 except has 2/3" vidicon tube, camera weight 5.5 lb with shoulder/hand grip \$1050

PHILCO

V1726 VHS Videocassette Recorder

Portable VHS-format videocassette recorder that provides up to 8 hours record/play time. Features 16-function infrared wireless remote control; variable-speed slow motion; still frame; video cue/review; video dub; audio dub; memory rewind; 112-channel tuner; 14-day/4-event programmable timer VCR 9 3/4"D x 9 1/2"W x 3 3/4"H; tuner 10"D x 9 1/2"W x 3 3/4"H \$1450

V1012 VHS Videocassette Recorder

Table-model VHS-format videocassette recorder with frame-by-frame advance, cue, and still functions. Features wired remote pause; electronic soft-touch transport controls; 24-hour programmable digital clock/timer. Dimensions 19"W x 14 1/2"D x 5 1/2"H. \$800

VCC099 Color Camera

Color-video/audio camera with f/1.4 zoom lens. Features electronic viewfinder; automatic/manual iris; automatic white balance control; indoor/outdoor light filter switch. Horizontal resolution 270 lines; video S/N ratio 40 dB; 11 1/4"D x 8 3/4"H x 2"W .. \$995

QUASAR

VH5623UW VHS Videocassette Recorder

Dolby stereo videocassette recorder with line inputs, improved field special effects, and full control wireless infrared (IR) remote-control system. Features 14-

day/8-event programmable timer; 105-channel Varactor tuner; 2-speed picture search; automatic rewind in all modes; double-speed play; all special effects in SP and SLP controllable via remote; one-touch recording; CATV adaptor compatible. Includes VCT30 cassette tape \$1550

VH5610 VHS Videocassette Recorder

VHS-format table-model videocassette recorder with 105-channel vhf/uhf tuning capability. Features 13-function wireless remote control; 4 heads; 8-program/14-day programmable timer \$1625

VH5310. Similar to VH5610 but wired or wireless remote-control unit optional \$1325

VH5210TW VHS Videocassette Recorder

Table-model videocassette recorder with 3-speed capability, 8-hr/1-day/1-program electronic timer. Features freeze frame; picture search; automatic rewind; synchro-touch transport controls; Varactor tuner; 4-function remote-control system with remote channel-change standard. Compatible with optional 9-function remote-control models VE540 wired remote, and VE541 wireless remote control. Comes with VCT60 cassette tape \$1140

VH5021UW VHS Videocassette Recorder

Uniquely styled 3-speed, 8-hour-compatible videocassette recorder. Features picture search; stop action; frame advance; slow motion at VCR; synchro-touch transport control; 1-day/1-program electronic timer; remote pause control \$875

Color Cameras

VK731. Color-video/sound camera with 2-speed power zoom f/1.6 lens with macro; light shoe ... \$1120

VK726. Similar to VK731 except zoom lens has narrower range \$1060

RCA

VGT650 VHS Videocassette Recorder

VHS-format 8-hour videocassette recorder with Dolby stereo playback. Features 4 heads; 14-day/8-event programmable timer; 16-channel electronic tuning; soft-touch transport controls; 2-speed picture search; stop action; variable slow motion; frame advance; cable-ready tuner; wireless remote control \$1500

VGT450 VHS Videocassette Recorder

14-day/4-event programmable VHS-format videocassette recorder. Features 16-channel electronic tuning; soft-touch transport controls; picture search; stop action; cable-ready tuner; wireless remote control \$1250

Color Video Cameras

CC015. Video color camera with 6:1 2-speed f/1.4 power-zoom lens; Newvicon pickup tube; ultrasonic Autofocus system; detachable electronic viewfinder; macro focus; automatic white balance; automatic/manual iris; fade-in/out switch; power saver switch; boom microphone; on-screen status indicators; ear-phone jack; compatibility switch; built-in VCR controls; clock/timer; calendar and recording-time indicators; positive/negative button \$1400

CC011. Video color camera with 6:8:1 2-speed f/1.8 power-zoom lens. Features Newvicon pickup tube; side-mounted electronic viewfinder; macro focus; automatic white balance switch; fade-in/out button; power saver switch; boom microphone; automatic/manual iris; battery warning indicator; earphone jack; compatibility switch \$1400

SANYO

VCR4200 Beta Videocassette Recorder

Beta-format table-model videocassette recorder with 3-day programmable recording. Features 2-speed operation; remote pause control; 3-motor quartz-locked tape drive; fluorescent display; noise-cancelling circuitry; all-electronic Varactor tuner; 12 channel-selector buttons; LED channel display; automatic rewind; sleep timer; automatic fine tuning (aft); digital tape counter with memory function; mic input jack; audio inputs for optional camera or second VCR; audio and video output jacks; single F-type antenna connector; extra-compact design. Video/chrominance S/N ratio

35/43 dB; audio S/N ratio 42 dB; wow and flutter 0.2% wrms in Beta II; power consumption 40 W; 18 1/2"W x 13 3/4"D x 5 1/4"H; 22 lb \$500

VCR4300. Similar to VCR4200, except has 7-day programmability; full remote control; high-speed Betascan search; instant freeze frame; power consumption 33 W \$700

Mini Components

VPR4800. Portable Beta-format videocassette recorder with Ni-Cd battery that recharges in only 1 hour. Features Betascan high-speed search; feather-touch transport controls; 2-speed operation; moisture sensor and heater; audio dubbing; full-function wired remote control; digital tape counter with memory; soft eject; 2-head, 3-motor transport. Power consumption 9.6 W at 120 V ac, 60 Hz; 10 3/4"W x 10 1/2"D x 4"H; 8.75 lb \$730

VTT481. Tuner/timer with 12-switch all-electronic Varactor vhf/uhf tuner and 14-day/5-event programmability. Features fluorescent display of program timing and time of day; LED power-on, charging, channel-selected displays; clock and timer set buttons; automatic fine tuning (aft); TV/VCR switch; audio and video inputs and outputs; antenna inputs and outputs. Power consumption 60 W at 120 V ac, 60 Hz; F-type antenna in/out; 10 3/4"W x 10 1/2"D x 4"H; 16 1/2 lb \$270

SANSUI

SV-R500 VHS Videocassette Recorder

Programmable VHS-format videocassette recorder with 2/6-hour record and 2/4/6-hour play capability. Features 4-head system; 8-event/14-day programmable timer; 2-speed frame-search function (7x and 21x normal); feather-touch transport controls; wired 10-function remote controller; counter memory; automatic rewind; pause switch; automatic r-f output selection; air-damped cassette holder; 14 preset channels with channel lock; quartz-locked direct-drive motor; up-front audio and video inputs; audio dub; moisture condensation eliminator. Audio: S/N ratio >40 dB; frequency range 100-10,000 Hz. Video: input 0.5-2.0 V p-p into 75 ohms unbalanced; S/N ratio >45 dB; output 1.0 V p-p into 75 ohms unbalanced; 17 3/4"W x 13"D x 5 1/8"H; 21.6 lb \$1200

SEARS

5360 Portable VCR

Portable 4-head Beta-format videocassette recorder with 5-hour Beta II/III record capability, 91-channel vhf/uhf tuner, and 8-program/14-day programmable timer. Features micro-touch controls; audio dub; soft eject; clean edit; dew-protection sensor; tape counter; TV/VCR selector; audio and video outputs; tuning LED; 2-speed BetaScan; time on/off presets; fluorescent timer display; LED-type channel display. Includes wired 11-function remote-control unit for BetaScan forward/reverse at 5x normal speed; slow-motion playback at 1/3 to 1/30 normal speed; frame-by-frame advance; pause/still functions. Power consumption 13.2 W on battery; 10.9"W x 10.4"D x 4.5"H \$1200

5322 Videocassette Recorder

Sears-Best table-model Beta-format videocassette recorder with Beta II/III 5-hour record time, 91 channel vhf/uhf tuner, and 8-program/14-day programmable timer. Features micro-touch controls; audio dub; soft eject; TV/VCR selector; clean edit; automatic program search; automatic rewind; dew-protection sensor; tape counter; audio and video outputs; automatic input selector; tuning LED; 2-speed BetaScan; frame-by-frame advance; stop motion; time on/off preset; fluorescent time/timer display; LED channel display; 11-function wired remote-control unit; standard and slow-motion playback; pause/still control. Power consumption 53 W; 18.3"W x 14.2"D x 6"H; 30.4 lb \$1000

5318 Beta Videocassette Recorder

Table-model beta-format videocassette recorder with up to 5 hour record/play capability. Features audio dubbing; BetaScan forward/reverse in Beta II and remote control; still action; simple edit; 7-day/1-event programmable timer; remote control; microphone and

4

VIDEO CASSETTE RECORDERS

multiple-function input jacks; automatic rewind; Beta III indicator; automatic input selector; micro-touch transport controls; Beta II/III capability; soft eject; fluorescent timer display; soft-lock 12-button electronic tuner; dew sensor. Power consumption 40 W; 22.2 lb \$900

5314 Videocassette Recorder

Beta-format videocassette recorder with 82-channel vhf/uhf tuning capability, using locking pushbuttons. Features up to 5 hours record time; selectable Beta II/III; audio dub; soft eject; automatic rewind at end of



play; dew-protection sensor; tape counter; TV/VCR selector; audio and video outputs; automatic input selector; timer on/off presets; fluorescent timer display; LED channel display; remote pause. Power consumption 19.2"W x 14"D x 5.4"H \$800

5310 Videocassette Recorder

Beta-format videocassette recorder with Beta II/III 5-hour record capability and 82-channel vhf/uhf tuner. Features micro-touch controls; soft eject; dew-protection sensor; tape counter; TV/VCR selector; tuning LED; audio and video outputs; automatic input selector; 1-event/24-hour programmable timer; time-on preset; fluorescent timer display; LED channel display; remote pause. Power consumption 40 W; 19.2"W x 14"D x 5.4"H; 22.2 lb \$700

Color Cameras

5389. Color camera with $\frac{2}{3}$ " MOS image sensor (pickup). Features 6x (12.5-75 mm) f/1.4 power-zoom lens with macro; automatic iris; white balance control electronic viewfinder. Video output 1.0 V p-p; video S/N ratio > 45 dB; horizontal resolution 260 lines; minimum illumination 100 LUX; audio S/N ratio 45 dB; power consumption 5.3 W; 12.2"D x 11.9"H x 6.4"W; 1.8 kg \$1700

5387. Color video camera with $\frac{2}{3}$ " Saticon pickup tube. Features 6x motorized f/1.4 zoom lens with macro; electronic viewfinder; automatic iris; fade-in/out control; VCR stop/start control; battery warning and low-light warning indicators; white balance control; indoor/outdoor-light filters; power-saver switch; boom microphone. Video input/output level 1.0 V p-p; horizontal resolution 300 lines nominal at center; video S/N ratio 46 dB luminance; minimum illumination 50 LUX; audio S/N ratio 45 dB; frequency range 100-10,000 Hz; power consumption 8.5 W. \$1200

53812. Color-video/sound camera with 6x (16-84 mm) zoom lens with macro setting and manual focus, electronic viewfinder, and built-in front/rear microphone on telescope boom. Features VCR start, low-light, battery warning, and 2-light white balance LEDs in viewfinder and f/1.6 zoom lens. Horizontal resolution 250 lines; video S/N ratio 45 dB; sensitivity 75 LUX; $\frac{1}{2}$ " video tube in viewfinder; operating/standby power consumption 7/1 W; 4.18 lb. Separate ac power adaptor available \$950

SHARP

VC-9600 VHS Videocassette Recorder

Front-loading VHS-format table-model videocassette recorder with 4 heads, detachable Sharpshooter™ wireless infrared remote control, and 105-channel cable-compatible vhf/uhf tuner. Features 3 speeds for

up to 8 hours record/play; power-assisted videocassette loading; high-speed video search in SP/LP/EP at 10x normal speed in both directions; still and frame advance in SP/EP; half- and double-speed play in SP/EP; soft-touch transport controls; 7-day/1-event programmable timer; aft (automatic fine tuning); 4-digit numeric tape counter; automatic rewind; microphone jack; audio dubbing; automatic TV/VTR output selector; dew sensor and indicator. Horizontal resolution 240 lines; video input/output level 0.5-2.0/1.0 V p-p, both into 75 ohms; audio input/sensitivity -20 dB > 50k ohms unbalanced line, -60 dB/2k ohms microphone; audio output level/impedance -5 dB/1k ohm unbalanced; video/audio S/N ratio > 45/> 40 dB, SP mode; audio frequency range 70-10,000 Hz; power consumption 40 W; 18 $\frac{1}{8}$ "W x 14 $\frac{1}{8}$ "D x 5 $\frac{3}{8}$ "H; 26.2 lb. \$1200

VC-9400 VHS Videocassette Recorder

Front-loading VHS-format table-top videocassette recorder with power-assisted cassette loading, electronic Varactor tuning, and up to 8 hours record/play. Features 12-button, 82-channel vhf/uhf tuning; SP/LP/EP record/play speeds; soft-touch transport controls; 7-day/1-3 event programmable timer; one-touch recording; 4-digit tape counter; automatic tuner/aux input selector; dew sensor and warning lamp. Specifications same as for VC-9600 except weight 20.9 lb, power consumption 30 W \$700

VC-3500 VHS Portable Videocassette Recorder

Compact portable VHS-format videocassette recorder with wired remote-control unit and up to 8-hour record/play time. Features built-in tuner/timer; high-speed (5x normal) forward/reverse video search on ac power; SP/LP/EP record/play speeds; soft-touch transport controls; pause function; 7-day/1-event programmable timer; 12-button, 82-channel vhf/uhf tuner; still function in EP; automatic rewind; 4-digit tape counter; universal 10-pin camera connector; mic jack; audio dubbing; automatic TV/VCR input selector; air-damped soft-eject mechanism; 5-minute power backup for programmable timer; switchable aft (automatic fine tuning). Specifications same as for VC-9600 except audio S/N ratio > 40 dB; power consumption 19 W at 120 V ac, 10 W at 12 V dc; 14 $\frac{7}{16}$ "W x 10 $\frac{1}{16}$ "H x 5 $\frac{1}{8}$ "H; 15.2 lb \$1000

Video Cameras

QC-70. Portable color video/sound camera with through-the-lens (TTL) optical viewfinder, telescoping microphone, and automatic/manual focus control. Features macro focusing; automatic iris control; folding handgrip; 6-dB boost sensitivity switch; 3-position color temperature selector; LED indicators for battery alarm, recording start, and under-expose condition; universal 10-pin connector; remote start/stop; accessory shoe for external lights; standby pause power saver. Pickup tube $\frac{2}{3}$ " Vidicon; horizontal resolution 240 lines; minimum illumination 70 LUX; video output level/impedance 1.0 V p-p/75 ohms; video S/N ratio 45 dB; audio input level/impedance -20 dB/10k ohms; audio output level/impedance -65 dB/1k ohm; power consumption 5.3 W at 12 V dc; 12"D x 6 $\frac{1}{4}$ "H x 2 $\frac{7}{16}$ "W; 3.52 lb, including lens, handgrip, cable \$860

QC-50. Lightweight color video/audio camera with f/1.6 2:1 (16-32mm) zoom lens and removable high-sensitivity condenser microphone. Features through-the-lens (TTL) optical viewfinder; automatic iris control; LED indicators for battery alarm, recording start, under-expose condition; universal 10-pin connector; 3-position color temperature switch; remote VCR start/stop trigger switch; folding handgrip; accessory shoe for external lights. Specifications same as for QC-70 except power consumption 5.5 W; 12"D x 8 $\frac{1}{16}$ "H x 2 $\frac{1}{16}$ "W; 2.65 lb \$560

SONY

SL-2500 Betamax Videocassette Recorder

Front-loading Beta-format color videocassette recorder with 5-hour capacity. Features wireless remote control; BetaScan rapid picture search in forward and reverse; Swing Search with slow-motion, frame-by-frame advance; normal and double speed in forward and reverse; Linear Tape Time Counter that shows actual minutes and seconds of elapsed time;

Tab Marking Indexing System for rapid access of up to 9 different tape segments; 14-pushbutton vhf/uhf tuner; B-I play; B-II and B-III record/play capability; 14-day/4-event programmability. 17"W x 13 $\frac{1}{2}$ "D x 3 $\frac{1}{2}$ "H \$1500

AG-400. BetaStack programmable videocassette autochanger stacks and automatically changes up to 4 Beta cassettes. Delivers up to 20 hours of record or play time with SL-2500 Betamax. Programmable operation to record up to 4 different programs on videocassettes of 4 different lengths \$170

SL-5800 Video Cassette Recorder

Five-hour programmable Betamax color video cassette recorder with double-azimuth video head. Features built-in programmable timer (preset recording of 4 programs over 2-week period) with LED digital clock/timer readout; variable BetaScan (searches in forward or reverse 5-20x normal speed with remote commander control unit); 3 X normal speed fast play; stop— $\frac{1}{2}$ normal speed variable slow motion; freeze-frame and frame-by-frame viewing; automatic tab marker (automatically marks electronic signal on beginning of each recorded program on tape) with memory; 14 pushbutton tuning; logic-controlled transport; audio dubbing; VTR/TV switch; B-I play, B-II record/play, variable slow motion, freeze-frame, frame-by-frame viewing, and cue/review in fast forward and rewind \$1295

AG-300 BetaStack. Programmable videocassette autochanger providing up to 20 hours of record/play time of 4 different programs on different channels over 2-week period, each on separate cassettes \$350

SL-5100 Betamax Videocassette Recorder

Front-loading Beta-format color videocassette recorder with 5-hour capacity. Features wireless remote control; BetaScan rapid picture search in forward and reverse; feather-touch full-logic microprocessor transport controls; pause/freeze-frame control; 7-day/1-event programmability; 14-pushbutton vhf/uhf tuner; B-I play; B-II and B-III record and play. 18 $\frac{1}{4}$ "W x 14 $\frac{3}{8}$ "D x 6 $\frac{1}{8}$ "H \$995

SL-5000 Betamax Videocassette Recorder

Front-loading Beta-format color videocassette recorder with 5-hour capacity. Features remote control; BetaScan rapid picture search in forward and reverse; feather-touch full-logic microprocessor transport controls; pause/freeze-frame control; 24-hour/1-event programmability; 14-pushbutton vhf/uhf tuner; B-I play; B-II and B-III record and play. 18 $\frac{1}{4}$ "W x 14 $\frac{3}{8}$ "D x 6 $\frac{1}{8}$ "H \$895

SL-2000 Betamax Portable Videocassette Recorder

Compact, lightweight portable Beta-Format color videocassette recorder with 5-hour capacity. Features 3-way power operation (rechargeable battery pack, car-battery adapter, ac power); feather-touch full-logic microprocessor transport controls; BetaScan rapid picture search in forward and reverse; Swing Search for slow-motion, frame-by-frame advance; normal and double speed in forward and reverse; B-I play; B-II and B-III record and play. 12"D x 8 $\frac{1}{2}$ "W x 3 $\frac{1}{8}$ "H \$1150

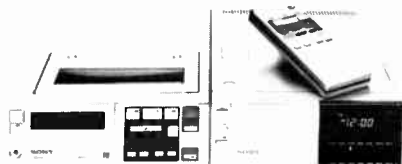

TT-2200. Compact tuner/timer for SL-2000 has 14-day/4-event capacity and features remote control for both timer and VCR; 14-pushbutton vhf/uhf tuner; conversational programming; automatic fine tuning (aft). Sets recording time to accuracy of 1-minute intervals; 12"D x 8 $\frac{1}{2}$ "W x 3 $\frac{1}{8}$ "H \$350

Color Camera

For Betamax video cassette recorders.
HVC-2400 Tricon Color Camera. Uses MF tricon pickup tube for high resolution. Features motor-driven 6:1 zoom; macro lens; built-in microphone; multifunction detachable electronic viewfinder; negative-

film conversion capability when used with Sony HVT-3000 Video PhotoLab adaptor \$1250
HVT-3000 Video PhotoLab Adaptor. Transfers color sides to video tape with HVC-2400 camera. Makes negative-to-positive conversion, framing, cropping, zoom, fade-in, fade-out possible with camera's controls \$180

SYLVANIA

VC4526 VHS Videocassette Recorder

Portable VHS-format videocassette recorder offers up to 8 hours record/play time. Features variable-speed



slow motion; still frame; video cue/review; video dub; audio dub; memory rewind; 16-function wireless infrared remote control; 105-channel tuning capability; 14-day/4-event timer \$1450

VC114 Color Video Camera

Compact color video camera with f/1.4 zoom lens and electronic viewfinder. Features automatic/manual ris; 270-line horizontal resolution; 40-dB video S/N ratio \$750

TOSHIBA

V-9035 Beta Videocassette Recorder

Five-hour portable VCR in Beta format. Features 2 speeds for up to 5 hours record/play time; quad track; 4-head design for super still, variable slow motion forward and reverse; frame-by-frame slow motion with no electronic noise; programmability for up to 8 programs over a 2-week period; touch reference solenoid logic controls; wired remote control; Comput-R-Tune electronic tuning; visual cue and review picture search with Beta scan and 2x scanning \$1545

V-9500 Beta Videocassette Recorder

Front-loading 5-hour Beta-format videocassette recorder. Features wireless remote control; dual speed Beta II and III with quad track; 4-head design for su-



per still, variable slow motion forward/reverse, frame-by-frame advance, variable visual picture search, and 2x scanning in Beta II and III with no electronic noise; programmability for up to 8 programs over 14-day period; frequency-synthesized tuning; 117-channel tuning capability; soft-touch controls; soft eject; automatic rewind; 10-minute battery backup \$1390

V-9200 Beta Videocassette Recorder

Front-loading 5-hour Beta-format videocassette recorder. Features dual-speed Beta II and III; electronic tuning with midband cable capability; programmability for one program over 3-day period; soft-touch transport controls; wired remote control; soft eject; automatic rewind. Special Beta III features include still picture; slow motion; frame-by-frame advance; visual cue-and-review \$850

Color Cameras

IK 1850AFS. Portable automatic-focus color video camera with f/1.4 zoom lens with a range of 11-70 mm; manual override of automatic focusing; electronic viewfinder and automatic iris; built-in microphone;

3/8" univicon-2 vidicon tube; high-performance external microphone; magnesium body \$1300
IK 1900. Portable color video camera with high-resolution Nikon lens. Features 3/8" Univicon 2 Vidicon tube; 8x power zoom lens with 12.5-1000 mm range; f/1.6 macro-focusing to 0.00 mm; True Image through-the-lens focusing system; color image; automatic iris; low-light (50 LUX) capability; automatic white balance adjustment system; high-performance external microphone \$899

ZENITH

VR9775PT Beta Videocassette Recorder

14-day/4-event Beta-format programmable videocassette recorder. Features full-function wireless remote control; electronic index counter with cue marker; direct camera connector; Beta III/II record, Beta I/II/III playback; low-profile design; picture speed search, slow-motion, stop-action, double-speed, normal-speed, frame-by-frame advance in forward and reverse play special effects; 14-position touch-command tuning system; feather-touch logic transport controls; LED remaining-tape indicator; electronic tape counter with numeric display; automatic clean edit control; fluorescent tape-speed indicator; automatic rewind at end of play; audio dub; program error indicator; 5 hours record/play time. Horizontal resolution > 240 lines; video input/output level 1.0 V p-p



into 75 ohms; audio input/output level -20/-5 dB; power consumption 30 W; 16 1/8" W x 14 3/8" D x 3 7/8" H; 20 lb 4 oz \$1400

VR9760W Beta Videocassette Recorder

Five-hour record/play Beta-format videocassette recorder. Features 14-day/4-event programmability; 14-position touch-command tuning; speed search, triple speed, frame-by-frame advance, variable-speed slow motion, pause/stop action multi-speed special effects; automatic program index; automatic rewind; audio dub; electronic tape counter with memory feature; bright/dim switch; Beta II/III record/play. Horizontal resolution; S/N ratio > 45 dB luminance; video input/output 1.0 V p-p; audio input/output -60 dB mic, -10 dB line/-5 dB; frequency range 50-10,000 Hz Beta II, to 7 kHz Beta III; audio S/N ratio > 40 dB; audio distortion < 4% BII, < 4.5% BIII; power consumption 60 W; 19 1/2" W x 15 1/4" D x 6 1/2" H; 36 lb 6 oz \$1250

VR8900W Beta Videocassette Recorder

Touch-command channel selection Beta-format videocassette recorder with dual-function remote control and 24-hour/1-event programmability. Features Beta III/II record, Beta III/II/I play; speed search in forward/reverse play; pause/stop action; 5-hour record/play time; electronically controlled touch-command channel selection; digital tape counter; front loading; full-logic microprocessor-controlled feather-touch transport controls. Video S/N ratio > 45 dB luminance; mic input level -60 dB; audio output impedance < 600 ohms; frequency response 50-10,000 Hz Beta II, to 7 kHz Beta III; power consumption 48 W; 18 1/2" W x 15" D x 6 1/4" H; 30 lb 14 oz \$900

VR8500PT Beta Videocassette Recorder

Beta-format videocassette recorder with 5-hour record/play capability, 24-hour/1-event programmability, and Beta II record and Beta III/II playback. Features picture speed search in forward/reverse; optional remote video action control; touch-command channel selection; pause/stop action; digital tape counter; full-logic microprocessor-controlled feather-touch transport controls. Video S/N ratio > 45 dB luminance; mic input -60 dB; audio output impedance < 600 ohms; frequency range 50-10,000 Hz BII, to

7 kHz BIII; power consumption 48 W; 18 1/2" W x 15" D x 6 1/4" H; 30 lb 14 oz \$800

VR9800/VRT9850 Portable VCR/Tuner System

Beta-format portable videocassette recorder with separate component tuner/timer. VCR features modular design; lightweight VCR portability; 4-way ac/dc operation (dc car cord, ac power supply, rechargeable battery pack, tuner/timer); multi-speed playback (picture speed search at about 15x normal speed in BII and 10x normal speed in BII, pause, frame-by-frame advance, slow motion in forward/reverse, double-speed forward play); dew warning indicator; automatic heater to evaporate moisture; battery caution indicator; electronic time counter; tape-speed indicator; automatic rewind; automatic clean edit control; direct camera connector; audio dub; defeatable display light; Beta III/II record, Beta III/II/I play. Horizontal resolution 240 lines; video S/N ratio > 40 dB; mic input level -60 dB; audio frequency range 50-10,000 Hz BII, to 7 kHz BIII; power consumption 8.4 W dc; 12.4" D x 8.75" W x 3.25" H. Tuner/timer features compact modular design; 14-position touch command tuning; 14-day/4-event programmability; wireless infrared remote control; multi-speed playback features (picture speed search, stop action, frame-by-frame advance, normal speed, double-speed forward play); program error indicator; automatic rewind; pushbutton signal-seeking vhf/uhf tuning control; power source for VR9800 VCR; quick Ni-Cd battery charger; 400-W unswitched accessory ac outlet; closed-caption recording ability (requires separate decoder for playback). Video input/output level 1.0 V p-p; audio input/output -5 dB; power consumption 20 W normal, 60 W charge; 12" D x 8.46" W x 3.15" H; 7.3 lb. System price \$1425
VRP9852. Ac battery eliminator/recharger for VR9800 VCR \$150
VRB9851. Rechargeable Ni-Cd battery pack for VR9800 VCR. Provides up to 1 hour recording or 2 hours playback time; recharges in 1 hour with ac power supply or tuner/timer unit \$50

Video Cameras

VC1800. Color video/sound camera with f/1.4 6:1 variable-speed power zoom lens with macro focus. Features infrared automatic focus system; adjustable-mount electronic viewfinder; telescoping boom microphone; built-in title generator; digital stopwatch display; power-save switch; remote pause/stop/start control; automatic iris adjust; record/review; color-correction filter; mic input jack. Minimum illumination 30 LUX; microphone input level -65 dB, low impedance; power consumption 6.4 W at 12 V dc; 11.7" D x 8.7" H x 8.3" W; 6 lb \$1350

VC1600. Color video/sound camera with combined zoom lens (f/1.4, 11-70 mm fl) and macro lens; automatic/manual iris control; 3/8" single color tube; signal system EIA standards, NTSC color; maximum illumination 40 LUX at f/1.4; automatic light control range 40-100,000 LUX; K-type 14-pin VCR connector; mini-jack microphones (-60 dB); electronic viewfinder (supplied with 1 1/2" monochrome picture tube; power requirements 12 V dc at 8.3 W for both camera and viewfinder (supplied from portable VCR or optional ac adapter); 13 3/4" D x 8 3/4" W x 7 1/4" H, including zoom lens, viewfinder, and grip \$1050

VC1200. Color video/sound camera with f/1.8 3.6:1 (14.5-52 mm fl) zoom lens with macro focus; electronic viewfinder; electret condenser microphone; remote pause/stop/start control; power-saver switch; automatic iris adjust; tri-electrode pickup tube; mic input jack; record/review switch; warning indicators; white balance indicator; automatic light sensitivity control; automatic gain control (agc); color temperature control; pistol-grip handle with wrist strap. Video output 1 V p-p unbalanced into 75 ohms; video S/N ratio > 45 dB; minimum illumination 100 LUX; power consumption 6.7 W at 12 V dc; 305 mm D x 245 mm H x 70 mm W; 1.7 kg \$750

CAR STEREO follows immediately.

5

CAR STEREO EQUIPMENT

Ai ALARON

RY-747 AM/FM-Stereo/Cassette Player

In-dash AM/FM-stereo radio with auto-reverse cassette deck. Features short chassis; adjustable shafts; lighted slide-rule dial; LED stereo and tape-direction indicators; pushbutton eject, stereo, rewind, fast-forward, tape program selector, mute switches; tone and balance controls; antenna trimmer; azimuth tape head adjuster; 6"W × 5"D × 1¾"H \$80

AIWA

CTR-70 AM/FM-Stereo/Cassette Player

In-dash AM/FM-stereo/cassette player with digital synthesizer tuner and auto-reverse cassette deck. Features 6 AM/6 FM station presets; top side priority



play mechanism; digital frequency display; automatic station search; locking fast forward/rewind; metal-tape capability; local/DX switch. Designed to fit X-body cars. Output power 8 W/channel \$270

CTR-50 AM/FM-Stereo/Cassette Player

In-dash AM/FM-stereo/cassette player with auto-reverse cassette transport. Features single function forward and rewind; punch-button tuning (4 AM/1 FM or 4 FM/1 AM); local/DX switch; top side priority play mechanism. Designed for X-body cars. Output power 8 W/channel \$200

CTR-30 AM/FM-Stereo/Cassette Player

In-dash AM/FM-stereo/cassette player with continuous silent reverse mechanism. Features high-sensitivity AM/FM receiver; DX/local and stereo/mono switches. Ultra compact 6½"W × 6¼"D × 1¾"H size \$180

CTR-20 AM/FM-Stereo/Cassette Player

In-dash AM/FM-stereo/cassette player with locking fast forward, automatic motor stop at end of tape play, ultracompact 6¼"W × 4¾"D × 1¾"H size. Output power 5 W/channel \$125

ALPINE

7308 AM/FM-Stereo/Cassette Player

In-dash PLL frequency-synthesized tuned AM/FM-stereo radio with metal-compatible stereo cassette deck. Features Dolby noise reduction; hard Permalloy head; LED digital frequency/tape counter display with tape memory and clear buttons; fits most domestic and imported cars; music sensor system for tape; electromechanical cassette-glide lock-in and electronic glide eject; FeCr/CrO₂/metal tape selector; locking fast forward/rewind; automatic eject at end of play and fast forward; automatic replay at end of rewind; electronic feather-touch 5-station-preset AM/FM tuner

with auto scan and seek, scan sense, FM tuner, noise-eliminator switches; FM muting; sliding bass, treble, balance, 4-way fader controls. Output power 6 W/channel continuous; 7½"W × 6¼"D × 2"H \$800

7337 AM/FM-Stereo/Cassette Player

ETR/PLL AM/FM-stereo preamplifier/radio with stereo cassette deck. Features SC tape head; metal/stereo dual-function switch; LiteTouch 10-station tuner presets; music sensor; automatic seek and FM mute; Dolby noise reduction; LiteTouch transport controls; separate bass, treble, detented volume controls; local/distant switch; fader control; key-off eject; automatic cassette glide; engine noise suppressor. Frequency response 40-18,000 Hz ±3 dB with metal tape; wow and flutter 0.09% wrms; S/N ratio 65 dB, Dolby on; FM usable sensitivity 16.3 dBf; 6¼"W × 5½"D × 2"H \$500

7140 AM/FM-Stereo/Cassette Player

Bilevel AM/FM-stereo receiver with automatic-reverse stereo cassette deck. Features ETR/PLL digital frequency synthesizer; digital frequency display; automatic seek and mute; LiteTouch 10-station presets; LiteTouch memory switch; music sensor; metal-local/distant dual-function switch; SCC tape head; automatic cassette glide; Dolby noise reduction; locking fast forward/rewind; key-off eject; loudness contour; SelectTouch switch; preamp fader; illuminated cassette loading. FM usable sensitivity 16.3 dBf; S/N ratio 70 dB, Dolby on. Wow and flutter 0.1% wrms; frequency response 40-16,000 Hz ±3 dB metal/CrO₂/FeCr tape; 7½"W × 5½"D × 2"H \$500

7136 AM/FM-Stereo/Cassette Player

In-dash PLL frequency-synthesized, digitally tuned AM/FM-stereo radio with automatic-reverse stereo cassette deck. Features 10-station tuning presets; digital-numeric frequency display; SCC tape head; automatic reverse at end of play, fast forward, rewind; key-off eject; dual-function metal/stereo switch; balance, preamp fader, Tone Tenor controls; local/distant switch; automatic loudness adjust; noise suppressor; Dolby noise reduction; locking fast forward/rewind; power antenna lead; tape-direction indicators. Output power 6 W at 1 kHz, 8% THD; output impedance 4 ohms; wow and flutter 0.1% wrms; frequency response 40-16,000 Hz ±3 dB metal/FeCr/CrO₂, to 14 kHz normal tape; S/N ratio Dolby off/on 55/65 dB; separation 40 dB; FM usable sensitivity 16.3 dBf; S/N ratio Dolby off/on 60/70 dB; capture ratio 2 dB; 6¼"W × 5½"D × 2"H \$450

7135 AM/FM-Stereo/Cassette Player

Bilevel ETR/PLL AM/FM-stereo/cassette player with digital frequency synthesized tuning, automatic-reverse transport, and SCC tape head. Features metal-tape compatibility; LiteTouch 10-station tuning preset system; music sensor; automatic seek, metal and local/distant dual-function switch; engine-noise suppression; LiteTouch memory system; separate bass and treble controls. Frequency response 40-16,000 Hz ±3 dB with metal tape; wow and flutter 0.01% wrms; tape S/N 55 dB; FM usable sensitivity 16.3 dBf; 6¼"W × 5½"D × 2"H \$350

7307 Tuner/Preamp/Cassette Player

In-dash AM/FM-stereo tuner/preamplifier with stereo cassette deck. Features Dolby noise reduction; CrO₂/FeCr selector; key-off eject; cassette glide eject; automatic replay at end of rewind; automatic eject at end of play/fast forward; music sensor in fast forward and rewind. Wow and flutter 0.09% wrms; tape frequency range 40-16,000 Hz; S/N ratio 65 dB with Dolby on. Radio features 5-station preset system; noise-eliminator switch; separate bass and treble controls; mute switch; loudness contour; DIN connector; tone-bypass switch. FM usable sensitivity 1.4 ; S/N ratio 72 dB with Dolby on; capture ratio 1.5 dB \$400

7138 AM/FM-Stereo/Cassette Player

Frequency-synthesized AM/FM-stereo/cassette player with 10-station tuning preset system. Features SCC tape head; memory logic electronics; Dolby noise reduction; automatic seek; metal/stereo switch; stereo indicator; Tenor Tone control; automatic loudness adjust; engine-noise suppression; local/distant switch; digital clock; manual up/down tuning; locking fast forward/rewind; Cassette Glide loading system; tape-direction indicators; program switch; power antenna lead. Output power 6 W at 1 kHz, 8% THD; output impedance 4 ohms. Wow and flutter 0.1% wrms; frequency response ±3 dB 40-16,000 Hz metal/FeCr/CrO₂, to 13 kHz normal tape; S/N ratio Dolby off/on 55/65 dB; separation 40 dB. FM usable sensitivity 16.3 dBf; alternate-channel selectivity 80 dB; capture ratio 2 dB; 7"W × 5¼"D × 2"H ... \$350

7225 AM/FM-Stereo/Cassette Player

High-power bilevel AM/FM-stereo receiver with automatic-reverse stereo cassette deck. Features SCC tape head; metal-tape capability; metal and local/distant dual-function switch; locking fast forward/rewind; preamp fader; separate bass and treble controls; engine-noise suppression; FM afc (automatic frequency control); program switch; detented volume control. Output power 16 W rms/channel into 4 ohms at 1 kHz, 8% THD. Other specifications same as for 7135 and 7140; 6¼"W × 5½"D × 2"H ... \$250

7123 AM/FM-Stereo/Cassette Player

In-dash AM/FM-stereo radio with metal-tape compatible stereo cassette deck. Features Dolby noise reduction; hard Permalloy tape head; music sensor; cassette glide lock-in insert, electronic glide eject system; FeCr/CrO₂/metal tape selector; locking fast forward/rewind; automatic eject at end of play and fast forward; automatic replay at end of rewind; 5-station memory presets; separate bass and treble controls; FM muting; automatic local/distant select; FM afc (automatic frequency control); balance control. Output power 6 W/channel continuous; preamp/deck capability through DIN jack; 7½"W × 5¼"D × 2"H \$330

7128 AM/FM-Stereo/Cassette Player

In-dash PLL digital frequency synthesized AM/FM-stereo radio with automatic-reverse stereo cassette deck. Features metal-tape compatibility; hard Permalloy tape head; music sensor system; cassette glide lock-in insert; automatic reverse at end of play, fast forward, rewind; metal/CrO₂/FeCr bias switch; lock-

ing fast forward/rewind; 5-station tuner preset system; automatic local/distant select; FM afc (automatic frequency control); manual up/down tuning. Output power 2.2 W/channel continuous into 4 ohms, 70-20,000 Hz at 0.8% THD. Wow and flutter 0.1% wrms; frequency response 40-15,000 Hz ± 3 dB all tapes; S/N ratio 50 dB; FM usable sensitivity 2.2 μ V; selectivity 50 dB; S/N ratio 55 dB; 7"W \times 5 $\frac{1}{4}$ "D \times 2"H..... \$300

7327 AM/FM-Stereo/Cassette Player

AM/FM-stereo tuner/preamp/cassette player. Features metal-tape capability; Dolby noise reduction; sencore head; designed to fit X-body cars; automatic music sensor; metal/FeCr/CrO₂ switch; automatic cassette glide lock-in insert; automatic eject at end of play and fast forward; locking fast forward/rewind; key-off eject; LED tape indicator; separate bass and treble controls; feather-touch loudness, mute, AM/FM switches; automatic local/distant select; FM afc (automatic frequency control); preamp/deck capability through DIN jack. Wow and flutter 0.09% wrms; frequency response 40-18,000 Hz ± 3 dB with metal tape; S/N ratio 65 dB, Dolby off. FM usable sensitivity 1.8 μ V; selectivity 60 dB; S/N ratio 72 dB, Dolby on; 6 $\frac{1}{4}$ "W \times 4 $\frac{1}{2}$ "D \times 2"H..... \$300

7121 AM/FM-Stereo/Cassette Player

Unit features automatic reverse at end of play, fast forward, rewind; Dolby noise reduction; metal-tape compatibility; hard Permalloy tape head; automatic cassette glide lock-in insert; metal/CrO₂/normal switch; tape-direction indicators; key-off eject; pushbutton loudness, FM mute, AM/FM switches; local/distant switch; adjustable Tone Tenor control; FM afc (automatic frequency control). Wow and flutter 0.1% wrms; frequency response 40-15,000 Hz ± 3 dB with metal tape; S/N ratio 65 dB, Dolby on. FM usable sensitivity 1.8 μ V; selectivity 60 dB; S/N ratio 72 dB, Dolby on; separation 35 dB at 1 kHz; capture ratio 2 dB. Output power 2.2 W/channel into 4 ohms, 70-20,000 Hz at 0.08% THD; 7"W \times 5 $\frac{1}{4}$ "D \times 2"H..... \$280

7120. Similar to 7121 but without cassette Dolby



noise reduction and key-off eject; tape S/N ratio 55 dB..... \$230

7124. Similar to 7120 except designed for all cars, including X-body; no afc; 6 $\frac{1}{4}$ "W \times 4 $\frac{1}{2}$ "D \times 2"H..... \$230

7140 AM/FM-Stereo/Cassette Player

In-dash AM/FM-stereo/cassette player with SCC tape head. Features 5-station tuner preset system; music sensor; metal-local/distant dual-function switch; preamp fader; automatic reverse; locking fast forward/rewind; separate bass and treble controls; FM afc (automatic frequency control). FM usable sensitivity 16.3 dB; S/N ratio 65 dB. Wow and flutter 0.1% wrms; frequency response 40-16,000 Hz ± 3 dB metal/CrO₂/FeCr tape; 6 $\frac{1}{4}$ "W \times 5 $\frac{1}{4}$ "D \times 2"H.\$270

7125 AM/FM-Stereo/Cassette Player

In-dash unit features auto-reverse cassette deck; metal/stereo switch; automatic reverse at end of play; hard Permalloy tape head; locking fast forward/rewind; FM afc (automatic frequency control); automatic local/distant switching; cassette glide mechanism that pulls cassette into play position; power antenna lead; program switch; stereo indicator; tape-direction indicators. Wow and flutter 0.1% wrms; frequency response 40-12,000 Hz ± 3 dB normal, to 15 kHz metal/CrO₂/FeCr tape; S/N ratio 55 dB. FM usable sensitivity 16.3 dB; alternate-channel selectivity 60 dB; AM suppression 45 dB; S/N ratio 65 dB; separation 35 dB at 1 kHz; capture ratio 2 dB. Output power 2.2 W, 70-20,000 Hz at 0.8% THD; output impedance 8 ohms..... \$200

Under-Dash Units

5400 Cassette Player/Amplifier/Equalizer

Automatic-reverse cassette deck with power amplifier and graphic equalizer. Features 5-band graphic equalizer with ± 12 -dB boost/cut range; Dolby noise reduction; SCC tape head; locking fast forward/rewind; metal/CrO₂ switch; output-power indicators; automatic cassette glide that automatically pulls cassette into play position; automatic reverse at end of play, fast forward, rewind; key-off eject; loudness contour; tape-direction indicators; detented volume control. Output power 8 W/channel into 4 ohms at 8% THD, 40-20,000 Hz. Equalizer center frequencies 60, 250, 1k, 3.5k, 10k Hz. Wow and flutter 0.1% wrms; frequency response ± 3 dB 40-13,000 Hz normal, to 16 kHz metal/FeCr/CrO₂ tape; S/N ratio Dolby off/on 55/65 dB; separation 40 dB; 6"W \times 5 $\frac{1}{4}$ "D \times 2 $\frac{1}{4}$ "H. \$300

7112 Auto-Reverse Cassette Player

Compact under-dash automatic-reverse stereo cassette player with metal/CrO₂/FeCr/normal tape capability. Features automatic reverse at end of play, fast forward, rewind; SCC tape head; locking fast forward/rewind; cassette glide that pulls cassette into play position; program switch; separate bass and treble controls; tape-direction indicators. Wow and flutter 0.14% wrms; frequency response ± 3 dB 40-13,000 Hz normal, to 16 kHz other tapes; S/N ratio 55 dB; output power 2.2 W, 70-20,000 Hz at 0.8% THD; output impedance 4 ohms; 6 $\frac{1}{4}$ "W \times 5 $\frac{1}{2}$ "D \times 2"H..... \$150

AUDIOVOX

HCC-1026 AM/FM-Stereo/Cassette Player

In-dash unit combines AM/FM-stereo radio and auto-reverse stereo cassette deck with Dolby noise reduction. Cassette features locking fast forward/rewind; side-load cassette mechanism; tape program select; manual eject; tape equalization with for 70 and 120 μ sec; wow and flutter 0.25% wrms; frequency range 30-15,000 Hz; S/N Dolby on/off 59/50 dB. Radio features preamp output jacks; AM/FM, FM mute, loudness pushbuttons; front-to-rear fader; separate bass and treble, tuning, volume, and balance controls; 10 W/channel at 1% THD; frequency response 40-15,000 Hz -3 dB; S/N ratio Dolby on/off 65/62 dB; FM image rejection 65 dB; FM i-f rejection 80 dB; separation 35 dB; supplied with 105-mm nose-piece..... \$390

AVX-955 AM/FM-Stereo Radio/Cassette Player

In-dash AM/FM-stereo receiver/cassette player with electronic tuning and auto-reverse cassette deck. DIN-specified for imported cars. Features built-in LED digital clock/radio frequency display with display priority switch for constant frequency or time display; electronically controlled tuning with green LED digital display; 6 AM/6 FM station presets; auto scan that searches and stops on next active station; FM-stereo Super Reach noise-quieting circuitry; local/distant switch; locking fast forward/rewind; tape-direction indicators. Wow and flutter 0.35% wrms; frequency range 50-10,000 Hz; maximum output power 6.5 W/channel at 10% THD; FM separation 25 dB; 7 $\frac{1}{8}$ "W \times 6"D \times 2"H..... \$380

IM-SPC AM/FM-Stereo Radio/Cassette Player

Pushbutton tuning AM/FM-stereo radio with auto-reverse cassette deck and built-in power amplifier. Features DIN-specified size for imported cars; Audiolock FM tuning circuit; locking fast forward/rewind; pushbutton eject; FM muting; separate bass and treble controls..... \$350

AVX-680 AM/FM-Stereo Radio/Cassette Player

In-dash unit combines AM/FM-stereo radio, stereo cassette player with Dolby noise-reduction system,

and built-in 40-W power amplifier. Features locking fast-forward/rewind, auto/manual cassette eject; bass, treble, mono/stereo, and 4-way balance, controls; LED tape and stereo FM indicators..... \$320

IM-CXP AM-FM/Cassette Deck

In-dash DIN-specified pushbutton AM/FM-stereo radio with Audiolock FM tuner and cassette player. Unit features locking fast forward/rewind; stereo/mono switch; 4-way balance control..... \$290

AVX-685 AM/FM-Stereo Radio/Cassette Player/EQ

In-dash unit combines AM/FM-stereo radio with Audiolock FM tuner and stereo cassette deck with 5-band graphic equalizer. Cassette features locking fast forward/eject control. Radio features front-to-rear fader; FM mute; mono/stereo switch; balance control. Equalizer center frequencies set at 60, 250, 1k, 3.5k, 10k Hz with ± 10 dB boost/cut range. Maximum output 20 W/channel, 16 W/channel with 10% THD; frequency range 50-10,000 Hz; FM sensitivity 5 μ V at 30 dB S/N supplied with 2 nosepieces for vertical or horizontal use; 3-way trimplate; compact chassis; adjustable shafts; 1 $\frac{3}{4}$ "H \times 6 $\frac{1}{4}$ "W \times 4 $\frac{1}{2}$ "D..... \$164

HCC-551 AM/FM-Stereo Radio/Cassette Player

In-dash unit combines AM/FM-stereo radio and stereo cassette deck; DIN-spec nosepiece designed for domestic and imported cars. Cassette features automatic reverse, locking fast forward/rewind, pushbutton eject, and tape program indicators; radio features AM/FM, loudness, mono/stereo switches; extended-range tone controls; low-distortion preamp output jacks; output power 6 W/channel continuous maximum; frequency range 50-10,000 Hz..... \$240

AVX-620 AM/FM-Stereo Radio/Cassette Player

Auto-reverse cassette player with AM/FM-stereo receiver features switchable FM-stereo Super Reach noise-quieting circuitry; locking fast forward/rewind; Flex installation pushbutton eject; 4-way balance control. Designed for most import cars. 6 $\frac{1}{4}$ "W \times 4 $\frac{1}{4}$ "D \times 1 $\frac{3}{4}$ "H..... \$200

AVX 730 AM/FM-Stereo Radio/Cassette Player

Pushbutton AM/FM-stereo radio with cassette player designed for import, X-body, Citation, and full-sized cars. Features Audiolock FM tuning; Superflex installation features; 5 pushbutton tuning; 4-way balance control; locking fast forward; AM/FM and mono/stereo switches; super-compact chassis. Wow and flutter 0.3% wrms; frequency range 50-10,000 Hz; amplifier output 6 W maximum; FM-stereo separation 20 dB; 7 $\frac{1}{8}$ "W \times 6"D \times 2 $\frac{1}{4}$ "H..... \$190

AVX 605 AM/FM-Stereo Radio/Cassette Player

In-dash unit combines AM/FM-stereo radio and stereo cassette deck; designed for imported, X-body and Citation cars. Cassette features compact chassis; side-load cassette mechanism; locking fast forward/eject control; wow and flutter 0.35% wrms. Radio features local/distant and AM/FM switches; tone and balance controls; LED stereo indicator; 6-W/channel power amplifier; frequency range 50-10,000 Hz; FM sensitivity 5 μ V at 30 dB S/N; supplied with 2 nosepieces for vertical or horizontal use; 3-way trimplate; compact chassis; adjustable shafts; 1 $\frac{3}{4}$ "H \times 6 $\frac{1}{4}$ "W \times 4 $\frac{1}{2}$ "D..... \$164

HCC-500 AM/FM-Stereo Radio/Cassette Player

In-dash AM/FM-stereo radio/Cassette deck designed for imported cars. Cassette features locking fast forward/eject; wow and flutter 0.35% wrms. Radio features dual ceramic filters; PLL multiplex demodulator; preamp output jacks; local/distant switch; balance control; LED stereo indicator; AM/FM selector; tone and volume controls; 5 W/channel continuous output power with 10% THD; frequency range 50-10,000 Hz; FM sensitivity 5 μ V for 30 dB S/N; separation 25 dB; 1 $\frac{1}{4}$ "H \times 6 $\frac{1}{4}$ "W \times 4 $\frac{1}{2}$ "D..... \$150

3200 AM/FM-Stereo Radio/Cassette Player

In-dash AM/FM-stereo receiver with auto-reverse stereo cassette player. Comes with 105-mm nosepiece for easy installation in import cars. Features locking fast forward/rewind; side-load cassette mechanism; adjustable shafts. Maximum combined stereo power

NEED MORE INFORMATION?

Write directly to the manufacturer or distributor. A list of names and addresses starts on page 4.

5

CAR STEREO EQUIPMENT

12 W; output wiring designed for two 4- or 8-ohm or four speakers; separation greater than 20 dB; sensitivity < 30µV at 20 dB S/N AM, < 5µV at 30 dB S/N



FM; wow and flutter less than 0.35% wrms; frequency range 50-10,000 Hz; 7¼"W × 5½"D × 2"H..... \$150

COMP Line

HCC-1200 AM/FM-Stereo Radio/Cassette Player

In-dash unit combines AM/FM-stereo receiver, stereo cassette deck, and LED digital quartz clock/radio frequency display with dimmer. Cassette deck features sliding fast forward/eject/rewind control; radio features 12-station pushbutton preset with memory, auto station seek control; 4-way balance control, mono/stereo, local/distant, AM/FM switches; preamp output jacks; frequency range 50-12,000 Hz; speaker impedance 4 ohms..... \$650

AUTOTEK

CSR3300 AM/FM-Stereo/Cassette Player

In-dash AM/FM-stereo receiver with automatic-reverse stereo cassette deck. Features pushbutton preset tuning; Dolby noise reduction; separate bass and treble controls; key-off eject; FET front end; SD tape head; metal-tape capability; loudness, mono/stereo, local/distant switches; variable line outputs. Output power 2 W/channel into 4 ohms, 30-15,000 Hz at 1% THD. Wow and flutter 0.15% wrms; frequency response ±3 dB 31.5-15,000 Hz metal, to 12 kHz normal tape; S/N ratio Dolby off/on 45/55 dB. FM 50-dB quieting sensitivity 22.1 dBf; S/N ratio 60 dB; 7"W × 5¼"D × 2"H..... \$300

CSR2300. Similar to CSR3300 except no pushbutton tuning presets; FM 50-dB quieting sensitivity 23.3 dBf..... \$260

CSR2200. Similar to CSR2300 except no metal-tape capability..... \$210

CSR3150 AM/FM-Stereo/Cassette Player

In-dash AM/FM-stereo receiver with automatic-reverse stereo cassette deck. Features pushbutton tuning; locking fast forward/rewind; local/distant switch; ACS (for improved FM reception); automatic cassette loading; 4-way speaker fader control; mini chassis for compact and import cars; FET front end. Output power



3 W/channel into 4 ohms, 50-15,000 Hz ±3 dB at 1% THD. Wow and flutter 0.15% wrms; frequency response 31.5-12,000 Hz ±3 dB; S/N ratio 45 dB. FM 50-dB quieting sensitivity 22.1 dBf; S/N ratio 60 dB; 160 mmW × 120 mmD × 44 mmH.... \$210

CR3050 AM/FM-Stereo/Cassette Player

High-power in-dash AM/FM-stereo receiver with stereo cassette deck. Features 5-station preset tuning; ACSII (Automatic Control Stereo) for better reception; 4-way fader control; soft FM mute; dual-gate MOSFET front end; locking fast forward/rewind. Output power 6.75 W at 1% THD, 50-15,000 Hz; frequency response 30-40,000 Hz ±3 dB. Wow and flutter 0.2% wrms; frequency response 40-14,500

Hz ±3 dB. FM usable sensitivity 17.3 dBf; 160 mmW × 110 mmD × 44 mmH..... \$170

BLAUPUNKT

"Berlin" 8000 AM/FM Stereo/Cassette Player

In-dash AM/FM-stereo/SW/LW receiver with unique remote control and metal-tape compatible auto-reversing cassette player and Dolby noise-reduction system. Features electronic scan tuning with 7 station presets; Sound Ambient Level Sensor (SALS) automatic adjustment of volume relative to ambient noise; ASU circuitry to suppress FM noise. Output power 20 watts/channel; frequency response on tape 30-15,000 Hz ±3 dB; S/N 56 dB with Dolby on; FM sensitivity 1.5 µV..... \$1395

CR-3001 AM/FM-Stereo/Cassette Player

In-dash receiver with frequency-synthesized and digital-display tuning and metal-compatible automatic-reversing cassette player with Dolby noise reduction. Features 12 station presets; ASU circuitry to suppress FM noise; switchable EQ for normal/CrO₂ and metal tapes. Power output 15 W/channel; tape frequency range 63-14,000 Hz; wow and flutter 0.15%; FM sensitivity 2.5µV..... \$630

CR-2001 AM/FM-Stereo/Cassette Player

In-dash receiver offers 5 AM/FM pushbutton tuning presets and auto-reverse cassette deck with Dolby noise-reduction system. Features ASU circuit to suppress FM noise; switchable loudness contour. Power output 5 W/channel; tape frequency range 35-14,000 Hz; wow and flutter 0.15%; FM sensitivity 1.8µV..... \$350

CR-5100 AM/FM-Stereo/Cassette Player

In-dash receiver with digital clock, 5 AM/FM preset buttons, and metal-compatible auto-reverse cassette deck with Dolby noise reduction. Features ASU circuitry to suppress FM noise; switchable EQ for normal/CrO₂ and metal tapes; separate bass and treble controls; switchable loudness compensation; local/distant switch; automatic night illumination of controls. Power output 5 W/channel; tape frequency range 40-14,000 Hz; wow and flutter 0.15%; FM sensitivity 2.5µV..... \$344

BOSE

CRC Digital Tuner/Cassette Player

DIN-size in-dash AM/FM-stereo tuner with stereo cassette player. Fits most vehicles manufactured since



1975. Features microprocessor-controlled PLL digital tuner with 12-station preset tuning; seek/scan/manual tuning; 4-digit LED frequency/time display; automatic FM muting; local/distant switch; FM fringe blend and noise-cancel switches; power-antenna lead; automatic-reverse cassette mechanism; Dolby noise reduction; normal/CrO₂/metal playback equalization selector; Permalloy tape head; locking fast forward/rewind; volume, balance, bass, treble controls; low-level preamp outputs to connect directly to Bose 1401 booster/equalizer..... \$575

CLARION

PE959A AM/FM-Stereo/Cassette Player

In-dash unit combines AM-PLL FM-stereo tuner, metal-compatible stereo cassette deck and LED digital clock/radio frequency display; requires separate power amplifier. Cassette deck features equalization selector for metal and CrO₂ tapes, auto reverse, locking fast forward/rewind, pushbutton eject. Programmable tuner features 5-station AM/FM pushbutton memory preset with electronic scanning; signal actuated stereo control (SASC) circuit; Dolby B circuitry (FM and cassette) with LED; local/distant switch; separate bass and treble controls; stereo/mono, loudness, program cancel switches; designed to fit all domestic and

imported cars; DIN output jacks and nose-piece, optional high-power fader; 2"H × 7"W × 5¼"D. \$900

9300T AM/FM-Stereo/Cassette Player

Compact Chassis Hi-Way Fidelity MK-II AM/FM-stereo radio with automatic-reverse stereo cassette deck. Features quartz-locked electronic tuning; digital display; 5 AM/5 FM station presets; touchbutton tuning memory; scan tuning; Magi-Tune™ FM front end; auto-



matic program control; locking fast forward/rewind; Ultra Permalloy tape head; Dolby noise reduction; metal-tape capability..... \$400

7500R AM/FM-Stereo/Cassette Deck

High-power Short Chassis Hi-Way Fidelity MK-II AM/FM-stereo receiver with automatic-reverse stereo cassette deck. Features Magi-Tune™ FM front end; 5-pushbutton tuning; automatic program control; locking fast forward/rewind; Ultra Permalloy tape head; Dolby noise reduction; metal-tape capability; separate bass, treble, 4-way balance controls; equalizer accessory terminal. Output power 20 W/channel... \$329

5700R AM/FM-Stereo/Cassette Player

Medium-power AM/FM-stereo receiver with stereo cassette deck. Features quartz-lock electronic tuning; digital frequency/time display; 5 AM/5 FM station touch-button presets; Magi-Tune™ FM front end; soft muting; locking fast forward/rewind; automatic stop at end of play; tape-end indicator; metal-tape capability; loudness and 4-way balance controls; Traveler's Advisory reception. Output power 6 W/channel..... \$309

2500R AM/FM-Stereo/Cassette Player

Medium-power GM-size (J-car) chassis AM/FM-stereo receiver with automatic-reverse stereo cassette deck. Features 5-pushbutton tuning; Magi-Tune™ FM front end; automatic program control; locking fast forward/rewind; Dolby noise reduction; metal-tape capability; separate bass, treble, 4-way balance controls; power-antenna lead; Traveler's Advisory reception. Output power 6 W/channel..... \$299

5550R AM/FM-Stereo/Cassette Player

Mini Chassis (designed for Japanese import cars) AM/FM-stereo receiver with automatic-reverse stereo cassette player. Features 5-pushbutton tuning; Magi-Tune™ FM front end; automatic program control; locking fast forward/rewind; metal-tape capability; loudness and 4-way balance controls; Traveler's Advisory reception..... \$229

R5500R AM/FM-Stereo/Cassette Player

Compact Chassis in-dash Magi-Tune™ (FM only) AM/FM-stereo radio with automatic-reverse stereo cassette deck. Features 5-pushbutton tuning; automatic program control; metal-tape capability; locking fast forward/rewind; loudness and 4-way balance controls; Traveler's Advisory reception..... \$229

5300R AM/FM-Stereo/Cassette Player

Compact Chassis in-dash AM/FM-stereo receiver with Magi-Tune™ FM front end and automatic-reverse stereo cassette deck. Features automatic program control; locking fast forward/rewind; Dolby noise reduction; metal-tape capability; separate bass, treble, 4-way balance controls; Traveler's Advisory reception..... \$229

5100R AM/FM-Stereo/Cassette Player

Medium-power Compact Chassis AM/FM-stereo receiver with automatic-reverse stereo cassette deck. Features locking fast forward/rewind; metal-tape capability; loudness and 4-way balance controls; power-antenna lead; adjustable shafts; Traveler's Advisory reception. Output power 6 W/channel..... \$179

5105R AM/FM-Stereo/Cassette Player

Mini Chassis AM/FM-stereo receiver with stereo cas-

sette deck. Features automatic-reverse cassette mechanism; locking fast forward/rewind; metal-tape capability; loudness and 4-way balance controls; power-antenna lead; Traveler's Advisory tuning ... \$179

3700R AM/FM-Stereo/Cassette Player

Medium-power Compact Chassis AM/FM-stereo receiver with 5-pushbutton tuning and stereo cassette deck. Features locking fast forward/rewind; automatic stop at end of play; tape-end indicator; loudness, stereo balance, and tone controls; power-antenna lead; adjustable shafts; Traveler's Advisory reception. Output power 6 W/channel \$169

3550R AM/FM-Stereo/Cassette Player

Medium-power Compact Chassis AM/FM-stereo receiver with automatic-reverse stereo cassette deck. Features locking fast forward/rewind; stereo/mono switch; balance and tone controls; Traveler's Advisory reception. Output power 6 W/channel \$159

3500R AM/FM-Stereo/Cassette Player

Medium-power Compact Chassis in-dash AM/FM-stereo receiver with automatic-reverse stereo cassette transport. Features stereo/mono switch; locking fast forward/rewind; stereo balance and tone controls; adjustable shafts; Traveler's Advisory reception. Output power 6 W/channel \$159

2100R AM/FM-Stereo/Cassette Player

Medium-power In-dash AM/FM-stereo receiver with stereo cassette deck. Designed for GM J cars. Features locking fast forward/rewind; end of play stop; tape-end indicator; loudness and 4-way balance controls; power-antenna lead; Traveler's Advisory reception. Output power 6 W/channel \$139

3150R AM/FM-Stereo/Cassette Player

Mini Chassis medium-power AM/FM-stereo receiver with stereo cassette deck, designed for Japanese import cars. Features stereo/mono switch; locking fast forward; automatic end of play stop; tape mode indicator; balance and tone controls; Traveler's Advisory reception. Output power 6 W/channel \$109

3100R AM/FM-Stereo/Cassette Player

Medium-power Compact Chassis AM/FM-stereo receiver with stereo cassette deck. Features automatic local/distant switching; dual-gate FET/balanced-mixer FM front end; stereo/mono switch; locking fast forward; automatic end of play stop; tape mode indicator; stereo balance and tone controls; adjustable shafts; Traveler's Advisory reception. Output power 6 W/channel \$109

CONCORD

In-Dash 100 Series

HPL-130 AM/FM-Stereo/Cassette Player

Quartz digital synthesized AM/FM-stereo receiver with stereo cassette player. Features seek and scan tuning; 6 AM/6 FM station presets; LED auxiliary and tape indicators; auxiliary in/out switch; exclusive signal-processor circuitry; power eject; automatic replay on rewind; preamp fader; locking fast forward/rewind; Dolby noise reduction; metal-tape capability; adjustable line output controls; Sen-alloy tape head; FM mute switch; 3-frequency bass equalizer; loudness control; stereo/mono switch; separate bass and treble controls. Output power 12 W/channel into 4 ohms, 20-20,000 Hz at 0.8% THD; $7\frac{3}{32}''W \times 5\frac{3}{32}''D \times 1\frac{3}{32}''H$ \$530

HPL-120 AM/FM-Stereo/Cassette Player

Digitally tuned AM/FM-stereo receiver with stereo cassette deck. Features green LED digital display; dual-gate MOSFET FM front end; r-f agc (automatic gain control) circuit; loudness switch; FM high-blend; tape equalization, AM/FM, local/distant switches; 4 preamplified outputs; separate left-right balance control; 40/80/120-Hz dedicated bass equalizer; bass EQ level control; Dolby noise reduction; treble control; SA tape head; automatic eject. Output power 12 W rms into 4 ohms, 20-20,000 Hz at 0.8% THD; $7\frac{1}{4}''W \times 5\frac{3}{32}''D \times 2''H$ \$400

HPL-118F AM/FM-Stereo/Cassette Player

Medium-power AM/FM-stereo receiver with stereo cassette deck. Features exclusive signal processor circuit for use with dbx® and Dolby C noise-reduction adapters, imaging devices, equalizers, reverb devices; aux input/output switch; LED aux and tape indicators; SLT (Station Locked Tuning) switch; tuner/tape, stereo/mono, FM high-blend, local/distant, FM muting switches; SA tape head; Dolby B noise reduction; tape equalization switch; automatic eject; loudness switch; 3-band bass equalizer; adjustable line outputs. Output power 12 W/channel into 4 ohms, 20-20,000 Hz at 0.8% THD; $7''W \times 5\frac{3}{32}''D \times 1\frac{3}{32}''H$... \$400
HPL-119. High-power version of HPL-118F. Consists of HPL-118F receiver/cassette player and HPA-25



plug-in amplifier modules. Output 48 W \$550

HPL-118 AM/FM-Stereo/Cassette Player

Pushbutton preset-tuned AM/FM-stereo receiver with stereo cassette deck. Features 5 AM/5 FM station presets; SLT (Station Lock Tuning) switch; tuner/tape, FM high blend, local/distant, stereo/mono, loudness, FM mute switches; adjustable line outputs; SA tape head; Dolby noise reduction; 3-band bass equalizer. Output power 12 W/channel into 4 ohms, 20-20,000 Hz at 0.8% THD; $7''W \times 5\frac{3}{32}''D \times 2''H$ \$380

HPL-115 AM/FM-Stereo/Cassette Player

Medium-power AM/FM-stereo receiver with stereo cassette deck. Features FM high blend, tuner on/off, loudness, local/distant, AM/FM, tape equalization switches; 4 preamplified outputs; dedicated 40/80/120-Hz bass equalizer; dual-gate MOSFET FM front end; Dolby noise reduction; r-f agc (automatic gain control) circuit; left-right balance and treble controls; SA tape head; automatic eject. Output power 12 W/channel into 4 ohms, 20-20,000 Hz at 0.8% THD; $7\frac{1}{8}''W \times 5\frac{3}{32}''D \times 1\frac{3}{32}''H$ \$350

HPL-112 AM/FM-Stereo/Cassette Player

Compact AM/FM-stereo receiver with stereo cassette deck. Features Dolby noise reduction; SA tape head; automatic eject; separate bass and treble controls; line output jacks; standard/metal tape selector; loudness switch. Output power 5 W rms/channel; $7\frac{3}{32}''W \times 4\frac{3}{4}''D \times 2\frac{1}{16}''H$ \$280

HPL-101 AM/FM-Stereo/Cassette Player

Compact AM/FM-stereo receiver with stereo cassette deck. Features SA tape head; automatic eject; separate bass and treble controls; loudness switch; tape equalization selector; $7\frac{3}{32}''W \times 4\frac{3}{4}''D \times 2\frac{1}{16}''H$ \$250

In-Dash 500 Series

HPL-515 AM/FM-Stereo/Cassette Player

Digital-display AM/FM-stereo receiver with stereo cassette player. Features digital frequency/time display; quartz-controlled digital clock; dual-gate MOSFET FM front end; dc servo-controlled heavy-duty transport motor; SA tape head; Dolby noise reduction; automatic eject; dedicated bass equalizer; equalizer level control; treble control; tape-speed pitch control; 4 preamplified outputs; standard/metal tape selector; loudness, FM mute, FM high-blend, local/distant, AM/FM, bi-amplifier switches; biamp level control; dedicated 1k/3.5k/10k treble equalizer; treble EQ level control. Output power 12 W rms/channel into 4 ohms, 20-20,000 Hz at 0.8% THD; $7\frac{1}{8}''W \times 6\frac{1}{2}''D \times 2''H$ \$470

HPL-508 AM/FM-Stereo/Cassette Player

AM/FM-stereo tuner with stereo cassette deck, designed to be used with outdoor amplifier. Features dc servo-controlled heavy-duty transport motor; X-cut SA tape head; tape speed pitch control; bi-amplifier switch and separate level control; treble equalizer level control; soft start/end; dual-gate MOSFET FM front end; Dolby noise reduction; automatic eject; dedicated bass equalizer with separate level control; treble

control; 4 preamplified outputs; variable line output controls; standard/metal tape selector; loudness, FM mute, stereo/mono, local/distant, AM/FM, tuner/tape switches; dedicated 1k/3.5k/10k Hz treble equalizer. Dimensions $7''W \times 6''D \times 2''H$ \$370

CRAIG

T687 AM/FM-Stereo/Cassette Player

In-dash entertainment center with scanning electronic tuning and presets for up to five each AM and FM stations, Power Play 4-channel amplifier, and Dolby noise reduction for tape and FM. Features auto-reverse transport; Sendust-alloy tape head; digital frequency/time display; separate bass and treble and front and back balance controls; metal/CrO₂ EQ switch; locking fast forward/rewind; loudness control. Power output 12.5 W/channel into 4 ohms 35-20,000 Hz at 1.0% THD; wow and flutter 0.2% wrms; FM usable sensitivity 20.9 dBf; FM alternate-channel selectivity 60 dB; capture ratio 2 dB \$600
T693. Similar to T687 but with 6 each FM and AM station presets; 2-channel amplifier (12 W/channel); sensitivity 20.2 dBf; selectivity 50 dB; capture ratio 1.5 dB; wow and flutter 0.15% \$450

T690 AM/FM-Stereo/Cassette Player

In-dash receiver/player with 5 station presets, auto-reverse tape deck, and Dolby noise reduction. Features Sendust-alloy tape head; meta/CrO₂ EQ; separate bass, treble, balance, fader controls; local/distant and stereo/mono pushbuttons; loudness control; automatic power antenna switching; dial-light dimming; line-level output jacks. Power output 12 W/channel into 4 ohms, 120-20,000 Hz at 5% THD; wow and flutter 0.15% wrms; FM usable sensitivity 65 dB; capture ratio 1.7 dB \$300
T692. Similar to T690 except no station presets; no Sendust-alloy tape head; no metal/CrO₂ switch; FM sensitivity 20 dBf; capture ratio 1.5 dB \$250
T691. Similar to T692 except no Dolby NR; no auto-reverse tape deck \$190

T619 AM/FM-Stereo/Cassette Player

In-dash receiver/cassette player with auto-reverse transport, Electronic Search and Play (ESP), and Dolby noise reduction. Features Sendust-alloy tape head; metal/CrO₂ tape EQ switch; locking fast forward/rewind; illuminated tape-direction indicators; separate bass, treble, balance, fader controls; local/distant and stereo/mono switches; FM muting; loudness control; power-off eject; automatic power antenna switching; line-level output jacks. Output power 12 W/channel into 4 ohms, 80-20,000 Hz at 5% THD; wow and flutter 0.18% wrms; FM usable sensitivity 18.8 dBf; FM alternate-channel selectivity 65 dB; capture ratio 2.0 dB \$280

T560 AM/FM-Stereo/Cassette Player

Designed for most import and X-body cars, unit has auto-reverse tape deck, Dolby noise reduction, and Electronic Search and Play (ESP). Features Sendust-alloy tape head; metal/CrO₂ tape EQ; separate bass, treble, balance, and fader controls; locking fast forward/rewind; loudness control; power-off eject; automatic power antenna switching; line-level output jacks. Power output 4 W/channel into 4 ohms, 100-20,000 Hz at 5% THD; wow and flutter 0.15% wrms; FM usable sensitivity 17.8 dBf; FM alternate-channel selectivity 65 dB; capture ratio 2.5 dB \$280
T530. Similar to T560 except no ESP. Has preset buttons for 5 AM or FM stations; no bass and treble controls; no automatic power antenna switching. FM sensitivity 18.0 dBf \$190

R230 AM/FM-Stereo/Cassette Player

In-dash tuner/player with preset tuning, auto-reverse transport, and Dolby noise reduction. Features Sendust-alloy tape head; metal/CrO₂ tape EQ selector; precision power loading of cassette; locking fast forward/rewind; illuminated tape-direction indicators; separate bass, treble, and loudness controls; FM muting; local/distant and mono/stereo switches; dial-light dimming; power-off eject; power antenna switching. Wow and flutter 0.24% wrms; frequency range 30-25,000 Hz; FM usable sensitivity 28.8 dBf; FM alternate-channel selectivity 70 dB; capture ratio 2.5 dB \$280

5

CAR STEREO EQUIPMENT

R200. Similar to R230 except no FM muting; FM sensitivity 20.8 dBf; capture ratio 2.8 dB \$250

T641 AM/FM-Stereo/Cassette Player

In-dash unit with 5 preset tuning pushbuttons, auto-reverse tape deck, and power-off eject. Features separate bass and treble, loudness, balance, fader controls; power antenna switching; line-level output jacks. Output power 12 W/channel into 4 ohms, 100-20,000 Hz at 5% THD; wow and flutter 0.15% wrms; FM usable sensitivity 21.3 dBf; FM alternate-channel selectivity 60 dB; capture ratio 2.4 dB \$220

T618. Similar to T641 except no present tuning; wow and flutter 0.1%; FM sensitivity 21.8 dBf; capture ratio 2.4 dB \$190

T614. Similar to T618 except no auto-reverse tape deck; no bass and treble controls; output power 4 W/channel; FM sensitivity 22.7 dBf; capture ratio 1.8 dB; wow and flutter 0.12% \$155

T640 AM/FM-Stereo/Cassette Player

In-dash system with auto-reverse tape deck, preset tuning, power-off eject. Features locking fast forward/rewind; separate bass and treble controls; local/distant and stereo/mono switches. Output power 4 W/channel into 4 ohms, 200-20,000 Hz at 5% THD; wow and flutter 0.15%; FM usable sensitivity 18.3 dBf; FM alternate-channel selectivity 60 dB; capture ratio 0.15% wrms \$170

T617 AM/FM-Stereo/Cassette Player

In-dash player with auto-reverse tape deck, precision power loading for cassettes, and reverse pushbutton. Features locking fast forward/reverse; separate balance and fader controls; local/distant and stereo/mono switches; power-off eject. Output power 4 W/channel into 4 ohms, 100-20,000 Hz at 5% THD; wow and flutter 0.12% wrms; FM usable sensitivity 23.4 dBf; FM alternate-channel selectivity 60 dB \$150

T610. Similar to T617 except no reversing tape deck; no precision power loading; no balance and fader controls; no reverse button; no mono/stereo switch; has separate stereo and matrix buttons; wow and flutter 0.15% wrms; FM sensitivity 25.2 dBf; capture ratio 2.7 dB \$100

T501 AM/FM-Stereo/Cassette Player

Designed for most import and X-body cars. Features auto-reverse tape deck; locking fast forward/rewind; local/distant and mono/stereo switches; aft (automatic frequency control); LED stereo indicator; power-off eject. Output power 4 W/channel into 4 ohms, 200-10,000 Hz at 5% THD; wow and flutter 0.17% wrms; FM usable sensitivity 19.9 dBf; FM alternate-channel selectivity 60 dB; capture ratio 1.5 dB \$130

T500. Similar to T501 except no auto-reverse tape deck, mono/stereo switch; output power 3.5 W/channel; wow and flutter 0.20%; FM sensitivity 24.3 dBf; FM selectivity 60 dB; capture ratio 2.5 dB. \$100

T624 AM/FM-Stereo/Cassette Player

In-dash AM/FM-stereo/cassette player with automatic-reverse transport. Features soft muting; locking fast forward/rewind; local/distant and mono/stereo

switches; separate balance and fader controls. Output power 4 W/channel into 4 ohms, 70-20,000 Hz at 5% THD; THD 0.8% at rated output; minimum recommended load 3 ohms. Wow and flutter 0.2% wrms; frequency response 40-14,000 Hz +1/-8 dB; S/N ratio 50 dB A weighted; separation 40 dB; fast-wind time 75 seconds with C60 cassette. FM 50-dB quieting sensitivity 20.8 dBf; frequency response 30-15,000 Hz +1/-5 dB; capture ratio 3.6 dB; alternate-channel selectivity 60 dB; separation 30 dB at 1 kHz; AM suppression 40 dB; S/N ratio 60 dB; THD 0.5%; 7 1/4"W x 4 3/4"D x 1 3/4"H; 1.4 lb. \$130

T103 Stereo Cassette Player

Under-dash stereo cassette player/power amplifier with auto-reverse cassette deck. Features separate bass and treble controls; locking fast forward/rewind; balance control; eject button. Output power 4 W/channel into 4 ohms, 150-20,000 Hz at 5% THD; wow and flutter 0.15% wrms; frequency response 45-10,000 Hz ±3 dB; S/N ratio 50 dB \$110

S611 AM/FM-Stereo/8-Track Player

In-dash unit features separate local/distant and mono/stereo switches; auto/manual program change; illuminated stereo and program indicators. Output power 4 W/channel into 4 ohms, 200-15,000 Hz at 5% THD; wow and flutter 0.15% wrms; FM usable sensitivity 19.9 dBf; FM alternate-channel selectivity 50 dB; capture ratio 0.15% wrms \$90

T623 AM/FM-Stereo/Cassette Player

In-dash unit features stereo/mono and local/distant switches; locking fast forward; afc (automatic frequency control); FM stereo indicator; separate volume, tone, tuning, balance controls. Output power 4 W/channel into 4 ohms, 400-20,000 Hz at 10% THD; THD 5% at 1 kHz, 3.5 W output; minimum recommended load 3 ohms. Wow and flutter 0.2% wrms; frequency response 63-14,000 Hz +0/-7 dB; S/N ratio 50 dB A weighted; separation/crosstalk 34/-45 dB. FM 50-dB quieting sensitivity 25.2 dBf; frequency response 30-15,000 Hz +1/-8 dB; capture ratio 3 dB; alternate-channel selectivity 60 dB; separation 30 dB at 1 kHz; image/i-f response ratio 90/65 dB; AM suppression 40 dB; S/N ratio 55 dB; THD 0.5%; 7"W x 4 3/4"D x 1 3/4"H; 2.25 lb. \$80

T104 Stereo Cassette Player

Road Rated™ under-dash stereo cassette deck with Dolby noise reduction. Features automatic-reverse transport; compact chassis; locking fast-wind lever; balance control; preamp outputs; bass, treble, volume controls. Output power 4 W/channel into 4 ohms, 150-20,000 Hz at 5% THD; THD 1.5%; wow and flutter 0.15% wrms; frequency response 40-10,000 Hz ±3 dB; S/N ratio Dolby off/on 50/58 dB; separation/crosstalk 35/-55 dB; fast-wind time 95 seconds with C60 cassette; 5 1/4"D x 5 1/2"W x 1 3/4"H \$155

FUJITSU TEN

CE-4133 AM/FM-Stereo/Cassette Player

Under-dash microcomputerized AM/FM-stereo radio with automatic-reverse cassette player. Features automatic program selector; Dolby noise reduction; auto repeat; normal and chrome/metal tape selector; ceramic tape head; Hall effect IC in tape-end-sense/auto-reverse control system; soft automatic cassette loading; key-off eject; antiroll system for reduced wow and flutter; fast forward/rewind mute; 4-way radio tuning; automatic scan tuning and tuning search; 5 AM/5 FM station presets; manual tuning

mode; preset program timing; ASC (automatic separation control); soft mute; r-f agc (automatic gain control) amplifier circuit; microprocessor-controlled PLL synthesizer tuning; local/distant switch; 5-band graphic equalizer; loudness switch; fader control; digital quartz clock; digital time/frequency display; black front panel. Rear-seat remote controller optional. Wow and flutter 0.09% wrms; frequency response 30-14,000 Hz ±3 dB; S/N ratio Dolby off/on 50/58 dB. FM 50-dB quieting sensitivity 24 dBf; frequency response 30-15,000 Hz ±3 dB; capture ratio 3 dB; alternate-channel selectivity 64 dB; separation 32 dB at 1 kHz, 65 dBf; image/i-f response ratio 65/90 dB. Equalizer center frequencies 60, 250, 1k, 3.5k, 10k Hz; boost/cut range ±12 dB; power consumption 2 A (1 W at 1 kHz); 7"W x 5 1/4"D x 2"H; 4.2 lb. \$780

EP-820 AM/FM-Stereo/Cassette Player

Microprocessor controlled AM/FM-stereo radio with preamp and auto-reverse cassette player with Dolby noise-reduction system. Unit features built-in 5-band graphic equalizer with center frequencies at 60, 250, 1k, 3.5k, 10k Hz, ±12 dB; quartz clock and electronic tuning with digital frequency/time display; 7 AM/7 FM station presets; up/down search and scan tuning. Cassette features metal-compatible tape head, equalizer switch for CrO₂ and FeCr tape; locking fast forward/rewind. Radio features FM noise blanker; FM muting; 4-way fader control. Frequency range 40-14,000 Hz \$600

CR-1134 AM/FM-Stereo/Cassette Player

High-power in-dash AM/FM-stereo receiver with auto-reverse stereo cassette deck. Features Dolby noise reduction; 3 FM/2 AM station presets; normal and



CrO₂/metal tape selector; ceramic tape head; ASC circuit; soft mute; fader control; 3-position adjustable shaft; universal DIN size. Output power 25 W x 2 or 7 W x 4 channels \$320

CR-1033. Similar to CR-1143 except lower power; has separate bass and treble controls; no fader control \$290

CR-1032. Similar to CR-1033 except has no Dolby NR or bass and treble controls; has high-cut filter and loudness switches \$250

CR-1130 AM/FM-Stereo/Cassette Player

In-dash unit with 3 FM/2 AM tuning presets and auto-reverse cassette player. Features separate bass and treble controls; high-cut filter; normal and CrO₂/metal tape capability; locking fast forward/rewind, FM muting; Automatic Separation Control (ASC) on FM; dual-gate MOSFET front end with agc action; ceramic filters for FM selectivity; loudness switch; FM stereo and tape direction indicators. Amplifier output 16 W/channel minimum into 4 ohms at 10% THD; frequency response 40-20,000 Hz ±3 dB; S/N ratio 70 dB A weighted. FM usable sensitivity 20 dBf; frequency response 30-15,000 Hz ±3 dB; alternate-channel selectivity 60 dB; separation 35 dB at 1 kHz; capture ratio 3 dB. Wow and flutter 0.09% wrms; frequency response 40-14,000 Hz ±3 dB; S/N ratio 53 dB A weighted; 7"W x 5 3/8"D x 1 1/8"H; 3.8 lb. \$300

CR-1031. Similar to CR-1130 except lower power (4 W/channel), no fader control \$290

CR-1030. Similar to CR-1031 except no separate bass and treble controls or fader control. Tape frequency response 40-14,000 Hz; amplifier output 4 W/channel \$240

CE-4431 AM/FM-Stereo/Cassette Player

Mini-size in-dash AM/FM-stereo radio with auto-reverse cassette player. Features digital frequency display; search tuning; local/distant switch; CrO₂/metal tape selector; mono/stereo switch; FM noise blanker; locking fast forward/rewind; MOSFET front end; hard

NOTICE TO READERS

Prices of items described are suggested prices only and are subject to change without notice. Actual selling prices are determined by the dealer.

Permalloy tape head; 6 AM/6 FM station presets; volume, tone, balance controls; tape-direction indicators; adjustable shaft. Dimensions 180 mmW × 120 mmD × 50 mmH; weight 5 lb \$280

DP-646 AM/FM-Stereo/Cassette Player

In-dash AM/FM-stereo radio with auto-reverse cassette deck. Features built-in 44-W amplifier; separate bass and treble controls; DSS switch; normal and chrome/metal tape selector; LTM (Life Time Metal) tape head; antiroll system; ASC (Automatic Separation Control) circuit; soft mute; universal (DIN) size \$250

DP-640S4 AM/FM-Stereo/Cassette Player

In-dash AM/FM-stereo receiver with automatic-reverse cassette deck. Features Hall IC in auto-reverse control system; FM noise blanker; locking fast forward/rewind; sharp FM tuning system; antiroll system for reduced wow and flutter. Output power 10 W \$185

GP-1010 AM/FM-Stereo/Cassette Player

In-dash unit with 5-button preset tuning and illuminated dial in cassette door. Features multi-color AM, FM stereo, tape-end, and tape-run LEDs; soft-touch local/distant and mono/stereo switches; locking fast-forward/eject; FM noise blanker; AM/FM selector behind tuning control and high/low tone switch behind volume/balance control; silver front panel. Output power 4 W/channel into 4 ohms at 10% THD; frequency response 63-20,000 Hz ± 3 dB. FM usable sensitivity 26 dB; frequency response 30-15,000 Hz ± 3 dB; alternate-channel selectivity 70 dB; separation 30 dB at 1 kHz; image/i-f response ratio 56/82 dB; capture ratio 6 dB. Wow and flutter 0.15% wrms; frequency response 63-14,000 Hz ± 3 dB; S/N ratio 53 dB A weighted; separation 34 dB; 6 1/4" W × 4 2/32" D × 1 23/32" H; 3.1 lb \$180
GP-1011. Same as GP-1010 except black front panel \$180

DP-7872 AM/FM-Stereo Tuner/Cassette Player

Universal in-dash AM/FM-stereo tuner with stereo cassette player. Features auto-reverse cassette deck; built-in noise blanker; locking fast forward/rewind; adjustable shaft \$175

DP-1006 AM/FM-Stereo/Cassette Player

In-dash miniature AM/FM-stereo radio/cassette deck. Cassette player features locking fast forward/eject; chrome tape compatibility; tape end indicator light; wow and flutter 0.15% wrms; frequency response 60-12,500 Hz ± 3 dB; S/N ratio 50 dB. Radio features 5-W/channel output power into 4 ohms, 30-20,000 Hz with 10.0% THD; frequency response 30-10,000 Hz ± 3 dB; dial in door; separate bass and treble controls; loudness and local/distant switches; FM muting; LED stereo indicator; FM 50-dB quieting sensitivity 23 dB; image rejection 70 dB; FM i-f rejection 65 dB; separation 35 dB. Adjustable shafts fit most cars. 1 3/4" H × 6 1/4" W × 4 1/2" D \$150
DP-1000. Similar to DP-1006 except no loudness switch or bass and treble controls \$130

DP-620 AM/FM-Stereo/Cassette Player

In-dash AM-stereo FM radio/stereo cassette deck designed for small imported and domestic cars. Cassette features locking fast forward/rewind; tape direction indicators; power-off eject; wow and flutter 0.12% wrms; frequency response 60-8000 Hz ± 3 dB; S/N ratio 50 dB; separation 35 dB. Radio features stereo/monoswitch; stereo LED; balance and tuning/select controls; 5-W/channel output power into 4 ohms, 150-20,000 Hz with 10.0% THD; FM tuner 50-dB quieting sensitivity 24 dB; selectivity 64 dB; separation 30 dB; frequency response 30-15,000 Hz ± 3 dB; 7" W × 5 29/64" D × 1 1/4" H. \$150

Cassette Players

SP-572. Auto-reverse stereo cassette player with loudness switch; tape anti-tangle mechanism; antiroll system for reduced wow and flutter; locking fast forward/rewind; program selector switch \$120
SP-600. Compact stereo cassette player with automatic eject; single fast-forward/rewind/eject lever; improved tone control; green guide light for cassette door; automatic power source switching; balance

control \$110

FULTRON

16-900 AM/FM-Stereo/Cassette Player

In-dash electronically tuned AM/FM-stereo radio with auto-reverse cassette deck. Features D.N.R. National Semiconductor dynamic noise reduction; preamp outputs; 6 AM/6 FM station presets; LED digital frequency/time display; PLL frequency synthesized tuning; locking fast forward/rewind; CrO₂ tape capability; separate bass and treble, balance, fader controls; local/distant switch; automatic FM muting; small chassis that fits most cars. Output power 4 W/channel into 4 ohms at 1 kHz with < 3% THD; FM frequency response 100-14,000 Hz 3 dB ... \$380

16-700 AM/FM-Stereo/Cassette Player

In-dash pushbutton AM/FM-stereo radio with auto-reverse cassette deck. Features D.N.R. (dynamic noise reduction); preamp outputs; separate bass and treble controls; mono/stereo switch; balance and fader controls; illuminated dial; FM stereo and tape-direction indicators; locking fast forward/rewind; small chassis that fits most cars. Specifications same as for 16-6900 \$200

16-5700 AM/FM-Stereo/Cassette Player

In-dash AM/FM-stereo receiver with auto-reverse cassette deck. Features D.N.R. (dynamic noise reduction); preamp outputs; separate bass and treble controls; mono/stereo and FM muting switches; balance and fader controls; illuminated dial; FM stereo and tape-direction indicators; locking fast forward/rewind; small chassis that fits most cars. Specifications same as for 16-6900 \$170

16-6100 AM/FM-Stereo/Cassette Player

In-dash pushbutton-tuned AM/FM-stereo receiver with stereo cassette deck. Features 5 AM/5 FM station presets; mono/stereo switch; FM muting; tone, balance, fader controls; locking fast forward; small chassis that fits most cars. Specifications same as for 16-6900 \$150

16-5500 AM/FM-Stereo/Cassette Player

In-dash AM/FM-stereo receiver with auto-reverse cassette deck. Features mono/stereo switch; FM muting; balance and tone controls; local/distant switch; automatic reverse; locking fast forward/rewind; FM stereo and tape-direction indicators; small chassis that fits most cars. Specifications as for 16-6900 \$140

16-5600 AM/FM-Stereo/8-Track Player

In-dash AM/FM-stereo receiver with stereo 8-track cartridge player. Features mono/stereo, FM muting, program-change and local/distant switches; tape program indicators; small size that fits most cars. Specifications same as for 16-6900 \$120

16-5080 AM/FM-Stereo/Cassette Player

In-dash mini AM/FM-stereo receiver/cassette deck designed for small cars. Features nose-pieces for universal installation; balance and tone controls; local/distant switch; locking fast forward. Specifications same as for 16-900 \$100

16-5000 AM/FM-Stereo/Cassette Player

In-dash AM/FM-stereo receiver/cassette player. Features mono/stereo, local/distant, FM muting switches; balance and tone controls; small chassis that fits most cars. Specifications as for 16-6900 \$90

JENSEN

RE518 AM/FM-Stereo/Cassette Player

In-dash AM/FM-stereo cassette player with PLL digital quartz synthesizer tuning and auto-reverse cassette deck. Features digital time/frequency display; electronic scan tuning; Dolby noise reduction; tape equal-

ization switch; 5 AM/5 FM tuning presets; Permalloy tape head; locking fast forward/rewind; separate bass and treble controls; local/distant switch; loudness compensation; stereo/mono switch; separate balance and fader controls; feather-touch transport controls. Output power 10 W; frequency range 30-15,000 Hz; S/N ratio 50 dB; universal chassis; 7 1/16" W × 4 3/4" D × 1 3/4" H \$399
RE512. Similar to RE518 but without Dolby NR, tape EQ, loudness compensation. Mini chassis; 6 1/16" W × 7 1/32" D × 1 3/4" H \$369

R425 AM/FM-Stereo/Cassette Player

In-dash unit with auto-reverse cassette player. Features Dolby noise reduction for tape and FM; full-logic transport controls; high-blend circuitry; Syntox® metal-compatible tape head; solenoid eject; locking fast forward/rewind; pushbutton station presets; loudness compensation; switchable FM muting; automatic local/distant selection; separate bass and treble, balance and fader controls; preamp outputs; feather-touch transport controls. Specifications same as for RE518, except dimensions 7 1/16" W × 5 1/16" D × 1 13/16" H \$350

RE508 AM/FM-Stereo/Cassette Player

In-dash player with PLL digital quartz synthesizer tuning and auto-reverse transport. Features digital time/frequency display; electronic scan tuning; 4 AM/4 FM station presets; Permalloy tape head; locking fast forward/rewind; automatic local/distant select; mono/stereo switch; feather-touch transport controls. Specifications same as for RE518, except dimensions 7 3/32" W × 4 23/32" D × 1 23/32" H \$300

T415 AM/FM-Stereo/Cassette Player

In-dash AM/FM-stereo tuner/cassette deck. Features auto-reverse transport; Dolby noise reduction for FM and tape; Syntox® metal-compatible tape head; solenoid eject; locking fast forward/rewind; preamp outputs; pushbutton station presets; high-blend circuitry; separate bass and treble controls; switchable FM interstation muting; loudness compensation; mono/stereo switch; feather-touch electronic switches. Frequency range 30-15,000 Hz; S/N ratio 55 dB; standard chassis; 7" W × 5 1/16" D × 2" \$300

R406 AM/FM-Stereo/Cassette Player

In-dash AM/FM-stereo unit with auto-reverse cassette deck. Features high-blend circuitry; Sendust metal-capable tape head; pushbutton station presets; locking fast forward/rewind; automatic local/distant select; mono/stereo switch; loudness compensation; separate bass and treble controls; FM interstation muting; balance and fader controls. Specifications same as for RE518, except dimensions 7" W × 5 23/32" D × 1 7/16" H \$290
S401. Similar to R406 but without auto-reverse deck. Features Syntox® metal-compatible tape head; solenoid eject; S/N ratio 55 dB; standard chassis; 7 1/16" W × 5 1/16" D × 1 3/32" H \$260

JR115 AM/FM-Stereo/Cassette Player

In-dash AM/FM-stereo receiver with auto-reverse cassette player. Features pushbutton station presets; locking fast forward/rewind; stereo/mono and local/distant switches. Specifications same as for RE518, except dimensions 7 1/16" W × 5 1/16" D × 1 23/32" H \$240
JR110. Similar to JR115, except no auto-reverse deck, FM muting. Features automatic loudness compensation. Output power 8 W; frequency range 50-15,000 Hz; S/N ratio 50 dB; mini chassis; 6 1/16" W × 4 3/4" D × 1 3/4" H \$200

R210 AM/FM-Stereo/Cassette Player

In-dash AM/FM-stereo receiver with stereo cassette deck. Features pushbutton station presets; automatic local/distant select; stereo/mono switch; locking fast forward/rewind; balance and fader controls. Output power 8 W; frequency range 50-15,000 Hz; S/N ratio 50 dB; mini chassis; 6 1/16" W × 5 1/16" D × 1 3/4" H \$200

JR105 AM/FM-Stereo/Cassette Player

In-dash AM/FM-stereo receiver with stereo cassette deck. Features automatic local/distant select; locking fast forward/rewind; stereo/mono switch; separate



5

CAR STEREO EQUIPMENT

bass and treble controls. Specifications same as for RE518, except dimensions $7\frac{1}{16}''W \times 4\frac{23}{32}''D \times 1\frac{1}{4}''H$ \$170

R200 AM/FM-Stereo/Cassette Player

In-dash AM/FM-stereo receiver with stereo cassette deck. Features automatic local/distant select; stereo/mono switch; locking fast forward. Output power 8 W; frequency range 50-15,000 Hz; S/N ratio 50 dB; mini chassis; $6\frac{3}{16}''W \times 4\frac{3}{4}''D \times 1\frac{1}{4}''H$ \$150

JR100 AM/FM-Stereo/Cassette Player

In-dash AM/FM-stereo/cassette player. Features automatic local/distant select; mono/stereo switch; locking fast forward. Output power 8 W; S/N ratio 50 dB; mini chassis; $6\frac{3}{16}''W \times 4\frac{1}{32}''D \times 1\frac{1}{4}''H$ \$150

J.I.L.

CD-83F AM/FM-Stereo/Cassette Player

Concept® in-dash AM/FM-stereo/cassette player with automatic cassette mechanism and digital tuning with DNR (dynamic noise reduction). Features DCFC dc-controlled function circuit; seek switch; AM/FM station presets; auto-reverse tape mechanism; Sen-Alloy tape head; locking fast forward/rewind; separate bass and treble controls; key-off eject; digital clock display; fader control; mute switch; local/DX switch. Tuner section: FM 50-dB quieting sensitivity mono/stereo 20/39 dB; FM S/N ratio mono/stereo 65/55 dB at 65 dB; THD mono/stereo 0.4%/0.1% at 1 kHz, 50 dB quieting; FM capture ratio 1 dB; adjacent/alternate-channel selectivity 15/75 dB; spurious/image/i-f response 72/73/75 dB; AM suppression 60 dB. Cassette deck section: wow and flutter 0.18% wrms; frequency range 30-15,000 Hz; S/N ratio 50 dB; THD <0.6% at 0 dB output; channel separation 30 dB. Amplifier section: output level >775 mV; THD <0.5% at 0 dB output..... \$550

CD-82FN AM/FM-Stereo/Cassette Player

Concept® in-dash AM/FM-stereo/cassette player with auto-reverse cassette mechanism and DNR. Features DCFC dc-controlled function circuit; Sen-Alloy tape head; locking fast forward; separate bass and treble controls; key-off eject; stereo hi-blend switch; fader control; muting switch; phase-locked-loop circuitry; local/DX switch. Specifications same as for CD-83F..... \$350

CD-80N AM/FM-Stereo/Cassette Player

Concept® in-dash AM/FM-stereo/cassette player with auto-reverse cassette mechanism and DNR. Features DCFC dc-controlled function circuit; locking fast forward/rewind; separate bass and treble controls; key-off eject; mute switch; phase-locked-loop circuitry; local/DX switch. Specifications same as for CD-83F..... \$280

CD-72 AM/FM-Stereo/Cassette Player

Concept® in-dash AM/FM-stereo/cassette player. Features pushbutton tuning and cassette player with DNR system; locking fast forward/rewind; auto stop; key-off eject; adjustable shafts; phase-locked-loop circuitry; local/DX switch; loudness switch. Specifications same as for CD-83F except output power 8 W rms/channel into 4 ohms; S/N ratio >60 dB; THD 0.5% at 6-W output into 4 ohms..... \$250

KENWOOD

KRC-1022 AM/FM-Stereo/Cassette Player

PLL synthesized tuner with manual and 12-channel preset tuning, auto-reverse cassette deck; designed for European car body size installation. Features automatic noise reduction system (ANRS); mono/stereo switch; Automatic Broadcast Sensor System (ABSS); muting switch; noise killer; balance control; seek tun-

ing; key-off cassette eject; Dolby noise reduction; tape-advance control; fader, bass, treble controls; local/distance and loudness switches; digital frequency display; display dimmer..... \$650

KRC-722 AM/FM-Stereo Tuner/Cassette Deck

In-dash unit with PLL synthesized tuning, digital frequency display, auto-reverse cassette deck, and Dolby noise-reduction system. Features (ABSS); (ANRS); auto-scanning; 5 AM/5 FM station preselect plus manual tuning; key-off eject; bass and treble controls; cassette standby; local/distance switch; metal tape capability. FM sensitivity 14.8 dB; frequency response 30-15,000 Hz ± 2 dB; S/N 70 dB mono. Wow and flutter 0.12% wrms; frequency response 30-15,000 Hz ± 2 dB; separation 35 dB; S/N 70 dB A weighted, Dolby on..... \$499
KRC-922. Similar to KRC-722 except has automatic seek/scan; loudness control; ceramic tape head; tape advance; FM tuner S/N ratio 70 dB mono.... \$549

KRC-512 Cassette Receiver

Mini-chassis-size cassette receiver with PLL synthesized tuning; auto seek; 5 AM/5 FM station presets; Dolby noise reduction; metal-tape capability; automatic local/distant switching; hard Permalloy head; bass and treble controls; preamp-out jacks; 4-speaker fader control; lighting for all knobs; auto-reverse cassette deck; automatic stereo/mono switching; manual tuning. Output power 5 W/channel; $6\frac{1}{2}''W \times 4\frac{3}{4}''D \times 1\frac{1}{4}''H$ \$429

KRC-511 Cassette Receiver

Stereo cassette receiver with auto-reverse cassette deck; cassette standby; key-off eject; Dolby noise reduction; digital clock; synthesized tuner; automatic noise-reduction control; fader control; preamp-out



jacks; auto load; digital scan; separate bass and treble controls; loudness control; 5AM/5 FM station presets; automatic antenna lead; hard Permalloy tape head. Output power 4 W/channel rms into 4 ohms at 1% THD..... \$429
KRC-411. Similar to KRC-511, except has loudness control; Dolby noise reduction; separate bass and treble controls. Designed for X-body vehicles $7\frac{1}{4}''W \times 4\frac{1}{2}''D \times 1\frac{1}{4}''H$ \$369

KZC-657 Cassette Deck/Amplifier

Auto-reverse cassette deck and 20-W/channel (into 4 ohms) amplifier system. Features Dolby noise reduction; preamp output jacks; metal-tape capability; key-off eject; soft-touch eject button; preamp output level, bass, treble, balance, volume controls; loudness switch. Wow and flutter 0.12% wrms; frequency range 30-16,000 Hz; S/N 60 dB with Dolby on; fast-wind time 90 seconds with C60 cassette.... \$299

KRC-312 AM/FM-Stereo Receiver/Cassette Deck

In-dash 20-watt/channel (into 4 ohms) AM/FM stereo receiver with auto-reverse cassette deck. Features 5-channel preset and manual tuning; local/distance switch; ANRC; hard Permalloy tape head; bass, treble, balance, fader controls; AM/FM switch. FM sensitivity 15.8 dB; S/N 68 dB mono. Wow and flutter 0.15% wrms; frequency response 63-12,500 Hz ± 3 dB; separation 35 dB; S/N 60 dB A weighted, Dolby on..... \$330
KRC-322. Similar to KRC-312 except can handle normal/CrO₂/metal tapes and requires power amplifier..... \$369

KXC-757 Cassette Deck

Under-dash metal-compatible stereo cassette deck with Dolby noise reduction and Sendust head for metal tape playback. Features cassette standby (in operation with KTC-767 tuner); auto reverse; fast forward/rewind; separate bass and treble controls; cassette door illumination; auto eject; bidirectional tape advance; 70- μ sec equalization (accepts chrome and

metal tapes); headphone jack. Wow and flutter 0.12% wrms; frequency range 30-16,000 Hz (normal); S/N 60 dB, Dolby on; $2\frac{1}{8}''H \times 6\frac{11}{16}''W \times 6\frac{1}{2}''D$ \$269

KRC-311 AM-FM/Cassette Deck

In-dash unit combines AM/FM stereo receiver and cassette deck. Receiver features analog tuning with 5-station preset; balance, tone, fader controls; LED stereo indicator; auto mono/stereo switching. Amplifier output 4 W/channel continuous; FM S/N ratio 63 dB; selectivity 70 dB; separation 30 dB. Cassette deck features auto reverse; key-off eject; fast forward/rewind; cassette standby; wow and flutter 0.12% wrms; S/N ratio 52 dB; frequency range 30-16,000 Hz..... \$279

KRC-212 Cassette Receiver

Stereo cassette receiver with manual tuning, 5 station presets, and ANRC. Features auto-reverse cassette deck; bass and treble controls; loudness switch; metal-tape capability; preamp output jacks; small chassis. FM usable sensitivity 15.8 dB; S/N ratio 68 dB. Wow and flutter 0.12%; frequency response 30-16,000 Hz ± 3 dB..... \$249

KRC-211 Cassette Receiver

Manual-tuned stereo cassette receiver. Features automatic mono/stereo and local/distant switching; ANRC; preamp output jacks; auto-reverse cassette deck; loudness switch; balance control; small chassis. FM usable sensitivity 0.15 μ V; S/N ratio 68 dB. Wow and flutter 0.12%; frequency response 30-16,000 Hz ± 3 dB; $6\frac{1}{4}''W \times 4\frac{1}{2}''D \times 2''H$ \$199

KRACO

KHP-1087 Designer Series Dashmaster

AM/FM-stereo receiver with auto-reverse tape player and Dolby noise reduction. Features 4 AM/4 tuning presets; automatic high blend (high-end signal boost); Sendust tape head; separate bass and treble controls; mute; locking fast forward/rewind; custom designer kit that includes 4 reversible face plates. Output power 12 W/channel..... \$280

KID-597 Designer Series Dashmaster

Pushbutton AM/FM/MPX radio with auto-reverse cassette tape player. Features automatic high blend (high-end signal boost); 5 preselect pushbuttons; mute; fader control; local/distant switch; locking fast forward/rewind..... \$280

ETR-1089 AM/FM-Stereo/Cassette Player

Pushbutton electronically tuned AM/FM-stereo receiver with auto-reverse stereo cassette deck. Features electronic tune scan; digital clock; digital frequency/time display; 5 AM/5 FM station tuning



presets; Sendust tape head; automatic high-end signal boost; custom designer kit with 4 reversible faceplates..... \$280

KHP-1087 AM/FM-Stereo/Cassette Player

In-dash AM/FM-stereo receiver with auto-reverse stereo cassette deck. Features 4 AM/4 FM station tuning presets; automatic high blend; Sendust tape head; separate bass and treble controls; FM muting; locking fast forward/rewind; custom designer kit with 4 reversible faceplates. Output power 12 W rms/channel at <1% THD..... \$280

KID-597 AM/FM-Stereo/Cassette Player

In-dash AM/FM-stereo receiver with auto-reverse stereo cassette deck. Features automatic high-blend; 5 preselect tuning buttons; FM muting; fader control; local/distant switch; locking fast forward/rewind..... \$270

KGE-803 AM/FM Stereo/Cassette Player

High-power AM/FM-stereo receiver with auto-reverse stereo cassette deck and 5-band graphic equalizer. Features high-end signal boost; program selector; AM/FM, high-belted, stereo/mono, equalizer switches; AM, FM, EQ, tape-direction indicators; balance and fader controls; custom designer kit with faceplates to match most car interiors. Output power 20 W/channel; equalizer center frequencies 60, 250, 1k, 3.5k, 10k Hz \$250

KGE-801 Radio/Tape Player/EQ/Amplifier

In/under-dash unit combines stereo cassette player, AM/FM-stereo radio, weather-band radio, 5-band graphic equalizer, 20 W/channel power amplifier. Equalizer has center-frequency slide controls set at 60, 250, 1k, 3.5k, 10k Hz and EQ bypass/on switch with LED; cassette player has locking fast forward/eject button, built-in auto stop, and LED tape play/end indicators; radio features pushbutton FM mute, AM/FM switch with LED indicators; stereo/mono switch; separate weather band; illuminated AM/FM dial scale in cassette door; adjustable shafts \$200

KGE-800. Same as KGE-801 except with 8-track player, without weather band \$240

KXI-89 AM/FM Stereo/Cassette Player

In-dash AM/FM-stereo receiver with auto-reverse stereo cassette deck. Features compact design to fit most small-size cars; fader control; local/distant switch; locking fast forward; AM/FM, FM mute, stereo/mono switches; FM stereo indicator \$190

KXI-87 AM/FM Stereo/Cassette Player

In-dash mini-size AM/FM-stereo receiver with auto-stop stereo cassette player, designed to fit most small-size cars. Features 5-button tuning preselects; fader control; local/distant and stereo/mono switches; locking fast forward; nospieces for all model cars \$170

KID-587 AM/FM Stereo/Cassette Player

In/under-dash AM/FM-stereo radio/cassette player. Cassette features fast forward and eject and LED tape run indicator. Radio features 5 AM/FM station presets; tone controls; LED FM stereo indicator; local/distant and AM/FM switches; balance and fader controls \$160

KID-575A AM/FM Stereo/8-Track Player

In/under-dash unit combines AM/FM-stereo radio stereo 8-track player. Unit features channel selector; AM, FM, channel indicator LEDs; balance control; AM/FM and local/distant switch; fader control; 5-button AM/FM preset tuning; volume and tone controls \$170

KXI-87 AM/FM Stereo/Cassette Player

AM/FM-stereo pushbutton radio with auto-stop cassette player. Designed for imported cars, compact X-body, and Citation in-dash installation. Features 5-buttons AM/FM tuning; fader control; local/distance switch; locking fast forward; auto stop. Comes with nospieces for all models and in-dash installation hardware \$170

KID-588B AM/FM Stereo/Cassette Player

In-dash AM/FM-stereo radio with auto-reverse cassette player. Features manual tape select; tape program selector switch; LED tape play and tape direction indicators; balance and tone controls; local/distant and FM mute switches; LED stereo, AM, and FM indicators \$170

Accessory

KCA-8. Stereo cassette adapter for 8-track cartridge tape players. Plugs directly into cartridge slot. Features automatic stop and rewind at end of play. \$50

MARANTZ

CAR340 AM/FM Stereo/Cassette Player

In-dash AM/FM-stereo receiver with auto-reverse stereo cassette deck. Features 5-station tuning presets; Dolby noise reduction; I.M.S. (Interference Management System); FM muting; separate bass and treble controls; metal-tape capability; preamp outputs;

speaker fader control; locking fast forward/rewind; automatic-antenna power lead; dial-scale dimmer lead. Output power 4 W/channel; THD 0.9% at 1 kHz; FM 50-dB quieting sensitivity 42.13 dB; capture ratio 2 dB; FM selectivity/separation 70/34 dB; FM frequency response 40-14,000 Hz ± 3 dB; wow and flutter 0.15% wrms; tape frequency response 40-13,000 Hz ± 3 dB; tape S/N ratio Dolby off/on 52/60 dB; $6\frac{1}{2}''\text{W} \times 4\frac{3}{4}''\text{D} \times 1\frac{1}{4}''\text{H}$ \$350

CAR302 AM/FM Stereo/Cassette Player

In-dash AM/FM-stereo receiver with stereo cassette deck. Features 5-station tuning presets; A.I.R. (Atmospheric Interference Rejection); FM muting; separate bass and treble controls; preamp outputs; Dolby noise reduction; automatic eject; locking fast forward/rewind; antenna-power lead; dial-scale dimmer lead. Output power 4 W/channel; THD 0.9%; preamp output level/impedance 500 mV/3k ohms. Wow and flutter 0.15%; frequency response 40-13,000 Hz ± 3 dB; S/N ratio Dolby off/on 48/56 dB. FM 50-dB quieting sensitivity 42.13 dB; capture ratio 2 dB; selectivity/separation 65/30 dB; frequency response 40-14,000 Hz ± 3 dB; S/N ratio 60 dB; $7\frac{1}{4}''\text{W} \times 4\frac{3}{4}''\text{D} \times 2\frac{1}{4}''\text{H}$ \$250

CAR322 AM/FM Stereo/Cassette Player

In-dash AM/FM-stereo receiver with auto-reverse stereo cassette deck. Features Dolby noise reduction; I.M.S. (Interference Management System); separate bass and treble controls; metal-tape capability; fader control; locking fast forward/rewind; power-antenna lead; dial-scale dimmer lead. Output power 4 W/channel; THD 0.9%. Wow and flutter 0.15%; frequency response 40-13,000 Hz ± 3 dB; S/N ratio Dolby off/on 52/60 dB. FM 50-dB quieting sensitivity 42.13 dB; capture ratio 2 dB; selectivity/separation 70/34 dB; frequency response 40-14,000 Hz ± 3 dB; S/N ratio 60 dB; $6\frac{1}{2}''\text{W} \times 4\frac{3}{4}''\text{D} \times 1\frac{1}{4}''\text{H}$ \$250

CAR330 AM/FM Stereo/Cassette Player

In-dash AM/FM-stereo receiver with stereo cassette deck. Features 5-station tuner presets; A.I.R. (Atmospheric Interference Rejection); FM muting; separate bass and treble controls; automatic eject; locking fast forward/rewind; C.M.S. (Continuous Music System); power-antenna lead. Output power 4 W/channel; THD 0.9% at 1 kHz. Wow and flutter 0.15% wrms; frequency response 40-13,000 Hz ± 3 dB; S/N ratio 52 dB. FM 50-dB quieting sensitivity 45.23 dB; capture ratio 2 dB; selectivity/separation 65/30 dB; frequency response 40-14,000 Hz ± 3 dB; S/N ratio 60 dB; $7\frac{1}{4}''\text{W} \times 4\frac{3}{4}''\text{D} \times 1\frac{1}{4}''\text{H}$ \$200

CAR312 AM/FM Stereo/Cassette Player

In-dash AM/FM-stereo receiver with stereo cassette deck. Features Compuskip; separate bass and treble controls; I.M.S. (Interference Management System); C.M.S. (Continuous Music System); locking fast forward/rewind; automatic eject; power-antenna lead. Output power 4 W/channel into 4 ohms; THD 0.9%. Wow and flutter 0.15% wrms; frequency response 40-12,000 Hz ± 3 dB; S/N ratio 50 dB. FM 50-dB quieting sensitivity 44.31 dB; capture ratio 2 dB; selectivity/separation 60/35 dB; frequency response 40-14,000 Hz ± 3 dB; S/N ratio 60 dB; $6\frac{1}{2}''\text{W} \times 4\frac{3}{4}''\text{D} \times 1\frac{1}{4}''\text{H}$ \$200

CAR310 AM/FM Stereo/Cassette Player

In-dash AM/FM-stereo receiver with stereo cassette deck. Features 5-station preset tuning; stereo/mono switch; FM muting; separate bass and treble controls; automatic eject; locking fast forward/rewind; C.M.S. (Continuous Music System); power-antenna lead. Output power 4 W/channel into 4 ohms; THD 0.9% at 1 kHz. Wow and flutter 0.15% wrms; frequency response 40-13,000 Hz ± 3 dB; S/N ratio 48 dB. FM 50-dB quieting sensitivity 45.23 dB; capture ratio 2 dB; selectivity/separation 60/30 dB; frequency response 40-14,000 Hz ± 3 dB; S/N ratio 60 dB; $6\frac{1}{2}''\text{W} \times 4\frac{3}{4}''\text{D} \times 1\frac{1}{4}''\text{H}$ \$195

CAR320 AM/FM Stereo/Cassette Player

In-dash AM/FM-stereo receiver with auto-reverse stereo cassette deck. Features I.M.S. (Interference Management System); C.M.S. (Continuous Music System); locking fast forward/rewind; tone control;

automatic eject; power-antenna lead. Output power 4 W/channel into 4 ohms; THD 0.9%. Wow and flutter 0.15%; frequency response 40-13,000 Hz ± 3 dB; S/N ratio 50 dB. FM 50-dB quieting sensitivity 44.3 dB; capture ratio 2 dB; selectivity/separation 60/35 dB; frequency response 40-14,000 Hz ± 3 dB; S/N ratio 60 dB; $6\frac{1}{2}''\text{W} \times 4\frac{3}{4}''\text{D} \times 1\frac{1}{4}''\text{H}$ \$165

MITSUBISHI CAR AUDIO

CZ-747 AM/FM Stereo/Cassette Deck

In-dash component combines AM/FM-stereo radio and auto-reverse, metal-compatible stereo cassette deck in compact dual chassis designed to fit almost any domestic or foreign car. Cassette deck features Dolby noise reduction; Sendust tape head; tape program search in either direction; normal/CrO₂/FeCr switch; Dolby and metal tape indicators; wow and flutter 0.15% wrms; frequency range 40-15,000 Hz with metal tape; S/N ratio 57 dB. Dolby on; stereo separation 35 dB. Radio features 5-button AM/FM electronic tuning with memory; auto electronic and manual electronic scan tuning; LED digital frequency/clock display with auto dimmer; FM Dolby noise reduction; bass, treble, fader, balance controls; FM S/N ratio 60 dB, Dolby on; selectivity 80 dB; frequency response 30-15,000 Hz at -3 dB; separation 35 dB at 1 kHz; capture ratio 2 dB. Unit also features ignition noise killer; key-off/end-of-play pinch-roller release; low-level connectors for separate 8-, 20-, 40-W/channel power amplifiers; $7\frac{1}{4}''\text{W} \times 4\frac{3}{4}''\text{D} \times 2''\text{H}$ \$500

RX-791 AM/FM Stereo Cassette Deck

In-dash high-power unit with 10-W/channel output at 1% THD, DIN chassis to fit most imported cars. Features auto-reverse deck; locking fast forward/rewind; eject button; program selector switch; Dolby noise reduction; tape indicator; cassette door illumination; 5-button AM/FM tuning; bass, treble, fader, balance controls; FM ignition noise killer; separate AM/FM dial illumination; Stereo Reception Control (SRC); adjustable shafts; power antenna lead. Wow and flutter 0.15% wrms; frequency range 50-12,500 Hz at 3 dB; S/N ratio 57 dB, Dolby on; separation 40 dB. FM S/N ratio 64 dB; selectivity 86 dB; frequency range 30-15,000 Hz; separation 35 dB at 1 kHz; capture ratio 3 dB; $7''\text{W} \times 5\frac{1}{4}''\text{D} \times 1\frac{1}{2}''\text{H}$ \$350

RX-735 AM/FM Stereo/Cassette Player

In-dash AM/FM-stereo receiver with auto-reverse stereo cassette deck. Features quartz PLL frequency-synthesized AM/FM tuning; 6 AM/6 FM programmable electronic station presets; automatic seek, scan,



manual rotary step tuning; super distant/local circuit; distance/local, mono/stereo switches; FM muting; locking fast forward/rewind; program selector switch; "pinch-off" tape protection; tape-running indicator; adjustable shafts; fader and balance controls for 4-speaker system; display dimmer lead. Output power 8 W rms/channel into 4 ohms; $7''\text{W} \times 4\frac{3}{4}''\text{D} \times 2''\text{H}$ \$320

RX-79 AM/FM Stereo Cassette Player

In-dash AM/FM-stereo receiver with auto-reverse cassette player. Features locking fast forward/rewind; 4-speaker capability; separate bass and treble controls; tuning, balance, fader controls with 5-button preset tuning; stereo/mono switch; pushbutton program selector; output power 18 W/channel \$290

CZ-725 AM/FM Stereo/Cassette Deck

In-dash unit features super-compact chassis to fit almost any domestic or foreign car. Features auto-reverse deck; locking fast forward/rewind; eject button; program selector switch; Dolby noise reduction; normal/chrome/ferrichrome selector switch; Dolby tape indicator; manual tuning; bass, treble, fader, balance controls; dial illumination; distant/local switch;

5

CAR STEREO EQUIPMENT

loudness control; low-level output for separate power amplifier; optional nosepiece for vertical installation. Wow and flutter 0.15% wrms; frequency range 50-12,500 Hz; S/N ratio 57 dB, Dolby on; 35 dB separation. FM S/N ratio 64 dB; selectivity 80 dB; frequency range 30-15,000 Hz; separation 35 dB at 1 kHz; capture ratio 2 dB; $6\frac{1}{8}''W \times 4\frac{3}{4}''D \times 1\frac{1}{2}''H$ \$230

RX-726 AM/FM-Stereo/Cassette Player

Super-compact AM/FM-stereo receiver with auto-reverse cassette player. Features locking fast forward/rewind; tape program selector; metal/CrO₂ equalization switch; hard Permalloy tape head; indicators for FM stereo and metal tape; manual tuning; fader and balance controls for 4-speaker system; loudness control; distant/local switch; adjustable shafts; power-antenna lead. Output power 7 W rms/channel into 4 ohms; $6\frac{1}{8}''W \times 4\frac{3}{4}''D \times 2''H$ \$200

RX-711 AM/FM-Stereo/Cassette Player

In-dash AM/FM-stereo receiver with full auto-stop cassette player. Features locking fast forward; tape-end indicator; dial in cassette door; hard Permalloy tape head; metal-tape compatibility; 5 AM/5 FM station presets; local/distant switch; stereo indicator; loudness control; fader and balance controls for 4-speaker system; adjustable shafts. Output power 8 W rms/channel into 4 ohms; $7\frac{1}{8}''W \times 4\frac{3}{4}''D \times 2\frac{1}{2}''H$ \$180

RX-723 AM/FM-Stereo Cassette Deck

Super-compact in-dash unit with loudness control and 7-W/channel amplifier. Features auto-stop deck; tape-end indicator; locking fast forward; eject button; manual radio tuning; local/distance switch; mono/stereo switch; fader and balance controls; nose piece for vertical installations; adjustable shafts; power antenna lead. Wow and flutter 0.15% wrms; frequency range 50-15,000 Hz; S/N ratio 50 dB. FM S/N ratio 62 dB; selectivity 68 dB; frequency range 30-15,000 Hz; capture ratio 2 dB; $6\frac{1}{2}''W \times 4\frac{1}{2}''D \times 1\frac{1}{4}''H$ \$160

Under-Dash Units

RX-103 FM-Stereo/Cassette Deck

Under-dash unit combines FM-stereo radio and stereo cassette player. Cassette deck features hard permalloy head; auto eject; 7-W/channel amplifier; bass, treble, balance controls; ignition noise killer \$170

GX-102 Cassette Deck

Under-dash auto-reverse cassette deck features locking fast forward/rewind; tape program selector; hard permalloy head; separate bass and treble controls; low-level DIN connector output; metal/chrome equalization. Output power 7 W/channel at 4 ohms \$170
GX-101. Similar to GX-102 except without separate bass and treble controls, auto-reverse deck .. \$100

CX-21 Deluxe Cassette Deck

Under-dash deluxe stereo cassette deck. Features hard Permalloy tape head; auto reverse; automatic eject; locking fast forward/rewind; program selector switch; dimmer control connection; noise reduction. Wow and flutter 0.15% wrms \$140

PANASONIC

CQ-6800 AM/FM-Stereo/Cassette Player

Compact AM/FM-stereo/cassette player with locking fast forward/rewind mechanism and manual-tune AM/FM tuner. Features local/DX switch; tape-play and FM-stereo indicators; afc (automatic frequency control) on FM; adjustable shafts. Output power 5 W/channel into 4 ohms; wow and flutter 0.3% wrms; tape frequency range 40-10,000 Hz; S/N ratio 45 dB; FM usable sensitivity 10 dBf; $7''W \times 4\frac{7}{8}''D \times 1\frac{3}{4}''H$ \$150

Supreme Series

CQ-S900 AM/FM-Stereo/Cassette Player

Compact in-dash pushbutton AM/FM-stereo receiver and metal-compatible auto-reverse cassette deck with Dolby noise reduction and hard permalloy head. Cassette deck features locking fast forward/rewind; metal/CrO₂ tape selector; wow and flutter 0.18% wrms; frequency response 40-12,500 Hz ± 3 dB; S/N ratio Dolby off/on 50/60 dB. Radio features seek/scan electronic tuning with 6 AM/6 FM preset buttons and digital time/frequency display; FM optimizer circuit; INQ circuit designed to suppress impulse noise on FM band; local/distant switch; fader, bass, treble controls; preamp output 1.0 V at 2000 ohms; amplifier output power 4 W/channel continuous at 400 Hz, both channels driven into 4 ohms with 1.0% THD; usable sensitivity 19 dBf; frequency response 30-15,000 Hz ± 3 dB; i-f rejection 80 dB; separation 35 dB at 1 kHz; $7''W \times 5\frac{1}{8}''D \times 2\frac{1}{8}''H$ \$450

CQ-S820 AM/FM-Stereo/Cassette Player

Compact AM/FM-stereo/cassette player with Repeatrack™ cassette player and electronic AM/FM tuning with digital display. Features seek/preset/manual tuning; local/DX switch for seek; FM optimizer; INQ circuit; adaptive FM front end; distributed multi-stage agc on AM; metal/CrO₂ tape capability; hard Permalloy tape head; 4-way balance controls (fader); loudness-compensated tone control; fully adjustable shafts. Amplifier output power 7.5 W/channel into 4 ohms; frequency response 40-35,000 Hz -3 dB. Wow and flutter 0.18%; frequency range 80-10,000 Hz; S/N ratio 50 dB. FM usable sensitivity 14 dBf; $7''W \times 5\frac{1}{8}''D \times 2\frac{1}{8}''H$ \$350

CQ-S761 AM/FM-Stereo/Cassette Player

Compact AM/FM-stereo/cassette player with auto-reverse mechanism and pushbutton AM/FM tuning. Features FM optimizer; INQ circuit; MOSFET and adaptive FM front end; agc on AM; locking fast forward/rewind; Dolby B tape noise reduction; metal/CrO₂/normal tape capability; W-cut hard Permalloy tape head; 4-way balance controls (fader); separate bass and treble controls; fully adjustable shafts. Output power 7.5 W/channel into 4 ohms; frequency response 40-35,000 Hz -3 dB. Wow and flutter 0.18% wrms; frequency range 40-12,500 Hz; S/N ratio Dolby on/off 60/50 dB. FM usable sensitivity 15 dBf; $7''W \times 5\frac{1}{8}''D \times 2\frac{1}{8}''H$ \$290
CQ-S768. Similar to CQ-S761 except no Ambience auto-reverse cassette deck with Ambience control switch; no Dolby NR \$290

CQ-S756. Similar to CQ-S761 except has loudness-compensated tone control instead of separate bass/treble controls \$270

CQ-S742. Similar to CQ-S761 \$260

CQ-S747 AM/FM-Stereo/Cassette Player

In-dash AM/FM-stereo/cassette player with high-power Repeatrack™ cassette player and manual pushbutton AM/FM tuning. Features FM optimizer; INQ circuit; MOSFET and adaptive FM front end; distributed-multi-stage agc on AM; locking fast forward/rewind; Dolby tape noise reduction; metal/CrO₂ tape selector; hard Permalloy tape head; 4-way balance controls (fader); separate bass and treble controls; radio monitor; compact chassis; fully adjustable shafts. Output power 20 W/channel into 4 ohms; frequency response 20-40,000 Hz -3 dB. Wow and flutter 0.13% wrms; frequency range 80-12,000 Hz; S/N ratio Dolby on/off 60/50 dB. FM usable sensitivity 14 dBf; $7''W \times 5\frac{1}{8}''D \times 1\frac{3}{4}''H$ \$250

CQ-S700 AM/FM-Stereo/Cassette Player

Compact Repeatrack™ cassette player with pushbutton AM/FM tuner. Features FM optimizer; INQ circuit; MOSFET and adaptive FM front end; distributed multi-stage agc on AM; locking fast forward/rewind; hard Permalloy tape head; 4-way balance controls (fader); separate bass and treble controls; LED signal-level meter; fully adjustable shafts. Output power 7.5 W/channel into 4 ohms; frequency response 40-35,000 Hz -3 dB. Wow and flutter 0.18%; frequency range 40-12,500 Hz; S/N ratio 50 dB. FM usable sensitivity 14 dBf; $7''W \times 5\frac{1}{8}''D \times 2\frac{1}{8}''H$ \$230
CQ-S717. Similar to CQ-S700 except no Repeatrack™

cassette player; no separate bass/treble controls; has W-cut hard Permalloy tape head \$220

CQ-S703 AM/FM-Stereo/Cassette Player

Ambience Repeatrack™ cassette player with pushbutton AM/FM tuner. Features Ambience control switch; FM optimizer; INQ circuit; MOSFET and adaptive front end; distributed multi-stage agc on AM; locking fast forward/rewind; hard Permalloy head; 4-way balance controls (fader); loudness-compensated tone control; fully adjustable shafts. Output power 7.5 W/channel into 4 ohms; frequency response 40-35,000 Hz -3 dB. Wow and flutter 0.12% wrms; frequency range 40-12,500 Hz; S/N ratio 50 dB. FM usable sensitivity 14 dBf; $7''W \times 5\frac{1}{8}''D \times 2\frac{1}{8}''H$ \$230
CQ-S708. Similar to CQ-S703 except has separate bass and treble controls, radio monitor \$220

CQ-S680 AM/FM-Stereo/Cassette Player

Compact Repeatrack™ cassette player with pushbutton AM/FM tuner. Features FM optimizer; INQ circuit; MOSFET and adaptive FM front end; distributed multi-stage agc on AM; locking fast forward/rewind; hard Permalloy tape head; 4-way balance controls (fader); loudness-compensated tone control; fully adjustable shafts. Output power 7.5W/channel into 4 ohms; frequency response 40-35,000 Hz -3 dB. Wow and flutter 0.18% wrms; frequency range 80-10,000 Hz; S/N ratio 50 dB. FM usable sensitivity 14 dBf; $7''W \times 5\frac{1}{8}''D \times 2\frac{1}{8}''H$ \$200
QS-S686. Similar to QS-680 except has Ambience Repeatrack™ cassette player; ambience control switch; no 4-way balance controls or loudness-compensated tone controls \$190

CQ-S661 AM/FM-Stereo/Cassette Player

Compact Repeatrack™ cassette player with manual AM/FM tuner. Features FM optimizer; INQ circuit; MOSFET and adaptive FM front end; distributed multi-stage agc on AM; Dolby tape noise reduction; locking fast forward/rewind; hard Permalloy tape head; separate bass and treble controls; radio monitor; compact chassis; fully adjustable shafts. Output power 7.5 W/channel into 4 ohms; frequency response 50-35,000 Hz -3 dB. Wow and flutter 0.13% wrms; frequency range 80-12,500 Hz; S/N ratio Dolby on/off 60/50 dB. FM usable sensitivity 14 dBf; $7''W \times 5\frac{1}{8}''D \times 1\frac{3}{4}''H$ \$200
CQ-S646. Similar to CQ-S661 except no Dolby NR \$170

Overhead Cockpit Series

RM-710 AM/FM-Stereo Tuner/Cassette Player

Overhead console-type car audio system with auto-reverse cassette player, Dolby B noise reduction, AM/FM-stereo tuner, and stereo preamplifier. Features locking fast forward/rewind; key-off eject; normal/CrO₂ tape selector; tape program sensor; AM/FM-stereo tuner with 5-way electronic soft-touch tuning; 6 AM/6 FM station presets; pushbutton manual tuning; LED tuning indicators; local/DX switch; impulse-noise quieting (INQ) circuit; 5-band graphic equalizer; electronic volume control with LED level indicators; sound attenuator switch; joystick balance and fader controls; loudness and dimmer switches; stereo power amplifier; 4-position dome light. Preamp frequency response 20-50,000 Hz ± 3 dB; THD 0.02% at 1 kHz. Wow and flutter 0.13% wrms; frequency response 30-14,000 Hz ± 3 dB; S/N ratio Dolby on/off 63/55 dB; separation 40 dB. FM usable sensitivity 16 dBf; THD 0.15%; S/N ratio 72 dB; image rejection 65 dB; frequency response 20-15,000 Hz ± 3 dB; separation 40 dB at 1 kHz \$1400

RM-310 AM/FM-Stereo/Cassette Player

Ceiling-mount car stereo system with Repeatrack cassette player. Features locking fast forward/rewind; key-off eject; high filter switch; AM/FM-stereo tuner with 3 station reference guides; FM-stereo auto/mono switch; LED function indicators; mute switch; local/DX switch; INQ circuit; center-detented balance and fader controls; 3-band graphic equalizer; loudness switch; stereo power amplifier; audio power indicators; 4-position dome light. Output power 10 W minimum/channel into 4 ohms at 1% THD, 30-20,000 Hz. Wow and flutter 0.15% wrms; frequency response

40-12,000 Hz ± 3 dB; S/N ratio 55 dB A weighted; separation 40 dB. FM section: usable sensitivity 16 dBf; S/N ratio 73 dB A weighted; image rejection 60 dB; frequency response 30-15,000 Hz ± 3 dB; separation 35 dB \$600

CX-1000 Under-Dash Stereo Cassette Player

Compact under-dash stereo Repeatrack™ cassette player. Features locking fast forward/rewind; separate balance, tone, volume controls; convenient FF/REW/eject mechanism; auto-eject at end of play. Output power 5 W/channel into 4 ohms; wow and flutter 0.3% wrms; frequency range 40-10,000 Hz; S/N ratio 45 dB; $5\frac{1}{2}'' \times 6'' \times 2''$ H \$90

PIONEER

KEX-65 AM/FM-Stereo/Cassette Player

In-dash auto-reverse cassette deck with quartz controlled electronic AM/FM tuner. Features Supertuner II front end; 10 FM/5 AM station electronic preset feather-touch pushbutton tuning; automatic/local scan; FM auto/mono switch; automatic FM mute; pulse-noise suppression; 4-digit green LED time/frequency display; separate bass and treble slide controls; Dolby noise reduction; metal/chrome tape selector; music search; locking fast forward/rewind; ferrite head; tape guard; key-off pinchroller release; loudness, volume, balance controls; installation bracket with special security keys; power-antenna activator. Requires separate power amplifier \$420

UKE-7100 AM/FM-Stereo/Cassette Player

Mini in-dash AM/FM-stereo radio/cassette player with Supertuner II and Dolby noise reduction. Features quartz PLL electronic tuning; auto-reverse cassette deck; music search; 4-digit green LED time/frequency display; 10 FM/5 AM station electronic preset feather-touch tuning; separate bass and treble controls; auto/local scan; FM auto/mono switch; auto FM muting; pulse noise suppressor; hard Permalloy head; locking fast forward/rewind; tape guard; key-off pinchroller release; loudness, balance, volume controls; metal/chrome tape selector; power-antenna activator \$400

KEX-50 AM/FM-Stereo/Cassette Player

Digital quartz AM/FM-stereo tuner with cassette deck. Features Supertuner II; 4-digit green LED time/frequency display; LED address indicators on preset buttons; metal/chrome tape selector; quartz PLL tuning; Dolby noise reduction; separate bass, treble, loudness controls; 10 FM/5 AM station electronic preset feather-touch tuning buttons; auto scan/seek tuning; FM auto/mono and local/scan switches; pulse-noise suppression; locking fast forward/rewind; auto replay after rewind; auto eject; illuminated cassette door; power-antenna activator. Requires separate power amplifier \$380

KE-6100 AM/FM-Stereo/Cassette Player

In-dash unit with digital quartz AM/FM-stereo Supertuner II and Dolby noise reduction. Features LED address indicators on preset buttons (10 FM/5 AM); 4-digit green LED time/frequency display; local/scan switch; pulse-noise suppression; quartz PLL tuning; chrome/metal tape selector; parallel fader control that permits use of 2 amplifiers; locking fast forward/rewind; automatic replay after rewind; loudness switch; automatic eject; power-antenna activator \$350

KE-5100 AM/FM-Stereo Receiver/Cassette Player

In-dash unit with electronically tuned AM/FM-stereo Supertuner II, digital time/frequency display, and PNS noise suppression. Features auto scan/seek; preset of up to 5 AM and 10 FM stations; quartz PLL synthesizer tuning system; FM auto/mono switch; auto replay/eject; locking fast forward/rewind; loudness control; parallel fader control fort 2 booster amplifiers; activates any automatic power antenna. Output 2.9 W/ch into 4 amplifiers 50-15,000 Hz at 5% THD. Wow and flutter 0.15 wrms; S/N ratio 52 dB; frequency response 50-12,000 Hz ± 3 dB. FM usable sensitivity 16.8 dBf (mono); selectivity 70 dB; $7\frac{1}{4}'' \times 6'' \times 2''$ H \$300

KEX-20 AM/FM-Stereo/Cassette Player

In-dash AM/FM-stereo electronic Supertuner II with stereo cassette deck. Features Electronic tuning with 10 FM/5 AM station presets; Dolby noise reduction; separate bass and treble controls; metal/chrome tape selector; electronic LED pointer and LED AM/FM band indicators; pulse-noise suppression; automatic muting on FM; auto/mono switch; locking fast forward/rewind; automatic replay after rewind \$300

UPX-9600 AM/FM-Stereo/Cassette Player

Mini in-dash unit with Supertuner II AM/FM-stereo tuner, Dolby noise reduction, and radio interplay feature. Features auto-reverse cassette deck; 5-station preset tuning; FM auto/mono switch; pulse noise suppressor; auto FM muting; tape guard; key-off pinchroller release; music search; hard Permalloy tape head; separate bass, treble, loudness controls; tape selector; power-antenna activator \$300

KEX-20 AM/FM-Stereo Tuner/Cassette Player

In-dash AM/FM-stereo radio/cassette deck with Dolby noise reduction. Cassette features locking fast forward/rewind; auto eject at end of play; auto replay at end of rewind; metal/chrome selector. Supertuner II electronic tuner with 5 AM/10 FM station electronic feather-touch preset tuning; LED station indicator; loudness control; PNS noise suppressor; automatic stereo/mono; auto muting on FM stereo; separate bass and treble; balance. Tape response 30-15,000 Hz; S/N Dolby off/on 52/60 dB; FM 50-dB quieting sensitivity 19.2 dBf; FM selectivity 74 dB; requires separate amplifier; $7\frac{1}{4}'' \times 7\frac{1}{4}'' \times 2''$ H. \$300

UKP-7600 AM/FM-Stereo/Cassette Player

Auto-reverse cassette deck with Supertuner II AM/FM-stereo radio. Features 5-station preset tuning; separate bass and treble controls; music search; tape guard; FM auto/mono switch; pulse noise suppressor; locking fast forward/rewind; key-off pinchroller release; hard Permalloy head; loudness switch; adjustable shafts; power-antenna activator \$280

UKE-3100 AM/FM-Stereo/Cassette Player

Mini quartz PLL tuned AM/FM-stereo radio with cassette deck. Features 4-digit green LED time/frequency display; 10 FM/5 AM station presets; auto/local scan; FM stereo/mono switch; auto FM muting; music search; tape guard; auto replay and eject; locking fast forward/rewind; key-off pinchroller release; head Permalloy head; tape play indicator; volume, tone, balance, loudness controls; power-antenna activator \$280

KP-7500 AM-Stereo FM/Cassette Player

In-dash AM/FM-stereo Supertuner and auto-reverse cassette player with permalloy head and Dolby noise reduction. Features metal/chrome selector; locking fast forward/rewind; automatic tape slack canceller. Radio features PNS noise suppression; automatic muting; loudness; auto stereo/mono; balance, volume, tone, fader controls; playback response 50-12,000 Hz; S/N ratio Dolby off/on 45/52 dB; output power 2.9 W/channel continuous, both channels driven into 4 ohms, 50-15,000 Hz with 5.0% THD; FM 50-dB quieting sensitivity 19.2 dBf; FM selectivity 74 dB; $7\frac{1}{4}'' \times 7\frac{1}{4}'' \times 2''$ H \$260

KP-6500. Similar to KP-7500 except without Dolby and auto reverse; 5-station preset tuning; auto eject and replay \$220

KP-5500. Similar to KP-6500 except without auto muting, fader, built-in PNS; muting switch; FM sensitivity 14.3 dBf \$180

KP-4500. Similar to KP-5500 except without auto eject, stereo/mono, station preset buttons; has auto reverse and auto muting; output power 3.2 W/channel; FM sensitivity 19.2 dBf; FM selectivity 50 dB \$160

KP-2500. Similar to KP-4500 less automatic tape slack canceller, loudness, auto reverse, auto muting; has auto eject and stereo/mono \$140

KP-1500. Similar to KP-2500 except designed for Japanese imports and X-body cars; mini chassis; FM muting; locking fast forward; output power 2.5 W/channel continuous; FM sensitivity 20.7 dBf; $6\frac{3}{4}'' \times 5\frac{3}{4}'' \times 1\frac{3}{4}''$ H \$120

KE-2100 AM/FM-Stereo/Cassette Player

In-dash cassette player with Supertuner AM/FM-stereo radio. Features electronic tuning; 10-station electronic presets; FM mono/stereo, local/DX, muting switches; electronic LED station pointer; locking fast forward/rewind; auto play after rewind; AM/FM LED indicator; auto eject; connector for pulse noise suppressor; adjustable shafts; power-antenna activator \$250

UKP-5600 AM/FM-Stereo/Cassette Player

Mini receiver/cassette system designed for subcompact and imported cars. Features mini cassette deck; AM/FM-stereo Supertuner II; music search; automatic tape-slack canceller; separate bass, treble, and loudness controls; PNS noise suppression; 5-station preset tuning; FM auto/mono switch; auto replay/eject; locking fast forward/rewind; hard permalloy tape head; key-off pinchroller release; activates any fully automatic power antenna. Output power 3.2 W/channel into 4 ohms, 50-15,000 Hz ± 3 dB; FM usable sensitivity 16.9 dBf (mono); selectivity 70 dB; $7\frac{1}{4}'' \times 3\frac{3}{4}'' \times 2''$ H \$250

UKP-7200. Similar to UKP-5600 except has auto-reverse cassette deck; no Supertuner II, base/treble controls, PNS noise suppression, auto replay/eject. Wow and flutter 0.13%; FM sensitivity 20.8 dBf; selectivity 50 dB \$240

KP-8500 AM-Stereo FM/Cassette Player

In-dash Supertuner AM/FM-stereo FM radio/cassette player with dual-Dolby noise reduction. Features auto eject; locking fast forward/rewind. 5-station preset pushbutton tuning; stereo/mono and local/distant switches; auto FM muting; volume, tone, balance controls. Wow and flutter 0.28% wrms; tape frequency response 50-12,000 Hz; S/N ratio Dolby on/off 53/45 dB; FM 50-dB quieting sensitivity 1.4 μ V into 75 ohms; alternate-channel selectivity 74 dB; $7\frac{1}{4}'' \times 7\frac{1}{4}'' \times 2''$ H; nose dimensions $1\frac{3}{8}'' \times 4\frac{1}{8}'' \times 1\frac{1}{4}''$ D \$200

UKP-5200 AM/FM-Stereo/Cassette Player

Mini 5-station-preset AM/FM-stereo radio with cassette player. Features music search; tape guard; auto replay and eject; key-off pinchroller release; loudness control; locking fast forward/rewind; FM mono/stereo switch; auto FM muting; FM-stereo indicator; hard Permalloy tape head; volume, tone, balance controls; adjustable shafts; power-antenna activator ... \$210

KP-3500 AM-Stereo FM/Cassette Player

In-dash AM/FM-stereo radio/cassette player designed to fit European cars. Features PNS noise suppression system; auto eject and replay; locking fast forward/rewind; stereo/mono and local/distant switches; volume, tone, balance controls. Maximum output power 6 W continuous; wow and flutter 0.28% wrms; tape frequency response 50-12,000 Hz; S/N ratio 45 dB; FM usable sensitivity 1.1 μ V; (23.2 dBf); FM 50-dB quieting sensitivity 1.4 μ V; selectivity 50 dB; capture ratio 4 dB; $7\frac{1}{4}'' \times 6\frac{3}{4}'' \times 2''$ H; nose dimensions $4\frac{1}{4}'' \times 1\frac{3}{8}'' \times \frac{3}{4}''$ D \$180

UKP-4200 AM/FM-Stereo/Cassette Player

Mini auto-reverse cassette deck with AM/FM-stereo radio. Features music search; tape guard; keyoff pinchroller release; tape direction LED; locking fast forward/rewind; FM stereo indicator; mono/stereo switch; loudness, volume, tone, balance controls; hard tape Permalloy head; adjustable shafts; power-antenna activator \$190

UKP-2200. Similar to UKP-4200 except no auto-reverse cassette deck \$170

TP-6006 AM/FM-Stereo/8-Track

In-dash AM/FM-stereo radio/8-track player with auto and manual program change, stereo/mono switch, LED FM and stereo indicators, and volume, balance and tone controls. Maximum output power 8 W continuous; wow and flutter 0.3% wrms; tape frequency response 50-10,000 Hz; $7\frac{1}{2}'' \times 7\frac{1}{8}'' \times 2''$ H \$130

Under-Dash Units

KP-909G Auto-Reverse Cassette Deck

Three-motor, direct reel drive auto-reverse cassette deck. Features Dolby noise reduction; tape guard;

5

CAR STEREO EQUIPMENT

separate bass and treble controls; microprocessor-controlled music search, music repeat, music scan, blank skip; feather-touch transport controls; high-density ferrite head; metal/chrome tape selector; key-off soft eject; locking fast forward/rewind; loudness, volume, balance controls; illuminated cassette door; Automatic-Guard eject; terminal for optional remote-control unit. Requires separate power amp. . . \$380

KP-707G Auto-Reverse Cassette Deck

Auto-reverse stereo cassette deck with Dolby noise reduction. Features tape guard; separate bass and treble controls with detents; chrome/metal tape selector; feather-touch transport controls; ferrite head; auto attenuator; balance control with center click; detented volume control; loudness control; locking fast forward/rewind; tape direction indicator; electronically governed motor. Requires separate power amplifier . . . \$200

KP-500 FM-Stereo/Cassette Player

Under-dash unit with FM Supertuner, PLL MPX demodulator. Features bass, treble, balance controls; FM muting; stereo/mono and loudness switches; auto eject; tape-play and stereo indicators. Output power 3 W/channel into 4 ohms 50-15,000 Hz at 5% THD;

wow and flutter 0.3% wrms; tape frequency response 50-10,000 Hz ± 3 dB; FM usable sensitivity 12 dB (mono); FM selectivity 74 dB; $7\frac{1}{2}''\text{W} \times 7\frac{1}{2}''\text{D} \times 3''\text{H}$. . . \$190

KP-404G Stereo Cassette Deck

Stereo cassette deck with Dolby noise reduction. Features music search; tape guard; separate bass and treble controls; ferrite head; metal/chrome tape selector; illuminated cassette door; key-off pinchroller release; auto replay and eject; locking fast forward/rewind; loudness, volume, balance controls. Requires separate power amplifier . . . \$160

KPX-600 Stereo FM/ Cassette Player

Under-dash FM-stereo Supertuner and stereo cassette player. Features auto replay and eject; locking fast forward/rewind; tape-play indicator; electronic governor motor; center detented volume, bass, treble, balance controls; FM muting; loudness contour switch; FM stereo indicator; FM stereo/mono switch. FM S/N ratio 68 dB; capture ratio 1.7 dB; separation 32 dB (65 dBf, 1 KHz); sensitivity 14.3 dBf; selectivity 74 dB. Fast-wind time 120 seconds with C60 cassette; wow and flutter 0.13% wrms; frequency response 30-15,000 Hz -3 dB; S/N ratio 52 dB; $7\frac{1}{2}''\text{W} \times 6\frac{1}{2}''\text{D} \times 2\frac{1}{2}''\text{H}$. . . \$140

KP-202G Stereo Cassette Deck

Stereo cassette deck with music search and tape guard. Features metal/chrome tape selector; separate bass and treble controls; illuminated cassette door; key-off pinchroller release; automatic eject; locking fast forward/rewind; loudness, volume, balance controls . . . \$140

KP-575 Cassette Player

Under-dash cassette auto-reverse cassette player with auto tape slack eliminator, locking fast forward/rewind, tape direction indicators, and loudness, volume, tone and balance controls. Wow and flutter 0.25% wrms; frequency response 50-10,000 Hz; S/N ratio 45 dB; maximum output power 6 W continuous; $6\frac{1}{4}''\text{W} \times 4\frac{3}{8}''\text{D} \times 2''\text{H}$. . . \$130

KP-373. Similar to KP-575 except without auto reverse; has auto replay and slide volume control; $4\frac{3}{8}''\text{W} \times 6\frac{1}{4}''\text{D} \times 2''\text{H}$. . . \$115

REALISTIC

12-1889 AM/FM-Stereo/Cassette Player

In-/under-dash unit combines AM/FM-stereo receiver, stereo cassette player, and LED digital radio frequency/clock display with LED dimmer switch. Cassette features key-off eject and locking fast forward/rewind; radio has stereo/mono switch; includes speaker and speaker cables. Output power 7 W/channel . . . \$180

12-1892 Stereo Cassette Player

In-dash stereo cassette player designed for X body and import cars; has locking fast forward and auto stop in play mode; includes speaker cables. Output power 4 W/channel . . . \$100

SANYO

FT C18 AM/FM-Stereo/Cassette Player

In-dash unit with metal-tape capability, pushbutton tuning, Automatic Music Select System, and FM optimizer. Features auto-reverse cassette deck with Dolby noise reduction; line-level outputs; DX/LOC switch; loudness control; separate bass and treble controls; backlit function labels. Output 500 mV, 30-20,000 Hz ± 3 dB; wow and flutter 0.15% wrms; S/N ratio 50 dB A weighted; frequency response 63-14,000 Hz ± 3 dB; separation 46 dB; FM usable sensitivity 19.2 dBf; alternate-channel selectivity 60 dB; capture ratio 2 dB; $6\frac{1}{4}''\text{W} \times 4\frac{3}{8}''\text{D} \times 2''\text{H}$. . . \$200

FTV 96 AM/FM-Stereo/Cassette Player

Unit has auto-reverse cassette deck, Dolby noise reduction, and AMSS (Automatic Music Select System). Features high-power amplifier; metal-tape capability; locking fast forward/rewind; loudness control; local/distant switch; tape-direction and FM-stereo indicators; stereo/mono switch; fader control; adjustable shafts; automatic-antenna control. Output power 10

Why Roll Your Own When Deutsche Grammophon Does It So Much Better?

Each of DG's new DOUBLETIME TAPES™ offers 90 minutes—a full one-and-a-half hours—of classical music enjoyment for only \$7.98 list. It's a great two-for-one value: two LPs worth of music for the price of a single album!

To "make" these tapes at home you'd have to spend more on records and blank tapes than your equipment probably cost in the first place. Is it really worth it?

If you want to know more about DG's comprehensive

classical cassette catalogue of performances

by the world's greatest artists, please send in the Reader Service Card at the back of this magazine, after circling Number 3.



1982 DG/Polygram Classics, Inc.



Photography: Waring Abbott

W/channel into 4 ohms; frequency response 100-20,000 Hz; THD 1%. Wow and flutter 0.09% wrms; frequency response 60-12,500 Hz ± 3 dB; S/N ratio 50 dB A weighted; separation 35 dB. FM 50-dB quieting sensitivity 18.2 dBf; alternate-channel selectivity 65 dB; capture ratio 2 dB; separation 35 dB; $7\frac{1}{4}'' \times 5\frac{1}{4}'' \times 2''$ \$200

FTV 92 AM/FM-Stereo/Cassette Player

High-power AM/FM-stereo receiver with auto-reverse cassette deck. Features AMSS (Automatic Music Select System); pushbutton tuning; FM optimizer; manual reverse; fader, bass, treble, loudness controls; locking fast forward/rewind; local/distant and stereo/mono switches; automatic-antenna control. Output power 9.5 W/channel into 4 ohms; frequency response 50-20,000 Hz; THD 1%. Wow and flutter 0.15% wrms; frequency response 63-12,500 Hz ± 3 dB with normal tape; S/N ratio 50 dB A weighted; separation 40 dB. FM 50-dB quieting sensitivity 21.6 dBf; alternate-channel selectivity 70 dB; capture ratio 2 dB; separation 40 dB; $7'' \times 5\frac{1}{8}'' \times 2''$. \$200

FTC 66 AM/FM-Stereo/Cassette Player

AM/FM-stereo radio with auto-reverse cassette deck and AMSS (Automatic Music Select System). Features Dolby noise reduction; metal-tape capability; FM optimizer; tape-protection circuitry; line output jacks; key-off pinchroller release; Sendust alloy head; EZ-C Install system; separate bass and treble controls; fader and loudness controls; local/distant and stereo/mono switches; locking fast forward/rewind; automatic-antenna control. Output power 3W/channel into 4 ohms; frequency response 100-20,000 Hz ± 3 dB. Wow and flutter 0.15% wrms; frequency response 63-14,000 Hz ± 3 dB; S/N ratio 50 dB A weighted; separation 46 dB. FM 50-dB quieting sensitivity 21.6 dBf; alternate-channel selectivity 70 dB; capture ratio 2 dB; separation 40 dB at 1 kHz; $6\frac{1}{8}'' \times 4\frac{1}{4}'' \times 2''$ \$200

FT9 AM/FM-Stereo/Cassette Player

Advanced signal-processing AM/FM-stereo radio with auto-reverse cassette deck. Features AMSS (Automatic Music Select System); FM optimizer; locking fast forward/rewind; loudness, fader, bass, treble controls; pushbutton memory tuning for 5 AM/5 FM stations; local/distant switch; automatic-antenna control. Output power 4 W/channel into 4 ohms at 10% THD; frequency response 50-20,000 Hz ± 3 dB. Wow and flutter 0.15% wrms; frequency response 60-12,500 Hz ± 3 dB; S/N ratio 50 dB A weighted; separation 40 dB. FM 50-dB quieting sensitivity 21.6 dBf; alternate-channel selectivity 70 dB; capture ratio 2 dB; separation 30 dB at 1 kHz; $7'' \times 5'' \times 2''$. \$180

FT C15 AM/FM-Stereo/Cassette Player

In-dash unit with Automatic Music Select System, FM optimizer, and full auto-reverse cassette deck. Features pushbutton tuning; separate bass, treble, fader controls; locking fast forward/rewind. Output power 4 W/channel into 4 ohms at 10% THD 100-20,000 Hz; frequency response 50-20,000 Hz ± 3 dB. Wow and flutter 0.15% wrms; frequency response 63-12,500 Hz ± 3 dB; S/N ratio 50 dB. FM usable sensitivity 20.8 dBf; alternate-channel selectivity 55 dB; capture ratio 2 dB; $6\frac{1}{4}'' \times 4\frac{3}{4}'' \times 2''$ \$180

FTC27 AM/FM-Stereo/Cassette Player

Mini-size high-power AM/FM-stereo receiver with auto-reverse cassette deck. Features FM optimizer; Dolby noise reduction; locking fast forward/rewind; separate bass and treble controls; stereo/mono and local/distant switches; EZ-C Install system; automatic-antenna control. Output power 9.5 W/channel into 4 ohms at 1% THD; frequency response 50-20,000 Hz ± 3 dB. Wow and flutter 0.1% wrms; frequency response 80-10,000 Hz ± 3 dB; S/N ratio 50 dB A weighted; separation 35 dB. FM 50-dB quieting sensitivity 20.2 dBf; alternate-channel selectivity 60 dB; capture ratio 3 dB; separation 30 dB at 1 kHz; $6\frac{1}{4}'' \times 4\frac{3}{4}'' \times 2''$ \$170

FT C12 AM/FM-Stereo/Cassette Player

In-dash unit with digital frequency/time display and full auto-reverse cassette deck. Features locking fast forward/rewind; distant/local, frequency/time, FM/AM, reverse switches. Output power 2.4 W/channel

into 4 ohms at 5% THD 100-20,000 Hz; frequency response 100-20,000 Hz ± 3 dB. Wow and flutter 0.1% wrms; frequency response 80-10,000 Hz ± 3 dB; S/N ratio 50 dB A weighted; separation 35 dB. FM usable sensitivity 17.2 dBf; alternate-channel selectivity 60 dB; capture ratio 3 dB; $6\frac{1}{4}'' \times 4\frac{3}{4}'' \times 2''$ \$150

FTC45 AM/FM-Stereo/Cassette Player

AM/FM-stereo receiver with auto-eject/auto-replay cassette deck. Features pushbutton memory tuning; automatic stereo/mono switching; fader control; locking fast forward/rewind; local/distant switch; separate volume, tone, balance controls. Output power 3 W/channel into 4 ohms at 10% THD; frequency response 100-20,000 Hz ± 3 dB. Wow and flutter 0.15% wrms; frequency response 80-10,000 Hz ± 3 dB; S/N ratio 50 dB A weighted; separation 40 dB. FM 50-dB quieting sensitivity 21.6 dBf; alternate-channel selectivity 60 dB; capture ratio 3 dB; separation 30 dB at 1 kHz; $6\frac{1}{4}'' \times 4\frac{3}{4}'' \times 1\frac{3}{4}''$. \$140

FT C13 AM/FM-Stereo/Cassette Player

In-dash unit with auto-reverse cassette deck, pushbutton tuning, fader control, and locking fast forward/reverse. Output power 4 W/channel into 4 ohms at 10% THD, 100-20,000 Hz; frequency response 50-20,000 Hz ± 3 dB. Wow and flutter 0.15% wrms; frequency response 63-12,500 Hz ± 3 dB with normal tape; S/N ratio 45 dB A weighted; separation 40 dB. FM usable sensitivity 20.8 dBf; alternate-channel selectivity 55 dB; capture ratio 3 dB; $6\frac{1}{4}'' \times 4\frac{3}{4}'' \times 2''$ \$140

FTV82 AM/FM-Stereo/Cassette Player

Auto-reverse AM/FM-stereo receiver/cassette player with Automatic Music Select System (AMSS); locking fast forward/rewind; fader control; local/distant switch; adjustable shafts; EZ Install system; automatic-antenna control. Output power 3 W/channel into 4 ohms at 5% THD; frequency response 150-20,000 Hz ± 3 dB. Wow and flutter 0.1% wrms; frequency response 80-10,000 Hz ± 3 dB; S/N ratio 50 dB A weighted; separation 35 dB. FM 50-dB quieting sensitivity 23.8 dBf; alternate-channel selectivity 60 dB; capture ratio 3 dB; separation 30 dB; $7\frac{1}{2}'' \times 4\frac{3}{4}'' \times 2''$ \$130

FT C26 AM/FM-Stereo/Cassette Player

In-dash mini-size, high-power unit with auto-reverse cassette deck. Features separate bass and treble controls; reverse, stereo/mono, FM/AM, local/distant switches; automatic control for electric antennas. Output power 9.5 W/channel into 4 ohms at 1% THD, 50-20,000 Hz; frequency response 100-20,000 Hz ± 3 dB. Wow and flutter 0.09% wrms; frequency response 80-10,000 Hz ± 3 dB; S/N ratio 50 dB A weighted; separation 35 dB. FM usable sensitivity 17.2 dBf; alternate-channel selectivity 60 dB; capture ratio 3 dB; $6\frac{1}{4}'' \times 4\frac{3}{4}'' \times 2''$ \$130

FTC36 AM/FM-Stereo/Cassette Player

Mini-size AM/FM-stereo receiver with auto-reverse cassette deck. Features AMSS (Automatic Music Select System); locking fast forward/rewind; balance and tone controls; local/distant, AM/FM, pushbutton eject switches; EZ-C Install system; automatic-antenna control. Output power 3 W/channel into 4 ohms at 10% THD, 100-20,000 Hz ± 3 dB. Wow and flutter 0.1% wrms; frequency response 80-10,000 Hz ± 3 dB; S/N ratio 50 dB A weighted; separation 35 dB. FM 50-dB quieting sensitivity 21.6 dBf; alternate-channel selectivity 55 dB; capture ratio 3 dB; separation 30 dB at 1 kHz; $6\frac{1}{4}'' \times 4\frac{3}{4}'' \times 1\frac{3}{4}''$. \$110

FTV77 AM/FM-Stereo/Cassette Player

High-power AM/FM-stereo receiver with auto-stop stereo cassette deck. Features automatic stereo/mono switching; locking fast forward/rewind; local/distant switch; volume, tone, balance controls; EZ Install system; automatic-antenna control. Output power 9 W/channel into 4 ohms at 1% THD; frequency response 50-20,000 Hz ± 3 dB. Wow and flutter 0.15% wrms; frequency response 80-10,000 Hz ± 3 dB; S/N ratio 50 dB A weighted; separation 40 dB. FM 50-dB quieting sensitivity 21.6 dBf; alternate-channel selectivity 60 dB; capture ratio 3 dB; separation 30 dB at 1 kHz; $7'' \times 5\frac{1}{8}'' \times 2''$ \$110

FT C8 AM/FM-Stereo/Cassette Player

In-dash unit with Automatic Music Select System and full auto-reverse cassette deck. Features vertical or horizontal mounting; separate bass, treble, fader controls; automatic up/down control for electric antennas. Output power 3.5 W/channel into 4 ohms at 10% THD; frequency response 80-10,000 Hz ± 3 dB with normal tape; S/N ratio 50 dB A weighted; separation 35 dB; FM sensitivity 20.8 dBf; alternate-channel selectivity 55 dB; capture ratio 3 dB; $6\frac{1}{4}'' \times 4\frac{3}{4}'' \times 2''$ \$130

FT C6 AM/FM-Stereo/Cassette Player

Mini-size in-dash unit with auto-reverse cassette deck and sensitive FM tuner. Features locking fast forward/rewind; separate bass and treble controls; reverse, FM/AM, distant/local switches; balance control; automatic up/down control for electric antennas. Output power 3.5 W/channel into 4 ohms at 10% THD; frequency response 100-20,000 Hz ± 3 dB. Wow and flutter 0.09% wrms; frequency response 80-10,000 Hz ± 3 dB with normal tape; S/N ratio 50 dB A weighted; separation 35 dB. FM usable sensitivity 20.8 dBf; alternate-channel selectivity 55 dB; capture ratio 3 dB; $6\frac{1}{4}'' \times 4\frac{3}{4}'' \times 2''$ \$100

FT526 AM/FM-Stereo/Cassette Player

AM/FM-stereo receiver with automatic-eject cassette deck. Features AMSS (Automatic Music Select System); locking fast forward/rewind; local/distant switch; volume, tone, balance controls; EZ Install system; automatic-antenna control. Output power 2.4 W/channel into 4 ohms at 5% THD; frequency response 100-20,000 Hz ± 3 dB. Wow and flutter 0.15% wrms; frequency response 100-10,000 Hz ± 3 dB; S/N ratio 50 dB A weighted; separation 35 dB. FM 50-dB quieting sensitivity 21.6 dBf; alternate-channel selectivity 60 dB; capture ratio 3 dB; separation 30 dB at 1 kHz; $7\frac{1}{2}'' \times 4\frac{3}{4}'' \times 2''$. \$100

FT C5 AM/FM-Stereo/Cassette Player

In-dash unit with auto-reverse cassette deck and mini-size chassis. Features separate tone, balance, volume controls; automatic stereo/mono switching; locking fast forward; automatic up/down control for electric antennas. Output power 3.8 W/channel into 4 ohms at 10% THD; frequency response 100-15,000 Hz ± 3 dB. Wow and flutter 0.2% wrms; frequency response 63-8000 Hz ± 3 dB with normal tape; S/N ratio 45 dB A weighted; separation 40 dB. FM usable sensitivity 24.2 dBf; alternate-channel selectivity 35 dB; capture ratio 4 dB; $6\frac{1}{4}'' \times 4\frac{3}{4}'' \times 2''$ \$90

FT C4 AM/FM-Stereo/Cassette Player

In-dash unit with mini-size chassis. Features auto eject at end of play; locking fast forward/rewind; separate tone, balance, volume controls; automatic up/down control for electric antennas. Output power 3.5 W/channel into 4 ohms at 10% THD; frequency response 100-20,000 Hz ± 3 dB. Wow and flutter 0.15% wrms; frequency response 80-10,000 Hz ± 3 dB with normal tape; S/N ratio 50 dB A weighted; separation 35 dB. FM usable sensitivity 20.8 dBf; alternate-channel selectivity 55 dB; capture ratio 3 dB; $6\frac{1}{4}'' \times 4\frac{3}{4}'' \times 2''$ \$80

FT C2 AM/FM-Stereo/Cassette Player

In-dash mini-size chassis unit. Features auto stop; local/distant, FM/AM, fast-forward, and eject switches; locking fast forward; balance, tone, volume controls; standard shaft spacing fits most compact cars. Output power 3.8 W channel into 4 ohms at 10% THD, frequency response 100-15,000 Hz ± 3 dB. Wow and flutter 0.2% wrms; frequency response 60-8000 Hz ± 3 dB with normal tape. S/N ratio 45 dB A weighted, separation 40 dB. FM usable sensitivity 24.2 dBf, alternate-channel selectivity 35 dB; capture ratio 3 dB; $6\frac{1}{4}'' \times 4\frac{3}{4}'' \times 1\frac{3}{4}''$ \$70

FT C1 AM/FM-Stereo/Cassette Player

Mini-size AM/FM-stereo receiver with stereo cassette deck. Features auto stop; auto stereo/mono switching; locking fast forward; tone, balance, volume controls; local/distant switch; AM/FM slide-bar band selector. Output power 3 W/channel into 4 ohms at 10% THD; frequency response 300-15,000 Hz ± 3 dB. Wow and flutter 0.2% wrms; frequency response 60-8000 Hz ± 3 dB; S/N ratio 50 dB A weighted;

5

CAR STEREO EQUIPMENT

separation 40 dB. FM 50-dB quieting sensitivity 26.2 dB; capture ratio 4 dB; separation 35 dB at 1 kHz; 6 $\frac{1}{2}$ "W \times 4 $\frac{1}{2}$ "D \times 1 $\frac{1}{4}$ "H.....\$60

In-Dash Plus Series

FT590 AM/FM-Stereo/Cassette Player

AM/FM-stereo tuner/cassette player with LCD (liquid-crystal display) frequency display, metal-tape capability, and Automatic Music Select System (AMSS). Features Dolby noise reduction; 5 AM/5 FM station presets; FM optimizer circuitry; line-level cassette deck inputs; tape-protection system; Sendust alloy head; full auto-reverse; locking fast forward/rewind; PLL frequency synthesizer tuner; auto scan tuning; Dolby FM; separate bass and treble controls; loudness switch; function labels that light up when engaged; exclusive EZ Install system. Line output frequency response 30-20,000 Hz \pm 3 dB at 500 mV. Wow and flutter 0.15% wrms; frequency response 63-14,000 Hz \pm 3 dB with metal tape; S/N ratio 50 dB A weighted; separation 40 dB. FM 50-dB quieting sensitivity 20.2 dBf; capture ratio 2 dB; alternate-channel selectivity 70 dB; separation 30 dB at 1 kHz; 7"W \times 5 $\frac{1}{4}$ "D \times 2"H.....\$380

FT30 AM/FM-Stereo/Cassette Player

AM/FM-stereo receiver with slide-ruler tuning dial, auto-reverse cassette deck, and AMSS (Automatic Music Select System). Features metal-tape capability; FM Optimizer circuitry; pushbutton tuning; function buttons that light up when engaged; Dolby noise reduction; separate bass and treble controls; loudness switch; fader control; locking fast forward/rewind; automatic control of power antennas; stereo/mono switch. Output power 4 W/channel into 4 ohms; frequency response 30-20,000 Hz \pm 3 dB; line output level 500 mV. Wow and flutter 0.15% wrms; frequency response 63-14,000 Hz \pm 3 dB with metal tape; S/N ratio 50 dB A weighted; separation 40 dB. FM 50-dB quieting sensitivity 21.6 dBf; alternate-channel selectivity 70 dB; capture ratio 2 dB; separation 30 dB at 1 kHz; 7"W \times 5 $\frac{1}{4}$ "D \times 2"H.....\$250

FT240 AM/FM-Stereo/Cassette Player

Stereo receiver with auto-reverse cassette deck. Features AMSS (Automatic Music Select System); FM optimizer; Dolby noise reduction; tape-protection system; bass, treble, fader controls; locking fast forward/rewind; loudness, AM/FM, distant/local switches; automatic power antenna control. Output power 3.5 W/channel into 4 ohms; frequency response 50-20,000 Hz \pm 3 dB. Wow and flutter 0.15% wrms; frequency response 30-12,500 Hz \pm 3 dB with metal tape; S/N ratio 50 dB A weighted; separation 40 dB. FM 50-dB quieting sensitivity 21.6 dBf; alternate-channel selectivity 70 dB; capture ratio 2 dB; separation 30 dB at 1 kHz; 7"W \times 5 $\frac{1}{4}$ "D \times 2"H.....\$180

FT510 AM/FM-Stereo/Cassette Player

Stereo receiver with auto-reverse cassette deck and Automatic Music Select System (AMSS). Features separate bass and treble controls; loudness, local/distant, AM/FM, stereo/mono switches; locking fast forward/rewind; exclusive EZ Install system. Output power 9.5 W/channel into 4 ohms; frequency response 50-20,000 Hz \pm 3 dB. Wow and flutter 0.1% wrms; frequency response 80-12,000 Hz \pm 3 dB with metal tape; S/N ratio 50 dB A weighted; separation 35 dB. FM 50-dB quieting sensitivity 23.8 dBf; alternate-channel selectivity 60 dB; capture ratio 3 dB; separation 30 dB at 1 kHz; 7 $\frac{1}{2}$ "W \times 5"D \times 2"H.....\$150

Under-Dash Players

FT150 Cassette Player

Stereo cassette player with Dolby noise reduction, Automatic Music Select System, auto-reverse transport, and locking fast forward/rewind. Output power

2.4 W/channel into 4 ohms at 5% THD, frequency response 100-20,000 Hz \pm 3 dB. Wow and flutter 0.1% wrms; frequency response 80-10,000 Hz \pm 3 dB; S/N ratio 50 dB A weighted, separation 35 dB; 6"W \times 5"D \times 2"H.....\$100

FT604 Cassette Player

Stereo cassette player with Automatic Music Select System, auto-reverse transport, locking fast forward/rewind, and balance and tone controls. Output 4W/channel into 4 ohms at 10% THD; frequency response 50-20,000 Hz \pm 3 dB. Wow and flutter 0.15% wrms; frequency response 60-10,000 Hz \pm 3 dB with normal tape; S/N ratio 50 dB A weighted; separation 46 dB; 6 $\frac{1}{2}$ "D \times 6"D \times 2"H.....\$80

FT60 Cassette Deck

Auto-reverse cassette deck with tone control; locking fast forward; lighted tape-direction indicators; mini-size chassis. Output power 4 W/channel into 4 ohms at 10% THD; frequency response 50-20,000 Hz \pm 3 dB. Wow and flutter 0.2% wrms; frequency response 63-10,000 Hz \pm 3 dB with normal tape; S/N ratio 50 dB A weighted; separation 46 dB; 6 $\frac{1}{2}$ "W \times 4 $\frac{1}{4}$ "D \times 1 $\frac{1}{4}$ "H.....\$70

FT50 Cassette Player

Mini-size stereo cassette player with locking fast forward; calibrated tone control; auto stop. Output power 3.8 W/channel into 4 ohms at 10% THD; frequency response 50-15,000 Hz \pm 3 dB. Wow and flutter 0.2% wrms; frequency response 63-10,000 Hz \pm 3 dB with normal tape; S/N ratio 45 dB A weighted; separation 40 dB; 6 $\frac{1}{4}$ "W \times 4 $\frac{3}{4}$ "D \times 1 $\frac{3}{4}$ "H.....\$50

SPARKOMATIC

SR-3400 AM/FM-Stereo/Cassette Player

In-dash AM/FM-stereo radio/cassette player with digital clock. Features auto stop; pushbutton eject; electronic loudness, muting, high filter, AM/FM controls; locking fast forward/rewind; bass, treble, balance, fader controls; LED stereo indicator. Wow and flutter 0.3% wrms; S/N ratio 40 dB; separation 45 dB; output power 40 W continuous at 1% THD; frequency response 20-20,000 Hz; 5 $\frac{1}{2}$ "D \times 1 $\frac{1}{4}$ "H...\$270

SR-3300. Similar to SR-3400 except auto-reverse cassette player with tape direction control and LED indicator; no digital clock with elapsed time and reset controls.....\$250
SR-330. Same as SR-3300 except output power 10 W.....\$220
SR3100. Similar to SR-3300 no auto reverse, tape-direction control/indicators, illuminated cassette door.....\$220
SR-310. Same as SR-3100 except output power 10 W.....\$190

SR-303 AM/FM-Stereo/Cassette Player

In-dash AM/FM-stereo radio/cassette player. Features continuous play; auto reverse; auto key-off and pushbutton eject; locking fast forward/rewind buttons with LEDs, wow and flutter 0.3% wrms; S/N ratio 38 dB. Radio features local/distant, program, and AM/FM switches; balance and fader controls for 4-way speaker adjustment, volume, tone, tuning controls; output power 8 W at 1.0% THD; FM sensitivity 7 μ V for 30-dB S/N; frequency response 60-12,000 Hz; 6 $\frac{1}{16}$ "W \times 4 $\frac{13}{16}$ "D \times 1 $\frac{1}{4}$ "H.....\$150

SR-302 AM/FM Stereo/Cassette Player

In-dash AM/FM-stereo radio with stereo cassette player. Cassette has fast forward and eject switch; wow and flutter 0.3% wrms; S/N ratio 38 dB. Radio features programmable 5 AM/FM station pushbutton tuning, separate balance and fader controls for 4-way speaker adjustment; local/distant switch; output power 8 W at 1.0% THD, frequency response 60-12,000 Hz, FM sensitivity 7 μ V for 30-dB S/N; 7 $\frac{1}{16}$ "W \times 4 $\frac{7}{8}$ "D \times 2 $\frac{1}{2}$ "H.....\$150
SR-202. Same as SR-302 except has 8-track instead of cassette player.....\$150

SR-305 AM/FM-Stereo/Cassette Player

High-power AM/FM-stereo/cassette player with 5-band equalizer. Features left-right balance and front fader controls; loudness control; FM muting; local/DX and mono/stereo switches; locking fast forward/

rewind; AM/FM switch. Output power 40 W at 1% THD; frequency range 20-20,000 Hz; wow and flutter 0.3% wrms; S/N ratio 38 dB; separation 42 dB; FM sensitivity 4 μ V for 30 dB S/N; i-f/image rejection 60/50 dB; 7"W \times 5 $\frac{1}{4}$ "D \times 1 $\frac{1}{4}$ "H.....\$150

SR-306 AM/FM-Stereo/Cassette Player

High-power AM/FM-stereo/cassette player with LED digital frequency display. Features volume, tuning,



tone controls; left-right balance and front fader controls; local/DX, mono/stereo, AM/FM switches; locking fast forward. Output power 40 W at 1% THD; wow and flutter 0.3% wrms; frequency range 20-20,000 Hz; S/N ratio 38 dB; FM sensitivity 4 μ V for 30 dB S/N; separation 28 dB at 1 kHz; i-f/image rejection 60/50 dB; 7"W \times 5 $\frac{1}{4}$ "D \times 1 $\frac{1}{4}$ "H.....\$130

SR-301 AM/FM-Stereo/Cassette Player

In-dash AM/FM-stereo radio/cassette player with AM/FM, muting, local/distant, mono/stereo switches; auto shutoff; balance, fader, tone control. Wow and flutter 0.3% wrms; output power 8 W at 1.0% THD; frequency response 60-12,000 Hz; 6 $\frac{1}{16}$ "D \times 1 $\frac{3}{4}$ "H.....\$120

SR-201. Same as SR-301 except has 8-track player with program selector and LEDs.....\$120

SR-304 AM/FM-Stereo/Cassette Player

In-dash unit with interchangeable nosepieces and trim plates for Japanese, European, GM X-body, Citation cars. Features volume, tone, balance, tuning controls; locking fast forward/rewind; AM/FM and stereo/mono switches; auto stop at end of play; tape-end light; cassette end loading. Output power 8 W rms at 1% THD, 75-10,000 Hz; FM usable sensitivity 8 μ V for 30 dB S/N (mono); separation 24 dB at 1 kHz; i-f/image rejection ratio 45/54 dB; Wow and flutter 0.3% wrms; S/N ratio 35 dB; separation 40 dB. 6 $\frac{3}{16}$ "W \times 4 $\frac{9}{16}$ "D \times 1 $\frac{1}{8}$ "H.....\$120

SR-300 AM/FM-Stereo/Cassette Player

In-dash unit with cassette end loading. Features volume, tone, balance, tuning controls; locking fast-forward/eject button; AM/FM and local/distant switches; stereo and tape-end indicators. Output power 7.5 W rms at 1% THD, 75-10,000 Hz. FM sensitivity 8 μ V for 30 dB S/N; separation 24 dB at 1 kHz; i-f/image rejection 50/45 dB. Wow and flutter 0.3% wrms; S/N ratio 35 dB; separation 40 dB. 7"W \times 4 $\frac{11}{16}$ "D \times 1 $\frac{1}{4}$ "H.....\$90

SR-200 AM/FM-Stereo/Cassette Player

In-dash AM/FM-stereo receiver with cassette player. Features volume, tone, balance, tuning controls; AM/FM, local/distant, mono/stereo switches; illuminated dial in tape door; program-selector and MPX lights. Output power 7.5 W rms at 1% THD, 75-10,000 Hz. FM sensitivity 8 μ V for 30 dB S/N; separation 24 dB at 1 kHz; i-f/image rejection 50/45 dB. Wow and flutter 0.3% wrms; S/N ratio 35 dB; separation 40 dB.....\$90

Under-Dash Players

SS-200 Cassette Player/Amp

Under-dash end-load cassette player with amplifier. Features left and right slide-type controls; fast-forward/eject and tone high/low switches; tape play light; auto stop at end of play. Output power 3 W at 1% THD, 100-8000 Hz. Wow and flutter 0.35% wrms; S/N ratio 30 dB; separation 35 dB. 6 $\frac{1}{16}$ "W \times 4 $\frac{9}{16}$ "D \times 1 $\frac{3}{4}$ "H.....\$35

SS-100 8-Track Player/Amp

Under-dash 8-track cartridge player with amplifier. Features slide-type volume, balance, tone controls; program selector; program indicator lights. Output power 3 W at 1% THD, 100-8000 Hz. Wow and flutter 0.35% wrms; S/N ratio 30 dB; separation 35 dB. 5 $\frac{3}{4}$ "W \times 5 $\frac{1}{2}$ "D \times 2 $\frac{1}{4}$ "H.....\$35

6

HEADPHONES

AKG

K-340 Stereo Headphones

Two-way electrostatic/dynamic headphones with fixed-charge electrostatic transducer/dynamic moving-coil transducer and passive diaphragm in each earcup. Connects directly to headphone jack of receiver or amplifier or across speaker output terminals. Frequency range 16-25,000 Hz; SPL 104 dB, 200-2000 Hz at 1.0% THD; nominal impedance 400 ohms; maximum continuous input 200 mW/channel at 117 dB SPL; includes three 9.8-ft 4-conductor cables with 3-conductor 1/4" stereo phone plug; 13.5 oz less cable \$195

K-240 Free-Field Headphones

Free-field stereo headphones; dynamic moving-coil transducer and 6 passive radiators in each circumaural cup. Frequency range 16-20,000 Hz; impedance 600 ohms, 16-20,000 Hz; maximum SPL 125 dB; supplied with 9.8-ft 4-conductor cable and 1/4" phone plug; 10 oz \$95

K-141 Monitor Headphones

Supra-aural stereo dynamic professional monitoring headphones with moving-coil transducers. Frequency range 20-20,000 Hz; maximum SPL 120 dB impedance matches 4-600 ohms; 9.8-ft 4-conductor cable and standard 3-conductor stereo phone plug; 9 oz \$75

K-140S Stereo Headphones

Supra-aural stereo headphones with dynamic moving-coil transducers. Frequency range 20-20,000 Hz; maximum SPL 119 dB; impedance 600 ohms, 20-20,000 Hz; 9.8-ft 4-conductor cable and 1/4" phone plug; 8 oz \$65

K-40 Stereo Headphones

Ultra-lightweight supra-aural stereo headphones with dynamic moving-coil transducers. Frequency range 30-18,000 Hz; maximum SPL 117 dB; matches 4-200 ohm outputs; 9.8-ft 4-conductor cable; 3-conductor stereo phone plug; 4.5 oz \$29

AUDIO-TECHNICA U.S.

ATH-7 Stereophones

Electret condenser stereophones. Frequency response 20-22,000 Hz \pm 2 dB; sensitivity 98 dB SPL

headphone/speaker switching and normal/high-level LED indicators; 8 1/4-ft cord, adapter size 3 1/2" H \times 2 3/8" W \times 7" D; 7.4 oz less cord \$150

ATH-6 Stereophones

Electret condenser stereophones. Frequency response 40-22,000 Hz \pm 2 dB; sensitivity 98 dB SPL at 1 kHz; impedance 4-16 ohms; includes impedance-matching adapter with headphone/speaker switching; 8 1/4-ft. cord; adapter size 1 3/4" D; 7.4 oz less cord \$100

ATH-5 Stereophones

Dynamic moving-coil stereophones. Frequency range 20-20,000 Hz; sensitivity 96 dB SPL at 1 kHz; impedance 4-16 ohms; 11 1/2-ft cord; 7.25 oz \$85

ATH-3 Stereophones

Dynamic moving-coil stereophones. Frequency range 25-20,000 Hz; sensitivity 94 dB SPL at 1 kHz; impedance 4-16 ohms; 11 1/2-ft cord; 7.25 oz \$65

ATH-2 Stereophones

Dynamic planar moving-coil stereophones. Frequency range 30-20,000 Hz; sensitivity 93 dB SPL at 1000 Hz; impedance 4-16 ohms; HD 0.7% maximum at 110-dB SPL; 8.25-ft cord; 7 oz \$50

ATH-1 Stereophones

Dynamic planar moving-coil stereophones. Frequency range 30-20,000 Hz; sensitivity 93 dB SPL at 1 kHz; impedance 4-16 ohms; 8 1/4-ft cord; 4.75 oz ... \$30

ATH-0.1 Stereophones

Moving-coil dynamic stereophones. Frequency range 35-20,000 Hz; sensitivity 100 dB at 1 kHz, 1 mW; matching impedance 4-16 ohms; acoustical foam ear cushions; 1.5-m cord; 1/4" plug; 1.8 oz without cord; black \$30

ATH-0.2F. Folding lightweight stereo headphones with case. Frequency range 35-20,000 Hz; sensitivity 105 dB SPL at 1 kHz, 1 mW; impedance 4-16 ohms \$40

ATH-0.3. Pendulum adjustment. Frequency range 30-20,000 Hz; 2.5-m cord; 1/4" phone plug; 1.9 oz without cord \$50

ATH-0.4. Super-lightweight (1.6 oz) stereo headphones. Frequency range 25-20,000 Hz; 2.5-m cord with mini stereo plug and adapter \$60

ATH-0.5. Same as ATH-0.3 except frequency response 25-20,000 Hz; brown \$80

ATH-0.6. Same weight as ATH-0.4 but frequency range improved to 20-20,000 Hz; impedance 4-16 ohms matching impedance \$90

Eskimo® Stereophone Earmuffs

For cold-weather listening; quickly convert lightweight, portable stereophones to musical earmuffs or to improve fit and increase comfort indoors; fit models with 35- or 45-mm elements; nonallergenic material \$8

BANG & OLUFSEN

U-70 Headphones

Orthodynamic stereo headphones. Frequency range

16-20,000 Hz; sensitivity 8 mW for 94-dB SPL; continuous load 2 W; distortion 1% maximum; 140-ohm impedance; 10-ft straight cord with 3-conductor phone jack; 10.6 oz \$100

BEYER DYNAMIC, INC.

DT-48 Dynamic Headphones

Moving-coil dynamic headphones. Frequency response 16-20,000 Hz \pm 2 dB; supplied with 10-ft straight cord \$190

DT-880 Dynamic Headphones

Stereo headphones utilize rare-earth magnet and vibrationless membrane. Semi-open design permits close coupling for full bass response with hear-through external access. Frequency range 15-25,000 Hz; sensitivity 94 dB SPL with < 1% harmonic distortion; nominal impedance 600 ohms; 6-ft coiled cord \$130

DT-550. Similar to DT-88, except frequency range 10-22,000 Hz; sensitivity 95 dB SPL 90

DT-330. Similar to DT-550, except frequency range 15-18,000 Hz; sensitivity 90 dB SPL; nominal impedance 40 ohms \$48

DT-109 Moving-Coil Mic/Headphone

Lightweight moving-coil stereo headphones with cardioid broadcast-quality moving-coil microphone; SPL 120 dB; left and right channels can be independently wired; removable ear cushions; high-impact plastic and stainless steel construction; field serviceable \$129

DT-660 Bass-Reflex Stereo Headphones

Stereo headphones with an enclosed bass-reflex system incorporates ducted-port and specially designed venting system to improve bass response. Frequency range 15-25,000 Hz; maximum continuous power level approximately 113 dB at 1 kHz; impedance 600 ohms; sound-pressure level 96 dB at 1 kHz; ambient isolation greater than -16 dB; 6-ft flat cord, extends to 12 ft \$98

DT-480 Dynamic Headphones

Moving-coil dynamic headphones. Frequency range 20-18,000 Hz; sensitivity 1mW at 400 Hz for 115-dB SPL; impedance 5, 100, 400, 2000 ohms; maximum input 1 W/phone \$120

DT-108 Moving-Coil Mic/Headphone

Moving-coil stereo headphones with noise-canceling microphone. Frequency range 40-12,000 Hz; SPL 120 dB; mic rotates 180°; foam-filled ear cushions and padded headband; field serviceable \$105

DT-100 Dynamic Headphones

Moving-coil dynamic headphones. Frequency range 30-18,000 Hz; sensitivity 1 mW at 400 Hz for 110-dB SPL; impedance 5, 100, 400, 2000 ohms; maximum input 1 W/phone \$93

DT-96A Dynamic Headphones

Moving-coil dynamic headphones. Frequency range 30-17,000 Hz; sensitivity mW at 400 Hz for 110-dB SPL; impedance 5-200 ohms; maximum input 100



at 1 kHz (0 dB = 0.00 μ bar/V); impedance 4-16 ohms. Includes impedance-matching adapter with

6

HEADPHONES

mW/phone; 5-ft cord; 8 oz \$80

DT-440 Dynamic Headphones

Open high-velocity dynamic headphones with polyvinyl chloride diaphragm in Novodur housing. Frequency range 20-20,000 Hz; sensitivity 1 mW for 100-dB SPL; impedance 600 ohms; chrome finish \$70

DT-220 Dynamic Headphones

Closed-ear dynamic headphones. Frequency range 20-20,000 Hz; sensitivity 1 mW for 100 dB SPL; 600-ohm impedance; maximum input 42 mW (for 116-dB SPL); 260 g (withouth cable) \$63

DT-302 Lightweight Headphones

Open-air high-velocity dynamic headphones connect directly to high- or low-impedance outputs. Frequency range 20-20,000 Hz; rated power 7 mW (2.1 V) for 600 ohms; sponge ear cushions; stereo phone plug; 2.3 oz without cord \$36

DT303. Same as DT302 but designed for TV listening; has volume control built into its 22.5-ft cable \$37

DT-301 Single Headphone

Single earphone for use with portable cassette recorders, transistor radios, dictating machines, TV receivers. Supplied with 5-ft cord and miniature phone plug \$19

DENON

AH-9 Open-Type Stereo Headphones

Open-earcup stereo headphones. Impedance 600 ohms; sensitivity 100 dB/mW; maximum input power 100 mW; frequency range 20-22,000 Hz; weight 100 g \$80

AH-7. Same as AH-9 except impedance 65 ohms \$50

AH-5. \$35

AH-5P. Double 90° fold allows storage in cassette-sized case (supplied). Portable model comes with



mini-plug, 5-ft mini-to-regular adapter cord for home use \$40

PML BY ERCONA

D-42 Stereo Headphones

Dynamic stereo/mono headphones; supplied with detachable, washable soft rubber ear cushions. Frequency range 30-20,000 Hz; output impedance 200 ohms (stereo), 100 or 400 ohms (mono); power/voltage at normal listening 0.3 mW/0.25V; 100 dB SPL with 0.3 mW input; 5 mW maximum power with 2% distortion; supplied with 6-ft unterminated cable; 9.5 oz \$45

RDF-224 Dynamic Headphones

Dynamic stereo/mono headphones; removable soft-foam-padded vinyl ear cushions; supplied with 8-ft coiled cable and 3-conductor phone plug. Frequency range 20-18,000 Hz; output impedance 8 ohms \pm 20% at 1 kHz; output level 100 dB at 1 kHz; maximum input 100 mW; 12 oz \$30

JVC

H-707 Moving-Coil Headphones

Moving-coil design weighs only 5.64 oz and features 46-mm diameter \times 38-micron thick diaphragms; open-back design; double headband for added comfort. Frequency range 20-20,000 Hz; nominal impedance 63 ohms; sensitivity 104 dB/mW at 1 kHz; maximum input power 100 mW; 9.75-ft cord \$60

H-505. Similar to H-707 except 8-ohm impedance;



106-dB sensitivity; 4.58 oz \$40

H-404. Similar to H-505 except 16-ohm impedance;

102-dB sensitivity; 3.7 oz \$30

Super-Lightweight Stereo Headphones

Lightweight stereo headphones designed for portable listening; come with mini-to-standard plug adapter.

H-M9T. \$50

H-M7T. \$40

KENWOOD

KH-7 Stereo Headphones

Dynamic stereo headphones with 1" polyester film drive elements. Features extra pair of earpads, 9.8-ft Y-type cord with standard $\frac{1}{4}$ " plug. Frequency range 20-23,000 Hz; sensitivity 98 dB/mW; maximum input power 150 mW/channel; impedance 32 ohms; 1.8 oz minus cord, 3.4 oz with cord \$80

KH-5 Stereo Headphones

Dynamic stereo headphones with 1" polyester film drive elements. Features extra pair of earpads, 9.8-ft



Y-type cord with standard $\frac{1}{4}$ " phone plug. Frequency range 20-22,000 Hz; sensitivity 98 dB/mW; maximum input power 150 mW/channel; impedance 32 ohms; 1.8 oz minus cord, 3.2 oz with cord \$55

KH-3 Stereo Headphones

Dynamic stereo headphones with 1.5" polyester film drive elements. Features extra pair of earpads, 6.5-ft Y-type cord with standard $\frac{1}{4}$ " phone plug. Frequency range 25-20,000 Hz; sensitivity 95 dB/mW; maximum input power 150 mW/channel; impedance 24 ohms; 2.1 oz without cord, 5.3 oz with cord ... \$30

KH-M5 Stereo Headphones

Dynamic stereo headphones with $\frac{1}{32}$ " high polymer film drive elements. Features 4.7-ft Y-type cord with standard $\frac{1}{4}$ " phone plug, extra earpads. Frequency range 20,000 Hz; sensitivity 102 dB/mW; maximum input power 50 mW/channel; impedance 32 ohms; 5 g without cord, 15 g with cord \$25

KH-2 Stereo Headphones

Lightweight dynamic stereo headphones. Features 2" polyester film driver elements and adjustable headband. Frequency range 40-20,000 Hz; sensitivity 95 dB/mW; maximum input power 100 mW/channel;

2.1 oz without cord, 1.9 oz with cord \$22

KOSS

ESP/10 Electrostatic Stereophones

Electrostatic circumaural stereo headphones with energizer. Headset bandpass response 20-22,000 Hz \pm 2 dB; sensitivity for 1.9 V rms at 1 kHz into E/10 energizer, 2.0 V rms pink noise 100-dB SPL; THD 0.38% at 1 kHz, 100 dB SPL; radiating surface area of electrostatic element 25 cm²/channel; black with silver accents; 10-ft cord. Energizer banpass response -3 dB at 15 Hz and 24 kHz; hum and noise 75 dB below sensitivity reference level (100 dB SPL); phase response at +30° at 20 Hz, -30° at 15 kHz; input impedance 2 ohms minimum at 20 Hz and 20 kHz, 180 ohms maximum at 800 Hz; minimum recommended amplifier power 35 W/channel; overload voltage (for relay cutout) 5.3 V rms pink noise into energizer; semipeak-indicating VU meters; LED overload indicators; automatic overload detector; wood-grain trim \$300

PRO/4X Stereo Headphones

Dual-element stereo headphones combine rare-earth moving-coil element with piezoelectric element in each earcup to provide a 10-40,000-Hz frequency range. Closed-design headphones weigh only 10 oz and come with coiled cord; labeled left/right earcups; adjustable headband \$85

TECH/VFR Stereophones

Dynamic stereo headphones with variable frequency-response controls; slide-type controls at base of each earcup permit fine tuning of shape of response curve. Frequency range 10-22,000 Hz; THD 0.3% at 1 kHz (100-dB SPL); sensitivity for 100-dB SPL 0.6 V rms



sine wave at 1 kHz, 0.275 V rms features Pneumalite ear cushions to exclude outside sounds; wide vinyl headband with self-adjusting yoke; black and chrome; equipped with boom microphone mount for professional applications; 4-conductor coiled cord; 16.8 oz less cord \$80

HV/XLC Stereophones

Lightweight high-velocity stereophones. Frequency range 15-35,000 Hz; sensitivity for 100-dB SPL 1.0 V rms sine wave at 1 kHz. Features separate volume and balance controls/cup; variable density contoured circumaural earcushions with twist-lock mechanism for easy removal; 10-ft coiled cord; 8.4 oz less cord \$80

TECH/2 Stereophones

Dynamic stereo headphones with 2" polyester driver elements. Frequency range 10-22,000 Hz; nominal impedance 245 ohms at 1 kHz; sensitivity for 100-dB SPL 0.7 V rms sine wave at 1 kHz, 0.3 V rms pink noise; THD 0.3% at 1 kHz, 100 dB SPL. Features adjustable cushioned vinyl headband with adjustable stainless-steel yokes and slidebars and Pneumalite ear cushions; 10-ft coiled cord; 15.9 oz less cord... \$60

HV/1A Stereophones

High-velocity stereophones with low-mass "Decilite" driver elements for 15-30,000 Hz coverage; oper-

ates from outputs of 3.2 to 600 ohms; distortion 0.5% at 100-dB SPL; sensitivity 0.9 V rms for 100-dB SPL, handles 5 V rms continuous with provisions for 14-dB SPL transient peaks; 157-ohm impedance; acoustical sponge ear cushions; extendable headband with self-adjusting, pivoting yokes and soft padded vinyl cover; 3-conductor coiled cord (10-ft extended); 10.1 oz\$50
HV 11C. Same as HV/1A except volume/balance control per earcup; sensitivity 1.1 V rms for 100-dB SPL; impedance 132.5 ohms; 10.8 oz\$60

K/6XLC Dynamic Stereophones

Dynamic stereo headphones with low-profile (57-mm) element with Mylar diaphragm and separate volume controls. Frequency range 10-22,000 Hz; less than 1% THD at 1 kHz, 100 dB SPL; sensitivity 1.0 V rms at 100 dB SPL; 10 oz without cord\$40
K/6X. Same as K/6XLC but without volume controls\$30

KSP Sound Partner Stereophones

Featherweight stereophone for on-the-go radio and tape listeners. Folds to compact size to fit into denim tote bag (supplied). Frequency range 20-17,000 Hz; sensitivity 100 dB SPL pink noise at 1 volt; impedance 43 ohms; total weight 3.5 oz, including 9-ft Y cord. Comes with accessory adapters to fit almost any sound system\$35

KC/180 Stereophones

Inexpensive stereo headphones with patented Pneu-malite® earcushions and Mylar cone elements. Frequency range 16-20,000 Hz; impedance 90 ohms; weight 220 g\$20

P/19 Portable Stereophones

For personal, portable listening. Can be used with portable radios, cassette players, TV receivers, as well as home receivers and amplifiers with included 6.36-mm adapter. Frequency range 20-17,000 Hz; impedance 43 ohms (ideal for battery-powered products for low power drain); 6-ft Y cord with 3.5-mm mini stereo plug\$20

MURA

HV-230 Stereo Headphones

Vented high-velocity stereo headphones with lightweight polymer film diaphragms; separate volume controls; frequency range 20-20,000 Hz; impedance 8 ohms; lightweight 10-ft coiled cord with plug\$35

HV-190 Stereo Headphones

Stereo headphones with ferrite-magnet speaker system. Frequency range 20-20,000 Hz; impedance matching 8-70 ohms; maximum input 250 mW; lightweight 12-ft coiled cord with 1/4" stereo plus; 8 oz less cord\$30

HV-100 Stereo Headphones

Lightweight vented high-velocity stereo headphones with thin Mylar diaphragms; voltage control; stereo/mono switch. Frequency range 30-15,000 Hz; 10-ft coiled cord with plug\$20

SP-504 Headphones

Stereo headphones with 3" dynamic drivers. Features separate volume and tone slide controls on each earcup and stereo/mono switch. Frequency range 30-18,000 Hz; impedance 8 ohms; adjustable padded headband; 10-ft coiled cord with plug\$22
SP-503. Similar to SP-504 minus tone controls. \$17
SP-502. Similar to SP-503 minus stereo/mono switch; has 2 1/4" dynamic drivers\$15
SP-500. Similar to SP-502 minus volume controls; frequency range 35-15,000 Hz; 8-ft cord\$12

SP-294 Stereo Headphones

Stereo headphones with 2 1/4" dynamic drivers; individual volume controls; stereo/mono switch. Frequency range 40-15,000 Hz; adjustable soft leatherette-padded headband and earcups; 10-ft coiled cord \$14
SP-194. Similar to SP-294 but minus stereo/mono switch\$12

SP-94 Stereo Headphones

Lightweight dynamic stereo headphones with 2 1/4"

drivers. Frequency range 40-15,000 Hz; impedance 8 ohms; oversize earcups for greater comfort; 8-ft cord with plug\$9

Red Set Series

Red Set VII

Deluxe ultra-lightweight (1.6-oz, less cord) stereo headphones with rare-earth drivers. Frequency range 20-20,000 Hz; sensitivity 98 dB at 1 kHz; maximum



input 0.2 W; matching impedance 4-25 ohms; 4-ft cord with mini plug; 8-ft extension cord with 1/4" stereo plug included\$35
Red Set V. Similar to Red Set VII except weight 2 oz; 6.6-ft cord; no extension cord\$25

Red Set III Stereo Headphones

High-velocity stereo headphones with Mylar diaphragms and subminiature ultralightweight samarium-cobalt magnets and anoxic copper wire designed to reduce signal attenuation. Frequency range 20-20,000 Hz; sensitivity 98 dB at 1 kHz; maximum input 0.2 W; matching impedance 4-25 ohms; 6.6-ft cord with 1/4" 3-conductor stereo plug; 1.6 oz less cord\$25

Red Set II Stereo Headphones

Ultralightweight stereo headphones with folding headband and cable terminated in 3.5-mm mini plug and comes with 1/4" plug adaptor. Frequency range 20-20,000 Hz; sensitivity 100 dB at 1 mW; maximum input 0.1 W; matching impedance 4-35 ohms; samarium-cobalt magnets with high-velocity Mylar diaphragms; 6.6-ft cord with 0.138" 3-conductor stereo plug\$16
Red Set I. Similar to Red Set II except no folding headband; matching impedance 4-30 ohms; 1/4" stereo plug\$15

PICKERING

OA-7 Stereo Headphones

Lightweight open-audio design; REE used in permanent-magnet compound; foam-cushioned headband; earpiece yokes incorporate pivoting system enabling snug fit. Nominal impedance 100 ohms; frequency response 20-22,000 Hz ±5 dB; sensitivity 110-dB SPL at 0.2 V; maximum input 0.1 W continuous; distortion 0.5% at 110-dB SPL; supplied with flat 10-ft cord; 6 oz\$70

OA-5A Stereo Headphones

Lightweight open-audio stereo headphones with 1.5" samarium-cobalt dynamic drivers. Impedance 100 ohms 10% at 1 kHz; maximum input 0.25 W/channel continuous; sensitivity 110 dB SPL at 0.2 V input, 1 kHz/channel; frequency range 20-22,000 Hz; distortion 0.25% at 110-dB SPL; adjustable padded vinyl headband with pivot yokes and nylon-tricot-covered foam ear cushions; 10-ft 4-conductor cord with no-break connector; includes adapter plug for use with portable radios, TVs, tape recorders; 5 oz less

NEED MORE INFORMATION?
Write directly to the manufacturer or distributor. A list of names and addresses starts on page 4.

cord\$60

OA-4 Stereo Headphones

Lightweight stereo headphones with 3/4" dynamic high-velocity drivers with synthetic film diaphragms and samarium cobalt magnets. Frequency range 10-20,000 Hz; distortion 0.5% at 100-dB SPL, 1000 Hz; sensitivity 105 dB at 1 kHz/channel; input impedance 40 ohms at 1 kHz; adjustable lightweight headband with silver-dollar-sized multi-density polyurethane foam earpieces; includes adapter and 7-ft Y-type straight cord with plug; 2 oz less cord\$50

OA-3A Stereo Headphones

Lightweight open-audio stereo headphones. Impedance 15 ohms ±10 at 1 kHz; input 0.2 W/channel continuous; sensitivity 100 dB SPL at 0.10 V input at 1 kHz for each channel; frequency range 20-20,000 Hz; distortion <0.5% at 110 dB SPL; comes with extended-adjustable headband with pivot yokes and padded vinyl cover; 10-ft 4-conductor cord with molded no-break connector; 8.5 oz\$45

OA-2 Featherfone® Stereo Headphones

Open-audio stereo headphones. Feature adapter plug for stereo/mono used; adjustable lightweight headband; earcushions with multidensity polyurethane; 7-ft Y-type straight cord with plug adaptors for mono and stereo. Designed for all portable applications. Frequency range 10-20,000 Hz; impedance 40 ohms at 1 kHz; maximum input power 0.5 W; 2 oz\$35

OA-202 Stereo Headphones

Open-audio stereo headphones with dynamic high-velocity drivers with 1" polyester diaphragms. Frequency range 10-20,000 Hz; distortion 0.5% at 110-dB SPL, 1 kHz; sensitivity 100 dB SPL at 0.25 V input, 1 kHz/channel; input impedance 50 ohms at 1 kHz; maximum input 0.2 W/channel continuous; adjustable padded vinyl headband with soft vinyl-covered foam earcushions; includes 7-ft Y-type straight cord with plug and special adapter plug for use with portable radios, TV sets, tape recorders; 6 oz or less cord\$30

OA-101 Featherfone® Stereo Headphones

Lightweight open-air stereo headphones. Feature lightweight headband; acoustically engineered polyurethane foam cushions; 5-ft Y-type straight cord with plug. Frequency range 20-18,000 Hz; distortion less than 0.5% at 100 dB SPL, 1 kHz; sensitivity 100 dB minimum SPL, 0.25 V input at 1 kHz each channel; impedance 40 ohms ±20% at 1 kHz; maximum input power 0.05 W; 2 oz\$25

PIONEER

Master-15 Stereo Headphones

Deluxe Pro Style lightweight stereo headphones with gold-plated plug and click-stop adjustable headband. Frequency range 16-22,000 Hz; sensitivity 103 dB/mW; maximum input power 200 mW; 10-ft cord; 5.2 oz without cord\$130

SE-115 Dynamic Stereo Headphones

Open-air variable-chamber stereo headphones with muting switch and 2 connection cords that attach at muting switch junction (3-ft with gold-plated mini plug, 8-ft with gold-plated 1/4" plug). Sensitivity 101 dB/mW; frequency range 10-22,000 Hz; maximum input power 100 mW; 2.6 oz without cord ... \$110
SE-111. Similar to SE-115 except no variable chamber; frequency range 16-22,000 Hz; 1.8 oz without cord\$90

SE-650 Lightweight Stereo Headphones

Lightweight enclosed stereo headphones in black and chrome finish and featuring independent left and right volume controls and adjustable headband. Frequency range 20-20,000 Hz; sensitivity 103 dB/mW; maximum input power 100 mW; 9-ft 10-in. cord; 10 oz without cord\$75

SE-7 Stereo Headphones

Open-type stereo headphones with polyester dome drivers. Frequency range 20-20,000 Hz; sensitivity 100 dB/mW; maximum input power 200 mW; 9-ft 5-in. cord; 9.8 oz with, 8 oz without cord\$70

6 HEADPHONES

SE-L7 Stereo Headphones

Variable Chamber® open-type stereo headphones with simulated-leather vinyl headband and ear pads. Frequency range 20-20,000 Hz; maximum input power 200 mW; 9½-ft cord; 8 oz without cord. \$65

SE-550 Stereo Headphones

Lightweight enclosed stereo headphones in black and chrome finish and featuring adjustable headband. Frequency range 20-20,000 Hz; sensitivity 103 dB/mW; maximum input power 100 mW; 9-ft 10-in. cord; 9 oz without cord. \$55

SE-540, similar to SE-550 except sensitivity 105 dB/mW; 9-ft cord; 11 oz. \$45

SE-4 Stereo Headphones

Open-type stereo headphones with polyester dome drivers. Frequency range 20-20,000 Hz; sensitivity 96 dB/mW; maximum input power 200 mW; 9-ft 5-in. Y-type cord; 7¾ oz without cord. \$50

SE-L5 Stereo Headphones

Dynamic open-air super-lightweight stereo headphones. Features oxygen-free copper litz cord and 10-ft connection cord. Sensitivity 101 dB/mW; frequency range 20-22,000 Hz; maximum input 200 mW; 2.5 oz without cord. \$50

SE-L3 Lite-Phones

Lightweight stereo headphones. Frequency range 18-22,000 Hz; maximum input power 100 mW; 9-ft 5-in. cord; 1.8 oz without cord. \$35

SE-205 Dynamic Stereo Headphones

Dynamic stereo headphones with adjustable headband. Frequency range 20-20,000 Hz; maximum input power 500 mW; 15 oz without cord; 8-ft 2-in. cord. \$30

SE-2 Stereo Headphones

Open-type stereo headphones with polyester dome drivers and adjustable headband. Frequency range 20-20,000 Hz; sensitivity 99 dB/mW; maximum input power 200 mW; 9-ft 5-in. Y-type cord; 7¾ oz without cord. \$30

REALISTIC

PRO-IIA Stereo Headphones

Professional headphones with 12-sq-in. Mylar diaphragm speakers and 1" voice coils; adjustable padded headband with airfilled ear cushions. Frequency range 10-22,000 Hz; comes with 10-ft coiled cord and standard ¼" plug; 4-16 ohms impedance; 19 oz. \$50

LV-10 Stereo Headphones

High-velocity vented-back headphones with 2" dynamic elements. Frequency range 20-20,000 Hz; distortion 0.5%; 4-16 ohm impedance; acoustic foam earpieces and soft vinyl-covered headband with self-adjusting yokes; 10-ft coiled cord and plug. \$42

PRO-30 Stereo Headphones

Lightweight uniform-phase stereo headphones with low-mass planar driver and rare-earth magnets; lightweight coiled cord. \$35

NOVA-PRO Stereo Headphones

High-acoustic-isolation stereo headphones with low-mass polyester drivers; volume control on each earcup. Frequency range 20-20,000 Hz; 4-16 ohm impedance; cushioned headband; 10-ft coiled cord. \$32

NOVA-40 Stereo Headphones

Stereo headphones with 3½" dynamic drivers. Frequency range 30-18,000 Hz; 4- to 16-ohm impedance; soft cushion earcups; padded adjustable head-

band; 10-ft coiled cord and ¼" plug. \$25

NOVA-10 Stereo Headphones

Stereo headphones with high-efficiency 2" speakers; adjustable vinyl headband with cushioned earpads. Frequency range 50-15,000 Hz; has 10-ft cord and ¼" plug. \$15

NOVA-16. Similar to Nova-10 except has separate Glide Path® level controls. \$20

RECOTON

ST88 High-Velocity Stereo Phones

Stereo headphones with volume controls. Features lightweight high-velocity samarium-cobalt magnets; stereo/mono switch; volume and tone controls. Frequency range 15-20,000 Hz; sensitivity 102 dB at 1 kHz; impedance 30 ohms; maximum input power 0.5 W; 10-ft cable with stereo phone plug. \$43

ST66 Ultralightweight Headphones

Designed for all mini recorders and players, stereo headphones weight only 2.47 oz exclusive of cable. Sensitivity 98 dB at 1 kHz; frequency range 20-25,000 Hz; input impedance 25 ohms; maximum input power 0.4 W; 10-ft cable with mini plug and ¼" stereo adapter. \$43

ST77 Ultralightweight Stereo Phones

Designed for all mini recorders and players and includes an adaptor for standard receivers. Weighs 1.65 oz, less cable. Sensitivity 98 dB at 1 kHz; frequency range 20-25,000 Hz; impedance 25 ohms; maximum power input 0.3 W; 10-ft cable with mini plug and ¼" stereo adapter. \$38

ST22 Stereo Headphones

Dynamic stereo headphones; all-aluminum earcups; leathery-soft ear cushions and headband; volume control for each channel. Frequency range 20-22,000 Hz; 8-ohm impedance; 4-16 ohms matching impedance; sensitivity 110 dB at 1 mW, 1 kHz; maximum input 0.5 W; 3" dynamic speakers; 10-ft coiled cord. \$30

ST-91 Stereo Headphones

Lightweight stereo headphones with samarium-cobalt magnets. Includes adaptor to allow use with mini and home tape players. Frequency range 20-25,000 Hz; impedance 200 ohms; sensitivity 100 dB at 1 mW; 1.23 oz minus cable. \$28

ST-11 Stereo Headphones

Lightweight stereo headphones with volume controls, stereo/mono switch, foam-filled earcushions. Frequency range 20-20,000 Hz; impedance 8 ohms; sensitivity 100 dB at 1 mW, 1 kHz; 10-ft coiled cord with phone plug. \$20

ST16 Stereo Headphones

Stereo headphones with volume control for each channel; stereo/mono switch. Frequency range 20-18,000 Hz; impedance 8 ohms; soft adjustable padded headband; soft ear cushions; 10-ft coiled cord with stereo phone plug. \$20

ST-90 Stereo Headphones

Foldaway lightweight stereo headphones with samarium-cobalt transducers, superthin polymer film diaphragms. Designed for use with mini and home players. Frequency range 20-20,000 Hz; impedance 32 ohms; sensitivity 96 dB at 1 mW; 0.83 oz minus cable. \$18

ST99 Miniature Stereo Headphones

Miniature stereo headphones consisting of pair of earpieces approximate size of a quarter. Earpieces slip into place over ears without headband. Includes lightweight 7-ft cord and mini plug. \$17

SANSUI

SS-L5 Dynamic Stereo Headphones

Isolation-free dynamic stereo headphones in around-the-ear design and 1¼" drivers. Impedance 100 ohms at 1 kHz; frequency range 20-20,000 Hz; maximum input power 500 mW; sensitivity 104 dB/mW at 500 Hz; 2-m cord; 4.8 oz without cord. \$50

MS-7 Dynamic Stereo Headphones

Lightweight on-the-ear mini-sized dynamic stereo headphones with adaptor plug that permits mini stereo phone plug to be used with standard home audio equipment. Impedance 40 ohms; frequency range 30-20,000 Hz; maximum input power 250 mW; sensitivity 100 dB/mW; 2.5-m cord; 1.1 oz without cord. \$40

SS-L3 Dynamic Stereo Headphones

Isolation-free, around-the-ear stereo headphones with 1¼" drivers. Impedance 60 ohms; frequency range 20-20,000 Hz; maximum input power 500 mW; sensitivity 104 dB/mW; 2-m cord; 4.4 oz without cord. \$30

MS-3 Dynamic Stereo Headphones

Lightweight on-the-ear mini-sized dynamic stereo headphones fitted with mini stereo plug and supplied with adaptor for use with standard home audio equipment. Impedance 30 ohms; frequency range 35-20,000 Hz; maximum input power 100 mW; sensitivity 97 dB/mW; 2.5-m cord; 1.8 oz without cord. \$20

SENNHEISER

HD224 Stereo Headphones

Dynamic stereo headphones. Frequency range 16-20,000 Hz; SPL 94 dB at 1 mW; THD 1.0%; nominal impedance 200 ohms; double-walled circumaural foam earpads cover entire ear; includes steel-stranded detachable 3000-mm cable; 252 g. \$144

HD 430 Stereo Headphones

Open-air design dynamic stereo headphones. Frequency range 16-20,000 Hz; sensitivity 94 dB with 1 mW input, nominal SPL at 1 kHz; HD 0.5%; impedance 600 ohms; padded earpad rims and adjustable suspension strap; 10-ft cable; 7 oz. \$126

HD 222 Closed-Earcup Headphones

Stereo headphones with ultralightweight diaphragms with powerful cobalt-samarium magnets in closed-earcup design. Wide-range response extremely flat 16-10,000 Hz; impedance 600 ohms; 8.8 oz. \$120

HD 424 Stereo Headphones

Deluxe open-air dynamic headphones. Frequency range 15-20,000 Hz; sensitivity 17.7 µbar/V, 1 mW (1.41 V)/channel for SPL of 102 dB; distortion 1% at 22 V, 1 kHz; impedance 2000 ohms; removable head and ear cushions; 10-ft cable; 6.5 oz without cable. \$115

HD 420 Stereo Headphones

Open-air design dynamic headphones. Frequency range 18-20,000 Hz; sensitivity 94 dB with 1 mW input, nominal SPL at 1 kHz; HD 1.0%; impedance 600 ohms; adjustable suspension strap and cushioned earpads; 10-ft cable; 4 oz. \$89

HD 414 Stereo Headphones

Open-air design dynamic headphones. Frequency range 20-20,000 Hz; sensitivity 17.7 µbar/V, 1 mW (1.41 V) for SPL of 102 dB; distortion 1% at 22 V, 1 kHz; impedance 2000 ohms; 10-ft cable; 5 oz without cable. \$79

HD 400 Stereo Headphones

Open-air design dynamic headphones. Frequency range 20-18,000 Hz; sensitivity 1 mW for SPL of 88 dB; impedance 600 ohms; 10-ft cable; 3 oz without cable. \$46

HD 40 Lightweight Headphones

Open-air design stereo headphones. Frequency range 22-18,000 Hz; sensitivity 90 dB with 1 mW input; distortion < 1%; 2 oz without cable. \$35

SIGNET DIVISION, A.T.U.S., INC.

TK33 Stereophones

Dipolar electret condenser stereophones with power adaptor feature high-compliance film moving diaphragm, 45 mm diameter and 2 microns thick; suede-finish inner headband and pivotal porous vinyl

ear pads. Passive impedance matching transformer adapter features stereophonic/speaker operation and hi/lo stereophonic sensitivity switches; 2 dual-color LED arrays in groups of 6, first 4 indicating medium-to-loud normal reproduction and last 2 indicating high-level peaks; no external power required; can accommodate 2 headsets. Frequency response 20-22,000 Hz \pm 2 dB; sensitivity 100 dB at 1 V, 1 kHz; THD 0.1% at 110-dB SPL; matching impedance 4-16 ohms; includes 8.2-ft cord with special plug and 3.5-ft adapter cable with 4-conductor plug. Stereo-impedance 9.7 ohm with cord; adapter 4 lbs; adapter 5.5" H \times 2.4" W \times 8.7" D \$330
TK33S. Additional stereophonic only for TK33. \$135

TK22 Stereophones

Moving-coil dynamic stereophones feature high-compliance polyester dome diaphragm, 20 microns thick and 45 mm diameter with 40-micron self-supporting silver/copper voicecoil and FXD magnet; full-swivel foam earpieces and soft suede-finish inner headband; frequency range 20-20,000 Hz; sensitivity 96 dB at 1 mW, 1 kHz; THD 0.4% at 110-dB SPL; matching impedance 4-16 ohms; includes 11 1/2-ft cord with plug; 9.2 oz with cord \$105

Miniature Stereo Headphones

TK20. Features fully rotating yoke-and-pivot suspension system; can be compactly folded and fitted into



belt pouch (supplied). Frequency range 25-20,000 Hz. 1.5 oz \$60
TK11. Features unique ball-joint pivot on each earcup; 4.9-ft cord with mini plug, mini-to-standard phone-plug adapter. Frequency range 30-20,000 Hz slightly less than 2 oz \$35

SONY

MDR Series Headphones

Ultra lightweight open-air stereo headphones with samarium-cobalt magnets, high-exursion driver elements, oxygen-free litz wire cables, and minimal headband pressure.

MDR-80T. Top-of-the-line headphones with 30-mm drivers, one-sided cable; frequency range 16-24,000 Hz; sensitivity 101 dB/mW; 2.2 oz less cable .. \$85
MDR-70T. Headphones with 30-mm drivers; frequen-



cy range 16-22,000 Hz; sensitivity 100 dB/mW; 1.8 oz less cable \$65
MDR-50T. Headphones with 30-mm drivers; frequency range 18-22,000 Hz; sensitivity 100 dB/mW; 1.8 oz less cable \$50
MDR4T. Ultralightweight headphones with scaled-down headband and driver housings; frequency range 20-22,000 Hz \$40
MDR-E33. Consists of 2 MDR-type drivers designed to hang comfortably from each ear; has no headband to add bulk or interfere with hair styles; especially suited for Sony Walkman users; frequency range 40-18,000

Hz; less than 1 oz less cable. Supplied with mini stereo plug only \$35
MDR-1T. Incorporates stereo Unimatch plug; frequency range 24-18,000 Hz \$30
MDR-3. Frequency range 20-20,000 Hz; sensitivity 96 dB/mW; impedance 32 ohms; 40 g less cable \$50
MDR-2. Similar to MDR-3 \$40

STANTON

Dynaphase Stereo Headphones

Specially designed for recording professionally, resulting in flattest response and superior acoustical behavior of driver elements. Feature 1 1/2" dynamic high-velocity elements with specially formulated synthetic film diaphragms and samarium-cobalt magnets; adjustable headband with pivot yokes and glove-soft padded vinyl cover; soft nylon tricot-covered foam earcushions; 10-ft 4-conductor cord with double molded no-break connector. Frequency range 20-22,000 Hz; distortion < 0.25% at 110 dB SPL, 1 kHz; sensitivity 110 dB minimum SPL at 0.2 V, 1 kHz; impedance 600 ohms \pm 10% at 1 kHz; maximum input power 0.25 W rms/channel; 5.5 oz less cord \$70

Stereo/Wafers XXI Headphones

Ultra-lightweight professional-standard headphone; frequency response 20-22,000 Hz \pm 4 dB; sensitivity 2 V for 100 dB SPL; maximum power input 0.1 W continuous; distortion 0.5% at 200-dB SPL; 100-ohm impedance at 1 kHz; brushed blue denim finish; 10-ft flat cord with heavy-duty plug; 5.9 oz \$70

Dynaphase 55 Stereo Headphones

Lightweight open-audio stereo headphones with 1.5" samarium-cobalt dynamic drivers; input impedance 100 ohms \pm 10% at 1 kHz; maximum input 0.25 W/channel continuous; sensitivity 110 dB SPL at 0.2 V input, 1 kHz; frequency range 20-22,000 Hz; distortion, 0.25% at 110-dB SPL at 1 kHz; adjustable padded-vinyl headband with pivot yokes and nylon tricot-covered foam ear cushions; 10-ft 4-conductor cord with no-break connector; includes adapter plug for use with portable radios and tape recorders; 5.5 oz less cord \$60

Micro/Wafer XII Stereo Headphones

Super-lightweight open-audio stereo headphones with 3/4" dynamic high-velocity drivers with synthetic film diaphragms and samarium-cobalt magnets. Frequency range 10-20,000 Hz; distortion 0.5% at 100 dB SPL/mV at 1000 Hz; sensitivity 105 dB SPL/mV at 1 kHz/channel; input impedance 40 ohms at 1 kHz; maximum input 0.15 W/channel continuous; adjustable lightweight headband with multi-density polyurethane foam earcushions; includes adapter plug for use with portable radios, TV sets, and tape recorders; 7-ft Y-type straight cord with plug; 2 oz less cord. \$50

Dynaphase 25 Stereo Headphones

Lightweight open-audio stereo headphones with dynamic high-velocity drivers with 1" polyester diaphragms. Frequency range 10-20,000 Hz; distortion 0.5% at 110 dB SPL, 1 kHz; sensitivity 100 dB SPL at 0.25 V input, 100 Hz; input impedance 50 ohms at 1 kHz; maximum input power 0.2 W/channel continuous; adjustable padded vinyl headband with soft vinyl-covered foam earcushions; includes adapter plug for use with portable radios, TV sets, and tape recorders; 7-ft Y-type straight cord with plug ... \$30

Model V Micro Wafer-F Headphones

Super-lightweight stereo headphones with adjustable folding headband. Feature acoustically engineered polyurethane foam cushions; 5-ft Y-type straight cord with plug. Frequency range 20-18,000 Hz; distortion less than 0.5% at 100 dB SPL, 1 kHz; sensitivity 100 dB minimum SPL, 0.25 V input at 1 kHz each channel; impedance 40 ohms \pm 20% at 1 kHz; maximum input 0.1 W; 2 oz less cord \$30

STUDER/REVOX

RH 310 Stereo Headphones

Open-type lightweight headphones designed for amplifiers rated for 4-to-600-ohm load impedance; frequency range 20-20,000 Hz \$100

illinois audio



SAVE • money • time • freight

CASSETTE TAPES

SONY UCS-X 90 NEW HIGH BIAS TAPE	\$30.00/10
SONY SHF-90 STANDARD BIAS TAPE	26.00/10
SONY EHF-90 HIGH BIAS TAPE	27.00/10
SONY FER-90 HIGH BIAS PREMIUM	28.00/10
TDK MA-C90 METAL CASSETTE TAPE	\$49.50/10
TDK SAX-C-90 NEW PREMIUM TAPE	38.00/10
TDK OD-C-90 OPTIMUM STD. BIAS	27.00/10
TDK SA-C90 SUPER AVALIN TAPE	24.50/10
TDK C-90AD NEW AUDIA TAPE	20.00/10
BASF PERFORMANCE C-90 QUALITY TAPE	\$16.00/10
BASF PRO II OR III C-90 SPECIFY	22.00/10
MAXELL C-90 LN LOW NOISE TAPE	\$23.50/12
MAXELL C-60UD ULTRA DYNAMIC	23.00/12
MAXELL C-90UD ULTRA DYNAMIC	29.50/12
MAXELL UD-KL-C60 TYPE I OR II	29.50/12
MAXELL UD-KL C-90 TYPE I OR II	39.50/12

REEL TO REEL TAPE

TDK LX-35-90 NEW TIN.	\$60.00/10
TDK LX-35-180M NEW 10 1/2 IN	170.00/10
MAXELL UD-35-90 ULTRA DYNAMIC 7"	57.50/10
MAXELL UD-35-180 SAME ON 10 1/2"	153.00/10
MAXELL UD-KL-35-90B BACKMOUNTED XL	69.50/10
MAXELL UD-KL-180B SAME ON 10 1/2	198.50/10
SCOTCH 207R-90 POLY-FOSITRAX	55.00/10
SCOTCH 207 R-180 10 1/2 IN	192.00/12

VIDEO TAPE

TDK L-500 BETA TAPE	\$100.00/10
MAXELL L-750 BETA TAPE	130.00/10
BASF T-120 VHS 2-4-6 TAPE	120.00/10

AUDIO TECHNICAL CARTS.	SHURE CARTRIDGES
MODEL 155-LC \$105.00	V-15 TYPE 4 WRITE
MODEL 140-LC 66.00	V-15 3 HE \$70.00
MODEL 125-LC 49.00	M-97 HE 49.00

AUTOMOTIVE STEREO

PIONEER KE-2100 ELECTRONIK READOUT	\$WRITE!
PIONEER KP-8500 AM-FM CASSETTE	140.00
PIONEER KE-5100 DIGITAL DECK	215.00
PIONEER UKP-7600 MINI-SIZE DECK	199.00
TS-695 6x9 3-WAY SPKR. SYSTEMS	82.50
TS-696 6x9 2-WAY SPKR. SYSTEMS	66.00
WRITE FOR ALL PIONEER AUTOMOTIVE PRICES !!!!	
JENSEN R-405 AM-FM IN DASH CASS.	\$168.00
JENSEN T-415 AM-FM CASS. PRE-AMP	185.00
JENSEN A-30 MATCHING POWER AMP.	41.00
JENSEN J-2033 6x9 TRIAX* II SPKRS.	94.00
JENSEN J-2037 6x9 CO-AX II* SPKRS.	68.00
WRITE OR CALL FOR OTHERS INCLUDING SANYO!!!!	

HEADPHONES

SONY MDR-50T NEW SUPERLIGHTWEIGHTS	\$33.00
MOSS MODEL HV-K STEREOHEADPHONES	41.50
MOSS MODEL PRO-4K NEW PRO PHONES	49.50
SENNHEISER HD-40 NEW LIGHTWEIGHTS	20.00
SENNHEISER HD-224 SUPERB LISTENING	80.00

—send for free catalog—

Name _____
 Address _____
 City _____
 State _____ Zip _____

illinois audio

12 East Delaware Place
 Chicago 60611



Phone Now
 (312)
 664-0020
 TOLL FREE
 (800)
 621-8042

6

HEADPHONES

SUPEREX

PEP-81 Electrostatic System

Consists of PEP-81 headphones and CC-81 control console; headphone frequency response 15-18,000 Hz ± 2 dB, 10-22,000 Hz ± 5 dB; distortion 0.2%; impedance-matched to CC-81 for 4-16 ohms; isolation-type headphones with fully adjustable vinyl-covered headband and foam cushions and 15-ft coiled cord; control console has level controls for both channels (20-dB range), speaker/phone rocker, on/off switch; can accommodate 2 sets of headphones; requires 5 W/channel minimum drive; console size 11" \times 3 3/4" \times 6 1/2" \$150

PEP-79E Electrostatic System

Consists of PEP-74 headphones and CC-79E control console; headphone frequency response 15-18,000 Hz ± 2 dB, 10-22,000 Hz ± 5 dB; negligible distortion; impedance-matched to CC-79E for 4-16 ohms; trans-air lightweight headphones with fully adjustable vinyl-covered headband and foam cushions and 15-ft coiled cord; control console is designed for use with main amplifier level controls, has self-protecting circuits; 2 1/2" H \times 7" W \times 4" D \$90

SM-700 Headphones

Dynamic headphones with 2 3/4" Mylar diaphragm. Frequency response 10-22,000 Hz ± 3 dB; impedance 35 ohms; sensitivity 10 mW (0.6V) for 110 dB at 400 Hz; 0.25% distortion at 400 Hz, 110-dB SPL; padded, fully adjustable steel and aluminum headband with foam-filled vinyl cushions; 15-ft cable, clothing clip, molded stereo plug \$70

PRO B VI Stereophones

Each earcup features dynamic woofer, ceramic tweeter, and L/C crossover. Impedance 4-16 ohms; frequency response 15-22,000 Hz; fully adjustable, vinyl-covered and padded spring steel headband with vinyl covered urethane foam cushions; 10-ft coiled cord and plug \$60

Classic CL-1 Headphones

Lightweight, isolating-type headphones. Frequency range 10-20,000 Hz; impedance 35 ohms; distortion 0.3% at 110-dB SPL 400 Hz; sensitivity 10 mW (0.6V) for 110-dB SPL at 400 Hz; padded fully adjustable steel and aluminum headband with foam-filled vinyl cushions; 15-ft (extended) retractable cable with clothing clip; and molded stereo plug; 10.6 oz without cable \$60

TRL-99 Headphones

Dynamic headphones with 2 3/4" Mylar diaphragm. Impedance 35 ohms; frequency response 15-20,000 Hz ± 4 dB; sensitivity 6 mW for 100-dB SPL; distortion 0.4% at 400 Hz, 110-dB SPL; padded, fully adjustable aluminum and steel headband with fabric-faced, foam-filled cushions; 15-ft cable, clothing clip, plug; 10 oz \$55

TRL-88 Trans-Linear Headphones

Featherweight open-air stereo headphones with 1.75-in micro-Mylar transducers. Frequency response 18-24,000 Hz ± 5 dB; dis 0.5%; 7-ft Y cord with molded plug; 4.25 oz \$50

TRL-3 Trans-Linear Headphones

Open design headphones. Frequency response 40-20,000 Hz ± 5 dB, 5-dB bass boost between 70 and 200 Hz; impedance 80 ohms; distortion 0.6% at 110 dB, 400 Hz; sensitivity 6 mW for 100-dB SPL; maximum input 5 V; padded, fully adjustable aluminum and steel headband; urethane foam, snap-on cushions; 15-ft (extended) retractable cable with clothing clip, molded plug, strain relief; 8.5 oz. . \$45

DP-903 Monitor Phone

Single hand-held earphone with swivel grip; blends left and right channels into single earphone. Frequency range 20-19,000 Hz; impedance 180 ohms; 7-ft cord with stereo plug \$20

TRL-66 Headphones

Dynamic headphones with 6-mm transducer; Impedance 8 ohms; frequency range 40-15,000 Hz; high impact unbreakable plastic headband with padding and foam-filled vinyl cushions; 7-ft Y cord with molded plug; 9 oz (less cable) \$20

TEAC

THD-101 Stereo Headphones

Open-air dynamic moving-coil stereo headphones. Features foam earpads; stereo phone plug with 3.5-mm to 1/4" adapter. Frequency range 20-20,000 Hz; sensitivity 95 dB/mW ± 2 dB at 1 kHz; maximum input 100 mW; impedance 30 ohms; 9.8-ft cable; 4 oz \$40

TECHNICS

EAH-830 Linear-Drive Headphones

Low-distortion high-power-handling capacity stereo headphones. Frequency range 15-35,000 Hz; maximum input power 3000 mW; 125-ohm impedance; 0.3% distortion; 3-meter coiled cord; Supra-Aural ear pads; precise-fit, soft leather head pads; 450 g. \$75

EAH-820 Linear-Drive Headphones

High-power-handling capacity stereo headphones. Frequency range 15-30,000 Hz; maximum input power 3000 mW; 125-ohm impedance; 0.3% distortion; 3-meter coiled cord; Supra-Aural ear pads; precise fit, soft, wide-contact leather head pads; 430 g \$55

EAH-810 Linear-Drive Headphones

Open-environment stereo headphones with wide waveform response at eardrum. Frequency range 20-25,000 Hz; maximum input power 1000 mW; impedance 63 ohms; distortion 0.5% at 100 dB; 3-meter cord; Supra-Aural ear pads; precise-fit, soft, wide-contact leather head pads; 230 g \$35

EAH-T805 Stereo Headphones

Frequency range 20-20,000 Hz; maximum input 200 mW; SPL 100 dB/mW; impedance 125 ohms . \$30

UHER by WALTER ODEMER

W 775 Stereo Headphones

Dynamic stereo headphones with one active and 6 auxiliary membranes per system; half-open design; Frequency range 16-20,000 Hz; SPL 94 dB; nominal impedance 600 ohms; nominal loading capacity 200 mW; distortion 1.0%; automatic strap adjustment; gimbal earcups; 3-m cable; 330 g \$184

W675 Featherweight Headphones

Lightweight (2.2 oz) mono/stereo headphones with 8-ft coiled cord. Frequency range 20-20,000 Hz; impedance 200 ohms at 1 kHz; has lightweight adjustable headband and yellow foam-cushioned earpieces.

With 5-pin plug for Uher cassette recorders \$84

VIDAIRE

983 Deluxe Stereo Headphones

Stereo headphones feature stereo/mono switch, volume controls, and padded headband. Frequency range 20-18,000 Hz; impedance 8-16 ohms; maximum input 0.5 W; 10-ft coiled cord with 1/4" stereo plug \$28

617 High-Velocity Stereo Headphones

Features snap-lock pivot in headstrap for compact storage in pocket. Frequency range 20-20,000 Hz; impedance 4-32 ohms; 5-ft shielded mini cord with 3.5-mm stereo mini plug and strain relief; optional adapter converts to standard 1/4" stereo phone plug \$18

960C Dynamic Stereo Headphones

Dynamic Stereo headphones. Frequency range 20-18,000 Hz; impedance 8-16 ohms; maximum input 0.5 W; 6-ft cord with 1/4" stereo plug \$15

YAMAHA

YH-1000 Stereo Headphones

Orthodynamic-design headphones with 12.7-micron 30-mg polyester film diaphragm between cerium-co-



balt disc magnets. Frequency range 20-20,000 Hz; output 103 dB/mW SPL; rated/maximum input 3/10 W; HD -50 dB at 90-dB SPL, -30 dB at 120-dB SPL; impedance 100 ohms; urethane foam-padded earcups; leather-finish headstrap; universal ball-joint tilt adjustment; lockable height-adjusting sliders; includes 7.9-ft cord with stereo plug; 19 oz with cord \$220

YH-100 Stereo Headphones

Orthodynamic stereo headphones with lightweight polyester film diaphragms in dual-support drive unit with mutually opposed anisotropic ferrite magnets. Frequency range 20-20,000 Hz; output 98 dB/mW SPL at 106 dB/V; rated/maximum input 3/10 W; HD 0.3% at 90 dB SPL; impedance 150 ohms; double padded headband with supra-aural earcups; includes 8-ft straight cord; 340 g less cord \$95

YH-1 Stereo Headphones

Lightweight orthodynamic design featuring sintered ferrite disc magnets with combination voice-coil diaphragm between. Frequency range 20-20,000 Hz; output 94 dB/mW SPL; 3 W rated/maximum input 3/10 W; HD 0.3% at 120 dB SPL; impedance 150 ohms; soft leather strap distributes weight over entire head; supra-aural pads; 8-ft straight cord; weight 10.2 oz with cord \$70
 YH-2. Same as YH-1 except output 93 dB/mW SPL; weight 8.1 oz with cord \$50
 YH-3. Similar to YH-2 except 1/3 W rated/maximum input; 7.4 oz with cord \$40

YHL-005 Lightweight Stereo Headphones

Natural-sound stereo headphones for casual music-anywhere use. Feature fatigue-reducing human-engineered design; rare-earth samarium-cobalt magnets; mini plug adapter. Impedance 45 ohms; frequency range 20-20,000 Hz; output SPL 102 dB/mW at 1 kHz; maximum input 100 mW; output SPL 122 dB; 8-ft cord; weight with/without cord 2.8/1.8 oz. \$40
 YHL-007. Similar to YHL-005 except smaller drivers, lighter weight (2.5/1.4 oz with/without cord), 119-dB SPL output \$30

NEED MORE INFORMATION?

Write directly to the manufacturer or distributor. A list of names and addresses starts on page 4.

7

MICROPHONES

AKAI

ACM-100 Condenser Microphone

High-impedance electret-condenser type general-purpose microphone \$58

ACM-80 Condenser Microphone

Medium-impedance electret-condenser type general-purpose microphone \$35

AKG

Condenser Mic/FET Preamplifiers

C422. Large-diaphragm stereo condenser microphone with FET preamplifier. Features 9 polar patterns/channel selected via remote control with M-S or Y-Y recording techniques; 0/-10/-20-dB preattenuator; 9-52 V phantom powered; LED aiming indicator; S-42E remote controller; MK-42/20 66-ft cable; W-42 windscreen; H-15/9 suspension mount/stand adaptor; foam-lined carrying case. Frequency range 20-20,000 Hz; sensitivity -42 dBm; impedance 200 ohms; 9 1/2" L x 1 1/2" dia; 15.5 oz. \$2365
C-34. Small-diaphragm stereo condenser microphone similar to C-422 except sensitivity -43.5 dBm; W-34 windscreen; H-15/6 suspension mount/stand adaptor; 7 3/4" L; 9.75 oz. \$1649
C-33. Same as C-34 except for selectable polar patterns; cardioid capsules for X-Y stereo recording with one capsule fixed to main housing, the other rotatable through 0°-180° angle; MK-32/20 66-ft cable \$950

C-414EB Polydirectional Condenser Microphone

FET condenser microphone with large-diaphragm capsule. Features selectable omni, cardioid, hypercardioid, or figure-8 pattern; flat/75/150-Hz) bass roll-off switch; 0/-10/-20 dB attenuator switch. Frequency range 20-20,000 Hz (all patterns); sensitivity -43.5 dBm; maximum SPL 138 dB with 0.4% THD; impedance 200 ohms; 12/48 V phantom powered; supplied with SA-18/3 stand adapter, W-26 windscreen, case; 1.75" diameter x 5.5" L; 12 oz \$755
C-414E1. Same as C-414EB except has 9 selectable polar patterns via phantom-powered remote control; remote-control unit can operate 2 microphones independently; includes one microphone, S-42E1 remote control, MK-23/20 66-ft cable, W-26 windscreen, SA-18/3 stand adapter, case \$1401

C-535 Pre-Polarized Condenser Microphone

Professional cardioid condenser microphone designed for demanding high-performance field use. Features special 4-position output switch for adjustable padding and bass rolloff to prevent possible overload and enable user to tailor response; removable windscreen; field-replaceable shock-mounted transducer; integral FET preamp. Frequency range 20-20,000 Hz; sensitivity adjustable; SPL 132 dB with 0.5% THD; impedance 500 ohms; power required 9-52 V; supplied with SA-31 stand adapter and case; 10 oz \$280

C-450 Modular Condenser Microphone System

Modular system consists of 3 interchangeable preamps, 7 interchangeable small-diaphragm cap-

sules, and associated accessories. All C-450 FET preamps have 5-30,000 Hz frequency range, 200-ohm source impedance, 500-ohm load impedance; C-451E preamp has 9-52 V power; C-451EB and C-452EB have 2-position bass rolloff; choice of matte-nickel or satin-black finish. All capsules are condenser-designed and have frequency range of 20-20,000 Hz. Capsules available are CK-1 cardioid, CK-1S cardioid with rising response, CK-4 figure-8, CK-5 cardioid with shock-suspended transducer and integrated windscreen/pop filter, CK-8 short shotgun, DK-9 long shotgun and CK-22 omnidirectional with built-in pop filter. Preamps and capsules available either separately or in combinations.

C-451E preamp \$226
 C-451EB preamp \$246
 C-452EB preamp \$246
 CK-1 cardioid \$113
 CK-1S cardioid \$113
 CK-3 hypercardioid \$112
 CK-4 figure-8 \$300
 CK-5 cardioid \$225
 CK-8 short shotgun \$215
 CK-9 long shotgun \$265
 CK-22 omnidirectional \$120

C-567E Pre-Polarized Condenser Microphone

Professional miniature wide-range omnidirectional lavalier condenser microphone with FET preamplifier. Features durable metal construction with shock/noise-resistant system and easy field-serviceable capsule. Frequency range 20-20,000 Hz; sensitivity -43.5 dBm; SPL 132 dB with 0.5% THD; impedance 500 ohms; power required 9-52 V; supplied with H-20 tie tack, H-21 tie bar, W-37 wire-mesh windscreen, H-16 belt clip, case; 3.5 oz \$225

D-330BT Hyper Cardioid Microphone

Hyper cardioid dynamic microphone with elastomer shock-suspended plug-in field-replaceable transducer system; designed for the professional vocalist. Features dual-band, 3-position equalizer switches and hum and noise rejection systems. Frequency range 50-20,000 ohms; dual windscreen/pop filter; nickel-plated zinc alloy die-cast housing; includes SA-31 stand adapter case; 2" dia. x 7.25" L; 12 oz. \$195

D-200E Two-way Cardioid Microphone

Cardioid dynamic 2-way microphone for the semi-professional recordist and musician. Frequency range 25-16,000 Hz ±3 dB; sensitivity -56 dBm ASA; distortion 0.5%; 200-ohm impedance; includes SA-20 stand adapter and case; wire-mesh grille and cotton-fiber screen; 1.5" diameter x 7" L; 8.5 oz. \$160

D-320B Hyper Cardioid Microphone

Hyper cardioid dynamic microphone with elastomer shock-suspended field-replaceable transducer; designed for professional entertainer. Features 3-position EQ switch and hum rejecter. Frequency range 80-18,000 Hz; sensitivity -57 dBm; impedance 200 ohms; dual windscreen/pop filter; nickel-plated zinc alloy diecast housing; includes SA-31 stand adapter and case; 2" diameter x 7.5" L; 10.5 oz \$155

D-1000E Cardioid Microphone

Cardioid dynamic microphone with elastomer shock-mounted transducer; doubles as studio and field mic; has mode switch that provides up to 13 dB bass rolloff at 100 Hz and up to 6 dB midrange shelf attenuation at 1 kHz. Frequency response 40-17,000 Hz ±3 dB; sensitivity -52 dBm; 200-ohm impedance; sintered bronze windscreen; nickel-plated housing; supplied with SA-12 stand adapter and case; 1.5" diameter x 6.25" L; 8.5 oz \$135

D-310S Cardioid Microphone

Cardioid dynamic microphone with elastomer shock-suspended transducer; designed for vocal music coverage in the home, studio, or on stage. Frequency range 80-18,000 Hz; sensitivity -58 dBm; impedance 200 ohms. Features integral on/off switch, windscreen/pop filter, and hum rejecter; nickel-plated zinc alloy diecast housing; includes SA-30 stand adapter and case; 1.75" diameter x 7.5" L; 8.5 oz \$135



D-310. Similar to D-310S but without integral on/off switch \$120

D-190E Cardioid Microphone

Cardioid dynamic microphone for speech or music performing and recording. Frequency range 30-15,000 Hz; sensitivity -52 dBm; 200-ohm impedance; sintered bronze windscreen; nickel-plated housing; supplied with SA-11 stand adapter and case; 1.5" diameter x 6.25" L; 6.5 oz \$115
D-190ES. Same as D-190E but with integral on/off switch \$130

D-160E Omnidirectional Microphone

Omnidirectional dynamic microphone designed for semiprofessional recordist. Frequency range 40-20,000 Hz; sensitivity -58 dBm; impedance 250 ohms; W-20 windscreen; nickel-plated finish; supplied with SA-23/2 stand adapter and case; 3/8" diameter x 5 1/2" L; 4.5 oz \$110

D-125E Cardioid Microphone

Cardioid dynamic microphone with shock-suspended transducer; for general-purpose applications; hum rejecter and heavy-duty wire-mesh windscreen. Frequency range 100-18,000 Hz; sensitivity -53.5 dBm; 200-ohm impedance; supplied with SA-30 stand adapter and case; 1.75" diameter x 7" L; 8 oz \$110

7

MICROPHONES

D-130E Omnidirectional microphone

Omnidirectional dynamic microphone with shock-suspended transducer; designed for newsfilm and ENG applications. Frequency range 50-15,000 Hz; sensitivity -54.5 dBm; impedance 200 ohms; hum rejecter and sintered bronze windscreen; nickel-plated zinc-alloy diecast housing; includes SA-30 stand adapter and case; 1.75" diameter x 7"L; 9 oz. \$100

D-40 Stereo-Pair Microphones

Package contains 2 D-40 low-impedance cardioid dynamic microphones, stand adapters, cable \$99

AUDIO-TECHNICA U.S.

AT815 Line/Gradient Microphone

Electret condenser shotgun microphone with permanently polarized element. Frequency range 40-20,000 Hz; sensitivity -50 dB; nominal impedance 600 ohms; maximum input SPL 120 dB; S/N 50 dB at 1 kHz, 1µbar; 1.5-V AA cell powered; 16.5-ft cable with professional XLR/A3F connector at mic end, 1/4" phone plug at equipment end; slip-in stand clamp; carrying case; windscreen; battery \$205
AT815/XLR. Same as AT815 except with XLR/A3M connector at output end of cable \$210

AT814 Unidirectional Microphone

Moving-coil dynamic cardioid microphone designed for professional recording and broadcasting studios. Frequency range 50-16,000 Hz; sensitivity -56 dB



(0 dB = 1 mW/10 dynes/cm²); EIA sensitivity -150 dB; 250-ohm nominal impedance. Features high-efficiency windscreen and balanced low-impedance output and includes 16.5-ft cable with XLR/A3F professional connector with 1/4" phone plug, tapered slip-in stand clamp, and carrying case \$135
AT814/XLR. AT814 with XLR/A3M connector on output end of cable \$140

AT813 Unidirectional Microphone

Incorporates electret condenser permanently polarized element with 4-micron polymer diaphragm. Frequency range 20-20,000 Hz; sensitivity -58 dB; 600-ohm nominal impedance; input SPL 125 dB; S/N 50 dB at 1 kHz, 1µbar; AA penlight battery powered. Supplied with 16.5-ft cable with professional XLR/A3F connector with 1/4" phone plug, slip-in stand clamp, carrying case, battery \$115
AT813/XLR. AT813 with XLR/A3M connector on output end of cable \$120

AT813R. Phantom-power version of AT813. External power only (9-65 V dc). Sensitivity -49 dB; impedance 200 ohms; maximum SPL 141 dB. Supplied with A3F/A3M connectors on cable \$165

AT831 Miniature Unidirectional Mic

Electret condenser permanently polarized element. Frequency range 50-18,000 Hz; sensitivity -58 dB; nominal impedance 600 ohms; maximum input SPL 130 dB; S/N 45 dB at 1 kHz, 1 µbar; 1.5-V N-type battery powered; balanced output via battery holder/belt clip with recessed on/off switch. Includes clothing clip, musical instrument adaptor for acoustic guitar, saxophone, etc.; windscreen; battery carrying case; 0.3" diameter x 0.9"L \$115

AT812 Unidirectional Microphone

Incorporates moving-coil dynamic element. Frequency range 50-18,000 Hz; sensitivity -60 dB; 600-ohm nominal impedance. Supplied with 16.5-ft cable with professional XLR/3M connector on output end of cable \$105

AT812/XLR. AT812 with XLR/3M connector on output end of cable \$110

AT811 Unidirectional Microphone

Incorporates electret condenser permanently polarized element. Frequency range 50-20,000 Hz; sensitivity -56 dB; 600-ohm nominal impedance; maximum input SPL 130 dB; S/N 50 dB at 1 kHz, 1µbar; battery powered. Supplied with 16.5-ft cable with professional XLR/A3F connector with 1/4" phone plug, slip-in stand clamp, carrying case, battery \$100
AT811/XLR. AT811 with XLR/A3M connector on output end of cable \$105

AT803S Subminiature Microphone

Electret condenser permanently charged element; omnidirectional pattern; 5-micron polymer diaphragm. Frequency range 50-15,000 Hz; sensitivity -57 dB; 600-ohm impedance; balanced output; battery holder/belt clip with on/off switch; uses 1.5-V N-type penlight cell. Includes clothing clip, windscreen, battery, carrying case; 16.5-ft cable; mic 0.4" diameter x 0.8"L \$100

AT801 Omnidirectional Microphone

Incorporates electret condenser permanently polarized element. Frequency range 40-18,000 Hz; sensitivity -48 dB; 600-ohm nominal impedance; maximum input SPL 125 dB; S/N 50 dB at 1 kHz, 1µbar; AA penlight battery powered. Supplied with 16.5-ft cable with professional XLR/A3F connector, slip-in stand clamp, carrying case \$90
AT801/XLR. AT801 with XLR/A3F connector on output end of cable \$95

AT802 Omnidirectional Microphone

Incorporates moving-coil dynamic element. Frequency range 50-16,000 Hz; sensitivity -56 dB; 600-ohm nominal impedance. Supplied with 16.5-ft cable with professional XLR/A3F connector, slip-in stand clamp, carrying case \$80
AT802/XLR. AT802 with XLR/A3M connector on output end of cable \$85

AT805S Miniature Microphone

Electret condenser permanently charged element; omnidirectional pattern. Frequency range 50-15,000 Hz; sensitivity -57 dB; 600-ohm impedance; unbalanced output; built-in switch. Uses E675 battery. Includes clothing clip, lavalier cord, windscreen, belt clip, battery, carrying case, 16.5-ft cable with 1/4" phone plug; mic 0.6" diameter x 2"L \$60

ATH817 Unidirectional Microphone

Electret condenser permanently polarized element. Frequency range 50-16,000 Hz; sensitivity -52 dB; nominal impedance 60 ohms; maximum input SPL 125 dB; S/N 45 dB at 1 kHz, 1µbar; 1.5-V AA cell powered; 13-ft integral cable with 1/4" phone plug; snap-in stand clamp battery \$52.50

AT816/2 Unidirectional Microphone

Stereo pair of unidirectional moving-coil dynamic microphones designed for home stereo recording. Frequency range 60-15,000 Hz; sensitivity -62 dB; nominal impedance 600 ohms (matches 150-1000 ohm inputs). Includes slip-on desk stands and 13-ft cables with 1/4" phone plugs \$65/pr.

BEYER DYNAMIC, INC.

M-130 Bidirectional Ribbon Microphone

Figure-8 bidirectional ribbon microphone incorporating two 0.012" aluminum ribbons that move one above the other with 0.020" separation; designed for studio broadcasting or recording. Frequency range 40-18,000 Hz; polar pattern provides 3-dB attenuation at 90°; ribbon design protects from overload or mechanical shock; supplied with standard 3-pin Switchcraft connector; 5.04"L \$420

M-160 Super Cardioid Ribbon Microphone

Super-cardioid dynamic double-microphone. Frequency response 40-18,000 Hz ±2.5 dB; sensitivity -152 dBm (EIA); 200-ohm impedance; low sensitivity at 120° to axis; suitable for stereo recording; Cannon XLR termination \$360

M-88 Super Cardioid Moving-Coil Microphone

Super-cardioid dynamic type. Frequency response 30-20,000 Hz ±2.5 dB; sensitivity -144 dBm (EIA); special transducer mounting eliminates body noise; withstands rough handling, humidity, temperature changes; for studio work, recording artists, instruments \$320

M600 Unidirectional Dynamic Microphone

True hypercardioid characteristic dynamic microphone with built-in presence boost; hum bucking coil; pop filter; lockable on/off switch; adjustable 3-posi-



tion bass attenuator. Frequency range 40-16,000 Hz; side attenuation >24 dB at 120°; 1 kHz; output level -56 dBm; EIA sensitivity -149 dB; impedance 250 ohms; load impedance >1k ohms; bass attenuation -8/-12/-16 dB; aluminum case with steel mesh grille, black anodized finish; XLR or equivalent male connector \$280

M-500 Unidirectional Ribbon Microphone

Hyper cardioid dynamic ribbon microphone with professional-application tailored presence boost. Frequency range 40-18,000 Hz; integral 4-stage blast filter for high-level sound sources; sensitivity -152 dBm (EIA), -60 dBm (1mW/Pa); 20-dB side attenuation at 120°; matte black aluminum case; 16 1/2-ft, 2-conductor cable with XLR-type connector; leatherette carrying case; 7.4"L \$240

M-260S Super Cardioid Ribbon Microphone

Super cardioid dynamic design. Frequency response 50-18,000 Hz ±2.5 dB; sensitivity -153 dBm (EIA); high-energy ribbon; 200-ohm impedance. Suitable for speech, music, or vocals; has on/off switch and Cannon XLR termination \$200

M-101 Omnidirectional Moving-Coil Microphone

Omnidirectional type. Frequency range 40-20,000 Hz; sensitivity -150 dBm (EIA); 200-ohm impedance. Withstands pressures associated with modern music (modulated voltages up to 2 V); low handling noise; 4 1/2" x 1 1/8"; Cannon XLR termination .. \$199

M-201 Hypercardioid Dynamic Microphone

Professional-application unidirectional dynamic microphone with hum-buckin coil construction. Frequency range 40-18,000 Hz; sensitivity -149 dBm (EIA), -56 dBm (1mW/Pa); impedance 200 ohms electrical, 1k ohm or more load; >20 dB side attenuation at 120°; 16 1/2-ft, 2-conductor cable and Switchcraft A3F connector; matte black brass case with windscreen, clamp, case. 6.3" long \$189

M-111 Omnidirectional Lavalier Microphone

Miniature omnidirectional dynamic lavalier microphone with filter providing flat frequency response when suspended over chest; designed for TV broadcasting. Frequency range 60-15,000 Hz (decreases 6 dB between 700-800 Hz and rises and rises to 8 dB from 1000 to 10,000 Hz); output -62 dBm; 200-ohm impedance; spring-mounted inner casing suspended within outer housing; available with standard Cannon 3-pin connector or 1-m cable and 6-pin connector for use with company's TS 73 or TS 83

wireless pocket transmitter; clamp and cord in black leatherette case; black matte finish; 3.35" L . . . \$182
M-112 Similar to M-111 minus chest filter; zinc-alloy diecast case \$160

MCE-5 Omnidirectional Tie-Clip Mic

Broadcast-quality clip-on omnidirectional electret condenser microphone designed for on-camera applications. Frequency range 20-20,000 Hz; S/N ratio 62 dB; maximum SPL 116 dB at 1 kHz; EIA sensitivity 141 dBm; electrical impedance 700 ohms; load impedance 2500 ohms; supplied with detachable windscreen and 1-m cable with 6-pin male connector to interface with MES5VNC pocket power supply \$160
MCE-5.1. Same as MCE-5 but with detachable windscreen and 3-meter cable terminated in 1/4" phone jack; self-contained battery compartment . . . \$190
MCE-5.9. This version has 3-meter open-ended cable for interface with wireless units \$140
MCE-5.11. Same as MCE-5.1 except for 3-pin XLR connector that operates on 48-V phantom powering or on self-contained battery (Mallory PX 23) . . \$250
MES5VNC(C). Pocket power supply for MCE-5; 9-volt \$100

M-69 Cardioid Moving-Coil Microphone

Dynamic cardioid design. Frequency response 50-16,000 Hz ± 3 dB; sensitivity -144 dBm (EIA); 200-ohm impedance; for indoor/outdoor applications; unaffected by temperature, humidity . . . \$160
M-69-SM. Same as M-69 but with on/off and bass-cut switch \$172

M-400 Moving-Coil Cardioid Microphone

Moving-coil dynamic super-cardioid type. Frequency range 50-15,000 Hz; sensitivity -146 dB (EIA); 200-ohm impedance; on-off switch; 3-pin XLR termination; blast filter; 24.6-ft cable; black anodized aluminum case and clamp \$128
M-400S. Same as M-400 except with on/off switch \$133

M-818 Matched-Pair Microphone

Cardioid dynamic matched-pair microphones. Frequency range 150-16,000 Hz; output level -55.8 dBm; 500-ohm impedance; front-to-back separation 18 dB; comes with attached 6.5-ft cables with 1/4" phone plug, 2 table stands, mic clamps, stereo adaptor cable, mounting bar, presentation case; 5.47" L \$150/pr.

CERWIN-VEGA!

Professional Series

UE-1 Cardioid Microphone

Uni-electret cardioid microphone designed for stage instruments. Features pop filter; on/off and tone impedance switches. Frequency range 80-20,000 Hz; impedance switchable 600/10k ohms; sensitivity -70 dB 3 dB into 600 ohms (0 dB = 1 V/ μ bar); 16-ft cable with 1/4" 3-conductor phone plug and Cannon XLR-3-11C equivalent connector; 7.914" L \times 1.930" diameter \$125

UD-1 Cardioid Microphone

Unidirectional cardioid dynamic microphone designed for live vocal applications or studio use. Features built-in pop filter and on/off switch. Frequency range 70-15,000 Hz; sensitivity -73 dB 3 dB (0 dB = 1 V/ μ bar); impedance 600 ohms; 16-ft cable with 1/4" 3-conductor phone plug and Cannon XLR-3-11C equivalent connector; 7.323" L \times 1.575" diameter \$100

CROWN

Pressure Zone™ Microphones

Hemispherically-patterned electret microphones engineered to respond to coherent wavefront at surface of acoustic boundary to eliminate comb filtering. Designed for television, theater, concert, and PA applications. Features reduced pressure-calibrated electret modules mounted within a few millimeters of rigid surface and facing a boundary; need for fewer channels; simplified design for easier set up; handles 150-dB SPL. Equipped with battery and phantom power

supply arranged in cylindrical metal tube with XLR connectors; available in gold or black.

General Purpose (PZM™-30GP). XLR connector, electret capsule, and mike cantilever mounted on 1/4" aluminum plate 5" \times 6"; wall or floor positioning or suspension above choir or orchestra \$350
Low Profile (PZM™-6LP). Cantilever holding electret capsule, mounted on 2" \times 3" aluminum plate; XLR connector at end of several feet of cable; suitable for conference rooms or TV programming \$350
Flush Mount (PZM™-20RMG). All connections at section of mike extending below level of capsule, ensuring invisibility of mike; suitable for mounting into podium, lectern, or pulpit; cantilever capsule protected from objects or papers by 3 small metal pegs \$350
Lavalier (PZM™-2LG). Designed to be worn on tie, scarf, or coat \$350



Tie Bar (PZM™-3LV). Smallest PZM™ microphone \$350

PZM™-31S Pressure Zone Microphone

Designed to complement the PZM 30GP to provide a frequency response with a deeper low end. Active element is an electret capsule mounted on a 6" \times 5" plate so that it faces boundary defined by plate and surface on which plate rests. Sound pickup pattern is hemispheric. Mike is usable with either PX-18 transformer or PA-18 active power supply. Frequency range 20-20,000 Hz; sensitivity -76 dB open circuit (0 dB = 1V/ μ bar); normal loading impedance 1k ohms; THD 3% at 150 dB SPL; S/N < 25 dB SPL; electrical impedance 150 ohms with PA-18 and PX-18; cable length 5.5 ft \$350
PZM™-6S. Similar to PZM™-31S but smaller size \$350

ELECTRO-VOICE

PL20 Dynamic Supercardioid Microphone

Supercardioid condenser microphone designed for critical recording and musical sound-reinforcement applications. Features integral blast filter; > 160-dB miking; nonreflecting gray finish. Frequency range 50-20,000 Hz \$516

PL80 Dynamic Supercardioid Microphone

Supercardioid microphone designed for real-life use. Features professional low impedance, integral blast filter, snow gray finish, contrasting charcoal Memraflex grille. Frequency range 50-20,000 Hz . . . \$216

PL77B Condenser Cardioid Microphone

Designed for phantom or battery powering. Has recessed on/off switch that controls battery power only. Features 2-position bass-contour switch; blast filter; nonreflecting snow gray finish and Memraflex grille. Frequency range 50-20,000 Hz \$198

PL11 Dynamic Supercardioid Microphone

Instrument microphone that can double for vocal applications. Features variable-D directionality that virtually eliminates boost at bass frequencies when used up close; blast filter; low impedance; steel case finished in nonreflecting gray. Frequency range 50-15,000 Hz; output level -56 dB \$187

PL76B Condenser Cardioid Microphone

Condenser microphone designed for vocal applications. Features nonreflecting snow-gray-finished diecast case. Frequency range 50-20,000 Hz; distortion < 1% at 136 dB SPL; power source 1.5-V AA cell \$168

PL95A Dynamic Cardioid Microphone

Special-element and 2-piece diaphragm dynamic cardioid microphone designed for wide-range linear frequency response. Features rugged steel case; pop filter; Memraflex steel grille; nonreflecting snow-gray finish. Frequency range 70-20,000 Hz; output level -60 dB \$162

PL9 Dynamic Omnidirectional Microphone

Omnidirectional instrument microphone with professional low-impedance, high-output characteristics. Features turned-steel case; Memraflex steel grille; nonreflecting gray finish. Frequency range 50-20,000 Hz; output level -58 dB \$156

PL19A Dynamic Cardioid Microphone

Vocal microphone with strong bass boost when held close. Features directional, antifeedback performance; locking on/off switch; diecast case; snow-gray finish and charcoal Memraflex grille. Frequency range 50-15,000 Hz; low-impedance output; output level -60 dB \$126

PL6 Dynamic Supercardioid Microphone

Continuously Variable-D directional microphone without up-close bass boost. Features extra-tight supercardioid directional pattern that minimizes feedback; rugged diecast case; Memraflex grille; nonreflecting gray finish. Frequency range 50-17,000 Hz; low-impedance output; output level -56 dB \$119

PL5 Dynamic Omnidirectional Microphone

Professional instrument microphone designed for high sound-pressure levels (SPLs). Features pop filter; low-impedance input/high output level; rugged steel case; Memraflex steel grille; nonreflecting gray finish. Frequency range 40-15,000 Hz; output level -55 dB; SPL-handling range up to 160 dB . . . \$97

PL88L Dynamic Cardioid Microphone

Vocal microphone with on/off switch. Offered in 2 versions: PL88L low impedance and PL88H high impedance. Feature snow-gray finish and contrasting charcoal grille. Frequency range 50-14,000 Hz. \$80

JVC

MU-S80 Calibrated Microphone

Calibrated microphone designed for use with JVC SEA-40, -60, -70, and -80 graphic equalizers. . . . \$200

M-510 Electret Condenser Microphone

Super-directional/undirectional pattern. Frequency range 40-20,000 Hz; sensitivity -68 dB (super), -71 dB (unit); S/N ratio > 50 dB; 13-dB gain loss in passive mode \$190

M-201 Electret Condenser Microphone

Frequency range 40-18,000 Hz; sensitivity -71 dB; S/N ratio > 47 dB at 1 kHz; output impedance 600 ohms. \$60

MARLBORO SOUND WORKS

M900 Cardioid Microphone

Unidirectional dynamic cardioid microphone with spherical wind screen. Frequency range 50-17,000 Hz; output at 1 kHz 74.6 dB low, 58.7 dB high impedance; 200-ohm low impedance, 20k-ohm high impedance; 16-ft detachable cable with XLR-connector \$89

M500 Cardioid Microphone

Unidirectional dynamic microphone for acoustic instruments. Frequency ranges 50-16,000 Hz; output level at 1 kHz 76 dB low impedance, 56 dB high impedance; 200-ohm low impedance, 20k-ohm high impedance; 16-ft detachable cable with XLR-connector \$87

M400 Cardioid Microphone

Cardioid condenser microphone; electret element built-in FET preamp and 1.5-V cell. Frequency response 40-18,000 Hz ± 3 dB; sensitivity 51 dB ± 3 dB high impedance; 20-ft detachable cable with heavy-duty Cannon-type connector \$49

M300 Cardioid Microphone

Cardioid dynamic microphone. Frequency response 60-15,000 Hz ± 3 dB; sensitivity 58 dB ± 3 dB high impedance; 20-ft detachable cable with heavy-duty Cannon-type connector \$42

M200 Cardioid Microphone

Cardioid dynamic microphone. Frequency response 60-13,000 Hz ± 3 dB; sensitivity 61 dB ± 3 dB high,

7

MICROPHONES

80 dB \pm 3 dB low impedance; 10-ft heavy duty detachable cable.....\$31

M50 Dynamic Microphone

Dynamic microphone. Frequency response 60-12,000 Hz \pm 3 dB; sensitivity 61 dB \pm 3 dB high impedance; 10-ft heavy-duty cable.....\$21

M30 Dynamic Microphone

Dynamic microphone. Frequency response 70-12,000 Hz \pm 3 dB; sensitivity 56 dB high impedance; 10-ft heavy duty-cable.....\$14

MURA

DX-118 Cassette Microphone

Type B microphone designed to fit most cassette recorders and supplied with dual plugs for audio and remote control. Impedance 500 ohms; sensitivity -70 dB at 1 kHz; frequency range 60-12,000 Hz; remote switch; 5-ft cable.....\$6

DX-211 Microphone

Type E single-plug microphone designed for tape recorders requiring high-quality mic with single miniature plug. Supplied with adapter to convert from miniature to standard 1/4" phone plug; on/off switch; 5-ft cable. Impedance 500 ohms; sensitivity -70 dB at 1 kHz; frequency range 60-12,000 Hz.....\$6

DX-242 Stereo Microphones

Type F matched-pair stereo microphones for stereo recorders. Supplied with adapters to convert from miniature to standard 1/4" phone plug; 5-ft cable. Impedance 500 ohms; sensitivity -70 dB at 1 kHz; frequency range 60-12,000 Hz.....\$20

EX-279 Lapel Microphone

Omnidirectional electret condenser microphone with clothing clip, 10-ft cable, mini plug, battery. Frequency range 30-16,000 Hz; impedance 600 ohms. \$26

NAKAMICHI

CM-300T Electret Tri Microphone

Tri-microphone system with 3 CM-300 microphone recording system; supplied with carrying case with space for headphones, cables, accessories...\$465

CM-300S. Similar to CM-300T except single-mic version.....\$170

DM-1000 Dynamic Cardioid Microphone

Cardioid moving-coil microphone with low-mass diaphragm and voice coil for extended high-end response; designed for vocals. Features triple metal screen pop, blast, wind filter; double casing and foam suspension for reduced sensitivity to vibration; immunity to hum and magnetic fields. Frequency response 30-20,000 Hz \pm 3.5 dB; sensitivity -76 dB at 1 kHz (0 dB = 1V/ μ bar); impedance 250 ohms; supplied with Cannon-type XLR-3 connector; anodized black matte finish; 10.4 oz.....\$300

CM-300 Electret Condenser Microphone

Studio-type system with interchangeable capsules. Basic set comes with CP-1 cardioid and CP-2 omnidirectional capsules, windscreens, 15-ft cable, XLR connector, battery, stand adapter. Features 10-dB attenuator pad; low-cut proximity effect compensator. Frequency response \pm 3.5 dB 30-18,000 Hz (CP-3); 30-20,000 Hz (CP-4) \pm 3.5 dB; impedance 200 ohms balanced; sensitivity \pm 2.5 dB -76 dB (CP-1, CP-2, CP-4), -74 dB (CP-3); 138-dB SPL maximum (CP-1, CP-2), 136-dB SPL maximum (CP-3); 118-dB SPL maximum (CP-4) at 3% distortion; dynamic range 114 dB (CP-1, CP-2), 107 dB (CP-3), 94 dB (CP-4).....\$170

CP-2. Omni capsule for CM-100 (included with CM-300).....\$20

CP-3. Optional small-diameter, super omnidirectional

capsule.....\$40

CP-4. Super-directional (shotgun) capsule.....\$60

CM-100. Similar to CM-300 but powered by 1.5-V cell; maximum SPL 118 dB at 3% distortion; dynamic range 94 dB; supplied with CP-1 cardioid capsule; accepts CP-2, CP-3, CP-4.....\$110

DM-500 Super Cardioid Microphone

Dynamic moving-coil microphone with windscreens and supercardioid polar pattern. Frequency response 50-15,000 Hz \pm 5 dB; impedance 250 ohms; sensitivity -73 dB \pm 2.5 dB.....\$100

NEUMANN

Fet-80 Condenser Microphones

Line of studio microphones that come in many configurations (omnidirectional, figure-8, cardioid, multiple pattern, multiple pattern stereo); can be battery or phantom (separate power supplies) powered except U-87 (which contains a switchable battery compartment).

KM-83. Omnidirectional.....\$375

KM-84. Cardioid.....\$375

KM-85. Cardioid, low-frequency rolloff.....\$375

KMS-84. Pop-proof cardioid.....\$799

U-47FET. Cardioid.....\$969

KMR-82. Shotgun.....\$799

KM-88. Switchable 3-pattern.....\$1098

KM-86. Switchable 3-pattern.....\$998

U-87. 3-pattern.....\$998

U-89. 117-V ac portable power supply for powering 1 or 2 fet-80 microphones.....\$74

PIONEER

DM-61 Dynamic Microphone

Unidirectional dynamic microphone. Frequency range 80-12,000 Hz; sensitivity 75 dB/ μ bar at 1 kHz; impedance 600 ohms.....\$130

DM-51 Dynamic Microphone

Unidirectional dynamic microphone. Frequency range 80-12,000 Hz; sensitivity 75 dB/ μ bar at 1 kHz; impedance 600 ohms.....\$100

DM-21 Dynamic Microphone

Unidirectional dynamic microphone. Frequency range 100-15,000 Hz; sensitivity 75 dB/ μ bar; impedance 500 ohms.....\$30

REALISTIC

33-1080 Cardioid Microphone

Cardioid-pattern microphone with professional back electret design, switchable low-frequency contour, foam windscreens, stand adapter. Frequency range 20-20,000 Hz; impedance 600 ohms with low-impedance balanced option; 16.5-ft heavy-duty cable with XLR connector; requires AA cell.....\$50

33-984 Highball Cardioid Microphone

Unidirectional dynamic microphone with on/off switch, ball-type screen pop/blast filter, rubber antishock ring. Frequency range 80-13,000 Hz; switchable impedance 600 ohms low, 10k ohms high (low-impedance balanced option); XLR-type connector; 16.5-ft cable with plug.....\$50

33-919 Dual-Pattern Microphone

Stereo electret condenser microphone with 2 internal condenser capsules and switchable wide/normal pickup patterns. Frequency range 30-15,000 Hz; sensitivity -72 dB \pm 3 dB; impedance 600 ohms; requires AA cell.....\$140

33-1070 Super Omni Dynamic Microphone

Omnidirectional dynamic microphone with all-metal body, rubber shock ring, windscreens/blast filter. Frequency response 40-17,000 Hz \pm 3 dB; impedance 500 ohms, unbalanced with balanced option; XLR-type connector; 16.4-ft cable with plug.....\$39.95

RECOTON

MM-670 Unidirectional Dynamic Microphone

Unidirectional dynamic microphone with on/off and

high/low impedance switches, black satin finish, wind filter. Frequency range 30-18,000 Hz; 20-ft cable with standard phone plug.....\$70

MM-3000 Unidirectional Dynamic Microphone

Unidirectional dynamic microphone with on/off switch, wind filter, aluminum finish. Frequency range 30-18,000 Hz; 20-ft cable with standard phone plug.....\$65

MM-660 Cardioid Microphone

Unidirectional electret condenser stereo microphone designed for outdoor use; 1.5-V battery-powered; sensitivity -68 dB at 1 kHz; frequency range 50-16,000 Hz; impedance 600 ohms. Includes windscreens and 3-m cord; aluminum casing; 295 g.....\$60

MM-620 Cardioid Microphone

Unidirectional cardioid electret microphone designed for performing, broadcasting, PA, home recording. Sensitivity -68 dB; frequency range 30-16,000 Hz; impedance matches 200-600 ohms; operates on 1.5-V AA battery. Supplied with 18-ft shielded cable with standard phone plug, swivel mic adapter, vinyl case; satin gold finish.....\$50

MM-770 Miniature Stereo Microphone

Ultraminiature stereo electret condenser microphone with 2 pickup elements. Features matrix circuit to provide superior stereo separation; color-coded on/off switch; 2 color-coded 3.5-mm plugs; 2 standard phone-plug adapters; foam windscreens; vinyl storage case. Frequency range 48-18,000 Hz; impedance 600 ohms; sensitivity -80 dB at 1 kHz; dc power source 1.35-V mercury cell; 76 mml \times 22mmW \times 22 mmD (including stand); < 3 oz; 1-m cord...\$50

MM-610 Unidirectional Microphone

Sensitive slimline unidirectional cardioid electret microphone with brushed satin gold aluminum finish, shielded cable, windscreens, swivel mic adapter, vinyl carrying case. Frequency range 40-15,000 Hz; sensitivity -66 dB; impedance matches 200-600 ohms; dc power 1.2-V AA cell; 18-ft cable with standard phone plug.....\$41

MM-330 Cardioid Microphone

Unidirectional dynamic cardioid microphone designed for performers. Features hi/lo and on/off switches; bull-head design; triple-mesh construction; 18-ft shielded cable with standard phone plug; swivel mic adapter; vinyl case; silver finish.....\$38

MM-680 Omnidirectional Microphone

Electret condenser omnidirectional microphone with on/off switch, wind filter, black aluminum finish. Frequency range 50-16,000 Hz; low impedance; 20-ft cable with standard phone plug.....\$35

MM-600 Unidirectional Microphone

Unidirectional cardioid electret microphone with on/off switch, swivel stand adapter, satin gold aluminum finish. Frequency range 50-13,000 Hz; impedance 200-600 ohms; power source 1.5-V AA cell; 9-ft cable with standard phone plug.....\$32

MM-760 Ultraminiature Electret Mike

Omnidirectional tie clip electret microphone. Output level 65 dB, frequency range 30-16,000 Hz; powered by 1.5-V AA battery (incorporated in plug assembly); 15-ft shielded cable; standard phone plug; vinyl case; brush gold finish; 3/8" diameter \times 3/8" L.....\$32

MM400 Stereo Microphone Set

Matched pair of microphones with universal plugs and adapters. Feature on/off switches, 500-ohm impedance, 3-ft cords.....\$29

MM-750 Miniature Microphone

Ultra-small lavalier microphone. Frequency range 50-12,000 Hz; impedance 600 ohms; sensitivity -72 dB; power source 1.5-V cell; 1/4" \times 1/4" Diameter; 20-ft cable with 3.5-mm mini plug.....\$26

DM150 Dynamic Microphone

Replacement microphone designed for voice and music. Features on/off switch, desk stand, 3.5-mm

phone plug, 2.5-mm remote-control plug. Impedance 500 ohms; 3-ft cord \$17

MM100 High-Impedance Microphone

Replacement for crystal or other high-impedance microphone. Features on/off switch; desk stand; phone plug; 5-ft cord \$16

DM100 Dynamic Microphone

Features desk stand, 5-ft cord, 3.5-mm phone plug, 2.5-mm remote-control plug. Impedance 500 ohms \$9
DM120. Same as DM100 except impedance 50k ohms \$15
DM130. Same as DM100 except impedance 200 ohms \$9

DM133 Budget Cassette Microphone

Inexpensive microphone with desk stand, 3-ft cord, 3.5-mm phone plug, 2.5-mm remote-control plug. Impedance 200 ohms \$7

SANUI

EM-5 Electret Condenser Microphone

Unidirectional single-point electret condenser microphone. Frequency range 70-15,000 Hz; impedance 1000 ohms balanced; frontal sensitivity -72 dB; power source 1.5-V R-1 cell \$37

DM-3 Dynamic Microphone

Unidirectional dynamic microphone. Impedance 500 ohms unbalanced; frequency range 100-10,000 Hz; frontal sensitivity -77 dB; 3-m cord with 6.3-mm phone plug \$20

SCHOEPS

Colette Series Microphones

Studio condenser microphones with interchangeable capsules and amplifiers. Can be 12-volt phantom or parallel powered, or 48-volt phantom powered. Transformerless construction for low output impedance; insulated transducer and 60-V polarization.

CMC 38. Figure-8 microphone. Frequency range 40-16,000 Hz; sensitivity 1.0 V/ μ bar; S/N ratio 75 dB; 132 dB SPL at 0.5% distortion; 80 g; 5.57" L \times 0.79" diameter \$780

CMC 341. Hypercardioid microphone. Frequency range 40-20,000 Hz; sensitivity 1.3 mV/ μ bar; S/N ratio 75 dB; 132 dB SPL at 0.5% distortion; 80 g; 5.57" L \times 0.79" diameter \$780

CMC 341. Hypercardioid microphone. Frequency range 40-20,000 Hz; sensitivity 1.3 mV/ μ bar; S/N ratio 77 ratio dB; 131 dB SPL; 80 g; 5" L \times 0.79" diameter \$730

CMC 34. Cardioid microphone. Frequency range 40-20,000 Hz; sensitivity 1.2 mV/ μ bar; S/N ratio 76 dB; 131 dB SPL; 80 g; 5" L \times 0.79" diameter. ... \$640

CMC 33. Special omnidirectional microphone designed for distant field placement. Frequency range 20-20,000 Hz; sensitivity 1.0 mV/ μ bar; S/N ratio 76 dB; 132 dB SPL; 80 g; 5" L \times 0.79" diameter \$640

SENNHEISER

MD 441 U Supercardioid Microphone

Supercardioid dynamic microphone. Frequency range 30-20,000 Hz; sensitivity 0.2 mV/ μ bar \pm 3 dB; brilliance switch for nominal 5-dB boost at 5 kHz; 5-position bass attenuator; front-to-back ratio 20 dB - 3 dB. Supplied with cable and quick-release mount for floor stand or MZT-441 table stand; takes MZW-441 windscreen; 1.3"H \times 1.4"W \times 9.6"L.
With low-impedance cable \$455
With high-impedance cable \$487

MD 211 U Omnidirectional Microphone

Omnidirectional dynamic microphone. Frequency range 40-20,000 Hz; sensitivity -58 dBm (0.13 mV/ μ bar) \pm 2.5 dB. Supplied with Cannon XLR connector and cable; 1" diameter \times 4 $\frac{3}{4}$ " L.
With low-impedance cable \$356
With high-impedance cable \$388

MD 431 U Supercardioid Microphone

Supercardioid dynamic vocal microphone. Frequency

range 40-16,000 Hz; sensitivity 1.4 mV at 94-dB SPL; output -55.5 dB at 1 mW/10 dynes/cm²; 200-ohm source impedance at 1 kHz. Features bass/proximity cutoff and pop filters; on/off switch with lock; metal housing with replaceable stainless-steel grille screen; double-housed and shock-mounted; can be used in mobile situations; includes quick-release clip with lock, XLR connector, 16-ft cable, phone plug \$352

MD 421 U Cardioid Microphone

Cardioid dynamic microphone. Impedance 200 ohms; frequency response 30-17,000 Hz \pm 5 dB; sensitivity 0.2 mV/ μ bar \pm 3 dB at 1 kHz; EIA rating -145.8 dB; output level -53 dBm (1 mW/10 dynes/cm²); front-to-back ratio 18 dB, variable bass attenuator; XLR connector and cable; 7" \times 1 $\frac{1}{4}$ " \times 1 $\frac{1}{16}$ ".
With low-impedance cable \$327
With high-impedance cable \$358

MD 416 U Cardioid Microphone

Cardioid dynamic microphone designed for close miking. Frequency range 50-15,000 Hz; sensitivity 0.13 mV/ μ bar \pm 3 dB; 200-ohm impedance. Features isolation system to eliminate handling noise; pop filter; Cannon XLR connector; threaded stand mount with quick-release clip; cable.
With low-impedance cable \$300
With high-impedance cable \$332

Electret Condenser Microphone System

One common powering module in balanced version (K3U) or unbalanced version (K1) serves 3 different compact heads. ME20 omnidirectional head frequency range 50-15,000 Hz; sensitivity 49 dBm; S/N ratio 64 dBm minimum. ME40 supercardioid head frequency range 50-15,000 Hz; sensitivity 49 dBm; S/N ratio 64 dBm minimum. ME80 shotgun head frequency range 50-15,000 Hz; sensitivity 45 dBm; S/N ratio 70 dB minimum

K3U. Powering module \$147

K1. Powering module \$122

ME20. Omnidirectional head \$87

ME40. Supercardioid head \$123

ME80. Shotgun head \$172

ME88. Spot microphone head \$255

MD 402 Supercardioid Microphone

Supercardioid dynamic microphone. Frequency range 50-15,000 Hz; output level -57 dBm at 94 dB SPL; windscreen, 15-ft cable; quick-release clamp ... \$80

MD 200 Microphone

Frequency range 60-13,500 Hz; pressure transducer; omnidirectional pickup pattern; output level 2.5 mV/pA \pm 3 dB at 1 kHz; impedance 600 ohms; phone-plug connector; 1.9" diameter; 4 oz. \$31
MD 400. Same as MD 200 except supercardioid with 22-dB rejection at 1 kHz. 120; pressure-gradient transducer \$39

SHURE

300 Bidirectional Ribbon Microphone

Power level -60 dB (0 dB = 1 mW/10 μ bar); frequency range 40-15,000 Hz; user-selectable high or low impedance; bidirectional pickup pattern; swivel mount to stand; recommended for speech and music applications; 20-ft cable and connector; color gray \$205

Unisphere® I Series Microphones

Dynamic cardioid microphone for high-quality recording and reproduction. Has built-in pop filter and dual impedance. Frequency range 50-15,000 Hz; power level -57 dB in low impedance; 15-ft cable.

565D \$123

565SD. Same as 565D plus on/off switch in handle \$126

565SD-CN. Same as 565D plus on/off switch and 20-ft cable with 3-pin professional connector \$132

516Q E-Qualidyne® Microphone

Unidirectional cardioid dynamic equalizer microphone for tape recording. Features equalization and response-shaping control; 4 switches on handle provide 16 different combinations of special effects to eliminate undesirable effects or enhance various instru-

ments. Frequency range 50-15,000 Hz; impedance 150 ohms. Comes with foam windscreen; swivel adapter; cable; mini-plug adapter cable; carrying case \$124
516EQ-RP. Pair of 516 EQ microphones \$221

Unidyne® III Series Microphones

Dynamic cardioid microphone for high-quality music and voice recording and reproduction. Dual impedance. Frequency range 50-15,000 Hz; power level -58.5 dB in low impedance. Supplied with 15-ft cable.

545D \$110

545SD. Same as 545D plus on/off switch in handle \$113

545SH. Same as 545D but with on/off switch in permanently attached stand mount \$113

545SD-CN. Same as 545D plus on/off switch and 20-ft cable with 3-pin professional connectors ... \$119

545L. Same as 545D but low impedance. Supplied with lavalier cord, clip, permanently attached 20-ft cable \$132

578 Omnidyne® Omnidirectional Microphone

Omnidirectional hand-held microphone for music, speech. Power level -60 dB; frequency range 50-15,000 Hz; dual impedance; 15-ft cable; accessory swivel bracket; chrome finish \$105

579SB "Vocal Sphere" Omnidirectional Microphone

Omnidirectional microphone with snap-in stand attachment, on/off switch, pop/blast filter. Designed for speech, rock vocal, music use. Power level -57 dB; frequency range 50-15,000 Hz; low impedance; 20-ft cable and connector; chrome finish \$92

Unisphere® A Cardioid Microphones

Hand-held cardioid microphones with slip-in stand attachment, pop/blast filter, on/off switch. Designed for speech, rock vocal, music. Power level -59 dB; frequency range 50-13,000 Hz; 15-ft cable with connector; chrome finish.

585SA. High impedance \$90

585SB. Low impedance \$90

585SAV. Similar to 585SA but has volume control on microphone barrel \$100

585SAC. High impedance with $\frac{1}{4}$ " plug \$93

585SBV. Similar to 585SB except has volume control in handle \$100

585SAVC. Similar to 585SAVC plus $\frac{1}{4}$ " plug. \$104

Unisphere® B Cardioid Microphones

High-impedance cardioid microphone. Power level -60.5 dB; frequency range 80-13,000 Hz. Hand-held with slip-in stand attachment; use for speech, rock vocal, music; has pop/blast filter, on/off switch; comes with 15-ft cable and connector; chrome finish.

588SA. High impedance \$75

588SB. Low impedance \$75

588SAC. 588SA with $\frac{1}{4}$ " plug \$78

588SBC. 588SB with 3-pin plug \$81

515 SAC Unidyne® B Microphone

Dynamic cardioid microphone for good-quality sound systems and tape recordings. Has locking on/off switch. Power level -61 dB; frequency range 80-13,000 Hz; high impedance. Comes with 15-ft cable with $\frac{1}{4}$ " phone plug, built-in shock mount \$55

575S Omnidirectional Microphone

Dynamic microphone designed for wall/panel mount, on desk or floor stand, or lavalier or handheld use. Features slide-to-talk on/off switch; high impedance. Frequency range 40-15,000 Hz; output power level -58 dB; black ARMO-DUR® finish with satin anodized cap, stainless-steel grille; 5 oz. Includes stand adapter, lavalier assembly; 7-ft single-conductor shielded cable \$36
575SB. Similar to 575S but low impedance \$36

Professional Microphones

SM7 Dynamic Cardioid Microphone

Unidirectional microphone with flat, bass-rolloff, presence-boost, bass/rolloff/presence-boost response tailoring. Power level -57 dB (0 dB = 1 mW/10 μ bar); frequency range 40-16,000 Hz; impedance 150 ohms for inputs of 19-300 ohms; dark gray foam

7

MICROPHONES

windscreen, dark gray enamel finish \$470

SM81-CN Condenser Cardioid Microphone

Unidirectional low-noise, low-distortion microphone with selectable 10-dB attenuator, 3-position low-frequency-response switch. Power level -40.5 dB; frequency range 20-20,000 Hz; impedance 150 ohms; low r-f susceptibility; range of power sources 12-48 V. Supplied with attenuator lock, windscreen, swivel adapter, cable; metallic vinyl finish \$348
SM81-LC. Same as SM81-CN except minus cable \$327
PS1. Power supply for SM81 microphones; powers 2 microphones; 108-132 V ac, 50/60 Hz \$136

SM33 Super Ribbon Cardioid Microphone

Supercardioid ribbon microphone for speech, instrumental, vocal recordings; has bass response selector switch. Power level -59 dB; frequency range 40-15,000 Hz; dual impedances (38 and 150 ohms); dark gray nonflare finish \$330

SM10A Unidirectional Head-Worn Microphones

Close-talking cardioid microphones for noise reduction. Power level -66 dB; frequency range 50-15,000 Hz; impedance 150 ohms \$120
SM12A. Same as SM10A plus one ear monitor. \$165
SM14A. Same as SM10A plus 2 ear monitors. \$215

SM59-CN Dynamic Cardioid Microphone

Unidirectional microphone with mechano-pneumatic shock-mount design and pop filter. Power level -61 dB; frequency range 50-15,000 Hz; impedance 150 ohms; aluminum, zinc, stainless-steel construction; champagne enamel finish \$195
SM59-LC. Same as SM59CN but less cable... \$174

Starmaker® Series Microphones

Small, lightweight, rugged dynamic cardioid microphones designed for stand-mount or handheld use. Frequency range 50-15,000 Hz; output power level -57.5 dB; low impedance.

SM77EB-C. Ebony Suedecoat*, less cable* ... \$122
SM77BR-LC. Brown Suedecoat \$122
SM77EB-CN. Same as SM77EB plus 25-ft cable with 3-pin connector \$143
SM77BR-CN. \$143
SM77TN-C. Tan Suedecoat*, less cable \$122
SM78BR-LC. \$157
SM77TN-CN. Same as SM77TN plus 25-ft cable with 3-pin connector \$143
SM78BR-CN. \$178
SM78EB-C. Ebony Suedecoat* plus pop filter, less cable \$157
SM78EB-CN. Same as SM78EB plus 25-ft cable with 3-pin connector \$178
SM78TN-C. Tan Suedecoat* plus pop filter, less cable \$157
SM78TN-CN. Same as SM78TN plus 25-ft cable with 3-pin connector \$178

SM63-CN Dynamic Omnidirectional Microphone

Miniature lightweight omnidirectional microphone with hum-bucking coil, shock mount, breath and pop filter. Output power -56.5 dB; frequency range 50-20,000 Hz; impedance 150 ohms; Veraflex* grille damage resistant to drops and impact, rust, moisture, corrosion; champagne finish aluminum case .. \$120
SM63-LC. same as SM63-CN except no cable .. \$99

SM11 Miniature Lavalier Microphone

Synaptic omnidirectional microphone with lavalier, tie-bar, tie-tack mounting options. Frequency range 50-15,000 Hz; power level -64 dB; low impedance. Weighs 0.28 oz. Comes with 48" cable, mounting accessories \$90
SM17. Similar to SM11 but includes musical instrument mounting accessories, 10-ft. cable..... \$95

SM57-CN Unidirectional Microphone

Dynamic microphone with cardioid polar pattern, suitable for instrument pickup. Frequency range 40-15,000 Hz; output power level -56.5 dB; dual impedance. Comes with 20-ft. cable with 3-pin professional connector \$142

SM-58CN Unidirectional Microphone

Dynamic microphone with cardioid polar pattern, suitable for vocal pickup. Frequency range 50-15,000 Hz; output power level -56 dB; dual low impedance; pop filter. Comes with 20-ft cable with 3-pin professional connector \$178

Accessories

A15 Series In-Line Adapters

Modifies microphone response. Has 3-pin male output, female input connectors.

A15AS. Switchable microphone attenuator . \$33.60
A15PRS. Switchable phase reverser \$29.40
A15HP. High-pass filter \$29.40
A15LP. Low-pass filter \$29.40
A15PA. Presence adapter \$29.40
A15RS. Response shaper \$29.40
A15LA. Line input adapter \$29.40
A15BT. Bridging transformer \$29.40
A15TG. Tone generator \$39.00
A27M. Stereo microphone mount \$26.70
A53M. Shock mount for 578, 579, SM59, SM63, SM81 microphones \$29.00
A55M. Shock mount for 515, 516, 545, 465, 585, 588, SM77, SM78 microphones \$29.00

A95 Series Line-Matching Transformers

Connect low-impedance microphones to high-impedance inputs or vice-versa. Designed for use with most microphones and input jacks.

A95U. low-Z, 3-pin; high-Z, 1/4" plug and jack \$22.50
A95UF. Low-Z, 3-pin; high-Z, 1/4" plug and jack \$27.00

SONY

M3500 Dynamic Cardioid Microphone

Dynamic unidirectional moving-coil hypercardioid microphone. Frequency range 40-18,000 Hz; impedance 6000 ohms. Comes with windscreen clamp, table stand, and case; Cannon XLR connector; each unit supplied with own frequency-response curve; all-metal construction with matte back chromium finish \$185

ECM-Z300 "Sound Crew" Electret Microphone

Back electret zoom microphone designed to interface with Sony HVC-2200 video camera. Manually zooms from cardioid to supercardioid to complement images captured by camera lens. Frequency range 100-15,000 Hz; 6.6 oz. Comes with dc power cable, carrying case, windscreen \$150

ECM-929T "Sound Crew" Electret Microphone

Bidirectional back electret cardioid-capsule microphone with stereo characteristics. Frequency range 50-15,000 Hz; output level -57.6 dBm. Comes with stand; windscreen; carrying case; left, right Unimatch plugs (threaded mini plugs with 1/4" phone-plug sleeves). Compatible with all consumer tape recorders. 5"L x 3/8" diameter \$115

ECM-23F Cardioid Microphone

Unidirectional back electret microphone. Features FET impedance translator; battery power; low-cut switch; pad switch; windscreen; carrying case; cable;

microphone holder; XLR-3 microphone connector. Frequency range 20-20,000 Hz; impedance 250 ohms; S/N ratio 44 dB; SPL 126 dB maximum; dynamic range 96 dB; output for both balanced and unbalanced circuits; 20-ft cable; 7 1/2"L x 1 1/8" diameter \$115

ECM-939LT Microphone

Stereo-pickup microphone designed to mate with Sony TCS-310, M-1000, M-1000B stereo cassette and microcassette recorders. Comes with mini plug; PC-61 Unimatch plug adaptor; microphone stand; windscreen; carrying case. Offers easy adaptability to remote-control operation when used with Sony MRU-



60 remote-control unit. Frequency range 60-20,000 Hz; dynamic range > 96 dB; coverage angle 0°-150°; 4 1/2"L x 2 3/4"W \$85

F-520 Dynamic Cardioid Microphone

Unidirectional microphone for vocal and instrument reinforcement. Frequency range 80-12,000 Hz; output impedance 250 ohms; 16-ft cable with fixed phone plug connector; 2" diameter x 6 3/4"L. \$100
F-420. Similar to F-520 except designed for public address and recording applications; frequency range 100-12,000 Hz \$75

ECM-170A Omnidirectional Mike

Omnidirectional electret condenser microphone for semiprofessional use, recording or lecturing outdoors. Frequency range 20-16,000 Hz; 200-ohm output impedance; S/N ratio 64 dB; maximum SPL 126 dB; dynamic range 96 dB; low-cut switch; output for balanced and unbalanced circuits; detachable windscreen; FET impedance translator; easy-to-hold grip; satin nickel finish; Sony type microphone connector; 16-ft cable; includes microphone cable, microphone holder, carrying case; 1" diameter x 6 1/8"L \$75

ECM-150 Omnidirectional Microphone

Miniature omnidirectional electret condenser microphone. Frequency range 40-13,000 Hz; output impedance 250 ohms; S/N ratio 60 dB; maximum SPL 117 dB; dynamic range 83 dB; plug adaptor for mini and phone connections; on/off switch; includes windscreen, case with microphone stand, tie clip, battery; fixed microphone connector; 6-ft 5-in cable; 1 1/32" diameter x 1 1/32"L \$65

F-V7ET Dynamic Cardioid Microphone

Dynamic cardioid vocal microphone with active circuitry that produces vibrato and echo effects. Comes with Unimatch plug that allows compatibility with all consumer tape recorders and microphone stand. Features on/off switch, normal/echo switch, speed effect switch. Frequency range 100-12,000 Hz; high impedance; 8 3/8"L x 1 1/8" diameter; 6.7 oz \$60

ECM-31M Cardioid Microphone

Unidirectional electret condenser microphone designed for indoor/outdoor interviews and features telescoping design. Frequency range 50-13,000 Hz; 250-ohm output impedance; battery-operated; 8-ft cable with mini cable plug; includes urethane windscreen, mic holder; 3/4" diameter x adjustable 10 3/4-19 1/16"L \$55

ECM-220T "The Instrument Mic"

Back electret condenser cardioid microphone for miking instruments, with unimatch plug to fit all home recorders. Frequency range 50-14,000 Hz; impedance 200 ohms \$50

F-V4T "The Vocal Mic" Microphone

NEED MORE INFORMATION?

Write directly to the manufacturer or distributor. A list of names and addresses starts on page 4.

Cardioid-pattern dynamic microphones for vocal applications, with unimatch plug to fit all home tape recorders. Frequency range 90-13,000 Hz; output level -58.8 dBm; impedance 600 ohms \$40

ECM-16T "The Tie Tac Mic"

Omnidirectional electret condenser microphone for lavalier applications, with unimatch plug to fit all home tape recorders. Frequency range 50-13,000 Hz; impedance 250 ohms \$40

F-99T "The Stereo Mic"

Stereo dynamic microphone for recording purposes, with left and right unimatch plugs to fit all home tape recorders. Frequency range 80-12,000 Hz; impedance 200 ohms \$40

ECM-210 S Unidirectional Electret Microphone

Unidirectional electret condenser microphone with transport control switch. Features dual pin plug for use with tape recorders that offer remote control; battery and desk stand; 10,000 hours of continuous operation on AA power source. Frequency range 50-12,000 Hz; S/N ratio 64 dB; maximum SPL 126 dB \$38

F-V3T "The Mic" Dynamic Microphone

Cardioid-pattern dynamic microphone with unimatch plug that fits all home tape recorders. Frequency range 100-12,000 Hz; impedance 600 ohms .. \$30

F-V2A Dynamic Microphone

General-purpose microphone with 1/4" phone plug that fits hi-fi tape recorders \$20

PBR-330 Parabolic Sound Reflector

Concentrates sound for greater reach when used with Sony ECM-170A and ECM-150 omnidirectional microphones. Features hand-held or stand mount .. \$70

STUDER/REVOX

M3500 Dynamic Cardioid Microphone

Dynamic unidirectional moving-coil microphone with hypercardioid pattern. Frequency range 40-18,000 Hz; impedance 600 ohms. Comes with windscreen, clamp, table stand, case; Cannon XLR connector. Supplied with its own frequency response curve. All-metal construction with matte-black finish. \$200

TASCAM by TEAC

PE-250 Moving-Coil Microphone

Professional moving-coil microphone designed for PA/recording applications. Features cardioid moving-coil design with 4-position low-frequency rolloff selector; 250-ohm balanced output with XLR connector; built-in threaded stand mount. \$250

PE-150 Electret Condenser Microphone

Professional PA/recording cardioid electret condenser microphone operates on 1.5-V AA cell and accepts 48-V phantom power with no switching or battery removal. Features -10-dB pad; off/flat/low-frequency rolloff switch; 200-ohm balanced output with XLR connector; stand adapter; 20-ft cable; 1.5-V AA cell \$150

PE-120 Electret Condenser Microphone

Professional PA/recording cardioid/omnidirectional

condenser microphone with 200-ohm balanced output and XLR connector \$100

TEAC

ME-120 Microphone

Cardioid or omnidirectional electret condenser microphone with 2-position response switch (40-18,000 Hz cardioid, 30-16,000 Hz omni). Supplied with stand adapter, 2 windscreens, 15-ft cable.... \$120

ME-80. Same as ME-120 except cardioid only, 50-16,000 Hz range \$90

ME-50. Similar to ME-80 except unbalanced/balanced 10k/200-ohm impedance; range 50-14,000 Hz. Supplied with foam windscreen and 1/4" plug..... \$50

TECHNICS

RP-3500E Electret Microphone

Cardioid electret-condenser microphone with high signal-handling ability for excellent dynamic range in music. Comes with tripod desk stand. Frequency range 50-12,000 Hz \$60



..... \$60

RP-V730 Dynamic Microphone

Unidirectional dynamic microphone designed for vocal and musical instrument recording. Comes with 3/8" mic holder adaptor. Frequency range 40-12,000 Hz \$40

RP-V340 Cardioid Microphone

Dynamic cardioid microphone designed for voice recording has built-in windscreen. Comes with 3/8" mic holder adaptor. Frequency range 100-10,000 Hz \$28

UHER by WALTER ODEMER

M 646 Cardioid Microphone

Electret condenser cardioid microphone. Frequency range 30-20,000 Hz; sensitivity 3.5 mV/pA; impedance 280 ohms. Supplied with table stand and windscreen; powered by internal primary battery or from recorder's mic cable with 8-pole plug \$203

M 634 Cardioid Microphone

Stereo-pair dynamic shotgun-type cardioid microphones with stereo bar; all-metal design. Frequency range 50-16,000 Hz; sensitivity 2.3 mV/pA; low-resistive impedance. Includes collapsible table stand, storage case \$194
M 534. Similar to M 634 except single microphone for desk use \$98

VIDAIRE ELECTRONICS

620 Unidirectional Ultradynamic Microphone

Professional microphone features hi/lo dual impedance; on/off switch; unidirectional pattern to eliminate unwanted noise; 2-position cable plug to change impedance; microphone holder; satin gold finish. Impedance 600/50k ohms; frequency range 30-18,000 Hz; sensitivity at 600/50k ohms -78/-60 dB; 20-ft cable with 1/4" phone plug \$53

942C Unidirectional Ball Microphone

Dynamic ball microphone with dual impedance; on/off switch; unidirectional pickup pattern to eliminate unwanted noise; microphone holder. Impedance 600/50k ohms; frequency range 80-15,000 Hz; sensitivity at 600/50k ohms -72/-52 dB; 20-ft shielded cable with 1/4" phone plug \$48

619 Unidirectional Microphone

Dynamic contoured microphone with dual impedance; on/off switch; unidirectional pickup pattern to eliminate unwanted noise; microphone holder; satin gold finish. Impedance 600/50k ohms; frequency range 80-15,000 Hz; sensitivity at 600/50k ohms -72/-52 dB; 20-ft cable with 1/4" phone plug. \$47

729 Tie-Clasp Electret Microphone

Highly sensitive omnidirectional tie-clasp electret condenser microphone. Comes with vinyl carrying case. Impedance 600 ohms; frequency range 50-16,000 Hz; sensitivity -65 dB at 1 kHz; current drain 160 microamperes; 1.3-V mercury cell included; 1" diameter x 1 1/2" L; 13-ft cable with 1/4" phone plug .. \$40

618 Omnidirectional Dynamic Microphones

Matched-pair microphones designed for all types of home and portable stereo tape recorders come with microphone stands. Impedance 500 ohms; frequency range 80-10,000 Hz; 5-ft cord with 3.5-mm mini-plug; optional adapter converts to standard 1/4" plug..... \$28/pr

WALD SOUND

J-3000 Stereo Headphones

Two-way super-thin stereo headphones. Nominal/matching impedance 25/4-150 ohms; frequency range 20-20,000 Hz; sensitivity 112 dB SPL at 1 mW; maximum input 300 mW; 40- and 29-mm Mylar drivers; 9-ft coiled cord; 245 g less cable \$60

J-2000 Stereo Headphones

Aluminum case surface/stereo headphones with volume controls. Nominal/matching impedance 25/8-100 ohms; frequency range 20-22,000 Hz; sensitivity 110 dB SPL at 1 mW; maximum input 250 mW; 9-ft Y-type cord; 230 g less cord \$40

J-1000 Stereo Headphones

Rare-earth supermagnet stereo headphones with ultrathin diaphragms, ribbon drivers. Nominal/matching impedance 25/8-100 ohms; frequency range 10-25,000 Hz; sensitivity 100 dB SPL at 1 mW; maximum input 250 mW; 150 g less cord. \$30

SC-3 Stereo Headphones

Super-lightweight stereo headphones with adjustable headband, soft foam earpads. Nominal/matching impedance 31/4-150 ohms; frequency range 20-22,000 Hz; sensitivity 98 dB SPL at 1 mW; maximum input 100 mW; 1.5 oz less cable \$20

For technical details on microphones and the techniques used by professional recording engineers, refer to the article titled "How To Make Live Recordings" that begins on page 12.

8

MIXERS

BOZAK

CMA-10-2DL Stereo Mixer/Preamplifier

Designed for professional reproduction of live and recorded stereo programs. Features 4 stereo inputs; 2 mic/line inputs; 2-channel output; program and input-cueing monitor; broad dynamic range; modular construction; rack mountability or portability. Gain phono 1 & 2/AUX 1 & 2 (hi-Z)/mic 1 & 2 65 dBV maximum/25 dBV maximum/85 dB; frequency response 20-20,000 Hz ± 0.25 dB; output +24 dBm; input impedance magnetic phono/high-level/microphone 47k/50k/200 ohms; load impedance 600 ohms unbalanced, 200 ohms minimum; THD <0.2% at +24 dBm, 20-20,000 Hz; noise equivalent to -125-dBm signal; power consumption 20 W; 19"W \times 5 1/4"H; 31 lb \$950

CERWIN-VEGA!

DM-1 Audio Mixer

For professional and semiprofessional recording setups. Features separate illuminated VU meters for both output channels; bass, treble, stereo balance controls; autofade; talkover mute. Frequency response 20-20,000 Hz ± 1 dB RIAA phono inputs, ± 0.5 dB line inputs; THD 0.05% at rated output, any frequency; IM distortion 0.05% at rated output, SMPTE; ASA standard A weighted noise with shorted inputs 85 dB high level, 80 dB below full output; impedance 47k ohms RIAA phono inputs, 100k ohms line inputs; output level 2.5 V rms program and monitor; clipping level 8.7 V rms (+21 dBm); load impedance 2k ohms; output source impedance 100 ohms or less; tone-control range ± 10 dB at 50 and 5k Hz, turnover frequency 500 Hz; autofade rate variable 2-20 seconds typical; mute level 0-20 dB typical; headphone output level/impedance 1 W/4 ohms; meter calibration 3 dB at 2.0 V rms, both output channels; 19"W \times 8"D \$714

DUBIE

CD-10 Sound Control System

Sound control system integrates up to 6 recorders and receiver/amplifier through one-time patch cord hookup; dubs, records, plays back, mixes sound-on-sound, monitors and fades; 6 solid state 4-position recorder controls; 8-position monitor select control; 2 fade controls; rear panel connections for recorders and amplifier/receiver. Maximum input signal 10 V at 1 kHz; frequency range dc-100,000 Hz on all functions; 4"H \times 13 3/4"W \times 5 3/4"D \$150
CD-5 Similar to CD-10 except 3 recorder capacity; 9 3/8"W \times 4 7/8"D \times 4"H \$100

GLI

3990 Preamplifier/Mixer

Preamp/mixer designed for creative audio, disco, and disco-format broadcast use. Phono/Aux section; features 2 sets of line and phono inputs with separate level control and crossfader transition slide; special-effects third set of line/phono inputs; master level control with complete cueing capabilities; 2 sets of stereo main outputs and mono output. Frequency re-

sponse 20-20,000 Hz ± 0.25 dB (phono and aux); HD and IM 0.01% (phono and aux); S/N ratio 80 dB below 10 mV unweighted (phono); 90 dB (aux inputs 1 and 2), 96 dB (aux input 3); overload 320 mV at 1 kHz (phono), 7 V (aux); slew rate 9 V/ μ sec (phono and aux); input impedance 47k ohms (phono), 40k ohms (aux inputs 1 and 2), 50k ohms (aux input 3); phono subsonic filter 18 dB/octave at 18 Hz. Microphone section: features balanced differential input, bass equalization and optoelectronic talkover with adjustable program mute attenuator. Frequency response 20-20,000 Hz ± 0.25 dB; bass equalization ± 8 dB at 80 Hz; S/N ratio 80 dB below 10 mV; HD and IM distortion 0.01%; gain 60 dB (signal processor out), 80 dB (main out), 32 dB (input), 20 dB (equalizer gain), 6 dB (mix), 20 dB (line amp); overload 315 mV; slew rate 9 V/ μ sec; program attenuation talkover -2 to -20 dB. Signal processor section features switchable signal processor section; input S/N ratio 100 dB below 100 mV; input impedance 100k ohms; output



1.75 V at 600 ohms and 10 V at S/N 107 dB below 2 V out; output distortion 0.005%. Audition output section can be directly connected to integrated or power amplifier. Output 2 V at 600 ohms and 7 V at 10k ohms; HD and IM distortion 0.01%, 20-20,000 Hz; talkover muting 10.5 dB with audition output muted. Headphone amplifier S/N ratio 95 dB below 2 W into 9 ohms; maximum output 3 W continuous into 8 ohms with 0.1% HD and IM distortion; slew rate 12 V/ μ sec; frequency response 20-20,000 Hz ± 0.1 dB; rack mountable; 19"W \times 7"H \$900

PMX-9000 Mixer/Equalizer

Combination mixer/graphic equalizer. Mixer features 2 sets switchable line and phono inputs each with slide level control and cross fader transition slider and mic input channel with standby and talkover; complete cueing facilities with level and selector controls. S/N ratio 76 dB below 10 mV (phono), 75 dB below clipping (mic), 85 dB (AUX); maximum input 220 mV at 100 Hz (phono), 200 mV (mic), 10 V (AUX); input impedance 47k ohms (phono), 600 ohms (mic); phono subsonic filter 18 dB/octave at 20 Hz; mic talkover 14 dB program level reduction; equalizer center frequencies at 60, 250, 1k, 3.5k, 12k Hz; boost/cut range ± 12 dB. Has bypass switch and switchable signal processor

loop; illuminated VU meters with calibrated sensitivity control (-20 to +3 dB range); master level control; 2 sets of main outputs; preset level indicators for all inputs and main outputs; rack mountable; 19"W \times 8 3/4"H \$469

JVC

MI-5000 Master Mixer

Six-channel master mixer; each channel features 10-dB input level slide controls with 20-dB master input level control, independent pan pots, LED overload indicators, 4-position mic/att/phono/line select switches, and echo switches with 3-second variable echo level control. Additional features include mix out/tape in monitor select switch; 2 VU meters; input jacks for phono, line, tape, mic; recording, monitor, headphone jacks. Minimum input/impedance 0.2 mV/200-5000 ohms (6-channel mix.), 1.4 mV/47k ohms (phono), 80 mV/100k ohms (line/tape); rated output level/impedance 0.3 V/600 ohms (rec/monitor), 0.3 mW/8-1000 ohms (headphones); frequency response 20-30,000 Hz -3 dB (mic/line), 30-20,000 Hz ± 0.5 dB (phono RIAA), 10-25,000 Hz -1 dB (tape in); distortion 0.5%; S/N ratio (IHF A) 56 dB (mic), 67 dB (line), 65 dB (phono) \$430

LT SOUND

MX-8 Mixing Board

8 \times 2 mic/line mixer uses 8 balanced ultra-low-noise solid-state microphone preamplifiers. Designed for studio and portable recording and PA use. Features gain control; echo; cue; solo; rotary fader control; 2 main outputs. Maximum output level +22 dBV; S/N ratio >85 dB; low and high boost/cut 18 dB \$349

NAKAMICHI

MX-100 Microphone Mixer

Provides left, right, and blend inputs and two outputs; 10k-ohm input for low-to-medium impedance mics; sensitivity 0.2 mV; overload 1 V (+74 dB); THD <0.05% up to 10 kHz; requires PS-100 Power Supply; 2 1/2"H37 1/2"W \times 4"D \$110

RECOTON

MX-200 Stereo Disco Mixer

Five-channel stereo disco mixer can be used for tapping applications. Features monitor switch with headphone jack; low-noise preamplifier for magnetic phono cartridges and low-impedance microphones; jack for supplied ac power adapter (normally operates on 2 9-V batteries). Input sensitivity/impedance 0.3 mV/600 ohms mic low, 3 mV/50k ohms mic high and magnetic phono, 150 mV/120k ohms all others; output level/impedance 0.3 V/50-500k ohms; distortion 0.5% at 0.2 V output; frequency response 20-20,000 Hz ± 3 dB \$125

MX100 Stereo Mixer

Four-channel stereo microphone mixer with independent control of each channel. Features 1/4" standard phone plug inputs, phono-jack outputs; operation as either 2- or 4-channel mixer with flip of switch; high/

low impedance switch \$40

SANSUI

AX-7 Mixer/Recording Console

Four-input stereo mixer with built-in reverb unit features monitor selector (source, mixing out, tape 1, 2, 3); front-panel jacks for connection of portable stereo tape deck, etc; recording mode (tuner AM/FM, mixing out, source/tape, 3-position tape copy); mixing balance control; master volume control; reverberation selector permits addition of reverb to input connected microphones, guitars, and/or line sources. Reverberation control (0-3.2 seconds); input line, guitar, mic sensitivities 1 mV, 20 mV, 150 mV; panpots left and right for each channel; level controls; attenuator; low-cut switch. Frequency response (source/tape) 20-20,000 Hz + 0 dB, -0.5 dB (mic/guitar/line) 20-20,000 Hz +0 dB, -1 dB; THD 0.1% at or below 2 V rms; IHF hum and noise (mic) 61 dB, (guitar) 58 dB, (line) 69 dB, (source) 78 dB; separation 70 dB at 1 kHz (source and tape); maximum output 5 V into 47k ohms at 0.2% THD; 16⁵/₁₆"W x 11¹/₄"D4³/₈"H \$300

SHURE

SE30 Gated Mixer/Compressor

Professional mixer provides 3 low-impedance balanced inputs switchable to microphone or line level; built-in gain-riding compressor with gated memory circuit that eliminates pumping; built-in battery supply; low-cut filters and tone oscillator; illuminated VU meter; gated memory indicator; mix bus jack; mic and line level outputs; stereo parallel jack; headphone jack; 120 V ac, 50/60 Hz; 15"W x 10"D x 3¹/₂"H.. \$675

M67 Professional Mixer

Professional mixer provides 4 low-impedance, transformer-coupled balanced microphone inputs, one convertible to line input. Balanced 600-ohm line and mic-level outputs; illuminated VU meter calibrated for +4 and +10 dBm output; very low noise and r-f susceptibility design; 120 V ac, 50/60 Hz; 11³/₈"W x 7¹/₂"D x 2³/₄"H \$345

M267 Professional Mixer

Professional mixer for recording or broadcast use. Four low-impedance balanced inputs switchable to mike or line level; simplex (phantom) power on each input; fast-acting limiter; built-in battery supply, headphone amplifier with level control; illuminated VU meter with LED peak level indicator; low-cut filters and tone oscillator; battery check switch; mix bus jack; mic and line level outputs; master volume control; 120 V ac, 50/60 Hz, 9.5 W; battery power; 12⁵/₃₂"W x 9"D x 2³/₃₂"H \$395
M68FC. Input connections are professional 3-pin connectors for 120 V ac (±10%, 50/60 Hz, 3 W).. \$198

M268 Microphone Mixer

Five-channel mixer featuring 4 high/low-impedance microphone inputs and one Aux-level input; simplex (phantom) power on each mic input mix bus jack; regulated power supply; 120 V ac, 50/60 Hz, 5 W; 12⁵/₃₂"W x 9"D x 2³/₃₂"H \$250

SONY

MX-670 Microphone Mixer

Six-in/2-out microphone mixer with full panning capability; for semi-professional or advanced amateur stereo recording; has ac/dc power operation for on-location or studio recording. Features pan pot control; 2-position mic input attenuator; preset indicators; cascade connector; built-in oscillator; master fader. Mic input sensitivity -72 dB at 0.2 mV (low impedance); line-in impedance 100k ohms, sensitivity -22 dB at 60 mV; phono in impedance 50,000 ohms, sensitivity -51 dB at 2.2 mV; mic attenuation off, -15 dB, -30 dB; output impedance (line out) 600 ohms (low), 10k ohms (high); headphone output impedance 8 ohms; frequency range 30-25,000 Hz; S/N ratio 60 dB; 17⁷/₈"W x 10"D x 3³/₈"H \$425

MX-510 Microphone Mixer

Five channel inputs; 2 channel outputs. Features 2-way (battery/ac current) power source; 5 mic inputs for low impedance mics; 3 line inputs for tape record-

er, tuner, amplifier; 2 phono inputs for record player; pan pot control; slide master fader control; preset indicators; 2 VU meters. Sensitivity -72 dB at 0.2 mV (mic in, low impedance), -22 dB at 50 mV (line in), -51 dB at 2.2 mV (phono in RIAA); impedance 100k ohms (line in), 50k ohms (phono in); mic attenuation off -20 dB; output level/impedance -5 dB at 0.435 V/10k ohms (line), -24 dB at 49 mV/8 ohms (headphone); frequency response 30-25,000 Hz; S/N 60 dB; 13³/₄"W x 9¹/₂"D x 3"H \$225

MX-10L "Sound Crew" Mixer

Four-input stereo mixer with panning feature for precise stereo imaging, individual faders for optimum mix-



ing of all sound sources, stereo master fader; mono/stereo output selector; battery or ac operation. latter with optional ac adaptor \$125

MX-5 Microphone Mixer

Three-in/one-out microphone mixer for semi-professional applications. Features preset indicators for reference during temporary level changes, auto input selector, distributor switch, and line input. Mic input sensitivity -51 dB at 2.2 mV (low impedance); line-in

impedance 82k ohms; sensitivity -5 dB at 435 mV; line out load impedance 1k ohm; level out -60 dB at 0.775 mV; 9"W x 5¹/₄"D x 2¹/₈"H \$45

TAPCO

Series 72 Mixing Consoles

Advanced mixing consoles with transformerless balanced inputs. Feature 8/12 or 16 channels; 60-mm slide faders; 3-control/4-frequency equalizer; send and return jacks in each channel; mic/line switching; rotary trim controls with LED overload indicators; optional ADR* (Adjustable Decay Reverb); monitor/effects Aux bus sends; 48-V phantom power for condenser microphones; solo system with head amplifier; mono summing master; 2 effects return channels; effects return to monitor control.

7208. 8 channels \$1914
7212. 12 channels \$2394
7216. 16 channels \$2994

8201B Stereo Mixer

Stereo mixer with 8 transformer balanced inputs through XLR connectors. Features mic/line switching; separate monitor bus; input channel patching/direct outputs per channel; low-noise circuitry; rack-mountable chassis; unique accessible jack panel; phantom powering for condenser microphones; Differential Autopad circuitry for maximum headroom; balanced low-impedance mic input, line input, patching /direct output connectors in each channel for external signal processing; multi-track recording, remixing for monitor or cue, individual channel sends; gain, constant volume; ±18-dB bass and treble controls; independent monitor send, effects sent, mic/line input switching \$1378

6200B Stereo Mixer

Six-channel stereo mixer with transformer balanced inputs into XLR connectors. Features channel patching direct outputs per channel; effects sends; stacking

COMPARE PRICES !

TEAC ⁴⁰⁷
DBX Auto Reverse **\$375**

V95RX

PIONEER ³⁸⁷
3 Heads with Dolby **\$419**

CT9R

AKAI ³⁷⁹
7" Reel to Reel Auto Reverse **\$499**

GX77D

AIWA ADM3800
3 Heads with Dolby

Call For Price

Tape Specials
TDK SA-C90 **\$2.40 ea.**
maxell UDXLII C-90 **\$2.90 ea.**
SONY UCXS-C90 **\$3.00 ea.**

SONY **Dolby B & C**
NEW

TCFX77
Call For Price

TOLL FREE 800-356-9514 Weekdays 9-9
 Saturdays 9-5

Over 100 Brands like:

- | | | | | |
|----------|----------|------|----------|-----------|
| Technics | Maxell | Sony | Cerwin | Acutex |
| Pioneer | Empire | Teac | Vega | Craig |
| Marantz | Altec | Akai | Onkyo | Scotch |
| Kenwood | Sharp | Dual | Audio | B.I.C. |
| Sansui | Phillips | Koss | Technica | Stanton |
| Jensen | Shure | TDK | Clarion | Pickering |

WDS

WISCONSIN DISCOUNT STEREO

2417 w. badger rd. madison, wi 53713

608-271-6889

"Prices Good Until Oct. 31, 1982"

CIRCLE NO. 16 ON READER SERVICE CARD

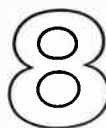

MIXERS

jacks for slave mixers; stereo VU meters; 6 line/high-impedance inputs; rumble (low-cut) filter; Autopad* circuitry; rack-mountable chassis \$658

6100RB Mono Mixer

Six-input mono mixer with transformer balanced inputs into XLR connectors. Features monitor send; 3-control/5-frequency equalization per channel; internal spring reverberation unit; input gain switch; input channel patching (channels 1 and 2); main and monitor VU meters; stacking jacks \$835

6000R Mono Mixer

Six-channel mono mixer with internal spring reverberation unit. Features footswitch jack; master reverb contour tone control; channel on/off switches; microphone equalize (brightness) switch; effects/reverb sends \$574

6000CF Mono Mixer

Six-input mono mixer with low-impedance inputs into XLR connectors. Features 6 high-impedance inputs through 1/4" phone plugs; Aux output with volume control; stacking jacks; separate bass and treble controls in each channel \$418

TASCAM by TEAC

M-30 Audio Mixer

Audio mixer with 8 mic inputs (6 low-impedance balanced, 2 high-impedance unbalanced and doubling as direct boxes); 8 tape inputs; 8 line inputs; mic/remix (tape)/line input selector; mic attenuator (0/20/40); 2-band parametric equalizer (sweep type with variable level and frequency) for 60-1500 and 1000-10,000 Hz plus 12.5 kHz shelving type equalizer (15 dB); mute switch; direct out (post fade, post equalize); cue out (pre/fade, preequalize); accessory send/receive; input



overload indicator; bus assign buttons; pan pot. Main section features 4 main program mixing buses; bus input to each main mixing bus; accessory send/receive for each bus; 4 bus outputs (one per bus); master fader; 4 VU meters with peak indicators; meter input selector for bus/monitor/submix; stereo headphones jack with gain control; monitor/submix signal selector. Bus mix section features 4 x 2 with gain and pan controls for each program bus with master stereo output control. Submix section features 8 x 2 submixer; pre/post/tape input selector; gain and pan controls; submix master gain control; stereo submix output; stereo submix input. Other features include 2 patchable stereo phono preamplifiers (RIAA standard). Frequency response 30-20,000 Hz \pm 2 dB; S/N ratio (at nominal input level) 1 mic or 1 line to 1 bus > 75 dB weighted, > 70 dB unweighted; crosstalk (adjacent buses or inputs) > 60 dB at 1 kHz; THD < 0.1% at 1 kHz, nomi-

nal input level, measured at bus output; fader attenuation > 60 dB; power supply 15 V dc; 18.25"W x 20.5"D x 6.3"H; 35.4 lb \$1300

System 20 Mixing Console

Professional-style audio mixing console consisting of 4 modular assemblies.

MM-20. Main mixing chassis with 2 mic and 4 line inputs. Features transformer-isolated mic preamps; tape/mic (live) overdub capability; headphone monitoring, corrective EQ; XLR mic input connectors; -20-dB mic attenuator switches; trimpots; accessory send/receive jacks; W-pot pre/post fader; direct output; panpots; bus input jacks; master monitor and headphone level controls; dc outputs for other modules. Mic input impedance/nominal level 600 ohms balanced/-60 dBV (1 mV); line input impedance/nominal level 50k ohms/-10 3k ohms/-10 dBV (0.3 V); headphone output impedance/nominal power 8 ohms/100 mW; frequency response 30-20,000 Hz \pm 3 dB; S/N ratio A weighted/unweighted mic 65/60 dB, line 75/70 dB; crosstalk > 60 dB at 1 kHz; THD < 0.1% at 1 kHz; fader attenuation 60 dB or more; trim range \pm 10 dB (line/mic); power consumption 15 W at 120 V ac, 60 Hz; 16.9"W x 15.8"D x 4.2"H; 9.2 lb \$395

EX-20. Expander module adds 4 transformer-isolated mic inputs to MM-20 complete patch bay. Features 4 mixing positions; accessory patch points direct outputs. Specifications the same as for MM-20 except power consumption 170 mA at +12 V dc (obtained from MM-20); 9.6"W x 4.4 lb \$325

PE-20. 4-input/4-output/4-channel parametric equalizer for System 20. EQ frequencies; low 60-1.5k Hz adjustable, middle 1-8 kHz adjustable, 10 kHz fixed; \pm 12-dB boost/cut range; S/N ratio > 80 dB; crosstalk > 60 dB; THD < 0.1% at 1 kHz; input impedance/nominal level > 100k ohms/-10 dBV (0.3 V); power consumption 120 mA at \pm 12 V dc regulated (obtained from MM-20); 15.8"D x 9.6"W x 4.2"H; 4.62 lb \$350

MU-20. Four VU-meter assembly with peak level indicators for System 20. Features -20 to +5-VU range; peak indicator level 10 dB above 0 VU; power obtained from MM-20; 16.4"W x 3.1"H; 2.2 lb \$150

Model 2A Audio Mixer

Features 6 inputs (microphone and/or line in any combination); 4 outputs; level controls for each input channel; master output level control; cue output jack on each input channel; accessory send/receive patch points on each output bus for reverb, graphic-equalizer, limiter, compressor, noise-reduction units and other signal processors; 4 AUX outputs in parallel; 4 line outputs; selectable high-cut filters at 5 kHz or 10 kHz; low-cut filters at 100 or 200 Hz; color coded push-push channel assignment buttons; pan on each channel; 14 9/16"D x 13 1/16"W x 3 17/32"H \$495

Model 1 Studio Series Mixer

Eight-in/2-out line level mixer; independent gain and pan for each input channel; master gain; foldback for each channel; Aux outputs in parallel with line outputs; separate bus inputs; contains 1-W amplifier with level control for 2 stereo headphone feeds. Line in (x8) and bus in (x2) impedance 30k ohms and nominal input level -10 dB; line out, Aux out (x2), cue out (x8) load impedance 10k ohms and nominal output level -10 dB; headphones (x2) load impedance 8 ohms; S/N ratio 78 dB weighted; frequency response 30-20,000 Hz \pm 1 dB; crosstalk -50 at 1 kHz; THD 0.3% maximum; power consumption 8W; 4 3/8"H x 17 1/4"D \$200

MB-20 Meter Bridge

For line-level applications; complements Model 2A au-

dio mixer; 4 VU meters; LED peak level indicator; built-in 4 x 2 monitor mixer; headphone amplifier; independent monitor switches; variable input sensitivity selector \$250

TEAC

M-35 Mixing System

Modular mixing system can be expanded from 8 x 4 to 20 x 4. Comes with 8 input, 4 submaster, 1 master modules, space for optional talk-back module. Modules offer flexible subsystem capabilities—cue system (16 x 1, echo system 8 x 1, monitor system 8 x 2 (bus/tape selectable), solo 8 x 1. Input module has mic/tape/line selector; cue send (pre fade, preequalize); echo send (post fade, post equalize); 4-range, variable level/frequency sweep-type parametric equalizer with low frequency selectable between 60-400 Hz or 400-1500 Hz, high frequency selectable between 1500-7500 Hz and 7500-12,500 Hz; solo; direct out; bus assignment (4); pan; overload indicator; input fader; balanced low-impedance XLR connector; accessory send/receive patch points phono jacks; line in phono jack; direct out phono jack. Submaster module features bus/tape monitor consisting of concentric gain and pan controls with bus/off/tape-monitor selector (2); tape cue that combines with input module cue send (2); echo receive button and level control with effects return variable and selectable between bus and monitor; submaster fader; effects receive phono jack; bus-in phono jack; 2 tape-in phono jacks; Aux output paralleled with line-output phono jack; 0 dBV (0.775 V)/-10 dBV (0.3 V) level switch. Master module features headphone select switch and level control; studio select switch and level control; control room select switch and level control; solo level control; master fader. Other features include: 4 VU meters with peak LED indicators; 1 VU meter with peak LED for monitoring cue out/off/effects out (echo send) functions; cascaded patch points for interfacing M-35EX expander or any other compatible submixer; talkback module; cue push switch and level control; slate push switch and level control; slate tone switch. Frequency response 20-30,000 Hz \pm 1 dB; S/N ratio at nominal input level 1 line to 1 bus = 80 dB weighted, 68 dB unweighted, 1 mic to 1 bus = 65 dB weighted, 60 dB unweighted; crosstalk to adjacent buses or inputs > 60 dB at 1 kHz; THD at nominal input level < 0.05%, measured at bus output; fader attenuation > 60 dB; power supply \pm 15 V dc; 24.4"D x 23.6"W x 7.3"H; 61.6 lb \$2300

M-35EX. 8-input expander for M-35. Comes with 8 input modules and can accept up to 4 additional input modules. When fully loaded, M-35EX increases capacity of M-35 to 20 x 4, 28 x 1 (cue), 20 x 1 (echo), 20 solo positions, 20 direct outputs, 20 equalization sections \$1650

201C. Input module \$195

209. Optional talkback module \$120

Model 2A Audio Mixer

Features 6 inputs (mike or line in any combination), 4 outputs; level controls for each input channel; master output level control; cue out jack on each input channel; accessory send/receive patch points on each output bus for reverb units, graphic equalizer, limiters, compressors, noise-reduction units, other signal processing equipment; 4 Aux outputs in parallel with 4 line outputs; selectable high cut filters at 5 kHz or 10 kHz; low-cut filters 100 Hz or 200 Hz; color-coded push-push channel assignment buttons with pan on each channel; 14 9/16"D x 13 1/16"W x 3 17/32"H. \$495

System 20 Audio Mixer

MM-20 master module. Features 2 mic inputs, XLR, balanced; 4 line outputs, -10 dBV, unbalanced, 6 output buses; 14 15/16"W x 14"D x 3 3/4"H; 9.24 lb \$395

MU-20 Meter Unit. Permits patching of any -10-dBV (0.3-V) unbalanced signal from mixer or external units; 14 1/2"W x 2 3/4"H x 1 7/8"D; 1.1 lb \$150

EX-20. Expander module with 4 mic inputs (XLR, balanced) and 4 output buses; 14"D x 14"D x 3 3/4"H; 4.4 lb \$325

PE-20. Parametric sweep-type equalizer module with 4 EQ modes; 3 frequency bands (low 60-1500 Hz \pm 12 dB; mid 1000-8000 Hz \pm 12 dB; high; 10 kHz fixed \pm 12 dB; 14"D x 8 1/2"W x 3 3/4"H; 4.6 lb. \$350

NEED MORE INFORMATION?

Write directly to the manufacturer or distributor. A list of names and addresses starts on page 4.



SIGNAL PROCESSORS

ADC PROFESSIONAL PRODUCTS

Sound Shaper Thirty Equalizer

Ten-band stereo graphic equalizer with LED indicator in each slide control knob for at-a-glance visualization of response curves, plus built-in spectrum analyzer/cf display. Features tape dub and monitor switches; line/record, bypass/equalize, subsonic filter, mic/line switches; display controls. Center frequencies 31.62, 125, 250, 500, 1k, 2k, 4k, 8k, 16k Hz; boost/cut range ± 12 dB; frequency response 5-100,000 Hz $-5/-1.0$ dB; dynamic range 10 V rms into 10k ohms; gain 0 dB ± 1 dB; harmonic distortion 0.015% at 1 V output; IM distortion 0.018% at 1 V output; hum and noise 95 dB below 1 V output; input/output impedance 75k/100 ohms at 1 kHz; load impedance 10k ohms; inputs and outputs 2 main, 4 tape monitor; subsonic filter slope 18 dB/octave; power consumption 23 W; $16\frac{1}{4}''\text{W} \times 8\frac{3}{4}''\text{D} \times 4\frac{1}{2}''\text{H}$; 11.8 lb. Accessories included: 2 pair audio cables; electret condenser microphone calibrated to built-in analyzer; 1.5-V (UM-5) cell for microphone \$400

Sound Shaper Twenty Equalizer

Twelve-band stereo graphic equalizer with LED in each slide control for at-a-glance visualization of response curve. Features LED meter level displays; tape monitor and dub switches; meter controls; line/record, bypass/equalize, subsonic filter, line/mic switches. Center frequencies 32, 56, 100, 180, 320, 560, 1k, 1.8k, 3.2k, 5.6k, 10k, 18k Hz; boost/cut range ± 12 dB; dynamic range 10 V rms at 10k ohms; frequency response 5-100,000 Hz $+0.5/-1.0$ dB; gain 0 dB ± 1 dB; harmonic distortion 0.015% at 1 V output; IM distortion 0.015% at 1 V output; hum and noise 98 dB below 1 V output; input/output impedance 75k/100 ohms at 1 kHz; load impedance 10k ohms; inputs/outputs 2 main, 4 tape monitor; subsonic filter slope 18 dB/octave; power consumption 23 W; $16\frac{1}{4}''\text{W} \times 8\frac{3}{4}''\text{D} \times 4\frac{1}{2}''\text{H}$; 11.8 lb. Accessories included: 2 pair audio cables \$330

Sound Shaper Ten. Similar to Sound Shaper Twenty except 10-band equalization, no tape dub or monitor switches, no output level control. Center frequencies 31.62, 125, 150, 500, 1k, 2k, 4k, 8k, 16k Hz; harmonic and IM distortion 0.018%; power consumption 17 W; $16\frac{1}{16}''\text{W} \times 6\frac{1}{2}''\text{D} \times 4\frac{1}{2}''\text{H}$; 8 lb. \$250

Sound Shaper Five Equalizer

Five-band stereo graphic equalizer with LED in each slide control knob. Center frequencies 60, 240, 1k, 3.5k, 10k Hz; boost/cut range ± 12 dB; dynamic range 5 V rms into 10k ohms; frequency response 5-100,000 Hz $+0.5/-1.0$ dB; gain 0 dB ± 1 dB; harmonic/IM distortion 0.018%/0.035% at 1 V output; hum and noise 95 dB below 1 V output; input/output impedance 75k/100 ohms; load impedance 10k ohms; inputs/outputs 2 main, 2 tape monitor; power consumption 17 W; $16\frac{1}{16}''\text{W} \times 6\frac{1}{2}''\text{D} \times 4\frac{1}{2}''\text{H}$; 8 lb. Accessories supplied: 2 audio cables \$130

ADS

ADS 10 Digital Time Delay System

Digital time-delay/amplifying system. Amplifier output power 100 W/channel continuous into 4 ohms, 20-20,000 Hz at 0.09% THD. Delay section: 3 initial delays, first delay variable 10-40 msec, longest delay variable up to 100 msec; reverberation decay time 0-1.6 sec (variable 0 to -60 dB); controls include ambience-channel bandwidth, stage depth (first delay), hall size (remaining delays), extra outputs for additional amplifier/speaker systems; Source Ambience Discriminator extracts ambience in recordings; reduces reverberation of FM announcer voices; can be driven from line-level (preamp or tape out) or speaker terminals (using optional cables); LED delay indicators; ambience outputs. Frequency response 30-13,000 Hz $+1/-3$ dB; THD + noise $<0.3\%$; dynamic range 83 dB. Power amplifier section: S/N ratio 94 dB A weighted; frequency response 30-20,000 Hz ± 0.5 dB. Delay/amplifier $15\frac{3}{4}''\text{W}$ (19''W optional) $\times 12''\text{D} \times 3\frac{1}{2}''\text{H}$ \$995

10-01. Similar to ADS 10 minus built-in power amplifier; optional bolt on rack handles (extends to standard 19''), walnut side panels available; black satin finish \$750

AKG

Reverberation Unit

Compact rack-mount studio stereo reverberation unit. Features adjustable input sensitivity (-22 to $+12$); adjustable decay time (1.5, 2.5, 3.5); separate L/R dry/reverb mixing (any ratio from pure dry to pure reverb); reverb bass-shelving EQ (± 10 dB at 100 Hz); separate L/R reverb parametric EQ (± 15 dB 500-5000 Hz); balanced 10k-ohm inputs and 240-ohm outputs via XLR-type connectors \$1495

AUDIO CONTROL

C-101 EQ/LED Spectrum Analyzer

Ten-band stereo graphic equalizer features 101-LED spectrum analyzer display. LED spectral display operates on various level; shows controllable peak-reading modes (fast or slow); horizontal LEDs indicate sound pressure level with external microphone or VU meter readings; switchable calibration levels from 2 (analyzes pink noise and microphone) to 4 dB/LED (displays wider dynamic range). Center frequencies 32, 60, 120, 480, 960, 1.92k, 3.84k, 7.68k, 15.5k Hz with ± 15 -dB boost/cut range, -1 dB subsonic rolloff at 25 Hz, -3 dB rolloff at 20 Hz, -21 dB rolloff at 10 Hz. Other features include continuously variable input level sensitivity with calibration; automatic mic/line input switching; pink noise generator; stereo paired equalizer sliders; equalization tape button; 18-dB/octave subsonic filter; phase correlation rumble reducer circuit. Frequency response 3-100,000 Hz ± 0.75 dB; distortion 0.025% at 1 V, 20-20,000 Hz; hum and noise -96 dB at 1 V, 10-kHz bandwidth; maximum input 7 V; input impedance 100k ohms; max. output 7 V; output impedance 680 ohms; $19''\text{W} \times 6.5''\text{D} \times 3.5''\text{H}$ \$599

Ten-Plus Equalizer/Analyzer

Advanced, easy-to-use equalizer/analyzer. Features 1-kHz warble test tone that can be advanced or

decremented one octave and CALIBRATED LED that works with calibrated condenser microphone for easy analysis; separate slide controls for each equalizer band; video soundtrack enhancement through separate inputs, outputs, front-panel switching; LED in each band slide-control knob for easy use under low-light conditions; sharp Tchebychev subsonic subsonic filter; tape equalization signaled by special flashing-LED mode; separate tape monitor and equalize program modes. Octave frequency band range 31.5-16,000 Hz; boost/cut range ± 12 dB; THD $<0.07\%$; S/N ratio 99 dB; frequency response 3-100,000 Hz ± 1 dB \$329

Ten. Similar to Ten-Plus but without analyzer. \$269

Richter Scale™

Unit combines 5-band half-octave bass equalizer, pink-noise generator/analyzer, electronic crossover, measurement microphone. Designed to enhance bass response. Features subsonic filter; source/tape monitoring; equalize program; low-frequency summing circuit (12 dB/octave at 200 Hz) for rumble reduction; ultra-low boost ($+15$ dB at 36 Hz) switch; 100-1000-Hz, 12-dB/octave electronic crossover circuit for subwoofer and bi-amplification modes; ebony faceplate with oak end panels. Center frequencies 31.5, 45, 63, 90, 125 Hz; boost/cut range ± 12 dB; stereo pink-noise source adjustable to each center band via rotary switch; -20 to $+3$ dB lighted meter registers mic input; subsonic filter 18 dB/octave; frequency response 3-100,000 Hz ± 1 dB; THD 0.04%; input/output impedance 100k/150 ohms; S/N ratio 90 dB; pink-noise output level 100 mV \$259

C-22 Octave Equalizer

Ten-band/2-channel octave equalizer with center frequencies at 32, 60, 120, 480, 960, 1920, 3840, 7680, and 15,500 Hz with ± 15 -dB boost/cut range, -1 dB subsonic rolloff at 10 Hz. Features stereo paired sliders, 18 dB/octave subsonic filter, equalization tape button, phase correlation rumble reducer circuit. Frequency response 3-100,000 Hz ± 1 dB; distortion 0.4% at 1 V; maximum input 7 V; input impedance 100k ohms; maximum output 7 V; output impedance 680 ohms; $3.5''\text{H} \times 19''\text{W} \times 6.5''\text{D}$ \$269

D-11 Equalizer/Pink-Noise Analyzer

Unit combines 10-band octave graphic equalizer, pink-noise generator/analyzer, measurement microphone. Features stereo pink-noise source adjustable to each band via rotary switch and 2-position range buttons; 18-dB/octave subsonic filter; -20 to $+3$ dB lighted mic input meter; tape/source monitor; ebony faceplate with oak end panels. Center frequencies 31.5, 63, 125, 250, 500, 1k, 2k, 4k, 8k, 16k Hz; boost/cut range ± 12 dB; frequency response 3-100,000 Hz ± 1 dB; THD 0.04%; S/N ratio 90 dB; input/output impedance 100k/150 ohms; pink-noise output level 100 mV \$239

D-10. Similar to D-11 but without pink-noise generator/analyzer, mic measurement \$179

D-10X Equalizer/CX Record Decoder

Unit features 10-band graphic equalizer with CX record decoder that allows one to hear music pro-

9

SIGNAL PROCESSORS

cessed through CBS's phonograph record-noise reduction system. Features ebony faceplate with oak end panels. Center frequencies 31.5, 63, 125, 500, 1k, 2k, 4k, 8k, 16k Hz; boost/cut range ± 12 dB; subsonic filter 18 dB/octave; frequency response 3-100,000 Hz ± 1 dB; THD 0.04%; S/N ratio 90 dB; input/output impedance 100k/150 ohms ... \$199

Five Graphic Equalizer

Five-band graphic equalizer with paired right and left slide controls, separate video input and switching, sharp subsonic filter. Features LED-lit slide controls; automatic tape equalization circuits, including LED RECORD indicator; separate jacks for VCR audio inputs and outputs. Center frequencies 40, 240, 1k, 3.5k, 15.5k Hz; frequency response 3-100,000 Hz ± 1 dB; THD < 0.07%; S/N ratio 99 dB \$150

D-520 Graphic Equalizer

Five-band graphic equalizer that concentrates on 3 bass octave, one wider midrange, and one ultra-high treble bands. Features 18-dB/octave subsonic filter; LED power indicator; tape-monitor circuit; paired left/right channel slide controls. Frequency response 15-30,000 Hz ± 1 dB; S/N ratio 107 dB; THD 0.04% \$135

AUDIOSOURCE

EQ-One Graphic Equalizer

Stereo graphic equalizer with built-in pink-noise generator and real-time spectrum analyzer (80 red, 10 green, 2 red LEDs) that works with supplied electret omnidirectional condenser microphone. Frequency response 3-100,000 Hz ± 0.75 dB; distortion 0.035%, 100-20,000 Hz, 0.2%, 20-50,000 Hz; hum and noise -90/-96 dB at 1/2 V output; maximum input and output level 5 V; input/output impedance 100k/68 ohms; center frequencies 31.5, 63, 125, 250, 500, 1k, 2k, 4k, 8k, 16k Hz; boost/cut range ± 12 dB; subsonic filter rolloff 18 dB/octave; 19"W \times 8.36"D \times 5.22"H; 8.4 lb \$400

BIAMP

EQ/270A Graphic Equalizer

27-band/third-octave graphic equalizer with center frequencies set from 40 to 16,000 Hz with boost/cut range of ± 12 dB. Features bypass switch; LED overload indicator; transformer-type connectors and phone jacks on inputs and outputs; transformerless balanced inputs and outputs; combining filters. Frequency response 10-90,000 Hz ± 1 dB, 15-30,000 Hz ± 0.1 dB; THD and IM distortion 0.0075%; hum and noise -90 dB at 0 dB, 115 dB below rated output; filter bandwidth 1/3 octave at 3-dB point with 6 dB attenuation; input impedance 600/50k ohms (switchable); maximum input +24 dB; slew rate 8 V/ μ sec; 19"W \times 10"D \times 3 1/2"H \$649

EQ/210 Graphic Equalizer

Ten-band stereo graphic equalizer with center frequencies at 32, 64, 125, 250, 500, 1k, 2k, 4k, 8k, 16k Hz and ± 15 -dB boost/cut range. Features bypass switch; LED overload indicator; 4 phone jacks/channel for balanced/unbalanced input/output lines. Frequency response 6-45,000 Hz +0/-1 dB, controls at flat; THD and IM distortion 0.005%; gain -3 dB unbalanced, 0 dB balanced; slew rate 1 V/ μ sec; output load impedance 600 ohms; input impedance 50k ohms balanced or unbalanced; maximum output level -24 dBm at 8 V unbalanced; S/N ratio 84 dB below 1 V output; rack mountable; 19"W \times 5 1/4"D \times 3 1/2"H \$325

EQ/110R. Mono version of EQ/210 \$215

Quad Limiter

Multichannel limiter/compressor with 4 threshold controls and LEDs for 4 independent channels.

Threshold variable from -40 to +18 dB; output impedance 600 ohms balanced or unbalanced; input impedance unbalanced/balanced 25k/50k ohms; frequency response 20-25,000 Hz ± 0.5 dB; THD 0.03% at 1 kHz; attack/release time 1/150 msec-1.5 sec; S/N ratio 102 dB; slew rate 8 V/ μ sec; 19"W \times 5 1/2"D \times 1 3/4"H \$325

CROWN

EQ-2 Synergistic Equalizer

Eleven-band/2-channel octave center equalizer with center frequencies at 20, 40, 80, 160, 320, 640, 1.25k, 2.5k, 5k, 10k, 20k Hz, ± 15 -dB boost/cut range. Each channel features octave frequency adjust controls; ± 20 -dB tone controls with bass hinge points adjustable 180-1800 Hz and treble hinge points adjustable 1000-10,000 Hz; equalizer- and tone-cancel master controls; overload indicators. Rear panel has unbalanced inputs, balanced inputs with switchable unity/10 dB gain selection, screwdriver-adjust attenuation controls, normal/inverted outputs. Frequency response 10-100,000 Hz ± 0.3 dB, 20-20,000 Hz ± 0.1 dB, controls flat with IHF load; hum and noise 90 dB below rated output, 20-20,000 Hz; IM distortion 0.01% at rated output; rated output 2.5 V rms into IHF load; input impedance 25k ohms unbalanced, 20k ohms balanced (transformerless); output impedance 300 ohms (normal), 600 ohms (balanced); satinized aluminum front panel with grey Lexan inlay; 7 1/2"H \times 19"W \times 14 1/2"D \$1299

dbx®

dbx® Type II Tape Noise-Reduction Systems

Type II systems reduce noise by more than 40 dB across entire audio-frequency spectrum and add 10 dB recording headroom when used with any tape recorder. Also decode dbx-encoded discs.

Model 228. Tape noise-reduction/dynamic-range-expansion system simultaneously encodes/decodes for tape NR. Suitable for 2-head tape decks, provides full monitoring capability with 3-head decks. Offers effective noise reduction of 30 dB of headroom, dynamic range of 110 dB. Reduces noise by as much as 20 dB from FM broadcasts, commercially recorded tapes, conventional LP records, and increases dynamic range by as much as 50%. Unit also enables playback of dbx encoded discs and cassettes. 19"W \times 1 3/4"H \$499

Model 224. Linear decibel compander offers simultaneous encode/decode process for full monitoring capability with 3-head open-reel and cassette recorders; also works with 2-head decks. Effective noise reduction 40 dB plus 10 dB headroom; dynamic range 110 dB peak signal to weighted background noise; frequency response ± 0.5 dB 40-20,000 Hz, -1 dB at 30 Hz; slew rate > 10 V/ μ sec; equivalent input noise -85 dB unweighted, 20-kHz bandwidth, referenced to 1 V; THD < 0.4% 30-100 Hz, < 0.1% 100-20,000 Hz; IM distortion < 0.2% SMPTE; power consumption 7 W; 17 1/8"W \times 7 1/2"D \times 1 3/4"H; 6 lb \$299

Model 222. Similar to Model 224 but designed for use with 2-head recorders. Has separate encode (record) and decode (playback) functions but no monitoring capability. Specifications same as well \$219

Model 21. dbx disc (and tape) decoder designed to reproduce full 90 dB of a live performance. Also designed to virtually eliminate pop, ticks, surface noise on records. Dynamic range 100 dB; nominal/maximum input 300 mv/6 V rms; output level 5.5 V rms; frequency response ± 0.5 dB 30-15,000 Hz; hum and noise < -100 dBV, referenced to 1 V, A weighted, 20-kHz bandwidth; THD < 0.5% at 1 kHz (encode/decode) up to 4 V rms output; IM distortion < 0.2% SMPTE; power consumption 5 W; 8 3/4"W \times 6 3/4"D \times 2 3/4"H; 2.5 lb \$109

dbx® Dynamic Range Expanders

Designed to increase the dynamic range of records, tapes, FM broadcasts by as much as 50%, reduce noise by as much as 20 dB.

Model 38X Series Two. Advanced expander makes loud passages louder, soft passages quieter. Bass, midrange, treble frequencies processed individually. Features 3 rows of LEDs that monitor degree of ex-

pansion in each range; expansion level control; transition level control; tape-monitor loop to restore loop required by expander in stereo system. Expansion ratio continuously variable 1.0-1.5 (0 to 50% increase), linear in dB; dynamic range 100 dB peak signal to weighted background noise; input level nominal/maximum 300 mv/7 V rms; output level 7 V rms; fre-



quency response ± 0.5 dB 20-20,000 Hz at 1.0 expansion; equivalent input noise -85 dBV unweighted, referenced to 1 V, 20-kHz bandwidth; THD 0.1% at 1.0 expansion; IM distortion 0.15% SMPTE; power consumption 30 W; 17 1/8"W \times 7 1/2"D \times 1 3/4"H; 4.5 lb \$249

Model 18X Series Two. Similar to Model 28X except has infrasonic filter in rms level detector to prevent mistracking caused by turntable rumble and record warp; 12 LEDs to monitor upward/downward expansion; power consumption 10 W; 17 1/8"W \times 7 1/2"D \times 1 3/4"H; 4.5 lb \$249

dbx® Signal-Improvement Units

Model 118. Dynamic range enhancer is a single-band linear decibel expander/compressor and limiter/peak unlimiter designed to expand dynamic range of any program source. Specifications same as Model 38X; power consumption 5 W; 10 3/4"W \times 3 3/4"H; 5 lb \$239

Model 110. Subharmonic synthesizer that passes low-frequency signals plus same signals a full octave lower (synthesized by sampling original signals) to recreate subharmonics. Dynamic range 100 dB peak signal to weighted background noise; input level nominal/maximum 300 mv/7 V rms; output level 7 V rms; frequency response 20-20,000 Hz ± 2 dB; equivalent input noise -85 dBV unweighted referenced to 1 V, 20-kHz bandwidth; THD 0.1% typical, main signal channel; IM distortion 0.15% SMPTE, main channel; power consumption 10 W \$269

dbx® Model 20/20 Equalizer/Analyzer

Automatic equalizing system combines microprocessor-controlled 10-band graphic equalizer, real-time analyzer, pink-noise generator, sound-pressure-level (SPL) indicator. Includes a calibrated microphone. EQ center frequencies 31.5, 63, 125, 250, 500, 1k, 2k, 4k, 8k, 16k Hz; EQ range +14/-15 dB; accuracy ± 0.1 dB at full boost/cut, ± 0.1 dB/step; gain 0 dB; THD 0.01% 20-20,000 Hz. Analyzer dynamic range 80 dB; display 30 LED \times 10 band; meter bandwidth at 90 dB SPL input 15-20,000 Hz; dynamic range 80 dB; generator accuracy ± 0.5 dB. Microphone type electret condenser; frequency response ± 1 dB 20-20,000 Hz; 25-ft cable. 19"W \times 12 1/2"D \times 5 1/4"H \$1700

EVENTIDE

H910 Harmonizer

Special-effects generator that serves as full-fledged digital delay line, pitch changer with 2-octave range, antifeedback device that permits boosting sound levels. Can be used to speed up/slow down tapes and create wide variety of special sound effects. Distortion < 0.2% at 1 kHz, referenced to output level; dynamic range > 90 dB from clipping to noise floor; pitch continuously variable 1 octave up and down; delay 0/30/60 msec in pitch change mode, 0-112.5 msec in 7.5-msec steps in delay-only mode, 0-82.5 msec in 7.5-msec steps in delay-only output; frequency response 20-12,000 Hz ± 1 dB at any delay, unity pitch ratio; power consumption 25 W; 19"W \times 9"D \times 3 1/2"H \$1500

JJ193 Digital Delay

CMOS-logic digital delay line designed for recording studio, concert hall, auditorium, radio station. Produces signal doubling, realistic echo effects, synchronization of sound reinforcement speakers, pre-echo delay. Features RAMs; variable time delay switches; 4 outputs and one input; 6-LED input level indicators; input level control. Input impedance 20k ohms bal-

anced, 10k ohms unbalanced; input level -10 to +3 dBm (full dynamic range); output impedance 300 ohms electronically balanced; maximum output level +22 dBm; distortion 0.2% at 1 kHz; dynamic range 90 dB from clipping to noise floor; frequency response 30-12,000 Hz ± 1 dB; 1.75"H \times 19"W \times 9"D \$1195
CD254. Similar to JJ193 except has 2 outputs; 0-254 msec time delay controllable by internal switches; no front-panel controls \$895
04. 4-output option. 2.046 seconds delay ... \$300
02. 4-output option. 1.022 seconds delay ... \$100

HM80 Harmonizer

Compact portable harmonizer features ± 1 -octave pitch control; 270-msec delay, word or short riff repeat; time reversal, dry-versus-effect output mix, feedback controls; dynamic range 80 dB; 10.5"W \times 8.25"D \times 2.25"H \$775

FL201 Instant Flanger

Oscillator, manual, remote, envelope controls can be used in any configuration. Features time delay circuitry; effect modifier block (designed to imitate motor or servo hunting bounce); depth control (effects percentage of direct-versus-delayed signal and relative phase of each); line in/out control and LED indicator; high level input and output (optional balanced line in/out available); LED mode indicators. Frequency response 50-15,000 Hz +1 dB (direct channel), 50-10,000 Hz +1.5 dB (delayed channel); distortion 0.05% below clipping (delayed); dynamic range 112 dB at 15 kHz (direct), 75 dB (delayed); delay time variable 200 μ sec-10 msec; input/output level 0 to +4 dBm; input impedance 10k ohms unbalanced; 19"W \times 9"D \times 3.5"H \$700

2830 Omnipressor

Dynamic modifier combines functions of compressor, expander, noise gate, limiter. Features continuously variable expansion/compression control (10:1 gate to -10:1 abrupt reversal); attenuation and gain limit controls (1000:1) bass/cut switch; logarithmic input/output/gain meter; in/out bypass switch. Frequency response 20-16,000 Hz +0/-0.5 dB; input/output level 0 to +8 dBm nominal; input impedance 10k ohms electronically balanced; output impedance 600 ohms nominal; gain unity, +10, +20 dB (agc disabled); compression continuously variable 1:1 to unity to 10:1 expansion continuously variable 1:1 to 10:1; S/N ratio -90 dBm at unity gain; attack time continuously variable 100 μ sec-100 msec; release time continuously variable 1 msec-1 sec; 115 V ac, 50-60 Hz $\pm 2\%$ or 230V ac, 50-60 Hz $\pm 2\%$; 19"W \times 9"D \times 3.5"H \$700

FISHER

EQ550 Stereo Graphic Equalizer

Twelve-band stereo graphic equalizer with separate slide controls for each channel, LED indicators built into control knobs, tape monitor switch. Features equalizer on/record/off function control. Center frequencies 16, 31.5, 63, 125, 250, 500, 1k, 2k, 4k, 8k, 16k, 32k Hz; boost/cut range ± 12 dB; frequency response 20-20,000 Hz +0.1/-0.3 dB; THD at 1 and 5 V output 0.01%/0.06% with controls at flat; gain +0/-0.5 dB with controls at flat; maximum output 7 V at 1% THD; S/N ratio 110 dB A weighted at 1 V output, controls at flat; input/output impedance 50k/2k ohms; 8 watts; 17 $\frac{1}{2}$ "W \times 11 $\frac{1}{4}$ "D \times 4 $\frac{1}{8}$ "H; 10 lb \$350

EQ350 Graphic Equalizer

Ten-band stereo graphic equalizer with tape monitor, line source, record switches. Center frequencies 31.2, 63, 125, 250, 500, 1k, 2k, 4k, 8k, 16k Hz; boost/cut range ± 12 dB; frequency response 20-20,000 Hz +0.1/-0.3 dB; THD at 1 and 5 V output 0.01%/0.06% with controls at flat; gain +0/-0.5 dB with controls at flat; S/N ratio 110 dB A weighted at 1 V output, controls at flat; input/output impedance 50k/2k ohms; maximum output 7 V at 1% THD; power consumption 6 W; 17 $\frac{1}{2}$ "W \times 11 $\frac{1}{4}$ "D \times 3 $\frac{1}{2}$ "H; 9.2 lb \$200
EQ2322. Similar to EQ350 except different control knobs and front-panel design \$200

EQ100 Graphic Equalizer

Seven-band graphic equalizer with tape monitor switch and LED power-on indicator. Center frequencies 65, 160, 400, 1k, 2.5k, 6k, 15k Hz; boost/cut range ± 10 dB; frequency response 20-20,000 Hz +0.1/-0.3 dB; THD at 1 and 5 V output 0.01%/0.06% with controls at flat; S/N ratio 100 dB A weighted at 1 V output, controls at flat; input/output impedance 50k/2k ohms; gain +0/-0.5 dB with controls at flat; maximum output 7 V at 1% THD; power consumption 6 W; 15 $\frac{1}{4}$ "W \times 8 $\frac{3}{4}$ "D \times 3 $\frac{1}{8}$ "H; 5 lb \$130

NR500 Tape Noise-Reduction System

Super D dual-process noise-reduction system designed for use with 3-head cassette decks. Companding system uses special phase-compensated split-band system that processes low and high frequencies separately to eliminate breathing effects. Features separate encode/decode channels; tape/source monitoring switch; internal calibration system to ensure compatibility with any tape deck; fluoroscan peak level meters. Companding 40 dB maximum; dynamic range 100 dB; THD 0.08% at 1 kHz, rated level; frequency range 20-30,000 Hz; noise-reduction capability 40 dB maximum; record/play input level/impedance 350 mV/330 ohms; power consumption 7 W; 17 $\frac{1}{8}$ "W \times 10 $\frac{1}{4}$ "D \times 1 $\frac{1}{4}$ "H; 8 lb 13 oz ... \$190

FURMAN SOUND

PQ-6 Stereo Parametric Equalizer/Preamp

Three-band stereo parametric equalizer designed as instrument preamp, feedback suppressor in PA system, or patchable outboard equalizer for recording studios, broadcast station, stage productions. Each channel features $\frac{1}{2}$ -octave narrow/4-octave broad bass, midrange, treble bandwidth controls with overlapping and variable frequency controls covering 20-2500 and 600-10,000 Hz respectively and +20 dB boost to minus infinity cut equalization controls; EQ



in/bypass with LED; loudness-compensation level control. Input 100k ohms unbalanced, with maximum input before clipping 430 mV rms for low level; output 10 ohms unbalanced, with maximum output level 8.3 V rms; total available gain 26 dB (low-level in), 6 dB (high-level in); frequency response ± 0.5 dB (bypass), 20-20,000 Hz (EQ flat); S/N ratio 109 dB (bypass), 99 dB (EQ in and flat); distortion 0.015% (bypass), 0.025% (EQ flat); brushed and anodized aluminum front panel and steel chassis; rack-mountable; available in 115V, 60Hz or 230 V, 50/60 Hz; 19"W \times 8"D \times 3.5"H \$525
PQ-3. Mono version of PQ-6; 1.75"H \$315

SG-10 Sweep Graphic Equalizer

Five-band stereo graphic equalizer with each band's center frequency continuously variable over 4-octave range. Features stereo/split circuitry that permits instant switching from 5-band stereo to 10-band mono operation; integral instrument preamps for low-level sources; overload indicator system; bypass switches with LED status indicators; low-cut filters for each channel; low-level outputs for driving instrument amplifiers; optional balanced inputs and outputs; center-detented slide controls. Frequency ranges 16-250 Hz band 1, 32-500 Hz band 2, 125-2000 Hz band 3, 500-8000 Hz band 4; 1000-16,000 Hz band 5; boost/cut range ± 15 dB; low-cut filter corner frequency 80 Hz; total available gain with equalizer output 26 dB low-level input, 6 dB high-level input; frequency response 20-20,000 Hz ± 0.5 dB EQ out or all EQ controls at 0; S/N ratio EQ out/EQ flat 109/99 dB; THD EQ out/EQ flat 0.015%/0.25%; inputs 430 mV rms low level, unlimited (depends on setting of input level control) high level; power consumption 10 W \$495

RV-1 Reverberation System

Reverberation system incorporates shock-mounted triple Accutronics 16" spring assembly, fast-attack

peak limiter, quasi-parametric midrange controls. Features input, direct, reverb level controls; LED limit threshold indicator (flashes green when gain reduction begins); midrange frequency (160-1400 Hz), ± 18 -dB midrange Eq; treble shelving (± 18 dB from 2500-10,000 Hz) controls. Input 33k ohms unbalanced at recommended -10 to +4 dBm level; output 47 ohms unbalanced, with maximum output level 8.3 V rms; frequency range 45-7000 Hz; decay time 1.8 sec with 30-40 msec initial delay; limiter compression ratio 10:1; S/N ratio 74 dB A weighted, EQ flat; aluminum front panel, steel chassis; rack-mountable; 19"W \times 8"D \times 1.75"H \$315

LC-2 Limiter/Compressor

Limiter/compressor features input and output level controls; attack, release, compression ratio controls; LED-style meter that displays gain over 20-dB range; LED power and overload indicators. Front-panel pushbuttons select between normal compression and de-essing or side-chain modes. Input impedance 10k ohms unbalanced (optional 20k ohms balanced at main input); maximum input before clipping for balanced input 8.7 V rms (+21 dBm); unbalanced, 17.4 V rms (+27 dBm) balanced; minimum terminating impedance 2.5k ohms; attack time 400 μ sec to 25 msec; release 200 msec to 5 sec; compression ratio 2:1 to 50:1; frequency response 20-20,000 Hz ± 0.5 dB; S/N ratio 92 dB unweighted, 5 dB gain reduction; THD 0.04%, no gain reduction, 0.07% with 5 dB gain reduction; 19"W \times 8"D \times 1 $\frac{1}{4}$ "H; 5 lb; 115 V ac 60 Hz, 230 V ac 50/60 Hz; power consumption 5 W \$315

GLI

EQ-1500 Bi-FET Graphic Equalizer

Ten-band stereo graphic equalizer with center frequencies at 30, 60, 120, 240, 1k, 2k, 4k, 8k, 16k Hz; boost/cut range ± 12 dB. Features high-speed operational amplifier BiFET IC circuitry; 20 slide controls (10/channel) with center detent; EQ defeat switch with LED status indicator; main, aux, tape monitor input switches; power switch with LED. Frequency response 20-20,000 Hz ± 0.5 dB (EQ flat), 0-500,000 Hz ± 0.1 dB (EQ bypassed); distortion 0.05% at 1 V rms out; THD and IM distortion



0.005% from 20-20,000 Hz at 5 V; slew rate 14 V/ μ sec; S/N ratio 90 dB below 2 V rms; maximum output 10 V before clipping; 19" rack mount ... \$250

DAVID HAFLER

160 Stereo Graphic Equalizer

Stereo graphic equalizer with 10 LED -20 to +3 dB level displays, equalize/bypass switch, center (flat position) detented slide controls, BiFET/bipolar transistor design, class-A operation. Equalizer range at octave intervals from 32 to 16,000 Hz; boost/cut range ± 12 dB; level control 8 dB; maximum output level 8 V rms; frequency response 4-80,000 Hz +0/-3 dB, 20-20,000 Hz +0/-0.3 dB; THD > 88 dB below 3 V rms (0.004%); IM distortion > 90 dB below 8 V rms (0.003%); input/output impedance 68k ohms bypassed with 300 pF / < 600 ohms to 25 kHz; hum and noise 115 dB below 8 V rms A weighted; separation > 88 dB at 1 kHz, > 55 dB at 20 kHz; microphone input frequency response 20-20,000 Hz +0/-0.5 dB; mic input sensitivity 1.8 mV for 0-dB meter indication, mic gain control at maximum; line monitor sensitivity adjustable 80 mV to beyond 8 V for 0-dB meter indication. \$300 kit/\$400 assembled

HARMAN/KARDON

EQ7 Stereo Graphic Equalizer

Ten-band octave equalizer with separate slide controls for left and right channels, variable-gain inputs, overload LED indicator, tape monitor, tape equalization. Center frequencies 31.5, 63, 125, 250, 500, 1k, 2k, 4k, 8k, 16k Hz; boost/cut range ± 12 dB; fre-



SIGNAL PROCESSORS

frequency response 5-140,000 Hz +0/-3 dB, all controls at 0; THD 0.02% at 2.0 V output, 20-20,000 Hz \$250

HEATH

AD-1706 Audio Processor

Incorporates dynamic range expander and noise-reduction circuit to increase total dynamic range up to 17 dB (any program source processed through unit gains up to 7 dB of dynamic range expansion and 10 dB of noise reduction); front-panel 12-dB/octave (7-kHz) high filter switch; built-in tape monitoring; LED noise-reduction and dynamic range expansion indicators; connects between tape output and tape-monitor jacks of preamp, integrated amplifier, receiver. Rated input 200 mV; input impedance 100k ohms; gain 0 dB expander off, +0.25 dB expander on; frequency range 20-20,000 Hz; sensitivity 500 μ V; hum and noise -70 dB, 20-20,000 Hz; output impedance 500 ohms; input overload 5 V rms at 1 kHz; black cabinet; 19"W x 14"D x 5 $\frac{1}{4}$ "H \$255

INFINITY SYSTEMS

Burwen DNF 1201A Dynamic Noise Filter

Processes any 2-channel or matrix-encoded material from turntable, tape deck, receiver, tuner. Features pushbutton controls for selecting noise reduction; sensitivity control with LED display. Frequency response (minimum bandwidth) -3 dB at 30 kHz, -10 dB at 1 kHz, -20 dB at 2.5 kHz; (maximum bandwidth) -0.5 dB maximum 10-20,000 Hz, -3 dB at 30 kHz, -25 dB at 100 kHz; attenuation rate 9 dB/octave; noise-reduction levels up to 30 dB beyond 5 kHz, 14 dB beyond 400 Hz; HD 0.2% maximum; gain 0 dB at 1 kHz, adjustable to 10 dB; internal noise 100 μ V rms, 20-20,000 Hz; has 8 phono jacks and tape-deck connectors; 17 $\frac{1}{2}$ "W x 8 $\frac{1}{4}$ "D x 2 $\frac{1}{8}$ "H \$350

Burwen TNE 7000 Noise Eliminator

Transient (pulse) processor reduces or eliminates medium and small clicks, pops, ticks from turntable or tape deck. Blanking period filled by transition voltage; has defeat, tape-monitor, threshold, sensitivity controls, LED indicators for transient noise elimination, high-frequency calibration. Frequency response 20-20,000 Hz \pm 0.5 dB; distortion 0.1% THD, 0.5% IM; internal noise 40 μ V rms; 16 $\frac{3}{4}$ "W x 7 $\frac{3}{4}$ "D x 2 $\frac{1}{8}$ "H \$350

INTEGREX

Four-Channel Dolby B Noise Reducer Kit

Stereo unit incorporates 4 Dolby channels for simultaneous encoding/decoding for 3-head tape machines; designed to reduce hiss in magnetic-tape recording machines; decodes commercially-available Dolby B-encoded reels or cassettes or Dolby B FM radio broadcast and/or encodes blank tapes from any source; cannot be used for discrete 4-channel encoding or decoding. Noise reduction 9 dB weighted (CCIR/ARM); minimum sensitivity 35 mV rms (tape and Dolby FM tuner inputs), 40 mV rms (aux input); impedance 40k ohms (all inputs), all outputs variable, low impedance (all outputs); maximum variable output level 580 mV rms (Dolby level); overload 18 dB above Dolby level for 0.3% THD; distortion 0.05% (all outputs at Dolby level); S/N ratio unweighted, referred to Dolby level, at monitor output 76 dB (from aux in), 80 dB (from tape and tuner in, Dolby on), 70 dB (from tuner in), at tape output 70 dB (from aux and tuner in), 76 dB (from tuner in, Dolby FM on). Kit includes 2-color fiberglass printed circuit board with component locations, all alignment circuits, solid mahogany cabinet; 15 $\frac{1}{2}$ "W x 6 $\frac{3}{4}$ "D x 2 $\frac{1}{8}$ "H . \$150
Dolby Calibration Tapes. Specify reel or cassette . \$9

DFM Dolby Noise Reducer

Decodes Dolby B-encoded cassette or reel tapes and Dolby-encoded FM broadcasts. Features front-panel on/off, 25/75- μ sec deemphasis input select, Dolby-decoding in/out switches; rear-panel input level calibration, output level, 25/75- μ sec deemphasis input select controls. Noise reduction 9 dB weighted (CCIR/ARM); sensitivity 35 mV rms minimum; variable output level 580 mV at Dolby level, overload 18 dB above Dolby level for 0.3% THD; distortion 0.05% referred to Dolby level; separation tape input 58 dB at 2 kHz, Dolby on; S/N ratio 79 dB Dolby level (CCIR/ARM); aluminum anodized case; 8 $\frac{1}{2}$ "W x 4"D x 2 $\frac{1}{8}$ "H \$100

JVC

SEA-80 Graphic Equalizer

Ten-band stereo graphic equalizer with center frequencies at 31.5, 63, 125, 250, 500, 1k, 2k, 4k, 8k, 16k Hz and \pm 12-dB boost/cut range. Features fluorescent analyzer display with left/right mode switch, memory, and level control (covers 32-16,000 Hz frequency range over 0-26-dB level range); pink noise generator; -6 dB SEA switch (doubles input sensitiv-



ity to accommodate high inputs without distortion); SEA record switch (transmits signal to tape deck); tape monitor switch; -20-dB mic switch. Input impedance 47k ohms (SEA and tape rec out); output impedance 2 V rms; frequency response 10-100,000 Hz +0/-1 dB; THD and IM distortion 0.003%; gain 0/-6 dB; 17 $\frac{1}{4}$ "W x 12 $\frac{1}{4}$ "D x 6 $\frac{1}{4}$ "H \$500
MU-S80. Electret condenser microphone for room acoustics measurements with SEA-80. Frequency response 30-16,000 Hz \pm 2 dB; sensitivity 72 dB \pm 3 dB; output impedance 600 ohms \$200

SEA-70 Graphic Equalizer

Stereo graphic equalizer with 12 frequency "tonezone" controls in each channel, 2-deck SEA recording/dubbing. Features wide dynamic range expansion; LED status indicators; \pm 12/ \pm 6 dB control-range switch \$400

SEA-60 10-Band Graphic Equalizer

Stereo graphic equalizer with spectrum analyzer. Features 10 equalizer controls; real-time spectrum analyzer; SEA Character switch with reverse for dynamic companding; function indicators; transistor inductors for expanded dynamic range; tape monitor function; -64-dB input attenuator. Input impedance 47k ohms S.E.A. and tape-monitor inputs; output impedance 100 ohms for S.E.A., tape-recorder outputs; rated output 2 V rms with S.E.A. controls set to flat; maximum output 6 V rms at 1 kHz, 0.01% THD; THD 0.005% 20-20,000 Hz at rated output; IM distortion 0.005% with S.E.A. controls set to flat; gain 0 dB; frequency response 10-100,000 Hz +0/-2 dB; S/N ratio 115 dB at 2 V output, IHF-A network short-circuited; S.E.A. center frequencies 31.5, 63, 125, 250, 500, 1k, 2k, 4k, 8k, 16k Hz; S.E.A. boost/cut range \pm 12 dB; 16 $\frac{3}{4}$ "W x 12 $\frac{1}{4}$ "D x 4 $\frac{1}{16}$ "H;

10.3 lb \$300

SEA-40 7-Band Graphic Equalizer

S.E.A. graphic equalizer with 7 controls per channel. Features function indicators; SEA Character switch with reverse for dynamic companding; transistor inductors for expanded dynamic range; -6-dB attenuator switch; S.E.A. record mode; illuminated function indicators; normal/reverse S.E.A. recording; tape monitor. Specifications same as for SEA-60 except S.E.A. center frequencies 63, 1600, 400, 1k, 2.5k, 6.3k, 16k Hz; 17 $\frac{1}{8}$ "W x 12 $\frac{1}{8}$ "D x 4 $\frac{1}{8}$ "H; 9 lb \$200

BN-5 Biphonic Processor

Binaural processor for binaural effects through speakers; input terminals line in/tape play at 80 mV/-20 dB, 100 ohms input impedance; output terminals line out at 300 mV,-8 dB output level 3.5k ohms tape output impedance; power consumption 7W; 15 $\frac{3}{8}$ "W x 9 $\frac{1}{2}$ "D x 3 $\frac{3}{8}$ "H \$280

KLH

DNF 1201A Dynamic Noise Filter

Processes any 2-channel or matrix-encoded material from turntable, tape deck, cassette deck, receiver, tuner; pushbutton controls select proper noise reduction; sensitivity control with LED displays. Frequency response (minimum bandwidth) -3 dB at 500 Hz, -10 dB at kHz, -20 dB at 2.5 kHz; (maximum bandwidth) \pm 0.5 dB maximum 10 Hz to 20 kHz, -3 dB at 30 kHz -25 dB at 100 kHz; attenuation rate 9 dB/octave; noise reduction levels up to 30 dB above 5 kHz, 14 dB above 400 Hz; HD 0.2% maximum; 0 dB gain at 1 kHz adjustable to 10 dB; internal noise 100 μ V rms 20 Hz to 20 kHz; has 8 phono jacks and tape deck connectors; 17 $\frac{1}{2}$ "W x 8 $\frac{1}{4}$ "D x 2 $\frac{1}{8}$ "H 4379

TNE 7000 Transient Noise Eliminator

Impulse suppressor reduces or eliminates medium and small clicks, pops, ticks from turntable or tape deck; blanking duration 100-600 millionths of a second; blanking period filled by transition voltage; has defeat, tape monitor, threshold, sensitivity controls; LED indicators for transient noise elimination and high-frequency calibration. Frequency response 20-20,000 Hz \pm 0.5 dB; distortion 0.1% (THD), 0.5% (IM); internal noise 40 μ V rms; 16 $\frac{3}{4}$ "W x 7 $\frac{3}{4}$ "D x 2 $\frac{1}{8}$ "H \$329

LT SOUND

ACC-2 Amplitude Control Center

Stereo unit has Allison Research vca with feed-forward circuit design, de-essing with switchable knee, or normal compression. Functions as compressor, limiter, expander, de-esser, on-board oscillator for amplitude-modulated tremolo effects. Each channel has compression ratio, compression attack and release controls; expander threshold expander ratio, attack, release controls; 3-color LED gain-reduction indicators. S/N ratio 90 dB below 1 V; typical distortion 0.001%; compressing/limiting slope variable between 1:1 and infinity; 19"W x 3 $\frac{1}{2}$ "H x 7 $\frac{1}{4}$ "D \$995
CLX-2. Similar to ACC-2 except has no tremolo-effects capability, expander ratio, expander threshold, attack, release controls. Has key function for keyed expansion or noise gating; 2"H \$695

TAD-4 Thompson Analog Delay

Stereo ambience unit for recording use features 2 separate channels each of analog delay and studio reverb. Controls continuously variable for echo EQ, reverb level, reverb EQ, echo repeat, direct level, echo level, reverb level. Delay time continuously variable 20-240 msec; delay time; bandwidth 12 kHz at 20-70 msec, 8.4 kHz at 100 msec; down to 3.5 kHz at 240 msec; dynamic range >90 dB; 19"W x 7 $\frac{1}{4}$ "D x 2"H \$650

TC-1 Thompson Vocal Eliminator

Removes most or all of solo vocalist from standard stereo records and leaves most of the background instruments and vocals untouched. Works on tapes and records. 19"W x 7 $\frac{1}{4}$ "D x 2"H \$595

NEED MORE INFORMATION?

Write directly to the manufacturer or distributor. A list of names and addresses starts on page 4.

ECC Echo Control Center

Single-channel unit functions as preamp for 2 low-impedance microphones and 2 low-level low-impedance line level aux inputs; 3-band equalizer; echo and reverb controls for mic level, EQ, echo. Features bi-FET op amp circuitry, relay on/off transient protection, mu-metal shielding for reverb unit. Delay dynamic range 85 dB below 1 V; distortion 0.5% at 1 kHz, 0.775-V out; delay range 20-240 msec; frequency response of delay ± 1.5 dB; mic input impedance 2000 ohms for 600-ohm or less mic; aux input impedance 47k ohms; output impedance 200 ohms for 2k-ohm loads; EQ range ± 18 dB for bass, midrange, and treble; rack-mountable; 7"D \times 2"H \$595

RCC. Reverb control center similar to ECC without echo capability; frequency response 10-40,000 Hz ± 0.5 dB direct, 20-5500 Hz reverb; dynamic range 72 dB below 1 V; THD, IM distortion 0.05% . \$295

PEQ-2 Parametric Equalizer

Dual 4-band parametric equalizer. Studio quality EQ has rumble filter, selectable peak-dip or shelving response on upper and lower bands, bypass switch, peak indicator, balanced and unbalanced inputs and outputs. Frequency range coverage 20-20,000 Hz; bandwidth 0.15-2.0 octaves; maximum level +22 dBm; maximum boost/cut ± 15 dB; input impedance 47k ohms; output impedance 47 ohms; THD 0.007%; IM distortion 0.002%; 19"W \times 7 1/4"D \times 3 1/2"H; 8.5 lb \$475

PEQ-1. Same as PEQ-2 but single-channel version and no low-frequency rumble filter; 5 lb \$249

RV-2 Stereo Reverb Unit

Reverb unit for line-level inputs only. Features -6 dB and peak amplitude LEDs; 3 equalization controls; direct, reverb, reverb drive controls; send-receive bus. Frequency response 2-40,000 Hz ± 0.5 dB (direct); reverb 20-5500 Hz; reverb time 2.5 sec; input impedance 47k ohms; output impedance 200 ohms for 2k-ohm loads; S/N ratio 90 dBm (direct); 19"W \times 7"D \times 2"H \$395

NR-2 Noise Reducer/Range Enhancer

Two-channel unit provides 2:1 compander noise reduction system and dynamic range enhancement system; for dual or independent tracking. Frequency response 20-20,000 Hz ± 0.75 dB; S/N ratio 90 dB; distortion 0.2% at 1 kHz; input impedance 47k ohms; output impedance 200 ohms for 2k-ohm loads; 12.75"W \times 6.15"D \times 2.5"H \$295

NR-4 Four-Channel Componder

Can switch 4 channels of noise reduction from record to play mode using 2 inputs simultaneously or 2-channel simultaneous record and tape monitor decode; has bypass switches. Frequency response 20-20,000 Hz ± 0.75 dB; THD 0.2% (compressed and expanded); slew rate 13 V/ μ sec; expander noise output -95 dBm; maximum input level +26 dBm; 12.75"W \times 6.15"D \times 2.5"H \$295

NR-8. Same as NR-4 except provides 8 channels of individually switchable record/play and bypass noise reduction or 4-channel simultaneous record and tape monitor decode \$495

SL-2 Stereo Limiter

Stereo unit functions independently or in a stereo tracking mode. Provides 3 controls for attack and release. Functions are a hard limiter, average limiter, or automatic level control. S/N ratio 90 dB below 1 V; typical distortion 0.01% (not undergoing limiting); 19"W \times 7 1/4"D \times 2"H \$249

LUXMAN

G-120A Graphic Equalizer

Ten-band stereo graphic equalizer with center frequency slide controls at 28, 55, 110, 220, 440, 880, 3.5k, 7k, and 14k Hz with ± 12 -dB boost/cut range. Features normal/bypass/record function selector; input attenuator selector; tape monitor switch; LED overload indicator. Frequency response 10-100,000 Hz -1.5 dB; THD and IM distortion 0.01% at 1-V output; S/N ratio 110 dB IHF A weighted; input sensitivity/impedance 1 V/65k ohms; 17 1/2"W \times 10 3/4"D \times 4 1/2"H \$350

MARANTZ

EQ-20 Equalizer

10-band stereo graphic equalizer with separate left and right-channel controls and 24-karat-gold-plated input and output jacks for low-oxidation/low-distortion audio connections. Features 20 detented slide controls; tape equalization recording capability; extra tape monitor with EQ defeat switch to bypass equalizer. Frequency response 10-25,000 Hz ± 1 dB; S/N ratio 110 dB A weighted at 1 kHz referenced to rated output (1 volt); THD 0.005% at rated output, 20-20,000 Hz; IM distortion 0.05% at rated output, SMPTE method; sensitivity for rated output 1100 mV line in and tape in; line input impedance 100k ohms; line output impedance 3.5k ohms; power consumption 8.5 W; 16 1/2"W \times 7 1/2"D \times 2 1/4"H; 5.25 lb \$250

MULTIVOX

MX-312 Multi-Echo Chamber

Solid-state computer-type tape dumping system using 16-ft endless tape; has one record, one erase, 4 playback heads and FG servomotor drive; produces up to 15 echo, 75 different repeat echo, reverb, echo/reverb, repeat echo/reverb, sound-on-sound, swell reverb effects. Features mic and instrument input controls; 9 modes of echo sound; repeat rate; reverb effect; sound-on-sound; 3-position tone switch, VU meter, 3-position reverb/echo blend switch, 4 footswitch jacks and 2 output jacks. Wow and flutter 0.15%; delay time 100-800 msec; 17"W \times 12"D \times 6 1/4"H \$730

MXD-5 Analog Delay Line

Echo delay line uses spring reverb with 20-to-200-msec range. Features include selective impedance matching in inputs and outputs to provide compatibility with almost any instrument, microphone, amplifier, recording console, PA mixer; LED indicators for monitoring input signal and overload; separate outputs for echo and direct- and echo-sound mix; 0/-20/-40-dB output level selector; jacks for optional footswitch. Size is 19"W \times 8"D \times 3 1/4"H; about 8 lb ... \$400

MXR

140 System Preamp

Control preamp combines functions of preamp, mixer, patch bay; can process 2 independent programs simultaneously. Features front-panel instrument input, 2 tape loops, 2 processor loops, integral headphone amplifier with independent level and selection controls, left mono, right mono, stereo reverse switching, RIAA equalization ± 0.2 dB; phono S/N ratio 87 dB; phono S/N 87 dB; phono gain 40 dB at 1 kHz; THD and IM distortion 0.005%; maximum signal output +18 dBV; rear-panel ac convenience outlet; black anodized extrusion with solid walnut end pieces; optional rack-mount ears available; 19" \times 3 1/2"H \$500

150 System Preamp II. Same as System Preamp, except includes second RIAA phono preamp, allowing independent selection of 2 turntables \$550

128 One-Third Octave Equalizer

31-discrete-band one-channel 1/3-octave equalizer with center frequencies at 20, 25, 31.5, 40, 50, 63, 80, 100, 125, 160, 200, 250, 315, 400, 500, 630, 800, 1k, 1.25k, 1.6k, 2k, 2.5k, 3.15k, 4k, 5k, 6.3k, 8k, 10k, 12.5k, 16k, 20k Hz and ± 12 -dB boost/cut range; EQ in/out switch; dynamic range 108 dB; THD 0.01% at 0 dBV (20-20,000 Hz) 0.009% at 0 dBV (1 kHz); IM distortion 0.01% at 0 dBV (60 Hz/7 kHz, 4:1); frequency response 10-20,000 Hz +0/-1 dB; maximum slew rate 7 V/ μ sec; max. input level +18 dBV; input impedance 20k ohms; output impedance 100 ohms; equivalent input noise -90 dBV; optional rack mount ears available; walnut side panels. \$386

127 Fifteen-Band Stereo Equalizer

Fifteen-band stereo graphic equalizer with bands spaced 1/3-octave apart and center frequencies at 25, 40, 63, 100, 160, 250, 400, 630, 1k, 1.6k, 2.5k, 4k, 6.3k, 10k, 16k Hz and ± 12 -dB boost/cut range; tape monitor and in/out switches; THD 0.02% at 0 dBV from 20-20,000 Hz, 0.009% at 0 dBV (1 kHz); IM distortion 0.01% at 0 dBV (60 Hz/7 kHz, 4:1);

frequency response 20-20,000 Hz, 0.009% at 0 dBV (1 kHz); IM distortion 0.01% at 0 dBV (60 Hz/7 kHz, 4:1); frequency response 20-20,000 Hz +0/-1 dB; maximum input +18 dBV; input impedance 20k ohms; output impedance 100 ohms; equiv. input noise -95 dBV; maximum slew rate 7 V/ μ sec; optional rack mount ears available; walnut side panel \$360

132 Dynamic Expander

Linear dynamic expander provides up to 8 dB of upward expansion and 21 dB of downward expansion. Features release time control; adjustable expansion control (1:1 to 1.6:1); LED gain change and noise-reduction display; level control; in/out, monitor/normal, pre/post switching. Maximum input level +12 dBV; maximum output +18 dBV input impedance 40k ohms; output impedance 100 dB; maximum slew rate 7 V/ μ sec; frequency response 20-20,000 Hz +0/-1 dB; attack time 5 msec maximum (depending on program material); release time variable between 50-500 msec; optional rack-mount ears available \$327

147 Ten-Band Stereo Octave Equalizer

Vertical format, 10-band, 2-channel graphic equalizer with center frequencies at 31, 62, 125, 250, 500, 1k, 2k, 4k, 8k, 16k Hz. Independent left and right level controls; switchable subsonic filter; complete tape monitoring facilities with ability to preequalize when recording; bypass switch control range ± 12 dB; maximum input/output level +18 dBV; input impedance 20k ohms nominal; output impedance 100 ohms; equivalent input noise -95 dBV; maximum slew rate 7 volts/ μ sec; THD 0.02% at 0 dBV (20-20,000 Hz), 0.009% at 0 dBV (1 kHz); IM distortion 0.009% at 0 dBV (60 Hz/7 kHz, 4:1); frequency response 20-20,000 Hz +0/-1 dB; 19"W \times 3 1/2"H; solid-walnut end pieces; optional rack-mount ears available \$230

114 Stereo Graphic Equalizer

Ten-band 2-channel graphic equalizer with center frequencies at 31, 62, 125, 250, 500, 1k, 2k, 4k, 8k, 16k Hz; 8 rear-panel phono jacks; 2 inputs, 2 low-impedance outputs, 2 tape-record outputs, 2 tape-monitor inputs; 2 switches control tape monitor function and equalizer bypass. Dynamic range 110 dB; boost/cut range ± 12 dB gain; unity ± 1 dB (controls centered); maximum output level +18 dBV (10k ohms); input impedance 20k ohms; equivalent input noise -95 dBV; frequency response 20-20,000 Hz ± 1 dB at 0 dBV; THD 0.05% at 0 dBV (20-20,000 Hz), 0.009% at 0 dBV (1 kHz); IM distortion 0.05% at 0 dBV (60/7000 Hz, 4:1) \$200

119 Componder

Can be used with open-reel and cassette decks. Dynamic range 100 dB; output impedance drives 600 ohms or greater; equivalent input noise -88 dBV (20-20,000 Hz); input impedance 100k; compress/expand ratio 2:1, tracking accuracy ± 1 dB per 20 dB; frequency response 30-20,000 Hz ± 1 dB at 0 dBV, 3 dB down at 20 Hz and 40 kHz; THD 0.15% at 0 dBV (200 Hz-20 kHz), 0.75% at 0 dBV (50-200Hz); IM distortion 0.75% at 0 dBV (60Hz/7 kHz, 4:1); level match control; bypass switch; black anodized aluminum housing with walnut side panels \$164

153 Five-Band Equalizer

Two-channel equalizer with center frequencies at 50, 100, 200, 2k, and 10k Hz. Independent left and right level controls with LED level set indicators; subsonic filter; tape-monitor and equalizer bypass switches; boost/cut range ± 12 dB; maximum input/output level +13 dBV; input impedance 20 kohms nominal; output impedance 100 ohms; equivalent input noise -95 dBV (20-20,000 Hz), 0.005% at 0 dBV (1 kHz); IM distortion 0.005% at 0 dBV (60 Hz/7kHz, 4:1); frequency response 20-70,000 Hz +0/-3 dB; sloping console design with solid wood end pieces \$150

NAKAMICHI

High-Com II Noise-Reduction System

Designed to improve dynamic range of high-quality cassette decks; compressor/expander with 2 independent frequency bands and 2:1 ratio for maximum



SIGNAL PROCESSORS

suppression of noise pumping; 20-dB reduction of noise plus 3-7 dB headroom improvement; built-in 400-Hz calibration tone; wide-range peak level meters; defeatable subsonic and multiple filters; removable 19" rack mount adaptors \$480

NR-200 Noise-Reduction System

Dolby-C noise-reduction system designed to be used with any high-quality tape recorder. Rack-mountable system has its own power supply; peak-responding LED recording-level meters; left, right, master recording-level controls; output control; calibration oscillator; MPX filter; and switch for choosing between Dolby B and C processing. Features encoder and decoder sections for true off-tape monitoring with 3-head cassette decks. Noise reduction Dolby B/C 10 dB beyond 2 kHz/20 dB 2k-8k Hz; frequency response 20-20,000 Hz ± 1 dB; THD < 0.1% (400 Hz, 0-dB level); power consumption 20 W; 19"W \times 10³/₁₆"D \times 2¹/₁₆"H; 12 lb 2 oz \$450

NR-100 Noise-Reduction System

Dolby-C noise-reduction processor designed for use with Nakamichi 7007XE, 700ZXL, 1000 ZXL cassette decks. Can be used without recorder recalibration and is selected by setting noise-reduction switch on cassette deck to EXT. Provides 4 channels of NR (both stereo channels in record and playback); noise reduction approximately 18 dB at 1 kHz, 20 dB 2k-8k Hz; power supplied by remote-control socket on recorder; 9⁷/₁₆"D \times 4²/₃₂"W \times 1¹/₂"H; cable length 27¹/₂" \$230

NIKKO

EQ-1 Graphic Equalizer

Ten-band stereo graphic equalizer (± 12 -dB boost/cut range) with detented 5-step boost/cut slider controls. Center frequency bands 31.5, 63, 125, 250, 500, 1k, 2k, 4k, 8k, 16k Hz; tape monitor switch; equalizer gain switch (-6/0/+6 dB); pre + post EQ and tape monitor switch; LED equalizer in/out switch; LED power switch. Frequency response 10-50,000 Hz ± 1 dB; THD 0.007%; S/N ratio 105 dB IHF A weighted; 19"W \times 9"D \times 3¹/₂"H \$320

EQ-2 Graphic Equalizer

Six-band stereo graphic equalizer with center frequencies at 40, 125, 400, 1.25, 4k, 12.5k Hz and ± 12 dB boost/cut range. Features tape monitor switch; EQ in/out with LED; 12-position EQ slider control; power-on with LED. Frequency response 10-50,000 Hz ± 1 dB; THD 0.05%, 20-20,000 Hz IHF A weighted; input impedance 100k ohms; output level/impedance 1 V, 5 V/560 ohms; gain 0 dB; rack mountable \$210

ATD-1 Time Delay Synthesizer

Designed to be used in audio systems where delay is piped through its own amplifier and speaker systems but operates successfully with single amplifier/speaker systems. Features 3 separate Hall Size controls for up to 15 different time delays; 5 Reverberation controls; 3 Hall Character controls to combine time-delayed signals for multiple-reflection effect; Stage Distance control; front-panel input level control with 5-step LED peak-level indicator; output-level control; Tape Mode button for mixed or discrete recording of direct and time-delayed signals; rear-panel terminals for connection to preamp tape-out terminals; rear-panel tape-in/out terminals for direct connection to tape deck; Delayed output to second amplifier; Main output for single amplifier/receiver systems. Delay time 27-135 msec large, 18-88 msec mid, 13-64 msec small; reverberation at 500 Hz 0.2-2 sec large, 0.2-1.5 sec mid, 0.1-1 sec small; input/output level 0.1 V/2-3 V; frequency response 20-20,000 Hz ± 0.1 dB main, 20-5000 Hz ± 3 dB delayed; THD 0.02% main (20-20,000 Hz), 0.6% delayed (500

Hz); unweighted S/N ratio 80 dB main, 60 dB delayed; 19"W \times 13"D \times 2¹/₂"H; 11 lb \$350

JC PENNEY

3032 Stereo Graphic Equalizer

Five-band graphic equalizer with equalizer position switch for record out/source. Features tape monitor; variable range controls and indicators; level control; tape recorder output, tape playback, source input/output jacks. Center frequencies 63, 240, 1k, 4k, 26 kHz; boost/cut range ± 12 dB; THD 0.02%; S/N ratio 95 dB; frequency response 5-100,000 Hz -3 dB; gain 0 dB; input sensitivity 0.5 V; rated output 0.5 V, 20-20,000 Hz at 0.02% THD; maximum output 6 V, 20-20,000 Hz; 16³/₈"W \times 10"D \times 3¹/₄"H .. \$160

PIONEER

SG-9 Stereo Graphic Equalizer

Graphic equalizer with ± 10 -dB EQ range in each of 12 channels (center frequencies at 16, 32, 64, 125, 250, 500, 1k, 2k, 4k, 8k, 16k, 32k Hz), using slide-type controls. Rated THD 0.006% 20-20,000 Hz with all controls flat, 1-V output. 16¹/₈"W \times 14"D \times 5¹/₄"H; 15.5lb \$395

SG-3 Stereo Graphic Equalizer

Seven-band stereo graphic equalizer with slide controls and LED indicators. Center frequencies 60, 150, 400, 1k, 2.4k, 6k, 15k Hz; boost/cut range ± 10 dB; THD 0.005% ± 1 dB at 1 kHz, 1-V output... \$180

SG-300 Stereo Graphic Equalizer

Seven-band graphic equalizer with center frequencies at 60, 150, 400, 1k, 2.4k, 6k, 15k Hz; boost/cut range boost/cut range ± 10 dB; THD 0.005% ± 1 dB at 1 kHz, 1-V output \$180

SR-9 Reverberation Amplifier

Reverberation unit with reverb on/off/record mode selector and 2 tape monitors. Reverb time 0-3.0 seconds at effect 1400 Hz; THD 0.05% at 1 kHz, volume control at minimum, 1-V output; S/N ratio 90 dB \$200

RG-9 Dynamic Range Expander

Unit features fluoroScan meter and indicators, dynamic processor on/off switch, input level control. Dynamic expansion 4, 7, 10, 13, 16 dB; impulse response attack/release time 0.3 msec/120 msec; THD 0.05% at 1 kHz, 16 dB expansion; S/N ratio 116 dB at 6.5 V output, 1 kHz at 16 dB expansion .. \$200

RG DYNAMICS

PRO-20 Dynamic Processor

Stereo dynamic processor designed to boost power, reduce noise, restore transient response, eliminate tape hiss, reveal details, enhance FM reception, improve phonograph record sound reproduction. Features input level control; maximum/minimum noise reduction, tape monitor on/off, tape on/off and main on/off dynamic processing switches; 4-20 dB dynamic processing control; dual 4-20 dB LED level displays. Total dynamic processing range 20 dB; downward processing range -3 to -8 dB; upward processing range 0 to +12 dB; attack/decay time 0.6 msec/80 msec-3 sec (program controlled); maximum output level/impedance 6.5 V/50k ohms at 1 kHz; minimum input signal 80 mV; THD 0.04% at 1 kHz, 1 V output, maximum processing; IM distortion 0.05% at 60 and 2k Hz, mixed 1:1; hum and noise maximum/minimum processing -90/-100 dB below 1 V output; frequency response 20-20,000 Hz ± 1 dB; input/output impedance 80k/300 ohms; power consumption 3 W; 17"W \times 12"D \times 3¹/₂"H; optional 19"W rack-mount version available... \$449

RG X-15 Dynamic Processor

Stereo dynamic signal processor similar to PRO-20 except over narrower control range. Features main output and tape recorder process/bypass switches; tape monitor in/output switch; 6-15-dB dynamic processing control; dual 6-15-dB LED level displays. Total dynamic processing range 15 dB; downward processing -6 dB; upward processing 0 to +9 dB; attack/decay time 0.6 msec/80 msec to 3 sec (pro-

gram controlled); maximum output signal level/impedance 6 V/50k ohms at 1 kHz; minimum input signal level 80 mV; nominal input signal level 200 mV; THD 0.12% at 1 kHz, 1 V output, maximum processing; IM distortion 0.12% 60 and 2k Hz mixed 1:1, 1 V output; hum and noise maximum/minimum processing -90/-100 dB; frequency response 20-20,000 Hz ± 1 dB; input/output impedance 100k/300 ohms; power consumption 3 W; 13³/₈"W \times 9"D \times 2¹/₄"H \$279

ROTEL

RE-1010 Stereo Graphic Equalizer

Ten-band stereo graphic equalizer with center frequencies at 32, 63, 125, 250, 500, 1k, 2k, 4k, 8k, 16k Hz and ± 12 dB boost/cut range. Features inductorless circuitry, 2 tape monitors with dubbing, EQ record function, bypass switch. Frequency response 15-45,000 Hz +0/-1 dB; HD 0.009%, 20-20,000 Hz, 1 V; input sensitivity/impedance 1.0 V/

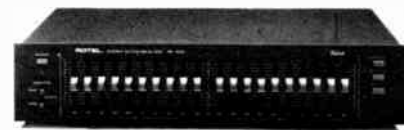

50k ohms (line and tape monitor 1 and 2); output sensitivity/impedance 1.0 V/600 ohms (line and tape monitor 1,2); hum and noise -108 dB; 16¹/₈" \times 11¹/₃₂"D \times 3²/₃₂"H \$200

RE-500 Stereo Graphic Equalizer

Seven-band stereo graphic equalizer with center frequencies at 40, 125, 400, 1k, 2.5k, 6k, 15k Hz and ± 12 dB boost/cut range. Features tone defeat and tape monitor switches. Frequency response 10-100,000 Hz +0/-2 dB; harmonic distortion 0.009%; S/N 100 dB; input sensitivity/impedance 0.775 V/55k ohms; output sensitivity/impedance 0.775 V/600 ohms; 16¹/₈"W \times 10"D 3¹/₈"H \$150

RN-560 Dolby B/C NR System

Dolby B/C noise-reduction system designed to provide as much as 20 dB of noise reduction to tape recordings. Features 400-Hz test tone circuit for accurate calibration; MPX filter; record and play level controls; LED peak level indicators; record and play LED indicators; recording (air) check switch. Can be adapted to all existing stereo cassette decks. Distortion 0.03% (400 Hz, bypass); input sensitivity/impedance 30 mV/30k ohms line, 30 mV/50k ohms record (from deck); output level/impedance 580 mV/100 ohms both line and record (from deck); frequency response 20-20,000 Hz ± 1.5 dB; 18¹/₂"W \times 12³/₃₂"D \times 4²/₃₂"H; 6.6 lb \$250

SAE

2800 Stereo Parametric Equalizer

Four-band parametric equalizer with control over cut/boost plus bandwidth frequency; separate controls for each channel; input level controls and peak indicators; tape equalization facilities for preequalized tape recordings; control functions are divided into 4 frequency bands (LO, LO-MID, HI-MID, HI); continuously variable frequency adjustment within each band covering 10-320 Hz, 40-1200 Hz, 240-7600 Hz, 1200-15,000 Hz; each band has slider control that adjusts gain over ± 16 dB range, detent at center (0-dB) setting; bandwidth adjustment is slider control calibrated in octaves from 0.3-3.6; each channel has master-level control that provides up to 70 dB of attenuation. Maximum output before clipping 9 V into 10,000 ohms; input impedance 100k ohms; output impedance 500 ohms; nominal rated output 2.5 V; frequency response (controls at flat) 20-12,000 Hz ± 0.25 dB; clipping level 8.5 V at 1 kHz; THD 0.01% at 2.5 V, 0.028% at 8.5V; -0.9 dB gain; front panel 19" \times 8¹/₄"H; chassis depth 3¹/₂" \$700

1800. Two-band version of 2800 with 10 band covering 40-1200 Hz and hi covering 1200-20,000 Hz; 19"W \times 5.25"H \times 3.5"D \$400

180 Parametric Equalizer

Two-band stereo parametric equalizer with adjustable bandwidth (0.3-3.6 octaves) and center frequency in each control group. Features tape equalization facilities and level match controls. Frequency response 20-20,000 Hz ± 0.25 dB; THD and IM distortion 0.02%; S/N ratio 90 dB; $17\frac{1}{2}''W \times 4\frac{3}{4}''D \times 3\frac{1}{2}''H$ \$300

5000A Click and Pop Filter

Filter designed to eliminate or considerably reduce audible effects of scratches, grit, mistracking, static, imperfections, normal wear of records during normal play and tape recording. Frequency response 20-20,000 Hz ± 1 dB; S/N ratio >96 dB; THD and IM distortion <0.1%; $10\frac{3}{4}''W \times 9\frac{1}{4}''D \times 3''H$; 8 lb \$225

SANSUI

SE-9 Graphic Equalizer

Microprocessor-controlled stereo graphic equalizer with unique motorized fader-setting system, 4-curve memory storage, spectrum-analyzer display, built-in pink-noise generator, external electret condenser microphone. All 16 (8 bands \times 2 channels) frequency controls are dual slide potentiometers, one section boosting/cutting its band by ± 12 dB, the other producing sliders. Using automatic adjustment procedure, fader-to-fader interaction is minimized. Auto-



matic setup procedure requires 30 seconds overall. Left/right frequency spectra shown on a display calibrated in 3-dB increments over a 24-dB range. Under and over LEDs warn of out-of-range conditions. Features 2-way dubbing, 2-deck monitoring facilities. Center frequencies 80, 160, 315, 630, 1.25k, 5k, 10k Hz; in/out level 1 volt with flat control settings; THD 0.008%; frequency response 10-10,000 Hz $+0/-1$ dB; S/N ratio 105 dB; input/output impedance 30k/600 ohms.

SE-9B. SE-9, brushed-aluminum front panel... \$700
SE-9B. SE-9, matte black front panel and rack-mounting hardware \$700

SE-7B Graphic Equalizer

Ten-band graphic equalizer with center frequencies at 32, 63, 125, 250, 500, 100, 2k, 4k, 8k, 16k Hz, ± 12 -dB boost/cut range. Features 2-deck tape monitoring and dubbing; stereo output level control; equalizer defeat/on/record controls. Frequency response 10-100,000 Hz $+0/-1$ dB; THD 0.08%; hum and noise -110 dB; matte black finish; $19''W$ (with detachable handles for rack mounting) $\times 11\frac{1}{4}''D \times 6\frac{3}{8}''H$ \$300

SE-7S. Same as SE-7B but with brushed aluminum finish faceplate and rosewood cabinet; $17\frac{1}{16}''W \times 11''D \times 6\frac{3}{16}''H$ \$300

GR-7 Stereo Graphic Equalizer

Ten-band graphic equalizer with reverberation amplifier and 2-channel microphone/guitar mixer. Features reverb display; panpots; level controls. THD 0.05%, 20-20,000 Hz; input sensitivity/impedance 150 mV/47k ohms source and tape; 0.8 mV/10k ohms mic 1 and 2, 9 mV/100k ohms guitar; output level/impedance 150 mV/47k ohms; equalizer boost/cut range ± 12 dB, 30-16,000 Hz; reverb echo time 0-3 seconds (-60 dB); duet time 20-40 msec; $16\frac{1}{16}''W \times 9''D \times 3\frac{3}{8}''H$; 7.3 lb \$260

SANYO

PLUS N33 Noise-Reduction System

Super D noise-reduction system uses companding scheme. Features a phase-compensated band-splitting filter; Decliner 2:1 compansion; optimized level sensing; mic/line mixing; fluorescent peak-indicating signal level meters; MPX filter. Dynamic range 100 dB; frequency response 10-30,000 Hz ± 1 dB; THD

0.08% at rated output, 1 kHz; noise reduction 40 dB maximum using a tape deck with 50-dB minimum S/N ratio; mic level/impedance 0.3 mV/400-10,000 ohms; record/play line input level/impedance 100 mV minimum/50k ohms; encode output level/impedance 80 mV/2k ohms; decode output level/impedance 530 mV/2k ohms; $17\frac{3}{8}''W \times 10\frac{3}{4}''D \times 1\frac{3}{4}''H$ \$300

H.H. SCOTT

852Z Stereo Graphic Equalizer

Ten-band stereo graphic equalizer with center frequencies at 32, 64, 125, 250, 500, 1k, 2k, 4k, 10k, 15k Hz with ± 12 -dB boost/cut range. Features 13 dual low-noise operational amplifiers; advanced variable active bandpass/bandstop filters; equalizer bypass switch; tape monitor switch. Frequency response 10-45,000 Hz ± 0.5 dB; THD 0.01% at 1 V output; S/N ratio 87 dB IHF-A; input impedance 50k ohms; output impedance 300 ohms; optional 19" rack mount; $17''W \times 10''D \times 3.5''H$ \$275

SHURE

SR107 Audio Equalizer

Ten-octave equalizer with rotary controls supplying 15-dB boost or cut at 31, 63, 125, 250, 500, 1k, 2k, 4k, 8k, 16k Hz; 15-dB master level control; LED overload indicator; 20-dB additional adjustable gain; bypass switch; balanced/unbalanced line input; balanced microphone output; balanced/unbalanced aux-level output; 19" (for rack mounting) $\times 8\frac{1}{2}''D \times 1\frac{3}{4}''H$; 120 V ac, 50/60 Hz, 6 W \$320

M63 Audio Master*

Combination equalizer, noise reducer, dynamic-range enhancer/compressor system. Features 2 high-level inputs and 5 outputs (high-impedance, high-level microphone, high-impedance microphone, low-impedance microphone, 600-ohm balanced line, headphone); high-pass and low-pass (6-dB/octave) filters; separate bass and treble boost/cut controls; output VU meter; power requirements 120 V ac, 50/60 Hz, 3 W; $11\frac{1}{4}''W \times 7''D \times 2\frac{1}{4}''H$ \$210

M610 Feedback Controller

Ten-band, cut-only equalizer with 8 linear potentiometers and 2 slide switches; high/low-impedance 3-pin input and output connectors; phono-jack aux-level input and output; bypass switch; master volume control; 120 V ac, 50/60 Hz, 3 W; $12''W \times 7''D \times 2\frac{3}{4}''H$ \$214

SOUND CONCEPTS

SD550 Ambience Restoration System

Dual-channel audio delay system; continuous delay variation from 50 to 100 msec; continuous reverb variation from 0 to 100%; high frequency rolloff from -3 to $+6$ dB; front mix level from 0 to 100%, rear level 0 to 100%; 50 or 100 msec delay range; rear output delay or quad direct; front output direct or delay mix; input front or quad rear; input impedance 60k ohms minimum; output impedance 300 ohms maximum; frequency response 20-10,000 Hz $+1/-3$ dB with 5 msec delay and 0 dB high frequency rolloff; dynamic range 90 dB minimum; S/N ratio 85 dB minimum, 90 dB weighted; 1% maximum distortion at 1 kHz and 1 V rms, consisting almost entirely of 2nd harmonic; $15\frac{1}{2}''W \times 9''D \times 3\frac{1}{2}''H$ \$739

IR2100 Image Restoration System

Expands stereo image beyond confines of space between speakers to reproduce sonic image presented to recording microphones; loudspeaker/listener angle continuously adjustable $20^\circ-100^\circ$; continuous adjustment of perimeter to central sound level balance; master volume control; connects in tape loop or between preamp and power amplifier; S/N ratio 80 dB; distortion 0.1% maximum; handheld with 15-ft remote cable; $6''H \times 3''W \times 1.5''D$ \$249
IR2200. Similar to IR2100 but limited to fixed listening angle of 40° and without master level control. Stand-alone unit has front-panel selection of bypass, tape/source switch, tape/direct switch with front-panel imaging control. S/N ratio >80 dB; distortion 0.1% maximum; unity gain; $7''W \times 3\frac{3}{4}''D \times 2''H$ \$169

SOUNDCRAFTSMEN

CX4200 Preamp/Equalizer

Dual-channel 10-band graphic equalizer/preamplifier with built-in CX disc decoder circuitry. Equalizer features Differential/Comparator* true unity gain circuitry for accurate (within 0.1 dB) output balancing crucial to handling high dynamic range material without reducing headroom; precision-wound passive coil inductors in filters for ± 15 dB gain in each octave and lower noise; THD and IM <0.01% at 2 V output; S/N ratio 114 dB at 10 V output. Preamp features 4 independent mono (2 stereo) preamps, each with variable ± 12 dB gain adjustments; moving-coil, moving-magnet, variable-reluctance cartridge inputs with 0.28-300 mV output; cartridge loading adjustable from 50 to 800 pF. Versatile signal-processor patch bay with subsonic filter, signal processor loop, equalizer, CX decoder, mono switch. Three tape decks can be accommodated with cross-dubbing. Frequency response 5-100,000 Hz ± 0.25 dB high-level, 20-20,000 Hz ± 0.5 dB phono; THD and IM 0.01% at 1 V output; phono impedance switchable 47k/100 ohms; phono S/N ratio 97 dB. Includes CX calibration and Frequency Spectrum Analyzer test record; brushed-aluminum, rack-mount, charcoal-finish front panel; hardwood side panels optional \$699
CX4100. Same as CX4200 but without phono gain and cartridge loading; equalizer filter circuits utilize op-amp synthesized inductors; equalizer controls have 12-dB boost/cut range \$549
CX4000. Same as CX4100 except no equalizer \$419

AE2000 Real-Time Analyzer/Equalizer

Differential/Comparator* analyzer/equalizer with readout accuracy of 0.1 dB combined with 100-LED



(10-octave) real-time display with adjustable decay rate and 2-channel 10-band graphic equalizer. Equalizer features precision wire-wound inductors for highest gain, lowest noise, lowest distortion. Analyzer has built-in pink noise generator and Auto-Scan mode with adjustable sweep rate from 0.1 to 10 seconds/octave. THD and IM <0.01% at 2 V output; S/N ratio 114 dB at maximum output; equalizer boost/cut range ± 15 dB; 47k-ohm high-level input for analysis

NOTICE TO READERS

Prices of items described are suggested prices only and are subject to change without notice. Actual selling prices are determined by the dealer.

of 3-head cassette deck or other signal processor; microphone preamp input impedance 2k ohms; frequency response 20-20,000 Hz ± 0.1 dB. Brushed-aluminum rack-mount front panel; hardwood side panels optional \$699
AS1000 Auto Scanner. Same as AE2000 but minus equalizer..... \$549
AE2420 Analyzer/Equalizer. Same as AE2000 but without 100-LED display and Auto Scan mode. \$499

TG3044 Third-Octave Equalizer

Third-octave stereo equalizer with 21 controls/channel: 15 center frequencies set at 40, 50, 63, 80, 100, 125, 160, 200, 250, 315, 400, 500, 630, 800, 1k Hz on $\frac{1}{2}$ -octave centers and 6 center frequencies set at 1.6k, 2.5k, 4k, 6.3k, 10k, 16k Hz on alternate $\frac{1}{2}$ octaves. Features pushbutton equalizer defeat, subsonic filter, tape monitor, tape record; Differential/Comparator circuitry for true unity-gain setting within 0.1 dB accuracy for highest dynamic range capability. THD and IM distortion 0.01% at 2 V output; S/N ratio 114 dB at 10 V output; input impedance 47k ohms. Rack-mount black anodized aluminum front panel \$649

DC2215 Differential/Comparator® Equalizer

Two-channel, 10-band equalizer with Differential/Comparator unity-gain circuit for accurate output balancing within 0.1 dB for widest dynamic range capability without reducing headroom. Features precision wire-wound passive coil equalizer filters for highest gain, lowest noise, lowest distortion; tape monitor, LED defeat/EQ defeat controls, EQ tape record controls. THD and IM distortion <0.01% at 2 V output; S/N ratio 114 dB at 10 V output; boost/cut range ± 15 dB. Includes Frequency Spectrum Analyzer Test record, Computone charts, cables; charcoal-finished brushed-aluminum rack-mount front panel; genuine hardwood end panels optional \$399

DC2214. Same as DC2215 except equalizer filter circuits use op-amp synthesized inductors; THD and IM distortion <0.01% at 2 V output; S/N ratio 106 dB at 10 V output; boost/cut range ± 12 dB \$299
SE540. Same as DC2214 but without Differential/Comparator circuitry; front panel available in silver or black with vinyl finish; not rack-mountable \$249

SUPEREX

GE-1 Graphic Equalizer

Five-band stereo graphic equalizer module with center frequencies at 60, 240, 1k, 3.5k, 10k Hz and 12 dB-boost/cut range. Features 2-deck switching with tape record/play EQ and tape monitor controls; programmable capability with optional Superex program cards. Frequency response 10-150,000 Hz ± 0.5 dB; HD 0.02% at 0 dB gain; rated output 2 V rms; dynamic range 8.5 V; S/N ratio 92 dB; input impedance 50k ohms; output impedance 600 ohms \$90

GE-2 Graphic Equalizer

Provides equalization control at the important high and low ends (high treble and deep bass) and midhigh range. Each stereo channel has 5 controls with center frequencies at 38, 68, 240, 1.6k, 15k Hz. Features exclusive 3 tape function system to permit recording with equalization, playing back with equalization, tape monitoring. Frequency response 10-150,000 Hz ± 0.5 dB; maximum gain/attenuation ± 14 dB; gain at flat setting 0 dB; distortion at 1 kHz 0.02% at 0 dB gain; output 2 V rms; dynamic range 8.5 V rms (flat settings); S/N ratio 92 dB at rated output; input/output impedance 50k/600 ohms; inputs EQ in, tape play; outputs EQ out, tape record \$120

GE-3 Graphic Equalizer

Ten-band stereo graphic equalizer with center frequencies at 31, 63, 125, 250, 500, 1k, 2k, 4k, 8k, 16k Hz and ± 14 -dB boost/cut range. Has separate

volume and balance slide controls and on/off monitor switch. Frequency response 20-20,000 Hz ± 0.5 dB; HD 0.04%; S/N ratio 85 dB; input impedance 68k

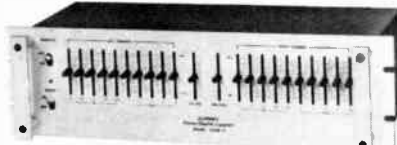

ohms; output impedance 600 ohms; rack mountable \$240

GE-4 Varigraphic Equalizer

Stereo bi-FET equalizer with variable center-frequency potentiometers that provide parametric-like control, true EQ curve modifier, total tape-recording flexibility with switching facilities for EQing during recording and/or playback. Features 5 and 5 controls/channel with frequencies at 33-78 Hz, 110-260 Hz, 470-1.1k Hz, 1.9-4.5kHz, 6.8-16 kHz; boost/cut range ± 2 dB; THD <0.01% at 1 kHz; S/N ratio 94 dB IHF A weighted; input/output impedance 100k/100 ohms; output 6 V rms maximum with 10k-ohm load; gain unity (0 dB) in flat positions; center Q 2.5; power consumption 3 W; 19"W \times 7.4"D \times 5.3"H; 11 lb \$210

GE-7 Parametric Equalizer

Stereo parametric equalizer with each channel having 4 separate EQ sections, each section incorporating separate frequency and bandwidth level controls. Variable-frequency controls on each channel are logarithmically paired. Features bi-FET technology; complete tape deck switching capability with separate switching for recording with EQ, playing back with EQ, and conventional monitoring function; handles and standard front-panel rack-mounted notches. Frequency selection continuously variable 30-820 Hz and 820-16k Hz; boost/cut range ± 18 dB (± 36 dB possible with 2 bands set for identical frequency), continuously variable; bandwidth 0.16-2 octaves, continuously variable; frequency response 5-100,000 Hz ± 2 dB with controls flat; THD <0.01%; IM distortion <0.005%; S/N ratio 89 dB IHF A weighted; input joutput impedances 50k/100 ohms; output 6 V rms max. with 10k load; gain 0 dB controls flat; power consumption 3 W; 19"W \times 7.4"D \times 5.3"H; 11 lb \$450

TAPCO

4400A Reverb System

Two-channel reverb system features 4-band reverb equalizer/channel, input mute, reverb mix controls, reverb in/out switches, input and output level controls, dual VU meters. Can be connected at mixer output, with channel patching or effects bus; inputs and outputs unbalanced. Frequency response 10-25,000 Hz; S/N ratio 80 dB; THD and IM distortion 0.05% \$495

TEAC

GE-20 Graphic Equalizer

Ten-band/2-channel graphic equalizer with center frequencies at 31.5, 63, 125, 250, 500, 1k, 2k, 4k, 8k, 16k Hz and ± 10 -dB boost/cut range. Each channel has 12 dB/octave high- (at 31.5 Hz) and low-pass (at 16k Hz) filters; input level control; LED input overload indicator. Features output level meter with output level control; operational amplifier-synthesized inductors. Frequency response 20-30,000 Hz ± 0.5 dB; THD 0.03%; S/N ratio 85 dB; input sensitivity/impedance 0.3 V, unbalanced/100k ohms; maximum output level +18 dB at 8V \$350

TECHNICS

SH-8065 Stereo Graphic Equalizer

Stereo unit with 33-band equalization that divides audio spectrum into $\frac{1}{2}$ -octave bands. Features low-noise semiconductor circuitry; dual selectable boost/cut ranges; equalizer position switch for optimizing when

equalizer is installed in tape loop or between preamp out and power amplifier in; reversible frequency response with characteristics switch; equalizer on/off switch; tape monitor switch; parallel left- and right-channel alignment for easy comparison when performing stereo equalization. Maximum/rated output 10/1 V at 1 kHz; THD 0.0025%, 20-20,000 Hz; S/N ratio 110 dB IHF-A weighted; frequency response 5-50,000 Hz -1 dB; input sensitivity/maximum 1/10 V at 1 kHz; input impedance 47k ohms; gain 0 dB 1 dB; boost/cut range ± 3 dB/ ± 12 dB; center frequencies 16, 20, 25, 31.5, 40, 50, 63, 80, 100, 125, 160, 200, 250, 315, 400, 500, 630, 800, 1k, 1.25k, 1.6k, 2.0k, 2.5k, 3.15k, 4.0k, 5.0k, 6.3k, 8.0k, 10.0k, 12.5k, 16.0k, 20.0k, 25.0k; 430 mmW \times 330 mmD \times 153 mmX; 6.8 kg \$500

SH-8020 Stereo Frequency Equalizer

Twelve-band stereo octave equalizer with center frequencies at 16, 31.5, 63, 125, 250, 500, 1k, 2k, 4k, 8k, 16k, 32k Hz and ± 12 -dB boost/cut range, with LEDs on slide pots and ± 12 dB (green) and ± 3 dB (yellow) variable control range LED display with switch. Features switches for tape/source monitoring,

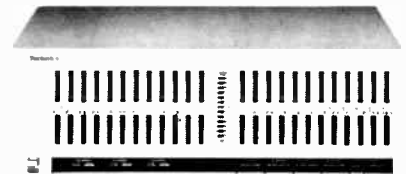

source/rec out EQ position, normal/reverse, EQ on/off with LEDs. Frequency response 5-100,000 Hz -3 dB; THD 0.01% from 20-20,000 Hz; S/N ratio 100 dB; input sensitivity/impedance 0.5 V/47k ohms; overall gain 0 dB ± 1 dB; 16 $\frac{1}{16}$ "W \times 9 $\frac{1}{32}$ "D \times 6 $\frac{1}{32}$ "H \$390

SH-8015 Graphic Equalizer

Stereo graphic equalizer with illuminated display that indicates the variable ranges. Features dual 5-band equalization for each channel (63, 240, 1k, 4k, 16k with Hz ± 12 -dB boost/cut range); equalizer on/off switch; equalizer position switch; tape monitor switch with LED indicator that permits monitoring signal source/tape deck output. Frequency response 5-100,000 Hz -3 dB; maximum output 6 V; THD 0.02%; input sensitivity 0.5 V; S/N ratio 101 dB IHF A weighted at 1 V output; overall gain ± 0 dB; output voltage 0.5 V at 0.02% THD; power consumption 12 W; 15 $\frac{1}{16}$ "W \times 10 $\frac{3}{32}$ "D \times 3 $\frac{3}{4}$ "H \$200

SH-8045 Stereo Graphic Equalizer

Dual-range, 12-band stereo equalizer with low-noise semiconductor circuitry. Features equalizer position switch; equalizer on/off switch; tape monitor switch; parallel left- and right-channel alignment for easy comparison when performing stereo equalization. Maximum/rated output 8/1 V at 1 kHz; THD 0.005%, 20-20,000 Hz; S/N ratio 108 dB (IHF'66); frequency response 5-70,000 Hz -1 dB; input sensitivity/impedance 1 V/47k ohms; maximum input 8 V at 1 kHz; gain 0 dB 1 dB; boost/cut range $\pm 3/\pm 12$ dB; center frequencies 16, 31.5, 63, 125, 250, 500, 1k, 2k, 4k, 8k, 16k, 32k Hz; 430 mmW \times 235 mmD \times 53 mmH \$200

SH-8030 Dimension Controller

New Space Dimension Controller with 5-band stereo equalizer, mixing capabilities, dimension display. Features slide-control equalizer section; microphone and program-source mixing facilities; effect position control for switching processor in and out of signal path; and 3-dimensional-effect dimension display with microphone and program-source mixing facilities; 3-dimensional-effect dimension display with peak-level scale. Frequency response 7-150,000 Hz $+0/-3$ dB line, 20-20,000 Hz RIAA ± 0.5 dB phono, 35-30,000 Hz -3 dB mic; THD line in at 150 mV output 0.005%; S/N ratio 80 dB IHF-A curve, line in; dimen-

(Continued on page 130.)

10

ACCESSORIES

ALLSOP

Allsop 3 Ultraline Cleaning System/Case

Designed to clean key components of auto-reverse cassette decks in 60-80 seconds. Features pop-out felt cartridges; large bottle of cleaning solution; replacement cartridges; tweezers. Stores in leather-look storage pouch \$15.95

Allsop 3 Cassette Deck Cleaner

Designed to clean pinch roller, capstan, heads of audio cassette decks in 20-40 seconds. Features 2 non-abrasive felt pads and ribbonless wiper arm. Includes cassette-sized cleaner and cleaning solution .. \$7.95
Refill Kit. Comprised of 3 large and 3 small non-abrasive felt pads, 1-oz bottle of cleaning solution \$2.95

Ultraline Refill Kit

Kit includes 4 pinch-roller and 2 head cartridges; large bottle of cleaning solution; tweezers \$7.95

Allsop 3 CHS VCR Cleaner

Cassette-format videocassette recorder cleaner cleans audio and video heads, pinch rollers, capstan in 4-6 seconds (shuts off automatically); designed for



VHS-format video recorders; has absorbent cleaning chamois and non-abrasive felt pads; includes cleaning solution \$29.95
Replacement cartridge with cleaning solution .. \$8.95

Allsop Beta VCR Cleaner

Beta-format videocassette recorder cleaner for audio, video, erase heads, pinch rollers, capstan. Cleans in 4-6 seconds; shuts off automatically; has absorbent cleaning chamois; includes cleaning solution. \$29.95
Beta replacement cartridge with cleaning solution \$8.95

R.B. ANNIS

Magnetometers & Demagnetizers

Model 25/S5. Deluxe jeweled pocket magnetometer with 5-0-5 gauss range; 2 1/2" diameter \$43.00
Model 20/B5. Standard pocket magnetometer similar to 25/S5 except no-jewel movement; 12" diameter \$11.60
Model K20/S5. Deluxe Han-D-Kit bulk tape eraser designed for 115-V ac, 50/60-Hz operation .. \$75.80
Model K20/B5. Standard version of K20/S5. \$45.20
Model 115. Han-D-Mag Audiophile demagnetizer designed for 115-V ac, 50/60-Hz operation .. \$29.70
Long Probe Han-D-Mag. Designed for 115-V ac, 50/60-Hz operation \$37.70

AUDIO CONTROL

C50A LED Realtime Analyzer

LED spectrum analyzer with pink noise generator and microphone. Features 101-LED spectrum display that shows fast/slow peak-indicating modes, sound pressure level with external mic or VU meter readings, pink noise, microphone analyses with switchable calibration levels from 2- to 4-dB/LED. Other features include continuously variable input level sensitivity with calibration; auto mic/line input switching .. \$399.00

AVANTI PRODUCTS

CC 6/60 Cassette Carrying Case

High-impact dark-blue cassette carrying case with translucent lid. Holds up to 10 cassettes. Packed with six 60-minute Ultra Low Noise boxed cassettes \$9.99

3WC 3-Way Case

Cassette storage case designed for easy mounting under vehicle dashboard, on wall, atop desk or cabinet. Portable carrier features retractable handle and foam-cushioned interior. Holds 12 cassettes .. \$6.49

BIB

Audiophile Edition

AE-309 Tape Head Demagnetizer

Designed to remove harmful build-up from tape recorder heads and guides. Recommended for use every 10 to 20 hours. Comes with 2 different-length removable probes \$21.95

AE-306 Tape Mending and Editing Kit

Designed to permit easy and accurate editing and repairing of 1/4" and 1/2" tapes. Tape splicer is fitted with specially designed clamps to hold tape securely in place while diagonal or butt splices are being made. Comes with nonmagnetic razor cutter, dispenser of high-quality splicing tape, easy-to-follow instructions \$9.95

AE-308 Cassette Spray'N'Clean

Consists of a special combination of materials for effective cleaning of cassette tape heads and tape path. Contains a nonabrasive cleaning cloth tape, tape-head cleaning fluid. Cleans heads and guides in 15 seconds \$7.95

AE-307 Fast Cassette Hand Winder

Enables user to rewind cassettes in as little as 45 seconds, saving wear and tear on tape transports and heads and conserving battery power in portable decks \$5.95

Videophile Edition

VE-3 Video Tape Eraser

Instantaneously erases recorded material from video tape; erasure capability -78 dB; thermal-protected circuit; generates powerful 2420-gauss magnetic

field that far exceeds that generated by VCR heads; fitted with safe thermal-protected circuit and red current indicator; comes with complete instructions for use \$49.95

VE-9 Video Tape Splicing Kit

Repairs broken video tape easily and accurately \$39.95

VE-11 Head Cleaning Cassettes

Removes harmful debris from tape path in 15 seconds; safe and nonabrasive; for VHS-format machines \$26.95

VE-12. Same as VE-11 except for Beta-format machines \$26.95

VE-6 Tape Head Demagnetizer

Demagnetizes heads and guides of all video recorders; off switch; comes with 2 removable probes \$24.95

VE-2A Video Maintenance Kit

Comprises 5 VE-5 cleaning tools, special formula tape head cleaning fluid, dust-away air blast, inspection mirror, antistatic cleaning cloth, maintenance manual for VHS- and Beta-format recorders; crosspoint screwdriver; permanent storage case \$23.95

VE-10 Video Recorder Maintenance Kit

Maintains VCR to professional standards. Packed in clear container same size as VHS cassette for convenient storage in standard videocassette box/cabinet. Comes with illustrated instructions for use with VHS and Beta VCRs \$13.95

VE-17A Videocassette Title Kit

Gives videocassette titles professional appearance. Kit contains 10 self-adhesive title card holders for edge of videocassette; 20 index cards; 10 self-adhesive cassette body card holders; 20 blank information cards; 2 sheets dry-transfer letters/numbers; print burnisher; full instructions for use \$9.95

VE-13A Video Lens Care Kit

Cleaning fluid, special brush with dust cap and antistatic cloth in handy carry-along wallet ... \$8.95

VE-15A Antistatic TV Screen Treatment

Retards attraction of dust and dirt by preventing static build-up on TV screen; removes smudges and fingerprints \$7.95

BIB Videocassette Storage Rack

Versatile, compact storage unit holds 10 VHS, Beta, or Philips-type videocassettes. Molded of strong, high-quality smoked plastic and supplied in nonslip self-adhesive protective feet. Can be used free standing or fixed with 2 screws to any vertical surface \$5.95

DISCWASHER

Video Head Cleaner

Dry, nonabrasive head cleaning system designed to

10

ACCESSORIES

clean components along entire VCR tape path, including video and audio tape heads that are usually untouched by other cleaning systems. Employs special fiber grid that safely removes tape oxides in 30 seconds. Available in Beta and VHS formats ... \$20.00

Perfect Path™ Head Cleaner

Designed to clean cassette heads in 15 seconds without fluids, using nonabrasive fiber grid. Simultaneously cleans heads and removes oxide build-up from tape path ... \$9.95

Perfect Path™ Capstan/Pinch Roller Cleaner

Cleaner works on all cassette decks. Uses nondestructive fluid that does not extract vital rubber stabilizers. Features Positive Drive system that ensures thorough pinch-roller cleaning ... \$10.95

Video cables

Two types of video cables are available: 75-to-75-ohm and 300-to-300-ohm version, both with F connectors. Designed to enhance and upgrade video signals ... \$10.95 ea

EV-GAME

Cleanmatic™ Video Head-Cleaning System

Nonabrasive cleaners can be used wet or dry. Specialized formulated cleaning ribbon and fluid. Available in VHS and Beta formats. Cleans and buffs video and audio heads, capstan, pinch roller. Supplied with bottle of cleaning fluid ... \$29.95

PIONEER

DT-510 Programmable Timer

24-hour programmable timer with fluorescent digital-numeric display. Slaved to ac power-line frequency. Functions: timer auto on/off, sleep timer, clock, seconds counter, service-interruption indicator. Features 2 accessory ac outlets with maximum power handling capacity 500 W ... \$120
DT-5. Similar to DT-510 ... \$120

REALISTIC

The company's tape accessory line is as follows:

44-232. Bulk tape eraser	\$15.95
44-215. Tape head demagnetizer	\$5.95
44-207. Illuminated head demagnetizer	\$13.95
44-1165. Electronic cassette demagnetizer	\$19.95
44-214. Cassette tape splicer	\$5.95
44-222. Tape recorder care kit	\$1.09
44-626. Cassette repair kit	\$3.95
44-1170. Cleaning swabs and 2-oz Freon head-cleaning solvent	\$2.99
44-612. Cassette storage album	\$2.99
44-209. Electronic cassette winder	\$9.99
44-280. 7" metal tape reel	\$6.95

RECORDER CARE/NORTRONICS

WM333 Splicer

Edits, repairs, adds leader to magnetic tape; designed for 1/4" open-reel, 8-track cartridge, cassette tapes; splits tape; has pop-out tape guide ... \$21.00

Professional Splicing Blocks

Grooved silver or gold anodized aluminum splicing blocks with 2 deep slits for straight and diagonal cuts; includes double-backed adhesive, and stainless-steel cutting blade; 5/8" × 1" × 3/4".

QM-311. For 1/4" tapes	\$23.00
QM-312. For 0.150" cassette tapes	\$23.00
QM-313. For 1/2" video and audio tapes	\$26.80

Reel Tabs

Precut Mylar or metal tabs in dispenser box; comes in quantities of 50, 200, or 1000; 1/2" Mylar tabs in

quantities of 200 or 1000 also available.

QM-521. 1/4" reel tabs; 50/package	\$5.00
QM-522. Cassette reel tabs; 50/package	\$5.00
QM-524. 1/4" metal-sensing reel tabs; 50/package	\$5.00

QM-707 Handylap

Kit includes lapping block with five 5 × 9-in coarse abrasive black lapping sheets of paper, five 5 × 9-in medium abrasive yellow sheets, five 5 × 9-in fine abrasive red sheets ... \$93.50
QM-702. Coarse lapping paper paper; black ... \$7.00
QM-703. Medium lapping paper; yellow ... \$13.20
QM-704. Fine lapping paper; pink ... \$13.20

QM-230 Cassette Bulk Eraser

Self-powered hand-held unit completely erases cassette tapes; requires no batteries or external power source; contoured Cyclocac case with woodgrain finish ... \$32.50

QM-211 Bulk Eraser

Bulk eraser generates 60-Hz magnetic field which completely erases pre-recorded reels, cassettes and 8-track cartridges up to 1/2" wide; features touch-control Microswitch that activates on fingertip pressure and deactivates when unit is put down; built-in thermal overload protect circuit; hand-contoured Cyclocac case; coiled cord ... \$56.80
QM-212. 220-V professional bulk eraser ... \$59.80

QM-250 Professional Bulk Tape Eraser

Demagnetizes professional cassette, 1/4", 1/2", 1" open-reel, broadcast 8-track cartridge, and 1/2" VHS/Beta video cassette tapes. Holds up to 10 1/2" reel sizes; 10"W × 7"D × 3.25"H ... \$336.40

PF-208 Tape Head Degausser

Professional tape head degausser with super High-Flux coil-core for demagnetizing heavy-duty 2" tape heads and guides. Has peak magnetic field strength of 1000 gauss; automatic-reset thermal protection; positive snap-action on/off switch; Krayton thermal plastic/rubber-covered probe tip; Lexan® plastic housing; 12 oz ... \$39.95

QM-202 Head Demagnetizer

Head demagnetizer for use with open-reel, cassette, 8-track recorders. Features long flexible plastic covered probe that reaches most inaccessible heads; leaf switch that activates with fingertip pressure and deactivates when unit is put down; thermal overload protection circuit; Cyclocac case ... \$22.80
QM-203. 220-V professional head demagnetizer ... \$23.20

QM-280A Cleaner/Demagnetizer

Removes residual magnetism and accumulated oxide and dirt deposits from 8-track heads; includes cord for 110-120 V ac 50/60 operationHz ... \$24.00

Head Cleaners

QM-140. For cassettes	\$3.00
QM-141. For cassettes; includes liquid head cleaner	\$3.40
QM-142. For cassettes	\$4.00
QM-180. For 8-track tape	\$3.20
QM-181. For 8-track tape; includes liquid head cleaner	\$4.00
QM-182. Combination 8-track head/capstan cleaner	\$4.40

Alignment Tapes

AT-210B. For cassette recorders	\$14.40
AT-200B. Master recording provides zero reference, azimuth alignment, DIN frequency response tests; includes 3-kHz tone for speed and flutter	\$52.00
AT-820. For 8-track; 8-minute cycle	\$12.00
AT-320. Designed for NAB-type endless-loop mono and stereo cartridge recorders/players; 7 1/2-ips master recording tests and adjusts head azimuth, program frequency response, program record level, stereo head phasing, cue tone sensitivity, tape speed	\$55.20
At-120. 1/4" reel-to-reel 7 1/2-ips master recording tape	\$51.80

Cassette Storage/Carrying Cases

Burl walnut vinyl book-like cassette case; cassettes and hubs lock in place.

QM-408. Holds maximum 8 cassettes	\$9.00
QM-412. Holds maximum 12 cassettes	\$10.80
QM-416. Holds maximum 16 cassettes	\$12.80

VCR Maintenance Products

QM-50. Deluxe video recorder care kit includes 10 oz Super Blast spray, 16 oz tape head cleaner spray, antistatic dustcloth, 25 cellular foam swabs, disposable wipers ... \$31.20
QM-95. VCR maintenance kit includes spray head cleaner, cellular foam swabs, antistatic dustcloth, screwdriver that removes headcover screws \$17.00
VCR-103. Tape head cleaner spray for VCR heads, pinch rollers, capstans; 3 oz ... \$4.80
VCR-105. Tape head cleaner liquid removes dust, dirt, tape oxide deposits from VCR heads and parts; 3.2 fl oz ... \$4.60
VCR-109. High-velocity jet air stream Super Blast Spray cleaner eliminates loose tape oxide dirt and dust; 10 oz ... \$5.20
VCR-205. Head demagnetizer with angled tip; removes residual magnetism from heads, rollers, guides ... \$25.20
VCR-211. Video bulk eraser erases Beta II and VHS-format cassettes. Generates 60-Hz magnetic field; touch-activated microswitch that deactivates when put down; Cyclocac case; includes power cord for 110-120 V ac 50/60 Hz operation ... \$56.80
VCR-130. Drop-in VHS-format VCR head/tape-path cleaner ... \$30.00
VCR-135. Same as VCR-130 except for Beta-format VCRs ... \$30.00
QM-313. Grooved anodized aluminum splicing block for repairing or editing videocassettes. Has 2 deep slits for straight or diagonal cuts; includes double-backed adhesive ... \$26.80
VCR-506. Illuminated inspection mirror for dark, hard-to-reach areas of VCR ... \$7.40
VCR-512. Cellular foam cleaning swabs for VCR heads and surfaces ... \$4.80

Care Tape Maintenance Products

AS-9. 3 oz spray cleaner and 100 6" cotton swabs ... \$6.80
AS-141. Cassette life extender features nonabrasive cleaning belt; includes liquid cleaner ... \$3.80
AS-183. 8-track head/capstan cleaner; designed for use every 10 hours; includes liquid cleaner ... \$4.40
AS-206. 8-track/cassette head demagnetizer; plugs into car cigarette lighter ... \$32.00

RECOTON

Video Maintenance

V106A. Videotape eraser designed for 117-V ac line power. Includes on/off switch and LED indicator, externally mounted protective fuse ... \$59.95
V118. Videotape splicing kit for editing and repairing VHS and Beta cassette tapes. Includes deluxe splicing block, splicing tape, cutting tools, hard plastic storage case ... \$43.95
V109. Nonabrasive Beta-format video head cleaner cassette ... \$18.99
V109CD. Same as V109 except on display card ... \$18.99
V107. Same as V109 except for VHS-format VCRs ... \$18.99
V107CD. Same as V107 except on display card ... \$18.99
V103. Deluxe VCR maintenance kit for cleaning heads, capstans, rollers. Includes 4 chamois wands, 2 oz solution with pump sprayer, cleaning cloth. \$10.99
V115. Video camera lens cleaning kit ... \$10.99
V116. 1.25-oz cleaning solution refill for V115 \$2.99
V117. Lens tissue refill for V115 ... \$1.69
V108. 5 no-residue chamois wands for cleaning video heads, capstans, rollers ... \$6.49
V102. 15 no-residue foam swabs for cleaning video heads, rollers, capstans ... \$5.99
V104. Economy-priced VCR maintenance kit containing 4 foam swabs, 1 oz cleaning solution ... \$4.79
V101. VCR head-cleaning solution in 2-oz bottle ... \$3.69
V111. 25 Beta self-stick Ident-A-Tape labels for identification of VCR cassettes ... \$3.39
V110. Same as V111 except for VHS video-

cassettes \$3.39

Video Storage Accessories

V1336 Lock. VHS and/or Beta storage system can handle up to 35 videocassettes. Designed to fit under VCR. Features 3 high-impact plastic storage trays with individual compartments, one locking drawer \$94.95
V1336. Same as V1336 Lock except no locking drawer, 36 videocassette capacity \$84.95
V1312. 12-capacity VHS and/or Beta storage system constructed of high-impact plastic \$45.95

Audio Tape Accessories

106TC. Car tape head demagnetizer. Plugs into vehicle cigarette lighter socket \$13.95
105TC. Cassette head demagnetizer designed for home use \$10.95
87TC. Car 8-track cartridge head demagnetizer with solid-state electronic circuit \$10.95
88TC. Car tape head demagnetizer for 8-track cartridge players. Plugs into vehicle cigarette lighter socket \$9.95
61TR. Ac-powered tape head demagnetizer .. \$9.49
50TR. Recording-tape splicer designed for 1/4" tapes \$6.49
83TC. Cassette tape splicer \$6.49
51TR. Spiral brush for removing oxide buildup from tape heads \$3.49
145TC. Cassette tuneup system containing nonabrasive cleaner, stereo balance test, head-alignment test \$2.99
90TC. 7/32"W x 150"L sensing tape \$2.79
139TC. Cassette salvage kit containing empty cassette shell with screws, label, cassette splicing tabs, plastic splicing block \$2.49
53TR. 100 soft cotton swabs on 6" wands ... \$2.19
94TC. Package of 4 deluxe cassette storage boxes \$1.99
54TR. Tape recorder head cleaner \$1.59
55TR. Tape recorder lubricant with silicone for all parts of recorder contacted by tape (except capstan) \$1.59
58TR. 1/2"W x 108"L splicing tape \$1.19
65TC-8. Package of 8 dust shields for 8-track cartridges. Snap onto open end of cartridge \$0.99

ROBINS

24-001 Video Cassette Eraser

Heavy-duty videocassette eraser for videocassettes and tapes, audio cassettes, cartridges, open-reel tapes. Erases in seconds; reduces tape to low-noise level; no tape contact or wear during erasure. Has built-in momentary contact switch; 110-120 V ac intermittent duty (1 minute on, 20 minutes off); 6 A; 4 lb; 5" x 5" x 3.5" \$58.50

24-017V Videocassette Tape Eraser

Said to be lowest-cost quality bulk eraser on market. Restores like-new performance to expensive videocassettes. Erases virtually all signals and leaves tape with low noise level, in seconds without wear-causing contact. Works with Beta, VHS, Technicolor formats and audio tape reels, cartridges, cassettes. . \$44.50

15-005 Whistle Stop Head Demagnetizer

Automatic electronic cassette head demagnetizer in cassette format removes accumulation of residual magnetism from heads of home or car cassette tape machines; whistling tone indicates erasing action \$26.50

24-004 Cordless Cassette Tape Eraser

Designed for all standard and micro/mini cassettes. Removes recorded material in 2 seconds. Erases tape below normal erase-head level; leaves low background noise levels. Particularly useful with dictation systems. Requires no outside power or batteries. Alnico magnet produces strong demagnetizing field. \$21.50

25-023 Universal Head Demagnetizer

Universal head demagnetizer with changeable tips permitting use with open-reel, cassette, cartridge equipment; 110-120 V ac 50/60 Hz operation \$15.50

29-500 VCR Head Cleaning Kit

Specially angled chamois-like applicators are used to apply a Broad Spectrum Freon TC based formula that quickly removes dirt, oxide buildup, plasticizers from tape head. Kit comes with 5 applicators, 1-oz bottle cleaning formula \$11.20
29-501. Wide Spectrum video head cleaner .. \$4.85

34-000 Cassette Attache Case

High-impact plastic attache-style case holds up to 16 cassettes and/or home and business computer cassettes; snap-lock carrying handle \$5.40
34-000C. Similar to 34-000 but with smoked top \$6.50

ROTEL

RY-1010 Spectrum Analyzer

Ten-bank octave peak-level spectrum analyzer with pink noise generator and separate mono electret condenser microphone. Displays sound characteristics as signal passes through component; measures line input, live microphone sources, residual noise levels. Features spectrum analyzer display; frequencies at 32, 53, 125, 250, 500, 1k, 2k, 4k, 8k, 16k Hz; 12 LEDs for each band showing peak level; 12/24/36-dB range selector switch; calibration control; one-octave bandwidth bankpass filter for 10 bands. Pink noise generator frequency response 20-20,000 Hz +0/-0.5 dB; output level 100 mV/3k ohms. Micro-



phone: omnidirectional type with music/voice tone control switch; frequency response 30-16,000 Hz ±2 dB; includes stand and cable. Additional characteristics include 3-position line mode switch for measuring each channel separately or simultaneously; input sensitivity/impedance 0.2 mV/30k ohms mic, 2 mV/30k ohms line; 16 1/16"W x 11 3/32"D x 3 7/32"H \$470

RUSSOUND/FMP

QT-1 Quad Patching/Control Center

Passive switching center expands tape monitor loop of audio system to accept 2- or 4-channel noise-reduction systems, graphic equalizers, matrix decoders, up to 4 mono, stereo, or quad tape recorders, with switching functions handled through front-panel switches or patch cords. Supplied with 16 shielded patch cord. Front panel switches include record mix, 2/4-channel play, monitor, aux input/output modes; front panel patching jacks for source/recorders in, recorders/source copy bus, recorder/monitor out, noise-reduction decode in/out. Rear panel connects all recorders and accessories with phono pin jacks. Insertion loss < 0.5 dB when operating recorders or decoders singly, 6 dB when mixing 2 channels or 2 recorder outputs; walnut vinyl finished cabinet; 13 7/8"W x 5"D x 4 13/16"H \$289.95
QT-1 R. Rack-mount version; black metal cabinet; 19"W x 5"D x 5 7/32"H \$299.95
SP-1. Same as QT-1 except for 2-channel stereo systems only; switching capacity for up to 4 stereo tape recorders and 5 stereo accessories in any combination of record, play, monitor, dub; supplied with 12

shielded patch cords; walnut vinyl finish cabinet and semigloss black front panel; 7 7/8"W x 5"D x 4 7/8"H \$189.95
SP-1R. Rack-mount version of SP-1; 7"W x 5"D x 4 7/8"H \$199.95

TMS-10 Tape Recorder Selector Switch

Connects up to 10 tape recorders or other line sources to be used singly or together in any combination of functions. Dimensions 16 1/2"W x 3 1/2"D x 3"H \$149.95
TMS-10W/R. Same as TMS-10 except walnut side panels or rack mountable \$159.95
6 1/2"W x 3 1/2"D x 3"H \$89.95
TMS-5. Similar to TMS-10 except 5-recorder capacity. Dimensions 6 7/8"W x 3 1/2"D x 3"H \$89.95.
TMS-5W. Same as TMS-5 but with walnut side panels \$99.95
TMS-3. Similar to TMS-5 except 3-recorder capacity \$55.95
TMS-3W. Same as TMS-3 but with walnut end panels \$65.95

SANSUI

AT-15 Programmable Timer

Automatically activates equipment for playback or recording at any set time within 24-hour period. Features digital clock and two 700-W total outlets. Measures 10 9/16"W x 4 13/16"D x 2 13/16"H; weighs 2.7 lb \$150

SCOTCH

ERK-130 Cassette Edit/Repair Kit

Contains precision splicing block; spindle for manually winding cassette tape; 6 polyester picks (adhesive tipped for retrieval of tape ends lost in housing); 6 130-mil splicing tabs \$3.39

Pre-Cut Tabs

SPT-7/32-36. 6 pre-cut 1.0-mil polyester splicing tabs \$1.39
SST-7/32-18. 8 pre-cut aluminized sensing tabs \$1.39
SK-7/32. 12.5 ft of 1.9-mil polyester splicing tape in dispenser kit \$2.29

Head Cleaners

S-C-HC. Cassette head cleaner \$1.79
S-8TR-HC. 8-track head cleaner \$2.99

SOUNDAIDS

Cassette Storage Cabinet

Wood cabinet with lock-jointed corners hold 68 cassettes in 4 drawers with recessed sides for easy removal of cassettes. Designed to fit standard record shelves and can function as record dividers or support shelves (with more than on cabinet); 12 3/4"H x 5 9/16"W x 12 3/16"D \$48.00

SOUNDCRAFTSMEN

AS1000 Spectrum Analyzer

Real-time analyzer with differential comparator circuitry and 0.1-dB readout accuracy. Features 2-dB/step display with total range of 58 dB with display position control; pink-noise generator with auto-scan feature. Generates octave-band test signals or all-band pink noise for frequency-response measurement

NOTICE TO READERS

Prices of items described are suggested prices only and are subject to change without notice. Actual selling prices are determined by the dealer.

10 ACCESSORIES

of single component or entire sound system. Bands 10; THD 0.01%; 19"W × 11"D × 3½"H; 15 lb \$499

SUPEREX

TSB-3 Graphic Tape Switching Console

Stereo tape switching console features color-coded tape duplication processes graphically illustrated on front panel; 3-deck capability; functions include duplicating recordings or broadcasting on 3 tape decks; mixing 2 sources for documentary effect; transfer of program material from one tape deck to another while monitoring and recording additional different program source; both inputs and outputs include stereo, one amplifier, 3 tape decks or auxiliary components; dubbing bank for use with any stereo amplifier or receiver with monitoring facilities; controls include 3 input and 3 output toggle switches and one output line selector toggle switch; rear-panel phono jacks; 6¼"W × 4¼"D × 2¼"H \$50.00

TDK

Videocassette Recorder Head Cleaners

Nonabrasive head-cleaning cassettes for Beta- and VHS-format videocassette recorders. Clean video and audio heads in 30 seconds and can be used up to 200 times. Maintenance record on cassette label.

LCL-30. Beta format \$25.00
TCL-30. VHS format \$25.00

CP36 Audio Cassette Cabinet

Holds up to 36 audio cassettes in 3 separate drawers that each hold 12 cassettes \$39.99

HD-11 Tape Head Demagnetizer

Portable hand-held universal tape head demagnetizer designed for open-reel or cassette tape decks; operating time < 1 second; red LED on and green LED ready-to-use indicators; side-mounted activator switch; plastic-covered metal tips; includes two 1.5 V cells \$43.75

HD-01 Head Demagnetizer

Automatic head demagnetizer with < 1-second operating time; housed in transparent cassette shell with surface-mount LED indicator to show demagnetization is occurring; self-contained battery \$30.00

HC-1 Head Cleaner

Nonabrasive cassette tape machine head clean-

er \$2.25

Empty Tape Reels

AR-7M. 7" metal reel \$8.99
AR-10M. 10½" metal reel \$13.99

TECHNICS

SH-4060 Audio Programmable Timer

Slimline audio programmable timer designed for use with tape recorders and any other audio products for timed-on functions. Features 3 basic modes (weekly 1, weekly 2, and once); accuracy assured by quartz oscillator; high-visibility FL display of 24-hour time, on/off function, preset channel number, day of week. Weekly 1 and weekly 2 permit: single on/off on any single day of week; on/off every day of week; on/off on Saturday and Sunday only; on/off on every day of week except Sunday; on/off every day of week except Saturday and Sunday. If off time is not programmed after on time, timer automatically turns off 1 hour after on time initiates \$150

SH-4020 Audio Timer

Economy audio timer slaved to frequency of power line. Features separate on/off time settings; sleep timer function; easy clock/timer setting; digital-numeric time display; slimline design; manual on/off switching of power outlets regardless of timer settings; clock settable to second \$100

9 SIGNAL PROCESSORS

(Continued from page 126.)

sion controller echo time 90 msec, sound-image localization 30° backward; EQ center frequencies 60, 250, 1k, 4k, 16k Hz over ±12-dB range; input sensitivity 150 mV line in, AUX, tape, 2.5 mV phono, 1.5 mV mic; output 150mV line and rec out; power consumption 25 W; 16½"W × 11½"D × 4¾"H; 10.6 lb \$420

SH-8040 Space Dimension Controller

Space Dimension Controller similar to that in SH-8030 except no graphic equalizer and facility for mixing only single microphone input with line input. Features effector position switch; dimension and signal-level display. Frequency response +0/-3 dB

6-50,000 Hz line-in and playback, 20-30,000 Hz mic; maximum output 8 V at 1 kHz, 0.01% THD; harmonic distortion 0.003% line-in; input sensitivity 150 mV line-in and playback, 1.5 mV mic; rated output 150 mV line and record out; S/N ratio 90 dB IHFA weighted line-in; maximum input 8 V line-in and playback, 130 mV at 1 kHz mic; input impedance 22k ohms line-in and playback, 10k ohms mic; output impedance 600 ohms; dimension controller echo time 64 msec; 430 mmW × 282 mmD × 53 mmH; 3.2 kg \$200

URSA MAJOR

Space Station SST-282 Digital Reverb System

Digital reverb, multi-tap digital delay, delay-effects system using PCM circuitry with RAM. Features re-

verb processors and adjustable controls for reverb parameters including initial delay pattern, decay time, and high- and low-frequency decay time, 8 audition delay tapes, built-in mixer; 16 programs of delay times; reverb/echo feedback. Frequency response 20-7000 Hz; dist. 0.1%; dynamic range 80 dB; delay time 256 msec; reverb decay 3.5 sec; echo decay 10 sec \$2195

8X32 Digital Reverberation Unit

Compact unit provides control over all important parameters while synthesizing clean and natural reverberation, and LED numeric display gives confirmation of all parameter settings. Unique LED displays show dynamic properties of input and reverberated signals. Features 32 registers that retain contents (up to 32 complete reverb set-ups) even with power off; basic programs include Plate I, Plate II, hall, space. Early reflection/initial delay times variable from 6 to 96 msec; early reflection/initial delay levels selectable in 8 steps; decay time variable from 0.2 to 19.9 sec, depending on program selected; 3 values of LF, 4 values of HF decay. Bandwidth 8 Khz; dynamic range 80 dB; sampling rate 20 kHz; 19"W × 10"D × 3½"H \$5995

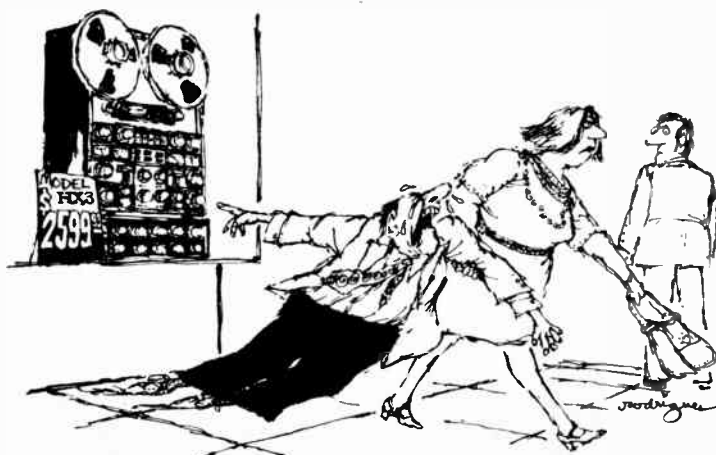

A case for getting organized

Magazines • Cassettes • Records • Videocassettes • Important Papers



A • MAGAZINE CASES

Store and protect your magazines the way libraries do! These open-back file cases keep your magazines neat and organized... and in order. Magazine title (almost 12,000 titles available!) is embossed on the spine. Specify titles on coupon. Colors selected by Publisher.
 ≠ Z-MC \$6.95 each, 3 for \$19.95, 6 for \$37.50



B • MAGAZINE BINDERS

Metal rods hold your magazines in their proper sequence. Binders available for almost 12,000 titles. Specify your choices. Colors selected by Publisher.
 ≠ Z-MB \$7.95 each, 3 for \$22.50, 6 for \$42.95



C • FILES FOR EVERYTHING

Now you can organize your important papers... newsletters... maps... receipts... photographs... clippings... anything you like! Order these handsome files in the sizes and colors* you prefer. Available with or without drawer.

Storage Files With Drawers:

(Add "D" after item number and specify color* and size.)
 \$10.95 each, 3 for \$29.95, 6 for \$58.95

Storage Files Without Drawers:

(Add "S" after item number and specify color* and size.)
 \$6.50 each, 3 for \$17.95, 6 for \$34.95

- ≡ 80 8 3/4" h x 4 1/4" w x 5 1/2" d (inside dimensions)
- ≡ 63 10 1/4" h x 4 1/2" w x 7" d
- ≡ 49 11 3/4" h x 3 1/2" w x 8 1/2" d
- ≡ 103 12 1/2" h x 3 1/2" w x 9" d
- ≡ 165 14 1/4" h x 4 3/4" w x 11" d

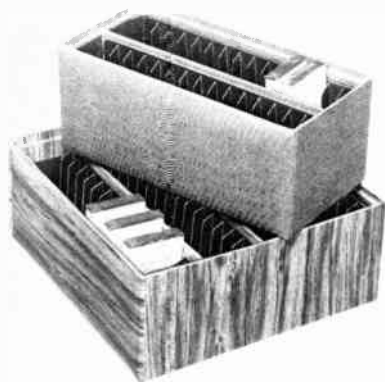

D • CASSETTE CASES

Put your tapes in order with these handy cassette cases. Each cassette gets its own slot. Pressure-sensitive labels are included for easy identification. Available in a variety of colors* for 30 or 60 cassettes.

30-Tape Cassette Case.

≡ JC-30 \$14.95 each, 3 for \$39.95

60-Tape Cassette Case.

≡ JC-60 \$19.95 each, 2 for \$37.95

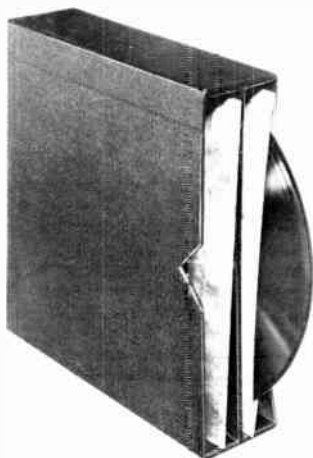

E • RECORD CASES

Protect your record collection with these deluxe record cases. Each one holds 20 12" LP albums. Center divider helps keep your records organized. Specify color.* ≠ J-R12 \$8.95 each, 3 for \$23.95



F • VIDEOCASSETTE CASES

No more pile of tapes on the TV set! These handy cases organize and protect your valuable videocassettes. Holds twelve VHS or Beta cassettes. Designer colors only. ≠ Z-VC \$12.95 each, 3 for \$34.95

DESIGNER COLORS

(for all products except magazine binders and cases)
 MAROON REPTILE • ORANGE REPTILE • GREEN REPTILE • BROWN REPTILE • BLACK REPTILE • DENIM • BURLAP • WOODGRAIN

ZIFF-DAVIS PUBLISHING CO.

P.O. Box 5120, Dept. ZM, Philadelphia, PA 19111

Mr. _____
 Mrs. _____
 Ms. _____
 (please print full name)

Address _____ Apt _____

City/State/Zip _____

Payment enclosed \$ _____

Charge my (Minimum charge or phone order \$10):

American Express MasterCard Visa Diners Club

Card No. _____ Exp. Date _____

Signature _____

*Available in Black, Brown and Green Kidskin or designer colors.

ITEM #	COLOR (if choice)	TITLE OR DESCRIPTION	QUAN	PRICE

POSTAGE AND HANDLING _____
 If your order is:
 Under \$10—add \$1.50
 \$10.01 to \$30.00—add \$2.50
 \$30.01 to \$40.00—add \$4.50
 \$40.01 to \$60.00—add \$6.00
 POSTAGE IS FREE IF YOUR ORDER IS OVER \$60!

SUB-TOTAL _____
 POSTAGE & HANDLING _____
 PA RESIDENTS
 ADD 6% SALES TAX _____
 TOTAL _____

Outside U.S.A., postage and handling charge is \$3.00 for each item ordered.

FOR FASTER SERVICE, CALL TOLL-FREE: (800) 345-8112 In PA (800) 662-2444

LATE ARRIVALS

Items that appear in this section arrived too late for inclusion in normal directory listings.

CYBERNET

D-801 Stereo Cassette Deck

Kyocera stereo cassette deck with Dolby B and C noise-reduction systems and 3-motor/2-capstan transport. Features 3-position bias/equalization switch; fine bias adjust control; 400-Hz calibration tone; electromagnetic braking to protect tape from damage during switching from one mode to another; direct-coupled FET input stages; APMR (Automatic Program Mute Recording); Auto Program Search; Sendust record/play and ferrite erase heads; soft-touch transport controls; LED indicators for mode and function; separate record-level and balance controls; 3-function electronic digital counter for indicating elapsed time/time remaining/stopwatch; peak-hold bargraph meters; auto memory/stop/replay/repeat. Wow and flutter 0.02% wrms; frequency response 30-20,000 Hz ± 3 dB with metal and CrO₂ tape; S/N ratio 78 dB with metal tape, Dolby C on \$625

D-601 Stereo Cassette Deck

Kyocera stereo cassette deck with Dolby B and C noise-reduction systems. Features 3-motor transport; FET input stages; APMR; automatic memory/stop/

replay/repeat; fine bias adjust control; MPX filter; Sendust record/play and ferrite erase heads; feather-touch transport controls; tape-mode LEDs; bargraph signal-level displays; mechanical tape counter. Wow and flutter 0.035% wrms; frequency response ± 3 dB 30-19,000 Hz low-noise, to 20 kHz metal and CrO₂ tape; S/N ratio Dolby B/C 68/78 dB; THD 1.5% \$550

D-701 Dubbing Stereo Cassette Deck

Dubbing stereo cassette deck has 2-speed dubbing capability. Features adjustable echo effect; up to 3 line mixing; automatic stop in all modes; memory switch for automatic stop on rewind for tape 2; tape 1 record-only, tape 2 record/play; QSARS (Quick-Start and Automatic-Recording Stop) system that simultaneously operates both transports with a single start button; mode LEDs; record/play standby for optional timer; feather-touch transport controls; APJS (Automatic Program Jump System) and APMR (Automatic Program Mute Record); cue and review; metal tape capability; Dolby B noise-reduction system. Wow and flutter 0.04% wrms; frequency range 30-20,000 Hz metal tape; S/N ratio 64 dB Dolby on \$480

TASCAM

Stereo Cassette Recorder

Studio 1 $\frac{1}{4}$ and 3 $\frac{3}{4}$ ips stereo cassette recorder with Dolby B noise-reduction and HX headroom-extension systems. Features 3 heads; FG dc servo capstan and

dc reel motors; front and rear line inputs; normal/high-bias/metal switch; bias adjust control; tape counter memory; headphone volume control; provision for optional dbx* noise-reduction adapter. Wow and flutter as 1 $\frac{1}{4}$ and 3 $\frac{3}{4}$ ips 0.06%/0.04% NAB weighted; frequency response ± 3 dB at 1 $\frac{1}{4}$ and 3 $\frac{3}{4}$ ips 35-14,000/35-20,000 Hz with high-bias tape; THD at 1 $\frac{1}{4}$ and 3 $\frac{3}{4}$ ips 1/2%/1% with high-bias tape; S/N ratio at 1 $\frac{1}{4}$ and 3 $\frac{3}{4}$ ips 58/63 dB, with dbx 92/92 dB; separation >35 dB at 1 kHz; input sensitivity/impedance 190 mV (-14 dBV)/10k ohms line unbalanced; output level/impedance 0.3 V (-10 dBV)/25k ohms unbalanced line; 19"W \times 13.6"D \times 5.8"H; 19.8 lb \$725

124 Syncaset Cassette Recorder

Front-loading Simul-Sync stereo cassette deck with Dolby B noise-reduction system and FG dc servo motor. Features Simul-Sync for monitoring on one track while simultaneously recording on the other through the same head; cross-feed switch for slight blending of both channels; mic blend control with left/blend and right mic jacks; normal/CrO₂ tape selector; mic/DIN and line input selector; 2 VU meters; Wow and flutter 0.07% NAB weighted; frequency range 30-16,000 Hz with CrO₂ tape; S/N ratio Dolby off/on 55/65 dB; input sensitivity/impedance 1 mV (-60 dBV)/10k ohms unbalanced mic, 0.3 V (-10 dBV)/10k ohms unbalanced line; output level/impedance 0.3 V (-10 dBV)/25k ohms; fast-wind time 90 seconds with C60 cassette; 16 $\frac{1}{4}$ "W \times 11 $\frac{1}{2}$ "D \times 6 $\frac{1}{4}$ "H \$450

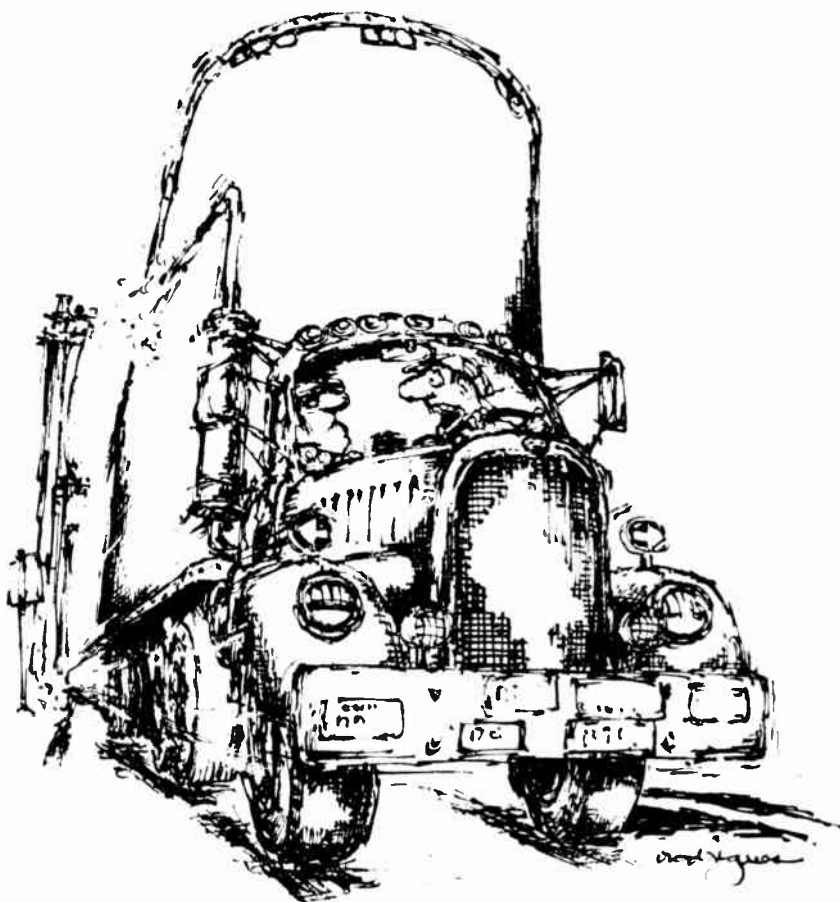

"... I said, 'Have you noticed the difference since I been usin' nothin' but ferrichrome on this cassette player?'"

TAPE RECORDING & BUYING GUIDE 1983 ADVERTISERS INDEX

READER SERVICE NO.	ADVERTISER	PAGE NO.
17	Akai America, Ltd	65
	Alpine Electronics of America, Inc.	3rd Cover
6	BASF Audio/Video Tapes	5
1	Cybernet	59
18	dbx, Inc.	35
3	DG Polygram Classics, Inc.	98
2	Denon	3
4	Discount Music Club	81
11	Discwasher	11
	Dolby	13
	Harman Kardon, Inc.	16,17
	Illinois Audio	107
5	J & R Music World	53
7	JVC Company of America	14
8	Maxell Corp. of America	77
9	Sansui Electronics Corp.	7
10	Sony Tape Sales Co.	57
12	Stereo Corp. of America	55
13	TDK Electronics Corp.	4th Cover
14	Technics	9
15	U.S. Pioneer	2nd Cover, 1
16	Wisconsin Discount Stereo	117



A truly beautiful car such as Lamborghini would only specify an equally beautiful car audio sound system. Alpine.

Because Alpine's passion has always been to recreate the purest, most accurate music possible. From brilliant, crisp highs. To powerful, solid lows.

And this year, Alpine takes high fidelity still higher. With electronically engineered, matched component systems that work together so precisely, so beautifully, that now you can own what you've always wanted to hear.

Higher Fidelity Car Audio Systems. They're at your Alpine Dealer now. For his location call toll-free, 800-421-1395. In California, 800-262-4150. © 1982 Alpine Electronics of America, Inc., 3102 Kashiwa Street, Torrance, California 90505.



ALPINE
car audio systems

Body by Lamborghini. Higher fidelity by Alpine.

Five of the music world's finest instruments are made by TDK.



Like any fine musical instrument, TDK Professional Reference audio cassettes and open reel tapes are products of genius. In TDK's case, it's the genius of constantly-advancing audio technology. And now, TDK technology has advanced again in the reformulation of our MA-R metal, SA-X high bias, and AD-X normal bias cassettes.

MA-R, SA-X and AD-X are formulated to an incredibly strict, new set of audio tape standards based on measurements and values no audio cassette manufacturer has ever attempted to meet. TDK cassettes deliver clarity, fidelity and quality unmatched by any other cassettes on the market today. MA-R, with its unique unibody metal

alloy frame and Reference Standard Mechanism is the first metal reference tape in the industry. SA-X pushes high bias to its limits. AD-X normal bias is extraordinary in its wider dynamic range and its freedom from saturation at high frequency. SA-X and AD-X both feature TDK's specially engineered Laboratory Standard Mechanism. Each cassette comes with a Lifetime Warranty.

TDK's superior technology is just as evident in our SA/EE (Extra Efficiency) and GX open reel tapes. TDK SA/EE is the first open reel tape to use TDK's famous Super Avilyn particle. This gives SA/EE almost double the coercivity and high frequency MOL of conventional open reel tapes. GX

mastering tape offers a wide dynamic range, high MOL and low noise. Both SA/EE and GX feature low distortion and extended frequency response.

MA-R, SA-X, AD-X, SA/EE and GX—they're five of the music world's finest instruments for all of the music and instruments you record. One final note. TDK's new Professional Reference Series of audio cassettes now comes in bold, new packaging. So they stand out in sight just as they stand out in sound.

TDK
THE MACHINE FOR YOUR MACHINE[®]