

Stereo Review's

\$1.50

TAPE RECORDING & BUYING GUIDE 1974

OPEN-REEL * CASSETTE * EIGHT-TRACK TAPE MACHINES
LATEST PRICES * SPECIFICATIONS * 4-CANNEL SECTION

Julian Hirsch Solves the Tape Recorder Specifications Puzzle
Guide to Buying Your First Tape Recorder * Quadraphonic Tape
Machines * Dolby and Other Noise-Reduction Systems * Tape
Recording Tips * Legal Side of Recording * How to Pick a
Microphone * Outstanding Recorded Tapes * Tape Accessories

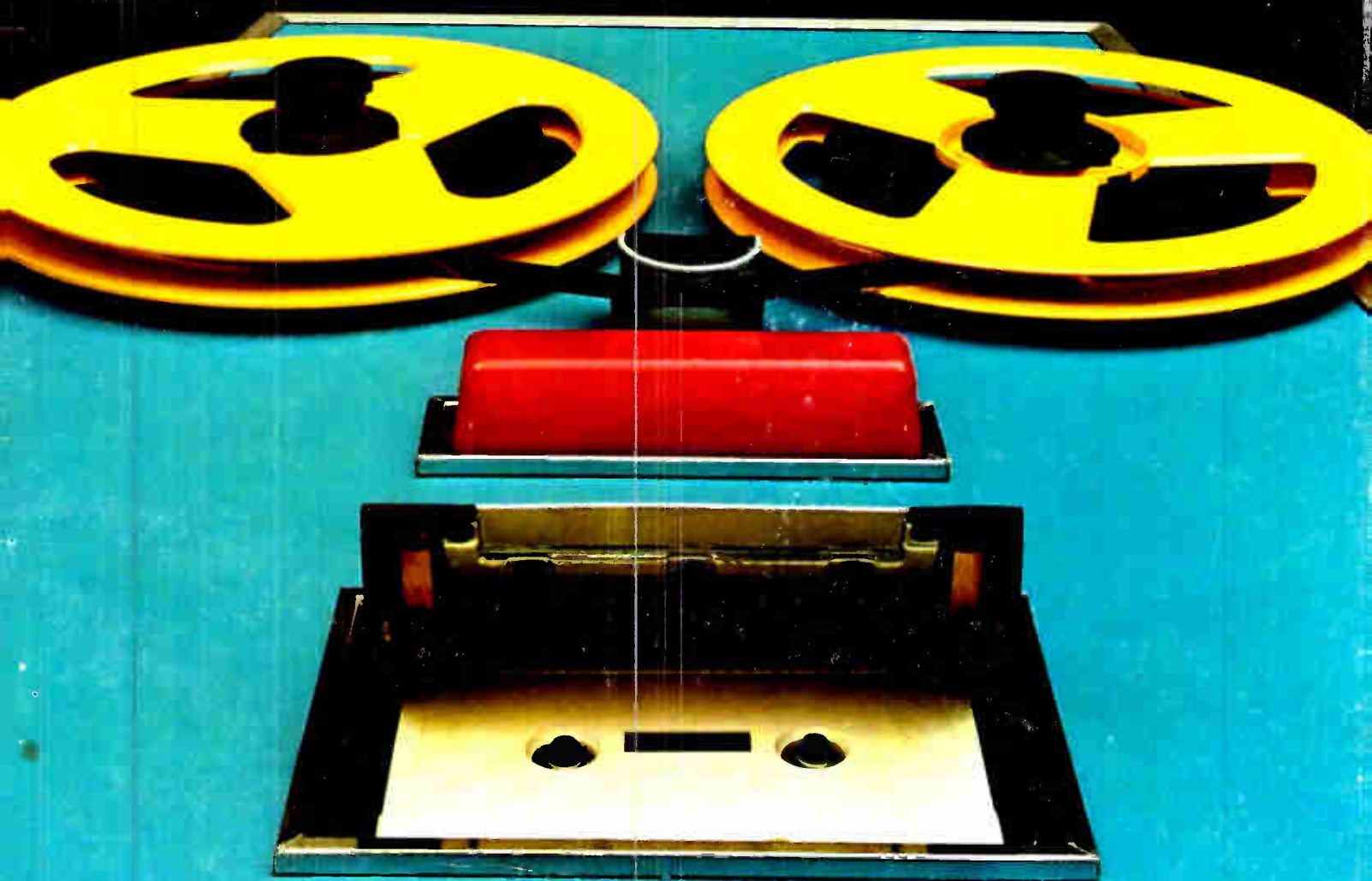

NOBODY'S RECORDING HEAD WEARS OUT AS FAST AS OURS

MOST CASSETTE RECORDERS USE A FERRITE RECORDING HEAD. IT DISTORTS HORRIBLY AT LOW FREQUENCIES BUT IT HAS GREAT WEAR CHARACTERISTICS.

THE HK1000 USES A PERMALLOY RECORDING HEAD. IT HAS EXCELLENT RECORDING

QUALITIES AND VERY LOW DISTORTION CHARACTERISTICS. IT DOESN'T WEAR AS WELL AS FERRITE SO WHEN IT WEARS OUT YOU REPLACE IT. WE CONSIDER IT A GREAT IMPROVEMENT OVER THE FERRITE HEAD.

THE HK1000 HAS A FEW MORE THINGS OTHER CASSETTE RECORDERS DON'T HAVE. CONSTANT CURRENT

DRIVE FOR ONE. IN FACT, EVEN STAND-

DARD REEL-TO-REEL MACHINES DON'T HAVE

CONSTANT CURRENT DRIVE. YOU'D HAVE TO GO TO A RECORDING STUDIO TO FIND ONE.

THE HK1000 HAS A SERVO-DRIVEN D.C. MOTOR. NO MATTER HOW MUCH LOADING IT GETS, IT STILL RUNS AT THE SAME SPEED.

IT HAS DOLBY.[®] IT HAS ITS OWN BUILT-IN MICROPHONE PRE-AMP. IT ACCEPTS, NOT ONE, BUT THREE DIFFERENT KINDS OF TAPE: STANDARD. LOW-NOISE. AND CHROMIUM DIOXIDE.

BUT THE REALLY OUTSTANDING THING ABOUT THE HARMAN/KARDON HK1000 CASSETTE RECORDER IS THE WAY IT SOUNDS.

IT CARRIES THE TRADITIONAL HARMAN/KARDON ULTRA-WIDEBAND CIRCUITRY AND PHILOSOPHY. THAT PHILOSOPHY SAYS THAT THE FREQUENCIES YOU CANNOT HEAR SIGNIFICANTLY AFFECT THOSE YOU CAN.

WE BACK UP THAT CONVICTION WITH TWO TESTS. THE FIRST IS MEASURABLE. OUR PRODUCTS PRODUCE THE BEST SQUARE WAVE RESPONSE IN THE BUSINESS.

THE OTHER TEST IS SUBJECTIVE. LISTEN TO AN HK1000. YOU'LL SEE WHY WE'RE NOT ABOUT TO THROW AWAY A GREAT SOUND BECAUSE OF A RECORDING HEAD THAT MERELY LASTS A LONG TIME.

harman/kardon

55 AMES COURT, PLAINVIEW, N.Y. 11803, U.S.A. ALSO AVAILABLE IN CANADA

CIRCLE NO. 5 ON READER SERVICE CARD



After so many high-fidelity and consumer publications rated our HD 414 "open-aire" headphones tops in sound, comfort and value, why would Sennheiser introduce another model?

The reason is perfection.

Not that our new HD 424 is perfect. But our engineers—the same engineers who developed our dynamic and condenser microphones for the recording industry—have made some significant advances. Enough, we feel, to warrant a new model. Enough, that a certain kind of music lover will appreciate the added fidelity, despite the added cost.

The primary difference is response. As linear as our HD 414 is, the HD 424 boasts even greater accuracy—particularly at low bass and high treble frequencies. Due to an improved transducer assembly and redesigned earpiece geometry. Heard on the HD 424, low organ notes assume an additional, fundamental richness without sacrificing the "tightness" of good transient response. While violins and other high-overtone



instruments retain the additional "transparency" their overtones produce.

No less important, especially for long listening sessions, is comfort. Retaining the "unsealed" free-air feeling so many praised in the HD 414, the new HD 424 provides even less (!) pressure on the ear, distributing it over wider, thinner acoustically transparent cushions. For this reason—and an improved, cushioned headband—the HD 424 actually seems lighter than the 5 oz. HD 414, even though it is slightly heavier.

Now, there are two Sennheiser "open-aire" headphones for you to choose from. The HD 414, rated best for sound and comfort. And a new model offering something more. That's why.

Hear them both at your Sennheiser dealer, or write us for more information. Sennheiser Electronic Corporation, 10 West 37th Street, New York 10018.



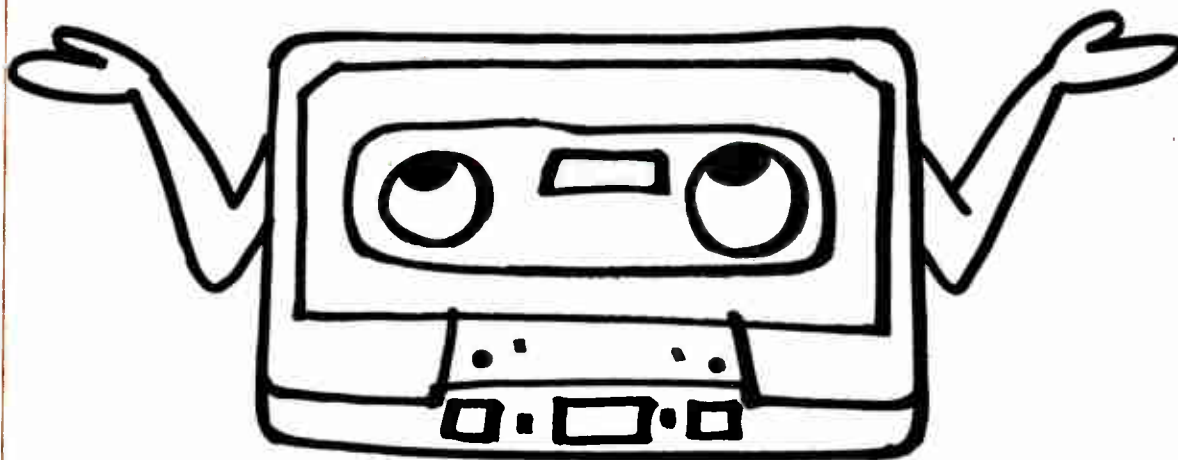

SOME CASSETTES JUST CAN'T COPE.

Ever buy a cassette that sticks and jams... sometimes gives up before it even gets started? How about the ones that pick up dirt better than a vacuum cleaner? And these aren't just the bargain cassettes either. Some of these things are so-called premium grade products.

If any of this sounds familiar to you, you're not using Columbia "Fail-Safe" cassettes. Columbia cassettes have graphite impregnated Mylar slip sheets and self-lubricating Delrin rollers to prevent sticking and jamming... any kind of orneriness. And sealed windows to keep out dirt, dust... anything that could give you problems.

We use gamma-ferric oxide low noise/high output tape. So it picks up every sound you hear... and then some. They can really cope.

We call Columbia cassettes "Fail-Safe." You'll call them "fantastic."



COLUMBIA
Blank Recording Tape

Columbia Magnetics, CBS, Inc., 51 West 52nd Street, New York, N.Y. 10019

CIRCLE NO. 13 ON READER SERVICE CARD

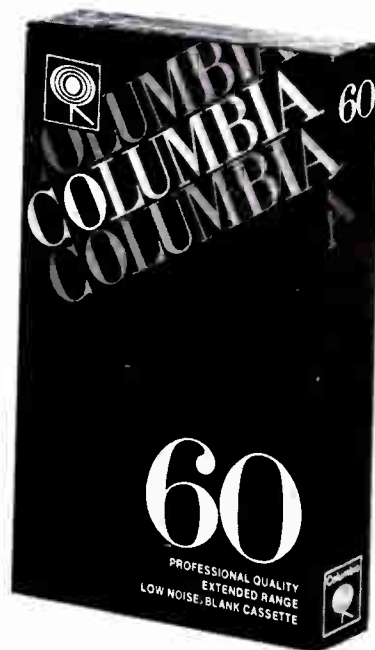

TAPE RECORDING & BUYING GUIDE 1974

FEATURES

DIRECTORY OF MANUFACTURERS	5
TAPE TERMINOLOGY	6
SOLVING THE TAPE RECORDER	
SPECIFICATIONS PUZZLE	JULIAN D. HIRSCH..... 11
YOUR FIRST TAPE RECORDER!	RALPH HODGES..... 23
HOW WILL YOU USE YOUR TAPE RECORDER?	27
TAPE RECORDING TIPS FOR BETTER RECORDINGS .	EUGENE WALTERS..... 28
THE LEGAL SIDE OF TAPE RECORDING	MARSHALL LINCOLN..... 32
HOW RECORDING TAPE IS MADE	JOSEPH KEMPLER..... 34
HOW TO PICK A MICROPHONE	J. GORDON HOLT..... 41
LAB TESTS ON HIGH-PERFORMANCE	
OPEN-REEL TAPES	CRAIG STARK..... 44
ACCESSORIES FOR TAPE MACHINES	J. GORDON HOLT..... 48
COMPARING NOISE-REDUCTION SYSTEMS	JULIAN D. HIRSCH..... 51
HOW THE DOLBY "B" SYSTEM WORKS	54
PROPER CASSETTE RECORDING LEVELS REDUCE	
DISTORTION AND NOISE	RALPH HODGES..... 55
WHAT'S THE STORY ON 4-CHANNEL	
TAPE MACHINES?	LEONARD FELDMAN..... 58
BEST OF RECORDED TAPES	64
TAPE Q & A	LARRY KLEIN..... 66
DECIBEL TABLE	111

PRODUCT INFORMATION

SECTION 1 OPEN-REEL TAPE MACHINES	69
SECTION 2 CASSETTE TAPE MACHINES	75
SECTION 3 8-TRACK TAPE MACHINES	82
SECTION 4 4-CHANNEL EQUIPMENT	85
Tape machines; headphones;	
decoders; miscellaneous	
SECTION 5 HEADPHONES & MICROPHONES	92
SECTION 6 BLANK TAPE & ACCESSORIES	102

EDGAR W. HOPPER, Publisher

ARTHUR P. SALSBERG, Editorial Director • STANLEY NEUFELD, Assoc. Publisher
 P. B. HOEFER, Managing Editor • BORYS PATCHOWSKY, Art Director
 JAMES J. SULLIVAN, Adv. Dir. • RICHARD J. HALPERN, Eastern Adv. Mgr.
 MADELEINE LITTMAN, Adv. Service Mgr. • ANDRE DUZANT, Tech. Illustrator
 FURMAN H. HEBB, Group Vice President, Electronics and Photographic

TAPE RECORDING & BUYING GUIDE is published annually by Ziff-Davis Publishing Company at One Park Avenue, New York, New York 10016. William Ziff, President; Hershel B. Sarbin, Senior Vice President, Secretary, and Treasurer; Philip Sine, Senior Vice President.

Copyright © 1974 by ZIFF-DAVIS PUBLISHING COMPANY. All rights reserved.



SX724

CROWN: ASK THE PRO WHO OWNS ONE

You may have puzzled about the rare availability of Crown tape recorders on the used market. Perhaps you even have a friend who refuses to part with his aging Crown at any price. Well, the typical Crown owner is not only a careful shopper, he knows when something is too valuable to lose. After all, why should he trade when his 4-year old Crown still turns out crisp, perfect recordings with greater fidelity than most brand new hi-fi tape decks?

One reason for this is that the Crown line is a professional line of tape recorders and players - that is, designed for audio pros who make their living by recording. Crown does not bow to the popular philosophy of "planned obsolescence", where the manufacturer automatically outdates last year's line by bringing out all new models each year. Indeed, since Crown first introduced modular solid state recording in 1963 (four years before any other manufacturer), the basic design has not been significantly altered - so advanced was its concept. State-of-the-art currency is maintained by incorporating new features into current models, only when they mean an advantage in either performance or price.

But even these are not the reasons a Crown owner would give for treasuring a venerable old model. He would say it's the sound - that matchless recording and playback fidelity that has become synonymous with the Crown name. For example, the SX724 4-track stereo deck at 7½ips delivers a frequency response of ±2dB 30-25,000 Hz, with hum and noise at -60dB, and maximum wow and flutter of 0.09%. (When comparing specifications, keep in mind that, unlike most hi-fi manufacturers, Crown guarantees its specs for minimum long-term performance; actual operation is often even better.)

If you would like your tape deck to record as good years from now, as when new, we suggest that you visit your local Crown dealer soon. (Just don't expect to find a used Crown - at any price.)

Made only in
AMERICA



CROWN
ELKHART, INDIANA 46514, U.S.A.

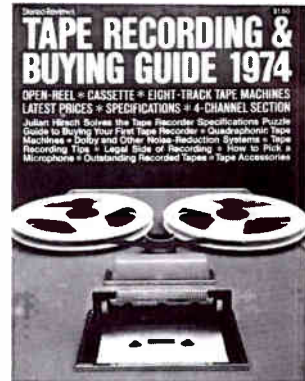

Mock-up of a combination open-reel/8-track/cassette recorder: only an artist's dream at present.

Cover Photo: Bruce Pendleton

Ziff-Davis Publishing Company
William Ziff
President

W. Bradford Briggs
Executive Vice President

Hershel B. Sarbin
Senior Vice President
Secretary and Treasurer

Philip Sine
Senior Vice President

Phillip T. Heffernan
Vice President, Marketing

Frank Pomerantz
Vice President, Creative Services

Arthur W. Butzwg
Vice President, Production

Edward D. Muhlfeld
Vice President, Aviation Division

Irwin Robinson
Vice President, Travel Division

George Morrissey
Vice President

Sydney H. Rogers
Vice President

Sidney Holtz
Vice President

Lawrence Sporn
Vice President, Circulation

Jerry Schneider
Administrative Dir., Ziff-Davis Annuals

Ziff-Davis Publishing Company
Editorial, Circulation, and Executive Offices
One Park Avenue, New York, New York 10016
212 725-3500

Midwestern Office
The Patis Group
4761 W. Touhy Ave., Lincolnwood, Ill. 60468
312 679-1100
Midwestern Adv. Manager, Arnold F. Hoffman

Western Office
9025 Wilshire Blvd., Beverly Hills, Calif. 90211
213 273-8050, 272-1161
Western Advertising Manager, Bud Dean

Japan
James Yagi, Oji Palace Aoyama
6-25, Minami Aoyama, 6-Chome, Minato-ku
Tokyo 407-1930/6821



1974 TAPE RECORDING & BUYING GUIDE is published annually by the Ziff-Davis Publishing Company, One Park Avenue, New York, N.Y. 10016. Also publishers of Stereo Review, Popular Electronics, Electronic Experimenter's Handbook, Communications Handbook, and Stereo Directory & Buying Guide.

TAPE RECORDING & BUYING GUIDE

CIRCLE NO. 4 ON READER SERVICE CARD

ADVENT CORP.	75, 97, 102, 107
195 Albany Street, Cambridge, Mass. 02139	
AKAI AMERICA, LTD.	69, 75, 82, 85, 92
2139 E. Del Amo Blvd., Compton, Calif. 90220	
AKG, North American Philips Corp.	92, 97
100 E. 42nd St., New York, N.Y. 10017	
ASTATIC CORP.	97
Conneaut, Ohio 44030	
ATLAS SOUND, Div. American Trading and Production Corp.	107
10 Pomeroy Road, Parsippany, N.J. 07054	
AUDIOTEX, GC Electronics	92, 97, 107
400 S. Wyman St., Rockford, Ill. 61101	
BASF SYSTEMS, INC.	102
Crosby Drive, Bedford, Mass. 01730	
BEYER/DYNAMIC, Revox Corp.	92, 98
155 Michael Dr., Syosset, N.Y. 11791	
BEYER/GOTHAM, Gotham Audio Corp.	92
741 Washington St., New York, N.Y. 10014	
BSR McDONALD, BSR (USA) Ltd.	82, 85
Route 303, Blauvelt, N.Y. 10913	
BSR-METROTEC, BSR (USA) Ltd.	108
Route, 303, Blauvelt, N.Y. 10913	
CAPITOL, Audio Devices, Inc.	102
100 Research Dr., Glenbrook, Conn. 06906	
CHANNEL MASTER DIV., Avnet, Inc.	82
Ellenville, N.Y. 12428	
CHEMTRONICS INC.	108
1260 Ralph Ave., Brooklyn, N.Y. 10019	
CLARK, DAVID CO., INC.	89, 92
360 Franklin St., Worcester, Mass. 01604	
COLUMBIA MAGNETICS, CBS, Inc.	102
51 W. 52nd St., New York, N.Y. 10019	
CONCORD, Benjamin Electronic Sound Corp.	75, 82, 85, 90, 108
40 Smith St., Farmingdale, N.Y. 11735	
CROWN INTERNATIONAL Subs. International Radio & Electronics Corp	70, 85
1718 Mishawaka Rd., Elkhart, Ind. 46514	
dbx INC.	108
296 Newton St., Waltham, Mass. 02154	
DOKORDER, INC., Denki Onkyo Co., Ltd.	70, 76, 82, 85
11264 Playa Court, Culver City, Calif. 90230	
DUBIE TAPE-AID CORP.	108
2305 N. Pennsylvania, Oklahoma City, Okla. 73107	
DYNACO INC., Div. Tyco Labs, Inc.	90
3060 Jefferson St., Philadelphia, Pa. 19121	
EDITALL, Elpa Marketing Industries, Inc.	108
Thorens Bldg., New Hyde Park, N.Y. 11040	
ELECTRO-VOICE, INC., Subs. Gulton Industries, Inc.	91, 98
600 Cecil St., Buchanan, Mich. 49107	
FERROGRAPH, Elpa Marketing Industries, Inc.	70, 109
Thorens Bldg., New Hyde Park, N.Y. 11040	
FISHER RADIO	76, 86, 89, 91, 93
11-40 45th Rd., Long Island City, N.Y. 11101	
GLENBURN/McDONALD, INC.	82
787 Susquehanna Ave., Franklin Lakes, N.J. 07416	

DIRECTORY OF MANUFACTURERS

If you have any additional questions about products described in this Guide, write direct to the company.

GRUNDIG ELECTRONICS	83
40 Kero Rd., Carlstadt, N.J. 07072	
HARMAN-KARDON DIV., Harman International Industries, Inc.	76, 86
55 Ames Court, Plainview, N.Y. 11803	
HEAR-MUFFS, INC.	89, 93
513 Rogers St., Downers Grove, Ill. 60515	
HEATH COMPANY	76, 83
Benton Harbor, Mich. 49022	
HITACHI SALES CORP. OF AMERICA	76, 83, 86, 91, 93, 99, 103
48-50 34th St., Long Island City, N.Y. 11101	
IRISH MAGNETIC TAPE, Div. Morhan National Sales Co., Inc.	103
270-78 Newton Rd., Plainview, N.Y. 11803	
JVC AMERICA, INC. Subs. Victor Co. of Japan, Ltd.	70, 77, 83, 86, 89, 109
50-35 56th Rd., Maspeth, N.Y. 11378	
KOSS CORPORATION	89, 93
4129 N. Port Washington Ave., Milwaukee, Wis. 53212	
LAFAYETTE RADIO ELECTRONICS CORP.	77, 83, 86, 89, 91, 93, 99, 103, 109
111 Jericho Turnpike, Syosset, N.Y. 11791	
LE-BO PRODUCTS CO., INC.	94, 109
71-08 51st Ave., Woodside, N.Y. 11377	
LONGINES SYMPHONETTE, Preferred Sounds, Inc.	103
Nursery Lane, Rye, N.Y. 10580	
MAGNESONICS CORPORATION	109
Box 127, Northridge, Calif. 91324	
MALLORY BATTERY CO.	103
S. Broadway, Tarrytown, N.Y. 10591	
MAXELL CORP. OF AMERICA	104
130 W. Commercial Ave., Moonachie, N.J. 07074	
MEMOREX CORP.	104
San Tomas at Central Expressway, Santa Clara, Calif. 95052	
MURA CORP.	90, 94, 109
50 South Service Rd., Jericho, N.Y. 11753	
NAKAMICHI RESEARCH (U.S.A.) INC.	77, 104, 109
220 Westbury Ave., Carle Place, N.Y. 11514	
NEUMANN, Gotham Audio Corp.	99
741 Washington St., New York, N.Y. 10014	
PANASONIC, Matsushita Electric Corp. of America	86, 109
200 Park Ave., New York, N.Y. 10017	
PICKERING & COMPANY, INC.	94
101 Sunnyside Blvd., Plainview, N.Y. 11803	

(Continued on page 113)

TAPE TERMINOLOGY

Acetate Base—The transparent cellulose-acetate plastic film that forms the backing for many magnetic recording tapes.

Automatic Reverse—The ability of some four-track stereo tape recorders to play the second pair of stereo tracks automatically (in the reverse direction) without the necessity for interchanging the empty and full reels after the first pair of stereo tracks is played. (See also *Four-Track Recording*)

Automatic Shut-Off—A device (usually a mechanical switch) incorporated into most tape recorders that automatically stops the machine when the tape runs out or breaks.

Azimuth Adjustment—The mechanical adjustment of a magnetic head whereby exact alignment of the head gap with a standard tape-recorder magnetic pattern is achieved. Of prime importance for optimum high-frequency performance and recorder-to-recorder playback compatibility. (See also *Head Alignment*)

Azimuth Loss—The signal loss caused by lack of alignment between the playback-head gap and the signal recorded on the tape.

Backing or Base—The flexible material, usually cellulose acetate or polyester, on which is deposited the magnetic-oxide coat that "records" the taped signal.

Bias—A constant signal or tone added to the audio signal during recording to circumvent the inherent non-linearity of magnetic systems. The best (and most commonly used) bias is a high-frequency (usually 50,000 to 100,000 Hz) alternating current fed to the recording head along with the audio signal to be recorded.

Bulk Eraser or Degausser—A hand-held (or larger) device used to erase magnetic tape without removing it from the reel. It generally produces a strong alternating magnetic field that neutralizes all previously recorded magnetic patterns on the tape.

Cartridge—A sealed plastic container that holds tape of 1/4-inch or narrower width. Designed to eliminate manual tape threading, cartridges operate on either the continuous-loop (single hub) principle or the reel-to-reel (double hub) system. Cartridge machines are usually smaller and simpler to use than ordinary open-reel units. (See also *Cassette*)

Capstan—The driven spindle or shaft in a tape recorder—sometimes the motor shaft itself—which rotates against the tape (which is backed up by a rubber pressure or pinch roller), pulling it through the machine at constant speed during recording and playback modes of operation. The rotational speed and circumference of the capstan determine tape speed.

Cassette—A type of tape cartridge operating on the hub-to-hub principle and now coming into wide use in portable and home machines.

Crosstalk—The undesired pickup of a signal from an adjacent track recorded on a tape.

Deck, Tape—A tape recorder designed specifically for use in a high-fidelity music system. It usually consists only of the tape-transport mechanism and preamplifiers for recording and playback. It does not include power amplifiers or speakers.

Decibel—Abbreviated "dB" or "db," it is a relative measure of sound intensity or "volume." It expresses the ratio of one sound intensity to another. One dB is about the smallest *change* in sound volume that the human ear can detect. (Also used to express voltage and power ratios logarithmically.)

Dolby—An electronic device or circuit that reduces the amount of noise (principally tape hiss) introduced during the recording process. It does this by boosting—in carefully controlled amounts—the strength of weak signals before they are recorded. During playback the signals (and the noise) are cut back by an exactly equivalent amount. The original dynamics are thus restored, but the noise is reduced by 10 to 15 dB. At one time found only in recording studios, simplified Dolby circuits designed especially for tape recording are now available to the audiophile as accessories or built into tape machines.

Dropout—During playback, the momentary loss of a recorded signal resulting from imperfections in the tape. These may take the form of non-magnetic foreign particles imbedded in and flush with the tape's surface. However, these imperfections are most commonly high spots on the tape surface that push the tape away from the magnetic head, thereby increasing the area affected (the "umbrella" effect).

Dual-Track Recorder—Usually a monophonic recorder with a recording-head gap that covers somewhat less than half the width of a standard quarter-inch tape, making it possible to record one track on the tape in one direction and (by turning the reels over) a second track in the opposite direction. Also known as "two-track" or "half-track."

Dub—A copy of another recording.

Dynamic Microphone—An electromagnetic pressure microphone that employs a moving coil in a magnetic field to convert sound pressure to electrical energy in a manner similar to that of an electric generator. Impedance and output are generally lower than those of the ceramic or crystal microphone types. Low impedance permits the use of longer connecting cables without high-frequency loss or hum pickup.

Dynamic Range—The voltage ratio (expressed in decibels) between the softest and loudest sounds a tape recorder or other device can reproduce without undesirable distortion in loud passages and excessive noise in soft ones.

Echo—A special facility found in some three-head tape recorders. Part of the slightly delayed output of the monitor head is fed to the recording head and mixed with the signal being recorded. The result is an "echo" of the material recorded a moment before.

Editing—The alteration of a tape recording by physical means to eliminate or replace undesirable portions, add portions not present in the original, or otherwise rearrange the original. Magnetic tape is unsurpassed for editing purposes, since it can be easily cut and spliced.

Equalization—The selective amplification or attenuation of certain frequencies. Also refers to recognized industry standards for recording and reproducing "characteristics" (such as the NAB Standard), the proper use of which can assure uniform reproduction of pre-recorded tapes and improvement of a system's signal-to-noise ratio.

Erasure—The neutralization of the magnetic pattern on tape by use of a strong magnetic field, thereby removing the recorded sound from the tape. During recording, the erase head on a recorder automatically removes any sound previously recorded on the tape just before the tape reaches the record head. (See also *Bulk Eraser*)

This material has been adapted from "101 Terms: A Glossary of Tape Recording Terms," published by the Magnetic Products Division of the 3M Company. Our thanks for their permission to bring it to you.

Extra Play—Also called “long play” or “extended play.” Refers to tape that gives more than standard playing time on a standard reel because it employs a thinner base together with a thinner but usually more responsive oxide coating, and thus more tape can fit on a reel.

Fast Forward—The provision on a tape recorder permitting tape to be run rapidly through it in the normal play direction, usually for search or selection purposes.

Feed Reel—Also called “stock,” “supply,” or “storage” reel. The reel on a tape recorder from which the tape is taken as the machine records or plays.

Flutter—Very short, rapid variations in tape speed, causing pitch and volume variations that were not present in the original sound. A form of distortion.

Four-Channel Sound—Stereo produced by four loudspeakers, each being fed a different signal. At present four-channel tape machines are equipped with special heads and electronics that enable them to play back—and sometimes record—four tracks at a time.

Four-Track or Quarter-Track Recording—The arrangement by which four different channels of sound may be recorded on quarter-inch-wide audio tape. These may be recorded as four separate and distinct tracks (monophonic) or two related (stereo) pairs of tracks. By convention, tracks 1 and 3 are recorded in the “forward” direction of a given reel, and tracks 2 and 4 are recorded in the “reverse” direction. (See also *Four-Channel Sound*.)

Frequency—The repetition rate of cyclic energy, such as sound or alternating electrical current, expressed in cycles per second (hertz or Hz) or thousands of cycles per second (kilohertz or kHz). By convention, “bass” frequencies in music extend from about 20 to about 200 Hz. “Treble” sounds are at the high-frequency extreme of the sound spectrum and may extend from 2 or 3 kHz to the frequency limit of audibility (about 18 to 20 kHz). “Middle” (or mid-range) frequencies occupy the remainder of the spectrum, from 200 Hz to about 3 kHz.

Frequency Range—The span between the highest and lowest pitched sounds that a tape recorder or other sound-system component can reproduce at a usable output or volume level.

Frequency Response—Always specified as a range, such as 50 to 15,000 Hz; but in order to be meaningful it must be further defined in terms of decibel variation from absolute flatness over a specified frequency range (e.g., ± 3 dB from 50 to 15,000 Hz). An indication of a sound system’s ability to reproduce all audible frequencies sup-

plied to it, maintaining the original balance among the low, middle (or mid-range), and high frequencies.

Full-Track Recording—Applies to quarter-inch-wide (or less) tape only. It defines track width as essentially equal to tape width.

Gain—The voltage ratio of the output level to the input level for a system or component of a system. Usually expressed in decibels.

Gap—The effective distance between opposite poles of a magnetic head, measured in microinches or microns. Especially critical for playback heads in which gaps must be narrow in order to resolve (reproduce) high-frequency (short wave-length) signals. Recording heads generally have wider gaps than reproducing heads.

Harmonic Distortion—Distortion characterized by the appearance in the output signal of spurious harmonics of the fundamental frequency. Usually expressed as a percentage of the output signal.

Harmonics—Overtones that are integral multiples of the fundamental frequency. In properly balanced a.c.-biased tape recorders, only the odd-order harmonics (primarily the third) are generated by the recording process and these are very low in amplitude.

Head—In a magnetic-tape recorder, the generally ring-shaped electromagnet across which the tape is drawn. Depending on its function, it either erases a previous recording, converts an electrical signal to a corresponding magnetic pattern and impresses it on the tape (record function), or picks up a magnetic pattern already on the tape and converts it to an electrical signal (playback function). Most home recorders have a separate erase head, but combine the record and play functions in a single unit. Professional machines and those intended for the serious amateur have separate heads for erase, record, and playback.

Head Alignment—Includes all mechanical adjustments necessary to assure proper spatial relationships between the head gaps and the tape—or, more specifically, a properly recorded tape track. It may be separated into five attributes describing correct head attitude. See Fig. 1.

Head Demagnetizer or Degausser—A device used to neutralize possible residual or induced magnetism in heads or tape guides. Unless the recorder has an automatic head-demagnetizing circuit and non-magnetic tape guides, periodic use of a head demagnetizer may be necessary to avoid addition of hiss noise to, or even partial erasure of, prerecorded tapes.

Hiss—A high sibilant sound, most often found in tape recording or tape playback. The better the tape system, the lower the hiss.

Impedance—The resistance to the flow of alternating current in an electrical circuit, generally categorized as either “high” or “low,” but sometimes given in ohms or millions of ohms (megohms). Commonly used to rate electrical input or output characteristics of component so that proper “match” can be made when interconnecting two or more devices (such as a microphone, tape recorder, and loudspeaker). Power loss or frequency discrimination can result from a “mismatch” of impedances between two units.

Index Counter—An odometer type of counter that indicates revolutions (not feet of tape), usually of the supply reel, thereby making it possible to index selections within a reel of tape and readily locate them later on a given machine.

Input Signal—An electrical voltage embodying the audio information that is presented to the input of an amplifier, tape recorder, or other electronic component.

Input—The terminals, jack, or receptacle provided for the introduction of the electrical input signal voltage into an amplifier or other electronic component.

Intermodulation Distortion—Distortion that results when two or more pure tones produce new tones with frequencies representing the sums and differences of the original tones and their harmonics.

Ips—Abbreviation for tape speed (inches per second).

Jack—Receptacle for a plug connector leading to the input or output

Fig. 1. (1) Azimuth, or skew, in which the width dimension (corresponds to track width) of the head gap is a precise 90-degree angle to the tape edge. (2) Height, in which the gap-width dimension is centered on the standard track location. (3) Tilt, in which the face of the head must be simultaneously tangent to the same degree with both edges of the tape and without distortion of either of the latter. (4) The adjustment to assure that the tape is tangent with, and contacting the specific portion of, head face containing head gap, and remains so during playing of tape. (5) Adjustment toward or away from tape to assure proper contact pressure (“wrap”) between head and tape.

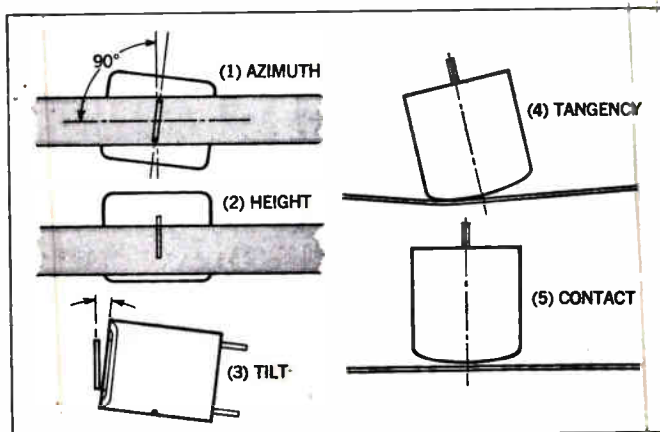

circuit of a tape recorder or other piece of equipment. A jack matches a specific plug.

kHz—Abbreviation for kilohertz, or one thousand cycles per second. For example, 19 kHz equals 19,000 Hz.

Leader and Timing Tape—Special tough non-magnetic tape that can be spliced to either end of a magnetic tape to prevent its damage and possible loss of recorded material. Either white or in colors, it usually has some type of marking that enables it to be used as a timing tape. It therefore can be spliced between musical selections to provide desired pauses in playback.

Level Indicator—A device on a tape recorder for indicating the level at which the recording is being made; it serves as a warning against under- or over-recording. It may be a light indicator or a meter. (See also *VU Meter*)

Low-Noise Tape—Magnetic tape with a signal-to-noise ratio 3 to 5 dB better than conventional tapes, making it possible to record sound (especially wide-frequency-range music) at reduced tape speeds without incurring objectionable background noise (hiss) and with little compromise of fidelity. Additional characteristics of most low-noise tapes include extremely good high-frequency sensitivity and a heavy-duty binder system for reduced ruboff of magnetic oxide and an increase in wear life over ordinary tapes.

Low-Print Tape—Special magnetic recording tape significantly less susceptible to print-through (the transfer of signal from one layer of tape to another), which results when tape is stored for long periods of time. These tapes are especially useful for "master recording" (making an original recording from which copies will be made) on professional-quality equipment.

Mil—One one-thousandth of an inch. Tape thickness is usually measured in mils.

Mixer—A device that allows two or more signal sources to be blended, balanced, and fed simultaneously into a tape recorder or amplifier.

Monophonic (Monaural) Recorder—Refers to single-channel recorders, as distinguished from stereophonic types. Current home recorders are almost all of the four-track stereo configuration.

Monitor Head—A separate playback head on some tape recorders that makes it possible to listen to the material on the tape an instant after the recording is made and while the recording is still in progress.

NAB Curves—Standard tape-recorder playback equalization curves established by the National Association of Broadcasters. (See also *Equalization*)

Noise—Unwanted electrical signals produced by electronic equipment, and rough or non-homogeneous oxide coatings on magnetic tape. Mostly confined to the extremes of the audible frequency spectrum where it occurs as hum and/or hiss, it may be reduced by good machine and tape design. (See also *Low-Noise Tape*)

Noise, Weighted—The noise measured within the audio frequency band using a measuring instrument that has a frequency-selective characteristic. The frequency sensitivity of the instrument is adjusted to correspond to that of the average human hearing response.

Open Reel—Tape systems that, for home applications, use up to 7-inch reels of tape. To start the tape, it must be threaded by hand from the full to the empty (or takeup) reel. Open-reel tape systems usually provide greater fidelity than cassette or tape cartridge systems, but that gap is closing rapidly. (See *Tape Speed*)

Output (also Maximum Output Level)—The useful signal delivered by a recorder using a particular type of tape, usually at an arbitrarily fixed level of harmonic distortion (1 or 3 per cent) and relative to the performance of a tape with standard characteristics (such as Scotch No. 111).

Oxide—The ferro-magnetic particles which, when properly dispersed in a plastic binder and coated on a backing or base, form the magnetic portion of magnetic tape. Conventional oxide particles are chemically known as gamma ferric oxide, are brown in color, acicular (needlelike) in shape, and of micron length. Less conventional



oxides have been developed that exhibit significantly different magnetic properties (and size).

Patch Cord—Sometimes called "signal lead." A short shielded wire or cable with a plug on either end (or with a pair of clips on one end) for conveniently connecting together two pieces of sound equipment such as a phonograph and tape recorder, an amplifier and speaker, etc. Not to be used for 120-volt current.

Pause Control—A feature of some tape recorders that makes it possible to stop the movement of tape temporarily without switching the machine from "play" or "record."

Playback—The reproduction of sound previously recorded on a tape. The opposite of *record*.

Playback Head—Magnetic head used to pick up a signal from a tape. Often the same head as is used for recording, but with its circuits changed by means of a record/play switch which also energizes the erase head. (See also *Head*)

Polyester Base—A plastic-film backing for magnetic tape used for special purposes where strength and resistance to temperature and humidity change are important. (Mylar is a du Pont trade name for their brand of polyester.)

Portable Recorder—Originally, any tape recorder designed for easy mobility and requiring connection to a 120-volt a.c. supply for operation. Recently the term has been applied specifically to battery-powered units that do not require external power for operation.

Prerecorded Tape—Tape recordings that are commercially available and generally embody the same material that is available on phonograph records.

Pressure Pad—A device that forces tape into intimate contact with the head gap, usually by direct pressure at the head assembly. Felt or similar material, occasionally protected with self-lubricating plastic, is used to apply pressure uniformly and with a minimum of drag on the backing (non-coated) side of the tape.

Pressure Roller—Also called "pinch roller" or "capstan idler." A hard-rubber roller that holds the magnetic tape tightly against the capstan, permitting the latter to draw the tape off the supply reel and past the heads at a constant speed. (See also *Capstan*)

Print-Through—Undesired transfer of magnetic pattern from layer to layer of tape on a reel. In most cases, will make recording unusable.

Raw Tape—A term sometimes used to describe tape that has not been used for recording. Also called "virgin" or "blank."

Reel-to-Reel—Designates those tape machines that do not use a cartridge or cassette. (See also *Open Reel*)

Rewind Control—A button or lever for rapidly rewinding tape from the takeup reel to the supply reel.

Saturation—The condition reached in magnetic tape recording where output does not increase with increased input, and hence distortion increases significantly. Useful for defining reference output levels, since it is independent of bias current.

Sensitivity—As used to describe the capabilities of raw tape, it indicates the relative output for a given input in the linear (low-distortion) portion of a tape's magnetic transfer characteristic. Sensitivity data plotted as a function of frequency (or wave length) gives frequency response, usually relative to a standard reference tape.

Separation—The degree to which two stereo signals are kept apart. Stereo realism depends on the successful prevention of their mixture in all parts of a hi-fi or tape system. Tape systems have separation capability superior to that of disc systems.

Signal-to-Noise Ratio—The voltage ratio, usually expressed in decibels, between the loudest undistorted tone recorded and reproduced by the recorder and the noise reproduced when the audio signal is reduced to zero.

Sound-on-Sound—A method by which material previously recorded on one track of a tape may be re-recorded on another track while simultaneously adding new material to it.

Splicing Block—A metal or plastic device incorporating a groove within which ends of the tape to be spliced are held. An additional diagonal groove provides a path for a razor blade to follow in cutting the tape. It makes splices very accurately using narrow-width ($7/32$ ") splicing tape. (See also *Tape Splicer*)

Splicing Tape—A special pressure-sensitive, non-magnetic tape used for joining two lengths of magnetic tape. Its "hard" adhesive will not ooze, and consequently will not gum up the heads or cause adjacent layers of tape on the reel to stick together.

Squeal—The audible noise caused by alternate sticking and release of tape. It may occur at heads, pressure pads, or guides where friction develops with the face or back side of a magnetic tape. It is largely eliminated by regular cleaning of suspected surfaces and by using a tape employing a built-in dry silicone lubricant.

Takeup Reel—The reel on the tape recorder that accumulates the tape as it is recorded or played.

Tape Guides—Grooved pins or rollers mounted between and at both sides of the tapehead assembly to position the magnetic tape correctly on the head as it is being recorded or played.

Tape Lifters—A system of movable guides that automatically prevents the tape from contacting the recorder's heads during fast forward or rewind modes of operation, thus preventing head wear.

Tape Loop—A length of magnetic tape with the ends joined together to form an endless loop. Used either on standard recorders, special "message-repeater" type units, or in four- or eight-track cartridge devices, it makes possible the repetitive playback of a recording without rewinding the tape.

Tape Monitoring—See *Monitor Head*

Tape-Transport Mechanism—The platform or deck of a tape recorder on which the motor (or motors), reels, heads, and controls are mounted. It includes those parts of the recorder other than the amplifier, preamplifier, loudspeaker, and case.

Tape Player—A unit that is not capable of recording and is used only for playing prerecorded tapes.

Tape Speed—The speed at which tape moves past the head in recording or playback modes. Standard tape speed for home use is $7\frac{1}{2}$ ips or half that speed ($3\frac{3}{4}$ ips). Speeds of $1\frac{7}{8}$ and $1\frac{5}{16}$ ips are found on some machines, but on reel-to-reel recorders are usually suitable only for non-critical voice recording. Some cartridge machines, using special tape and circuits, achieve very good results at the slow speeds. Professional recording speed (for making original master tapes of music, for example) is usually 15 ips and sometimes higher.

Tape Splicer—A device, similar to a film splicer, for splicing magnetic tape automatically or semi-automatically. Different models vary in operation, most using splicing tape; some professional units employ heat. (See also *Splicing Block*)

Telephone Pickup—Any of several devices used to feed telephone conversations into a tape recorder, usually without direct connection to the telephone line and operating by magnetic coupling.

Tensitized Polyester—A polyester tape backing that has been pre-stretched principally in the lengthwise direction to increase resistance to further stretching.

Tone Controls—Control knobs on a tape-recorder amplifier used to vary bass and treble response to achieve the most desirable balance of tone during playback.

Track—The path on the magnetic tape along which a single channel of sound is recorded.



Two-Track Recording—On quarter-inch-wide tape, the arrangement by which only two channels of sound may be recorded, either as a stereo pair in one direction or as separate monophonic tracks (usually in opposite directions).

Uniformity—In terms of magnetic tape properties, a figure of merit relating to the tape's ability to deliver a steady and consistent output level when being recorded with a constant input. Usually expressed in decibel variation from average at a mid-range frequency.

VU Meter—A "volume unit" meter that indicates audio-frequency levels in decibels relative to a fixed 0-dB reference level. The meter movement differs from those of ordinary voltmeters in that it has a specified ballistic response adapted to monitoring speech and music. Used in many home and most professional recorders to monitor recording levels and maintain them within the distortion limits of the tape.

Wave Length—In tape recording (and referring specifically to the tape magnetization created by pure single-tone recording), the shortest physical distance between two peaks of the same magnetic polarity; also, when expressed in mils, the ratio of tape speed (in ips) to recorded frequency (in kilohertz).

Wow—A form of distortion in sound-reproducing systems caused by relatively slow periodic variation in the speed of the medium (such as tape) and characterized by its effect on pitch.

Wrap—The length of the tape's path along which tape and head are in intimate physical contact. Sometimes measured as the angle of arrival and departure of the tape with respect to the head. A "good wrap" means a good tape-to-head-gap relationship. (See also *Head Alignment*) □

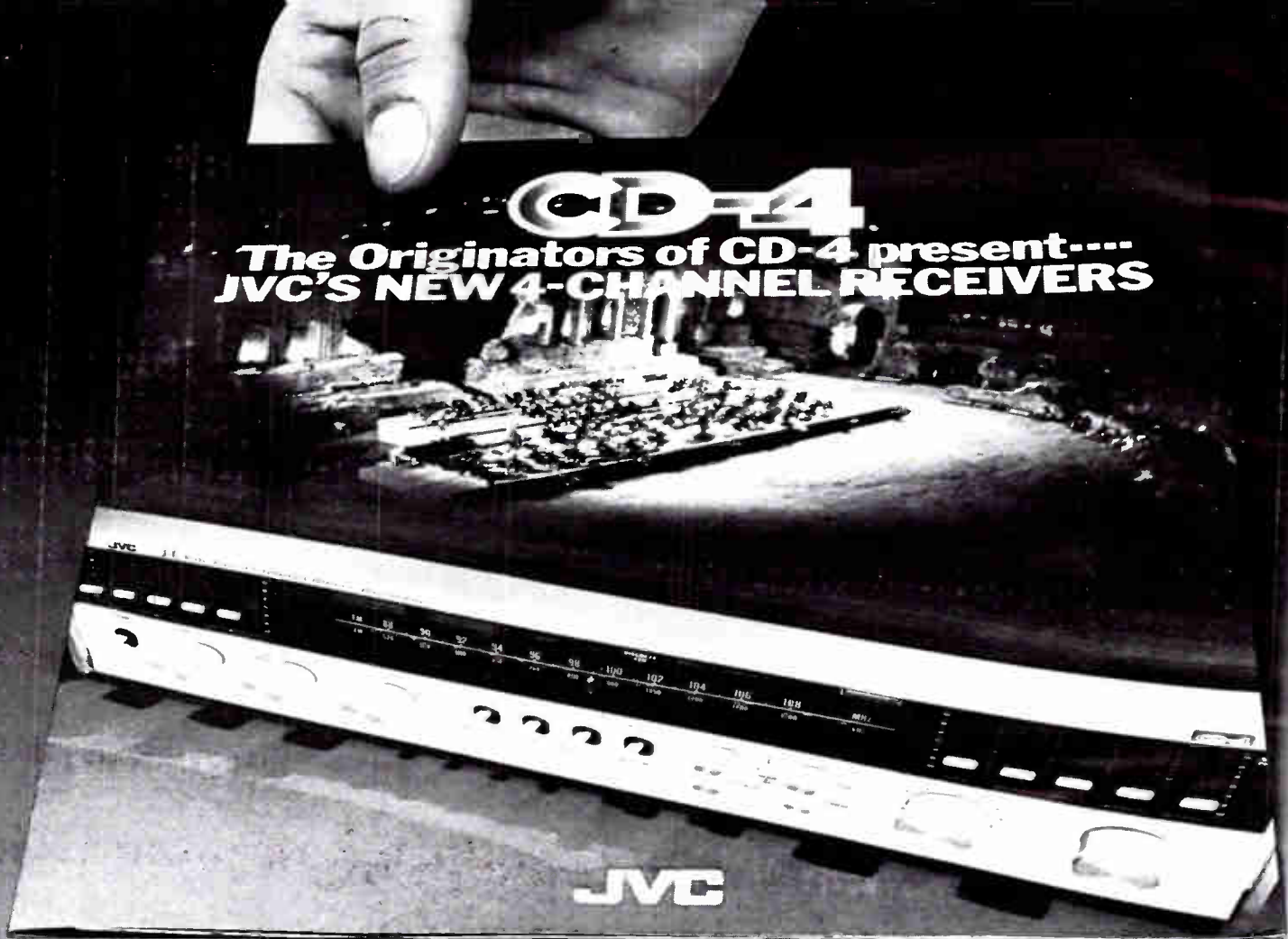

be discrete

Going quad — you'll want to know everything there is to know about 4-channel and our discrete 4-channel system, CD-4. For the ultimate in quad, JVC introduces 3 receivers designed for all of today's 4-channel sources . . . plus advanced engineering features for future 4-channel innovations, like discrete 4-channel broadcasting.

The new JVC receivers — 4VR-5436, 46 and 56 feature a built-in discrete CD-4 demodulator plus matrix decoder circuits with an automatic switching computer (4VR-5446 & 56) so you can play a mixed stack of CD-4 and matrix discs without making any adjustments. Each CD-4 receiver is equipped with JVC's patented Sound Effect Amplifiers that break the sonic spectrum into 5 bands so you exercise tonal control and complete freedom over sound in all crucial frequency ranges to compensate for room acoustics and individual tastes. Then there's JVC's Balanced Transformer Less Circuitry that links up the amps so that all four are used when playing 2-channel stereo for double the rms output power.

These are only a few of the many JVC innovations that reflect the ultimate in 4-channel engineering and performance. Get all the facts today. Write for your copy of this brochure. Use the handy coupon or visit your local JVC Hi-Fi Dealer. For his name and address, call this toll free number: 800-243-6000. In Conn., call 1-(800)-882-6500.

JVC
CD-4
 Compatible Discrete
 4-Channel Record System

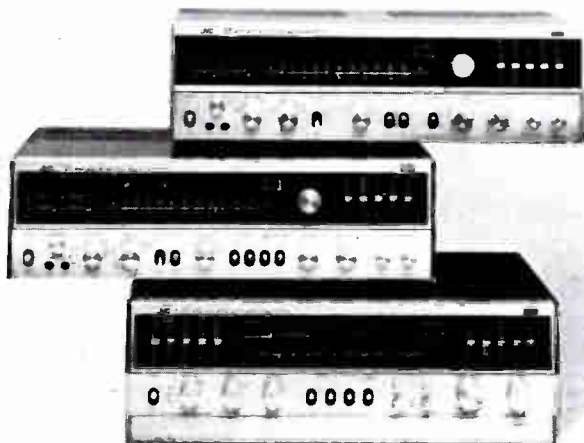

JVC America, Inc., 50-35B 56th Road, Maspeth, New York 11378
 Please send me a FREE copy of the New JVC Brochure "The Originators of CD-4 present . . . JVC'S NEW 4-CHANNEL RECEIVERS".

Name _____ Age _____
 Address _____
 City _____ State _____ Zip _____
 Dealer _____

JVC
 Hi-Fi

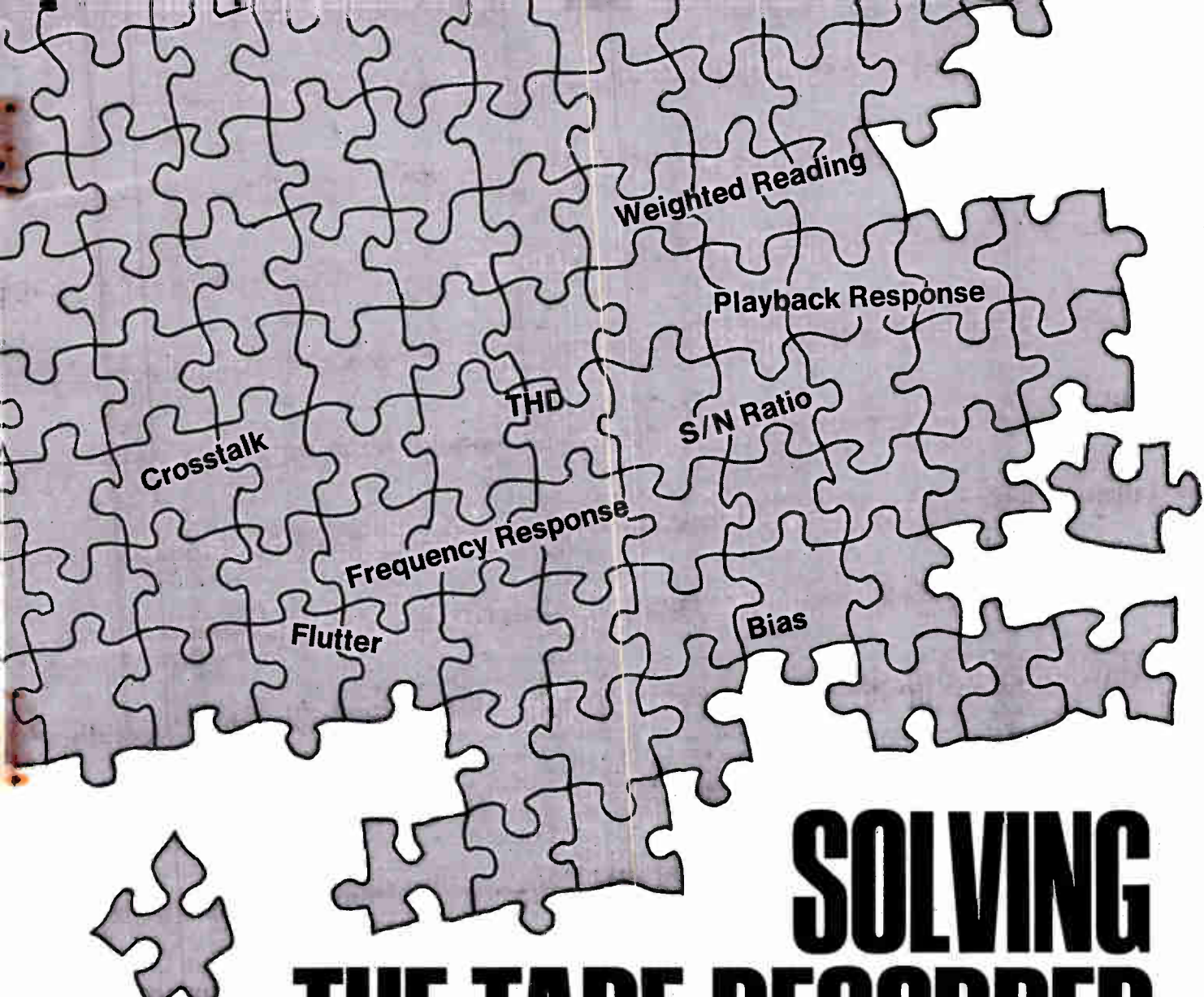

SOLVING THE TAPE RECORDER SPECIFICATIONS PUZZLE

What they mean and how to interpret them can aid you
in making a judicious buying decision

By **JULIAN D. HIRSCH**
Hirsch-Houck Laboratories

THE USE of published specifications as a basis for judging product performance is probably more practical for a tape recorder than for any other hi-fi component. This fortunate situation occurs because a tape recorder (at least, a good one) has relatively little effect on the quality of programs recorded or played back through it. The noise level may be increased somewhat and, in most

cases, there will be a small (hopefully inaudible) amount of flutter added to the sound. The frequency response and distortion existing in the incoming signal will usually determine the final quality; a properly operated recorder causes remarkably little degradation of sound.

This is in sharp contrast to loudspeakers, whose sound has thus far defied all efforts to define it in terms of measured parameters, and to amplifiers, most of which are capable of such high quality that a discussion of their sonic characteristics belongs more in the area of opinion than provable fact. The tape recorder, on the other hand, is a highly refined but nevertheless imperfect device, many of whose capabilities and imperfections can be inferred from its electrical and mechanical specifications.

Not all recorders are specified with equal thoroughness. The best machines, however, carry an impressive array of figures and technical terms, probably more confusing than edifying to a non-technical reader. Using the published specifications of a typical high-quality open-reel recorder as an outline, here are definitions and explanations of some of the specifications, with observations on those with greatest significance as well as those of little or no importance.

Most of the specifications for an open-reel recorder can also be applied to a cassette recorder. Until recently, many of the operating features of open-reel tape machines were not available in the cassette format, and there were considerable differences in some of their performance characteristics. This situation is changing rapidly and the gap (including price!) between cassette and open-reel machines is closing.

Tape-recorder performance ratings, like those of other components, are based on specified test conditions, which unfortunately are rarely specified by the manufacturer in his literature. Wherever appropriate, we will indicate the standard test conditions or those used in Hirsch-Houck Laboratories' tests of recorders for STEREO REVIEW and POPULAR ELECTRONICS where we deviate from standard practice or where no standard exists.

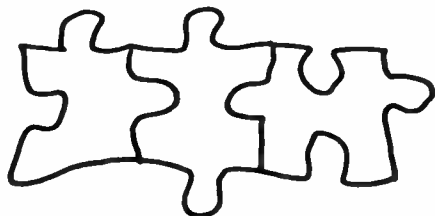

Drive System. A tape transport may use one, two, or three motors. A three-motor machine has a constant-speed motor to drive the capstan, which

determines the tape speed. Each tape reel is driven by its own torque motor which maintains a constant tape tension, within the tensile limits of the tape base material. During high-speed operation (fast-forward or rewind), the capstan does not contact the tape and one reel motor operates at high speed while the other supplies a controlled amount of "drag" to prevent tape spills.

Many inexpensive open-reel machines and most cassette recorders use a single motor which drives the capstan at constant speed and operates the reels through a system of belts and slip clutches. Single-motor transports usually have somewhat more flutter than three-motor types. However, this is also a function of the overall quality of construction and three inexpensive and poorly balanced motors could be inferior to a good single-motor transport.

Three-motor tape transports are inherently more reliable, due to the elimination of belts and clutches which require periodic adjustment or replacement. They lend themselves to remote control, via electrically actuated solenoids; many of the better three-motor machines are equipped for optional remote control. A very practical advantage of a three-motor transport is its higher speed in fast-forward or rewind, typically two to three times as fast as a single-motor machine.

Some cassette decks (and a few open-reel recorders) use two motors; one for the capstan and one driving the tape hubs through belts. At least one cassette machine has a three-motor transport.

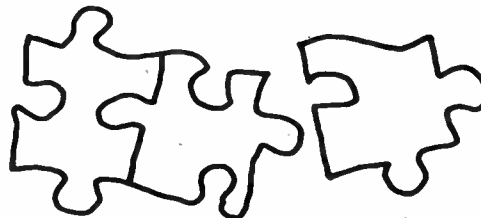

Types of Motors. To ensure constant tape speed, the capstan of a tape recorder should be driven by a constant-speed motor, such as a synchronous motor, whose speed is a function of the power-line frequency and is independent of line voltage or minor load variations. Synchronous motors are almost universally used for capstan drive in high-quality recorders, with induction motors to drive the reels. The torque and speed characteristics of induction motors are well suited to this application. Many single-motor machines also use them for capstan drive. The speed constancy of an induction motor (it can vary slightly with load changes or large line-voltage changes) is adequate for most home recording purposes, but not for professional applications, where precise timing is important.

AKAI's 4-Channel Challenge

We challenge any other manufacturer in the world to surpass the performance of AKAI's new 4-channel component combination. You can pay more. But you can't buy better.

Here they are.

First is AKAI's new AS-980 4-channel receiver. Endowed with sophisticated features for unparalleled performance. Sensitive and powerful, the AS-980 provides a continuous output of 120W (30 x 4). Plus 4 separate 4-channel modes: Discrete, SQ, RM, and built-in CD-4 with individual separation controls ... It's everything you'd expect AKAI's *ultimate* receiver to be.

Unequaled reproduction quality is yours with AKAI's new GX-280D-SS. It's a fully discrete 4-channel tape deck that's also 2-channel compatible. The utilization of 4 individual heads—including AKAI's exclusive GX glass and crystal heads (dust free and virtually wear free)—and 3 superbly engineered and balanced motors make this unit *the* professional 4-channel tape deck for recording and playback.

Together, these units are AKAI's unbeatable 4-channel challenge—providing professional 4-channel capabilities that no other equipment combination can match.

Both the AS-980 receiver and the GX-280D-SS tape deck are available at your nearest AKAI Dealer ... Whenever you're ready to make that ultimate step up. That's AKAI's 4-channel challenge.



FREE! AKAI includes with the purchase of any tape recorder, BASF low-noise, hi-output reel-to-reel tape or 8-track cartridge, or Chromdioxid™ cassette. Up to \$16.00 retail value. (Offer good only in continental U.S.)

From
AKAITM
The Innovators

Two-speed synchronous motors are widely used, since they do not require mechanical shifting of belts or drive wheels when changing tape speed (except in a three-speed machine, where this is usually done to select the lowest speed).

A few very fine tape transports use an electronically servo-controlled d.c. motor for their capstan drive. This system, although expensive, provides complete electrical control of tape speed, including such possibilities as vernier adjustment or even continuous adjustment over a wide range. It is also entirely unaffected by line voltage or frequency variations. Many cassette recorders also use servo-controlled d.c. motors, and at least one has a more sophisticated direct-drive motor operating at capstan speed.

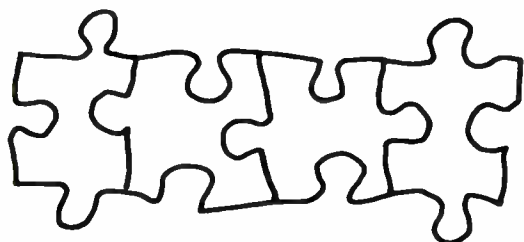

Tape Heads. Most recorders can be classified as two-head or three-head machines. As a minimum, an erase head and a combined record/playback head are required. The electronic portions of two-head recorders are switched between the record and playback functions, which accounts for this being the most popular system in low-priced recorders.

For best performance, different gap widths are required on the recording and playback heads. A combination head is usually designed to favor the playback function, which compromises some of its recording characteristics. The ideal solution is to have separate heads for the two functions and this is now the rule in all but the least expensive open-reel recorders.

The separate playback head makes it possible to monitor the program from the tape an instant after it was recorded. Separate recording and playback amplifiers are also required for this feature, which is now found on most tape decks with any pretensions of high-fidelity performance. Off-the-tape monitoring simplifies setting optimum program levels. Distortion or hiss from excessive or insufficient level shows up immediately, as well as hum and unexpected background noises.

Almost all cassette recorders have two heads, required by the Philips patented cassette design. A few have been built with separate record and playback heads, with a third head for non-critical moni-

toring or with a single head structure containing separate record and playback gaps.

Most home tape recorders, either open reel or cassette, are *four-track* (quarter-track) machines. A stereo program is recorded on two tracks in one direction, and when the reels are interchanged the second pair of tracks is recorded in the opposite direction. A number of open-reel recorders, and a few cassette machines, are designed to play in both directions without physically interchanging the reels or turning over the cassette. Usually, the reversal can be accomplished automatically with the aid of a piece of conducting tape attached to the recorded tape or by a sub-sonic tone added to the tape recording. In the case of cassettes, the stalling of the transport at the end of play initiates the reversal instead of simply shutting off the recorder.

In order for the playback head to contact the second pair of tracks in the reverse direction, it must be shifted mechanically or a second head can be used. A few recorders can also record in the reverse direction. In this case, as many as six heads may be needed.

For more demanding applications where ease of editing, maximum dynamic range, and lowest distortion are required, the *two-track* (half-track) format is used. The two tracks occupy the entire tape width and are recorded in one direction only. Many semi-professional machines are optionally available with two-track heads.

Quadraphonic open-reel recorders employ the standard four-track format, using only one direction of tape movement. Except for the additional recording and playback amplifiers, they are essentially similar to stereo machines. An alternate arrangement used in a number of open-reel recorders is a conventional three-head, four-track stereo configuration, plus a separate four-channel playback head with two additional amplifiers for playback only of four-channel tapes. At this time, no four-channel cassette recorders have reached the market, but there have been public demonstrations of both four-track and eight-track quadraphonic cassette recorders.

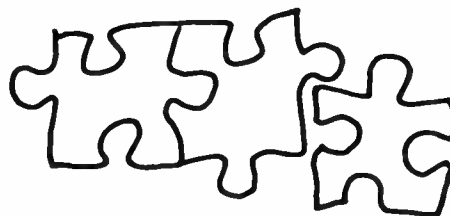

Tape Speeds. Most home tape recorders operate at $7\frac{1}{2}$ ips (19 cm/sec) and $3\frac{3}{4}$ ips (9.5 cm/sec). The higher speed provides slightly extended high-

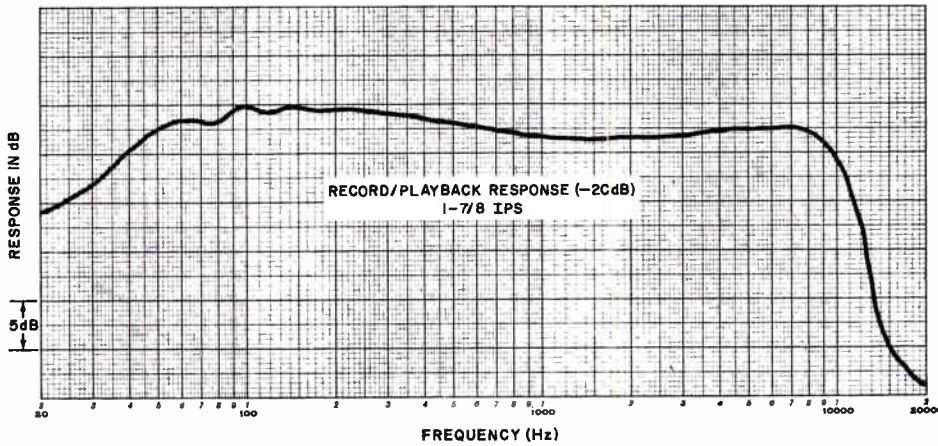

Response of high-quality open-reel recorder at 1 7/8 ips. Note that it does not compare with cassette recorder response at the same speed.

frequency response, but many of today's open-reel recorders can cover the audible frequency range with equal effectiveness at either speed. Nevertheless, a 7 1/2-ips recording is easier to edit and will almost always have a better S/N ratio, lower distortion, and lower flutter than one made at 3 3/4 ips on the same machine. Balancing this is the economy of the slower speed, which requires half as much tape for the same recording time. Some recorders also have a 1 7/8 ips (4.75 cm/sec) speed, principally for recording voice or non-critical musical material.

A few high-priced machines offer 15 ips (38 cm/sec), either in addition to the two normal speeds or replacing the slower one. This feature is usually found in recorders designed to handle 10 1/2-inch reels, which provide the same playing time as a 7-inch reel operating at 7 1/2 ips. Compatibility with tapes that have been made on professional machines, or which must be played on them, is the principal reason for using the 15-ips tape speed.

The cassette recorder operates only at 1 7/8 ips. However, by virtue of special head designs and tape formulations, many of them are capable of true high-fidelity performance. The best cassette machines compare favorably with a good open-reel recorder in listening quality.

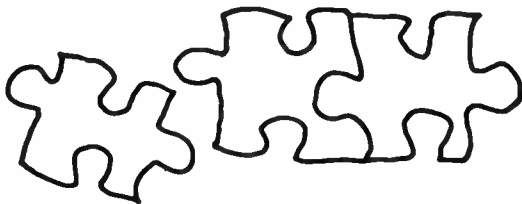

Fast Winding Time. Many manufacturers specify the time required to move a given length of tape in fast-forward or rewind. Some single-motor transports require as much as 3 minutes or more to handle a 1200-foot (370 m), 7-inch reel of standard 1.5-

mil tape. Three-motor machines typically operate about twice as fast. With thinner tape (1 mil or 0.5 mil), either 1800 feet or 2400 feet can be wound on a 7-inch reel and proportionally longer times are required.

For a given playing time, most cassette recorders are comparable to three-motor open-reel machines in their fast speed operation. Times of 75 to 90 seconds are typical for a C-60 cassette (equivalent to 1200 feet of tape at 7 1/2 ips). A few cassette transports can move a C-60 tape in 60 seconds and a couple are as fast as 40 to 45 seconds.

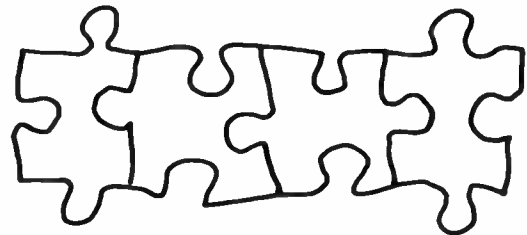

Wow and Flutter. Wow and flutter are the audible effects of frequency modulation of the program material, caused by uneven motion of the tape across the heads. When the speed fluctuation occurs at a low rate (under 10 Hz), the characteristic "wow" sound can be heard. This is especially apparent on tones of extended duration, such as the organ and the decay of piano notes. Faster rates, up to 200 Hz or more, are heard as "flutter"—a slight muddying of the sound and in extreme cases, a "gargling" quality.

Wow and flutter measurements are frequently combined into a single flutter rating, expressed as a percentage of frequency modulation. For example, a 0.2% flutter will cause a 1000-Hz tone to vary between 998 Hz and 1002 Hz. Higher and lower frequencies will be affected proportionately. The audibility of flutter depends on several factors, including: magnitude, rate, and program material (duration and frequency range of tones).

The human ear is most sensitive to flutter affecting frequencies in the vicinity of 3000 Hz, which is why a frequency of 3150 Hz is now generally used for flutter measurement. Standard test tapes are recorded with a 3150-Hz tone that has a very low intrinsic flutter (typically less than 0.02%). The tape is played on the recorder and its output measured with a flutter meter. This is essentially a calibrated FM receiver, fix-tuned to 3150 Hz, with a meter indicating the percentage of frequency modulation.

Unweighted rms flutter measurements respond equally to flutter rates over a wide range (such as 0.5 Hz to 10 Hz for flutter, 10 Hz to 200 Hz for flutter, or 0.5 Hz to 200 Hz for a combined measurement). Since the most audibly objectionable flutter rates occur between 1 and 10 Hz, current IEEE standards call for a *weighted peak* flutter measurement, emphasizing that frequency range and reducing the contribution of higher and lower frequencies to the final measurement. Some recorder manufacturers use a similar weighting curve applied to rms rather than peak measurements. These are usually identified as "Wrms" flutter measurements.

Weighted readings are always less than unweighted readings, usually by about 20 to 30%. A peak measurement will always be greater than an rms measurement. A comparison among published flutter ratings for different recorders is only valid if the same technique was used in all cases.

Cassette recorders are tested in the same manner, except that presently available test cassettes have a residual flutter level between 0.1% and 0.2%, which is more than that claimed for the latest recorder designs. To test these machines, a standard test tone is recorded and played back into the flutter meter. Some flutter is introduced when recording and some during playback, (these may add or cancel each other at different times). By taking several readings and averaging them, it is possible to establish an approximate flutter rating.

In multi-speed recorders, flutter is usually less at the higher speeds. Bi-directional recorders may show slight differences in flutter when running in forward and reverse directions due to variations in the tape tensioning and guidance system. As a rule these effects are minor.

In most cases, a flutter level of 0.1% or less will not be audible. Most of the better open-reel recorders (and a few cassette decks) can meet this requirement. Typical good cassette recorders have 0.15% to 0.25% flutter, while low-priced open-reel machines fall in the same range. With some types of music this can be audible but, in general, it would be apparent only to a critical listener. Flutter levels

exceeding 0.3% are not consistent with high-fidelity reproduction.

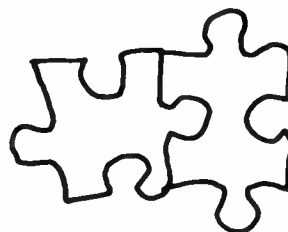

Signal-to-Noise (S/N) Ratio. The dynamic range of a tape recorder is limited by the maximum level that can be recorded and played back with acceptably low distortion and by the residual noise level in the playback output. The ratio of these two levels, expressed in decibels, is the signal-to-noise ratio (S/N). Strictly speaking, it is the signal plus noise-to-noise ratio, $(S + N)/N$, but the difference is minor in this case.

Usually, a single figure (e.g., 55 dB) is given as the S/N rating. Implicit in such a rating is a specific (but often unstated) distortion level at maximum signal input. A total harmonic distortion (THD) of 3% is generally used as a reference for S/N rating of home tape machines. Like all hi-fi components, the distortion of a tape recorder increases with program level, especially near its maximum capability. However, one cannot assume that 3% THD will coincide with a "0 dB" or other indicated maximum recommended recording level on the machine's meters. As a rule, the reference distortion will be reached with an input of +3 dB to +6 dB, allowing some reserve recording "headroom" for brief peaks that might not register on the meters. In the case of cassette recorders, the headroom is usually not more than 2 or 3 dB at middle frequencies (and sometimes considerably less) and reduces greatly at higher frequencies due to the greater recording equalization necessary to achieve a wide frequency response.

The audible noise level in the playback output consists mostly of hiss or wideband random noise. Usually there will be some low-frequency noise as well (such as power-line hum), but this is much less audible due to the characteristics of human hearing. An unweighted noise measurement responds equally to hum and hiss and may give an unduly pessimistic result in terms of the subjective character of the noise. Therefore, it is customary to "weight" the noise measurement to discriminate against the less audible low and high frequencies. Sometimes the weighting curve is specified (e.g., ANSI "A" weighting, etc.) but often it is not. As with flutter, S/N ratings can only be compared when they are based on the same reference distortion and noise weighting characteristics.



If Mozart were alive today, he'd be recording on "Scotch" brand recording tape.

Mozart was a child prodigy. He wrote a concerto at six, a sonata at seven and a symphony at eight.

a hint from the master. Use "Scotch" brand—the Master Tape.

But, even more important, he grew up to be a pro.

That's why if Mozart were alive today, he'd be recording on "Scotch" brand recording tape. Just like the pros in today's music business.

Because nearly 80% of all master recording studios use "Scotch" brand recording tape.

So next time you record something, maybe you should take



"Scotch" is a Registered Trademark of 3M Co.

The Master Tape

CIRCLE NO. 9 ON READER SERVICE CARD

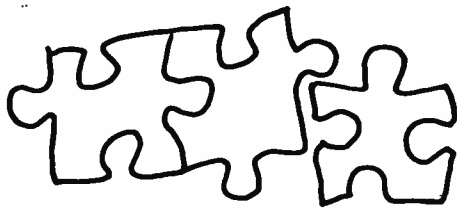

Headphone Output Level. Many recorders have outputs for low-impedance (4 to 16 ohms) stereo headphones. The output level is sometimes specified, either in millivolts or milliwatts. Without knowledge of the sensitivity of the specific headphones to be used, this is useful only for comparing recorders. As a rule, headphone volume is fairly low and might not be suitable for monitoring a recording in the presence of the live sound, even if it is adequate for normal listening. Very few recorders will deliver satisfactory volume with high-impedance phones (200 to 600 ohms), so be sure to check the compatibility of the recorder and the phones you intend to use if this is of importance.

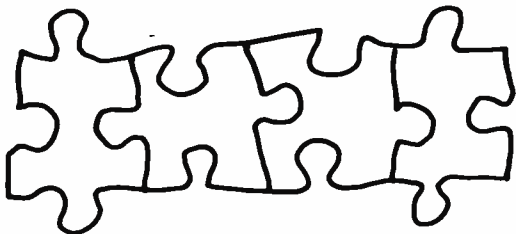

Features. Many of the specifications for most tape recorders are devoted to what might be termed *features* rather than actual performance specifications. Some items, such as input and output levels and impedances, fit into both categories. With the possible exception of microphone sensitivity and impedance, there is little likelihood of difficulty with the interface between recorder and other components. There is a large overlap between recorder-input sensitivities and amplifier tape-output levels as well as between amplifier-input sensitivities and recorder-output levels.

Most recorders made for the European market have DIN connectors, usually in addition to the standard U.S. phono connectors. The DIN is a German standard system in which the input and output signals are carried by a single connector. Compatible receivers and amplifiers have similar connectors and a single cable between recorder and amplifier makes all signal connections. The DIN input level to a recorder is much lower than standard line-input levels so that special adapters and attenuators are needed if an American-type amplifier or receiver is connected to a DIN input socket.

Reel size is standardized at 7 inches for home

recorders, but 10¹/₂-inch professional-size reels can be used on some models. Usually such recorders have a switch to adjust the reel braking for the two sizes. Automatic end-of-play shut off, including mechanical disengagement of the tape drive, is now found on almost all cassette and open-reel recorders. In the more expensive units, the "Mic" and "Line" inputs have separate recording-level controls and can be mixed. Lower priced models, including most cassette recorders, transfer the recording inputs from "Line" to "Mic" when microphones are plugged in.

Better grade cassette recorders almost universally incorporate the Dolby "B" or some other noise reducing system, such as the ANRS used in JVC recorders. A few expensive open-reel recorders are also "Dolby-ized" the price differential for this feature is considerable in this case since the tape monitoring capability requires four Dolby circuits instead of the two used in cassette recorders.

A number of open-reel recorders, as well as most of the better cassette machines, have switchable bias for different tape formulations. In the case of open-reel machines, this allows for "standard" or "low noise" tapes. With cassette recorders, the choice is between ferric-oxide and chromium-dioxide tapes, although some provide for two grades of ferric oxide as well as CrO₂. To obtain optimum results with CrO₂, it is desirable to change the recording and playback equalization as well as the bias. The best cassette recorders do this; others change only bias and playback equalization, bias and recording equalization, or simply bias alone.

Most three-head open-reel recorders permit special effects such as sound-on-sound and echo recording, usually in mono only. Except for such applications as language instruction, these are probably of minor importance. In general, they are accomplished by playing back the output of one channel into the input of the other while the second is being recorded, together with new program material. Sometimes this calls for the use of external patch cables but many machines have front-panel switches to make the necessary interconnections.

An important variation on this is the synchronized recording capability of a few deluxe open-reel recorders. These can be operated so that the recording head of one channel serves as a playback head. A performer, listening on headphones, to previously recorded material can record a second track in synchronism with the first. With a four-channel recorder, this makes possible the creation of many musical effects which are typical of commercial recordings, but have in the past been unavailable to the home recordist. □



If Mozart were alive today, he'd be recording on "Scotch" brand recording tape.

Mozart was a child prodigy. He wrote a concerto at six, a sonata at seven and a symphony at eight.

a hint from the master.

Use "Scotch" brand—the Master Tape.

But, even more important, he grew up to be a pro.

That's why if Mozart were alive today, he'd be recording on "Scotch" brand recording tape. Just like the pros in today's music business.

Because nearly 80% of all master recording studios use "Scotch" brand recording tape.

So next time you record something, maybe you should take



"Scotch" is a Registered Trademark of 3M Co.

The Master Tape

CIRCLE NO. 9 ON READER SERVICE CARD

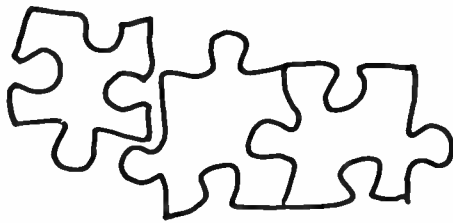

Distortion. Tape-recorder distortions are difficult to summarize in a single specification, since they vary widely with level, frequency, and the nature of the test signals. At middle frequencies, such as 1000 Hz, the THD is easy to measure. At frequencies exceeding one half to one third of the recorder's maximum response frequency, the harmonic levels in the playback will be reduced or eliminated by the machine's inherently limited response so that THD cannot be used to measure nonlinearity at the higher audio frequencies where it is most serious. Two-tone intermodulation distortion (IM) measurements are needed for this but there is no universal standard for such tests at present.

The THD distortion ratings published for tape recorders (e.g., "less than 1%") can be assumed in the absence of other information to be measured with a 1000-Hz signal recorded at an indicated level of 0 dB on the recorder's meters. This is the procedure followed at Hirsch-Houck Laboratories and we believe it to be typical of industry practice. Since distortion is also affected by tape speed, it should be specified at each operating speed.

Like many other tape-recorder specifications, distortion can also be affected by the type of tape used. Fortunately, in the case of open-reel recorders, the differences are minor, within any one classification of tape ("standard," "low noise," etc.). Most manufacturers do not specify the tape used in their own tests, but our test reports do. In the case of the cassette recorder, the tape is a critical factor and *must* be known for any meaningful interpretation of the ratings.

Difference in over-all frequency response with change of tape formulation (at fixed "Std" bias setting).

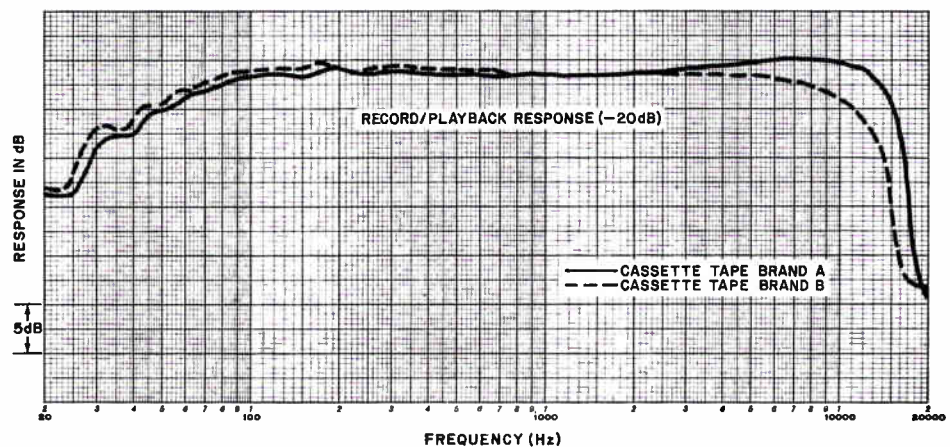

Frequency Response. A frequency-response specification, as a minimum, should include the limits (e.g., 40-20,000 Hz), the variation over that range (± 3 dB), and the tape speed ($7\frac{1}{2}$ ips, 19 cm/sec). The frequency response also depends on the tape used, but with most open-reel recorders this is not very critical.

Most tape recorders, especially at the lower tape speeds, cannot achieve their rated frequency response at maximum recording level. This is due to saturation of the magnetic tape coating at the higher frequencies which are boosted by the recording equalization and appear as a roll-off of high-frequency response. It is customary to measure frequency response at a lower level, not more than -10 to -15 dB, to avoid high-frequency saturation problems.

Recorders differ considerably in their susceptibility to high-frequency tape saturation. The recording equalization, which is a key factor, is rarely (if ever) specified and cannot be measured from outside the machine. The easiest way to judge a recorder's high-frequency headroom is to measure its frequency response at 0 dB and at a lower level such as -20 dB. The smaller the difference in high-frequency response between the two measurements, the better the recorder in this respect.

In the Hirsch-Houck Laboratories' tests, we record at -20 dB using a sweeping oscillator and play back into a chart recorder synchronized to the frequency sweep. Similar results, with less resolution, can be obtained by recording spot frequencies and readings the playback levels on a meter.

Cassette recorders present special problems. The high-frequency recording equalization is greater than that used in open-reel machines and the test level should not exceed -20 dB. One manufacturer even recommends a -30 dB level for testing his machine. For best results, the recording bias should be matched to the tape characteristics. This is im-

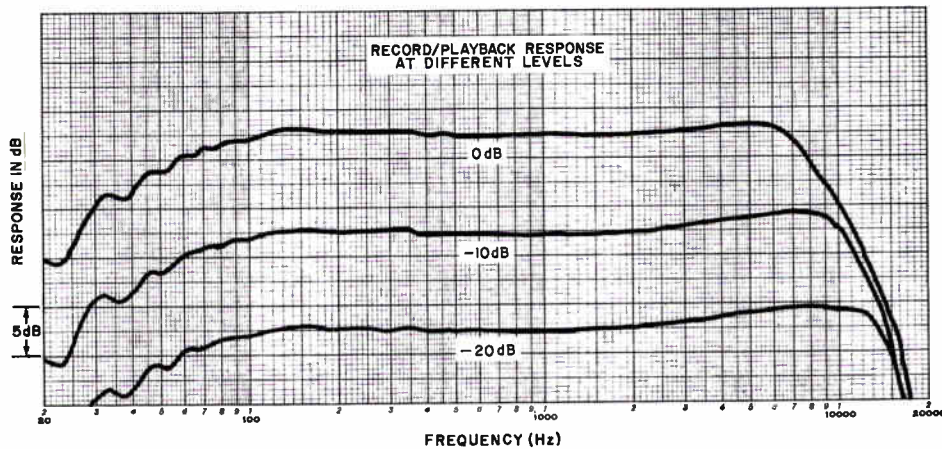

Effect of recording level on frequency response of a cassette recorder.

portant even with open-reel recorders but is absolutely vital with cassette decks. Not only must the bias be set for the type of tape, but for the specific brand. A few recorder manufacturers specify the tapes for which their machines are set up at the factory, but most do not. Except for the two- or three-position switches used to set the bias for a general category of tape, external bias adjustments are rare in open-reel recorders and almost non-existent in cassette recorders. For the consumer, this means that he must restrict himself to the specific tape used by the manufacturer in his final adjustment of the machine, unless he is competent to re-adjust the bias himself. Most recorder manufacturers will be glad to suggest suitable tapes, if they are not listed in the instruction manual. Alternatively, the consumer can try several brands and standardize on the one that sounds best.

When using chromium-dioxide (CrO_2) tape, it is only necessary to have a machine with a switch that selects the appropriate bias (and generally, equalization) for this tape. Although CrO_2 tape can only be used on recorders equipped for it, it has the advantage of being magnetically interchangeable among manufacturers. Chrome cassettes, of any

manufacture, are so nearly alike in their bias requirements that the user is not restricted to any particular brand.

A frequency-response rating of "40 to 20,000 Hz, ± 3 dB" means that the output can vary a total of 6 dB from its maximum to its minimum, within that frequency range. Without an actual response curve (rarely supplied by the manufacturer, but included in most equipment test reports), one cannot assume that two recorders with identical ratings will sound alike. One may have a rising response at the high end and will sound bright. Another, still within the ± 3 dB rating, could have a falling high-frequency response and sound subdued or even dull. Between these extremes there are an infinite number of response variations which can only be defined graphically. If the variation were small, such as ± 1 dB, the ratings could be compared with greater validity, but most recorder manufacturers use a broader tolerance to encompass the wider range of variations found within an extended range of frequencies.

Another aspect of recorder frequency response, not always specified separately, is its *playback response*. This indicates the accuracy of its playback

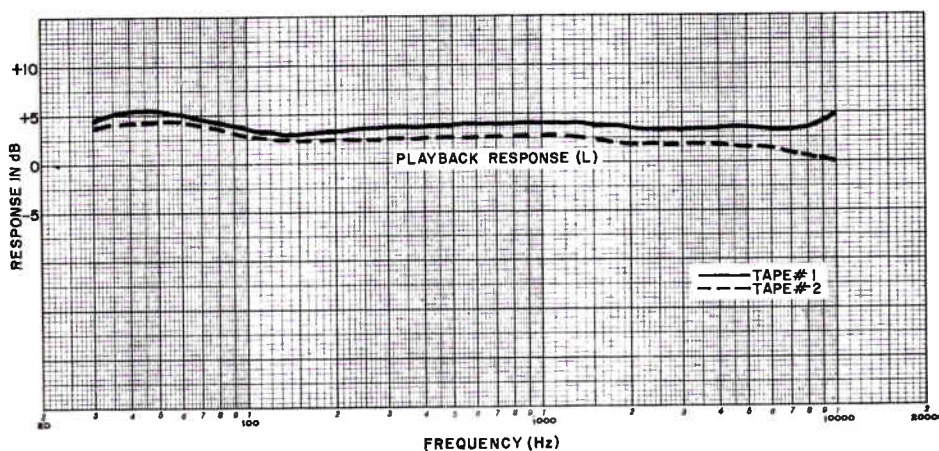

The playback response of a cassette recorder using two different samples of the same test tape.

Here is a case of two recorders with almost identical specs within the audible range: Recorder (A) response ± 3 dB, 25-14,500 Hz with rising high end (solid curve); Recorder (B) response ± 3 dB 25-13,000 Hz with falling high end (dashed curve). Compared to (A) recorder (B) would sound somewhat dull.

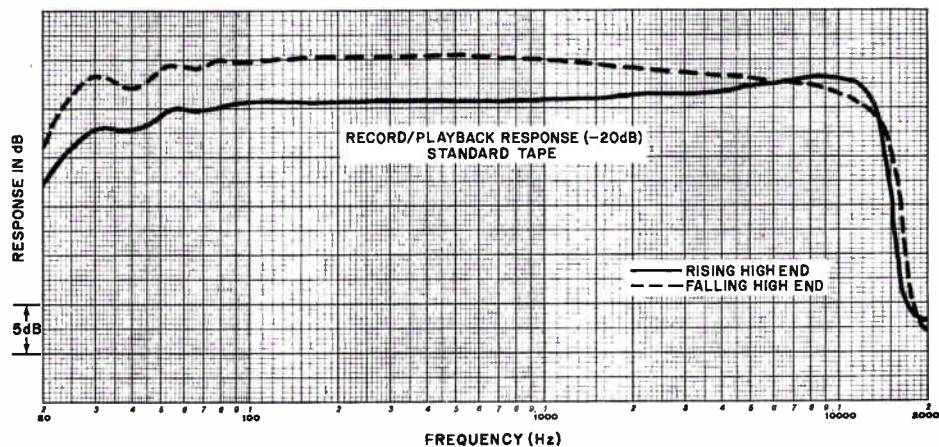

equalization and its suitability for playing commercially recorded tapes or tapes made on another recorder. Playback response is measured with a standard test tape, which usually has a relatively limited range compared to the coverage of most of today's recorders. Typically, these are 50-15,000 Hz at 7½ ips, 50-7500 Hz at 3¾ ips, and 31.5-10,000 Hz for cassettes.

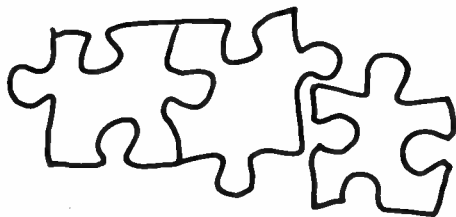

Crosstalk and Stereo Channel Separation. These are different manifestations of the same effect—leakage of a signal from one track of the tape to another. This leakage is largely a function of head design but can also occur in the wiring to the heads and in the recorder's electronics.

Both effects are usually specified at a middle frequency, such as 1000 Hz, although they vary with frequency. Crosstalk is the more serious, from a listening standpoint. It is a transfer of signal from one pair of tracks to the other. When playing the tape in the forward direction, the second pair of tracks are

being played backwards, and the crosstalk will be in the form of noise or garbled sounds, with no relationship to the desired program. When the leakage occurs between the two stereo channels in the same direction of tape travel, its only effect is to slightly dilute the audible separation of the program. Since any tape recorder is likely to have much better channel separation than the program being recorded actually requires, this "problem" is trivial. Typical specifications for a high-quality recorder might be: Crosstalk more than 60 dB at 1 kHz; separation more than 50 dB at 1 kHz.

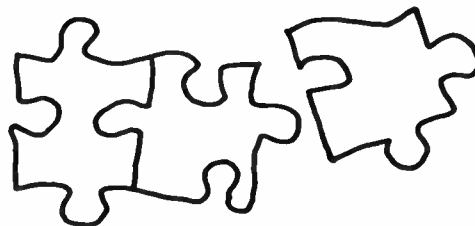

Bias Frequency. The bias frequency is often specified, but has little direct bearing on the suitability of the recorder for home service. As long as it exceeds about five times the highest frequency to be recorded, there is no need to be unduly concerned about the actual bias frequency. Most recorders have a bias frequency between 75 kHz and 125 kHz.

MISCELLANEOUS CHARACTERISTICS

There are a number of tape-recorder characteristics which are never mentioned in published specifications. Most of them are probably of little interest to the average user, who can generally obtain the information from the manufacturer if he wishes. A few items which may be meaningful to the home recordist deserve mention, however.

Meter Characteristics. The level meters of

many recorders are marked as "VU" meters, usually incorrectly. The abbreviation "VU" means *volume unit*, and the characteristics of a VU meter are detailed in an IEEE/ANSI specification. These include a frequency response within ± 0.5 dB from 25 to 16,000 Hz, and a 0 VU reading corresponding to 1 milliwatt at a specified impedance (usually 600 ohms). When a signal which will result in a 0 VU reading is applied, the meter pointer should

read 99% of that reading in 0.3 second, with an overshoot of 1 to 1.5%, and should return to its rest in approximately the same time when the signal is removed.

Typical home-recorder meters rarely have the ballistic characteristics of a VU meter and are more correctly described as "dB meters" (assuming that their dB calibrations are correct, which is not always the case). In our recorder tests, we apply toneburst signals to check the response of the meters. Some overshoot considerably but most are too slow and read substantially less than a true VU meter on transient signals.

It is important to know the general response characteristics of a recorder's meters to be able to allow sufficient reserve range for brief program peaks. Most meters, including true VU meters, are average-responding devices and will not indicate the peak level of the signal. Some recorders have peak-reading meters, able to respond in a few milliseconds. In some units, the meters read the outputs of the recording amplifiers thereby including the effect of the equalization and reducing the likelihood of over-recording a signal having strong high-frequency content.

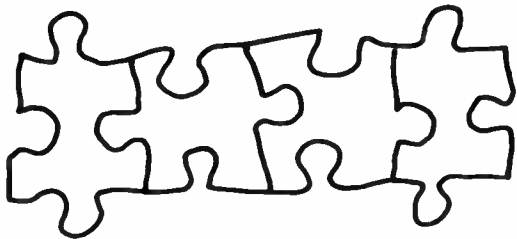

Limiters and Automatic-Gain-Control Circuits. Many recorders use electronic circuits to establish correct recording levels. In a number of cassette recorders, and a few open-reel machines, these are *automatic-gain-control* (a.g.c.) circuits, which may entirely replace manual recording level controls. An a.g.c. circuit operates the recording inputs at maximum gain in the absence of a signal and quickly reduces the gain to accommodate any signal level. Although the attack is fast (a few milliseconds), the release time (return to higher gain) is much slower, typically a number of seconds. Such a.g.c. systems are convenient for recording conferences where voices may originate at different distances, but are unsuitable for recording music. During pauses in the program, the upward surge of background noise is noticeable and frequently objectionable.

Limiters, found in some of the better cassette and open-reel recorders, are quite different in their effect. Although a limiter, as used in home recorders, may be very similar in its attack and release times to

an a.g.c. system, it does not come into operation at normal program levels. The recording-level controls are set in the usual manner and, under most conditions, the limiter circuit has no effect. However, if the level exceeds the recorder's rated maximum (usually +1 to +2 dB on its meters), the limiter reduces the gain almost instantly. If the recording level is set too high, the result may be quite similar to an a.g.c. system, with "pumping" and audible variation of background noise. With correct levels, the action of a good limiter will not be detectable yet it can provide effective insurance against distortion from unexpectedly high signal levels.

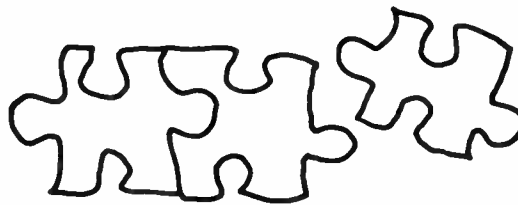

Microphone Input Circuits-Dynamic Range.

The noise level of a good open-reel recorder, or a Dolby-equipped cassette recorder, is negligible for most practical purposes. When taping from records or FM radio, the noise in the input signal will usually exceed that introduced by the recorder.

A notable exception is the case where microphones are used for a "live" recording. Assuming that ambient background noise is low and that precautions have been taken to eliminate hum pickup, the noise (hiss) in the recorder's microphone preamplifiers will often be unpleasantly audible, especially when operating near maximum gain. Although no recorder manufacturer we know of specifies the noise contribution of his microphone amplifiers, our laboratory measurements include a check of the increase in noise at maximum microphone gain as well as at lower settings. Some recorders will increase the noise by only 3 dB or less through the microphone inputs (as compared to the line inputs), while others add 20 dB or more.

Another important consideration, frequently omitted from recorder specifications, is the maximum signal capability of the microphone amplifiers. It is entirely possible on many recorders, when recording high-level performances such as rock groups, to overload the microphone amplifiers. The distortion this produces is independent of the gain-control settings or the meter readings. Obviously, the more input signal a recorder can handle without distortion, the less likely this is to occur. An external microphone attenuator can be used to prevent this and some recorders have built-in microphone attenuators.

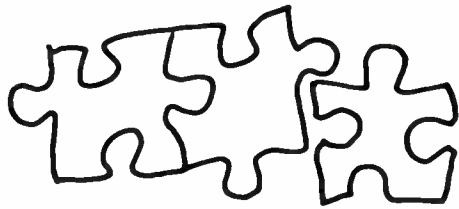

Headphone Output Level. Many recorders have outputs for low-impedance (4 to 16 ohms) stereo headphones. The output level is sometimes specified, either in millivolts or milliwatts. Without knowledge of the sensitivity of the specific headphones to be used, this is useful only for comparing recorders. As a rule, headphone volume is fairly low and might not be suitable for monitoring a recording in the presence of the live sound, even if it is adequate for normal listening. Very few recorders will deliver satisfactory volume with high-impedance phones (200 to 600 ohms), so be sure to check the compatibility of the recorder and the phones you intend to use if this is of importance.

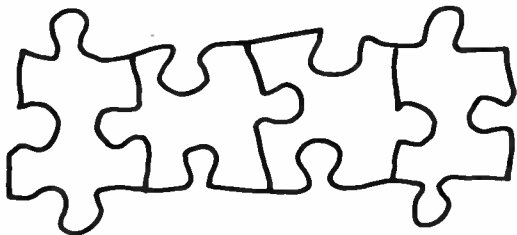

Features. Many of the specifications for most tape recorders are devoted to what might be termed *features* rather than actual performance specifications. Some items, such as input and output levels and impedances, fit into both categories. With the possible exception of microphone sensitivity and impedance, there is little likelihood of difficulty with the interface between recorder and other components. There is a large overlap between recorder-input sensitivities and amplifier tape-output levels as well as between amplifier-input sensitivities and recorder-output levels.

Most recorders made for the European market have DIN connectors, usually in addition to the standard U.S. phono connectors. The DIN is a German standard system in which the input and output signals are carried by a single connector. Compatible receivers and amplifiers have similar connectors and a single cable between recorder and amplifier makes all signal connections. The DIN input level to a recorder is much lower than standard line-input levels so that special adapters and attenuators are needed if an American-type amplifier or receiver is connected to a DIN input socket.

Reel size is standardized at 7 inches for home

recorders, but 10½-inch professional-size reels can be used on some models. Usually such recorders have a switch to adjust the reel braking for the two sizes. Automatic end-of-play shut off, including mechanical disengagement of the tape drive, is now found on almost all cassette and open-reel recorders. In the more expensive units, the "Mic" and "Line" inputs have separate recording-level controls and can be mixed. Lower priced models, including most cassette recorders, transfer the recording inputs from "Line" to "Mic" when microphones are plugged in.

Better grade cassette recorders almost universally incorporate the Dolby "B" or some other noise reducing system, such as the ANRS used in JVC recorders. A few expensive open-reel recorders are also "Dolby-ized" the price differential for this feature is considerable in this case since the tape monitoring capability requires four Dolby circuits instead of the two used in cassette recorders.

A number of open-reel recorders, as well as most of the better cassette machines, have switchable bias for different tape formulations. In the case of open-reel machines, this allows for "standard" or "low noise" tapes. With cassette recorders, the choice is between ferric-oxide and chromium-dioxide tapes, although some provide for two grades of ferric oxide as well as CrO₂. To obtain optimum results with CrO₂, it is desirable to change the recording and playback equalization as well as the bias. The best cassette recorders do this; others change only bias and playback equalization, bias and recording equalization, or simply bias alone.

Most three-head open-reel recorders permit special effects such as sound-on-sound and echo recording, usually in mono only. Except for such applications as language instruction, these are probably of minor importance. In general, they are accomplished by playing back the output of one channel into the input of the other while the second is being recorded, together with new program material. Sometimes this calls for the use of external patch cables but many machines have front-panel switches to make the necessary interconnections.

An important variation on this is the synchronized recording capability of a few deluxe open-reel recorders. These can be operated so that the recording head of one channel serves as a playback head. A performer, listening on headphones, to previously recorded material can record a second track in synchronism with the first. With a four-channel recorder, this makes possible the creation of many musical effects which are typical of commercial recordings, but have in the past been unavailable to the home recordist. □

YOUR FIRST TAPE RECORDER!

Guidelines to making a decision you won't regret

By Ralph Hodges



ANYONE about to buy his first tape machine must first choose from one of three tape formats available: open-reel, cassette, or eight-track cartridge.

The three formats were developed at different times and were intended for different, rather specific purposes (and I should explain that "format" refers both to the forms in which the tapes come to you *and* to the non-interchangeable machines on which they are played). *Open-reel*, which is the format that usually comes to mind when someone says "tape recorder," was the first of the existing configurations. The open-reel tape is wound in a pancake shape on a plastic reel similar to home movie-film reels. And, like such film, the tape in an open-reel machine has to be physically handled. You must unwind a length from the "supply" reel, thread it through the tape machine's guides and across its tape heads, and finally attach it firmly (usually by winding one or two layers over the loose end) to the hub of the "take-up" reel.

Open-reel machines for consumer use are almost always *four-track*, which is to say that they are designed to record and play back two-channel stereo in both directions of the tape—one stereo pair running in one direction and a second pair running in the other, as shown. Utilizing the available space in this way saves tape, and the other two formats follow the example set by open-reel, though in different ways. (Discrete *four-channel*, or quadraphonic, open-reel tapes are *not* recorded in both directions; all four tracks are played in one pass by the special machines equipped to handle them.)

Some open-reel tape machines require that you switch the reels around in order to play or record in the reverse direction. Others—the automatic-reversing types—are designed to reverse direction when all the tape has been transferred from the supply reel to the take-up reel (completion of the forward side), winding the tape back onto the original supply reel as side two is played.

The eight-track and cassette formats came later. They are both "cartridge" systems, with the tape being enclosed in a plastic shell—ideally, you should never have to touch it. Eight-track cartridges

were initially designed for use in automobiles, where disc recordings and open-reel tape would be impractical. These cartridges are somewhat larger than cassettes and contain only one reel on which a long continuous loop of tape is, remarkably, wound and *unwound* simultaneously. You simply plug an eight-track cartridge into the player or recorder, and it does the rest. As its name implies, the cartridge has eight parallel tracks—it accommodates four stereo programs or, more recently, two four-channel programs. But the tape never reverses direction; instead, the tape head in the machine is periodically and automatically shifted to intercept the various sets of tracks.

Cassettes and the machines on which they are played were first envisioned as low-fidelity devices for recording speaking voices only, but somewhere along the line the cassette became a serious music medium. Cassette tapes themselves are small—a bit larger than a pocket address book. In their layout they resemble a miniaturized open-reel system, except that the two reels (simple hubs, actually) are *within* the plastic shell, and the tape is accessible only through openings along an edge of the housing. Cassettes are also recorded and played in two directions and must usually be flipped over for side two, although some automatic-reversing machines for home and automobile use are available.

Now that you know what the three formats are, let's look at their respective merits for your modest—or elaborate—tape-recording purposes. The considerations will be: fidelity, suitability, flexibility, reliability, and portability. Maybe one of these points will be a deciding factor in your case; maybe others will intrigue you and encourage you to dig deeper.

● **Fidelity.** If you plan to do most of your listening to commercially prerecorded tapes, *their* fidelity will determine the limits of the fidelity you get in playback. It is rare that audiophiles are overwhelmingly impressed by the sound of a prerecorded tape produced by one of the big duplicating companies. In general, prerecorded tapes, at their infrequent best, sound almost as good as discs. Of the three

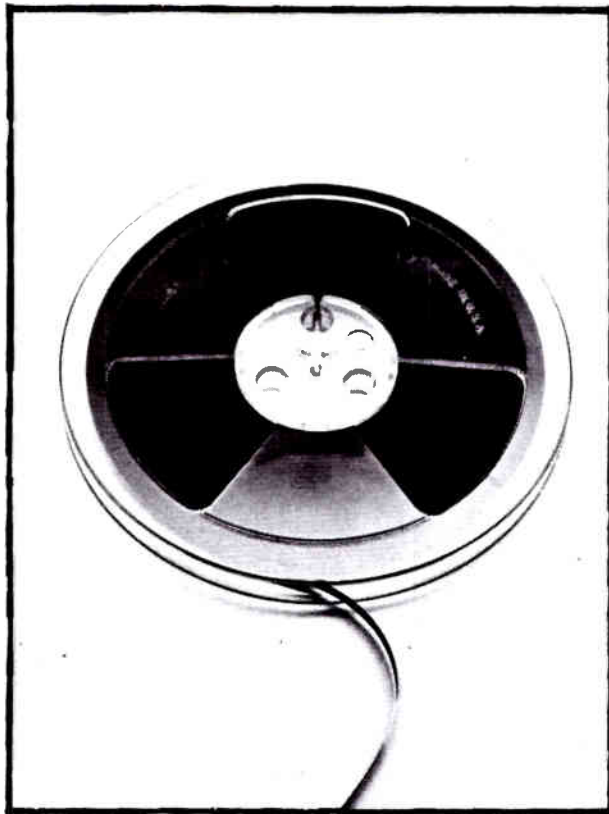

Open-reel tape is wound in a pancake shape on a plastic reel similar to home movie-film reel.

formats, open-reel prerecorded tapes are probably still the best in overall frequency response, noise level, dynamic range, and so forth. Cassettes rank second, and eight-track cartridges are a somewhat distant third. This is no necessary reflection on the *potentials* of the formats—or how they might sound if you make your own tapes. It's simply the way things are with the prerecorded products.

A prerecorded tape that doesn't have hiss is rare in *any* format. Dolby B processing, the hiss-reducing treatment for tape introduced to consumers some years ago, is available on a number of cassette releases and (so far) on a few open-reel prerecorded tapes. According to Ampex, it will soon be offered on eight-track cartridges. This process is the most effective way of dealing with hiss on your tapes, but you will have to pay more for a tape machine with Dolby circuits or buy a separate, add-on Dolby unit. Equipment with built-in Dolby circuits is much more expensive in the open-reel format than with cassettes, probably because the open-reel machines generally use *four* Dolby modules (to encode for recording and simultaneously to decode the monitor-head output). Cassette machines, on the other hand, almost all use *two* Dolby modules that are switched to encode during recording and to decode during play. The exceptions are the very

expensive cassette decks (about \$700 and up) with full-response monitor heads.

There are no Dolbyized eight-track cartridges available at this moment (their introduction has just been announced by Ampex, however), but there is a Dolby-equipped eight-track record/play deck (from Wollensak) that will enable you to make your own Dolbyized cartridges. I would expect the results to far outshine any commercially recorded cartridge. And the same would be true for tapes you make on your own Dolbyized equipment in the two other formats as well. Open-reel and even cassette recordings that are home-made on the best equipment are often audibly perfect. There are, however, certain unavoidable inconveniences in recording on eight-track cartridges, and these will be discussed later on.

● **Suitability.** None of the three formats is compatible with any other, which means that you cannot play a cartridge on an open-reel or cassette machine. (However, there are a few tape decks available that have special *separate* facilities for two of the three formats. There are also adaptors that will permit cassettes to be plugged into eight-track players, but they seem somewhat unreliable at best.) Therefore, you must think about the suitability of a particular tape format to your present and future needs and way of life. For example, if you bought your present automobile with a tape player already installed, chances are it's an eight-track unit, and this is a persuasive argument for owning a home eight-track recorder/player to generate new material for car play and to be able to play at home the tapes you have acquired to listen to while driving. But if you're starting from scratch, an *automatic-reversing* cassette player is fully as convenient (and safe) to use in a car—and *four* cassettes will fit in the space occupied by *one* eight-track cartridge. Also, with a cassette deck connected to your high-fidelity system, you'll be able to make tapes to play either at home or in your car.

One question you'll have to deal with sooner or later is whether to buy a tape *recorder* or a tape *deck*. A *recorder*, in current parlance, is a machine that comes complete with its own amplifiers and speakers—in other words, a self-contained music system. A *deck* is designed to be connected to an existing music system (appropriate plug-in jacks must be provided on the amplifier or receiver), and it will never make a sound until it is. Recorders and decks are available in all three formats. (It might also be mentioned that many recorders can function as decks as well if they are connected to an external music system through special output jacks; in this

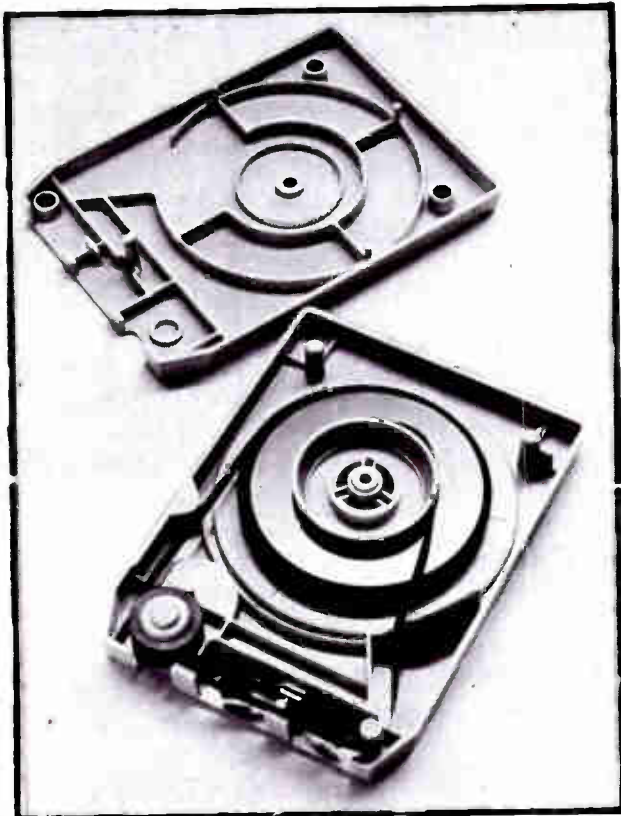

Inside view of the 8-track cartridge with its single reel and continuous loop of recording tape.

mode of operation the recorder's own built-in speakers and amplifiers are simply by-passed.)

Four-channel prospects enter into the question of suitability to your needs. Should you want four-channel sound, which of the formats is best for you? In the eight-track and open-reel formats, four-channel recording is now a reality. You can buy discrete quadraphonic eight-track tapes and a few open-reel quadraphonic releases, as well as special machines to play them and even to record your own. But be warned that the equipment to play the *Dolbyized* discrete quadraphonic open-reel tapes that are emerging is going to be expensive.

Philips, the firm that licenses the cassette format, endorses discrete four-channel cassettes only in a form that is technically difficult to cope with. It involves four parallel tracks running in one direction, and four tracks running the other—and eight-track cassette, in other words. The technical problem arises because the track width of an eight-track cassette is half that of the eight-track cartridge.

There are other factors that could influence your buying decision. For example, the availability of the kind of music you like in one format or another. Eight-track offers the largest selection of prerecorded tapes, especially for youth-oriented music. In contrast, reports are that sales of prerecorded cas-



Cassettes are more like open-reel systems except two reels are housed within a plastic shell.

ettes last year amounted to a considerably smaller share of the prerecorded tape market than the year before. Prerecorded open-reel tapes, although constituting the smallest library, have been growing in popularity since Dolby-ized offerings were introduced.

If you are concerned about the availability of the kind of music you like prerecorded for a tape format you are considering, a quick check of the Schwann catalog will reassure (or discourage) you.

● **Flexibility.** The idea behind the first high-fidelity cassette deck was to approach the same performance and flexibility afforded by open-reel equipment, but in a form that was more compact and easier to use. By and large, this goal has been reached. Cassettes are generally available in playing times from 15 to 90 minutes in each direction of tape travel, which nicely corresponds to what can be recorded on the various lengths of open-reel tapes (on 7-inch reels at $7\frac{1}{2}$ inches per second). Cassettes are much easier to handle (threading some open-reel machines requires a knack that some master more quickly than others), and dozens of them will fit in an ordinary shoe box. Editing a cassette tape is considerably more difficult than editing an open-reel recording, but some people seem willing to attempt

it. Since the prices of the best cassette decks generally end where those for good open-reel decks begin (somewhere around \$300), the two formats do not really compete on the basis of cost.

Look at the eight-track cartridge and you'll immediately see that it's a system basically intended for *playback*. Cartridge recording is a clumsy business, and for this reason there have been few cartridge records on the market until recently. The longest-playing cartridges I know of run 94 minutes in four segments of 23½ minutes each. Every 23½ minutes the endless loop of tape in the cartridge completes one full circuit, and the tape head shifts automatically, with a "chunk," to engage another set of the parallel tracks on the tape. It does this three times (once for the Q-8 four-channel cartridges), and then you're back where you started. The cycling process is the same for recording as for playback, and since there is a break in the program every time the tape head has to reorient itself, the recordist has to keep careful track of the passing minutes if he doesn't want his music interrupted. He can't just look (as he can with cassettes and open-reel) to see whether he is running out of tape—even if he *could* see it, which he can't, he couldn't tell. A timer is therefore required. Some Wollensak and JVC eight-track recorders, incidentally, have such timers built in.

Although most eight-track decks provide a fast-forward speed, you can't reverse an eight-track cartridge. Thus, backtracking for editing or any other purpose is simply out of the question. To return to a specific point on the tape you must fast-forward along through the entire loop until the spot comes up again.

All this has effects on the prerecorded product as well. A disc's worth of music offered in eight-track form has three interruptions instead of the disc's one. This is okay for popular songs, but disturbing for long classical works such as Beethoven symphonies or Strauss tone poems. On one such cartridge I heard recently each track-switching break was preceded by an aesthetically disturbing fade-out—then a fade-in after the track switch! In a car one could perhaps live with such anti-musical distractions, but not in the home.

● **Reliability.** According to reports, cassette and eight-track troubles are most frequently caused by the tape and its container, and open-reel difficulties generally result from failures of the transport mechanism. Whatever the causes, the malfunctions manifest themselves in two ways: mechanically (the moving parts become erratic or inoperative) and electrically (one or more channels become weak,

distorted, or noisy, or go dead altogether). Electrical problems can occur with any format, at any time; it's up to the designer of the equipment to foresee and prevent them. But tape-motion troubles, if they are caused (as happens with cassettes and cartridges) by the tape pack itself, reflect on the whole format. Open-reel has tape-pack problems of its own—warped reels and, sometimes, rippled tape edges. But transferring open-reel tape to a new reel is easier than prying open a cassette or cartridge to rescue the jammed tape inside.

Tape jamming within the plastic container has plagued cassettes since their beginning, and only in the past year or so has it seemed that jamming will diminish to a "normal" defect rate. Eight-track cartridges have a special problem. Since layers of tape wound on the reel must be free to slide past each other, the tape has to be treated with some kind of dry lubricant, and it appears that in time the lubricant can wear out (or off). If there is a way to avoid this, it is simply to buy only cartridges of the very highest quality—good advice, incidentally, for any of the tape formats. The tape industry does offer warranties on its products.

● **Portability.** This is a consideration that will interest only certain readers. Some are looking for carry-along entertainment, and for them cassettes and cartridges should be equally suitable. The size of a portable tape player is mostly determined by the size of its speaker. There are some ultra-small cassette portables hardly larger than the cassette itself.

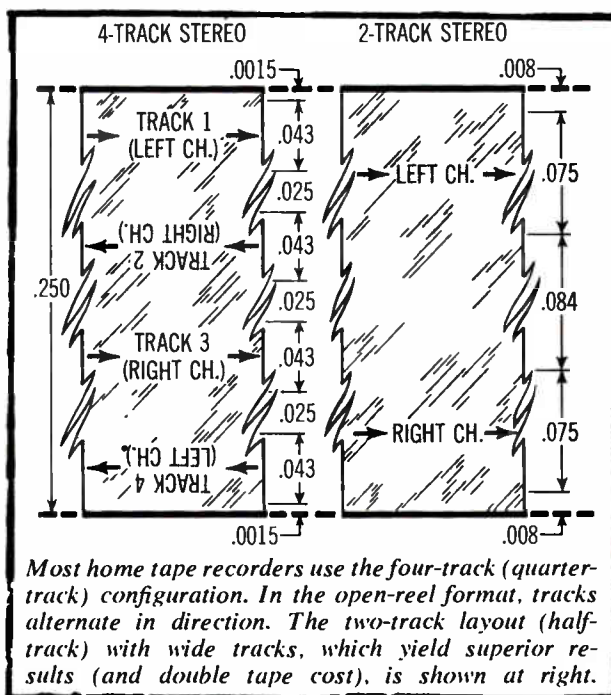

HOW WILL YOU USE YOUR TAPE RECORDER ?

BEFORE buying a tape recorder, take the time to critically examine your own personal requirements. The most important question is: what do you plan to do with the recorder?

For Playback Only

To play commercially recorded open-reel tapes, a two-speed ($3\frac{3}{4}$ and $7\frac{1}{2}$ ips), four-track recorder is necessary. Special recording facilities (sound-on-sound, microphone mixing, etc.) are not required. In fact, no recording capability at all is needed, but the "playback only" tape decks of a few years ago are no longer being manufactured, at least for home use.

Since a growing number of commercial open-reel tape releases are being made with Dolby "B" processing, a simple accessory Dolby noise-reducing unit might be advisable. Built-in Dolby circuits are only found in a few rather expensive machines. The main requirements for the recorder itself are reasonably low flutter and noise level, plus accurate playback equalization. Most moderately priced tape decks are perfectly satisfactory for this purpose. Many recorders are available with built-in playback amplifiers and speakers (sometimes detachable for better stereo listening). These are never comparable in quality to even a low-priced hi-fi system. In any case, the inherent limitations of high-speed duplicated commercial tapes make "state-of-the-art" recorder performance unnecessary.

Most of these comments apply equally to cassette recorders, except that Dolby circuits are usually built into machines selling for more than \$200. For serious listening to cassette recordings, a Dolby-ized playback system is imperative. Many, if not most, current cassette releases are Dolby-ized. For listening only, there is even a Dolby-

equipped cassette player (not a recorder) available from one manufacturer.

For Recording and Playback

Many people—perhaps the largest group of tape recorder users—dub phonograph records and FM broadcasts to build up a tape library. As with the "listening only" tape unit, no special recording flexibility is required for this, but a good overall record/playback frequency response is desirable. The tolerable limits of recorder flutter, distortion, and noise level depend somewhat on the quality of the associated record-playing equipment and FM tuner. An unweighted flutter of 0.2% or less, and a S/N ratio of 55 dB or better, combined with a useful frequency range from 30 Hz to 14 or 15 kHz, will usually result in a tape copy virtually indistinguishable from the original program. For certain types of music, such as piano, it's desirable to have less than 0.1% flutter, but this also depends on individual hearing acuity.

In practice, most medium-priced open-reel recorders, as well as most over-\$200 cassette machines, are capable of an excellent job of disc or FM dubbing. In the over-\$300 price range, one can expect "perfect" results in this application from most open-reel and cassette recorders.

The majority of home tape-recording requirements fall into one of the two preceding categories.

If "live" recording is your goal, an open-reel recorder is most desirable, since its tapes can be edited. The quality and price of the recorder you choose must be dictated by the specific nature of your recording needs. For example, no recorder can sound any better than the microphones will allow, and good microphones are expensive. One should be prepared to spend about half as much for the microphones as for the recorder, for a comparable quality of sound.

For anything more than casual recording, even the more expensive recorders may lack the desired input flexibility and require an external mixer. Costs escalate rapidly—not so much in relation to audible performance as operating flexibility. Clearly, each case must be evaluated individually.

Also, you can fit more cassettes than cartridges into your coat pocket. However, if you already have a large collection of cartridges, this might influence your choice and make you decide on one of the portable eight-track players.

Other readers may want to make high-quality recordings on location. The best—and in some cases the smallest—machines for this purpose are the special-application, battery-powered open-reel units (Nagra, Stellavox, Uher, and so forth) designed for recording film soundtracks and other professional uses. Ironically, the smaller they are, the more horrendously expensive they are. There are a few pocket-size battery-operated cassette portables

that do a surprisingly good job of recording music with their built-in microphones. And Sony makes a *stereo* portable cassette recorder with built-in Dolby circuits and provisions for chromium-dioxide tape.

The foregoing discussion of the present state of tape recording and its formats should provide you with the basic information you need in choosing the *format* for a first tape recorder. It seems clear that all three formats are going to be with us for quite a while, and your choice of format and particular model should be made on the basis of your current recording requirements rather than on an attempt to guess what the distant future holds. □

TAPE RECORDING TIPS FOR BETTER RECORDINGS

By Eugene Walters

THERE'S a widespread belief that, when recording, the needles of the VU meters should never go into the red area. On the loudest music passages, so the homily goes, the needle should just graze the 0 dB mark that forms the lower boundary of the red "danger" zone. Some recording tape manufacturers tell us to go ahead and record in the red. This is because most tape decks are biased at the factory for standard or low-noise tapes. But today's quality tapes are modified oxide types with much higher coercivity. What this means is that they need more drive to get *all* of the recorded sound onto the oxide. And once you give them that extra recording level, they'll repay in kind with higher output level, better dynamic range, and lower hiss.

Experiment with your next batch of tape. Let the needle crest close to +3 dB—the far right of the red danger zone. Keep medium-loud passages at or near 0 dB, and make sure that the needle *always* exhibits some wiggling on the softest passages. "Riding the gain" like this may tend to smooth out some of the more dramatic dynamic swings in your recordings, but you'll also succeed in getting a lot more super sound out of the tape on playback.

The sure way to tell if this "overdriving" of the tape is working is to play it back and listen critically. Of course, if you're working with a three-head, open-reel deck or preamplifier with monitoring facilities, you can listen to the tape on headphones

while you're recording it and learn instantly if you're distorting or not. In fact, it's often a good idea to spot-check the tape if you have monitoring facilities, and you can run the monitor through your rig's speakers just by flipping a switch or pressing a button on the tape deck.

But only certain types of machines let you monitor in this way. Monitoring, which is listening to the new recording on the tape an instant after it's made, is accomplished through a separate playback head assembly that can be switched on separately with its own preamplifiers. Pro's do it, why not you too?

LIVE RECORDING

When you buy a *good* tape deck—open reel or cassette—you rarely get microphones with it. If you think that manufacturers are doing you and themselves a disservice, you're mistaken. A decent pair of matched mikes that perform well with your new \$300 deck could add as much as another \$100 or so to the price. Additionally, there's a wider range of personal choice among microphones than with tape machines.

There are less expensive mikes, of course, but if you drop much below \$45-\$50 each, you'll face very definite recording limitations: like frequency response vs polar patterns. For example, a \$50 omnidirectional mike (which picks up equally well from all directions) may have a reasonably flat frequency response from 50 to about 15,000 Hz. A

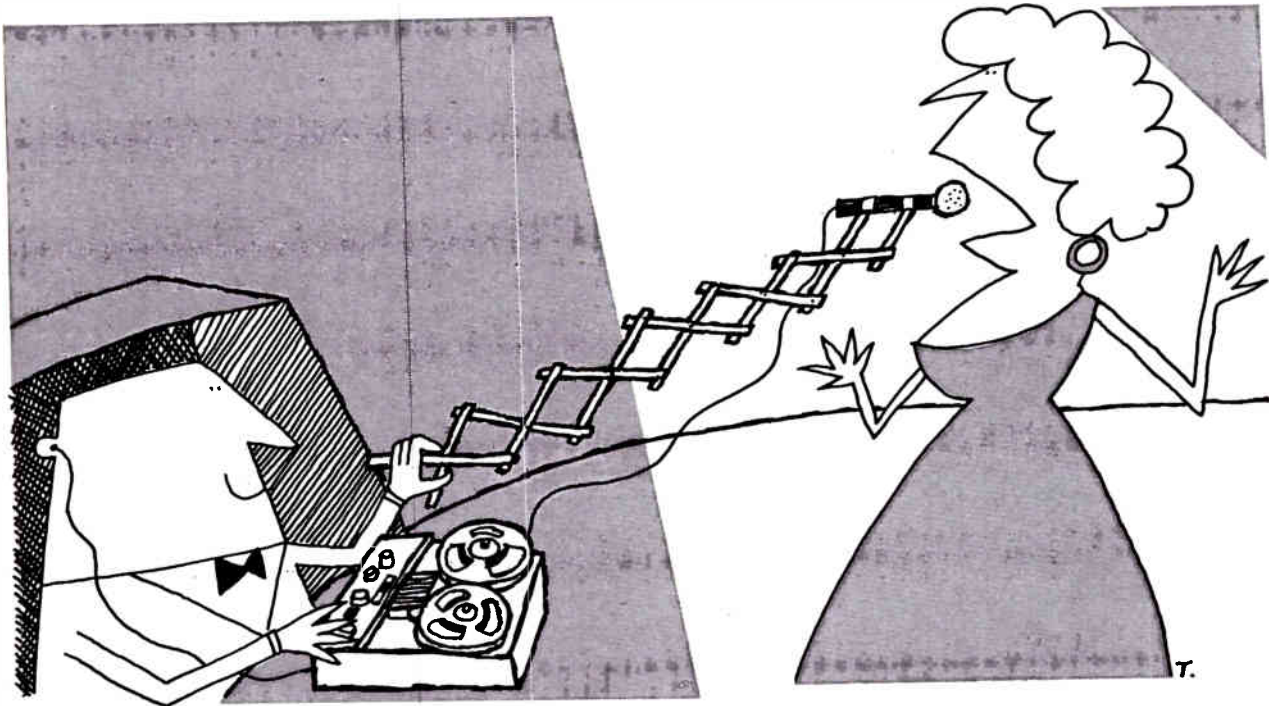

cardioid (or directional) microphone at the same price and from the same manufacturer will start to cut off somewhere between 10,000 and 12,000 Hz. In this case, you've given up some frequency response for directionality. So there's a trade-off involved. If you decide to use two mikes on a singer who's plunking away on an acoustic guitar, watch what you use! The guitar needs a "bright" mike with good frequency response. Good choice here: a ribbon microphone on the guitar (for its brightness and directionality) close in, and a dynamic placed very close in on the performer's mouth. But this dynamic *must* be the type with built-in triple windscreen and pop filter; otherwise, with close miking, every plosive syllable will come out loud, explosive, and very sibilant.

Each live recording situation presents particular problems. For example, if you're high on piano music, you might experience difficulties in getting a warm, natural sound. It's very difficult to get this type of piano sound in a typical living room because room acoustics and size are generally unsatisfactory. If you're in a large room, hall, or auditorium, you're home free. In your living room, try tying back or removing all draperies. Move as much upholstered furniture as you can out of the room and roll the rug back. Here, you have to convert your living room from an acoustically dead one to a live environment with lots of echo.

The ideal microphone type for the piano is the bidirectional ribbon. Placed about 10 feet from the

instrument, the main body of the sound will be picked up by the front of the mike, while reverberation will come in on the rear lobe. If you can set up a second ribbon microphone about 15 to 18 feet away in the same fashion, and either mix or record on the other stereo channel, you'll end up with a truly rich and lush piano sound.

If you don't have any ribbon mikes, but have several dynamics, start with a minimum of two set about 12 to 18 feet from the piano. If your room is "dead," use omnidirectionals—not cardioids—so they can pick up room reverberation.

Vocalists are always better off hand-holding a dynamic microphone since they usually can't hold still enough to maintain optimum recording distance from a microphone on a stand. Besides, it gives them something useful to do with their hands.

TAPING OFF-THE-AIR

For really professional sound, let someone else do it. Use the professional microphones, performers, techniques, recorders, echo chambers, and other niceties of the pro by simply recording off the air. FM radio offers a golden opportunity to obtain an excellent taped music collection at very low cost. But there are problems with this which may have little to do with your tape equipment, as follows:

Inexpensive FM tuners sometimes let the 19-kHz subcarrier sneak through unfiltered; this mix-

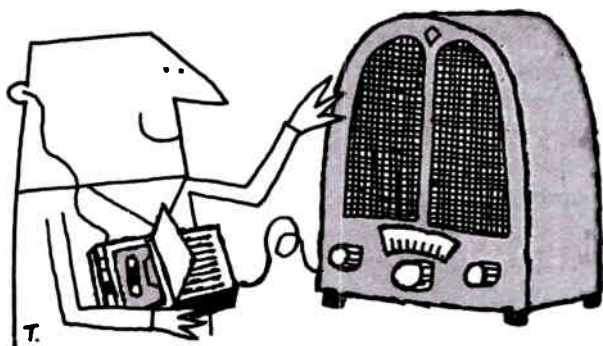

es with the bias oscillator signal in the tape recorder with very unpleasant results. Sharp selectivity, satisfactory sensitivity, and good image rejection are all important if you want studio-crisp recordings off the air. A good outdoor FM antenna is always highly desirable. You'll know if your receiver is up to the job the first time you seriously tape a music broadcast.

Another consideration is the quality of the broadcast material itself. Some FM stations broadcast distorted signals, do not bother to clean a record before playing, use worn styli, poor turntables, hummy preamplifiers, etc. Sometimes atmospheric conditions affect broadcast quality—although not much if you're running a receiver with a $1.8 \mu\text{V}$ IHF sensitivity, with a good antenna, and you're 40 or 50 straight-line miles from the transmitter.

Any recorder—open reel or cassette—can record off-the-air or directly from your record player by plugging into the "Tape Output" or "Tape Record" jack on the back of your stereo receiver. Signal level at these jacks is on the order of 0.5 to 2 volts. Usually high impedance, it will match most tape line inputs. Impedance at this output (and at tape recorder line inputs) is on the order of 10,000 to 15,000 ohms. Microphone input impedance on transistor tape decks is usually around 200 to 500 ohms.

The ideal off-the-air recording situation is when a sound-conscious FM station airs a live concert or its own master tapes of a live performance. This is where you get some great dynamics, true hall acoustics, and very low hiss level.

Hiss is something that's an underlying part of all tape recording, although it can be eliminated insofar as your hearing is concerned. Every time you make a tape recording, you inject a hiss level of about 3 dB (a barely noticeable jump). When you dub from tape to tape, each transfer adds another 3 dB of hiss. And this is where Dolby noise reduction comes in. Originally intended for professional use, one of the four Dolby frequency bands (the highest one) is used in the Dolby "B" system popularized for home equipment use. The Dolby must be used

at the first tape interface (between the music source and the tape). After that, every tape-to-tape dub is automatically "Dolbyized," and there is an overall reduction of noise (hiss) level of 8 to 15 dB.

Many cassette decks come equipped with Dolby noise-reduction circuitry today. It generally adds about \$50 to \$75 to the price tag. It's worth it, especially when you hear the high-quality sound that cassettes can provide in combination with it. Outboard Dolby noise-reduction units are available, too, in the event your recorder doesn't incorporate the system.

Dolby circuitry *reduces* hiss, but it can be reduced even further. Using high recording levels, riding the gain, and watching VU meter needles peg near +3 dB (with high-energy tape), can also reduce hiss by improving the tape's signal-to-noise ratio.

TAPING FROM RECORDS

One potential headache is in recording from records. You may have some priceless antique shellacs or some brand-new borrowed discs that you want to get on tape. Either way, you need good, reliable playback equipment for those records, and the discs should be absolutely clean. Give them a wipe off with a reliable aid, such as "Discwasher," and, while playing, use a "Dust Bug" or similar record-care equipment to clean out the record grooves a few seconds before the needle gets there.

The turntable itself should be the best you can afford; after all, turntable noise will be recorded for posterity. Obtaining sufficient signal level is a problem at times if a combination of a very-low-output magnetic phono cartridge and an insensitive "Tape Output" circuit from a receiver or amplifier occurs.

TAPING QUADRAPHONIC SOUND

If you want to tape your own four-channel programs, and have a quadraphonic (discrete) open-reel deck, get yourself four closely matched microphones and set up shop in your favorite church or auditorium (or living room). One word of caution: if you have had no significant experience in two-channel live recording, save your four-channel efforts for a little while. Positioning the mikes is as chancy and different as are the needs and tastes of the person operating the recorder.

Recording matrixed four-channel sound is no trick at all. Whether your source of encoded material is a record or an encoded broadcast, just record it as ordinary two-channel stereo. You can then play it back as regular stereo or through a decoder to recover the rear-channel information.

Encoded matrix material, whether it is SQ or QS, is basically two-channel information that has had something added to it—the rear-channel difference signals. When played back as regular stereo, the result is the same as when an encoded record is played as stereo: a slightly enhanced program that is spread out a little beyond the speakers. Whether or not you actually ever play the taped material as four-channel makes no difference. The information will be there on the tape ready for you to use whenever you want to.

ADDING TRACKS

One aspect of open-reel recording is the ability to add another track of music (or speech) after one of the two stereo tracks has already been used. There are two ways of doing this—called “sound-with-sound” and “sound-on-sound.” Both require some special switching in the recorder and not all open-reel recorders have this feature.

For sound-with-sound (SWS), one of the two stereo tracks is recorded monophonically (for example, a musical accompaniment for a vocal). Then by pressing the SWS button, one half of the record head becomes a playback head—playing back the music while you record your vocal or other material on the second stereo channel. When

you play the completed recording back, the accompaniment is on channel 1, your vocal on channel 2. In recorders with separate record and playback heads, the switching is a little hairier, since the regular playback head cannot be used for monitoring. It’s an inch or so away from the record head and the two tracks would be out of synchronization.

For sound-on-sound (SOS), the operation is basically the same, except that the material originally recorded on channel 1 is mixed with the new material and it all goes on channel 2. In both SWS and SOS, the record head must be switched so channel 1 is used for playback while channel 2 is recording. This method of synchronization is sometimes referred to as “Sel-Sync.”

BATTERY-OPERATED TAPE MACHINES

One of the sad inequities of home recording is that after you buy some expensive microphones, you may find that the most live recording you do is with your \$39.95 mono cassette portable with its own microphone—as you chase after the kids and adult parties and other recording situations. Certainly the battery portable is a useful tape recorder for such situations. And with ALC (Automatic Level Control) built-in, candid recording situations become the rule instead of the exception.

If you use the battery portable, remember a couple of cardinal rules: make sure the batteries are in good condition at the beginning and the *end* of your recording outing. Batteries that start to weaken during your session will slow down the motor during recording. The result is that playback at proper speed will be gradually faster and faster, until near the end your voices all sound like Mickey Mouse.

Alkaline batteries, while offering longer life, develop a leakage peculiar to this type. A light chalky film starts to cover the negative (flat bottom of the cell) terminals, making electrical contact chancy. If you use alkaline batteries, be sure to examine them frequently. Scrape off that white powder with a bit of emery cloth. (A small square of emery cloth will store nicely right in the recorder’s battery compartment.) Eveready’s new “Super 99” cell offers an interesting alternative. Priced only slightly higher than standard carbon-zinc cells, this one is also carbon-zinc, but turned inside-out for greater power output.

One last point—don’t cut corners on tape. Experiment with different brands and types to determine which serves your needs best before devoting a substantial amount of time on a recording session. □

TEN EVERYDAY TAPE TIPS

1. Clean tape paths and heads regularly (say, every 20 operating hours).
2. Demagnetize tape heads at same time as above.
3. Reduce dropouts by “playing” both sides of a blank tape before recording.
4. Don’t start recording until the tape has run a few seconds to clear leader tape.
5. When through playing or recording a cassette, rewind tape so that clear leader tape is exposed.
6. Remove cassette tape slack before inserting into deck (the eraser end of a pencil makes a fine tool for this purpose).
7. Wind tapes stored for a long time before playing to avoid layers of tape sticking.
8. Don’t store tapes in warm or damp areas or near loudspeakers or any other object with magnetic fields.
9. Two small tabs at the rear of a cassette can be removed to make it impossible to record. If you change your mind later, simply cover holes with masking tape.
10. Mark tapes clearly if Dolby system was used during recording.

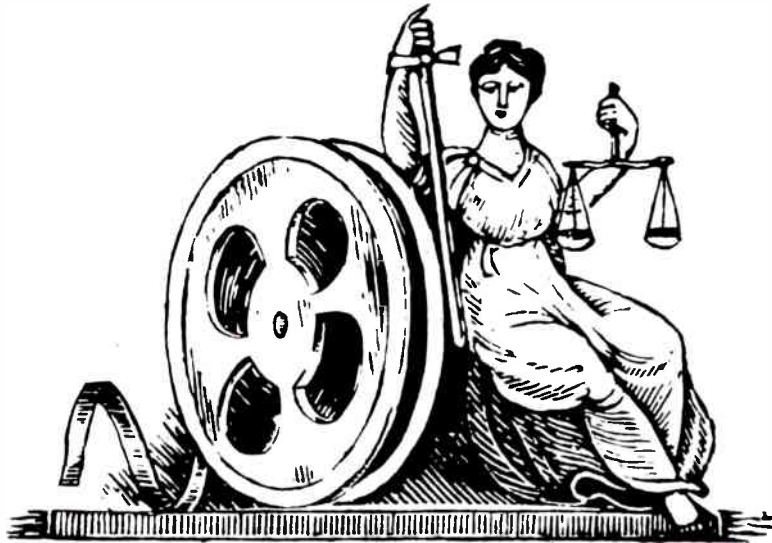

THE LEGAL SIDE OF TAPE RECORDING

Guidelines for what you can and cannot record with legal impunity

By MARSHALL LINCOLN

THE tape recorder has given the world a handy, accurate recording service for both business and pleasure. Its versatility and usefulness, however, have given rise to a number of legal and ethical questions which ultimately influence how, where, and when it can be used.

Questions facing tape recorder owners include such gems as: May we use our recordings for anything we wish without limitations? To what other electronic equipment may we connect our recorders without causing the law to look our way? Are there any special limitations placed on private citizens on the manner in which we use our recorders (limitations which do not apply to certain privileged groups)?

For those of us who own them, tape recorders have become part of our everyday lives; so, it is easy to overlook the fact that their use can create legal pitfalls. Some of these pitfalls may seem trivial at times, but it is good policy for each of us to be aware of circumstances which can bring the unwary under the scrutiny of the law.

Recording Phone Conversations. Let us consider the case of a tape recorder being used as an "automatic notebook" for taking accurate notes of lectures, interviews, business calls, etc. When you are talking face to face with someone and openly using a tape recorder, there can be little doubt that the conversation is being taped. But in the absence

of face-to-face confrontation, as in the case of a telephone conversation, are you free to record? As many tape recorder owners have learned, they are *not* free to arbitrarily record telephone conversations.

A private citizen may record his own telephone calls only if his phone is connected to his recorder via a "coupling arrangement" containing a beeper. (The beeper generates an audio tone every 15 seconds or so to alert anyone on the line to the fact that the conversation is being taped.) Direct connection requires paying your telephone company for installation and use of the coupling device.

A much simpler and superior way to record phone conversations is with an inductive coupler or telephone pickup coil, a low-cost item which can be purchased from any number of dealers. Inductive pickups have the advantage that they do not create interference on the telephone line since no physical connection is made to the phone wires. *But* when telephone recording methods were being considered by the FCC, Bell Telephone was categorically opposed to inductive pickups.

The FCC pointed out that inductive couplers would eliminate any need for recorder salesmen to make special arrangements with the phone company whenever they wished to demonstrate their equipment. The telephone company took the position that its opposition to the inductive pickup

was based on the fact that it wanted to ensure the privacy of its customers' calls. It insisted that some sort of signal must be put on the line to warn everyone that the call was being taped. The FCC finally yielded to the phone company's arguments.

Broadcasters were once required to use beepers because they were not permitted to connect their telephones to their transmitters. When FCC rules were amended to permit broadcasters to connect regular phone calls into their transmitters (a fringe benefit of the Carterfone case of a few years ago), it meant that stations might not actually record calls before broadcasting them. So, they did not use a beeper because the rule specifically applied to *recordings* made from telephone lines.

The FCC rule on this matter states that broadcasters may either record for broadcast or to directly broadcast telephone conversations with the only warning being a simple announcement at the beginning that the conversation may be taped or broadcast. In some cases, such as when the caller dials an "open-mike" number, the broadcasters are not even required to make the announcement. The FCC reasons that it may be assumed the public will know their voices may be recorded or broadcast because they dialed the number.

This convenience has been a great boon to broadcasters since they can dispense with the beep tone which they may consider annoying on the air. However, the FCC has not allowed individual citizens the same convenience of simply stating at the start of a call that it will be taped for their own use.

Recording from a Receiver. You can record anything you wish from a radio or TV receiver tuned to any frequency in the spectrum without first having to obtain permission from anyone. However, the nature of the transmission taped determines how you may use your recordings. Any radio or TV public information or entertainment broadcast is public domain and can be recorded and played back for a non-commercial purpose. But if you record from a commercial channel (police, fire, aircraft, mobile telephone, etc.), you are *forbidden* under the FCC's "Secrecy of Communications" regulation from playing the recording for anyone else. Furthermore, you are enjoined from even repeating the contents of any transmission heard.

Recording from Records or Tapes. You are probably violating the rights of performers or others if you tape discs or prerecorded tapes. One section of the Copyright act states, "Where any person knowingly distributes infringing copies of any work . . . to affect prejudicially the owner of the copyright, he is guilty of an offense under this

Act." This might conceivably be construed to mean a person taping a record who then loans the recorded tape to another party for dubbing purposes. Another part of the act refers to "profit." Does this mean money saved? Needless to say, persons who tape record material on a hobby level for personal use can and are doing so with reasonable safety, for how could an enforcement agency ever cope with the problem? Although some of your tapes might be considered to be technical violations of the law, chances of penalty are extremely small. It all rests with your conscience.

Recording Live Performances. At live performances—especially concerts given by well-known performers—you can run into a whole series of prohibitions designed to prevent you from using your recorder. For one thing, instrumental and vocal performers nowadays are plagued by bootleg record companies which secretly tape performances and sell record copies to an unsuspecting public. The performers, needless to say, receive no compensation whatsoever from the bootleggers. (Some shady operators get in as members of the audience with a small, battery powered recorder hidden on their persons. They use the recorders to make their "master tapes." The quality of the recordings possible from these small tape recorders may not be first class, but it is passable for hard rock and other loud music. Too, if the buyer has never heard a live performance by a given soloist or group, he has no real way of determining whether or not the selection was pirated.)

The hard-nosed attitudes of performers' agents and theater managers toward anyone they see carrying a tape recorder into a live performance is understandable. They are protecting their interests and the interests of the performers. Additionally, managers face stern union rules which forbid any recordings to be made unless a whole gang of union electricians is on hand (always assuming, of course, that you have received permission to make recordings). These rules are in union contracts; so there is nothing a theater manager can do about the situation.

When you plan to take a recorder to a live performance, remember that you are treading on dangerous ground. If you are caught with a recorder at a performance, chances are good that you will be hustled out the nearest exit. It would be better (and safer) to check with the theater manager before walking in with a tape recorder. If you are convincing in the telling of why you want the recording, there is always the remote possibility that permission will be granted—but don't count on it. □

How Recording Tape Is Made

Materials composition, handling, and manufacturing methods are all critical elements in "building" tape performance

By JOSEPH KEMPLER

Coating, orientation, and drying processes complete the tape is wound onto large-diameter cores at the output of the coating machine. Slitting will later cut the tape to the right width.

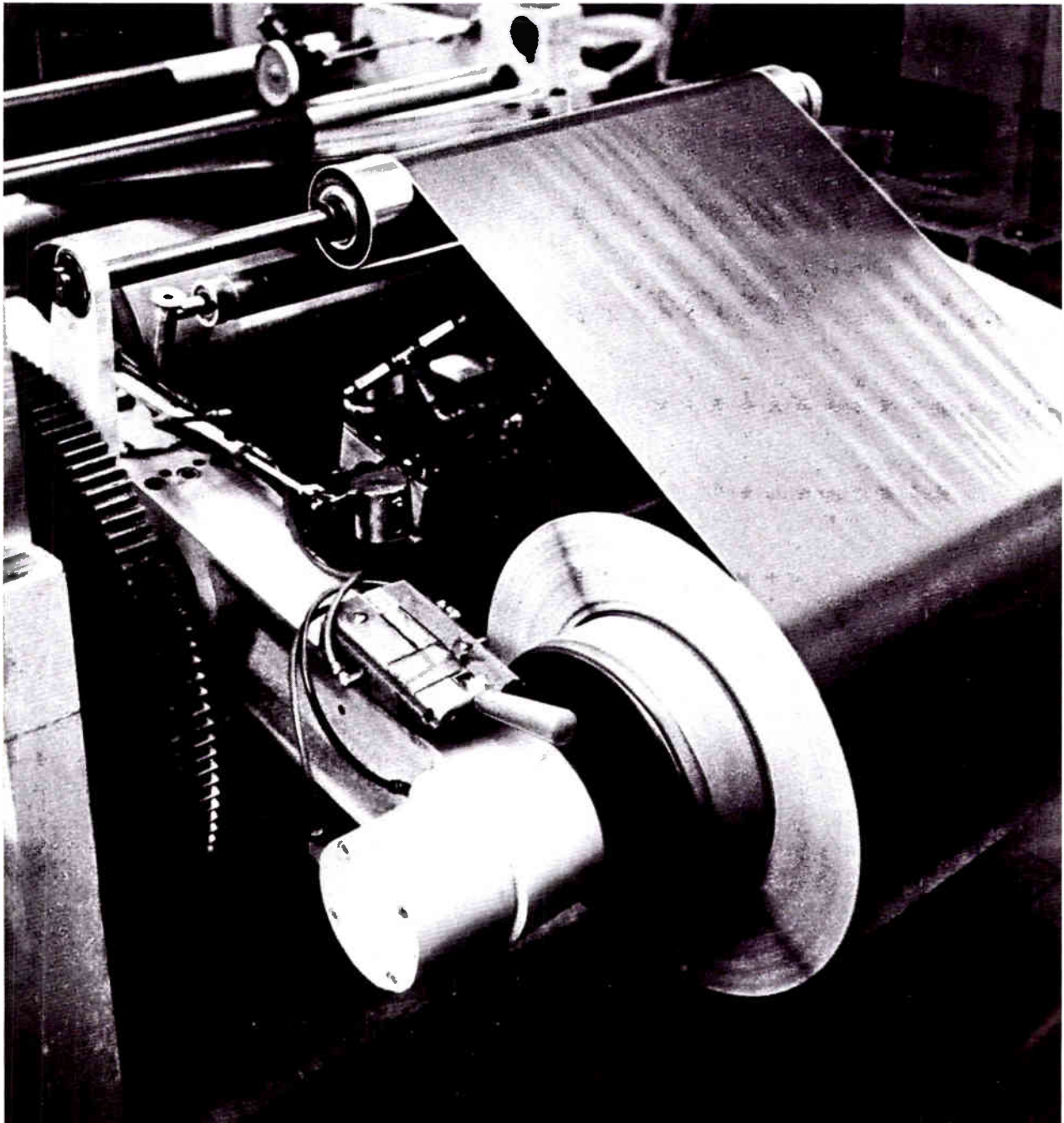

THE WORLD today is fairly bursting at the seams with recording tape. Many of our normal business, social, and entertainment activities would grind to a halt without it. At least three different tape formats are currently in use for entertainment purposes alone, and each of these has its own particular areas of special competence. Little wonder, then, that all this activity has resulted in a proliferation of special-purpose tape types manufactured to do a particular job particularly well.

The types of audio tapes available to the home user go by such names as general purpose, low noise, low print, high-output/low-noise, and so on. Within each of these categories there is also likely to be a variety of thicknesses, lengths, and base materials available. Recently, moreover, some tapes have appeared that employ special coatings on their *non-oxide* surfaces that are designed to improve mechanical handling or storage characteristics. And, finally, there are the various types of tape used in cassettes, eight-track cartridges, and in open-reel machines, some of them specially treated to perform optimally in their special formats.

Despite the profusion of products, all tape types do resemble each other superficially, if one ignores occasional differences in color, surface shininess, or the use of a back coating. But these are physical qualities, not electromagnetic ones, and similar appearance does not necessarily mean similar performance. An examination of some of these common factors, however, as well as some of the differences, is helpful in understanding what makes one tape superior to another for a given recording task.

All magnetic tapes consist of a *coating*, or emulsion, permanently bonded to a *plastic film*, or base. The coating contains the magnetic material, the "active" ingredient that makes recording and reproduction possible. The base film, which determines the mechanical properties of the tape, acts as the physical support for the coating. Open-reel tapes are always wound with the coated side facing the hub. In cassettes and eight-track cartridges, the reverse is true—the coating faces out because of the tape-path arrangements in these formats.

In most cases, it is easy to distinguish the shiny base side from the relatively dull coated side. However, many modern tapes (particularly cassette tapes) have a polished coating that is nearly as shiny as the base. And recent developments, such as the use of dull black conductive back coatings applied to the base of the tape, have further confused the issue. This back coating helps in several ways: it eliminates static electricity, it affords the capstan and pinch roller a better grip, and it allows the tape to hold its "pack" better on its hub or reel. But un-

less care is exercised, the question of "dull" or "shiny" can sometimes lead to confusion; the shinier side may well be the side to record on.

The color of the magnetic coating has been undergoing some changes as well. The usual oxide-coating color is brown, because this is the normal color of the iron oxide used in the majority of tapes. Chromium dioxide, however, is a black powder—but that is not to say that *all* black tapes are made with chromium dioxide. Many iron-oxide tapes are black, too, or at least dark grey, because of black carbon particles added to reduce electrostatic-charge buildup on the tape (such charges can cause noise, and sometimes even jamming in cassettes). Widespread opinion to the contrary, the color of the coating has no necessary bearing on the tape's performance in the electromagnetic area.

THE BASE MATERIAL

The film that serves as the base for the magnetic coating is in most cases either cellulose acetate (often called just "acetate") or polyester (the best-known brand being Du Pont's Mylar). The buyer can tell them apart by simple inspection: acetate is translucent and polyester is opaque when a reel is looked at edgewise against a bright light.

A good base material must be strong enough for its intended use; it must also be flexible, smooth, and dimensionally stable. Both acetate and polyester have proved themselves capable of meeting these specifications, but polyester is the better of the two, especially if it is to be used or stored under extreme or varying conditions of temperature or humidity. It is significantly stronger than acetate and chemically more stable (acetate, because of the slow loss of its plasticizer, becomes subject to brittleness and cracking with age). Further, tapes expand or contract on their reels under the effects of changing temperature and humidity, and these dimensional changes generate stresses within the tape pack that can cause a number of physical problems, among them radial deformation ("spoking"), curled edges, or "cupping." Tapes wound unevenly or at too high a tension are particularly vulnerable to such deformations, and although polyester and acetate can both be affected, the changes in polyester are much less severe.

Acetate-base tape does have two important advantages, however, and they have made it popular even in professional recording studios: it costs less than polyester, and it breaks cleanly when accidentally snapped, with little or no stretch at the point of the break. Polyester, on the other hand, stretches as much as 100 per cent or more before breaking, of-

USUAL APPLICATIONS OF TAPE-BASE MATERIALS

<i>Material and thickness</i>	<i>Major applications</i>
1.5-mil acetate	Reel-to-reel, standard play
1.5-mil polyester	Reel-to-reel, standard play
1.0-mil polyester	Reel-to-reel, long play; and cartridge tape
0.5-mil polyester	Reel-to-reel, double play
0.5-mil T-polyester	Reel-to-reel, double and triple play; also cassettes up to 60 minutes
0.3-mil T-polyester	90-minute cassettes
0.25-mil T-polyester	120-minute cassettes

ten making it impossible to repair a recorded tape without losing critical material. To combat this shortcoming, polyester-base tape is made available in "tensilized" form, or T-polyester. Tensilizing is a prestretching process that increases both the break strength and the stretch resistance by a factor of nearly two. Long-playing cassettes with very thin tapes were made possible only through the use of T-polyester.

THE MAGNETIC COATING

The tape's magnetic coating consists of several ingredients that are carefully—uniformly—mixed and dispersed for maximum homogeneity in the finished product. A good coating must meet all the many physical and electromagnetic requirements for its intended use. Since some of these requirements may be conflicting, best results often depend on a number of carefully chosen design compromises. For instance, the coating must be physically tough and durable to resist wear—but at the same time it must *not* be abrasive to the tape heads. It must also be dense and scratch-resistant, but not brittle or stiff, for these characteristics would eventually lead to edge damage and momentary signal loss (dropouts).

The basic ingredients of a typical magnetic tape coating are the magnetic material, the binder, and various additives (plasticizers, lubricants, *etc.*). The key ingredient is, of course, the material that makes the tape magnetic. In most tapes, this ingredient is iron oxide, but other materials such as chromium dioxide and "cobalt-doped" iron oxides have been introduced for use in cassette tapes. Since these materials, in the view of some manufacturers, have certain shortcomings in addition to having magnetic properties that can benefit performance, they are now being challenged by the newest iron-oxide formulations. These latest tapes, whose improved qualities derive from better oxides and novel processing, have the additional advantage that they do not require special bias or equalization settings.

The typical oxide particle used for magnetic recording, whether of iron or some other substance, is a tiny needle-shaped crystal approximately six times as long as it is wide. The particles come in various sizes, but the length-to-diameter ratio remains substantially the same. So-called "standard" tapes use a relatively "large" particle about 25 millionths of an inch long by 4 millionths of an inch thick. The oxide particles used for low-noise tapes are several times smaller, the size reduction being responsible for the lower tape hiss. High-output/low-noise tapes may use still other iron oxides that, in addition to being smaller, are smoother, more uniform, and therefore capable of being more densely packed in the coating. The needle shape of these oxide particles makes them magnetically anisotropic, which is to say that they have different magnetic properties in different directions. Anisotropic oxide particles are much easier to magnetize and harder to *demagnetize* (important features of a good tape) in the long direction than in the short.

To take advantage of anisotropy, the oxide particles are physically rotated when the tape coating is still wet so that their long dimensions line up with the length of the tape. As a result, the tape has better magnetic properties in the direction that the record and play heads are effective—*i.e.*, along the tape length. Once the tape coating is dry, of course, the particles are fixed in place by the binder and cannot move around. They can, however, be magnetized in either of two directions or polarities, in accordance with the polarity of the external mag-

At the input end of the coating machine, a "web" of base material (clear acetate film in this case) is fed from the jumbo rolls and then carried at high speed to the "slurry" applying section.

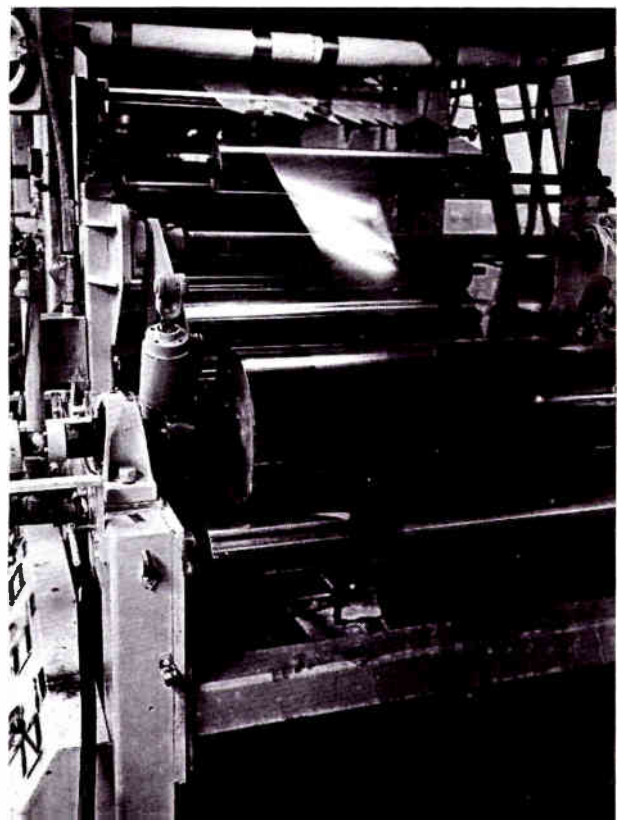

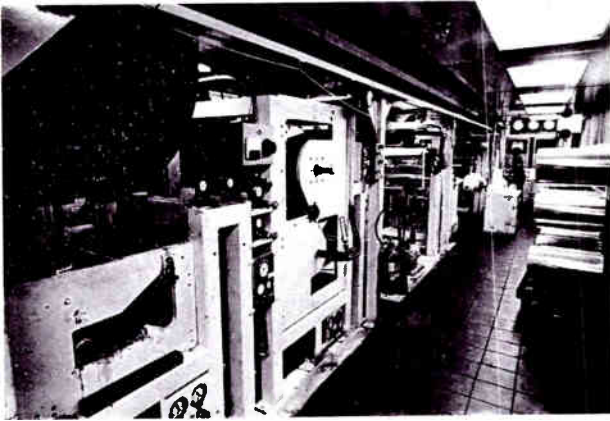

Above is but a small part of one of the giant coating machines: in this section the film is fed into the machine, coated, and exposed to a magnetic field to orient the iron-oxide particles.

Hysteresis loop displayed on scope simultaneously shows magnetic force needed to magnetize a given tape as well as amount of magnetism it will retain once it is magnetized.

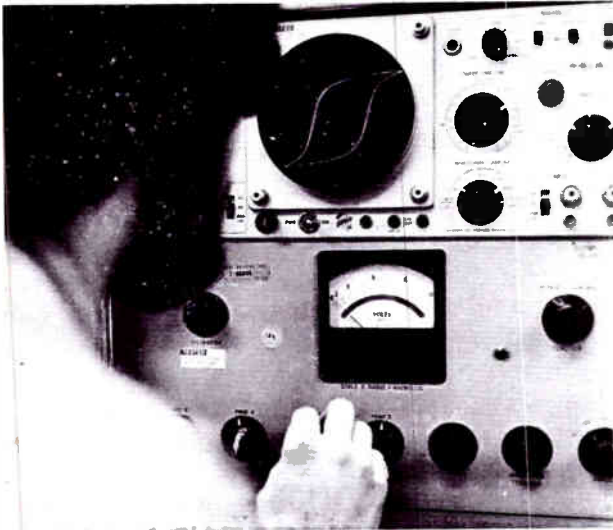

netic field applied by the recording head. The word "permanent," as used in connection with these tiny magnets, implies a resistance to change. Indeed, the particles do resist a change in their magnetic state: a minimum magnetic force (*coercive* force) is required to overcome this resistance. The amount of coercive force, expressed in *oersteds*, is therefore one of the important specifications for a magnetic oxide—and for a type of tape, too, for that matter. Specifically, it is the minimum magnetic force which must be applied to the tape by the recording head before a recording is made. The same coercive force is required to erase a recording already made, since this also involves a change in the magnetic state of the tiny particles. A high-coercive-force tape such as chromium dioxide requires more magnetic energy to record and erase than a tape with a lower coercive force.

A second significant property of any permanent

magnet is its ability to "store" magnetism. The quantity of magnetism which a tape can "take" and retain is called its *magnetic induction*, and the unit of measure is the *gauss*. It is obvious that the higher the induction the better, since the induction determines the amount of output signal a tape can produce in the playback head.

BINDER AND OTHER ADDITIVES

Next comes the binder, the coating substance that fixes the oxide to the plastic base. Ideally, the binder also maintains an optimum separation between the individual oxide particles by providing a spacing coating surrounding each particle. Particles which are not properly separated will partially cancel each other's magnetic energy and thus reduce the tape's potential output.

The basic binder materials are various compositions of plastic resins. All the important physical properties of the coating—resistance to wear, friction, loss of oxide, and many others—are determined by the binder. Of the total coating volume, the oxide particles occupy only about 30 to 40 per cent. If, in an effort to achieve a greater signal output, more oxide is put in, a weaker cohesion of the coating could result. It is quite a technical feat to "build" a high-output/low-noise tape with superior recording performance without sacrificing some of the tape's desirable physical properties.

Depending on the use for which the tape is intended, the basic binder materials may be supplemented by additives which change or improve certain properties that affect physical performance. For example, some binders are rather stiff, especially when the coating is thick, and plasticizers added to the binder will give the coatings a necessary flexibility. Different lubricants (there are many effective ones beyond the much-publicized silicone) may also be added to reduce friction between the tape, the heads, and the tape guides, and even between layers of tape in eight-track cartridges. And, of course, not every tape needs a lubricant; some use a low-friction binder that obviates the use of an additional ingredient.

Since tapes are composed principally of plastic, they are electrical non-conductors and therefore susceptible to the buildup of electrostatic charges. These charges attract dropout-producing dust; they may also produce popping noises during use, and even cause jamming in cassettes. To prevent this, electrically conductive agents such as carbon powder may be added to the binder to prevent the buildup of electrostatic charges. A superior method of increasing a tape's conductivity is to use the carbon

in a backcoating rather than in the binder. This not only eliminates static much more efficiently, but also improves the mechanical performance of the tape. Furthermore, the removal of the carbon from the coating leaves more room for oxide, thus raising the output level.

There are many other binder additives such as wetting agents, stabilizers, fungicides, *etc.*, and each performs a specific function. A well-designed tape, however, will have as few additives as possible, for each additional ingredient must be integrated into the coating without displaying any short- or long-term tendency to migrate or undergo other undesirable changes.

MANUFACTURING PROCESS

Combining all the elements that make up a quality finished tape requires strict control of materials and procedures throughout the manufacturing processes. Each step must be right the first time or the tape will be defective. There is no opportunity for later adjustment or correction. Quality control begins with the first inspection of the incoming raw materials. Since all materials have *some* minor variations in either physical or chemical properties, the inspection must determine which materials fall within the established tolerances. The oxide material, for instance, is tested for its magnetic properties using such sophisticated equipment as vibrating sample magnetometers and hysteresis-loop tracers. Electron microscopes are employed to examine the particles visually under a magnification of many thousands of diameters. Properties such as particle size, size distribution, and imperfections can then be readily observed.

All manufacturing-process chemicals and solvents undergo chemical analysis with such equipment as gas chromatographs, infrared spectrometers, and other instruments which analyze their composition in minute detail, detecting the smallest trace of impurity. Even base film is examined for thickness uniformity, cleanliness, physical stresses, *etc.* Base materials also require special ambient conditioning before use to assure that they are "relaxed," wrinkle-free, and without contaminants.

Much effort and expense is devoted to all these preliminaries, since no chances can be taken by a supplier of first-class tape. Critical users rightly expect that not only will the product be good, but that it will be *consistently* good, reel after reel, over the years.

The first manufacturing step is the milling—the mixing/interdispersing of all the coating ingredients. The most familiar type of machine used in this step is the ball mill, a large rotating drum partly filled

with small steel balls. (Perhaps needless to say, in this as in other areas of tape manufacture, different companies have developed their own techniques and hardware.) The various ingredients are loaded into the mill and a solvent for the plastic binder material is added. The entire composition is then thoroughly mixed by the mill until it is homogeneously uniform and smooth. The ultimate purpose of the process is to have each oxide particle wetted, coated with binder, and isolated from its neighbors. When the milling is finished, the result is a thickish liquid, of paint-like consistency, called *slurry*.

Milling is an extremely critical operation because either too little or too much is harmful to the quality of the finished slurry. Insufficient milling may result in undispersed groups of oxide particles which cause hiss, noise bursts, lower output, poor amplitude uniformity, and coating weak spots which will eventually turn into dropouts. On the other hand, overmilling breaks the particles down to too small a size, causing loss of high frequencies, increase in print-through, and other problems. Milling time can range from several minutes duration all the way up to two weeks. Magnetic and physical tests are performed on the liquid slurry to determine the precise end point of the milling process for a desired result.

After filtering and several other conditioning steps, the slurry is fed to the coater, a giant machine that resembles a rotary printing press. The minimum number of separate processing stages built into the coater machine are called the take off, the coating zone, orientation, drying, and the take up—the taking off and on referring, of course, to reeling the raw base material off and then, when coated, onto a spool, and orientation having to do with the

Storage in the "bank" is an interlude in the high-speed manufacturing process. Many different tape types are here being aged on their jumbo rolls before being slit and, finally, packaged.

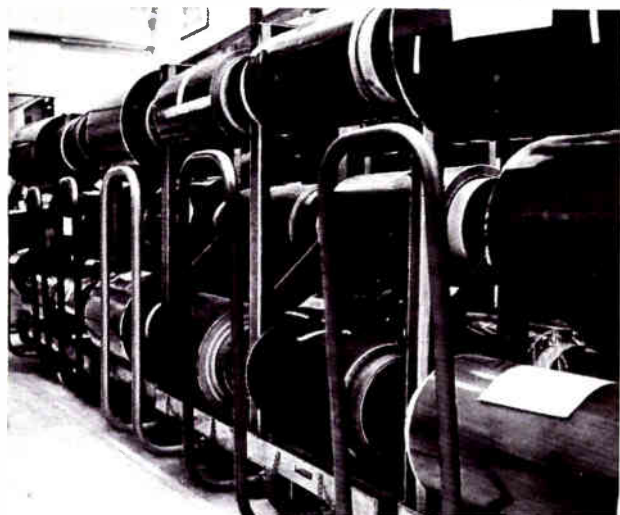

magnetic aspect of the coating. Some coaters perform more individual functions, but these five operations are essential to even the simplest machine.

A typical high-speed coating process begins with a large roll of base film, 15,000 feet (or more) long and several feet wide, which is loaded on the input side of the machine. The film is threaded through the entire complex of continuous operations in the coater, the whole is started up, and in due time the coated film issues from the take-up end, many hundreds of feet away from the start. The process is designed to be continuous to the degree that there is even a method of supplying new rolls of base film automatically as the previous rolls are used up.

The base film goes first through a base treatment and conditioning section until the coating zone is reached, at which point the slurry is applied in a precise and uniform thickness. Many coating methods are used. One of them resembles, in principle, the spreading of soft butter on bread with a huge knife. Another could be likened to the operation of a precision paint roller, and a third imitates the inking roller used in printing magazines such as the one you are now reading. And there are perhaps a dozen other methods capable of doing the job right. The coating thickness on typical consumer tapes ranges from 70 to 650 microinches; some backcoatings are as thin as 20 microinches (compare with the 4,000-microinch thickness of a dollar bill). During the coating operation, thickness uniformity is monitored and controlled continuously by measuring the coating's absorption of either X-rays or of a radioactive source. This control is vital because variations in thickness will cause corresponding variations in low-frequency output; it can also change optimum operating points for bias

The slitting operation reduces the wide rolls of coated film to the form the consumer knows. This slitter is producing 1/4-inch-wide tape and winding it directly onto the 7-inch plastic reels.

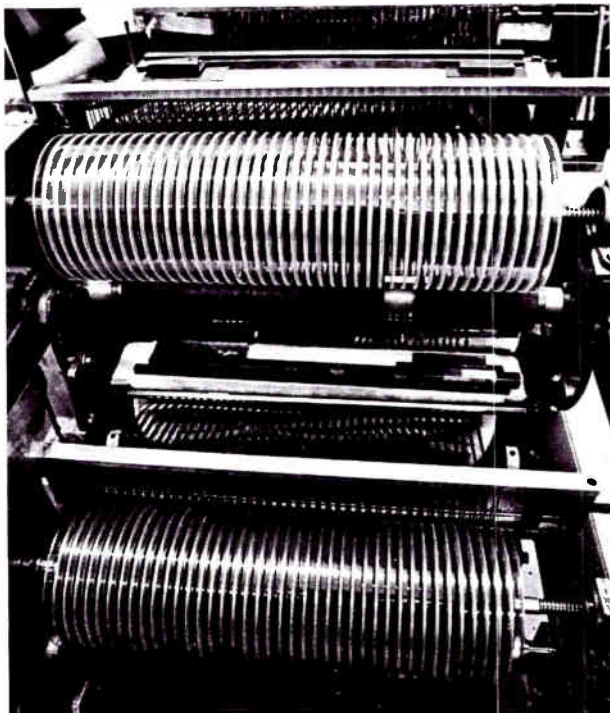

or recording level, disturb amplitude stability, and generate other havoc. Thin coatings make particularly strenuous demands on the coating equipment. A cassette tape, for instance, with an average coating thickness of 200 microinches, may require a thickness control of ± 5 microinches to maintain a ± 2.5 per cent thickness tolerance.

A good coating requires more than thickness uniformity. It must also be extremely smooth, completely free of streaks, voids, or even microscopic blemishes. Perfection of this kind is costly and difficult to achieve. It is not always necessary for home recording, but it is of paramount importance in computer tapes and in recording-studio mastering tapes. The tape manufacturers who successfully produce such tapes naturally have the capability of achieving the desired degree of perfection for the home user as well.

After coating, the oxide particles in the slurry are oriented by passing the already coated base, still wet, through a powerful electromagnetic field that lines the particles up parallel to the long dimension of the tape. Then the tape moves into the drying tunnel, where heated air evaporates the solvent from the coating at a carefully controlled rate. Drying which is too fast can cause some solvents to evaporate too rapidly, leaving the coating with pits and pinholes that cause noise and dropouts. Conversely, an incompletely dried tape may stick to itself or gum up the recorder's heads. Both of these problems can occur if temperature, air volume, and air velocity are not closely adjusted for the specific tape being manufactured.

The coated tape coming out of the drying tunnel—it is still in the form of a sheet of film several feet wide—is wound with carefully controlled ten-

Another slitting machine winds large 14-inch "pancakes" of tape. The dubbing machines used in the preparation of "prerecorded" tapes are designed to accept their tape input in this odd format.

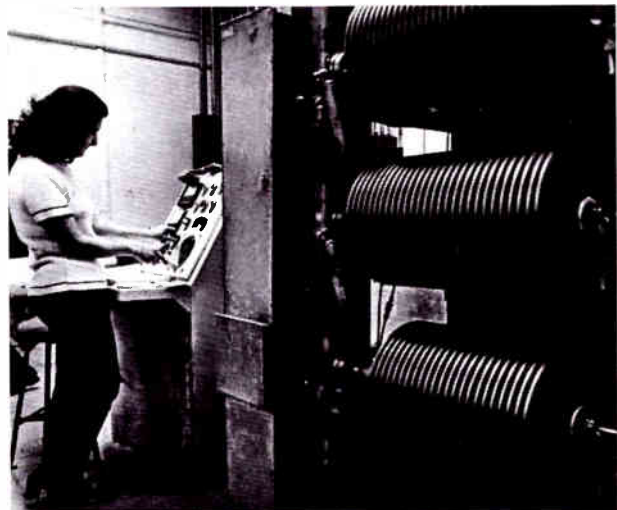

sion onto large-diameter cores to make up jumbo rolls. The large cores reduce the number of layers in the rolls and thus minimize stresses in the tape. When good high-frequency response is an important requirement, quality tape may undergo polishing of its freshly coated surface. Intimate contact with the heads is necessary if high-frequency losses are to be avoided. For example, if a 10,000-Hz signal is recorded on a cassette tape running at $1\frac{7}{8}$ ips, at 6-dB output loss will take place if there is only a 10-microinch gap between tape and head. Any roughness of the tape coating will tend to cause such gaps, since only the high points on the surface will come into contact with the heads.

The polishing treatment is accomplished in several ways. Brushing, burnishing, and even rubbing tape surfaces against each other have all been used with reasonably good results. In one popular method, the tape is passed between two or more highly polished heated rollers that exert a very high pressure on the tape. A mirror-like smoothness is obtainable with this technique. (Obvious differences in the visual shininess of two coatings can sometimes indicate the one with the better high-frequency performance, but the method is not foolproof, since there are many other invisible factors which can also influence high-frequency response.)

Slitting the wide rolls of tape to the widths in which they will be used is the final manufacturing step. Cassette tapes have a width of 0.149 inch; all other audio tapes for home use are slit to the $\frac{1}{4}$ -inch width—more precisely, 0.248 inch. Slitting is done by rotary cutters running at high speeds. In most cases, the entire roll width is slit simultaneously. But, despite the mass-production nature of the process, slitting has to be a precision operation because of the critical demands that will be made of the end product. First, tape width must be very accurate—the width tolerance on a cassette tape is ± 1 mil, for instance. Tape which is too wide will stick in the recorder guides and suffer edge damage through folding or scraping; tape which is too narrow may weave as it passes through the tape transport. Second, finished tape must not exhibit skew or “snakiness,” which occurs if the tape is not slit in a perfectly straight line, for it causes the tape to move past the heads at a constantly changing angle with respect to the head gap and creates a continuously varying azimuth misadjustment with resultant variations in high-frequency output. And finally, the slit edges must be cut cleanly. A poorly slit edge will generate dirt and dropouts and affect the sound quality on the track closest to the edge. On the other hand, it should be noted that the edges can never be as smooth as the coating, and a slight pol-

ishing action consequently takes place as the tape edges rub against the guides and reel flanges. The material thus rubbed off the edges is frequently deposited on rubber pinch rollers or even on the heads, appearing as two thin lines of oxide just a tape-width apart. This occurrence is not abnormal *providing it is not excessive*, and is one of the reasons periodic cleaning of your tape recorder is necessary.

Such things as the application of back-coatings, attaching of leaders and auto-reverse switching foils, preparation of tape for loading into cartridges and cassettes, and more are manufacturing steps that may or may not be performed, depending on the tape's ultimate application. Most open-reel tapes, at least, are completed at slitting, at which time they are tested, wound on reels, demagnetized, and packaged for shipment.

QUALITY CONTROL

Laboratory quality-control tests of the finished products are carefully performed using various procedures. For example, the important quality of surface smoothness could be evaluated by eye or by running a frequency-response test. To secure *quantitative* measures, however, a precision surface analyzer is used that produces a chart of the actual physical profile of the tape—with a sensitivity of 1 microinch!

The basic quality-control tests performed are:

1. *Physical*—dimensions, strength, smoothness, life, head wear, temperature-humidity stability, *etc.*
2. *Magnetic*—coercive force, induction, and other purely magnetic properties.
3. *Recording performance*—bias characteristics, frequency response at various speeds, distortion, uniformity, noise, dropouts, print-through, and others.

Quality control may even extend to checking boxed tape after it has arrived for warehousing or on dealers' shelves. Tapes are examined critically from the customer's point of view: cartons of tape may be shipped back and forth across the country by various means, for example, to see how well the tape and its packaging stand up under typical shipping and storage conditions.

As might be gathered from the foregoing discussion, it takes a great deal of effort, much experience, and extensive manufacturing and testing facilities to produce a tape that does all the things it should do, reliably and consistently, reel after reel, year after year. But it is all in a good cause: better and better tape recordings! □

HOW TO PICK A MICROPHONE

Transducer types and how they perform, microphone specifications and buying tips that can improve live-recording quality of better-grade tape machines.

By J. GORDON HOLT

GIVEN a recorder of above-average quality, the better the mikes, the better the sound. You can't justify skimping on mikes with the excuse that you won't hear any improvement if you pay more than such-and-so dollars for them. You will. But if money means anything to you, you're probably going to have to set your sights lower than the pinnacle of perfection and exercise a modicum of judgement in choosing your mikes. The following is offered in the hopes of making the job easier.

If this is to be your first microphone purchase, you are probably in the market for a pair of mikes for stereo recording. This means that you must think in terms of twice the per-mike prices. This doesn't mean you must buy both at once, of course. Special purpose mikes (for solo highlighting, for instance) will be purchased singly, as needed, and these need not be (in fact, should not be) identical to your main pair.

TRANSDUCER TYPES

Although as a user you are more interested in a mike's performance than in how it converts sounds into electrical signals, we can make some valid generalizations about the performance capabilities of each transducer type. Ceramic mikes are generally of poor quality and, since they are inherently high-impedance devices, are not usable anyway with the low-impedance mike inputs of solid-state recorders.

Moving-coil (dynamic) types range from cheap and dirty (\$10) to expensive and excellent, with a top price of around \$200. More money than that will buy you extra features like adjustable frequency response or extreme directionality (for spotlighting from a distance), but not extra audio quality.

Ribbon mikes range from modestly priced (\$45) and quite good to expensive (\$200). A ribbon can be made lighter than a coil and thus can have better transient response, but its very lightness tends to make some ribbon mikes fragile and susceptible

to damage from wind (or close breathing). That this can be overcome is proved by at least one manufacturer who is making ribbon mikes of very high quality which are as rugged as dynamics. So fragility is not necessarily a ribbon shortcoming.

The class of condenser mikes includes some of the best performers available (their diaphragms can be even lighter than ribbons) and also some mediocre ones. As a group, all are characterized by outstanding detail or "snap." But, whereas the \$400-and-up professional types (whose elements must be kept charged by a power supply) are generally extraordinarily good, the \$100 (and under) electret types, with permanently charged capacitor, have neither the smoothness nor frequency range of the very best (and costlier) ribbon or dynamic microphones.

WHAT ABOUT SPECIFICATIONS?

Impedance. Although not as critical as loudspeaker/amplifier matching, a mike's impedance range should suit the load impedance provided by the recorder's mike inputs. Solid-state recorders call for the use of low-impedance mikes, which means anything between 150 and 600 ohms. If possible, try to get a mike rated between 250 and 300 ohms impedance. (Tube-type recorders usually require a high-impedance mike, on the order of 10,000 ohms or more.)

Output. Most currently available mikes produce roughly the same amount of audio signal voltage for a given sound level, and most mike preamps are designed to handle optimally the kind of voltages a typical mike will deliver under typical conditions. The latter are considered to range from a speaking voice at a mike distance of 3 feet to a full chorus and orchestra at 10 feet. If you don't expect to use a mike closer than a few feet from a loud sound source or more than, say, six feet from a quiet sound (like normal speech), you need not be concerned about a mike's output. If you anticipate atypical conditions, be concerned.

The subject of output ratings is complex. Suffice

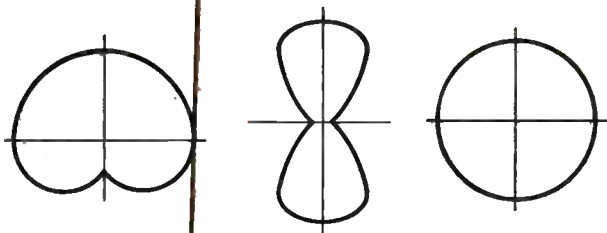

Fig. 1. Microphone directional characteristics: (left to right) cardioid, bidirectional, omnidirectional.

it to say here that a typical mike will be rated at around -56 dB relative to $1 \text{ mW}/10 \mu\text{bar}$, -75 dB relative to $1 \text{ V}/\mu\text{bar}$, or -150 dB EIA G_M . Any mike rated 5 dB or more above or below those figures may give you trouble, depending on the direction of the difference and your proposed use. Excessive mike output is easily remedied by adding an attenuator (available from Shure, E-V, and others) but inadequate output is not correctable without replacing either the mike or the preamp.

Directivity. The sensitivity of some microphones is affected by the direction from which sounds reach them. Some are most sensitive to frontal sounds and least so at the rear (unidirectional and cardioid). Some are equally sensitive at front and rear (bidirectional or figure-8), and some are equally sensitive to sounds coming from all directions (nondirectional or omnidirectional). See Fig. 1. None of these directional characteristics is inherently superior to the other, but there are times when one will do a specific job better than anything else. For example, conference recording of a group of people around a table calls for an omnidirectional characteristic—as does recording a moving sound source from a fixed mike position. Bidirectional mikes are excellent for spotlighting a soloist in the midst of other instruments. But for most purposes, the most versatile mike you can own is the so-called cardioid type.

Some directional mikes are more uniformly directional than others. Some cardioids are cardioid at middle frequencies only, becoming omnidirectional at low frequencies and increasingly “beamy” at high frequencies. This is why a directional mike that is reasonably uniform over the audio range often shows a family of polar patterns on its specification sheet. Directional uniformity is in fact one of the things you pay for when you pay more for one of two mikes that appear to be identical performers in all other respects.

For advanced recordists with the money to pay for them, there are mikes with variable polar patterns and there are special-purpose long-reach mikes for spotlighting a single sound from a considerable distance. Both tend to be very costly and

both have their places, but not usually as the first mikes you buy for cutting your teeth on stereo (or quadrasonic) taping.

Frequency Response. Basically, what your microphone dollar is going to buy is what you look for in a loudspeaker: frequency range and response smoothness. When you say to yourself, “that mike’s too expensive for me,” what you’re actually saying is, “I have to give up some range or smoothness.” Deciding just how much of what to give up is the serious recordist’s most difficult decision.

The best condenser mikes have response curves that look like a perfectionist’s flight of fancy. They go from 20 to 20,000 Hz, almost as straight as a ruler. Below that level of performance, though, you’ll find some mikes that are deficient, to varying degrees, at the low end but fine at the top; some that are peaky or down in response at the high end; and some whose major imperfections are irregularities in the middle range, causing honky or raucous coloration.

You can glean an idea of how good a microphone is in these respects from both its price and the manufacturer’s claim for frequency range or response; but, in order to judge in advance how a mike is likely to sound, you must be able to get a look at its published frequency-response curve. If you can’t obtain a curve for a mike you’re considering, don’t buy it. When you do see a curve, here’s how to tell how it will probably sound. See Fig. 2.

First, mentally divide the audio spectrum between 50 and 10,000 Hz into two parts to the left and right of 1000 Hz on the published curve. If most of the curve through both segments is the same height (that is, if there is no visible tilt to the line), the mike will sound properly balanced with

Fig. 2. How to break down a response curve to get interpretive analysis. See article for explanation.

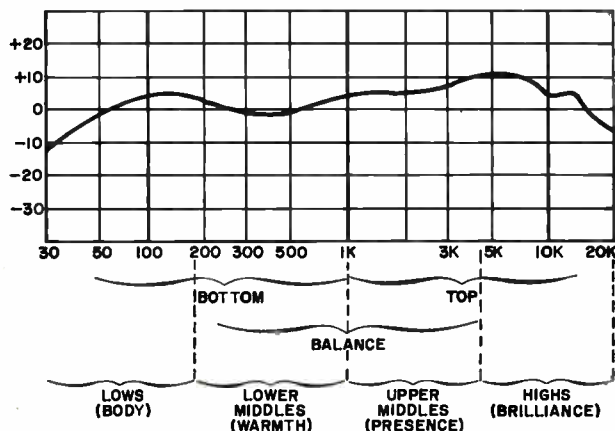

regard to highs and lows. If most of the right-hand segment rises progressively to around 10,000 Hz, the sound will be bright, somewhat sibilant, and rather forward. If it falls through that range, it will be dull. If the lower (left-hand) segment tapers downward the sound will be thin. If it rises down to around 50 Hz, it will be heavy and have a tendency to boom. A 3-dB response deviation should be noticeable to anyone. A deviation of 5 dB is conspicuously evident, while 10 dB represents an apparent doubling or halving of level—a tremendous change. Read the vertical dB scale on the curve accordingly.

Next, split the audio spectrum into four equal-width (not equal-frequency) segments and compare their average heights. If the first (left-hand) segment is up, the sound will be bass-heavy; down and it will be sparse and tight at the bottom. If the second segment is up, the sound will be overly fat and a bit wooly; down and it will sound somewhat constricted. If the third segment is up, the sound will be forward and brassy; down and it will sound muted and lacking in life. If the fourth segment is up, the sound will be sizzly, sibilant, and wiry; down and it will be dull, soft, and lacking definition. The degrees to which these flaws are audible will, as before, depend on the extent of the deviations from flat, according to the dB scale.

Now, look for slight peaks or severe troughs in the curve. Low-end deviations will add heaviness or subtract certain notes from the sound. Lower-middle to upper-middle deviations will cause various kinds of colorations in the sound. Treble peaks above about 5000 Hz cause roughness, metallic edge, or excessive and spitty sibilance.

Finally, observe what the curve does above 8 kHz. If it rises, details will be enhanced but sibilance and hard transients will be exaggerated. If it falls above 8 kHz, the sound will be sweet, somewhat soft, and deficient in snap (transient information). Incidentally, when comparing mike curves, be sure you take into account the scale used for the curve (Fig. 3).

YOUR CHOICE

Now it's decision time. Unless you feel you can justify a \$1000 mike setup, you are going to have to sacrifice some frequency range at the top or bottom, or both, and also some smoothness in between. Should you pick a mike that lacks 10 Hz or so of low-end range but has a smoother and more extended top than the competition? Or should you opt for the best low end you can afford and give up some assets at the high end? That's something only you can decide. However, here are a few pointers.

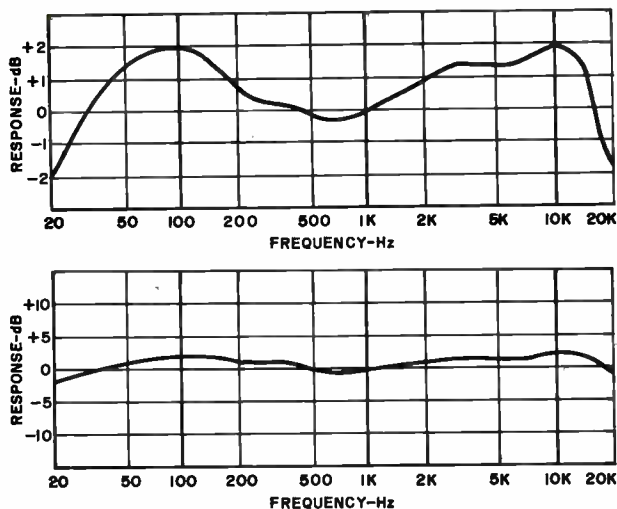

Fig. 3. Which mike has smoother response? Neither. They're identical curves drawn to different scales for dB.

If your first love is organ music, you'll want all the low-end range you can get, but not low-end rise. If you expect to be doing a lot of recording of music in which strings play a major role, choose the smoothest and most extended high end you can afford, a mike that tapers off above 8 kHz rather than rising above there (if you can't find one that's flat to 15 kHz). For classical or quiet folk voice, the low end is unimportant, and a mike that rises slightly (3 dB or so) from 500 to 5000 Hz is ideal. For large choruses, low-end smoothness is secondary to high-end smoothness, and the range above 8 kHz should taper off rather than rise. For close voice or rock recording, extended low end is called for, as is a gradual rise from around 1000 to 8000 Hz, with a fall above that. A general rule of thumb is: for classical recording, you want the smoothest and most uniform response across the whole audio range; for pop-type recording, good low end but a generally rising response above 1000 Hz.

Most home recordists, who aren't overly critical of sound but want something considerably better than just good, usually find what they are looking for in the range between \$45 and \$100 per mike. Picky recordists with better-than-average hi-fi systems at home usually find something in the range of \$90 to \$200 (per mike); while the real live-recording aficionados who have access to performing groups good enough to warrant top-notch recordings frequently jump in with both feet and invest in professional condenser mikes. The best mikes in the world won't assure a good recording if your technique is poor; but if your mikes don't have what it takes, it won't matter much how good your recording technique is, you won't wind up with a decent recording. □

LAB TESTS ON HIGH-PERFORMANCE OPEN-REEL TAPES

BY CRAIG STARK

ALTHOUGH a number of comparative evaluations of open-reel audio tapes have appeared in the past, the number of such tapes on the market has increased substantially—as have, of course, the number of tape choices open to the serious recordist. Most of these newer entries can be classified as (for lack of a better term) “high-performance” tapes. As a group, they represent a significant advance in the state of the tape-recording art.

Recorder manufacturers have kept pace with tape developments by providing external controls to set up the recording electronics for different tape types, or by pre-adjusting their machines for the improved tapes at the factory. As for older recorders, some of them will readily accommodate the new tape formulations after readjustment by a service specialist or an experienced amateur using the necessary test equipment. If this is not possible, a moderate treble cut introduced with the tone controls on the amplifier or receiver may make the new low-noise and low-noise/high-output tapes perfectly usable on a machine adjusted for the earlier “standard” tapes—frequently with a noticeable improvement in signal-to-noise ratio and high-frequency response.

Because of their degree of compatibility with existing equipment and their appeal to the recordist interested in the best performance obtainable, it was decided to limit this series of tape tests to the latest available high-performance offerings, using, whenever possible, the popular 1-mil thickness. But before turning to the specific tapes, we might review some of the basic principles of tape recording in order to appreciate what is involved in making the best use of a “superior” tape.

The internal adjustments in your tape recorder,

as well as the tapes you use with it, represent compromises between conflicting demands. Therefore, to exploit the potential of *any* tape fully, your recorder should be adjusted for that tape’s specific characteristics. These compromises involve three factors: distortion, high-frequency response, and signal-to-noise (hiss) ratio.

An ultrasonic signal (called “bias”) is fed to the tape along with the signal to be recorded. The proper amount of bias to use (it is user-adjustable on some expensive machines) is usually determined by recording a 400-Hz tone and measuring its playback level. Up to a point, raising the bias current not only increases the playback level (thus helping to achieve a good signal-to-noise ratio) but also decreases distortion—a double gain. But beyond a so-called “peak bias” point, an increase in bias causes attenuation of the high-frequency response.

It is an unfortunate fact of recording life that the amount of recording bias current that enables the tape to have maximum output and minimum distortion at low and middle frequencies also causes severe treble losses. To some degree, these losses (plus those resulting from slow-speed operation)

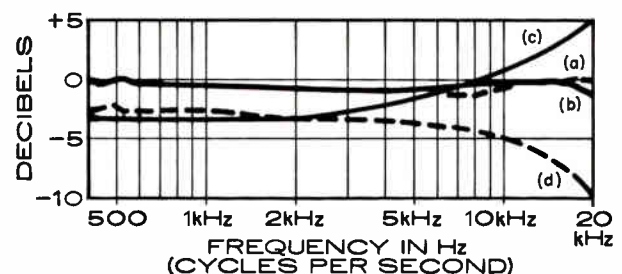
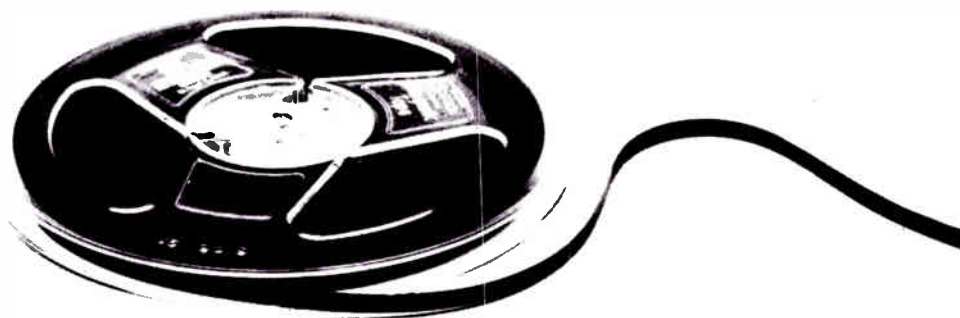

Fig. 1. Effects of recorder adjustment on tape performance. Record-playback frequency responses are shown for (a) 3M 111 and (b) 203 tapes with the recorder adjusted for each. Curve (c) shows 203 with 111 settings; (d) is 111 with 203 settings.



might be mitigated by reducing the bias current below its optimum level, but this would simply raise the distortion, so a better way has to be found.

“Recording equalization” provides a part of the solution. The main purpose of equalization is to tailor the frequency response of the input signal—the “message,” so to speak—to match the needs of the tape, or the “medium.” However, a secondary purpose is to adjust the treble response during the recording process so as to compensate for the various losses. The large amounts of treble boost (up to about 20 dB at 20,000 Hz) used during recording are possible only because the higher musical harmonics are normally much weaker than the middle and low frequencies. However, there are circumstances in which this isn’t so, and therefore the amount of permissible treble boost is limited. For example, it is possible to run into trouble when recording, say, a women’s chorus, cymbals, or electronic music. In such cases the high frequencies are *not* much lower in amplitude than the rest, so that giving them a large boost in the record-equalization stage can overload either the tape or the machine’s electronics, thus producing distortion. The obvious

cure is to turn down the record level so that the VU meters don’t hit 0 VU even on the loudest passages. Though this eliminates the distortion problem, the result is a recording that plays back at a lower average level and therefore runs the risk of an unacceptable signal-to-noise ratio.

Understanding the “trade-off” relationship between distortion, extended high-frequency response, and signal-to-noise ratio makes it clear what a “better” tape means. “Better” is improved performance in one area without loss of ground in the other two areas. For example, a tape with better high-frequency response (if used with increased bias, slightly less recording treble equalization, and slightly increased recording-signal level) can reduce noise (hiss).

To illustrate this, the curves in Figure 1 show four conditions: (a) the recorder has been adjusted for optimum performance using 3M’s venerable “standard reference tape,” Type 111; (b) the recorder has been readjusted for the requirements of one of that company’s first (1962) “low-noise” tapes, Type 203; (c) the same “low-noise” tape with the machine set for “standard”; and (d) Type 111 used with “low-noise” recorder settings. From these curves several conclusions can be drawn.

First, within the limits of experimental error, it is clear that *either* type of tape can provide flat (± 2 dB) frequency response from 20 to 20,000 Hz if the machine has the potential to reproduce all these frequencies at the outset and is adjusted specifically for the tape in question (curves “a” and “b”). Since the low-frequency response of both tapes was identical, only frequencies above 400 Hz are shown in Figure 1.

Second, when both tapes are recorded with “standard” settings, the “low-noise” tape produces

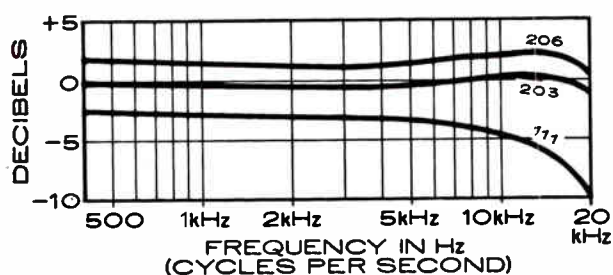

Fig. 2. At identical recording levels, different tapes provide different outputs. With the machine adjusted for 3M 203 tape, 111 tape has somewhat less overall output on playback, while 206 tape plays back with significantly more output.

slightly *less* overall output for a given recording input signal. This can be offset, however, by the fact that, for a given distortion level, one can correspondingly raise the recording level when using the "low-noise" formulation—which is to say that if your recorder is adjusted for a standard tape and you buy the low-noise variety, you will be able to run the VU meters a couple of decibels above 0 VU and obtain comparable output and distortion levels.

Third, the rising high-end response of the low-noise tape when used with the "standard" machine adjustments (curve "c" again), unless compensated for somehow, would cause the sound to be over-bright. Other than having adjusted the machine for low-noise tape in the first place, the best way to deal with this rising high end is to turn down the treble control on the amplifier. With that one simple step the correct musical balance would not only be restored, but the hiss level would be lowered also. All this should help make it clear that, in the table of comparative test results, all else being equal, the tapes with the most elevated frequency response at the high end of the spectrum are *potentially* the quietest.

Finally, curve "d" in Figure 1 shows what happens to a "standard" tape when it is used on a recorder adjusted for a "low-noise" type. It is obviously over-biased, with the results that the output level is lower (compare curve "a") and the high-frequency response is severely impaired. Clearly, then, if the owner's manual for a recorder indicates that it has been adjusted for a "low-noise" tape, one should *not* use a "standard" formulation if the highest-fidelity recording is desired.

LOW-NOISE/HIGH-OUTPUT

Latest on the market today are the "low-noise/high-output" tapes. Starting with the same basic bias, equalization, and record-level requirements as conventional low-noise tapes, they provide, as Figure 2 graphically shows, a significantly higher output for the same level of input signal. If you have a recorder that permits off-the-tape monitoring, you can verify this by setting your machine so that a conventional low-noise tape produces the same volume in "source" and "monitor" positions. Then put on one of the newer low-noise/high-output tapes and compare again. The playback volume will be significantly higher, which means, of course, that for a given listening level it will be possible to turn down the playback control, thus lowering the hiss level as well.

There is another advantage in the premium low-noise/high-output tapes. Many of today's home recordists use the slower 3³/₄-ips tape speed—ob-

viously in the interest of tape economy. Audiophile recorders almost universally specify a 2 to 3 dB better signal-to-noise ratio at the 7¹/₂-ips speed than at 3³/₄. This is because the higher the speed, the greater the signal output from the tape. But if a recorder is set up for a low-noise tape to begin with, Figure 2 shows that low-noise/high-output tapes, with their higher output, will give about the same S/N ratio at 3³/₄ ips as regular low-noise tapes do at 7¹/₂.

Two of the tapes included in the present tests (3M 206 and Capitol 2) incorporated a new "back-treatment" process that is, I think, an indication of things to come. The back treatment involved in these cases consists of applying a roughening substance to the non-oxide surface of the tape, thus providing more grip for the drive mechanism and, in addition, making for a smoother wind at high speeds. I hope this addition becomes standard practice in the industry.

HOW TESTS WERE MADE

As for the tests themselves, the results appear in the accompanying table, together with annotations explaining the significance of the data. It should be mentioned also that the tapes were tested on a Crown International SX-822 recorder and measured with a General Radio Company Model 1523 graphic level recorder and plug-in sweep oscillator; my thanks go to both these companies for their generosity in lending the equipment. Finally, some slight amplification of a few points is in order to help the tape user assess and make use of the data supplied in the table.

The experienced recordist knows that record-level indicators on tape machines are calibrated differently by different manufacturers, quite aside from the requirements of the manufacturer's "recommended" tape. With high-quality machines, their usual "rule of thumb" is to set the VU meter to read 0 VU at a level 6 to 8 dB less than that which produces 3 per cent THD (total harmonic distortion) of a mid-frequency test signal. (This allows for the fact that VU meter needles have a mechanical inertia that prevents their following peak signal levels accurately.) This was the procedure I followed, using 3M 203 tape as a typical example of today's low-noise types.

In the table, the column headed *Signal-to-noise ratio* contains figures computed mathematically from the measured data of the previous three columns. The procedure for each tape was to take the output level for a 0-VU recording level (column two) and add to it the additional recording level the tape will take before reaching 3 per cent distortion (column three). The resulting figure is the *theoreti-*

All measurements are in decibels (dB)	Bias noise (weighted)	Output with 0-VU input	Input for 3% THD at output	Signal-to-noise ratio	Frequency response					
					3 kHz	5 kHz	7 kHz	10 kHz	12 kHz	15 kHz
Low-Noise Tapes										
Ampex 344	-62.9	+0.5	+8.9	72.3	-1	-0.9	-0.4	-0.3	0	+0.2
Audiotape Formula 15	-61.5	-0.7	+7.7	68.5	+0.2	+0.6	+1.1	+1.5	+2	+2.1
BASF LP35 LH	-62.9	-0.1	+10.4	73.2	0	+0.4	+0.6	+1.5	+1.7	+2
Irish 274	-62.7	+0.6	+8.9	72.2	-0.8	-0.7	-0.6	-0.3	+0.1	+0.4
3M (Scotch) 203	-63.8	0	+8	71.8	-0.7	-0.4	-0.1	+0.1	+0.2	0
Maxell LNE35-7	-62.7	+0.3	+9	72	-0.1	+0.4	+1	+1.7	+1.9	+2.5
Memorex 1800	-60.1	+0.4	+9.7	70.2	+0.2	+1.1	+1.7	+2.3	+2.7	+2.5
Realistic Supertape	-59.7	-1	+8.1	66.8	0	+0.2	+0.7	+0.9	+0.9	+0.6
Soundcraft GTA-12	-57.5	-4.6	+14.2	67.1	+0.7	+2.1	+3	+3.7	+4.9	+5.2
Wabash Primus 2	-62	-2.3	+10.2	69.9	+0.2	+1.2	+1.9	+2.4	+2.7	+2.9
Low-Noise/High-Output Tapes										
Capitol 2	-60.4	+2.5	+9.2	72.1	-0.5	-0.2	0	+0.1	+0.2	+0.1
3M (Scotch) 206	-62	+2	+9.6	73.6	-0.6	-0.5	-0.3	+0.2	+0.3	+0.3
Maxell UD35-7	-62.4	+1.2	+11	74.6	-0.1	+0.2	+0.9	+1.8	+2.3	+2.8
Sony SLH-180	-61.7	+1.4	+9.4	72.5	0	+0.6	+1	+1.7	+2.2	+2.3
TDK SD 150H-7	-61.2	+2.2	+10.6	74	-0.2	0	+1	+1.5	+1.6	+2.7
Wabash Primus Master	-60.3	0	+9.7	70	+0.2	+0.7	+1.3	+1.6	+1.9	+1.9

INTERPRETING THE CHART

THE tapes were tested with the recorder's bias equalization adjusted to obtain the flattest possible response with the 3M Type 203 "reference tape" (see Fig. 1, curve "b"). A recording level 8 dB below that which produced 3 per cent total harmonic distortion (THD) at 400 Hz with the 3M tape was chosen as the "0-VU" input signal. Each tape tested was carefully bulk-erased; all measurements were made near the center of the reel.

- **Bias noise.** This is the noise that results during playback after the tape has been run through the machine in the record mode but with no input signal being fed to the record head. The figures reflect each tape's response to the noise introduced by the bias signal and the recorder electronics during the record-playback process. The higher the negative figure, the quieter the tape. The measurements were made with a filter conforming to the extended ASA "A" curve, which places greatest emphasis on those noise frequencies likeliest to be audible.

- **Output with 0-VU input.** These figures indicate the playback levels obtained from each tape after recording with the same "0 VU," 400-Hz input signal, and are therefore a relative measure of each tape's sensitivity at that frequency, compared with that of the reference tape (0 dB).

- **Input for 3% THD at Output.** These figures are the recording levels above 0 VU (for a 400-Hz signal) each tape will tolerate before reaching 3 per cent total harmonic distortion (THD) on playback. The higher the figure, the higher the recording level the tape can take before overload distortion (magnetic saturation) occurs.

- **Signal-to-noise ratio.** As described in the text, these figures were computed from the data of the previous three columns. First the recording level for 3 per cent distortion for each tape was combined with its output for a 0-VU recording level to determine the tape's maximum output level at 3 per cent distortion. This output level was then compared with the weighted bias-noise figure to yield the signal-to-noise ratio at close to the maximum permissible recording level. A high ratio theoretically indicates a tape with superior performance.

- **Frequency response.** The figures given for six frequencies from 3,000 to 15,000 Hz show each tape's departure from flat frequency response when recorded and played back on the test machine adjusted for the reference tape. The 0-dB point for each tape is its output at 400 Hz. In general, a rising high-frequency response indicates a tape with a potentially better signal-to-noise ratio at the higher frequencies. Since the low-frequency responses of all the tapes were virtually identical, no figures for frequencies below 3,000 Hz are given. The recording level for the frequency-response measurements was the standard -20 dB.

cal maximum output level of which the tape is capable at 400 Hz with the specified distortion. Subtracting the weighted bias noise (column one) then gives a maximum signal-to-noise ratio for each tape, which is the figure listed in the fourth column. Though the results obtained from this calculation may not always agree completely with an actual measurement, they should be close enough to give a reliable indication of the tapes' relative performance capabilities.

Today's tapes are certainly better than their predecessors, and tomorrow's will be better still. Reel-to-reel tape is the backbone of all music recording, and though it has come a long way from the days of paper tape coated with so-called "barn paint," there is still room for improvements.

Judging by past performance, the tape industry can be relied upon to make the necessary improvements to keep pace with developments in the machines on which the tape is to be used. □

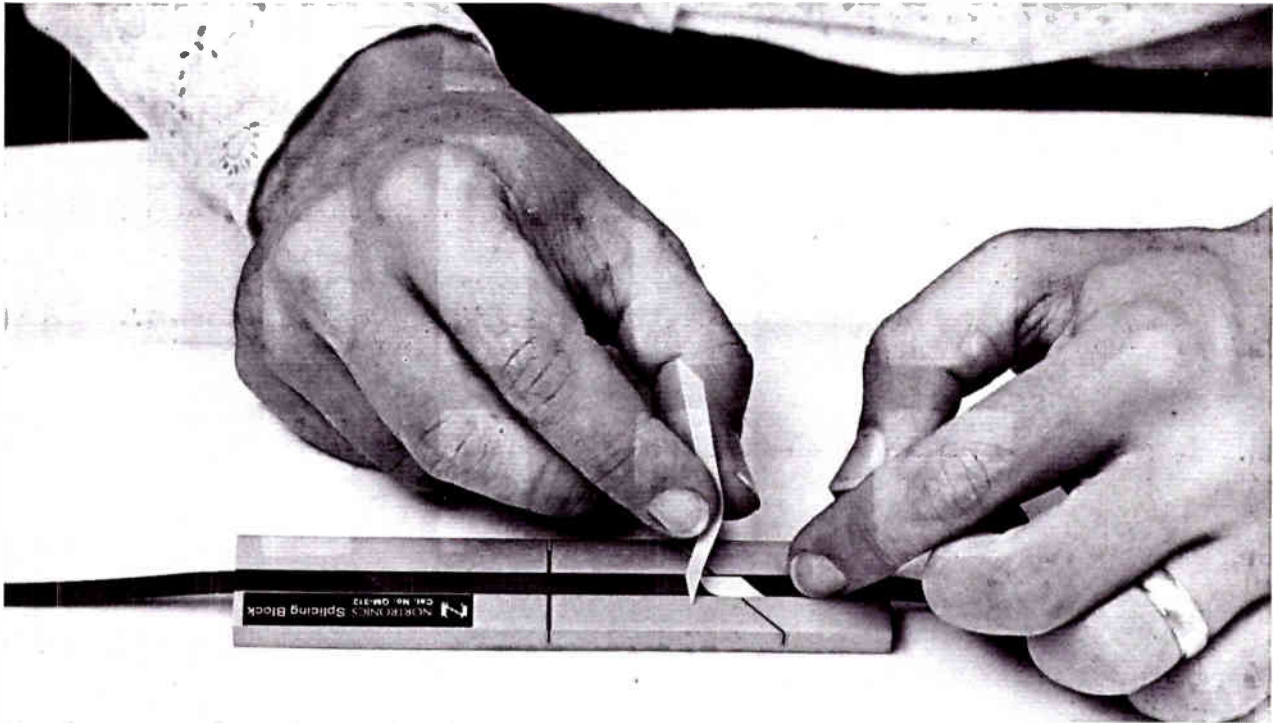

The Nortronics QM-312 splicing block designed especially for 0.15-inch cassette tapes.

ACCESSORIES FOR TAPE MACHINES

Tape accessories are the spice of a recordist's life—sustaining and enhancing fidelity, extending tape machine life and saving time.

By J. Gordon Holt

ANYTHING that is not absolutely needed for a tape machine to play or record may be considered to be an accessory. These range from little plastic clips that prevent tape from unwinding up to multi-channel mike mixers and noise-reduction devices.

The importance of accessories cannot be minimized, however. They can lengthen the life of your tape recorder, save time and effort, and enhance recordings.

GADGETS FOR TAPES

The reel clips, previously mentioned, fasten to the edge of a tape reel to prevent the tape from unwinding when it is subjected to shaking, as in transit through the mail. These work, but only with a full

reel of tape. With a partially full reel (or even a full one, for that matter), the same objective can be obtained by folding the end of the tape over the reel flange and fastening it with a bit of Scotch-brand mending tape.

Gummed-paper title labels for identifying recorded reels are available from hi-fi gadget suppliers, but equally suitable labels can be bought at much lower cost from stationery stores. The same goes for those bright red "china-marking" pencils that are sold for marking the cutting points on a tape that you're editing. They are cheaper when they aren't sold specifically for editing tape. And they can also be used for putting temporary identifying information on plastic or metal reels; the writing is removed from the reels with an alcohol-soaked rag.

Tape splicers come in all shapes and sizes, and are one of the few things in the hi-fi field about which it can be said that you get exactly what you pay for. The least expensive ones will do a slightly better job than you can do with scissors and your bare hands; the most expensive ones—bars of cast aluminum several inches long with a slightly undercut channel along them to hold the tape—make the quietest, strongest splices and will allow you to assemble bits of tape a fraction of an inch long into a smooth, strong splice, if the need for this should ever arise. The semi-automatic splicers are less flexible than the professional-type editing blocks, but require less manual dexterity and less skill to use. If your recorder is a 4-track type, though, try to get a splicer that trims a minimal amount from the width of the tape, for the left-channel tracks extend to the edges of the tape and excessive trimming here will cause a momentary loss of left-channel signal level.

Cassette editors are available, but are best used only for repairing broken tapes. Cassette splicers are likely to be conspicuously audible. Cartridge tapes can be edited on an open-reel editor, but since it is almost impossible to get the tape back into the cartridge, my suggestion here is to forget it.

Bulk erasers, for cleaning off old recordings with-

Robins' TM-2 magnetic tape editing pen which removes single sounds, noise, etc. from tape.

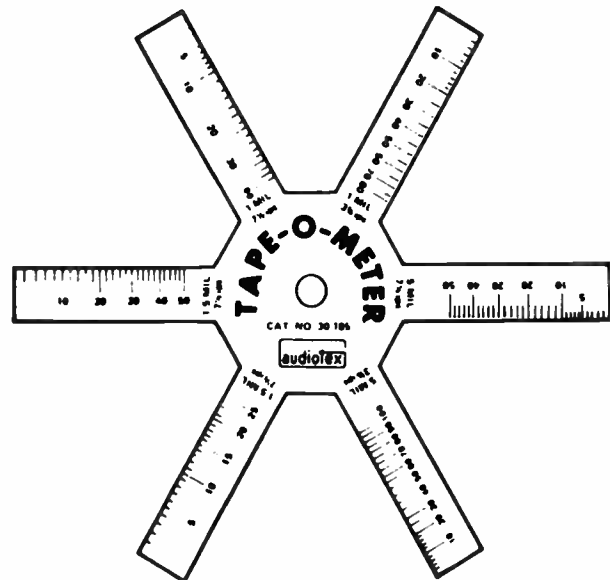
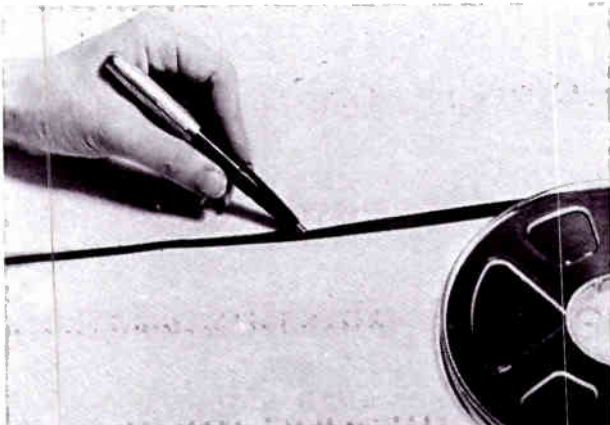

Audiotex "Tape-o-meter" for determining recording time (in min.) remaining on feed reel.

out unwinding the tape, are also variable in their efficacy. Some don't erase completely, so try your prospective purchase with an *old* recorded tape. Recordings tend to "harden" with age, becoming more difficult to erase, so a bulk eraser that will clean off a recording several years old will cope with practically anything. The exception here is in the cassette field, where some of the new high-potency oxides are even harder to erase than a "hardened" ferrous-oxide tape. Before buying a cassette eraser try it with chromium-dioxide tape.

Hand-held erasers, if of sufficient potency, are usable on open-reel, cassette, or cartridge tapes, but don't try degaussing recorder heads with them, as they may weaken the magnets in the recording-level meters.

Induction-type telephone pickups, for recording phone conversations without making a direct line tap, vary widely in their performance and their sensitivity. Many will hum loudly with most tape recorders, while some have too much output to feed a microphone input and too little to feed a high-level line input. Your best bet here is to try the one you're thinking of buying, using a telephone in the store, or buy it with the understanding that you can return it for credit or a refund if it doesn't work with your recorder. And remember: It must have a "beeper." Check with your local telephone company's legal department.

There are several kinds of noise-reduction devices available, the best-known of which is the Dolby-B, intended for home tape recording. Increasing numbers of recorders are now being made with built-in Dolby circuits, but several add-on Dolby

units are available for use with existing recorders. These will be usable for decoding Dolby FM transmissions as they become the rule rather than the exception. All Dolby licensees must meet minimum-performance requirements set up by Dolby Labs, so the actual noise-reduction performance of all Dolby units is about the same.

Where the units differ is in accuracy of adjustment, which affects high-end response and in the noise and distortion characteristics of the circuitry other than the Dolby parts. In addition, at least one available unit has built-in provision for switching the Dolby playback sections directly in series with the main system preamp so the Dolby circuit can be used for deprocessing FM as well as any other incoming signal sources.

The advanced live-recording enthusiast almost invariably discovers that two mikes are not always enough to do a job properly and starts investigating input mixers. These range from relatively inexpensive units all the way up to astronomically priced devices (for professional consoles to feed dozens of mikes to 16 tape tracks). And, again, you get pretty much what you pay for. For under \$100, you're likely to get some audible hum and hiss as well as



Cassette bulk tape eraser, the TMC-1 from Robins, operates from 50-60 Hz, 110-V line.

rather high distortion. About \$120 will buy you a semi-professional unit with four inputs, panning provision in one input, and good performance; while \$300 or more can purchase a variety of professional mixers with six or more inputs.

RECORDER MAINTENANCE

All of the available head degaussers are potent enough to do their job, but some may not be suitably shaped to reach your recorder's heads, so check this before buying. Special degaussers are available for use in cassette or cartridge machines

and some combine cassette degaussing with a head-cleaning cycle.

You can check for magnetic fields with an inexpensive magnetometer, as well as how much magnetism your tape head has retained.

The most worthwhile alignment tapes are those made for professional users and service technicians, and not only are these quite costly, they also require the use of suitable test equipment and a certain level of technical sophistication. Test tapes designed for "ear evaluation" of recorders are likely to give a recordist more unnecessary worry than enlightenment.

The best of the tape head cleaners is a cotton-tipped "Q-tip" swab saturated with a suitable solvent, and both are sold as hi-fi accessories. The cotton swabs are available at lower cost from drug stores, but I don't know of an alternate source of suitable solvent. (Carbon tetrachloride works fine, but inhaling the fumes causes liver damage, so that solvent is in disfavor these days.) Although fairly expensive, all of the head-cleaning solvents sold as such do a good job, if you can reach your recorder's heads with the cotton swabs. If you can't, which is often the case with cassette and cartridge machines, you can buy special cassettes and cartridges loaded with a slightly abrasive cleaning tape that will do almost as good a cleaning job on heads and guides as a "Q-tip." The capstan and pinch wheel must sometimes still be cleaned with a solvent in order to keep wow and flutter within specs.

Be careful with the solvents, though. The plastic trim on many tape recorders will readily dissolve in most head-cleaning fluids.

I don't recommend silicone lubricants for tape any more than for discs, and for the same reasons: they combine with dust to form an abrasive gunk and they tend to foul the head surfaces, necessitating frequent cleaning. Most tapes are already suitably lubricated and no more is required.

Tape stroboscopes are of value mainly to professional users and service technicians who are in a position to do something about a case of speed inaccuracy. For home recordists, periodic cleaning of the transport, plus an occasional pitch comparison (by ear) between the beginning and end of a commercially recorded tape will serve to ensure that constant speed is being maintained. To determine speed accuracy, compare the pitch of a pre-recorded tape with its equivalent disc release (making sure the disc is actually running at $33\frac{1}{3}$ rpm).

If you do much taping from discs, don't overlook record-care accessories that will reduce surface noise. If you don't, you'll be listening to those same clicks and pops each time you listen to the tape. □

COMPARING NOISE-REDUCTION SYSTEMS

How a variety of noise-reduction methods for home tape machines increases dynamic range of recordings

By JULIAN D. HIRSCH

Hirsch-Houck Laboratories

ONE of the major obstacles to achieving realism in the recording and reproduction of sound is the restriction of dynamic range due to the limitations of recording and reproducing equipment and materials. Dynamic range can be defined, for our purposes, as the ratio between the highest signal level that can be handled without excessive distortion and the residual noise level in the system.

Dynamic range of many musical performances exceeds that of even professional tape recording equipment. Maximum levels must be restricted to avoid tape saturation and distortion. When transferring to a master disc, excessive levels can cause groove overlapping or perhaps a recorded velocity beyond the tracking ability of available phono cartridges. As a result of this limitation, the fainter sounds must inevitably be submerged and lost in the background noise which is inherent in the tape coating or the recorder's electronic circuits.

The dynamic-range problem is being attacked on several fronts. Improved tape formulations and head designs allow higher signal levels to be recorded and have lower intrinsic noise levels. With the latest semiconductor devices, electronic circuit noise is approaching the theoretical minimum. Skillful recording techniques and microphone placement can do much to reduce the dynamic range of the program *before* it is actually recorded. Finally, a number of electronic noise reduction systems have been developed.

The home recordist, lacking the professional's financial resources and extensive experience, nevertheless has a choice of several commercially available noise-reduction systems to assist him in improving the range of his recordings. Although most of these systems are capable of effective performance, they are limited in their compatibility with each other.

It is possible to classify noise-reducing systems as *closed* or *open*. A closed system must be used both when making a recording and when playing it back. The special characteristics of the recording

processor are complemented by exactly equal and opposite characteristics in the playback processor. Therefore, at least in the ideal case, there is no effect on frequency response or distortion, but merely an improvement in overall S/N ratio.

Although the most effective noise-reduction systems are of the closed type, there are obvious disadvantages to the requirement of having a specially processed recording. Open systems overcome this objection, since they function with any type of input program. Any special information required to operate the playback processor comes from the program itself, rather than from a complementary recording characteristic. In general, open noise-reducing systems are either less effective than closed types or are more noticeable in their operation.

In a sense, the use of recording pre-emphasis and playback de-emphasis can be considered as a closed noise-reducing system, since it improves the overall S/N ratio of a recording (or broadcast) process. However, it is a static system, operating independently of program level, and will not be considered here. Similarly, a simple low-pass or band-pass filter (such as those found in most amplifiers and receivers) is a static open-type noise-reducing system, but it usually affects the audible program as well as the noise. All the noise-reducing systems we will discuss are *dynamic*; their action is controlled by the signal characteristics.

Closed NR Systems. Dynamic closed noise-reducing systems are also known as "compressor/expanders," or "compandors." The recording gain is controlled by the signal level, increasing the amplification of weak signals so that they are above the background noise and decreasing the amplification of loud signals to keep them within the recorder's maximum limits. The playback transfer function (output versus input) is the inverse of the recording function. Thus, the level of weaker signals is reduced, relative to the stronger ones. Since any noise introduced in the recording and playback process is reduced together with the lower level signals, the net result is the preservation of the orig-

Simplified diagram showing operation of the Dolby "B" system.

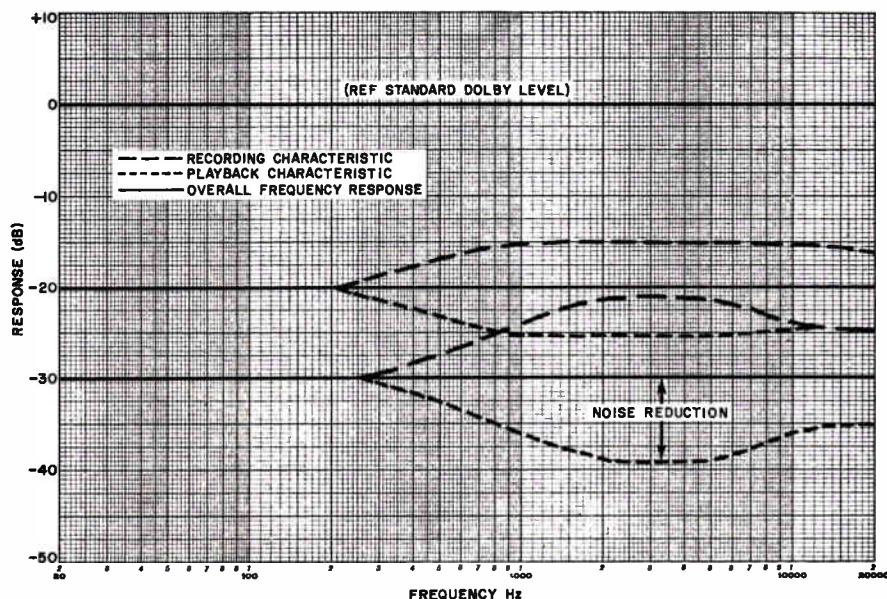

inal program dynamics, with a reduction in the noise added during the recording and playback process.

Some companders operate over the entire audio-frequency range. They can reduce low-frequency noise, such as hum or rumble, as well as the usually more audible high-frequency hiss. The professional "A-Type" Dolby system is of this type, with the unusual feature that it functions as four independent systems, each covering a portion of the audio range. Another professional compandor, manufactured by Burwen Laboratories, provides an extraordinary 55 dB of noise reduction. Both of these systems are far too expensive for use in consumer products or by hobbyists. However, a relatively inexpensive compandor, the dbx 117, operates at all frequencies and can provide an overall S/N improvement of as much as 20 dB.

The widely used "B-Type" Dolby system affects only the middle and high frequencies. Depending on the frequency content of the program, its action may begin as low as 500 Hz or as high as several kilohertz. In either case, the amount of recording "boost" (and playback "cut") is a function of program level. The Dolby "B" system has no effect on strong signals. It provides a progressively increasing noise-reducing action as the signal level drops below -20 dB (relative to a standard maximum recording level).

The single-band, relatively simple Dolby "B" system is now built into most high-quality cassette recorders, as well as a few of the finest open-reel machines. It is offered as an external "add-on" accessory by several manufacturers. The Dolby system is also used by a limited number of FM broad-

cast stations, and a few FM tuners incorporate the Dolby playback circuits.

The JVC Automatic Noise Reduction System (ANRS) is somewhat similar to the Dolby "B" system in its basic concept, although its recording and playback characteristics do not precisely match those of the latter and its circuitry is completely different. Both the Dolby and ANRS systems can provide a noise reduction of 6 to 10 dB with little or no effect on the audible program. With either system, an encoded program can be played back without decoding. It will sound slightly "bright," but this usually can be corrected with the amplifier treble tone control. The final result can be very satisfactory, although not exactly as it was meant to be heard (the tone-control action will actually provide some noise reduction). When a Dolby tape is played back through a ANRS unit (or vice versa), the results are even better, but under certain conditions the differences in filter tracking can be heard as a "swish" or other transient. This "quasi-compatibility" does not exist when using wide-band companders, since a compressed program generally sounds less natural than one with unmodified dynamics.

The ANRS system was originally developed for JVC's CD-4 discrete disc quadrasonic demodulators where it is used to reduce noise on the ultrasonic sub-channel signals. It is also built into a number of JVC cassette recorders and is available from JVC as an "add-on" accessory.

Open NR Systems. Among the open-type noise-reducing systems, the Philips Dynamic Noise Limiter (DNL) is probably the best known. The DNL is a low-pass filter, cutting off at about 5000 Hz. In the absence of program content above that frequen-

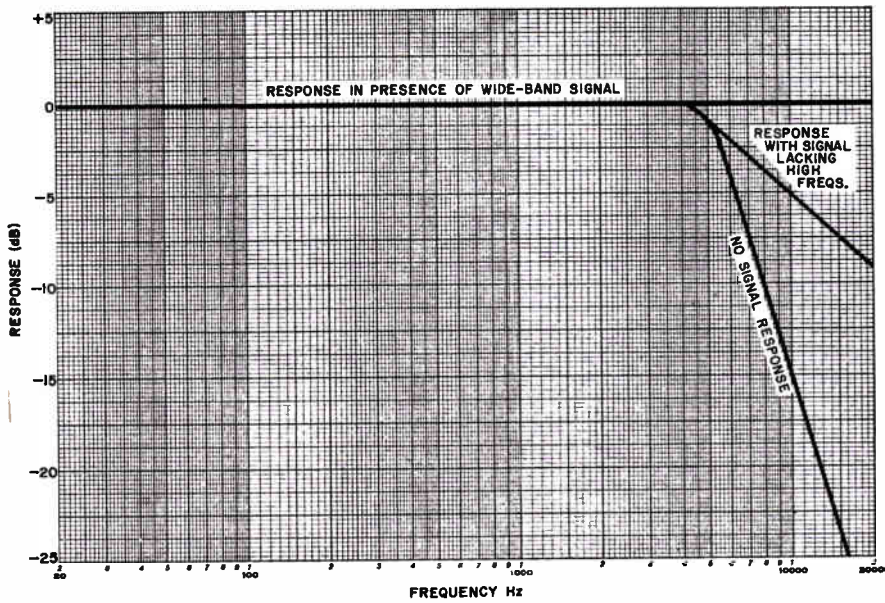

Operation of an open-ended dynamic filter.

cy, the filter is "on" and reduces hiss appreciably. Even a small amount of high-frequency program energy causes the filter to "open up" slightly, and the process is smooth and gradual. Accordingly, the filter is effectively out of the circuit at most musical program levels. In most cases, the Philips DNL operates with little or no audible side effects, but with a fairly noisy background its action can often be heard as a "swish" when the filter is varied.

The Philips DNL system is found in several of their cassette recorders (sold in the United States under the Norelco name), as well as in the deluxe Nakamichi 1000 cassette recorder. While it is not as effective as either the Dolby or ANRS systems, it has the important advantage of being usable with any type of program material.

A more elaborate open noise-reducing system is used in the Kenwood KF-8011 "De-Noiser." This accessory unit has four contiguous band-rejection filters covering the range from 3 kHz to 15 kHz. Each filter is controlled by the program content in its own frequency range, attenuating the affected band by as much as 15 dB in the absence of significant program level. The Kenwood "De-Noiser" operating threshold can be adjusted to suit any requirement. Each of its four bands can be engaged or de-activated at will. It has the unique feature of being usable in the recording path, thereby reducing

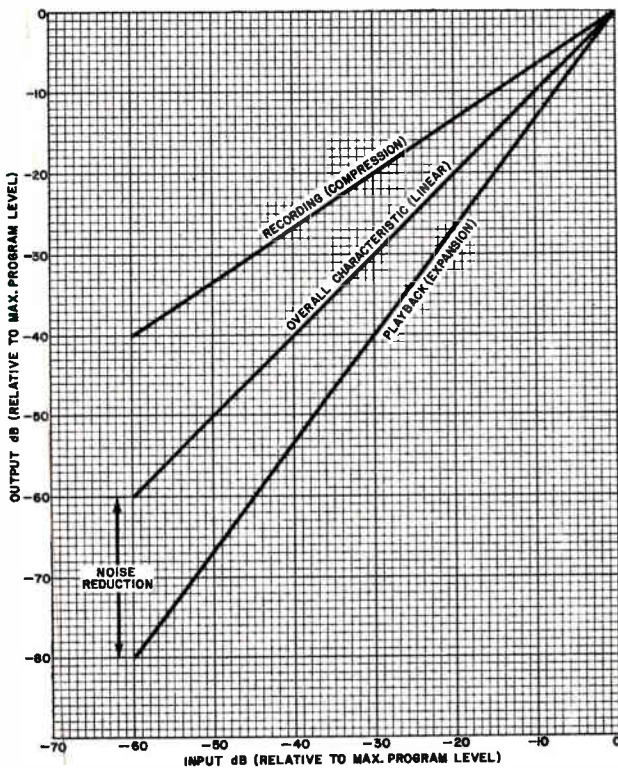

How a compandor system operates. See article for details.

HOW THE DOLBY "B" SYSTEM WORKS

If ever an invention arrived "just in time," it was the Dolby noise-reduction process. Since 48 or even 50 dB of signal-to-noise ratio (achieved with better cassettes without Dolby) was just marginally acceptable as background hiss on tape, as far as the serious recordist was concerned, another few dB of quieting would push the medium over into the realm of "true" high fidelity. And that is exactly what Dolby did! The concept is really quite simple (although its successful execution took much work and experimentation). Since tape hiss is basically a high-frequency form of disturbance that is masked by loud program content, Dolby devised circuitry which pre-emphasized high frequencies during the recording pro-

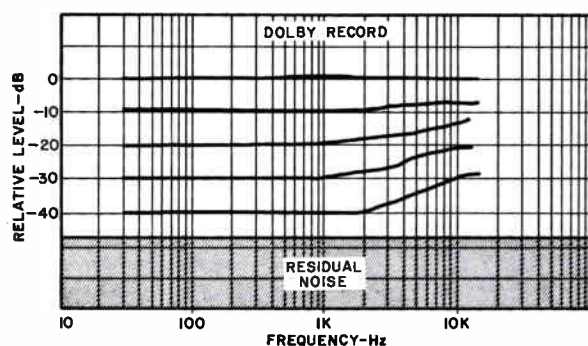

cess—but only the high frequencies associated with low-level musical passages.

The degree of this pre-emphasis is dynamically regulated, based upon actual musical levels. Note from the illustrations that loud passages are not emphasized at all, while successively lower musical levels are subjected to increasing pre-emphasis.

Recordings made in this way and played back on ordinary machines would sound shrill, particularly when low-level musical passages are reproduced. The playback part of the Dolby system, however, works conversely, rolling off the highs for low-level signals while leaving loud musical passages unaltered with respect to frequency response. The result of this two-part process is net flat musical frequency response, but with a highly significant reduction of background hiss or noise introduced during the record and playback process by the tape and associated electronics.

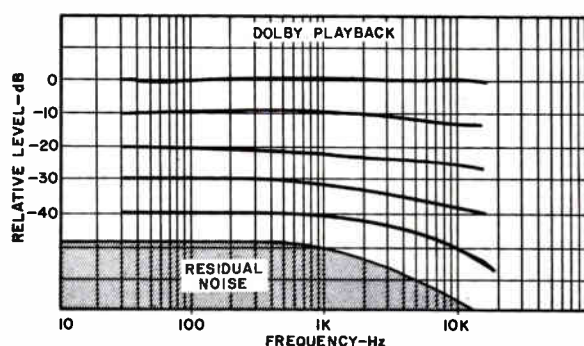

any noise on the incoming signal (which none of the other systems can do) and then being used again on playback for additional noise reduction. Like the DNL, the Kenwood system can often be heard as it operates, but this effect can be minimized by proper adjustment of its operating controls.

Recently, we heard of a "new" open-type noise-reducing system which promises to give effective S/N improvement without any audible side-effects. Actually, it is "new" only in its application to a consumer product, having been used for years in processing weak radar returns and photographs received from space satellites.

This is the *autocorrelator* featured in the Phase Linear 4000 preamplifier. In its present form, it is intended primarily for reducing phonograph record hiss, but would seem to offer hope to tape recordists as well. The autocorrelator, in effect, splits the signal into two paths and multiplies it by itself. The program portion of each channel is coherent with that in the other, resulting in a reinforced signal after multiplication. Random noise, on the other hand, has no definite phase or waveform relationship in the two signal paths and tends to be reduced in the

multiplication process. The result of the autocorrelation is a substantial improvement in S/N ratio. At this time, we have not had sufficient experience with the Phase Linear system to evaluate it, but a demonstration of its noise-reducing properties was most impressive.

Summarizing, one can say that closed noise-reducing systems are, in general, the most effective although they may limit one's choice of program material. Among these, the Dolby "B" system is so widely used as to be truly universal, as well as doing a most effective job.

For the tape hobbyist who records "live" programs, a full-range compandor such as the dbx 117 offers some interesting possibilities, since its 20-dB improvement factor is the best of any home noise-reducing system and is effective at all frequencies.

For listening to previously recorded tapes or cassettes, the various open-type systems are all worthwhile (of course, a Dolbyized tape should be played through a Dolby decoder). One thing is certain—there is no need to tolerate background hiss in any tape format. It *can* be eliminated or greatly reduced at moderate cost. □

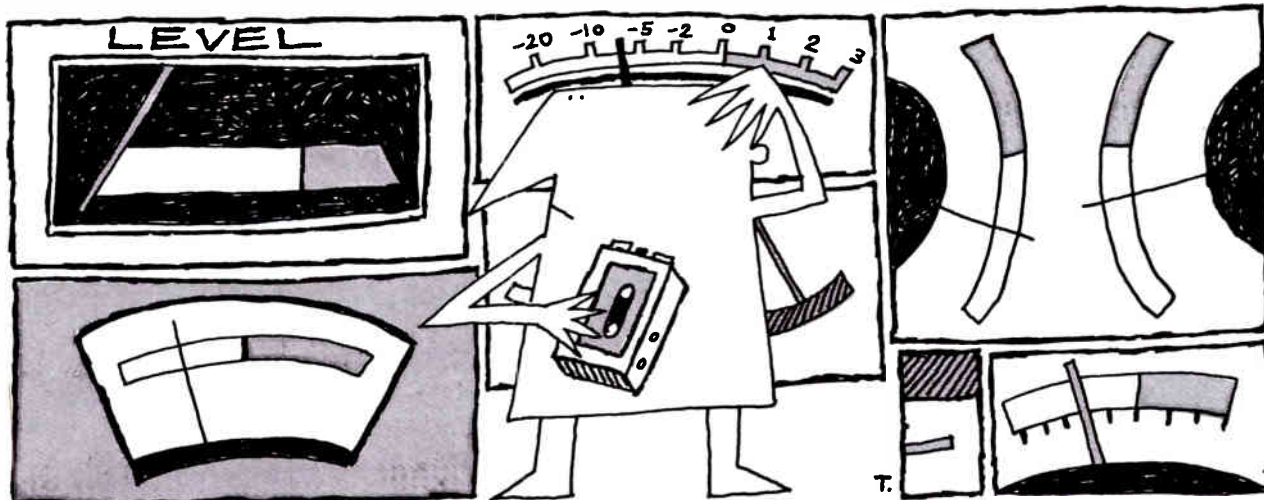

PROPER CASSETTE RECORDING LEVELS REDUCE DISTORTION AND NOISE

How to combat meters that lie, varied tape formulations, narrow tracks and slow speed

By Ralph Hodges

IN THE tape-recording-machine field, cassette recorders may be likened to 35-mm cameras. Both require special care to approach the quality produced by larger-format equipment, while retaining the advantages of small size, convenience features, etc.

While tape overload (magnetic saturation) is the bane of tape recording in all its forms, it is nowhere so prevalent as with the cassette. All the parameters of the cassette medium—thin tape, narrow recorded tracks, very slow tape speed—add up to very little magnetic-oxide material per inch of tape, and very little material per unit of time. To skimp on oxide is to invite magnetic saturation, and this is likely to occur most often at high frequencies. This is due to the treble boost applied to offset inevitable high-frequency losses and to fight the hiss that is rampant with cassettes. The combination record-playback

head of most cassette decks is an additional complication. A head that is ideal for playback is itself prone to overload when *recording* high-level signals.

METERS THAT LIE

Many recordists—particularly those who tape live music—are finding that working with cassettes can be a game of blindman's buff. The game is blind because the recording-level meters, your hedge against distortion-producing levels, are not always to be trusted; dB numbers that are "safe" in one situation can lead you astray in another for a variety of reasons.

For example, too many of the meters have response characteristics approximating those of VU devices, and while this may sound admirably rigorous and "professional," this type of meter is not

really appropriate for cassette-type recording.

True VU meters conform to a well-defined standard of ballistic damping. As a result, they respond to the recording signal in a kind of lagging, lingering manner. This is good, because it makes the meters readable. An undamped meter, responding to every brief spike of the musical waveform, would wiggle, shudder, and overshoot its way across the dial in a blur of movement. However, it's also bad because a VU meter is incapable of registering momentary peaks that might be just long and strong enough to cause audible trouble. This is very much a matter of degree.

At one time the VU meter was admired for its tendency to stolidly ignore a little bit of "blasting," since the ear is tolerant of very short bursts of distortion, and to distract the recording engineer with split-second overloads that no one would ever hear seemed self-defeating. But mind you, these rules applied only to the finest recording equipment of that time. And even so, a good deal of practical experience was necessary to interpret a VU's readings accurately and safely in every situation.

With cassettes, and particularly in live recording situations, a VU meter is definitely not the level indicator of preference. The cassette has a hair-trigger readiness to overload not shared by studio recording equipment. Signal peaks of very short duration must be taken into account; they can produce very audible distortion. And large peaks come along frequently in live recording.

When you dub a disc, FM broadcast, or any kind of second-hand program source onto a cassette, you are dealing with material that has been "pre-limited"—all the severe peaks have been chopped off (not audibly, one hopes). This stands to reason when you consider that a full-scale live performance may have a dynamic range well exceeding 80 dB, whereas a disc or tape recording with a 60-dB dynamic range is really pushing the state of the art.

Most cassette decks have been designed with copying chores in mind; and in this application, brief meter excursions up to 0 dB and a little above usually create no problem with standard tape. But the live cassette recordist quickly finds that, to keep the meter needle from going berserk on fortissimos, he must choose levels that have it resting on its bottom peg, barely moving, for distressingly long periods. And even if he doesn't succumb to the temptation to inch the level controls up gradually (sheer disaster when a climax takes him by surprise), he may *still* not be entirely safe if the meters aren't fast enough.

The new breed of super tapes, however, demand

more drive. If your recorder doesn't have a high-output tape bias switch that recalibrates the level meter, as well as a standard tape bias position, then musical climaxes should be recorded with the meter needle moving deep into the red (say, +2 dB). Another bias switch, often available, is for use with chromium-dioxide tape.

METERS THAT LEVEL WITH YOU

Of late the recording industry has been taking peak levels very seriously, and many of the newer consoles and mixing desks are festooned with light displays that register and hold peaks, and even "remember," for later reference, the maximum levels achieved during a recording session. Some of these devices have already begun filtering down to the consumer sphere, where they exist—in a simpler, modified form—in some cassette decks. Among these devices are:

Peak-Reading Indicator Lights. These are warning flashers that supplement the meters (usually more-or-less conventional VU-type level indica-

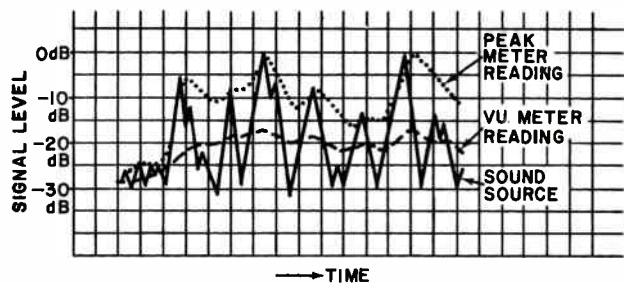

Fig. 1. Response of two meters to dynamic profile of typical music signal (solid line). The VU meter (dashed line) roughly indicates average level. Because of fast attack and slow release, peak-reading meter (dotted) follows contour of peak levels.

tors) by flickering on in the presence of sharp, potentially troublesome transients that the meters are too slow to register. Logically enough, LED's (light-emitting diodes), with their virtually instantaneous response, are becoming rather popular in this application. The levels that trigger these indicators, and the time constants they follow, are discretionary with the manufacturer, who has presumably taken the trouble to find out what types of signal are likeliest to cause audible distortion with his machine.

Peak-reading meters. As noted earlier, an unaided meter fast enough to respond accurately to brief musical transients would have to be so underdamped that it would whip all over the dial in an undecipherable fandango. But if a conventional meter is driven by its own little amplifier, the time constants of the meter's response to the recording signal can be controlled electrically for whatever

result is desired. The combination of a meter and a driving amplifier with a fast attack time and slow release time (the electronics hold onto the transient somewhat longer than it actually lasts) produces a reasonably valid peak-reading indicator. (Fig 1.) One manufacturer's device of this type gets to within 2 dB of actual value for a signal lasting only 50 milliseconds. (Compare this with a VU meter's attack time, which is somewhere around 2 to 4 tenths of a second.) Another manufacturer advertises an attack time of 20 *microseconds* (and release time of 70 milliseconds) for his meters' amplifiers.

Because of their slow release times, peak-reading meters tend to display a somewhat compressed picture of the actual signal dynamics. This tends to make them fairly readable. At the same time, since they ride along the peaks of the musical waveform, ample indication of excessive levels is given.

Equalized meters. A conventional recording-level meter reads the "flat" signal as it comes from the inputs of the tape recorder. The signal applied to the tape, however, has received a strong high-frequency boost to offset hiss and treble losses. This means that the tape can easily get into trouble with excessive high-frequency levels that the meters know nothing about. The obvious remedy is to have the meters monitor levels *after* the recording-equalization stage—in other words, equalized meters. As a rule, this requires separate driving amplifiers for the meters, which may or may not have peak-reading time constants. Also, the meter movements should be able to tolerate substantial amounts of high-frequency energy without burning out.

Peak limiters. A limiting circuit controls the gain of the recording amplifiers, typically acting only

Fig. 2. In ideal limiting circuit, instead of following high-level signals into overload region (dashed lines), the amplifiers are gain-controlled to permit little or no signal increase above a certain threshold.

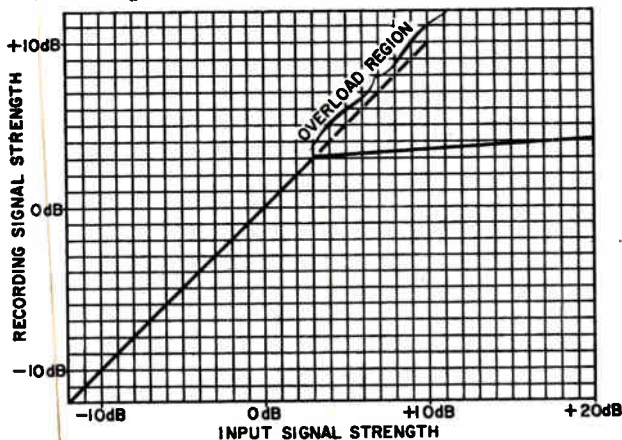

when a preset threshold level (usually a level that produces 1 to 3 percent distortion) is reached. A good limiter just won't let the signal going onto the tape get any stronger than that, no matter what the level at the inputs. (Fig 2.) All the worrisome transient peaks are thereby simply eliminated.

An audibly unobtrusive limiting circuit has to be designed with a rather fast attack time and a *very* slow release time—several seconds or so. Otherwise the decaying tails of cymbal crashes and similar abrupt, loud sounds would disconcertingly "bob up" in level. Therefore, any limiter which is working (in many live-recording situations, it will work quite a lot) is going to introduce considerable compression in the recorded signal. And since no limiter found in consumer equipment is likely to be sophisticated enough to be inaudible under every circumstance, there should be a switch to take it out of the circuit when it's not wanted.

But how does the ear react to being deprived of the high-level musical transients we tend to associate with excitement and "realism" in reproduced sound? Up to a point, the ear is forgiving. The action of a limiter will be heard if it is allowed to affect the average levels of the program. But if the recordist chooses levels that result in only the briefest clipping of peaks, the limiter may very well go unnoticed in the final recording.

WHAT WON'T HELP

All over the recording world, the perils of high-level transients have been a little slow in receiving acknowledgment. In fact, none of the developments that made the cassette a high-fidelity medium has any direct bearing on the tape-overload situation. The B-Type Dolby noise reduction system is a help only because it permits lower recording levels *overall* while still retaining a good signal-to-noise ratio. Chromium-dioxide tape is somewhat more resistant to overload distortion than iron oxide, but it's clear from the proposed standards for CrO₂ playback equalization that its potential is generally being exploited in another way—to *increase* the recorded levels of high frequencies and thereby further improve the S/N. This is probably the correct priority to follow for most cassette users. However, it eases the plight of the overload-prone cassette medium hardly at all.

Complete mastery of reading level meters and other devices in every situation probably won't come until you've had a chance to assess what went wrong with a number of previous recordings. Which is another way of saying that there's no substitute for experience in tape recording, as seasoned recordists are already aware. □

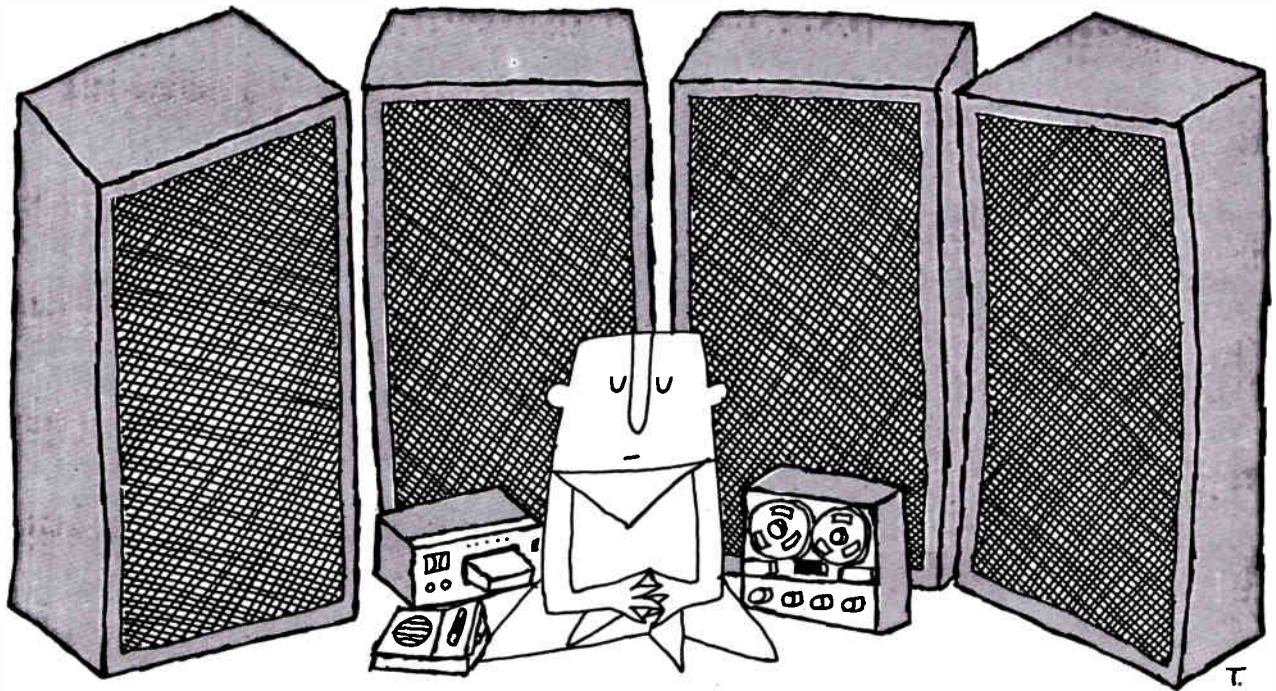

WHAT'S THE STORY ON 4-CHANNEL TAPE MACHINES?

A status report on quadrasonic sound from open-reel, 8-track and cassette tape recorders
By Leonard Feldman

FOR ALL the controversy and confusion surrounding quadrasonic discs these days, it seems odd that the tape forms of program sources have made so little progress in the area of four-channel sound. Superficially, at least, tape presents no problems when it comes to "surround sound." Multi-track recording (as many as 16 or even 24 channels) has been the rule rather than the exception in professional recording studios for years now. Aside from artistic or aesthetic considerations, it is no great problem for a recording mix-down engineer to create a four-channel master tape from such multi-track masters. Why, then, has tape lagged behind in consumer acceptance of quadrasonic formats?

QUADRASONIC SOUND

Before examining the realities of the tape scene as they apply to four-channel sound, perhaps a fundamental justification for quadrasonics is in order for those who still view this form of home music reproduction with some skepticism. Stereo sound, for all its dimensional enlargement of sonic space, was and is only a two-dimensional form of playback. A wall of sound can be created using two channels, with specific musical instruments positioned anywhere between the two loudspeakers in a stereo setup. In typical home listening rooms, the sound field is confined to a flat surface—the stereo wall of sound. Such rooms are much smaller than a concert hall or auditorium in which music is performed. Often, furnishings are such that little or no reverberance is added to the reproduced sound by

the room acoustics. Such reverberance or "ambience" in a concert hall is what enables us to sense that we are in a large hall. (Rustling of audience, clearing of hoarse throats, and the like are also psychoacoustic identifying factors, but not nearly as great as "hall ambience.")

It might be argued that in a large auditorium, using "classical" two-channel recording techniques, this sense of ambience is recorded along with primary musical information—and indeed that is true. But, when the recording is reproduced at home through two frontally located loudspeakers, both the primary and the reverberant sounds are reproduced via the two front speakers. There is no way that the random reverberant sound can be "pushed" into the room and behind the listener where it belongs.

First attempts at four-channel musical recording for home use sought to place this ambience where it belonged—all around the listener. If four-channel recordings (and reproducing equipment) did nothing more, they would be worthwhile. But quadraphonics, once given to recording studios as a new tool, has been put to more ambitious tests. Musical arrangements which surround the listener with instruments placed around him have become popular,

well be the medium that saves the hearing of our youth!

OPEN-REEL FOUR-CHANNEL TAPE

No real problem was posed in translating open-reel tape formats to quadraphonics. For years, stereo open-reel tape machines had four-track capability, as shown in Fig. 1. One stereo program was recorded and played back on tracks 1 and 3, while a second stereo program was recorded and played in the reverse direction, using tracks 2 and 4. To get four-channel recordings on open-reel tapes, it was only necessary to devise new tape record and play heads which incorporated four magnetic gap circuits instead of two, as shown in Fig. 2. Driven by additional record and playback preamplifiers, each gap magnetized one of the available four tracks during record; on playback, each recorded track was picked up by a separate section of the playback head and suitable playback preamplifying circuits.

The only element of the system that is altered is the available length of recording time in a given length of tape. (Obviously, with full tape width used for the four channels of recording, playing time is cut in half for any tape speed.) This open-reel tape format inherently offers best fidelity and the most

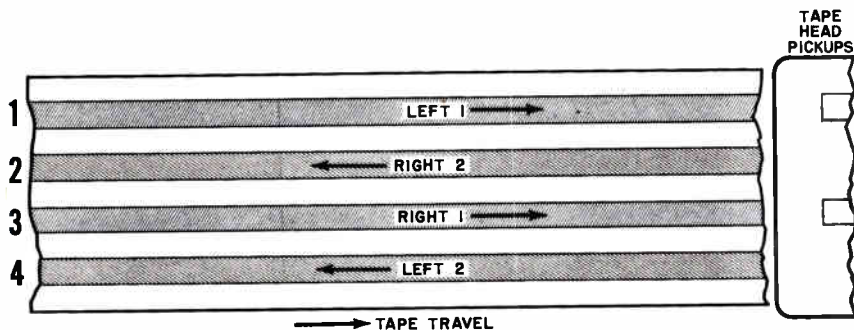

Fig. 1. Arrangement of two stereo programs on open-reel 4-track tapes. The "notches" on the pickups are the head gaps here and in other figures.

particularly in the area of pop and rock music. Listeners to this kind of fare have, for a long time, wanted to be totally immersed in the musical experience. Using stereo equipment, they have tried to "turn on the entire room" by employing inordinately loud listening levels. With four-channel sound, they can achieve the same involvement even at moderate listening levels. Four-channel sound may

"discrete" four-channel sound of all. Separation in excess of 40 or 50 dB between channels is easy to achieve, compared with the 20 or 25 dB of separation offered by even the most carefully recorded (and played back) CD-4 "discrete" phono discs. Why, then, has the open-reel four-channel machine become the preferred "pet" of only a limited number of dedicated audiophiles?

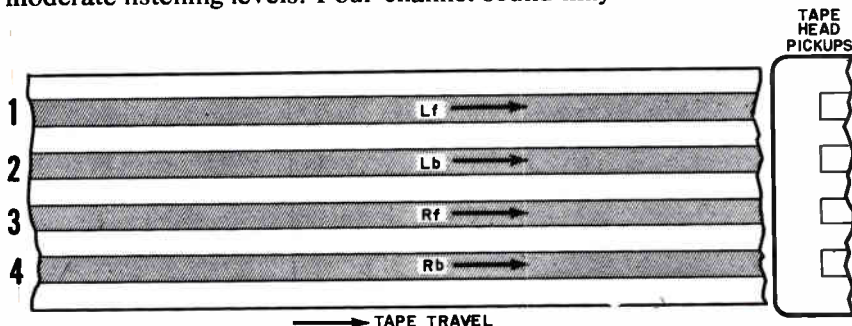

Fig. 2. In 4-channel open-reel machines, all four tracks are recorded and played at once, in one direction, reducing the playing time.

If you thumb through any hi-fi equipment catalogue you will be surprised to learn that open-reel machines, stereo or quadraphonic, carry very high price tags. Unlike a decade ago, when good stereo decks could be bought for \$200 or \$300, components of this type are now largely confined to the over-\$500 category and, in the case of good quadraphonic decks, they approach the "\$1000.00 and up" bracket. The answer lies in the rapid development and improvement of cassette tape decks.

CASSETTE FOUR-CHANNEL TAPE

Cassette machines, which just a few years ago were regarded by the high-fidelity fraternity as an interesting curiosity capable of only low-fi voice

or better), and the signal-to-noise ratios which approached 50 dB, even before the advent of Dolby noise reduction.

With Dolby noise reduction, improvement in signal-to-noise ratio is as great as 10 dB, pushing the effective S/N ratio up from 48 to 50 dB to 58 or 60 dB. This is enough to qualify the cassette machine as a true high-fidelity component.

Track layout of a standard cassette differs from that used in open-reel tapes. Here, related stereo tracks are placed side by side, as diagrammed in Fig. 3. Thus, one stereo program is heard when the cassette is played in one direction; when it is inverted and played in the other direction, a second full program is heard. This format was decided upon by

Fig. 3. Cassette track utilization for stereo differs from that of open-reel tapes.

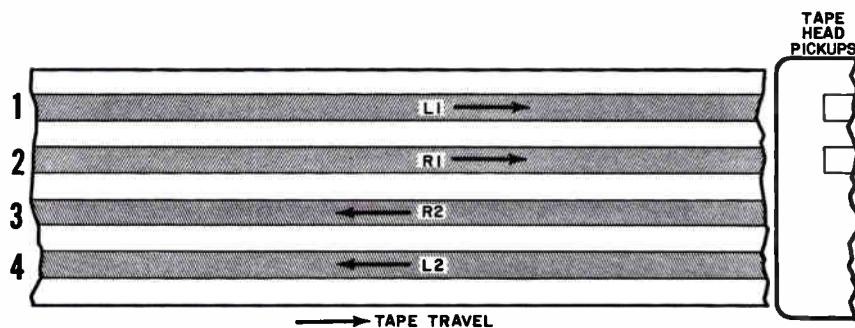
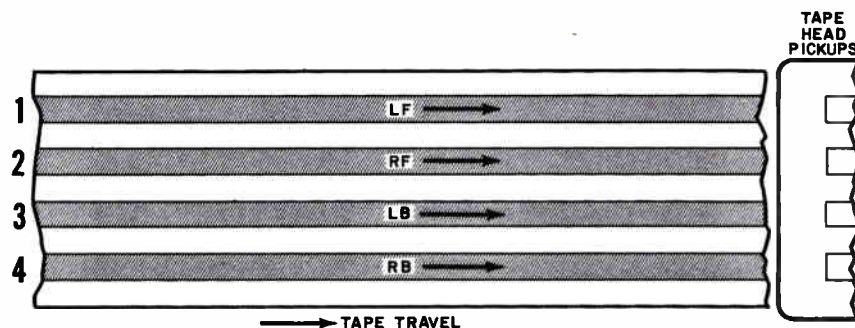

Fig. 4. Simplest transition to quadraphonic cassettes would be track arrangement shown, but this was not to be, as shown in Fig. 5.



recording, have undergone the greatest technological advance of any single component in hi-fi. Frequency response of better machines has improved steadily so that today it is not unusual to find cassette machines capable of response from 30 Hz to above 15,000 Hz (which is as good as present FM broadcasting, by the way). Record/play heads for cassette machines have undergone major refinements. Tape formulations have improved remarkably, as having machining tolerances, tape-drive systems, and associated electronics. When you consider the fact that cassettes operate at an incredibly low speed of $1\frac{7}{8}$ ips and that the tape itself is scarcely wider than $\frac{1}{8}$ inch (compared with $\frac{1}{4}$ -inch widths used in both 8-track cartridge and open-reel tapes), the frequency response achieved is truly phenomenal. So, too, are the wow and flutter figures (which, in top-quality machines, are as low as 0.1%

Philips Company of Holland, licensors of the cassette principle to all other manufacturers. This arrangement makes cassettes fully compatible, that is, a stereo cassette played on a mono machine has its two channels picked up simultaneously by a wide playback head gap, while a mono cassette played on a stereo machine induces the same magnetic information in both stereo head gaps (and hence both speakers).

At first glance, the simplest transition to quadraphonic cassettes might be made by using all four available tracks, recorded in the same direction, much as is being done for open-reel pre-recorded tapes. The track arrangement would be that shown in Fig. 4. New record and play heads would have to be engineered, but this would be no more difficult than the transition in open-reel machines. The problem lies with the compatibility of cassettes. Since

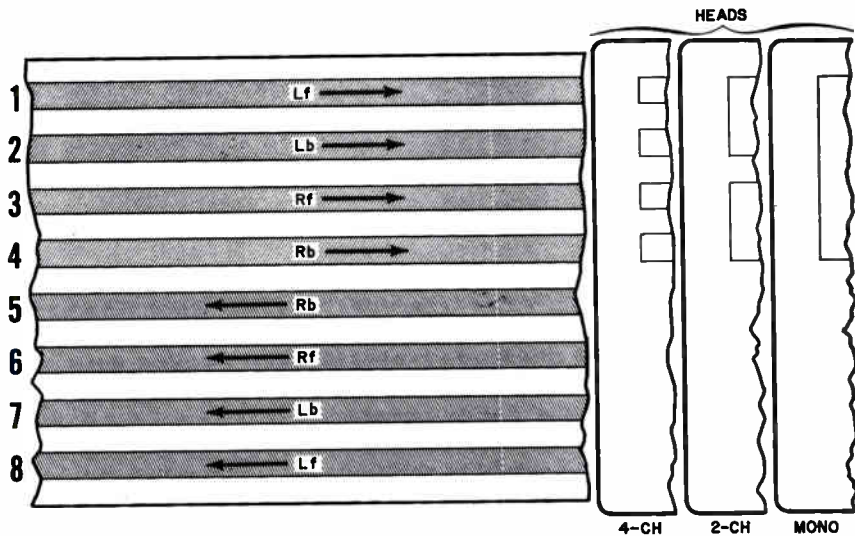

Fig. 5. Further division of cassette tracks to eight would maintain quad-stereo-mono compatibility and playing time while reducing the track width. Tape width remains $\frac{1}{8}$ inch.

Philips decrees that all cassettes must be compatible with all machines, the solution using the track layout of Fig. 5 would not fill the bill. A listener playing a quadraphonic cassette on a stereo machine would hear, first, the two front channels (with no contribution from the two rear channels). Upon inverting the cassette, he would not only be treated to the back channels *only*, but would hear their content played *backwards*.

Accordingly, Philips has repeatedly suggested that the way to four-channel cassettes must involve a further reduction of track width. Specifically, this is eight *very* narrow tracks all within the width of a little more than $\frac{1}{8}$ inch, as shown in Fig. 5. Each track would be just a few thousandths of an inch wide and, while manufacturers might be able to keep their record/play heads in reasonable alignment so as to prevent cross-talk and poor frequency response, signal-to-noise ratios would take a "step backwards," negating some of the improvement brought about by the Dolby system. An even more

severe problem would be faced by cassette duplicating firms (who "dub" pre-recorded music onto cassettes at much higher speeds for reasons of economy). Cassette tapes, moving at high speeds, have a tendency to wobble up and down. Therefore, with decreased track widths proposed by Philips, alignment problems in duplicating could become horrendous.

Despite the problems envisaged, at least one company has announced production plans for a quadraphonic cassette tape deck following the Philips 8-track proposals. But, seeing is believing. It has also been suggested that "matrix" encoding from four channels to two channels might be the best solution for cassettes. Indeed, the two encoded channels of a matrix system could be recorded onto cassettes without any change of parameters, format, frequency response, or signal-to-noise specifications, much as is done with matrix-encoded records. It would seem a pity to have to go this route with any tape format, however, since tape, of all storage

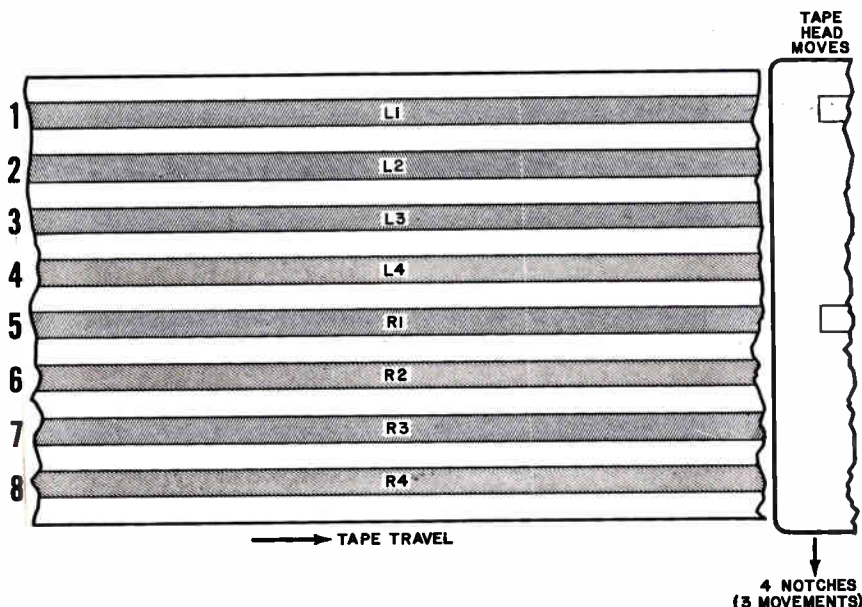

Fig. 6. Cartridge stereo tapes have four programs, each using two of the available eight tracks (L1 = left of 1st program, etc.)

media, seems so right for discrete approaches to multi-track recording.

CARTRIDGE FOUR-CHANNEL TAPE

The last of the tape formats to be considered in terms of its four-channel applicability is the 8-track cartridge. First dubbed "Quad-8" cartridges, and later Q-8 by RCA, four-channel sound on cartridges appeared very early in the quadraphonic era. Stereo 8-track cartridges of the "endless loop" variety had been introduced years before, primarily as a background music program source for automobile use. The track arrangement of stereo 8-track cartridges is shown in Fig. 7. Four full programs of two tracks each is standard. As each program is completed, a metal foil strip bonded to the tape itself actuates a switch and solenoid which moves the tape playback head downward (or upward) an appropriate distance so that the succeeding program can be played. Play is continuous, of course, and in most machines the cartridge will repeat playings of its various programs until it is physically extracted from its slot.

In Q-8 cartridges, only two program loops are possible, since each uses four of the eight available tracks, arranged as shown in Fig. 8. New machines designed to play these cartridges have a built-in measure of compatibility, that is, a stereo cartridge inserted in the slot of such a machine will have all its four programs played in sequence, while a Q-8 quadraphonic cartridge, equipped with a special slot in its plastic housing, will cause the head to move only once when switching from the first quadraphonic program to the second. On the other hand, a quadraphonic cartridge inserted in a stereo cartridge player will first play the front channels of program "A," followed by the back channels of program "A," the front channels of program "B" and,

finally, the back channels of program "B." One might term this one-way compatibility.

Even though 8-track cartridges operate at higher speeds than cassettes ($3\frac{3}{4}$ ips) and one would expect the fidelity and S/N ratio to be better than that obtained in slower-speed cassettes, the reverse is true. The fact that the head itself is required to move from program to program makes permanent, precision head alignment almost impossible. The endless-loop principle in which tape is drawn from the inside of the wound tape and returned to the outer diameter involves a tricky drive system which does not lend itself to the extremely low wow and flutter figures possible with either open-reel or cassette drive mechanisms.

The closed-loop tape also makes it impossible to have a "fast rewind" feature on these machines (there is no rewind of any kind possible, since it is not possible to squeeze the tape back into the center of the roll), although some late-model machines do feature a somewhat faster-than-play "fast forward" mode. Signal-to-noise ratios (tape hiss) are generally poorer than those found in better cassette machines, even before Dolby is applied and, not surprisingly, Dolby noise reduction has not been applied to either pre-recorded 8-track cartridges or to the playback machines with which they are used. A few machines now have record as well as playback facilities, but the vast majority are built for playback of pre-recorded music only. In short, the 8-track format just has not caught on with the true audio buff. That is not to say that these mechanisms could not be built for improved specifications—they simply have not been up to now. Some of these shortcomings are masked by road and engine noise, of course. And it's in automobiles where cartridges made their mark. Also, 8-track offers a much greater pre-recorded library than other formats. □

Fig. 7. Q-8 cartridges have two full programs of quadraphonic sound, each occupying four of the available eight tracks.

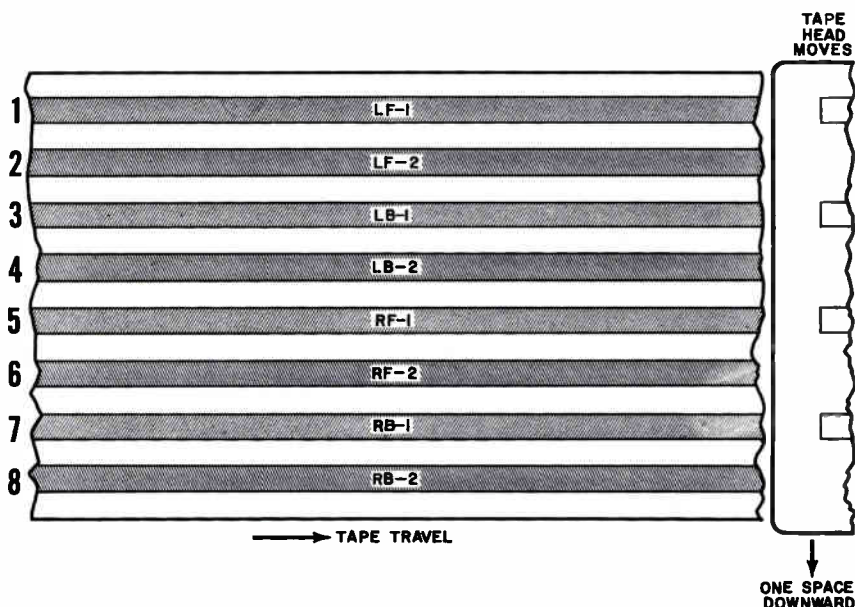

NOW...
 understanding
 more about music
 can be as easy
 as listening
 to your
 favorite
 recordings.

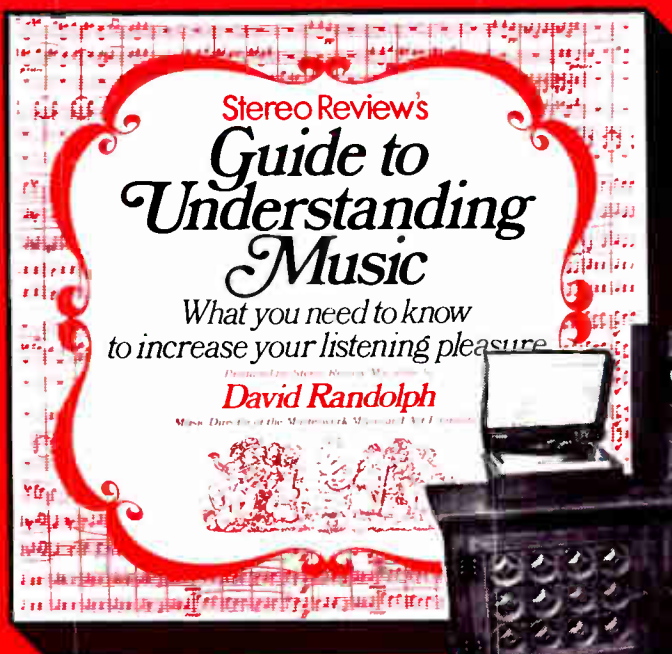

Stereo Review is proud to announce an important new set of recordings created to help you expand your understanding of music.

This unique four-disc album is interesting, easy to comprehend, and instructive. It is the first project of its kind to approach the understanding of music through its basic elements:

rhythm . . . melody . . . harmony . . . texture

If you have wanted to know more about music — or simply to *enjoy* it more — Stereo Review's **GUIDE TO UNDERSTANDING MUSIC** will be the most rewarding step you can take in that direction.

Written and narrated exclusively for Stereo Review by David Randolph, Music Director of the Masterwork Music and Art Foundation, this fascinating set of stereo records will help you become a more sophisticated, more knowledgeable listener — and a more completely satisfied one as well. It will give you an "ear for music" you never thought you had.

In the **GUIDE TO UNDERSTANDING MUSIC**, David Randolph first discusses, by means of recorded narration, how the composer uses and unifies all the basic musical elements. After each musical point is made in the narration, a musical *demonstration* of the point under discussion is provided. Thus you become a part of the creative musical process by listening, by understanding, by seeing how music's "raw materials" are employed by composers and performers to attain their highest level of expressivity and communication through *musical form*.

FOUR LONG-PLAY STEREO RECORDS

- Record I** — The Elements of Music
 - 1. Rhythm 3. Harmony
 - 2. Melody 4. Texture
- Record II** — Sense and Sensation in Music (The Instruments of the Orchestra) How Music Is Unified
- Record III** — Form in Music Words and Music
- Record IV** — Can Music Tell a Story or Paint a Picture? The Interpretation of Music

The **GUIDE TO UNDERSTANDING MUSIC** contains **OVER 200 MUSICAL EXAMPLES** which have been carefully chosen from among thousands of recordings by major record companies as the best illustrations of musical points made in the recorded narration. In addition, supplementary musical demonstrations were specially recorded for this album.

FREE BOOKLET INCLUDED

The accompanying booklet is a valuable complement to the album. It presents David Randolph's straightforward professional approach to music, and shares the insights and understanding of his many years of experience in bringing music to

listeners . . . as well as advice on how you can make the best use of the album.

If you already have some knowledge of music, the *Guide to Understanding Music* can expand and enrich that knowledge. If you've always wanted to understand music but have been discouraged because it looked too difficult and time-consuming, the *Guide to Understanding Music* can show you how easily and quickly you can make yourself at home with *any* music.

First Time Ever Offered

The *Guide to Understanding Music* has been several years in the planning and production stages to assure that it would be as complete, as up-to-date, and as effective a presentation of its subject as possible. The exclusive four-disc recording is now ready, available for the first time through Stereo Review. The special low price is just **\$19.98, postpaid**, for all four 33 1/3 rpm stereo long-play records, a price made possible by the availability of the consultative and production facilities of Stereo Review and its staff. Under ordinary auspices, a work of this nature and importance would cost much more.

SPECIAL SCHOOL AND LIBRARY OFFER

Of particular importance is the role the **GUIDE TO UNDERSTANDING MUSIC** can play as a teaching tool for music departments in schools throughout the country. Orders for 3 sets or more are available to schools and libraries at the **SPECIAL DISCOUNT PRICE** of only **\$17.98** per album, a savings of 10% off the regular price of **\$19.98**. This special quantity price is also available to individuals and organizations who may have a need for more than one album. Schools may submit orders on standard purchasing forms. Individuals and organizations are requested to use the coupon on this page and enclose payment with order.

Records, Ziff-Davis Service Division 595 Broadway, New York, N.Y. 10012.

Yes, I want to enrich my musical background;

Please send the *Guide To Understanding Music* @ \$19.98, postpaid. TRBG 74

Please send _____ (3 or more) *Guide To Understanding Music* @ \$17.98 per album, postpaid.

My check (or money order) for \$ _____ is enclosed.

CHARGE: American Express BankAmericard

Account # _____ Address _____

Signature _____ City _____

Print Name _____ State _____ Zip _____

ENCLOSE PAYMENT WITH ORDER IF NOT CHARGED

BEST OF RECORDED TAPES

A roundup of some of the most outstanding recordings issued in tape format during the past year.



Pierre Boulez is conductor on the top-rated recording of Bartok's "Miraculous Mandarin."

ARTIST/COMPOSER	TITLE	LABEL	CAT. NO.	FOR-MAT
*Bach	Concertos	Angel	8XS36841	(8)
			4XS36481	(c)
Batten, Skip		Signpost	TP8401	(8)
			CS8408	(c)
Bartok	Concerto for Orchestra	Columbia	MAQ32132	(4/8)
*Bartok	Miraculous Mandarin	Columbia	MT-31368	(c)
*Bee-Gees	Life in a Tin Can	RSO	TP870	(8)
			CS870	(c)
Beethoven	Piano Concertos	London	W480270	(r)
			D10270	(c)
Biggs, E. Power	Famous Organs	Columbia	MT31961	(c)
Blunstone, Colin	Ennismore	Epic	EA31994	(8)
Brown, Savoy	Jack the Toad	Parrot	M79859	(8)
			M79659	(c)
			M79059	(r)
Buffett, Jimmy	White Sports Coat	Dunhill	M802350150	(8)
*Captain Beefheart	Clear Spot	Reprise	M82115	(8)
			M52115	(c)
Chopin	Recital	Columbia	MA32041	(8)
			MT32041	(c)
Clarke, Allan	My Real Name . . .	Epic	EA31757	(8)
			ET31757	(c)
Davis, Miles	On the Corner	Columbia	CA31906	(8)

*Recordings of special merit, as reported by Stereo Review Critics.
(8) 8-track cartridge; (c) cassette; (r) open-reel; (4/8) 4-channel, 8-track cartridge

ARTIST/COMPOSER	TITLE	LABEL	CAT. NO.	FOR-MAT
*Denver	Rocky Mountain High	RCA	CT31906	(c)
			P8S1972	(8)
			PK1972	(c)
Denver	Farewell Andromeda	RCA	APS10101	(8)
			APK10101	(c)
Donovan	Cosmic Wheels	Epic	EA32156	(8)
			ET32156	(c)
Eagles	Desperado	Asylum	TP5068	(8)
			CS5068	(c)
Electric Light	II	UA	C040	(r)
*Elephant's Memory	Elephant's Memory	Apple	8XW3389	(8)
			4XW3389	(c)
Entwhistle, John	Rigor Mortis Sets In	Track	MCAT321	(8)
			MCAC321	(c)
Fisher, Matthew	Journey's End	RCA	APS1-0195	(8)
			APK1-0195	(c)
Fitzgerald, Ella	History of . . .	Verve	81408817N	(8)
Garland, Red Quintet	Jazz Junction	Prestige	M82423DP	(8)
Geils, J. Band	Bloodshot	Atlantic	M52423DP	(c)
			TP7260	(8)
			CS7260	(c)
Grey, Joel	Live	Columbia	CA32252	(8)
			CT32252	(c)
Havens, Richie	On Stage	Stormy	81166012	(8)
		Forest	51166012	(c)
Hoodoo Rhythm Devils	What the Kids Want	Blue	M557	(8)
Jackson, Milt	Sunflower	Thumb	M857	(c)
		CTI	CT86024	(8)
			CTC6024	(c)
Jansch, Bert	Moonshine	Reprise	M82129	(8)
			M52129	(c)
Jefferson Airplane	Thirty Seconds Over . . .	Grunt	BFS1-0147	(8)
			BFK1-0147	(c)
Jeffrey, Paul	Family	Main-stream	M8376	(8)
			M5376	(c)
Kantner, Slick, Freiberg	Baron von/Chrome Nun	Grunt	BFS1-0148	(8)
			BFK1-0148	(c)
*King, Albert	I'll Play the Blues . . .	Stax	ST83009	(8)
			STC3009	(c)
King, B. B.	Guess Who	ABC	M8759	(8)
			M5759	(c)
			M759	(r)
King, B. B.	Back in the Alley	Bluesway	M80516050	(8)
*Kinks, The	Everybody's in Show Biz	RCA	P8S1972	(8)
			PK1972	(c)

Bobby Short whose "K-ra-zy for Gershwin" is a big hit on Atlantic's cassettes, 8-track.



ARTIST/COMPOSER	TITLE	LABEL	CAT. NO.	FORMAT
Kottke, Leo	My Feet Are Smiling	Capitol	8XT11164	(8)
			4XT11164	(c)
Laws, Hubert	Morning Star	CTI	CTB6022	(8)
			CTC6022	(c)
Lewis, Jerry Lee	The Session	Mercury	MCTB2803	(8)
			MCT42803	(c)
Lightfoot, Gordon	Old Dan's Records	Reprise	M82116	(8)
			M52116	(c)
Mance, Junior	Touch	Polydor	8F5051	(8)
			CF5051	(c)
Matt the Hoople Marx, Groucho	Matt An Evening With . . .	Columbia A & M	CA32425	(8)
			8T3515	(8)
			CS3515	(c)
McRae, Carmen	I Want You	Main- stream A & M	M8387	(8)
			M5387	(c)
Mendes, Sergio & Brasil 77	Primal Roots	A & M	4353	(8)
			4353	(c)
Merman, Ethel	Sings Merman	London	M14901	(8)
			M84901	(c)
			L-77901	(4/8)
			GA31614	(8)
Mingus, Charles *Mitchell, Joni	and Friends in Concert For the Roses	Columbia Asylum	TP5057	(8)
			CS5057	(c)
*Modern Jazz Quartet	Legendary Profile	Atlantic	TP1623	(8)
			CS1623	(c)
*Moody Blues	Seventh Sojourn	Threshold	M24807	(8)
			M24607	(c)
			M24007	(r)
			U8505	(8)
Move, The Nash, Johnny	Split Ends My Merry-Go-Round	Epic	EA32158	(8)
			ET32158	(c)
*Nelson, Rick	Garden Party	Decca	65391	(8)
			735391	(c)
Nilsson, Harry	Little Touch of Schmilsson Nitzinger	RCA	APS1-0097	(8)
			APK1-0097	(c)
*Nitzinger	Nitzinger	Capitol	8XT11091	(8)
			4XT11091	(c)
Pride, Charley	Sunshiny Day	RCA	P8S1997	(8)
			PK1997	(c)
Prine, John	Diamonds in Rough	Atlantic	TP7240	(8)
			CS7240	(c)
Previn	Guitar Concerto	Columbia	MA31963	(8)
			MQ31963	(c)
			MAQ31963	(4/8)
			M51037	(c)
Procol Harum Rachmaninoff Rapp, Tom	Grand Hotel Piano Concerto No. 2 Sunforest	Chrysalis RCA Blue Thumb	ARK1-0031	(c)
			M-856	(8)
			M-556	(c)
Ravel Reed, Lou	Un Barque. . . . Berlin	Columbia RCA	MA32159	(c)
			APS1-0207	(8)
Rheinberger Richard, Little	Concertos Second Coming	Columbia Reprise	APK1-0207	(c)
			MT32297	(c)
Rivers, Johnny	Blue Suede Shoes	UA	M82107	(8)
			M52107	(c)
			EA075-G	(8)
Ross, Diana	Touch Me	Motown	CA075-G	(c)
			M8772	(8)
			M5772	(c)

J. Geils Band's recording of "Bloodshot" is available on both cassettes and cartridges.



Carly Simon's "No Secrets" is popular with her fans in the cassette and 8-track formats.

ARTIST/COMPOSER	TITLE	LABEL	CAT. NO.	FORMAT
Rundgren, Todd	Wizard, a True Star	Bearsville	M82133	(8)
			M52133	(c)
Santana/McLaughlin	Love, Devotion. . . .	Columbia	CA32034	(8)
			CT32034	(c)
Scriabin	Etudes	Columbia	MA31620	(8)
			MT31620	(c)
Sea Gull Cossacks	Songs from Volga	London	M99808	(8)
			M99608	(c)
Seals & Crofts	Diamond Girl	Warner	M82699	(8)
			M52699	(c)
Short, Bobby	K-ra-zy for Gershwin	Atlantic	PT2-608	(8)
			CS2-608	(c)
Simon, Carly	No Secrets	Elektra	85049	(8)
			55049	(c)
Shostakovich Siegel-Schwall Band	Symphonies 1 & 9 Sleepy Hollow	Columbia Wooden Nickel	MT31307	(c)
			P8WN1010	(8)
Springsteen, Bruce	Greetings from Asbury Park	Columbia	PKWN1010	(c)
			CT31903	(c)
Stewart, John	Cannons in the Rain	RCA	P8S2111	(8)
			PK2111	(c)
*Stevens, Cat	Catch Bull at Four	A & M	8T-4365	(8)
			CS4365	(c)
*Streisand, Barbra	Concert at Forum	Columbia	CA31760	(8)
			CT31760	(c)
			CR31760	(r)
			ZA32039	(8)
Sweet Thursday	Sweet Thursday	Great Western Gramaphone	ZT32039	(c)
Three Dog Night	Seven Separate Fools	ABC/Dunhill	M85118	(8)
			M55118	(c)
Travers, Mary	All My Choices	Warner	M82677	(8)
			M52677	(c)
Tucker, Tanya	Delta Dawn	Columbia	CA31742	(8)
			CT31742	(c)
Vaughn, Sarah	Feelin' Good	Main- stream	M8379	(8)
			M5379	(c)
Vienna, Music of	Album 3	Angel	8XS36956	(8)
			4XS36956	(c)
Vinegar Joe	Rock 'n Roll Gypsies	Atco	TP7016	(8)
			M5102	(c)
Walker, Jerry Jeff		Decca	65384	(8)
			735384	(c)
West, Bruce & Laing	Whatever Turns You On	Col./ Windfall	CA32216	(8)
			CT32215	(c)
West, Bruce & Laing	Why Dontcha	Col./ Windfall	CA31929	(8)
			CT1929	(c)
Wishbone Ash	Wishbone Four	MCA	MCAT327	(8)
			MCAC327	(c)
Young, Berry, Webster	Tenor Sax	Atlantic	8T2-307	(8)
			CS2-307	(c)

TAPE

Q & A

Answers to a selection of the most common
tape-recording questions from Stereo Review readers

By Larry Klein

TAPE TWITTER

When my tape recorder is in the fast-forward mode or rewinding a tape, I hear through my speakers a rapid high-pitched twittering that is clearly a recorded "message" on the tape. The sound is faint but quite audible. Does this mean that my tape recorder's heads are misaligned or that the tape is rubbing across—and wearing down—the heads?

First of all, the sound you are hearing has nothing to do with alignment. Your second guess may be more accurate, but almost all recent recorders have some provision for preventing tape-to-head contact when the recorder is in a fast-forward or rewind mode. The twittering may result simply from the proximity of the tape's rapidly shifting magnetic field to the playback-head gap without there being any actual physical contact between the tape and head. With the machine set to rewind, but switched off, tighten the tape by hand over the guides and check to see if there is any tape-to-head contact. If there is any clearance at all, then you have nothing to worry about.

TAPE-MAGNETISM LIFE

I have read that a signal on tape tends to deteriorate

as time passes because of a weakening of the magnetic field. Is this true?

A Library of Congress study on tape life indicates that the magnetism of the signal does not deteriorate, but print-through (transference of the signal to adjacent tape layers) may occur. This can be minimized by using special low print-through tape or by using a standard-thickness tape and recording at a level somewhat lower than normal.

Almost all tape recorders wind the tape tighter in the fast-forward or rewind modes; therefore it is not a good idea to store recorded tapes for long periods after they have been rewound at fast speeds. To minimize print-through, tape manufacturers recommend that tapes stored for long periods be rewound from time to time at normal playing speeds to release tensions that may build up as a result of fluctuating temperatures in the storage area.

CHROMIUM-DIOXIDE TAPE CHARACTERISTICS

There seem to be all sorts of rumors floating about on chromium-dioxide tape, and I wonder whether you can clarify any of the questions involved. For example, I have heard that it is difficult to erase once a signal has been recorded on it, that it wears tape heads excessive-

ly, and that it is unstable and poisonous under certain environmental conditions. Do you have data on any of this?

To take your questions in order: yes, CrO₂ is more difficult to erase, but today's latest cassette and open-reel recorders seem to be able to handle it reasonably well. Oddly enough, some bulk tape erasers that we have tried have not been as effective as a cassette recorder's erase head in removing previously recorded material. This may be because the erase head is able to focus more magnetic-erase energy where it is needed.

On the subject of head wear, my impression, based on conversations with manufacturers of both tape and recorders, is that today's chromium-dioxide tape is equivalent to ferrous-oxide tapes in this regard. In other words, you'll find normal oxide tapes that have both better and worse wear qualities than chromium-dioxide does.

I checked with the chemistry department of a large research outfit about the stability and toxicity of CrO₂. I was told that whereas some chromium compounds are relatively unstable and have to be stored under special conditions, once they convert to their stable forms—and chromium-dioxide is one of their stable forms—it is not easy to volatilize or to chemically change them into something else. Specifically, CrO₂ releases an oxygen atom and changes into chromous oxide at 300 degrees centigrade. To the best of anyone's knowledge, neither the oxygen nor the CrO has any special toxic properties.

8-TRACK CARTRIDGE CLEANING

I have a good collection of 8-track cartridges and every so often I clean the little rubber pressure rollers in the cartridges. I decided to do this after reading that it is a good idea to clean the capstan and pressure roller in open-reel recorders. Is this a good practice and does it help my machine?

It seems a good idea to me, although I have never seen it suggested as a recommended practice. The only caution I can think of is to keep the cleaning fluid (rubbing alcohol would be best) away from the tape itself as it may dissolve the lubricant normally used in cartridge tapes. Pull out two or three inches of the tape so as to form a loop over the cartridge's pressure roller and rotate the roller by hand while rubbing it briskly with a cotton swab dampened with the alcohol. And make sure the roller is dry before pushing the tape back in place.

TAPE-INPUT LEVEL

If I am recording directly from a tuner or another tape recorder, should the program-source gain control be set at full volume, or should the level be reduced and the gain raised on the tape machine that is doing the recording? I have been given conflicting recommendations; one is to have the signal full strength and the other is to have a relatively weak signal as the program source. What do you suggest?

In general, a signal source such as a tuner or another tape recorder will have the best signal-to-noise ratio in its output signal if its output level control is set to the highest gain position.

RECORDING SPEEDS

I'm wondering what real difference there is between recording speeds of 3¾ and 7½ ips in relation to the listening response of the average person. I cannot distinguish between the two myself, and it seems to me a waste of tape to record at 7½ ips when I can get twice as much material on the tape at 3¾ ips.

Potentially, a tape machine is always capable of a wider frequency response, somewhat lower distortion, and (usually) a better signal-to-noise ratio and reduced wow and flutter when recording at a higher speed. Whether this improvement will be audible is another question. If the speakers or other equipment you are using with the tape recorder have a frequency response limited to 10,000 Hz then any extension of the recorder's frequency response to 12,000, 14,000, or 20,000 Hz achieved by recording at 7½ ips will not be audible. In regard to the other factors, the same sort of approach applies. If the lowering of quality resulting from recording at 3¾ ips is not audible to you, or others who listen to your tapes, there is no reason, in respect to fidelity alone, to record at the higher speed.

RECORDING-CHANNEL ISOLATION

Is there a recommended procedure for making a stereo recording in which the performer(s) on one channel are completely isolated from the performer(s) on the other channel? For example, I would like to have a vocalist on one channel and her instrumental accompanist on the other. Can this be done easily?

Professionally, channel isolation is accomplished by having each channel recorded in a separate acoustically isolated studio and having each performer listen to the other with headphones. The results, although in stereo, are somewhat less than real and unless there is a special reason for recording this way, it is not a recommended technique. A simpler and quite flexible way of attaining interchannel separation is to use two directional (cardioid) microphones as far apart as convenient and facing in opposite directions. The performers then can face each other while recording and each microphone will pick up very little of the sound originating at its rear. This technique is most effective if the recording is made out-of-doors or in a large and/or dead room, since in a small, live room the sound bouncing off the walls will interfere with the results.

TANDEM TAPE RECORDERS

Since I own two tape recorders, I would like to be able to hook both of them up to my hi-fi system. This would allow me to tape long broadcasts without interruptions for reel changes. Can you design a setup for me that will let me do this?

Simply plug in a Y adapter to each channel's tape input jack and connect both tape recorders simultaneously. Incidentally, you might check to be sure that when the two recorders' indicators or meters give equivalent signal-level readings, they are actually recording at the same level. □

**Superb performance - lavish engineering
- a new standard in high fidelity**



THE ALL NEW REVOX 700 SERIES

Stereo Tape Recorder A700 Digital Stereo Tuner/Pre-amplifier A720 Power Amplifier A722

Revox Corporation in USA; 155 Michael Drive, Syosset, NY 11791 & 3637 Cahuenga Blvd. West, Hollywood, California 90068

Revox in England: Lamb House, Church Street, London W4 2PB Revox Sales and Service in Canada.

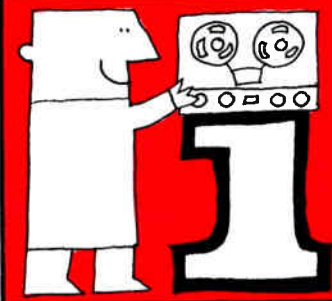

OPEN-REEL TAPE MACHINES

AKAI

GX-210D Stereo Tape Deck

Two-speed (7½ & 3¾ ips); 4-track, 2-channel stereo system. Response 30-25,000 Hz ±3 dB



(low-noise tape); 30-23,000 Hz ±3 dB (regular tape). Will handle up to 7" reels. Wow & flutter 0.08% rms at 7½ ips; distortion 1.5% (1000 Hz, 0 VU); (S+N)/N 50 dB. Three motors; two heads (one record/erase GX and one playback GX). Features two line and one phone output jack, two mike and two line input jacks plus DIN jack. 14.5" × 14.6" × 8.9" \$449.95

GX-600D Stereo Tape Deck

Two-speed (7½ & 3¾ ips); 4-track, 2-channel stereo/mono system. Will handle up to 10½" reels. Response 30-23,000 Hz ±3 dB at 7½ ips; wow & flutter 0.07% rms; distortion less than 0.7%. (S+N)/N 56 dB. Has three heads and three motors; two line and one phone output jacks; two mike and one line input jacks; one DIN jack. 17.4" × 18.7" × 9" \$750.00

GX-600DB. Same except with Dolby noise-reduction circuit. (S+N)/N 64 dB with Dolby \$850.00

GX-285D Stereo Tape Deck

Two-speed (7½ & 3¾ ips); 4-track, 2-channel stereo/mono system with Dolby noise-reduction circuitry. Will handle up to 7" reels. Wow &



flutter 0.08% rms at 7½ ips. Response 20-25,000 Hz ±3 dB (with Akai SRT tape), 30-23,000 Hz ±3 dB (regular tape). (S+N)/N 63 dB (with Dolby), 55 dB (without), both using SRT tape. Three motors, three heads (4-track stereo/mono glass and crystal ferrite record/playback, 4-track erase). Has two line & one phone output jacks; two mike and two line input jacks, plus DIN jack. Sound-on-sound, sound mixing, and sound-with-sound facilities plus tape and source monitoring switches. 17.1" × 18.1" × 10.2" \$750.00

4400 Open-Reel "Convert-a-Deck"

Stereo design featuring front-panel converter switch which changes unit from recorder to deck. Has SOS, SWS, sound mixing, dual monitoring, output level control, pause control with start button release, automatic shutoff. Two speeds (7½ & 3¾ ips), three heads, one motor. (S+N)/N 50 dB; wow & flutter 0.15%; distortion 1.5%, all at 7½ ips \$349.95

GX-400D Open-Reel Tape Deck

Stereo design featuring four heads, servo capstan motor with two outer rotor motors, reverse in both record & playback, pause control, playback volume control, line/mike mixing, SOS, normal and SRT tape selector switch, automat-

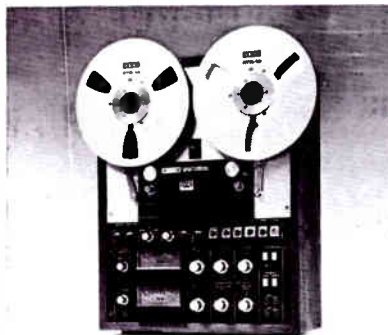

ic shutoff/stop. Features Akai's automatic distortion-reduction system. Three speeds (15, 7½, 3¾ ips); (S+N)/N 55 dB; wow & flutter 0.04%; distortion 1.0%, all at 15 ips. Takes 10½" reel \$1195.00

1721W Tape Recorder

Two-speed (3¾ & 7½ ips), 4-track, 2-channel stereo or mono design. Wow & flutter 0.14% rms at 7½ ips. Response 30-21,000 Hz ±3 dB at 7½ ips. THD 2%. 5 W/ch dynamic power at 8 ohms (3 W/ch continuous). (S+N)/N -50 dB. Bias frequency 63 kHz. Has one record/playback & one erase head. Inputs: mike (0.5 mV) & line (150 mV). Two built-in 5" × 7" speakers. Features p.a. capability, automatic shutoff, equalizer preamp for direct phono input, selector switch for regular or low-noise tape, and tape monitoring facilities. Comes with pair of dynamic mikes with stands. 14½" × 14½" × 9½" \$299.95

GX-370D Tape Recorder Deck

Two-speed (3¾ & 7½ ips), 4-track, 2-channel



stereo or mono design. Wow & flutter 0.15% rms at 7½ ips. Response 30-21,000 Hz ±3 dB at 7½ ips. THD 1.5%. (S+N)/N -50 dB. Bias frequency 100 kHz. Has two record/erase heads & one playback head. Line output 1.23 V. Inputs: mike (0.8 mV) & line (150 mV). Features selector switch for regular or low-noise tape; automatic or manual reverse record/playback; three motors; automatic gain controls; automatic stop & shut-off; sound-on-sound and mixing facilities. Has universal power supply. 17¾" × 20" × 9¾" D \$799.95

4000DS Tape Recorder Deck

Two-speed (3¾ & 7½ ips), 4-track, 2-channel stereo or mono design. Wow & flutter 0.07% rms at 7½ ips. Response 30-26,000 Hz ±3 dB at 7½ ips. THD 1.5%. (S+N)/N -50 dB. Bias frequency 100 kHz. Has separate record, bias, and erase heads. Line output 1.23 V. Inputs: mike (0.8 mV) & line (60 mV). Features dual selector switch for regular or low-noise tape;

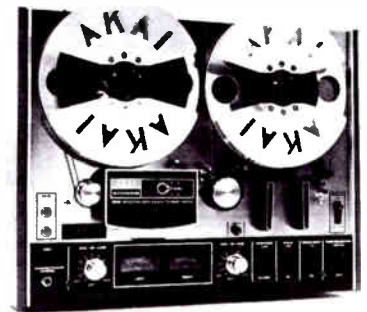

sound-on-sound; sound-with-sound; mixing; automatic shut-off; pause control. Universal power supply. 16" × 12½" × 7½" \$269.95

GX-1900D Reel/Cassette Deck

Combines a two-speed (3¾ & 7½ ips), 4-track, 2-channel stereo/mono reel-to-reel tape recorder and a cassette stereo recorder. Will record both ways. Wow & flutter 0.12% rms at 7½ ips. Response 30-22,000 Hz ±3 dB at 7½ ips. THD 2%. (S+N)/N -50 dB. Has two heads

1 Open-Reel Tape Machines



(record/playback & erase). Output 1.23 V. Input: mike (0.5 V) & line (50 mV). Features automatic stop & shut-off, pause lever, and universal power supply. 15" x 18 1/2" x 10" .. \$519.95

CROWN INTERNATIONAL

CX722 Tape Recorder

Three-speed (15, 7 1/2, 3 3/4 ips), 2-track, 3-motor design. Will handle up to 10 1/2" reels. Has three heads. Response 20-20,000 Hz \pm 2 dB. Wow & flutter 0.09% at 7 1/2 ips. Features braking, automatic shut-off, two VU meters, pause control, and optional counter \$1495.00
CX724. Same except 4-track version; response 20-25,000 Hz \pm 2 dB \$1495.00

CX822 Tape Recorder

Three-speed (15, 7 1/2, 3 3/4 ips), 2-track, 3-motor design. Will handle up to 10 1/2" reels. Response 30-30,000 Hz \pm 2.0 dB. Wow & flutter 0.06% at 15 ips. (S+N)/N 60 dB. Has braking, two VU meters, automatic shut-off, pause control, monitoring facilities, optional counter, and remote record. \$1995.00
 Four track version \$1995.00
 Four-channel in-line version \$2995.00

SX724 Tape Recorder

Two-speed (7 1/2, 3 3/4 ips), 2-ch, 1/4-track, 3-motor design. Will handle up to 10 1/2" reels. Response 20-25,000 Hz \pm 2 dB. Wow & flutter 0.09% at 7 1/2 ips. (S+N)/N 60 dB. Has braking, two VU meters, automatic shut-off, monitoring facilities, pause control, and optional counter. 15 and 1 7/8 ips available. \$1095.00
SX724-P4C. 2- and 4-track version; plays 4-channel in-line \$1495.00

DOKORDER

7100 Reel-to-Reel Tape Deck

Two-speed (7 1/2 & 3 3/4 ips), 3-head, 4-track stereo tape deck. Features a four-pole induction

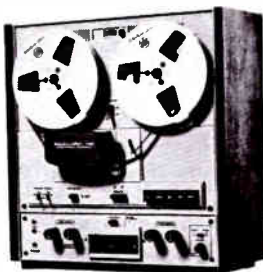

and 2 six-pole eddy-current type induction motors; automatic tape lifters; automatic shut-

off; tape selector switch; echo & sound-on-sound; tape/source monitor. Wow & flutter 0.08% W rms at 7 1/2 ips. (S+N)/N 55 dB. Response 40-21,000 Hz at 7 1/2 ips \$399.95

7200 Tape Recorder Deck

Two-speed (7 1/2 & 3 3/4 ips), 4-track stereo record/play design. Wow & flutter 0.8% at 7 1/2 ips. Response 40-20,000 Hz \pm 3 dB at 7 1/2 ips. (S+N)/N -53 dB. Bias 130 kHz. Has mike (0.8 mV) & line (80 mV) inputs. Line output 0.775 V. Features automatic continuous playback, both directions; four heads (erase, record, forward play, reverse play); three motors; tape bias select switch for standard or low-noise tape; sound-on-sound; echo; sound-with-sound. Has tape monitoring facilities and pause switch. 16 7/8" x 17 3/4" x 6 3/4" D \$499.95

7500 Tape Recorder Deck

Two-speed (7 1/2 & 3 3/4 ips), 4-track record/play design. Wow & flutter 0.08% at 7 1/2 ips. Response 40-20,000 Hz \pm 3 dB at 7 1/2 ips. (S+N)/N -55 dB at 7 1/2 ips. Bias 130 kHz. Has mike



(0.8 mV) & line (80 mV) inputs. Output 0.775 V. Features bidirectional recording and automatic repeat playback. Six heads (2 each erase, record, playback). Has 3 motors. Tape bias switch for standard or low-noise tapes. Features sound-on-sound, sound-with-sound, echo, and tape monitoring. 16 7/8" x 17 3/4" x 6 3/4" D. \$599.95

9100 Tape Recorder Deck

Two-speed (7 1/2 & 3 3/4 ips), 4-track record/play design. Response 40-21,000 Hz \pm 3 dB at 7 1/2

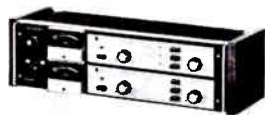

ips. (S+N)/N -55 dB at 7 1/2 ips. Wow & flutter 0.06% at 7 1/2 ips. Bias 100 kHz. Has mike (0.5 mV), line (77.5 mV), and mag. phono (2.5 mV) inputs. Line output 0.775 V. Features automatic reverse & repeat for record & playback. Has built-in head demagnetizer; 3 motors; six heads (2 each erase, record, playback); tape counter memory; photoelectric automatic shut-off. Bias control for various tapes with separate right & left channel adjustments. Has tape select switch; line, mike, or phono mixing; sound-on-sound facilities; echo; provision for optional remote control. Tape monitoring facilities. Universal power supply. 17 3/4" x 20" H x 15 1/4" D \$799.95

FERROGRAPH

Super Seven Series Tape Recorders

Three speeds (7 1/2, 3 3/4, 1 7/8 ips). Has three heads and three motors; braking; VU meters;



electronics editing; sound-on-sound, sound-with-sound, echo, and re-record facilities; variable speed wind/rewind; 10 1/2" reel capacity; solid-state FET front end at mike input; 4-digit counter. Has full range of inputs and outputs. Response (record/play) 30-17,000 Hz \pm 2 dB at 7 1/2 ips, 40-14,000 Hz \pm 3 dB at 3 3/4 ips, 50-7000 Hz \pm 3 dB at 1 7/8 ips. Available in 2- and 4-track stereo models; with or without amplifiers and speakers; 15, 7 1/2, 3 3/4 ips operation; optional Dolby-B noise reduction with every speed configuration. 117-V, 60-Hz operation \$1000 to \$1200

JVC

RD-1450 Tape Recorder Deck

4-track, 2-speed (7 1/2 & 3 3/4 ips), 2-channel stereo design. Similar in appearance to Model RD-1695. Response 30-20,000 Hz \pm 3 dB at 7 1/2 ips; (S+N)/N -52 dB; wow & flutter 0.10% rms at 7 1/2 ips. Has 95 kHz bias & erase; three heads (erase, record, playback). Input sensitivity: mike 0.3 mV; aux. 77.5 mV. Line output 0-1.2 V. Features sound-on-sound, automatic stop, tape monitoring, and special switch for low-noise or standard tape. 12 3/4" x 15 3/4" x 6 7/8" D. \$229.95

RD-1555 Stereo Recorder Deck

Four-track, 2-speed (7 1/2 & 3 3/4 ips), 2-channel stereo design with automatic reverse. Response 30-20,000 Hz \pm 3 dB at 7 1/2 ips; (S+N)/N -50 dB; wow & flutter 0.16% rms. Has three motors and four heads. Features direct-coupled preamps, solenoid motion controls, jack for optional remote control, sound-on-sound, and tape-selector switch. 17" x 16" x 8 1/4" D. \$499.95

RD-1552 Tape Recorder Deck

4-track, 2-speed (7 1/2 & 3 3/4 ips), 2-channel stereo design. Response 20-24,000 Hz \pm 3 dB



at 7 1/2 ips; (S+N)/N -52 dB; wow & flutter 0.1% rms at 7 1/2 ips. HD 1.5%. Has 95 kHz record & erase bias. Inputs: mike (0.3 mV) & aux. (80 mV). Line output 0-1 V. Features three

heads (record, erase & playback) and 3 motors (capstan drive, supply & take-up reels). Has solenoid motion controls, pause button, sound-on-sound, bias switch for low-noise or standard tapes, and input mixing facilities. 15 $\frac{3}{4}$ " x 17 $\frac{3}{4}$ " W x 8 $\frac{1}{2}$ " D \$399.95

RD-1695 Tape Recorder Deck

4-track, 3-speed (7 $\frac{1}{2}$, 3 $\frac{3}{4}$ & 1 $\frac{7}{8}$ ips), 2-channel stereo design. Response 30-18,000 Hz \pm 3 dB at



7 $\frac{1}{2}$ ips; (S + N)/N -52 dB; wow & flutter 0.13% rms at 7 $\frac{1}{2}$ ips. Has mike (0.5 mV) & aux. (80 mV) inputs. Line output 0-1 V. Has switch for either low-noise or standard tape; two heads (record/play and erase). 7 $\frac{1}{2}$ " x 15 $\frac{3}{4}$ " W x 12 $\frac{3}{4}$ " D \$179.95

RD-1553 Tape Recorder Deck

4-track, 2-speed (7 $\frac{1}{2}$ & 3 $\frac{3}{4}$ ips), 2-channel stereo design. Similar in style to Model RD-1552. Response 20-24,000 Hz \pm 3 dB at 7 $\frac{1}{2}$ ips; (S + N)/N -53 dB; wow & flutter 0.10% at 7 $\frac{1}{2}$ ips. HD 1.5% at 1 kHz. Has 95 kHz record bias & erase; three motors (capstan drive, supply, and takeup reels); mike (0.3 mV) & aux. (80 mV) inputs; and 0-1 V line output. Features built-in 1000-Hz signal oscillator for bias adjust; solenoid motion controls; jack for optional remote control; sound-on-sound and input mixing facilities. 17 $\frac{1}{2}$ " x 16 $\frac{1}{2}$ " x 8" D \$499.95

PIONEER

RT-1050 Stereo Tape Deck

Two-track, two-speed (15 & 7 $\frac{1}{2}$ ips), three-motor, three-head stereo deck. Has 4/8 pole, two-speed hysteresis synchronous motor (cap-



stan drive) and 6-pole inner-rotor induction motor (reel drive). Response 30-22,000 Hz \pm 3 dB at 15 ips; 40-20,000 Hz \pm 3 dB at 7 $\frac{1}{2}$ ips; wow & flutter 0.04% W rms at 15 ips; (S + N)/N 57 dB; stereo channel separation 53 dB at 1000 Hz; 125 kHz bias frequency. Features 3-step bias selector; 4-step EQ selector; dual-scale level meters; recording peak indicator; lockable electronic controls (including pause); two pairs of line inputs; full complement of inputs and outputs. 120-V, 60-Hz operation. 18 $\frac{1}{8}$ " W x 17 $\frac{7}{8}$ " H x 9 $\frac{5}{8}$ " D... \$699.95

RADIO SHACK

999B Stereo Tape Deck

Three speeds (7 $\frac{1}{2}$, 3 $\frac{3}{4}$, 1 $\frac{7}{8}$ ips); 4 tracks; 3 heads. Has two VU meters and level controls. Provisions for professional sound-on-sound recordings. Tape/source monitor. Response 40-20,000 Hz at 7 $\frac{1}{2}$ ips; wow & flutter 0.2%



rms at 7 $\frac{1}{2}$ ips. Overall size 16" x 13 $\frac{1}{4}$ " x 7 $\frac{3}{8}$ " \$199.95

909B Stereo Tape Recorder

Three speeds (7 $\frac{1}{2}$, 3 $\frac{3}{4}$, 1 $\frac{7}{8}$ ips); 4 tracks. Will take up to 7" reel. Response 50-18,000 Hz;



wow & flutter 0.25% at 7 $\frac{1}{2}$ ips. Has built-in electronics with 3 $\frac{1}{2}$ W/ch output. Supplied with speakers, microphones, VU meters, and counter. Permits sound-with-sound recording. Overall dimensions 14" H x 24 $\frac{1}{4}$ " W x 7 $\frac{1}{8}$ " D. Weight 26 lbs \$239.95

REVOX

A77 MkIII 1102 Tape Deck

Two-speed (3 $\frac{3}{4}$ & 7 $\frac{1}{2}$ ips or 7 $\frac{1}{2}$ & 15 ips), 2-track, 3-motor, 3-head deck. Will handle up to

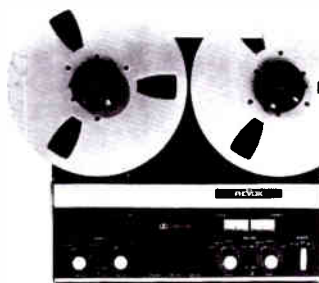

10 $\frac{1}{2}$ " reels. Response 30-20,000 Hz \pm 2.5 dB at 7 $\frac{1}{2}$ ips. Wow & flutter 0.08% peak at 7 $\frac{1}{2}$ ips. (S + N)/N 61 dB at 7 $\frac{1}{2}$ ips. Has a servo braking system, VU meters, automatic shut-off, relay and solenoid operation, full remote control, and off-the-tape monitoring. Options include plug-in 10 W/ch continuous power amplifiers, a suitcase version with built-in speakers, metal cage for rack or custom mounting. 16 $\frac{3}{8}$ " H x 14 $\frac{3}{8}$ " W x 7 $\frac{1}{8}$ " D \$899.00
Model A77 MkIII 1104. A 4-track version of Model 1102. Same options available.. \$899.00

A77 MkIII Dolby B Deck. Same as 1102 or 1104 but with Dolby B noise-reduction system. Has separate compressors and expanders for each channel. (S + N)/N 70 dB (ASA A curve weighted) at 7 $\frac{1}{2}$ ips, 2-track. Corresponding improvements at other speeds and track width accompanied by a reduction in distortion.. \$1099.00

A700 Stereo Tape Recorder

Three-motor, three-speed (15, 7 $\frac{1}{2}$, 3 $\frac{3}{4}$ ips) recorder. Features computer-type digital control logic with memory circuits; quartz-crystal speed-control reference; frequency and phase servo system for capstan speed control; two tape-tension sensors governing servo-controlled reel motors. Has logic-controlled tape tension which is automatically maintained even with mixed reel sizes; electronic tape-motion sensor; minutes and seconds readout on tape counter. Plug-in head assembly (1/4 or 1/2 track available); three heads with fourth control head (optional). Fail-safe auto stop logic to eliminate possibility of tape breakage; electronic pause control operating on all functions; instant repeat play control; continuous unattended re-

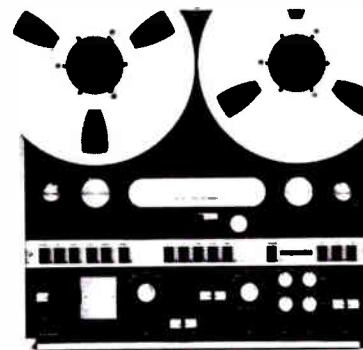

cord or play function; solid-state switching of audio circuits. Features built-in four-input mixer; switched selection of 12 input sources including four balanced hi/lo mike inputs; built-in magnetic phono preamp; master record-level slide fader; stereo echo; five independent stereo outputs; standard zero-level line outputs and level & tone-controlled outputs; VU meters with instantaneous over-modulation indicators; variable speed (+ or - 7 halftones with remote-control accessory); variable speed (2.5 to 21.5 ips with external oscillator); input or off-tape metering \$1695.00

SONY BY SUPERSCOPE

TC-270 Stereo Tape Recorder

Economy design featuring quarter-track stereo/mono play & record, three speeds (7 $\frac{1}{2}$, 3 $\frac{3}{4}$



& 1 $\frac{7}{8}$ ips), straight-line record & playback level controls, two VU meters, automatic end-of-tape shutoff, and sound-on-sound. 5 W/ch continuous power. Response 30-18,000 Hz \pm 3 dB at 7 $\frac{1}{2}$ ips. (S + N)/N 50 dB; wow & flutter 0.12% at 7 $\frac{1}{2}$ ips. Sensitivity: aux. 0.06 V; low-imp. mike -72 dB (can be used as phono input with optional RK-66 adapter). Has line output 0.43 V at 0 VU; two lid speakers. 8 ohms. 20 $\frac{1}{4}$ " W x 15 $\frac{1}{4}$ " D. Comes with carrying case \$299.95

TC-280 Stereo Tape Recorder Deck

Economy quarter-track stereo/mono design featuring three speeds (7 $\frac{1}{2}$, 3 $\frac{3}{4}$ & 1 $\frac{7}{8}$ ips), tape select switch, sound-with-sound, sound-on-

1 Open-Reel Tape Machines



sound, dual VU record meters, pause control. May be operated vertically or horizontally. Response 40-18,000 Hz ± 3 dB at 7 1/2 ips with regular tape (40-21,000 Hz ± 3 dB with SLH-180 tape). (S+N)/N 52 dB with standard tape (55 dB with SLH-180 tape). Sensitivity: aux. 0.06V; mike (low-imp) -72 dB (mike input can be used as mag. phono input with RK-66 optional adapter). Line output 0.775 V at 0 VU. Wow & flutter 0.10% at 7 1/2 ips. 15 3/4" x 7 3/8" x 14 1/8" D. Comes with walnut base \$199.95

TC-580 Tape Deck
Three-speed (7 1/2, 3 3/4, 1 7/8 ips), 4-track, 3-head, 3-motor stereo unit. Will handle up to 7" reels. Response 30-25,000 Hz ± 3 dB; wow & flutter 0.09% at 7 1/2 ips; Built-in electronics with 20 W/ch output. Supplied with speakers and microphones. Has VU meters, automatic shutoff, pause control, echo effects, sound-on-sound, counter, phono input, tone controls, monitoring facilities. Carrying handle included. 20" H x 17 1/8" W x 11 3/8" D \$579.95

TC-630 Tape Recorder System
Three-speed (7 1/2, 3 3/4, 1 7/8 ips), 4-track, 3-head, one-motor stereo unit. Will handle up to 7" reels. Response 30-22,000 Hz; wow & flutter 0.09% at 7 1/2 ips; Built-in electronics with 20 W/ch output. Supplied with speakers and microphones. Has VU meters, automatic shutoff, pause control, echo effects, sound-on-sound, counter, phono input, tone controls, monitoring facilities. Carrying handle included. 20" H x 17 7/8" W x 11 3/8" D \$449.95

TC-353-D Stereo Tape Deck
Features three speeds (7 1/2, 3 3/4, 1 7/8 ips) and three heads. Has line & mike mixing, pause control, automatic shutoff, VU meters. Sound-on-sound with optional Sony MX-6S mixer \$249.95

TC-640B Tape Deck
Two-speed (7 1/2, 3 3/4 ips), 4-track, 3-head stereo unit. Will handle up to 7" reels. Response 30-20,000 Hz ± 3 dB; wow & flutter 0.07% at 7 1/2 ips; (S+N)/N 55 dB. Features VU meters, braking, automatic shutoff, pause control, echo effects, sound-on-sound, counter, monitoring facilities; and solenoid operation. 15 1/2" H x 14 1/2" W x 9 1/2" D \$449.95

TC-353 Stereo Tape Recorder/Speakers
Three-speed (7 1/2, 3 3/4, 1 7/8 ips), 3-head stereo tape recorder with integrated speakers. 7 W/ch dynamic power. Features separate record/playback preamps, sound-on-sound and echo, tape/source monitoring facilities, and a tape-select switch for use of high-output low noise



tape or standard tape. Has VU meters, retractable pinch roller for easy tape threading, automatic tape lifters to protect heads during fast-forward and rewind, non-magnetizing record head. Full complement of controls. Has p.a. capabilities, pause control with lock, built-in reel locks, four-digit tape counter, stereo headphone monitor jack. Can be operated vertically or horizontally. 20 3/8" x 13 3/8" x 10 3/8" D \$399.95

TC-377 Stereo Recorder Deck
Features 3-speed (1 7/8, 3 3/4 & 7 1/2 ips), 3-head, 4-track design. Response 30-20,000 Hz ± 3 dB at 7 1/2 ips. (S+N)/N 52 dB (standard tape) 55 dB (SLH-180 tape). Has aux. (0.06 V sensitivity) & mike (-72 dB sensitivity) inputs & line output (0.775 V). Bias frequency 160 kHz. Wow & flutter 0.09% at 7 1/2 ips. Has two VU meters, one induction motor. Features mike-line record level mixing controls, tape select switch for Sony standard or low-noise, high-output tape. Has pause control and an automatic total mechanism shut-off. Reversible walnut base for vertical or horizontal operation. Sound-on-sound capability with the MX-6S mixer. 16 1/2" x 8 3/8" x 15 1/2" \$329.95

TC-458 Stereo Tape Deck
Two-speed (7 1/2 & 3 3/4 ips); automatic-reverse stereo deck with ferrite & ferrite roto bi-lateral



heads; response 30-20,000 Hz ± 3 dB at 7 1/2 ips (standard tape), 30-25,000 Hz (SLH-180 tape). (S+N)/N 53 dB (standard), 56 dB (SLH-180 tape). Wow & flutter 0.06% rms (NAB) weighted; four heads (2 erase, 1 record, 1 playback); induction a. c. servo motor; two illuminated VU meters. Includes tape-tension regulators, tape path adjuster, built-in reel locks, 4-digit tape counter; closed-loop-dual-capstan tape drive. Can be adapted for sound-on-sound, echo. 120-V, 60-Hz operation. 15 1/2" H x 16 3/4" W x 7 1/2" D \$479.95

TC-755 Stereo Tape Deck
Two-speed (7 1/2 & 3 3/4 ips), 3-head, 3-motor deck with 10 1/2" reel capacity. Response 30-20,000 Hz ± 3 dB (standard) and 30-25,000 Hz ± 3 dB (SLH-180 tape); wow & flutter 0.05%. Provides mechanical memory capability with timer, bias select switch, ferrite heads, tape



path adjustment, twin illuminated VU meters, 4-digit tape counter, and built-in reel locks. (S+N)/N 53 dB (standard), 56 dB (SLH-180 tape). 120-V, 60-Hz operation. 17 1/8" W x 17 3/4" H x 8 1/2" D \$699.95

TANDBERG

Series 11 Tape Recorder
Portable (15 V, ten 1 1/2-V cells), mono design. Three speeds (7 1/2, 3 3/4, 1 7/8 ips), and has three



heads. Will handle up to 7" reels. Has automatic level-input controls, mike & line mixing, and built-in speaker. Response 40-16,000 Hz ± 2 dB at 7 1/2 ips, wow 0.1% at 7 1/2 ips, (S+N)/N 58 dB unweighted. 13" W x 10" D x 4".
Model 11-1. Full-track \$795.00
Model 11-2. Two-track \$795.00
A.c. power supply \$79.50

Series 15 Tape Recorder
Mono design with built-in 4" x 7" speaker. Three speeds (7 1/2, 3 3/4, 1 7/8 ips). Response 40-16,000 Hz ± 2 dB at 7 1/2 ips, wow 0.1% at 7 1/2 ips, (S+N)/



N at max. record level 55 dB. 5 W/ch continuous output with both channels driven. Has 0.75 V preamp outputs, low-Z mike & high-and low-level inputs. 13 3/8" W x 11 7/8" D x 6 3/4".
Model 1541. Four-track \$313.50
Model 1541F With foot remote control \$418.00
Model 1521. Two-track \$295.00
Model 1521F. With foot remote control \$399.00

9000X Tape Recorder Deck
Three-speed (1 7/8, 3 3/4 & 7 1/2 ips) play/record stereo design. Wow (Wrms) 0.07% at 7 1/2 ips.



Response 40-22,000 Hz ± 2 dB at 7 1/2 ips. Sensitivity: mike (low imp.) 50 μ V; radio 5 mV; line 30 mV. Output: radio 0.75 V; line 1.5 V. Features crossfield heads; remote control of start/stop, fast forward/rewind, record & playback, mono mixing; A-B test; sound-on-sound; echo; peak record/playback meters; adjusted for low-noise, high-output tape. Supplied in half- and quarter-track versions. On request, can be equipped for 4-channel playback. Walnut cabinet. 15 3/4" x 7" x 16 1/8" D \$699.50

3300X Tape Recorder Deck

Three-speed (1 1/8, 3 3/4 & 7 1/2 ips) design featuring crossfield recording techniques; peak-reading record meters; four heads for sound-on-sound, sound-with-sound, and echo; input mixing; and photoelectric end stop. Has inputs for dynamic mike, receiver/tuner, and record

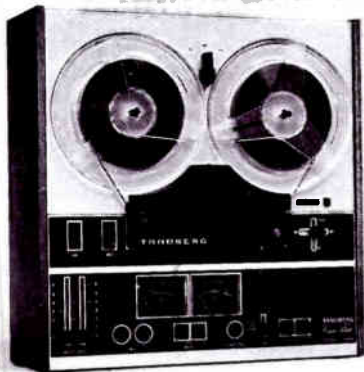

player. Supplied in half- or quarter-track versions. On request, can be equipped for 4-channel playback. Walnut cabinet (rosewood on special request). 15 3/4" x 7" x 16 1/8" D. \$429.90

Series 14 Tape Recorder

Same as Series 15 except 2-speed (3 3/4 & 1 7/8 ips) design.

Model 1441. Four-track without case \$290.00

Model 1421. Two-track without case . . \$270.00

9200XD Dolbyized Stereo Deck

Three-speed (7 1/2, 3 3/4 & 1 7/8 ips), Dolbyized deck; Max. wow 0.06% W rms at 7 1/2 ips; response 25-24,000 Hz ± 3 dB, 30-22,000 Hz

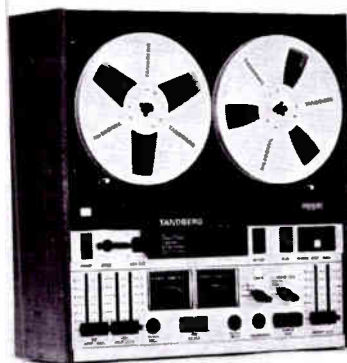

± 2 dB at 7 1/2 ips; crosstalk 50 dB stereo at 1000 Hz; max. tape dist. at 0 dB record level 2%. Features one-hand tape threading; peak-reading dB meters; linear-motion input and output level controls; crossfield heads; (S + N)/N 73 dB at 7 1/2 ips \$899.50

TEAC

2300S Stereo Tape Deck

Two-speed (7 1/2 & 3 3/4 ips) four-track, two-channel deck. Features push-button transport control with logic circuitry; dual VU meters; separate bias/equalization switches; record/pause

lights; total remote-control capability. Has dual-speed hysteresis synchronous capstan motor and two eddy-current induction reel motors. Response 30-24,000 Hz at 7 1/2 ips; 30-16,000 Hz at 3 3/4 ips; wow & flutter 0.08% at 7 1/2 ips. (S + N)/N 58 dB. 17 3/16" x 15 7/16" x 8 7/16" D \$469.50

3300S Stereo Tape Deck

Two-speed (7 1/2 & 3 3/4 ips), four-track, two-channel deck. Will handle up to 10 1/2" reels; offers remote-control capability; push-button transport control with logic circuitry; dual level bias oscillator for low-noise recording; d.c.-coupled equalization network. Features dual VU meters; pause control with indicator light; separate mike/line level controls; tape/source monitor switch; stereo headphone jacks; 4-digit resettable tape counter. 17 3/16" W x 17 7/16" H x 8 7/16" D \$689.50

3300S-2T. Same except two-track, two-channel with 15 or 7 1/2 ips speeds \$739.50

4300 Auto-Reverse Stereo Deck

Two speed (7 1/2 & 3 3/4 ips), three-motor, four-head stereo deck with automatic reverse. Fea-



tures push-button transport control, pause control with indicator light, dual VU meters; separate equalization switches; separate mike/line inputs; separate mike/line level controls. Will handle up to 7" reels; records in four-track, 2-channel stereo. Includes memory counter for automatic repeat and memory marker level guides. Response 30-28,000 Hz; wow & flutter 0.06% both at 7 1/2 ips. (S + N)/N 55 dB. 17 3/16" x 19 1/4" x 8 1/2" \$669.50

5300 Stereo Tape Deck

Two-speed (7 1/2 & 3 3/4 ips), four-track, two-channel deck. Will handle 7" reels. Features direct-capstan drive servo-controlled motor; d.c. reel motors; automatic reverse; push-button transport control. Has separate bias & equalization switches; dual-scale VU meters; remote control for all functions including record & pause; memory marker level guides; solenoid-controlled pause/cue button. Response 30-28,000 Hz; wow & flutter 0.04%, both at 7 1/2 ips. (S + N)/N 60 dB. 17 3/16" W x 21 3/4" H x 8 1/2" D \$759.50

5500 Auto-Reverse Stereo Deck

Two-speed (7 1/2 & 3 3/4 ips), four-track, two-channel deck with automatic-reverse play. Features three motors, four high-density Permaflux heads, and dual-process Dolby noise-reduction system, permitting simultaneous Dolbyized recording with decoded tape monitoring; Dolby FM/Copy function; MPX filter switch; Dolby calibration oscillator; source/tape monitor switch. The 4-head machine with separate playback, reverse playback, record, and erase also has a "punch-in" feature which permits change from play to record mode without going through a stop; a four-digit resettable tape counter; memory marker level guides. Response 30-28,000 Hz; wow & flutter 0.04%, both at 7 1/2 ips. (S + N)/N 65 dB (with Dolby). 17 3/16"

W x 21 3/4" H x 8 1/2" D \$899.50

4070G Stereo Tape Deck

Two-speed (7 1/2 & 3 3/4 ips), 4-track, 3-motor stereo design. Has four high-density ferrite heads (6 head functions). Will handle up to 7" reel. Response 30-20,000 Hz ± 3 dB, wow & flutter 0.05% at 7 1/2 ips, (S + N)/N 58 dB. Has braking, VU meters, automatic reverse and shutoff, pause control, bias adjustment, counter, separate bias & equalizer switches and monitoring facilities. Remote control available optional extra. 17 7/8" H x 18" W x 9 7/16" D \$729.50

7010GSL Auto-Reverse Tape Deck

4-track, 2-channel stereo or mono with four heads (erase, record, playback, and reverse



playback). Two speeds (3 3/4 & 7 1/2 ips), 3 motors. Will handle 7" & 10 1/2" reels. Response 30-20,000 Hz ± 3 dB at 7 1/2 ips. (S + N)/N -58 dB; HD 1% at 1000 Hz at normal listening levels. Has mike (0.25 mV) and line (0.1 V) inputs. Line output 0.3 V. 21 7/8" x 17 7/8" W x 9 1/2" D \$1149.50

7300 Stereo Tape Deck

Two-speed (7 1/2 & 3 3/4 ips), four-track, two-channel deck. Features direct-drive d.c. capstan/servo control motor; two d.c. reel motors; built-in mixer to blend up to 4 mikes or lines; separate master input level control for all mike/line inputs; separate output level control. Has two sets of output jacks; dual VU meters; 3-position bias/equalization switches; separate cue & edit facilities; push-button transport



control; logic circuitry and motion sensing. Response 30-28,000 Hz; wow & flutter 0.04%, both at 7 1/2 ips. (S + N)/N 58 dB. 17 3/8" W x 21 1/16" H x 8 7/8" D \$1349.50

7300-2T. Same except two-track, two-channel with 15 & 7 1/2 ips operation. Response 25-30,000 Hz; wow & flutter 0.03%, both at 15 ips. (S + N)/N 60 dB \$1349.50

1 Open-Reel Tape Machines

Model RS-714US. Similar to RS-714US except this model includes an automatic reverse feature \$549.95

7030GSL Tape Deck

2-track, 2-channel stereo or mono with four heads (erase, record, playback, and 4-track playback). Two speeds (7½ & 15 ips), 3 motors. Will handle 7" & 10½" reels. Wow & flutter 0.06% at 7½ ips. Response 30-20,000 Hz ±3 dB at 7½ ips. (S+N)/N -60 dB. HD 1% at 1000 Hz at normal listening levels. Has mike (0.25 mV) and line (0.1 V) inputs. Line output 0.3 V. Similar in design and styling to Model 7010GSL. 21⅞" × 17⅞" × 9⅞" D ... \$1099.50

TECHNICS BY PANASONIC

RS-1030US 2/4 Track Tape Deck

Two-speeds (15 & 7½ ips). Response 20-26,000 Hz at 15 ips (30-22,000 Hz ±3 dB); 20-23,000 Hz at 7½ ips (30-20,000 Hz ±3 dB). Two-track record/play, four-track (stereo) playback. Wow & flutter 0.12% W rms at 7½ ips. (S+N)/N 55 dB (2-track). Accepts 10" or smaller reels. Four heads including three HPF ultra-longlife types. Low-noise/normal tape selector. Three motors, one dual-speed hysteresis synchronous for capstan drive. Tape tension selector, optional remote. Features automatic stop, tape pause, and 4-digit counter. 22" H × 17" W × 7⅞" D. ... \$999.95

RS-714US Tape Deck

Two-speed (7½, 3¾ ips), 4-track, 3-motor stereo design.



Will handle up to 7" reels. Has 3 ferrite heads. Response 30-22,000 Hz at 7½ ips, wow & flutter less than 0.1% at 7½ ips, (S+N)/N better than 50 dB. Has VU meters, automatic shutoff, pause control, sound-on sound, counter, remote control (optional extra), solenoid operation, and monitoring. 20" H × 17" W × 7⅞" D \$499.95

TELEX

423 Tape Deck

Basically same design as Model 433. Response 50-15,000 Hz ±3 dB, (S+N)/N 50 dB, wow & flutter 0.2%, all at 7½ ips. THD 1.5%. 12⅞" H \$274.95

433 Tape Recorder Deck

Quarter-track stereo design featuring sound-on-sound, reverb (echo), 2-channel input mixing, tape monitoring, and pause control. Three-speed (7½, 3¾, 1⅞ ips), 3-head, 3-motor design. Has automatic shutoff. Response 40-

SEE SECTION 4 FOR 4-CHANNEL



18,000 Hz ±3 dB at 7½ ips, (S+N)/N 54 dB, flutter & wow 0.2% at 7½ ips. 15¼" W × 14⅞" H × 8¾" D \$379.95

Lab Series 2001 Tape Deck

Two-speed (7½, 3¾ ips), 4-track, 3-head, 2-motor stereo design. Will handle up to 8½"

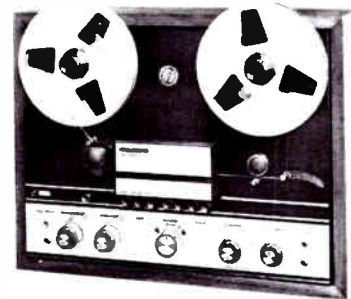

reels. Response 45-18,000 Hz ±2 dB, wow & flutter 0.18% at 7½ ips, (S+N)/N 52 dB. Has VU meters, automatic shutoff, pause control, counter, solenoid operation, and monitoring facilities. 14½" × 19⅞" × 8" D \$799.95

TOSHIBA

PT-862D Stereo Tape Deck

Three-head system for either tape or source monitoring, echo recording; mechanical auto-



matic shut-off; tape selector switch, recording bias control; sound-on-sound; 4-digit tape counter; three speeds (7½, 3¾, 1⅞ ips); will handle up to 7" reels; 4-track, 2-channel stereo record & playback; universal power supply, 50-60 Hz; inputs: mike, line input, DIN; outputs: line-output, headphone, DIN; 4-pole condenser motor; controls: tape selector, speed change, power switch, volume control, mode selector; response 20-25,000 Hz; wow & flutter 0.09% W r.m.s.; crosstalk 60 dB; channel separation 55 dB; (S+N)/N 56 dB. 15⅞" W × 12¼" H × 7⅞" D \$269.95

TAPE RECORDING & BUYING GUIDE

FREE McIntosh CATALOG and FM DIRECTORY

Get all the newest and latest information on the new McIntosh Solid State equipment in the McIntosh catalog. In addition you will receive an FM station directory that covers all of North America.



MX 113

FM/FM STEREO - AM TUNER AND PREAMPLIFIER

SEND TODAY!

McIntosh Laboratory, Inc.
 East Side Station P.O. Box 96
 Binghamton, N.Y. 13904
 Dept. SR

NAME _____
 ADDRESS _____
 CITY _____ STATE _____ ZIP _____

If you are in a hurry for your catalog please send the coupon to McIntosh. For non rush service send the Reader Service Card to the magazine.

CIRCLE NO. 8 ON READER SERVICE CARD



CASSETTE TAPE MACHINES

ADVENT

201 Dolbyized Cassette Deck

Play/record stereo design. Response 35-14,500 Hz at ± 2 dB. THD less than 1 1/2% with chromi-

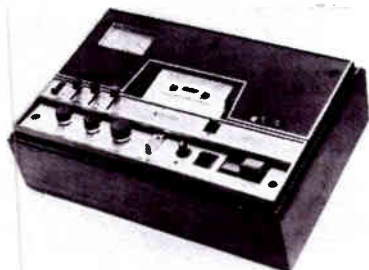

um-dioxide tape; wow & flutter less than 0.15%; (S+N)/N 54 dB (Dolby off). Has VU meter, counter, automatic shutoff, pause control, and line inputs. 4 7/8" H x 13 3/4" W x 9 1/4" D. Oiled-walnut cabinet \$280.00

202 Dolbyized Cassette Playback Deck

Stereo cassette player. Features Dolby circuitry and standard playback equalization for chromi-



um-dioxide tape (regular equalization also provided). Response 30-15,000 Hz ± 2 dB; wow & flutter less than 0.2% DIN. Has hysteresis synchronous motor, automatic shut-off, digital counter. Overall size 3 7/8" H x 9 1/8" W x 10 3/8" D \$130.00

Model 202hp. Same except includes built-in headphone amplifier \$150.00

AKAI

CS-30D Stereo Tape Deck

Features digital tape counter, tape selector switch, tape run lamp, and dual VU meters. Response 40-15,000 Hz (chromium-dioxide tape), wow & flutter 0.15% rms; distortion 2% at 1000 Hz (0 VU), (S+N)/N 46 dB. Induction-type motor. 16.1" W x 5" H x 8.7" D .. \$159.95

GXC-75D Stereo Cassette Deck

Four-track, two-channel system; response 33-16,000 Hz (with chromium-dioxide tape), 30-14,000 Hz ± 3 dB (low-noise tape); wow & flutter 0.1% Wrms; distortion 1.0% (1000 Hz, 0 VU).

(S+N)/N 50 dB; 58 dB (with Dolby). Three heads (one GX record/playback, two erase); hysteresis synchronous outer-rotor motor; two VU meters. Has full complement of controls. Universal power supply 100-240 V, 50-60 Hz. 18.1" W x 5.8" H x 11.9" D \$429.95

CS-33D Dolbyized Cassette Deck

Stereo design with built-in Dolby circuit. Features digital tape counter, tape selector switch, tape run lamp, and two VU meters. Response 40-15,000 Hz (chromium-dioxide tape), wow &



flutter 0.15% rms; distortion 2% at 1000 Hz (0 VU), (S+N)/N 56 dB with Dolby. 16.1" W x 5" H x 8.7" D \$199.95

GXC-36D Cassette Deck

Features glass and crystal ferrite head; induction motor, pause control, tape selector switch



for low noise & chromium-dioxide tapes, automatic stop, OLS switch. (S+N)/N 44 dB; distortion 2.0%; wow & flutter 0.3% \$229.95

GXC-65D Dolbyized Cassette Recorder



Features glass and crystal ferrite head, automatic distortion-reduction system, Dolby automatic change, "Invert-O-Matic" reverse cassette, tape selector (chromium-dioxide or low-noise), pause control, and two VU meters. Frequency response 30-16,000 Hz; wow & flutter

0.2% rms. (S+N)/N 50 dB. Overall distortion 1% \$349.95

GXC-46D Dolbyized Cassette Recorder

Similar to Model GXC-65D in that it has Dolby, glass-encased crystal ferrite heads, and automatic noise-reduction system. Does not have "Invert-O-Matic." With signals over 8000 Hz circuit adjusts recording level to prevent distortion. Response 30-16,000 Hz. Wow & flutter 0.12% weighted rms. (S+N)/N 50 dB (58 dB with Dolby). Has universal power supply. 16 1/2" x 5 3/8" x 12" \$319.95

GXC-38D Cassette Deck

Features glass and crystal ferrite head, induction motor, Dolby, automatic stop, OLS switch,



pause control, tape selector switch for low noise & chromium-dioxide tapes. (S+N)/N 50 dB; wow & flutter 0.30%; distortion 2.0% \$269.95

CONCORD

Mark 7 Dolbyized Cassette Deck

Features stereo design with Dolby-type noise-reduction system providing (S+N)/N of 56 dB



(48 dB without Dolby). Response 30-15,000 Hz; HD 1.3% at -3 VU; bias 105 Hz; wow & flutter 0.13%. Input sensitivity: stereo mike 0.2 mV; stereo aux. 0.12 V. Output 1 V. Features "End-matic," which automatically disengages tape mechanism and will shut off motor in fast-forward or rewind operation; mechanical pause; dual bias (for standard & chromium-dioxide tapes); dual VU meter. 7 1/4" W x 11 1/4" D x 3 1/2" \$229.95

Mark 6. Same as Mark 7 except without Dolby system \$159.95

2 Cassette Tape Machines

Mk IX Dolbyized Cassette Deck

Plays and records. Response 30-15,000 Hz, 1.5% THD, wow & flutter 0.2%, (S + N)/N 50 dB. Has VU meters, counter, eject button, automatic shutoff, pause control, monitoring facilities, mike and high- and low-level line inputs. For use with either chromium-dioxide or conventional tapes. Comes with dust cover. 4 1/2" H x 10 3/8" W x 10 1/8" D \$289.95



ties, mike and high- and low-level line inputs. For use with either chromium-dioxide or conventional tapes. Comes with dust cover. 4 1/2" H x 10 3/8" W x 10 1/8" D \$289.95

F-106EB Stereo Cassette Deck

Features dual bias selection for standard or super-dynamic tapes, pause control, remote-control switch, automatic shutoff, automatic end-of-reel indicator, and dual record-level controls. Response 40-12,000 Hz, wow & flutter 0.2%, (S + N)/N 46 dB. Has mike & aux. inputs and line output. 10 1/2" x 10 1/4" x 3 1/2" H. \$109.95

DOKORDER

MK-50 Dolbyized Cassette Deck

Four track, 2-channel stereo operation with Dolby noise-reduction system. Two heads (one



molybdenum Permalloy record/playback, one ferrite erase); electric governor d. c. motor; response 30-15,000 Hz, 30-18,000 Hz (chromium dioxide tape); (S + N)/N 60 dB (with Dolby); channel separation 30 dB; crosstalk 35 dB. Features automatic shut-off; cue & review; tape selector switch; tape-travel indicator; two VU meters; self-locking pause control; piano-key transport controls; 3-digit tape index counter; slider controls; separate left/right mike inputs & headphone jack. 110-120 V/220-240 V, 50-60 Hz. 4" H x 16" W x 11 3/4" D \$249.95

FISHER

SR-110 Cassette Recorder Deck

Dolbyized record/play stereo design. Has separate control for chromium-dioxide tapes; expanded-scale VU meters; independent record-level controls; auto-stop; counter on mike inputs. Response 30-12,000 Hz (CrO₂, 14,000 Hz); (S + N)/N 50 dB. Wow & flutter (weighted) 0.2% rms. Sensitivity: mike 0.2 mV (±3 dB) 0 VU at 1500 ohms; aux. 100 mV (±2 dB) for 0 VU at 5000 ohms. Output 1 volt (±2 dB) for 0 VU at 5000 ohms. 5 1/2" x 15 1/2" x 10 1/2" D.



RC-80B Cassette Deck

Dolby-ized record/play stereo design. Has separate control for chromium-dioxide tapes, VU meters. Response (standard tapes) 30-12,000 Hz. 7 1/8" W x 3 1/2" H x 11 1/8" D. With pair M-5 dynamic mikes \$249.95
18-W Walnut base \$9.95

HARMAN-KARDON

HK1000 Dolbyized Cassette Deck

Stereo cassette recorder deck with built-in Dolby noise-reduction circuit. Has front-panel bias



switch for standard, low-noise, and chromium-dioxide tapes. Features memory relay, peak-reading VU meters, sliding controls for playback & record level, and microphone input. Response 30-15,000 Hz ±1.5 dB; wow & flutter 0.15 (weighted); speed variation 1%. Constant-current-drive record head \$329.95

HEATH

AD-110 Cassette Deck

Play/record stereo design. Response 30-12,000 Hz ±3 dB, 0.25% distortion, wow & flutter

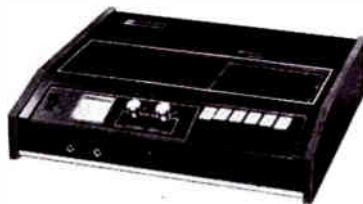

less than 0.25%, (S + N)/N 45 dB. Has VU meters, eject button, pause control, mike & line inputs, and adjustable bias. 11" H x 13 3/8" W x 3 1/8" D. Walnut cabinet. Kit..... \$129.95

AD-1530 Dolbyized Cassette Deck

Combines a pre-assembled tape transport, a

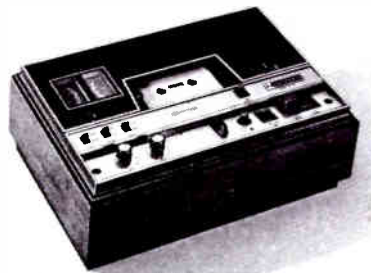

Dolby noise-reduction (B type) system, and necessary preamps to record or play stereo cassette tapes. Has built-in test circuit to adjust Dolby system; a bias & equalizing switch for chromium-dioxide or standard tapes; VU meters; and mike inputs. Walnut cab. \$249.95
Kit \$249.95
Dust cover \$4.95

HITACHI

TRQ-262 Stereo Cassette Deck

Plays and records. 20-18,000 Hz response,



wow & flutter 0.15%, (S + N)/N 50 dB. Has VU meters, counter, eject button, automatic shutoff, pause control, monitoring facilities. Has provision for mike & line inputs. 3 3/8" H x 13 1/8" W x 9 5/8" D \$149.95

TRQ-282 Stereo Cassette Deck

Plays and records. Response 40-12,000 Hz, wow & flutter 0.3%, (S + N)/N 46 dB. Has VU



meters, counter, eject button, pause control, monitoring facilities, mike & line inputs. 3 3/8" H x 8 1/8" W x 10 3/4" D \$119.95

TRQ-252 Stereo Cassette Deck

Plays and records. Response 40-12,000 Hz, (S + N)/N 45 dB. Has VU meters, counter, eject button, mike inputs. 3 3/16" H x 7 3/8" W x 10 13/16" D \$129.95

TRQ-2000 Dolbyized Cassette Deck

Features a cassette stereo tape recorder/player with Dolby circuitry. Has two VU meters, slide-

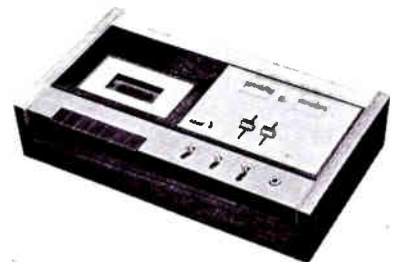

type volume controls, and walnut cabinet. \$239.95

ALWAYS

take along your copy of this Guide when shopping for hi-fi components. It is a comprehensive reference to complete technical details and prices.

SDT-3420 AM-FM/Phono/Cassette Recorder

Combines an AM-FM stereo receiver with 5 W/ch dynamic power at 5% THD, a BSR auto-



matic record changer, a cassette recorder, and a pair of air-suspension speaker systems. Has separate tape record-level controls and comes with a dust cover \$299.95

ST-3401 AM-FM/Cassette Recorder/Player

Combines an AM-FM stereo receiver with 5 W/ch dynamic power at 5% THD with a cassette tape recorder. Has separate record-level controls, sleep switch, two VU meters. Supplied with two 2-way speaker systems \$259.95

TRK-1271 Cassette Recorder/Radio

AM-FM radio with cassette recorder and wireless microphone. Mike looks and works like conventional built-in condenser unit but can be lifted out for wireless recording at distances to 50 feet; can also be used with line input connector. Unit features variable monitor and sound mixing facilities \$159.95

JVC

CD-1655 Cassette Deck

Stereo record/play design. Response 30-15,000 Hz ± 3 dB. Ferrite record/play heads. Tape



selector switch for chromium-dioxide and standard tapes. Built-in noise-suppressor circuit, automatic stop, two VU meters, calibrated step recording-level controls. $4\frac{1}{2}'' \times 14\frac{11}{16}'' \times 9\frac{9}{16}''$ D \$129.95

CD-1667 Cassette Deck

Stereo record/play design. Response 30-16,000 Hz ± 3 dB with chromium-dioxide tape (30-13,000 Hz with standard tape). (S+N)/N -50 dB; wow & flutter 0.15% rms; bias record &



erase 95 kHz. Has record/play and erase heads. Inputs: mike (0.7 mV) & line (80 mV). Line output 0 to 1 V. Features two VU meters and bias switch for chromium-dioxide and standard tape. Features ANRS (automatic noise-reduction system). $15'' \times 4\frac{3}{8}'' \times 10\frac{1}{2}''$ D \$229.95

CD-1669 Solenoid Cassette Deck

Response 30-16,000 Hz ± 3 dB. (S+N)/N -60 dB; wow & flutter 0.13% rms. Ferrite record/play heads. Features both equalizer and tape bias switches; built-in automatic noise-reduction system; memory counter; dual-drive mechanism; memory counter; calibrated step recording-level and playback controls. $5\frac{1}{8}'' \times 16\frac{1}{2}'' \times 12\frac{1}{16}''$ D \$429.95

CD-1668 Cassette Deck

Deluxe version of the Model CD-1667. Has dual drive mechanism to reduce wow & flutter



(0.13% rms). Memory counter, ferrite record/play heads, calibrated recording-level controls, automatic stop, and automatic eject. Overall size $17'' \times 5\frac{1}{2}'' \times 15''$ D \$299.95

CD-1665 Cassette Deck

Economy stereo record/play design. Response 40-13,000 Hz ± 3 dB. (S+N)/N -50 dB; wow & flutter 0.15% rms. Has record/play and erase heads. Inputs: mike (0.7 mV) & line (80 mV). Line output 0 to 0.6 V. $4\frac{1}{2}'' \times 11\frac{1}{8}'' \times 9\frac{3}{8}''$ D \$99.95

LAFAYETTE

LRK-900A Cassette/Receiver System

Deck with power amplifier and AM-FM stereo tuner. Plays and records. 10 W/ch output. Wow & flutter 0.25%; (S+N)/N 48 dB. Has bias switch for standard or chromium-dioxide tapes, VU meters, counter, eject button, tone controls, automatic shutoff, pause control, monitoring



facilities, mike inputs, phono input, bias adjust, sound-with-sound. Has built-in circuit for 4-channel synthesizing of conventional 2-channel sources. Requires two additional speakers for 4-channel use. $4'' \times 10\frac{3}{4}'' \times 11\frac{7}{8}''$ D \$219.95

RK-725 Record/Playback Deck

Deck featuring a low-impedance stereo amplifier for stereo headphone listening. Response 50-13,000 Hz; (S+N)/N 45 dB; channel separation 30 dB. Input sensitivity: mike 1 mV; aux. 100 mV. Wow & flutter 0.25% rms. Has standard/chromium-dioxide level control; illuminated VU record-level meters; 3-digit tape counter with reset button; front panel left- and right-channel mike and input jacks; six push-button tape functions including pause. Walnut wood case, brushed aluminum front panel. $12\frac{7}{8}'' \times 9\frac{1}{16}'' \times 3\frac{3}{16}''$ \$99.95

RK-D50 Dolbyized Cassette Deck

Record/playback deck with Dolby. Has push-

button tape selectors for standard, chromium-dioxide, or UD tapes; memory rewind; sound-with-sound facilities; lockable pause control; two illuminated VU record-level meters; two peak record-level indicator lights; 3-digit tape counter with reset button; automatic shut-off. Has 4-pole hysteresis synchronous motor. Response 30-20,000 Hz ± 3 dB; (S+N)/N 59 dB (Dolby in), 49 dB (Dolby out); channel separation 30 dB at 1 kHz. $14\frac{1}{4}'' \times 3\frac{3}{4}'' \times 10''$ D \$239.95
Dynamic mike for use with RK-D50 ... \$19.50

RK-760B Cassette Deck

Features dual-channel VU record-level meter; push-button tape selector for standard or chro-



mium-dioxide tapes; sound-with-sound mixing; automatic shut-off in all modes at end of tape; 3-digit tape counter with reset button; front-panel stereo headphone jack powered by low-level stereo preamp. Records and plays back 4-track stereo and 2-track mono. Response 30-12,000 Hz ± 3 dB; (S+N)/N 48 dB; channel separation 30 dB at 1 kHz. $10\frac{1}{4}'' \times 4\frac{1}{2}'' \times 10\frac{5}{8}''$ D \$124.95
Dynamic mike for RK-760B \$8.60

NAKAMICHI

Remote Control Box



Electronic touch control (duplicating control system on the 1000 & 700). Controls all tape motion, including record, within 15 feet \$49.00

1000 3-Head Cassette Deck

Stereo record/play deck has response of 35-20,000 Hz ± 3 dB (CrO₂) tape. Wow & flutter less than 0.10% (weighted peak); (S+N)/N 60 dB (Dolby in); THD 2% at 1 kHz, 0 dB. Features three heads (erase, record, playback); record-head azimuth alignment beacon; Dolby noise-reduction circuit + DNL; closed-loop driven double capstans with staggered flywheels; two d.c. driving motors; two peak level meters; instantaneous spill-proof device; automatic shut-off, memory rewind, and automatic rewind;



2

Cassette Tape Machines

variable pitch control, 3-point sound pickup for live recording; peak limiter; optional remote control. Inputs: mike 0.5 mV, 600 ohms; blend mike 0.5 mV, 600 ohms; line 100 mV, 100,000 ohms. Outputs: line 1.2 V (max.) variable; headphones 3 mW, 0 dB. 11¹/₁₆" H x 20¹/₁₆" W x 8³/₁₆" D..... \$1100.00

700 3-Head Cassette Deck

Same as the Model 1000 except does not have



automatic rewind or DNL. 10¹/₁₆" H x 20¹/₂" W x 5¹/₈" D \$690.00

PIONEER

CT-4141A Dolbyized Cassette Deck

Stereo design featuring d.c. brushless motor, 85 kHz bias & a.c. erase. Bias change for standard & chromium-dioxide tape. Response 30-12,500 Hz with standard tape (30-15,000 Hz with chromium-dioxide tape). (S + N)/N 58 dB with Dolby. Wow & flutter 0.13%. Inputs: line

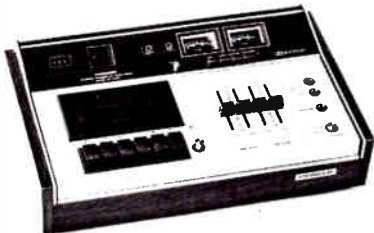

50 mV; mike 0.5 mV. Line output 0.775 V, 120 V, 60 Hz operation, 15³/₈" W x 3⁷/₈" H x 9¹/₂" D..... \$239.95

CT-5151 Dolbyized Cassette Deck

Dolbyized cassette deck with independent bias and equalization circuit selection for regular, low-noise, or chromium-dioxide tapes. Features solid ferrite heads; twin VU meters; LED peak indicator (calibrated to light when level exceeds reference level by +4 dB); switchable level limiter; electronically controlled d.c. motor; electromagnetic automatic stop circuit; tape-motion pilot light; skip button for locating desired program material; three-digit tape counter and tape memory rewind button for preci-



sion cueing. Response 30-16,000 Hz (CrO₂); 30-13,000 Hz (standard) tape; (S + N)/N 58 (with Dolby), 48 dB (without); wow & flutter 0.12% Wrms; bias frequency 85 kHz. 120-V, 60-Hz operation. 15³/₈" W x 3⁷/₈" H x 9¹/₂" D \$269.95

CT-3131A Cassette Deck

Stereo record/playback design featuring switch for standard or chromium-dioxide tape; automatic stop; a level memory marker; dual record-level meters; tape running pilot; and skip button. Wow & flutter 0.13%; (S + N)/N -48 dB for standard tape (50 dB for chromium-dioxide tape). Response 30-12,500 Hz for standard tape (30-15,000 Hz for chromium-dioxide tape). Sensitivity: line input 50 mV; mike 0.5 mV; line output 0.775 V. 120V, 60 Hz operation. 15³/₈" x 3⁷/₈" x 9¹/₂" D \$179.95

RADIO SHACK

SCT-6C Cassette Deck

Stereo record/play design. Has individual channel record-level controls, VU meters, mike and

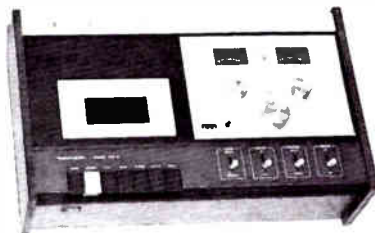

auxiliary inputs, preamp outputs. Has Dolby noise-reduction circuit, tape bias switch for recording chromium-dioxide cassettes. Capable of sound-on-sound recording. Has dual illuminated record-level meters, pause control, and automatic end-of-tape shut-off. Response 30-14,000 Hz (with chromium-dioxide tape) ±2 dB; wow & flutter 0.14% rms. Oiled walnut cabinet with brushed aluminum trim. 16¹/₂" x 10¹/₄" x 4¹/₂" \$249.95

SCT-5C Cassette Recorder

Stereo record/play design. Has dual VU meters. Response 50-12,000 Hz ±2 dB (playback-

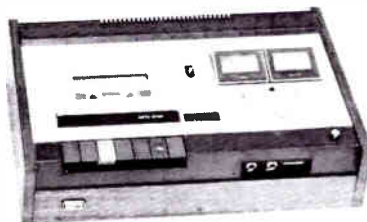

only response 40-14,000 Hz ±2 dB). Wow & flutter 0.2%. Overall size 13³/₈" x 9³/₈" x 3⁷/₈" \$149.95

SCT-2C Cassette Recorder

Portable stereo design. Has dual VU meters, monitor switch, slide controls. Operates from

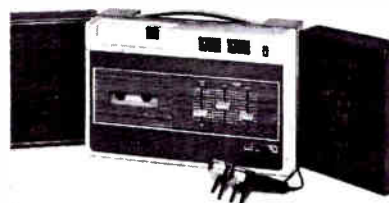

117-volt power source or six "D" cells. Supplied with two mikes (one with remote-control switch). Has two removable wing speaker systems. 11" x 8¹/₂" x 6¹/₂" \$149.95

SANSUI

SC-700 Cassette Recorder Deck

Stereo design with Dolby noise-reduction system. Input sensitivity: mike 0.5 mV; line 70 mV.



Wow & flutter 0.12% weighted rms. Response 40-13,000 Hz with standard tape; 40-16,000 Hz with chromium-dioxide tape. (S + N)/N with low-noise tape 50 dB (with Dolby 56-58 dB). Bias frequency 100 kHz. Features 3 mike mixing, dual VU meters, and universal power supply. 15¹/₄" x 10¹/₈" x 4¹/₈" D \$229.95

SC-737 Cassette Recorder Deck

Stereo design with built-in Dolby circuits; provi-



sions for chromium-dioxide tape; MCF ferrite heads; constant and peak-reading VU meters; three mike inputs. Response 30-13,000 Hz (regular tape); 30-16,000 Hz (CrO₂) (S + N)/N 50 dB. Dolby out, but with chromium-dioxide tape. Radar-type tape-direction indicator. 18¹/₄" W x 4³/₄" H x 11¹/₈" D \$299.95

SANYO

RD-4300 Dolbyized Cassette Deck

Stereo design with pause control, equalization adjustments for choice of tape, and two record-



level meters. Has tape monitoring facilities, cue control, and automatic shut-off. Response 40-15,000 Hz ±3 dB. (S + N)/N 50 dB. Wow & flutter 0.15%. Has mike & line inputs and built-in memory counter (will automatically rewind & stop at point of start). 17" x 9" x 5" .. \$299.95

RD-4350 Dolbyized Cassette Deck

Stereo design with built-in memory counter; separate record/playback level controls; adjustable recording equalization controls; mike/aux. input control; lighted VU meters with push-button tilt-up mechanisms for easy viewing; and mechanical automatic stop. Response 40-15,000 Hz ±3 dB; (S + N)/N 50 dB; wow & flutter 0.15%. Has two mike inputs and two stereo line outputs. Dolby noise suppression circuit. 17" x 9" x 5" \$329.95

RD-4250 Dolbyized Cassette Deck

Features servo-controlled tape drive mechanism and ferrite heads; large VU meters; tape



counter; 7-button function control including both cue and pause functions; adjustable recording equalization; automatic stop. Has Dolby noise reduction circuit. Response 40-15,000 Hz \pm 3 dB; (S + N)/N 50 dB; wow & flutter 0.2%. Has two mike inputs and two stereo line outputs. 19" x 9" x 5" \$289.95

SONY BY SUPERSCOPE

TC-10 Car Cassette Player

Stereo design. 12-V negative ground operation. 6 W/ch continuous. Response 50-10,000 Hz. Wow & flutter 0.25%; (S + N)/N 45 dB. 3.2 ohms impedance. 7 1/4" x 2 1/8" x 7 1/8" D. With mounting hardware but less speakers. \$109.95
TC-20. Same except deluxe styling and for both negative & positive ground operation. Wow & flutter 0.28%. 7 1/4" x 2 7/8" x 8 1/4" D. \$129.95
TC-30. Same as TC-10 except has automatic reverse. (S + N)/N 50 dB. 7 1/4" x 2 7/8" x 9 3/8" D. \$159.95

TC-161SD Dolbyized Cassette Deck

Features dual bias for standard or chromium-dioxide tape. Response 20-18,000 Hz with



chromium-dioxide tape. (S + N)/N 54 dB at 1 kHz & 59 dB at 5 kHz. Wow & flutter 0.1%. Bias frequency 85 kHz. Has dual VU meters, illuminated cassette compartment, memory-type counter; headphone level switch. Has mike & line inputs (0.06 V sensitivity) and line output (0.775 V). Walnut base. 15 3/4" x 5" x 10 1/8" D \$299.95

TC-121A Stereo Cassette Deck

Records/plays. Response 40-13,000 Hz; wow & flutter 0.22% (S + N)/N 45. Has low-imp. mike

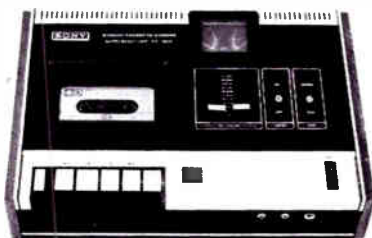

input; 560,000 ohm imp. aux. input. Output: phono 100,000 ohms. Level 0.775 V. Includes stereo headphone monitor jack, record level indicator, pause control, and automatic shut-

off. 13" x 3 7/8" x 8 1/16" \$114.95

TC-129 Stereo Cassette Deck

Records/plays. Response 40-14,000 Hz; wow & flutter 0.22%; (S + N)/N 45. Has low-imp. mike input; 560,000 ohm imp. aux. input. Output: phono 100,000 ohms imp. Level 0.775 V. Features straight-line record level controls; tape select switch; dual illuminated VU meter; three-digit tape counter; push-button operation; pause control with lock. Has stereo headphone jack; built-in dust cover; automatic shut-off; non-magnetizing record head. Walnut base. 13 3/8" x 4" x 9 1/4" \$149.95

TC-131SD Dolbyized Cassette Deck

Includes Dolby circuitry; has special tape select switch for chromium-dioxide or standard tapes; ferrite head; built-in peak limiter. Has straight-line record level controls, illuminated VU meters, automatic total mechanism shut-off (TMS); locking fast-forward and rewind; pause control with lock; 3-digit tape counter; record indicator pilot lamps; stereo headphone jack; non-magnetizing record head. Response 40-15,000 Hz; wow & flutter 0.22% (S + N)/N 48 dB. Overall size 15 3/16" x 3 3/4" x 9 1/16". Walnut base \$199.95

TC-152SD A.C./D.C. Cassette-Corder Deck

Operates from four "D" cells or 117 V a.c. line. Records/plays stereo. Has built-in mono amplifier and single speaker for monitoring (both channels simultaneously). Features a Dolby circuit for either record or playback. Response 40-15,000 Hz; wow & flutter 0.28% (S + N)/N 48 dB. Has tape select switch; automatic shut-off; battery check switch; line in/line out for deck operation; separate monitor/playback volume and tone controls; 3-digit tape counter; built-in peak limiter. Comes with two patch cords, four "D" cells, shoulder strap \$299.95

TC-224 Portable Cassette-Corder

Records/plays discrete stereo without external speakers or microphones. Features two built-in condenser mikes and two separate built-in speakers. Has two VU meters; 3-digit tape counter. locking fast-forward and rewind; back-space review button; fast cueing; stereo headphone jack. Response 50-10,000 Hz. Operates from four "C" cells, 120 V, 50-60 Hz; or 6 V d.c. Has earphone, carrying case, hideaway handle \$179.95

TC-126 Portable Cassette-Corder

Records/plays mono or stereo; response 50-10,000 Hz (standard tape), 50-13,000 Hz (chromium-dioxide tape); wow & flutter 0.26%. Features record level/battery indicator; two line outputs; one stereo headphone jack; two aux. and two mike inputs; record interlock; non-magnetizing record head; recording control; locking fast-forward & rewind buttons; dual differential balance flywheels; stereo/mono selector switch; built-in speaker; 3-digit tape counter; automatic shut-off. Operates from "C" cells, optional Ni-Cad battery pack, or 120-V, 60-Hz a.c. Comes with four "C" cells, mike, earphone, a.c. power cord, and carrying case \$189.95



mium-dioxide tape); wow & flutter 0.26%. Features record level/battery indicator; two line outputs; one stereo headphone jack; two aux. and two mike inputs; record interlock; non-magnetizing record head; recording control; locking fast-forward & rewind buttons; dual differential balance flywheels; stereo/mono selector switch; built-in speaker; 3-digit tape counter; automatic shut-off. Operates from "C" cells, optional Ni-Cad battery pack, or 120-V, 60-Hz a.c. Comes with four "C" cells, mike, earphone, a.c. power cord, and carrying case \$189.95

TC-126CS. Same as TC-126 but with external stereo speakers and attache-type carrying case \$229.95

CF-620A Cassette Recorder/Radio

Cassette recorder combined with AM/FM stereo tuner. Plays and records. Response 30-12,000 Hz, wow & flutter 0.22%, (S + N)/N 46 dB. Supplied with mikes and speakers. 6 W/ch continuous power at 5% HD. Features VU meters, counter, eject button, pause control, monitoring facilities, mike & line inputs, bias adjust and automatic shut-off. 5 7/16" H x 16 1/2" W x 12 1/4" D \$329.95

CF-550A Cassette Recorder/Radio

Combines AM/FM stereo receiver with cassette recorder. Has two built-in condenser mikes and four built-in speakers, built-in battery charger for optional NiCad battery (6 V) and automatic shut-off. Will operate from a.c. power line. Response 50-10,000 Hz. Has two line (0.06 V) and two mike inputs. 1 1/2 W/ch continuous power output at 5% THD. Portable design. 13 1/4" x 9 3/8" H x 4 3/4" D \$249.95

SUPERSCOPE

CD-301 Stereo Cassette Deck

Record/play deck. Response 40-10,000 Hz (standard tape); 40-14,000 Hz (chromium-dioxide tape); (S + N)/N -48 dB standard/-51 dB CrO₂ tapes. Features two slanted VU meters; limiter switch to limit maximum recording level; illuminated function indicators; headphone monitor jack; left and right mike inputs and record-level controls; record mode light; 3-digit tape counter; interlocked piano-key type controls. Comes with walnut base and two audio patchcords. Overall size 12 1/2" W x 3 1/4" H x 8 7/8" D \$99.95

CD-302 Stereo Cassette Deck

Similar to CD-301 except includes the Dolby noise reduction system. (S + N)/N -48 dB; Dol-



by in -60 dB; CrO₂ -51 dB. Has the same controls and features as the Model CD-301 \$149.95

AN IMPORTANT WORD ABOUT PRICES. . . .

Although we have made every effort to obtain current prices on all products listed in this Guide, because of the "floating" of world currencies and devaluations and revaluations by various countries, ALL prices are subject to some adjustment. The prices you will find listed are the latest manufacturers and/or importer were able to supply before press time . . . and are subject to change.

2 Cassette Tape Machines

SYLVANIA

CT160W Cassette Recorder Deck

Stereo design with dual VU level meters, automatic shut-off, and slide-type controls. Input sensitivity: mike 0.2 mV \pm 3 dB at 200 ohms; 100 mV \pm 3 dB at 100,000 ohms. Output 1 V \pm 3 dB. Response 30-12,000 Hz \pm 4 dB. Wow & flutter 0.2% rms. Supplied with two dynamic microphones & desk stands. 5 $\frac{5}{8}$ " \times 11 $\frac{7}{8}$ " D \times 8" H. Walnut cabinet. \$119.95

MST2738W Phono/Cassette/Receiver

Combines a Garrard automatic turntable, a Pickering magnetic cartridge, viscous-damped cue/pause control, an anti-skating device; an AM-FM stereo receiver; a stereo cassette re-



recorder; and a pair of sealed air-suspension speaker systems (18" \times 11 $\frac{1}{4}$ " \times 9" D) each with 8" woofer & 3" tweeter. Has built-in Phase Q4 matrix to synthesize regular two-channel stereo program material. 20 W/ch dynamic power at 1% HD (12 $\frac{1}{2}$ W/ch continuous). Power bandwidth 25-20,000 Hz; response 25-20,000 Hz \pm 1 $\frac{1}{2}$ dB. FM sensitivity 2.5 μ V; capture ratio 5.5 dB. Walnut cabinet with dust cover. Comes with pair of microphones. Control center 9 $\frac{1}{4}$ " \times 23 $\frac{1}{2}$ " \times 15 $\frac{3}{4}$ " D \$419.95

TANDBERG

TCD-310 Cassette Recorder Deck

Features Dolby noise-reduction system; three motors; two peak-reading record meters; chromi-



um-dioxide/low-noise, high-output tape switch; automatic endstop. Wow & flutter 0.15% (Wrms). Response 50-12,000 Hz \pm 2 dB. Has mike (0.1 mV), radio (5 mV), and line (40 mV) inputs. Output 0.775 V. Wall mountable. Walnut cabinet. 19" \times 4 $\frac{1}{4}$ " \times 9 $\frac{1}{8}$ " D \$449.90

TEAC

AC-5 Car Cassette Player

Features continuous stereo playback; automatic reverse; universal mounting; and servo-controlled motor. Wow & flutter 0.25%. Frequency range 40-10,000 Hz. Output 6 W/ch dynamic (EIA) power at 5% THD. 12 V d.c. negative-ground operation. 2 $\frac{3}{8}$ " \times 7" \times 8 $\frac{3}{8}$ " D. Speaker optional \$159.50

AC-9 Car Cassette Player

Similar to AC-5 except higher fidelity. Has tone

controls; fast-wind in both directions; automatic reverse; tape-travel indicating lamps. Speaker optional \$199.50

360S Dolbyized Stereo Cassette Deck

Features Dolby noise reduction system; wow & flutter 0.07%. Has 400-Hz Dolby calibration tone generator; MPX filter switch; 8 external Dolby calibration controls; automatic output stabilizing network; separate 3-position bias

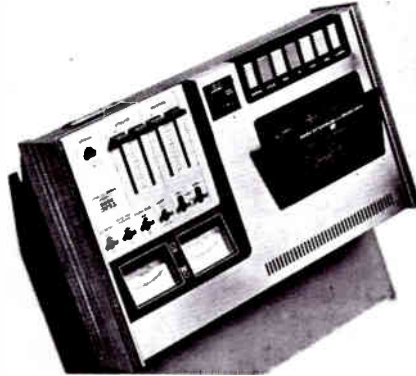

and equalization switch; memory rewind counter; total automatic shut-off in record and play mode; dual VU meters. Response 30-16,000 Hz (40-15,000 Hz \pm 3 dB with CrO₂ tape). (S+N)/N 60 dB (Dolby in); 55 dB (without Dolby). 17 $\frac{1}{4}$ " W \times 4 $\frac{3}{4}$ " H \times 10 $\frac{1}{4}$ " D \$379.50

250S Dolbyized Stereo Cassette Deck

Features Dolby noise-reduction system; standard/chromium-dioxide tape selector switch;

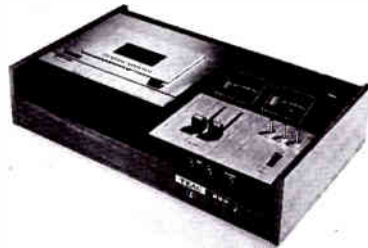

straight-line record-type level control; dual VU meters; high-density "Permaflux" heads; and tape-run indicator light. Response 30-13,000 Hz; 30-15,000 Hz (with chromium-dioxide tape); (S+N)/N 58 dB (Dolby in). Wow & flutter 0.15%. 16 $\frac{1}{2}$ " W \times 4 $\frac{1}{8}$ " H \times 9 $\frac{7}{8}$ " D \$289.50

160 Dolbyized Cassette Deck

Features Dolby noise-reduction system; high-density "Permaflux" heads; separate bias and equalization switches; straight-line level controls (two record, two output); two VU meters; tape-run indicator light; and 3-digit resettable tape counter. Has left and right low-imp. mike jacks; stereo headphone jack; pause control; two heads. Response 30-13,000 Hz with standard tape (30-14,000 Hz with chromium-dioxide tape); wow & flutter 0.15%. (S+N)/N 58 dB (with Dolby). 16 $\frac{1}{2}$ " W \times 4 $\frac{3}{4}$ " H \times 10 $\frac{1}{8}$ " D \$249.50

140 Stereo Cassette Deck

Features dual VU meters; straight-line record-level controls; high-density "Permaflux" heads; separate equalization and bias switches; tape-run indicator; 3-digit resettable tape counter; left and right low-imp. mike jacks; 8-ohm stereo headphone jack; locking pause control; and automatic shut-off. Response 30-13,000 Hz (standard tape); 30-14,000 Hz (chromium-dioxide tape). (S+N)/N 50 dB; wow & flutter 0.15%. 16 $\frac{1}{2}$ " W \times 4 $\frac{3}{4}$ " H \times 10 $\frac{1}{8}$ " D \$199.50

355 Dolby-ized Cassette Deck

Stereo design. Plays and records. Response 30-14,000 Hz, wow & flutter 0.13% (S+N)/N 58 dB. Has hysteresis motor, VU meters, counter, eject button, automatic shutoff, pause con-

trol, monitoring facilities, and mike & line inputs. 4 $\frac{9}{8}$ " H \times 16 $\frac{1}{2}$ " W \times 9 $\frac{7}{8}$ " D \$329.50

450 "Challenger" Cassette Deck

Features Dolby-B type noise-reduction system. Has switchable controls for bias and equaliza-



tion for various tape types; mike/line inputs (mixable); two separate erase and record/playback heads. (S+N)/N 51 dB (60 dB with Dolby); wow & flutter 0.07%. Response 30-10,000 Hz with standard tape (30-14,000 Hz with low-noise tape); 30-16,000 Hz with chromium-dioxide tape). Inputs: mike 0.25 mV; line 0.1 V. Output: 0.3 V. Has universal power-line inputs. 7" H \times 17 $\frac{1}{2}$ " W \times 10 $\frac{5}{8}$ " \$449.50

TECHNICS BY PANASONIC

RS-271US Cassette Recorder Deck

Dolbyized stereo design with standard and chromium-dioxide tape selection and HPF ul-



tra-longlife heads. Wow & flutter 0.2% (S+N)/N 55 dB (with Dolby), 45 dB (without). Response 20-13,000 Hz (standard tape), 20-14,000 Hz (chromium-dioxide). Has two VU meters, memory rewind, lockable pause control, automatic stop, mike/line selector, electronically controlled motor speed. 15 $\frac{5}{8}$ " \times 10 $\frac{7}{8}$ " \times 5" \$249.95

RS-279US Cassette Recorder Deck

Dolbyized stereo design with standard and chromium-dioxide tape selection and HPF ul-



tra-longlife heads. Three-head system permits off-tape monitoring. Wow & flutter 0.1%. (S+N)/N 60 dB (with Dolby), 50 dB (without). Response 20-17,000 Hz (chromium-dioxide tape), 20-15,000 Hz (standard tape). Has two motors including electronically controlled direct drive for capstan, optional remote control, memory rewind, pause control, electronic autostop. Mike/line input selection. 5 $\frac{3}{8}$ " H \times 16 $\frac{3}{8}$ " W \times 13 $\frac{1}{2}$ " D \$499.95

RS-276US Cassette Recorder Deck
 Dolbized with standard and chromium-dioxide tape selection. Wow & flutter 0.1%. (S + N)/N



50 dB (60 dB with Dolby). Response 20-15,000 Hz (standard tape), 20-17,000 Hz (chromium-dioxide tape). Has line & mike inputs, two-motor system including one direct drive, memory rewind, and optional remote control. 5 7/8" x 16 1/2" x 13 1/4" D \$399.95

RS-263US Cassette Recorder Deck
 Dolbized stereo design with standard tape & chromium-dioxide selection. Wow & flutter 0.2%. Response 30-13,000 Hz (standard tape); 30-14,000 Hz (chromium-dioxide). (S + N)/N 45 dB (55 dB Dolby). Has mike & line inputs, automatic stop, memory rewind and pause control. 14" x 5" x 9 5/8" D \$199.95

RS-277US Cassette Recorder Deck
 Similar to RS-263US in performance but has added features: automatic reverse, pause con-



trol, and output level adjust. 17 1/4" x 5 1/8" x 11 3/8" D \$299.95

RS-676US Cassette Recorder Deck
 Vertical design with front-loading features Dolby circuit (including switch selector and calibrator for pre-encoded Dolby FM broadcasts); two motors including electronic control for capstan drive; solenoid operation; hot-pressed ferrite head; meter peak-check switch; selectable MPX filter; chromium-dioxide/normal tape selector (either manual or automatic). Has full auto stop in any mode; mechanical pause; single level control for record mode with aux. left/right balancer; digital counter; memory rewind with automatic replay; mike/line/tuner inputs with mike level control for mixing. Response 30-16,000 Hz ±3 dB (chromium-dioxide tape); 30-14,000 Hz ±3 dB (gamma ferric-oxide tape). Wow & flutter 0.10%; (S + N)/N 52 dB; HD 1.3% \$449.95

TOSHIBA

PT-415 Cassette Deck
 Stereo design featuring a Dynamic Noise Limiter (DNL); tape selector (standard or chromium-dioxide). Output 0-1 V. Response 30-15,000 Hz, with chromium-dioxide tape. Wow & flutter 0.1% rms weighted; (S + N)/N 50 dB (unweighted). Sensitivity: line 80 mV; mike 0.56 mV. Fast-forward and rewind 100 sec. Has universal line inputs. 14 1/2" x 4" x 10 1/4" \$199.95

PT-490 Dolbized Cassette Deck
 Features stereo play/record; mechanical auto-

matic shut-off; 3-step tape selector (adjusts bias and frequency response), two record-level meters, and automatic reverse. Output 0 to 1 V. Frequency response 30-15,000 Hz. Wow & flutter 0.1% weighted rms. (S + N)/N 50 dB (60 dB with Dolby). Input sensitivity: line 80 mV; mike 0.56 mV (10,000 ohms). 16 7/8" x 5 1/2" x 11 1/2". \$329.95
PT-470. Same as PT-490 except does not have



automatic reverse \$249.95

WESTBURY

4101 Recorder/Player Deck
 Records/plays. Features automatic eject, fast-forward, repeat and pause controls; slide con-



trols, record-level meters; repeat switch; eject at end 4 and end of each channel. Has indicator lamp; headphone jack. Wood cabinet. 14" x 11" x 5" \$109.95

WOLLENSAK

4765 Cassette Recorder Deck
 Dolbized design featuring beltless, direct dual-drive system; mike & line mixer switch for

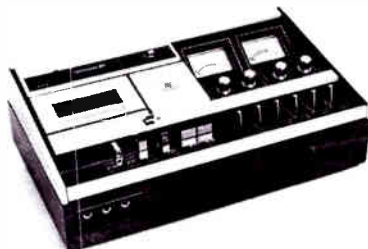

sound-on-sound mixing; Dolby calibration oscillator; tape bias switch for standard and chromium-dioxide tapes; end-of-tape sensing; dual VU meters. Wow & flutter 0.15% (DIN) weighted. Sensitivity: mike 0.65 mV for 0 VU; line 150 mV; Output 1 V; headphone output 0.2 mV at 8 ohms. Response 35-14,000 Hz ±2 dB with standard tape. (S + N)/N 50 dB with Dolby off (60 dB at 4000 Hz with Dolby) \$329.95

4770 Cassette Recorder Deck
 Has dynamic noise reduction circuit on playback and multi-function tape selector switch which adjusts bias, equalization, and VU meter level. Plays and records. Includes memory rewind, automatic shut-off, master record level, and pause lock \$239.95

4780 Cassette Recorder Deck
 Has Dolby noise-suppression circuit and multi-function tape selector control which adjusts bias, equalization, and VU meter level. Plays and records \$299.95

SAVE!

MONEY • TIME • FREIGHT

- ♪ QUALITY STEREO EQUIPMENT AT LOWEST PRICES.
- ♪ YOUR REQUEST FOR QUOTATION RETURNED SAME DAY.
- ♪ FACTORY SEALED CARTONS—GUARANTEED AND INSURED.
- ♪ SAVE ON NAME BRANDS LIKE:

A.D.C.	KLH
A.R.	SHURE
DYNACO	KOSS
SONY	FISHER

AND MORE THAN 50 OTHERS
 BUY THE MODERN WAY
 BY MAIL—FROM



Department 217S
 1019 North Dearborn Street
 Chicago, Illinois 60610
 312-664-0020

CIRCLE NO. 6 ON READER SERVICE CARD



LOW PRICES
 On Famous Brand
 Nationally Advertised
STEREO COMPONENTS



146 OLD BROOKFIELD RD. (NORTH)
 DANBURY, CT. 06810
 DANBURY, CT. (203) 744-6421
 N. Y. CITY (212) 369-6212

CIRCLE NO. 3 ON READER SERVICE CARD



8-TRACK TAPE MACHINES

AKAI

CR-81D 8-Track Recorder Deck

Stereo design. Response 50-16,000 Hz ± 3 dB; wow & flutter 0.25% rms; (S + N)/N 47 dB. Has



line output 1.23 V. Inputs: mike 0.5 mV & line 50 mV. Has automatic stop and continuous playback, two VU meters, and input for optional remote control. Universal power supply. 13 $\frac{7}{8}$ " x 5 $\frac{1}{2}$ " x 10 $\frac{7}{8}$ " D. \$199.95

GXR-82D 8-Track Record/Play Deck

Stereo design. Response 40-17,000 Hz ± 3 dB; (S + N)/N 47 dB; record/play & erase heads;



wow & flutter 0.25% rms. Features pause switch; automatic stop and continuous playback; fast-forward; automatic and manual program selection; VU meters; headphone monitoring jack; DIN jack; line input and output jacks. 100-240 V, 50-60 Hz operation. 13.6" x 5.3" x 10.5" \$279.95

BSR McDONALD

TD-8S 8-Track Playback Deck

Deck includes a 2-stage stereo preamp, 0.75 V



output. Comes with cabinet and connecting cables. 7 $\frac{3}{8}$ " W x 10 $\frac{1}{2}$ " x 3 $\frac{3}{4}$ " \$49.95
TD-8SW. Same as TD-8S except has variable level-output control and wood-grain cabinet \$59.95

CHANNEL MASTER

6644 8-Track Play/Record Deck

Has push-button selector switches for fast-for-

ward, automatic stop, pause, repeat, and re-



start, plus power "on-off." Includes right & left illuminated recording meters and right & left recording level controls; recording indicator light; automatic stop indicator light; automatic track changing; manual track selection; blackout track indicator lights. Has inputs for right & left microphones; output for stereo headphones. Comes with four patch cords. 4 $\frac{1}{4}$ " H x 15 $\frac{1}{4}$ " W x 10" D \$139.95
 Model 6497 stereo mike optional extra.

6613 8-Track Play Deck

Designed to be used with any stereo system; variable output adjustable to amplifier input sensitivity. Features automatic track changing; manual track selection; blackout indicator lights. Has output jack with connecting cable. 4" H x 9" W x 9 $\frac{1}{2}$ " D \$54.95

6681 8-Track/Phono/Receiver

Home music system with built-in 8-track record/play unit, record changer, AM-FM stereo



receiver, plus two speakers. 20 W music power/ch; 5 W rms/ch. Features illuminated recording meters; slide controls for volume, play, balance, treble, bass, and both recording levels; push-button controls for auto stop, repeat, pause, restart, fast-forward, and ALC. Three-speed Garrard changer features viscous cueing and pause and adjustable anti-skate. Two-way dual-cone air suspension speakers with diffuser horn. 9 $\frac{1}{2}$ " H (with cover) x 22" W x 15 $\frac{1}{2}$ " D; speakers 22" H x 13" W x 10" D. \$349.95

See Section 4

for 4-Channel

CONCORD

F-128 8-Track Stereo Deck

Records and plays. Has two VU meters, a three-digit tape counter, slide record-level con-

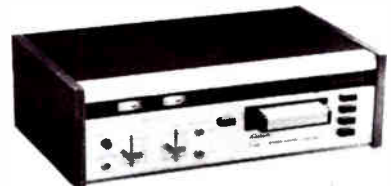

trols, fast-forward control, and headphone jack. Response 50-10,000 Hz, wow & flutter 0.3% rms, (S + N)/N 45 dB \$179.95

CD-8 8-Track Player Deck

Conventional design. Will play stereo cartridges. Has automatic & manual program selector and cartridge ejection. Wow & flutter 0.2%. Frequency range 100-8000 Hz. (S + N)/N 43 dB. Adjustable output 120 mV to 550 mV. 4 $\frac{1}{4}$ " x 9 $\frac{1}{2}$ " x 9 $\frac{3}{8}$ " D \$54.95

DOKORDER

MC-60 8-Track Recorder Deck

Stereo design. Response 30-12,000 Hz; (S + N)/N 47 dB; wow & flutter 0.3% rms. Line

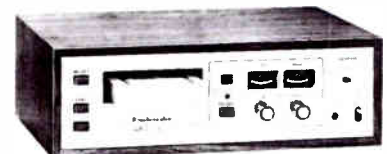

input 60 mV; output 0.775 V. Circuit uses 12 transistors, two IC's, and 16 diodes. Universal power supply. 18 $\frac{1}{2}$ " x 14 $\frac{1}{2}$ " D x 8 $\frac{7}{8}$ ". \$149.95

GLENBURN

SP-10-8-Track Playback Deck

Has solid-state, 3-stage stereo preamp (750 mV



output); integrated program-change mechanism with vertical head movement; high-speed,

jam-proof tripping mechanism; illuminated program indicator; automatic and manual track switching; high-torque, heavy-duty a.c. synchronous motor; cartridge slot with dust cover. Comes complete with walnut cabinet, a.c. and audio connecting cables. 8 $\frac{1}{4}$ " x 10" x 4". \$49.95

GRUNDIG

S850 AM-FM/8-Track System

Combines an AM-FM stereo receiver and an 8-track record/play tape system. Wow & flutter 0.2% rms (playback). (S+N)/N 45 dB (playback). Response 100-8000 Hz. Has two record-level meters. 20 $\frac{1}{2}$ " x 5 $\frac{1}{8}$ " x 20 $\frac{1}{2}$ " D... \$259.95
S860 Same except with a BSR 4-speed automatic turntable \$299.95

RTV 2508 AM-FM/8-Track System

Combines an AM-FM stereo receiver, an 8-track tape player, and a pair of separately housed speaker systems (10" x 16" x 6 $\frac{1}{2}$ ") each with 6 $\frac{1}{2}$ " woofer & 2 $\frac{1}{2}$ " tweeter. 7 W/ch dynamic power at 5% HD \$169.95
RTV 2508-P. Same except with a BSR 4-speed automatic turntable & dust cover \$199.95

CR 815 8-Track Tape Deck

Response 50-10,000 Hz; 2% HD; (S+N)/N 38 dB. Has line and mike inputs; line and headphone outputs. Includes record-level meter. 15 $\frac{1}{8}$ " x 4 $\frac{7}{8}$ " x 10 $\frac{3}{8}$ " D \$199.95

HEATH

GD-28 8-Track Stereo Deck

Home playback deck for use in component system. Response 50-10,000 Hz. Simulated



walnut-finished cabinet measures 10 $\frac{3}{8}$ " x 4 $\frac{1}{2}$ " x 8 $\frac{1}{4}$ " \$59.95

HITACHI

SP-2900 8-Track Recorder/Receiver

AM-FM stereo receiver with a cartridge tape recorder and a pair of separately housed two-way speaker systems. 5 W/ch dynamic power at 5% THD. Features automatic stop/pause, fast-forward, tuning meter, and two VU meters. \$339.95

SDP-2820 8-Track/Phono System

Combines a cartridge tape player, a BSR automatic record changer, and a pair of separately housed speaker systems. Features 5 W/ch dynamic power at 5% THD. Supplied with dust cover \$279.95

TPQ-124 8-Track Player Deck

Home player deck for use in audio systems. Has select/eject controls, program indicator lights, and dust cover on loading slot. 11 $\frac{1}{4}$ " x



10" x 4" \$89.95

TRQ-134 8-Track Recorder Deck

Stereo design featuring dual VU meters, slide-

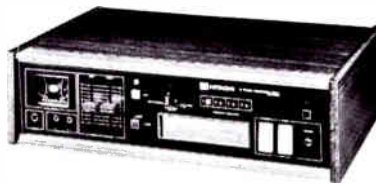

type controls, fast-forward, and automatic stop. Comes with walnut cabinet \$169.95

JVC

ED-1102 8-Track Tape Deck

Playback stereo design. Response 30-15,000 Hz; (S+N)/N -45 dB; wow & flutter 0.2% rms. Output 0.8 V. 3 $\frac{3}{8}$ " x 6 $\frac{3}{8}$ " W x 9 $\frac{3}{8}$ " D .. \$49.95

ED-1261 8-Track Tape Deck

Record/play stereo design. Response 30-14,000 Hz \pm 3 dB; (S+N)/N -50 dB; wow & flutter 0.2% rms. Record & erase bias 57 kHz. Has mike (0.8 mV) & line (80 mV) inputs. Line output 0 to 1 V. Has two VU meters, synchronous motor, pause button, and automatic start. 4 $\frac{5}{8}$ " x 16 $\frac{3}{8}$ " W x 10 $\frac{3}{8}$ " D \$169.95

ED-1240 8-Track Tape Deck

Record/play stereo design. Response 30-15,000 Hz (40-12,000 Hz \pm 3 dB); (S+N)/N 50 dB from



peak level; wow & flutter 0.2% rms; crosstalk 50 dB & 40 dB channel separation, both at 1 kHz. Features automatic eject control, two VU meters, four front-mounted tape controls. 120-V, 60-Hz operation. 4 $\frac{1}{4}$ " H x 13 $\frac{1}{2}$ " W x 9 $\frac{1}{8}$ " D \$129.95

LAFAYETTE

RK-800B 8-Track Playback Deck

Stereo playback deck designed to be used with audio system. Response 30-12,000 Hz. Has repeat channel selector button; built-in solid-state stereo playback preamp; push-button track selector; illuminated track indicator lights; spill-proof capstan mechanism. 9" W x 4 $\frac{1}{8}$ " H x 9 $\frac{1}{4}$ " D \$59.95

RK-82 8-Track Playback Deck

Stereo playback deck designed to be used with audio systems. Response 50-8000 Hz. Has push-button track selector; illuminated track indicator lights; dust-proof cartridge slot door. 8 $\frac{7}{8}$ " W x 4 $\frac{3}{4}$ " H x 8 $\frac{1}{2}$ " D \$49.95

RK-885 8-Track Record/Playback Deck

Record/play deck designed to be used with any stereo receiver or amplifier with tape in/out jacks. Has mike input jacks for "live" stereo recording with optional microphones; dual VU meters; recording volume controls; mode switch; record indicator light; illuminated channel indicator lights. Comes with connecting cables. 13" W x 5 $\frac{3}{8}$ " H x 8 $\frac{3}{8}$ " D \$99.95
 Microphone for RK-885 \$8.60

RK-890A 8-Track Deck

Stereo record/play design. Has stereo/mono mode switch, meter overload protection, separate mike & aux. inputs and line-level outputs. Features sound-with-sound, dual VU meters,

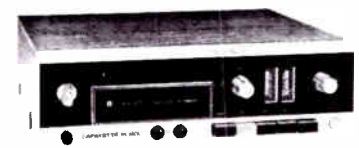

Sensitivity: mike 1 mV, aux. 100 mV. Response 30-12,000 Hz, wow & flutter 0.25%, output level 1 V max. With walnut metal case. 12" x 3 $\frac{3}{4}$ " x 9 $\frac{1}{8}$ " D \$159.95

SR-80 8-Track/AM-FM Receiver

Combines an AM-FM stereo receiver, an 8-track cartridge recorder/player, with two acoustically matched wide-range speaker systems, each with 6 $\frac{1}{2}$ " speaker with multicellular diffuser. Has inputs for attaching a record changer or another tape recorder; microphones. Has full complement of controls and separate record-level meters for left and right channels. Speakers 14 $\frac{3}{8}$ " x 9 $\frac{7}{8}$ " x 5 $\frac{1}{2}$ " D. Control center 18" W x 10" D x 4 $\frac{1}{2}$ " H \$179.95
 Recording microphone for SR-80 \$19.50
SR-50. Same as SR-80 except comes with stereo cassette recorder/player instead of 8-track recorder/player \$179.95
 Recording microphone for SR-80 \$19.50

LSC-9000 Cartridge/Phono/Tuner

Combines 4-speed Garrard 2025 automatic turntable with ceramic turnover cartridge and diamond stylus with 50 W/ch dynamic power amp, AM/FM stereo tuner, a pair of 3-way air suspension speaker systems, and an 8-track cartridge player. Speaker cabinets measure 14 $\frac{7}{8}$ " x 11 $\frac{1}{4}$ " x 6 $\frac{3}{4}$ " D, each with 8" woofer and two 3 $\frac{1}{2}$ " tweeters. Unit has slide-type controls for balance, volume, bass & treble. Mike input. Control center measures 23 $\frac{1}{2}$ " x 9 $\frac{1}{4}$ " x 15" D. Walnut vinyl cabinet includes a dust cover. \$249.95

SR-30-A Cartridge Player/Receiver

8-track cartridge player combined with an AM/FM stereo receiver and matching speaker systems (each containing multicellular diffuser). Has separate slide controls for bass, treble, and balance, a front-panel headphone jack, FM stereo light, black out and illuminated slide-rule tuning dials, plus a full complement of inputs and outputs. \$119.95

LRK-855 8-Track/AM-FM Receiver

Combines an AM/FM stereo receiver and 8-track record/playback unit with built-in 4-channel circuits. Has adapter circuits for deriving 4-channel sound from 2-channel sources. Basically is a 2-channel stereo recorder and playback unit. 7 $\frac{1}{2}$ W/ch dynamic (IHF) power at 0.2% HD at 1 W output. Response 20-20,000 Hz \pm 1.5 dB. Input sensitivity; mag. phono 4 mV ceramic 130 mV, aux. 275 mV. FM sensitivity 3.5 μ V. 4 $\frac{1}{2}$ " x 19 $\frac{1}{2}$ " x 13 $\frac{1}{4}$ " \$219.95

RADIO SHACK

TR-800 8-Track Recorder Deck

Has dual VU meters with "Glide Path" level controls, pause control, "Auto-Stop" switch,



and mike inputs. Response 50-15,000 Hz; wow & flutter 0.2% rms. Walnut wood cabinet with brushed aluminum front panel. 15 $\frac{1}{16}$ " x 10 $\frac{3}{16}$ " x 4 $\frac{1}{4}$ " \$159.95

3 8-Track Tape Machines

TR-881 8-Track Recorder Deck
Has VU meters for each channel and independent record-level controls. Features pause control and "Auto-Stop" switch that stops tape after four programs during record. Has mike input. Response 50-12,000 Hz; wow & flutter 0.3% rms. Oiled walnut wood case with brushed aluminum panel. Overall size 17 1/4" x 5" x 9 5/8" \$109.95

RCA

MYC555 8-Track Changer Deck
8-track stereo tape changer which plays up to five 8-track stereo cartridges in sequence automatically through any console or compact stereo system equipped with tape jacks. Can provide over six hours of uninterrupted music. Automatic and manual cartridge and track selection. Automatic shut-off after last cartridge. Walnut-grained vinyl cabinet on reinforced wood fiber. 8 7/8" x 12 1/2" W x 10 5/8" D \$109.95

SONY BY SUPERSCOPE

TC-228 8-Track Recorder Deck
Stereo design. Response 30-13,000 Hz; (S + N)/N 45 dB. Bias frequency 95 kHz. Wow & flutter 0.17%. Has two VU meters, one d.c.-type motor. Aux. (70 mV sensitivity) & mike (-70 dB sensitivity) inputs & line output (0.5 V sensitivity). Features automatic total mechanism shut-off. Walnut case. 14 3/8" x 4 3/4" x 8 3/4" D ... \$189.95

TC-208 8-Track Playback Deck
Response 50-10,000 Hz; wow & flutter 0.25% rms weighted. Features program select and re-



peat buttons, fast-forward button, program indicating light, automatic track switching. 120-V, 60-Hz operation. 8 3/4" x 4 1/8" H x 9 1/2" D \$89.95

SUPERSCOPE

TDR-820 8-Track Record/Play Deck
Features two illuminated VU meters, straight-line record-level controls, tape select switch for standard and low-noise cartridge tapes, automatic shut-off at end of cycle, and automatic cartridge eject. Has illuminated channel indicators, program selector switch, locking fast-forward and pause, front-panel microphone input jacks, line input/output jacks, and record interlock. Housed in walnut-grained cabinet with white gold anodized front panel. \$149.95



TDR-830. Same except has built-in internal/external Dolby system \$179.95

TD-28 8-Track Player Deck
Has built-in automatic tape program selector which plays all four programs; illuminated pro-

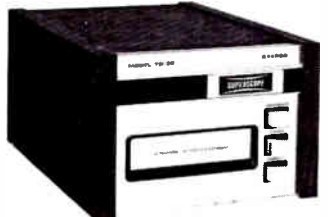

gram indicators. Features a program selector push switch for selecting specific programs and a fast-forward for bypassing unwanted material; repeat switch for continuous replay. Response 50-10,000 Hz; (S + N)/N -48 dB; 117-V, 60 Hz operation. Walnut wood-grained cabinet with white gold-anodized faceplate. 7 1/4" W x 4 7/8" H x 9 3/4" D \$59.95

SYLVANIA

MST3736W Phono/8-Track/Receiver
Combines a Garrard automatic turntable with Pickering magnetic cartridge, viscous-damped cue/pause control, and anti-skating device; an AM-FM stereo receiver; an 8-track stereo tape player; and a pair of sealed air-suspension speaker systems (18" x 11 1/4" x 9" D) each with 8" woofer and a 3" tweeter. Has built-in Phase

Q4 matrix to synthesize regular two-channel stereo program material. 20 W/ch dynamic power at 1% HD (12 1/2 W/ch continuous). Power bandwidth 25-20,000 Hz; response 25-20,000 Hz ± 1 1/2 dB. FM sensitivity 2.5 μV for 30 dB quieting; capture ratio 5.5 dB. Walnut cabinets with dust cover. Control center 9 1/4" x 23 1/2" x 15 1/4" D \$329.95

TELEX

48H 8-Track Changer
Selects at random 16 hours of continuous, non-repetitive sound. Switches and selects 12 stereo 8-track cartridges. 5 W/ch continuous



into 8 ohms. Third harmonic distortion less than 2% at 4 W. Supplied with dust cover. 18 1/4" x 9" H x 16 1/4" D \$299.95
Optional matching speakers Sp 3-H Pair \$69.95
Model 48D. Deck only with 1 V preamp output. Response 40-12,000 Hz, (S + N)/N 42 dB, flutter 0.2% max. \$249.95

WOLLENSAK

8055 8-Track Recorder Deck
Features record/play of 8-track stereo cartridges; automatic "on-off"; automatic eject

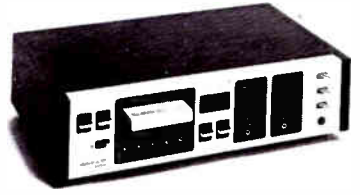

after playing one or all tracks; automatic record level; time counter; pause control; fast-forward; dual VU meters. Frequency response 30-15,000 Hz. Wow & flutter 0.25%. (S + N)/N 50 dB. Line output 1 V at 0 VU. Sensitivity: mike 25 mV; aux. 80 mV. 17 3/8" x 4 7/8" x 10 1/2". Walnut cabinet \$189.95

8075 8-Track Recorder Deck
Features record/play of 8-track Dolbyized cartridges as well as cartridges using the new



3M ferric-oxide tape. Has minutes/seconds timer for precise timing of recordings; fast-forward mode 3 1/2 times actual speed; special cueing system. Response 30-15,000 Hz ± 3 dB with Scotch special high-performance tape (30-12,000 Hz with standard tape). (S + N)/N 60 dB at 4000 Hz and above (Dolby system on). Sensitivity: mike 0.25 mV; aux. 80 mV. 19 3/4" x 5" x 10 1/4" \$299.95

NOTICE TO OUR READERS

We consider it a valuable service to our readers to continue, as we have in previous editions of the TAPE RECORDING & BUYING GUIDE, to print the prices submitted by the manufacturers for items described as available at press time. With few exceptions, prices submitted by manufacturers should be considered "audiophile net."
We are aware that prices vary across

the country in different trading areas. It is obvious that we are not in a position to quote local prices for the various trading areas in the United States on each of the items listed.
We would like to point out that almost all manufacturers' and distributors' prices are subject to change without notice.



4-CHANNEL EQUIPMENT

AKAI

GX-400DSS 4-Channel Tape Deck

Designed for 4-channel record/playback. Will handle up to 10 1/2" reels. Has four GX glass and



crystal heads; closed-loop dual-capstan drive system; ADRS; quadra-sync for synchronizing one track onto another; automatic and manual reverse in playback and record; three motors; separate input controls for front and rear channels for mike/line mixing; separate output controls for front and rear channels; standard or low-noise tape selector switch; four-digit tape counter; tape/source monitor switch; separate illuminated pause control with lock. Has three speeds (15, 7 1/2 & 3 3/4 ips); four illuminated VU meters; front/rear mike inputs on front panel; front/rear headphone inputs on front panel; remote-control input socket on back panel. Oiled walnut cabinet \$1495.00

1730D-SS 4-Channel Tape Deck

Features surround stereo. Four-track, 4 & 2 channel play and record with two erase heads



(2-channel & full track) for compatibility with 2-channel stereo. Features automatic shutoff, pause control, universal voltage selector, and two speeds (7 1/2, 3 3/4 ips). Response 30-22,000 Hz ± 3 dB, wow & flutter 0.12% rms, dist. 1.5%, all at 7 1/2 ips. Has mike (0.4 mV) and line

(40 mV) inputs plus line (1.23 V) output. 16 1/2" x 18" x 9 1/2" \$399.95

GX-280D-SS 4-Channel Tape Deck

Play/record design for 2 and 4 channels. Features 4 heads, 3 motors, automatic reverse, and sound-on-sound facilities \$799.95



CR-80D-SS 4-Ch. 8-Track Deck

Features 2- or 4-channel play/record. Response 30-16,000 Hz ± 3 dB. Wow & flutter 0.25% rms;

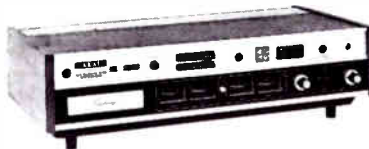

(S + N)/N 47 dB. Has four mike (0.5 mV) & line (50 mV) inputs; four record-level meters; universal power supply \$329.95

BSR McDONALD

TD-8QW 8-Track Stereo/4-Ch Deck

Deck automatically selects stereo or discrete 4-channel tapes. Includes 0.40 V stereo/4-ch



preamp. Comes with wood grain cabinet and connecting cables \$79.95

CONCORD

CD-8-4 4-Channel, 8-Track Tape Deck

Designed as either 2- or 4-channel cartridge

tape player. Wow & flutter 0.15%. Response



100-9000 Hz; (S + N)/N 44 dB; 1.5% THD at 1000 Hz. Output adjust 500 mV. 4" H x 8 3/4" W x 10 1/2" D. Walnut cabinet \$114.95

CROWN INTERNATIONAL

CX844 Tape Recorder

Three-speed (15, 7 1/2, 3 3/4 ips), 4-channel, 4-track, 3-motor design. Will handle up to 10 1/2" reels. Has 3 heads. Response 20-25,000 Hz ± 2 dB. Wow & flutter 0.09% at 7 1/2 ips. Features braking, pause control, four VU meters, remote record, and automatic photocell shutoff \$2995.00

SX744 Tape Recorder

Two-speed (7 1/2 & 3 3/4 ips), 4-track, 4-channel, 3-motor design. Will handle up to 10 1/2" reels. Has 3 heads. Response 20-25,000 Hz ± 2 dB. Wow & flutter 0.09% at 7 1/2 ips. Features braking, pause control, four VU meters, and automatic shut-off \$1995.00

DOKORDER

7140 2/4 Ch Stereo Tape Deck

Provides complete 4-channel record & playback facilities. Has three motors (synchronous capstan and eddy-current induction reel), mechanical speed change; solenoid operation. Tape speeds 7 1/2 & 3 3/4 ips; wow & flutter $\pm 0.08\%$



max. at 7 1/2 ips. Will handle 5" & 7" reels; operates horizontally or vertically. Has three sepa-

4 Tape Machines

rate heads; full tape/source monitoring; NAB equalization. Response 30-22,000 (± 3 dB 40-20,000 Hz) at 7 1/2 ips; (S+N)/N 55 dB at 7 1/2 ips; crosstalk 55 dB at 1000 Hz; stereo channel separation 45 dB at 1000 Hz. Includes Multi-Sync function which permits recording separate tracks individually and re-recording of any individual track in perfect sync with other three tracks. Built-in sound-on-sound, sound-with-sound, and echo circuitry. Includes four VU meters, quick-change heads, turntable height adjustments, automatic end-of-reel shut-off, and easy-threading operation. 16 7/8" W x 17 3/4" H x 6 3/4" D \$569.95

MC-70A 4-Ch/8-Track Player System
Will play either 4- or 2-ch tape cartridges automatically. Program selector indicator light



shows which channel is being played while selector switch makes program change fast. Has push-button repeat switch. Response 50-12,000 Hz. 20 W music power into 8 ohms; rms power 3 W/ch into 8 ohms. (S+N)/N 45 dB; crosstalk 40 dB. Four speaker systems included each with 5" full-range cone speaker; 5 W max. input; 8 ohms imp. Response 50-10,000 Hz. (8 1/8" W x 14 3/16" H x 4 7/8" D—front; 8 1/8" W x 14 3/16" H x 2 1/16" D—rear). Oiled finish on plywood. 14 3/16" x 5 1/4" H x 8 1/2" D \$149.95

FISHER

40 4-Channel System
Combines an AM/FM stereo receiver, a 4-speed automatic turntable with magnetic cartridge, and a 4- and 2-channel 8-track tape cartridge player. Includes matrixing circuit to provide 4-channel reproduction from conventional 2-channel programs. 25 W/ch (100 W total) dy-



namic (EIA) power at 5% HD. FM sensitivity 2.5 μ V. 25" x 8 3/4" x 17 1/2" D \$499.95

HARMAN-KARDON

8+ 4-Channel, 8-Track Deck
Designed for both 2- and 4-channel playback. Features automatic switching for stereo or quadraphonic. Track selector lights, powered ejection of cartridge. Response 30-12,000 Hz. Has heavy-duty a.c. motor. Supplied with cabinet \$89.95

HITACHI

TPQ-144 8-Track 4-Channel Deck
Designed for either 2- or 4-channel playback.

Has four preamplifiers & walnut cabinet. \$129.95

CS-4000 4-Channel 8-Track Player
Automotive design featuring separate volume and tone controls, channel selector, 4-channel



indicator, 4-way balance controls. Has built-in 4-channel synthesizer to convert regular two-channel tapes into 4-channel. 7 W/ch dynamic power at 5% THD. Safety lock and key. 6 5/8" x 2 3/4" x 7 1/8" D \$129.95

CS-1440 8-Track Auto Player
Conventional design but has speaker matrix to synthesize regular 2-channel tapes into 4-channel or will play 2-channel across the front or rear speakers. Has safety lock and key \$74.95

JVC

4RD-1405 4-Channel Tape Deck
Will play/record 2- and 4-channel reel-to-reel tape. Two speeds (3 3/4 & 7 1/2 ips). Response 30-



18,000 Hz ± 3 dB at 7 1/2 ips with low-noise tape. (S+N)/N -52 dB; wow & flutter 0.1% at 7 1/2 ips. 57 kHz bias & erase. Has two heads (record/play & erase), mike (0.5 mV) & line (80 mV) inputs, and line output (0-1.2 V). Features low-noise or standard tape switch. 7 5/8" x 16" x 13 1/2" D \$309.95

4ED-1205 4-Channel 8-Track Deck
Will play back 2- and 4-channel and record 2-channel cartridge tapes. Response 40-12,000



Hz ± 3 dB. (S+N)/N -50 dB from peak level; wow & flutter 0.2% rms. Has line output (0-1 V) and mike (0.8 mV) & aux. (80 mV) inputs. Features fast-forward, four input-level controls, tape counter, automatic repeat and stop. 16 5/8" x 4 5/8" x 11" D \$229.95

LAFAYETTE

RK-84 4-Channel Tape Deck
Plays all 4- and 2-ch tape cartridges. Plugs into

tape or aux. inputs of any 4-ch receiver or amplifier. Features 2- or 4-ch mode selector; 2- or 4-ch indicator lights; push-button track selector; individual channel indicator lights. Has four built-in stereo playback preamps. Max. output 0.5 V. Response 50-8000 Hz. 8 7/8" W x 8 1/2" D x 4 3/4" H \$69.95

RK-48A 4-Channel Tape Deck
Can be used as a 2- or 4-channel stereo, 8-track playback tape deck. Features a "Continu-



ous Repeat" track selector button. Has 1 V output. Hum & noise -49 dB. 4 1/2" x 9 1/2" x 10 1/2" D \$99.95

SQR-40 4-Ch, 8-Track/Receiver System
Receiver features sensitive AM-FM stereo tuner, 4-channel "SQ-M" decoder, "Composer" derived 4-channel from 2-channel sources, discrete 4- & 2-channel 8-track tape player, and four separate amplifiers. Comes with four wide-range walnut speaker systems (8 1/2" W x 14 1/2" H x 5 1/2" D). 21 1/2" W x 11 1/8" D x 4 5/8" H. \$189.95

PANASONIC

RS-862S 8-Track Recorder/Radio
Four-channel, 8-track player which will record in 2-channel. Has AM-FM stereo radio, four built-in amplifiers, two VU meters. With op-



tional mike can be used for sound with sound. Features automatic stop, fast-forward, a stereo broadcast indicator light, continuous tone control, two headphone jacks, and a 4-channel MPX jack. Comes with four matching 2-way walnut speakers with latticework grilles \$399.95

PIONEER

RT-1020L Stereo Tape Deck
Three-motor, 3-head stereo tape deck with 4-channel reproduction capability. Has 4/8 pole two-speed hysteresis synchronous motor (capstan drive) and 6-pole inner-rotor induction motor (reel drive). Operates at 7 1/2 & 3 3/4 ips. Wow & flutter less than 0.08% (W rms) at 7 1/2 ips. (S+N)/N 55 dB; dist. less than 1%. Response 40-20,000 Hz ± 3 dB at 7 1/2 ips. Crosstalk 60 dB, stereo channel separation 50 dB both at 1000 Hz. Inputs: mike 0.25 to 80 mV; line 50 mV to 25 V; DIN 15 mV. Outputs: line 316 mV; DIN 316 mV; headphone 40 mV (4 to 16 ohms). Features 3-position bias selector, 2-position equalizer selector, lockable pause lever, 4-digit tape counter, independent left/right tape monitor switches, 4-ch./2-ch. playback mode selector, independent right/left recording mode selectors, 4-ch front, rear monitor mode

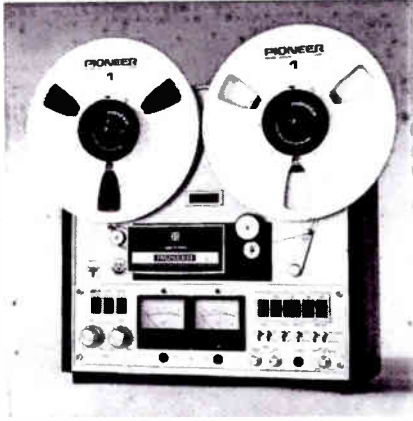

selector, independent mike & line recording level controls, output level controls. Will accept up to 10 1/2" reels. 17 7/8" W x 17" H x 8 7/8" D. \$649.95
RT-1020H. Same as RT-1020L except 15 & 7 1/2" ips; response 30-22,000 Hz ±3 dB at 15 ips; wow & flutter 0.04% W rms at 15 ips. 120-V, 60-Hz operation \$649.95

RADIO SHACK

TR-284B Quadraphonic Player

8-track play only for 2- or 4-channel reproduction. Supplied with four separately housed speaker systems (7 7/8" x 5 1/2" x 9 7/8" each). Walnut cabinets. 15" x 5" x 11 3/4" \$169.95

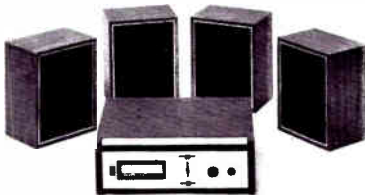

Auto Q8 4-Channel Car Player

Will play 4- or 2-channel 8 track tapes. Mounts under dash. 12-volt d.c. negative-ground operation. Supplied with mounting bracket but less speakers. 7" x 9" x 4" \$99.95

Q-800 4-Channel Tape 8-Track Deck

Will play 2- or 4-channel programs. Has "Auto-Stop." Tape head automatically senses and

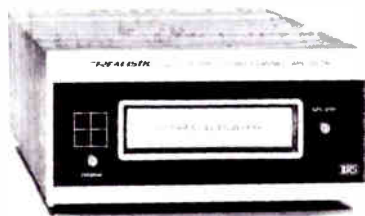

adjusts to either 2- or 4-channel tapes. Walnut-grain wood cabinet with aluminum front panel \$99.95

494 4-Channel Deck

Three-speed (7 1/2, 3 3/4 & 1 7/8 ips), four-track, three-head design. Has four discrete channels, four VU meters, and level controls. Response 50-18,000 Hz; wow & flutter 0.13% rms at 7 1/2 ips. Records discrete 4-channel and standard 2-channel stereo. Walnut wood cabinet with brushed aluminum front panel. 16" x 14 1/8" x 6 5/8" \$299.95

RCA

YZD444 4-Channel 8-Track Player

4-channel, 8-track stereo player with separate

bass, treble, and stereo balance controls; depth control for front-to-back balance. Automatic operation, automatic 2- and 4-channel sensing, and automatic or manual track selection. Jacks for external amplifier and speaker system. Four separate speakers systems (18" H x 11" W x 7" D) each with 8" woofer & tweeter. Housed in walnut veneer hardwood cabinets. Control center 4 3/4" H x 15 3/4" W x 11" D. \$119.95

SANSUI

QD-5500 2/4 Ch Record/Play Deck

Two-speed (7 1/2 & 3 3/4 ips) deck. Will record and play back 4-track stereo or 4-channel. Wow & flutter 0.07%. Response 15-25,000 Hz at 7 1/2 ips. (S + N)/N 60 dB. Has three heads, three motors, three-way mixing. Features four mike &



four line inputs. Standby position for easy editing. Overall size 16 3/8" W x 21 7/8" H x 10 3/8" D \$769.95

SANYO

RD-8200 8-Track 2/4 Ch Player Deck

Will play 2- or 4-channel 8-track cartridges. Features fast-forward, automatic sensing sys-



tem for 2- & 4-channel cartridges. Response 50-12,000 Hz. (S + N)/N 45 dB. Wow & flutter 0.2%. 13" x 12 3/8" x 4 3/4" \$149.95

DXR-5111 4-Channel Music System

Combines an AM-FM 4-channel receiver and four separately housed (9" x 6" x 14") speaker systems, each with 6 1/2" speaker. 7 1/2 W/ch (20 W total) dynamic power at 5% HD. Has SQ decoder and will accept 4-channel discrete tapes. 17" x 4" x 10 1/2" D \$189.95

DXL-5485 4-Ch AM-FM/8-Track System

Combines an AM-FM 4-channel receiver, a 2/4 channel 8-track tape deck, and four separately housed speaker systems (9" x 14" x 7" D) each with 6 1/2" speaker. Response of tape deck 50-12,000 Hz. Wow & flutter 0.25% max. (S + N)/N 50 dB. 10 W/ch (40 W total) dynamic power at 5% HD. Has SQ matrix decoder. 18 1/2" x 5" x 10 1/2" \$269.95

DXL-5486 2/4 Ch Music System

Combines an AM-FM stereo receiver, a 2/4-channel 8-track tape deck, SQ circuitry; four amplifiers; and four separately housed speaker systems (11 7/8" W x 7 3/8" D x 17 3/8" H) each with an 8" full-range air-suspension speaker, a mid-range whizzer, and a directional tweeter. 10 W/ch power output. Four-channel discrete tapes or CD-4 records (with adapter) are played

through the system's four power amplifiers. Features bass & treble slide controls, 4-ch headphone output jacks; phono inputs; output jacks for 2- or 4-ch tape recording . . . \$299.95

GXT-4831 2/4 Ch Music System

Combines an AM-FM stereo receiver; 4-ch matrix decoder circuit; four power amplifiers; 2/4 ch 8-track tape deck; automatic record changer; and four separately housed bookshelf speaker systems (9 7/8" W x 7" D x 15 3/8" H) each with a full-range speaker. Will handle SQ records or 4-ch discrete 8-track tapes. 10 W/ch power output. Has inputs for 4-ch stereo playback from reel-to-reel tape recorders and outputs for tape recording from radio, built-in 8-track deck, or from the phonograph. 19 1/2" x 14 1/2" x 9 1/2" \$299.95

GXT-4621 2/4 Ch Music System

Combines an AM-FM stereo receiver; four amplifiers; matrix decoder circuit; cassette tape



deck; automatic 3-speed record changer; and four separately housed speaker systems (9 7/8" W x 7" D x 15 3/8" H) each with full-range speaker. The cassette deck will record in 2-ch stereo at the same time 2-ch stereo or 4-ch SQ stereo discs are played; recorded cassettes may be played back in 4-ch stereo. 10 W/ch power output. 19 1/2" x 14 1/2" x 9 1/2" \$329.95

DXT-5489 2/4 Ch Music System

Combines AM-FM stereo receiver; four amplifiers; SQ circuitry; 2/4 ch 8-track tape deck; Garrard automatic record changer; four separately housed speaker systems (11 7/8" W x 7 3/8" D x 17 3/8" H) each with an 8" full-range air-suspension speaker, a mid-range whizzer, and a directional tweeter \$349.95

GXT-4651 2/4 Ch Music System

Combines AM-FM stereo receiver, four amplifiers; decoder matrix circuitry; cassette tape deck; Garrard automatic record changer; four separately housed speaker systems (same as in DXT-5489). 12 1/2 W/ch power output. Features two recording level meters; automatic stop; automatic eject on cassette deck. 21 1/2" x 14 1/2" x 9 1/2" \$399.95

DXL-5491 2/4 Ch Music System

Combines AM-FM stereo receiver; four amplifiers; matrix circuitry; 8-track record deck; four



separately housed speaker systems (same as in DXT-5489). 20" x 12 1/2" x 6" \$399.95

GXT-4881 2/4 Ch Music System

Combines AM-FM stereo receiver; Garrard automatic record changer; 8-track tape deck; four amplifiers; decoder matrix circuitry; and four separately housed speaker systems (same as in DXT-5489). 12 1/2 W/ch power output. 21 1/2" x 14 1/2" x 9 1/2" \$449.95

DXT-5341 2/4 Ch Music System

Combines AM-FM stereo receiver; cassette tape deck; 8-track tape player; automatic record

4 Decoders & Miscellaneous



changer; decoder matrix circuitry; four amplifiers; and four separately housed speaker systems (same as in DXT-5489). 12 1/2 W/ch power output. 20" x 14" x 10" \$499.50

RD-8010 8-Track 2/4 Ch Player Deck
Will play both 2- and 4-ch 8-track cartridges. Features include automatic selection of correct playback circuits; channel indicator lights; program selector switch. Response 50-12,000 Hz; (S+N)/N 42 dB; wow & flutter 0.2%. 9" x 8 1/2" x 3 1/4" \$69.95

SONY BY SUPERSCOPE

TC-277-4 Quadradial Tape Deck
Reel-to-reel, 3-speed (7 1/2, 3 3/4, 1 7/8 ips), 4-channel, in-line design. Response 50-16,000 Hz ±3 dB at 7 1/2 ips; S/N 52 dB; wow & flutter 0.12% at 7 1/2 ips. Has two heads (4-channel erase & record/play), four inputs, and four line



outputs (1/ch). Input sensitivity 0.06 V. 15 1/2" x 7 3/4" x 15 1/2" H \$399.95

TC-854-4S 4-Channel Tape Deck
Three-motor, 3-speed (3 3/4, 7 1/2 & 15 ips) design with 10 1/2" reel capacity. Will record/play 2 or 4 channel. Features vari-speed pitch control and Sony's "Synchro-Trak" for precise synchronization of each track. Response 30-18,000 Hz ±2 dB at 7 1/2 ips (S+N)/N 56 dB with standard tape (59 dB with SLH-180 tape). Wow & flutter 0.04% at 7 1/2 ips. Has four VU meters, sound-on-sound capabilities, record equalization switch for standard or low-noise, high-output tape. 17 3/8" x 22" x 10" D.... \$1795.00

TC-84 4-Channel Cartridge Player
Features 2 or 4 channel playback for cars. Response 50-12,000 Hz; wow & flutter 0.25% (S+N)/N 45 dB. Designed for 12 V d.c. negative-ground operation. Has four individual level controls, one motor. 11 1/4" x 3" x 8 1/8" D. Supplied with mounting hardware \$169.95

TC-258 Quadradial 8-Track Deck
Playback of 4/2 channel 8-track cartridges. Features program select button; repeat button for same program; fast-forward; program indicating lamps; 4 ch/2 ch indicating lamp; automatic 2 ch/4 ch switching. Response 40-12,000 Hz; wow & flutter 0.25%. 8 3/4" W x 4 1/8" H x 9 1/8" D.



120-V, 60-Hz operation \$119.95

TC-388-4 Quadradial Tape Deck
Open reel, 2-speed (7 1/2 & 3 3/4 ips) 2- and 4-channel recorder. Response 20-25,000 Hz



(standard tape) and 20-25,000 Hz ±3 dB (SLH-180 tape) at 7 1/2 ips. (S+N)/N -52 dB standard tape; 55 dB SLH-180 tape. Has four auxiliary inputs; impedance 100,000 ohms; four mike inputs; sensitivity -72 dB. Three heads (erase, record, playback); four VU meters. Wow & flutter 0.09% at 7 1/2 ips (rms (NAB) weighted). Features pan pot on-off switch; mike attenuator (-20 dB); built-in reel locks; line output level control. 16 1/8" W x 19 3/4" H x 8 7/8" D.. \$549.95

SUPERSCOPE

QRT-440 4-Ch Receiver/8-Track
Will reproduce SQ records, FM broadcasts or tapes; simulate 4-ch reproduction from stan-

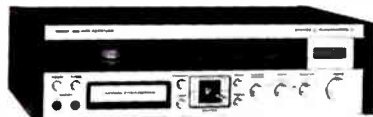

ard stereo sources. Will play Q-8 cartridges through built-in 8-track 2/4-ch tape player. FM usable sensitivity 5 µV (IHF); stereo separation 32 dB at 1 kHz; response 20-12,000 Hz ±1.5 dB; THD 1.5% stereo; capture ratio 5 dB. Has complete set of controls; signal-strength tuning meter; four-channel FM output. 18 1/4" W x 5 1/4" H x 14 1/2" D \$349.95

TD-48 4/2 Ch Cartridge Player
Has automatic 2- and 4-channel switching that sets tape player for correct operation; illuminated 4-channel indicator; built-in automatic program selector; illuminated program indi-



cators; fast-forward, repeat, and program selector push switches; walnut wood-grained cabinet. Response 50-10,000 Hz; (S+N)/N -48 dB; 117-V, 60 Hz operation, 7 1/8" x 4 7/8" H x 9 3/4" D \$89.95

TEAC

3340S 4-Channel Tape Deck
Four-channel, three-motor, three-head stereo tape deck with 15 & 7 1/2 ips speeds. Features "Simul-Sync" which allows recording four discrete but fully synchronized channels on each track of a 4-track tape; permits synchronized overdubbing, professional mix-down and special effect tapes. Up to eight inputs (four mike, four line) can be recorded simultaneously. Push-button transport control with logic circuitry. Has 4/8 pole dual-speed hysteresis synchronous motor and two eddy-current induction reel motors. Hyperbolic-shape Permaflux heads, shielded for max. channel separation and protection from leakage flux fields. Unit includes separate bias level and EQ switches; total remote capability; four expanded-scale VU



meters; 2-ch/4-ch play switch; front & rear stereo headphone jacks; pause control with indicator light; Quik-Lok reel holders. Response 25-24,000 Hz at 15 ips; 25-22,000 Hz at 7 1/2 ips; wow & flutter 0.04% at 15 ips, 0.06% at 7 1/2 ips. (S+N)/N 55 dB. 17 3/8" W x 20 1/2" H x 8 3/4" D \$1099.50

2340R 4-Channel Tape Deck
Four-channel, three-motor, three-head deck which includes 2-ch play with automatic reverse. Has front-panel bias switch; 8 source mixing ability (4 line, 4 mike); four separate VU meters; tape/source monitor switches; mike inputs; mike/line level controls; output level controls. Records 7 1/2 or 3 3/4 ips; will accept up to 7" reels; wow & flutter 0.08% at 7 1/2 ips; response 30-22,000 Hz at 7 1/2 ips. (S+N)/N 55 dB. 17 3/8" W x 18 3/4" H x 8 3/4" D \$899.50

TECHNICS BY PANASONIC

RS-740US 4-Channel Tape Deck
Two speeds (7 1/2, 3 3/4 ips). Response 30-20,000



Hz ± 3 dB at 7 1/2 ips, wow & flutter less than 0.1%. Has four independent VU meters, special front and rear separation controls, tape-bias adjustment switch, front or rear headphone monitoring and pause control, mike & line inputs, digital counter, and automatic shutoff, 3 heads \$449.95

RS-858 DUS 4-Channel 8-Track Deck
Will record/play all 2- or 4-channel cartridge programs. Has four separate input level con-



trols, four VU meters, mike & line inputs plus pause control and noise-suppressor switch. Response 30-15,000 Hz; wow & flutter 0.2%. 8 1/4" x 21 1/8" x 11 1/4" \$299.95

TELEX

2 + 2 Tape Deck

Four- or two-channel reel-to-reel design. Can provide discrete 4-channel playback only. Has



3 motors, 3 speeds (7 1/2, 3 3/4, 1 7/8 ips), automatic shutoff/tape-break switch. Response 40-18,000 Hz ± 3 dB, (S + N)/N 48 dB, wow & flutter 0.2% at 7 1/2 ips. 16 1/2" W x 11" x 6 1/4". \$262.45

TOSHIBA

PT-884 2- and 4-Channel Tape Deck

Reel-to-reel type; 4 ch. record/playback. Three speeds (1 7/8, 3 3/4 & 7 1/2 ips), 3 heads. Response 30-20,000 Hz ± 3 dB with low-noise tape. (S + N)/N 50 dB. Wow & flutter 0.09% at 7 1/2 ips. Has regular & low-noise tape switch. 15 3/4" x 17 1/2" H x 8 3/4" D \$499.95

WOLLENSAK

8054 4-Channel Player

Plays 8-track, 2- and 4-channel quadrasonic



cartridges. Has a channel-selector key, automatic programming facilities for 2- or 4-channel, fast-forward. Response 30-15,000 Hz, wow & flutter 0.25%, (S + N)/N 52 dB \$119.95

8060 8-Track, 4-Channel Tape Deck
Record-play deck. Can record and play stereo and matrixed four-channel but play-only dis-



crete four-channel material. Has digital counter for accurately timing recordings, cueing, automatic eject, pause lock, fast-forward, and stereo headphone jack \$239.95



CLARK, DAVID

4 CH-A Headset

Combination design. Can be used as a regular 4-channel headset or with a decoder can be used to synthesize 4-channel response from any 2-channel program source. Has high-level output at 30 Hz and uniform frequency response up to 16,000 Hz \$80.00
With DC-2A decoder \$95.00

FISHER

QP-44 2/4 Channel Stereo Headphones
Response 20-18,000 Hz. Switchable 2-channel/4-channel operation. Sensitivity: 10 mV for average listening. Max. power 0.2 W. 8 ohms. 10-ft coiled cord. 20 ounces \$69.95

HEAR-MUFFS

QM-440 "Quadramuffs"

Features a velour-covered curved polyurethane cushion worn around the back of the head while



reclining. Contains four 3 1/2" dynamic drivers and is supplied with double stereo phone plugs. Response 20-18,000 Hz. Compatible with 4-16 ohm output impedance. THD unmeasurable at 95 dB SPL. 1.5 W/ch max. power handling capacity. 26 ounces \$49.95

JVC

5944 4-Channel Headphones



2- or 4-channel design. Response 20-20,000 Hz. HD 0.5% at 1 mV. Has a built-in phase changeover switch \$49.95

KOSS

4-Channel Quadrafones

All three versions are designed to be used for either 2- or 4-channel operation. Each earpiece has dual 1 1/2" dynamic drivers. These are connected in parallel for regular 2-channel stereo use. 3.2 to 600 ohm operation. Dist. 0.5% at 109 dB SPL. Capacity 5 V continuous with provision for 14 dB transient peaks. Has balance control on each earpiece. 22 ounces. **K/6LCLQ.** Response 20-17,000 Hz. Has foam-



filled vinyl ear cushions for ambient noise isolation averaging 18 dB \$45.00
K0/747Q. Response 20-19,000 Hz. Has fluid-filled ear cushions for 40 dB ambient noise isolation \$60.00
PRO/5Q. Response 20-20,000 Hz. Has fluid-filled ear cushions for 40 dB ambient noise isolation \$75.00

K2 + 2 4-Channel Headphones

Dynamic type. Features four separate drive elements (2 in each phone) for 4-channel reproduction, arranged in conventional 4-channel format. Has switch for conventional stereo operation. Frequency response 10-20,000 Hz. Sensitivity -87 dB ± 3 dB SPL from each cup with 1 V continuous signal at 1000 Hz. Imped-



ance 300 ohms each driver. For use with 3.2 to 600 ohm source impedances. Power input 5 V continuous maximum per phone. 10-ft. coiled cord. 26 ounces. Fluid-filled ear cushions. Comes with carrying case \$85.00

LAFAYETTE

F-4400 4-Channel Headphones

Four separate 2 1/4" speakers, each in its own acoustically isolated chamber, deliver 4-channel sound from 4-channel amplifiers and receivers. Exclusive, patented baffle plate increases front-to-rear separation. Has 4-channel/2-channel switch. Built-in circuitry derives 4 channels from 2-channel sources. Frequency response 20-20,000 Hz. Impedance 4-16 ohms. Foam-filled vinyl leatherette earpieces and adjustable headband. With 9 1/2-ft cable, connectors. \$44.95

4 Headphones

MURA

QP-280 "Quadset" Headset

Has 4-channel/stereo switch; 10-ft coiled cord with dual plugs marked for easy identification. Response 20-20,000 Hz. Power rating 0.2 W; impedance 8-16 ohms. Custom leather-type padding on earcups and headband . . . \$24.95

QP-300 Deluxe "Quadset"

Features two woofers and two tweeters in each earcup for a total of eight dynamic speakers. Electronic crossover network. Impedance 8-16 ohms. Frequency response 20-20,000 Hz \pm 5 dB. Maximum allowable input 500 mW. Comes with 6-ft cable, plugs marked for easy identification, and zipper carrying case \$69.95

RADIO SHACK

Nova-44 4-Channel Headphones

Quadraphonic/stereophonic dynamic design. Each earcup has separate speakers for two



channels. Dual plugs provided for stereo or 4-channel use. Ported earcups. Frequency range 20-20,000 Hz; 8 ohms. 15-ft coiled cord \$39.95

SCINTREX

HQ4 4-Channel Headphones



Has four separate drivers which will deliver sound from any discrete or matrixed four-channel source. Has quad/stereo switch for maximum utilization of the four drivers in the 2-ch stereo mode. Response 20-20,000 Hz. Impedance 4-300 ohms. Sensitivity 100 dB SPL 1.1 mW. Max. input 14 mW; max. output 110 dB. HD at 1 kHz 0.7%. Ambient noise isolation 40 dB. Has liquid-filled ear cushions 14-ft coiled cord with dual jacks. Black with chrome-plated headband. 24 ounces \$59.95

STANTON

Dynaphase Sixty-Five Four C

Has two speakers in each earpiece for 20-20,000 Hz response. Equipped with two plugs



(blue for front, black for rear); earpieces marked "L" and "R" for accurate listening orientation. Sensitivity: 100 dB SPL (at 0.1 V input at 1 kHz each channel). Maximum power input 1.25 V rms continuous with provision for 10 dB SPL transient peaks. Dist. 1/2% at 110 dB SPL. Input imp. (at 1 kHz) 15 ohms \pm 20%. Vinyl-covered foam ear cushions; adjustable headband. 11-ft coiled cord with four-channel/stereo switch, front & rear plugs. 19 ounces. \$64.95

SUPEREX

QT-4 "Quad-Tette" Headphones

Has four identical reproducers (two to an earcup) with frequency response of 25-17,000 Hz. 15-ft. cord. Ivory/Cordovan \$50.00

QT-4B "Quad-Tette" Headphones

Has four identical reproducers (two to an ear-



piece) with frequency response of 20-18,000 Hz. 15-ft. cord and 2-4 ch. sw \$65.00

TELEDYNE

PH-220 4-Channel Headphones

Features dual stereo plug system consisting of front and rear stereo connectors for 4-channel or one plug may be used for conventional 2-channel stereo listening. Two separate full-range driver elements in each earcup. Padded earcushions and fully adjustable cushioned headband \$48.49

IF YOU NEED. . .
 . . . additional information on any of the products listed, don't hesitate to write the manufacturer. See list of addresses on page 5.

TELEPHONICS

TEL-32Q Four-Channel Headphones

Each channel has individual woofer and tweet-



er. Response 20-20,000 Hz; dist. not measurable at 95 dB-SPL. 20 ounces \$47.75
 Optional 4-ch balance controller \$28.50

TOSHIBA

HR-40 2-Ch/4-Ch Headphones

Features 4-channel/2-channel changeover system with two plugs (front & rear). Dynamic driv-



er 3" x 4". Frequency range 20-20,000 Hz; rated input power 1 mW/ch; imp. 4-16 ohms. Comes with 6.6-ft. cord. Total weight 27 1/2 ounces \$54.95

4 Decoders & Miscellaneous

CONCORD

CSQ-2-4 SQ Decoder

Designed specifically to reproduce SQ matrixed program material. Will also synthesize regular 2-channel stereo records. Gain 1.3 dB. Response 20-20,000 Hz. Input imp. 1 megohm. Dist. 1% THD max. Must be connected at output of a preamp. 3 1/4" H x 9 3/4" W x 7" D. Walnut cabinet \$87.95

DYNACO

Quadaptor

The simplest type decoder for recovering 4-channel information from 2 channels. Does not require two additional power amplifier channels. Provides level adjust for rear speakers. Unit connects between speakers and power-amp outputs. Is a passive device. 4 1/2" x 4 1/2" x 6 3/4" D. Kit \$19.95
 Assembled \$29.95

ELECTRO-VOICE

EVX-44 Universal 4-Channel Decoder

Automatically provides correct decoding of all types of matrixed 4-channel program material.



Provides optional front-to-rear separation enhancement. Connects into hi-fi system between preamp & power amp or through tape jacks. Has inputs for 2- and 4-channel tape sources. (S + N)/N 70 dB below 1/4 V. Gain is unity. Maximum input 4 V rms. Response 20-20,000 Hz ± 1 dB. 2 1/4" x 8" x 7" D. \$99.95

FISHER

TX-420 4-Channel Converter

Designed to be used with present stereo systems to provide 4-channel reproduction. Has 4-



channel preamps and 2-channel stereo power amp. Includes a 4- or 2-channel 8-track cartridge player and decoding (matrixing) system for producing 4-channel material from 2-channel conventional or encoded sources. 18 W/ch (2 channels) dynamic power into 8 ohms (15 W/ch continuous) at 0.5% HD. Power bandwidth 30-20,000 Hz. Sensitivity: tuner & aux. inputs 200 mV. 16 3/16" x 4 3/4" x 11 3/4" D. \$299.95

HITACHI

IMA-40 Integrated Rear Amplifier

Converts 2-channel stereo system into 4-channel (discrete, SQ, RM). 13 W/ch rms; 5.5 W/ch

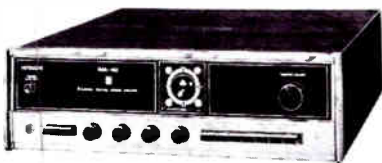

rms at 25-35,000 Hz and 1% THD, 8 ohms). Features joystick 4-channel balance control, speaker switch, and tape monitors for 2- and 4 channels. \$219.95

LAFAYETTE

QD-4 4-Channel Adapter

Synthesizes 4-channel sound from regular 2-channel stereo records, tapes. Does not require an additional stereo amplifier. Has 4-position function switch, rear level control, phono jacks. 5 3/4" W x 4 1/8" D x 2 7/8" H. \$24.95

4-Channel Adapter for Cars

Derives 4-channel sound from present 2-channel car stereo tape system or FM radio. Front panel contains rear-level speaker control, 2- or 4-channel mode switch, and front (L & R) speaker-level controls. If present system has four speakers, only adapter is required; if two speakers, two more speakers must be added. For 12-V negative ground systems. Includes two 3-ft., two 6-ft., and two 15-ft. connecting cables. 5 1/2" W x 1 3/4" H x 2 1/2" D. #99-85128. \$7.95
99-62994. Pair of 3" x 5" matching rear deck speaker systems. \$7.95

SQW Decoder

Features full SQ logic (front/back logic and wavematching logic). Will also handle RM and other matrixes; derives 4-ch sound from 2-ch program sources. Has 2- and 4-ch inputs. Outputs: two sets of 4 outputs for decoded or discrete; 2-ch tape outputs. Controls: power "on-off", master volume, function switch tape/source, power indicator, tape/source indicator, and tape and source sensitivity slide switches. \$99.95

SYLVANIA

DMQ2784W 4-Ch. 8-Track Converter

Will play 2- or 4-channel 8-track tapes. Has two power amplifiers and is designed to be used with your present 2-channel stereo system for



4-channel output. 12 1/2 W/ch continuous power into 8 ohms and at 1% THD. Frequency range 25-35,000 Hz; power bandwidth 30-35,000 Hz. Wow & flutter (cartridge tape player) 0.3%. Has tape monitor switch, inputs for matrixed four-channel program sources, and tape outputs. \$229.95

TEAC

AN-300 4-Ch. Dolby Noise Attenuator

Has four separate Dolby-B type noise-reducing systems within a single housing. Features four VU meters. With channels operated in pairs the unit affords simultaneous decoded stereo monitoring or full 4-channel Dolby encoding. Has a standard 400-Hz recording calibration tone on all four channels and a 420-Hz pulse circuit for easy identification of the calibration tone. Increased (S + N)/N of 10 dB at 10,000 Hz (5 dB at 1000 Hz). Sensitivity: tape and line 0.1 V. Outputs: record and monitor 0.3 V. Has multiplex filter. Response 20-20,000 Hz ± 1.5 dB. 6 3/4" H x 16 1/8" W x 10 1/8" D. \$429.50

AX-300 4-Channel Mike/Line Mixer

Has a preamplifier and features inputs for six



low-impedance microphones (four circuits mike/line switchable and two circuits mike only). Has a six in and four out format. (S + N)/N is -62 dB (-72 dB line); mike (600 ohms balanced) input 0.1 V max.; line input 0.3 V (7 V max.). 6 1/8" x 16 1/8" W x 10 3/8" D. \$399.50

A COMPLETE SET OF MATCHED STORAGE CASES

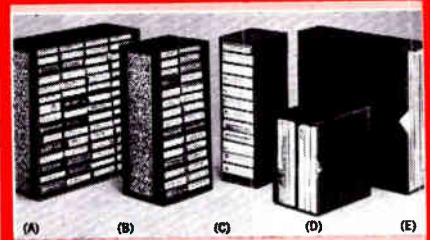

- (A) 60-unit cassette case. 13 1/2" high x 12 3/4" deep x 5 1/2" wide.
- (B) 30-unit cassette case. 13 1/2" high x 6 1/2" deep x 5 1/2" wide.
- (C) 12-unit cartridge case. 13 1/4" high x 6 1/2" deep x 4 1/4" wide.
- Units A, B and C have tilted compartments to prevent spillage and include pressure sensitive labels for titling.
- (D) 6-unit 7" reel case. 8" high x 7 1/2" deep x 5" wide. Holds reels in original boxes.
- (E) 20-unit 12" record case. 13 1/4" high x 12 1/2" deep x 3 3/4" wide. Holds records in original jackets.

Here's the ideal solution to the problem of keeping your records and tapes stored conveniently and attractively. Now you can keep them side-by-side on your bookshelf or cabinet, easy to identify and readily available.

Sturdily constructed and covered in a handsome leatherette, the outer case is elegantly embossed in gold and comes in your choice of three popular decorator colors—black, brown and green—lending themselves readily to the decor of any room.



CHARGE YOUR STORAGE CASE ORDERS TO YOUR AMERICAN EXPRESS OR BANKAMERICARD ACCOUNT



ZIFF-DAVIS PUBLISHING COMPANY, Dept. 23
One Park Avenue, New York, N.Y. 10016 TRBG 74

My remittance in the amount of \$_____ is enclosed for the cases indicated.

Charge: American Express BankAmericard

Account # _____

Signature _____

_____ 60-unit Cassette Cases @ \$15.95 each;

3 for \$45.00

_____ 30-unit Cassette Cases @ \$11.95 each;

3 for \$33.00

_____ 12-unit 8-Track Cartridge Cases @

\$7.95 each; 3 for \$22.00

_____ 6-unit 7" Reel Cases @ \$5.25 each;

3 for \$15.00

_____ 20-unit 12" Record Cases @ \$5.95

each; 3 for \$17.00

Add 50c per unit ordered for postage and handling. Outside U.S.A. add \$1.00 per unit ordered. Payment must be enclosed with order if not charged.

Check color choice for back of case (sides in black only): Brown Green Black

Print Name _____

Address _____

City _____

State _____ Zip _____



HEADPHONES & MICROPHONES

AKAI

ASE-22 Dynamic Headphones

Moving-coil type. Response 20-20,000 Hz. Sensitivity 1.0 mW, distortion 1% at 1.0 mW. 8



ohms impedance. 1/2 W maximum input per phone. Has individual earphone volume controls. 6-ft. coiled cord. Weight 20 ounces. \$39.95

AKG

K-180 Dynamic Headphones

Has adjustable drivers for subjectively controllable sound. Response characteristics vary due



to change in volume. Response 16-20,000 Hz. Efficiency: 1 mW for 112 dB SPL. Distortion less than 1% at 125 dB SPL. Impedance: 600 ohms each driver for multi-impedance matching 4 to 1000 ohms. 21 ounces. \$69.00

AUDIOTEX

Marquis Stereo Headphones

Open-air, lightweight design. Response 20-20,000 Hz; 8 ohms impd. matches all amplifier 4-16 ohm outputs. 6-ft cord and plug. Cushioned earpieces and adjustable padded headband. 30-5205 \$39.95

Mark IV Stereo Headphones

Wide-range dynamic type. Frequency range to above audibility at 1% distortion between 10-18,000 Hz. Removable, soft cushions; padded headband. 10-ft coiled cord with stereo plug.

Imp. 8 ohms. Matches all 4-16 ohm outputs. 30-5206 \$59.95

Mark III Stereo Headphones

Slide-type volume control on each earpiece; response 20-18,000 Hz. 12-ft coiled cord with

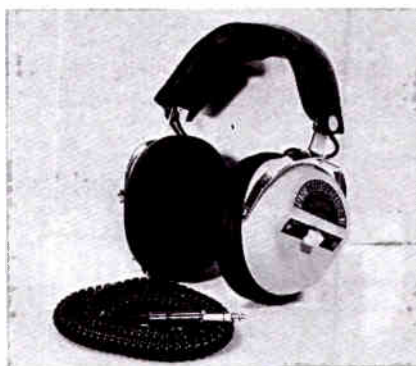

stereo plug. 8 ohms. Matches all 4-16 ohm outputs. 30-5204 \$34.95

Mark II Stereo Headphones

Response 20-20,000 Hz; 8 ohms. Comes with 6-ft flexible cord and stereo plug. 30-5202 \$19.95

Mark I Stereo Headphones

Response 30-15,000 Hz; 8 ohms. Comes with 10-ft coiled cord and stereo plug. 30-5200 \$15.95

Headphone Remote Control

Plugs directly into amplifier to control volume and balance of headphones; noise-free slide

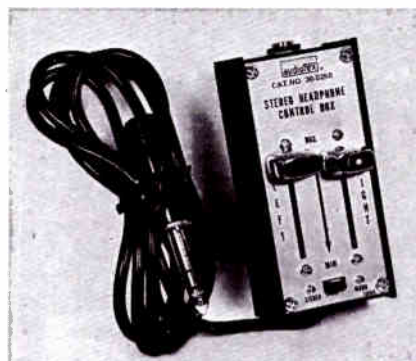

controls for each earpiece permit adjustment of volume and balance. Special switch allows for mono/stereo selection. Has 5-ft cord and 3-conductor stereo phone plug. 30-5250 \$12.95

BEYER/DYNAMIC

DT-48 Dynamic Headphones

Moving-coil type. Originally designed as an audiometry instrument for measuring human hearing in lab research. Range 16-20,000 Hz ±2

dB. Response virtually flat. Comes with 10-ft cord \$120.00

DT48-K. Same as DT-48 except with plug-in coiled cable. \$125.00

DT900 Dynamic Headphones

Moving coil type. Response 30-18,000 Hz. 5-2000 ohms impedance. 200 mW maximum input per phone. 6-ft. cord \$29.95

DT96A Dynamic Headphones

Moving coil type. Response 30-17,000 Hz. Sensitivity 1.0 mW at 400 Hz produces 110 dB (re 2×10^{-4} μ bar). 50-200 ohms impedance. 100 mW maximum input per phone. 5-ft. cord. 8 ounces \$47.50

DT100 Dynamic Headphones

Moving coil type. Response 30-18,000 Hz. Sensitivity 1 mW at 400 Hz produces 110 dB (re 2×10^{-4} μ bar). 5-100-400-2000 ohms impedance. 1 W maximum input per phone \$64.00

DT480 Dynamic Headphones

Moving coil type. Response 20-18,000 Hz. Sensitivity 1 mW at 400 Hz produces 115 dB (re 2×10^{-4} μ bar). 25-200 ohms impedance. 1 W maximum input per phone. \$90.00

BEYER/GOTHAM

DT-48S Stereo Headphones

Dynamic design extending from 20-18,000 Hz ±2 dB. Dist. 0.3% below 100 Hz & 0.1% above.



Peak power demand 200 mW or 1 V max. per phone. Input 10 mV. Impedance: 5 ohms each for stereo (10 ohms total for mono).. \$121.00
 DT-48SN. 50-ohm mono design \$121.00
 DT-48SP. Stereo design with separate plugs on each phone. \$121.00
 TR-48. Plug-in transformer for 600-ohm input \$22.00
 TR-48. Pair for stereo use \$40.48
 UG-8. Speaker/phone switcher box \$11.33

CLARK, DAVID

100A Headphones

Dynamic type with frequency response 20-10,000 Hz ±3 dB. Sensitivity 1.0 mW at 1000 Hz produces 100 dB (reference 0.0002 μ bar).

Distortion less than 0.2% at 100 phn. 17 ohms impedance and 1.0 W maximum input per phone. 8-ft. coiled cord. 16 ounces. Also available in impedances of 300, 600, and 1200 ohms \$50.00

200 Headphones

Permanent-magnet type with frequency response 20-17,000 Hz. Sensitivity 1.0 mW at 1000 Hz produces 105 dB (reference 0.0002 μ bar). 8 ohms impedance. 1.0 W input. 17 ounces \$29.00

250 Headphones

Similar to 200, but with individual earphone volume control \$34.00

300 Headphones

Permanent-magnet type with frequency response 20-17,000 Hz. Sensitivity 1.0 mW at 1000 Hz produces 105 dB (reference 0.0002 μ bar). 8 ohms impedance. 1.0 W maximum input per phone. 10-ft. coiled cord ... \$21.00

FISHER

HP-70 Dynamic Headphones

Response 30-18,000 Hz. Sensitivity 2.5 mW for



average listening. Max. power 0.5 W. 16 ohms. 10-ft. coiled cord. 12 ounces \$29.95

HP-100 Dynamic Headphones

Response 18-22,000 Hz. Sensitivity 2 mW for average listening. Max. power 0.7 W. 50 ohms. 10 ounces .8 ft. coiled cord \$49.95

HEAR-MUFFS

HM-1A Headphones

Stereo headphones; washable cotton velour cover; 10-ft coiled cord; 3 1/2" dynamic drivers; compatible with 4-16 ohm output impedance; response 20-18,000 Hz; THD 1% at 115 dB SPL; 1.5 W/ch max. power handling capability; 20 ounces \$29.95

HM-4000 "Supermuffs"

Stereo headphones; washable high-pile acrylic cover; 10-ft coiled cord; 4" dynamic drivers; compatible with 4-16 ohm output impedance; response 20-20,000 Hz; THD unmeasurable at 95 dB SPL; 1.5 W/ch continuous power handling capability; 21 ounces \$34.95

HITACHI

HD-66 Dynamic Headphones

Response 20-18,000 Hz. Distortion less than 1.0% at 1 mW. 8 ohms impedance. 0.5 W maximum input per phone. 12 ounces \$24.95

KOSS

ESP-9 Electrostatic Headphones

Frequency response 15-15,000 Hz \pm 2 dB. Sensitivity 80 dB SPL (reference 0.0002 dyne/cm²). Distortion less than 0.2% at 110 dB SPL. 4 to 16 ohms impedance. 6-ft. coiled



cord. 19 ounces. Black, fluid-filled earcups for ambient noise isolation. Designed for critical studio monitoring \$175.00

ESP-6 Electrostatic Headphones

Frequency response 30-19,000 Hz \pm 5 dB. Sensitivity 80 dB SPL (reference 0.0002 dyne/cm²). Distortion less than 0.2% at 110 dB SPL. 4 to 16 ohms impedance. 10-ft. coiled cord. 27 ounces. Black, fluid-filled earcups for ambient noise isolation. Self-contained polarizer \$95.00

PRO-4AA Dynamic Headphones

Frequency response 10-20,000 Hz. Distortion is negligible at 95 dB SPL. 3.2 to 600 ohms impedance. 10-ft. coiled cord. 19 ounces. Fluid-filled earcups for ambient noise isolation \$60.00

PRO-600AA Dynamic Headphones

Same as PRO-4AA except nominally 600 ohms voice-coil impedance for matching audio transmission lines. 600 ohms characteristic impedance. Available on special order \$65.00

KO-727B Dynamic Headphones

Frequency response 10-16,000 Hz. Distortion unmeasurable at 95 dB SPL. 3.2 to 600 ohms impedance. 10-ft. coiled cord. 19 ounces. Dark green finish \$34.95

KO-747 Stereo/Mono Headphones

Compatible with both stereo and mono music sources. Features a volume control on each



earcup for fine adjustments in level and balance. Incorporates the firm's new driver element. Has extendible, stainless-steel headband with self-adjusting, pivoting yoke to permit the phones to fit any head size. Frequency response 30-20,000 Hz. Two-tone brown. Fluid-filled washable ear cushions \$45.00

KRD-711 "Red Devil" Headphones

Dynamic type. Frequency response 10-17,000 Hz. THD less than 1/2% at 110 dB SPL. 3.2 to 600 ohms impedance. 5 V maximum input per phone. 10-ft. coiled cord. 12 ounces. Red solid plastic \$24.95
K-711. Same as above, but in jet black. \$24.95

K-6LC Dynamic Headphones

Frequency response 10-16,000 Hz. Distortion unmeasurable at 95 dB SPL. 3.2 to 600 ohms impedance. 10-ft. coiled cord. Individual earphone volume controls. Brown/beige .. \$29.95
Model K-6. Same except without volume controls \$19.95

SP-3XC Headphones

Frequency response 10-14,000 Hz. 3.2 to 600 ohms impedance. 10-ft. coiled cord. Brown \$15.95

HV-1 Dynamic Headphones

Has 2" dia. driver & will operate from 3.2 to 600 ohm outputs. Response 20-20,000 Hz; capacity 5 V continuous with provision for 14 dB-SPL transient peaks. 9.3 ounces. 10-ft coiled cord \$39.95

HV/1LC Dynamic Headphones

Has 2" velocity operated driver; designed to operate from 3.2 to 600 ohm outputs. Response



20-20,000 Hz; capacity 5 V rms continuous with provision for 14 dB-SPL transient peaks miniature rotary-type volume/balance control per earcup; 9.9 ounces, less cord; 3-conductor, 10-ft coiled cord; acoustical sponge earcushions, self-adjusting headband with pivoting yokes and padded vinyl cover \$50.00

T-4A Connector Box

Accepts up to five sets of stereophones. 14-ft. cord with 3-conductor phone plug fits standard headphone jack. Private listening for five persons at one time. Unit measures 6" diameter and has walnut-like base combined with black trim and aluminum plug-in panel. \$12.95

T-10A Chairside Listening Station

Offers remote control for two sets of stereophones. Features separate volume controls for each stereophone and a speaker "on-off" switch. Wires directly to amplifier or receiver. Unit measures 6" diameter and has a walnut-like base \$19.95

T-5A Remote Control Station

Similar to T-10A. Has jacks for two sets of stereophones. Left- and right-channel volume controls and speaker "on-off" switch. Has walnut-like base combined with black trim. \$9.95

T-3 Speaker/Headphone Transfer Switch

Provides a speaker "on-off" switch and stereo-telephone jack. Connects to speaker terminals of amplifier or receiver. Adds low-impedance jack to system for wide-range performance of stereophones \$7.95

T-1 Monitoring Adapter

For use with dynamic phones in monitoring tapes from high-impedance sources such as tape recorders with preamps only. Adapter contains matching transformers to match 600 to 10,000 ohm outputs down to 4 ohms. Equipped with two output jacks for stereophones and two pin-type jacks for inputs \$7.95

LAFAYETTE

F-2001 Electrostatic Headphones

Stereo design. Frequency response 5-35,000 Hz. Maximum power handling capacity 10 W. Delivers 3 octaves of sound beyond conventional phones. Comes with self energizer with

speaker/phone switch and inputs for attaching two phones. Has adjustable cushioned vinyl headband and 5" x 4 1/2" earphone cushions. Impedance 4-16 ohms. Weight 16 ounces. Includes color-coded speaker cables ... \$49.95

F-1000 Two-Way Stereo Headphones

Individual left- and right-channel volume controls. Response 20-20,000 Hz. Each earcup contains a 2 1/2" two-way woofer/tweeter transducer. Lightweight form-fitting design. Impedance 8 ohms. Comes with 6-ft coiled cord \$39.95

F-600 Open-Acoustic Headphones

Open-acoustic stereo design. Response 20-20,000 Hz. Lightweight open-air foam ear cushions with adjustable headband. Imp. 200 ohms. Comes with 5-ft cord and plug \$29.95

F-990 Stereo Headphones

Response 20-20,000 Hz. Has two 3 1/2" wide-range transducers; air-tight earphone cushion-



ions; fully adjustable cushioned headband. Imp. 8 ohms. Comes with 6 1/2-ft cable and standard stereo phone plug \$34.95

LE-BO

Stereo Headphones

Features chrome slide-type individual volume controls; response 30-19,000 Hz; impedance 8-16 ohms; padded ear cushions; adjustable headband; comes with 10-ft coiled cord & stereo plug. Green. \$28.95

MURA

SP-99 Stereo Headset

Lightweight headset designed to be worn either over the head or under the chin. Impedance 4-16 ohms. Frequency response 30-16,000 Hz. 2 W max. output. Comes with 6-ft cord .. \$11.50

SP-100 Stereo Headset

Lightweight headset. Frequency response 30-15,000 Hz. Comes with 8-ft cord \$11.50

SP-202 Stereo Headset

Features volume controls for each earpiece. Response 30-15,000 Hz. Imp. 8 ohms. Comes with 10-ft coiled cord \$14.95

SP-402 Stereo Headset

Features fully padded headband and oversized ear cushions. Individual volume and tone controls and stereo/mono switch included. Response 30-18,000 Hz. 8 ohms imp. 10-ft coiled cord \$19.95

SP-600 Stereo Headset

Open-air design to accommodate surrounding sounds while listening. Mylar speakers for improved response. Response 20-20,000 Hz. 1 mW power required. 8 ohms impedance. Comes

with 10-ft coiled cord \$29.95

SP-103A Stereo Headset

Features tone and volume controls on each earcup. Response 20-20,000 Hz. Has stereo/mono switch, 8 ohms impedance. 10-ft coiled cord \$37.95

SP-205 Stereo Headset

Features slide-type volume and tone controls; Mylar speakers; stereo/mono switch. Impedance 8 ohms. Response 30-20,000 Hz ± 5 dB. Includes 16-ft coiled cord and zippered storage case \$49.95

SP-206 Stereo Headset

Features Mylar speakers and vented housing with bass-reflex-type enclosure. Has individual volume and tone controls. Response 20-20,000 Hz ± 4 dB. Impedance 8 ohms. Stereo/mono switch. Comes with 25-ft coiled cord and zippered storage case \$59.95

PICKERING

OA-1 Headphones

Lightweight, open-air design. 8 ohms. Max. input 300 mW. Sensitivity: 100 dB at 600 Hz.



Response 30-19,000 Hz. Is equipped with 7-ft cord \$19.95

OA-3 Headphones

Lightweight, open-air design. 15 ohms $\pm 10\%$ at 1000 Hz; max. power input 0.2 Wrms/ch; response 20-20,000 Hz; dist. 1/2% at 100 dB SPL; sensitivity 100 dB SPL at 0.10 V input at 1000 Hz each channel. 1 1/2" Mylar diaphragm dynamic transducer. Extend-adjust. headband with full pivot yoke and padded vinyl cover; soft vinyl foam ear cushions; 10-ft, 3-cond. coiled cord. 7.5 ounces (without cord) \$39.95

4933 Headphones

Dynamic type. 8 ohms impedance; response 60-10,000 Hz ± 3 dB; 50-17,000 Hz ± 6 dB; sensitivity 100 dB SPL; 0.5 W max. input; distortion 1% at 115 dB SPL; 10-ft cord. 21 ounces \$39.95

4955 Headphones

Dynamic type. 8 ohms impedance; response



40-11,000 Hz ± 3 dB; 30-18,000 Hz ± 6 dB; sensitivity 100 dB SPL; max. input 0.5 W rms; distortion 1% at 115 dB SPL; 10-ft coiled cord. 28 ounces \$59.95

PIONEER

SE-205 Stereo Headphones

Dynamic type covering a frequency range of 20-20,000 Hz. Cone-type speaker in each earpiece. Matching imp. 4 to 16 ohms. Max. input power 500 mW each channel. Comes with 8.2-ft cable. 16 ounces \$24.95

SE-305 Stereo Headphones

Dynamic type covering a frequency range of 20-20,000 Hz. 8 ohms imp. each channel; matching imp. 4 to 16 ohms. Max. input power 500 mW each channel. Comes with 16-ft, 5-in coiled cord. 15 ounces \$34.95

SE-405 Stereo Headphones

Dynamic type covering a frequency range of 20-20,000 Hz. 8 ohms imp.; input power 500 mW



each channel. Unit features polyester-film diaphragm; special ear pads with sliding-type adjusting headband and clickstops for easy listening; volume controls for both left and right channels. 16 1/2-ft coiled cord \$44.95

SE-505 Headphones

Two-way stereo dynamic design with a woofer & tweeter in each phone; 8 ohms each channel. Response 20-20,000 Hz. Sensitivity 108 dB/0.3 V; Features both tone & volume controls on each phone. maximum input 500 mW each phone. With 16-ft coiled cord \$59.95

SE-L40 Headphones

Features open-back design. 4 to 16 ohms. Maximum input 0.5 V. Response 20-20,000 Hz; sensitivity 96 dB/0.1 V. Has 1 1/2" dynamic speaker. 9 1/2-ft cable. Comes with carrying case. \$39.95

RADIO SHACK

Nova-15 Headphones

Dynamic type. Ported open-back earcups. Response 20-20,000 Hz. 10-ft cord. 4 to 16 ohms impedance \$21.95

Pro-1 Headphones

Dynamic type. Ported open-back earcups. Response 20-20,000 Hz. 10-ft cord. 4 to 16 ohms ear cushions. Has individual earphone volume controls \$49.95

Custom Pro Headphones

Dynamic type. Response 20-20,000 Hz. Impedance 4 to 16 ohms; bass port \$24.95

Nova Pro Headphones

Stereo dynamic design with volume controls on each earcup. Response 20-20,000 Hz; 8 ohms impedance. 10-ft. coiled cord \$34.95

SANSUI

SS-2 Dynamic Headphones

Moving-coil type. Response 20-18,000 Hz, distortion 1% at 1 mW. 8 ohms impedance. 500



mW max. input per phone. 6-ft. cord. 12.6 ounces. Black and white \$16.95

SS-10 Dynamic Headphones

Moving-coil two-way speakers. Response 20-20,000 Hz. 8 ohms impedance. 500 mW max.



input per phone. 10-ft coiled cord. Has individual headphone volume controls and "Y" connector on additional 6.5-ft. cord for simultaneous use of extra headset. 22 ounces. Cream \$32.95

SCINTREX

Mark IV Stereophones

Features flat response 15-20,000 Hz; response 20-15,000 Hz ± 3 dB. Sensitivity (100 dB SPL)



10 mW. Maximum input 2 W; max. output 120 dB. HD 0.6% at 1000 Hz at max. dB. Ambient noise isolation 40 dB at 1000 Hz. 4-8 ohms impedance. ABS ear cups and fluid-filled ear cushions. Features patented dual-driver cavity assembly. Comes with 14-ft coiled cord with special strain-relief feature. Black with chrome-plated headband. 18 oz \$45.00

98 Stereophones

Features patented dual-cavity design and contoured response for accented bass and treble to match hearing characteristics. 4-300 ohms impedance. Sensitivity 6 mW; max. input 1 W; max. output 110 dB. Response 15-20,000 Hz. HD 1% at 1000 Hz at max. dB. Ambient noise isolation 40 dB at 1000 Hz. ABS ear cups and liquid-filled ear cushions. Chrome-plated headband. Comes with 14-ft coiled cord with strain-relief feature. 16 oz \$34.95

PRO-500 Stereophones

Response 15-20,000 Hz; 20-18,000 Hz ± 3.5 dB. HD 0.9% at 1000 Hz at max. dB. Sensitivity



(100 dB SPL) 4 mW; max. input 1 W; max. output 110 dB. 4-16 ohms impedance. Ambient noise isolation 40 dB at 1000 Hz. Equipped with patented dual-driver cavity assembly. Liquid-filled ear cushions. Individual volume controls in each earcup. 14-ft coiled cord with strain-relief feature. 18 oz \$60.00

10/10 Stereophones

Response 15-20,000 Hz; 30-14,000 Hz ± 3 dB. 4-8 ohms impedance. Sensitivity (100 dB SPL) 10 mW. Maximum input 2 W; max. output 120 dB. HD 0.6% at 1000 Hz at max. dB. Ambient noise isolation 40 dB at 1000 Hz. Has ABS ear cups and liquid-filled ear cushions. Equipped

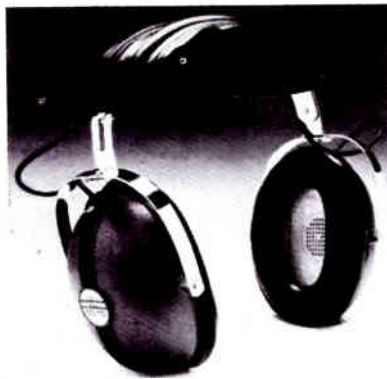

with dual-driver cavity assembly. Blue/chrome. 14-ft coiled cord with strain-relief feature. 18 oz. \$36.95

"Supra" Lightweight Stereophones

Open-air design with "Supraform" acoustics and high velocity drivers. Weighs only 6.5 oz,



including cord. Response 20-20,000 Hz; 20-12,000 Hz ± 6 dB. Impedance 4-200 ohms. HD at max. dB less than 1%. Sensitivity 0.5 mW at 100 dB SPL. Max. input 4 mW; max. output 110 dB. Foam plastic ear cushions, 10-ft coiled cord

with strain-relief feature. Chrome-plated headband \$34.95

88 Stereophones

Lightweight (9 oz) circumaural design which will withstand rugged use. Impedance 4-16 ohms. Sensitivity (100 dB SPL) 8 mW. Maximum input 1 W; max. output 110 dB. Response 15-20,000 Hz. HD 0.9% at 1000 Hz at max. dB. Ambient noise isolation 20 dB at 1000 Hz. Cyclac ear cups with foam ear cushions. Has automatic frequency compensation. Black with Polypropylene headband. 14-ft coiled cord with strain-relief feature \$24.95

SENNHEISER

HD414 Headphone

Patented dynamic "open-aire" design. 2000 ohms/ch. Response 20-20,000 Hz. Sensitivity 17.7 μ bar/V. Normal power 1 mW/ch (1.41V) for sound pressure of 102 dB. HD 1% at 22 V & 1000 Hz. Can be connected to any preamp output. 5 ounces without cord. 10-ft. cable \$42.95

HD424 Headphone

Deluxe dynamic headphone with patented "open-aire" design. 2000 ohms/ch. Response 15-20,000 Hz. Sensitivity 17.7 μ bar/V. Normal power 1 mW/ch (1.41 V) for sound pressure of 102 dB; HD less than 1% at 22 V and 1000 Hz. Can be connected to any preamp output. 6.5 ounces without cord. Removable head and ear cushions. 10-ft cable \$69.95

HD44 Headphone

Lightweight stereo headphone (1.2 ounces without cable). Patented dynamic "open-aire" system with under-the-chin configuration. 600 ohms/ch. Response 52-10,000 Hz. Normal power 1 mW/ch (1.41 V) for average listening level. Comes with 10-ft cable \$24.95

STANTON

Dynaphase Sixty Headphones

Dynamic design; two-way system—woofer & tweeter with individual LC crossover. Response 40-11,000 Hz ± 3 dB. Sensitivity 95 dB for 1 mW at 1000 Hz (100 dB sound pressure level). Distortion 1% at 115 dB SPL. Impedance 8 ohms. Power input 0.5 W rms max. per phone. 10-ft. coiled cord. 28 ounces. Can use same accessories as the Dynaphase Forty. Blue and black \$59.95

Dynaphase Forty Headphones

Dynamic design. Response 60-10,000 Hz ± 3 dB. Distortion 1% at 115 dB SPL. 8 ohms impedance at 1000 Hz; Power input 0.5 W rms max. per phone. 10-ft cord. 21 ounces. Blue-black/chrome \$39.95
Model 5748. Same as Dynaphase Forty except 600 ohms imp \$47.95

Dynaphase Seventy-Five Headphones

Dynamic design with remote control for volume & tone, 13-ft coiled cord. Response 40-11,000 Hz ± 3 dB. Sensitivity 100 dB SPL (at 0.11-V at 1000 Hz). Max. input 0.5 W rms; dist. 1.0% with 115 dB SPL. Input 12 ohms imp. Features two-way design with separate woofer & tweeter with LC crossover network. 28 ounces \$74.95
Model 5741. Same as used on Dynaphase Seventy-Five. Separate volume & tone controls for each channel, stereo/mono switch & 17-ft. extension coiled cord \$19.95
Model 5742. 25-ft. extension coiled cord. \$7.95

Dynaphase Fifty Headphones

Same as Dynaphase Forty except has volume control on each earpiece \$49.95

STAX

SR3 Stereo Headset

Electrostatic design supplied with matching power-supply unit. Frequency range 25-30,000 Hz. Capacitance 120 pF including cord. Maximum sound level 115 dB. Use with any amplifier of 5 W or more. Has connections for two headsets, switch for loudspeaker or headphone, and a 9-ft cord \$115.00
Power supply alone \$40.00
Headset alone \$80.00
12-ft extension cord \$14.95

SRA-3S Headphone Amplifier

Features inputs for magnetic phono, Stax condenser cartridge (hi-level), and aux. Outputs for two Stax headphones (or up to four, using two extension cords), tape recorder. Includes filter and stereo/mono switches. 5" W x 4" x 11" D \$175.00

SUPEREX

PEP-79 Electrostatic Headphones

Frequency response 10-22,000 Hz \pm 5 dB. Consists of PEP-71 stereophone (same as in PEP-77D) and console that accommodates one set of stereophones. Designed to use level controls of main amplifier or receiver; no a.c. connection. Console, wood-grain vinyl over steel \$85.00

PRO-B-VI Headphones

Has acoustic-suspension woofer and ceramic tweeter. Response 15-22,500 Hz. 4 to 16 ohms impedance. 2 W maximum input per phone. 15-ft. coiled cord. Cordovan, ivory, or transparent \$60.00

PEP-77D Electrostatic Headphones

Frequency response 10-22,000 Hz \pm 5 dB. 4 to 16 ohms impedance. 5 W minimum input to



energizer. Uses "console" energizer (included). Provides two-phone accommodation and separate channel grounds. 15-ft. coiled cord. 12 ounce headphones \$120.00

ST-V Headphones

Moving-coil dynamic type. Response 20-18,000 Hz. 4 to 16 ohms impedance. 2 W maximum input per phone. Individual earphone volume controls. 15-ft. coiled cord \$30.00

EA500 Stereo-Headphone Amp

Compact, solid-state design. Response 20-20,000 Hz \pm 1 dB at maximum volume setting, tuner input, and with both channels driven. THD less than 0.5%. Maximum sine-wave output: 500 mW into 8 ohms both channels driven. Hum level 75 dB below full output on mag. phono inputs. Unit has front-panel input (tuner-phono) selector, left & right volume controls, two parallel stereo headphone jacks, illuminated power switch, rear-panel mag. phono input, tuner input. 3" x 10 $\frac{1}{4}$ " x 8 $\frac{1}{2}$ " D \$80.00

SST Headphones

Response 20-20,000 Hz. Maximum music power 2 watts. Has volume and tweeter controls at each earpiece. Supplied with 15-ft coiled cord. Cordovan or ivory. 4-16 ohms. . . \$40.00

ST-F-2 "Feather-Fone"

Weighs only 8 ounces (excluding 15-ft coiled cord) with a 25-17,500 Hz response. Maximum power 0.5 watt. Ivory/Cordovan \$24.95

ST-N "Newport"

Contemporary design dynamic stereophones with post and yoke headband. Response 30-15,000 Hz. Cordovan \$19.95

930 Headphones

Moving-coil dynamic type. Response 40-14,500 Hz. Adjustable stainless headband. 7-ft cord \$14.95

SW-IV Headphones

Dynamic element. Response 30-15,000 Hz. Adjustable headband. 10-ft coiled cord. Black with red trim \$24.95

927 Headphones

Woofer/tweeter headphone. Response 25-19,000 Hz. Dynamic woofer, ceramic tweeter, L-R crossover. Fully adjustable stainless headband. 10-ft coiled cord \$35.00

SYLVANIA

SP20BN Stereo Phones

Full-frequency phones with liquid-filled earcups to reduce room noise and increase comfort. Lightweight construction and with adjustable headband. Has 14-ft coiled cord. Bronze-colored vinyl finish \$19.95

SP40 Stereo Phones

Response 20-20,000 Hz. Distortion less than 1% at 120 dB. Features foam-filled earcups for good coupling to ear for extended bass response. Lightweight construction and with adjustable headband. 8-ft coiled cord. Black and white vinyl finish with chrome trim ... \$39.95

TEAC

HP-101 Dynamic Headphones

Stereo design. Frequency response 18-20,000 Hz. 8 ohms. Input sensitivity 1 mW, maximum power 500 mW. 6-ft. cable \$39.00

HP-102. Same as HP-101 except 10,000 ohms impedance \$39.00

HP-100 Stereo Headphones

High-velocity stereo headphones which permit listening to ambient sounds as well as music. Response 15-20,000 Hz; 8-16 ohms impedance (each channel); sensitivity 115 dB at 1 kHz, 1 mW; max. input 0.5 W. Has 2 $\frac{1}{4}$ " Mylar cone drive for each channel. Comes with 13 $\frac{1}{2}$ -ft coiled cord \$29.50

TECHNICS BY PANASONIC

EAH-80A Electret Headphones

Electret element supplies advantages of elec-



trostatic without its drawbacks. Distortion-canceling design. Adapter/control box included for direct connection to speaker output and control of speaker and headphone output. Lightweight headset (12.5 oz) with self-adjusting assembly. 6-ft, 7-in cord to control box plus 6-ft, 7-in coiled cord to headphone. Max. input (to adapter) 5 V; input imp. to adapter 4 to 16 ohms. Sensitivity (1 V, 500 Hz) 101 dB. Max. sound pressure level output 115 dB. Distortion (101 dB, 500 Hz) 0.8%. Response 20-20,000 Hz \$79.95

TELEDYNE

PH-222 Stereo Headphones

"Open-back" design with each earcup having a ported back and "open-air" polyfoam cushions. Response 25-18,000 Hz. 6 ounces ... \$24.98

PH-219 Electrostatic Headphones

Stereo design with an electrostatic driver in each earcup. Response 25-19,500 Hz. Fluid-filled ear cushions. Comes complete with energizer, speaker/headphones switch, 10-ft coiled cord, and standard $\frac{1}{4}$ " plug \$59.98

TELEPHONICS

TEL-14 Dynamic "Two-Way" Headphones

Moving coil woofer and tweeter in each earpiece. Response 20-20,000 Hz; dist. 0.2% max. at 95 dB-SPL. 17 ounces \$29.95

TEL-26 Dynamic Headphones

Sensitivity 102 dB-SPL at 1 kHz for 1 mW; dist. 0.2% max. Volume and tone controls on each



earpiece; stereo/mono switch. Black and chrome finish; coiled cord. 16 ounces. \$36.95

TEL-29 Dynamic Headphones

Lightweight. Has individual volume controls; coiled cord; response 30-18,500 Hz; chrome finish. 7 ounces \$19.95

TEL-111 Electret Headphones

Response 18-24,000 Hz; sensitivity 104 dB; dist. 0.2% at 115 dB SPL. Separate power pack



requires no external a. c. power. Black and chrome finish. Designed for studio monitoring. 17 ounces \$87.50

TELEX

Studio 1 Headphones

Dynamic design. Response 20-22,000 Hz. Sen-



sitivity 105 dB SPL/mW. Distortion 1.0% at 122 dB SPL. 3 to 16 ohms impedance. 1.0 W maximum input per phone. Has volume controls on each earphone. 15-ft. coiled cord. 24 ounces \$69.95
Studio 2. Same but without volume controls \$59.95

300 Stereo Headphones

Dynamic design. Has 15-ft coiled cord. 8 ohms.

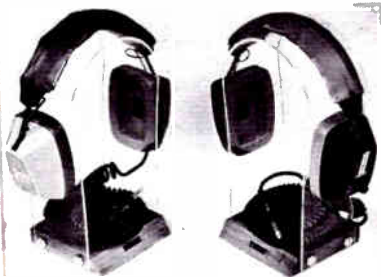

Gold with cinnamon brown trim \$34.95
400. Designed for additional convenience. Has volume control on each earpiece; audio metric driver \$44.95

TOSHIBA

HR-80 Dynamic Headphones

Dynamic headphones; response 20-20,000 Hz; rated input power 15 mW/ch. Imp. 4-50 ohms. Comes with 6.6-ft cord \$17.95

HR-50 Stereo Headphones

Two-way dynamic headphones with stereo effect changeover switch (stereo/binaural); rated power 1 mW/ch; response 20-20,000 Hz; crossover 400 Hz; imp. 4-16 ohms. Comes with 6.6-ft. cord \$29.95



ADVENT

MDC-1 Microphones

Matched pair of low-impedance microphones. Cardioid pickup pattern. Frequency response



50-16,000 Hz. Balanced output. Has 20-ft cables and stands. Pair \$90.00

1974 EDITION

AKG

D-109 Dynamic Microphone

Sensitivity -56 dB ASA. Response 50-15,000 Hz ± 3.5 dB. 200 ohms impedance. Omnidirectional pattern. Use for speech. Has lavalier, dust filter or windscreen, 30-ft. cable, and chrome finish. Connector not included. \$49.00

D-160E Dynamic Microphone

Sensitivity -55 dB ASA. Response 50-15,000 Hz ± 3 dB. 200 ohms impedance. Omnidirectional pattern. Use for tape recording. Has slip-in stand attachment, dust filter or windscreen, with detachable windscreens. With windscreens presence rise, without windscreens linear response. Comes with 15-ft. cable, XLR connector, and chrome finish \$69.00



D-190E Dynamic Microphone
 Sensitivity -53 dB ASA. Response 40-15,000 Hz ± 3 dB. 200 ohms impedance. Cardioid pattern. Use for music. Has slip-in stand attachment, dust filter or windscreens, XLR connector. Comes with 15-ft. cable \$59.00
Model D-190TS. Same as D-190E except high impedance operation with "on-off" switch. Has 24-ft. cable and phone plug \$79.00

D-200E Dynamic Microphone

Sensitivity -55 dB ASA. Response 30-15,000 Hz ± 3 dB. 200 ohms impedance. Cardioid pattern. Use for music and tape recording. Has slip-in stand attachment, dust filter or windscreens. Comes with 15-ft. cable, XLR connector, matte grey finish \$79.00
Model D-200TS. Same as D-200E except for high impedance operation with "on-off" switch, 24-ft. cable, and phone plug ... \$99.00

D-707E Dynamic Microphone

Sensitivity -52 dB ASA. Response 50-15,000 Hz ± 3.5 dB. 200 ohms impedance. Cardioid pattern. Use for tape recording. Comes with slip-in stand attachment, pop or blast filter, chrome finish, 15-ft. cable, and XLR connector \$49.00
Model D-707TS. Same as D-707E but for high impedance operation with "on-off" switch, 24-ft. cable, phone jack \$69.00

D-1000E Dynamic Microphone

Sensitivity -53 dB ASA. Response 40-16,000 Hz ± 3 dB. 200 ohms impedance. Cardioid pattern. Use for rock vocals. Has slip-in stand attachment, pop or blast filter, chrome finish, 15-ft cable, and XLR connector \$69.00
Model D-1000TS. Same as D-1000E but for



high impedance operation with "on-off" switch, 24-ft. cable, and phone plug .. \$89.00

ASTATIC

857 Unidirectional Microphone

Designed for recording and rock music applications. Slim-line design with ball head filtering to



minimize wind and close-talking pop effects. Overall dimension of basic microphone are 2 1/16" dia. x 6 1/8" long. Has professional 3-pin cable connector. Weight 8 oz. less cable.

857 L. Low impedance with non-switch cable connector \$66.00
857 H. High impedance with non-switch cable connector \$66.00
 Models with "on-off" switch cable connector available at slightly higher price.

AUDIOTEX

Low-Impedance Microphone

Designed as a replacement unit for many tape recorders built prior to 1969 as well as some later models. Cord terminated in miniature and subminiature plugs to fit most tape recorders; adapter for recorders using concentric jack included. 200 ohms. 30-2300 \$7.50
30-2302. Same except 50,000 ohms impedance \$7.50
30-2304. Same except equipped with 5-pin and 3-pin DIN plugs found on all European and some American and Japanese recorders. 200 ohms \$7.95

Dynamic Microphone

For recording groups and soloists; cardioid pattern. Wide, flat frequency response. 50-13,000



Hz; output -58 dB (on high impedance). Rugged construction, built-in windscreens. 20-ft cable with standard phone plug and adapter for floor or desk stand. Built-in volume control with on-off switch. Dual (hi/lo) impedance. 30-2314 \$39.95

Omnidirectional Microphone

Response 55-13,000 Hz; output -62 dB (on high impedance). Rugged construction. Comes with 15-ft cable, standard phone plug, swivel holder, on-off slide switch, and windscreens for outdoor use. Dual (hi/lo) impedance. 30-2312 \$34.95

Omnidirectional Microphone

Response 80-13,000 Hz. High impedance. Comes with 10-ft cable with standard phone plug, on-off slide switch, desk stand. Sensitivity: -58 dB. 30-2310 \$29.95

Microphone Mixer



BLANK TAPE & ACCESSORIES

ADVENT

Chromium-Dioxide Cassettes

Comes in screw-type housing with special lead-



er tape that cleans heads. In lots of six, comes with free optional storage album.

C-60	\$2.49
C-90	\$3.39
C-120	\$4.49

BASF

LP-35 Recording Tape

Polyester base, tensilized 1-mil., long play.

900 ft., 5" reel	\$3.41
1800 ft., 7" reel	\$5.64
1800 ft., 7" reel (3 pack)	\$16.27

DP-26 Recording Tape

Polyester base, tensilized 3/4-mil., double play.

1200 ft., 5" reel	\$5.12
2400 ft., 7" reel	\$8.14
2400 ft., 7" reel (3 pack)	\$23.12

TP-18 Recording Tape

Polyester base, tensilized, 1/2-mil., triple play.

1800 ft., 5" reel	\$7.98
3600 ft., 7" reel	\$12.26

LP-35LH Long-Play Tape

1-mil polyester base. Low-noise, high-output.

900 ft., 5" reel	\$4.10
1800 ft., 7" reel	\$7.14

DP-26LH Double-Play Tape

3/4-mil polyester base. Low noise, high-output.

1200 ft., 5" reel	\$5.86
2400 ft., 7" reel	\$9.55

TP-18LH Triple-Play Tape

1/2-mil polyester base. Low-noise, high-output.

1800 ft., 5" reel	\$9.12
3600 ft., 7" reel	\$13.67

"Chromdioxid" SM Cassettes

Plastic box.

30 min/side C-60	\$3.24
45 min/side C-90	\$4.74
60 min/side C-120	\$6.17

LHSM Cassettes

Plastic box.

C-60	\$2.55
C-90	\$3.79
C-120	\$4.71

SKSM Cassettes

Plastic box

C-30	\$1.33
C-45	\$1.42
C-60	\$1.50
C-90	\$2.05
C-120	\$2.88

"Sound Loop 8" Cartridges

45 minutes	\$2.43
64 minutes	\$2.60
90 minutes	\$2.99

"Sound Loop 8+" Cartridges

Low-noise, high-output cartridges.

45 min	\$2.94
64 min	\$3.15
90 min	\$3.49

CAPITOL

Capitol 1 Cassettes

C-30, 15 min/side	\$0.99
C-60, 30 min/side	\$1.19
C-90, 45 min/side	\$1.79
C-120, 60 min/side	\$2.49
C-30, Three pack	\$2.79
C-60, Three pack	\$3.39
Cassette head cleaner	\$0.99
Cassette saver	\$2.29

Capitol 1 8-Track Cartridges

32 min/150 ft	\$1.69
40 min/190 ft	\$1.99
64 min/300 ft	\$2.29
80 min/380 ft	\$2.39
100 min/470 ft	\$2.69
4 pk of 40 min	\$5.98
4 pk of 80 min	\$6.98
Cartridge head cleaner	\$1.19

Capitol 1 Open-Reel Tape

Standard play, 1.5-mil polyester

600 ft., 5" reel	\$1.89
1200 ft., 7" reel	\$2.49

Extra play, 1.0-mil polyester

900 ft., 5" reel	\$2.39
1800 ft., 7" reel	\$3.19

0.5-mil polyester, tensilized

1200 ft., 5" reel	\$2.69
1800 ft., 5" reel	\$3.69
2400 ft., 7" reel	\$3.99
3600 ft., 7" reel	\$5.99

Capitol 2 (UHL) Ultra-High-Output, Low-Noise Tape

Standard play, 1.5-mil, polyester base.

678. 600 ft, 5" reel	\$4.29
1278. 1200 ft, 7" reel	\$6.69

Extra play, 1.0-mil, polyester base.

968. 900 ft, 5" reel	\$5.89
1868. 1800 ft, 7" reel	\$8.49

All Capitol 2 UHL tapes have special leaders designed to be written upon and each end has a spliced-in switching foil.

Capitol 2 High-Performance, All-Purpose Tape

Standard play, 1.5-mil, acetate base.

652. 600 ft, 5" reel	\$2.98
1252. 1200 ft, 7" reel	\$4.79

Standard play, 1.5-mil, polyester base

672. 600 ft, 5" reel	\$2.98
1272. 1200 ft, 7" reel	\$4.79

Extra play, 1.0-mil, polyester base.

962. 900 ft, 5" reel	\$3.59
1862. 1800 ft, 7" reel	\$5.98

Double-play tape, 0.5-mil, tensilized polyester base.

1232T. 1200 ft, 5" reel	\$5.29
2432T. 2400 ft, 7" reel	\$8.99

Triple-play tape, 0.5-mil, tensilized polyester base.

1832T. 1800 ft, 5" reel	\$6.98
3632T. 3600 ft, 7" reel	\$10.89

Capitol 2 Low-Noise Tape

Standard play, 1.5-mil, acetate base.

1259. 1200 ft, 7" reel	\$4.29
------------------------	--------

Standard play, 1.5-mil, polyester base.

1279. 1200 ft, 7" reel	\$4.79
Extra play, 1.0-mil, polyester base.	
1869. 1800 ft, 7" reel	\$6.89

Capitol 2 Cassettes

High-output, low-noise cassettes with "Cushion-Aire" back coating.

C-40. 40 min	\$2.49
C-60. 60 min	\$2.98
C-90. 90 min	\$4.39
C-120. 120 min	\$5.95

Stak-Pak with two cassettes housed in storage



chest.

C-40. 40 min	\$4.98
C-60. 60 min	\$5.98
C-90. 90 min	\$8.79
C-120. 120 min	\$11.89

Capitol 2 Audiopak 8-Track Cartridges

8-150. 32 min	\$2.39
8-190. 40 min	\$2.59
8-300. 64 min	\$2.79
8-380. 80 min	\$2.97
8-470. 100 min	\$3.29

Capitol 2 Premium Audiopak

Ultra-high output/low-noise 8-track cartridges.

8-190U. 40 min	\$2.69
8-380U. 80 min	\$3.29
8-470U. 100 min	\$3.59

COLUMBIA

Cassette Tapes

Each side color-coded for easy identification. High-output/low-noise gamma-ferric oxide. Response 20-20,000 Hz. Tensilized polyester



sitivity 105 dB SPL/mW. Distortion 1.0% at 122 dB SPL. 3 to 16 ohms impedance. 1.0 W maximum input per phone. Has volume controls on each earphone. 15-ft. coiled cord. 24 ounces \$69.95
Studio 2. Same but without volume controls \$59.95

300 Stereo Headphones

Dynamic design. Has 15-ft coiled cord. 8 ohms.

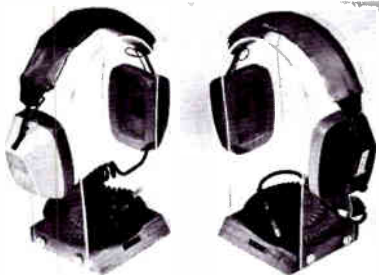

Gold with cinnamon brown trim \$34.95
400. Designed for additional convenience. Has volume control on each earpiece; audio metric driver \$44.95

TOSHIBA

HR-80 Dynamic Headphones

Dynamic headphones; response 20-20,000 Hz; rated input power 15 mW/ch. Imp. 4-50 ohms. Comes with 6.6-ft cord \$17.95

HR-50 Stereo Headphones

Two-way dynamic headphones with stereo effect changeover switch (stereo/binaural); rated power 1 mW/ch; response 20-20,000 Hz; cross-over 400 Hz; imp. 4-16 ohms. Comes with 6.6-ft. cord \$29.95



ADVENT

MDC-1 Microphones

Matched pair of low-impedance microphones. Cardioid pickup pattern. Frequency response



50-16,000 Hz. Balanced output. Has 20-ft cables and stands. Pair \$90.00

1974 EDITION

AKG

D-109 Dynamic Microphone

Sensitivity -56 dB ASA. Response 50-15,000 Hz ± 3.5 dB. 200 ohms impedance. Omnidirectional pattern. Use for speech. Has lavalier, dust filter or windscreen, 30-ft. cable, and chrome finish. Connector not included. \$49.00

D-160E Dynamic Microphone

Sensitivity -55 dB ASA. Response 50-15,000 Hz ± 3 dB. 200 ohms impedance. Omnidirectional pattern. Use for tape recording. Has slip-in stand attachment, dust filter or windscreen, with detachable windscreen. With windscreen presence rise, without windscreen linear response. Comes with 15-ft. cable, XLR connector, and chrome finish \$69.00



D-190E Dynamic Microphone
 Sensitivity -53 dB ASA. Response 40-15,000 Hz ± 3 dB. 200 ohms impedance. Cardioid pattern. Use for music. Has slip-in stand attachment, dust filter or windscreen, XLR connector. Comes with 15-ft. cable \$59.00
Model D-190TS. Same as D-190E except high impedance operation with "on-off" switch. Has 24-ft. cable and phone plug \$79.00

D-200E Dynamic Microphone

Sensitivity -55 dB ASA. Response 30-15,000 Hz ± 3 dB. 200 ohms impedance. Cardioid pattern. Use for music and tape recording. Has slip-in stand attachment, dust filter or windscreen. Comes with 15-ft. cable, XLR connector, matte grey finish \$79.00
Model D-200TS. Same as D-200E except for high impedance operation with "on-off" switch, 24-ft. cable, and phone plug ... \$99.00

D-707E Dynamic Microphone

Sensitivity -52 dB ASA. Response 50-15,000 Hz ± 3.5 dB. 200 ohms impedance. Cardioid pattern. Use for tape recording. Comes with slip-in stand attachment, pop or blast filter, chrome finish, 15-ft. cable, and XLR connector \$49.00
Model D-707TS. Same as D-707E but for high impedance operation with "on-off" switch, 24-ft. cable, phone jack \$69.00

D-1000E Dynamic Microphone

Sensitivity -53 dB ASA. Response 40-16,000 Hz ± 3 dB. 200 ohms impedance. Cardioid pattern. Use for rock vocals. Has slip-in stand attachment, pop or blast filter, chrome finish, 15-ft cable, and XLR connector \$69.00
Model D-1000TS. Same as D-1000E but for



high impedance operation with "on-off" switch, 24-ft. cable, and phone plug .. \$89.00

ASTATIC

857 Unidirectional Microphone

Designed for recording and rock music applications. Slim-line design with ball head filtering to



minimize wind and close-talking pop effects. Over-all dimension of basic microphone are 2 1/16" dia. x 6 1/8" long. Has professional 3-pin cable connector. Weight 8 oz. less cable.
857 L. Low impedance with non-switch cable connector \$66.00
857 H. High impedance with non-switch cable connector \$66.00
 Models with "on-off" switch cable connector available at slightly higher price.

AUDIOTEX

Low-Impedance Microphone

Designed as a replacement unit for many tape recorders built prior to 1969 as well as some later models. Cord terminated in miniature and subminiature plugs to fit most tape recorders; adapter for recorders using concentric jack included. 200 ohms. 30-2300 \$7.50
30-2302. Same except 50,000 ohms impedance \$7.50
30-2304. Same except equipped with 5-pin and 3-pin DIN plugs found on all European and some American and Japanese recorders. 200 ohms \$7.95

Dynamic Microphone

For recording groups and soloists; cardioid pattern. Wide, flat frequency response. 50-13,000



Hz; output -58 dB (on high impedance). Rugged construction, built-in windscreen. 20-ft cable with standard phone plug and adapter for floor or desk stand. Built-in volume control with on-off switch. Dual (hi/lo) impedance. 30-2314 \$39.95

Omnidirectional Microphone

Response 55-13,000 Hz; output -62 dB (on high impedance). Rugged construction. Comes with 15-ft cable, standard phone plug, swivel holder, on-off slide switch, and windscreen for outdoor use. Dual (hi/lo) impedance. 30-2312 \$34.95

Omnidirectional Microphone

Response 80-13,000 Hz. High impedance. Comes with 10-ft cable with standard phone plug, on-off slide switch, desk stand. Sensitivity: -58 dB. 30-2310 \$29.95

Microphone Mixer



Allows combination of up to four mikes mono or two mikes to each stereo channel; separate control for each mike; on-off switch; stereo/mono selector switch; 9-volt battery operated. Standard 1/4" phone jack inputs, phono pin jack outputs. 30-2320 \$22.95

Microphone Boom

Fits all standard mike floor stands. Has adjustable counterweight; movable clamp and hinge design for any desired position. Standard 5/8-27 thread. 31" long. 30-2370.. \$12.95

Floor-Type Stand

Heavy cast-iron, self-leveling base with polished chrome-plated telescoping tubing. Adjusts from 34" to 64". Top of tubing has standard 5/8-27 thread to fit all standard mikes. 30-2360..... \$14.95

Folding Microphone Stand

Folds and unfolds in seconds; weight 3 1/2 pounds; chrome-plated tubing extends to 60"; folded size 33". Legs have rubber tips to prevent skidding and scratching. 30-2362 \$17.95

BEYER/DYNAMIC

M-500 Dynamic Ribbon Microphone

Super-cardioid; response 40-18,000 Hz ± 2.5 dB. Sensitivity: -153 dBm (EIA); 200 ohms imp.



Has four-stage integral blast filter and Cannon XLR termination. Especially designed for rock vocals: low pop and breath noise even when singer's lips touch microphone \$140.00

M-160 Double-Ribbon Microphone

Super-cardioid dynamic type. Response 40-18,000 Hz ± 2.5 dB. Sensitivity: -152 dBm (EIA); 200 ohms impedance. Low sensitivity at 120 degrees to axis. Suitable for stereo recording. Cannon XLR termination \$230.00

M-260 Dynamic Ribbon Microphone

Super-cardioid design. Response 50-18,000 Hz ± 2.5 dB. Sensitivity -153 dBm (EIA). High-energy ribbon. 200 ohms imp. Suitable for speech, music, or vocals 1 1/4" mesh head x 6" long. Cannon XLR termination \$110.00
M-260SM. Same as M-260 except with "on-off" and bass-cut switch \$125.00

M-550S Moving-Coil Microphone

Omnidirectional dynamic type. Response 70-18,000 Hz. For tape recording and general applications. Sensitivity: -152 dBm (EIA); will work with all impedances. Suitable for use indoors and outdoors. Comes with clamp, table stand, cable with jack plug, "on-off" switch, and presentation case \$37.50

M-810-N Moving-Coil Microphone

Dynamic cardioid design. Response 50-16,000 Hz. Sensitivity: -148 dBm. Suits all impedances. Designed for tape recording applications. Comes with windshield, clamp, and detachable 16-ft cable with jack, all housed in lined case \$65.00

"Soundstar" X1N Dynamic Microphone

Dynamic cardioid design. Response 30-18,000 Hz ± 2.3 dB. Sensitivity: -146 dBm (EIA); 200 ohms imp. Front-to-back attenuation greater than 20 dB. For tape recording, music, and vocals. Has built-in pop screen and hum compensation coil. Cannon XLR termination .. \$80.00
"Soundstar" X1HL. Same as X1N except with high/low imp. switch \$90.00

M-69 Moving-Coil Microphone

Dynamic cardioid design. Response 50-16,000 Hz ± 3 dB. Sensitivity: -144 dBm (EIA); 200 ohms imp. For indoor/outdoor applications; unaffected by temperature or humidity .. \$95.00
M-69-SM. Same as M-69 but with "on-off" and bass-cut switch \$110.00

M-67 Moving-Coil Microphone

For tape recording, interviewing, and general outdoor/indoor work. Cardioid type. Response 40-18,000 Hz ± 2.5 dB. Sensitivity: -148 dBm



(EIA); 200 ohms imp. Special transducer mounting minimizes handling noise. Has built-in "on-off" bass-cut switch. 7 3/4" x 1 1/2". Cannon XLR termination \$120.00

M-101 Moving-Coil Microphone

Omnidirectional type. Response 40-20,000 Hz. Sensitivity: -150 dBm (EIA); 200 ohms imp. Withstands pressures associated with modern music (modulated voltages up to 2V). Low handling noise. 4 1/2" x 7/8". Cannon XLR termination \$115.00

M-201 Moving-Coil Microphone

Super-cardioid dynamic type. Response 40-18,000 Hz. Sensitivity: -149 dBm (EIA); 200 ohms imp. 6" x 1 3/16". Cannon XLR termination. Comes with clamp and presentation case \$165.00

M-88 Moving-Coil Microphone

Super-cardioid dynamic type. Response 30-20,000 Hz ± 2.5 dB. Sensitivity: -144 dBm (EIA). Special transducer mounting eliminates body noise. Will withstand rough handling, humidity and temperature changes. For studio work, recording artists, and instrumentalists \$218.00

ELECTRO-VOICE

635A Dynamic Microphone

Sensitivity -149 dB EIA. Response 80-13,000 Hz ± 3 dB. 150 ohms impedance. Omnidirectional pattern. Hand-held with slip-in stand attachment and lavalier neckcord assembly. Use for tape recording and broadcasting. Has a four-stage pop or blast filter, 15-ft. cable, Switchcraft A3F connector. Fawn beige matte finish \$56.70

670 Dynamic Microphone

Sensitivity -152 dB EIA. Response 60-14,000 Hz. User selects high or low impedance. Single-D cardioid. Hand-held with slip-in stand attachment. Use for speech, rock vocals, music, and tape recording. Has built-in "Acoustifoam" pop or blast filter, "on-off" switch, 15-ft. cable, and Switchcraft A3F connector. Frequency response varies with distance from microphone (maximum bass response is 1/4" from source). Features an anodized brass finish \$49.20

670V Dynamic Microphone

Sensitivity -152 dB EIA. Response 60-14,000 Hz. User selects high or low impedance. Single-D cardioid. Hand-held with slip-in stand attachment. Use for speech, rock vocals, music, and tape recording. Has built-in "Acoustifoam" pop or blast filter, "on-off" switch, 15-ft. cable and Switchcraft A3F connector. Features a special thumb-actuated volume control for user convenience. Bass response varies with distance from sound source. Anodized finish \$54.00

RE10 Dynamic Microphone

Response 90-13,000 Hz. Super-cardioid polar pattern. 150 ohms impedance. Output -56 dB (0 dB = 1 mW/10 dynes/cm²). Sensitivity -150 dB EIA. Has 18-ft. cable. 6 3/4" x 1 3/8" with carrying case \$99.60

RE55 Dynamic Microphone

Response 40-20,000 Hz. Omnidirectional pattern. 150 ohms impedance. Output -55 dB (0 dB = 1 mW/10 dynes/cm²). Sensitivity -149 dB EIA. 18-ft. cable. 10 1/2" x 1 7/32" with carrying case \$162.00

671 Dynamic Microphone

Sensitivity -154 dB (EIA) low-Z; -156 dB (EIA) hi-Z. Response 60-14,000 Hz. User selects high



or low imp. Cardioid pattern. Features hand-held design with slip-in stand clamp, integral Acoustifoam pop or blast filter, "on-off" switch, 15-ft cable, and A3F connector. Directional single-D emphasizes low-frequencies when used close-up. Satin chrome finish. .. \$54.75

660 Dynamic Microphone

Sensitivity -150 dB (EIA) low-Z; -150.5 dB (EIA) hi-Z. Response 90-13,000 Hz. User se-

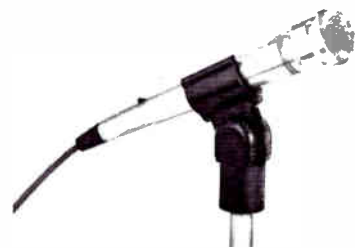

lects high or low imp. Super-cardioid pattern. Can be used hand-held or in stand clamp. Variable-D for smooth response on or off-axis with no proximity effect. Professional-style 15-ft cable and mike-end connector. Satin chrome finish..... \$64.80

631A Dynamic Microphone

Sensitivity -149 dB EIA. Response 80-13,000 Hz. May be ordered hi or lo impedance. Omnidirectional pattern. Hand-held with slip-in stand attachment. Use for speech, vocals, music, and tape recording. Has silent, magnetic "on-off" switch with removable actuator button; 15-ft cable; Switchcraft A3F connector. Satin chrome finish..... \$41.40
 All of the above prices are "Net."

HITACHI

NDM-32 Dynamic Microphone

Sensitivity -78 dB. Response 70-12,000 Hz ± 4 dB. Impedance 600 ohms. Omnidirectional with desk stand. Use for speech and recording applications. Supplied with plug connector and wind screen. 16-ft. cable. Black \$35.00

LAFAYETTE

Deluxe Ball Dynamic Microphone

General-purpose, omnidirectional, dual-impedance (50,000 & 250 ohms), selectable at cable end. Output at high impedance -59 dB. Frequency response 100-10,000 Hz. Has "on-off" switch. Includes ball screen, 6-ft detachable cable with mike plug at one end, black metal desk stand, and floor-stand adapter. Die-cast case finished in satin aluminum. Case is 6 7/8" long \times 2 1/8" max. dia. of ball \$18.50

Condenser Microphone

Unidirectional cardioid pattern with high front-to-back rejection ratio and flat frequency response from 30-16,000 Hz. Impedance 600 ohms but can be used with inputs up to 20,000 ohms. FET circuitry. Powered by one "AA" penlight cell. Foam windscreen, 15-ft shielded cable, standard 1/4" phone plug, metal tripod-type desk stand, floor-stand adapter, and battery are included \$29.95

Modern Dynamic Microphone

Lightweight omnidirectional dual impedance (50,000 & 250 ohms), selectable at cable. Response 100-10,000 Hz. Output -60 dB. "On-off" slide switch. Comes with floor-stand adapter, 20-ft detachable cable with mike plug, and wire mesh grille. Tapered metal case finished in satin-black and aluminum. 7" long \times 1 3/8" dia. \$14.25

Electret Condenser Microphone

Lightweight condenser microphone with omnidirectional pattern; response 20-13,000 Hz; FET circuitry for high sensitivity, low noise, and low power consumption; powered by inexpensive battery. 600 ohms imp. (usable with inputs to 20,000 ohms); output level -74 dB. Comes with foam windscreen, desk stand, 10-ft shielded cable. 6" long \times 5/8" dia. \$18.95

Cardioid Dynamic Microphone

Dual-impedance, general-purpose microphone; unidirectional pickup; response 100-10,000 Hz; output level -57 dB; dual impedance switch selected; on/off switch; chrome finish; pop-proof wire mesh grille; 20-ft detachable cable; stand swivel adapter. 8" long \times 1" dia. \$19.95

NEUMANN

FET-80 Condenser Microphones

A line of studio microphones that come in many configurations from omni, figure-8, cardioid,

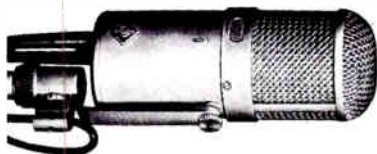

multiple pattern to multiple pattern stereo. All can be either battery or phantom (separate power supplies) powered.

U-47FET \$434.50
Other FET-80 models from \$283.80

PML

DC-20 Condenser Microphone

Omnidirectional pattern. Response 30-20,000

Hz. Sensitivity -56 (1.5 mV); noise 23 dB; impedance 200 ohms. Comes with stand adapter and connecting cable \$122.95

DC-21. Same except cardioid pattern. \$122.95

DC-73 Condenser Microphone

Cardioid pattern. Has electrical pop filter. Response 30-20,000 Hz (100-20,000 Hz); Sensitivity -60 dB. (1.0 mV); noise 21 dB; impedance 200 ohms. Comes with stand adapter and connecting cable \$160.95

DC-96 Condenser Microphone

Cardioid pattern. Response 30-18,000 Hz. Sensitivity -61 dB (0.9 mV); noise 17 dB; impedance 200 ohms. Comes with stand adapter and connecting cable \$242.95

EK-71 Condenser Microphone

Omnidirectional pattern. Response 80-18,000 Hz. Sensitivity (hi-Z) -38 dB (2.5 mV); impedance hi-Z. Comes with stand adapter and connecting cable \$97.95

EC-71. Same except cardioid pattern .. \$97.95

FP-92K Electret Microphone

Omnidirectional pattern. Pre-polarized with built-in 6 V battery. Response 30-20,000 Hz. Sensitivity -66 dB (0.5 mV); noise 23 dB; impedance 200 ohms. Comes with stand adapter and connecting cable \$146.95

FP-92C. Same except cardioid pattern \$146.95

FP-92C+. Same except has windscreen and shockmount \$183.95

FP-92K+. Same as FP-92K except has windscreen and shockmount \$183.95

S/BE CL3 Electret Microphone

Tie-bar design. Omnidirectional pattern. Response 80-17,000 Hz. Sensitivity -30 dB; noise 23 dB; impedance 200 ohms. Requires 22 1/2 V battery \$163.95

Power Supplies

Battery supply for DC-20, DC-21, DC-73, DC-96. 48 V d. c. output. Impedance 50,200, 600, and hi-Z.

7320-M. Mono \$49.95

7320-S. Stereo \$55.95

110 V. a. c. supply for DC-20, DC-21, DC-73, DC-96.

6320-M. Mono \$74.95

6320-S. Stereo \$102.95

Battery supply for EC-71 and EK71.

7140-M. Mono \$45.95

7140-S. Stereo \$53.95

RADIO SHACK

Pro-100 Microphone Kit

Supplied as a pair with 13-piece accessory package including wind screens, table stands, floor stand adapters, lavalier cords, and cables. Response 10-10,000 Hz. Switchable 250 and 10,000 ohm impedance. \$34.95

Highball Dynamic Microphone

Cardioid design. Response 50-15,000 Hz. Features "on-off" switch and internal push-on impedance change 50/250 ohms or 50,000 ohms. Has pop filter and 15-ft. cable .. \$39.95

Highball 5 Dynamic Microphone

Cardioid design. Response 70-13,000 Hz. Has change plug for 600 to 20,000 ohm impedance. Includes stand adapter and 15-ft. cable \$32.95

Electret-1045 Condenser Microphone

Cardioid design. Response 30-15,000 Hz. Can be switched from low imp. (600 ohms) to high imp. (20,000 ohms). Has windscreen and desk stand. Powered by single penlight battery \$32.95

Electret-1044 Condenser Microphone

Omnidirectional pattern. Response 30-15,000 Hz. Can be switched from 600 to 20,000 ohm impedance. Has foil diaphragm, windscreen, and mike stand. Powered by single penlight battery \$27.95

SENNHEISER

MD-211U Dynamic Microphone

Omnidirectional unit. Response 40-20,000 Hz. Sensitivity -58 dBm (0.13 mV/ μ bar) ± 2.5 dB. Has extremely wide, flat response unusual in a moving-coil microphone. 4 3/4" \times 1" dia. Fitted with Cannon XLR connector \$181.00

MD21N Dynamic Microphone

Omnidirectional, 200-ohm impedance design. Response 50-15,000 Hz ± 3 dB. Sensitivity 0.2 mV/ μ bar at 1000 Hz. EIA rating -145.8 dB. Output level -53 dBm (1 mW/10 dynes/cm²). Fitted with small Tuchel connector. Has balanced output. 10 ounces. 4 3/4" \times 1 7/8" \times 1 7/8". \$104.00

MD421U Dynamic Microphone

Cardioid, 200-ohm impedance design. Response 30-17,000 Hz ± 5 dB. Sensitivity 0.2 mV/ μ bar ± 3 dB at 1 kHz. EIA rating -145.8 dB. Output level -53 dBm (1 mW/10 dynes/cm²). Has front-to-back ratio 18 dB, -2 dB and a variable bass attenuator. Fitted with XLR connector. 14 ounces. 7" \times 1 7/8" \times 1 3/16" \$154.00

MD411HLM Dynamic Microphone

Super-cardioid. Features a built-in triple-impedance transformer to permit mike to be con-



nected directly to any tape recorder. High impedance is 25,000 ohms for tube units; 800 ohms medium impedance for transistor recorders; 200 ohms low impedance for recorders of either type fitted with low-impedance input transformers. Response 50-12,000 Hz. Side attenuation 20 dB at 120 degrees. Sensitivity 1.25 mV/ μ bar at 1 kHz; EIA rating -154 dB; output level -58.1 dBm (1 mW/10 dynes/cm²) all at high-imp. setting. Comes with table stand, floor stand adapter, and zippered case. 8 ounces \$54.00

MD441 Dynamic Microphone

Super-cardioid design. Response 40-20,000 Hz; sensitivity 0.2 mV/ μ bar ± 3 dB. Has brilliance switch for nominal 5 dB boost at 5 kHz; 5-position bass attenuator. Front-to-back ratio is 20 dB, -3 dB. Comes with quick-release mount that fits on floor stand or accessory table stand MZT-441. Windscreen for microphone is Model MZW441. 1.3" H \times 1.4" W \times 9.6" long . \$236.00

SHURE

300 Ribbon Microphone



Sensitivity -153 dB (EIA). Response 40-15,000 Hz. User selects high or low impedance. Bidirectional. Hinge mount to stand. Use for speech and music. Has 20-ft. cable and connector. Gray \$107.40

515SA "Unidyne B" Microphone

Dynamic type. Sensitivity -154 dB (EIA). Response 80-13,000 Hz. High impedance. Cardioid pattern. Hand-held with slip-in stand attachment. Use for speech, rock vocals, and music. Has "on-off" switch and 15-ft. cable. Chrome finish \$28.20
Model 515SB. Same as Model 515SA except low impedance \$28.20

545 "Unidyne III" Microphone

Dynamic type. Sensitivity -149 dB (EIA). Response 50-15,000 Hz. User selects high or low impedance. Cardioid pattern. With slip-in stand attachment and hinge mount to stand. Designed specifically for speech, music, and tape recording. Supplied with 15-ft. cable and Amphenol-type MC4M connector. Chrome finish \$60.00

Model 545S. Similar to Model 545 but has cable connection through hinge and "on-off" switch in upright \$64.20

Model 545SD. Same as Model 545 but has "on-off" switch on microphone barrel \$64.20

Model 545L. Similar to Model 545 but has lavalier cord and clip \$50.25

546 "Unidyne III" Microphone

Dynamic type. Sensitivity -154 dB (EIA). Response 50-15,000 Hz. User selects high or low impedance. Cardioid pattern. Hinge mount to stand. Use for speech, rock vocals, and music. Comes with 20-ft. cable and connector. Chrome finish \$97.20

548SD "Unidyne IV" Microphone

Dynamic type. Sensitivity -141 dB (EIA). Response 40-15,000 Hz. User selects high or low impedance. Cardioid pattern. Hand-held with slip-in stand attachment. Use for speech and music. Has "on-off" switch, 15-ft. cable, and connector. Chrome finish \$75.00

55S Dynamic Microphone

Sensitivity -148 dB (EIA). Response 50-15,000 Hz. User selects high or low impedance. Cardioid pattern. Hinge mount to stand. Use for speech and music. Supplied with Amphenol-type MC3M connector and 15-ft. cable. Chrome finish \$59.85
Model 55SW. Same as Model 55S except has built-in "on-off" switch \$61.20

565 "Unisphere 1" Microphone

Dynamic type. Sensitivity -148.5 dB (EIA). Response 50-15,000 Hz. User selects high or low impedance. Cardioid pattern. Hinge mount to stand. Use for speech, rock vocals, and music. Has pop or blast filter, 15-ft. cable, and connector. Chrome finish \$67.80
Model 565SD. Same as Model 565 except has "on-off" switch \$70.80
Model 566. Similar to Model 565 except with shock mount \$103.20

578 Dynamic Microphone

Sensitivity -154 dB (EIA). Response 50-15,000 Hz. User selects high or low impedance. Omnidirectional pattern. Hand-held. Use for speech and music. Has "on-off" switch, a 15-foot cable, and connector. Supplied with chrome finish \$56.25
Model 578S. Similar to Model 578 except has swivel assembly \$63.00

579SB Dynamic Microphone

Sensitivity -151 dB (EIA). Response 50-15,000

Hz. Low impedance, omnidirectional pattern. Has slip-in stand attachment, "on-off" switch, pop or blast filter. Use for speech, rock vocals, and music. Supplied with 20-ft. cable and connector. Chrome finish \$47.25

580SA(B) Dynamic Microphone

Sensitivity -151 dB (EIA). Response 50-13,000 Hz. User specifies high or low impedance. Cardioid pattern. Hand-held with slip-in stand attachment. Use for speech and music. Comes with "on-off" switch, 15-ft. cable, and connector. Chrome finish \$43.65

585SA(B) Dynamic Microphone

Sensitivity -151 dB (EIA). Response 50-13,000 Hz. User specifies high or low impedance. Cardioid pattern. Hand-held with slip-in stand attachment. Use for speech, rock vocals, and music. Has pop or blast filter, "on-off" switch. Supplied with 15-ft. cable and connector. Chrome finish \$47.25
Model 585SAV. Similar to Model 585SA(B) but has volume control on microphone barrel \$48.45

588SA(B) Dynamic Microphone

Sensitivity -155 dB (EIA). Response 80-13,000 Hz. User specifies high or low impedance. Car-



dioid pattern. Hand-held with slip-in stand attachment. Use for speech, rock vocals, and music. Has pop or blast filter, "on-off" switch. Comes with 15-ft. cable and connector. Chrome finish \$40.80

SONY BY SUPERSCOPE

ECM-16 Condenser Microphone

Sensitivity -57.8 dB (0 dB = 1 V/10 μ bar). Response 50-13,000 Hz. Low impedance, omnidirectional pattern. Lavalier-type for speech and tape recording. Supplied with mini connector. Internal battery operation. 6-ft. cable. $\frac{9}{16}$ " dia. \times $1\frac{1}{16}$ " long. Silver \$29.95

ECM-18 Condenser Microphone

Sensitivity -56.8 dB (0 dB = 1 V/10 μ bar). Response 50-12,000 Hz. Low impedance, cardioid pattern. Hand-held type for speech, music, and tape recording. Supplied with mini connector, dust filter or windscreen. 6.5-ft. cable. Internal battery operation. Silver gray and black \$22.95

ECM-22P Condenser Microphone

Sensitivity -54.8 dB (0 dB = 1 V/10 μ bar). Response 40-15,000 Hz; Low impedance, bal-



anced 250/600 ohms. Cardioid pattern. Hand-held with "slip-in" stand attachment. Use for speech, rock, vocals, music, and tape recording. Comes with dust filter or windscreen and 20-ft. cable. Connector not included. Internal battery/phantom powering \$99.95

ECM-99 Condenser Microphone

Sensitivity -53 dB (0 dB = 1 V/10 μ bar). Response 50-12,000 Hz. Low impedance. Cardioid (dual) pattern. Hand-held with "slip-in" stand attachment. Use for music and tape

recording. Comes with dust filter or windscreen, 10-ft. cable, mini (2) connector, one-point stereo pickup. Internal battery operation. Nickel satin finish \$49.95

F-98 Dynamic Microphone

Sensitivity -58 dB (0 dB = 1 V/10 μ bar). Low impedance. Cardioid pattern. Hand-held. Use for speech and tape recording. Supplied with mini connector and 6.5-ft. cable \$12.95

ECM-170 Condenser Microphone

Sensitivity -56 dB. Response 20-16,000 Hz. Low impedance. Omnidirectional pattern. Use for live recording of large ensembles. Has voice/music switch for adjusting frequency response. Comes with two-conductor shielded cable, accessory windscreen, and microphone holder \$69.95

ECM-220 Condenser Microphone

Sensitivity -57/-41 dB. Response 50-12,000 Hz. Impedance 200/10,000 ohms. Unidirectional pattern. Use for live music pickup. Has "on-off" switch; dual-impedance switch; built-in windscreen. Comes with microphone holder, battery, and audio cable \$39.95

ECM-250 Condenser Microphone

Sensitivity -57 dB. Response 50-14,000 Hz. Low impedance. Cardioid pattern. For all types of recording. Has built-in windscreen, making it suitable for outdoor recording. Comes with battery, mike stand adapter, cable, and carrying case \$49.95

ECM-270 Condenser Microphone

Sensitivity -56 dB. Response 40-16,000 Hz. Low impedance. Unidirectional pattern. Use for recording live musical performances. Lightweight for stage, nightclub, and other situations where performer holds mike. Comes with accessory windscreen, microphone holder, and cable \$69.95

ECM-280 Condenser Microphone

Sensitivity: -56 dB. Response 30-18,000 Hz. Low impedance. Cardioid pattern. Has bass roll-off switch and a built-in windscreen. An additional removable windscreen works in conjunction with the unidirectional pickup pattern for outdoor recordings free from wind and background noise. Incorporates FET electronics. Comes with battery, mike stand adapter, cable, and carrying case \$79.95

TEAC

MC-201 Microphone

Electret. Response 50-15,000 Hz. Balanced



600 ohms. Has slip-in stand attachment, windscreen, and 10-ft. cable. \$80.00

TELEDYNE

EO-200 Omnidirectional Microphone

Electret condenser microphone. Response 30-16,000 Hz. Output -59 dB at 600 ohms. Can be used with most medium- and high-impedance inputs as well. Features an FET frequency converter, XL-type connector; powered by two AA

penlite cells. Has non-glare finish, "on-off" switch, integral wind-breath filter, 20-ft shielded cable, and stand adapter. 6 ounces. \$36.00

EC-100 Unidirectional Microphone



Same specifications as EO-200 except unidirectional cardioid instead of omni... \$36.00

EO-300 Omnidirectional Microphone

Lavalier-type electret condenser microphone. Has integral "built-on" tie clasp. 1/2" dia. x 1 1/8" long. Battery-operated power supply built into plug; operates from single mercury cell. Response 50-13,000 Hz; output level -59 dB at 600 ohms. May also be used with most medium- and high-impedance inputs. Non-glare finish. Includes PL-280-type connector and 20-ft shielded cable. \$24.00

EO-350 Omnidirectional Microphone

Tulip-type electret condenser microphone with FET preamp and battery supply in barrel. Response 50-15,000 Hz. Output: -50 dB at 600 ohms. 1 3/8" dia. x 7" long. On-off switch, 18-ft cable, XL connector. \$30.00

EC-340 Unidirectional Microphone

Similar to Model EO-350, with unidirectional pickup pattern 1 1/2" dia. x 8 3/4" long... \$39.60

MK-055 Omnidirectional Microphone

Dynamic generating element for robust handling capabilities. Response 70-14,000 Hz. Output: -55 dB at 600 ohms. Does not require battery. 1 3/8" x 6 3/4". Comes with 18-ft cable, XL connector. \$34.80

MC-057 Unidirectional Microphone

Similar to Model MK-055, but with unidirectional pickup pattern. Response 80-16,000 Hz. 1 1/2" dia. x 8 3/4" long. \$39.60

EO-330 Omnidirectional Microphone

Electret condenser microphone with 80-12,000 Hz response. Output: -50 dB at 600 ohms. Can be used with most medium and high-impedance inputs as well. On-off switch. 3/4" dia. x 7 1/2" long, 18-ft cable. \$19.80

MC-057 Unidirectional Microphone

Dynamic generating element, acoustic filter grille to protect diaphragm and minimize pop and hiss; on-off switch; non-reflective gold-anodized finish. Response 70-16,000 Hz. Output: -55 dB at 600 ohms. May also be used with medium and high-impedance inputs. 1 1/2" dia. x 8 3/4" long, 18-ft cable. \$49.80

TURNER

500 Microphone

Dynamic type. Sensitivity -151 dB (EIA), response 40-12,000 Hz. User selects high or low impedance. Cardioid pattern. Hand-held with "slip-in" stand attachment. For use in recording speech, rock vocals, and music. Pop or blast filter. Detachable 20-ft. cable. Supplied with XLR connector. Satin chrome finish. \$100.00
Model S-500. Same except with rotary "on-off" switch. \$105.00

35 Microphone

Dynamic type. Sensitivity -151 dB (EIA), response 40-12,000 Hz. User selects high or low impedance. Cardioid pattern. Hand-held for use in speech applications. 25-ft. cable. Non-reflecting desert gold finish. \$70.00

700 Microphone

Dynamic type. Sensitivity -151 dB (EIA), response 40-15,000 Hz. User selects high or low impedance. Cardioid pattern. Hand-held with

"slip-in" stand attachment. For speech, rock vocals, and music. Pop or blast filter, "on-off" switch. Detachable 20-ft. cable. Comes with



Switchcraft A4F connector. Satin chrome finish. \$95.00

2300 Microphone

Dynamic type. Sensitivity -151 dB (EIA), response 50-15,000 Hz. High-impedance, omnidirectional. Hand-held with "slip-in" stand attachment. For speech, rock vocals, music, and tape recording. Has 20-ft cable, "on-off" switch, and phone plug. Satin chrome finish. \$80.00

Model 2302. Same except low-impedance version. \$80.00

S-2850 Microphone

Dynamic type. Sensitivity -161 dB (EIA), response 70-12,000 Hz. User selects high or low impedance. Cardioid pattern. Hand-held with "slip-in" stand attachment, lavalier clip. Use for speech and tape recording. Does not include connector but does have "on-off" switch and 12-ft. cable. Black. \$50.00

45 Cardioid Microphone

Dynamic design. Sensitivity -155 dB (EIA), response 100-13,000 Hz. High impedance. Use for speech, group singing, and music. Supplied with 20-ft. cable, phone plug, stand adapter, and "on-off" switch. \$45.00
Model 45A. Same except low-impedance version. \$45.00

2250 Cardioid Microphone

Dynamic design. Sensitivity -155 dB (EIA), response 70-13,000 Hz. High impedance. Use for speech, rock vocal groups, and music. Supplied



with 20-ft. detachable cable, phone plug, stand adapter, and "on-off" switch. Comes with Cryovac carrying case. \$65.00
Model 2255. Same except low-impedance version. \$65.00

600 Microphone

Dynamic type. Sensitivity -151 dB (EIA), response 50-15,000 Hz. High impedance. Cardioid pattern. Hand-held with "slip-in" stand attachment. For speech, rock vocals, and music. Pop or blast filter, "on-off" switch. Detachable 20-ft. cable. Satin chrome finish. \$70.00
Model 602. Same except low-impedance version. \$70.00

WE'LL SAVE YOU MONEY
 ON FAMOUS BRAND
 NATIONALLY ADVERTISED
STEREO COMPONENTS
 WRITE TODAY FOR OUR QUOTE AND
 OUR COMPLETE PRICE CATALOG.
 FAST DELIVERY IN FACTORY SEALED CARTONS
FOR IMMEDIATE QUOTE
 CALL (202) 723-6060
 THE COST OF YOUR CALL WILL BE DEDUCTED
 FROM ANY ORDER OVER \$200.00.

A.D.R. AUDIO
 6200 CHILLUM PLACE N.W.
 WASHINGTON, D.C. 20111
 Master Charge / BankAmericard
 Honored of Mail Orders

CIRCLE NO. 14 ON READER SERVICE CARD

HUGE SAVINGS ON FAMOUS BRAND STEREO COMPONENTS

DISCOUNTS
 ON NATIONALLY ADVERTISED
 TURNTABLES • CARTRIDGES
 COMPACTS • RECEIVERS
 AMPLIFIERS • TAPE RECORDERS

Wholesale Prices! Audio Warehouse Sales, One of the Capitols largest stereo wholesalers will fill and deliver all your mail orders promptly in factory sealed cartons, at prices that will amaze you.

Write for quote on Famous Brand, Stereo Components. We guarantee satisfaction.

AUDIO WAREHOUSE SALES
 3310 NEW YORK AVE. N.E.
 WASHINGTON, D.C. 20002
 (202) 832-1616

CIRCLE NO. 15 ON READER SERVICE CARD



BLANK TAPE & ACCESSORIES

ADVENT

Chromium-Dioxide Cassettes

Comes in screw-type housing with special lead-



er tape that cleans heads. In lots of six, comes with free optional storage album.

C-60	\$2.49
C-90	\$3.39
C-120	\$4.49

BASF

LP-35 Recording Tape

Polyester base, tensilized 1-mil., long play.

900 ft., 5" reel	\$3.41
1800 ft., 7" reel	\$5.64
1800 ft., 7" reel (3 pack)	\$16.27

DP-26 Recording Tape

Polyester base, tensilized 3/4-mil., double play.

1200 ft., 5" reel	\$5.12
2400 ft., 7" reel	\$8.14
2400 ft., 7" reel (3 pack)	\$23.12

TP-18 Recording Tape

Polyester base, tensilized, 1/2-mil., triple play.

1800 ft., 5" reel	\$7.98
3600 ft., 7" reel	\$12.26

LP-35LH Long-Play Tape

1-mil polyester base. Low-noise, high-output.

900 ft., 5" reel	\$4.10
1800 ft., 7" reel	\$7.14

DP-26LH Double-Play Tape

3/4-mil polyester base. Low noise, high-output.

1200 ft., 5" reel	\$5.86
2400 ft., 7" reel	\$9.55

TP-18LH Triple-Play Tape

1/2-mil polyester base. Low-noise, high-output.

1800 ft., 5" reel	\$9.12
3600 ft., 7" reel	\$13.67

"Chromdioxid" SM Cassettes

Plastic box.

30 min/side C-60	\$3.24
45 min/side C-90	\$4.74
60 min/side C-120	\$6.17

LHSM Cassettes

Plastic box.

C-60	\$2.55
C-90	\$3.79
C-120	\$4.71

SKSM Cassettes

Plastic box

C-30	\$1.33
C-45	\$1.42
C-60	\$1.50
C-90	\$2.05
C-120	\$2.88

"Sound Loop 8" Cartridges

45 minutes	\$2.43
64 minutes	\$2.60
90 minutes	\$2.99

"Sound Loop 8+" Cartridges

Low-noise, high-output cartridges.

45 min	\$2.94
64 min	\$3.15
90 min	\$3.49

CAPITOL

Capitol 1 Cassettes

C-30, 15 min/side	\$0.99
C-60, 30 min/side	\$1.19
C-90, 45 min/side	\$1.79
C-120, 60 min/side	\$2.49
C-30, Three pack	\$2.79
C-60, Three pack	\$3.39
Cassette head cleaner	\$0.99
Cassette saver	\$2.29

Capitol 1 8-Track Cartridges

32 min/150 ft	\$1.69
40 min/190 ft	\$1.99
64 min/300 ft	\$2.29
80 min/380 ft	\$2.39
100 min/470 ft	\$2.69
4 pk of 40 min	\$5.98
4 pk of 80 min	\$6.98
Cartridge head cleaner	\$1.19

Capitol 1 Open-Reel Tape

Standard play, 1.5-mil polyester

600 ft., 5" reel	\$1.89
1200 ft., 7" reel	\$2.49
Extra play, 1.0-mil polyester	
900 ft., 5" reel	\$2.39
1800 ft., 7" reel	\$3.19
0.5-mil polyester, tensilized	
1200 ft., 5" reel	\$2.69
1800 ft., 5" reel	\$3.69
2400 ft., 7" reel	\$3.99
3600 ft., 7" reel	\$5.99

Capitol 2 (UHL) Ultra-High-Output, Low-Noise Tape

Standard play, 1.5-mil, polyester base.

678. 600 ft, 5" reel	\$4.29
1278. 1200 ft, 7" reel	\$6.69

Extra play, 1.0-mil, polyester base.

968. 900 ft, 5" reel	\$5.89
1868. 1800 ft, 7" reel	\$8.49

All Capitol 2 UHL tapes have special leaders designed to be written upon and each end has a spliced-in switching foil.

Capitol 2 High-Performance, All-Purpose Tape

Standard play, 1.5-mil, acetate base.

652. 600 ft, 5" reel	\$2.98
1252. 1200 ft, 7" reel	\$4.79

Standard play, 1.5-mil, polyester base

672. 600 ft, 5" reel	\$2.98
1272. 1200 ft, 7" reel	\$4.79
Extra play, 1.0-mil, polyester base.	
962. 900 ft, 5" reel	\$3.59
1862. 1800 ft, 7" reel	\$5.98
Double-play tape, 0.5-mil, tensilized polyester base.	
1232T. 1200 ft, 5" reel	\$5.29
2432T. 2400 ft, 7" reel	\$8.99
Triple-play tape, 0.5-mil, tensilized polyester base.	
1832T. 1800 ft, 5" reel	\$6.98
3632T. 3600 ft, 7" reel	\$10.89

Capitol 2 Low-Noise Tape

Standard play, 1.5-mil, acetate base.

1259. 1200 ft, 7" reel	\$4.29
Standard play, 1.5-mil, polyester base.	
1279. 1200 ft, 7" reel	\$4.79
Extra play, 1.0-mil, polyester base.	
1869. 1800 ft, 7" reel	\$6.89

Capitol 2 Cassettes

High-output, low-noise cassettes with "Cushion-Aire" back coating.

C-40. 40 min	\$2.49
C-60. 60 min	\$2.98
C-90. 90 min	\$4.39
C-120. 120 min	\$5.95
Stak-Pak with two cassettes housed in storage	



chest.

C-40. 40 min	\$4.98
C-60. 60 min	\$5.98
C-90. 90 min	\$8.79
C-120. 120 min	\$11.89

Capitol 2 Audiopak 8-Track Cartridges

8-150. 32 min	\$2.39
8-190. 40 min	\$2.59
8-300. 64 min	\$2.79
8-380. 80 min	\$2.97
8-470. 100 min	\$3.29

Capitol 2 Premium Audiopak

Ultra-high output/low-noise 8-track cartridges.

8-190U. 40 min	\$2.69
8-380U. 80 min	\$3.29
8-470U. 100 min	\$3.59

COLUMBIA

Cassette Tapes

Each side color-coded for easy identification. High-output/low-noise gamma-ferric oxide. Response 20-20,000 Hz. Tensilized polyester

base. Delrin rollers; constant-tension pressure pad for consistent tape-to-head contact; mounted in three-sided Mumetal shield to prevent pickup of hum and noise.

2CL-40, 40 min	\$2.29
2CL-60, 60 min	\$2.79
2CL-90, 90 min	\$3.49
2CL-120, 120 min	\$4.49
2CL-HC, Head cleaner	\$1.79

8-Track Tapes

Back-lubricated high-output/low-noise gamma-ferric oxide tape. Response 20-20,000 Hz. Three-point Delrin tape suspension; silicone/rubber pinch roller; foam pressure pad; one-piece hub.

8CL-40, 40 min	\$2.69
8CL-80, 80 min	\$2.99
8CL-100, 100 min	\$3.49
8CL-HC, Head cleaner	\$1.69

Open-Reel Tapes

High-output/low-noise gamma-ferric oxide tape. Index and timing chart included with all packages.

4CL-1200, 7" x 1200 ft, 1.5-mil polyester	\$3.75
4CL-1800, 7" x 1800 ft, 1.0-mil polyester	\$4.49
4CL-2400, 7" x 2400 ft, 0.5-mil polyester	\$6.19
4CL-3600, 7" x 3600 ft, 0.5-mil polyester	\$8.29

HITACHI

"Ultra-Dynamic" Cassettes

UDC-60, 60 min	\$3.70
UDC-90, 90 min	\$4.80
UDC-120, 120 min	\$6.70

Low-Noise Cassettes

C-30, 30 min	\$1.65
C-60, 60 min	\$2.25
C-90, 90 min	\$3.20
C-120, 120 min	\$4.30

All "suggested list" prices

IRISH

200 Series Professional Tape

Standard, 1 1/2-mil, polyester base, 1/4"	
231-131, 600 ft, 5" reel	\$2.75
231-151, 1200 ft., 7" reel	\$4.80
Extra-length, 1-mil, polyester base, 1/4"	
241-131, 900 ft., 5" reel	\$3.60
241-151, 1800 ft., 7" reel	\$5.60
Double-length, 1/2-mil polyester tensilized base.	
251-151, 2400 ft., 7" reel	\$9.15
0.5-mil, polyester tensilized base, 1/4"	
261-151, 3600 ft., 7" reel	\$12.40

270 Series Tape

Low-noise, high-output type.

1-mil, polyester base, 1/4"	
274-151, 1800 ft, 7" reel	\$7.95
274-173, 3600 ft, 10 1/2" NAB aluminum reel	\$22.25
Low-noise, high-output, back coated.	
276-151, 1200 ft, 7" reel	\$6.75
276-173, 2500 ft, 10 1/2" NAB aluminum reel	\$17.60
276-273, 2500 ft, 10 1/2" NAB aluminum reel	\$33.65
277-151, 1800 ft, 7" reel	\$10.75

Hi-Fi Series Cassettes

Soft plastic boxes	
199-C40, 20 min/side	\$1.25
199-C60, 30 min/side	\$1.45

Professional-Series Cassettes

In album/mailer	
261-C40, 20 min/side	\$1.80
261-C60, 30 min/side	\$1.85
261-C90, 45 min/side	\$2.90
261-C120 60 min/side	\$3.45

Low-Noise, Extended-Range Cassettes

Flip-top plastic box	
262-C40, 20 min/side	\$2.35



262-C60, 30 min/side	\$2.55
262-C90, 45 min/side	\$3.35

Chromium-Dioxide Cassettes

Flip-top plastic box	
263-C60, 30 min/side	\$3.75
263-C90, 45 min/side	\$4.75

"3-in-a-Bag"

261-C60-3PA	\$4.95
-------------	--------

"2-in-a-Bag"

261-C90-2PA	\$5.40
-------------	--------

Cassette Package

Four cassettes plus a storage tray.	
261-C60-4P	\$8.50
261-C90-4P	\$12.70
261-C120-4P	\$14.90

8-Track Cartridge Package

Four 40-minute, 8-track cartridges, one head cleaner, plus storage tray.	
8T-160-P	\$12.50

8-Track Cartridge Package

Four 80-minute, 8-track cartridges, one head cleaner, plus storage tray.	
8T-320-P	\$14.90

LAFAYETTE

Tensilized Reel-to-Reel Tapes

Tensilized Mylar. 0.5-mil.	
300 ft, 3" reel, double-play	\$0.69
600 ft, 3 1/2" reel, double-play	\$0.99
3600 ft, 7" reel, triple-play	\$4.98

Mylar-Base Reel-to-Reel Tapes

On clear plastic reels.	
1200 ft, 5" reel, 0.5-mil	\$1.75
1800 ft, 7" reel, 1.0-mil	\$2.14
2400 ft, 7" reel, 0.5-mil	\$3.10

Tape for Auto-Reversing Machines

Has metal sensing strip at each end to activate the automatic-reversing mechanism in machines with this feature. May also be used on machines which do not reverse tapes.	
1200 ft, 5" reel, 0.5-mil Mylar	\$1.99
1800 ft, 7" reel, 1.0-mil Mylar	\$2.89
2400 ft, 7" reel, 0.5-mil tensilized Mylar	\$3.99

Chromium-Dioxide Cassettes

Chromium-based coating to provide low distortion, increased high-frequency levels, and reduced inherent tape noise. For recorders with chromium-dioxide bias switches.	
60 min	\$2.49
90 min	\$3.25

Criterion Ultra-Dynamic Cassettes

Low-noise, high-output. Wide dynamic range with high-frequency response of 30-20,000 Hz. Head cleaner section at one end, sensing foils at each end to activate machines having reversing mechanism, but may be used on all cassette recorders. Hard, clear plastic storage box.	
C-60UD, 60 min	\$2.40
C-90UD, 90 min	\$3.60
C-120UD, 120 min	\$4.75

Voice-Grade Cassettes

C-40, 40 min	\$0.79
C-60, 60 min	\$0.99
C-90, 90 min	\$1.49
C-120, 120 min	\$2.19

8-Track Mylar Cartridges

40 min	\$1.69
70 min	\$1.95
80 min	\$2.25

LONGINES SYMPHONETTE

Music-Grade Cassettes

M40, C-40, 40 min	\$1.99
M60, C-60, 60 min	\$2.29
M90, C-90, 90 min	\$2.99
M120, C-120, 120 min	\$3.49

Voice-Grade Cassettes

V40, C-40, 40 min	\$1.59
V60, C-60, 60 min	\$1.79
V90, C-90, 90 min	\$2.29

All-Purpose Cassettes

AP60, C-60, 60 min	\$1.29
AP90, C-90, 90 min	\$1.79
APS60, C-60 three-pack	\$3.87
APS90, C-90 three-pack	\$5.37

8-Track Cartridges

8M40, 40 min, single in sleeve	\$2.49
8M80, 80 min, single in sleeve	\$2.99

Cassette Tote Box

2AP60C (2-C60's)	\$2.19
2AP90C (2-C90's)	\$2.99

Head Cleaners

CMS-2 Cassette Maintenance Kit	\$2.99
8HCS-4 8-track (4-way head cleaner kit & demagnetizer)	\$4.99

MALLORY

Duratape Cassettes

Includes special head-cleaning leader. Packaged in Philips box.	
LNF30, 30 min	\$1.45
LNF60, 60 min	\$1.95
LNF90, 90 min	\$2.95
LNF120, 120 min	\$3.45

Professional Duratape Cassettes

Cobalt-energized, extended frequency. Packaged in Philips box.	
EFR30, 30 min	\$1.95
EFR60, 60 min	\$2.95
EFR90, 90 min	\$3.95

Fliptape Cassettes

Low-noise cassettes designed specifically for youth market. Packaged in poly box.	
FL40P, 40 min	\$1.45
FL60P, 60 min	\$1.55
FL90P, 90 min	\$2.25
FL120P, 120 min	\$2.75

Duratape 8-Track Cartridges

8T-40, 40 min	\$2.50
8T-80, 80 min	\$2.95
8T-HC, Head cleaner	\$1.85

Duratape Open-Reel Tape

3 x 150, 1 1/2-mil, 150 ft, 3" reel, polyester (4 pak)	\$2.05
5 x 600, 1 1/2-mil, 600 ft, 5" reel, tensilized polyester	\$1.95
5 x 1200, 1/2-mil, 1200 ft, 5" reel, tensilized polyester	\$3.05
5 x 1800, 1/2-mil, 1800 ft, 5" reel, polyester	\$4.90
7 x 1200, 1 1/2-mil, 1200 ft, 7" reel, polyester	\$2.65
7 x 1800, 1-mil, 1800 ft, 7" reel, tensilized polyester	\$3.45
7 x 2400, 1/2-mil, 2400 ft, 7" reel, tensilized polyester	\$4.30
7 x 3600, 1/2-mil, 3600 ft, 7" reel, polyester	\$6.50

6 Blank Tape

MAXELL

Ultra-Dynamic Cassettes (High Bias)

UDC-46, 23 min/side	\$3.00
UDC-60, 30 min/side	\$3.35
UDC-90, 45 min/side	\$4.90
UDC-120, 60 min/side	\$6.55

Low-Noise Cassettes (Normal Bias)

LNC-30, 15 min/side	\$1.93
LNC-60, 30 min/side	\$2.20
LNC-90, 45 min/side	\$3.35
LNC-120, 60 min/side	\$4.45

Low-Noise Tape (Normal Bias)

1.5-mil polyester	
LNE-50-7, 1200 ft., 7" reel	\$6.00
LNE-50-10R, 2500 ft., 10 1/2" reel	\$15.00
1-mil polyester	
LNE-35-7, 1800 ft., 7" reel	\$7.70
LNE-35-10R, 3600 ft., 10 1/2" reel	\$19.50
0.5-mil polyester	
LNE-25-7, 2400 ft., 7" reel	\$10.30
0.5-mil polyester	
LNE-18-7, 3600 ft., 7" reel	\$12.40

Extended-Range Tape (High Bias)

Ultra-dynamic, high-energy type.	
1.5-mil polyester	
UD50-7, 1200 ft., 7" reel	\$6.70
UD50-10R, 2500 ft., 10 1/2" reel	\$16.70
1-mil polyester	
UD35-7, 1800 ft., 7" reel	\$8.40
UD35-10R, 3600 ft., 10 1/2" reel	\$21.20

8-Track Cartridges (Normal Bias)

8T-200, 40 minutes	\$2.95
8T-300, 60 minutes	\$3.35
8T-400, 80 minutes	\$3.60

MEMOREX

Low-Noise, High-Output Tape

Standard play, 1.5-mil polyester, 1/4"	
600 ft, 5" reel	\$2.39
1200 ft, 7" reel	\$4.59
2500 ft, 10 1/2" reel	\$10.99
Long-play, 1-mil polyester, 1/4"	
900 ft, 5" reel	\$3.39
1800 ft, 7" reel	\$5.69
3600 ft, 10 1/2" reel	\$15.49
Double-play, tensilized polyester, 1/4"	
1200 ft, 5" reel	\$4.59
2400 ft, 7" reel	\$7.79

MRX₂ Oxide Cassettes

C-30, 15 min/side	\$1.79
C-45, 22 1/2 min/side	\$1.95



C-60, 30 min/side	\$2.19
C-90, 45 min/side	\$3.19
C-120, 60 min/side	\$4.19

Chromium-Dioxide Cassettes

C-45, 22 1/2 min/side	\$2.69
C-60, 30 min/side	\$3.19
C-90, 45 min/side	\$4.69

8-Track Cartridges

45 min	\$2.49
60 min	\$2.69
90 min	\$2.89

Accessories

Library (6 empty cassette albums) ..	\$3.29
8-track head cleaner	\$1.59
Cassette head cleaner	\$1.59
Empty 7" album	\$1.59

NAKAMICHI

Cassette Tape Album

Chromium-dioxide tape packed six cassettes to a fabric album of LP record jacket size.	
C-60	\$29.80
C-90	\$39.80

SCOTCH

Cassettes

High Energy
Features "High Energy" tape for quality sound; fully compatible with all cassette recorders. Has "Posi-Trak" back treatment. Album package.

45 min	\$3.00
60 min	\$3.25
90 min	\$4.90

Low-Noise/High-Density
Multi-purpose cassette featuring full dynamic



range throughout the audible sound spectrum. "Posi-Trak" back treatment. Album package.

45 min	\$2.25
60 min	\$2.50
90 min	\$3.75
120 min	\$5.00

Highlander/Low-Noise

For all-purpose cassette use. Polyester base.

45 min	\$1.35
60 min	\$1.50
90 min	\$2.50
120 min	\$4.10

Open-Reel Tapes

High-Output/Low-Noise
Provides 50% increase in signal output and additional 3 dB in dynamic range over conventional low-noise tapes.

No. 206. Polyester base, "Posi-Trak" backing, leader, and trailer. 1.5-mil. 60 min at 7 1/2 ips; 7" reel. \$6.50
No. 207. Polyester base, "Posi-Trak" backing, leader, and trailer, 1-mil. 90 min at 7 1/2 ips; 7" reel. \$8.10

Low-Noise/Dynarange

Provides high-fidelity recording even at 3 3/4 ips. Multi-purpose tape providing full dynamic range throughout audible spectrum. S/N is 4 to 6 dB better than standard tapes.

No. 211. Polyester backing, white yellow trailers. 1.5-mil. 30 min at 7 1/2 ips (5" reel); 60 min (7" reel). 30 min \$2.85
60 min \$4.25
No. 212. 1.0-mil. 45 min at 7 1/2 ips (5" reel); 90 min (7" reel). 45 min \$4.00
90 min \$7.00
No. 213. 0.5-mil tensilized. 120 min at 7 1/2 ips (7" reel) \$10.50
No. 214. 0.5-mil tensilized. 90 min at 7 1/2 ips (5" reel); 180 min (7" reel). 90 min \$7.00
180 min \$12.50

Highlander/Low-Noise

All-purpose economy tape for vocals as well as speech.

No. 228. 1-5 mil. 60 min at 7 1/2 ips (7" reel)

.....	\$3.25
No. 229. 1-mil. 90 min at 7 1/2 ips (7" reel)	\$5.25
.....	\$5.25

8-Track Cartridges

Features low-noise oxide coating on heavy-duty lubricated polyester backing.

High-Output/Low-Noise

Full 2-dB increase in output over premium tapes. Captures full balanced sound.

8TR-45 HO/LN. 45 min	\$3.25
8TR-90 HO/LN. 90 min	\$3.55

Low-Noise/Dynarange

All-purpose cartridge	
8TR-45. 45 min	\$2.60
8TR-90. 90 min	\$3.25

SONY BY SUPERSCOPE

Professional Recording Tape

Extra-heavy-formula Oxi-coat homogenized oxide coating; polyester back, "lubri-cushion" impregnated lubricant.

PR-150-3. 300 ft, 3 1/4" reel, 1 mil	\$1.99
PR-150-9. 900 ft, 5" reel, 1 mil	\$2.99
PR-200-12. 1250 ft, 5" reel, 0.5 mil	\$4.49
PR-150-18. 1800 ft, 7" reel, 1 mil	\$4.99
PR-200-24. 2400 ft, 7" reel, 0.5 mil	\$7.49

Low-Noise, High-Output Tape

On 1-mil polyester base.	
SLH-180-18. 1800 ft, 7" reel	\$6.49

Auto-Sensor Cassette Tape

C-45 Plus 2. 23 min/side	\$1.39
C-60 Plus 2. 31 min/side	\$1.49
C-90 Plus 2. 46 min/side	\$2.19
C-120 Plus 2. 61 min/side	\$3.19

Ultra-High-Fidelity Cassette Tape

With Auto-Sensor	
UHFC-60 Plus 2.31 min/side	\$2.39
UHFC-90 Plus 2.46 min/side	\$3.49
UHFC-120 Plus 2. 61 min/side	\$4.99

Chromium-Dioxide Cassettes

CRO-60. 60 min	\$3.29
CRO-90. 90 min	\$3.99

8-Track Cartridges

8T-40 Plus 2. 21 min/side	\$2.99
8T-60 Plus 2. 31 min/side	\$3.49
8T-80 Plus 2. 41 min/side	\$3.99

Empty Tape Reels

Computer-styled tape reels, with box.	
MTRB-7. 7"	\$0.99
MTRB-5. 5"	\$0.79
MTRB-3. 3 1/4"	\$0.69

SOUNDCRAFT

Cassette Tapes

2SC-30. 30 min	\$0.79
2SC-40. 40 min	\$0.89
2SC-60. 60 min	\$1.39
2SC-90. 90 min	\$1.69
2SC-120. 120 min	\$1.99
2SC-HC. Head cleaner	\$1.39

8-Track Tapes

8SC-40. 40 min	\$1.69
8SC-80. 80 min	\$1.99
8SC-HC. Head cleaner	\$1.29

Open-Reel Tapes

4SC-1200. 7" x 1200 ft	\$2.69
4SC-1800. 7" x 1800 ft	\$3.29
4SC-2400. 7" x 2400 ft	\$4.99
4SC-3600. 7" x 3600 ft	\$6.99

TDK

"Extra Dynamic" Cassettes

Exclusive "stagnitite" coating for highest MOL (maximum output level), wide dynamic range,

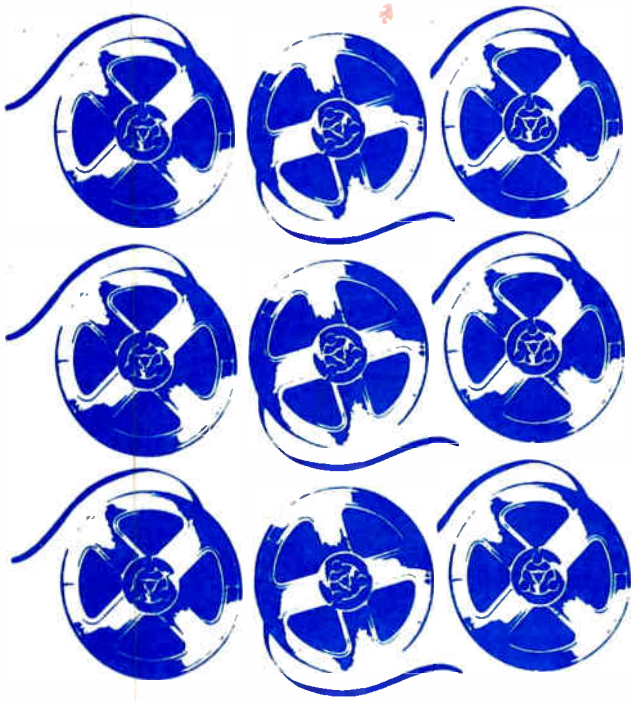

FREE INFORMATION SERVICE

- a** Here's an easy and convenient way for you to get additional information about products advertised in this issue. Just follow the directions below... and the literature will be sent to you free of charge.
- b** Tear out one of the perforated postage-free cards. Please print or type your name and address where indicated.
- c** Circle the number on the card that corresponds to the key number at the bottom of the advertisement that interests you. (Key numbers for advertised products also appear in the Advertisers' Index.)
- d** Simply mail the card. No postage is required.
- e** This address is for our "Free Information Service" only. All other inquiries are to be directed to, Tape Recording & Buying Guide, One Park Ave., New York, N.Y. 10016.

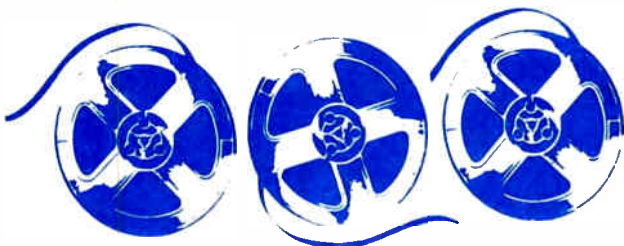

(Void after Feb. 19, 1975)

1 2 3 4 5 6 7 8 9 10 11 12 13 14 15 16 17 18
19 20 21 22 23 24 25 26 27 28 29 30 31 32 33 34 35 36
37 38 39 40 41 42 43 44 45 46 47 48 49 50 51 52 53 54
55 56 57 58 59 60 61 62 63 64 65 66 67 68 69 70 71 72
73 74 75 76 77 78 79 80 81 82 83 84 85 86 87 88 89 90
91 92 93 94 95 96 97 98 99 100 TR743

PRINT NAME _____

ADDRESS _____

CITY _____ STATE _____ ZIP _____

(zip code must be included to insure delivery)

(Void after Feb. 19, 1975)

1 2 3 4 5 6 7 8 9 10 11 12 13 14 15 16 17 18
19 20 21 22 23 24 25 26 27 28 29 30 31 32 33 34 35 36
37 38 39 40 41 42 43 44 45 46 47 48 49 50 51 52 53 54
55 56 57 58 59 60 61 62 63 64 65 66 67 68 69 70 71 72
73 74 75 76 77 78 79 80 81 82 83 84 85 86 87 88 89 90
91 92 93 94 95 96 97 98 99 100 TR743

PRINT NAME _____

ADDRESS _____

CITY _____ STATE _____ ZIP _____

(zip code must be included to insure delivery)

(Void after Feb. 19, 1975)

1 2 3 4 5 6 7 8 9 10 11 12 13 14 15 16 17 18
19 20 21 22 23 24 25 26 27 28 29 30 31 32 33 34 35 36
37 38 39 40 41 42 43 44 45 46 47 48 49 50 51 52 53 54
55 56 57 58 59 60 61 62 63 64 65 66 67 68 69 70 71 72
73 74 75 76 77 78 79 80 81 82 83 84 85 86 87 88 89 90
91 92 93 94 95 96 97 98 99 100 TR743

PRINT NAME _____

ADDRESS _____

CITY _____ STATE _____ ZIP _____

(zip code must be included to insure delivery)

FREE INFORMATION SERVICE

(SEE REVERSE SIDE)

FIRST CLASS

PERMIT NO. 217

CLINTON, IA.

BUSINESS REPLY MAIL

NO POSTAGE NECESSARY IF MAILED IN THE UNITED STATES

POSTAGE WILL BE PAID BY—

1974 TAPE RECORDING & BUYING GUIDE—

P.O. BOX 2910
CLINTON, IA. 52732



FIRST CLASS

PERMIT NO. 217

CLINTON, IA.

BUSINESS REPLY MAIL

NO POSTAGE NECESSARY IF MAILED IN THE UNITED STATES

POSTAGE WILL BE PAID BY—

1974 TAPE RECORDING & BUYING GUIDE—

P.O. BOX 2910
CLINTON, IA. 52732



FIRST CLASS

PERMIT NO. 217

CLINTON, IA.

BUSINESS REPLY MAIL

NO POSTAGE NECESSARY IF MAILED IN THE UNITED STATES

POSTAGE WILL BE PAID BY—

1974 TAPE RECORDING & BUYING GUIDE—

P.O. BOX 2910
CLINTON, IA. 52732

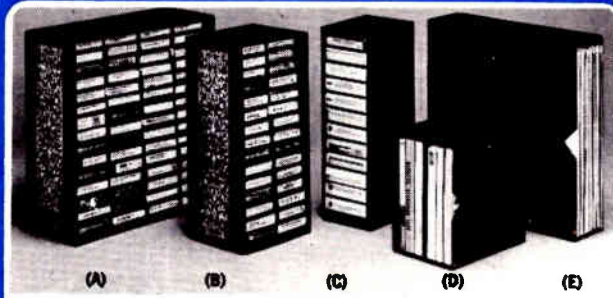
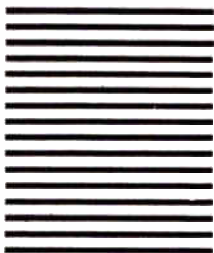

A COMPLETE SET OF MATCHED STORAGE CASES

Here's the ideal solution to the problem of keeping all your records and tapes stored neatly, safely, conveniently and attractively. A complete set of matched storage cases, designed by the editors of STEREO REVIEW magazine, for your records and all your tapes: cassette, cartridge and 7" reel. Now you can keep them side-by-side on your bookshelf or cabinet, easy to identify and readily available.

These cases are sturdily constructed and covered in a handsome leatherette. The outer case is elegantly embossed in gold and comes in your choice of three popular decorator colors—black, brown and green—so that they lend themselves readily to the decor of any room.

STEREO REVIEW large capacity storage cases are just what you've been looking for—they're the ideal solution to keeping your records and tapes neatly stored for easy use.

- (A) 60-unit cassette case 13½" high x 12½" deep x 5½" wide. \$15.95 each; 3 for \$45.00.
- (B) 30-unit cassette case. 13½" high x 6½" deep x 5½" wide. \$11.95 each; 3 for \$33.00.
- (C) 12-unit 8-track cartridge case. 13¼" high x 6½" deep x 4½" wide. \$7.95 each; 3 for \$22.00.
- Units A, B and C have tilted compartments to prevent spillage and include pressure sensitive labels for titling.
- (D) 6-unit 7" reel case. 8" high x 7½" deep x 5" wide. Holds reels in original boxes. \$5.25 each; 3 for \$15.00.
- (E) 20-unit 12" record case. 13¼" high x 12½" deep x 3½" wide. Holds records in original jackets. \$5.95 each; 3 for \$17.00.

HERE'S HOW TO ORDER

CASH: Mail your order along with your name, address and remittance in the amount indicated above for the units being ordered PLUS an additional 50¢ per unit for postage and handling.

CHARGE: Your American Express or BankAmericard account! Mail your order, name, address and credit card number. You will be billed for the amount of your order.



BE SURE YOU IDENTIFY THE TYPE OF CASE ORDERED AND INDICATE YOUR COLOR CHOICE FOR THE BACK OF THE CASE—BLACK, GREEN OR BROWN (SIDES IN BLACK ONLY).

MAIL ALL ORDERS TO: Ziff-Davis Publishing Co., Dept. 721A, One Park Ave., New York, N.Y. 10016. Outside U.S.A. add \$1.00 per unit ordered.



high S/N. Response 20-23,000 Hz. Includes new 45-min. "record-album-length." Polyester base.

- ED-C45, 45 min \$3.35
- ED-C60, 60 min \$3.75
- ED-C90, 90 min \$5.60

"Super Dynamic" Cassettes

High-performance gamma ferric oxide for wide dynamic range, low-noise, and distortion-free output. Response 30-20,000 Hz. Polyester back.

- SD-C45, 45 min \$2.75
- SD-C60, 60 min \$3.00
- SD-C90, 90 min \$4.50
- SD-C120, 120 min \$6.00

"Dynamic" Cassettes

Features company's new M-400 gamma ferric-oxide coating. Includes new 3-hour "4-record-album-length" cassette plus new single-album-length cassette. Polyester back.

- D-C45, 45 min \$2.25
- D-C60, 60 min \$2.50
- D-C90, 90 min \$3.75
- D-C120, 120 min \$5.00
- D-C180, 180 min \$6.85

"Krom" Chromium-Dioxide Cassettes

Outstanding linearity at very high frequencies. Use on machines with CrO₂ bias. Polyester back. Packed in plastic boxes.

- KR-C60, 60 min \$3.75
- KR-C90, 90 min \$5.60

"Endless" Cassettes

Endless-loop design with safety feature against accidental reversal. Usable in conventional cassette machines. Polyester backing. Packed in plastic boxes.

- EC-20S, 20 sec \$5.00
- EC-30S, 30 sec \$5.00
- EC-1, 1 min \$5.00
- EC-3, 3 min \$5.25
- EC-6, 6 min \$5.75
- EC-12, 12 min \$6.85

Head Cleaner Cassette

Chromium trioxide removes deposits, laps and polishes pitted heads. Unique check-off chart on box keeps record of cleaner life.

- HC-1 \$1.50

"Super Dynamic" 8-Track Cartridges

Full-fidelity 8-track cartridges with gamma ferric oxide. Response 20-23,000 Hz. High saturation and output level (MOL). Has broad dynamic range, high S/N, and minimum distortion.

- 8TR-40SD, 40 min \$3.75
- 8TR-80SD, 80 min \$5.00

"Super Dynamic" Open-Reel Tape

High-resolution gamma ferric oxide for wide dynamic range, low noise, and distortion-free output. Response 20-30,000 Hz.

- 1200-SD, 1200 ft, 7" low-torque reel . \$4.50
- 1800-SD, 1800 ft, 7" reel \$6.25
- 3600-SD, 3600 ft, 10 1/2" NAB reel .. \$15.60



ADVENT

MPR-1 Microphone Preamplifier

For use with low-impedance balanced or unbalanced microphones. Switchable gain for either 40 or 60 dB. Operated by power supply of Advent 201 cassette deck. 5 1/4" x 2 3/4" x 1" D

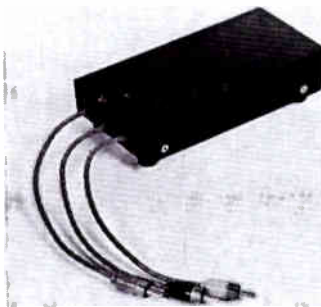

..... \$25.00

100A Dolby System

Noise-reduction unit with Dolby system for home tape recording/playback. Also plays Dolby-encoded pre-recorded commercial tapes and FM broadcasts. Provides four-input mixing



(two on each channel), headphone monitoring, and sound-on-sound recording. Harmonic and IM distortion 0.1%. 5" x 12 7/8" x 8 3/4" D. Cabinet extra \$250.00

101 Dolby System

Similar in principle to Model 100A, but can only be used in record or playback mode (uses same

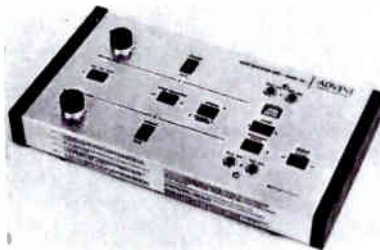

circuitry), but not simultaneously for two operational modes \$125.00

ATLAS SOUND

MS-50 Floor Stand

Triangular-based general-purpose microphone stand; grip-action clutch; scuff-resistant steel base with protective pads; upper tube chrome plated, lower tube and stand base in black; height 35" to 63"; base 14 1/2"; weight 6 1/2 lbs. \$14.15

MS-10C. Popular version with charcoal wrinkle 10" dia. base; weight 10 lbs. \$16.40

MS-11C Floor Stand

General-purpose stand; grip-action clutch; low-profile chrome base with added weight for extra stability; 34" to 62"; 10" dia. chrome base; weight 13 lbs. \$20.85

MS-12C. Economy version with charcoal wrinkle-finish base. \$17.25

MS-11S Floor Stand

Automatic clutch stand; instantaneous changes in height by grasping control sleeve and raising or lowering microphone; removing hand automatically locks stand height; low silhouette chrome base; 39" to 62"; 10" dia. chrome base; weight 13 lbs. \$38.65

MS-20 Floor Stand

Heavy-duty professional stand; grip-action clutch; extra height; oversize 1 1/8" dia. tube assembly with 3/8"-27 thread top adapter; low-contour base; 37" to 66"; 12" dia. charcoal base; weight 15 lbs. \$26.65

CS-42 Floor Stand

Folding base stand for portable use; grip-action clutch; three legs collapsible for storage; 34" to 62"; charcoal finish legs; 16" dia. base; weight 9 lbs. \$22.25

BB-1 Boom Stand

Baby boom attachment; attaches to any adjustable microphone stand; locks in any position; boom arm 31" long; chrome tube 3/8"-27 threaded; counterweight in charcoal wrinkle. \$12.60

BB-44 Boom Stand

Contemporary mike boom attachment; single positive-action triangular knob to control motion



and positioning of die-cast one-piece universal swivel; for use with any 3/8"-27 threaded adjustable microphone stand; 31" long chrome tube; tapered gloamed black counter-weight; recessed cable guide. \$13.30

AUDIOTEX

The company carries a complete line of tape accessories for use with open-reel, cassette, and 8-track equipment.

- 30-2150. Cleaning pen for tape heads \$1.95
- 30-126. Kleentape for open-reel recorder heads \$2.25
- 30-026. Tape cleaning cloth \$0.90
- 30-129. Tape Care Kit, Jr. contains head cleaner, cotton swabs, and cleaning cloth \$1.60
- 30-630. "Blast-off" tape head cleaner, 3-oz. aerosol can \$1.75
- 30-128. Same except in 6-oz aerosol can \$2.25
- 30-124-1. Recording head cleaner, 2-oz bottle \$1.00
- 30-124-2. Recording head lubricant, 2-oz bottle \$1.00
- 30-636. Tape player care kit contains cleaner and head lubricant, two 6" brushes, 10 plastic pouches to protect tape reels, cassettes, or cartridges \$2.95

Splicing Tapes

- 30-109. Mylar base with cold-setting, non-flowing pressure-sensitive adhesive. 1/4" tape, 100-in roll \$0.55
- 30-113. Same except 3/8" tape \$0.70
- 30-110. Same except 1/2" tape \$0.75

Eze-Splice Tape Splicer

All metal construction; cutting blade included. 30-100. 1/4" for all reel tape \$2.95

30-652. 1/8" for cassette tape \$2.95

Cassette Tape Splicer

Semi-automatic. Has cut position for diagonal cut on tape ends, trim position for final splice. 30-104. For 1/4" reel-to-reel tape \$4.95

30-650. For 1/8" cassette tape \$4.95

Deluxe Tape Splicer

Built-in splicing tape dispenser; 100-inch roll of tape included. Cuts tape diagonally and trims

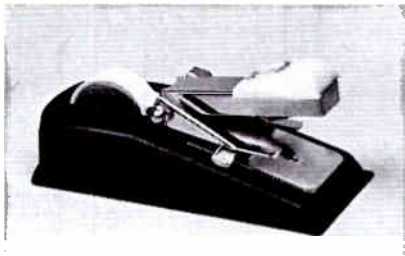

with waistline cut. 30-106. For all reel tape
..... \$6.95

Test Tapes

Checks for performance and alignment. Contain recordings to measure frequency response and equalization, flutter, wow, distortion, stereo balance, separation and channel identification, and tape-head alignment.

- 30-212. Cassette type \$5.95
- 30-213. 4- and 8-track cartridge \$8.95
- 30-214. 4-track stereo, 7 1/2 ips, 5" reel ...
..... \$6.80
- 30-2610. 2-track mono, 7 1/2 & 3 3/4 ips. In-
cludes bottle of head cleaner \$4.95

Metallic Sensing Tape

For use on recorders with electronic switching controls or, when used with cartridge players, provides automatic track switching. 30-135
..... \$2.50

Level-Test Cartridge

For presetting and adjusting volume, tone, and balance prior to final recording. Convenient 1-minute length. 8-track. 30-215 \$3.95

Bulk Tape Eraser

For reels, cassettes, or cartridges. Use as table



or hand-held model. UL and CSA approved.
30-140 \$17.95

Head Demagnetizers

Flat tip coated with soft plastic to prevent head damage; momentary push-button switch operation, 6-ft cord.

- 30-112-2. Extra-long tip for 4- and 8-track
players \$11.95
- 30-112. Professional-type unit for all heads
..... \$11.95

BSR-METROTEC

FEW-3 Frequency Equalizer

Stereo frequency equalizer provides 12 zones



of control for each channel. Has two VU meters, defeat switch, and switch back control for both playback and recording. Distortion 0.007%.
..... \$199.95

FEW-2 Frequency Equalizer

Two-channel, five-zone per channel, frequency equalizer. Response: flat setting 5-100,000 Hz ± 1 dB; tone control range ± 12 dB at 60, 240, 1000, 3500, and 10,000 Hz. IM dist. 0.05% at 2 V output; HD 0.05% at 2 V output (20-20,000 Hz); max. output 9 V \$99.95

CHEMTRONICS

Tape Head Cleaner

Aerosol cleaner formulated for cassette, reel-to-reel, and 8-track recorders and players. Removes dirt, film, and oxides from heads, tape guides, capstan rollers, and other critical parts. Furnished with spray extender for pinpoint application. #THC-6 \$2.65
504-3. Same except 2-oz. bottle with special felt applicator \$1.70
HC-3 Same, except 3-oz. spray can \$1.40

Non-Slip Drive/Belt Restorer

Restores hardened and glazed rubber drives and belts. Fast drying. Prevents slippage and insures uniform speed. 2 ounces. #507-7. \$1.59

Cassette Head Cleaner

Non-abrasive buffing tape. Cleans graphite deposits from tape head. To be used the same as regular cartridge. #CHC \$1.98

Cassette Maintenance Kit

Performs double cleaning function of tape head and capstan shaft cleaner. Uses special cleaning liquid applied directly to non-abrasive buffing tape. #CHC-Kit \$2.98

8-Track Head Cleaner

Cleans graphite deposits from tape heads with gentle wiping action. In use it is inserted in tape player and run for 30 seconds for every 50 hours of operation. #TR-8 \$1.98

8-Track Maintenance Kit

Cleans player head and capstan shaft with special cleaning liquid applied to tape. Prepared cartridge is inserted in player and job is done in seconds. Designed to be used weekly. #TR-8 Kit \$3.05

Double-Head Cleaner

Requires no liquids or solvents. Works automatically in seconds. Has click timer. Removes graphite deposits from magnetic head and capstan shaft and prevents build-ups which often cause tape pull-out and breakage. Use after every 40 hours of play. #DH-8 \$3.49

Cassette Combo 3-in-1 Test Cartridge

Specially designed maintenance unit in a cassette; non-abrasive leader removes oxide deposits from head; tape checks proper head alignment to minimize crosstalk, also checks proper balance between stereo channels. #C-3 \$2.69
8T-3. Same, except for 8-track cartridge recorder/players. \$2.69

CONCORD

DBA-9 Dolby Adapter

Record/playback noise-reduction system using Dolby-B type circuits. Has individual record and output level controls; dual VU meters. Input imp. 25,000 ohms. Sensitivity 30 mV; output 0.58 V adjustable. Output imp. 2500 ohms. Response 20-15,000 Hz ± 0.5 dB. HD 0.2%. Noise reduction 8 dB at 2000 Hz & 10 dB at 5000 Hz. Supplied with Dolby-level pre-recorded tape (1 cassette & 1 3" reel) for calibration. 10 3/4" W x 3" x 7 1/2" D \$114.95

DBA-10 Dolby Adapter

Record/playback noise-reduction system using Dolby B-type circuitry. Has individual input/output channel-level controls with calibration adjustments available from front panel. Includes a built-in calibration tone signal and twin DIN/Dolby NAB meters. Response 20-20,000 Hz ± 0.5 dB, HD 0.4%. Input sensitivity 30 mV, output 0.58 V adjustable. Noise reduction 8 dB at 2000 Hz, 10 dB at 5000 Hz. 13 1/2" x 3 1/2" x 7 1/4" D \$139.95

dbx

117 Dynamic Range Enhancer

A compressor/expander that permits listener to restore up to 20 dB of the dynamic range missing from records, tapes, or FM broadcasts. As a classical compressor/expander, allows the recordist to make full dynamic range tapes on moderately priced recorders and obtain 20 dB or more improvement (S + N)/N \$159.00

150 Series Noise Reduction Systems

Allows recordists to make noise-reduced tapes to studio standards on better-grade audiophile recorders. Fully compatible with company's studio professional models but with single-ended inputs/outputs and RCA-type phono connectors to facilitate connections to audiophile recorders, amplifiers, etc. Provides 30 dB noise reduction with 10 dB more headroom. Extruded aluminum and solid walnut cabinet. 3 1/2" H x 9" W x 10 1/2" D.

Model 157. Two-channel simultaneous record and play. \$567.00

Model 152. Two-channel switchable record or play. \$410.00

Model 154. Four-channel switchable record or



play (may also be used as two-channel simultaneous record and play). \$646.00

DUBIE TAPE-AID

CD-5 Control System

Combination mixing, fading, and switching system which allows up to three tape recorders to

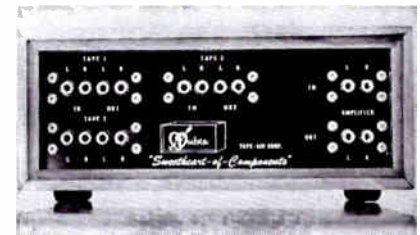

be integrated with an amplifier into single semi-professional sound studio. Permits operator to record on up to three tape recorders simultaneously; dub from any recorder to any other recorder; mix output of any two recorders and record the blended signal on a second recorder; or copy tapes from one recorder to another while the third recorder is taping the output of the amplifier. Walnut cabinet. 9 1/4" x 4 1/2" x 3 1/4" \$79.95

EDITALL

KP-2 Editing Kit

Complete kit includes splicing block, 30 splicing tapes, demagnetized razor blade, and

grease pencil \$4.50

KS-2 Editing Kit

For 1/4" tape, includes a 4" x 3/4" x 1 1/4" block,

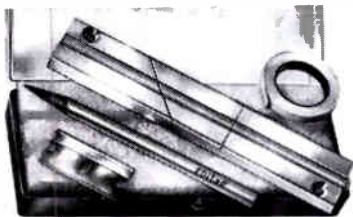

marking pencil, roll of splicing tape, and cutting blade \$11.50

KS-3 Editing Kit

Same as KS-2 except includes larger block (5 3/4" x 1" x 3/8") \$13.50

Metal Splicing Blocks

- S-1, For 150" cassette-type tape ... \$12.50
- S-2, For 1/4" tape compact machines \$10.50
- S-3, For 1/4" tape console machines \$12.50
- S-3.5, For 1/2" tape \$27.50

FERROGRAPH

RTS-2 Recorder Test Set

Will test wow & flutter, frequency response, (S + N)/N ratio, gain, distortion, crosstalk, era-

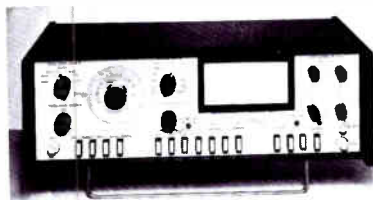

sure, input sensitivity, output power, and drift. Input required 35 mV to 5 V. Has output for oscilloscope. 17 3/8" x 10" x 5 3/8" H. \$1500.00

JVC

SEA-10 Sound Effects Amplifier

Five-zone sound-effects amplifier/equalizer circuit, switchable to 40, 60, 250, 1000, 5000, 10,000 and 15,000 Hz. Permits sound equalization during recording as well as playback. 5 1/4" x 7 1/2" x 10" D \$109.95

NR-1020 ANRS Noise-Reduction Unit

Automatic noise-reduction unit for use with reel-to-reel, cassette, and cartridge tape decks. Improves (S + N)/N by 5 dB at 1000 Hz and 10 dB at 10,000 Hz. Includes built-in 400-Hz oscillator, two meters, two recording-level and two playback-level controls, reel-to-reel and cassette calibration tapes. 3 3/8" x 13 1/8" x 7 1/2" D \$139.95

LAFAYETTE

Deluxe Bulk Tape Eraser

Tape degausser for erasing 1/4" tapes or smaller and demagnetizing tape, magnetically stripped film, tools, and watches. Has custom-finished case, non-magnetic top, "on-off" switch, power cord, built-in fuse, pilot light, and non-magnetic Bakelite plate for reel rest. Separate spindle positions for 10 1/2", 7", 5", and 3" reels. Coil consumes 5 amps. 7 1/4" x 4 1/4" x 3 1/2" \$14.95

Tape Head Demagnetizer

Pencil-shaped with one extending probe which allows for reaching all heads in all positions. With "on-off" switch \$3.79

Telephone Pickup Coil

Designed to feed into the microphone input of tape recorder of any high-gain amplifier. Easily

fastened to the telephone by rubber suction-type attachment. Has 4 1/2-ft shielded cable with 1/8" miniature plug \$1.10

DNR-50 Noise-Reduction Unit

Can be used with any tape deck or self-contained tape recorder having audio inputs and outputs. Increases S/N 10 dB at 10,000 Hz; 5 dB at 1 kHz. Has built-in Dolby reference meter with three-position function switch; separate slide lever record level controls, play/record push-button switch. Response 20-15,000 Hz ±2 dB. Must be used with separate Dolby calibration tape. 9" x 7 3/8" x 3 1/8" \$79.95
Dolby cassette calibration tape \$4.89

LE-BO

Cassette Storage Unit

Contemporary styled tape storage cabinet; designed to blend with all audio system equipment cabinets; walnut finish; removable hinged plastic dust cover; velvet-lined individual compartments; holds 40 cassettes. TA-154 \$29.95

Cartridge Storage Unit

Wood construction with drop-down tray. Holds 45 8-track cartridges, individually packed. Walnut-grain finish; velvet-flocked interior. TA-140 \$39.95

Cartridge Demagnetizer

Designed for demagnetizing 8-track car players; plugs into 12-volt lighter socket; solid-state. TA-44 \$8.95

MAGNESONICS

Erasette Tape Eraser

Will erase a cassette or 8-track cartridge to -65 dB from 0 reference. Battery operated (four "A" cells). 4" x 3 1/2" x 2 3/4" \$15.95

MURA

A-10 Stereo Volume Control

Stereo/mono switch enables headset to be used with radio, TV, electronic organ, or other mono program sources. Features electronic slide controls and 15-ft extension cord \$9.95

NAKAMICHI

Head Demagnetizer

Slim-line, easy-to-use recorder head demagne-



tizer, specially designed for the company's Models 1000 and 700 cassette decks .. \$15.80

PANASONIC

RP-966 Outboard Dolby Unit



Has built-in oscillator for proper recording level meter, Dolby level meter for proper Dolby level adjustment, recording level control for matching program source levels to tape deck levels, and Dolby for FM broadcasts in both playback and record \$69.95

PIONEER

SR-202W Reverberation Amp

Double-scatter system blends direct signals from source with reverb effect. Reverb time 0-2.5 seconds at 1 kHz. -1D less than 0.2% at 1 kHz reverb time. Minimum output level 330 mV. Response 20-35,000 Hz ±2 dB (min. reverb time) and 20-50,000 Hz ±10 dB (max. reverb time). (S + N)/N 65 dB at 330 mV output. Universal power supply \$139.95

SD-1100 Stereo Display

Designed for measurement and scoping of all audio components and stereo characteristics. Will show any waveform and measure voltage level and phase shift. Has built-in audio oscillator 20-20,000 Hz with automatic or manual sweep. Can also be used for 4-channel analysis. With universal power supply \$599.95

ROBINS

Cassette Storage Album

Library-designed album holds 12 cassettes. Built-in stops prevent tape from unwinding and becoming slack. Walnut wood-grained cover. 10 7/8" x 9 3/8" x 1 1/4". #TSA-1W \$4.15

Cassette Tape Mailers

15 cardboard mailers ready for addressing. Has stops to protect tape from unwinding. #TCB-18 \$1.80

Cassette Head Demagnetizer

Removes excessive magnetic build-up. Designed to be used every 15-20 hours of player/recorder use. 110 V, 50-60 Hz operation. #TD-10 \$9.95

Head Cleaner Tape

Non-abrasive tape for cleaning cassette recorder/player heads. Removes accumulated oxide, grime, and foreign particles. #THC-4 .. \$2.50

Test/Clean Cassette

Performs three functions to help maintain optimum recorder/player performance: cleans heads, tests for correct head alignment, and tests stereo balance equalization between channels. #THC-6 \$2.95

Cassette Tape Splicing Block

Precision splicing block cuts tape at 45 or 90 degree angle. Comes in self-contained, pocket-size carrying case complete with cutting block and 25 pre-cut self-stick splicing patches. #TS-215 \$12.15

Cassette Bulk Tape Eraser

Removes recorded sounds from entire tape in seconds. #TMC-1 \$25.70

Bulk Cartridge Erasers

Erases any cartridge in seconds. Operates from 110 V, 50-60 Hz source. #TMC-2 Deluxe model \$41.50

Cartridge Head Demagnetizers

Removes excessive magnetic build-up from recorder/player heads. Use after 15-20 hours of player/recorder use.

#TD-12 For home cartridge units. 110 V, 50-60 Hz operation \$13.75
#TD-15 For auto cartridge units. Plugs into cigarette lighter in car. \$14.50

Cartridge Head Cleaner

Special polyester non-abrasive tape which removes oxide, grime, and dust particles from heads. #THC-10 \$2.50

Test-n-Clean Cartridge

Performs five functions to maintain trouble-free cartridge player/recorder performance: cleans player heads, tests track selector, tests stereo channel balance, tests speaker phasing, and tests head alignment. #THC-11 . . . \$6.10
THC-8. Same except doesn't include speaker phasing or track selector test functions . \$2.95

Head Demagnetizer

Demagnetizer for reel-to-reel recorder heads. Probe has soft plastic shield for safe contact with heads and angled to reach recorder heads without removing cover plates. 3 1/2" x 1 1/4" dia. Operates from 110 V, 50-60 Hz. #TD-3 . . . \$7.70

Bulk Tape Eraser

Reduces background noise levels of tape from 2 to 4 dB below erase-head level. For 1/4" tapes on reels up to 7" dia. 2 3/8" x 3 3/4" x 6 1/4". Operates from 110-120 V, 50-60 Hz sources. #TM-77 . . . \$39.85

Stereo Tape Splicer

Splices 4-track stereo tapes without sacrificing program material on the outer tracks. Cuts tape diagonally and trims "Gibson Girl" waists on sides of splices to prevent adhesive from contacting critical parts of recorder. See-through windows of operating lever show cut and trim positions. Integral tape dispenser comes with roll of 1/2" x 100" splicing tape. #TS-8D. . \$15.70

Cassette Splicer

Has built-in dispenser with splicing tape in base. Steel construction. Fast and easy to use #R33029 . . . \$6.50

RUSSOUND**TMS-1W Tape Recorder Selector**

Allows up to three tape recorders or other signal sources to be interfaced through the tape input/output of a single receiver or amplifier. Record or play any or all, at the same time, in any combination. Use for tape duplicating, editing, mixing, program production. Also inter-

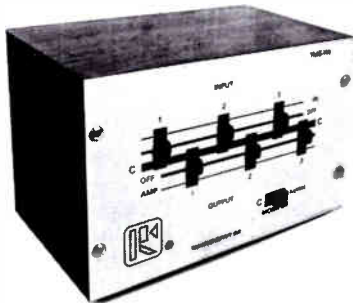

connects graphic equalizers. Dolby and dbx devices, sound-effects generators, echo chambers, delay lines, and synthesizers. Walnut cabinet. . . . \$32.95
TMS-1. Same but in utility steel cabinet. \$22.95

GIMP Mike Preamp/Mixer

Provides gain control at performer's location; drives up to 500 feet of cable without loss, eliminating the use of mixer for many recording applications. Expands recorder versatility by allowing each line input to mix two additional mikes and allows inexpensive mikes and instrument pickups to drive recorder directly at line level. Uses transistor battery (not supplied) for power. . . . \$49.95

IMP-1 Impedance Matching Amp

"Impedaverter" matches any mike or pickup to any amplifier, recorder, or line. Reduces hum

and high-frequency loss even when driving long lines. Dual inputs and outputs permit bridging mike and audio lines; splitting output to separate recorders and amplifiers. Choice of five switchable gain position: -20 dB, 0 dB, 0 dB with phase inversion, +20 dB, and +35 dB. Powered by two transistor batteries (not supplied). Utility steel case. . . . \$39.95

SHURE**SA-1 "Solo-Phone"**

Stereo amplifier for headphones. Permits two sets of phones to be used simultaneously. Has balance control, dual input for tape/tuner or phono. Inputs: phono 47,000 ohms equalized for magnetic cartridge, tuner 250,000 ohms. Output 8 ohms, 100 mV. 10 1/4" x 3 1/2" x 3 7/8" D . . . \$32.00

Model SA-1F. Same as SA-1 except panel-mounting version . . . \$38.00

M68 Microphone Mixer

Five channels. A transistorized portable mixer for p.a. and tape recorders. Has four mike inputs for high- or low-impedance microphones, one high-level auxiliary input for tape, tuner & accessories, individual volume control to balance each of five inputs, and a master volume control to simultaneously control level of all inputs. Has high-impedance mike and auxiliary outputs. 105-130 V, 50/60 Hz . . . \$87.60

M67 Microphone Mixer

Four low-impedance balanced mike inputs & one line input. Has built-in tone oscillator for calibration. Response 20-20,000 Hz ± 2 dB. Has automatic switchover to battery if power fails. Gain 90 dB max. (150-ohm mike into 600-ohm line). Battery power supply \$25.00 extra. 11 3/8" x 7 1/2" x 2 1/2" . . . \$169.20

M688 Stereo Microphone Mixer

For use with stereo tape recorders which do not have built-in mixing. Accepts four high-



low-impedance mikes through four inputs plus a stereo auxiliary high-level input, each with its own volume control. Three of the mike inputs have front-panel switches for left- or right-channel output, fourth microphone input has pan control. A stereo master volume control adjusts level of all inputs. (list) . . . \$119.40

M63 Audio Control

For use with mike mixers. Provides volume, bass, treble & high- and low-frequency rolloff. Has VU meter, two high-level inputs for mike mixer, tape recorder, tuner. Five different outputs: 600 ohms balanced line, high-imp. high-level, high-imp. mike level, low-imp. mike level (balanced), and headphone . . . \$100.20

M62V Audio Level Control

Automatic microphone volume control. Prevents blasting. Output adjustable to predetermined level. Response 20-20,000 Hz ± 2 dB. Compression 40 dB input change, 6 dB output. For single mike. Has "on-off" bypass switch. Can be battery operated or from M68 mixer. 11 3/8" x 5 1/4" x 2 1/2" D . . . \$63.00

M64 Stereo Preamp

Provides gain and equalization to operate magnetic phono cartridges and tape playback heads with amplifiers without equalization. Response flat 20-20,000 Hz ± 2 dB, phono RIAA curve 40-15,000 Hz ± 2 dB, tape for 7 1/2 ips NAB curve 50-15,000 Hz ± 2 dB. Max. input phono & tape 100 mV, flat 250 mV. . . \$34.00

A97A Matching Transformer

Designed to permit transistorized tape record-

ers to be used with high-quality, low-impedance microphones. Designed to improve the overall audio input signal as well as permit the use of long cables without loss of high frequencies and without hum and noise pickup. 2 1/2" long x 3/4" diameter . . . \$13.20

SONY BY SUPERSCOPE**HE-2 Head Demagnetizer**

Designed with high flux density to provide



maximum reduction of residual magnetism . . . \$9.95

BE-7 Cassette Bulk Eraser

Erases all cassettes without a.c. power or batteries . . . \$19.95

MX-16 8-Channel Mixer

Has 8 mike/line inputs plus four fixed and four variable outputs. Features "front center" signal distribution capability which allows a third channel to be added to the stereo mix between outputs #1 & #2. In addition, the input attenuator pad for each channel has a mike/line selector switch & a straight-line gain pot. Has four VU meters . . . \$595.00

MX-6S Stereo/Mono Mixer

Connects to all Sony solid-state recorders and provides mixing facilities for up to three mikes



& three high-level sources. Can be used for both stereo & mono. Required for sound-on-sound recording with Models 252-D, 666-D, 560D, and 225 . . . \$34.95

MX-8 Stereo/Mono Mixer

For all multi-microphone uses. Mixes down any combination of six microphones/lines stereo or mono. Straight-line graphic controls indicate settings while sliding colored reference tabs indicate previous settings . . . \$59.95

MX-14 Stereo/Mono Mixer

Active six-channel mixer for mixing down six channels of input into two of output. Operates on 8 "C" cells. Straight-line volume controls for each input. Has reference tabs and two VU meters . . . \$199.95

NR-115 Dolby Adapter

Designed to be used with any two- or three-head open reel, cassette, or 8-track cartridge tape recorder. Has line-input facility; built-in 400-Hz oscillator for input/output balancing; record/playback mode switch; illuminated meter with right/left channel switching; two playback semi-fixed controls; and two input level controls. . . . \$99.95

SB-200 Sound-on-Sound/Echo Adapter

For adding special sound effects. Can be used with any stereo tape recorder having separate facilities for recording each channel. Sound-on-sound may be used with two- or three-head recorders; echo on three-head recorders only. Has separate buttons for sound-on-sound and echo; volume control for regulating intensity of echo . . . \$39.95

(Continued on page 112)

DECIBEL TABLE

Voltage Ratio (Equal Impedance)	Power Ratio	← - db + →	Voltage Ratio (Equal Impedance)	Power Ratio
1.000	1.000	0	1.000	1.000
0.989	0.977	0.1	1.012	1.023
0.977	0.955	0.2	1.023	1.047
0.966	0.933	0.3	1.035	1.072
0.955	0.912	0.4	1.047	1.096
0.944	0.891	0.5	1.059	1.122
0.933	0.871	0.6	1.072	1.148
0.923	0.851	0.7	1.084	1.175
0.912	0.832	0.8	1.096	1.202
0.902	0.813	0.9	1.109	1.230
0.891	0.794	1.0	1.122	1.259
0.841	0.708	1.5	1.189	1.413
0.794	0.631	2.0	1.259	1.585
0.750	0.562	2.5	1.334	1.778
0.708	0.501	3.0	1.413	1.995
0.668	0.447	3.5	1.496	2.239
0.631	0.398	4.0	1.585	2.512
0.596	0.355	4.5	1.679	2.818
0.562	0.316	5.0	1.778	3.162
0.531	0.282	5.5	1.884	3.548
0.501	0.251	6.0	1.995	3.981
0.473	0.224	6.5	2.113	4.467
0.447	0.200	7.0	2.239	5.012
0.422	0.178	7.5	2.371	5.623
0.398	0.159	8.0	2.512	6.310
0.376	0.141	8.5	2.661	7.079
0.355	0.126	9.0	2.818	7.943
0.335	0.112	9.5	2.985	8.913
0.316	0.100	10	3.162	10.00
0.282	0.0794	11	3.55	12.6
0.251	0.0631	12	3.98	15.9
0.224	0.0501	13	4.47	20.0
0.200	0.0398	14	5.01	25.1
0.178	0.0316	15	5.62	31.6
0.159	0.0251	16	6.31	39.8
0.141	0.0200	17	7.08	50.1
0.126	0.0159	18	7.94	63.1
0.112	0.0126	19	8.91	79.4
0.100	0.0100	20	10.00	100.0
3.16×10^{-2}	10^{-3}	30	3.16×10	10^3
10^{-2}	10^{-4}	40	10^2	10^4
3.16×10^{-3}	10^{-5}	50	3.16×10^2	10^5
10^{-3}	10^{-6}	60	10^3	10^6
3.16×10^{-4}	10^{-7}	70	3.16×10^3	10^7
10^{-4}	10^{-8}	80	10^4	10^8
3.16×10^{-5}	10^{-9}	90	3.16×10^4	10^9
10^{-5}	10^{-10}	100	10^5	10^{10}
3.16×10^{-6}	10^{-11}	110	3.16×10^5	10^{11}
10^{-6}	10^{-12}	120	10^6	10^{12}

Stereo Testing! Spectacular Sound!

NEW STANDARD in Stereo Testing!

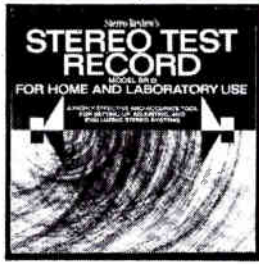

Model SR12 STEREO TEST RECORD

The most complete . . . most sophisticated . . . most versatile Test Disc available today. Whether you're an avid audiophile who'll settle for nothing but peak performance from his stereo components . . . a casual listener who'd like more insight into the challenging world of stereo reproduction . . . or a professional technician who needs precise standards for lab testing . . . the SR12 is a must for your record collection.

Make these important stereo checks BY EAR . . . Frequency response • Separation • Cartridge tracking • Channel balance • Hum and rumble • Flutter • Cartridge and speaker phasing • Anti-skating adjustment • "Gun shot test" for stereo spread • Multipurpose musician's "A." Equal-tempered Chromatic octave • Guitar-tuning tones.

7 critical TEST EQUIPMENT checks . . . Attention professionals: SR12 is also designed to be used as a highly efficient design and measurement tool. In the following tests, recorded levels, frequencies, etc. have been controlled to laboratory tolerances—affording accurate numerical evaluation when used with oscilloscope, chart recorder, output meter, intermodulation-distortion meter and flutter meter.

- 1,000-Hz square waves to test transient and high-frequency response of phono pickups.
- 500 to 20,000 Hz frequency-response sweep.
- Sine-wave tone-bursts to test transient response of pickup.
- Intermodulation test using simultaneous 400-Hz and 4,000-Hz signals.
- Intermodulation sweep to show distortion caused by excessive resonances in tone arm and cartridge.
- 1,000-Hz reference tones to determine groove velocity.
- 3,000-Hz tone for flutter and speed tests.

Sample waveforms—illustrating both accurate and faulty responses are provided in the Instruction Manual for comparison with the patterns appearing on your own oscilloscope screen.

FREE—An informative manual which includes charts, tables and diagrams.

The Most Spectacular Sound Exhibition of STEREO FIDELITY Ever Available on Disc and Cassette



STEREO DEMONSTRATION RECORD AND CASSETTE

The result of two years of intensive research in the sound libraries of Deutsche Grammophon Gesellschaft, Connoisseur Society, Westminster and Cambridge. The Editors of Stereo Review have selected those excerpts that best demonstrate the many aspects of the stereo reproduction of music. The record offers you a greater variety of sound than has ever before been included on a single disc.

ELECTRIFYING EXPERIENCE IN LISTENING

The Record is a series of independent demonstrations designed to show off one or more aspects of musical sound and its reproduction. Entirely music, the Record has been edited to provide self-sufficient capsule presentations of an enormous variety of music arranged in a contrasting and pleasing order. It includes all the basic musical and acoustical sounds that you hear when you listen to records, isolated and pointed up to give you a basis for future critical listening.

WIDE RANGE OF DEMONSTRATIONS

- Techniques of separation and multiple sound sources
- Acoustic depth
- The ambiance of a concert hall
- Sharp contrasts of dynamics
- Crescendo and diminuendo
- Very high and very low pitched musical sounds
- Polyphony (two or more melodies going on at once) with both similar and contrasting instruments
- Tonal qualities of wind, string and percussion instruments
- Sounds of ancient instruments
- Sounds of oriental instruments
- Sound of the singing voice, both classically trained and untrained
- Plus a large sampling of finger snapping, hand clapping, foot stamping and other musical and percussive sounds.

13 SUPERB SELECTIONS:

STRAUSS: Festive Prelude, Op. 61 (excerpt) DGG • OEBUSSY: feux d'artifice (excerpt) Connoisseur Society • BEETHOVEN: Wellington's Victory (Battle Symphony) (excerpt from the first movement) Westminster • MASSAINO: Conzona XXXV à 16 (complete) DGG Archive • CORRETTE: Concerto Comique Op. 8, No. 6, "Le Plaisir des Dames" (third movement) Connoisseur Society • KHAN: Raga Chandranandan (excerpt) Connoisseur Society • ROORIGO: Concert—Serenade for Harp and Orchestra (excerpt from the first movement) DGG • MANITAS DE PLATA: Gypsy Rumba (complete) Connoisseur Society • MARCELLO: (arr. King): Psalm XVII "The Heavens are Telling" (complete) Connoisseur Society • PRAETORIUS: Terpsichore: La Bourrée XXXII (complete) DGG Archive • BERG: Wozzeck (excerpt from Act III) DGG • BARTOK: Sonata for two pianos and Percussion (excerpt from the first movement) Cambridge • BEETHOVEN: Wellington's Victory (Battle Victory) (excerpt from the last movement) Westminster.

FREE—Booklet which discusses and describes each of the selections performed.

SB-300 Tape Recorder Selector

When connected to receiver or amplifier, unit expands tape monitoring capabilities to enable recording and monitoring from up to three separate tape sources. Dubbing and transferring of tape from one machine to another can be done without picking up switching clicks or pops. Shielded cables for interconnecting all switch functions. . . . \$44.95

NR-335 Dual-Process Dolby Adapter

Specifically designed for three-head machines. Permits simultaneous operation in both record and playback modes. Features built-in head-phone jack; two mike input jacks; two professional VU meters; a two-position mike attenuator switch; tape/source monitor switch. Has built-in 19-kHz filter switch; two playback volume controls, two record-level controls; built-in 400-Hz oscillator for input/output balancing . . . \$259.95

TEAC

AN-180 Outboard Dolby System

Record/playback control center with Dolby noise-reduction system. Recording section

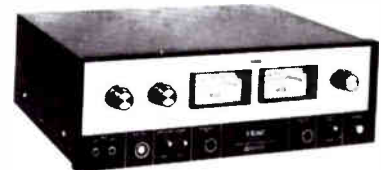

contains microphone & line preamps plus Dolby recording circuitry. Playback section has playback line preamps & Dolby playback circuitry. Can be used with any good tape deck. Has separate input level controls for mike and line inputs for each stereo channel, two VU meters, internal test-tone oscillator, Dolby level standard tapes, source/tape monitor switch. A multiplex filter prevents recording interference from pilot tone frequencies or unsuspected multiplex carrier by the FM tuner . . . \$349.50

AN-80 Outboard Dolby System

Less elaborate version of AN-180. Input mixing feature omitted and only one Dolby circuit per



channel. Circuit operates for recording, then playback, but not together. Provides 10 dB noise reduction . . . \$179.50

AN-60 Outboard Dolby System

Frequency response 20-15,000 Hz ±2 dB. Increased (S + N)/N 10 dB at 10,000 Hz & 5 dB at 1000 Hz. Input sensitivity 0.1 V. Output to tape deck 0.3 V & line 0.58 V. Has 400-Hz tone oscil-



lator & a reference meter for calibration. Dolby calibration tape for both open reel & cassettes supplied. Overall size 3 3/4" H x 6 3/8" W x 10 5/8" D . . . \$99.50

CHARGE YOUR ORDER TO YOUR AMERICAN EXPRESS OR BANKAMERICARD ACCOUNT

RECORDS, Ziff-Davis Service Division, 595 Broadway, New York, N.Y. 10012

My check (or money order) for \$ _____ is enclosed.

TRBG 74

Charge: American Express BankAmericard

Account # _____

Signature _____

- _____ SR12 Test Records @ \$5.98 each, postpaid (\$8 outside U. S. A.)
- _____ Stereo Demonstration Records @ \$5.98 each, postpaid (\$8 outside U. S. A.)
- Check one: 33 1/2 RPM 45 RPM
- _____ Stereo Demonstration Cassettes @ \$6.98 each, postpaid (\$8 outside U. S. A.)

Print Name _____

Address _____

City _____

State _____

Zip _____

ENCLOSE PAYMENT WITH ORDER IF NOT CHARGED

MILESTONES IN . . . MAGNETIC TAPE RECORDING

- 1900 Poulsen patents the magnetic wire recorder.
- 1932 First practical magnetic tape developed by BASF.
- 1935 The Magnetophon tape machine by AEG demonstrated in Berlin.
- 1936 First symphony (Mozart's "Symphony #39 in E Flat") recorded on tape by Sir Thomas Beecham.
- 1945 Magnetophon tape recorders introduced to the United States.
- 1948 First direct tape broadcast ("The Bing Crosby Show").
- 1958 RCA cartridge tape system introduced.
- 1963 Philips cassette tape system introduced.
- 1965 Lear 8-track cartridge introduced.
- 1969 Dolby "B" noise-reduction system makes its appearance.

TAPE RECORDER GUIDE ADVERTISERS INDEX

READER SERVICE NO.	ADVERTISER	PAGE NO.
14	A.D.R. Audio	101
	Akai America Ltd	13
15	Audio Warehouse Sales	101
3	Carston Studios	81
13	Columbia Magnetics	2
4	Crown	4
5	Harman/Kardon	2nd Cover
6	Illinois Audio	81
	JVC America, Inc	10
8	McIntosh Laboratory Inc	74
9	3M Company	17
	Revox Corporation	68
10	Sennheiser Electronic Corporation	1
63	Sony/Superscope, Inc	114, 3rd Cover
12	TDK Electronics Corp	4th Cover

Directory Of Manufacturers

(Continued from page 5)

PIONEER , U.S. Pioneer Electronics Corp.	71, 78, 86, 94, 109
178 Commerce Rd., Carlstadt, N.J. 07072	
PML , Hervic Electronics, Inc.	99
1508 Cotner Ave., Los Angeles, Calif. 90025	
RADIO SHACK , Div. Tandy Corp.	71, 78, 83, 87, 90, 94, 99
2615 W. 7th St., Fort Worth, Tex. 76107	
RCA CORP. , Consumer Products Div.	84, 87
600 N. Sherman Dr., Indianapolis, Ind. 46201	
REVOX CORP.	71
155 Michael Dr., Syosset, N.Y. 11791	
ROBINS INDUSTRIES CORP.	109
75 Austin Blvd., Commack, N.Y. 11725	
RUSSOUND/FMP, INC.	110
Portsmouth Ave. Traffic Circle, Stratham, N.Y. 03995	
SANSUI ELECTRONICS CORP.	78, 87, 94
32-17 61st St., Woodside, N.Y. 11377	
SANYO ELECTRIC INC.	78, 87
1200 W. Artesia Blvd., Compton, Calif. 90220	
SCINTREX, INC.	90, 95
400 Creekside Dr., Tonawanda, N.Y. 14150	
SCOTCH , 3M Co. Magnetic Products Div.	104
3M Center, St. Paul, Minn. 55101	
SENNHEISER ELECTRONIC CORP.	95, 99
10 W. 37th St., New York, N.Y. 10018	
SHURE BROS., INC.	99, 110
222 Hartrey Ave., Evanston, Ill. 60204	
SONY BY SUPERSCOPE , Superscope, Inc.	71, 79, 84, 88, 100, 104, 110
8150 Vineland Ave., Sun Valley, Calif. 91352	
SOUNDCRAFT , Columbia Magnetics, CBS, Inc.	104
51 W. 52nd St., New York, N.Y. 10019	
STANTON MAGNETICS, INC.	90, 95
Terminal Drive, Plainview, N.Y. 11803	
STAX , Audiophile Imports	95
8 E. Erie St., Chicago, Ill. 60611	
SUPEREX ELECTRONICS CORP.	90, 96
151 Ludlow St., Yonkers, N.Y. 10705	
SUPERSCOPE INC.	79, 84, 88
8150 Vineland Ave., Sun Valley, Calif. 91352	
SYLVANIA INC , Entertainment Products Group	80, 84, 91, 96
700 Ellicott St., Batavia, N.Y. 14020	
TANDBERG OF AMERICA, INC.	72, 80
Labriola Court, Armonk, N.Y. 10504	
TDK ELECTRONICS CORP.	104
755 Eastgate Blvd., Garden City, N.Y. 11530	
TEAC CORP. OF AMERICA	73, 80, 88, 91, 96, 100, 112
7733 Telegraph Rd., Montebello, Calif. 90640	
TECHNICS BY PANASONIC	74, 80, 88, 96
200 Park Ave., New York, N.Y. 10017	
TELEDYNE , Olson Electronics, Inc.	90, 96, 100
260 S. Forge St., Akron, Ohio 44327	
TELEPHONICS , Div. of ISC	90, 96
770 Park Ave., Huntington, N.Y. 11743	
TELEX COMMUNICATIONS DIV.	74, 84, 89, 96
9600 Aldrich Ave. S, Minneapolis, Minn. 55420	
TOSHIBA AMERICA, INC.	74, 81, 89, 90, 97
280 Park Ave., New York, N.Y. 10017	
TURNER CO., INC. , Div. Conrac Corp.	101
909 17th St., N.E., Cedar Rapids, Iowa 52402	
WESTBURY , Div. Mercury Electronics Corp.	81
315 Roslyn Rd., Mineola, N.Y. 11501	
WOLLENSAK , 3M Co.	81, 84, 89
3M Center, St. Paul, Minn. 55101	

first came the word...



And then there was music. And then came Sony tape recorders to capture the words and music with perfect fidelity. Right from the start. Sony has always been first with the best, the newest and the broadest

selection of tape recording equipment in the world. Sony tape recorders, Sony accessories, Sony microphones, Sony recording tape. We could go on and on and on. We are. **SONY** Ask anyone.

Brought to you by **SUPER TAPE**





for the sweetest sounds of all... TDK's "total performers"

There's no doubt about it. TDK's great new Dynamic-series cassettes offer serious home recordists sound reproduction unequalled by any other cassette sold today. And the reason is very simple. *They deliver total performance!*

Total performance means more than just full-range frequency response and high-end sensitivity. It also means having the proper balance of all the other characteristics essential to reproducing "real-life" sound. Like high MOL (maximum output level). Broad dynamic range. Wide bias tolerance. High signal-to-noise ratio. TDK's Dynamic-series cassettes have them all!

You'll quickly discover this fact when you record your favorite music on one of TDK's Dynamic-series cassettes. You capture all the highs and lows, all the harmonics and overtones, all the emotion and feeling

that gave the original performance its richness, fullness and warmth.

Look for TDK's "total performers" at quality sound shops everywhere. Extra Dynamic (ED) cassettes offer the discriminating audiophile an entirely new dimension in recording fidelity. Super Dynamic (SD), the tape that turned the cassette into a true high-fidelity medium, still has better-balanced total performance characteristics than any other brand made... and is also available in open reel. And Dynamic (D) is an entirely new hi-fi cassette that provides budget-minded recordists with excellent quality at moderate prices. All provide optimum performance on any cassette recorder, without need for special bias.

For sound you feel as well as hear, discover the dynamic new world of TDK's total performers!

DYNAMIC-series cassettes are:

Extra Dynamic (ED): top-of-the-line, for those who want the very best. 45, 60 and 90 minutes.

Super Dynamic (SD): first true hi-fi cassette started a revolution in the tape industry. 45, 60, 90 & 120-min.

Dynamic (D): characteristics superior to most "premium" cassettes. 45, 60, 90, 120 and world's only 180-min.

And the BRILLIANT-series includes:

Krom (KR): chromium dioxide tape cassettes with TDK quality and reliability, for CrO₂ bias. 60 & 90-min.

the new dynamic world of

TDK

TDK ELECTRONICS CORP.
755 Eastgate Boulevard, Garden City, New York 11530

CIRCLE NO. 12 ON READER SERVICE CARD