

ON THE HORIZON:  
DIGITAL AUDIO DISCS

AUGUST 1978 • \$1.25

# Stereo Review®

## • SPECIAL SPEAKER ISSUE •

How to Buy Loudspeakers • Julian Hirsch's Test Methods  
Engineers' Forum on Design Problems • Exotic Loudspeakers

EQUIPMENT TEST REPORTS: Akai AM-2800 Integrated Stereo Amplifier  
Beyer ET1000N Electrostatic Headphones • Lafayette LR-5555 Receiver  
Optonica RT-6501 Stereo Cassette Deck • Ortofon M20E Super Phono Cartridge

A FEW WORDS FROM PATTI SMITH • NEWPORT JAZZ'S 25TH ANNIVERSARY



The big  
difference  
between this  
cassette deck  
and Pioneer's new  
CTFF1000  
isn't sound.

262940 SIT B0311E99 6414 NOV79  
E CLENN SMITH  
RT 2  
BOX 911  
SMITHS  
AL 36877  
SCF  
08

14024 14276  
Stereo Review





The Pioneer CT-F1000: \$600\*

For years, Nakamichi has enjoyed a reputation for building the world's finest cassette deck.

Now Pioneer is introducing something Nakamichi won't enjoy at all: the Pioneer CT-F1000. A cassette deck that offers all the features and performance of Nakamichi's best cassette deck, at less than half the price.

#### PIONEER VS. NAKAMICHI: THE HEAD TO HEAD COMPETITION.

The \$1,650\* Nakamichi 1000II and the \$600\* Pioneer CT-F1000 are both honest three headed cassette decks that let you monitor right off the tape as you record.

Both have separate Dolby systems for the playback and recording heads. So when you're making a recording with the Dolby on, you can monitor it exactly the same way.

Both have two motors to insure accurate tape speed.

Both feature solenoid logic controls that let you go from fast forward to reverse, or from play to record without punching the stop button, and without jamming the tape.

And both are filled with convenient items like automatic memories for going back to a selected spot on a tape, multiplex filters for making cleaner FM recordings, separate bias and equalization switches for getting the most out of different kinds of tape, and even a pitch control adjustment that lets you match the pitch of a cassette to the tuning of your guitar or piano.

#### A \$1,000 GAP IN PRICE; NO GAP IN SOUND.

When we built the CT-F1000, however, we did more than match the Nakamichi's renowned features. We also matched its renowned performance.

Both machines boast totally inaudible total harmonic distortion levels of less than 1.5%.

Both have all but conquered the problem of wow and flutter. (An identical 0.05% for each machine.)

Both offer similarly impressive signal to noise ratios: 64 decibels Pioneer, 65 decibels Nakamichi. (At these levels

# It's value.

we dare you to hear any noise at all, let alone any difference.)

And finally, where the CT-F1000 delivers a frequency response of 30 to 17,000 hertz, the Nakamichi deck goes from 35 to

20,000 hertz. (We offer a little more at the bottom; they offer a little more at the top. Either way, the specifications are close enough to be called virtually identical.)

#### A FEW PIONEER ADVANTAGES THAT AREN'T MONETARY.

To prevent you from making distorted tapes, the CT-F1000 has a peak limiter that the Nakamichi machine lacks.

Our tape heads are made out of a special single crystal ferrite material that's been proven to last longer than the Nakamichi's permalloy variety.

And our Dolby system can be calibrated by hand while the Nakamichi 1000II requires a screwdriver.

Admittedly, the Nakamichi 1000II does feature a fancy azimuth control for aligning your heads before every recording session. But we've developed a more accurate way to mount the heads in the first place. So you can spend your time recording, instead of aligning.

#### A FEW CONCESSIONS TO NAKAMICHI.

Obviously, at almost \$1,000 more, the Nakamichi 1000II must offer some advantages over the CT-F1000.

And we'd be remiss if we didn't point out that their VU meters extend slightly higher than ours.

And that they have extra input for premixed program sources.

And although their signal to noise ratio is hardly different than ours, the Nakamichi 1000II does feature an extra Nakamichi-invented noise reduction system.

Considering the slimness of these advantages, the choice is clear-cut:

You can buy a Nakamichi 1000II and get an incredibly expensive cassette deck.

Or you can buy a CT-F1000. And get one that's simply incredible.

**PIONEER**  
We bring it back alive.





The Nakamichi 1000II: \$1,650



# Empire's Blueprint for Better Listening...

No matter what system you own, a new Empire phono cartridge is certain to improve its performance.

The advantages of Empire are threefold. One, your records will last longer. Unlike other magnetic cartridges, Empire's moving iron design allows our diamond stylus to float free of its magnets and coils. This imposes much less weight on the record surface and insures longer record life.

Two, you get better separation. The small, hollow iron armature we use allows for a tighter fit in its positioning among the poles. So, even the most minute movement is accurately reproduced. Three, Empire uses 4 poles, 4 coils, and 3 magnets (more than any other cartridge) for better balance and hum rejection.

The end result is great listening. Audition one for yourself or write for our free brochure, "How To Get The Most Out Of Your Records." After you compare our performance specifications we think you'll agree that, for the money, you can't do better than Empire.

Empire Scientific Corp., Garden City, New York 11530

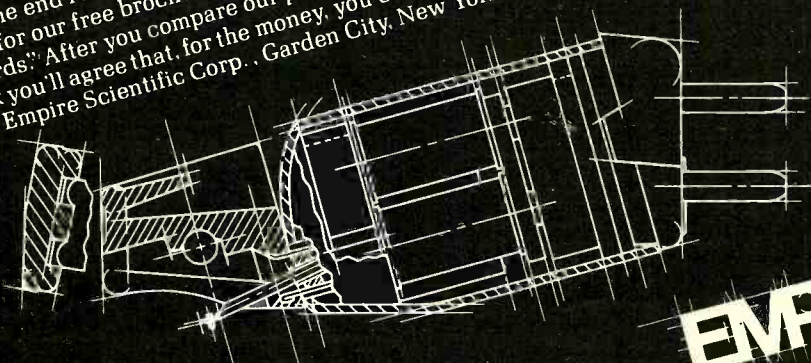

**EMPIRE**  
Already your system sounds better.

MODEL	4000 D/III	4000 D/I	2000Z	2000I	2000 E/III	2000 E/II	2000 E/I	2000 E	2000
REQUENCY RESPONSE	10Hz-50kHz ± 3 dB	15Hz-45kHz ± 3 dB	20Hz-20kHz ± 2 dB	20Hz-20kHz ± 1½ dB	20Hz-20kHz ± 2 dB	20Hz-20kHz ± 2 dB	20Hz-20kHz ± 3 dB	20Hz-20kHz ± 3 dB	20Hz-20kHz ± 3 dB
TRACKING FORCE RANGE	¾-1½ gm	1-1½ gm	¾-1½ gm	¾-1½ gm	¾-1½ gm	¾-1½ gm	1-2 gm	1½-2½ gm	1½-3 gm
SEPARATION: 15Hz to 1kHz 1kHz to 20kHz 20kHz to 50kHz 20Hz to 500Hz 500Hz to 15kHz 15kHz to 20 kHz	28 dB 23 dB 15 dB	24 dB 20 dB 15 dB	20 dB 30 dB 25 dB	18 dB 27 dB 22 dB	20 dB 28 dB 20 dB	20 dB 25 dB 18 dB	18 dB 23 dB 15 dB	18 dB 23 dB 15 dB	16 dB 21 dB 13 dB
M. DISTORTION @ 3.54 cm/sec	2% 2kHz-20kHz	2% 2kHz-20kHz	0.8% 2kHz-20kHz	0.8% 2kHz-20kHz	1% 2kHz-20kHz	1.5% 2kHz-20kHz	2% 2kHz-20kHz	2% 2kHz-20kHz	2% 2kHz-20kHz
STYLUS	2 mil bi-radial	2 mil bi-radial	2 x .7 mil elliptical	2 x .7 mil elliptical	2 x .7 mil elliptical	2 x .7 mil elliptical	2 x .7 mil elliptical	3 x .7 mil elliptical	7 mil spherical
EFFECTIVE TIP MASS	4 milligram	4 milligram	2 milligram	2 milligram	6 milligram	6 milligram	6 milligram	9 milligram	1 milligram
COMPLIANCE	30x10 <sup>-6</sup> cm/dyne	30x10 <sup>-6</sup> cm/dyne	30x10 <sup>-6</sup> cm/dyne	30x10 <sup>-6</sup> cm/dyne	20x10 <sup>-6</sup> cm/dyne	18x10 <sup>-6</sup> cm/dyne	17x10 <sup>-6</sup> cm/dyne	16x10 <sup>-6</sup> cm/dyne	14x10 <sup>-6</sup> cm/dyne
TRACKING ABILITY	32 cm/sec @ 1kHz @ 1 gm	30 cm/sec @ 1kHz @ 1½ gm	38 cm/sec @ 1kHz @ .9 gm	38 cm/sec @ 1kHz @ 1 gm	32 cm/sec @ 1kHz @ 1 gm	28 cm/sec @ 1kHz @ 1½ gm	28 cm/sec @ 1kHz @ 1½ gm	28 cm/sec @ 1kHz @ 1½ gm	32 cm/sec @ 1kHz @ 2 gm
CHANNEL BALANCE	within 1 dB @ 1kHz	within 1½ dB @ 1kHz	within 2 dB @ 1kHz	within 1 dB @ 1kHz	within 1 dB @ 1kHz	within 1½ dB @ 1kHz	within 1½ dB @ 1kHz	within 1½ dB @ 1kHz	within 1½ dB @ 1kHz
INPUT LOAD	100k Ohms/ channel	100k Ohms/ channel	47k Ohms/ channel	47k Ohms/ channel	47k Ohms/ channel	47k Ohms/ channel	47k Ohms/ channel	47k Ohms/ channel	47k Ohms/ channel
TOTAL CAPACITANCE	under 100 pF/channel	under 100 pF/channel	300 pF/channel	300 pF/channel	400-500 pF/channel	400-500 pF/channel	400-500 pF/channel	400-500 pF/channel	400-500 pF/channel
OUTPUT @ 3.54 cm/sec	3 mV/channel	3 mV/channel	3 mV/channel	3 mV/channel	4.5 mV/channel	4.5 mV/channel	7 mV/channel	7 mV/channel	7 mV/channel



FORMERLY HI FI/STEREO REVIEW

# Stereo Review®

AUGUST 1978 • VOLUME 41 • NUMBER 2

## The Equipment

NEW PRODUCTS	18
<i>Roundup of the latest audio equipment and accessories</i> .....	
AUDIO/VIDEO NEWS	
<i>Digital Audio Discs Move a Little Closer</i> .....	IVAN BERGER..... 26
AUDIO BASICS	
<i>Equalizers: Having Sound Your Way</i> .....	RALPH HODGES..... 30
AUDIO QUESTIONS AND ANSWERS	
<i>A return to some recurring speaker problems</i> .....	LARRY KLEIN..... 32
TAPE TALK	
<i>Tape Types, Acetone, Coercivity, and Home Brew</i> .....	CRAIG STARK..... 36
TECHNICAL TALK	
<i>The Testing of Loudspeakers—Part I</i> .....	JULIAN D. HIRSCH..... 40
EQUIPMENT TEST REPORTS	
<i>Hirsch-Houck Laboratory test results on the Optonica RT-6501 stereo cassette deck, Ortofon M20E Super phono cartridge, Lafayette LR-5555 AM/FM receiver, Beyer ET1000N electrostatic headphones, and Akai AM-2800 integrated stereo amplifier</i> .....	JULIAN D. HIRSCH..... 42
GUIDELINES FOR SPEAKER BUYERS	
<i>An easy introduction to a hard subject</i> .....	LARRY KLEIN AND ROBERT N. GREENE..... 64
EXOTIC LOUDSPEAKERS I HAVE KNOWN	
<i>However bizarre their design principles, they still have to work</i> .....	PETER W. MITCHELL..... 73
LOUDSPEAKER FORUM	
<i>A panel of engineers wrestles with some still unresolved design problems</i> .....	83

## The Music

NEWPORT JAZZ FESTIVAL: 25TH ANNIVERSARY	
<i>A brief but stormy history in retrospective</i> .....	CHRIS ALBERTSON..... 68
PATTI SMITH	
<i>A talk with the girl who has learned a lot from Debby Boone</i> .....	STEVE SIMELS..... 78
BEST RECORDINGS OF THE MONTH	
<i>Instrumental: the Fitzwilliam's Shostakovich Quartets . . . Earl Wild's Dohnányi and Liszt . . . Eva Knardahl's Grieg Lyric Pieces. . . . Country: Bobby Bare's "Bare". . . . Jazz: Ron Carter's "Peg Leg". . . . Broadway: Grease (original soundtrack)</i> .....	89
POPULAR DISCS AND TAPES	94
<i>Television's Brilliant "Adventure"</i> .....	STEVE SIMELS..... 95
<i>Kate Bush: Uncaged Bird</i> .....	PETER REILLY..... 98
<i>Aretha: She May Be Just Your Speed</i> .....	PHYL GARLAND..... 104
<i>Springsteen: A Little Too Much Darkness?</i> .....	STEVE SIMELS..... 108
<i>Bob Seger: Still a New Face</i> .....	NOEL COPPAGE..... 112
<i>Piaf at Carnegie Hall</i> .....	PETER REILLY..... 114
POP ROTOGRAVURE	124
.....	RICK MITZ..... 124
CLASSICAL DISCS AND TAPES	126
<i>Serkin's 75th Birthday Concert</i> .....	ERIC SALZMAN..... 127
<i>Falla's Epic "Atlántida"</i> .....	GILBERT CHASE..... 130
<i>Shostakovich's Satiric Opera "The Nose"</i> .....	ERIC SALZMAN..... 132
<i>Prokofiev's Film Music: Two New Recordings</i> .....	DAVID HALL AND GEORGE JELLINEK..... 142

## The Regulars

BULLETIN	5
EDITORIALLY SPEAKING	WILLIAM ANDERSON..... 8
LETTERS TO THE EDITOR	10
THE POP BEAT	PAULETTE WEISS..... 60
GOING ON RECORD	JAMES GOODFRIEND..... 62
ADVERTISERS' INDEX	147

COVER: Design by Borys Patchowsky; photo by Bruce Pendleton

COPYRIGHT © 1978 BY ZIFF-DAVIS PUBLISHING COMPANY. All rights reserved. Stereo Review, August 1978, Volume 41, Number 2. Published monthly by Ziff-Davis Publishing Company; Editorial and Executive Offices at One Park Avenue, New York, N.Y. 10016. Telephone: 212 725-3500. Philip B. Korsant, President; Furman Hebb, Executive Vice President; Selwyn Taubman, Treasurer; Philip Sine, Secretary. Also publishers of Boating, Car and Driver, Cycle, Flying, Popular Electronics, Popular Photography, Psychology Today, Skiing, Stereo Directory, and Tape Recorder Annual. One-year subscription rate for U.S. and possessions, \$9.98; Canada, \$10.98. All other countries, one-year subscription rate \$14.98, cash orders only, payable in U.S. currency. Second-class postage paid at New York, N.Y., and at additional mailing offices. Authorized as second-class mail by the Post Office Department, Ottawa, Canada, and for payment of postage in cash. SUBSCRIPTION SERVICE: Forms 3579 and all subscription correspondence should be addressed to Stereo Review, Circulation Department, P.O. Box 2771, Boulder, Colorado 80323. Please allow at least eight weeks for change of address. Include your old address as well as new—enclosing if possible an address label from a recent issue. Material in this publication may not be reproduced in any form without permission. Requests for permission should be directed to Jerry Schneider, Rights and Permissions, Ziff-Davis Publishing Co., One Park Avenue, New York, N.Y. 10016.





## Record Ecology in DiscKit Form —you'll save more than money

DiscKit is a milled walnut tray and dust cover that saves you 15% with the Discwasher products in the kit. (\$46 versus \$54 separately)

DiscKit includes: 1) The Discwasher System Record Cleaner with D3 Fluid, 2) the Zerostat anti-static pistol and test light, and 3) the SC-1 Stylus Cleaner.

But you'll save more than money. You'll save your rec-

ords from imbedded micro-dust, your cartridge stylus from abrasion and your ears from a lot of static.

Record Ecology from Discwasher—a substantial bargain.

(Walnut tray and dust cover are available separately as

the Discorganizer, \$12.50.)

All from Discwasher, Inc., 1407 N. Providence Rd., Columbia, Missouri 65201.







# Stereo Review BULLETIN

---

● WHEN THE WHITE HOUSE IS WIRED FOR SOUND THIS SUMMER, it will not be with bugging devices, but with new component hi-fi equipment presented by members of the Institute of High Fidelity. A drawing was held to determine which manufacturers would contribute specific components to the installation in the President's living quarters. The luck of the draw went to Altec (equalizer), JVC (turntable), Kenwood (cassette deck), Koss (headphones), Pioneer (receiver), Shure (phono cartridge), Sony (speakers), and TDK (tapes). Installation is being supervised by Leonard Feldman, the IHF's technical director. When Feldman inspected the premises, he found that three more pairs of speakers would be needed because the existing system fed sound to four rooms, and that a separate installation in the solarium was also ready for replacement. He asked for another drawing to select the additional components needed. According to Feldman, decorators had concealed the speakers of the system originally installed during the Kennedy administration behind false book fronts and even wallpaper.

● VIDEODISC SOFTWARE for RCA's SelectaVision will be developed in a project supervised by Herbert S. Schlosser, former president of the National Broadcasting Company and recently elected executive vice-president of RCA Corp. According to Edgar H. Griffiths, president of RCA, developing a comprehensive software program is a major challenge that must be overcome before the company can decide whether to market its SelectaVision videodisc system.

● THE FIRST TV TUNERS incorporated in AM/FM receivers were demonstrated at the summer Consumer Electronics Show and are scheduled to be on the market in the fall. The manufacturer is Wintec, and the models are the 60-watt-per-channel R 1060 and the 120-watt R 1120. Separate tuning knobs for VHF and UHF are provided calibrated by frequency.

● KANSAS has been named Deputy Ambassadors of Good Will for UNICEF (the United Nations Children's Fund). It is the first music group to be so honored by the UN. Kansas is donating part of the proceeds from its June Madison Square Garden concert to UNICEF and will participate in many UNICEF activities during 1979, the International Year of the Child. Kansas' fifth album, "Point of Know Return," released by Epic last October and still on the charts, has been certified gold, platinum, and double platinum by the RIAA, and it is approaching triple platinum status (3 million units sold in the U.S. alone).

● THE OFFICIAL GUIDE TO HIGH FIDELITY, an authoritative book on hi-fi component systems published by the Institute of High Fidelity, has been revised and updated. The 207-page second edition contains a new chapter on graphic equalizers, filters, expanders, and other signal-processing accessories. For the benefit of beginners, each chapter in the new edition is preceded by a short, easy-to-understand summary of its contents without difficult technical details. To order, send check or money order for \$5.50 to Institute of High Fidelity, 489 Fifth Avenue, New York, N. Y. 10017.

● THE 8TH ANNUAL INTERNATIONAL PIANO FESTIVAL AND COMPETITION will be held August 6-12 at the University of Maryland in College Park. In addition to the semi-finals and finals of the competition, events will include recitals by recording artists Jean-Philippe Collard, Jeanne-Marie Darré, Alicia de Larrocha, Jörg Demus, Lili Kraus, and Charles Rosen and master classes by Darré, Demus, Kraus, Rosen, famed pedagogue Adèle Marcus, and Soler expert Frederick Marvin. Full tuition is \$120, but individual admissions are available. Write: Department of Music, University of Maryland, College Park, Md. 20742.



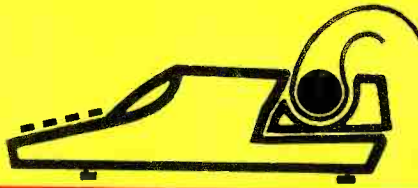

⊗ **RADIO FREQUENCY INTERFERENCE:** Leonard Feldman, technical director of the Institute of High Fidelity, spoke at a Senate subcommittee hearing in June on radio-frequency-interference legislation proposed by Senator Barry Goldwater. Feldman said: "Every purchaser of an audio component should not have to bear the cost of including multiple RFI filters and/or shielding in high fidelity components when a large percentage of purchasers will never experience any interference problem and when it is clear that only a small percentage of interference problems can be avoided by the incorporation of such elaborate filtering and shielding." He added that such filters would degrade the performance of audio systems, negating improvements in state-of-the-art hi-fi components and making consumers dissatisfied with new products.

⊗ **THE FIRST ELVIS FAN SUMMER FESTIVAL** will take place September 1-10 at the Las Vegas Hilton. The Hilton Showroom, where Presley appeared regularly for eight years, will be dedicated to his memory, and a life-size bronze statue of the singer will be unveiled. During the festival Robert Summer, president of RCA Records, will present fifteen gold albums and three platinum albums to Elvis' father, Vernon Presley. Scheduled for August release on RCA is "Elvis Sings for Children," an album of songs such as Five Sleepy Heads and Let Me Be Your Teddy Bear which Elvis sang to children in his movies. It is expected that by the end of the year Presley's sales will reach one billion records.

⊗ **AUDIO AND VIDEO PRODUCTS** are the subjects of two pamphlets prepared by the Electronic Industries Association's Consumer Electronics Group (EIA/CEG). Entitled "A Consumer Audio Products Guide" and "A Consumer Video Products Guide," the pamphlets are free and can be ordered from the EIA/CEG Office of Consumer Affairs, 2001 Eye Street, N.W., Washington, D.C. 20006.

⊗ **MUSICA, THE FIRST GUIDE TO CLASSICAL MUSIC ON AMERICAN AND CANADIAN RADIO STATIONS**, has been republished in a new and updated edition. In alphabetical order by state and city, it lists more than 1,000 AM and FM stations that broadcast classical music, giving call letters, wave length, radius, and days and hours when concert broadcasts are aired. FM stations that broadcast in stereo are indicated. In addition to the continental United States and Canada, the guide covers Alaska, Hawaii, Puerto Rico, and the Virgin Islands. To order, send \$3.95 plus 75¢ postage (or \$1 for first class) to Musica, Box 1266(R), Edison, N.J. 08817.

⊗ **TODD RUNDGREN** is the first major rock star to record a program for the home video market. Visiondisc Corporation taped Rundgren live, in concert, during his recent five-day engagement at the Bottom Line in New York, and prepared a one-hour video cassette for July release. According to the company's executive vice-president Charles Arden, "Visiondisc Corporation is also in negotiations with other top recording stars who hope to achieve a significant position in the new home video market." For the names of dealers handling Visiondisc cassettes write: Visiondisc, P. O. Box 102, Cooper Station, N. Y. 10003.

⊗ **A NEW CHROMIUM-DIOXIDE TAPE, CROLYN II**, is scheduled to go into full production late this summer, according to E. I. duPont, originator of chromium dioxide. Overall sensitivity has been increased to match that of the currently popular "chrome-substitute" ferric-oxide tapes, and both distortion and signal-to-noise characteristics of the new chrome formulation are said to be superior. While duPont does not market any audio tape under its own name, together with one licensee (BASF) it manufactures all the magnetic powder used for chromium-dioxide tapes throughout the world.





# The single biggest mistake you can make.

From the outside, all speakers look pretty much the same. But buying an off-brand, bargain speaker can be a very big mistake.

Since speakers are the only components that actually produce sound, when you compromise your speakers you compromise your entire music system. Fortunately, there's one way to make sure you wind up with a speaker that sounds as good as it looks: Buy a speaker with a name as good as the rest of your components.

At Kenwood, we didn't just start with a bunch of commercially available speaker parts. We started with a goal: *To deliver a crisp, clean sound that accurately reproduces the original music.*

To begin with, we create each raw frame speaker.

For the tweeter and the midrange, we used a computer to design light-weight, extra-rigid cones. And by properly designing the weight of the voice-coil with the cone assembly in the woofer, we have eliminated the crossover-coil: One of the major causes of speaker distortion.

We mount our speakers on a lumber-core baffle board made of special anti-resonant material. And design the enclosure to assure an acoustic match between cabinet and components.

Though you can't see all that by just looking at a Kenwood speaker, you'll know it the first time you listen.

Next time you're at your Kenwood dealer, compare our \$180.00\*, 3-way LS-407B with any off-brand speaker. Or, for that matter, with any speaker at all.

You'll save yourself from making a big mistake.

**Your speakers' reputation should be as good as your receiver's.**



 **KENWOOD**<sup>®</sup>

For the dealer nearest you, see your Yellow Pages, or write Kenwood, P.O. Box 6213, Carson, CA 90749.

\*Nationally advertised value. Actual prices are established by Kenwood dealers. Walnut grain vinyl finished cabinet. In Canada: Magnasonic Canada, Ltd.



# Editorially Speaking

By William Anderson



## DOES DISCO CAUSE CANCER?

It seems eons ago, but it was in fact only about the day before yesterday that Bob Dylan wrote that national anthem of the generation gap called *Ballad of a Thin Man* in which he informed the "Mr. Joneses" of the world that "Something is happening, but you don't know what it is." He was referring, of course, to the "rock revolution," an upheaval that took place not only in the musical sphere but in the social one as well. It is at least an irony, and maybe even a rare instance of poetic justice, that many of those who self-righteously made *Thin Man* their theme song thirteen years ago should so soon find themselves on the far side of a new generation gap, fuming impotently as they see the world's cameras shifting from rock to the Next Big Something—disco.

Except to those with stubborn musical/emotional/career investments elsewhere, it should come as no news that disco, in its vari-

ous manifestations live and recorded, is now a multi-billion-dollar phenomenon that can rightly be called an industry. For example: DJ's, whose uniquely sensitive feeling for what is danceable (and when) can make or break a disco, are about to form a union. Fabulous new discos bloom almost nightly: Xenon, New York's latest, spent a reported \$2 million on its *Star Wars* decor. Dance schools that promise to teach you disco in a hurry are opening and reopening everywhere, many of them under the direction of those dozens of young hustlers who claim to have taught John Travolta to shake it for the movie *Saturday Night Fever*. The Bee Gees' \$12.98, two-disc album of the soundtrack from that bellwether of a whole new genre—the disco film—has been on the *Billboard* LP chart for thirty weeks as of this mid-June writing. And, finally, this latest in a long line of dance manias has created a whole new stratum of "disco so-

ciety," rather like the old "café society," plus a strain of quasi-professional skills, most of them expert dancers, whose theatrically over- (or under-) dressed presence is by itself enough to catalyze the dancing and set off the Flashbulbs of Publicity. *Something*, Mr. Dylan, is clearly happening.

That something is customarily labeled a "fad" (even after five years), "mindless noise," "nothing but a numbingly repetitious beat," and much, much worse by dispossessed rockers. Sadly, they do not remember—or choose to forget—that Mr. Jones once heaped the identical insults on *their* music, and that his forebears were no more imaginative in condemning ragtime or jazz. If disco causes cancer, there is no proof of it yet. But what it *can* do is set on edge the teeth of a generation that has never known what it is to surrender to dancing. In that sense, both "mindless" and "repetitious" are quite accurate descriptions: "mindless" because disco demands a visceral rather than an intellectual response, "repetitious" because that's what the body's own natural rhythms—the pulse, the heart, breathing—are. One might (indeed, many have) apply the same descriptions to greater or lesser dance manias of the past: the waltz, the Charleston, jitterbugging, even the twist. I'm a bit too lazy today to chart the periodicity of these eruptions, but something tells me that there must be a cycle involved. If there is, then there is even less reason to take these "criticisms" seriously, particularly when they come from those who are out of touch with their feet and whose own music is, for me, just as uncomfortably loud.

Though I find it difficult to abandon myself to anything more recent than the waltz, I cannot see that this new dance mania is anything but a healthy return to healthy concerns: a rediscovery of one's physical self, and that of one's partner, in the pure, liberating joy of rhythmic movement (yes, I know that sounds like sex). What do mindless, inarticulate disco fans have to say about all this? To their credit, just about nothing; they're too busy dancin'.

## Stereo Review

### PUBLISHER

EDGAR W. HOPPER

### EDITOR

WILLIAM ANDERSON

### MANAGING EDITOR

WILLIAM LIVINGSTONE

### EDITORIAL COORDINATOR

LOUISE GOOCH BOUNDAS

### ART DIRECTOR

BORYS PATCHOWSKY

### TECHNICAL DIRECTOR

LARRY KLEIN

### TECHNICAL EDITOR

RALPH HODGES

### MUSIC EDITOR

JAMES GOODFRIEND

### POPULAR MUSIC EDITOR

PAULETTE WEISS

### SPECIAL PROJECTS EDITOR

STEVE SIMELS

### ASSISTANT MUSIC EDITOR

VIVIANNE WINTERRY GOODMAN

### PRODUCTION EDITOR

JOHN HARRISON

### ASSISTANT EDITOR, RESEARCH

RICHARD SARBIN

### COPY EDITOR

DAVID STEIN

### EDITORIAL ASSISTANTS

BARBARA AIKEN, DIANE NAKAMURA

### CONTRIBUTING EDITORS

CHRIS ALBERTSON

NOEL COPPAGE

RICHARD FREED

PHYL GARLAND

ROBERT N. GREENE

DAVID HALL

ROY HEMMING

JULIAN D. HIRSCH

GEORGE JELLINEK

IGOR KIPNIS

IRVING KOLODIN

PAUL KRESH

STODDARD LINCOLN

J MARKS-HIGHWATER

RICK MITZ

LINCOLN PERRY

PETER REILLY

CHARLES RODRIGUES

ERIC SALZMAN

CRAIG STARK

JOEL VANCE

### LONDON EDITOR

HENRY PLEASANTS

### ADVERTISING DIRECTOR

JAMES J. SULLIVAN

### ADVERTISING SERVICE MANAGER

LINDA BLUM

### EXECUTIVE ASSISTANT

PEGI McEENEANEY

### Editorial and Executive Offices

Ziff-Davis Publishing Company

One Park Avenue, New York, New York 10016

212 725-3500

Eastern Advertising Manager: Richard J. Halpern

Eastern Advertising Representative: Charles L. P. Watson

### Midwestern Office: The Pattis Group

4761 West Touhy Ave., Lincolnwood, Illinois 60646

312 729-1100

Arnold S. Hoffman

### Western Office

9025 Wilshire Boulevard

Beverly Hills, California 90211

213 273-8050, 272-1161

Western Advertising Manager: Linda Bartlett

Japan: James Yagi

Oji Palace Aoyama, 6-25, Minami Aoyama

6-Chome, Minato-ku, Tokyo, Japan

Telephone: 407-1930/6821, 582-2851

### Circulation Office

P.O. Box 2771, Boulder, Colorado 80323

EDITORIAL CONTRIBUTIONS must be accompanied by return postage and will be handled with reasonable care; however, publisher assumes no responsibility for the return or safety of art work, photography, or manuscripts

Member Audit Bureau of Circulations



### ZIFF-DAVIS PUBLISHING COMPANY

Philip B. Korsant, President

Furman Hebb, Executive Vice President

John R. Emery, Sr. Vice President, Finance

Phillip T. Heffernan, Sr. Vice President

Edward D. Muhlfeld, Sr. Vice President

Philip Sine, Sr. Vice President, Secretary

Lawrence Sporn, Sr. Vice President, Circulation and Marketing

Arthur W. Butzow, Vice President, Production

Frank Pomerantz, Vice President

George E. Morrissey, Vice President

Sydney H. Rogers, Vice President

Sidney Holtz, Vice President

Albert S. Traina, Vice President

Paul H. Chook, Vice President

Edgar W. Hopper, Vice President

Robert N. Bavier, Jr., Vice President

Selwyn Taubman, Treasurer

W. Bradford Briggs, Vice Chairman

### ZIFF CORPORATION

William Ziff, Chairman

I. Martin Pompadour, President

Hershel B. Sarbin, Executive Vice President



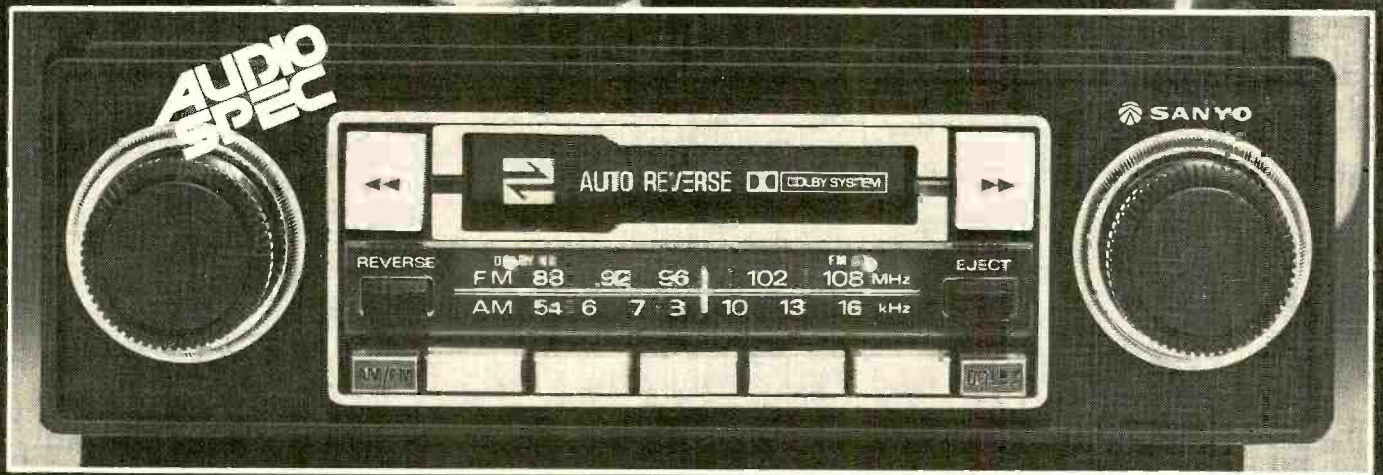

# NEW SANYO AUDIO/SPEC. SOMETHING THIS GREAT HAS TO BE SHARED.

Install it, then get set for some pretty amazing reactions.

Your friends with expensive home component systems will be astonished by the FM tuner's sensitivity (some models are as good as  $1.0\mu\text{V}$ ). Tape recording purists will be taken aback when you switch on the Dolby\* noise reduction to show them what "quiet" is all about.

And even hard-to-impress people will get turned on when you crank up the bi-amplified power stage to an awesome 28 watts RMS total system output. Here's sound to knock your socks off.

AUDIO/SPEC is a series of single chassis in-dash and under-dash tape players (8-track or cassette) . . . with or without stereo radio. Every one delivers real high fidelity sound to just about any vehicle on the road. A fabulous high performance line of AUDIO/SPEC speakers is also available.

Visit a Sanyo car stereo dealer. Be prepared to be amazed at what it can do for you.

**Free.** Send name and address for our informative new booklet, "How to buy car stereo without getting taken for a ride" (a \$1.25 value). Write Sanyo Electric Inc., Car Stereo Dept., 1200 W. Artesia Blvd., Compton, Calif. 90220.

\*Dolby is reg. trademark of Dolby Labs, Inc. Features described available on many models.

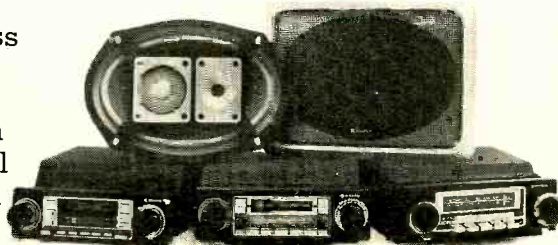

## SANYO AUDIO/SPEC

That's life.

CIRCLE NO. 43 ON READER SERVICE CARD





## Airline Stereo

● I can't believe, in this day and age, how poor the music systems are on airplanes. The headphones used by the major airlines remind me of the toy stethoscope in a doctor kit my five-year-old nephew plays with. I'm surprised that the major stereo-component manufacturers haven't come up with lines of in-flight headphones. Of course, if the airlines showed silent movies and had singing stewardesses, I wouldn't complain, but who wants to listen to music through ill-fitting, earpinching, cold and clammy plastic tubes? After all the songs about flying and jet planes, we should be able to hear them with respect while we're flying high.

STEPHEN P. ECKHARDT  
Irvine, Calif.

*The airlines used to supply better-quality headsets, with built-in transducers, but perhaps too many of them left the planes with the passengers. The current models are far cheaper to produce and hardly worth stealing, since to make one work at home you'd have to take the arm of the seat (where the transducer is) along too.*

## Texts and Translations

● I was pleased to see George Jellinek's favorable review of Humperdinck's *Königs-kinder* in the June issue. I agree that it is a fine recording—but I wish I had some idea of what in thunder is going on in the opera! The accompanying booklet is in both German and English right up to the synopsis and libretto, at which point it becomes German only. This is an inexcusable situation. Strangely, the same company managed a complete translation for the recording of Schumann's *Genoveva*. Maybe they like to be inconsistent so as to keep customers confused. It would be a valuable service if reviews of operas indicated whether adequate texts are supplied. Since I live in the boondocks, I have to obtain more than 95 per cent of my records by mail, and it would be nice to know what I am getting.

ALBERT W. STEWART  
Roanoke, Va.

*Music Editor James Goodfriend replies: We nearly always do say if adequate texts are included with a release, and the information just happened to be omitted in the case of Königs-kinder. Since this was an import of a release intended primarily for the German domestic market, the failure to supply an English text seems quite "excusable." But there is hope: the same recording will be issued late this year in England by the British branch of EMI—with, of course, full translations. You may be able to obtain an English text then by writing to England or borrowing a copy from another collector or a library.*

## Steeleye Span

● I enjoy STEREO REVIEW very much, but I am sometimes worried about the consistency of standards employed by the magazine's critics. For a recent example, in the June issue Steve Simels described Steeleye Span's "Storm Force Ten" as a disappointing album. I agree with this, but he went on to say that

*(Continued on page 12)*

# LETTERS TO THE EDITOR

## Movie Music

● With reference to Steve Simels' "Rock Goes to the Movies" (June) I would like to have his definition of "rock." It seems that he means anything written to be played loud and with a strong beat. Well, cancel "strong beat." Should we say "insistent"? Point: *You Light Up My Life* is a ballad. Point: the music from *Star Wars* owes a great deal more to Richard Wagner and Edward Elgar than to Bob Dylan. Point: Simon and Garfunkel's *Mrs. Robinson*, etc. are more like Scottish border ballads than anything else. Where did Mr. Simels study music?

EDWARD R. PALMER  
Bridgewater, N.J.

● How is it possible for Steve Simels to write an article about movie-soundtrack albums and omit any mention of Pink Floyd's music for the films *More* and *The Valley*? Although the films themselves weren't particularly noteworthy or financially successful, the songs *Childhood's End*, *Stay*, and *Cymbelline* rank among Pink Floyd's best work.

MURRAY SWIM  
Wilkes-Barre, Pa.

*Steve Simels replies: Mr. Palmer raises some interesting questions, but since nobody really knows what rock is, far be it from me to attempt any serious answers. A general rule of thumb, however, might be that anything played on rock radio, or aimed at and embraced by the rock audience, is rock-and-roll. Which means that Richard Strauss (Zarathustra), Star Wars, and the Not Ready for Prime Time Players qualify, whereas, say, A Star Is Born and Barry Manilow do not. If that sounds blatantly subjective, it is!*

*As for Mr. Palmer's specific points: (1) You Light Up My Life is indeed a ballad, but in melodic structure, lyrics, arrangement, and production it's closer to Elton John than to Richard Rodgers; (2) the Star Wars soundtrack is a progressive-FM staple, and the main title was a sizable disco hit; (3) the list of rock musicians with folk roots, be they Scottish or whatever, extends well beyond Simon and Garfunkel; and (4) if you must know, I studied piano with a saintly, white-haired old lady*

*who in her youth had been a pupil of Percy Grainger.*

*To Mr. Swim I can only say that it's possible because my memory is not infallible. It just happens that I forgot about those films.*

## I Due Foscari

● It is unreasonable for George Jellinek to assume, in his June "Best of the Month" review, that the new Philips *I Due Foscari* cannot be surpassed in the near future. The performance is a respectable one, but it is hardly ideal. To cite but one problem, José Carreras hammers away mercilessly, in a Mario del Monaco fashion, at Jacopo's music, which calls for much sharper and more refined dynamic contrasts. Carlo Bergonzi would surely have provided the tonal shading, phrasing, and seasoned artistry that is sadly lacking in Carreras' singing. It is most difficult, therefore, to comprehend Philips' decision to replace Bergonzi with Carreras in its early-Verdi opera recordings.

LAURA DOHERTY  
Castro Valley, Calif.

*The Editor replies: Difficult, but not impossible. It is an often-lamented fact of artistic commerce that record companies do not make recording decisions solely on an aesthetic basis, for they also try to count on selling a few records. In the case at hand, the question of artistry completely aside, Carreras sells better than Bergonzi. The fault, if fault there is, is not Philips'.*

*A particularly fascinating, privileged view of the whole recording process—what gets recorded, with and by whom, and why—is the principal business of Brown Meggs' most recent novel, *Aria* (Atheneum, New York, 1978). It is a fiendishly enciphered roman à clef with a superfluity of clues, hints, suggestions, implications and sly winks that should keep opera buffs in particular guessing for a long time. But it is also, finally, about the record business, and if you see yourself as One Upon Whom Illusion Hath No Claim, then you owe yourself this entertaining education. (Mr. Meggs is the former chief operating officer of Capitol Records.)*



# Before Sound Guard<sup>®</sup>, you only played a record in mint condition once.



Magnification shows the record vinyl wearing away.



Same magnification shows no record wear.

methods, removes all common record contaminants—from dust particles to oily fingerprints.

And whether your records need a light cleaning to remove surface dust or a thorough cleaning to remove deep-seated contaminants, Sound Guard record cleaner does both.

preservative maintains sound fidelity by reducing record wear. And with its built-in, permanent anti-static property, it resists dust accumulation.

## And now, two new Sound Guard products:

**1. Sound Guard<sup>™</sup> record cleaner**, developed from extensive research into record cleaning problems and

## 2. Sound Guard<sup>™</sup> Total Record Care System

puts Sound Guard record preservative and Sound Guard record cleaner in one package—for the best possible total care for all of your records.

Available in audio and record outlets.

\*Tests available on request.

You can see how the picture has changed.

Independent tests\* show that records treated regularly with Sound Guard preservative keep the same full amplitude at all frequencies, the same absence of surface noise and harmonic distortion as records played just once in mint condition.

With its patented dry-lubricant film, Sound Guard

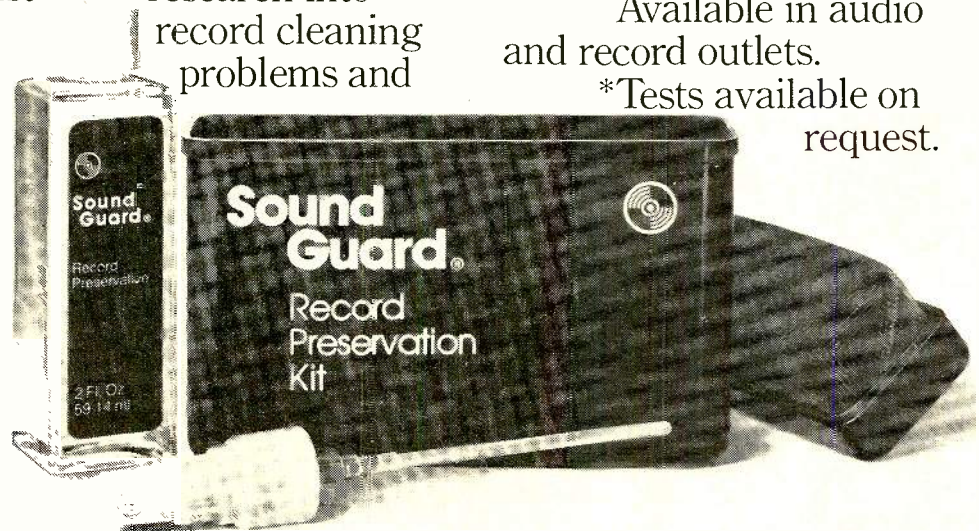
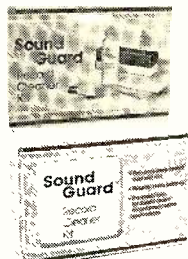

## Sound Guard<sup>®</sup> keeps your good sounds sounding good.



Sound Guard preservative—Sound Guard cleaner—Sound Guard Total Record Care System  
Sound Guard is Ball Corporation's registered trademark. Copyright © Ball Corporation, 1977. Muncie, IN 47302

CIRCLE NO. 9 ON READER SERVICE CARD



the group "was already floundering in earlier releases." The only Steeleye Span releases between "Commoner's Crown," justly esteemed by Mr. Simels, were "All Around My Hat," which was cited as a "Best of the Month" album and got an excellent review from Noel Coppage, and "Rocket Cottage," which Eric Salzman described in a feature review as "merely impeccable." I realize that record reviewing is a very subjective activity, but if different reviewers can differ so widely (for another example, Coppage vs. Simels on Mike Oldfield's "Ommadawn" last year), one begins to wonder what the value of a single critical opinion is.

Why not let several critics listen to the same new release independently? Each would

then express his opinion to an editor, who would simply evaluate the range of opinions on a given release. This could be included with the review itself, which would still be written by one reviewer (one can only expect so much from a committee). I know that this would mean extra work for the staff, but as a subscriber I would feel a lot more secure in making record purchases if I had some idea how controversial a new recording was. This method would also serve to identify records deserving "universal acclaim" as well as undisputed turkeys.

BOB LEWIS  
Berkeley, Calif.

The Editor replies: We have done multiple re-

views (the multiple two, at least) from time to time, and even printed them together—to the apparent everlasting confusion of some of our readers, who feel that there ought to be but one "STEREO REVIEW position" on everything. But it would be just too time and space consuming to do it as a rule—we can't keep up with the flood of new releases even now. In the final analysis, of course, every recording is controversial in the sense that you can always find someone who loves it and someone else who hates it. For myself, I seem to be constitutionally suspicious of unanimity and received opinion; they never fail to inspire me to check with my own ears.

## Il Trittico

● George Jellinek, in his June review of the new Columbia recording of Puccini's *Il Tabarro*, states that Renato Scotto takes all three soprano leads in that company's set of *Il Trittico*. It is true that Mme. Scotto appears in the title role on the award-winning *Suor Angelica* and on the new *Tabarro*, but she does not appear on the Columbia *Gianni Schicchi* (Ileana Cotrubas sings the lead there). However, Mme. Scotto did sing all three roles in the *Trittico* at the Metropolitan Opera in January 1976 and on the Met's national tour in April/May 1976, being the first soprano in the history of that theater to do so.

ROBERT J. LOMBARDO  
New York, N.Y.

## Juke-box Bargains

● In regard to Warren Summers' question to Larry Klein ("Audio Q. and A." for June) about buying used 45's that have been played in juke boxes: I have been buying such records since 1959 (a local drug-store chain sells them for 35¢ each, and has since 1959) and now have several hundred. A good visual inspection will usually suffice; beware of obvious damage and a grayish film that accumulates on discs that have been in the box too long. You may find rare MOR records that the record stores don't stock because they never made the charts.

RUSSELL B. POWELL  
Cleveland, Ohio

## More Duruflé

● There is no need for David Hall (in his June review of recordings of the Maurice Duruflé Requiem) to "regret the absence from the catalog of the other two pieces in Duruflé's Op. 6," since the whole opus is available on the Musical Heritage Society's MHS 1819. In addition, and still better, one gets Duruflé's luminous Mass ("Cum Jubilo"), Op. 11, and Four Motets on Gregorian Themes, Op. 10. The Mass is particularly, indeed peculiarly, beautiful.

To jump to another subject, I was disturbed by Richard Freed's June "Best of the Month" review of the recording of Berlioz's *Les Nuits d'Été* directed by Pierre Boulez. Mr. Freed calls Stuart Burrows and Yvonne Minton great singers. Hmmm—what does that make Gedda, Bjoerling, Simoneau, or other tenors who are much better than Burrows in various ways. to say nothing of mezzos who may hon-

(Continued on page 14)

# Soundcraftsmen equalizers

The new high-performance "State-of-the-Art" Equalizers that set un-equalled Industry Standards!

**SOUNDCRAFTSMEN FIRSTS:**  
**1<sup>ST</sup>** to invent low-noise home equalizers  
to invent the 10-octave pre-amp/equalizer  
to invent the CLASS H amplifier  
to invent the high performance 114 dB S/N,  
44 dB range, home equalizer

EQUALIZERS are used everywhere in the music-making chain: by live performers, recording studios, mixing consoles, AM and FM stations, and so on. In every step, each of the engineers use EQUALIZERS to make the music sound the way they think it should sound. So after everyone else makes the music sound the way they like it, it's up to you to use that same instrument—THE EQUALIZER—to make the final adjustment, and make the music sound the way you like it to sound in your own home.

**THE EQUALIZER YOU BUY SHOULD HAVE THESE FEATURES:**

We include all the accessories and features that are a must to make EQUALIZING easy, as well as an amazingly rewarding new experience... An ENVIRONMENTAL DO-IT-YOURSELF TEST RECORD edited and announced by Soundcraftsmen especially for use with the Soundcraftsmen equalizer... COMPUTONE CHARTS for making a record of, and resetting in seconds, any desired EQ curve... A Full-Channel FREQUENCY SPECTRUM LEVEL CONTROL on each channel for instant "no distortion" in/out balancing... LIGHT-EMITTING-DIODES for precise visual signal level balancing... A GRAPHIC DISPLAY of each EQ curve.

**FREE BROCHURE**

equalizers  
pre-amplifiers  
amplifiers

**WHYS & HOWS  
of equalization**

Includes TEST REPORTS, complete specifications, Class H amplifier ENGINEERING REPORT, EQ COMPARISON CHART, and the "WHYS & HOWS" of equalization—an easy-to-understand explanation of the relationship of acoustics to your environment. Also contains many unique IDEAS on how the Soundcraftsmen Equalizer can measurably enhance your listening pleasures. "How typical room problems can be eliminated by Equalization," and a 10-POINT DO-IT-YOURSELF EQ evaluation checklist so you can FIND OUT FOR YOURSELF WHAT EQ CAN DO FOR YOU!

**GUARANTEED TO IMPROVE YOUR SYSTEM  
MORE THAN ANY OTHER ADD-ON COMPONENT**

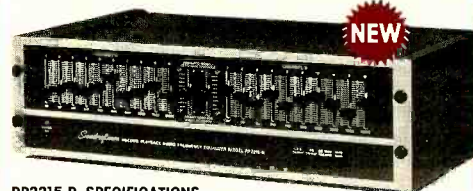

### RP2215-R SPECIFICATIONS

**IN-OUT MONITORING:** Continuous Visual L.E.D. input-to-output level.  
**HARMONIC DISTORTION:** Less than .01% at 2 V.  
**IM DISTORTION:** Less than .01% at 2 V.  
**SIGNAL-TO-NOISE:** a. 114 dB at 10 V output.  
b. 100 dB at 2 V output.

**INDIVIDUAL OCTAVE CONTROLS:** (44 dB total adjustment range)  
a. ± 22 dB—each octave (all other octaves set at max.)  
b. ± 15 dB—each octave (all other octaves set at zero)

**EQUALIZER GAIN/CUT CAPABILITY:** + 32 dB - 38 dB (all controls max.)  
**"FREQUENCY SPECTRUM LEVEL"** zero-gain controls for each channel.

**FILTER TYPE:** Precision-tuned passive wire-wound inductors  
**PRICE: \$370.00** (including cabinet)

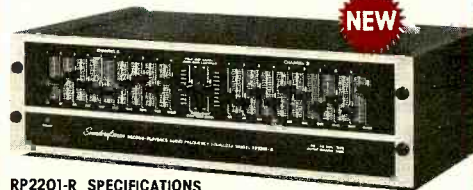

### RP2201-R SPECIFICATIONS

**SIGNAL-TO-NOISE:** 105 dB below full output  
**INDIVIDUAL OCTAVE CONTROLS:** (32 dB total adjustment range)  
a. ± 16 dB—each octave (all other octaves set at max.)  
b. ± 12 dB—each octave (all other octaves set at zero)

**EQUALIZER GAIN/CUT CAPABILITY:** + 22 dB - 28 dB (all controls max.)  
**FILTER TYPE:** Op-Amp-Synthesized inductors  
**PRICE: \$299.00** (including cabinet)

### OTHER SOUNDCRAFTSMEN HIGH-PERFORMANCE PRODUCTS



RP2204-\$349.00 RP2212-\$369.50 PE2217-\$549.00 PE2217-R-\$549.00 MA5002-\$799.00

Manufactured in California, U.S.A. by Soundcraftsmen, 1721 Newport Circle, Santa Ana, CA 92705



**THE INSIDE STORY ON HOW TO IMPROVE YOUR HEARING.**

**AA-1200 AM/FM Stereo Receiver:**  
 Continuous Power Output of 120 Watts/Channel Min. RMS at 8 ohms from 20 to 20,000 Hz with no more than 0.08% Total Harmonic Distortion, Separate Watt Meters with 3 Watt and 100 Watt Ranges (Switchable), 2 Tape Inputs, 1 Phono Input, 3 AC Outlets, Separate Bass, Midrange and Treble Controls, Dual Power Supply for Reduced Transient Crosstalk.  
 FM Sensitivity (IHF) — 1.7  $\mu$ V; FM Selectivity (IHF) — More than 80 dB; Stereo Separation — More than 42 dB at 1 kHz.

**AA-1175 AM/FM Stereo Receiver:**  
 Continuous Power Output of 75 Watts/Channel Min. RMS at 8 ohms from 20 to 20,000 Hz with no more than 0.08% Total Harmonic Distortion, 2 Tape Inputs, 1 Phono Input, 3 AC Outlets, Separate Tuning and Signal Strength Meters, High and Low Frequency Filters, Separate Bass, Midrange and Treble Controls, Dual Power Supply for Reduced Transient Crosstalk.  
 FM Sensitivity (IHF) — 1.7  $\mu$ V; FM Selectivity (IHF) — More than 80 dB; Stereo Separation — More than 42 dB at 1 kHz.

**AA-1150 AM/FM Stereo Receiver:**  
 Continuous Power Output of 50 Watts/Channel Min. RMS at 8 ohms from 20 to 20,000 Hz with no more than 0.1% Total Harmonic Distortion, 2 Tape Inputs, 1 Phono Input, 2 AC Outlets, High and Low Frequency Filters, Separate Tuning and Signal Strength Meters, Tape Dubbing Facilities and Tape Monitors.  
 FM Sensitivity (IHF) — 1.8  $\mu$ V; FM Selectivity (IHF) — More than 70 dB; Stereo Separation — More than 42 dB at 1 kHz.

**AA-1135 AM/FM Stereo Receiver:**  
 Continuous Power Output of 35 Watts/Channel Min. RMS at 8 ohms from 20 to 20,000 Hz with no more than 0.2% Total Harmonic Distortion, 2 Tape Inputs, 1 Phono Input, 2 AC Outlets, Tape Dubbing Facilities and Tape Monitors, FM Mute Switch.  
 FM Sensitivity (IHF) — 1.8  $\mu$ V; FM Selectivity (IHF) — More than 70 dB; Stereo Separation — More than 40 dB at 1 kHz.

**AA-1125 AM/FM Stereo Receiver:**  
 Continuous Power Output of 25 Watts/Channel Min. RMS at 8 ohms from 20 to 20,000 Hz with no more than 0.3% Total Harmonic Distortion, 2 Tape Inputs, 1 Phono Input, Phase Lock Loop Multiplex Section.  
 FM Sensitivity (IHF) — 1.9  $\mu$ V; FM Selectivity (IHF) — More than 70 dB; Stereo Separation — More than 40 dB at 1 kHz.

**AA-1115 AM/FM Stereo Receiver:**  
 Continuous Power Output of 15 Watts/Channel Min. RMS at 8 ohms from 40 to 20,000 Hz with no more than 0.5% Total Harmonic Distortion, Phase Lock Loop Multiplex Section, Tape Monitor, Speaker Selector Buttons for 2 Sets of Speakers, Tape Dubbing, Loudness Switch, Enumerated Bass and Treble Balance and Volume Controls.  
 FM Sensitivity (IHF) — 1.9  $\mu$ V; FM Selectivity (IHF) — More than 60 dB; Stereo Separation — More than 40 dB at 1 kHz.

**AA-1115 AM/FM Stereo Receiver:**  
 FM Sensitivity (IHF) — 1.9  $\mu$ V; FM Selectivity (IHF) — More than 60 dB; Stereo Separation — More than 40 dB at 1 kHz.

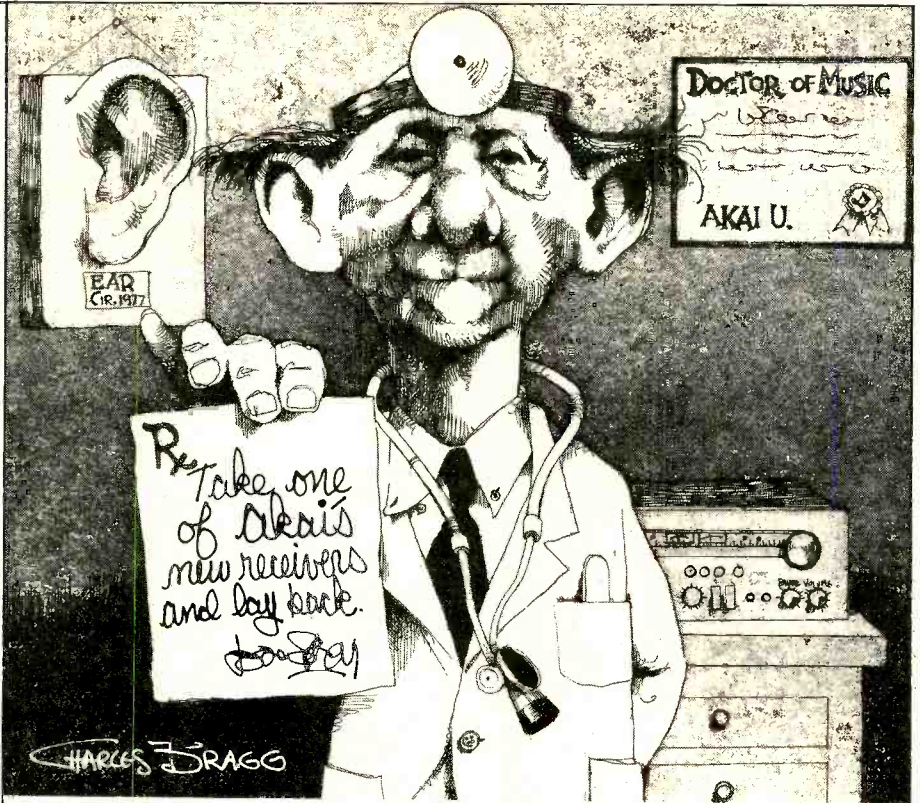

# INTRODUCING SIX WAYS TO IMPROVE YOUR HEARING.

AKAI introduces just what the doctor ordered to improve your hearing: six great-sounding receivers that put real heart into your system, whether you listen to tape, records or FM.

Choose from six power ranges — 15 to 120 watts per channel — with prices you can afford. So now, no matter what receiver you want — a good basic unit or a unit with all the features an audiophile demands — AKAI's for you. You can feel confident that dollar for dollar, spec for spec, you're getting the true-to-life sound you expect from the name AKAI. And a receiver that delivers better tuner

sensitivity and less distortion at all volume levels is what a good receiver is all about.

Compare performance, features, design and value at your AKAI dealer. And start hearing what you've been missing.

Model	Watts/RMS	OHMS	Power Bandwidth	Total Harmonic Distortion
AA-1115	15	8	40-20,000 Hz	no more than 0.5%
AA-1125	25	8	20-20,000 Hz	no more than 0.3%
AA-1135	35	8	20-20,000 Hz	no more than 0.2%
AA-1150	50	8	20-20,000 Hz	no more than 0.1%
AA-1175	75	8	20-20,000 Hz	no more than 0.08%
AA-1200	120	8	20-20,000 Hz	no more than 0.08%

## AKAI

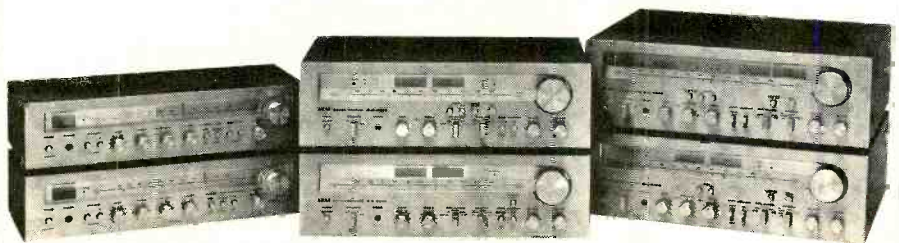

**ART COLLECTORS:**

For an 18" x 24" reproduction of this Charles Bragg etching suitable for framing, send \$2 to AKAI, Dept. SR, P.O. Box 6010, Compton, CA 90224. ATTN: Doctor.



estly be taken to surpass Minton? Very seldom, at least to my mind, do singers and players achieve greatness. Much as I revere Bjoerling, I would hesitate to say more than that he was one of the best tenors the world has ever known—and that seems at least a trifle rash. But “great”? Can’t we hold some terms of esteem back for something truly unusual, lest we fall into the trash barrel with those for whom bad is good, mediocre is star quality, and everything above that is a supernova, or whatever superlatiye they come up with next? As for *Nuits d’Été*—oh taste and see, oh Richard Freed, the old Danco recording (alas, now out of print) or the pirate recording of it with Gedda.

ROGER HORN  
Clarion, Pa.

Yes, but are they “great”?

## Handy D’Indy

● I was interested to learn, from Michael Flynn’s June letter, about the Supraphon disc of music by Vincent d’Indy, and I would like to report that I have in my own collection a superb (and fairly recent) recording by Pierre Dervaux and the Orchestre Philharmonique des Pays de la Loire (French EMI CO69-14043) of not only the *Istar* variations but also the complete Wallenstein trilogy based on Schiller’s poem: *Le Camp de Wallenstein*, *Max et Thécla*, and *La Mort de Wallenstein*. This is indeed powerful, dramatic music, and it should be heard more often. I’d give my

eyeteeth, by the way, for an up-to-date recording of the D’Indy Second Symphony, in B-flat. It’s a mystery to me why the monumental heroics of this work have not found their way onto discs since the old San Francisco Symphony performance under Pierre Monteux on Victor passed on to that giant record bin in the sky.

RICHARD K. PATTERSON  
Hyde Park, N.Y.

## Hall and Oates

● I was really happy to see Hall and Oates on the cover of the April issue, since I am one of their most ardent fans. And it made my day that the article included a rare photo of Daryl Hall actually *smiling!*

ANDI J. ZACK  
Arlington, Va.

## Warren Zevon

● After having the tasty satisfaction of giving Steve Simels thumbs down for his review of Warren Zevon’s first effort (“Letters to the Editor,” October 1976), I was delighted to hear that a new Zevon album was out. I quickly bought it in bloodthirsty anticipation of another Simels blue-ribbon endorsement of another Zevon “masterpiece,” which is just what his May review provided. Playing the first cut (*Johnny Strikes Up the Band*), I took some pleasure in hearing the same old “Zevong,” but during the refrain of *Roland the*

*Headless Thompson Gunner*, I was appalled to find myself tapping my foot to the tune. When *Excitable Boy* came on, I was weakened and staggering, and the first “Oo-wah-oo” by Sweet Linda and Co. dealt me the finishing blow. I give up. Zevon has *got it!* I am won over.

You’re a lucky man, Simels. Warren didn’t leave you up a tree on your last review. But you’d better watch out, fella. I’ve still got my eye on you.

SCOTT PHELPS  
Nashville, Tenn.

## Vintage Lightfoot

● Noel Coppage is correct (in May “Best of the Month”) in remarking that *The Circle Is Small* on Gordon Lightfoot’s new “Endless Wire” LP has been “around for a while.” It has, in fact, been hanging around for ten years. Lightfoot first recorded it in 1968 on his “Back Here on Earth” album (United Artists 6672). It just goes to prove that oldies are still goodies!

TOM COCOZZOLI  
East Lansing, Mich.

## Price Correction

● The price of \$1,200 quoted for the Tandberg TR-2075 MkII receiver in the June test report applies only to units with a special-order Lucite cabinet. A unit with the standard rosewood-veneer cabinet is \$1,100.



**“In our simulated live-vs-recorded listening test, the D-6 (with controls in the up position) was 100 per cent perfect at any point in our listening room! The D-6 is the only speaker in our experience to achieve this!”... “After listening to the D-6 for a while, the colorations heard from many other speakers stand out like the proverbial sore thumb!”**

—Hirsch-Houck Laboratories in Stereo Review, Sept. 1973—

## A tough act to follow, but we did it.

If you think it’s difficult to improve upon the D-6, you’re right. So, we simply made it bigger.

The Design Acoustics D-8 loudspeaker, with its additional driver complement produces greater sound pressure levels with less amplifier power, while maintaining the same high degree of accuracy that won the D-6 a rave review from Stereo Review’s Julian Hirsch. It also happens to look elegant while doing all this.

Whichever one suits your needs, you’ll own one of the finest loudspeakers available. And that is the tall and the short of it.

For additional information, send this coupon to the address below.

Name \_\_\_\_\_

Address \_\_\_\_\_

City \_\_\_\_\_ State \_\_\_\_\_ Zip \_\_\_\_\_



Design Acoustics, Inc., Dept. SR-8-8, 2426 Amsler St., Torrance, CA 90505



# FIDELITY TURNS INTO REALITY.

## With The ADS 10 Digital Time Delay System.

If you are a typical reader of this magazine, you already own a good stereo system and your next component will be a time delay ambience-reproduction system.

The best two-channel stereo sound is still a limited illusion, a sonic painting on the wall between the stereo speakers. You don't have to open your eyes to know that you are hearing a reproduction rather than the real thing. Stereo cannot produce a window view of the recording locale, but as long as the sound is only projected at listeners from in front, stereo cannot produce the feeling of **being there** in the same acoustic space with the musicians. Better recordings and finer stereo components can improve the quality of the picture-window view but they cannot make the breakthrough to a convincing sense of "reality" in the reproduction. The you-are-there illusion in sound, that feeling of hearing the sound in **three** dimensions, can only be achieved by re-creating the enveloping "ambient" sound field which surrounds the listener in any real acoustic space. Critics and reviewers have agreed that there is nothing you can add to a decent stereo system for \$1000 which will improve its performance as much as a good time delay ambience system can.

The ambience system you will want to own is the ADS 10 — the most sophisticated and the only complete time delay system now offered to the public. The ADS 10 is a fully optimized, fully integrated, third generation digital system containing everything you need to add to your existing stereo (ambience circuitry, amplifier and speakers) — free of the limitations and compromises of earlier time delay units. Its component parts work at maximum efficiency with each other, with no money wasted on redundant parts or unused capacity. The ADS 10 speakers were developed specifically for this application.

Building the amplifiers into the same chassis as the time delay circuitry, sharing the same power supply and cabinet allows us to offer a full 100 watt per channel amp

at the price of a far smaller separate amplifier. This also simplifies installation in your home by eliminating another piece of gear requiring additional shelf space and interconnecting cables.

As for the ADS 10's time-delay and ambience-producing circuitry, we invite you to compare it with others. We believe you will find it to be the best-sounding, most natural and musical, most flexible and most logically designed ambience system available. The ADS 10 has more flexibility of control than any other system, but it is simple to operate. Design of the controls has been human-engineered so that you can easily select the size of the hall (from an intimate club to a cathedral), the depth of the stage, the location of your 'seat' and the reverberant qualities of the hall itself. An irritating problem of earlier time delay systems — the unnatural sound of the ambience-enhanced human voice, as in FM listening, for example — is resolved in the ADS 10 by a special circuit. Provision is made for adding ambience to the front channels for 'dry' recordings, as well as to your own tape recordings. An ambience-enhanced headphone outlet provides the most natural, most musical headphone listening you've ever known.

Visit your ADS dealer. Bring your favorite records with you and listen to them through the ADS 10. Experience the difference between fidelity and reality. Change the hall. Deepen the stage. Move your 'seat.' Check the features and the performance of the ADS 10 against any other time delay system. You'll discover the ADS 10 Acoustic Dimension Synthesizer is the system for which you've been waiting.

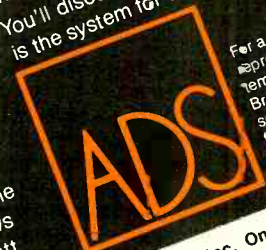

For a comprehensive explanation of ambience reproduction and the ADS 10 Time Delay System, request your free copy of the ADS 10 Brochure. For full information on the scientific basis, design, installation, features and functions of the ADS 10, we invite you to order the ADS 10 Owner's Manual at \$5.00 per copy.

**ADS, Analog & Digital Systems, Inc. One Progress Way, Wilmington, MA 01857**  
 Please send me a copy of the ADS 10 Owner's Manual. \$5.00 is enclosed.  
 Please send me a copy of the ADS 10 Brochure.  
Name \_\_\_\_\_ Address \_\_\_\_\_ Zip \_\_\_\_\_  
10C 78 FP SR8



# Mitsubishi Pre-empts the Receiver.

Introducing the docking tuner/preamplifier and amplifier. Exclusively Mitsubishi.

It is not a receiver. It is what receivers try to be.

It is two components. Tuner and preamplifier on one chassis. That docks with our dual monaural power amplifier.

It has The DM Factor. Dual Monaural construction. Exclusively Mitsubishi.

It means more than mere stereo. It means inside our stereo tuner/preamplifier are two perfectly matched mono preamplifiers. Just like our component preamplifiers. But not like any receiver.

Because it is not a receiver.

It is a tuner with THD in stereo at 0.08%. With signal to noise in stereo at 75dB. With switchable selectivity for uncompromising reception.

With incredible clarity and

definition. Ten violins sound like ten violins, not one big mushy solo.

It is a dual monaural pre-

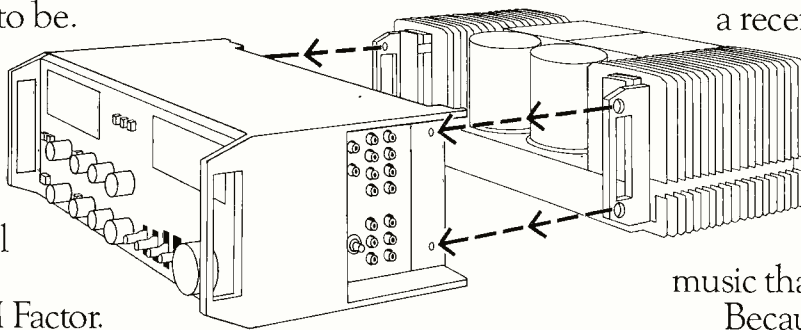

amplifier with interchannel separation at better than 80 dB at 20kHz. Far better than any receiver. With THD at less than 0.002%. For effective elimination of leaks, crosstalk, or any influence able to distort the stereo image.

With the ability to handle the moving coil cartridge. For signal to noise at -77dB (0.1mV input). Previously unheard of in any preamplifier.

It is a tuner/preamplifier that docks with a dual monaural power amplifier. 100 watts or 150 watts. With max RMS output power into 8 ohms from 15Hz to 30kHz.

With THD at no more than 0.05% at rated output.

It is a single, uncluttered unit with the convenience of a receiver. But the integrity of the exclusive DM Factor. The prime factor in making sure our equipment doesn't fictionalize any music that it plays.

Because the equipment is Mitsubishi. And Mitsubishi has a standard: what comes out must be as real as everything that went in.

Listen to the most expensive receiver you can. Then hear our DA-C20 dual monaural tuner/preamplifier and self-docking amplifier.

Hear what our standard really sounds like.

And, believe us, it doesn't sound like any receiver in the world.

**MITSUBISHI**  
AUDIO SYSTEMS





FM BAND MULTIPLE BAND / MODE SELECTOR

lock 105 104 103 102 101 100 400 99 98 97 96 95 94 93 92 91 90 89 88 87 86 85 84 83 82 81 80 79 78 77 76 75 74 73 72 71 70 69 68 67 66 65 64 63 62 61 60 59 58 57 56 55 54 53 52 51 50 49 48 47 46 45 44 43 42 41 40 39 38 37 36 35 34 33 32 31 30 29 28 27 26 25 24 23 22 21 20 19 18 17 16 15 14 13 12 11 10 9 8 7 6 5 4 3 2 1 0  
MHz kHz  
stereo  
FM  
AM

MITSUBISHI DA-C20  
DUAL MONITORIAL CONSTRUCTION  
TUNER + PREAMPLIFIER

TUNING



# New Products latest audio equipment and accessories

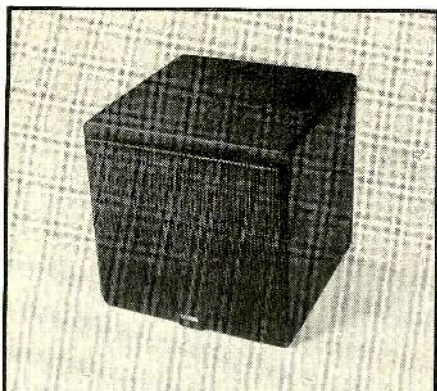

## New Canton Speaker Is a Perfect Cube

□ Canton's Gamma 800 is a perfectly cubical speaker system with dimensions of 11 inches per side. It contains an 8-inch woofer, a 1 1/5-inch dome mid-range, and a 3/4-inch dome tweeter in an air-suspension enclosure. The crossover frequencies are 750 and 2,200 Hz, with respective slopes of 12 and 24 dB per octave. The finish is black with a perforated metal grille. Power-handling capability for the Gamma 800 is 80 watts continuous, 120 watts peak, both referred to a nominal impedance of between 4 and 8 ohms. Usable frequency range is given as 23 to 30,000 Hz. Price: \$279 (\$285 on the West Coast).

Circle 115 on reader service card

the system, which has a nominal impedance of 8 ohms. The Advent/1's performance is said to approach that of the larger New Advent Loudspeaker very closely, the only significant difference being in the deep bass, where the Advent/1 has 2 dB less output at 32 Hz. The cabinet, measuring 22 x 13 1/4 x 9 1/4 inches, is available clad in walnut-grain vinyl or walnut veneer. Respective prices: \$99.95 and \$120.

Circle 116 on reader service card



## Sony Speaker Has Forward-mounted Woofer

□ By mounting its 15-inch woofer on a protruding frame, Sony has brought the effective points of sound origin for all the drivers in the new SS-G7 speaker system into the same vertical plane. The object is to keep all these sound-origin points at an equal distance from the speaker-mounting panel; Sony research finds such positioning beneficial to the accuracy of the system. The SS-G7 is a three-way ported design intended for floor installation. The 4-inch mid-range has an oversize voice-coil and dust cap, giving it the appearance of a dome driver. The 1 1/2-inch dome tweeter has a titanium diaphragm with a synthetic-leather surround. Output-level controls for the mid-range and tweeter drivers are located on the speaker-mounting panel, which has been fashioned with a unique checked pattern intended to reduce sound reflections and resultant diffraction effects. The woofer cone is formed of a carbon-fiber material for low mass and rigidity, while the enclosure itself is constructed of wood and selected synthetic materials in a manner said to defeat the formation of audible resonances.

The SS-G7 has a power-handling capability of 200 watts and a rated effective frequency range of 30 to 20,000 Hz. A 94-dB sound-pressure level is produced at a distance of 1 meter with an input of 1 watt into the system's nominal 8-ohm impedance. The SS-G7 measures 37 x 20 x 17 1/2 inches, including its removable foam grille. Approximate price: \$1,000.

Circle 117 on reader service card

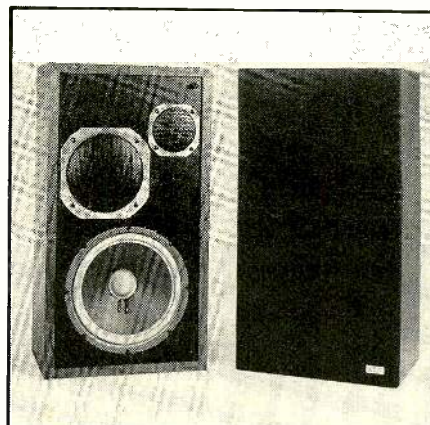

## New Three-way Speaker System From KLH

□ The Model 327, latest in KLH's series of three-way loudspeaker systems, is an air-suspension design with a 10-inch woofer, 4-inch cone mid-range, and 2 1/2-inch cone tweeter. Crossover frequencies are 900 and 3,600 Hz. For a 1-watt input of band-limited pink noise, the Model 327 delivers an output of 90.5 dB at 1 meter. Frequency response is given as 55 to 18,000 Hz and power-handling capability as 80 watts. At least 20 watts of amplifier power are recommended to drive the system. The enclosure, measuring 23 1/4 x 14 x 10 3/4 inches, is clad in walnut-grain vinyl and equipped with a removable black grille. Brushed-aluminum escutcheons surround the mid-range and tweeter drivers, and visually opaque screens conceal them. Price: \$179.

Circle 118 on reader service card



## Ferro-fluid Voice-coil Gap in Advent/1 Loudspeaker

□ The new Advent/1 is a product very similar in design to the original Advent loudspeaker system. It is a two-way air-suspension system employing a 10-inch woofer and a 1 3/8-inch cone tweeter, both drivers manufactured by Advent. Crossover frequency is 1,500 Hz. The tweeter's voice-coil gap is treated with ferro-fluid to improve damping and power-handling capability. A minimum amplifier power of 15 watts is recommended to drive



## Cizek's Latest Loudspeaker

□ The new Cizek Model 3 employs the crossover techniques of its manufacturer's previous designs to create an impedance characteristic that is flat and largely resistive over

(Continued on page 20)



# HIGH BIAS.

These cassette deck manufacturers use SA  
as their reference for the High(CrO<sub>2</sub>) bias/EQ setting:

AIWA • AKAI • CENTREX • JVC  
KENWOOD • MERITON • NAKAMICHI  
OPTONICA • PIONEER • ROYAL SOUND  
SANSUI • SHARP • TEAC • TOSHIBA  
UHER • YAMAHA

And are joined by these  
in recommending SA for use in their decks:

BANG & OLUFSEN • DUAL • FISHER  
HARMAN/KARDON • LAFAYETTE  
SANKYO • TANDBERG  
AND MANY OTHERS.



There's been a quiet revolution going on in the cassette world. □ Leading makers of quality cassette decks have adopted TDK SA as their reference standard tape for "High" (CrO<sub>2</sub>) bias and equalization settings. Why TDK SA? Because TDK SA's advanced tape formulation and super precision cassette mechanism let them (and you) take full advantage of today's advanced cassette deck technology. □ In addition, a growing number of other companies are recommending SA for use with their machines. □ So for the ultimate in cassette sound and performance, load your deck with SA and switch to the "High" or "CrO<sub>2</sub>" bias/EQ settings. You'll consistently get less noise, highest saturation and output levels, lowest distortion and the widest dynamic range to let you get the best performance from any quality machine. □ But you needn't believe all this just because we say so. All you have to do is check our references.

 **TDK**<sup>®</sup>

The machine for your machine.

TDK Electronics Corp., 755 Eastgate Blvd., Garden City, N.Y. 11530.  
In Canada: Superior Electronics Industries, Ltd.

CIRCLE NO. 56 ON READER SERVICE CARD



# New Products latest audio equipment and accessories

almost the entire frequency range of the system. The impedance is a virtually perfect 4 ohms ( $4.25 \text{ ohms} \pm 0.2 \text{ ohm}$ ) down to 100 Hz, where there is a gradual rise to 16 ohms at the woofer's resonance frequency of 42 Hz. The Model 3 is a two-way design in a sealed enclosure. The drivers consist of an 8-inch woofer and a 1-inch dome tweeter, and frequency response is  $42 \text{ to } 17,000 \text{ Hz} \pm 2 \text{ dB}$  (guaranteed within 1 dB). Recommended amplifier power is from 15 to 100 watts; for a 1-watt input the system provides a sound-pressure level of 88 dB at a distance of 1 meter. The Model 3 has two rear-panel controls, one of which adjusts the high-frequency output. The other alters the "Q" of the woofer from 0.5 to 0.8, giving a slightly rising low-frequency characteristic and changing the nominal impedance to 7.25 ohms. The Model 3 is finished in walnut with a removable foam grille. Dimensions are  $19 \times 11\frac{3}{4} \times 7\frac{1}{2}$  inches. Price: under \$100.

Circle 119 on reader service card



## Snap-apart Racks For Component and Disc Storage

□ A line of shelf assemblies from Nomadic Furniture is specially designed with audio equipment, records, and tapes in mind. The six available models are all four feet wide and range in height from 33 to 78 inches. All are hand-made and fasten with invisible snap-apart hardware that permits them to be knocked down into sides, shelves, and cross pieces. Hardwoods available include oak, mahogany, and alder/birch. Prices are from \$49 to \$399. Nomadic Furniture, 9525 Cozycroft Avenue, Units M & N, Chatsworth, Calif. 91311.

Circle 120 on reader service card

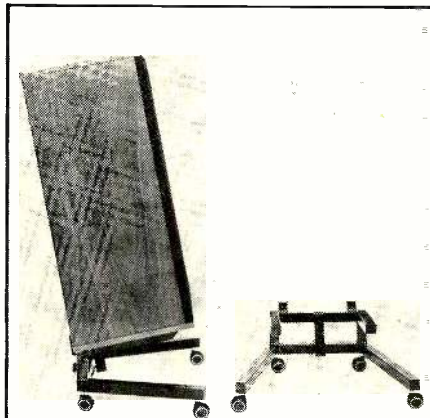

## Osawa's Adjustable Speaker Stand

□ Osawa & Co. (U.S.A.) Inc. is importing AFV Ltd.'s Universal Vari-Tilt Stand from England. The speaker-system support has a hinged platform that permits tilting the speaker back at any desired angle. A threaded shaft at the back of the stand bears against an upright affixed to the platform to adjust the degree of tilt and lock the platform in place. The stands are of all-metal construction clad in a black-nylon protective finish. They can be ordered with or without casters and in a variety of sizes to suit most speaker systems. Price: \$74.95 per pair. Another AVF stand, the Mark IV AC, is somewhat similar but lacks the variable-tilt feature. Price: \$49.95 per pair.

Circle 121 on reader service card



## Disc-care Device Has Reservoir for Cleaning Fluid

□ Transcriber's "Sound Saver" Classic 1 disc-cleaning system consists of a resilient velvet pad mounted on a wooden handle that contains a reservoir for the cleaning agent. Within the reservoir numerous tiny glass beads trap the cleaning fluid, which is introduced through a stoppered hole at the top of

the handle. The capillary action of the beads transforms the fluid to a static-reducing vapor that travels through the pad to the disc surface. According to the manufacturer, the Classic 1 system leaves no residue behind on the record. It comes packaged, together with a 2-ounce bottle of cleaning fluid, in a covered plastic storage tray that retains vapor and supports the cleaner so that its velvet pile is not compressed. A single charge of fluid is said to last about two weeks, depending on the number of discs treated. Price: \$15. Refills of the fluid cost \$2.25 for  $\frac{1}{4}$  ounces or \$6 for 4 ounces.

Circle 122 on reader service card

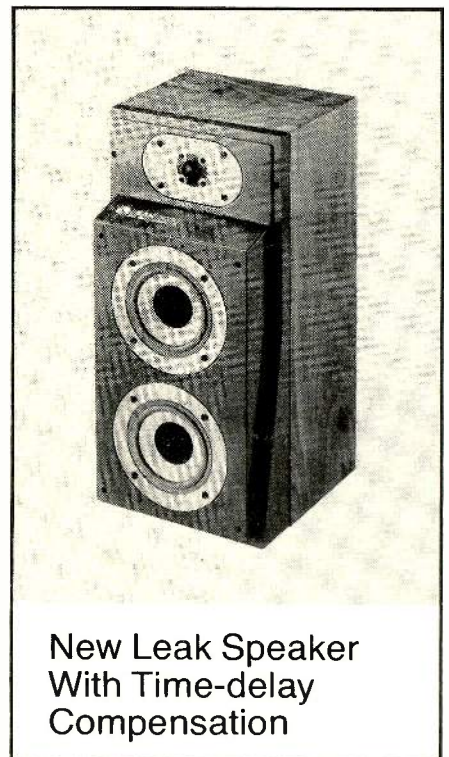

## New Leak Speaker With Time-delay Compensation

□ Model 3030, Leak's latest addition to its 3000 series, has a set-back at the top of its enclosure (where the  $\frac{3}{4}$ -inch dome tweeter is mounted) to ensure equal arrival times at the listener's ear for the outputs of the tweeter and the two 5-inch woofers. These woofers, which have vacuum-formed polystyrene cones, operate over the frequency range of 48 to 4,000 Hz. The tweeter extends response to 22,000 Hz. Nominal impedance is 8 ohms. The enclosure is sealed. Amplifier power of 15 watts is said to be adequate to drive the Model 3030 to satisfactory levels. The system is suitable for floor, shelf, or stand installation. Carefully matched walnut veneers are used to finish the cabinet, which has a black, semi-opaque removable grille. Dimensions are  $20\frac{1}{2} \times 9\frac{3}{4} \times 11$  inches. Price: \$230.

Circle 123 on reader service card

(Continued on page 22)



# No more "plop."

The Accutrac + 6 doesn't drop records. Instead, it lowers them onto the platter.

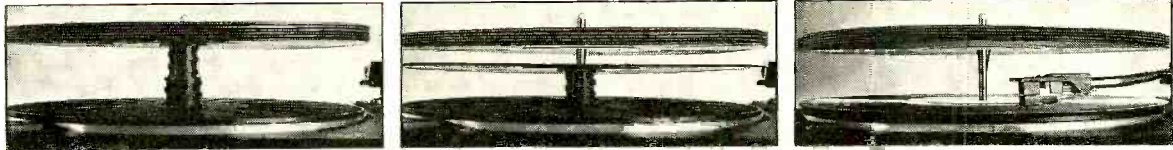

When you play 6 records, normally they "plop" onto the platter.

Ouch!

But the new Accutrac® + 6 is computerized to protect your records: no more "plop!" Instead, it lowers the records onto the platter, v-e-r-y g-e-n-t-l-y.

Ahhh.

Its Accuglide™ spiral spindle defies gravity.

Touch the computerized control key, and a platform spirals up through the platter to locate-and-lower each record. No record drop. No record damage.

But the computerized controls of the Accutrac + 6 make it more than the ultimate in record safety. It's also the ultimate in convenience.

Because with the new Accutrac + 6, what comes down must come up. Just touch the "raise record" key, and it lifts all 6 records back up to the starting position. Ready for your next command.

Which brings us to the fact that the Accutrac + 6 is also the ultimate in record control.

With its computerized programming keys you can command the Accutrac + 6 to play the tracks on each record in any order you like. As often as you like. Even skip the tracks you don't like.

And you never have to touch the tonearm to do it, because the Accutrac + 6 is engineered with a computerized "hands-off" tonearm.

In fact, once you close the dust cover you never have to touch the records or tonearm again to hear your programmed selections.

With Accutrac + 6 model 3500R, you can control everything from across the room with a full-system remote control transmitter and receiver. There's even remote volume control on model 3500RVC.

No other 6 record system gives you the record safety, convenience and control of the new Accutrac + 6. But the truly incredible feature of the new Accutrac + 6 is its low price. From under \$300\* for model 3500.

So forget everything you know about 6 record systems. And remember to see the new Accutrac + 6. It defies gravity, and your imagination.

 **Accutrac + 6**  
A BSR Company

\*Price shown in this ad is approximate. Selling price is determined by the individual dealer. ©Accutrac is a registered trademark of Accutrac Ltd. ADC Professional Products. A Division of BSR Consumer Products Group, Rte. 303, Blauvelt, N.Y. 10913.

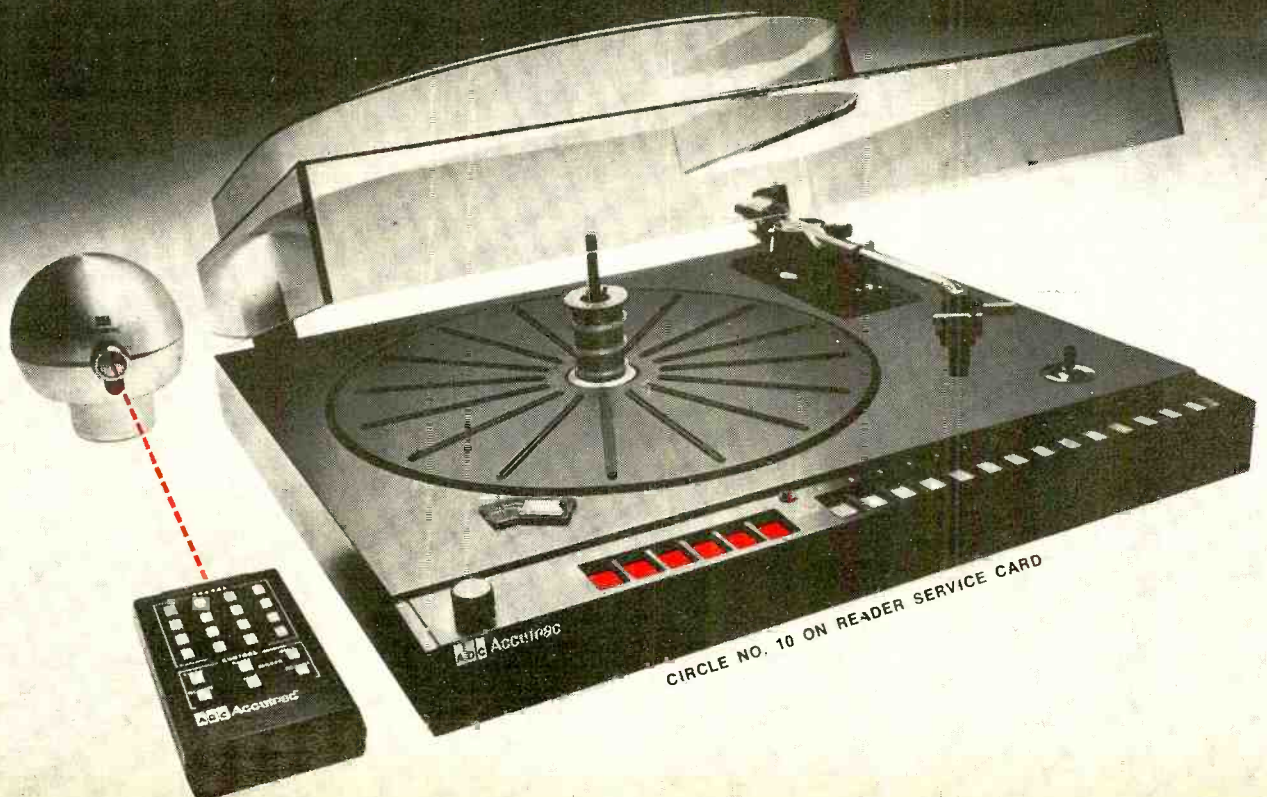



# New Products latest audio equipment and accessories



**Kenwood's New  
Top-of-line Speaker**

□ The new LS-890 is Kenwood's finest speaker system. The three-way design is built into an enclosure with two circular ports and employs a 13-inch woofer, 4¾-inch mid-range, and 1¾-inch cone tweeter. The crossover network has steep dividing slopes and acts at frequencies of 1,300 and 5,000 Hz. Nominal system impedance is 8 ohms. The sensitivity of the LS-890, measured at 1 meter with an input of 1 watt, is 92 dB. Amplifier powers ranging from 20 to 120 watts are recommended for use with the system. Frequency range is given as 30 to 20,000 Hz. Panels of particle board and lumbercore are used in the construction of the enclosure, which measures approximately 25¾ x 15 x 13 inches and is finished in birch veneer. The removable grille is of dark acoustically transparent foam. Price: \$350.

*Circle 124 on reader service card*



**U.S. Debut for  
English-made  
Tangent Speakers**

□ Inception Audio has announced the introduction of the English-made Tangent line of speaker systems to the U.S. Six models are involved, all but one of which are two-way designs. The exception is the top-of-the-line

three-way RS-6 (\$494.50), with a ¾-inch dome tweeter, a 5½-inch mid-range, and a 5½-inch woofer. These same drivers are also used in the rest of the Tangent line, except for the Model SPL 1 (\$97.50), which employs a 1¼-inch dome tweeter and a 4-inch mid-range/woofer. All systems have a nominal impedance of 8 ohms (6 ohms minimum), and the line is evenly divided between sealed and ported enclosures. Power-handling capabilities range from 45 to 100 watts. All six systems come in a choice of teak- or walnut-veneer finishes with brown grilles. Dimensionally they range from 11 x 7 x 8 inches for the SPL 1 to 32 x 12 x 12½ inches for the RS-6. Prices begin at \$97.50. Importer: Tangent Marketing International, Inception Audio, Ltd., 21 Progress Avenue, Unit 1, Scarborough, Ontario, Canada M1P 4S8.

*Circle 125 on reader service card*



**Concept Speaker  
System Employs  
Heil Driver**

□ The Model CE-M is the largest of a line of three loudspeakers from Concept that use Heil Air-motion Transformers for mid and high frequencies and passive radiators for extremely low frequencies. In the CE-M the top of the enclosure is constructed with appropriate openings so that the dipole-radiation characteristic of its Heil driver is not restricted. A 12-inch woofer takes over below 1,300 Hz, and this is assisted in low-frequency propagation by a 14½-inch passive radiator mounted immediately below it. The CE-M has a pair of unusual drive-level indicators: a green LED that signals amplifier inputs of from 2 to 10 watts and a red LED that begins blinking for an input level of 28 watts and glows steadily for 75 watts or more. The system's controls, mounted on a strip just beneath the lower edge of the grille, permit separate adjustment of the frequency ranges between 2,300 and

23,000 Hz, 300 and 3,000 Hz, and 200 and 400 Hz. Rated frequency response of the CE-M is 25 to 23,000 Hz ±3 dB. At least 25 watts continuous amplifier power is advised, and 300 watts is given as the maximum permissible input. A 1-watt input yields a sound-pressure level of 91 dB at 1 meter. The nominal impedance is 6 ohms. Dispersion is 120 degrees lateral and 30 degrees vertical throughout the response range of the Heil driver. The system's dimensions are 45 x 18 x 15½ inches, and the finish is oiled walnut. Price: \$595. The two smaller systems in the Concept line are the CE-1 and the CE-2.

*Circle 126 on reader service card*

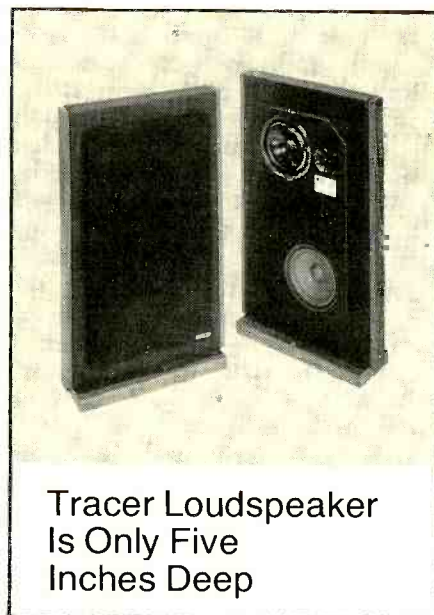

**Tracer Loudspeaker  
Is Only Five  
Inches Deep**

□ The Tracer Model 1001 "Sound Window," manufactured by BML Electronics, is a three-driver no-crossover design with enclosure dimensions of 33 x 20 x 5 inches. Two of the drivers are 7½-inch woofers, one of which is referred to as an "Active Bass Radiator." The woofers work into five interconnected sub-chambers within the enclosure that are said to be tuned to different resonance frequencies. Higher frequencies are handled by a piezoelectric tweeter with a 3½-inch horn. Because of the tweeter's inherent impedance characteristics, no crossover network is needed to exclude low frequencies from its input. Frequency response of the Model 1001 is given as 35 to 23,000 Hz +3, -5 dB. At least 10 watts of amplifier power are recommended for driving the system, which has a power-handling capability of up to 200 watts of program material. An input of 1 watt yields a sound-pressure level of 92 dB at a distance of 1 meter. Nominal impedance is 4 ohms. The Model 1001 is finished in oiled walnut veneers with a black grille. Price: \$299.95.

*Circle 127 on reader service card*

*(Continued on page 24)*



# OUR NEW CASSETTE DECK WOULD BE DAZZLING EVEN WITHOUT THE COMPUTER.

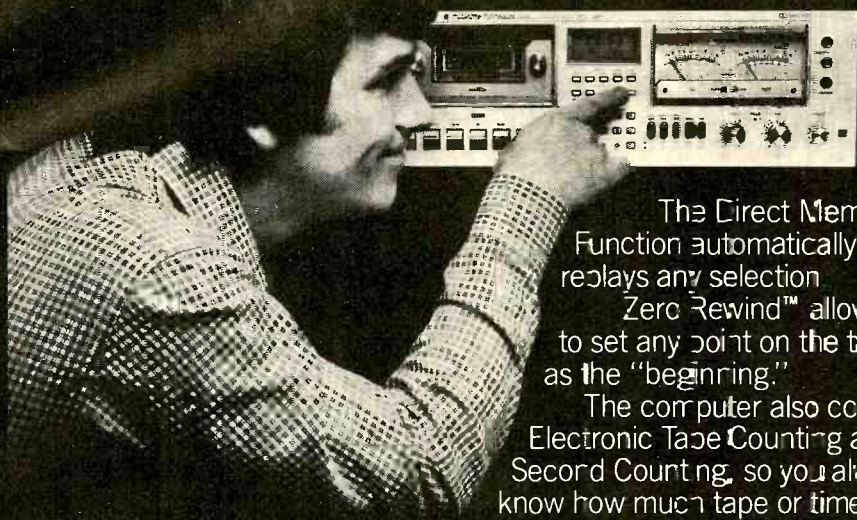

The first cassette deck controlled by computer—a micro-processor with no fewer than five memories—would be enough to dazzle anybody.

You merely program the computer: tell it how and when you want to listen to which song.

It controls Sharp's exclusive Auto Program Locate Device. This unique feature skips ahead or back to any song you select (up to 19 songs) and plays it automatically.

The Direct Memory Function automatically replays any selection.

Zero Rewind™ allows you to set any point on the tape as the "beginning."

The computer also controls Electronic Tape Counting and Second Counting, so you always know how much tape or time you have left.

A Liquid Crystal Display shows you current mode and function.

The built-in digital quartz clock acts as a timing device; it displays timed-programming operations, so you can actually program your RT-3388 to record automatically from a radio or TV at any pre-selected time and then switch itself off.

But what really makes the RT-3388 so special is that the musical performance of the deck is

every bit as dazzling as the electronic performance of the computer.

Just a few specs tell the story: S/N ratio; 64dB with Do by.\* Wow and flutter, a minimal 0.06%. Frequency response, 30-16,000 Hz ( $\pm 3dB$ ) for FeCII.

Without the computer, the RT-3388 would merely be one of the best engineered cassette decks you could find.

But how nice that you can have the deck with your own private computer to run it. (The RT-3388 is just one of a complete line of Sharp® cassette decks with the unique ability to find and play your music for you.)

When your Sharp dealer shows you the RT-3388, we suggest that you ask to hear some music first.

Then go ahead and let the computer dazzle you.

Sharp Electronics Corp.

10 Keystone Place  
Paramus, N.J. 07652

**SHARP**

**SHARP'S RT-3388.  
THE FIRST COMPUTER THAT PLAYS MUSIC.**

CIRCLE NO. 53 ON READER SERVICE CARD



\*Dolby is a registered trademark of Dolby Laboratories



# New Products latest audio equipment and accessories

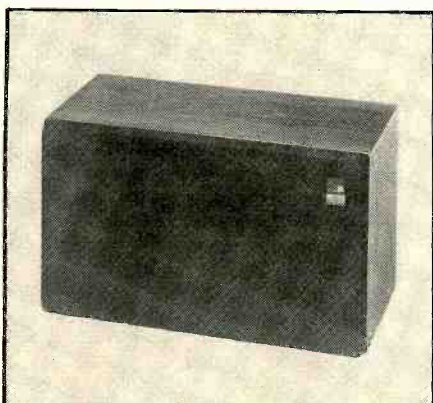

## Koss' Fourth "Computer-designed" Speaker System

□ Like the other Koss dynamic speaker systems, the new Model CM/530 had its low-frequency performance calculated and maximized through the use of a computer. The smallest of the CM Series, the CM/530 has an 8-inch woofer, an 8-inch passive radiator, and a 1-inch silk-dome tweeter. Crossover frequency is 3,000 Hz, and nominal impedance is 4 ohms. The system's frequency response has 3-dB-down points at 36 and 17,000 Hz. The recommended range of amplifier powers is 15 to 75 watts per channel. A 1-watt input results in a sound-pressure level of 87 dB at a distance of 1 meter. The CM/530 is fused (2 amperes) and is provided with a three-position high-frequency level control. Systems are manufactured in "mirror-image" pairs for symmetrical stereo performance. The cabinet finish is pecan with a removable brown grille. Overall measurements are 24 x 13 $\frac{3}{4}$  x 11 $\frac{3}{4}$  inches. Price: \$175.

Circle 128 on reader service card



## More Record-care Items from Bib

□ Bib Hi-Fi Accessories has announced two new and unusual record-care products: a powered record-static eliminator and a

straight-line-tracking version of the familiar Groov Kleen. The static eliminator, called the Groov Stat 3000 (shown), adopts the principle of similar products on the market (including a unit previously introduced by Bib), but it employs a small 1 $\frac{1}{2}$ -volt storage cell as a power source instead of depending on the voltage developed by a manually stressed piezoelectric element. In operation, the Model 3000 emits "clouds" of positive and negative ions at a potential of 14,000 volts; these ions can be effective in neutralizing static charges on the record surface. A high-pitched whistle and a neon light indicate operation of the unit. The Groov Stat 3000 is little larger than a pack of cigarettes and comes with a small electro-scope to test for the presence of record static. Price: \$29.95. Replacement energizing cells cost about 40¢.

The Parallel Tracking Groov Kleen makes use of the familiar fine-bristle brush and dust-collecting "roller" assembly to play the record right along with the tone arm. However, a radial track now guides the assembly instead of a pivoted arm. According to the manufacturer, this prevents skating forces from causing the cleaner to "out-run" the tone arm in playing a record. The cleaner is carried across the disc surface entirely by the action of the inwardly spiraling groove; it is supported by low-friction Teflon bushings encircling a slender radial rod. The entire device mounts on the turntable by means of a height-adjustment pedestal with an adhesive base. The radial track can be pivoted aside to facilitate record removal and replacement. Price: \$12.95.

Circle 129 on reader service card



## Latest AFS Mobile Speaker Features Variable Mounting

□ Acoustic Fiber Sound Systems' Model 6099 combines a 5 $\frac{1}{4}$ -inch woofer and 1-inch dome tweeter in a wedge-shaped cabinet suitable for surface or flush mounting in automobiles and other vehicles. The system provides a load of between 4 and 8 ohms to the amplifier, has a rated frequency response of 50 to 20,000 Hz  $\pm$  5 dB, and a power-handling capability of 40 watts continuous. Sensitivity is 87 dB for a 1-watt input measured at a distance

of 1 meter. The Model 6099 has a removable foam grille, and it comes supplied with an 18 $\frac{1}{2}$ -foot cable. Dimensions are 11 x 9 $\frac{1}{2}$  x 4 $\frac{3}{4}$  inches. Price: \$79.95.

Circle 130 on reader service card



## Rack-style Hi-fi Housing by Gusdorf

□ Gusdorf Corporation has introduced several furniture pieces meant for housing hi-fi components and accessories. The Model 1525 "Home Entertainment Étagère" (shown) has four shelves for supporting components; two are wooden and two are smoked Plexiglas. The shelves are supported by four upright chrome-finished poles. There is a record-storage area in the base with a lift-up door. All the wood surfaces have simulated-walnut finishes. Dimensions are about 73 x 29 x 15 inches. Price: about \$135. The Model 1415 is a smaller equipment cabinet constructed entirely of wood; it has three shelves and a record-storage area in the base. Dimensions are 48 x 23 $\frac{3}{4}$  x 17 inches. Price: about \$84.

For record storage only, Gusdorf offers the Model 1335 record cabinet. The 1335 has two large shelves, each with a lift-up door. It is mounted on casters and has dimensions of 37 $\frac{3}{4}$  x 27 x 15 inches. Finish is simulated walnut. Price: about \$75.

Circle 131 on reader service card

NOTICE: All product descriptions and specifications quoted in these columns are based on materials supplied by the manufacturer.

Recent fluctuations in the value of the dollar will have an effect on the price of merchandise imported into this country. Please be aware that the prices quoted in this issue may be subject to change.



VO



What a man serves is often a reflection of the man.

**Seagram's V.O.**

Bottled in Canada. Preferred throughout the world.

CANADIAN WHISKY. A BLEND OF CANADA'S FINEST WHISKIES. 6 YEARS OLD. 86.8 PROOF. SEAGRAM DISTILLERS CO., N.Y.C.



# You haven't heard your record collection yet.

And you won't hear it unless you have an extremely sensitive cartridge. A cartridge that can pick up all of the subtle harmonics. A cartridge like the XLM MK III from Audio Dynamics Corporation.

The XLM MK III features our new tapered cantilever, which when combined with our tiny .004" x .008" rectangular nude diamond results in 50% less mass than our previous lowest mass cartridge, the highly acclaimed XLM MK II.

What's more, the frequency response is ruler flat. 10Hz to 20kHz  $\pm$  1dB. It tracks at  $\frac{3}{4}$  to  $1\frac{1}{2}$  grams.

So listen to the XLM MK III cartridge. It's like listening to a whole new record collection.

 Audio Dynamics Corporation  
Pickett District Road  
New Milford, Conn. 06776  
A BSR COMPANY



For music you never knew was there.

CIRCLE NO. 7 ON READER SERVICE CARD

## Audio/Video News

### DIGITAL AUDIO DISCS MOVE A LITTLE CLOSER

**P**HILIPS and RCA, long-time rivals in the race to produce the first commercial video discs (Sony is a newer entrant), are also involved in an apparently similar contest to produce super-fidelity audio recordings using the same (or similar) technology. But there's a possibility that Mitsubishi—not yet an announced contender in the video race—may already have a head start.

The similarity between video discs and digital audio discs is no coincidence. Both require ultra-wide bandwidth, with frequency response that must be measured in megahertz, or millions of wave cycles per second, instead of the mere 20,000 Hz or so required for conventional analog audio recording. You can, in fact, record digital sound on any properly adapted video-tape system, a fact Sony intends to exploit with its PCM (pulse-code modulation) sound-recording adapter for the new home video-cassette recorders. Mitsubishi, too, has shown prototypes of a digital sound recorder built around a video-cassette unit.

But if a mass market for digital sound recordings is to develop, it will have to be on discs, for many of the same reasons that commercial prerecorded tapes have not supplanted the phonographic disc. Since their recorded surfaces are fully exposed, not wrapped in layers around a hub or reel, records can be mass-produced ("stamped out like cookies" is the expression commonly used) relatively quickly and at relatively low cost. Tape duplication still requires that the entire length of tape be fed, inch by inch, through an expensive duplicator.

**O**f the rival systems, RCA's is most like a conventional phono disc, with a stylus that tracks a groove physically. But, unlike the undulating phonograph groove, RCA's groove spirals smoothly inward, with the signals conveyed by changes in capacitance between the stylus and the disc's metal base rather than by stylus motion. The digital disc's superior information-carrying capacity could mean a dynamic range of 85 to 90 dB (about 25 dB better than high-quality stereo discs today) or 12-inch discs carrying anywhere from two to twenty hours of music. (Wagnerian opera aside, the two-hour version seems likely to have more market appeal.)

But the discs will cost more than conventional ones, and they will require new players. Will customers find the improved sound worth the cost? By the time you read this, RCA will have made its first simultaneous analog and digital recordings of a symphony orchestra, with listening tests scheduled to determine how well consumers will appreciate the digital version—and how much extra they're willing to pay for it. If reactions are sufficiently favorable, the first RCA digital "phonographs" will probably be video-disc players with optional added digital-sound playback capability. RCA has said that its retail target price for video-only disc players is

under \$400 (less than half the price of videocassette recorders) and that audio capability should add about \$20 to \$50 to that figure.

Philips, however, is already talking about having a  $\frac{4}{8}$ -inch-diameter "compact disc" on sale by "the early 1980's"—and the 1980's are only about a year and a half away. The Philips disc has no physically trackable grooves; a reflective information-carrying inner surface is scanned optically by a miniature laser element mounted in the pickup arm. A protective layer, Philips says, will keep dust, scratches, and fingerprints from affecting reproduction. Despite the record's small diameter, Philips claims a playing time of one hour in stereo, with multiple-channel capability possible (though probably with shorter playing times). Performance is claimed to include a dynamic range of 85 dB. The price, Philips predicts, will be "comparable to that of a good-quality hi-fi record player."

Sony, unlike RCA and Philips, introduced its audio disc *before* its video version. The video-disc system (which plays two hours on a two-sided, 12-inch record) is compatible with the company's audio-disc system, but neither Sony disc is compatible with the similar Philips (or dissimilar RCA) ones.

Both the Philips and Sony systems, incidentally, employ a "constant-speed" groove. In conventional discs, signals recorded in the smaller-circumference inner grooves are squeezed more tightly together than they are at the record's beginning, with resulting loss of fidelity. But by speeding up the disc's rotation—both in recording and playback—as the arm moves closer to the record's center, the inner-groove recorded material is spread out as evenly as that in the outer grooves, and problems are avoided.

Mitsubishi showed another laser-scanned system (not compatible with the MCA-Philips video or Philips audio discs) at the Consumer Electronics Show last summer. It was a single-sided disc with thirty minutes of playing time (few phonograph discs exceed twenty-five minutes per side), but a two-sided, one-hour-per-side disc is anticipated soon, and a two-sided disc with three and one-half hours per side is possible within a year or two.

**W**HO else is working on pure-digital audio discs? Well, there's Hitachi, Matsushita, Tokyo Denka, IBM, and Teac, for certain. Since Pioneer is working on a video-disc system (with MCA), and Pioneer is also heavily involved in audio, it's probably safe to include them, too. Not to mention TED, the oldest video-disc system, which was established jointly by the Decca and Telefunken recording companies in Europe.

So far, almost none of these systems are compatible with one another. But compatibility will probably be attained before mass marketing begins, for only then can the disc market become sizable enough to attract record companies. And without records to play, no one needs the players. —Ivan Berger



As the number one professional speaker company, we have to satisfy the most discriminating ears. Recording engineers and artists. What they're listening for is faithful sound reproduction of a live performance. And for over forty years, that's exactly what we've been able to deliver.

The same professionalism pays off for you when Altec Lansing leaves the studio and gets down to some serious playing at home.

The patented Altec "Tangerine™" radial phase plug, for example, is one of our most recent breakthroughs, and it's built right into the compression drivers on our Models 15 and 19. Unlike old circumferential phase plugs, our new radial design actually widens your high-frequency bandwidth. So now you



can get super-high efficiency and a range of highs you've never heard from a compression driver.

At the same time, we've also enhanced low-frequency response.

Our new computer-designed, tuned and vented enclosure gives you the best ratio of lower limit vs. sensitivity.

Finally, we improved the dividing network with a new frequency-selective, dual-range equalizer. You'll get smooth transitions without the roughness and distortion associated with ordinary crossover designs.

So listen to our speakers and hear how our work for professionals comes into play. For the name of your local dealer and a full line catalog, just write us: Altec Lansing International, 1515 S. Manchester Ave., Anaheim, CA 92803, (714) 774-2900.



CIRCLE NO. 4 ON READER SERVICE CARD

## THE NO.1 PROFESSIONAL SPEAKER

AT WORK. AND PLAY.



Studio: Mother Music Sound Recorders, Orange, CA





1½" Mylar® dome tweeter for extra-wide 170° high frequency dispersion.

High and mid frequency controls are continuously variable to adjust response to suit any room, program material or individual taste.

Two 3½" midranges with individual tuned isolation chambers.

Low frequency driver with specially treated polyurethane foam suspension for lower distortion, free cone movement, and smoother response.



# An inside look at Jensen's Total Energy Response.

You're looking at the heart of one of the most uniformly accurate sound reproducers made today.

Jensen Lifestyle speakers present a faithful reproduction of music, with all its complexities and tonal balances. They accurately distribute this sound throughout your listening room. Which is what Total Energy Response is all about. It's the uniform radiation of sound throughout the entire listening area ... at all frequencies.

Unlike many speakers that require special on-axis listening positions—or others that bounce the sound all over your room—Lifestyle is engineered to deliver a wide spectrum of musical information through

out the listening area. In proper perspective. With all the depth and imaging your source material is capable of. And at real-life volume levels.

## How does Jensen achieve Total Energy Response?

With a series of drivers and crossover components designed for wide dispersion and engineered to work in total unison with each other for proper stereo imaging.

In fact, for perfectly integrated speaker systems and total quality

control, we make every element that goes into the manufacture of our Lifestyle speakers. From the heavy duty magnets to our hand-wound, high power voice coils. Even the computer-designed crossover network.

At Jensen we take pride—and extra care—in producing the specially designed Mylar dome tweeters that provide 170° high frequency radiation. The same goes for the polyurethane foam cone suspension woofers. And the critical midrange units with tuned isolation chambers.

But please, give a critical listen to these speakers in person. We think you'll agree, a notably superior design concept has resulted in audibly superior sound reproduction.

### The Jensen dome tweeter.

A significant factor in Jensen's Total Energy Response. High frequency sound waves travel in a straight line. But the rounded shape of this element creates a sound wavefront pattern of the same shape. Thus, as these rounded sound waves travel outward from the dome, they fill the entire listening area.

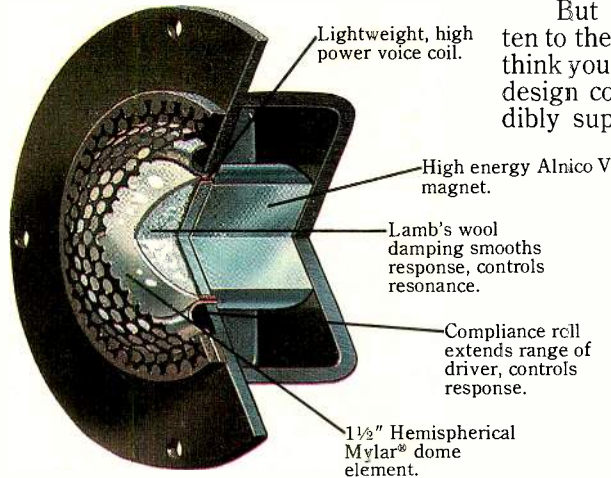

# JENSEN

LIFESTYLE SPEAKER SYSTEMS

Division of Pemcor, Inc.  
Schiller Park, Illinois 60176

CIRCLE NO. 29 ON READER SERVICE CARD



# THE AMERICAN CARTRIDGE THAT'S A STAR ABROAD

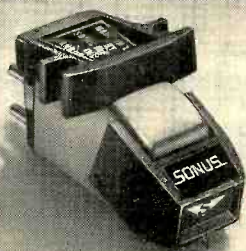

When we introduced the Sonus Blue cartridge, we were amazed at the speed with which discriminating audiophiles responded to its astounding ability to improve the quality of record reproduction. And we must admit that we've gotten some pretty good reviews in America.

But what really surprised us were the enthusiastic reviews of European audiophile publications.

**Hi-Fi Choice** (England): "A best buy... must be the Sonus Blue... overall balance of sound quality and laboratory performance is first rate... On listening tests, the Blue ranked number one."

**Banc D'Essais—Nouveaures** (France): "Listen to the Sonus cartridge... it reproduces even the most complex musical passages with superlative clarity."

**Stereolab—Test** (Germany): "... The Sonus showed up as very balanced and clean... compared to other outstanding cartridges, it stands up effortlessly! ... Quality level: Without question top class."

We feel more strongly than ever before that the addition of a Sonus cartridge to any fine quality stereo system will result in noticeable sonic improvements. Write for copies of these reviews, further information, plus the name of your local Sonus dealer.

Manufactured in the U.S.A. by:

**SONIC RESEARCH, INC.,**

27 Sugar Hollow Rd., Danbury, Conn. 06810

# SONUS

**High Definition Phono Cartridges**

CIRCLE NO. 46 ON READER SERVICE CARD

## Audio Basics

By Ralph  
Hodges



### EQUALIZERS: HAVING SOUND YOUR WAY

**A** SET of conventional tone controls bears somewhat the same relation to a component equalizer as a harmonica bears to a pipe organ. In other words, the so-called equalizer is an elaboration on the tone-control theme—sometimes a very complex elaboration. Ordinary bass and treble controls affect, respectively, the lower and higher frequencies by making them relatively louder or softer. Their effect will be obvious to anyone who gives such controls a few sweeping twists back and forth. They can make a profound difference in what is heard; the trouble is, it is often *too* profound.

The purpose of tone controls is to enable the user to make substantial changes in the low-to-high frequency balance of reproduced sound. For example, if the sound is too shrill and piercing (and this could occur for a variety of reasons), turning down the treble control may provide some relief. A recording that sounds lifeless may sometimes be improved by turning the treble up (although at the risk of increasing the hiss that always lurks in the background of all recordings). The bass control is intended to perform similar repairs on sound that is either boomy and over-full or, on the other hand, anemic and lacking in body.

Unfortunately, audio problems are rarely as simple as that. The tonal balance of a recording, an audio system, or a listening room can be—and often is—in much greater disarray than a straightforward bass or treble tone control can begin to cope with. For example, it often happens that modern-day listening rooms impart undue emphasis to the *mid-treble* region (producing harsh violins and overbearing brass) without having much effect on the uppermost treble tones. A simple treble control permits you to reduce the mid-treble harshness, but only at the cost of losing the sparkle of cymbals and other instruments with very high, delicate overtones. This puts the listener in the position of choosing the lesser of two evils.

The equalizer, with its more subtle approach, subdivides the frequency range into many bands instead of the two or three of conventional tone controls. Then, if there is a need to reduce the mid-treble without affecting the very highest frequencies, you'll find separate controls for the mid- and uppermost

treble. Or if the mid-bass offends even though the deep bass is fine, there are separate controls for those frequency ranges (or bands) too. Add a fifth control for the very center of the mid-range, and you have a basic five-band equalizer, which is the most common (and least expensive) unit.

**A**UDIOPHILE equalizers usually have vertically oriented slider controls rather than knobs. This is a convenience, not a necessity; the advantage is that the slider positions at any moment roughly outline a graph of the frequency-response characteristic that is then being imposed on the audio system. (This "graph" does not, of course, show the *actual* overall system frequency response, which is a complicated business to measure; it merely shows the *changes* in response that you have introduced to make things sound more to your

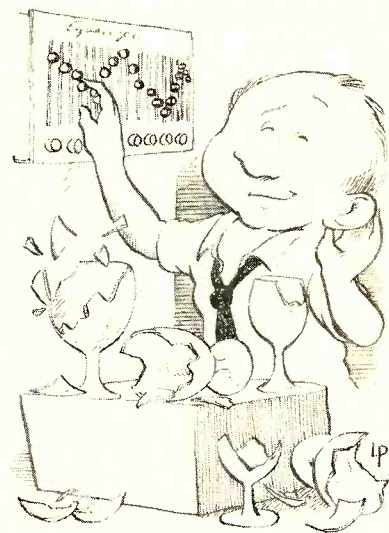

liking.) Such devices are thus widely known as "graphic" equalizers. There are other types whose control positions are not so immediately informative, but these are used mostly in professional applications.

The range of sound frequencies we can hear extends over approximately ten octaves,



and the five-band graphic equalizer usually assigns two octaves to each control, which has earned it another name: the two-octave-band equalizer. This configuration provides reasonably selective adjustment of frequency balance without becoming overly expensive or complicated to use. For the more ambitious and discerning listeners who wish to make very exacting alterations in tonal balance, there are single-octave-band equalizers with ten controls; these usually have one set of controls per channel (for a total of twenty in a stereo setup) and require a little more ear training to adjust. The effect of altering the position of just one single-octave-band control is not at all easy to assess by ear until a certain amount of experience has been acquired—if then. Many single-octave-band equalizers are designed to be adjusted with the help of at least some simple instrumentation. Sometimes the final settings serve as fixed corrections for faulty room acoustics or overall system response, and only slight variations are made as the program requires.

At the top of the equalizer category are 1/3-octave-band units with over twenty controls per channel. These are not intended to be set by ear, or even with the assistance of simple instruments. When one is purchased, a technician comes to adjust it once and for all and then locks the front panel to protect the settings from exploratory fingers. Again, these devices are generally used for permanent corrections of systems or room acoustics. They are becoming quite popular with recording studios for improving the response of monitor loudspeakers in control rooms. And even here we haven't reached the limit. Equalizers with 1/10-octave-band controls—or even narrower—are available for special purposes.

By now it should be obvious that the more complex, effective, and subtle an equalizer is, the more difficult it is to use for quick and easy frequency-response corrections by the average music listener. Up until a few years ago this was an exasperating situation, but now an almost ideal solution seems to be at hand: the "parametric" equalizer. Suppose you wish to affect a very specific and relatively narrow band of frequencies in a very precise way—to eliminate sibilants in a singer's voice, for example. A two-octave-band equalizer might affect the back-up instruments as much as it does the sibilance, and the "center" frequency to which the two-octave-wide mid-treble control is tuned is unlikely to be just the right one anyway. A one-octave-wide equalizer with more subdivisions can be tricky to adjust. But a parametric equalizer will enable you to put a little dip in the frequency response that you can then sweep up and down in frequency until it exactly hits the spot where the problem is. And then, with another control, you can widen or narrow the band of frequencies the dip spans, so that the effect on the accompanying music can be all but inaudible.

Using a parametric equalizer can be a liberating experience. All the flexibility you might hope for from a single-octave-band or even more elaborate equalizer is there, together with an ease of adjustment that positively invites experimentation. Alas, the good parametrics are rather expensive at the moment, and it is unlikely that prices will be reduced very much in the future. But if you must have a super-flexible equalizer, the parametric is the way to go at the moment.

# Why now, more than ever, we can ask, "Is it live, or is it Memorex?"



Quite simply, new MRX<sub>3</sub> is the best cassette Memorex has ever made. Better, even, than our own MRX<sub>2</sub> Oxide cassette. Here's exactly why: MRX<sub>3</sub> is made with a new, high-energy ferric oxide particle to give you the following improvements in sound reproduction.

- 1) **Brighter highs, richer lows.** Higher output at saturation, specifically a 3.0 dB improvement over MRX<sub>2</sub> Oxide at high frequency maximum output level and a 3.0 dB boost at low frequencies.
- 2) **Less distortion.** 4.0 dB less distortion than MRX<sub>2</sub> Oxide.
- 3) **Wide dynamic range for broad recording flexibility,** the most important indication of tape quality. Boosted MOL and low noise level give you an excellent signal-to-noise ratio and 2.5 dB improvement in dynamic range over MRX<sub>2</sub> Oxide.

In short, new MRX<sub>3</sub> Oxide offers sound reproduction so true that now more than ever, we can ask, "Is it live, or is it Memorex?"



**MEMOREX**  
Recording Tape.  
Is it live, or is it Memorex?



Great specifications  
won't impress your ears...  
Great sound will!



Speaker Shown:  
Apollo 8853

According to the 1978 Stereo Review Stereo Directory and Buyers Guide, there are at least 111 manufacturers of high fidelity speaker systems. All of whom would have you believe that they have perfected "The Listening Experience". Most of them will try to tell you how their speakers sound by their specification claims.

Frankly, that is impossible. You have to listen to a speaker to adequately judge its quality.

At AAL we utilize the finest domestic and international raw drivers. Superb craftsmanship is performed by union workers. Computer aided design yields optimum performance. All of this adds up to great sound... Which is what speakers are all about.

## Listen to us!

American Acoustic Labs  
629 West Cermak Rd.  
Chicago, Illinois 60616



## Audio Q. and A.

By Larry Klein

*A four-way monitor speaker system in the JVC Audio Research Center in Japan. Note the relative sizes of the tweeter and super tweeters visible at belt-buckle level.*



**F**or this month's Special Issue on Loudspeakers, this column will be entirely devoted to answering some recurring questions about understanding, choosing, and using speakers.

### Power and Performance

**Q.** *Can a powerful amplifier—say, 100 or more watts per channel rms—be damaged by driving a high-efficiency speaker that requires only a few watts? Also, when a speaker's minimum power requirement is, say, 20 watts and its maximum 100, what changes take place audibly and technically as the power level is increased, assuming that the amplifier's distortion remains low?*

**A.** To answer the first part of the question, I cannot conceive of any situation where damage to a high-output amplifier could result from using a high-efficiency speaker. Of course, the speaker could be damaged if its power-handling capability is exceeded by the amplifier. In regard to a speaker's minimum and maximum power ratings, we are confronted with distortion at both extremes: in one case, that of the amplifier, in the other, that of the speaker. If an amplifier has inadequate power to drive a given speaker, the amplifier will be driven into clipping, producing a raspy type of distortion on loud peaks that sounds something like that caused by a phonograph stylus' tracking improperly. The amplifier will also be unable to handle lower bass passages, and the distortion from that cause will inevitably result in a generally "mushy" bass quality. A low-power amplifier driven into "hard" clipping is more likely to damage speaker systems than a powerful amplifier that would not be overdriven at the same output level, because "hard" clipping of the audio waveform produces far more spurious high-frequency energy than normally occurs even in loud program material. It is likely that more tweeters have been destroyed by overdriven 40-watt amplifiers than by any of the 150-watt and over super-amps.

In general, the harder any component, electronic or mechanical, is driven, the more it will distort. But the distortion is usually not significant until the component approaches its maximum rating. The drivers in speaker sys-

tems distort in different ways. In a three-way system, an overdriven woofer will "double" or "triple"—that is, it will turn a pure 50-Hz tone, for example, into a mixture of 50-, 100-, and 150-Hz tones, because of the large amount of second- and third-harmonic distortion generated. Also, a rattling or snapping sound may be produced by the voice coil's striking the back of the magnet structure. Overdrive of the mid-range usually produces a raspy quality in the sound, but an overdriven tweeter will probably not make any nasty noises; it will simply and quietly burn out.

### Wires

**Q.** *I want to set up several extension systems in addition to my main speakers and would like to keep the phasing consistent throughout my system. Is there any type of lamp cord available that has coded leads? And how heavy should the wire be?*

**A.** All lamp cord produced at present has some kind of lead coding. There may be a molded ridge or a flat side on one of the pair of wires (see drawing), one conductor may be silver colored and the other copper, or

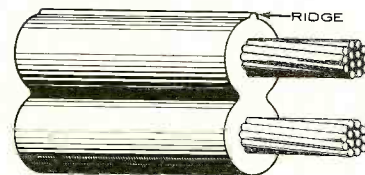

there may be a colored thread wrapped around one of the conductors. Ordinary 18-gauge lamp cord is usually okay for short runs (10 feet or so) to 8-ohm speakers. If your main speakers are 4-ohm types or your leads have to be longer, heavier 16-gauge zip cord is preferred. In any case, stay away from the thin (about half the diameter of lamp cord) "speaker" wire sold by many dealers, since if the wire is too thin (has too much resistance) for your setup, there will be some effect on the bass response of your speakers and some loss of amplifier-power potential.

(Continued on page 34)



# Free details on a different kind of record club

offering... BACH, BEETHOVEN, BRAHMS, FLEETWOOD MAC, LINDA RONSTADT, CHICAGO, KANSAS BARRY MANILOW, BOSTON, ELTON JOHN, JAMES TAYLOR, JEAN-LUC PONTY, CROSBY, STILLS & NASH, STEVE MILLER BAND, PETER FRAMPTON, BARBRA STREISAND, EAGLES, CHUCK MANGIONE and every other composer and artist in print.

You can now own every record or tape that you may ever want . . . **at tremendous savings** and with **no continuing purchase obligations**. You can get valuable **free dividend certificates**, you can get **quick service** and all the **100% iron-clad guarantees** you want.

Now you can **stop price increases** that leave you with less music for your record and tape budget. You can guarantee yourself **more music for less money** through membership in Discount Music Club.

Look at these benefits:

**TREMENDOUS SAVINGS** on every record and tape in print—no “agree-to-purchase” obligations of any kind.

**DISCOUNTS OF 43% TO 73%** off mfg. suggested list . . . special catalog features hundreds of titles and artists.

**ALL LABELS AVAILABLE** including most imports through special custom ordering service. If we don't stock it we'll get it for you.

**SCHWANN CATALOG** lists thousands of titles; classical, pop, jazz, ballet, opera, musical shows, folk, rock, vocal, instrumental, country.

**DISCOUNT DIVIDEND CERTIFICATES.** Dividend Gifts—Every shipment carries a dividend gift or dividend certificate. Certificates redeemable immediately for extra discounts.

**NEWSLETTERS.** Happenings in the world of music; concerts, critiques, new releases . . . special super-sale discounts of up to 73%.

**DISCOUNT ACCESSORY GUIDE.** Diamond needles, cloths, tape cleaners, etc. Discount Music Club is your complete one stop music and accessory buying service.

**QUICK SERVICE.** Same day shipping on many orders . . . rarely later than the next several days. Partial shipments always made in the event of unforeseen delay . . . all at no extra cost to you.

**100% IRON-CLAD GUARANTEES** on all products and services. Everything is guaranteed factory fresh and free of defects or damages of any sort. Your total satisfaction is unconditionally guaranteed.

**Discount Music Club is a no-obligation membership club that guarantees tremendous discounts on all stereo records and tapes and lets you buy what you want...when you want...or not at all if you choose.**

**These are just a few of the money-saving reasons to write for free details. You can't lose so why not fill out and mail the coupon for immediate information.**



**Discount Music Club**  
Department 9-0878

650 Main St., New Rochelle, N.Y. 10801

NAME \_\_\_\_\_

ADDRESS \_\_\_\_\_

CITY \_\_\_\_\_

STATE \_\_\_\_\_ ZIP \_\_\_\_\_



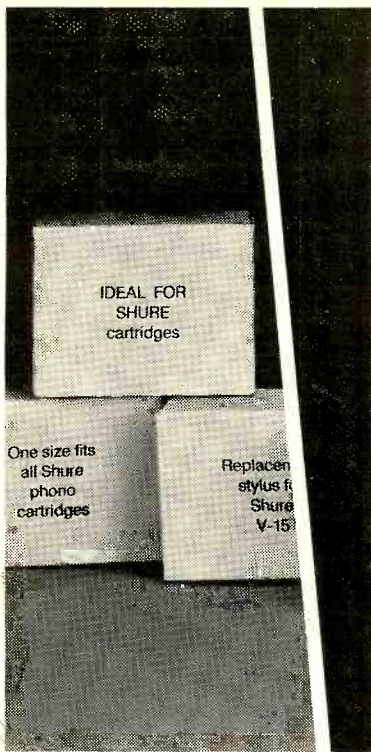

## Needle in the hi-fi haystack

Even we were astounded at how difficult it is to find an adequate other-brand replacement stylus for a Shure cartridge. We recently purchased 241 random styli that were not manufactured by Shure, but were being sold as replacements for our cartridges. Only ONE of these 241 styli could pass the same basic production line performance tests that ALL genuine Shure styli must pass. But don't simply accept what we say here. Send for the documented test results we've compiled for you in data booklet # AL548. Insist on a genuine Shure stylus so that your cartridge will retain its original performance capability—and at the same time protect your records.

Shure Brothers Inc.  
222 Hartrey Ave., Evanston, IL 60204  
In Canada: A.C. Simmonds & Sons Limited



Manufacturers of high fidelity components, microphones, sound systems and related circuitry.

## Audio Q. and A. . . .

### Specialized Speakers

**Q.** *I have heard it said that one should use one type of speaker for classical records and another type for rock, yet neither you nor Julian Hirsch has ever mentioned a need for specialized speakers. How come?*

**A.** I'm not sure what those who espouse such views have in mind. Except under very special circumstances, it seems to me that what is needed is a speaker system that can deliver an accurate acoustic analog of the electrical audio signal fed to it by the amplifier. Those who push the idea of different speakers for different music are saying, in effect, that certain music requires more or less speaker distortion, peaks in the bass, mid-range, or treble frequencies, or something else other than a flat, accurate response. I think that the best reproduction of any kind of music requires low distortion and an extended, smooth, non-peaked frequency response from all your equipment. Since the musical instruments have been recorded with a specific loudness in relation to each other, you want your speaker to reproduce those individual relative levels accurately no matter what kind of music is involved. If the recording has been engineered so that the brass has an extra "nasal" quality, the bass extra "sock," and the strings extra "bite," the speakers should deliver those qualities—neither more nor less. And the only way a speaker can do that is if it doesn't have any built-in "nasality," "sock," or "bite."

A speaker that does a fine job of reproducing chamber music may not be suitable for rock, but only because it lacks the efficiency and acoustic-output capability (in the bass or overall) to achieve the sound-pressure levels desired. If the attempt to achieve a desired loudness level for rock (or some contemporary electronic music) drives either your amplifier or your speakers into distortion because of inadequate amplifier power, low speaker efficiency, or inadequate power-handling capacity on the part of the speakers, then other speakers with greater efficiency and power-handling capacity would, of course, do a better job. However, all other performance criteria—frequency range and smoothness, distortion, dispersion, and so forth—continue to be valid. A speaker that is able to deliver loud rock music with true high fidelity should do just as good a job when reproducing the more moderate levels of a string quartet. Fidelity is fidelity.

### Fusing

**Q.** *I'm about to buy a set of speakers and am interested in fusing them, having read a review that suggests such a move. Can you tell me how to go about it?*

**A.** It is difficult to select the proper fuse for a speaker system without extensive trial-and-error testing—which apparently is the way most manufacturers arrive at their recommended values. The problem is this: in a two- or three-way speaker system, one of the drivers is inevitably going to be more susceptible to overdrive damage than the others.

Therefore, the current rating of the fuse should be chosen so as to protect the "weakest" unit. To complicate matters, the impedance of a speaker changes with frequency, and it is the speaker's impedance that determines the current flow from the amplifier for a given audio-signal level. In other words, the amount of current flowing through the system and the various drivers within it varies with the frequency of the signal. Without knowing what amount of current is "safe" for each driver throughout its operating range and how much current is actually reaching it, I simply don't have enough information to help you select the proper fuse, but the manufacturer of your speakers should certainly be able to.

### Fuse Blowing

**Q.** *I fused my low-efficiency acoustic-suspension speakers following the manufacturer's recommendations, and for several years everything was fine. During that time I was using an amplifier made by the same manufacturer rated at 60 watts per channel. To update my system I recently switched to a 200-watt-per-channel power amplifier. The sound from my old speakers is more open and clean, but I blow speaker fuses fairly regularly. I know I'm not playing my music any louder than before, so why should the fuses blow?*

**A.** The fuse blowing and the "open sound" are probably related, but not in an immediately obvious way. I suspect that your previous amplifier had an inadequate power reserve for your speakers and was therefore clipping the peaks of high-amplitude transient waveforms [see (B) in diagram]. Although

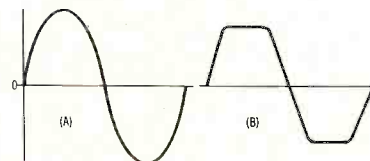

the clipping was not severe enough to cause harsh distortion, it nevertheless did "blur" the sound. Your new, high-powered amplifier is able to deliver these peaks with their full, unclipped amplitude [see (A)], which makes the music sound "cleaner"; but the unclipped peaks apparently also deliver more power to your speakers than their selected fuses can handle.

This hypothesis is not inconsistent with your statement that you are playing your system no louder than before, since the subjective "loudness" you hear is determined essentially by the average level of the program, not by the height of the momentary musical peaks. When you set the level so that you hear the same average loudness from the new amplifier as you did from the old one, substantially more power is delivered on peaks—and your speaker fuses blow. (A 200-watt peak produces slightly over 7 amperes of current in a 4-ohm speaker and about 5 amperes in an 8-ohm speaker load.)

Since fuse selection is usually a trial-and-error process, it could be that the manufacturer of your speakers will want to review his fuse recommendations. Substituting a slow-blow fuse with the same amperage rating as your present one might be a safe solution.



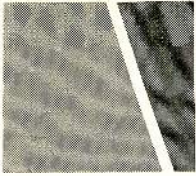

**fact:**  
**the IV does more... *much more!***

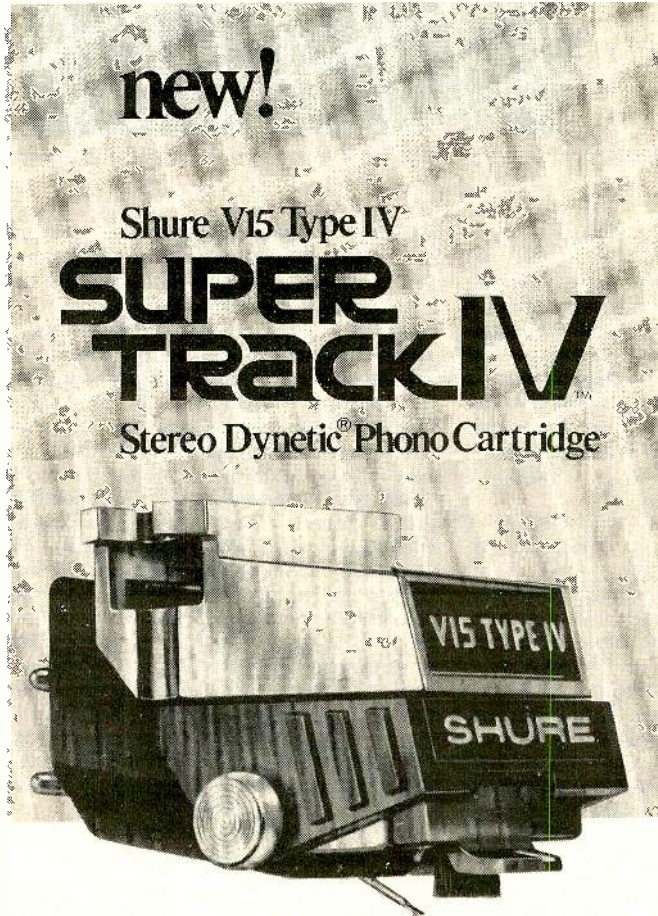

The creation of the new V15 Type IV is a tour de force in innovative engineering. The challenge was to design a cartridge that would transcend all existing cartridges in musical transparency, technical excellence, and uniformity. The unprecedented research and design disciplines that were brought to bear on this challenge over a period of several years have resulted in an altogether new pickup system that exceeds previous performance levels by a significant degree—not merely in one parameter, but in totality.

In fact, this pickup system has prevailed simultaneously over several extremely difficult music re-creation problems which, until now, have defied practical solutions. Most of all, this is an eminently musical cartridge which is a delight to the critical ear, regardless of program material or the rigorous demands of today's most technically advanced recordings.

**THE V15 TYPE IV OFFERS:**

- Demonstrably improved trackability across the entire audible spectrum—especially in the critical mid- and high-frequency areas.

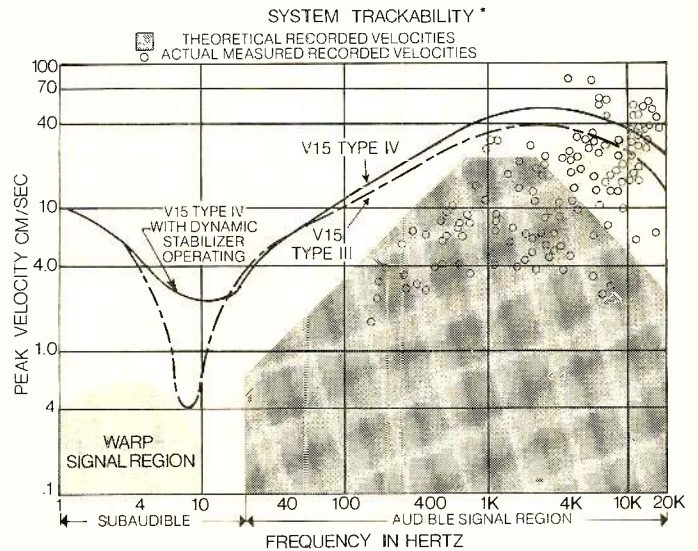

\*Cartridge-tone arm system trackability as mounted in SME 3009 tone arm at 1 gram tracking force

- Dynamically stabilized tracking overcomes record-warp caused problems, such as fluctuating tracking force, varying tracking angle and wow.
- Electrostatic neutralization of the record surface minimizes three separate problems: static discharge; electrostatic attraction of the cartridge to the record; and attraction of dust to the record.
- An effective dust and lint removal system.
- A Hyperelliptical stylus tip configuration dramatically reduces both harmonic and intermodulation distortion.
- Ultra-flat response—individually tested to within  $\pm 1$  dB.
- Lowered effective mass of moving system results in reduced dynamic mechanical impedance for superb performance at ultra-light tracking forces.

For more information on this remarkable new cartridge, write for the V15 Type IV Product Brochure (ask for AL569), and read for yourself how far Shure research and development has advanced the state of the art.



Shure Brothers Inc., 222 Hartrey Ave., Evanston, IL 60204 In Canada: A. C. Simmonds & Sons Limited  
 Manufacturers of high fidelity components, microphones, sound systems and related circuitry.



# Loudspeakers designed for your room

## ALLISON

Room matched loudspeaker systems

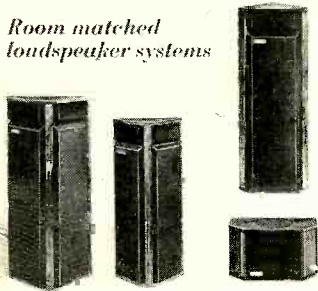

ALLISON ACOUSTICS INC

Allison Acoustics has consolidated, in a new publication, information on all Allison loudspeaker systems with a description of the room-matching principle.

An introductory section explains why loudspeakers designed for flat response in anechoic chambers (the usual procedure) cannot be flat in a listening room, and how the design of Allison Room-Matched™ speaker systems enables them to generate flat power output in a real room.

An entirely new class of direct-radiator drivers has been developed for use as mid-range and tweeter units in Allison systems. They employ convex diaphragms driven centrally. In the case of the tweeter, the diaphragm is forced to flex in a manner simulating the motion of a pulsating hemisphere. This yields high acoustic output combined with almost perfectly uniform dispersion up to 20 kHz. The operative principle is described in the catalog for the first time.

The rest of the catalog is devoted to descriptions of the four Allison models, a statement of Full Warranty for Five Years, and what we believe to be the most comprehensive set of mechanical, electrical, and performance specifications ever published on loudspeaker systems for consumer use.

A free copy of the catalog, review reprints, and a list of Allison dealers are available on request.

## ALLISON ACOUSTICS

7 Tech Circle, Natick, Massachusetts 01760

CIRCLE NO. 3 ON READER SERVICE CARD

# Tape Talk

By Craig Stark



## Tape Types and Terms

**Q.** Several companies offer four or five different C-90 cassettes, but the terms on the packaging aren't clear to me. What are the real meanings of terms like high bias, low noise, high density, extended frequency, etc.? What is the difference in taping quality between different lengths of the same tape (for example, 90 minutes vs. 120 minutes)? What is equalization? At \$4 to \$6 a shot, I'd like to make a knowledgeable choice.

GLENN A. WALKER  
Waukegan, Ill.

**A.** Some of the terms you're asking about relate to tape *quality* and others to tape *types*. Let's start with the latter. There are basically three main kinds of cassette tape from which to choose today: (1) ferric oxide, (2) chromium dioxide (or an equivalent), and (3) ferrichrome. Of the three, the ferrics are the most abundant, so a manufacturer may offer two or three *grades* of ferric-oxide cassette, but usually only one each of the other two types. Both cassette packages and the selector-switch markings on many decks sometimes use chemical symbols rather than words to designate the three types: Fe<sub>2</sub>O<sub>3</sub> for ferric, CrO<sub>2</sub> for chromium dioxide, and FeCr for ferrichrome.

Each of the three main tape types can also be referred to by means other than the name or chemical symbol of its magnetic material, and here is where some of the packaging terminology may get a bit confusing. Every tape, regardless of type, makes use of two kinds of electronic conditioning: *bias* and *equalization*. "Bias" is the name given to an ultrasonic current that is fed into the record head right along with the audio signal to be recorded. The bias current lowers distortion and increases the tape's sensitivity to the audio signal, so that you get a high playback level (in comparison with the background tape hiss) when you replay what you've recorded. Since different magnetic materials require different amounts of bias current for optimum performance, you can refer to a tape type in terms of its bias requirement. Ferric oxides require the least bias of the three types, and this bias level is variously called "standard," "normal," "low," "LH" (low noise, high output), "LN" (low noise), or, simply, "ferric bias." Actually—and this does confuse the issue a

bit—not all ferric oxides have exactly the same bias requirement, but for the moment let's assume that they do and speak of this level of bias current as 100 per cent.

On this scale, chromium-dioxide (or equivalent) cassettes require a bias current of approximately 150 per cent, and this is often referred to as "CrO<sub>2</sub> bias" or "high bias." (Typically, ferrichrome tapes use either the ferric-bias setting or one that is about 110 per cent of "standard" bias.) The reason for the "high bias" designation is in part competitive. For nearly a decade, the only tapes that used this level of bias current actually had chromium dioxide as their magnetic medium. In recent years, however, sophisticated methods (usually involving cobalt treatment) have produced magnetic particles that require this same high bias level but are, in fact, basically ferric particles, and the makers of such tape products as 3M Master II, TDK SA, Fuji FX-II, and Maxell UD XL-II don't want to speak of "chrome bias," since they are competing against true chromium-dioxide cassettes from a variety of manufacturers.

Still another way of designating tape types is by the playback *equalization* they are designed to use. Playback equalization generally consists of a bass-boost/treble-cut frequency-response shaping that is designed to compensate for the fact that normal playback heads have the opposite characteristic. Above a certain frequency, however, treble losses in recording are very severe, so the rising-output-with-rising-frequency character of the playback head must be utilized in a way that varies with the tape type. Ferric cassettes use "120-microsecond" equalization (an engineering way of saying that the "turnover" frequency is 1,326 Hz), while CrO<sub>2</sub> types and most ferrichrome tapes use a "70-microsecond" (2,274 Hz) equalization.

The remaining terms, such as "low noise," "high density," "extended range," "ultra dynamic," "high output," and the like, tend (at best) to be quasi-descriptive terms for the virtues of particular ferric-oxide formulations and don't really qualify as technical nomenclature. Within each manufacturer's offerings, the guide to comparative quality is simply price, for no tape maker is going to turn out two different ferric cassettes with the cheaper one the better.

Concerning the influence of tape length on  
(Continued on page 38)



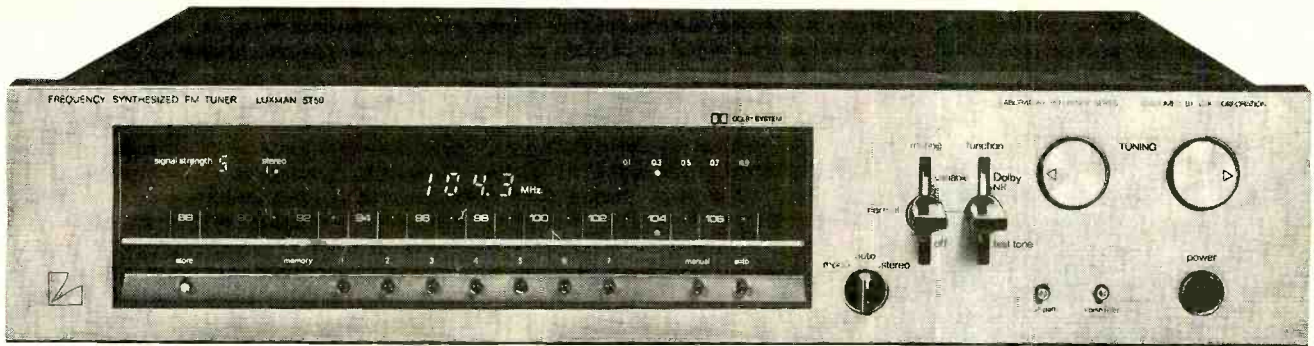

## The Laboratory Reference Series tuner.

# A very remarkable component—by itself or as part of a complete LRS system.

Although the LUX Laboratory Reference Series was conceived—and introduced—as a completely new concept in systems, we believe you'll find the LRS tuner alone merits special consideration.

At a glance, the 5T50 is strikingly clean and elegant. The tuning display itself is digital, supplemented by what might be considered an advanced touch of nostalgia for the dial of old. One linear dial is calibrated in 1 MHz increments, and another provides for 200 kHz indication. However, instead of a pointer, LED's traverse the dials, giving linear readout of tuned stations.

### Electronic tuning and memory.

Tuning is accomplished electronically, by a touch on either of two buttons. Station selection can be switched to either manual or automatic scanning mode, and tuning speed can be adjusted from slow to rapid. A further tuning option is provided through the tuner's C-MOS IC memory system, which stores seven stations in digital code. A touch of the appropriate button provides instant reception, with the station exactly center-tuned.

### Tuning accuracy within 0.003 per cent.

Tuning is always exact, no matter how you select the FM station. Using a quartz crystal frequency synthesizer instead of a tuning capacitor and coil assembly, the 5T50 gives a degree of accuracy (within 0.003 per cent) and stability that cannot be found in conventional tuners. The station is received center-tuned and it remains that way—just as accurate and as stable as the FM transmitter frequency itself—which, for reasons of precision, is also referenced to a crystal.

But the utmost in design and performance doesn't stop here. From front end to output terminals, the 5T50 utilizes the best circuitry. For example, dual-gate MOSFET's in the RF amp and mixer. And a buffer circuit—which helps achieve outstanding image, IF and spurious response rejection—follows the crystal oscillator. In the IF section, a ceramic filter plus two pairs of 4-pole block filters provide for excellent

selectivity without sacrificing low distortion characteristics. A double-tuned quadrature detector also keeps distortion low, at the same time protecting against signal overload. And to assure excellent stereo separation (45 dB at 1kHz and at least 40 dB at high and low frequencies), the multiplex section employs a Phase-Locked-Loop circuit.

### Special tuning refinements.

To help you take advantage of this advanced internal design—which includes a Dolby\* decoding circuit for Dolbyized FM broadcasts—we've included a number of advanced external features. So tuner operation is just as precise as performance. For example, a multipath check button lets you detect multipath distortion audibly—no need for an oscilloscope. There's also an antenna attenuator for adjustment if signals are too strong in your reception area. For quick level adjustment when recording Dolbyized broadcasts, a 400-Hz test tone button is provided. The tuner output level is adjustable, along with interstation muting threshold. A digital display provides easy-to-read signal strength indication. And if incoming signals are weak, there's a high blend noise filter to assure low-noise stereo FM.

### Other LRS components.

Of course, only you know if you're considering a new tuner at this time, or an entirely new system. If the latter, we'll simply advise you that the LRS system has carried the separates concept to "an extreme." That is, the preamplifiers have no tone controls—these are provided by the LRS graphic equalizer or separate tone control unit. The power amplifiers are available with or without meters—supplemented by a separate LED peak indicator. And if low distortion is important to you, the total harmonic and IM distortion of the LRS power amplifiers at rated power is no more than 0.008 per cent. That's double-0 eight.

However, if a superb tuner is really all that interests you at this time, that's fine. Chances are you'll see and hear it as part of the complete LRS system—where it will look and sound the most impressive. Suggested price: \$1,495.

\*Dolby is a trademark of Dolby Laboratories, Inc.

# LUX Audio of America, Ltd.

160 Dupont Street, Plainview, New York 11803 • In Canada: White Electronics Development Corp., Ontario



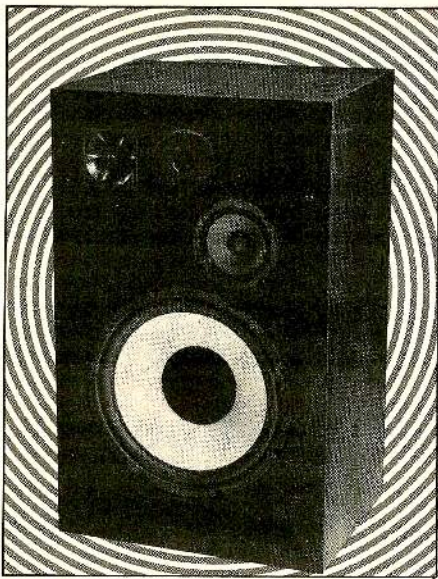

## WHO WANTS A SPEAKER WITH PRESENCE?

Nobody should. What you want in a speaker is *absence*. Absence of anything between you and the disc or tape you are playing.

If you can actually hear your speakers they aren't good enough. They should be adding nothing to the sounds you hear. That goes for boomy bass (which instead should be clean, crisp and pure)...for lost signals in the middle of the range ...and for tweeters (which shouldn't sound harsh).

For a new listening experience, compare the Emanation ES-4 with speakers costing much, much more. You'll find out how beautiful *absence* is.

Or try any of the other fine speakers from Emanation, ranging from the very affordable ES-1 to the extravagant ES-6.



Emanation Sound Inc.,  
146 Olive St., New Haven,  
CT 06511 (203) 865-4087

## Tape Talk . . .

recording quality, while there is often a measurable difference between a C-60 and a C-90, it is usually so slight that you would probably never notice it in use. With C-120's, however, both the base material and the oxide coating on it must be made so thin that quality is almost bound to suffer in one area or another.

### No on Acetone

**Q.** *I was told at one time that acetone makes an excellent head cleaner. Does using acetone pose any danger to the heads? If so, what other cleaner would you recommend?*

SCOTT CHANDLER  
San Francisco, Calif.

**A.** Short of nitric acid, I can think of few more dangerous chemicals to use as a head cleaner than acetone. It will cut through accumulated oxide dust and gunk all right, but it can also attack the glue that holds the head laminations together, along with the plastic facing material used on some erase heads. Should a drop spill, it will also mar the plastic meter faces and plastic trim parts on your deck. In short, *never* use acetone for tape-head cleaning. Xylene, too, is very quick, but it is also fatal to heads.

The most effective commercial tape-head cleaners I know of use a fluorocarbon base; most of the cleaners you will find on audio dealers' shelves are basically colored alcohol, which is also safe, though a bit slower. If you want to buy your own alcohol cleaner, I recommend the pure isopropyl variety rather than a so-called "rubbing-alcohol compound," which may leave an undesirable lubricant film.

### Coercivity Confusion

**Q.** *I read the other day that "coercivity" means "that field intensity required to reduce intrinsic induction from saturation to zero." This seems to refer to tape erasure. But if I just want to record my tapes instead of erase them, is a tape's coercivity important?*

PETER RICHMOND  
Waterbury, Conn.

**A.** Yes. All else being equal, a tape's coercivity rating is an indication both of the bias required by the tape and of its high-frequency response. The larger the coercivity number, the more bias will be needed and the better the treble response.

While it seems paradoxical, when you record a tape using a.c. bias you are actually working on the demagnetizing slope of the tape's characteristic, not the initial magnetizing slope. The bias signal is usually about ten times, as powerful as the audio signal that accompanies it. The rapidly varying bias current alternately drives the tape into saturation first in one direction, then in the other, and as the tape leaves the influence of the record head (a point just past the trailing edge of the record-head gap), and the record signal impinging on it starts to decay, the tape retains the signal level it has when the audio-plus-bias field equals the tape's coercivity. Further, since the large treble losses encountered in re-

recording (especially at slow speeds) are largely a function of the tape's tendency to demagnetize itself at very short wavelengths (high frequencies), a high coercivity number means fewer losses from this cause, and hence more high-frequency output.

### Home-Brew Tapes

**Q.** *Why is it that I can get better cassette quality by dubbing my new LP's than by buying the prerecorded cassette of the same work? My copies sound louder, have less distortion, less hiss, and better frequency response. Yet the companies have professional equipment and can use the master tape rather than an LP copy for their source. Can you explain this discrepancy?*

GREG WOOTEN  
Muncie, Ind.

**A.** For years, the whipping boy for this disgraceful situation has been the nameless person doing the duplicating, who allegedly uses a duplicator with a speed so fast that it can't record the high frequencies, doesn't bother to set recording levels properly, and would rather play pinocle than pay attention to proper quality control.

I won't excuse these people from *all* responsibility. When you get a cassette that's wound wrong-side-out—and sounds as if it had been recorded that way, too—there's plainly a quality-control problem at the duplicating plant. But a couple of years ago at a meeting of the International Tape Association (ITA) in Tucson, I had a chance to discuss the matter with some of the people in the duplicating business, and they gave me a somewhat broader perspective.

So far as the duplicating machinery is concerned, today's high-speed duplicators can provide response to 15,000 Hz with a signal-to-noise degradation from the master of only a couple of decibels. They *can*, but they obviously *don't*. The explanation I was given is that the producers, who will spend what amounts to \$3 apiece for the program material in a cassette, insist on spending no more than about 48¢ for the raw cassette itself. These figures are only approximations, but they do mean, among other things, that not only is the blank tape inside prerecorded cassettes *not* of "premium" quality, generally it is not even first-line tape.

As my own tape tests have repeatedly shown, when you use less than top-quality tape, you tend to lose in both signal-to-noise ratio and high-frequency saturation capability. Taking these factors together, the result is that if you want to achieve anywhere near reasonably acceptable high-frequency performance, you must record at a lower overall program level than you would if you were using a premium cassette. And that adds up to more hiss, more distortion on signal peaks, a lower overall level on replay, and less than the state-of-the-art treble performance the best tapes provide.

As long as consumers buy their product, the producers will not spend the 98¢ (instead of 48¢) that would eliminate the difference you hear, Mr. Wooten. Considering the usual pass-along mark-ups, the additional 50¢ (more or less) would probably translate into—at a guess—perhaps an additional \$1.50 in consumer list price. How many of us would be willing to pay it?



"I'm very impressed with the way Radio Shack has translated latest technology into good looks and precision record playing in the 400."

Peter Nero  
Composer/  
Pianist

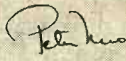
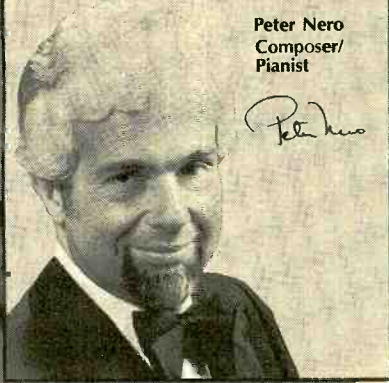
# "Direct" to you from Radio Shack



## Realistic® Direct-Drive Automatic . . . Finest Turntable We've Ever Offered

Two motors, damped cue/pause, S-shape tonearm, speed controls, \$39.95-value Realistic/Shure cartridge

The LAB-400 makes studio performance both affordable and convenient. Its massive die-cast platter rests directly atop a 16-pole brushless DC servomotor. The platter and motor rotate at the same speed, either 33 1/3 or 45 RPM — no idler wheels, reduction gears or belts to alter the music that's stored in your record's grooves. The result: wow and flutter is less than 0.03% WRMS and rumble is better than -63 dB (DIN B). The fully automatic tonearm has an effective length of 8 1/16", for flawless tracking down to 1/2 gram. Handsome walnut vinyl veneer base with ultra-modern, slim design. Elliptical-stylus magnetic cartridge and detachable hinged dust cover — significant "extras" that aren't extra. All for \$199.95.\*



### FREE! New '79 Catalog

Come in for your copy and see what's *really* new in electronics. Bigger than ever! 176 pages, over 100 in full color. 2000 exclusive items.

\*Price may vary at individual stores and dealers.

### Fully Automatic Tonearm Operation

You need never touch the tonearm — just select record size and push start switch. An independent motor does the rest, cueing the arm, gently lowering it onto the record, and removing it at disc's end. With repeat mode, cue/pause, anti-skate and tracking force controls.



Two speeds with controls for ±4% pitch adjustment.



Neon light with strobe disc for checking speed.



Low-profile styling with precision shock-mounts to stop acoustic feedback.

# Radio Shack®

A DIVISION OF TANDY CORPORATION • FORT WORTH, TEXAS 76102  
OVER 7000 LOCATIONS IN NINE COUNTRIES



# Technical Talk

By Julian D. Hirsch

*Julian Hirsch is caught checking out the acoustics of God's own anechoic chamber.*

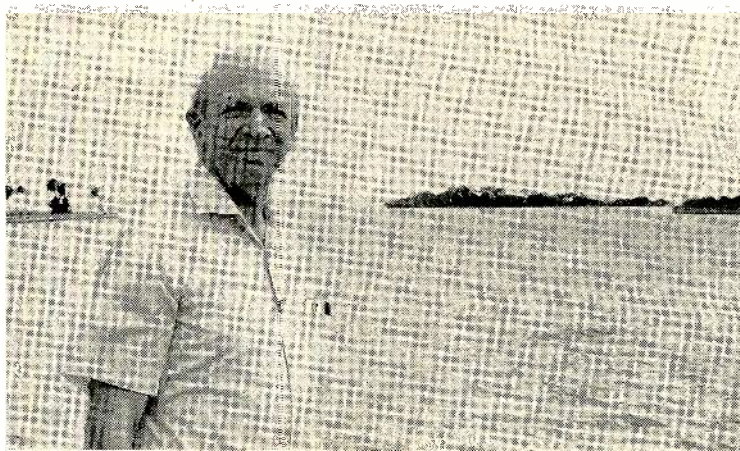

## ● Testing Loudspeakers—Part 1 ●

EVALUATING loudspeaker performance, by either subjective or objective means, is the most difficult and controversial task facing a hi-fi equipment reviewer. That is one of the very few statements I can make on the subject of loudspeakers with absolutely no fear of contradiction! Starting from this unarguable position, I can say with equal assurance that everything that follows will elicit strong objections from some citizens of the hi-fi world, as well as agreement from others.

Before describing our loudspeaker test procedure I would like to mention a few personal beliefs on the subject that strongly influence our approach. Unlike the electronic audio components of a hi-fi system, significant loudspeaker ratings or performance-testing procedures are *not* specified or defined in any universally accepted form (I exclude such ratings as power-handling ability or impedance, which have been defined by such groups as the IEEE and the EIA but which have little or nothing to do with the *sound* of a speaker). Furthermore, I believe that there will *not* be any standards governing loudspeaker measurements in the foreseeable future. The reason is quite simple: there is absolutely no agreement as to what a loudspeaker is *supposed* to do, and therefore there can hardly be any agreement on measuring how *well* it does it! Every loudspeaker designer has his own concept of the function of a speaker and how it should sound, and he presumably designs his product to meet these self-imposed personal standards.

Let me say at the outset that I am not especially concerned here with the more subtle aspects of loudspeaker performance, such as why two speakers having essentially identical response characteristics by almost any method of measurement somehow manage to sound somewhat different. My *apparent* indifference to these qualities, which are of the utmost importance to a large segment of the audio fraternity and are a matter of at least some concern to *everyone* interested in sound reproduction, is based on the rather obvious idea that we should learn to walk before we try to run. In other words, it is desirable first to be able to specify and measure some of the *gross* properties of a speaker, and later we might begin to worry about the finer points.

The "frequency response" of a speaker is most often taken to be the sound-pressure level, plotted as a function of frequency and measured in an anechoic environment at some particular direction and distance from the speaker (they are hardly ever specified). A variation of this is a series of anechoic measurements made at a number of different angles to the speaker axis, which produces a "family" of curves and gives some indication of the speaker's directional properties.

To me, one of the major objections to this approach is that no one listens to a speaker in surroundings that in any way resemble the inside of an anechoic chamber. Such "frequency-response" curves often bear little or no relationship to what the listener actually hears in the real world. A knowledgeable speaker engineer can look at a family of curves and get a pretty good idea of the general sound quality of a speaker, but, unfortunately, most laymen could not.

I should also point out that a suitable anechoic chamber is both large and expensive, and investing in one is warranted only for an organization entirely dedicated to speaker evaluation—in other words, a very large manufacturer—or else a well-financed *research* laboratory. Hirsch-Houck Labs does not have one, nor do any of the other independent reviewers with whom I am acquainted; most *manufacturers*, in fact, do not have large anechoic test facilities. Still, if this were the "right" way to test speakers, it could be accomplished easily enough by simply moving out of doors, as I used to do years ago.

The outdoors is in some ways an ideal anechoic environment with no built-in low-frequency cutoff; the only problems are the effects of ambient noise on the measurements, of the speaker's sound on one's close neighbors, and of fickle weather on everyone and everything involved. Fortunately, considering the difficulties, an anechoic measurement (whether outdoors or indoors) is *not* (in my opinion) the right way to judge the quality of response of a speaker that is to be used in a home environment.

In any normally furnished listening room, we do not hear *only* the sound radiated along a speaker's axis (or in any other single direction). The sound radiates in all directions (though not, as a rule, with equal intensity) throughout the hemisphere into which the speaker faces—and into a spherical volume if the speaker is of the true "omnidirectional" type. But even with conventional forward-facing systems, most of the sound that eventually reaches our ears has been reflected at least once, and probably several times, from such room boundaries as wall, floor, and ceiling surfaces. At usual listening distances (at least 10 feet, say, from the speaker), what we hear from any speaker is a combination of direct and reflected sound, with most of it being reflected. That is why the frequency distribution of that sound depends not only on the characteristics of the speaker but also on the absorptive properties of the room's surfaces and furnishings.

Obviously, listening-room characteristics, though extremely important in determining ultimate sound quality, are completely outside the control of the speaker designer—though certain assumptions can be made about the properties of a "typical" listening room. In such a room, it is the *total* radiated power of the speaker (its "power response"), rather than the pressure response in any single direction, that is responsible for what the listener hears. Thus, the specification of the total acoustic power output into a hemispherical or a spherical volume, as a function of frequency, is probably the most meaningful way of describing the "frequency response" of a speaker (again, this is my opinion, shared by some and contested by others). In a given room, the more uniform that acoustic power

---

### Tested This Month

---

Optonica RT-6501 Cassette Deck  
Ortofon M20E Super Cartridge  
Lafayette LR-5555 AM/FM Receiver  
Beyer ET1000N Headphones  
Akai AM-2800 Integrated Amp

---



output is with frequency, the "flutter" the perceived response will be at almost any location within the room.

One of the best ways to measure the total acoustic power output of a speaker is in a reverberant chamber. This is the opposite of an anechoic environment—instead of *all* the sound energy being absorbed in the room boundaries, *none* of it is. Since the sound is reflected many times within the enclosed volume, it is effectively "homogenized" and the same level will be measured at any point in the room. From a practical standpoint, a reverberant chamber is about as unlikely a structure as an anechoic chamber—less likely, in fact, since none of the inner surfaces should be parallel to each other and they should be constructed of the hardest, least absorbent materials possible. Also, one could

berant frequency responses as measured by their manufacturers or by other suitably equipped laboratories. These speakers have excellent frequency-response characteristics, typically within about  $\pm 2$  dB from 500 to 20,000 Hz (reverberant measurements at low frequencies, like anechoic measurements in the same range, are subject to considerable error in test chambers of practical size). When we measure the response of one of these calibrated speakers in our test/listening room, it is easy to see where our curve departs from the "known" response of the speaker. The difference arises from a combination of room-acoustic effects and the response of our microphone. From this difference we derive a correction curve to be applied to our measurements of other speakers to convert them to the equivalent of a reverberant response. This

speaker sound, much less describe them in detail, accurately, and quantitatively.

Until recently, we used an Altec 21BR150 condenser microphone for our acoustic measurements. It is, of course, calibrated, but the diaphragm resonance at about 12,000 Hz and the rapid fall-off of response above 15,000 Hz made it less than ideal for today's wide-range speakers. We recently acquired a Bruel and Kjaer 4133 microphone, which is essentially flat for more than an octave above and below the audio range and which we expect will make our speaker-response measurements even more accurate, as well as extend them to at least 20,000 Hz.

I mentioned that room reflections (and standing-wave patterns) prevent the making of "live-room" measurements at low frequencies also, but our measurement method eliminates most of their influence. For low-frequency response measurements, we place the microphone as close as possible to the woofer cone. This yields a frequency response that corresponds to the true anechoic response (which would require either a huge chamber or an outdoor measurement), and it is completely free of room effects. This measurement has an upper frequency limit, determined by the point at which the diameter of the woofer cone becomes an appreciable fraction of the wavelength of the sound. This is usually about 200 to 300 Hz with typical bass drivers. The figure on this page shows the close-miked bass-response curve of a typical speaker system.

If the woofer system is ported, a second measurement must be made, on the same chart as the woofer-cone response, with the microphone placed directly at the port opening. Since the port area is usually much smaller than that of the cone, it contributes less to the total bass output. A correction factor is applied to the port response proportional to the relative areas of the port and driven cone. A similar procedure is followed when a passive-cone radiator is used as a substitute for a port. In either case, the two curves are combined to form a single bass frequency-response curve.

*Next month I'll go into the details of our test techniques for high frequencies.*

*(Test Reports overleaf)*

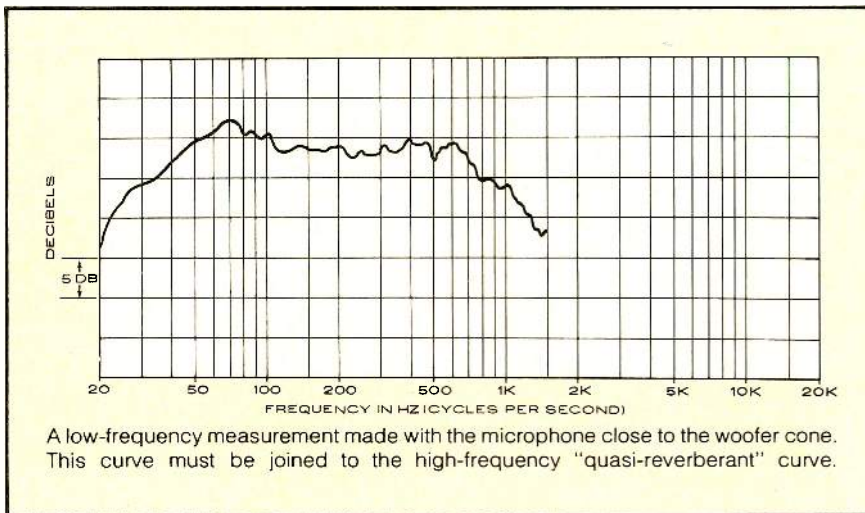

logically point out that we are no more likely to listen to music in a completely reverberant environment than in a totally dead room.

It turns out (fortunately) that the typical home listening room's acoustic environment is much closer to that of a reverberant chamber than to an anechoic one. This holds true even if the room is normally furnished and carpeted. In a true reverberant chamber, the sound-pressure level is constant throughout the room, whereas in an anechoic chamber it can be measured only on a direct "line-of-sight" axis to the source, its intensity decreasing rapidly with increasing distance from that source.

In a normal room, we have both these conditions present simultaneously to some degree. Close to a conventional speaker (within perhaps 2 or 3 feet), we are in the *direct* or *near field*, and the measured sound-pressure level (SPL) decreases rapidly as we move away from the speaker. Beyond a few feet, however, the change of level with distance becomes more gradual, and when we are ten feet or more from the speaker we find that the SPL is almost constant (a variation of no more than 2 dB or so is common throughout most of the room). It is in this part of the room that we place our calibrated microphone, so that we make what is best described as a "quasi-reverberant" measurement.

Naturally, we are concerned with how closely our technique matches a true reverberant-field measurement. We have on hand several speaker systems that came with rever-

berant frequency responses as measured by their manufacturers or by other suitably equipped laboratories. These speakers have excellent frequency-response characteristics, typically within about  $\pm 2$  dB from 500 to 20,000 Hz (reverberant measurements at low frequencies, like anechoic measurements in the same range, are subject to considerable error in test chambers of practical size). When we measure the response of one of these calibrated speakers in our test/listening room, it is easy to see where our curve departs from the "known" response of the speaker. The difference arises from a combination of room-acoustic effects and the response of our microphone. From this difference we derive a correction curve to be applied to our measurements of other speakers to convert them to the equivalent of a reverberant response. This

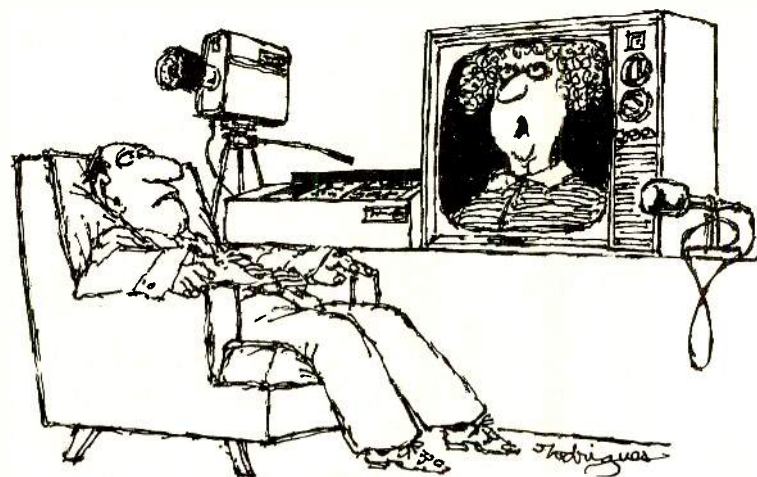

"When was the last time you took me anywhere? Night after night you just sit there playing with this stupid video recorder!"



# Equipment Test Reports

By Hirsch-Houck Laboratories



Optonica RT-6501  
Stereo Cassette Deck

**T**HE Optonica RT-6501 cassette deck incorporates a computer-like microprocessor that gives it a number of unusual and interesting operating features. One is an "Auto Program Locate Device" (APLD) that enables the user to skip ahead (or go back past) up to nineteen program selections on a tape side in order to begin playback with the particular one desired. The device works by scanning the tape as it runs in the high-speed modes and counting the blank spaces between selections. (The blank spaces must be about 3 seconds in duration; an "editor" button can be used during recording to insert spaces of the right length automatically.) Since some program material may have "natural" pauses, an alternative method of cueing is provided, this one using the built-in electronic digital counter. If the counter reading at which a desired selection begins is known, this number can be punched in on the front-panel, calculator-type keyboard, and the RT-6501 will advance or rewind to precisely that point (provided the counter has been "zeroed" in at the start of the side). A liquid-crystal display (LCD) panel is used to show the counter reading, transport status, and commands being executed or stored in the memory.

The same LCD panel is used for the readout of a crystal-controlled digital clock timer, which can be set to show the time of day in either 12- or 24-hour modes (whether or not the deck is running). The timer can be used to switch the deck on or off at a preset time for completely unattended operation, and it also controls a switched 400-watt convenience outlet on the back of the machine for associated equipment (the 400-watt rating should be adequate for all but the most powerful amplifiers). At the touch of yet another button, the time display can (without losing track of clock time) be used to show the elapsed running time of the cassette in use, permitting calculation of the amount of recording or playing time still available. A pair of 1.5-volt

AA cells inserted into a compartment on the rear apron of the RT-6501 keeps the clock and memory going even when the deck is turned off (the off position is marked **STAND-BY** on the front-panel power switch). The batteries are said to last for one year.

The RT-6501 is a front-loading design with a Permalloy record/playback head and a ferrite erase head. The transport is driven by a single d.c. servomotor. Cassettes are inserted into clips on the inside of the tilt-down loading door, whose large, clear window provides ample visibility. The front portion of the door can be easily removed by two knurled screws, giving access to the heads for routine cleaning and demagnetizing. An illuminated panel behind the cassette helps show how much tape remains on a side. Beneath the cassette well is a row of piano-key levers for the usual transport functions.

The microprocessor buttons and display, reminiscent of a hand-held calculator, occupy the center section of the front panel. Further to the right is a pair of illuminated record-level

meters marked  $-20$  to  $+5$  dB. Their rather subdued lighting matches that of the adjacent liquid-crystal display. Just below the meters are two red LED indicators. One of these is used to show when the machine is in the record mode. The second is a peak indicator that shows momentary high signal levels too brief to register accurately on the meters. (In our tests the peak-reading LED began to flash with an input level of approximately  $+7$  dB.)

The other operating controls are located below the meters. Pushbuttons control the lighting of the LCD panel, engage the memory-rewind feature (which is conventional in operation), turn the Dolby system on and off, and separately select either high or low bias and either 70- or 120-microsecond playback equalization. The former bias and equalization settings are for  $\text{CrO}_2$  (or equivalent) tapes, the latter for regular ferric oxides. For ferrichrome tapes, the low bias and 70-microsecond switch positions are used. Separate record-level controls are provided for microphone and line-level inputs (they are arranged in concentric pairs). A single output-level control simultaneously varies the signal at the line-output jacks and the front-panel headphone jack.

In addition to the battery compartment and switched a.c. outlet, the rear panel carries the input and output jacks. The RT-6501 measures about  $17\frac{3}{8}$  inches wide,  $14\frac{1}{8}$  inches deep, and  $5\frac{3}{4}$  inches high; it weighs just under 20 pounds. Price: \$360.

● **Laboratory measurements.** The Optonica RT-6501 comes factory-adjusted for Maxell UD (ferric), Maxell UDXL II ( $\text{CrO}_2$ -type), and Sony ferrichrome (FeCr) tapes, all of which we used for our basic tests.

A 0-dB indication on the record-level meters required a line input of 51 millivolts (mV) or a microphone-input level of 0.2 mV. With the output-level control fully turned up, the output for a 0-dB meter indication was 700 mV at the line-output jacks and 80 mV into a

(Continued on page 44)

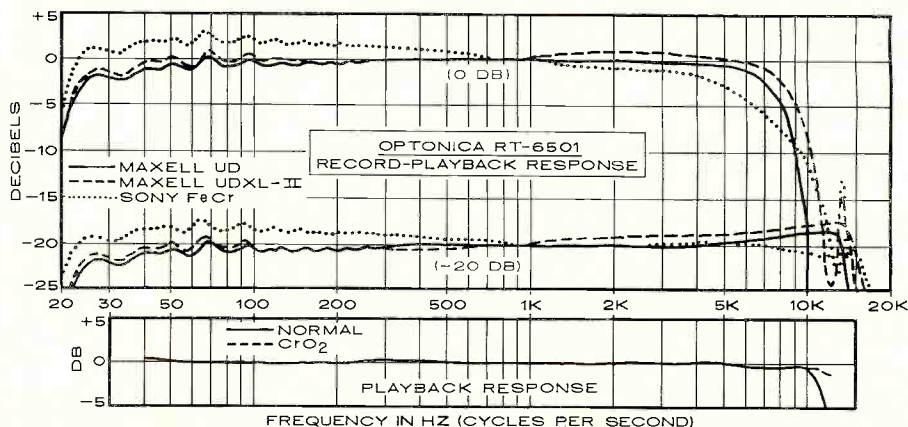



# The most powerful argument for our new receiver is not just power.



True, it's tempting to be swept up by our power.

150 watts per channel minimum RMS at 8 ohms, from 20Hz to 20kHz, with no more than 0.07% Total Harmonic Distortion, is nothing to sneeze at.

But raw power means nothing. What's important is how that power is delivered. In the case of the STR-V7, it's brought to you by Sony in a very classy package.

You get a combination of features and controls that are impressive on their own—but almost unheard of in a single machine.

To start with, we've built in a Dolby system, for decoding Dolbyized FM broadcasts.

The advantages of our tuner,

though, need no decoding. They include a normal and narrow FM IF bandwidth selector. It makes life simple for people in areas where their signals are crowded together elbow to elbow.

In our preamp section, the V7 comes equipped with a special phono EQ circuitry. Thanks to Sony's high IQ, it allows for direct connection of a low-output, moving-coil cartridge phono source. Without calling for an external step-up transformer or pre-amp.

When you're gifted with as much power as the V7, you need a way to keep track of it. This receiver keeps tabs with two power-output meters, monitoring the power being fed to the speakers. So overload can't result from oversight.

And all that power comes from our direct coupled DC power amp. And our power is stable, thanks to a high-efficiency, high regulation toroidal-coil transformer.

There's a lot more to the STR-V7 than power. This receiver takes the best that contemporary technology has to offer, and offers it in a single machine.

Other manufacturers may have the power to bring you power. But only Sony has the power to bring you more than just power.

# SONY® AUDIO



pair of 8-ohm headphones. The headphone listening levels were adequate with both low- and medium-impedance phones of ordinary efficiency. Microphone overload occurred at an input level of 30 mV. The record-level meters tracked very accurately from input levels of +5 down to -6 dB, with a very slight error setting in below that point, so that a true -10 dB input registered as -9 dB. The meter ballistics were somewhat slow compared with genuine VU-meter characteristics, rising to only about 70 per cent of full-scale indication with 0.3-second tone bursts.

We checked the playback frequency response with our new TDK AC-337 test tape, since we have found good agreement between it and those we have used in the past and since it permits us to extend the measurement range to 12,500 Hz. This tape can be used to check the playback equalization for ferric tapes directly, and by applying the proper correction factors it can also be used to evaluate CrO<sub>2</sub> equalization. With this tape we found that the playback response of the RT-6501 was extremely flat, within ±0.5 dB from 40 to 10,000 Hz and down only 1.5 dB at 12,500 Hz in the ferric switch position. Playback response in the CrO<sub>2</sub> position was almost identical, with a very slight dropoff of 1 dB at 10,000 Hz and 1.9 dB at 12,500 Hz.

The overall record-playback frequency response was very smooth—well within the manufacturer's specifications and certainly as wide as we could reasonably expect from a deck in this price class. The low-frequency "head bumps" that typically cause undulations of several decibels in the region below 100 Hz were quite well controlled. The flattest overall response was obtained with the Maxell UD (ferric) tape, which varied by only ±1 dB all the way from 40 to about 7,000 Hz, rising smoothly to +1.5 dB at 13,000 Hz, above which it dropped off rapidly. The response

with Maxell UDXL II, using CrO<sub>2</sub> bias and equalization, was very nearly as flat over the same range, reaching a gradual peak of about +2 dB around 14,000 Hz and dropping to -2.5 dB at 16,000 Hz. Sony ferrichrome had a somewhat elevated low-end response and a very slightly more irregular curve, but it, too, was within ±3 dB all the way from 20 to about 17,000 Hz.

The Dolby-level meter calibration (which occurs at +3 dB on the scale) proved to be within 0.2 dB of the playback level from a standard 200-nW/m Dolby test tape. Tracking error between Dolby-in and Dolby-out sweeps across the frequency range of the machine was typically less than ±0.5 dB—and never worse than ±1 dB—at levels of -20, -30, and -40 dB. This is fine performance.

The RT-6501 provided a higher-than-usual margin (about 7 or 8 dB) between an indicated playback level of 0 dB and the 3 per cent third-harmonic distortion point traditionally used for signal-to-noise (S/N) measurements. In practice, this means that recording levels that cause the peak-indicating LED to flicker occasionally are still acceptable for low-distortion recordings. The unweighted S/N ratios measured 53 dB with the Maxell UD and Sony ferrichrome tapes and 54.5 dB with Maxell UDXL II. Using CCIR/ARM weighting brought the S/N ratios up to 54.5 dB for the UD and 58 dB for the UDXL II and ferrichrome. Finally, adding Dolby noise reduction to the weighted measurements resulted in a 64.5-dB S/N for the Maxell UD ferric and 68 dB for the CrO<sub>2</sub>-equivalent Maxell UDXL II and the Sony ferrichrome. These are truly superb signal-to-noise measurements, especially remarkable in view of the moderate price.

The flutter of the RT-6501 measured a low 0.054 per cent with a TDK test tape and 0.072 per cent on a combined record-playback measurement using the wrms standard. The

DIN peak-weighted figures (which are always much higher) tested out at 0.07 and 0.09 per cent, respectively—both excellent. Fast-forward and rewind times were moderately slow—135 seconds for a C-60 cassette—but were exactly as specified.

● **Comment.** The performance of the Optonica RT-6501 leaves very little to be desired in terms of low distortion, high signal-to-noise ratio, and low wow and flutter. Its frequency response is good (especially with ferrichrome and chrome-type formulations), though in direct comparisons with extremely demanding program material some very slight dulling of the very highest frequencies was detectable, particularly in the ferric position. We doubt, however, whether even this essentially minor limitation would be noticeable in the vast majority of applications for which audiophiles would normally use a cassette deck.

No machine could offer as many different kinds of computer control as this and at the same time permit an instant understanding of its features and functions. However, the owner's manual methodically takes one step-by-step through each of the control features (all of which we have not had space to describe fully), despite occasional lapses into somewhat unconventional English. We could wish that the seven piano-key levers had been more clearly differentiated (only the RECORD lever is color coded), but one quickly becomes accustomed to their locations. And once we had mastered them, we found the computer features a sheer delight.

In our view, the Optonica RT-6501 is a truly fine performer that would be well worth its price even without its unique microprocessor. With the latter included, it is easily one of the best cassette-deck values we've come across.

Circle 105 on reader service card

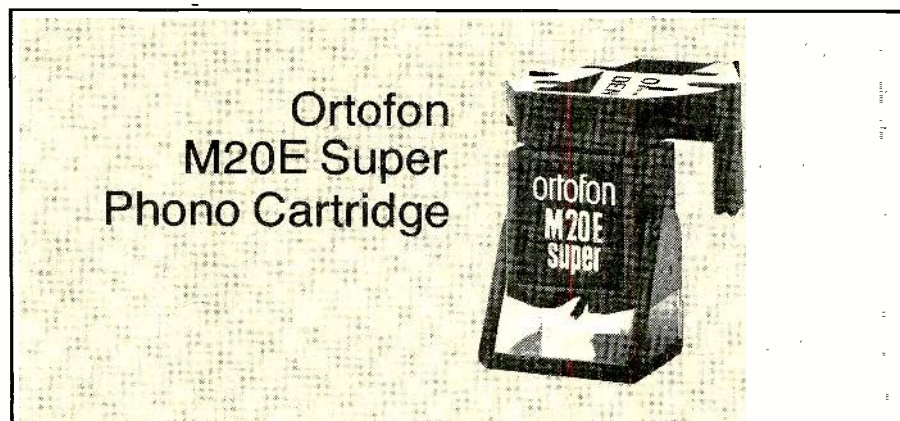

FOR several years, the M15E Super headed the Ortofon line of VMS (variable magnetic shunt) phono cartridges. It has now been superseded by the new M20 Super series. In the VMS units, the flux from a fixed internal magnet is distributed between four pole pieces in accordance with the movement of a

thin-walled armature of magnetic material near the pivot of the stylus-cantilever tube.

The M20E Super has a high-compliance stylus assembly fitted with an elliptical nude diamond having radii of 0.3 x 0.7 mils. It operates at tracking forces between 0.75 and 1.25 grams, with 1 gram being the nominal rated

tracking force. This cartridge is meant for use in low-mass tone arms, since its high lateral compliance of  $40 \times 10^{-6}$  cm/dyne could result in an undesirably low resonance frequency in a more massive arm.

The M20E is rated to deliver 0.8 millivolt per channel at 1,000 Hz for a recorded velocity of 1 centimeter per second (cm/sec). The stylus has a nominal 20-degree vertical-tracking angle and an effective mass of 0.5 milligram. The weight of the cartridge is 5 grams. Ortofon cartridges are designed to give their flattest frequency response when loaded by 47,000 ohms in parallel with 400 picofarads (pF) of capacitance. This is higher than the load capacitance presented by most modern record players, whose tone-arm wiring and connecting cables have been designed for the capacitance of 100 pF or so required by CD-4 cartridges. Even with some added capacitance from the amplifier input circuit, a load of 200 pF is fairly typical and will result in a high-frequency peak and an upper-mid-range dip in the response of the M20 cartridges. For that reason, Ortofon makes available a tiny dual-capacitor assembly that slips on the back

(Continued on page 46)



# The one alternative to separates: The Yamaha CA-2010 Integrated Amplifier.

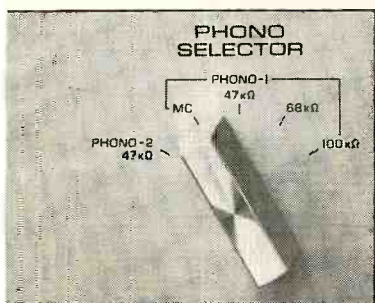

**The Head Amplifier.** Discerning music lovers all over the world are discovering the transparent highs and extended frequency response of the moving coil phono cartridge. While other manufacturers require the addition of an expensive preamp or step-up transformer to boost the low output signal, Yamaha included a special head amplifier in the CA-2010. It's available with the flip of a switch on the front panel. And to help you get the most out of moving magnet cartridges, there's a 3-position phono impedance selector.

**The Preamplifier.** To assure exact, repeatable bass and treble settings, the controls are precision calibrated in 1/2dB steps. Dual turnover frequencies for both ranges double the versatility of these accurate tone controls. Completely independent Input and Output Selectors let you record one source while listening to another. And the power meters are easily switched to REC OUT readings in millivolts, so you can monitor the actual output level to your tape deck for cleaner, distortion-free recordings.

**The Power Amplifier.** 120 watts RMS, with no more than 0.03% THD 20Hz to 20,000Hz into eight ohms.

For tighter, cleaner bass response, the amplifier can be switched to DC operation. Class A operation is switchable on the front panel, delivering 30 watts RMS, with no more than 0.005% THD 20Hz to 20,000Hz into eight ohms.

The twin power meters are fast-rise, peak delay—they can track even the briefest of transient bursts. Plus they can respond to levels from 1mW to 316W (into eight ohms).

**Real Life Rated.™** The specifications of the individual components of the CA-2010 are superior to many separates. Individual specifications alone, however, can't possibly reflect actual in-system performance. That's why Yamaha measures overall performance from phono in to speaker out, rather than at designated points along the signal path. Furthermore, we measure noise and distortion together over a broad output range, rather than individually at the optimum output.

Our Real Life Rated measurement is called Noise-Distortion Clearance Range (NDCR). On the CA-2010, NDCR assures no more than 0.1% combined noise and distortion from 20Hz to 20kHz at any power output from 1/10th watt to full-rated power.

**Superb tonality from a musical tradition of technical excellence.** The tonal accuracy of our audio components is referenced to the same standards used to evaluate the tonal accuracy of our world-renowned musical instruments. The result is a rich, clear tonality that is unknown elsewhere. You really must hear it.

You really must hear the same resolutely accurate music reproduction available from all four Yamaha Integrated Amplifiers and four superb tuners. All are made to a single standard of excellence—a standard rooted in a 90-year tradition of musical perfection.

For a personal audition of the new Yamaha CA-2010, as well as the rest of our complete line of components, just visit your nearest Yamaha Audio Specialty Dealer. If he's not listed in your Yellow Pages, drop us a line.



Audio Division, P.O. Box 6600, Buena Park, CA 90622

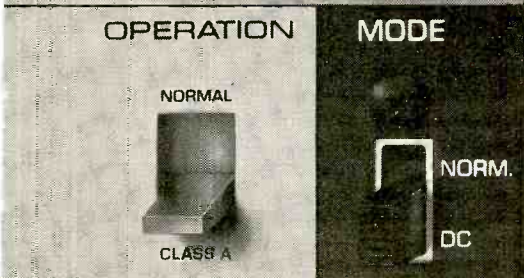
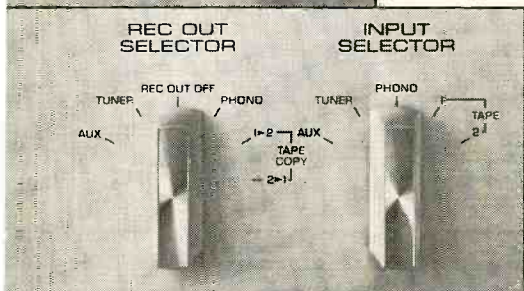

**0.03%**  
-96dB S/N

**Real Life  
Rated™**

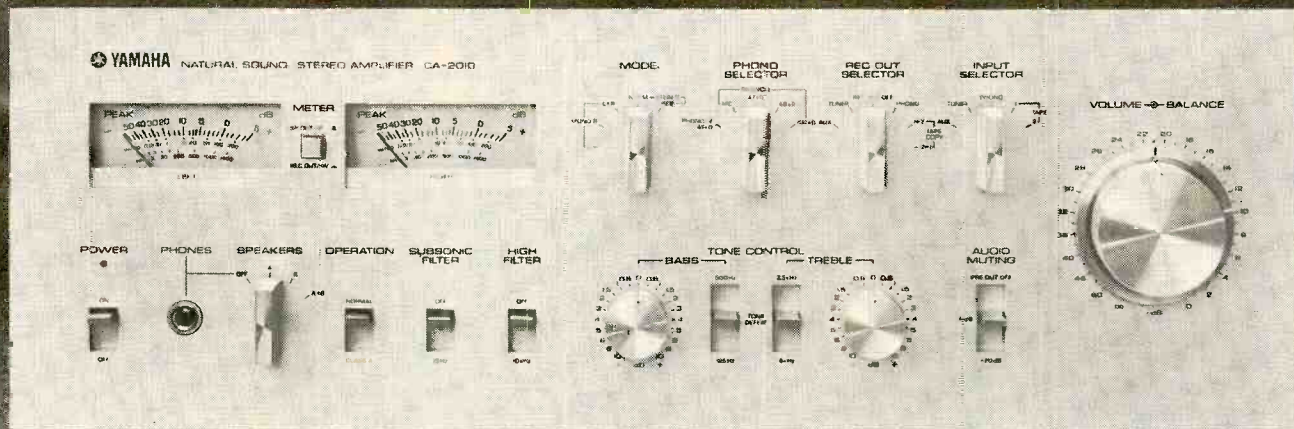



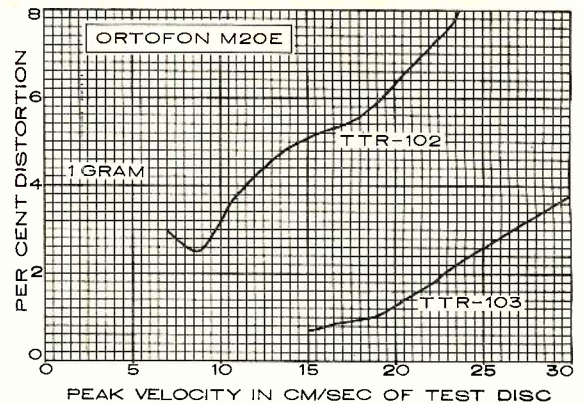
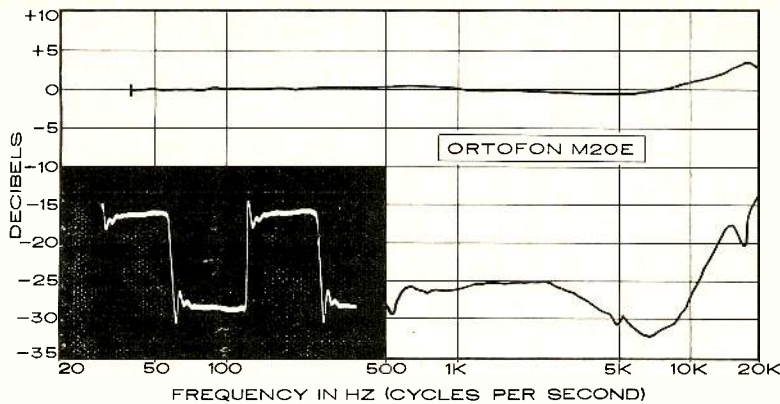

In the graph at left, the upper curve represents the smoothed, averaged frequency response of the cartridge's right and left channels; the distance (calibrated in decibels) between it and the lower curve represents the separation between the two channels. The inset oscilloscope photo shows the cartridge's response to a recorded 1,000-Hz square wave (see text), which indicates resonances and overall frequency response. At right is the cartridge's response to the intermodulation-distortion (IM) and 10.8-kHz tone-burst test bands of the TTR-102 and

TTR-103 test records. These high velocities provide a severe test of a phono cartridge's performance. The intermodulation-distortion (IM) readings for any given cartridge can vary widely, depending on the particular IM test record used. The actual distortion figure measured is not as important as the maximum velocity the cartridge is able to track before a sudden and radical increase in distortion takes place. There are very few commercial phonograph discs that embody musical audio signals with recorded velocities much higher than about 15 cm/sec.

of the cartridge and contacts its output pins directly. The CAP210 adds 210 pF from each channel output to ground, which will present the cartridge with its proper load in most record-playing installations. The CAP210 is supplied with the M20 Super cartridges as well as with the lower-cost VMS20E. People who bought these cartridges before March 1978 (when the change became effective) may purchase the CAP210 separately. Price of the M20E Super: \$145. The CAP210 is \$7.50.

● **Laboratory Measurements.** The cartridge was tested in a tone arm typical of those used on medium-price record players, with an effective mass of 20 grams referred to the stylus position. We measured the frequency response of the M20E Super with and without the CAP210 capacitor. The total circuit capacitance was about 200 pF without it and 400 pF with it. The CAP210 reduced a high-amplitude peak at about 18,000 Hz to a much lower amplitude, although the response still rose somewhat at that frequency. There were slight differences between the two channels, but the average response as measured with the CBS STR100 record was within  $\pm 2$  dB over the 40- to 20,000-Hz range of the record. The channel separation was very good, averaging about 25 dB up to beyond 10,000 Hz and about 15 dB at 20,000 Hz.

The square-wave response with the CBS STR112 record showed a single cycle of moderately high-amplitude overshoot followed by low-level ringing at approximately the stylus-resonance frequency of 20,000 Hz. The cartridge output was 5.4 millivolts at 3.54 cm/sec from the CBS STR100 record, and the channel levels were balanced within 1.35 dB. The measured vertical angle of the stylus system was 18 degrees. The low-frequency resonance in the 20-gram arm was at 7 Hz, with an amplitude of about 7 dB.

At 1 gram, the M20E Super tracked our low- and mid-frequency test records easily, as well as the 80-micron level of the German Hi Fi record. The more conventional IM-distortion measurements, using the Shure TTR-102 record, were slightly disappointing; the distortion was under 4 per cent at velocities of 12 cm/sec or less, but rose steadily to 10 per cent

at 27 cm/sec. Although it is not easy to correlate IM measurements on a cartridge with its listening properties, we have found that most high-quality cartridges we have tested have less measured distortion at low and medium velocities, although they may mistrack much more violently at the higher velocities on this record.

A somewhat similar effect was noted when we measured the high-frequency tracking distortion with the shaped 10.8-kHz tone bursts of the Shure TTR-103 record. The distortion was low (0.8 to 1.3 per cent) at velocities of 15 to 20 cm/sec, but it rose steadily at higher velocities to 3.8 per cent at 30 cm/sec.

● **Comment.** The M20E Super proved to be very much above average in its ability to track the very high velocities on the Shure "Audio

Obstacle Course" test records. It played all levels of all bands on the Era III record without audible mistracking. With the more difficult Era IV record, it showed signs of mistracking in level four of the bells and the flute sections, but coped with all of the harp selections. Based on the limited experience we have had with this record, this indicates a superior tracking ability. Aside from the tracking tests, we can say that the sound of the Ortofon cartridge is as neutral and smooth as its frequency-response curves would indicate. This has always been true of its predecessors, and the tradition has been carried forward into the new model.

Circle 106 on reader service card

(Continued on page 48)



"I'll be glad when he comes out of the coma, doctor. It's costing me fifty dollars a day videotaping his favorite TV shows."





## Yes, the new Dual 604 is direct drive. Now let's talk about something really important.

You may have noticed that most turntable stories begin and end with the drive system. The tonearm is more or less an afterthought.

But not with Dual. Because the tonearm can make a big difference in how records sound and how long they last. Which is why Dual is very serious about tonearm design and performance. And why we can be very serious about tonearms in our advertising.

Let's consider the 604 tonearm.

The straight-line tubular design provides maximum rigidity with minimum mass. The four-point gimbal centers and pivots the tonearm precisely where the vertical and horizontal axes intersect. And the counter-balance houses two specially-tuned anti-resonance filters that absorb parasitic resonances originating in the tonearm/cartridge system and chassis.

Operation is semi-automatic, with another unique

Dual difference: the mechanical sensor. Switch it in and you feel when the stylus is positioned precisely over the 12" and 7" lead-in grooves. At the end of play, the tonearm lifts and returns to its post, and the motor shuts off. Automatically.

Now let's talk about the drive system. It employs a newly developed DC electronic motor with a highly sensitive CMOS regulator circuit and integral frequency generator. Platter speed is checked against rated speed 120 times per revolution. Wow and flutter are less than 0.03 percent, rumble is better than 70 dB. Well beyond the limits of audibility.

But the important story with any turntable is simply this. The drive system merely turns the record. It's the tonearm that plays it.

Dual 604, semi-automatic, less than \$260. Dual 621, fully automatic plus continuous repeat, less than \$300. Both with base and cover. Actual resale prices are determined individually and at the sole discretion of authorized Dual dealers.



*For the life of your records*

United Audio, 120 So. Columbus Ave., Mt. Vernon, NY 10553

CIRCLE NO. 50 ON READER SERVICE CARD



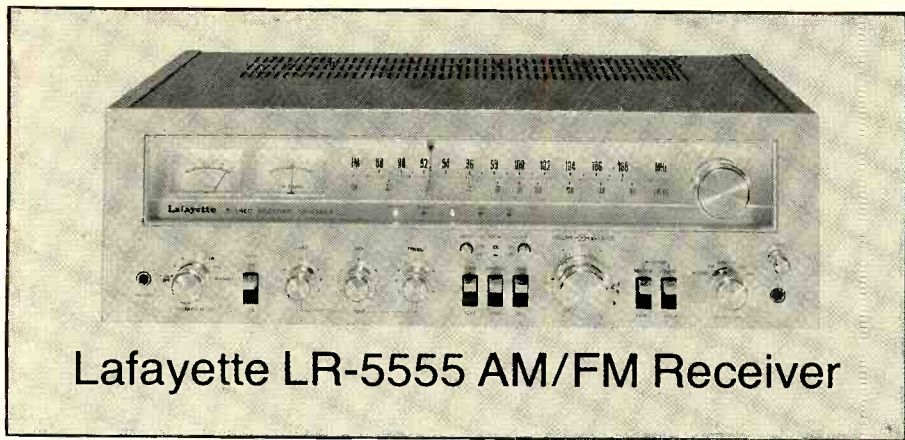

Lafayette LR-5555 AM/FM Receiver

by the signal strength. Thus the receiver will not un-mute, regardless of signal strength, until it is tuned accurately to the center of the channel. A phase-locked-loop IC serves as the multiplex decoder. The power-output stages are direct-coupled hybrid IC's. A combination of a relay and electronic circuits protects the receiver and the speakers against damage from component failure or improper load conditions. The receiver is covered by Lafayette's two-year limited warranty.

The Lafayette LR-5555's cabinet has wood side panels finished in walnut-grain vinyl. The receiver is about 20 inches wide, 6¾ inches high, and 13¾ inches deep, and it weighs approximately 31 pounds. Price: \$329.95.

● **Laboratory Measurements.** The one-hour preconditioning period at one-third power made the top of the cabinet fairly warm over the power-supply section but had less effect elsewhere on the receiver. The 1,000-Hz clipping output into 8 ohms was 66 watts per channel, and into 4- and 16-ohm loads it was 90 and 41 watts, respectively. The 8-ohm IHF clipping headroom was 0.8 dB relative to the receiver's rated 55-watt output. The dynamic headroom at 1,000 Hz, as measured with a short tone burst, was 1.2 dB.

When we measured harmonic distortion with a 1,000-Hz test signal it was apparent that the LR-5555 had been rated with great conservatism. Beginning with 0.013 per cent at 0.1 watt, the distortion increased smoothly and gradually to 0.04 per cent at the rated 55 watts and 0.063 per cent at 65 watts, just before clipping occurred. The SMPTE (Society of Motion Picture and Television Engineers) IM distortion was somewhat higher, but it had a similar characteristic, increasing from 0.085 per cent at 0.1 watt to 0.185 per cent at 55 watts and 0.21 per cent at 65 watts. It also increased at very low power levels to about 0.5 per cent at a couple of milliwatts output.

The low distortion of the LR-5555 was not limited to the middle frequencies. At rated output it was 0.05 per cent or less from 20 to 5,000 Hz, increasing to about 0.11 per cent at 20,000 Hz. At lower power levels, the distortion curve was similar, but the distortion decreased as power was reduced. All these readings were of total harmonic distortion plus noise, as defined by the new IHF standard.

For a reference 1-watt output, the required input at 1,000 Hz was 20 millivolts (mV) through the AUX inputs. The phono sensitivity (Continued on page 52)

**A**BOUT in the middle of the Lafayette stereo-receiver line is the Model LR-5555, rated to deliver 55 watts per channel to 8-ohm loads between 20 and 20,000 Hz with no more than 0.3 per cent total harmonic distortion. That power level may seem modest by some standards, but it is more than adequate for the vast majority of listeners, and in the LR-5555 it is combined with a full array of operating features and a degree of flexibility that is rarely found in its price range.

The LR-5555 has triple tone controls (bass, mid-range, and treble), each of which has eleven detented positions with a definite "flat" center setting. In addition, a tone-defeat switch bypasses them entirely. The power and speaker-switching functions are combined in a single control knob, which can connect the amplifier to any of three pairs of speakers or to two combinations of two pairs simultaneously. It can also silence all speakers for headphone listening via the front-panel jack. Next to this control is a lever switch for the high-cut filter.

In the center of the panel are lever switches for tone-control bypass, stereo/mono mode selection, and loudness compensation. Above them are two MUTING pushbuttons. The AUDIO button drops the volume by 20 dB, and the FM button controls the interstation-noise muting circuit. To the right is a large detented volume control which is concentric with a center-detented balance ring. Two tape-recording monitor switches connect the receiver's amplifiers to the playback outputs of two tape decks individually. Tapes can be copied from deck 1 to deck 2, but not vice versa.

The program selector has positions for PHONO, FM, FM MPX (with high-frequency channel blending to reduce noise on weak stereo signals), AM, and AUX. Finally, at the lower right of the panel is a stereo microphone jack and its level control, which functions independently of the setting of the volume control (the microphone signals do not appear at the tape-recorder outputs and are not affected by any controls except their own level adjustment and the tone controls).

On the upper half of the front panel, behind a clear glass window, is a long dial scale with linear FM calibrations. Colored lights below the scales identify the program source and show when a stereo FM signal is being received. The large tuning knob is to the right of the dial, and to the left are two large tuning meters. Only the relative-signal-strength meter is illuminated for AM; for FM the channel-center meter is also lit.

The rear apron of the receiver has inputs for 75- and 300-ohm FM antennas and an AM ferrite-rod antenna. The three pairs of speaker outputs are insulated spring-loaded connectors that are easy to use and hold the stripped end of a wire quite firmly. A slide switch next to the phono inputs selects HI or LO sensitivity to suit the cartridge output. One of the two a.c. convenience outlets is switched.

The Lafayette LR-5555 makes effective use of integrated circuits. Two IC's are used in the FM i.f. amplifier, and one of these is a multipurpose device that serves as an amplifier, limiter, muting control, and quadrature detector. The muting function is controlled by the tuning accuracy of the receiver as well as

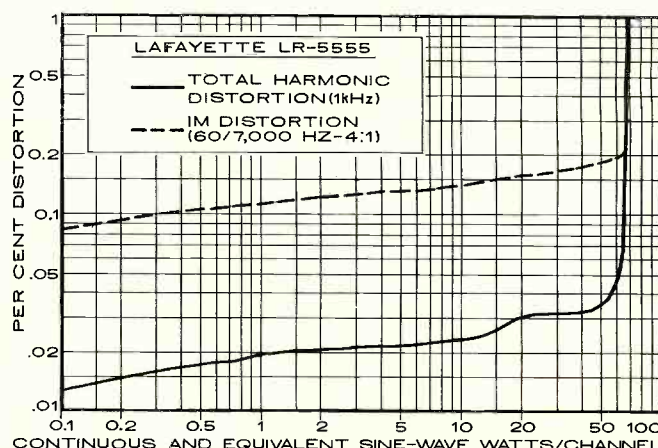
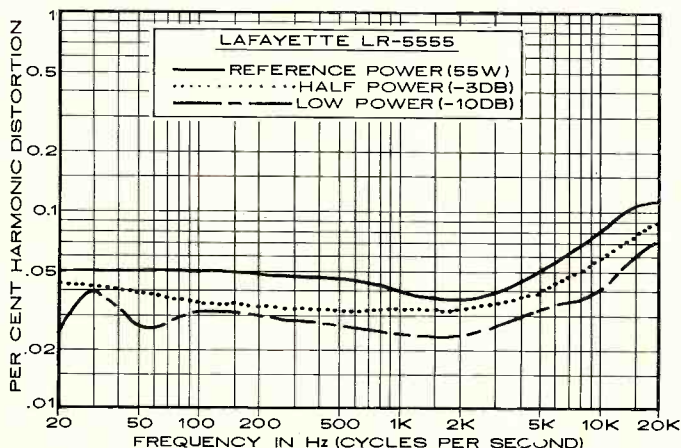



# HITACHI

## The New Leader In Audio Technology



...introduces the world's most  
powerful 50 watt receiver.

The new Hitachi SR 804 stereo receiver has the revolutionary Class G amp that instantly doubles its rated power from 50 to 100 watts to prevent clipping distortion during those demanding musical peaks (note the clipped and unclipped waves in the symbolic graph above). The SR 804 is conservatively rated at 50 watts RMS, 20-20,000 Hz into 8 ohms with only 0.1% THD.

Class G is just one example of Hitachi's leadership in audio technology. Power MOS/FET amplifiers, R&P 3-head system cassette decks, Uni-torque turntable motors, and gathered-edge metal cone speakers are just some of the others. There's a lot more. Ask your Hitachi dealer.



**HITACHI**  
When a company cares,  
it shows.

CIRCLE NO. 26 ON READER SERVICE CARD

Audio Component Division, Hitachi Sales Corp. of America, 401 West Artesia Boulevard, Compton, CA 90220, (213) 537-8383



# JBL'S NEW L19: NOW YOU DON'T HAVE TO BUY THE STATION TO OWN THE SPEAKER.

When professional sound engineers choose a broadcast monitor, they look for two qualities: accuracy and compactness.

Station monitors have to be compact. There's no room for big speakers in a crowded station. And, of course, they must be accurate. Engineers need to know exactly what they're broadcasting.

That's why JBL's 4301 compact professional broadcast monitor has made such a hit with people who listen to sound for a living. It's efficient. The

sound is clean and clear. And when they turn it up, it won't let them down.

Wouldn't it be great if you could get something like the 4301 for your house?

Introducing the JBL L19. The acoustical twin of the 4301. Accurate. Compact. Hand-rubbed





black walnut enclosure. Beveled grille. And one more small feature: the price. \$150 each.

If you'd like a lot more information about the L19, write us and we'll send you an engineering staff report. Nothing fancy except the specs.

But you really should come listen to the L19. And be sure to ask for it by its first name: JBL. That name guarantees you'll get the same craftsmanship, the same components, the same sound heard in the top broadcasting and recording studios all over the world.

JBL's new L19. Why don't you do like they do on radio? Get yourself a pair.



GET IT ALL.



Stand by. You're on KRTH-FM, Los Angeles—one of the top music stations in the country. And the sound is JBL.





was 0.54 or 0.24 mV, depending on the setting of the phono-sensitivity switch. The microphone-input sensitivity was 0.72 mV. The A-weighted noise levels, referred to 1 watt, were approximately the same for the AUX and PHONO inputs, between -75 and -77 dB (very good), while the microphone-input noise level was -59 dB. The phono input overloaded at a very high 350 mV with the LO sensitivity setting and at a more than adequate 165 mV with the HI setting. The measured phono-input impedance was 52,000 ohms in parallel with 16 picofarads.

The bass tone-control turnover frequency varied from about 100 to 250 Hz as the knob was moved from its center position, and the treble-control curves were hinged at about 2,500 to 3,000 Hz. The mid-range control action was centered at about 1,000 to 1,500 Hz, and it affected most of the audio range from 100 to 10,000 Hz. We also noted that the tone-control bypass switch increased the overall gain by about 2 dB when it was operated.

The loudness compensation boosted both low and high frequencies when the volume-control setting was reduced, although the high-frequency boost became significant only at settings of -30 dB or lower. The high-cut filter had a poor characteristic, with a 6-dB-per-octave slope setting in at about 2,000 Hz. It nearly duplicated the action of the treble tone control (although it produced a little more attenuation above 10,000 Hz), and it removed considerable program together with the noise.

The RIAA phono equalization (extended) was accurate within +0.5, -1 dB from 20 to 20,000 Hz, with most of the variation taking place below 50 Hz. The IC phono-preamplifier stages provided effective isolation between the cartridge and the equalizing circuitry, so that the cartridge inductance had no effect on the phono response. The microphone input had a frequency response of +0.5, -1 dB from 20 to 20,000 Hz.

The FM-tuner section of the LR-5555 was, like its amplifier, well above average for a moderate-price component. The IHF sensitivity was 11 dBf in mono and 16.3 dBf in stereo, and the respective 50-dB quieting sensitivities were 14.3 dBf and 36 dBf. The ultimate signal-to-noise ratio was 74 dB in mono and 69 dB in stereo. In these ratings, as in most others, the LR-5555 comfortably surpassed its specifications. The distortion in mono was 0.075 per cent, and in stereo it was 0.115 per cent. The stereo distortion at 100 Hz was 0.09

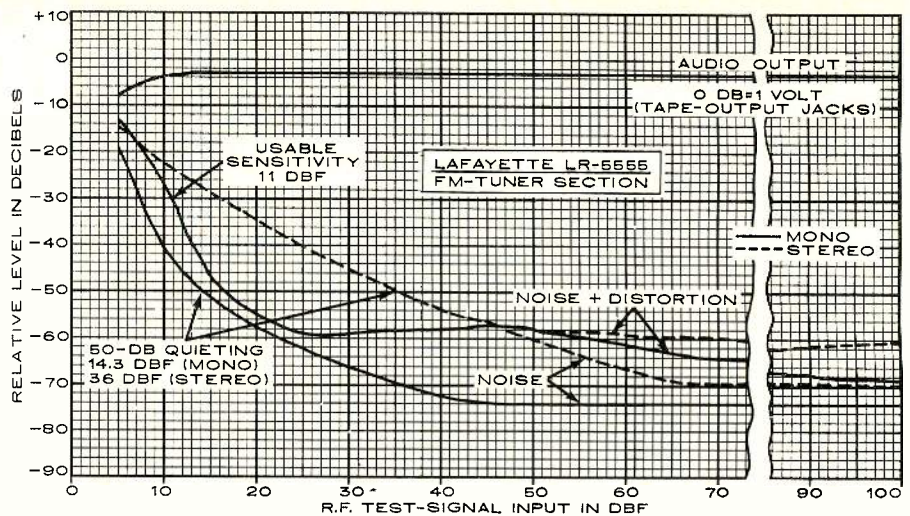

per cent, and at 6,000 Hz it was 0.25 per cent. We cannot help noting that only a couple of years ago this caliber of FM performance was

sponse from 50 to 15,000 Hz, with the lowest output at the low-frequency end and a rise in output at the highest frequencies. In spite of this rise, the 19-kHz pilot carrier was very effectively suppressed to -65 dB. The channel separation was exceptional, both in its magnitude and its uniformity. It was about 50 dB over most of the mid-range, falling to 45 dB at 100 and 10,000 Hz. Even at the measurement limits of 50 and 15,000 Hz, it was 36.5 and 41 dB, respectively.

The capture ratio of the tuner was substantially better than the rated 1.25 dB (in itself a very good figure). We measured it as 0.87 dB at a 45-dBf input and 1.06 dB at a 65-dBf input. The AM rejection was only fair at 45 dBf, where it measured 52 dB, but it was a reasonably good 64 dB at 65 dBf. The image rejection was 76 dB, as was the alternate-channel selectivity, and the adjacent-channel selectivity was about 5 dB. All of these performance figures show the tuner section of the LR-5555 to be at least very good, and many of them rate as excellent.

The muting and stereo-switching thresholds were identical at 8.3 dBf (1.5 microvolts). This is unusually low, since it will allow a weak stereo signal to be received with an unacceptably high noise level. In such a case, the receiver's mode switch can be switched to mono, which will accomplish the same thing as the higher automatic stereo-threshold setting used in most tuners and receivers. The tuner's hum level of -65 dB, though slightly higher than most, was not audible in use. The AM-tuner frequency response, which was all we measured on that part of the receiver, was of typical quality, being down 6 dB at 60 and 3,100 Hz.

### NEW TEST METHODS

● Hirsch-Houck Laboratories is now using the Institute of High Fidelity's new *Standard Methods of Measurement for Audio Amplifiers* (IHF-A-202 1978). For convenience in making comparisons with previously tested products, we will correlate the new measurement results, when appropriate, with measurements made using our previous techniques. Copies of the new standard are available for \$7 from the Institute of High Fidelity, Dept. AS, 489 Fifth Avenue, New York, N.Y. 10017.

found in only a handful of "super tuners," all of which cost far more than the entire LR-5555 receiver.

The tuner section had a slight frequency-response error, with distinctly different responses in the two channels. The average of the two was within  $\pm 2$  dB of the correct re-

● **Comment.** On the basis of the test data, it appears that the Lafayette LR-5555 is a very fine receiver, especially at its price level. In use tests, it produced no surprises, and our initial impression was reinforced. We have been impressed for some time by the generally high level of performance available these days in moderate-price components, and nowhere is this illustrated better than in the LR-5555.

The only reservations we have about the LR-5555 concern its high-cut filter (which, in our view, is virtually useless) and the microphone input, which unfortunately does not

(Continued on page 57)

The LR-5555's rear panel has spring-loaded speaker connectors at lower right, inputs and outputs at center left, FM and AM antenna terminals at upper left.

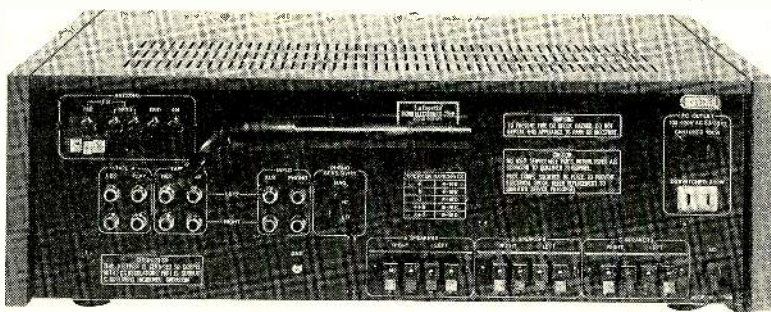



*Summer is now Playing -  
Don't miss it.*



*Out-of-doors, people all decked out in their summer attitudes. Even the occasional downpour makes for a nice moment. We recommend waiting it out with a splash of crystal-clear Smirnoff and tonic or fresh grapefruit juice. Splash gently though, you might miss the performance.*

**Smirnoff**  
*leaves you breathless*

SMIRNOFF® VODKA 40% ALC/VOL (80 PROOF) DISTILLED FROM GRAIN.  
© 1988 SMIRNOFF VODKA, INC. HARTFORD, CT

CIRCLE NO. 22 ON READER SERVICE CARD



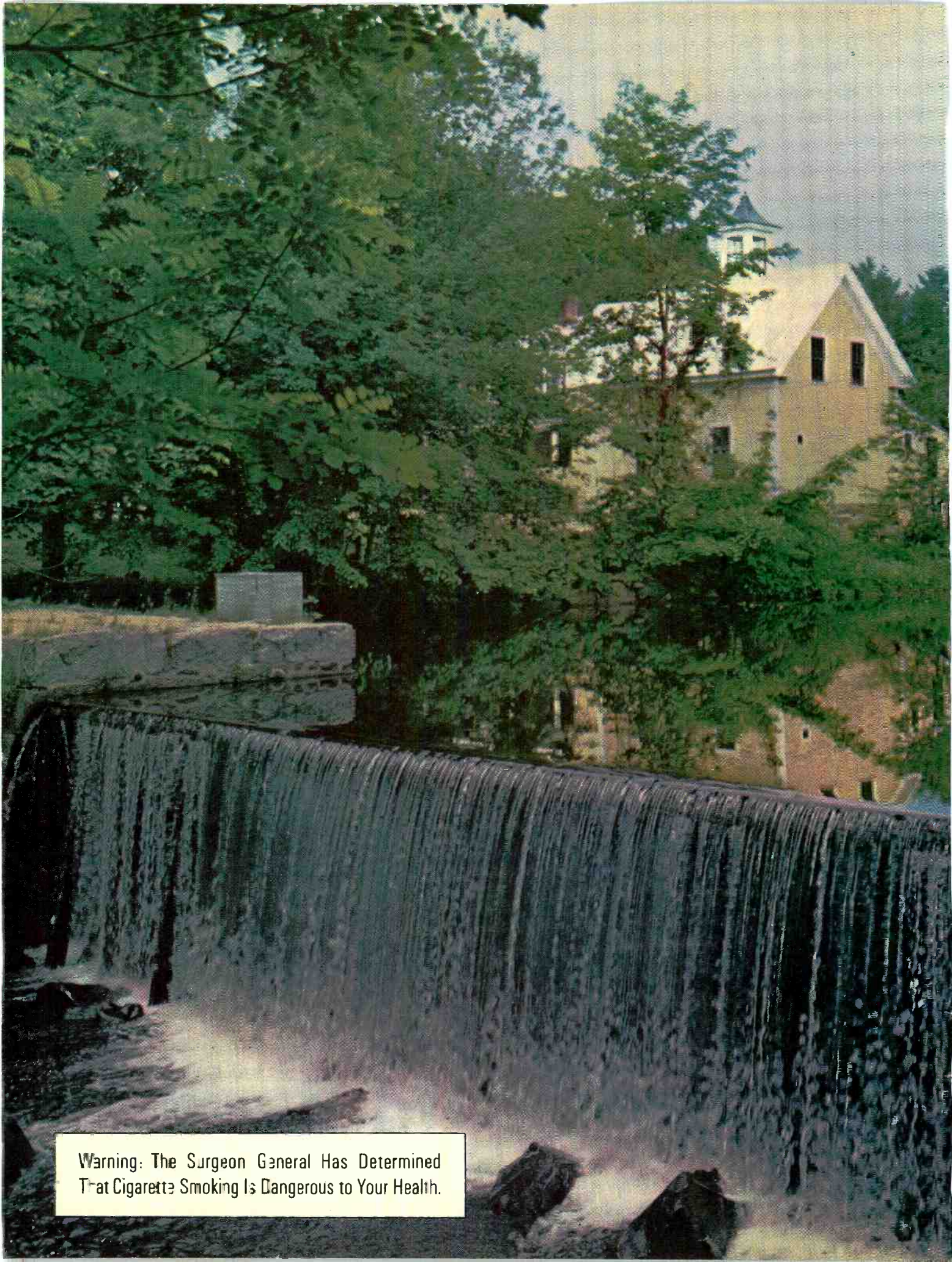

Warning: The Surgeon General Has Determined That Cigarette Smoking Is Dangerous to Your Health.



The most refreshing taste you can get in any cigarette.



No wonder it's America's #1 menthol.

Kings, 17 mg. "tar", 1.3 mg. nicotine; Longs, 18 mg. "tar", 1.3 mg. nicotine; F03, 17 mg. "tar", 1.3 mg. nicotine av. per cigarette, FTC Report Aug. '77



Introducing Technics Linear Phase bookshelf speaker series. Each with staggered speakers, a wide frequency response and flat amplitude. It may sound complicated, but it made Technics Linear Phase our biggest idea in speakers.

And now with the 3-way SB-X50 and SB-X30 plus the 2-way SB-X10, our biggest idea is small enough for shelf mounting. Like our other Technics Linear Phase Speakers, they all have the ability to reproduce a musical waveform that's virtually a mirror image of the original. Our engineers call it waveform fidelity.

# Technics

by Panasonic

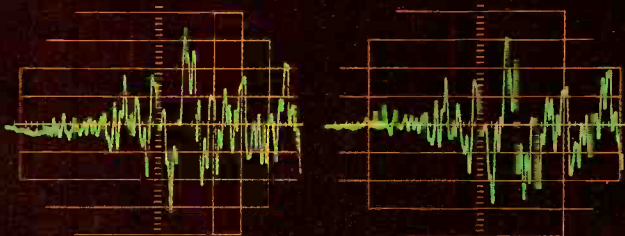

Piano Waveform.

Piano Waveform reproduced by SB-X50.

Look at the waveforms. If seeing is believing, you've just become a believer in Technics Linear Phase. Because that's accuracy that sounds better than good. It sounds live.

How we got that much accuracy into such small enclosures was extremely complicated. But our engineers found the key. A straight horn on a dome tweeter. It not only improved high frequency dispersion, it also gave us the unconventional staggered speaker configuration we wanted, in the conventional enclosure you want.

But what's more important is what Technics Linear Phase bookshelf series does for your hi-fi. For the first time you can have the accuracy of Technics Linear Phase in a speaker system small enough for shelf mounting.

## How Technics made their biggest idea in speakers, smaller.



SB-X50

SB-X10

CIRCLE NO. 57 ON READER SERVICE CARD



feed the tape-recording outputs. But these features do not have to be used if there is no need for them, and the rest of the receiver is fully up to the standards set by equipment costing considerably more.

The Lafayette LR-5555 is priced near the low end of the range for quality receivers, and it is definitely a product aimed at a broad market rather than a relative handful of audiophiles. Nevertheless, its FM performance rivals in many respects that of the super tuners

of a couple of years ago, and its amplifier section leaves little to be desired in respect to low noise and distortion. The operating flexibility of the LR-5555 will certainly meet the needs of the average owner, and with room to spare. Finally, all of the receiver's controls worked smoothly and with a feeling of quality. The FM muting is smooth and silent; it allows the sound to come up slowly from a dead-silent background only after a station is tuned in "on the nose." Sloppy tuning habits may lead

to frustration, no doubt, but with this receiver one can at least be reasonably sure that any station that is heard will be heard correctly. We made a careful A-B comparison between the LR-5555 and several other receivers costing up to four times as much. In reception of the sonically best of the local music stations, there were *no* audible differences between them.

Circle 107 on reader service card

## Beyer ET1000N Electrostatic Headphones



**T**HE well-known Beyer line of dynamic stereo headphones has been supplemented by a new, high-quality electrostatic model, the ET1000N. Like all electrostatic phones, they must be driven from the loudspeaker output of an amplifier through a special coupler/power supply. The necessary d.c. polarizing voltage is supplied by a rectifier energized from the a.c. power line, and separate coupling transformers in the accompanying N1000 coupler/power supply make it possible to operate either one or two headsets from the single unit.

The Beyer ET1000 headset has the outward appearance of a supra-aural or "open-air" headphone, with relatively shallow, inconspicuous earpieces that rest on the head with flat, barely visible ear cushions. The back plate of each earpiece is made of sintered bronze, the porous nature of which apparently allows it to function as an acoustic resistance between the rear of the diaphragm and the outside air. The softly padded headband fits close to the head, and combined with the slim ear cushions it gives the ET1000 a uniquely comfortable fit.

The specifications of the Beyer ET1000N state that it can deliver a 100-dB  $\pm 3$  dB sound-pressure level (SPL) at 1,000 Hz when driven by a 2-volt signal; it has a maximum rated output level of 115 dB  $\pm 3$  dB. The maximum rated output at 1,000 Hz (with a distortion level under 1 per cent) is 110 dB. The ET1000 phones are quite light, weighing 13

ounces (370 grams) without the 8-foot (2.5-meter) straight rubber-covered cord that connects them to the N1000 unit.

The N1000 is a compact box measuring 8 inches wide, 3½ inches deep, and 2 inches high. In its rear are DIN speaker sockets into which the furnished connecting cables are plugged. The other end of these cables is also fitted with a DIN plug, which will have to be cut off for connection to most amplifiers used in this country. Loudspeakers can be plugged into another pair of DIN sockets on the back of the N1000. When the pushbutton switch on the panel of the N1000 is off, the speakers are connected directly through to the amplifier outputs. If your amplifier has switching for two or more sets of speakers, the N1000 may be connected directly to the second set of speaker outputs. The two five-pin DIN sockets on the front of the power supply accept the plugs fitted to the ends of the ET1000 headphone cords. Price: ET1000N complete with N1000 coupler/power supply, \$289. Additional ET1000 headsets, \$180 each.

● **Laboratory Measurements.** The Beyer ET1000N was tested with a slightly modified ANSI standard headphone coupler and was driven from the speaker output of an amplifier. The frequency-response curve we obtained agreed very closely with one supplied by Beyer, in spite of the fact that they used a different coupler and microphone system. On all the essential qualities of the headphone,

we were in complete agreement. The most striking characteristic of the response curve was its smooth and extended mid-frequency and bass response. The output at 20 Hz was less than 5 dB below the 1,000-Hz level, which would be remarkable performance for a circumaural (sealing) type of headphone and is unique in our experience with a vented, or supra-aural, headphone.

Above 1,000 Hz, the response was almost as smooth, although here the coupler characteristics begin to impose themselves on the measurements. Still, the overall response of  $\pm 4$  dB from 20 to 20,000 Hz places the ET1000 among the elite of headphones, and in fact it is the flattest and widest frequency response we have ever measured from a stereo headphone.

At the rated 2-volt drive level, a 1,000-Hz signal produced a 98-dB SPL—within the phones' ratings. The distortion at that level was unmeasurable—below the system noise level (less than 0.05 per cent). We increased the drive until just before the acoustic-output waveform clipped, and at that point (15 volts) the distortion was only 0.3 per cent, equally divided between second and third harmonics, and the output SPL was 114 dB, again within ratings. In order to reach the 1 per cent distortion rating at 1,000 Hz, it was necessary to drive the phones into an obviously clipping condition. We measured the distortion at 20 Hz (2 volts) and found it to be 5.6 per cent; at 6,000 Hz it was 0.22 per cent at 2 volts and 0.56 per cent at 15 volts. The headphone impedance was 35 to 40 ohms over most of the mid-range, falling to 5 ohms at 20 Hz and 6 to 7 ohms at 20,000 Hz.

● **Comment.** Aside from its fine measured response, we found the Beyer ET1000 phones to be among the most comfortable to wear (although that, of course, is a purely personal reaction). As the manufacturer points out, the shape of the close-fitting headband and ear cushions gives this headset a truly unique fit and "feel"—one can almost forget that phones are being worn.

The sound, not surprisingly, was superb. To be sure, on most program material it did not sound very different from a few other top-quality electrostatic phones with which we compared the ET1000. However, we did note less of a "headphone" quality with the Beyer phones. With most phones, we tend to hear the sound coming from the rear; with these, it was directly to the sides, as well as within the head. This is probably as good as can be done

(Continued overleaf)



with a conventional stereo-headphone configuration. The coupler/power supply is not equipped with overload indicators, probably because the primaries of the coupling transformers are protected by thermistors that attenuate the drive signal automatically if it becomes excessive. We operated the phones from a receiver able to deliver about 80 watts

per channel and drove the receiver amplifiers into clipping without any harm to the phones. (The resulting sound level was very high!)

Beyer's ET1000N headphone system is far from cheap, although it is priced competitively with other comparable headphones. Anyone who uses headphones for serious listening would do well to try the ET1000N before

making a purchase. Headphone evaluation is ultimately a highly subjective process, but it is hard to imagine a headphone sounding better than these, or being more comfortable to wear—which certainly goes a long way toward justifying their cost.

Circle 108 on reader service card

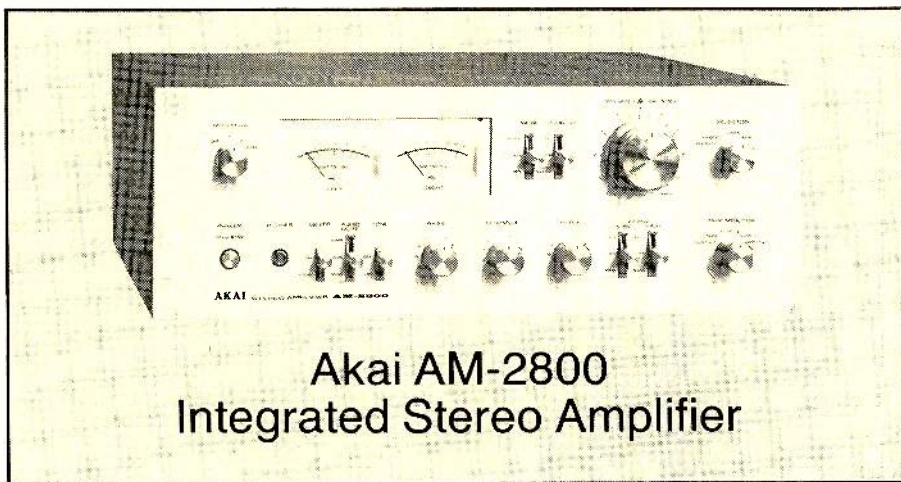

**T**HE AM-2800 is Akai's top-of-the-line integrated stereo amplifier, rated to deliver 80 watts per channel to 8-ohm loads from 20 to 20,000 Hz with less than 0.08 per cent total harmonic distortion. Its silver-colored panel and knobs match the styling of the companion tuner, Model AT-2600. Among the more prominent front-panel features of the AM-2800 are its pair of power meters, whose two calibrated scales cover the ranges of 0.01 to 3 watts and 1 to 100 watts, based on 8-ohm loads. The large detented volume control is concentric with a balance-adjustment ring. Smaller knobs select the speakers (either, both, or neither of two pairs), the program source (two magnetic-phono inputs and two high-level inputs), and the tape-monitoring functions. These last include provisions for

cross-connecting two tape decks for dubbing from either machine to the other, listening to the playback from either one, and listening to the selected program source.

On the lower portion of the front panel there are three eleven-position detented tone-control knobs for bass, mid-range, and treble, together with a lever switch for bypassing the tone-control circuits. An AUDIO MUTING switch reduces the volume by either 15 or 30 dB when moved up or down from its center position. A third switch is the meter-sensitivity selector for displaying full-scale power readings of 3 or 100 watts. To the right of the tone controls is a pair of three-position lever switches for the low- and high-frequency filters, each of which has a center "off" position and provides a choice of two cutoff fre-

quencies when moved up or down. The low cutoff frequencies are 30 and 60 Hz, and the high cutoffs are 7,000 and 10,000 Hz.

Between the meters and the volume control are two lever switches, one of them setting the operating mode of the amplifier (stereo, mono, or channel reverse) and the other controlling the loudness-compensation circuit, which is somewhat unusual in having a choice of either LOW or LOW & HIGH compensation. Both settings boost the lows relative to the mid frequencies as the volume-control setting is reduced, but the LOW & HIGH position also adds treble boost. The remaining front-panel control is the pushbutton power switch, with a red pilot light above it.

The rear apron of the AM-2800 has insulated "push connectors" for the speaker outputs and a DIN socket that duplicates the functions of the TAPE 1 circuits. The PHONO 1 input has a fixed resistance of 50,000 ohms, but a nearby switch selects a PHONO 2 input resistance of 33,000, 47,000, or 100,000 ohms. Two of the three a.c. convenience outlets are switched.

The Akai AM-2800 measures about 17½ inches wide, 6½ inches high, and 16⅓ inches deep and is furnished in a walnut-veneer cabinet. It weighs 29 pounds. Price: \$400.

● **Laboratory Measurements.** After the one hour preconditioning at one-third rated power output, the top of the AM-2800 was only slightly warm. This was not too surprising, in view of the considerable weight and size of the amplifier relative to its power rating. With a 1,000-Hz test signal, the power output at clipping, into 8 ohms with both channels driven, was 107 watts (the IHF clipping headroom was 1.26 dB). The 4- and 16-ohm clipping

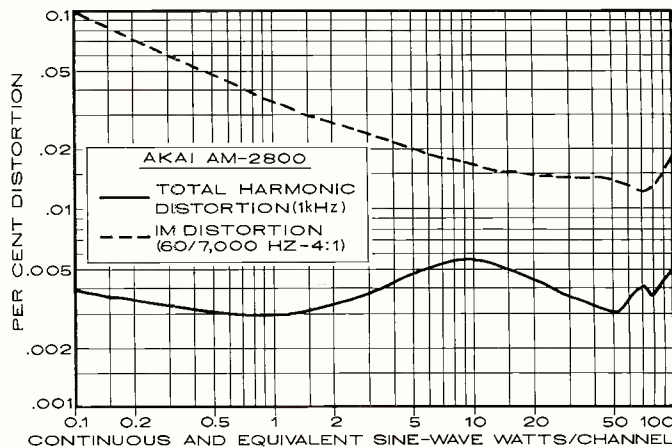
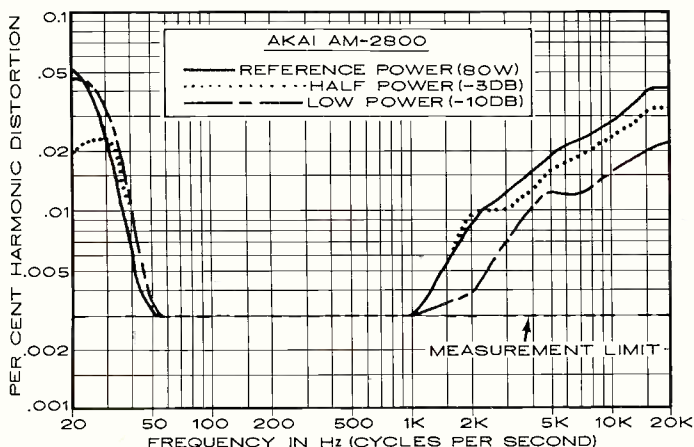



## NEW TEST METHODS

● Hirsch-Houck Laboratories is now using the Institute of High Fidelity's new *Standard Methods of Measurement for Audio Amplifiers* (IHF-A-202 1978). For convenience in making comparisons with previously tested products, we will correlate the new measurement results, when appropriate, with measurements made using our previous techniques. Copies of the new standard are available for \$7 from the Institute of High Fidelity, Dept. AS, 489 Fifth Avenue, New York, N.Y. 10017.

power outputs were 144 and 67 watts, respectively. The dynamic headroom at 1,000 Hz was 2 dB; in other words, the AM-2800 could deliver about 58 per cent more power than its continuous rating for short intervals.

The input sensitivity for the IHF standard output level of 1 watt was 15.5 millivolts (mV) through the high-level inputs and 0.275 mV through the phono inputs. The A-weighted signal-to-noise (S/N) measurements were 72 and 71 dB, respectively, referred to 1 watt. The phono input overloaded at a very safe 170-mV input (at 1,000 Hz).

The total harmonic distortion at 1,000 Hz was far below its rated 0.08 per cent. It remained between 0.003 to 0.006 per cent from 0.1 watt to more than 100 watts output. Intermodulation distortion with 60 and 7,000 Hz mixed in a 4:1 amplitude ratio was 0.1 per cent at 0.1 watt and decreased smoothly to 0.015 per cent or less in the range from 10 to 100 watts output. We also employed the new IHF IM-distortion test, which uses two equal-amplitude tones spaced 1,000 Hz apart, over the range from 2,500 to 20,000 Hz, at an output whose peak level corresponds to that from an 80-watt sine-wave signal. This distortion was a low -71 dB (0.028 per cent) at 20,000 Hz and decreased to -83 dB (0.007 per cent) at frequencies of 5,000 Hz and below.

At rated power output into 8-ohm loads, the AM-2800's total harmonic distortion from 50 to 1,000 Hz was less than our test-instrument residual of approximately 0.003 per cent. It rose to its maximum readings of 0.05 and 0.04 per cent at 20 and 20,000 Hz, respectively. At lower power levels, the distortion was very nearly the same as at full power. The amplifier was completely stable with capacitive loads as large as 2 microfarads.

The tone-control curves were conventional, with the bass control's action starting at less than 200 Hz and moving up to about 500 Hz as the control was rotated from its center position. The treble control's response was "hinged" at about 2,500 Hz. The mid-range control had a maximum range of about  $\pm 7$  dB, centered in the 1,000-Hz region, but it affected the response over the entire frequency range from 100 to 10,000 Hz.

The loudness contours were also conventional, although they were more useful than most because of the 15- and 30-dB attenuator settings, which allowed the volume control to be set for a useful response boost without excessive frequency imbalance. The filters had gradual 6-dB-per-octave slopes and their cutoff frequencies were chosen so as not to

remove an undue percentage of the program; however, they also had relatively little effect on any noise that was present. The low-frequency filter, especially in its 30-Hz setting, was of some value in rumble reduction, though not as effective as a real rumble filter with a sharper cut-off action. The measured cutoff frequencies (the -3-dB response points) of the filter were 25 and 60 Hz; the high cutoffs were 6,000 and 9,000 Hz.

The phono preamplifier proved to be exceptionally good even by the most critical standards. The RIAA-equalization accuracy was better than the resolving ability of our instruments, varying less than 0.25 dB from 20 to 20,000 Hz from the extended RIAA response curve, and it was not affected detectably by the inductance of a phono cartridge connected to the input. The measured input impedance of the phono input was 50,000 ohms in parallel with about 30 picofarads (pF), so that the user has the option of adding capacitance to the record-player signal circuits if the cartridge requires a higher capacitance.

On our test unit, the two power meters read somewhat differently (this is a matter of an internal adjustment). The more accurate of the two was usually within 10 to 15 per cent of the actual power delivered to an 8-ohm load, which is quite adequate for its intended purpose as a rough guide to the amplifier output. The meters had an unusual ballistic response, appearing to be overdamped in the lower third of the scale and underdamped in the upper third. In the middle, they had approximately the standard "VU meter" response to 0.3-second tone bursts. The underdamped behavior at the higher readings caused the pointers to strike their stops rather violently at times, even though the average power was well below the meter's full-scale reading. The amplifier itself has a very effective relay-operated protective system.

Although the controls are generally very clearly marked and easily operated, the BALANCE ring concentric with the detented VOLUME control is *not* detented and can be moved accidentally while adjusting the volume.

● **Comment.** Aside from the few criticisms mentioned above, we found the Akai AM-2800 to be a very satisfactory amplifier. Certainly it is as free of distortion of any kind as anyone could wish, and it is obviously rated with great conservatism. It was also completely free of audible noise, of either the random or switching variety, and had the mechanical smoothness in its control operation that we expect to find in a quality component.

We have not made any comments about the circuits employed in the Akai AM-2800, since the amplifier's performance speaks most eloquently for their effectiveness. They are apparently completely conventional; the power-output stages use complementary-symmetry transistors, and the power-amplifier section is direct-coupled throughout. In sharp contrast to some recent high-quality preamplifiers that use rather complex phono-preamplifier stages, the AM-2800 has a simple two-transistor pair for this purpose. Nevertheless, our measurements (and listening tests) confirm that this preamplifier section is as good as they come. It certainly has all the flatness, overload resistance, low noise, and independence from cartridge interaction that one could desire.

Circle 109 on reader service card

# Introducing the new AT605 FEEDBACK FIGHTER!



Now, enjoy freedom from acoustic feedback with the new AT605 Audio Insulator System from Audio-Technica.

Add the AT605 System and stop howling from feedback at high sound levels, reduce distortion or cartridge mistracking from sound energy conducted from speaker to turntable.

Solve problems of outside vibration like subways, heavy trucks, or jarring foot-steps. Or reduce transmission of annoying sound to adjacent apartments with the AT605 System under your loudspeakers. Gain new freedom of speaker placement, and improve performance especially of high-energy, low-frequency transients.



The slightly-curved bottom surface of each AT605 flattens as weight increases so that only the right number and size of resilient rubber projections support your equipment. Four insulators support up to 36 lbs. (9 lbs. each).

The felt-covered upper support is easily adjusted for accurate leveling. A precision bubble level is included. And each unit is enclosed in an attractive brushed chrome housing.

If feedback limits the quality of your system, or restricts your choice of equipment location, the AT605 Audio Insulator System can help. At all Audio-Technica dealers for just \$24.95 suggested retail. Win the fight against feedback today!

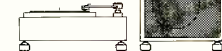

**audio-technica**  
INNOVATION □ PRECISION □ INTEGRITY

AUDIO-TECHNICA U.S., INC.  
Dept. 88F 33 Shiawasse Avenue  
Fairlawn, Ohio 44131  
In Canada: Superior Electronics, Inc.



# The Pop Beat

By Paulette Weiss



## SONGWRITERS' HALL OF FAME

WHEN Ruth Ellington offered to donate her late brother's piano to the Songwriters' Hall of Fame last May, a little acceptance ceremony was set up. But Duke Ellington would have been seventy-nine on May 29, the day following the presentation, so it seemed appropriate to make a public celebration of the event. The hall's curator, folksinger Oscar Brand, chuckled as he explained how it had all ballooned into a champagne party that Duke would have loved.

"Joe Morgen, who was the Ellington publicity agent for a quarter of a century, said, 'Let's celebrate at your place.' I said, 'Fine. We have a lot of room—we'll send out invitations.' 'Let me do it,' he said, and took up residence here together with Walter Wager of ASCAP, Charlie Scully of SESAC, and Russ Sanjek of BMI, and within five days we had a full-fledged media happening. *Everybody* was here—it was tremendous."

That it was. The large L-shaped hall in midtown Manhattan could hardly contain all of those—Duke's friends and colleagues as well as media representatives—who came to pay affectionate tribute to the man. Because so many loved and admired him, the speeches flowed as freely as the champagne.

Songwriter Sammy Cahn, president of the National Academy of Popular Music (parent organization of the hall), presided, as jovial as a proud papa at a daughter's wedding. Despite the good spirits, so many speeches might have weighed down even this buoyant affair had there not been a glorious reward in sight. That reward eventually came pouring out of Ellington's gold-trimmed, dark-blue concert-grand piano, as, one by one, nine great jazz pianists paid loving homage to the Duke by playing on the composer's own instrument.

First came Jimmy Rowles with a pensive *Serenade to Sweden*, followed by an even more introspective Bill Evans with *Reflections*. Cabaret sophisticate Bobby Short contributed a relaxed *Mood Indigo*, and it led into the first up-tempo selection of the afternoon, *What Am I Here For* by Marian McPartland. Newport Jazz Festival impresario George Wein ran through a jaunty version of *In a Sentimental Mood*, and Polish pianist Adam Makowicz played a fine *Sophisticated Lady* with lots of arpeggios and runs. Dorothy Donegan, introduced by Cahn as "one of the greatest

living pianists," played *Prelude to a Kiss* and segued into a foot-stomping *Take the A Train*.

"The Duke, wherever he is, must be smiling because I've never heard a better montage of piano playing," said Cahn. He then introduced Brooks Kerr, who called his selection, *I Never Felt This Way Before*, "a little bit of quiet ecstasy." Hazel Scott finished with a spiritual, *Come Sunday*.

It's a shame that in the whirlwind arrangements for the affair, no one thought to have it recorded. But although no album will be commercially available, two discs displayed that day have become closely associated with the event. The first is "A Tribute to Duke" (Concord Jazz CJ 50), reviewed in the Best of the Month section in April and released to benefit the Ellington Cancer Society. This disc captures another group of performers gathered to honor the maestro, among them Tony Bennett, Rosemary Clooney, and Bing Crosby. The second disc, "Luv You Madly Orchestra" (Salsoul SA 8507), was unavailable at the party, the result of a pressing-plant strike. Ellington's nephew Stephen James is both arranger and conductor on the disc, and he has disco-fied his uncle's music in hopes of bringing new young audiences into the fold. (Would Duke, who so hated formulas and repetition that he never looked back at his own old scores, approve?)

THE Songwriters' Hall of Fame itself is a fascinating place. It houses memorabilia ranging from Fats Waller's piano to Elvis Presley's guitar pick. There is a real, sawed-off desk corner inscribed "From the Desk of Frank Loesser," once sent to John Steinbeck as a joke. A pair of shoes worn by Gene Kelly

in *An American in Paris* lies in state next to Fred Astaire's top hat and gold-tipped cane, the latter given him by Cole Porter. Oscar Hammerstein II's "Good Boy" award from P.S. 9 is displayed as proudly as Mary Martin's gold record for *The Sound of Music* amid other precious-metal trophies. There is signed original sheet music galore, instruments to be played, and plaques honoring songwriters, performers, and patrons.

A homey kind of aural chaos reigns, since there are four programs being broadcast simultaneously. Two of these are geared to automatic slide shows on songwriters and the history of American pop music. There is a tape featuring the warbling of Astaire and Jimmy Durante, and a local jazz station is carried on speakers near the exhibit's entrance. It is, in all, the best-humored, least pretentious, and most enjoyable museum I've ever been to.

Although Tin Pan Alley perhaps looms disproportionately large, reflecting the background of the National Academy of Popular Music's board of directors, curator Brand, himself on the board, has been successful in getting more diverse representation. "The first thing I did when I joined the Academy was to make the point that pop music in America runs from traditional music to rock, and Tin Pan Alley is just one stop on that road," he said. "The first time I brought in my synthesizers [for display], Sammy saw the electric guitar and said, 'What the hell is this doing here? Running us all out of business.' Mitch Parrish [*Stardust* lyricist] still spits every time he passes that guitar."

BUT Brand believes its eclectic archives will make the hall an important institution in the field of popular music within five years. "We are not," he explains, "just an archive for the Hall of Fame, but for all of popular music in America. Before we're finished, we will have a library of books, songsheets, and memorabilia on a tremendous scale. The archive will be the major part of our existence. Anyone writing a book, doing a program or a thesis, or just interested in popular music will be able to turn here."

The hall is not supported by grants or foundations; the NAPM (headquartered in the hall) is strictly a music-business fraternity, and all funds are from voluntary contributions. The museum charges no admission and welcomes tour groups, but because funds are so limited, it is open only four hours a day (11 to 3), Monday through Saturday. The hall depends on donations for both its exhibit area and archives, so if you know of anyone who's got an early American psaltery or an old pair of Elton John's glasses gathering dust around the house, keep this address in mind: National Academy of Popular Music, One Times Square, New York, N.Y. 10036.





# PROFESSIONAL

**On location: Stanton is there where TGIF  
(Thank God, It's Friday) is filmed.**

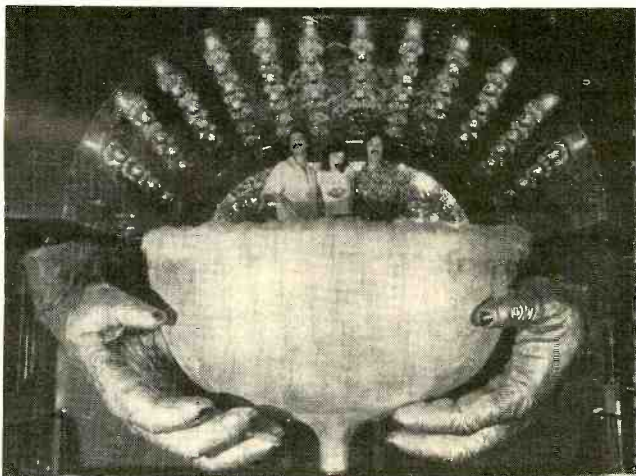

Go to the Club called Osko's in the Los Angeles Area. Revel in the sound around you, supplied to Osko's by Sound Unlimited Systems, Inc., a prime packager of Disco systems. They have supplied 90 systems to Stationary facilities and 60 to Mobile operations.

Sound Unlimited swears by Stanton's 500AL because they have used it for many years until Stanton came out with the 680 EL. Now they use this model exclusively in all of their installations, and endorse it without reservation.

Whether your usage includes recording, broadcasting, archives, Disco or home entertainment, your choice should be the overwhelming choice of the Professionals in every field . . . Stanton Cartridges.

P.S. "Thank God It's Friday" has turned out to be a dynamite film starring Disco Star, Donna Summer.

For further information write to: Stanton Magnetics, Terminal Drive, Plainview, N. Y. 11803

© STANTON 1978



# STANTON!

CIRCLE NO. 44 ON READER SERVICE CARD



# Going on Record

By James Goodfriend



## FESTIVO AND PRIVILEGE

THE marketing rationale of the record industry is sometimes a lot closer to the thinking in other industries than one might imagine. In the clothing business, for example, one can buy a dress for almost any price you might name—five dollars, ten dollars, fifty, a hundred, a thousand—and though that sort of range does not exist in the record business, the thought that a \$3.49 Beethoven Sixth might have a market separate from and in addition to that of a \$7.98 Beethoven Sixth certainly does. That thought has been implemented so many times that I am forced to believe it is true. Being true doesn't make it any the less odd, though, for the difference between a five-dollar dress and a fifty-dollar dress is in both the style and the material, but the difference between the cheaper disc and the more expensive one is *not* in the material—it's much the same vinyl, processing, and packaging—and if it is in the style, there are frequent occasions when the style of the cheaper item seems superior to that of the expensive one.

All this is prelude to telling you that Philips and Deutsche Grammophon have dropped onto the market a pair of new "mid-price" labels to handle mostly reissue material, Festivo for the former, Privilege for the latter (though the Schwann catalog identifies it only by numerical series, which begins with the prefix 2535). "Mid-price," in this case, means \$6.98, and if that doesn't seem very "mid," remember that the *full* price for DG and Philips is currently \$8.98. We are dealing with a smaller than usual price difference here, but the rationale may still hold.

At first glance, one is tempted to describe both these series as commercially "useful" in exactly the way mentioned before: they offer adequate lower-price versions of standard works for those who, for whatever reason, will not buy the higher-price versions. Playing through many of the forty or so albums in the first releases, though, one finds a number of discs whose value goes considerably beyond that of a good buy at the price, and since space here is limited, it is *those* discs I have singled out for attention.

The Philips/Festivo Beethoven Violin Concerto, with Grumiaux and Alceo Galliera conducting the New Philharmonia Orchestra (6570 051) would get a nod from me at virtual-

ly any price. It is about the most elegant performance of that work I know on records, and I prefer it to every other version currently available. The reissue also gives us a considerable bonus in the two Beethoven Romances for Violin and Orchestra, performed by Grumiaux with Haitink and the Concertgebouw, which were not present on the original. That, in my opinion, adds up to a great bargain.

The Deutsche Grammophon/Privilege list contains no equivalent bargain thus far, but it certainly has records of equivalent quality. The Beethoven Third Piano Concerto with Sviatoslav Richter and Kurt Sanderling conducting the Vienna Symphony is pianistically marvelous, orchestrally at least adequate, and it contains a bonus in the form of the B-flat Major Rondo for Piano and Orchestra (2535 107). Another extraordinarily beautiful record, though of far rarer repertoire, offers three early piano quartets (WoO. 36, Nos. 1, 2, and 3) by Beethoven, with Christoph Es-



chenbach and members of the Amadeus Quartet (2535 174). This is, so far as I know, the only recording currently available of these rather Mozartian works by the fourteen-year-old Beethoven, and though they are not masterpieces, they are well worth the hearing, particularly in performances as fine as these.

Richter is featured again, at his dramatic best, in a selection of Rachmaninoff *Préludes*,

rather oddly coupled with a performance of Moussorgsky's *Pictures at an Exhibition* by Rudolf Firkušny (2535 272). Firkušny's *Pictures* is really one of the better ones currently on the market (Richter's own, now on Odyssey, is the *ne plus ultra*), and Richter's Rachmaninoff *Préludes* are well worth owning even if one has them complete by someone else. Schwann, by the way, says they are played here by Firkušny, which obviously is not the case.

The remainder of the DG release contains a rather too zippy account of the Chopin *Préludes* by the late Géza Anda (2535 154); exceedingly effective performances of Bartók's Second and Third Piano Concertos, also by Anda with Ferenc Fricsay and the Berlin Radio Orchestra (2535 262); the Tchaikovsky Fourth, Fifth, and Sixth Symphonies in *echt*-Russian performances by the Leningrad Philharmonic with Mravinsky (2535 235/6/7); a nice disc of Weber overtures by Rafael Kubelik and the Bavarian Radio Symphony (2535 136); a *very* nice disc of Mozart's *Coronation Mass*, *Exsultate Jubilate*, and *Et Incarnatus Est* featuring Maria Stader (2535 148); and fine and still very competitive accounts of Mozart's Piano Concertos Nos. 23 and 24 by Kempff and the Bamberg Symphony under Ferdinand Leitner (2535 204).

Most of the other items in the Privilege series fall pretty much into the "useful" category, though a few, notably the Brahms Double Concerto with Schneiderhan and Starker and the Bach *Brandenburgs* with Baumgartner and the Lucerne Festival Orchestra, have not stood the test of time particularly well. Mahler's *Das Lied von der Erde*, on the other hand, with Nan Merriman, Ernst Haefliger, Eugen Jochum, and the Concertgebouw Orchestra, sounds considerably better musically to me now than when it first came out in 1963—the result, I suppose, of my having heard so many disappointing recordings of that work in the interim.

OF the remaining Philips/Festivo releases, the high points are a beautifully performed Schubert *Die Schöne Müllerin* by Gérard Souzay and Dalton Baldwin (6570 076, and how nice to find a lieder record in a reissue series); the most magical account I know of Ravel's *Ma Mère l'Oye*, coupled with *La Valse* and *Boléro*, by Monteux and the London Symphony (6570 092); a not very historically authentic but magnificently played Vivaldi *Seasons* by Szeryng and the English Chamber Orchestra; a topflight Tchaikovsky Sixth Symphony by Markevitch and the London Symphony; and a very good Sibelius Second Symphony by George Szell and the Concertgebouw. Most of the rest are, again, good-for-the-price, with a few (Haitink's account of Mendelssohn's *Midsummer Night's Dream*, Inbal's Debussy, Varviso's Wagner overtures) coming across a bit too lamely even for that.

The majority of these recordings date from the Sixties, a few earlier, and one or two later, and most of them have been released here before, some in different format. It is hard to generalize about the sound quality, but certainly not one of the discs presents any real problem in the listening. One can generalize about the pressings, though, which are excellent (an apparent average of about one blemish per record), with only occasional end-of-side distortion. I reviewed entirely from discs, but all the releases are to be available also on cassette at \$6.98.



# THE LS70 CAR SPEAKER SOUNDS LIKE A HOME SPEAKER BECAUSE IT'S MODELED AFTER ONE OF THE BEST.

	LS70	EPI70
Frequency Response	70-20 KHz	60-20 KHz
Crossover	1800 Hz	1800 Hz
Dispersion	Nearly hemispherical in musical range	Nearly hemispherical in musical range
Tweeter	1" air spring	1" air spring
Woofer	6" long traverse	6" long traverse
Impedance	8 Ohms nominal, 4 Ohms D.C.	8 Ohms nominal, 4 Ohms D.C.
Grille	Acoustically transparent perforated metal	Acoustically transparent matte-black foam

Up until now there have been car speakers and there have been home speakers, but quite frankly, they've been in two different leagues.

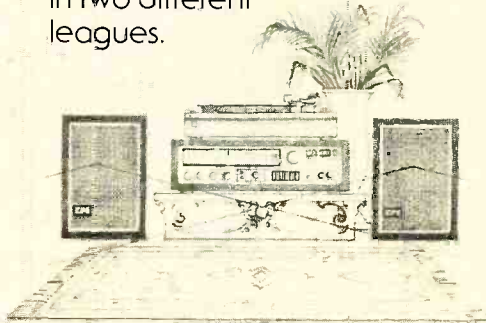

We patterned the LS70 after the much acclaimed EPI 70.

We decided to change that. We designed the LS70, a high performance, 2-way system that fits into a standard 6" x 9" cutout, to meet the same high standards we set for our much acclaimed EPI 70 loudspeaker.

The result is a car speaker that performs like no car speaker ever performed. You get remarkably clear, accurate, "Linear Sound." The term is derived from the way a frequency response

graph looks when it records perfectly accurate sound reproduction; a straight line runs all the way from the deep bass end to the high treble end.

To achieve this, we add no artificial boosting to the bass. Our treble delivers all the subtle overtones that just fade away on most speakers.

Next, you get dispersion that other speaker manufacturers can only dream about — it fills your car with a complete range of natural, uncolored sound.

Plus, LS70's can handle over 60 watts per channel.

Most other speakers blow up at considerably less than this.

Granted, the LS70's cost somewhat more than most car speakers, but in return you're getting a system that is every bit as good as exotic separate-component systems.

Stop into your local EPI Car Stereo dealer and see the LS70's for yourself. See if it's not a system that you can feel right at home with.

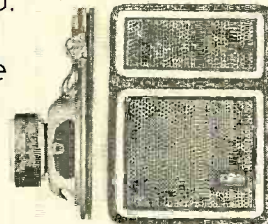

## LS70 CAR SPEAKER

THE FIRST CAR SPEAKER SYSTEM THAT YOU CAN FEEL RIGHT AT HOME WITH.

Pat. Pending.



Epicure Products Incorporated, Newburyport, MA 01950  
 CIRCLE NO. 19 ON READER SERVICE CARD



**O**F all the components in an audio system, the loudspeaker should be chosen with the greatest care; not only does it have more influence on the overall sound than any other component, but it offers the greatest opportunity to make a bad buy. If you select any one of, say, half a dozen similar-price, name-brand 50-watt amplifiers, the resulting system sound will be pretty much the same. Not so with loudspeakers. Recogniz-

you've made a good choice, fine. If not, your ears, being accomplished nit-pickers whether you realize it or not, will shortly start hearing the flaws, and you will have started your education with an expensive lesson.

## Speaker Reviews

If your ears aren't yet trained, it is reasonable for you to be unsure about

---

---

# GUIDELINES FOR SPEAKER BUYERS

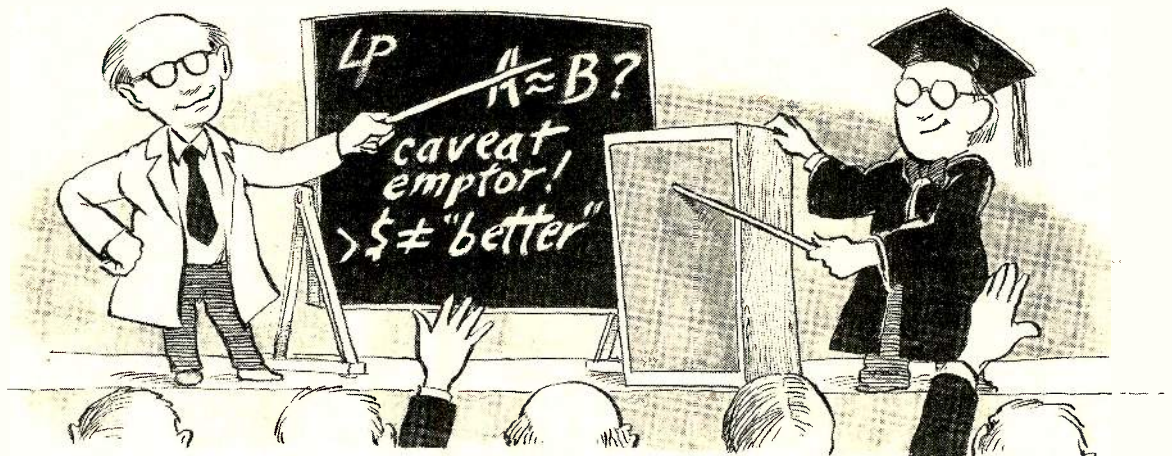

An easy introduction to a hard subject  
by Larry Klein and Robert N. Greene

---

---

ing, then, that you may have to live with your choice for a long time, and that a wrong decision could sooner or later drive you up your listening-room wall, how *should* you go about making up your mind?

### Eyes and Ears

At some point you're going to have to use your ears in the selection process, so let's tackle that subject first. If you feel that any old speaker will do because your ears aren't trained anyway, you're wrong! The training process will begin the moment you start listening to your own system. If

their ability to select speakers wisely. If you're serious about speakers but unsure of your ears, the best source of guidance is the speaker test reports in the legitimate hi-fi magazines. Finding these reports isn't as difficult or as time-consuming as you might think; manufacturers who have received good reviews usually have reprints available.

Although there's a certain amount of disagreement on details among reviewers, to our knowledge none of the responsible periodicals have ever given a good review to a truly bad speaker. But good products, for some obscure reason, do occasionally receive tepid reviews (not here, of course!).

[A note of caution: speaker systems



in general have improved tremendously over the years. A system rated as one of the very best five or ten years ago might now be judged as simply just another good speaker among many. Therefore, be sure to check the *dates* on the reprints of speaker reviews (or quotes from them) to avoid being misled. (An index of STEREO REVIEW's test reports on speakers and other products can be obtained by sending 25¢ in coin and a stamped, self-addressed, long envelope to STEREO REVIEW, Dept. TRI, One Park Avenue, New York, N.Y. 10016.)

If you're not interested in the technical aspects of why a reviewer came to certain conclusions, skip right to the "comment" section of the review. This will give you a good idea—usually in layman's language—of how the test lab *felt* about the unit. And reading a variety of reviews will also give you some idea of what, in general, to expect from systems of varying technological complexity and price.

Reviews and magazine advertisements serve another helpful purpose—familiarizing you with the names of widely distributed speaker brands. This is an oblique way of approaching our next warning sign, the one advising you to be cautious about speaker systems made by companies you've never heard of or sold *only* by the store you're dealing with. These house-brand or private-label speakers are usually made up inexpensively and are priced with an excessive markup. This practice allows the dealer to realize a good profit on a package system (including a receiver, turntable, etc.) even while giving a large discount on the other, name-brand components. But what the customer ends up with is a pedigreed receiver to be played through speakers of questionable parentage. (This is similar to the practice seen sometimes in photographic retailing of selling a well-known camera in conjunction with accessory lenses that appear to have been made from the bottoms of Coke cottles.) True, there are more than two hundred companies marketing speakers today, many of them well respected, so you're not likely to know *every* one. But if the brand name in question cannot be found except at *one* dealer's shop, play it safe: ask questions or move on. If you can trust your ears absolutely and are sure that the A-B demonstration of the speakers is not somehow rigged, then an obscure or house-brand speaker just *may* be a good buy. But *caveat emptor*.

And the very fact that there *are* so many companies putting out speakers means that no more than a small percentage of their products will ever be

reviewed. And remember also the corollary to this: the fact that a given unit has *not* been reviewed doesn't necessarily mean that it lacks merit.

## The Numbers Game

There's no automatic correlation between the number of drivers in a system and its quality. More is not necessarily better. There are some two-way systems that produce excellent results. The addition of a third or even a fourth driver may be based on sound engineering principles, or it may be just so much window dressing added to justify a higher price. [See the "Loudspeaker Forum" article on page 83 of this issue for a discussion of this question.]

And, speaking of price, a costlier system is not automatically a better

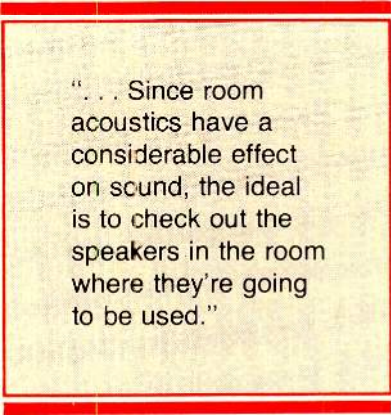

“... Since room acoustics have a considerable effect on sound, the ideal is to check out the speakers in the room where they're going to be used.”

system. For example, a given \$100 speaker might just be better designed and therefore sound more accurate than one marketed at double or triple its price. Notice that we said “more accurate,” not “better.” “Better” can be a purely subjective matter, but accuracy cannot. A speaker is either accurate or it isn't; either it will produce sound that closely corresponds to the electrical audio signal fed to it from the amplifier or it won't.

You may, indeed, find differences of opinion regarding any given speaker. Some may feel that a certain model lacks bass, that the mid-range has inadequate or excessive “presence,” or that the high frequencies are too bright or too dull. These disagreements can arise regarding even the most accurate of speakers because of differences in sonic *taste*—and, equally important, differences in the acoustic environment the speakers are being heard in. And there are those who simply don't care for the sound of a truly accurate reproducer, an opinion to which they are certainly entitled—but they are not en-

titled to claim that their low-accuracy speaker is producing hi-fi sound. Accuracy is an *absolute*, totally unrelated to whether one is a novice or an old pro. You'll find that experienced listeners prefer accuracy of reproduction over audio pyrotechnics, although even the experts sometimes disagree as to details of performance.

If you can arrange to audition speakers in your own home, by all means do so. Since room acoustics have a considerable effect on sound, the ideal is to check out the speakers in the room where they're going to be used. If this isn't possible, the next best thing—not for comparison, but for general orientation purposes—is careful listening to friends' systems. If you can manage to borrow a pair of speakers and a receiver, it could help you to start getting some idea about how your home-listening conditions will interact with loudspeakers—at least with the type you borrowed.

If this is not possible, note down the dimensions of your room (including ceiling height) and the nature of its acoustics. A room filled with hard surfaces and little in the way of sound-absorbent material will be rather on the “live” (echo-y) side, and one having heavy drapes, carpeting, a lot of books, soft furniture, etc. will be acoustically “dead.” You might try snapping your fingers or clapping your hands while standing in the middle of the room to determine the degree of liveness. If the sound “rings” or seems to echo back noticeably, you have a very live room. If you have this information at hand, your audio dealer can more easily advise you on which of his stock of speakers might best suit your conditions. Although you need not agree with his judgment absolutely (after all, *you* have to live with the speakers, not him), there are areas in which his experience can be particularly helpful.

One of these areas is speaker efficiency. Efficiency is a factor that can get confused with quality, but there is no necessary correlation; many of the most highly regarded speakers are quite *inefficient*. The efficiency of a speaker, however, can have some effect on the overall cost of a system. A large and/or acoustically dead room will require greater amplifier power to produce a given level of sound volume from a given speaker. As there is a general correlation between amplifier power and price, you may or may not find this matter of interest. Also, the laws of acoustics seem to dictate that, for a speaker enclosure of a given size, there is a tradeoff between efficiency and low-bass response (say, below 50 Hz). To put it another way, in order to have



# SPEAKER BUYERS...

high efficiency *and* low bass, the enclosure must be fairly large—but a large enclosure does not *guarantee* low bass.

## Comparisons, Good and Bad

Hearing live music—particularly rock music—in a concert hall and listening to reproduced music by the same performers are *not* analogous experiences. The sounds that musicians feed into microphones at recording sessions and the sounds that reach your ears in a concert hall are electrically and acoustically entirely different. This may be why some people feel that A-B listening comparisons between speakers are really of only limited value. But experienced listeners have no problems in this regard except when dealing with very *subtle* differences among very good loudspeakers. These exceptions aside, A-B comparisons are not that difficult to make *if* you know what to listen for and how to listen for it—which brings us back to your ears and how to use them to best advantage in your quest for the right speakers.

To start, don't try to compare more than two speakers at a time; it can be confusing for a novice. Also, you may find it easier to make evaluations by listening to single speakers rather than stereo pairs. When auditioning a single speaker in a showroom, however, its location is likely to influence its frequency response for better or worse. This can easily be checked by switching to the other member of the pair, which will probably not be in as favorable (or unfavorable) a location.

A speaker system's bass response should be free of spurious resonances. This can easily be checked by listening to several male announcers on different FM stations. Depending on the voices and the setup in the studio, a few of them may sound boomy, but if they *all* sound like they're talking from the bottom of an oil drum, you can be sure that the speaker has a peak somewhere in the area of 100 Hz. For some listeners, this provides a pleasingly heavy bass with pop or rock music, but it is paid for with a loss of upper-bass clarity and (usually) absence of *genuine* low bass frequencies.

A speaker system inherently unable to reproduce low bass has a choice of

how to react when fed, say, a 40-Hz tone. It may either make no sound at all (which is preferable) or else produce sound containing a small amount of the original 40-Hz signal, some 80-Hz tones, and a lot of 120-Hz output. The spurious 80- and 120-Hz harmonic signals are products of "doubling" and "tripling"—phenomena that occur when a speaker is driven beyond its linear limits, which is most likely to happen at low-bass frequencies. With such a speaker, the sonic difference between, say, a kettle drum and a trap drum is largely obscured.

As for the mid-range frequencies, the sound of such instruments as the brasses should not be projected out into your face (boosted) or sunk too far into the background (depressed). The forward type of projection is frequently associated with a nasal, "honky"

"... What should be emphasized is that, although choosing speakers is a difficult process, it is obviously not quite an impossible one."

quality that shows up particularly in female voices (more in the alto than in the soprano range—almost any of Carly Simon's records will serve for mid-range evaluation). If, on the other hand, the mid-range is too withdrawn, vocalists will sound the same way.

To evaluate high-frequency performance, listen to recordings of music that includes cymbals or triangles. Try to isolate the ringing or "shimmering" sound typical of these instruments, which should be clearly present and seem light and airy. The instruments should *not* sound as though they were tin cans being struck. If the speaker is accurate it will, reproduce whatever noise (hiss and record-surface noise) there is in the program material, but it won't exaggerate it. Conversely, if a speaker shows up no flaws at all but makes everything sound pleasantly bland, it should be reserved for those listeners who want only background music. (This could, incidentally, indicate that the dealer has, for whatever reason, adjusted the high-frequency

controls on the speaker improperly.)

Until now we've been talking about what to listen *for*; just a bit now on what to listen *to*. Except for the radio-announcer voice tests mentioned above, it is best *not* to use FM broadcasts as test material. Aside from the technical limitations inherent in the medium, the signal quality put out by any given station, the program material, and the reception can all be considerably less than perfect, and they will almost certainly be somewhat variable. Instead, take a couple of your favorite records with you when you shop for speakers. Your own records will be representative of the kind of music you usually listen to and will present at least one familiar constant in a situation filled with unfamiliar variables.

If you can, make one of your test records a piece of well-recorded choral music. It may not be flashily (and distractingly) impressive, but such music is good test material because it is difficult to reproduce well. Good speakers will permit you to hear a number of individual voices, not just a vocal blur.

## Nothing But the Best?

One final word of advice that may make it easier for you to concentrate on what's gone before. Don't let yourself get hooked on the idea that you must have the *best*. On a purely objective basis, "the best" doesn't exist. Certainly some professionals in the field have strong opinions concerning loudspeakers in general—and sometimes equally strong personal preferences. But we know of no method of isolating the *absolute* best among the many fine speakers we've heard over the years. The closest we care to come to this is a statement to the effect that a unit "ranks with the finest speakers available." In any actual listening situation, differences in associated audio equipment, program material, acoustical environment, and room placement have so much effect on the sound of a speaker system that any hasty judgment that one of them is "best" might easily be rendered invalid by only a slight change in the circumstances.

What should be emphasized is that, although choosing speakers is a difficult process, it is obviously not quite an impossible one. Armed with your own good sense, two working ears, and the information we've provided, you should be able to make a sound choice. And remember, the highest compliment you can pay any speaker system is just to forget that it's there. After all, it isn't the *speakers* you want to listen to, it's the *music*. □



# RODRIGUES LOOKS AT SPEAKERS

1.



"...AS A MATTER OF FACT I HAVE A PAIR OF THESE IN MY OWN HOME..."

2.



"...AS A MATTER OF FACT I HAVE A PAIR OF THESE IN MY OWN HOME..."

3.



"...AS A MATTER OF FACT I HAVE A PAIR OF THESE IN MY OWN HOME..."

4.

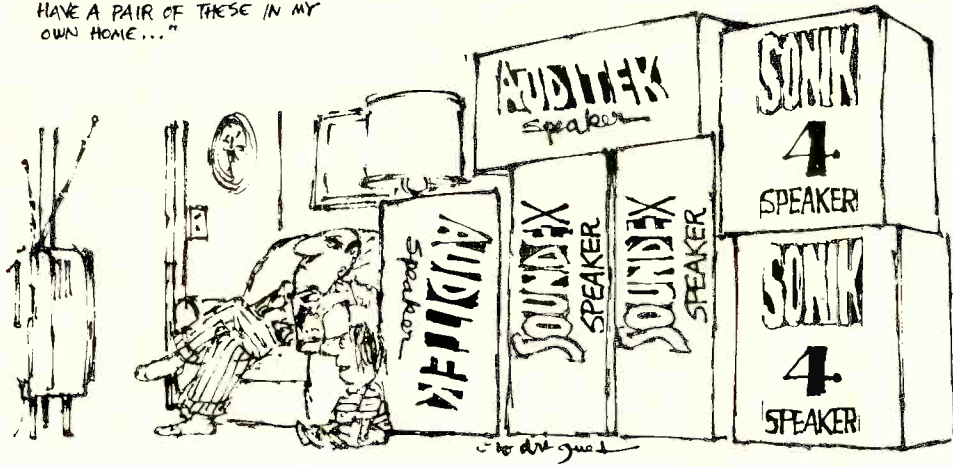

© by Art Quaid





Lew Bush/Festival Productions

## NEWPORT

*Vibraphonist Gary Burton plays to a rapt afternoon audience at the 1967 Festival in Newport.*

# NEWPORT JAZZ FESTIVAL: 25TH ANNIVERSARY

A horde of rioting flower children accomplished  
in one evening what Old Guard society could  
not in years of trying: they got jazz  
kicked out of Newport

By Chris Albertson





## NEW YORK

Beaver Harris and the 360° Experience get the help of some of New York's finest Latin percussionists.

At the beginning of this century, jazz music—still only in its embryonic stages—manipulated the emotions as well as the bodies of voluptuaries in the fleshly dives of New Orleans. Its pioneers pushed their synopated rhythms and earthy wails through air fetid with cigar smoke and cheap perfume, competing with the throaty catcalls of scarlet women and the bellowing laughter of pimps, professional gamblers, and their willing prey. Though no one had yet recognized it as such, a wholly original American art form was emerging in a setting so opposite to that created for the day's high society in Newport, Rhode Island, that if anyone had suggested that gilded resort would one day be jazz's Summer Home, it would have been as absurd as the notion that Jackie Onassis might take up residence in the blasted urban squalor of today's South Bronx.

As the century wore on and the infectious sound of jazz began to make its way onto phonograph records and into the speakeasies of the Prohibition

Era, a youthful generation of well-to-do, flat-chested flappers and their carousing collegiate escorts came under its spell, and soon the Victrola began to shake even the rafters of Newport's palatial multimillion-dollar "cottages" with the lively expressions of the people from the other side of the tracks. But snobbery continued to govern life at Newport, and when its residents gathered for an evening of live music, it was inevitably of the socially acceptable, classical kind.

By the early Fifties, jazz—having since taken on many variant forms—was well established throughout the world and was generally regarded as America's most original contribution to the arts. It had been performed in the world's most hallowed concert halls and was acknowledged as an influence by some of the most revered contemporary composers in the classical field. Yet, in many ways, it still carried the stigma of having been born out of wedlock in a society of outcasts. Ironically, however, it was that hint of raffishness, outgrown though it was, that may have

been the underlying reason for Newport's becoming the home of the world's most famous jazz festival in 1954.

In his book *Newport Jazz Festival* (Dial Press, New York, 1977), photographer/writer Burt Goldblatt puts forward the intriguing notion that Elaine Lorillard, a prime force behind the Newport Festival in its early years, brought jazz to the staid resort as an act of revenge. Louis P. Lorillard (of the famous tobacco family) was highly respected by Newport's stodgy Old Guard, but his wife is said to have been rather unpopular among the ladies there because, as Patrick O'Higgins, the Festival's publicist for three years, put it, "they feared her, or they feared that she was cleverer or more amusing or whatever." When the Lorillards helped to present two concerts by the New York Philharmonic during the summer of 1953, the attendance was inordinately poor, suggesting that there might have been an unofficial boycott because of Mrs. Lorillard's involve-



# NEWPORT...

"Mrs. Louis Brugiere announced that she was prepared to spend ten million dollars, if necessary, to rid Newport of the jazz menace."

ment. That is, of course, pure conjecture. But Newport's Old Guard—who had expressed resentment at the presence of jazz musicians there—did show up the following year, when Elaine Lorillard's efforts produced America's first jazz festival. "I think what happened was, they said we'll all go to this bloody Festival because it's going to be a terrible flop," O'Higgins told Goldblatt. "Mrs. Lorillard was going to be chased out of town, and much to their surprise it had the exact opposite effect."

From the moment Eddie Condon's Dixieland group opened the first evening's proceedings with a rousing version of *Muskrat Ramble* to the extended drum solo Gene Krupa played in the closing number the following night, the first Newport Jazz Festival was an unqualified success. It had featured such imposing talent as Dizzy Gillespie, Gerry Mulligan, the Modern Jazz Quartet, Oscar Peterson, George Shearing, and Lennie Tristano, and it had reunited Billie Holiday with Lester Young and Teddy Wilson. It had also drawn a sizable, enthusiastic crowd, received tremendous press coverage, and made a profit. Despite all this—or perhaps because of it—some of Newport's most powerful society matrons continued to show antipathy toward the Festival: Mrs. Van Alen said she could put up with the music, but that the people were "so vulgar," and Mrs. Louis Brugiere announced that she was prepared to spend ten million dollars, if necessary, to rid Newport of the jazz menace. One ventures to guess that her threat was idle, for even half that sum would surely have persuaded George Wein—the man Mrs. Lorillard had put in charge of the Festival—to move to a more hospitable location.

LAST month, the Newport Festival celebrated its twenty-fifth anniversary, though it can be argued that the absence of a 1961 event actually made it the twenty-fourth. George Wein is still at the helm, but Mrs. Lorillard has long been out of the picture, and—

though it still bears the name—the Newport Festival has not been held at Newport since 1971, when a crazed mob of youths crashed onto Festival Field and disrupted a performance by Dionne Warwick. While a stunned audience of close to twenty thousand looked on in disbelief, the "flower children" proceeded to wreck everything in sight, including a grand piano. A similar, somewhat milder disturbance had occurred in 1960, forcing cancellation of the following year's Festival, but arrangements were made with the Newport authorities for resumption in 1962. The 1971 incident, however, was fatal. Jazz and Newport came to a parting of the ways. A rowdy segment of the

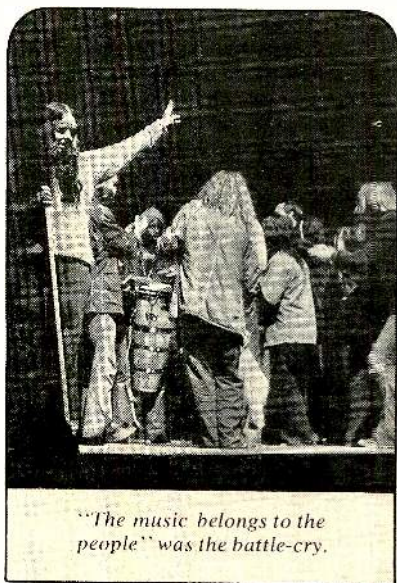

"The music belongs to the people" was the battle-cry.

Woodstock generation had unwittingly played right into the hands of those staid society matrons.

In 1972, George Wein moved the Newport Festival to New York City, where it has remained and thrived, but attending a series of concerts in the city cannot begin to match the experience a weekend outing at Newport offered. Missing are the relaxed atmosphere created by the resort's idyllic setting and the intimacy that brought performers, critics, and fans together during the off hours. Nevertheless, Wein is to be commended for keeping an important cultural event alive, and the echoes of Newport Jazz past linger on in an impressive number of recordings made there between 1956 and 1971.

Sad to say, most of these recordings are not currently available. But it is comforting to know that they exist, along with considerable film and videotape footage and many hours of record-

ings made for broadcast by the Voice of America since 1965. Columbia has retained in its catalog two fine vintage Newport items, "Miles & Monk at Newport" (CS 8978), featuring the Miles Davis Sextet with John Coltrane and Cannonball Adderley and the unusual combination of the Thelonious Monk Quintet and Dixieland clarinetist Pee Wee Russell (1963), and "Ellington at Newport" (CS 8648), a 1956 recording that contains what may well be the most memorable performance ever given at any Newport Festival. That is Duke's *Diminuendo and Crescendo in Blue*, which went on for fifty-nine choruses highlighted by tenor saxophonist Paul Gonsalves's marathon solo that in itself lasted twenty-seven choruses, bringing an enthusiastic crowd of thousands to their feet and the brink of a riot. It is a stunning tour de force that no jazz collection should be without. Also available on Columbia are two more recent albums, made since the Festival moved to New York: "Ella Fitzgerald: Newport Jazz Festival Live at Carnegie Hall, 1973" (KG 32557, two discs), a mostly fine, occasionally shaky performance for which Ms. Fitzgerald gets fine support from something called the Chick Webb Orchestra and such featured soloists as Roy Eldridge, Tommy Flanagan, and Eddie "Lockjaw" Davis, and "V.S.O.P." (PG 34688, two discs), Herbie Hancock's mixture of the good and the dreadful, recorded at New York's City Center during the 1976 Festival.

OTHER Newport items likely to be found in a well-stocked record shop include "Herbie Mann Live at Newport" (Atlantic SD-1413), a south-of-the-border set from the 1963 Festival; and two Dave Brubeck sets, "Newport 1958" (Columbia Special Products JCS 8082) and "Last Set at Newport" (Atlantic SD-1607), the latter featuring the famous quartet with Gerry Mulligan and recorded just before the fateful 1971 trashing. The six-disc Buddah/Cobblestone series from the 1972 premiere festival in New York (CST 9025-2, CST 9026-2, CST 9027, and CST 9028), has been deleted, but copies are still available in some stores, and volumes one through four contain all-star jam sessions worth looking for. It's still too early to tell what, if anything, will be released from this year's Newport events, but RCA has forthcoming an album of the Toshiko Akiyoshi/Lew Tabackin Big Band recorded at Lincoln Center's Avery Fisher Hall last year, and if the technical quality does the performance justice, even the survivors of Newport's Old Guard should find it to be a bit of all right. □



# The NEW "A" Series From Synergistics!

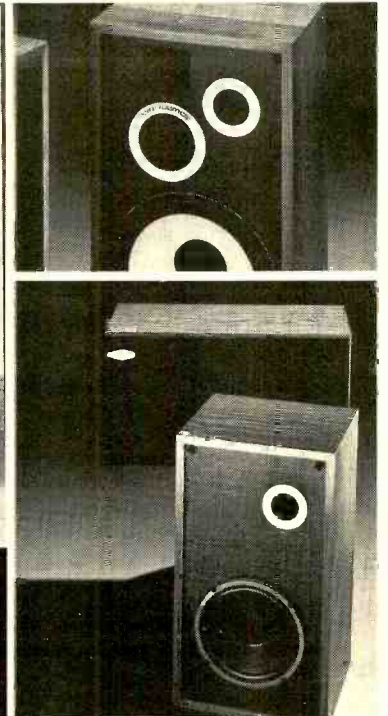
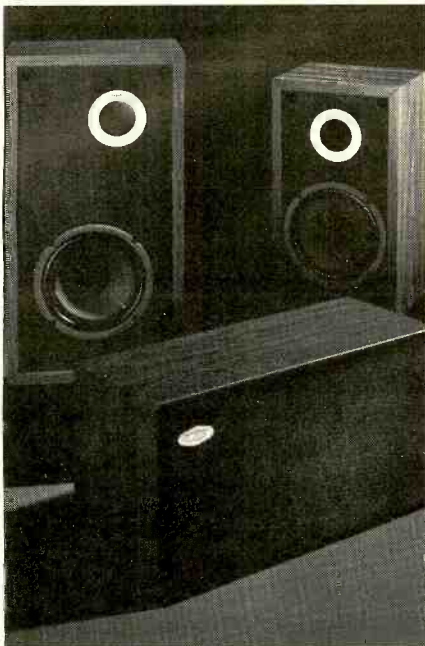

Eight new high accuracy, high efficiency speakers, all designed to maximize the total performance of your component system.

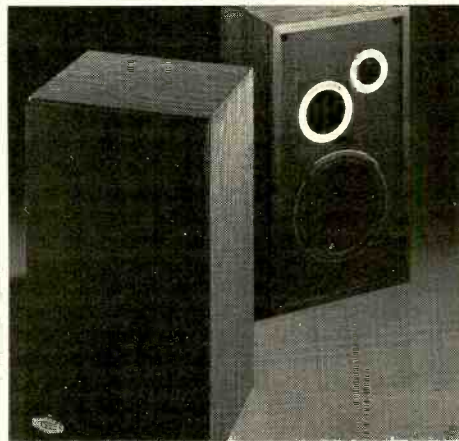

When you buy a stereo system, choosing the best possible speakers is your most important decision because your speakers largely determine your system's overall sound quality. But how can you be sure which speakers are the best for the system you have in mind? One manufacturer has the answer: Synergistics.

Designed by one of the most respected research teams in the industry, all eight "A Series" Synergistics models offer maximum musical accuracy, without the tonal coloration found in other high efficiency speakers. Our speakers not only excel in their own right, they also dramatically enhance the sound quality of today's amplifiers and receivers.

Match your favorite popularly-priced low or moderately powered receiver to the Synergistics model recommended for it, and your receiver can operate at lower power levels, with more power in reserve to handle sudden musical peaks without distortion. Thanks to Synergistics, you no longer have to spend so much of your total system budget on electronics to get

the sound quality you want. Instead, you can invest more on better speakers, where you'll easily hear the improvement in sound.

Synergistics has taken the guesswork out of selecting the best speakers for your system, so you'll get the maximum overall sound quality possible within your total system budget.

**Synergistics: Cooperative interaction in a system where the total effect is greater than the sum of its parts.**

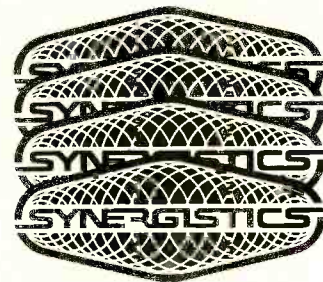

For More Information Write To: Synergistics P.O. Box 1245 Canoga Park, California 91304

CIRCLE NO. 55 ON READER SERVICE CARD



## How to recognize the 5 most perplexing problems in high fidelity speakers:

It is not the purchase price that gives value to an audiophile quality speaker but its ability to overcome the major problems inherent in reproducing sound. Recognize these problems, and the solution to determining a speaker's worth becomes readily apparent.

**One. Coloration:** Speakers should be seen and not heard. Speaker cabinets and components can "color" — add their own tones — to a musical piece.

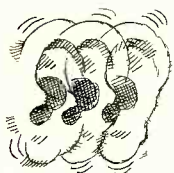
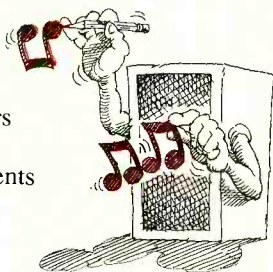

**Two. Sonic instability:** Standard alignments of woofer, midrange and tweeter can cause orchestral musicians to seem out of place. Piano and violin solos often seem to be played by two or more instruments.

**Three. Vocal passivity:** No instrument is more expressive than the human voice. And none is more difficult to reproduce.



**Four. Volume distortion:** If it cannot reproduce music faithfully with the volume adjusted either up or down, a speaker cannot offer audiophile responsiveness.

**Five. Unnatural nature:** The sounds of creation are also music to the ear. A warbling bird, babbling brook or clapping hands that do not express immediacy take the very life from nature.



## How to eliminate the 5 most perplexing problems in high fidelity speakers:

The solution is RTR's new D-Series speakers. From the Corinthian columned 600D and 300D to the curvilinear 100D and 75D bookshelves, every component is RTR designed, manufactured and assembled for problem-free performance.



True clarity and natural warmth so apparent in the D-Series start with RTR's new 1.5 inch soft dome midrange. This break-through system offers optimal midrange response and broad dispersion while eliminating crossovers in the critical 1500-3000 Hz range. Nothing enhances, colors or subtracts from programmed material.

This same devotion to musical purity extends to the performance of the newly-stated RTR woofers and articulate dome tweeters. Throughout the system, reproduction is faithful to the human voice, musical instruments and natural sounds.

As a final triumph for the D-Series, RTR incorporates "resolved point source radiation field" — achieved by uniquely repositioning woofers, drivers and tweeters to create an almost unbelievably stable sonic image. Instruments and voices remain positioned as they were live.

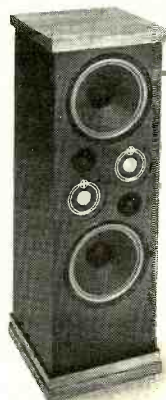

Audition the 100D, 300D and 600D at your RTR dealer soon. And ask why RTR not only designs and assembles all of its components but manufactures each as well. That's "Total Capability" — the big difference between RTR and other makers of audiophile-quality speakers. At RTR we don't just build speakers, we build solutions.

RTR Industries, 8116 Deering Ave.,  
Canoga Park, CA 91304



**Listen...  
you'll be hearing  
more from RTR.**



Magnepan's Tympani 1D electrostatic speakers. Each panel measures 3 x 6 feet.

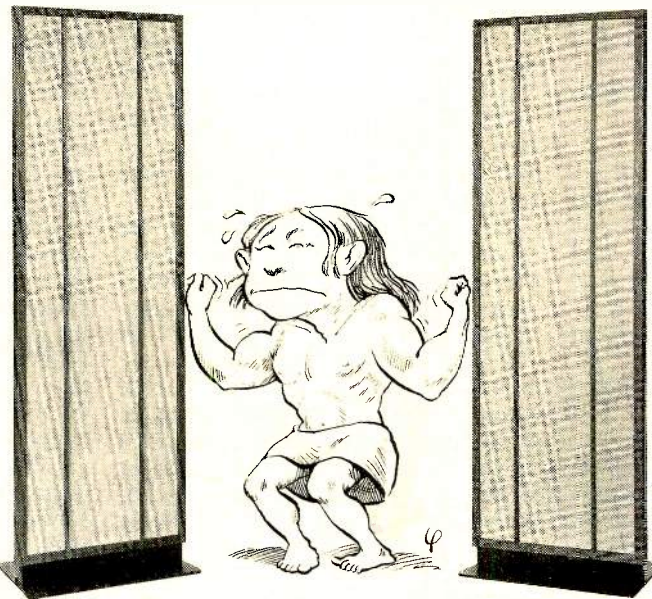

# EXOTIC LOUDSPEAKERS I HAVE KNOWN

Whatever their working principles and however bizarre their physical realization, exotic speakers still have to be judged by the same criteria that apply to other such

devices: uniform frequency response, adequate power-handling ability, and all the other qualifications that pertain to the sonic accuracy of loudspeaker reproduction.

**B**ECAUSE most available speaker systems consist of paper, plastic, or even metal diaphragms, of magnet assemblies, coils of wire, and (usually) wooden boxes, it is possible to forget that there are other ways of producing sound—quite a variety of ways, in fact. At present, most of these techniques produce designs that fully deserve the designation “exotic,” being somewhat unconventional in their operating principles, often large and physically complex, and usually rather expensive. Frequently the high cost means that the buyer is paying for a lot of development effort and unusual manufacturing techniques. An exotic technology and a high price tag are not in themselves guarantors of sonic excellence, of course, but many of the creators of these designs are convinced that their work represents the glorious future if not the immediately accessible present of the art of loudspeaker design. Just what are the design principles of these unique systems?

## The Plasma Speaker

Let's begin with the newest and most exotic of the novel designs: the Hill Type-1 by Plasmatronics, developed by Dr. Alan Hill, an Albuquerque, N.M., laser physicist. Many of the difficulties of the conventional loudspeaker driver are associated with the mass and resonances of the diaphragm. The Plasmatronics design eliminates the diaphragm altogether and employs electrical force to vibrate the air directly! This ideal is the sort of thing speaker designers have long dreamed of, so it should come as no surprise to learn that the “massless” driver has been achieved once before in audio history—in the Ionovac tweeter some fifteen years ago. But substantial advances in plasma technology have occurred in recent years, and these are reflected in the Hill de-

sign, which is somewhat different from the Ionovac in its approach.

The key to this design is the formation of a plasma—a gas comprised of charged atomic particles. Two electrodes are mounted with an air gap between them, and a high d.c. voltage is applied to the electrodes. If the voltage is high enough, an electrical discharge, incandescent in appearance, jumps the gap, ionizing the air in its path (breaking up the air molecules and knocking electrons free), and current flows continuously across the gap through the plasma thus created. The plasma attains a temperature of several thousand degrees, and like any hot gas it tends to expand until its pressure is in equilibrium with the ambient air pressure in the room. The volume of the plasma zone then stabilizes—as long as the current flow in the electrical discharge is held reasonably constant.

In the Plasmatronics speaker the audio signal is amplified and combined with the d.c. voltage that sustains the

By Peter W. Mitchell



# EXOTIC...

discharge. Thus the audio modulates the flow of electric current through the plasma. This varies the heating of the plasma, modulating its pressure, and the plasma zone pulsates in response to the applied audio signal to generate vibrations (sound waves) that spread throughout the surrounding air.

The plasma is contained in a quartz cell several cubic centimeters in volume, and because the driver's operation is limited to the mid-range and treble (so that the audio modulation that is imposed results in only tiny changes in the total volume of the plasma), distortions are held to negligible levels.

The plasma driver operates as a mid-range/tweeter covering the range from 700 Hz up to ultrasonic frequencies. Because of the small size of the pulsating sound source, it yields uniformly wide dispersion and phase-coherent response across its operating range, and the makers claim exceptionally good stereo imaging as a consequence. And of course such common transient aberrations of diaphragms as ringing, hangover, and breakup are nonexistent, since there is no diaphragm as such. A high-voltage gas-discharge system is potentially prey to some *special* problems, however, such as the production of ozone, electrically and sonically noisy operation, and rapid erosion of the electrodes. These drawbacks have reportedly been eliminated, so that the speaker is now both safe and practical as a consumer product. Part of the solution involves the injection of a trickle of helium into the plasma to tailor its heat-flow properties and to provide an

inert atmosphere around the electrodes so that they won't burn away. Bottles of compressed helium are built into the loudspeakers and must be replaced two or three times a year, adding a maintenance cost of about 30¢ per hour of operation to the system's \$6,000 purchase price for a stereo pair.

As noted earlier, the plasma driver operates from 700 Hz on up. To fill in the bottom of the audio-frequency range, the Hill Type-1 employs a 5-inch mid-bass cone driver for the 100- to 700-Hz range, plus a 12-inch cone woofer in a large enclosure to cover the range from 100 Hz down to infrasonic frequencies. A large class-A amplifier (a direct-coupled vacuum-tube design) is included in the system to drive the plasma transducers, providing audio amplification for mid-range and treble frequencies plus the large sustained amounts of energy required to maintain the plasma discharge. The package also includes an electronic crossover, so that your present amplifier can be conveniently used to drive the dynamic woofers. The entire system for each channel is contained in a five-foot-tall enclosure, with the lavender plasma glow visible behind a protective grille.

Considerable space has been devoted to discussing the Plasmatronics speaker design because it is unique as an embodiment of a long-cherished ideal in speaker development. Now, perhaps, we shall find out how important the idea of the "massless," zero-inertia "diaphragm" really is as a goal and how close other more "practical" designs approach it in sonic quality.

## The Electrostatic Speaker

We leap from the newest exotic design to the oldest: the electrostatic

speaker. Conceived on paper a century ago and manufactured in commercial form fifty years ago, the electrostatics were at first unreliable. They were superseded by the rapidly improving electrodynamic speakers during the 1930's and disappeared from public view until they were revived by modern plastics technology in the 1950's. When a man named Peter Walker introduced the Quad electrostatic speaker system in England and Arthur Janszen developed the Janszen tweeter and the full-range KLH Nine in the U.S. in the mid-50's, they jointly set a standard for effortlessly natural reproduction and sonic detail which few other designs have equaled. (Note for trivia collectors: the name "Quad" is actually an acronym derived from the initials of an earlier Walker product, an integrated amplifier called the Quality Unit Amplifier—Domestic.)

Unlike the plasma speaker, the electrostatic does employ a diaphragm: a very thin plastic membrane suspended between perforated metal plates. A high-voltage d.c. charge is maintained between the diaphragm and the plates. As a rule, the audio signal is stepped up to a high voltage by means of a transformer and then applied to the plates, modulating an electrostatic force on the charged membrane in such a way as to cause it to vibrate and produce sound. The mass of the membrane is low, yielding excellent transient response. More important, the design does not rely on the stiffness and rigidity of a speaker cone to keep diaphragm motion under full control. The electrostatic drive force is exerted uniformly over the entire area of the membrane, so diaphragm flexing, cone breakup, and coloration owing to diaphragm resonance are brought to a *very* low level.

Left to right, the Hill Type-1 by Plasmatronics, Koss Model 1, and the Acoustat SXM monitor speaker. Size comparison should not be made from photos on these pages.

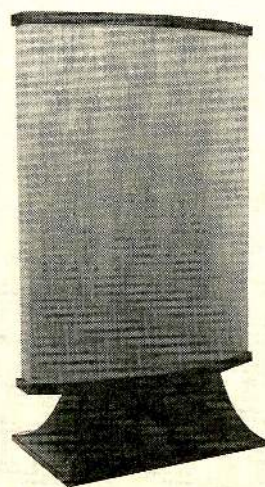
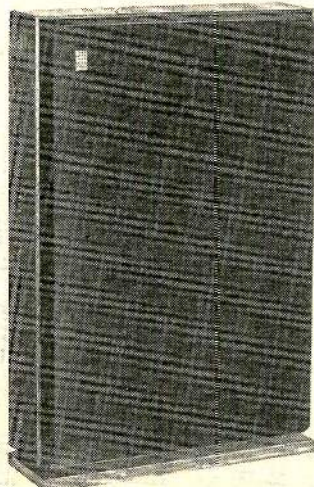
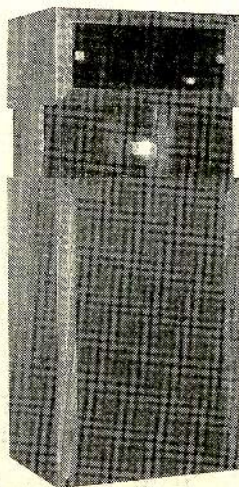



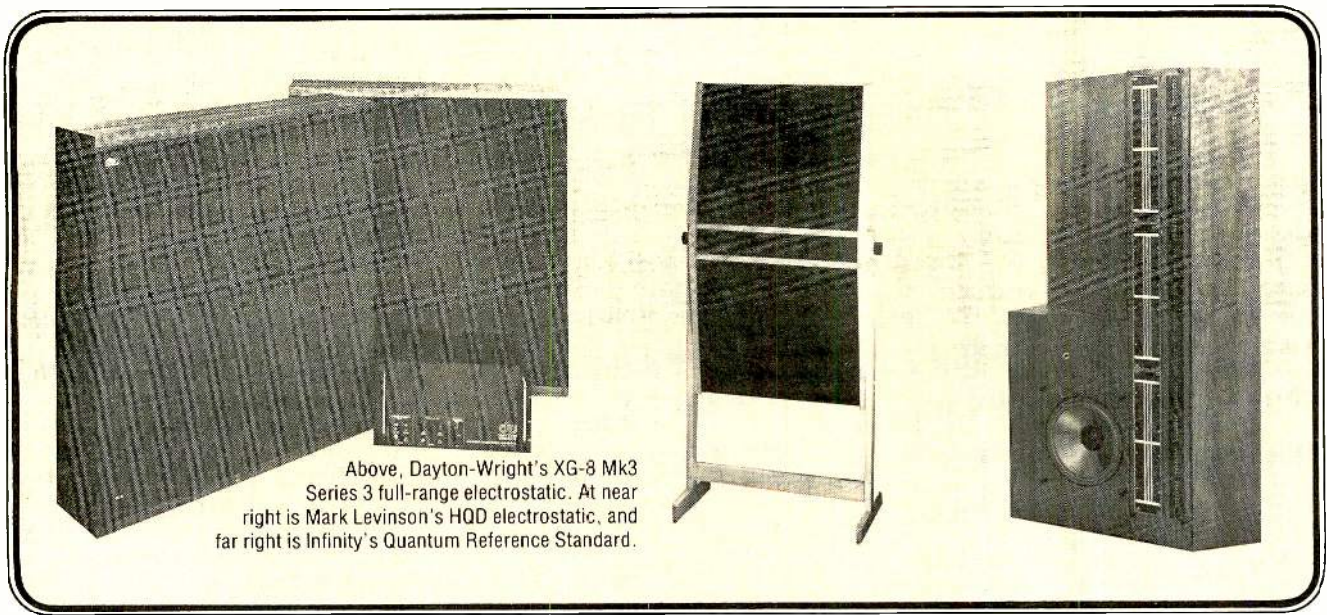

Above, Dayton-Wright's XG-8 Mk3 Series 3 full-range electrostatic. At near right is Mark Levinson's HQD electrostatic, and far right is Infinity's Quantum Reference Standard.

Of course the electrostatic design has limitations of its own. For reasonably good efficiency the membrane-to-plate separation must be kept small, but this limits the back-and-forth excursion available for the membrane movement. So, to achieve reasonably high loudness levels, the electrostatic speaker must be made physically large (the volume of sound obtained from any speaker depends on both the amount of motion of the diaphragm and its area), but the large size of the diaphragm makes its dispersion poor, especially at high frequencies. This is why there are two- and three-way electrostatic designs. The deep-bass output of the system, already curtailed by the limited membrane excursion, is further restricted by the mutual cancellation of the front and rear sound waves produced by the vibrating diaphragm, since electrostatic systems are customarily operated in free air rather than being enclosed in a box that would act to contain or isolate the rear wave and keep it from interfering with the front wave.

Fortunately, the large size of most electrostatic panels (as much as 3 feet wide by 5 to 6 feet tall) ensures that only frequencies below about 100 Hz will be attenuated by interference cancellation. Finally, the combination of the electrical capacitance of the panels with the inductance of a step-up transformer presents an unusual load impedance to the amplifier—very different from the essentially resistive load that most amplifiers are designed to drive. Results may range from reduced effective power output to increased distortion to outright amplifier failure unless

the amplifier is chosen with proper consideration for its intended application.

Each electrostatic system on the market represents a different composite approach to these considerations. The Koss Model One contains several interleaved bass panels in order to pack a large diaphragm area into a 4-foot-tall package. The \$2,200 Acoustat X (and its larger brother, the \$2,700 XSM) comes with its own amplifier built into the base of the speaker, a high-voltage amp with output tubes that drive the electrostatic panels directly without the intercession of a step-up transformer. The \$6,000-per-pair Beveridge Model 2SW is supplied with its own high-voltage amplifiers, an accessory control unit, and a pair of subwoofers to augment the deep-bass output.

The Beveridge 2SW also employs a unique method of controlling its stereo imaging: the formation of an acoustic "line source" with a cylindrical radiation pattern. For each channel a 6-foot-tall electrostatic panel is mounted within an equally tall cabinet with "waveguides" that taper together at the front of the box, terminating in a narrow vertical slot, running the full height of the speaker, through which all of the sound emerges. Thus the sound field produced by the speaker is laterally uniform over its 6-foot height, and all frequencies are propagated with the same very wide dispersion. Because of this broad, uniform sound spread, 2SW's have unusual stereo-imaging characteristics, and in most rooms they are said to work best when the two speakers of a stereo pair are mounted on opposite walls of the room facing each other.

Perhaps the most novel approach

taken to raise the loudness capability of an electrostatic speaker is that of Dayton-Wright in its XG-8. The driver elements are sealed in a plastic bag filled with sulfur hexafluoride, an inert gas having a higher breakdown voltage than air. This enables the membrane and plate voltage to be raised for increased efficiency and output without incurring as great a risk of electrical discharge across the air gap between membrane and plates. However, the system still requires a careful choice of driving amplifier.

The "ultimate" system, at least with respect to cost, is the Mark Levinson HQD assembly. Each channel consists of two Quad electrostatics mounted on a special stacking frame, augmented at the high-frequency end by a modified ribbon tweeter and at the low end by a 24-inch woofer. The array is triamplified using a three-way electronic crossover and three Levinson ML-2 power amplifiers per channel, for a total cost in the rather exclusive neighborhood of \$15,000.

## Planar Magnetics

A driver with many of the advantages of the electrostatic—but without some of its practical problems—is the idea behind the planar magnetic transducer. It combines the geometry of the electrostatic with the electrical behavior of the standard electrodynamic speaker. Like the electrostatic, it employs a thin, light-weight plastic membrane as a diaphragm, and this is suspended parallel to a metal screen or perforated metal plate. A uniform magnetic force field is established, either



by making the perforated plates of the screen magnetic or by mounting bar magnets on it, and an electrically conductive grid is affixed directly to the membrane. When audio-signal current from the amplifier flows through the wires on the membrane, the interactions of the fixed and varying magnetic fields create a push-pull force (similar to that on the voice coil of a conventional cone speaker) and the membrane vibrates. The essential similarities to the electrostatic design are that the membrane is low in mass, does not have to be stiff or rigid, and is subjected to a uniform driving force all over its area; thus minimizing any tendency toward flexing, "breakup," or resonance in the diaphragm. The planar magnetic should have nearly the same transient response and freedom from coloration as the electrostatic, without requiring a high-voltage supply and without presenting the hard-to-drive, complex load to the amplifier that electrostatics do.

One line of speakers employing this approach is the Magneplanar series, some models of which were formerly distributed by Audio Research but all of which now come directly from the manufacturer, Magnepan Inc. The top speaker in the series is the Tympani 1D, a free-standing panel 3 feet wide by 6 feet tall, costing \$1,400 per pair. As with some electrostatics, its dispersion is only moderately good and its stereo imaging is rather dependent on the placement and aiming of the large panels in the listening room. Since its woofer panels are free-standing rather than enclosed in a box, the sound is free of cabinet-caused colorations or resonances, but it is subject to the same front-to-rear low-bass cancellations as any open-back baffle. Nonetheless, many listeners find its bass output satisfactory without separate subwoofers. Smaller and lower-price models of the speaker are also available from Magnepan, with proportionately reduced bass output and maximum loudness capabilities.

Another approach to planar magnetic design is illustrated by Infinity's Quantum Reference Standard, a biamplified system retailing for \$6,500 per pair. Instead of using large, uniformly driven membranes, it employs groups of smaller separate modules, each of which operates individually on the same principle. Each QRS speaker stands 6 feet tall, 3 feet wide, and 2 feet deep. It contains twenty of the tweeter

modules, thirteen front-facing and seven rear-facing, arrayed in a vertical line over the full height of the speaker. Three mid-range planar magnetic modules are arrayed in another vertical line, and the system is supplied with an electronic crossover. Separate amplification is required for the woofer, a 15-inch cone in a large cabinet. The woofer has two voice coils in an arrangement (invented by William Watkins) that increases the power transfer from the amplifier to the woofer at frequencies close to the system's resonance. In view of the imposing size of the QRS and its large number of transducer elements, it is not surprising that the system is capable of spanning the entire audio-frequency range with considerable acoustic power. The planar

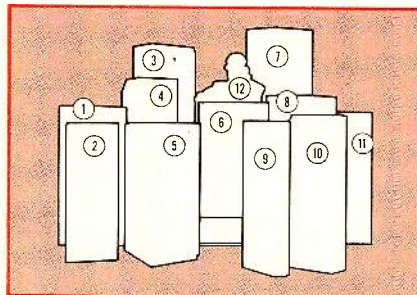

## THIS MONTH'S COVER

(1) Audioanalyst "Anthem Array" (height 44 inches); (2) Lafayette Criterion 3003 (39 inches); (3) Infinity "Quantum Line Source" (66 inches); (4) Acoustic Research AR9 (52¾ inches); (5) ESS amt Monitor (39¼ inches); (6) Marantz Model 940 (45¾ inches); (7) Beveridge "Cylindrical Sound System" (78 inches); (8) RTR Model 600 D (48 inches); (9) Allison Model Three (40 inches); (10) Dynaco Model 80 (42½ inches); (11) Design Acoustics D-8 (44 inches); (12) Contributing Editor Charles Rodrigues (height 62 inches) has shared his cartoonist's view of the hi-fi world with STEREO REVIEW readers since our first issue in February 1958. His work appears in this issue on page 67 and elsewhere.

magnetic tweeter, which has smooth and peak-free response extending into the ultrasonic range, is also used in some of Infinity's lower-price loudspeakers; it is identified as the EMIT (ElectroMagnetic Induction Tweeter). A similar tweeter module is used in some speakers made by KLH (Infinity's corporate sister company), where it is identified as the DvR tweeter after designer Daniel von Recklinghausen. And England's Rank Hi Fi group uses its own version in a number of systems available here as imports.

Just as the electrostatic design has been applied to headphones as well as loudspeakers, so too has the planar magnetic approach—in headphones by Yamaha and Burwen Research. Finally, although it is not a magnetic device in any sense, there is a planar driver manufactured exclusively by Pioneer: the high-polymer-film transducer. This involves a synthetic plastic material which has the fortuitous property of changing dimensionally when an electrical voltage is applied to it. What Pioneer does is fashion a thin rectangular film of the material and then gather it into a cylinder. With the application of a varying audio voltage, the rectangle increases and diminishes in size, and these dimensional changes in effect create a pulsating cylindrical sound source. The high-polymer (HP) driver presents no particular load complexities to the amplifier, and it has excellent lateral dispersion characteristics. So far, however, it has found application only as a tweeter in some of Pioneer's otherwise conventional multi-way speaker systems and (in a slightly different configuration) in a line of the same company's headphones.

## Heil Air-motion Transformer

Take a planar magnetic diaphragm (a thin plastic membrane with a conductive laminated "voice-coil" grid) and, instead of using the diaphragm in flat form, fold it accordion-fashion into many small pleats. Then, when the pleated diaphragm is mounted in a uniform high-intensity magnetic field and audio-signal currents flow through the conductor on the diaphragm, the magnetic forces which normally make the diaphragm move back and forth will cause the pleats to expand and contract instead. This is the principle of the Heil air-motion transformer (AMT). If the pleats are deep, when adjacent folds squeeze together the air between them is expelled in a rush, and when the folds pull apart a partial vacuum is created in the increased volume and air rushes in to fill the void. Thus the velocity of the air as it is being alternately squeezed out of the folds and sucked back in can be made to be substantially greater than the velocity of the material of the folds themselves in their squeeze-and-open motion. This principle was discovered in its speaker application by Dr. Oskar Heil, the seventy-year-old German/American physicist who has licensed his invention to ESS. Since the level of the resulting sound is proportional to the velocity of the air, this is a rather efficient device capable of producing high acoustic out-



put with only moderate amplifier power.

The Heil AMT was introduced as a tweeter module married to conventional woofers in various ESS loudspeaker systems. But many audiophiles, impressed by the AMT's clarity, precise transient response, and high efficiency, have been eagerly awaiting the arrival of an AMT woofer with the same virtues. However, when ESS recently introduced its new Heil Transar/ATD full-range system (\$3,250 per pair, including an amplifier for the woofer and an electronic crossover), it turned out that the Transar woofer does not operate as an air-motion transformer.

Of course it was clear at the outset that a Heil AMT woofer could not simply be an enlarged version of the tweeter. The tweeter employs a large magnet assembly around the diaphragm area, shaped to focus a uniform magnetic field onto the diaphragm. A scaled-up woofer version would have involved an impossibly large and costly magnet assembly, so another design approach had to be taken. A prototype Heil AMT woofer was indeed developed, but a flaw was discovered: a cavity resonance occurred within the woofer system that affected the sound at frequencies above the intended operating range of the driver. In the AMT tweeter a similar resonance falls above the audible range and is therefore unimportant, but in an AMT woofer it would fall in the mid-range, where the ear is most sensitive to such "coloration." So ESS had to move in a direction that would eliminate the cavity resonance (and at the same time reduce the efficiency which an AMT woofer might have had) while preserving as many as possible of the AMT's other essential virtues: very low moving mass and a drive force distributed over all diaphragm surfaces, with resulting freedom from audible resonances.

The Transar/ATD woofer consists of a vertical column of five 4-inch plastic diaphragms (whose total area is comparable to that of a conventional 12-inch woofer), all facing upward and connected together by a system of carbon-fiber drive rods so that the five surfaces move up and down together precisely in phase. A voice-coil/magnet assembly at the bottom of the column drives the five diaphragms up and down by pushing on the tie rods. Between successive diaphragms in the column there are reflector plates mounted at 45-degree angles which serve simply as sonic reflectors; the air vibrates at the same velocity as the diaphragms.

The selection of Lexan plastic for the diaphragms, their unusual construction (it involves using bubbles to stiffen them), and the selection of car-

bon fiber for the drive rods are all steps aimed at ensuring that the natural resonances of these materials will fall well outside the operating frequency range of the woofer so as not to color its sound. The Lexan diaphragms are only a few thousandths of an inch thick, which means that mass is extremely low, and the use of several small diaphragms rather than one large one ensures that no portion of a diaphragm is very far from the point where the driving force is being applied to make it vibrate. Indeed, every portion of each diaphragm is within about one inch of a drive rod, ensuring that "cone break-up" (causing some portions of a diaphragm to vibrate out of phase with the rest) cannot occur. Finally, the entire woofer system is vibrating in free air (it is not enclosed in a cabinet), thus eliminating yet another source of possible resonances.

This design yields manifestly clear and non-resonant sound, but at a price: like any other woofer operating in free air instead of in an enclosure, the Transar's woofer is subject to bass cancellation when its front and rear waves meet in the air. The ESS Transar/ATD includes a wooden frame around the woofer column (50 inches high, 40 inches wide, and 6 inches deep) in order to ensure that cancellation occurs only at very low frequencies. In addition, the amplifier supplied for the woofer provides bass equalization.

**L**IKE the Transar woofer, Ohm's Walsh driver employs a more or less conventional voice-coil assembly, but it drives a single full-range cone of radically different design. Made of several different materials with compliances,

masses, and damping carefully distributed, the single-cone system is inherently free of the problems of electrical crossovers since it has none. The operating principle of the Walsh driver—which is fairly low in efficiency—may be thought of as a transmission line or simply as a cone with precisely controlled break-up modes. In any case, the design is capable of superb and near-omnidirectional response.

## Last Words

One of the oldest, tiredest truths about loudspeakers is that every design represents a compromise among conflicting goals and possibilities. This survey of some of the more exotic of them suggests that the old dictum remains valid even when the designer has the freedom to explore the most advanced technology without regard to cost. In short, the magic ingredients for making a perfect loudspeaker are not yet known. And even if they were available and cheap, we might not all agree on what a "perfect" loudspeaker *should* sound like. Making a buying decision among today's designs, whether at the \$100 or the \$3,000 price level, involves far more than researching design principles. It also involves making choices among the performance qualities that are most important to you. If you are lucky, you will find a speaker whose designer wanted pretty much what you do. □

Peter W. Mitchell, who has been active in hi-fi journalism for some years, is also president of Mystic Valley Audio, which provides technical consulting and writing services.

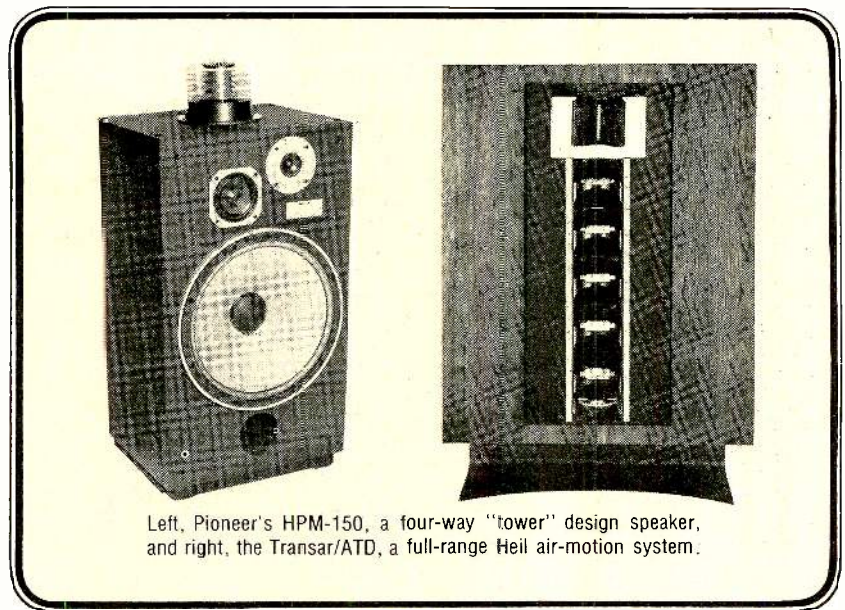

Left, Pioneer's HPM-150, a four-way "tower" design speaker, and right, the Transar/ATD, a full-range Heil air-motion system.





All photos by Fepe Diniz



---

# Patti Smith

If you met her for the first time at a dinner party, would she be the kind of person you would want to strangle halfway through the fruit cup?

---

**P**ATTI SMITH has a talent for polarizing the populace, and while the "either you love her or you hate her" cliché is an old and noble rock tradition (consider the initial public reactions to the Stones and David Bowie), I have rarely seen it so clearly applied. If you've ever heard her in concert, you'll know that she has some of the most loyal fans in Christendom, but most of the people I know think she's the most obnoxious bitch on feet.

This extends to her pop-star peers as well. Mick Jagger savaged her in an interview recently (the unkindest cut of all, given Patti's worship of the Stones), Flo and Eddie do a joke about her in their act (it suggests that she uses Industrial Strength Janitor in a Drum as a feminine-hygiene spray), and the usually amiable Southside Johnny was overheard to bellow "She tries *TOO HARD!!!*" at one of *STEREO REVIEW*'s record-awards parties the minute he caught sight of her. So what is a basically nice working-class chick (her own phrase) to make of such unwarranted abuse?

In an attempt to come to grips with that and other issues, I chatted with Patti recently. Just back from a successful European tour and only days away from the beginning of an American one, with a comeback album (she was laid up for over a year due to an injury) and a single doing surprisingly well, she was apparently disposed to confront Dat Ole Debbil Media again: though not to repay the insults listed above in kind. "For someone like me," she observed, "who's come out for solidarity, that would be suicidal." Still, though we talked at length about Art, Religion, her place in history, and the Meaning of Life (not to mention rock-and-roll), and despite the fact that I think I like her, as a fan, even more now that we've talked (that has not always been the case in my experience as an interviewer), I came away with the crucial question not quite answered: If

you met her for the first time at a dinner party, would she be the kind of person you would want to strangle halfway through the fruit cup?

My answer is *probably* no, but then I think you've already gathered that I'm prejudiced in Patti's favor. However, I ought to tell you a few things up front that may give you a glimmer of insight into my conversation with the Wild Mustang of American Rock. First of all, she has an unswerving faith in the validity of the work she is doing; only a supremely confident artist could continue to maintain, as she does, that everybody's least favorite Patti Smith song, *Radio Ethiopia*, represents her finest achievement to date in any medium. Second, she takes herself pretty seriously; on stage she can be hilariously self-effacing, but in an interview situation, at least, she's about as humorless as she is on her records. Third, in many ways she's a throwback, a true child of the Sixties. She talked at such length about "enlightened consciousness" and made so many references to things like "joyous struggle" that I think if I hadn't known who she was I might have mistaken her for a refugee from some California religious cult whose members sit around wearing bed sheets after changing their names to things like Baba Rum Raisin. Finally (and, I think, most tellingly), for all the seemingly anarchic quality of her act on stage *and* off, she is a thoroughgoing pro in the most traditional show-biz sense: she knows exactly how to present herself at all times. The photographer who accompanied me on this journey into the Ozone was not able to get a single spontaneous pose out of her; the minute she saw his hands move anywhere near his camera, she immediately "became" Patti Smith and stared the lens down.

*To break the ice, I began our conversation by asking about her experience on the Stanley Siegel Show a few weeks earlier. (Siegel hosts a New York talk show, and once a week, on camera, he gets on the couch to unload on his psychiatrist. The morning Patti was his guest, he spent most of the time trying to figure out why she scared him.)*

Patti grinned. "Well, I like a little subversive action on our television sets. I don't mean token, sick violence like Linda Blair getting a plunger stuck up her butt; I don't know if you saw *that*. I mean there's violence on TV but there's not much *consciousness-raising* stuff."

*Consciousness-raising stuff?*

"Well, yeah. He let me read my poems, and if my amp hadn't blown up I could have played my guitar. I was given a lot of freedom on that show. Everybody said to me, 'Uh-oh, the guy's really nasty,' but I didn't think so." She flashed me her little ain't-I-a-devil smile, which she continued to do throughout our chat at the most unlikely moments.

"Of course, I can out-nasty just about anybody. I think that what happened, though, was that he had met his match in one respect. I understand his game. Which is not a bad game. He's not an unidealistic guy, his idealism just comes out in a different way."

*Then you didn't feel at all exploited, held up for freak value?*

"Nah. If I felt exploited at all, it was on the *Today* show. I don't like people introducing me like they did, as outlandish and crazy. 'Cause it sets me up, y'know, like I'm a rat. They back me up against a wall, and I'm not really a hard person to get along with.

"By the same token, there's not much difference between being introduced as a crazy on the *Today* show and the rock press calling me 'the

---

By Steve Simels



# Patti Smith...

Queen of Punk.' I mean, people much younger than Siegel, people who are supposed to be much more in tune, have less understanding sometimes."

*But couldn't that be your fault in some small way? You've been known to be a little . . . er . . . obscure.*

She bristled. "No way. I've done nothing but try to communicate as directly and honestly and high as I could. Of course, no matter what you say, people always opt for their own idea of you. I mean, why does a sportswriter from Manchester, England, say to me after I talk to him 'But you're not anything like I read about you'?"

"I'm constantly being portrayed in one skin, in one guise, whereas I'm impossible to pin down. I'm not a *defensive* chameleon, I'm just one who changes from moment to moment. But critics have this great Aristotelian point of view, they want to classify everything. Fans don't do that kind of stuff. Kids—and I call them kids because it's the most affectionate term I can imagine—seem to grab the concept of what I do on a much more universal level than most critics."

*This lack of appreciation for the almost obsessive support Patti has received from the critics rather surprised me. Come on, you're the critics' darling, I chided.*

She stared at me fixedly. "I don't know what press you've been reading. Really, most rock criticism is frustrated gossip and bullshit. Very few critics understand what we're doing, whether they praise us or put us down. They don't ever really explore the content of our work, or what our motivations are as a rock-and-roll band."

"I think that the high level of introspection and loyalty and belief that rock critics had in the Sixties really doesn't exist right now. People's motivations for writing have shifted. I mean, when I do criticism, when I write, whether it's about the Stones, or David Bowie, or Television, or Bob Marley, whoever I believe in, I try to explore all the subliminal territory I can, I try to translate all their most positive strong energies into whatever language I'm dealing with, and offer this to the people. I mean, I'm not overly sensitive, but the things that critics dwell on now have nothing to do with the core of my work."

*Well, some people have difficulty reconciling your highly self-conscious notions of Art with the idea of rock-and-roll.*

"Look, I do everything with the same fervor, with the same intensity, whether it's writing a poem, doing a drawing, or playing electric guitar. Personally, I feel that playing electric guitar is the heaviest thing that I can do; it's the most exploratory, it's the most daring, the most risky. And I don't feel that's opposed to Art. My definition of Art is much more advanced, I think, more futuristic than most critics'."



**"... most rock criticism is frustrated gossip and bullshit. Very few critics understand what we're doing, whether they praise us or put us down."**

"I mean, I said in *Babel* [her recently published book of verse] that in another decade rock-and-roll would be Art. But when I say a decade, I mean for other people. For me, since 1954 or something, it has been Art. Since Little Richard, Elvis Presley, Jimi Hendrix. I mean these guys are masters. And I'm an illuminated apprentice who seeks to go beyond my masters."

*But still, Little Richard or Hendrix didn't theorize about what they were doing. They just sort of did it, like folk musicians.*

Patti wouldn't buy it. "Being great is no accident. Little Richard wasn't an accidental phenomenon; he knew what he was after. He might not define it with intellectual terminology, but he was defined by what he did. I don't think Jackson Pollack wrote a manifesto first and then did all his painting according to it."

"Now, as for what I'm trying to do

as an artist . . . well, the highest thing an artist goes for is communication with God. Which is universal communication. I've always spewed out my subconscious through improvising poetry, language. Now my language is being extended into sound, which I find much more universally communicative. People respond to it. I mean, what makes opera communicative? When I was a child, I loved opera, loved Puccini. I'd sit there and I'd cry. I didn't understand what it was about, I didn't understand Italian, obviously, but the sound, the concentration and perfection of that sound, would just take me soaring."

She seemed to enjoy the memory. "Y'know, I actually did opera when I was young. I played young tenor gypsy boys in some Verdi. As a matter of fact, had I lived at a different time and in a different place, had I lived in Italy, I'd probably be in opera right now. Being an American in the Fifties, though, trying to pursue opera in South Jersey . . . whew. Nobody was gonna buy that."

*Strange mental pictures of Patti as Gilda in Rigoletto danced before my eyes, but I decided to get back to rock-and-roll. How long had she been playing the guitar, pursuing her apprentice explorations? Somehow I couldn't see her as a Joan Baez-style folkie.*

"It was subsequent to getting the band together, really, although Sam Shepard [the playwright] gave me an old black Gibson in 1970. See, I have no desire to be Eric Clapton and play like that. That's really great, but there's this streak in me—I have no discipline. I never learned grammar either, I'm a very intuitive creator. What I'm doing now with the guitar is . . . I have the footage of Hendrix from *Monterey Pop*. I watch that a lot. And I practice the guitar to [the music of Alan] Hovhanness. He's about my favorite guy; he inspired a lot of *Radio Ethiopia*."

"I have my own way of pursuing things, of focusing my anarchistic spirit into form. It's the long way around, I guess, but I do it. Of course, I must say that I don't opt for beauty."

*True enough. Patti will never get played on MOR stations, although I have heard a story about her having done a night of Cole Porter songs at Reno Sweeney, one of New York's cabarets.*

"Yeah, sure, I can do that stuff. My mother raised me on all those white jazz singers like June Christie and Chris Connor. In fact, I'd go on Mike Douglas and sing *My Funny Valentine*, which is one of my favorite songs. I'll



attempt anything. But that's what I meant before. People just don't understand. If I went on Douglas and did that, there would be people thinking I'd sold out, without ever realizing that maybe I just want to sing *My Funny Valentine*, just want that chance. I ain't any one particular way."

She was warming up for the bombshell now. "Y'know, the same girl that takes Jimi Hendrix as a master has learned a lot from Debby Boone this year."

*What!? Debby Boone, the Baroness of Bland? Say it ain't so, Patti.*

"I really mean it. I've watched Debby Boone sing *You Light Up My Life* maybe fifteen, twenty times. Each time . . . perfect. Each time with total, focused, concentrated commitment to delivering that song. Which I think is real good.

"Now I ain't a Debby Boone fan, specifically, and I ain't gonna start wearing chiffon tent dresses tomorrow. But I did learn something by watching that. Especially considering the fact that I'm about to have a hit single. I've got to be able to deliver that song [*Because the Night*] with all the strength and integrity and all the clarity that I was able to deliver it with in the studio. And if Debby Boone can do it, I certainly can do it."

*Of course, Debby Boone doesn't take the chances you take on stage. You'd hardly describe her performances as "on the edge."*

Patti paused thoughtfully for a second. "See, I feel I have a double responsibility on stage. For me, what I attempt is limitless. And I'm not afraid of failure. But I also understand that I have a certain obligation not to spend a night just communicating with myself. But that's the risk you take when you improvise. That's the risk you take when you take a risk.

"That's what I've been doing with my guitar. Some nights when I play—do you know that line of Hendrix's? 'Move over, rover, and let Jimi take over'? Well, some nights I feel like . . . 'Okay, Jimi, step aside.' And other nights I'm frozen 'cause I don't have the chops to fall back on, and if I lose my muse I'm naked.

"I have changed, though. I've learned to relax. When I first started performing, if it wasn't real every second, if it wasn't magic, I would get desperate. I didn't want to cheat anybody, that's my morality. I'm not moral in many ways, but I'm a very responsible person, y'know."

She eyed me warily, and then out of

the blue: "Well, aren't you gonna ask me about Springsteen now?"

*Ulp. Well, actually, Patti, you've been so ambivalent about him in the other interviews I've read, I thought it might be in bad taste. But, since you've mentioned it, how much of the success of your new album "Easter" do you think is attributable to your having written a song with Bruce?*

"I think the reason we got such heavy airplay this time was mostly on our own steam. There was a lot of curiosity about us, now that I'm out of traction and back in action. But the



**"I've learned to relax. When I first started performing, if it wasn't real every second, if it wasn't magic, I would get desperate."**

song is really good, y'know; Bruce gave me a structure that really fits the kind of singing I used to do when I was younger.

"Of course, I think that FM radio playing the single more than the album is pretty gutless. I think that it's taken a lot of guts and foresight for AM stations to play our single, because when you play something by my group, you're not just playing a piece of music that's abstract, but a whole political outlook. But FM . . . it's like they'll play the single so they don't have to deal with my saying "fuck," or "nigger." I was banned for a year and a half on WNEW [New York's big "progressive" FM station] because one night I came on and criticized them for being pseudo-liberal. Which is weird; it's like the biggest enemies of progression are our own people.

"I fought for FM radio as a kid in the Sixties; alternative radio was built by us. And now it's no longer alternative.

And unless we keep fighting, everything we fought for in the Sixties is gonna go down the drain."

*Well, one hopes not, but it is hard to understand the near total refusal of the FM stations to program anything remotely New Wave. Speaking of which, I ask in an attempt to inject some fan-mag-style frivolity, which of the newer bands are you listening to?*

"Well, I love the Clash, and I really love the Sex Pistols. I think Johnny Rotten's great, I have a real crush on him. See, all those kids were my friends before they had bands, so it's real gratifying to me to see them up there."

*But what about Graham Parker or Elvis Costello?*

"Well, I don't know too much about Graham Parker, but I don't like Elvis Costello. I don't hate him, but . . . I mean, as a politician I'm into solidarity, but as a fan I'm relentless, a real Nazi. You ask the fan in me and you're gonna get a pretty narrow view.

"Basically, if there isn't somebody I want to bleep in a band, I couldn't care less. Unless it's such great abstract music it carries me away. Otherwise, if it's a rock-and-roll band, there better be somebody bleepable or forget it."

*Although it may not satisfy Wilfrid Mellers, that struck me as being about the most honest assessment I'd ever heard of why people get involved with rock in the first place. And certainly she wasn't about to top it. So, since it was somewhat reminiscent of stuff she has written about the Stones, I asked her to wind things up with some thoughts about the lately much abused Mod Princes. It's significant, I think, that this produced what were probably her most sincere and heartfelt responses of the whole conversation.*

"Well," she answered after a pause, "I think we can be a big inspiration to them. Y'know, when I was playing in England for the first time, they were playing at Earls Court at the same time. I almost went broke, spending a fortune buying scalper's tickets for me and the band to go see them every night. I mean, I'd be late for our own show.

"But I don't expect anything from them except the work they've already done. I'd have to say, if there's any one thing that made me start a rock-and-roll band, it was the Rolling Stones. In certain ways, I'm where I am today because of how they inspired me. And since I'll be Patti Smith all my life, but a rock band is a one-time thing, what more could I ask from them than that?" □



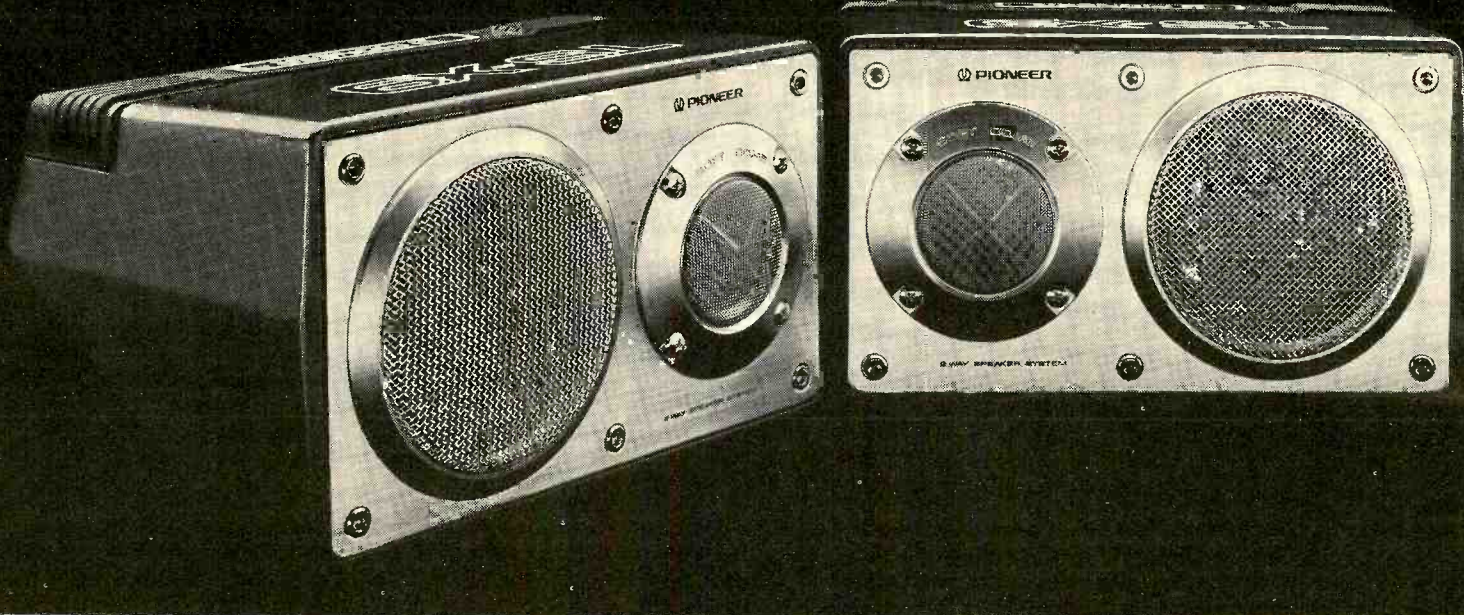

## IF YOU HAVE A TIN EAR, DON'T SPEND THE MONEY.

You're looking at the finest, high-performance, 2-way, acoustic-suspension speakers ever created for the automobile.

The TS-X9 speakers.

Each has a 3 $\frac{5}{8}$ " low-frequency cone and a 1" high-frequency dome radiator, with a built-in crossover network.

Each can handle 40 watts. More than a lot of home speakers we can think of.

Each delivers 50-22,000 Hz. More than almost *any* speakers we can think of.

And if you can appreciate sound this terrific, buy a pair of TS-X9's. Or our less-expensive TS-X6's.

But for those not blessed with the hearing of

a fox, we do have alternatives. We have some two-dozen different kinds of speakers for cars alone.

Pioneer is one of the most respected audio manufacturers in the world. With superb design, engineering, and manufacturing. And we apply this know-how to every single speaker we make, regardless of price.

So, no matter what kind of ear or money you have, do see your Pioneer dealer. Do ask him to demonstrate the other leading brand first, and then

Pioneer.

Believe us, you *will* hear a difference.

Even if your ears are full of oatmeal.



## CAR SPEAKERS BY PIONEER.

Pioneer Electronics of America, 1925 E. Dominguez St., Long Beach, CA 90810.



---

# LOUDSPEAKER FORUM

A panel of engineers wrestles with some still unresolved  
(and therefore controversial) design problems

---

**N**OT long ago, Len Feldman, technical director of the Institute of High Fidelity, placed a fatherly hand on my shoulder and asked whether I would care to take on the chairmanship of the about-to-be-formed IHF Loudspeaker Standards Committee. I looked him straight in the eye and replied unhesitatingly, "Len, I would rather die!"

It seemed to me that anyone would have to be exceptionally brave—or foolish—to take on the chairmanship of a committee set up to establish standards for measuring loudspeakers when their manufacturers can't even agree on how to specify the diameter of a woofer cone. And that is why I gracefully declined the opportunity to win world-wide fame—and a probable stomach ulcer.

Exactly what *is* the problem? There are several: first of all, the designers are far from being in full agreement as to exactly what a speaker has to do in order to provide maximum fidelity. (Most manufacturers, for example, have a particular favorite distortion that their design is meant to eliminate.) And even among those who agree on what a speaker *should* do, there's little agreement about the best way of measuring how well it is *doing* it. The cause of disagreement is the fact that a speaker system is a *transducer*—meaning that its audio-signal input is in electrical form, while its audio-signal output is in acoustic form. The electrical input signal is applied across two terminals and is easily defined and measured. In contrast, the acoustical output signal exists in three dimensions, is substantially affected by its environ-

ment, and is extremely difficult to measure in such a way that the numbers, curves, and graphs consistently correspond with what the ear hears. To confuse the matter even further, speaker-system engineers and psychoacousticians are seldom in agreement as to precisely what the ear can and can't hear under various conditions. (The phase-linearity question is a good example of such a psychoacoustic—rather than electroacoustic—dispute.)

And if you add to all the above the fact that commercial considerations (otherwise known as the Need to Sell the Product) frequently dictate the choice or promotion of a specific design quite apart from its *technical* virtues, it is small wonder that controversies persist and flourish in hi-fi speakerland.

The questions that follow were sent to almost two dozen speaker engineer/manufacturers for their answers. Our intention was to elicit a cross section of viewpoints rather than to include every known manufacturer of loudspeakers—an impossible task anyway, considering that there are now at least 250 loudspeaker brand names in the marketplace. We apologize to those manufacturers we have omitted who may have liked to contribute to the discussion, and remind them that the door to our letters column is always open. We thank those manufacturers whose views we present below and hope we have not accidentally misrepresented them on one point or another. And finally, we trust that they and our readers will find what follows as interesting to read as it was to put together.

—Larry Klein

---

## ● How important is phase alignment in loudspeakers? How successful are the various phase-corrected or linear-phase designs?

On the face of it, it seems like a good idea to require a speaker system, in its propagation of complex sound waves, to preserve the phase relationships among the signals of various frequencies found in the original program material. (Everyone agrees that phase relationships among a speaker sys-

tem's drivers that are *reproducing the same frequencies*—usually in the crossover regions—are important, since clearly audible frequency-response aberrations can result from designs that are inadequate in this regard.) But, as might be expected considering the variety of designs in the marketplace, this question produced substantial disagreement among the participants in this informal loudspeaker forum.

Among the supporters of linear-phase designs, we have Audioanalyst: "Good imaging and transient response are impossible

unless a system is phase-correct." B & O: "Accurate impulse response (but not necessarily tone-burst response) is important for transient reproduction, and phase response is therefore important." JBL: "Phase effects or, more properly, group-delay characteristics are very important." Technics: "Linear-phase speaker systems have a distinct advantage in respect to sound localization and depth of imaging." Wharfedale: "Phase coherence within a system is important for transient performance and firmness of the stereo image." Wharfedale goes on to



# SPEAKER FORUM

make some points also made by virtually all the other supporters (and several nonsupporters) of phase coherence: (1) not all the speakers that claim to be fully phase corrected are, (2) some designs have made improper tradeoffs by sacrificing other areas of performance for phase linearity, and (3) many achieve phase coherence only directly on axis, which is *not* where most listening takes place. Koss and Wharfedale share a position on phase coherence expressed in a neatly turned phrase by Wharfedale: "One should remember that phase coherence is intended to embroider a silk purse rather than enhance a sow's ear."

Among the moderates on the phase question are Design Acoustics, who are willing to concede that phase effects might be audible *if* they are listened for on extremely short pulses (which do not occur in music), in a very dead acoustic environment, and if the phase disturbance is very gross. Marantz also states that linear phase is a desirable goal "when it can be accomplished without degrading any other characteristic." And Infinity finds that "the audibility of phase anomalies depends very much on the nature of the program material and particularly on whether it is itself free of such anomalies."

The anti-phase-coherence contingent, which includes the remainder of our respondents, provides comments that range from the scholarly to the cynical. Robert Berkovitz, AR's director of research, did considerable research on the phase question—which essentially involves psychoacoustic, *not* acoustic or electrical investigation. Berkovitz's findings, confirmed by several other research projects, were that the "normal" time delays in a conventional well-designed speaker system are much smaller than the human ear could detect on musical signals. Jensen states that although time-domain shifts of 5 milliseconds or so can have an adverse effect on stereo imaging, a standard flat-baffle speaker system can be designed with shifts under 2 milliseconds—changes that are too small to be generally audible in a conventional listening room.

Marantz points out that many authorities state that time delays of 2 to 8 milliseconds are inaudible and that these delays correspond to a path-length difference of 1.9 to 7.2 feet—far in excess of delays introduced by conventional speakers. Klipsch reflects a general viewpoint in stating that "those phase-corrected designs that are successful are so simply because good drivers are used over appropriate frequency ranges with a good crossover network."

For two slightly cynical closing comments on the subject we turn to Advent, where it is suspected that the brouhaha over phase "resulted mostly from the recent availability of equipment that could measure it," and to E-V, where it is believed that "seeing a speaker accurately reproduce a square wave on an oscilloscope will undoubtedly make it sound better to some listeners."

## ● Is there any advantage to a three-way system over a two-way? Or a four-way over a three-way?

Given the variety of designs in the marketplace, one might imagine that this question would stir up a hornet's nest of controversy. Not so. Infinity provides a concise statement of the situation which many of the other manufacturers are in agreement with:

"From a theoretical point of view, the physical size of the drivers governs two mutually conflicting parameters. The larger the driver, the more low-frequency power can be radiated, other things being equal. The smaller the driver, the higher the frequency at which it begins to become directional. A large woofer will enable more power to be radiated at low frequencies, but will start to become directional at a relatively low frequency (say 600 Hz for a 12-inch woofer). At the other end of the scale, a tweeter small enough to achieve good dispersion up to the highest audible frequencies will generally not handle sufficient power down to below

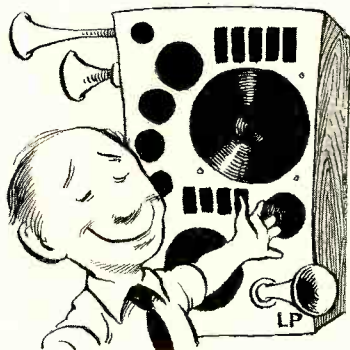

*The largest group of component buyers thinks that bigger—and more—is better*

about 2,000 Hz. Thus, with a 12-inch woofer, for example, a three-way system becomes inevitable unless either low-frequency power-handling ability or dispersion is sacrificed."

Marantz adds that a loudspeaker system should measure equally well on and off axis. When small woofers are used, a two-way system will suffice. When greater low-frequency bandwidth and acoustic output are desired, larger speakers are needed, and they require more drivers to cover the audio band and maintain a constant radiated acoustic-power output.

Altec and several others discuss the problems that must be dealt with in multiple-crossover systems. Technics makes the point that the frequency response around the crossover region becomes very rough.

And Bose explains that designers have to take special pains to match the amplitude and phase response of the drivers through the crossover region so that the total energy radiated remains constant. This relates to the question of exactly where in the frequency range the crossover takes place. Design Acoustics feels that the main advantage of a three-way speaker is that the "very important mid-range octaves do not have to cope with crossover problems." B & O concurs, adding that the use of a "higher number of 'ways' allows crossover frequencies to be kept away from critical areas" while agreeing with JBL that it is easy to reach a point of diminishing returns. The only disagreement among our respondents is whether that point is reached with a three-way (Audioanalyst, Wharfedale) or a four-way system (Jensen, JBL).

Allison feels that there are potential advantages in a three-way over a two-way design and believes that the three-way is now the best choice, though he "would not argue vigorously with a designer who thought he could do a little better by going to a four-way system." ADS relates the number of crossovers required directly to system size. The small boxes do very well as two-way systems. And, for good technical reasons, as box size goes up a three-way system becomes desirable. When a sub-woofer system is employed, a four-way system with the lowest crossover between 100 and 150 Hz seems to compensate for room-interference effects better than comparable three-way designs. Celestion also feels that the acoustic advantages can be argued either way. Infinity makes a strong point that there is no necessary *direct* correlation between the number of drivers in a system and its fidelity. From the point of view of fidelity alone, ignoring for the moment questions of power-handling capability, there are many two-way systems that are considerably more satisfactory in overall performance than many three-way and four-way systems. The consumer is therefore best advised to ignore the number of drivers in a system. E-V makes the same point, stating that it is unfortunate that "the largest group of component buyers thinks that bigger—and more—is better."

## ● What are the advantages—or disadvantages—of the electronic-crossover, biamplified speaker systems?

ADS neatly describes the technical differences between the conventional and the biamplified approach: "In conventional operation, the entire spectrum of audio frequencies is amplified by a single stereo amplifier. A passive crossover in the speaker, consisting of inductors, capacitors, and resistors, separates the audio signal into low-, middle-, and high-frequency portions to drive the woofer, mid-range, and tweeter, respectively.

"In a biamplified system the signal from the preamp goes first to an electronic crossover whose active electronic filters split the signal into low-frequency and upper-frequency portions. These go to separate power amplifiers which amplify the low and mid-high bands independently; the output signals



are then fed directly to the woofer and to the mid-range/tweeter combination."

Usually a lower-power unit serves the high-end drivers, and the tweeters (like the woofers) are connected *directly* to the speaker terminals of their respective amplifiers, eliminating the passive crossover network installed inside the speaker system and any loss of fidelity it may cause.

Most of the responding manufacturers answered our question by providing a concise listing of advantages and disadvantages as they saw them. Altec, ADS, Jensen, and Yamaha spell out the major advantage of biamping: any distortions (such as clipping or IM) that might occur in the high- or low-frequency amplifier are simply not reproduced by the amplifier and speaker handling the other end of the audible spectrum. E-V and Celestion concur, and add that there is also improved control of speaker motion by the amplifier because the intervening large crossover inductors (mostly found between woofer voice coil and amplifier) have been eliminated.

JBL and Technics point out that, for equivalent results, less total power is required from the two amplifiers than from a single large one. Wharfedale adds that having electronics dedicated to a particular driver or frequency range makes it easy to "incorporate trickery" such as anti-Doppler circuits, motional feedback, and so forth. Design Acoustics agrees, and Bose states that electronic crossovers simplify the problem of achieving proper phase and amplitude characteristics.

It would seem that biamping has strong general support—except that many of those manufacturers who pointed out the *theoretical* advantages also feel that biamping doesn't buy the listener much, if anything, from a practical standpoint. Both Allison and Bose make the point that the claimed advantage of lower distortion through biamping has "disappeared" with today's clean, powerful amplifiers. Other manufacturers have equally negative views: "Severely subject to the law of diminishing returns" (B & O); "An expensive way of chasing vanishingly small advantages" (Burhoe); "Virtually no audible benefit" (Wharfedale). Yamaha points out that the use of an electronic crossover does nothing to solve the problem of selecting the optimum crossover point. Klipsch argues the possibility of special technical problems. JBL expands on that point by stating that setup is left entirely in the consumer's hands and that most manufacturers do not provide adequate information as to how their system may be properly biamped/triamped. AR reinforces JBL's view, stating that "sophisticated measurement techniques are required to design *any* loudspeaker system adequately, and adding electronic crossovers in the home *is* designing a system." Several other manufacturers agree. Altec points out that an electronic-crossover design requires a fairly high level of knowledge to make it sound right. Advent, like a few other manufacturers of speakers with the biampification *built in*, feels that such an approach represents "the kind of component integration that makes total sense and affords maximum benefit—and there should be more of it."

## ● What is your view on wide-dispersion as opposed to limited-dispersion speaker systems?

Before the advent of phase linearity, this topic was the major subject of debate among speaker designers and advanced audiophiles. Unlike the matter of phase, which ultimately comes down to the psychoacoustic question of what the human ear can or can't hear, the dispersion question involves not only psychoacoustic but aesthetic judgments. Even those engineers who feel that phase linearity in speakers does little or nothing to enhance the listening experience usually have no objection to its inclusion if no problems are engendered in other areas. When it comes to dispersion, however, you'll find engineers with strong views on every conceivable side of the issue.

Although none of the respondents says it straight out, the question of dispersion or radiation pattern deals essentially with how *soon* and how *much* of the speaker's sound will reach (and be reflected from) the walls, ceiling, and floor of the room. A forward-



*What is pleasing to many people, however, is not necessarily accurate reproduction*

facing, narrow-dispersion speaker is going to produce fewer and later room reflections; an omnidirectional speaker will produce more and earlier room reflections. In either case, what subjective effects do these room reflections produce? When things are working right, they add warmth, depth, dimension, airiness, and a sense of reality to the sound. When problems occur, the sonic images of the performers wander or are blurred and imprecise, frequency response is irregular, and perceived tonal balance changes with listening location.

Today, most designers appear to seek a compromise between the extremes of omnidirectional and narrow dispersion. Most engineers (B & O, JBL, Altec, Allison, E-V, Jensen, Marantz, and AR) also make the specific point that uniform horizontal dis-

persion throughout the audible frequency range is vital to good performance, and some maintain that *uniformity* of dispersion is actually much more important than very *wide* dispersion.

A number of other interesting points are made. Altec states succinctly that narrow-dispersion speakers tend to make location of the listener critical, while omni- or rear-radiating speakers tend to make location of the speaker systems critical. JBL states that the company's point of view has changed in recent years from "a preference for narrow dispersion (from our heritage in the recording and motion-picture industries) to a fairly broad dispersion."

Allison believes that a speaker system should behave as much as possible like a point source (that is, it should radiate uniformly in every direction, vertically as well as horizontally). At the same time, the drivers should be very close to one or more room surfaces so that there will be virtual coincidence between the speaker's direct output and its reflections from these room surfaces.

AR feels that "rear-radiating systems are not so much wide-dispersion systems as they are scattered-dispersion systems, relying on reflected sound from all the room surfaces to give a certain effect. These systems do not in the true sense give an accurate reproduction of the 'sound stage' on a recording, but do give a 'room-of-sound' effect that is pleasing to many people. What is pleasing to many people, however, is not necessarily accurate reproduction. For the loudspeaker to act purely as a transducer, room effects should be minimized and recordings made to contain the necessary ambience themselves."

Technics more or less straddles the various issues. "We cannot say which is better, because it depends on the listener's purpose, the acoustics of the listening room, recording methods, and so forth. Generally speaking, a very wide-dispersion system does a good job of reproducing the 'atmosphere' of the orchestra, but it is not suitable for reproduction of close-miked recordings—which includes most recent issues."

Koss has a somewhat similar view, observing that "it all hinges on the user's expectations" whether he wants a sharply focused, localized sound provided by narrow-dispersion systems or the large, open, airy quality of wide-dispersion systems. Koss goes on to say that "there is no right or wrong; only the listener can determine how much room effect he wants to hear, and the wide-dispersion systems will quite naturally tend to sound more variable in variable room conditions."

Bose's position is that "in live listening situations, sound never comes from 'points' but always from moderately large areas. The basic idea behind a 'controlled-dispersion' design is to disperse the sound in such a way as to achieve the spaciousness of live sound while maintaining precise detail and accurate localization. This can be accomplished very effectively by careful use of sound reflected from rear and side walls, and the space between the speakers, along with the proper proportion of direct sound." And, finally, we have Wharfedale stating that "omnidirectional speakers are unsatis-



# SPEAKER FORUM

factory in that the stereo image is diffuse and sensitive to the room. We do not accept the principle that the imposition of one's listening-room acoustics on top of the original ambience of the performance will enhance naturalness. On the contrary, this must contradict the definition of hi-fi."

## ● How safe is it to use an amplifier with a power rating much higher than that of the speakers?

It will probably surprise most readers, but almost all the manufacturers agree that the major speaker-safety problem comes about because of *underpowered*, not *overpowered*, amplifiers. As Bose puts it, "one problem with too small an amplifier is that the user may operate it in 'clipping' (overload) too often. A clipping amplifier generates a disproportionate amount of high-frequency energy that is routed to the tweeter by the crossover, resulting in tweeter burnout." Audioanalyst, Jensen, Marantz, ADS, Burhoe, Technics, E-V, Celestion, Allison, Advent, Altec, and Infinity all explicitly make the point that a higher-power amplifier that is *not* being driven into clipping is safer than a lower-power unit that is. Advent cites the data they've collected on their first model. They found that "a 25- to 30-watt receiver driven to clipping a large percentage of the time would burn out a tweeter, yet a Phase Linear 700-watt amplifier driving the speaker to much higher levels would not. It was actually *safer* to have ten times the power!" Altec makes the same point in a more picturesque way: "Clipping occurs when the input signal to an amplifier is sufficiently large to demand an output signal greater than the peak output voltage of which the amplifier is capable. Many audio buyers believe that amplifiers are like milk bottles: when they're empty—there ain't no more. Not true. With an amplifier, you don't run out of milk; it keeps pouring, but the milk turns sour. And, like sour milk to a baby, sour signals can make your loudspeaker system sick."

JBL advises that "a good rule of thumb is to choose an amplifier with an output-power rating about 6 dB greater (four times) than the steady-state power level at which a given loudspeaker system may be rated. Beyond this there is the risk of tweeter/mid-range burnout or other speaker damage. A 6-dB factor will give an adequate margin for most musical peaks over the highest average level the speaker might be expected to handle. Given the sensitivity of most current bookshelf systems, a stereo pair of such speakers can deliver sound-pressure levels in the 100-dB range in most listening rooms with only a 40- or 50-watt amplifier. However, while *average* power requirements will rarely exceed this, *peak* power demands for transient accuracy easily justify amplifier power capability in the 150- to 200-watt range for more robust bookshelf speakers."

Several manufacturers do advise that

some care be exercised when super-power amplifiers are used. For example, Advent finds that "the primary danger from a high-powered amp is mechanical damage. Dropping the tone arm or bumping the turntable may cause such large speaker-cone excursions that the woofer's spider (inner cone support) ruptures." Several manufacturers also warn against excessive boost of the treble control (Technics, ADS), use of loud *test* signals, or some types of electronic music (Yamaha, Infinity, and Koss). Wharfedale and Advent both make the point that audible distortion is a sure sign that an amplifier is clipping a high percentage of the time. The solution? Wharfedale advocates the rule: "If you can hear distortion, turn down the volume." And E-V reaffirms the point that even a 10-watt amplifier, if turned up loud enough, will destroy the typical high-frequency transducer, adding sadly, "but that's some people's idea of a party."

## ● Are there any other questions we haven't asked that you would like to answer?

Most of the respondents took advantage of the opportunity to provide additional comments, Allison making the point, among others, that frequency-response specifications are virtually meaningless as presently derived and presented by most companies, and urging that some technique that measures a speaker's integrated total output in all directions be universally adopted. Audioanalyst emphasizes that the "location of stereo loudspeakers in a listening area is often overlooked as unimportant. But improper location can ruin the performance of otherwise excellent speakers. Experimentation by the user is *very* important."

Bose maintains that "perhaps the most fundamental question concerns the philosophy of sound reproduction and speaker design that leads a manufacturer to choose a specific approach. Since a complete answer must necessarily address some very basic questions of aesthetic goals, psychoacoustics, and practical limitations of mechanical and electronic technology, its length would probably exceed that of all the preceding questions."

Burhoe wants to make the point that "distortion, a factor that is difficult to express effectively in simple figures, is the *second* most important specification. It does no good to have a system with a great frequency response if it is all muddled up by distortion." Burhoe further feels that the reason subjectivity reigns in speaker evaluation is that present-day loudspeakers are woefully inadequate: "As speakers get closer to the ideal, subjective preferences will become less important."

JBL is pleased to observe that "with more and better instrumentation available, the more serious loudspeaker manufacturers seem to be converging on similar solutions to the same problems, and it should not be surprising that one manufacturer's best efforts may audibly resemble those of another. As an industry, we seem finally to be getting away from pronounced sonic colorations."

Koss also affirms that "the design of a speaker system is a complex problem" and finds that "use of computer optimization has made it possible not only to improve performance but to ease the burden of design so we can investigate, analyze, and re-define areas of performance which usually remain untouched."

Technics maintains that although many believe that "speaker systems are inferior to other audio equipment in regard to distortion, they are better than records or tapes. In speaker systems, it is only the three-dimensional frequency response that is inferior to other components. We look forward to improvements in this area through upcoming technology."

And, finally, Wharfedale feels that it is important to reaffirm the definition of hi-fi. "High fidelity means faithful to, or preferably indistinguishable from, the original." Burhoe amplifies this by asking—and answering—a leading question: "Why is it important that loudspeakers be accurate?" "Why is there any doubt?" □

## SPEAKER-FORUM PARTICIPANTS

**Altec** — Irwin Zucker, Director, Product Development

**ADS** — Dr. Godehard A. Guenther, President

**Advent** — Andrew G. Petite, Director of New Product Development

**Acoustic Research** — Tim Holl, Director of Engineering

**Allison Acoustics** — Roy F. Allison, President

**Audioanalyst** — Malcolm Scholl, President

**Burhoe Acoustics** — Winslow N. Burhoe, Director of Research Development

**Bose** — John J. Wawzonek, Marketing Manager, Audio Components

**Bang & Olufsen** — S. K. Pramanik, Product Specifications

**Celestion** — John J. Bubbers, President

**Design Acoustics** — George Sioles, President

**Electro-Voice** — Jim Long, Director of Product Management, and Ray Newman, Chief Engineer, Loudspeaker Systems

**Infinity** — Denis Wratten, Vice President, Marketing

**JBL** — John Eargle, Vice President, Product Development

**Jensen** — James F. Novak, Vice President, Engineering

**Klipsch** — Robert L. Moers, President, and Don Petersen, Sales Manager

**Koss** — John R. Bruss, Senior Electro-acoustic Systems Engineer

**Marantz** — Dick May, Manager, Loudspeaker Engineering

**Technics** — Shinichiro Ishii, Speaker System Designer

**Wharfedale** (a division of Rank HI FI, which also includes Leak) — Ken Russell, Director of Engineering

**Yamaha** — Alan Ohara, Audio Division



# Loudspeakers: Then And Now.

There was a time when it took a big speaker to get full, rich high fidelity sound.

It's not true anymore.

Now Visonik has developed a series of ultra-compact high fidelity loudspeakers that are heard but hardly seen.

This remarkable accomplishment is the DAVID® line of five speakers. Each is an ideal combination of maximum sound and minimum size.

To achieve the sound of a large, well-engineered speaker from a speaker the size of the DAVIDS® is no small accomplishment.

Visonik blends equal parts of technology, precision German engineering, and careful craftsmanship to arrive at this mini miracle.

The result is a speaker small enough to fit in the palm of your

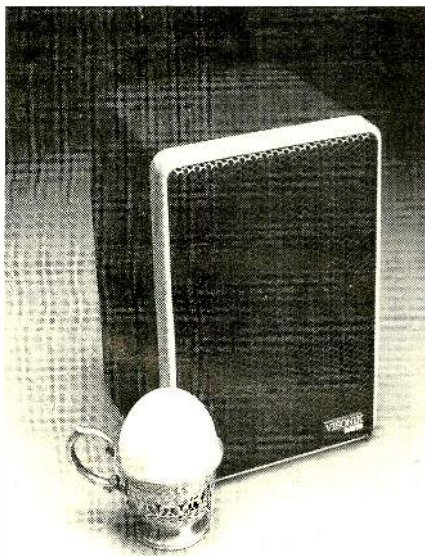
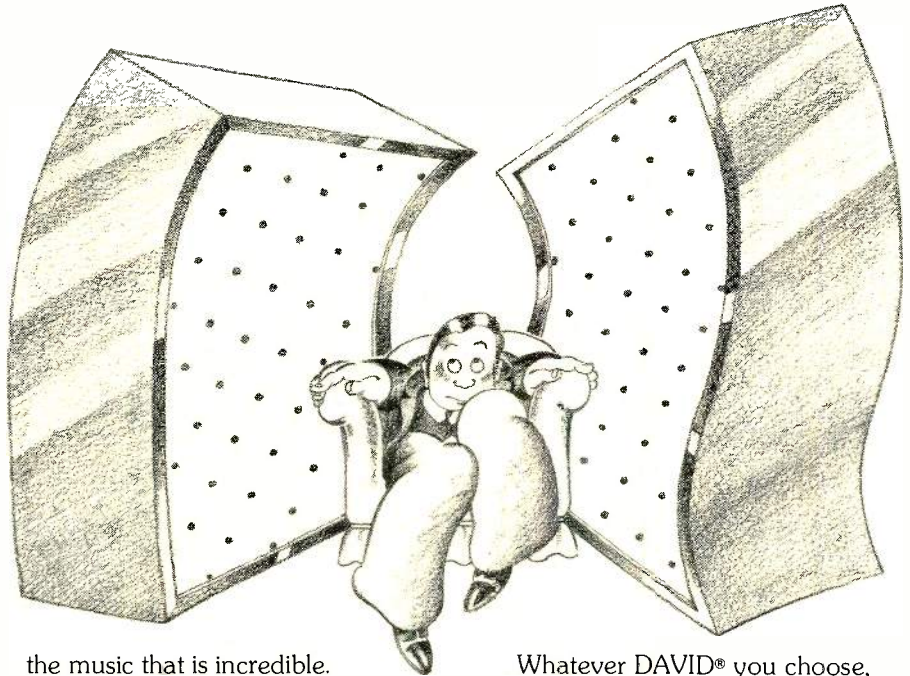

hand, with the sound of a speaker you could barely lift off the floor. And with dispersion and imaging of

the music that is incredible.

The smallest of the DAVIDS® are the two-way D-302 and D-502, perfectly made for easy placement within your home, or even in a car or van (in an MO version with mounting bracket).

While identical in size to the D-302, the two-way D-502 has more power handling capacity and deeper bass response. Commensurately fuller sound and greater power handling capacity are achieved with the D-602, D-702, and three-way D-803.

With the exception of the D-302, the DAVIDS® have an LED overload indicator to signal overload risk to the tweeters.

The D-602, 702, and 803 come in a choice of a walnut wood veneer cabinet for a touch of visual warmth, or the standard black finish cabinet.

Whatever DAVID® you choose, whether the tiny D-302 or its big

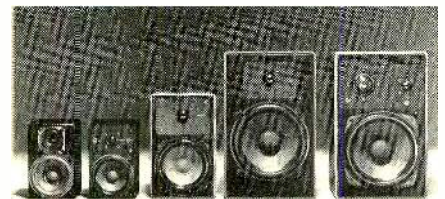

(but still relatively small) brother, the D-803, you can be sure you will own a loudspeaker whose size makes it possible to have the best sound wherever you want it.

See and hear today's concept in loudspeakers at your Visonik dealer. Write us or call this toll-free number for the name of your nearest dealer. (1) 800 423-2355, extension 606. In California, call (1) 800 232-2175, extension 606.

## VISONIK® HIFI

You'll hear more from us.™

Visonik of America, Inc./1177 65th Street/Oakland, CA 94608

\*Registered Trademark. Visonik K. G.™©1978, Visonik of America, Inc





Tandberg TCD 330



Teac 860



Pioneer CTF 8282

# You paid a lot for good specs. Now spend a little more and hear them.

Just because you put a great deal of money into your tape deck, it doesn't necessarily mean you'll get a great deal of sound out of it.

Unless of course, you're using the tape that's engineered to get the most out of high-performance equipment. Maxell.

Maxell is specifically designed to give you extended frequency response, the highest possible signal-to-noise ratio and



the lowest distortion of any tape in its price range.

Which is why people who own the finest tape decks use Maxell more than any other brand.

Of course, there are other reasons. Like the fact that every Maxell tape has a unique non-abrasive head cleaner. And a full warranty that covers the one thing other manufacturers don't cover. Everything.

Try Maxell. It's sure to make the sound that comes out of your tape deck worth every penny you put into it.



CIRCLE NO. 33 ON READER SERVICE CARD

Maxell Corporation of America, 60 Oxford Drive, Moonachie, N.J. 07074.



# STEREO REVIEW'S SELECTION OF RECORDINGS OF SPECIAL MERIT BEST OF THE MONTH



## Stereo Review

P.O. Box 2771  
Boulder, Colorado 80321

**No sales talk—  
just a great deal of Stereo Review,  
the world's foremost audio magazine!  
You save 50%!**

Mr. \_\_\_\_\_  
Ms. \_\_\_\_\_ (please print full name) \_\_\_\_\_ 4548

Address \_\_\_\_\_ Apt. \_\_\_\_\_

City \_\_\_\_\_

State \_\_\_\_\_ Zip \_\_\_\_\_

Additional postage for foreign orders: add \$1 a year for Canada, \$5 a year for all other countries outside the U.S. and Possessions. Cash only on foreign orders, payable in U.S. currency. Prompt delivery: your first issue will be shipped 30 to 60 days from receipt of your order.

## Discount Order Form

CHECK APPROPRIATE BOXES

- YES.** Send me a year of **Stereo Review** for just \$4.99—50% off the regular subscription price of \$9.98.
- I prefer two years for \$9.98.
- I prefer three years for \$14.97.

**CHECK ONE:**  Bill me later.  
 Payment enclosed.

**5999** Send me 1 year of Popular Photography for \$5.99.

### FOR NEW SUBSCRIBERS ONLY

**T**HE Fitzwilliam String Quartet has apparently not recorded anything but Shostakovich, and for all I know never *plays* anything but Shostakovich. Likely or unlikely as that may seem, from the sound of their recordings it appears that these four young Britons were born for the project on which they have so successfully embarked: the recording of all fifteen of the late Russian master's quartets for L'Oiseau-Lyre. Following the initial disc of Quartets Nos. 7, 13, and 14 (DSLO 9, reviewed August 1976) and the one coupling Nos. 8 and 15 (DSLO 11, May 1977), the third installment is now at hand. It comprises the radiant Fourth of 1949 and the more introspective Twelfth which began the final segment of the cycle in 1968, and it is more compelling than either of its two fine prede-

cessors. To be sure, this is so in large part because of the nature of the music itself: the Fourth Quartet is one of the most attractive works in the entire series, and the Twelfth, too (especially welcome because it has not been available domestically until now), has an immediacy of appeal that draws the listener directly and happily into its own world.

Quartet No. 12 is in only two movements, the first comprising a meditative moderato and an only slightly more animated allegretto, and the second, three times as long, in no fewer than four distinct parts (essentially it is a very energetic allegretto interrupted by two slower sections). The work's character is "inward," but not somber; there are no long stretches of brooding, though there are ruminative sections, some of

playing is gorgeous, the recording itself is perfection, and you will never hear surfaces like these in the ordinary run of domestic pressings—because they make no sound at all.

The climax of the Fitzwilliam's association with Shostakovich's music, according to the liner blurb, "came when the composer himself visited them in New York to hear them play"; the true climax of that association, surely, will be the completion of this marvelous cycle, which I hope will be extended to include the Quintet, with a really first-rate pianist. And then I would like to find out what else the Fitzwilliam does play, to hear the group in Beethoven, Schubert, and Bartók. And I suspect these musicians might be the ones to fill one of the serious gaps in the chamber-music discog-

movement, in-  
fects. It seems  
uggest that the  
t of reflective  
t the composer  
t he found—a  
ean of affirma-  
illiam's violist  
in his pointed  
d with exulta-

ayers are thori-  
ks is no more  
xpect by now,  
aying per se—  
tone displayed  
and collective-  
d commitment  
each other—is  
ver be simply  
l less startling-  
revious discs.  
the discovery  
helled on the  
siderations of  
he artistry of  
ans has deep-  
r since the last  
e it just has to  
ny event, the





Angel Records

ERNST VON DOHNÁNYI (1877-1960): brilliantly accomplished

raphy by giving us an integral set of the Bloch quartets. There can be no question about their being the ones for Shostakovich. —Richard Freed

**SHOSTAKOVICH:** *String Quartet No. 4, in D Major, Op. 83; String Quartet No. 12, in D-flat Major, Op. 133.* Fitzwilliam String Quartet. L'OISEAU-LYRE DSLO 23 \$7.98.

## Virtuoso Earl Wild Presents the Wit of Dohnányi, The Blaze of Liszt

**E**ARL WILD is evidently a pianist whose time has come. His recordings of a group of Liszt and Dohnányi works, along with some other recent issues, were made in England during the Sixties but have been sold only through mail order. Now reissued on the Quintessence label, they are available in stores at bargain prices and will serve to alert another, possibly wider, public to the brilliance and virtuosity of this exceptional pianist.

By rights, the featured music should be the Liszt. The Hungarian Fantasia is one of Wild's specialties, and he plays the blazes out of the *Mephisto* Waltz. But the scene stealer on the disc containing these two works is a very different kind of Hungarian music—the Dohnányi *Variations on a Nursery Tune*. The tune is the venerable *Ah, Vous Di-*

*rai-Je Maman*, better known in these parts as *Baa, Baa, Black Sheep*, or *Twinkle, Twinkle, Little Star*, or, just possibly, through Mozart's variations on the same tune. Ernst von Dohnányi, a brilliantly accomplished composer of aristocratic lineage, was essentially a late, late Romantic whom history and the turn of events passed by. But he had one great and modestly enduring success—these clever, witty, and vastly amusing variations. He wrote them for himself (he was a very good pianist) and recorded them twice.

The recording at hand, made in 1967 in Kingsway Hall, London, is noteworthy for, among other things, the participation of Dohnányi's son, the gifted conductor Christoph von Dohnányi. It is also noteworthy for its great gobs of spirit, humor, and fantasy—right from the wonderfully pompous and tragical introduction, through the surprisingly melodious mid sections, to

the spritely wicked finale—and on into a brilliant etude encore. This is musical fun of the first order, and the record has surprisingly up-to-date sound, needing (for my taste) only a slight nudge in the mid range for a bit of increased presence, and excellent surfaces. —Eric Salzman

**DOHNÁNYI:** *Variations on a Nursery Tune, Op. 25; Capriccio in F Minor, Op. 28.* Earl Wild (piano); New Philharmonia Orchestra, Christoph von Dohnányi cond. **LISZT:** *Hungarian Fantasia; Mephisto Waltz No. 1, Op. 110, No. 2.* Earl Wild (piano); Royal Philharmonic Orchestra, Russell Stanger cond. QUINTESSENCE PMC-7054 \$3.98.

## Bobby Bare: What There Is About The Good Old Boy That's Worth Saving

**"M**Y teeth's gone bad,' says the man with the yard full of rusty cars, 'toilet's on the blink, and heavy-weights today can't hit.'" Now, there aren't too many places in all of music where you can get lyrics like that, and there isn't anyone else who can deliver such lyrics with the cocky, good-natured aplomb of Bobby Bare. He is just now celebrating a switch to Columbia (from RCA) with an album called simply "Bare," and it seems to be a kind of summing up by Bare and his long-time consultant on the absurdity of it all, Shel Silverstein. Side one is the sort of inside-out good-old-boy humor Bare's so at ease with, and side

CHRISTOPH VON DOHNÁNYI: gifted



EARL WILD: exceptional virtuosity



Colbert Artists Management, Inc.

Judd Concert Bureau





BOBBY BARE: worth knowing well

two reinforces that old impression that he's not just country but also slightly folkie.

The thing about the album is not so much that the music is great, but that it understands Bare and helps you try to understand him too—and Bare is definitely worth knowing well. He represents what there is about the good-old-boy that's worth saving (now that you've been shown the other side of this coin by Billy Carter, I'll bet you could use a little reminder), and he also sings in an almost stark way, so defenseless and plain and natural, so unapologetic about being himself. It's that quality of Bare's personality that this album gives you access to, and what you find out about him will hold up long after Silverstein's zingers, good lines, and O'Henry endings have lost their snap. But this time it seems okay that he put those in there, cartoons though they may be, because they speak the way Bare does; he's a language-oriented entertainer, as so many Southern ones are. I guarantee that the better you get to know him the more you're going to like him, and that'll put you in good company. Among the friends and "other musicians" gathered together on this album are Waylon Jennings, Chet Atkins, Willie Nelson, and the like.

—Noel Coppage

**BOBBY BARE: Bare.** Bobby Bare (vocals, guitar); Fred Carter Jr. (guitar); Joe Osborn (bass); Ben Keith (steel guitar); Shel Silver-

stein (vocals); other musicians. *Big Dupree; Finger on the Button; The Gambler; Yard Full of Rusty Cars; Greasy Grit Gravy; Too Many Nights Alone; Childhood Hero; February Snow; This Guitar Is for Sale; Sing for the Song.* COLUMBIA KC 35314 \$5.98, © CA 35314 \$6.98, © CT 35314 \$6.98.

## "Peg Leg": Ron Carter's Sequel to "Piccolo" Is a Package of Pure Delight

THE Ron Carter Quartet's last album, "Piccolo" (Milestone M-55004, two discs), was so fine that one had to wonder if the follow-up release could be anything but a disappointment. It isn't. In fact, "Peg Leg," recorded at Carter's favorite studio, Rudy Van Gelder's, is a pure delight. The quartet has been augmented by woodwinds—which gives the already unique group a different, intriguing character—and by guitarist Jay Berliner, whose acoustic playing on *Sheila's Song (Hasta Luego, Mi Amiga)*, one of Carter's many Spanish-influenced compositions, is particularly effective.

The woodwinds, arranged and conducted by Robert M. Freedman, blend beautifully with the quartet's work, often providing no more than subtle accents, so the dominant sound remains that of the group. If you have heard the Ron Carter Quartet in person or on the "Piccolo" album, you already know that it can get as funky as a Sanctified church on Sunday and that it can also melt your emotions with sounds that in the hands of lesser artists might be downright unctuous; but that in itself is

RON CARTER: wholly original

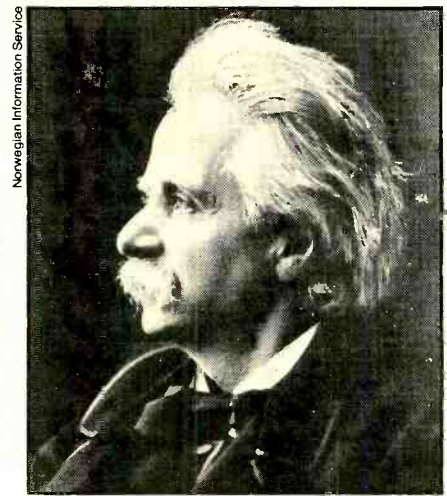

EDVARD GRIEG (1843-1907): Schubertian

not a unique quality. It is, however, unique—in times when many of the country's finest jazz players want to play pop star—to have a group of first-rate musicians who not only value the intrinsic ingredients of jazz, but employ them in a wholly original manner and obviously enjoy doing so.

—Chris Albertson

**RON CARTER: Peg Leg.** Ron Carter (piccolo bass, bass, percussion); Kenny Barron (piano); Buster Williams (bass); Ben Riley (drums). *Peg Leg; Sheila's Song; Chapter XI; Epistrophe; My Ship; Patchouli.* MILESTONE M-9082 \$7.98, © 8161-9082(H) \$7.95, © 5161-9082(H) \$7.95.

## Eva Knardahl and Grieg's Lyric Pieces: Personal and National Styles Neatly Melded

FOR all the enormous popularity of a few of his works, Edvard Grieg remains a composer more honored in reputation than in performance. The Lyric Pieces are a case in point. Mentioned in virtually every discussion of Romantic piano music or musical nationalism, the pieces themselves are in the repertoire of very few pianists and, with certain popular exceptions, have only rarely been recorded. It is not the names of the pieces that are unfamiliar, but the music. Years ago Walter Gieseking became something of their champion, and a few of them were on one of Arthur Rubinstein's very best records (RCA Victor LM 1872, out of print). More re-



cently there has been an excellent selection of them on a Deutsche Grammophon disc by Emil Gilels and even a complete recording on Vox by Isabel Mourão as part of a six-record set of all of Grieg's piano music.

Now, as the start of another complete survey of the piano music, we have all the Lyric Pieces neatly divided among four discs, all available separately, by the Norwegian pianist Eva Knardahl on the Bis label. Miss Knardahl, who gave her first public performance in Norway at six and was later, for fifteen years, pianist with the Minneapolis Symphony, brings a great deal more to Grieg's music than just a common national heritage. She is a pianist of fluency, neatness, and precision, but she is also wonderfully musical and expressive. She seems to miss no point at all in this music, but she makes the points with little exaggeration. The scale of each piece is subtly observed in relation to the others and properly presented, and while some other pianists may make more of individual pieces, I find it hard to imagine a more knowing performance of the whole. In all, it is a remarkable recorded achievement, and, as we have come to expect of Bis records, the technical recording also has been carried out with skill and taste.

If there are high and low points in the set (and there are), they are reflective of Grieg's music rather than of the playing. The highest plateau is unquestionably that of the six pieces of Book V, Op. 54, found together with the six of Book VI, Op. 57, on Volume 3 of the set. Book V comprises the strangely haunting *Shepherd Boy*, a *Norwegian March*, the *March of the Dwarfs*, a highly poetic *Notturmo*, a lyrical *Scherzo*, and the proto-impressionist *Bell Ringing*. The consistency of quality is exceptional here, and the lyric invention is on a Schubertian scale. If one were to buy only a single album from the group, this should be the one. I confess, though, that I enjoyed the first volume almost as much. Made up mostly of early works, this string of elf dances, folk songs, album leaves, melodies, and elegies is strong on clarity and simplicity, with the beginning touches of personal and national style coming through like colored highlights in a charmingly drawn composition.

In all, it is a splendid set, and I look forward with eagerness to the forthcoming recordings of the remainder of Grieg's piano music.

—James Goodfriend

GRIEG: *Lyric Pieces*. Volume 1: *Book I, Op. 12; Book II, Op. 38; Book IV, Op. 47*. Volume 2: *Book III, Op. 43; Book VII, Op.*

Annette Charles, John Travolta, and (gasp!) Eve Arden punish the parquet in *Grease*.

62; *Book IX, Op. 68*. Volume 3: *Book V, Op. 54; Book VI, Op. 57*. Volume 4: *Book VIII, Op. 65; Book X, Op. 71*. Eva Knardahl (piano). Bis LP 104/7 four discs \$8.98 each (from Qualiton Records, 65-37 Austin Street, Rego Park, N.Y. 11374).

## RSO's *Grease*: The Fifties Never Sounded So Good In Real Life

SOMEONE once described that great avatar of the Fifties, Marilyn Monroe, as a great big melting banana split—in other words, a glorious, delectable mess. The same description aptly fits the new original-soundtrack recording of *Grease* just out on the RSO label. It drips with such currently hot box-office names as John Travolta (he sounds just barely okay in such things as *Sandy* and *Greased Lightnin'*, but I'm sure his fans will forgive him) and Olivia Newton-John (who adds her expected maraschino touch to such immortals as *Look at Me, I'm Sandra Dee* and *Hopelessly Devoted to You*). On the plate surrounding them is an assortment of sugar cookies: Frankie Valli singing the title song; Sha-Na-Na lumbering through *Hound Dog*, *Tears on My Pillow*, and several others; Cindy Bullens on *Freddy My Love* and a duet with Louis St. Louis in *Mooning*; and even good old Frankie Avalon singing *Beauty School Drop-Out*.

This frolic about and ode to one of the most boring generations in American history has been knocking them

dead for several years now on Broadway, and, from what I hear on this album, I have a feeling that the film will be one of the blockbusters of the year. Even if (as Simone Signoret titled her autobiography) *Nostalgia Isn't What It Used To Be*, there is still an enormous amount of simple-minded fun left in this hallelujah to a recent past. And, under the musical supervision of Bill Oakes, the whole score jumps out at you twice life-size so that something such as *Rock n' Roll Party Queen*, performed by Louis St. Louis, becomes a sly mockery of itself by reason of the totally uncalled-for grandiosity of the presentation.

Looking back at that era in my personal life, all I seem to remember is that Pontiacs were designed to look a lot like poor Jayne Mansfield; that there were a lot of tasteful tsk-tsks about Elvis; that Sinatra began to record some of the best things he (or any other American popular singer) has ever done; and that I tried greasing my hair back but the pompadour kept caving in on me, so that I looked like Peter Lorre after a Channel swim. *Grease* brings all those bland, dull years back with an entertaining whoosh of excitement that was never there in reality. Believe me, the Fifties were a lot tamer than this humorously lively, high-spirited album would lead you to believe. But, then again, no one ever got to see those two Thirties tots, Ginger Rogers and Fred Astaire, doing the waltz from *Swing Time* in and out of a bread line either. So I guess pure entertainment calls for a certain suspension of disbelief, wouldn't you say?—Peter Reilly

GREASE. Original-soundtrack recording. John Travolta, Olivia Newton-John, Frankie Avalon, Frankie Valli, Stockard Channing, Sha-Na-Na, others (vocals); orchestra. RSO RS-2-4002 two discs \$9.98.





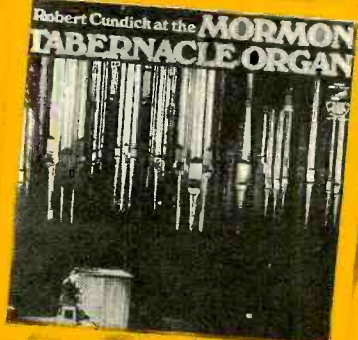

# CENTURY RECORDS®

**"The Best Fidelity I Ever Heard..."**  
Louis R. Virgil, Bricktown, NJ

**"like sitting in front of a live band..."**  
Gene Collins, Downey, CA

**"Magnifacular!"**  
Jack Proffer, Inglewood, CA

**"all recordings should sound like this..."**  
Richard Green, Skokie, IL

**"Far better than my 400 other conventional records..."**  
Dennis Schnobrich, Canoga Park, CA

**"Super - Just Super"**  
Mark Schaefer, Green Bay, WI

**"Greatest thing that ever happened to sound."**  
Lou Ferronato, Jr., San Francisco, CA

## DIRECT-TO-DISC RECORDINGS

Century Records • 6550 Sunset Blvd., Hollywood CA 90028 • (213) 464-3250  
CIRCLE NO. 13 ON READER SERVICE CARD





# POPULAR DISCS AND TAPES

Reviewed by CHRIS ALBERTSON • NOEL COPPAGE • PHYL GARLAND • PAUL KRESH  
PETER REILLY • STEVE SIMELS • JOEL VANCE

**AIRWAVES: *New Day*.** Airwaves (vocals and instrumentals). *Love Stop; You Are the New Day; Nobody Is; Keep Away the Blues; The Cat*; and six others. A&M SP-4689 \$7.98, © AAM-4689 \$7.98, © AAM-4689 \$7.98.

Performance: **Good**  
Recording: **Clean**

Airwaves is a trio of British studio musicians who write, sing, and play premeditated pop, commercial fluff designed to catch on, turn a profit, and then skulk away. But some of it is very classy fluff: *Nobody Is* rocks along nicely, *So Hard Living Without You* is well crafted, and *You Are the New Day* is a very fine a cappella performance. Until the Swedish group Abba came along, the British had a near monopoly on well-made commercial pop, and Airwaves at least shows that Mother England is still in there pitching. J.V.

**RANDY BACHMAN: *Survivor*.** Randy Bachman (vocals, guitar); vocal and instrumental accompaniment. *Just a Kid; One Hand Clap-in; Lost in the Shuffle*; and five others. POLYDOR PD-1-6141 \$7.98, © 8T-1-6141 \$7.98, © CT-1-6141 \$7.98.

Performance: **Poor**  
Recording: **Good**

"Survivor" makes it hard to believe that Randy Bachman has been a professional mu-

sician and songwriter for more than fifteen years or that he was an important element in two successful groups, the Guess Who and Bachman-Turner Overdrive. The writing and singing here are pallid and puerile. Why Bachman's talents went so awry on this solo effort is something of a puzzle, but at least part of the trouble seems to be the concept of the album: Bachman as "martyr" recalling his life and work as a rock musician exposed to the outrageous fortune of the cruel world, etc. Whatever you may think of the scenario in the abstract, it doesn't produce much of value in this case. Bachman plays five types of guitar besides singing here. But I suppose he had to overdub the stigmata. J.V.

**BOBBY BARE: *Bare*** (see Best of the Month, page 90)

**BRITISH LIONS.** British Lions (vocals and instrumentals). *Booster; Eat the Rich; Chance to Run*; and six others. RSO RS-1-3032 \$6.98.

Performance: **Mediocre**  
Recording: **Good**

In case you're interested, the British Lions are the latter-day, Ian Hunter-less Mott the Hoople, an outfit that made two totally unmemorable albums before deciding that a change of name might revive a sagging career. The group's decked out with yet another new lead singer and the blessings of no less a kingmaker than Robert Stigwood, who, it appears, can do no wrong commercially these days. Their sound is just a trifle more punkish than it used to be, but I suppose they come by it honestly; Mott, after all, was always one of the more obviously working-class outfits. Sad to say, though, the album is a pretty mediocre affair—*Eat the Rich* is about the extent of their lyrical sophistication—despite a better than adequate cover of Garland Jeffrey's underground classic *Wild in the Streets*. On balance, though, as comeback bids go, it's not a totally dishonorable effort. S.S.

**ROY BUCHANAN: *You're Not Alone*.** Roy Buchanan (guitar); vocal and instrumental ac-

companiment. *Turn to Stone; 1841 Shuffle; Down by the River; Supernova; You're Not Alone*; and two others. ATLANTIC SD 19170 \$7.98, © TP 19170 \$7.98, © CS 19170 \$7.98.

Performance: **Frustrating**  
Recording: **Good**

Somehow this album doesn't come off. Roy Buchanan plays with his customary demonic brilliance—he is one of the few guitarists who nearly exhaust the emotional possibilities of the instrument by the very passion of their personalities—but after all the glorious fury, the music is still somehow irresolute. Weak material accounts for some of the sense of anticlimax, but not all of it. Maybe what's missing is a release from tension, for both Buchanan and the listener. One of the thrills of hearing him play is to feel how close he comes to hysteria without giving in to it—the man seems driven by something—but it is a thrill that fatigues. I sometimes fear that at the peak of his frenzy, Buchanan and his guitar will both short-circuit—or if they don't, I will. J.V.

## RECORDING OF SPECIAL MERIT

**JOHNNY CASH: *I Would Like to See You Again*.** Johnny Cash (vocals, guitar); instrumental accompaniment. *I Would Like to See You Again; Lately; I Wish I Was Crazy Again; Who's Gene Autry?; Hurt So Bad; After Taxes*; and five others. COLUMBIA KC 35313 \$5.98, © CA 35313 \$6.98, © CT 35313 \$6.98.

Performance: **On target**  
Recording: **Very good**

Johnny Cash comes across with clarity, simplicity, and directness, and all one of his albums needs to be is stylistically compatible with those qualities. This one is beautifully so; I find it the most satisfying Johnny Cash album in years. The backing is clean-acoustic-jangly, the songs are crisp-and-knowing to smart-ass, and the elegance the John R. Cash delivery is capable of is actually achieved more often than not. All this and Waylon Jen-

### Explanation of symbols:

- Ⓜ = reel-to-reel stereo tape
- Ⓢ = eight-track stereo cartridge
- Ⓒ = stereo cassette
- = quadrasonic disc
- Ⓡ = reel-to-reel quadrasonic tape
- Ⓟ = eight-track quadrasonic tape

Monophonic recordings are indicated by the symbol Ⓜ

The first listing is the one reviewed; other formats, if available, follow it.



nings joining in on a couple of cuts too. The title song, as this is written, is a regional hit, and the interesting thing about that is that it *hasn't* lit up the sky in at least one other region. A decade ago John R. Cash did everything nationally. His having a regional identification now in addition to a national one gives him more room in which to move, and the spirit of some such feeling seems to affect this album. Its attitude is one of the most attractive things about it. The thing with an old pro is to catch him when he's really *applying* himself, since getting up for one more game is the hardest thing an old pro has to do. This album is one of those rare catches. N.C.

**CHARLIE: Lines.** Charlie (vocals and instrumentals). *She Loves to Be in Love; No More Heartache; Life So Cruel; Watching T.V.; Out of Control;* and four others. JANUS JXS-7036 \$7.98.

Performance: **Very good**  
Recording: **Good**

Charlie is a very classy quintet that reminds me somewhat of that fine, departed group Ace in its mixture of rhythm-and-blues, light jazz, and solid ensemble playing. Among the delights on this album, Charlie's second, are *L.A. Dreamer*, which describes a jerk trying to ingratiate himself in the lotus-land scene; *No Strangers in Paradise*, which takes a poke at the sale of indulgences in church services; and *She Loves to Be in Love*, about a fan sending letters to her fave raves in England and waiting patiently for their next tour. The mild cynicism that runs through Charlie's music is complemented by inventive arrangements and polished vocal work. It will be interesting to see how this band develops; it is quite impressive even now. J.V.

**FLOATERS: Magic.** Floaters (vocals); instrumental accompaniment. *Magic (We Thank You); I Dedicate My Love to You; The Time Is Now; What Ever Your Sign;* and three others. ABC AA-1047 \$6.98. © 8020-1047(H) \$7.98, © 4020-1047(H) \$7.98.

Performance: **On cloud nine**  
Recording: **Good**

This quintet is as welcome as a breath of fresh air at 3 a.m. during a smoky standup party (so many folks crowded into so small a space there's nowhere to sit down). The name is apt, for they do seem to float along, employing light, high-pitched vocals, with four of the five hovering in the background behind a shifting lead singer. Their tempos are usually restrained, though they do break out a bit on *What Ever Your Sign*, a play on astrology shaved down to suit party patter. This is good music for close dancing and low lights. P.G.

**FOGHAT: Stone Blue.** Foghat (vocals and instrumentals). *Stone Blue; Sweet Home Chicago; Easy Money; Midnight Madness;* and four others. BEARSVILLE BRK 6977 \$7.98, © M8 6977 \$7.97, © M5 6977 \$7.97.

Performance: **Better than usual**  
Recording: **Good**

This is the first Foghat album in some time not cut in the middle of or between long and tiring road tours, and as a result the group's self-penned material seems better than usual; but it's still just average. The band proudly notes its origins as a British blues group and offers three selections as proof of its roots: Elmore

James' heartbreakingly powerful *It Hurts Me Too*. James' arrangement of Robert Johnson's *Sweet Home Chicago*, and *Chevrolet*, which is credited to "Earl McDaniel"—I assume that's a misprint and should read "Eugene McDaniel," better known as Bo Diddley. The performances on these numbers are energetic and pious, but let's face it, folks: no matter how laudable the intentions of British blues groups, and even though they were playing black American blues in the early 1960's when American groups were not ("they gave us back our heritage" and so on),

British blues groups have never been all that good. Best were the early Rolling Stones, who used and fused the blues to their own purposes. Eric Clapton was a fine blues guitarist, but he, too, adapted the form to his own art. John Mayall, whose devotion to the blues is almost religious, continues to turn in performances that are thumpingly dull. A nation's music is usually better left to nationals, and I think Foghat should leave the blues to the Americans. J.V.

(Continued overleaf)

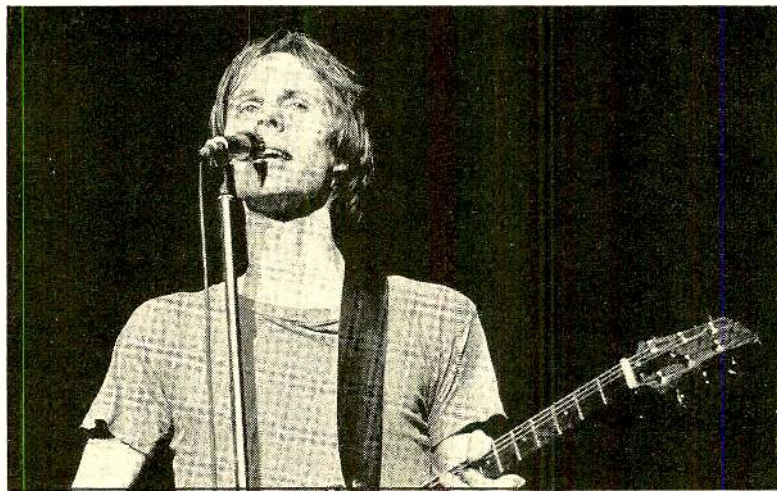

TOM VERLAINE: the future of rock-and-roll?

## Television's Brilliant "Adventure"

IT'S crow-eating time again for this reviewer, because Television's new "Adventure" is an embarrassingly brilliant album. I'm embarrassed because in retrospect it is not really all that different from its predecessor, which I dismissed as a production triumph and not much else, and because it really is accessible, which is the last virtue I would have expected from Television. I've been skeptical about this band, and for good reasons, including the memory of too many blisteringly incompetent live gigs in the days when they were so far underground they didn't even have a cult following and too many "I have seen the future of rock-and-roll and his name is Tom Verlaine" reviews in the *Village Voice* after they did. Besides, anybody who calls himself Verlaine is too pretentious for his own good.

Or so I thought. Call me a bandwagon jumper if you will, but I have suddenly connected with what they're doing, and it turns out that most of the hype is justified. Television really is the Last, Best Psychedelic Band, and Verlaine and Richard Lloyd are breathtaking, absolutely remarkable guitar stylists. Their sound together has, in reviewer Noel Coppage's phrase, an almost machine-tooled purity that recalls the pseudo-Oriental modal approach of the old Haight-Ashbury outfits (nearest reference point being Quicksilver Messenger Service), only without the

excess—there isn't a wasted note or a cliché idea here. Add to this a near architectural grasp of pop-song structure and Verlaine's pinched yet oddly affecting vocals and you have a very potent mix indeed, moving despite its icy reserve.

But I must add that I remain unconvinced by Television's lyrics, which many have touted as some kind of literary breakthrough; they continue to strike me as being absurdist-obscure. But, then again, Fran Lebowitz is clearly right (in her new book, *Metropolitan Life*) to scoff at those who try to figure anything out by listening to the lyrics of popular songs. The lyrics on "Adventure" hardly matter. It's the *sound* of the band that is crucial, a sound that is unique and so compelling that it has given me more pleasure than anything else I can remember since the days when Roger McGuinn's twelve-string guitar was bouncing off the eccentric rhythm work of David Crosby. Even if you are put off by all the New Wave brouhaha, you should get between a pair of headphones with this astonishing album posthaste. —Steve Simels

**TELEVISION: Adventure.** Television (vocals and instrumentals). *Glory; Days; Foxhole; Careful; Carried Away; The Fire; Ain't That Nothin'; The Dream's Dream.* ELEKTRA 6E-133 \$7.98, © ET8-133 \$7.98, © TC5-133 \$7.98.



# IF SOUND COULD CRY.

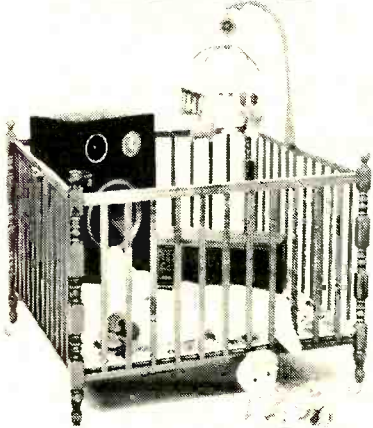

Sound's beauty is best expressed in music. So imagine its frustration when music is destroyed.

Sadly, the destruction is all around us. Most rooms are acoustical nightmares. Muffling. Bouncing. And absorbing musical energy.

If you care, however, your music can be protected. The answer is to equalize your room's frequency response, eliminating acoustical disturbances. Listen around. You'll hear our stereo graphic equalizers making sound, sound better.

Then if sound could cry, its tears would be those of joy.



MODEL 210  
STEREO GRAPHIC EQUALIZER

## SPECTRO ACOUSTICS

3200 GEORGE WASHINGTON WAY  
RICHLAND, WASHINGTON 99352  
TELEPHONE (509) 946-9608

CANADA:  
TC ELECTRONICS  
QUEBEC, CANADA

INTERNATIONAL:  
FIMC  
30 GREENHILL RD.  
WESTWOOD, MASS. 02090

AN AMERICAN MANUFACTURER  
OF HIGH FIDELITY COMPONENTS

CIRCLE NO 52 ON READER SERVICE CARD

**RICHIE FURAY: *Dance a Little Light*.** Richie Furay (vocals, guitar); other musicians. *It's Your Love; Your Friends; Ooh Dreamer; Yesterday's Gone; Someone Who Cares*; and five others. ASYLUM 6E-115 \$7.98, © ET8-115 \$7.98, © TC5-115 \$7.98.

Performance: **Icky**  
Recording: **Okay**

An album like this one forces you to get your priorities straightened out. There are, after all, worse things in life than having to listen to two whole sides of Richie Furay: for instance, discussing the substructure of pessimism in *Paradise Lost* with Grace Jones, contracting Legionnaire's disease, or spending a weekend in Philadelphia. Even so, this is one of the more cringe-making vinyl extrusions I've encountered in many a moon. Furay, last heard from during an ill-fated recorded alliance with Chris Hillman and J. D. Souther, has an annoying John Denverish high tenor, and his songwriting is all Granola and Ooh-baby-I-love-you. His new LP is utterly worthless, with the possible exception of a run-through of the old Drifters hit *This Magic Moment* that is a bit less adenoidal than I expected. Upon sober reflection, I think that, all things considered, I'd rather spend that weekend in Philadelphia. S.S.

**GENERATION X.** Generation X (vocals and instrumentals). *Gimme Some Truth; Wild Youth; From the Heart; Ready Steady Go; Kleenex; Promises Promises*; and six others. CHRYSALIS CHR 1169 \$7.98.

Performance: **Cute, but who cares?**  
Recording: **Deliberately muddy**

Generation X may not use session men, as they point out on the back of their debut album, but if they're not careful they're going to wind up as the Herman's Hermits of punk nonetheless. Forget the spiky haircuts and black leather; these kids are not only cheerful and Shaun Cassidy cute, but they respect their elders, as evidenced by their faithful cover version of John Lennon's *Gimme Some Truth* and declarations of affection for the Stones and the Who in *Ready Steady Go*. Add to that unexpectedly reactionary stance the fact that, at least at this early stage of their development, they're not terribly assured musicians, even allowing for the limitations of the genre, and you have an act that in ten years may be headlining a Las Vegas punk nostalgia revue—which, come to think of it, will probably serve us right. For the moment, though, I pass. S.S.

### RECORDING OF SPECIAL MERIT

**THE GOOD BROTHERS: *Pretty Ain't Good Enough*.** The Good Brothers (vocals and instrumentals); instrumental accompaniment. *Baby What You Want Me to Do; The Cowboy from Rue St. Germaine; Doin' It; Don't Let It Die; Pretty Ain't Good Enough; Get Her Back*; and five others. RCA AFL1-2755 \$7.98, © AKS1-2755 \$7.98.

Performance: **Driving**  
Recording: **Very good**

This is the first U.S. Good Brothers album. A previous one was released in their native Canada, where admirers include the King of Canada, Gordon Lightfoot, who wrote the liner notes for "Pretty Ain't Good Enough." He talks there about a "core of humor and loose-

ness" in the Good Brothers' style, and that's getting at the essentials. In view of how this one is titled, a natural way of phrasing it is that the Good Brothers go out of their way to avoid prettiness. Their sound has a sort of roughed-up-after-the-fact quality. It also has an infectious way of dealing with the beat and, here at least, of dealing with a good cross section of old tunes and new originals. There are several engaging instrumentals and now and then a snatch of lyric worth waiting for. The group is country-rock, strictly speaking, but with a touch of folk—but Canadian country, you understand, is something of a category unto itself. And it's in the sleepers, the unspectacular songs like *Don't Let It Die* where the cooking is the thing, that you really start to appreciate this group. I'm game for another Good Brothers album any time. N.C.

### RECORDING OF SPECIAL MERIT

**ISLEY BROTHERS: *Showdown*.** Isley Brothers (vocals and instrumentals); instrumental accompaniment. *Showdown; Groove with You; Ain't Givin' Up No Love; Rockin' with Fire*; and four others. T-NECK JZ 34930 \$7.98, © JZA 34930 \$7.98, © JZT 34930 \$7.98.

Performance: **Superior**  
Recording: **Very good**

One of the pleasures of life is hearing Ronnie Isley sing. He is certainly one of the major pop/rock vocalists of the last two decades, and no one, with the exception of the late Otis Redding, could or can take on a chew-'em-up jump song or a ballad with equal ease. The Isley Brothers' popularity has soared over the last five years because of their rhythm songs and their live appearances (they have one of the great stage acts). The jump tunes are exciting, but it is in ballads that the Isleys really turn on their twenty years of experience. And Ronnie shines brightest in ballads too. There are three fine examples here: *Groove with You, Ain't Givin' Up No Love, and Coolin' Me Out*, on all of which he gives such model performances that they ought to be required listening for every young singer. J.V.

**JETHRO TULL: *Heavy Horses*.** Jethro Tull (vocals and instrumentals). ... *And the Mouse Police Never Sleeps; Acres Wild; No Lullaby; Moths; Journeyman*; and four others. CHRYSALIS CHR 1175 \$7.98, © 8CH 1175 \$7.98, © CCH 1175 \$7.98.

Performance: **Misdirected**  
Recording: **Good**

I can recommend Ian Anderson's lyrics unreservedly; they stand by themselves as excellent verse. His descriptions of small towns and the countryside are delightful and evocative. Unfortunately, these superior lyrics are tortured hither and yon by jerky rhythm patterns and further degraded by Anderson's guttural vocals. The images and moods conjured up by the lyrics are shattered by the arrangements and performances. Anderson has been quoted as saying that he doesn't think there is any point in being a "safe" rock musician doing predictable things and that he feels the responsibility to take chances. If that is so, well, he took his chance here and lost. He should have dared rather to find some melodies that would complement his lyrics instead of savaging them. J.V.

(Continued on page 98)





# psychology today CASSETTES

These lectures and discussions on a wide range of important topics are presented by experts from all areas of the behavioral sciences. They are valuable for laymen as well as clinicians, educators, counselors, and therapists.



**FLOW AND MINDFULNESS** — Daniel Goleman  
How to make any activity, even daily chores, a pleasure. Dr. Goleman instructs in mindfulness, the meditation that lets things flow. #42

**DEEP RELAXATION** — Daniel Goleman  
Relax away your tension. Dr. Goleman leads you through a deep relaxation procedure that you can learn and do on your own. #43

**MEDITATION** — Daniel Goleman  
Dr. Goleman tells how to do an easy, basic meditation technique. He also talks about the Eastern origins of meditation and discusses common problems of beginners. #36

**FROM PSYCHOLOGIST TO YOGI: AN INTERVIEW WITH RAM DASS**

Yogi Ram Dass, former Harvard psychologist Richard Alpert, explains why he abandoned Western psychology for the spiritual disciplines of the East. #77

**MEDITATION OF THE HEART: A GUIDED VISUALIZATION** — Ram Dass  
Ram Dass guides you through a meditation exercise designed to help you relax, reduce psychological tensions, and develop the compassionate side of your nature. #78

**ASSERTIVENESS TRAINING**  
Robert Alberti & Michael Emmons  
The authors of "Your Perfect Right" and "Stand Up, Speak Out, Talk Back!" explain the theory and practice of assertiveness training. #51

**SOLVING PERSONAL PROBLEMS**  
Michael Mahoney  
Psychologist Mahoney describes his self-help method which listeners can use at home to stop smoking, fight depression, lose weight, ease family squabbling, and attack other personal problems. #52

**UNDERSTANDING AND MANAGING JEALOUSY**  
Gordon Clanton  
Sociologist Clanton discusses the nature of jealousy, and explains how it affects both individuals and society. He suggests techniques for coping, and comments on changing attitudes towards sexual jealousy. #55

**MENTAL STRESS AND PHYSICAL ILLNESS**  
Kenneth R. Pelletier  
Clinical psychologist Pelletier teaches listeners how to recognize illness-provoking stress reactions, and suggests preventive and treatment methods for stress-induced illnesses. #56

**TWO TECHNIQUES FOR TREATING STRESS DISORDERS** — Kenneth R. Pelletier  
Pelletier teaches individuals suffering from stress-related disorders how to assume a meditative body posture and perform a visualization exercise to relieve pain and attack their illness. #57

**THE RESPONSIBLE WORLD OF REALITY THERAPY** — William Glasser  
William Glasser, the father of Reality Therapy, outlines the steps involved in applying his principles to the problems of patients, classrooms, institutions, and your own personal life. #27

**THE FUNCTION AND MEANING OF DREAMS**  
Calvin S. Hall  
Psychologist Hall talks about common themes in dreams, dream symbolism, age and sex differences in dream contents, and gives pointers on how to better recall and record these valuable inner messages. #60

**ALTERNATIVES TO MARRIAGE** — Carl Rogers  
Dr. Rogers discusses marrying versus living together, why it is important to be your own person, the importance of deep communication, why the family is a failing institution. #3

**NON-VERBAL COMMUNICATION**  
Ernest Beier & James Gill  
Body language, gestures, facial expressions, and other kinds of non-verbal "speech" form a rich language. Two psychologists show how this silent language reveals feeling, and suggests why our non-verbal messages are not always consistent with our verbal ones. #24

**ROGERS/SKINNER DEBATE on Education and the Control of Human Behavior**  
Carl R. Rogers and B. F. Skinner  
Edited by Professor Gerald A. Gladstein, University of Rochester  
These debates between Carl Rogers and B. F. Skinner provide invaluable insights into their differing views on free will, the causes of behavior, the importance of mental events, the effects of environment, and the goals of psychology. The 6-cassette set provides nearly 4 hours of dialogue between Rogers and Skinner. The interchange of ideas between these two outstanding authorities on education and human behavior bring the subjects alive in a unique and vital way. Complete Set — 6 Tapes \$49.50 (Outside U.S.A. \$55.00). #S900

**EVERYDAY HEROICS OF LIVING AND DYING**  
Ernest Becker  
Winner of the 1974 Pulitzer Prize for "The Denial of Death", Dr. Becker speaks from his hospital bed shortly before he died of cancer. He lucidly explains his profound theory that the fear of death is behind much of the creativity in human culture and the heroism of individuals. These are some of this brilliant man's last and most moving words about our endless effort to transcend death's inescapability. #29

**COPING WITH DEATH AND DYING**  
Elisabeth Kübler-Ross  
Dr. Kübler-Ross is the leading authority on dying. In these 5 cassettes she draws on more than a decade of her own experience at the bedside of many hundreds of dying patients. Three tapes detail the stages of adjustment to dying — Fear of Death; Verbal and Non-Verbal Symbolical Language; Stages of Dying: Denial, Pseudo-Denial, Anger, Bargaining, Depression, Acceptance or Resignation. The fourth tape describes how children face death, and in the fifth tape, she discusses the needs of the family and friends of someone who dies suddenly. These tapes will assist individuals and families to face the loss of a loved one with greater understanding. Complete Set — 5 Tapes \$39.95 (Outside U.S.A. \$44.95) #S903

**HOW TO HANDLE DEPRESSION** — Frederic F. Flach  
Dr. Flach discusses all aspects of depression, its effects on family life, its relationship to alcoholism, and its prevention and treatment. 2 Cassette Set — \$15.00 (Outside U.S.A. \$18.00) #S400

**PERSONAL POWER** — Carl Rogers  
Dr. Rogers discusses the abuses of power in interpersonal relationships and explains the benefits of a power-free "person-centered" approach to intimate relationships. #65

**REMARRIAGE: PLUSES AND MINUSES**  
Haig Koshkarian  
A discussion of the necessary emotional growth divorced persons must undergo before remarriage. Koshkarian also describes effects of remarriage on children and explains how to ease the situation. #71

Cassettes are \$8.95 ea.  
(unless otherwise noted)  
Outside U.S.A. \$9.95 ea.

Charge your order to your American Express, Visa, Master Charge or Diners Club Account.



# In the Black II

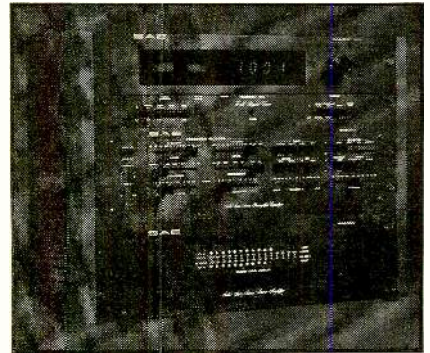

Performance, beauty, quality — three attributes that have always been the hallmarks of SAE products. SAE systems in the past have had them, this system's predecessor had them, and the new In The Black system has them and much more.

The 2900 Parametric Preamplifier offers our new flexible parametric tone control system, full dubbing and tape EQ. New phono and line circuitry results in unparalleled clarity and definition with distortion of less than 0.01% THD & IM.

The 2200 Stereo Power Amplifier with fully complementary circuitry delivers 100 Watts RMS per channel from 20-20K into 8 ohms; at less than 0.05% Total Harmonic Distortion, from 250mW to full rated power.

The 8000 Digital FM Tuner has linear phase filters, phase-lock multiplex, and of course, our famous digital readout tuning indicator system.

Combine these products together and you have a system that ensures superior performance in all areas, excellent control flexibility, and the sonic quality that is typically SAE.

For Complete Information Write:

**SAE**  
Scientific Audio Electronics, Inc.  
P.O. Box 60271 Terminal Annex, Los Angeles, CA 90060

CIRCLE NO. 41 ON READER SERVICE CARD

PSYCHOLOGY TODAY CASSETTES, Dept. D881, P.O. Box 278, Pratt Station, Brooklyn, N.Y. 11205  
Please send the following cassettes at \$8.95 each (unless otherwise noted). Outside U.S.A. \$9.95 each.

Enclosed is \$ \_\_\_\_\_\*. Purchase orders under \$10 not accepted. Cash orders only accepted from outside U.S.A.

CHARGE:  American Express  Master Charge  Visa  Diners Club

Acct. # \_\_\_\_\_ Exp. Date \_\_\_\_\_ Master Charge Interbank # \_\_\_\_\_ 4 #'s over your name

Tape #	Quan.	Tape #	Quan.

Signature \_\_\_\_\_  
Print Name \_\_\_\_\_  
Address \_\_\_\_\_  
City \_\_\_\_\_  
State \_\_\_\_\_ Zip \_\_\_\_\_

\*Residents of CA, CO, FL, IL, MI, MO, NY STATE, DC, and TX add applicable sales tax.



A LOT of people are not going to like what they hear Kate Bush saying in her new album, "The Kick Inside," about being a woman in the Seventies. And perhaps even more are going to object to the way she says it, for in many of her songs she treads on a territory (sex-as-sex-as-sex) long held to be a male preserve. She does so with the same brisk authority and self-possession that has characterized at least some British women since the days of Emmeline Pankhurst, suffragist *extraordinaire*, and for this reason she will surely offend a great many men.

But probably as many women will be equally upset by Kate Bush's candor and honesty, though for a much different reason, the gall-



Harvest Records

## Kate Bush: Uncaged Bird

ingly accurate one given by Germaine Greer in her book, *The Female Eunuch*. Greer says that as far as women's rights and equality are concerned, they are an accomplished fact, that indeed for the last fifty years the cage has been open, *but the bird has refused to fly out*. Bush's frankness and sense of what a female friend of mine calls "gut nooky" will hardly endear her to those women who still cling to the perch while making complaining Twee-tie-Pie denials of their own sexuality.

What is different, however, about Kate Bush—and what makes her songs important—is not agitprop but excellence. With such songs as *Room for Life*, *Feel It*, or *L'Amour Looks Something Like You*, listeners know that they are in the presence of a real person, a real woman who lives in the here-and-now dealing with life as it is being lived, not as it is *supposed* to be lived in the

perfume ads. Bush's females are fully as hungry as males are—not in the angry, doomed, and rather dreary way of the romantic-gone-wrong of *Looking for Mr. Goodbar*, but simply as healthy, alive human beings with sensual and sexual appetites to satisfy. And they are as guiltless about expressing their hunger as most males have been for years.

Consider this from *Feel It*: "Feel your warm hand walking around/I won't pull away, my passion always wins/So keep on a-moving in, keep on a-tuning in/Synchronize rhythm now. . . ." Or this from *L'Amour*: "I'm dying for you just to touch me/And feel all the energy rushing right up-a-me/L'Amour looks something like you." Bush performs these songs with a direct sincerity in an appealing, rather quavery, high-pitched voice that communicates not lubricity but the joy of satisfactory love-making. What we have here is not the eye-rolling lewdness of Xaviera Hollander (the greatest management consultant of modern times), the kinkiness of a Pauline Réage, or even the brittle comedy of sexual manners of an Erica Jong, but a human being telling about one aspect of her humanity.

**T**HERE is a great deal more to Kate Bush and her album than matters sexual, however, and aside from two clinkers—*Wuthering Heights*, a weary rehash about "cruel Heathcliff," and *James and the Cold Gun*, a song about 007 that seems as deliberately nonsensical as the plots of some of the Bond films—all her songs have a lively sense of truth-telling about them. In the lovely *The Man with the Child in His Eyes*, the protagonist confesses, "And here I am again my girl/Wondering what on earth I'm doing here/Maybe he doesn't love me/I just took a trip on my love for him." Probably the strongest song in the album is *Room for the Life*, which in one way is a call to those still-caged Twee-tie-Pies and in another is a simple statement of the perils of freedom, liberation, and independence in the life of any Seventies woman: "Night after night in the quiet house/Plaiting her hair by the fire, woman/With no lover to free her desire/How long do you think she can stick it out/How long do you think before she'll go out, woman/Hey get up on your feet and go get it now/Like it or not we keep bouncing back/Because we're women."

**N**OBODY'S said it better than that in quite a while—not even Katherine Hepburn, who was asked a few years ago if she missed having had a home life because of the demands of her career and replied, "Well, we can't have it *all*, can we?" Kate Bush seems to know and to believe and, most important, to communicate that what women *can* have, if they are honest with themselves, is quite enough. You've come a long way, Emmeline baby!

—Peter Reilly

**KATE BUSH: *The Kick Inside***. Kate Bush (vocals, piano); instrumental accompaniment. *Moving*; *The Saxophone Song*; *Strange Phenomena*; *Kite*; *The Man with the Child in His Eyes*; *Wuthering Heights*; *James and the Cold Gun*; *Feel It*; *Oh to Be in Love*; *L'Amour Looks Something Like You*; *Them Heavy People*; *Room for the Life*; *The Kick Inside*. HARVEST SW-11761 \$6.98, © 8XW-11761 \$7.98.

**DAVID JOHANSEN**. David Johansen (vocals); instrumental accompaniment. *Funky but Chic*; *Girls*; *Pain in My Heart*; *Not That Much*; *Donna*; and four others. BLUE SKY JZ 34926 \$7.98, © JZA 34926 \$7.98, © JZT 34926 \$7.98.

Performance: **Thin**  
Recording: **Thick**

David Johansen is a former member of the New York Dolls, a semi-transvestite group whose shock technique made them locally successful (they were forerunners of American punk) but whose records flopped. His solo album, as you might expect, is loud and coarse, and it appears to have been produced and performed as an exercise in musical nihilism. There is also a cynical feel to its release, as if it was assumed that youngsters are too dumb to appreciate anything but noise. Bad music is bad enough without insulting the audience to boot. Pass this one by. J.V.

**JOHN KAY: *All in Good Time***. John Kay (vocals, guitar); instrumental accompaniment. *Give Me Some News I Can Use*; *The Best Is Barely Good Enough*; *That's When I Think of You*; *Ain't Nobody Home in California*; *Hey, I'm Alright*; and five others. MERCURY SRM-1-3715 \$7.98, © 8-1-3715 \$7.95, © 4-1-3715 \$7.95.

Performance: **Offhand**  
Recording: **Okay**

John Kay, the aging punk who fronted Stephenwolf, has mellowed so much that I half-expected him to break into a chorus of *Born to Be Mild* here. He's even allowed himself to be photographed without his trademark sunglasses. Unsurprisingly, given this sudden failure of nerve, "All in Good Time" comes perilously close to being just another piece of Poolside Rock hack work. Still, there are some of the old blues flashes, and Kay's flair for the topical song remains intact. These qualities, plus a healthily self-deprecating sense of humor (best displayed in *The Best Is Barely Good Enough*, an amusing account of sexual one-upmanship), prevent the album from becoming thoroughly sticky. Just don't expect the "heavy-metal thunder" he used to sing about so convincingly and you'll be fine. S.S.

**THE KINKS: *Misfits***. The Kinks (vocals and instrumentals). *Misfits*; *Hay Fever*; *A Rock 'n' Roll Fantasy*; *In a Foreign Land*; *Permanent Waves*; *Black Messiah*; and four others. ARISTA AB 4167 \$7.98.

Performance: **Very good**  
Recording: **Very good**

Let's hear it for adult rock. This is not a great Kinks album, but it is solid enough to suggest that what this country needs is more rock made by people who, in Ray Davies' words, ". . . don't want to live in a rock 'n' roll fantasy, don't want to live on the edge of reality." "Misfits" is relatively free of the usual frills on a Kinks album (the sleazy horn section is gone), and it touches on various Ray Davies themes with a song about a transvestite (again) and some new stuff about politics that is almost apolitical (compared with some of Davies' old stuff on the subject). The band rocks a little slicker than it once did, but it still finds spontaneity now and then and still toys with nuance more than most rock bands were ever able to. At times I'm bothered by not be-



ing able to figure out what *drives* Davies, as the voice of the Kinks, nowadays—but at other times that doesn't bother me a bit. N.C.

**ELLEN McILWAINE.** Ellen McIlwaine (vocals, guitar); instrumental accompaniment. *Isn't That So; You May Be All I Need; Lover's Lane; We Got Each Other*; and six others. UNITED ARTISTS UA-LA851-H \$7.98, © EA851-H \$7.98, © CA851-H \$7.98.

Performance: **Rat-a-tat-tat**  
Recording: **Good**

Ellen McIlwaine's new musical style is fast and sharp, and her performing manner is urgently staccato. The material that she's chosen here, however, is not very responsive to such goosing, and most of the time she ends up sounding like the breathless moll in an old-time gangster movie. It all really comes tumbling down in her version of Elton John and Bernie Taupin's *The Last Good Man in My Life*, in which she strays so far from the song's intention that it emerges as neither fish nor fowl (nor apple nor orange). Confusing.

P.R.

#### RECORDING OF SPECIAL MERIT

**MINK DEVILLE:** *Return to Magenta*. Mink DeVille (vocals and instrumentals). *Soul Twist; "A" Train Lady; Desperate Days; Just Your Friends*; and five others. CAPITOL SW-11780 \$7.98.

Performance: **Spectacular**  
Recording: **Excellent**

I am tempted to say that Jack Nitzche's production work is the real star here, but that would be unfair. Good as his work is (and it's among the most creative and musical I've heard in what seems like ages—there are some startlingly intelligent things going on in terms of aural perspectives and snappy arrangements), this is clearly a collaborative venture. Willy DeVille and the rest of the band seem equally responsible for the measurable improvement "Return to Magenta" displays over their excellent debut opus. In particular, Willy's singing is less mannered and more personal, more stylistically assured. The obvious Mick Jagger/Lou Reed affectations are all but gone; in fact, he cuts quite a convincing old-time r-&-b figure. The album veers schizophrenically, but most attractively, between Phil Spectorish ballads and sizzling hard (pre-metal) rock, and if you can imagine the Asbury Jukes doing Howlin' Wolf, or John Fogerty's Creedence Clearwater with Latin influences, you'll have a pretty fair idea of what it sounds like—which is, in a word, terrific.

S.S.

#### RECORDING OF SPECIAL MERIT

**MICKEY NEWBURY:** *His Eye Is on the Sparrow*. Mickey Newbury (vocals, guitar); instrumental accompaniment. *Gone to Alabama; Wish I Was; Saint Cecilia*; and seven others. HICKORY HA-44011 \$6.98, © 8311-44011(H) \$7.95, © 5311-44011(H) \$7.95.

Performance: **Very fine**  
Recording: **Good**

Mickey Newbury doesn't categorize easily. He's not c-&-w, he's not folk, and he's not really a troubadour. He's just Mickey Newbury. His songs have a wistful, empty-plain aura about them that's truly American, and



For a free booklet on old bottles, crocks and jugs, write Boss Edens at The Distillery.

THESE OLD BOTTLES go back to the days when Jack Daniel made them to observe special occasions.

One was for winning the Gold Medal at the 1904 World's Fair. And another, in 1896, on the 100th anniversary of Tennessee statehood. He even had his nephew make a special bottle for his favorite hotel, the Maxwell House, in Nashville.

But when it came to whiskey, Mr. Jack insisted on charcoal mellowing every drop. He was too good a whiskey man to change that, no matter what the occasion.



CHARCOAL  
MELLOWED  
DROPS  
BY DROP

Tennessee Whiskey • 90 Proof • Distilled and Bottled by Jack Daniel Distillery  
Lem Motlow, Prop., Inc., Lynchburg (Pop. 361), Tennessee 37352  
Placed in the National Register of Historic Places by the United States Government.



**Audio Discount**  
**WAREHOUSE SALES**  
 DIRECT TO PUBLIC  
**"HOT STUFF"**  
 CALL TOLL FREE  
**800-631-2175**  
 FOR ORDERS & PRICE QUOTES

**LARGEST SELECTION  
 LOWEST PRICED ANYWHERE**

RECEIVERS	TURNTABLES	TUNERS
SPEAKERS	CHANGERS	CARTRIDGES
TAPE DECKS	AMPLIFIERS	HEADPHONES
PRE-AMPS	COMPACTS	CAR AUDIOS

**BIC**  
**960** — PAK B WITH WOOD BASE,  
 DUST COVER, SHURE CARTRIDGE



**\$129**

**PIONEER SX-750**



**\$249**

50 Watts Per Channel

**PIONEER**



**\$391**

RT-707 3-MOTOR 4-HEAD AUTO-  
 REVERSE STEREO TAPE DECK. 1/4  
 TR., 7 1/2", 3 3/4" LIST \$575.00

**TEAC**

**A-103** Stereo Cassette Deck with Dolby System **\$165**

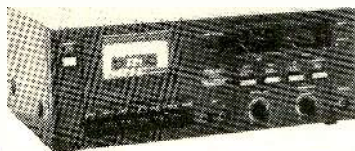

**KOSS**

**PRO/4 Triple A.**  
**\$42.95**



**TDK**

Case of 10 — \$28.

Avilyn has greater sensitivity than even the best chrome tape, especially in the low and middle range, it performs with less distortion.

**CALL TODAY  
 TOLL FREE**

**800-631-2175**

MASTER CHARGE/BANKAMERICARD  
 HONORED ON PHONE ORDERS

175 MONMOUTH RD.  
 W. LONG BRANCH, N.J. 07764  
 201-229-3300



CIRCLE NO. 6 ON READER SERVICE CARD

his performances have a warm, sympathetic quality that is intimate without being cloying or overly folksy. His new album is another handsomely crafted piece of work that deserves wider popularity than it will probably get. He deliberately keeps a low profile, but his innate sincerity as a composer-performer shines through such things as *Juble Lee's Revival*, *Wish I Was*, and *Gone to Alabama*. A fine, unclamorous album by a man who transmits deep feelings with astonishing ease. P.R.

**RECORDING OF SPECIAL MERIT**

**O'JAYS: *So Full of Love*.** O'Jays (vocals); instrumental accompaniment. *Sing My Heart Out*; *Use ta Be My Girl*; *Cry Together*; *Strokey Stroke*; and four others. PHILADELPHIA INTERNATIONAL JZ 35355 \$7.98, © PZA 35355 \$7.98, © PZT 35355 \$7.98.

Performance: **Looking up**  
 Recording: **Very good**

What a joy it is to hear the O'Jays actually singing again! This album has everything that was lacking in their last set, "Traveling at the Speed of Thought" (Philadelphia International PZ 34584). There, the overblown bass and frantic pace blurred into a hectic haze as the O'Jays shrieked away in the background. Here, fortunately, the focus is exclusively on the vocal excellence of this trio, who, at their best, can bring an impassioned interpretation to the simplest of lyrics. Evidently the recording of this disc spurred composer/producers Kenny Gamble and Leon Huff to rise above the triteness that has marred their recent efforts. *Sing My Heart Out* is an intense evocation of the emotions that must surge through a performer as he faces his audience, and *Cry Together* seems more honestly realistic than most fighting-and-making-up songs. Armed with first-rate material, the O'Jays weave a spell of soulful inspiration. More!

P.G.

**STELLA PARTON.** Stella Parton (vocals); instrumental accompaniment. *Four Little Letters*; *Love Is a Word*; *Haven't You Heard*; *Lie to Linda*; *Down to Earth*; and five others. ELEKTRA 6E-126 \$7.98, © ET8-126 \$7.98, © TC5-126 \$7.98.

Performance: **Real nice**  
 Recording: **Real good**

As everyone knows by now, there is more than enough of Dolly Parton to go around. But for those insatiables who yearn for even more, Elektra has been offering Dolly's sister Stella in albums of her own; this is her second on the label. Slimmer, more in the Angie Dickenson style in looks, but sharing her sister's real nice country ways and lachrymose adjustment to life, Stella gives the inimitable Parton touch to such songs as *Haven't You Heard* ("Mommy's gone crazy... my daddy is gone..."). In it she plays both the conniving but guilt-ridden virago who has lured away her best friend's husband and the little boy who's trying to comfort poor Mommy—who, naturally, is a wreck about the whole ugly business. You'd better believe that it's the kind of gasper that'll set the mobile-home circuit ablaze with its real-life drama. Stella's repertoire doesn't include any of Dolly's songs (obviously no personal affront is intended, because Dolly and the rest of the Parton clan join Stella in her final number, *Down to Earth*), but it doesn't matter since Stella

seems to have her own sources. Actually, this is a good, very professional recording. P.R.

**PEZBAND: *Laughing in the Dark*.** Pezband (vocals and instrumentals). *Loves Goes Underground*; *I'm Leavin'*; *Stop! Wait a Minute*; *Come On Madeline*; *I'm the One*; *Better Way to Win*; and six others. PASSPORT PB-9826 \$7.98, © 8167-9826(H) \$7.95, © 5167-9826(H) \$7.95.

Performance: **Déjà vu**  
 Recording: **Good**

Suddenly it's 1966, and England is still merry. That's the effect Pezband has on first, second, and third hearing. But can a group that sings an item called *Come On Madeline* be serious? The young lady's name has not been used in a pop song (so far as I remember) since the 1920's ditty *Paddlin' Madeline Home* (about the joys of returning one's sweetie to her door in a canoe). And what of *Gimme Gimme*, which owes part of its title and some of its construction to an American bubblegum hit of 1969, *Gimme Gimme Good Lovin'* (by Flying Elephant, a forgotten studio group)? Can this be for real? Well, suppose Pezband has made a considered choice to play 1960's British pop/rock laced with American touches—there's nothing wrong with that. It's not the most expedient way to sell records or grab for pop stardom in today's market, but who knows?—maybe the British Invasion can be repeated. The band members even wear—get ready—*neckties*.

My own feeling is that Pezband is earnest and sincere. The music ain't cosmic, but it sure feels good. J.V.

**RECORDING OF SPECIAL MERIT**

**JOHN PRINE: *Bruised Orange*.** John Prine (vocals, guitar); instrumental accompaniment. *Fish and Whistle*; *There She Goes*; *Sabu Visits the Twin Cities Alone*; *Aw Heck*; and six others. ASYLUM 6E-139 \$7.98.

Performance: **Appealing**  
 Recording: **Excellent**

This was attractively produced by John Prine's friend Steve Goodman and generally sounds great, although it does a little less with words than we've come to expect of Prine. Goodman repeatedly gives Prine just the right-size backing and manages to give a feeling of unity while changing from rock to folk, via country, or from electric guitar and organ through pedal steel and harmonica and on to recorder and other quaint woodwinds. Sounds as if the producer knows Prine better than any of his other producers have, which of course is the case. So it is one of the best-sounding Prine albums so far. Lyrically, though, Prine seems to be doing just enough to get by. The automatic things about him—such as how concrete his language is, as when he starts a song with "My heart's in the icehouse"—happen in this one, and of course that alone puts it a cut above many other albums; yet he has made an awful lot of lines sound like throwaways. He challenges you less often than he would have a year or so ago, and the only thing that bothers me about that is deciding whether it means that he's not up to it or I'm not. N.C.

**PURE PRAIRIE LEAGUE: *Just Fly*.** Pure Prairie League (vocals and instrumentals).  
 (Continued on page 102)



# Stereo Review's

## 'HOW TO' REPRINT SERIES

Whether you are about to buy your first high-fidelity component or your fifteenth, you need to have all the facts you can get your hands on if you want to insure your complete satisfaction. Yes, the audio field is a complicated one, but *Stereo Review* has been running a kind of monthly seminar on the subject for almost two decades now, furnishing the kind of basic buying, installation, and operating guidance you can get nowhere

else. Today, over 450,000 readers use it monthly as the first, best textbook in their on-going audio educations. If you have come a little late to class, here's your chance to catch up. Any questions you may have about *How to Buy*, *How to Set Up*, *How to Use*, or *How to Understand* audio equipment are probably answered in one or more of the reprints listed below.

✓ DENOTES NEW REPRINTS AVAILABLE FOR THE FIRST TIME.

1. ROOM ACOUSTICS (How to Correct Your Room Acoustics)
2. GUIDELINES TO SPEAKER SHOPPING
3. RECORD DEFECTS (Their Causes & Cures)
4. LOUDSPEAKER POWER NEEDS (How Much Power Do You Need for Your Speakers)
- \* 5. HOW IMPORTANT IS AUDIO-COMPONENT COMPATIBILITY?
6. GUIDE TO UPGRADING YOUR COMPONENTS
7. HOW TO SELECT A MICROPHONE
8. HOW TO CHOOSE AN AMPLIFIER
9. HI-FI TROUBLESHOOTING CHARTS
10. SPEAKER MYTHS (How to Avoid Bad Choices)
12. HOW TO SELECT AN FM TUNER
13. HI-FI DEMONSTRATION DISCS
- \* 14. AUDIO EQUALIZERS (Understanding and Choosing Equalizers)
15. CLEAN UP AND TUNE UP YOUR AUDIO SYSTEM
17. USING FM INTERSTATION HISS TO TEST RECORDERS AND SPEAKERS
18. HOW TO BUY A RECEIVER
19. HOW TO BUY A PHONO CARTRIDGE
20. THE PROFESSIONAL APPROACH TO TAPE RECORDING
- \* 21. HOW TO ELIMINATE RADIO-FREQUENCY INTERFERENCE
- ✓\* 22. NOISE REDUCERS
- ✓ 23. UNDERSTANDING RECORD PLAYERS
- ✓ 24. HOW TO BUY HI FI (A Beginners Guide To Hi Fi)
- ✓ 25. HOW TO BUY A CASSETTE DECK

\*Reprints marked with Asterisk \$1.50. All others, \$1.00. Minimum order \$3.00.

STEREO REVIEW REPRINTS, Dept D878  
P.O. Box 278, Pratt Station  
Brooklyn, New York 11205

Please send the reprints listed below:

\$1.00 EACH

Reprint #	Quan.	Reprint #	Quan.

\$1.50 EACH

Reprint #	Quan.	Reprint #	Quan.

NUMBER OF REPRINTS ORDERED:

@ \$1.00 \_\_\_\_\_ @ \$1.50 \_\_\_\_\_

TOTAL ENCLOSED  
(MINIMUM ORDER \$3) \_\_\_\_\_ †  
† Residents of CA, CO, DC, FL, IL, MI, MO, NY STATE, TX,  
AND VT add applicable sales tax. Outside U.S.A. add  
\$1.00 per order.

Print Name \_\_\_\_\_

Address \_\_\_\_\_

City \_\_\_\_\_

State \_\_\_\_\_ Zip \_\_\_\_\_



Place in the Middle; Slim Pickin's; Love Will Grow; and six others. RCA AFL1-2590 \$7.98, © AFS1-2590 \$7.98, © AFK1-2590 \$7.98.

Performance: **Variable**  
Recording: **Very good**

When this album is bad, as in *You Don't Have to Be Alone* or *Working in a Coal Mine*, it is most annoying, but when it is good, as in *Love Is Falling* or the title song, it is only mildly annoying. Pure Prairie League has evolved into a straight rock band—quite straight, I'd say, since it's dropped the cowboy pretenses—and is now trying to sound the way the Norman Rockwell-like cover photo looks. It is a group without a distinctive style of its own. One can see what sets Commander Cody slightly apart

from the others, or what sets the Eagles apart, and so on, but with Pure Prairie League the identifying gimmick seems to be that this is one that *isn't* set apart. "Just Fly" is as weak as its songs. N.C.

**HELEN REDDY: We'll Sing in the Sunshine.** Helen Reddy (vocals); instrumental accompaniment. *Catch My Breath; Blue; Lady of the Night*; and six others. CAPITOL SW-11759 \$6.98, © 8XW-11759 \$7.98, © 4XW-11759 \$7.98.

Performance: **Gritty**  
Recording: **Good**

Instead of becoming the superstar it seemed she was about to be a few years ago, Helen

Reddy has become a superprofessional. Her albums have been like a flight of highly polished, beautifully weighted chrome darts, all aimed at the MOR charts. From the beginning, her lyric readings have lacked communicative passion, no matter how strong they were. Nowhere is it more obvious that she chooses to substitute a fierce, gritty pose of defiance for a true sharing of a variety of feelings with the listener than in her more dramatic material, such as *Lady of the Night*. Possessing sentiments is not necessarily to indulge in sentimentality, a difference that Reddy doesn't seem to grasp. She's gotten as mechanical in her anger as Julie Andrews is in her mannered smilin'-through cheer. And, unfortunately, even with her undoubted technical gifts, she's gotten just as boring. This cold and tense group of performances could use a ray of the sunshine of the title. P.R.

**THE ROLLING STONES: Some Girls.** The Rolling Stones (vocals and instrumentals). *Miss You; When the Whip Comes Down; Just My Imagination; Some Girls; Lies; Far Away Eyes*; and four others. ROLLING STONES COC 39108 \$7.98, © TP 39108 \$7.98, © CS 39108 \$7.98.

Performance: **Contemptuous**  
Recording: **Good**

After the collage of fluff that was "Black and Blue," I thought that nothing could get me interested in the Stones again, but I just *had* to review "Some Girls." Hearing *Miss You* and *Far Away Eyes* on the radio, I marveled at how these guys could actually manage to fit so much contempt for so many—Stones fans, disco fans, Latin women, country audiences—onto one little single. The album cover of this one, with its take-off on Frederick's of Hollywood drag-queen sleaze, shows quite explicitly not only what the Stones think of women, but also what they think of themselves: they consider both to be cheap, tawdry trash good only for a quick, transient kick. It's fitting that they should end this way (and though it be protracted beyond belief, the end is certainly coming), because anyone who heaps as much contempt on as many people as the Stones have these past few years must inevitably come to an even greater contempt for themselves. "Some Girls" is supremely indicative of what "decadence" is really about: passivity and boredom.

Almost all the songs here are supposedly about women or the Stones' feelings toward them, yet not one depicts a real relationship or any genuine emotion other than greed. What, for instance, is *Miss You* about? Where is the expression of true longing, the lineaments of true love? Mick seems to be singing from some indifferent twilight, occasionally emerging just long enough to embarrass himself with a limp display of would-be heavy vocal calisthenics: "People think I'm craaaazzzzzy. . . ."

The title track is perhaps the most disgusting song of all in its attitude toward women—or perhaps toward other humans in general. If empathy is too much to expect, one might at least ask for some insight, and "Some girls take the shirt off my back/And leave me with a lethal dose" just doesn't quite fill the bill. What it really comes down to is a matter of what portion of humanity can be bought and sold.

Money is a crucial factor in *Beast of Burden*, which may be why what might have been

# "SPECTACULAR"

and other comments from audio critics  
about Ohm L loudspeakers:



Comments from  
**Stereo Review:**

"In summary, the Ohm L...is easily good enough to meet the sort of critical standards usually applied to much larger and considerably more expensive speaker systems.

The upper mid-range and high frequencies were virtually perfect. The balance between lows and highs was excellent... Blindfolded, one would never guess its compact dimensions." (Copyright 1977 by Ziff-Davis Publishing Company. Reprinted from *Stereo Review*, June 1977, by permission. All rights reserved).

Comments from  
**The Complete Buyer's Guide to Stereo/Hifi Equipment:**

"Ohm was among the first companies to take advantage of A.N. Thiele's research into vent-

ed loudspeakers, with some pretty spectacular results...In listening to the Ohm L, the immediate reaction is one of surprise at the openness of the sound. In addition, the frequency response of the speaker is exemplary. And the mid-range, which is often a weak point in speakers of this size and price, is very good. There is no sense of strain, and voices sound utterly natural....(it's) more suitable for use in larger rooms than its dimensions might indicate and we recommend it highly."

For a free reprint of thirteen complete reviews of Ohm speakers priced from \$100 to \$700, please write us at:

241 Taaffe Pl.,  
Brooklyn, N.Y.   
11205  
**We make loudspeakers correctly.**



a worthwhile song about the difficulties of love degenerates so quickly into cliché: "You can put me out on the street/Put me out with no shoes upon my feet." And are those imitation Bee Gees falsetto chirpings that we hear in the bridge? The Stones have always followed the trends of the day, but once they took them up as a challenge. Now they just tag along after them meekly, melding them with those Same Old Stones Riffs and occasional bits looted from other (usually black) sources. *Respectable*, for instance, is *All Down the Line/Silver Train* stapled to an old Isley Brothers cop. It's almost fun, except that you've heard it all before. Meanwhile, Keith Richard and Ron Wood play guitar solos. They play a lot of guitar solos on this album, on all kinds of guitars. I'm told that between the two of them they own hundreds, and I think that's very nice for them. But why do they play with such faraway hands?

*Just My Imagination* is just inferior, though comparing it with the Temptations' original does remind you of what, besides true gutbucket kick, has been missing from the Stones' music for a long time: heart. Even those who would say that the Stones never had much heart in the first place (which I don't believe) would have to give the band that used to stand inside these shells credit for honesty. And there are two songs here that sound like they might be about halfway honest. Keith's *Before They Make Me Run* suggests that he might have a future in drugged-out country rock. This is the only song on the album that's about an instantly recognizable real-life situation—Keith's recent Canadian drug bust. There's a similar sort of tentative tiptoe toward self-recognition, on Mick's part this time, in *Shattered*, but any real soul searching is averted through pretentious quasi-sociological jottings: "Rats on the West Side, bedbugs uptown..." Like *When the Whip Comes Down*, *Shattered* could be in part about a male hustler, but seen without compassion (something even male hustlers, perhaps especially male hustlers, deserve) or even understanding.

Supposedly the Stones selected the ten tracks here from about eighty recorded in Paris at the same time. A guitarist friend remarked cynically the other day that now they can just sit back and keep releasing the rest for the next five years. If these are really the best of the bunch, I would invite you to join me in responding to such a gesture of contempt in kind: by sitting back and not buying any more of this drivel, for who has really bought it this time is the Stones themselves.

—Lester Bangs

**TODD RUNDGREN: *Hermit of Mink Hollow*.** Todd Rundgren (vocals and instrumentals). *All the Children Sing; Can We Still Be Friends; Hurting for You; Onomatopoeia; Determination; You Cried Wolf*; and five others. BEARSVILLE BRK 6981 \$7.98, Ⓜ M8 6981 \$7.97, © M5 6981 \$7.97.

Performance: **One-man bland**  
Recording: **Good**

It's been a while since anyone worked so hard to make such a bad album as this. Todd Rundgren apparently did everything: wrote all the songs, played all the instruments, dubbed all the voices, and, of course, did his customary plastic-coated Phil Spector number on the production. Some of the songs could be interesting if they weren't so overarranged. *Bread*,

for example, has Rundgren the writer completely undone by Rundgren the arranger. The overall effect is that of prolonged, vaguely melodic noise. It actually gives me a headache if I crank the machine up too loud. But that's not what bothers me most about it. What bothers me most is the idea that someone would go to such trouble to run off such a piece of junk. People have turned out albums almost as unpleasant with a tenth of the effort, which seems more in touch with the times, what with the energy shortage and all.

N.C.

**SEALS AND CROFTS: *Takin' It Easy*.** Jim Seals (vocals, guitar); Dash Crofts (vocals, mandolin); other musicians. *Takin' It Easy*;

*One More Time; Midnight Blue; You're the Love; Sunrise; Magnolia Moon*; and five others. WARNER BROS. BSK 3163 \$7.98, Ⓜ M8 3163 \$7.97, © M5 3163 \$7.97.

Performance: **Ornate and formal**  
Recording: **Ditto**

Still at it, still fortified by good taste, still plugging the Bahai faith, still painstakingly produced by Louie Shelton, Seals and Crofts have nevertheless changed quite a bit over the years. It's just that it's been so gradual. If you listened to this one and their first or second album back-to-back, it might be an eyebrow-cocking exercise. A lot of their rakishness and spontaneity have been polished out; indeed, here they seem more like front men than any-

# The Distinction Series

Sonic excellence, created by  **crown**



DL-2 Controller (plus power supply and phono pre-amp)

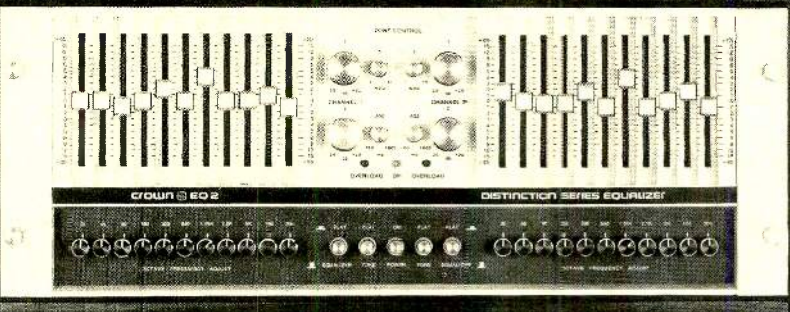

EQ-2 Equalizer



SA-2 Power amplifier, 221 watts/ch., min. RMS into 8Ω, 1 Hz-20 kHz, THD 0.05%

The Distinction Series was developed for the discriminating listener who demands equipment meeting the highest standards of audio technology. For further information, see your dealer or write:

 **crown**  
 1718 W. Mishawaka Road, Elkhart, Indiana 46514





Atlantic Records

## Aretha: She May Be Just Your Speed

IT has been more than ten years since Aretha Franklin sent up the mighty shout that set the tone and tempo for the soul explosion of the Sixties, and she remains the doyenne of soul today. In an era that has seen musical fashions fluctuate madly within a mere fortnight, Aretha has elected to continue sounding much as she did a decade ago. And that should be good enough for just about anybody who enjoys rhythm-and-blues.

In terms of overall quality, Aretha's latest album, "Almighty Fire," is comfortably in the upper half of her total output, though not quite up to her peak efforts. She has apparently found a suitable collaborator in Curtis Mayfield, who serves here as composer, producer, and lead guitarist; he also performed

the first two functions on a previous album, "Sparkle" (Atlantic SD 18176), that seemed to make most folks happy. Mayfield has a knack for coming up with buoyant (though seldom memorable) melodies that give ample latitude for Aretha to holler, moan, and "whoo-oo-oo-yeah" her way through with the sort of gospel-derived funk that has been her hallmark. She can do just about anything she wants without having Mayfield's songs get in her way; even the lyrics seem to exist only to serve her highly stylized manipulation of them. (I'm still trying to figure out just what she's saying on the title track—subtitled *Woman of the Future*—though whatever the message is, she gives it a wondrous wallop.)

THERE are several reasons why this set goes over well, beginning with the enticing album cover, on which musical notation and images of flames are superimposed over Aretha's sensitive face. Many of the cuts have her working more closely with a female background group than on some of her other recent outings, and the combination has always seemed to spur her on to more spirited heights. Though the songs that follow the rousing opener on the first side border on monotony, the flip side projects Aretha in a more intimate mood, and she does some of her best work when she sings directly to the listener. *Close to You* and *This You Can Believe* are clear standouts, but the final number—*I'm Your Speed*, a deceptively simple ballad accompanied only by sparse but choice piano chords—is a special treat. It is the only selection on "Almighty Fire" composed by Aretha (together with Glynn Turman, the accomplished actor who is her new mate), and it rings true to the heart. That, perhaps, is why she sounds so much happier this time out than she often has in the past. —Phyl Garland

**ARETHA FRANKLIN: *Almighty Fire*.** Aretha Franklin (vocals); Curtis Mayfield (guitar); vocal and instrumental accompaniment. *Almighty Fire (Woman of the Future); Lady, Lady; More Than Just a Joy; Keep On Loving You; I Needed You Baby; Close to You; No Matter Who You Love; This You Can Believe; I'm Your Speed.* ATLANTIC SD 19161 \$7.98, © TP-19161 \$7.97, © CS 19161 \$7.97.

thing else, as their own instruments don't figure into the sound very much and their own voices, while not often actually awash in a wave of "background" singing, might as well be. They aren't very assertive, that is, possibly because several of the songs won't let them be. On the other hand, the boys seem to have widening musical horizons—among other things they strike up a disco tune here, *You're the Love*, and do a pretty slick job of it. Musicians, like people, are always in a state of becoming, and I doubt that Seals and Crofts are really becoming the compulsive planners, the please-everyone middle-of-the-road huggers much of this album suggests. I suspect they were taking it easy, at least once they got into the studio, letting the producer have his head. If normal patterns hold, they'll do this until it's clearly been taken too far, and then they'll swing back to the basics and

make simpler and more distinctly Seals and Crofts albums. And frankly, I'd rather have one of those. N.C.

**STANKY BROWN.** Stanky Brown (vocals and instrumentals). *Around Town; Chains; Falling Fast; Master of Disguise; She's a Taker; You Make It Happen for Me;* and four others. SIRE SRK 6053 \$7.98.

Performance: **Good**  
Recording: **Good**

Stanky Brown is a New Jersey group with a sound they describe as "suburban" to distinguish it from the r-&-b-based sound of Asbury Park disseminated by Bruce Springsteen and Southside Johnny. The music is fresh-faced and well-scrubbed, aimed at white top-forty pop, but it has a bit of class and the band has a good ensemble sound. *Falling Fast* and

*Master of Disguise*, both originals, are solid items, and the group has politely raunchy fun with the fine old Gerry Goffin/Carole King tune *Chains*, which the Beatles recorded in 1963. Nice work, lads. J.V.

**THE STATLER BROTHERS: *Entertainers . . . On and Off the Record*.** The Statler Brothers (vocals); instrumental accompaniment. *Do You Know You Are My Sunshine; Yours Love; The Best That I Can Do; You're the First; Tomorrow Is Your Friend; Who Am I to Say;* and five others. MERCURY SRM-1-5007 \$7.98, © MC8-1-5007 \$7.95, © MCR4-1-5007 \$7.95.

Performance: **Very good**  
Recording: **Good**

The Statler Brothers use the Southern gospel quartet sound for secular purposes; in fact, they manage to keep that sound pretty much intact and at the same time suggest somehow that they themselves are reasonably hip, up-to-date secular characters. I haven't liked many of their albums, at least compared with the impression they make live, but this one wears pretty well. It doesn't make a lame attempt at humor as their past ones often have, and it has one of those Jerry Kennedy production treatments that would give Mr. Clean an inferiority complex. Nothing spectacular, you understand, but a couple of songs that aren't too bad and some good quartet singing throughout. N.C.

### RECORDING OF SPECIAL MERIT

**KATE TAYLOR.** Kate Taylor (vocals); James Taylor (guitar, vocals); Stephen Gadd (drums); Will Lee (bass); other musicians. *A Fool in Love; Smuggler's Song; Harriet Tubman; Stubborn Kind of Woman; Rodeo; Jason and Ida; It's Growin'; Happy Birthday Sweet Darling;* and three others. COLUMBIA JC 35089 \$7.98, © JCA 35089 \$7.98, © JCT 35089 \$7.98.

Performance: **Well Tailored**  
Recording: **Bold and good**

We haven't heard from this particular Taylor in a while, but she still has those family peculiarities of inflection and phrasing that, to me, go better with boys' voices than with girls'. However, she demonstrates here that making good albums goes beyond the question of whether the singer has a hell of a lot of style. The *album*, now, is neat, mostly. The brothers, except for Livingston, sing in the background now and then, and she does *Rodeo*, one of Liv's songs. The only thing that threatens to torpedo the project, actually, is one of James' songs, *Happy Birthday Sweet Darling*, a non-rewrite of the old chant grafted onto a grindingly monotonous refrain; it's possibly the rottenest song of the year. But then there's a little jewel called *Smuggler's Song*, by Ethan Signer and Clay Jackson, that toys with the idea of profiting from a dear one's misfortune and the ensuing ambiguities that we usually don't admit, even to ourselves, even in a song. And there are other nice, low-profile things, including one James helped write. James and Lew Hahn, as producers, deserve kudos for the good, clean sound and for letting the bass be relatively as loud as you'd hear it in a club—which for some reason it usually isn't in albums by folk-rock singers. And Kate, for all her flat-statement  
(Continued on page 106)



1947.  
The MG-TC.

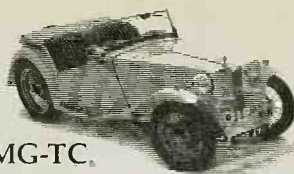

1953.  
The Corvette



1970.  
The 240-Z

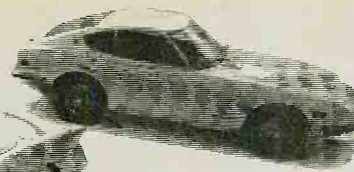

# Now, the Mazda RX-7.



## If not this time, when?

The MG-TC in 1947. Tweed caps and stringback gloves. The 'Vette in 1953. Easing into the drive-in with the top laid back. The 240-Z in 1970. Makin' it down to Malibu at 6,500 on the tach. Those were cars that made you feel different about driving. They don't come along very often. But now there's the 1979 Mazda RX-7.

Its performance: 0 to 50 in 6.3 seconds with the smooth power of Mazda's latest rotary engine. Surefooted handling with the impeccable balance of a front mid-engine design.

Yet the RX-7 is civilized, with standard features like AM/FM stereo with power antenna. Quartz clock. Electric rear window defroster and side window demisters. Tinted glass. Full instru-

mentation, including a combination tach and voltmeter. The GS-Model shown here adds things like 5-speed, wider tires, electric remote hatch release, windshield sunshade band, rear stabilizer and more.

For once in your life, do what you really want to do. How often do you get a chance to own a car you'll remember for the rest of your life?

**WARRANTY** Mazda warrants that the basic engine block and its internal parts will be free of defects with normal use and prescribed maintenance for 3 years or 50,000 miles, whichever comes first, or Mazda will fix it free. This transferable limited warranty is free on all new rotary-engine Mazda RX-7's sold and serviced in the United States and Canada.

### From \$6,395\*

GS-Model shown: \$6,995\*

## The car you've been waiting for is waiting for you.

# MAZDA

\*POE price for S-Model: \$6,395. For GS-Model shown: \$6,995. (Slightly higher in California.) Taxes, license, freight and optional equipment are extra. (Wide alloy wheels shown above \$250 extra.) Mazda's rotary engine licensed by NSU-WANKEL.

CIRCLE NO. 34 ON READER SERVICE CARD



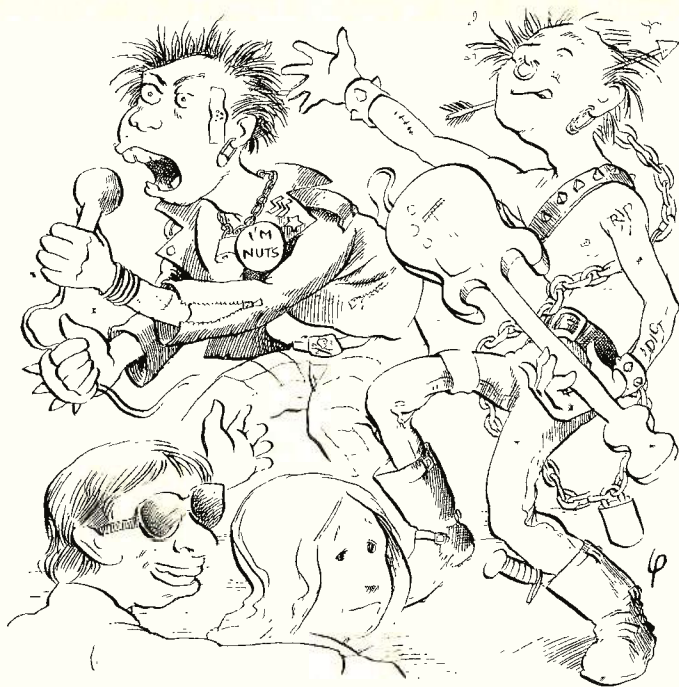

"Now that's Punk Rock." . . . "It sure is!"

delivery blandness, does have an accurate voice that's easy enough to take—it lets you get through it easily to what the *song* says, which is often just what you want. And this time she's reasonably loose most of the time

and, best of all, sounds capable of making an even better album than this. N.C.

**TOBY BEAU.** Toby Beau (vocals and instrumentals). *Moonshine; California; Same Old*

*Line; Into the Night; My Angel Baby; Buckaroo; and five others.* RCA AFL1-2771 \$7.98.

Performance: **Good sing, no write**  
Recording: **Very good**

Language to a lyricist is like a ground ball to a shortstop: he's got to be unawed by it; he's got to play *it* and not let it play him. The lads in Toby Beau let the language play them. One song after another has a sort of amateurish, "Look Ma, I'm songwritin'" tone to it, and the tunes are only slightly more lively than the words. The singing, especially the harmony singing, is the real attraction. The instrumentals, though dependable, are Southern California amorphous (the boys are actually from Texas), from acoustic to "tasteful" electric. They ought to try it again with a real script. N.C.

**U.K. U.K.** (vocals and instrumentals). *Alaska; In the Dead of Night; By the Light of Day; Presto Vivace and Reprise; and four others.* POLYDOR PD-1-6146 \$7.98, Ⓢ 8T-1-6146(A) \$7.98, © CT-1-6146(A) \$7.98.

Performance: **Art-rock clichés**  
Recording: **Excellent**

U.K. is a sort of progressive version of Foreigner; that is, it's a bunch of fairly well-known Big Names out of the Yes/Genesis axis regrouped and ready, if you believe the hype, to play the best music of their careers. That music, unfortunately, turns out mostly to be the usual art-rock clichés: percussive electric-bass ostinatos, ridiculously baroque synthesizer decorations of the most basic

## Like.

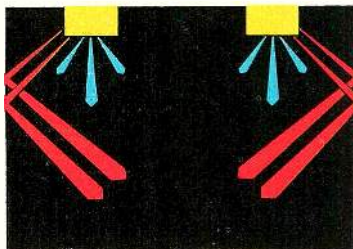

The Model 301. A true bookshelf speaker that fills an entire library with music. Its size is small, its sound is big. Like all Bose speakers, the Model 301 directs sound off your walls for an open, spacious sound. The Direct Energy Control shapes the sound to suit your music, and your room. You get large, life-like sound you don't expect from a speaker of its size and price.

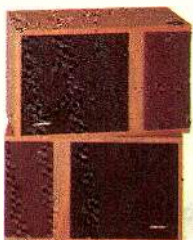

## More Like.

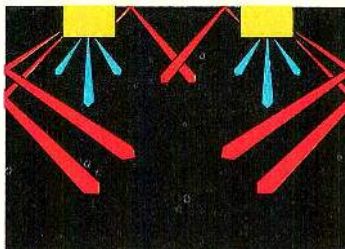

For sound that's even more like live, try the Model 501. A floor-standing speaker that delivers wall-shaking bass through a 10-inch, high-performance woofer. Each speaker is "asymmetrical." The left speaker works with the right to create full, rich, balanced stereo. Throughout your entire room. And you can use the Direct Energy Control to shape the sound to fit your room.

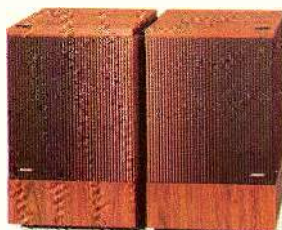

## Most Like.

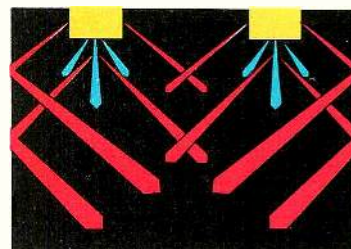

Still closer to the sound of live is the high-performance Model 601. Six drivers in each enclosure are precisely positioned to fill the room with clean, accurate music. This configuration produces the exceptional spatial realism of the Model 601. A Symmetry Control lets you adjust the spatial characteristics to fit your living room. The Model 601 delivers life-like sound better than any other speaker. Except one.

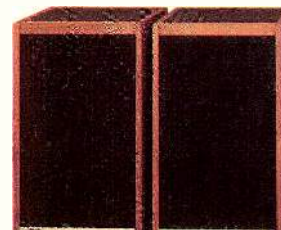



blues riffs, and the like. The rest is just bad soundtrack material for a grade-B sci-fi film, despite the presence of Eddie Jobson, who demonstrated a mildly adventurous bent during his tenure with Roxy Music. Hacks making a last dash for the cash, you see, sound pretty much alike no matter what genre they're fooling with. S.S.

**LOUDON WAINWRIGHT III: *Final Exam*.** Loudon Wainwright III (vocals, guitar); instrumental accompaniment. *Pen Pal Blues*; *Mr. Guilty*; *The Heckler*; *Two Song Set*; *Natural Disaster*; *Heaven and Mud*; and five others. ARISTA AB 4173 \$7.98.

Performance: **Disappointing**  
Recording: **Good**

Loudon Wainwright III seemed so promising only a few years ago. It seemed that at last we would hear from the middle class in rock terms, but of course it never happened. Now he's come up with a disappointingly cheesy kind of album that tries to have it both ways: he's *with it*, but he's also got it all *figured out*. His songs try to hit the teen and twenties market from the perspective of his thirtyish sensibilities. It doesn't work. *Final Exam* is about the enormously increased pressure on kids to excel in this decade; *Pen Pal Blues* is some sort of deliberately simple-minded, teeny-bopper throwaway and sounds it; and his apologia for all of this, *Watch Me Rock (I'm Over Thirty)*, is a stale variation on the old mellowed-with-time bit. Sadly, this disc is boring and more than a little patronizing about the emotional acuity of today's kids. P.R.



**KRAFTWERK: *The Man Machine*.** Kraftwerk (vocals and instrumentals). *The Robots*; *Spacelab*; *Metropolis*; and three others. CAPITOL SW-11728 \$7.98, © 8XW-11728 \$7.98. © 4XW-11728 \$7.98.

Performance: **Craft work**  
Recording: **Stainless steel**

"The Man Machine" has the typically German electronic rock sound that Kraftwerk pioneered, all gleaming glass and chromium. It starts off with eerie, compelling electronic voices, accompanied by electronic percussion, proclaiming that "we are the robots," and you just know that the machines have indeed taken over. They hang around long enough to repeat the title *Spacelab* over and over as the music takes you into orbit, and after a short intro *Metropolis* snaps into the best purely dance music on the album. *Neon Lights* is the longest and most impressive cut; it runs more than nine minutes and takes some memorable electronic excursions into disco.

Very cerebral. The singing machines return for the title-track finale, which is performed to a relatively relaxed dance tempo. All in all, this is a very professional, very interesting record. —Edward Buxbaum

**LOVE AND KISSES: *How Much, How Much I Love You*.** Love and Kisses (vocals); instrumental accompaniment. *How Much, How Much I Love You*; *Beauty and the Beast*; *Maybe*. CASABLANCA NBLP 7091 \$6.98, © NBL8 7091 \$7.98, © NBL5 7091 \$7.98.

Performance: **Top-drawer**  
Recording: **Good**

How do you follow a smash disco album like "Romeo and Juliet"? With a sixteen-minute, twenty-one-second danceathon called "How Much, How Much I Love You," that's how. Of course, you use the same ingredients: male and female choruses playing against one another, a rich variety of romantic melodies to keep the dancing mood changing, and an irresistibly upbeat recurring theme to accompany the repeated title phrase. Conductor/producer/arranger/musician Alec R. Costandinos really knows how to feed your Saturday night fever.

The second side of "How Much, How Much" has a less successful disco retelling of the Beauty and the Beast story and a five-minute filler called *Maybe* that isn't disco at all, but is a nice little song for these days. In any case, side one alone is worth the price.

—Edward Buxbaum

(Continued on page 110)

## Live.



The ultimate. The Bose 901 Series III. Designed to re-create every dimension of live-performance sound for the greatest listening pleasure imaginable. Nine matched, full-range drivers in each enclosure deliver the purest highs, and the most powerful lows. Sound reflected in precisely determined patterns creates a feeling of spaciousness unsurpassed by any other speaker. The Acoustic Matrix™ enclosure allows the Bose 901 to deliver



a bass unduplicated in a conventional enclosure. Exclusive, high-efficiency drivers put out tremendous sound without a lot of expensive power. Listen to the Bose 901. There are no speakers. Just music. As if you were hearing it for the first time. Live. For a comprehensive literature package on the advanced technology behind Bose Direct/Reflecting® speakers, send \$1.00 to Bose, Dept. L, the Mountain, Framingham, MA 01701.

# BOSE®

The closest you can get to live music without being there.



## Springsteen: A Little Too Much Darkness?



So what does a critic (who, believe it or not, can be a fan like anybody else) do when an artist he loves inordinately releases an album that, no matter how hard he tries to rationalize it, strikes him as something of a let-down? One could, I suppose, get somebody else to review the damn thing, but that would be unseemly cowardice. There's nothing for it but to get on with the unsavory business and tell you that I am rather disappointed with Bruce Springsteen's long-awaited new album, "Darkness on the Edge of Town." And I am not even altogether sure why.

It's not that I don't think there's a lot of good music here. But it's my opinion that Springsteen's recorded output till now constitutes the finest body of work by any rock-and-roll musician in this decade, and I'm kind of bugged that his new album is unlikely to alter the contrary opinions of those cold-hearted folks not already on his side. There are a lot of reasons why it won't. For starters, "Darkness" is much more of a piece than one would have expected. It sounds very much like a live set, and the arrangements, as a result, have a certain sameness. For another thing, it's a very down-tempo effort—not so much ballad-heavy as it is restrained, without the multiple bridges and the r-&-b flashes of earlier albums. Most tellingly, there are several bits here—melodic snippets, lyric lines, even vocal mannerisms (such as the wordless Cry of the Wounded Water Buffalo that opens *Something in the Night*)—that we've heard before, and in better songs. This doesn't bother me particularly (most rock composers are notorious self-plagiarizers), but somebody who thinks that Springsteen is a Johnny-One-Note endlessly rehashing overheated teen dreams is not going to revise that opinion after hearing "Darkness."

Unless, of course, he really listens to it. In point of fact, this album is quite a bit different thematically from anything the man has done before, and I think Springsteen was absolutely right to remind an interviewer that you wouldn't knock a new John Ford movie just

because he's done other westerns. Granted, Bruce is a genre writer, but the story of "Darkness on the Edge of Town" is as different from that of "Born to Run" as *Stagecoach* was from *My Darling Clementine*. For that matter, even the locations are different; "Darkness" has a much more white-middle-class landscape than usual, and instead of the Asbury Park boardwalk and Spanish Johnny, we get a Seven-Eleven store and some dude from L.A. in a Camaro.

The story running through the album is a surprisingly bitter one. The kid who at the close of *Thunder Road* was pulling out of town to win has now grown up some, settled down, gotten married, and, by the end of the record, divorced. The easy promises of freedom have all gone sour, and whether he's been totally ground down by it all is left hanging somewhat ambiguously. The crucial song is *Racing in the Street*, which, despite its lyrical tie-in with Martha and the Vandellas, is

unlikely to alter the  
opinions of those not  
already on his side

actually an update of the Beach Boys' *Don't Worry Baby*. Over a long, affectingly mournful melody, Bruce recounts the story of a guy whose whole life has been drag racing, shutting down all the contenders on the street, impressing the girls. But whereas the heroine of the Beach Boys' opus would lovingly help her boy friend through a dark night of the soul brought on by secret fears about the speed of his car, as Bruce tells it she's years older, cries herself to sleep nights, and wishes she'd never known him or the life he represents. To

say that *Racing in the Street* is the greatest car song ever written, which it is, does not change the fact that it's too depressing to dance to. And that, I suppose, probably accounts for most of my dissatisfaction with the album. I have not, heretofore, looked to Springsteen for the somber, unrelieved mournfulness of a Jackson Browne.

Yes, there are some great things here—such as *Badlands*, a big martial rocker that's as potent as any he's ever written, and *Candy's Room*, which is a new departure musically, with its quasi-Yardbirds guitar riffs and insinuatingly sexy melody. (Candy seems to be a cousin of the fascinating, unknowable Bitch Goddess that Bruce fell for in *She's the One*.) Yes, the E Street Band still makes the most majestic sounds in rock-and-roll, even if Clarence Clemons' saxophone is deliberately played down this time. And yes, *Prove It All Night* (the single), has a wonderful early-Sixties soul flavor and sounds superb on a car radio. So if "Darkness on the Edge of Town" doesn't really work at parties, if I insist upon being disappointed because it doesn't measure up to something he did three years ago when the world was a different place and both he and I were different people, well, that's my problem, not Bruce's. And for all my nitpicking, I'd still rather listen to the Boss on an off day than almost anyone else at his or her most inspired. Ask me again about this one in six months. I'll probably love it. —Steve Simels

**BRUCE SPRINGSTEEN:** *Darkness on the Edge of Town*. Bruce Springsteen (vocals, guitar, harmonica); Roy Bittan (piano); Danny Federici (organ); Gary Tallent (bass); Steve van Zandt (guitar); Max Weinberg (drums); Clarence Clemons (saxophone). *Badlands*; *Adam Raised a Cain*; *Something in the Night*; *Candy's Room*; *Racing in the Street*; *The Promised Land*; *Factory*; *Streets of Fire*; *Prove It All Night*; *Darkness on the Edge of Town*. COLUMBIA JC 35318 \$7.98, © JCA 35318 \$7.98, © JCT 35318 \$7.98.







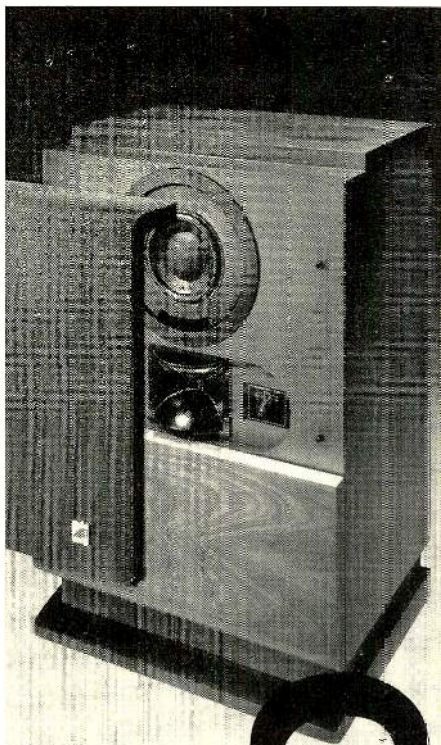

**We build  
a speaker  
that sounds  
like music**

It can accurately reproduce the 120+ dB peaks that are found in some live music. That's more than just being able to play music loud. It can accurately reproduce the music bandwidth—from below 25Hz to 20KHz. And the Interface:D's vented midrange speaker reproduces midrange sounds with the clarity and purity that allows precise localization of sound sources—both lateral and front-to-back.

The Interface:D is the only commercially available speaker we know of that can meet these criteria. Audition them at your Interface dealer.



**Electro-Voice®**

a gulton company

600 Cecil Street  
Buchanan, Michigan 49107

**Interface:D™**

**WALTER MURPHY: *Phantom of the Opera*.** Walter Murphy (vocals and instrumentals); instrumental accompaniment. *The Phantom of Your Dreams*; *Dance Your Face Off*; *I'm Your Man*; *A Night at the Opera*; *The Music Will Not End*; *Reverie for Christine*; and six others. PRIVATE STOCK PS 7010 \$7.98.

Performance: **Spirited**  
Recording: **Nothing special**

Walter Murphy, whose first hit disco record was "A Fifth of Beethoven," has now come up with the season's most unusual concept album. Expanding the horizons of disco by the use of connecting story lines is not unique, but a discofied Victorian horror story certainly is. And, bless him, it works!

The setting is turn-of-the-century Paris. The mighty organ sound of Bach's Toccata and Fugue in D Minor fills the room. But wait! Bach becomes rock as the disfigured Phantom of the Opera launches into *I Am the Phantom of Your Dreams*. He sings about Christine, a soprano in the chorus with whom he has fallen in love. After rocking a Beethoven sonata at a party (*Dance Your Face Off*), the Phantom convinces Christine that *I'm Your Man* and that he alone can make her a great opera star. The Phantom arranges for the prima donna to fall ill, and Christine has her big break. Enter the romantic lead, Raoul. At a masked ball (*Keep Dancin'*, which has a good disco beat), Raoul and Christine meet and share their love in the album's best number, *Gentle Explosion*. The Phantom is understandably furious, and . . .

I won't tell you how it ends. Suffice it to say that it's all great fun and even lots of good dancing. Several of the songs, especially *I'm Your Man* and *Gentle Explosion*, are good enough to qualify "Phantom of the Opera" as perhaps the first disco musical. Anyone want to take bets on there being a staged version?

—Edward Buxbaum

**RECORDING OF SPECIAL MERIT**

**TAVARES: *Future Bound*.** Tavares (vocals); instrumental accompaniment. *The Ghost of Love*; *Timber*; *We're Both Ready for Love*; *Slow Train to Paradise*; and four others. CAPITOL SW-11719 \$7.98, © 8XW-11719 \$7.98, © 4XW-11719 \$7.98.

Performance: **Seamless**  
Recording: **Very good**

If there were only one cut on this album, it would still generate a certain amount of excitement, so long as that cut was *More Than a Woman*, which was featured in the film *Saturday Night Fever*, a disco lover's delight. Fortunately, that number is but an appetizer here for a discful of consistently tasteful fare that is as good for listening as for dancing. Though the beat throughout is obviously tailored to suit the disco formula, it is sufficiently varied to avoid the thoompa-thoompa tedium that so commonly limits this type of music. "Future Bound" lilts and cajoles rather than blasts, even when the energy level is high. The five vocalists known as Tavares fit into the scheme seamlessly with the controlled cool they sing about on *Feel So Good*. My favorite here is *Timber*, in which they employ high falsetto chants powered by the same sort of electricity that Earth, Wind and Fire usually generates. As a bonus, producer Freddie Perren has exhibited more than a little imagination in the unexpected use of harpsichord in

some of the backgrounds. By now, this disc is undoubtedly turntable bound all over the country. P.G.

**THANK GOD IT'S FRIDAY.** Original-soundtrack recording. Donna Summer, the Commodores, Diana Ross, Love and Kisses, Santa Esmeralda, Cameo, D. C. LaRue, Patti Brooks, Thelma Houston, Paul Jabara, others (vocals); instrumental accompaniment. CASABLANCA NBLP 7099 three discs \$12.98, © NB 7099 \$12.98, © NB 7099 \$12.98.

Performance: **Numbing**  
Recording: **Good**

Following in the tremendous wake of *Saturday Night Fever*, the lengthy soundtrack recording from *Thank God It's Friday* is the latest spume from what looks to be a whole wave of films capitalizing on the disco craze. Such a cashing in was all but inevitable, for discos, with their flashing lights and sonically high-pressure environments, have become a staple of contemporary life, like fast-food outlets. The physical release from the restrictions of workaday life that dancing provides is one thing, however, and music as music is another. It is in purely musical terms that disco recordings frequently fall short, for most of them are not designed to be *listened to*.

A few truly imaginative artists and producers have broken out of the innate tedium of the disco form by stressing musical content and making the incessant beat serve rather than dominate the songs. The Bee Gees accomplished just that in their major contributions to *Saturday Night Fever*, and those songs stand up well even when performed by other artists in different styles. And the soundtrack of that film as a whole achieved a level of musical excellence in its own right, independent of the fine film it accompanied. In comparison—and the comparison cannot be avoided—*Thank God It's Friday* comes in a poor, though popular, second.

That beat, that satanically monotonous beat, pounds away through most of these five uneven sides, intermittently giving way to such oases of pleasure as the Commodores' *Too Hot to Trot*, Paul Jabara's *Trapped in a Stairway*, Diana Ross' *Livin', Lovin', Givin'*, and Donna Summers' *Last Dance* (in two equally compelling versions). Summers, the acknowledged Queen of Disco, is the center that somehow fails to hold here. She certainly has talent, and she proves that she can sing with as much guts and feeling as anyone, but the overblown tawdriness of her musical surroundings nullifies the appeal of her contributions outside the disco genre.

If the music throughout had not been so obviously contrived to fit a formula, this set, or at least part of it, might have been salvaged. The cash registers will jingle regardless, but after hearing all five numbing sides, I could only exclaim, "Thank God it's over!" P.G.

**RECOMMENDED DISCO HITS**

● **PATRICK JUVET: *Got a Feeling*.** CASABLANCA NBLP 7101 \$7.98.

● **MADLEEN KANE: *Rough Diamond*.** WARNER BROS. BSK 188 \$7.98.

● **D. C. LARUE: *Confessions*.** CASABLANCA NDLP 7098 \$7.98.

(Continued on page 112)



# THE JVC QUARTZ-LOCKED TURNTABLE.

First we invented it. Now we've made it more precise than ever.

The turntable evolution comes full swing with the introduction of the new Quartz turntable series. We introduced the first quartz-controlled turntable in 1974, and we've been improving our designs ever since. Including:

## Super Servo Frequency Generator

To detect minute variations in platter speed, and send corrective information to the electronic circuit controlling turntable rotation, it provides near-perfect speed accuracy. And, our Super Servo is factory-set for years of accurate, dependable use.

## Direct Drive DC Servomotor

For quick-start/stop and high-torque operation. Our powerful motor drive system and its companion speed-monitoring circuits reduce wow-and-flutter and speed drift nearly to the vanishing point.

## Gimbal Support and TH Tone Arm

Our exclusive unipivot gimbal support holds the tone arm firmly, yet is

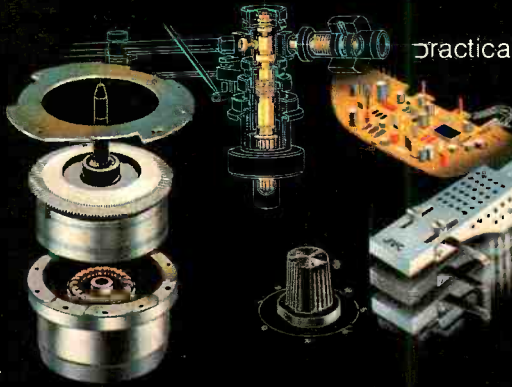

practically friction-free. We also developed a new Tracing Hold (TH) tone arm to provide stability and tracing accuracy needed for a cartridge to follow even the most complex record grooves without error. These, plus features like digital readout, electronic switching mechanisms and solidly-constructed bases, are just some of the reasons to consider the precision of JVC's Quartz-Lock series for your music system.

And you can choose from manual, semi-automatic or totally-automatic models—JVC's most comprehensive turntable line ever.

See them at your JVC dealer soon. JVC America Company, Div. of US JVC Corp., 58-75 Queens Midtown Expwy., Maspeth, N.Y. 11378. Canada:

JVC Electronics of Canada, Ltd., Ont.

# JVC

We build in what the others leave out.



QL-A7



QL-F4

CIRCLE NO. 30 ON READER SERVICE CARD





Sheri Lynn Behr

## Bob Seger: Still a New Face

POSSIBLY everyone but Kitty Wells and I already noticed this, and maybe even she did (*I've been exiled to the suburbs, that's my excuse, but now I've been sprung, praise the Lord*), but in case it's news to somebody, Pretty Good Rock is making a comeback. Not what you'd exactly call *progressive* rock, if you're a true child of the Sixties. But none of this extreme rock, either, something between punk and disco, something that kicks the beat along with a new vitality and . . . isn't bizarre. At least not if you just listen to it; I concede that Elvis Costello in any kind of costume would look a little bizarre. But listen. There's some stuff with some drive to it, some new energy. It's getting so you can drive your car and tune in an FM rock station and actually catch yourself listening.

Just now I've been listening to this new album by Bob Seger and his Silver Bullet Band, "Stranger in Town," on Capitol, and it seems

a veritabobble celebration, as the late Pogo would have said, of the return of Pretty Good Rock. Seger in the early Seventies was a stranger in every town except Detroit. In those days it seemed that everybody in Detroit, a few pop writers, and approximately fourteen other people knew about him. Now he's having it both ways: he's still a new face most places around the country, having been noticed only in the last couple of years, and so he can capitalize on this culture's conditioning to want (or think it wants) newness, and yet he's a seasoned veteran who's had a lot of time to find out what works for him and what doesn't, what he likes and doesn't like, and what he can play with gusto and what he can't.

I'm much too lazy to analyze the whole return of Pretty Good Rock to see if that's what propels it—veterans who still manage to seem new—but Seger's album persuades me that they *could* propel it if there are enough of them left in stock. Seger's songs here have actual tunes to them—maybe not original tunes, maybe derivative as all get out, but they're too busy going somewhere to apologize. Rock doesn't need only killer tunes, but it needs *some*. Seger's lyrics, and those of the other three writers he invokes, contain no great revelations and certainly no poetry (pop music still is in a nonverbal state, by and large), but they're not an embarrassment if you want to listen to them. *Feel Like a Number* and *Till It Shines* are worth going out of your way to hear, too.

**B**UT what really puts this one across is the way Seger and the Silver Bullets handle the beat. It sounds like a simple thing, to say a musician should stay on the beat. *All* musicians play on the beat, you say, or else they aren't musicians. But there are *degrees* of being on the beat, as I found out by playing a little rhythm guitar; there are times when an individual picker finds the beat second nature, the most natural thing in the world, and there are times when he has to fight to stay on it. You take a whole band of such individuals and put them on a *schedule*, a recording regimen, and it's a wonder recordings sound as spontaneous as they do. So Seger may have profited here by sheer luck, a coincidental coming-together of several people's bio-rhythms, or he may have nudged the whole process along with some of the know-how he's picked up over the years. Or maybe a little bit of both.

Whatever, it's a gas: a rock album that seems peculiar to its time, even though it may seem, from moment to moment, awfully clearheaded and ungimmicky for its time. I see it as a good influence, a call to ignore more and more trendy junk and get on with the unbusiness of rocking people's socks off.

—Noel Coppage

**BOB SEGER AND THE SILVER BULLET BAND: *Stranger in Town*.** Bob Seger (vocals); Silver Bullet Band (instrumentals); Muscle Shoals Rhythm Section; other musicians. *Hollywood Nights; Still the Same; Old Time Rock & Roll; Till It Shines; Feel Like a Number; Ain't Got No Money; We've Got Tonite; Brave Strangers; The Famous Final Scene.* CAPITOL. SW 11698 \$7.98.

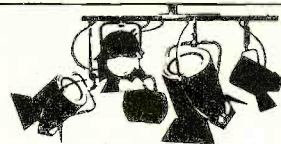

## THEATER • FILMS

**THE ACT (John Kander-Fred Ebb).** Original-cast recording. Liza Minnelli, Roger Minami, Gayle Crofoot, Danny Buraczkeski, Michael Leeds, Albert Stephenson, Carol Estey, and Laurie Dawn Skinner (vocals): John Kander (piano); orchestra, Stanley Lebowsky cond. DRG RECORDS DRG 6101 \$8.98.

Performance: **Spangles to spare**  
Recording: **Excellent**

When Liza Minnelli walked off with her first Tony Award for her appearance in *Flora, The Red Menace* on Broadway at the age of nineteen, she was the youngest actress ever to win a Tony for starring in a musical. She won her second Tony for a one-woman show she did at the Winter Garden in 1973, and her third this year for, as everyone knows, *The Act*, another Broadway musical, in which she played Michelle Craig, a former movie star making her debut at a Las Vegas night club.

In the original-cast recording, the listener is mercifully spared the dismal soap-opera plot of *The Act*, but on the other hand there are no knock-'em-dead dance routines to watch either, putting what is perhaps an unfair burden on the series of Kander-Ebb songs supplied in full in the album. These are in no sense the worst this team has ever furnished for our high-voltage heroine, who alternately belts them out and murmurs them into what was probably a battery of microphones, but they don't measure up to the giddy mark set in *Cabaret*, either, so it is a little hard to take them all in a row, long and lavish as most of them are, without feeling slightly stunned, as by contact with an electric eel. Even so, there isn't anybody else around who could do the justice Liza Minnelli does to *City Lights*, as everyone who saw the number during the early-June Tony award show on television can testify. And at times—as when she sings *My Own Space*, in the closest she apparently can come these days to *sotto voce*, to composer John Kander's gentle accompaniment—the recorded score achieves a kind of touching simplicity. *Arthur in the Afternoon*, a saga of sexual redemption, and *The Money Tree*, a wry ballad of a jilted woman's disillusion, are redeemed by quirky, agile lyrics as much as by the treatment they receive.

Like the show and the hard-working, hard-breathing star who dominated it, the record is blatantly prepackaged, hypermanic and relentless, glittering like a Christmas aisle in Bloomingdale's. Yet, in its own circusy way, it's fun. Whether what Clive Barnes has called Liza Minnelli's "calculated spontaneity" is for real or not, I'm sure fans of the American musical will agree that she's *certainly something*. P.K.

**GREASE** (see Best of the Month, page 92)

(Continued on page 116)



**Now there is a speaker whose principal limitation is the source material itself.**

**Infinity's Quantum Reference Standard. \$6500.**

At Infinity, over the years of our young corporate life, we've spared neither time, ingenuity nor financial commitment in obsessive pursuit of our objective: the world's most accurate speaker system.

Our first speaker system ten years ago—the Servo Statik—became an instant legend in the audio world. Its sound was, and is, magnificent (although admittedly, a diva's temperament was not its most endearing quality).

Our Quantum Line Source introduced the technology of our EMIT™ Electromagnetic Induction Tweeter and the Infinity/Watkins Dual-Voice-Coil Woofer™\*, broadening the parameters of high and low-frequency reproduction.

And now the Quantum Reference Standard introduces the most important midrange advance in our history: EMIRM,™ our Electromagnetic Induction Ribbon Midrange driver—in a speaker whose accuracy is no less than astonishing.

Each speaker of the mirror-image pair employs EMIRM, as well as EMIT, in dipole line-sources of 186 cm, resulting in a homogenous, coherent source of mid and high-frequency energy.

The QRS woofer extends the Watkins principle to a diameter of 38cm/15" to further increase power-handling at very low frequencies: from below 20 to 80 Hz.

An electronic crossover and equalization control center allows one to help compensate for varying listening environments and program material. Hinged baffles aid in facilitating stereo imaging under different listening conditions.

What does it all add up to? A speaker system with better transient performance, lower coloration, smoother and more extended response, better stereo imaging and higher power-handling capacity than any we have ever heard (our own Servo Statik included).

Response is 17 Hz through 32 kHz  $\pm$  2 db. QRS performs optimally with other state-of-the-art components; we recommend an amplifier of at least 100 watts per channel for the mid and high-frequency sections and one of at least 150 watts for the bass section.

A virtuoso performer, QRS can comfortably deliver jackhammer rock at levels guaranteed to straighten your cochlea; it can reveal seldom-heard warmth and presence in the human voice; it can reproduce the sound of the full symphony playing at full volume—with every section delineated, every color and nuance articulated.

So precise is QRS that one can distinguish the kind of concert grand being played; clearly hearing the difference between the crisp, centered tone of the Steinway and the romantic sonority and bravura of the Blüthner.

If you want to know more, please ask an Infinity dealer (or ask us) for a QRS brochure.

But if, like most of us, you don't happen to have an extra \$6500 in the cookie jar, don't despair; there are other speakers bearing the Infinity name, technology and performance standards, and they range in cost down to a little more than \$100. Each is incomparable at its price.

Few of us can afford the Reference Standard. But there's a Quantum for everyone.

 **Infinity**

We get you back to what it's all about. Music.

CIRCLE NO. 25 ON READER SERVICE CARD

©1978 Infinity Systems, Inc., 7930 Deering Ave., Canoga Park, CA 91304. (213) 883-4800 TWX (910) 494-4919. Manufacturer's suggested retail price is optional with dealer. \*Manufactured by Infinity Systems, Inc. under license from Watkins Engineering.







Peters International

## Piaf at Carnegie Hall

As giants go she was actually quite short—under five feet. Her only theatrical gimmick, aside from a rag of a little black dress and a single spotlight, was genius. Edith Piaf died in 1963, leaving behind her the memory of a brief, sensational life lived out to its frayed edges and a series of recordings that assure her immortality. The new Peters International record of a concert Piaf gave at Carnegie Hall in 1957 is more evidence that her audience of *inconditionnels* was right to give her their hearts and that there has never been anyone quite like her—at least not anyone the world can hear on discs.

Piaf first came to America in 1947 in a one-woman show (along with Les Compagnons de la Chanson), which drew respectful attention but little more. The problem was that she was presented in a Broadway theater and the force of her performances didn't seem to carry much beyond the first few rows. It wasn't until a year or two later, when she was booked into the old Versailles night club (New York was going through one of its Francophile periods at the time, and any of the tonier places with a liquor license was liable to announce "limited engagements" of such now-forgotten singers as Marjane, Lucienne Boyer, Patachou, and Line Renaud), that Piaf took American audiences by storm. Her performances were packed, night after night, month after month. She played the Versailles for several years, and on each visit she made new converts out of everyone, from the average guy who didn't know Piaf from pilaf to film stars who thought they'd already seen and heard it all (Dietrich and Stanwyck both num-

bered themselves among her greatest fans).

No French performer since Chevalier, and none after Piaf, swept all before her in the way she did. But because of personal problems as monumental as her talent, she never reached the American mass audience. Her recording of *La Vie en Rose* on Columbia did well, but there seemed to be no follow-up. Unlike Chevalier, Piaf could not force herself to become the professional kid-from-gay-Paree. There was a thread of darkness running through her work, her life, her voice that we hostages to a Disneyland happy-end philosophy couldn't bring ourselves to share in those days (not until Dylan did our own pop begin to grow up). But it may just have been that she remained so quintessentially French;

*The voice can still  
bring goose-bumps  
to the soul. . .*

she was so well loved and understood in her own country that perhaps she felt no need to master a new language and national psychology even if it were within the range of her frail resources.

"Edith Piaf at Carnegie Hall" is a beautiful document of her attempts to communicate to an English-speaking audience. She recites her

little set-piece, descriptive openings in an English so careful and so obviously phonetically learned that she sounds Chinese. In a surprisingly little-girl voice, she gamely tells the audience about theez-mehloody-thaht's-driving-her-crahee and then launches (in French) into her great hit *Padam, Padam*. Sung by anyone else this song is no more than a clever little bal-musette piece about a refrain that keeps running about in one's head. Piaf turns it into an obsessional tour de force with the jolting effect of an ice cube touched to the back of the neck. By the end of the song one is quite willing to admit that, yes, unidentifiable memories can lead to madness. And it is the same with practically everything else here: in French she is almost a force of nature; in English (as in *One Little Man*, *If You Love Me, Really Love Me*, or *The Highway*) she's only an accomplished melodramatist, not quite up to the level of, say, our own Streisand.

FORTUNATELY, most of the program is in Piaf's own language. In such of her hits as *Bravo pour le Clown*, *Monsieur Saint Pierre*, or *C'est pour Ça*, the listener, whether able to understand French or not, is aware of being in the presence of a very great artist. The voice itself—a cross between the bawdy salute of a Montparnasse whore, the cry of a frightened but brave child alone in the dark, and the quiet musing of a human being who values her own humanity above all else—can still bring goose-bumps to the soul. Her technique, her delivery, her interpretations remain unique. If much of her life was ravaged by her uncontrolled and apparently uncontrollable emotional character, what pinnacles she must have reached in herself during her performances! And what an incredible communicator of those pinnacles she was. No matter how sad, how tragic the material, in a Piaf performance there is always a surging pulse of life, a sense of elation and renewal.

The exceptionally good engineering by Stephen Temmer has produced a clean, live sound. This is not the definitive Piaf album—that would have to be her concert at the Olympia—but it is a must for her legion of admirers and the best possible introduction for anyone who hasn't heard her yet, who doesn't know of her at all, or knows of her only from the gaudy stories of her life that still appear from time to time. Edith Piaf was the nonpareil mistress of the French chanson, and it will be impossible for anyone to forget it as long as we have the indisputable evidence of these recordings. —Peter Reilly

**EDITH PIAF: At Carnegie Hall—January 13, 1957.** Edith Piaf (vocals); chorus and orchestra, Robert Chauvinny cond. *C'est pour Ça*; *Je T'ai dans la Peau*; *Lovers for a Day*; *Les Groggnards*; *C'est à Hambourg*; *Heaven Have Mercy*; *La Goulante du Pauvre Jean*; *Padam, Padam*; *Les Feuilles Mortes*; *Marriage*; *The Highway*; *La Fête Continue*; *Heureuse*; *One Little Man*; *L'Homme à la Moto*; *Je N'en Connais Pas la Fin*; *Télégramme*; *L'Accordéoniste*; *If You Love Me, Really Love Me*; *Bravo pour le Clown*; *La Vie en Rose*; *Monsieur Saint Pierre*. PETERS INTERNATIONAL PLC 2014/5 two discs \$11.98. © PCC 2015/5 \$11.98.



# Time and a bit of genius make the difference.

It wasn't easy to create the world's finest DC receiver. It took time. A great deal of it. For research. For development. For testing. And it also took a bit of genius — the kind of genius that Sansui engineers are world famous for. But we at Sansui were determined. And we succeeded. So now there is a patent pending on Sansui's unique new DC amplifier circuitry.

The Sansui G-6000 DC receiver, like Sansui's entire G-line of DC receivers, incorporates this unique technology. It delivers music reproduction so superb you will actually hear the difference.

With Sansui's DC amplifier circuitry you get better low frequency response. It extends all the way down to zero Hz (DC), from main-in. That's one reason it's called a DC receiver.

With Sansui's DC amplifier circuitry you get better high frequency response. It goes all the way up to 200,000Hz, from main-in. Just try to find another receiver with frequency response this wide.

With Sansui's DC amplifier circuitry you also get fuller and faster response to musical transients. This is measured in slew rate and rise time. And the slew rate and rise time figures of the Sansui G-6000 are far better than those of any competitive models.

And with Sansui's DC amplifier circuitry there is virtually no distortion. While eliminating the capaci-

tors, we've solved the time delay problem that causes transient intermodulation distortion (TIM). And total harmonic distortion is a mere 0.03% at full rated power: 65 watts/channel, min RMS, both channels driven into 8 ohms from 20-20,000Hz.

The Sansui G-6000 DC receiver is much more than its extraordinary amplifier circuitry. It is also a superb FM section, with excellent sensitivity, selectivity and signal-to-noise ratio, virtually without distortion.

The G-6000 also gives you high-technology protection circuitry that keeps both your speakers and receiver safe, always. It offers perfectly positioned and highly accurate power, tuning and signal meters. And human engineering, for greatest ease-of-operation. The G-6000 is also elegantly styled with a beautiful simulated walnut grain finish.

Listen to the G-6000 or any of Sansui's full line of DC receivers at your franchised Sansui dealer today. You'll easily hear the difference that Sansui DC makes.

## SANSUI ELECTRONICS CORP.

Woodside New York 11377 • Gardena, California 90247  
SANSUI ELECTRIC CO., LTD., Tokyo, Japan  
SANSUI AUDIO EUROPE S.A., Antwerp, Belgium  
In Canada: Electronic Distributors

*Sansui*

CIRCLE NO. 42 ON READER SERVICE CARD

## The Sansui G-6000 DC Receiver







AMERICA'S #1 VALUE LEADER  
STEREO CORPORATION OF AMERICA

**WE'RE THE BEST!!** AND WE'LL PROVE IT!

Our prices are the lowest! Check with us before you buy any stereo equipment. Give us the opportunity to beat the best deal you've been able to find. We weren't rated #1 for nothing.

**WRITE OR CALL FOR OUR CURRENT STEREO PRICE FLYER!!!**

- We discount over 60 major brands!
- We're one of the oldest audio mail-order houses in the U.S.A.
- Largest inventory/lowest prices! We get the best deals from the manufacturers, you get the best deals from us.



**WRITE US NOW FOR THE LOWEST PRICE QUOTE!**

**SHOP BY PHONE!**  
(212) 253-8888  
9-5 Mon. thru Sat.  
N.Y. time  
Master Charge  
BankAmericard

**EXCLUSIVE!**  
Night Owl Order Line!  
(212) 253-8911  
5-9 P.M. Mon.-  
Thurs. only!  
Orders/Quotes Only!



STEREO CORPORATION OF AMERICA

SR - 1629 Flatbush Ave.  
Brooklyn, New York 11210

CIRCLE NO. 54 ON READER SERVICE CARD

# "IMMENSE"

Stereo Discounters  
"New Super Discount"  
Hi-Fi Catalog!



- "Immense" Selection
- "Immense" Discounts
- "Immense" Service

Choose from over 75 of the top-name brands in Hi-Fi equipment and accessories, plus the latest in records and tapes - all at incredibly discounted prices!

**CALL TOLL FREE TO ORDER: 1-800-638-3920**

We give quotes by phone. VISA, MasterCard accepted. Send for our FREE CATALOG and compare our Selection and Prices. You'll see how we get our name!



Name \_\_\_\_\_  
Addr. \_\_\_\_\_  
City \_\_\_\_\_  
State \_\_\_\_\_ Zip \_\_\_\_\_

SR878

**STEREO DISCOUNTERS**  
6730 Santa Barbara Court • Balto., Md. 21227

# JAZZ



## RECORDING OF SPECIAL MERIT

**JACKIE CAIN AND ROY KRAL: *Concerts by the Sea*.** Jackie Cain (vocals); Roy Kral (vocals, piano); Brian Atkinson (vibraphone); John Mosher (bass); Gary Nash (drums). *Magic to Do; Waltz for Dana; Tiny Told Me;* and six others. STUDIO 7 ST7-402 \$6.98.

Performance: **Elegant**  
Recording: **Very good**

Here are the Kral's in another of their hip, witty, elegant albums. Jackie and Roy are to jazz what Nick and Nora Charles are to the mystery-story genre. Their musical badinage has been filling album after album over the years, and this newest—recorded live at Concerts by the Sea, a club on the Redondo Beach pier—is more genuine, bottled-at-the-spa fizz. As usual, they lob the musical ball to each other with glorious ease, and their versions of even such pretentious songs as Mel Tormé's *Born to Be Blue* have the wry, deft touch of two very wise souls. When they hang out with their peers, as they do in the Gershwin's *Who Cares*, it becomes the kind of suave glitter time that one thought had vanished from the current recording scene.

P.R.

**RON CARTER: *Peg Leg*** (see Best of the Month, page 91)

**STANLEY CLARKE: *Modern Man*.** Stanley Clarke (alembic and acoustic bass, narration, vocals); Dee Dee Bridgewater (vocals); orchestra. *He Lives On; Slow Dance; More Hot Fun; Dayride; Modern Man; Warrior;* and six others. NEMPEROR JZ 35303 \$7.98, © JZA 35303 \$7.98, © JZT 35303 \$7.98.

Performance: **Overproduced**  
Recording: **Good**

Stanley Clarke is a fine bass player who has been associated with some fine recordings, but this is not one of them. It is a boring, directionless mélange of pretentious sounds borrowed from a variety of uninteresting sources. In the words of the great Mark Twain: "Noise proves nothing. Often a hen who has merely laid an egg cackles as if she had laid an asteroid."

C.A.

**ERROLL GARNER: *Paris Impressions*.** Erroll Garner (piano, harpsichord); Edward Calhoun (bass); Kelly Martin (drums). *The Song from Moulin Rouge; I Love Paris; My Man; Paris Bounce; La Petite Mambo; French Doll; Paris Blues;* and eleven others. COLUMBIA SPECIAL PRODUCTS © JC2L 9 two discs \$11.96.

Performance: **Mostly excellent**  
Recording: **Good mono**

Erroll Garner had one of the truly unique piano styles in jazz history. It was a happy

blend of traditional and modern elements, and it appealed to a very wide audience that included jazz fans of divergent tastes. This album was recorded twenty years ago, just a few months after Garner returned from his first trip to Paris, and it has been reissued by Columbia Special Products almost exactly as it was, with only a slight change on the back cover. It is by no means Garner's best, but it contains some fine examples of his playing.

The problem with "Paris Impressions," apart from four unfortunate bouts with the harpsichord, is that the producers felt it necessary to give the album a theme. Thus, Garner was stuck with some material that obviously did not sit well with him but was included because either title or lyrics had some French reference. A single disc would have sufficed and could have been excellent, but that is not necessarily to say that half of this collection does Garner an injustice. My favorite cuts, both written by Garner, are a ballad called *Paris Midnight* and the rollicking *Moroccan Quarter*, which demonstrates the kind of rhythmic excitement Garner was capable of generating. "Paris Impressions" is worthwhile, but "Concert by the Sea" (originally Columbia CL 883, later released in sinfully simulated stereo as CS 9821) remains Erroll Garner's finest album.

C.A.

## RECORDING OF SPECIAL MERIT

**KEITH JARRETT: *Bop-Be*.** Keith Jarrett (piano, soprano saxophone, percussion); Dewey Redman (tenor saxophone, musette); Charlie Haden (bass); Paul Motian (drums, percussion). *Mushi Mushi; Blackberry Winter; Pyramids Moving; Silence;* and three others. ABC/IMPULSE IA 9334 \$6.98, © 8027-9334(H) \$7.95, © 5027-9334(H) \$7.95.

Performance: **Superb**  
Recording: **Excellent**

Though his star has shone brightest on ECM, Keith Jarrett has continued to record an occasional session for the Impulse label, and this sounds like one of the more successful ones—in fact, I like it better than his previously released material on that label. Jarrett himself does not, however—or so I've been told. These are takes that Jarrett had rejected, the story goes, and he didn't know of the album's existence until he spotted its eyesore of a cover in a record shop. If I were Keith Jarrett, the cover alone would send me up the wall; it looks like it was created on a kitchen table with press-on letters by a colorblind two-year-old. Furthermore, Charlie Haden's name is misspelled four times, and the printing job is so cheap that one is hard put to read the information on the back.

As I said, there is nothing wrong with the music. This is the quartet Jarrett has been working with off and on for the past seven years or so, and it brings out a side of him not normally heard on ECM. Those ECM recordings—extended solo improvisations mirroring the artist's shifting moods in a highly personal manner, often stressing the lyrical rather than the rhythmical, and the often somber, almost classical collaborations with Jan Garbarek—tend to make us forget that Jarrett is also an excellent player of straight jazz. That aspect of his considerable talent comes to the fore here, especially on *Mushi Mushi* and *Gotta Get Some*, two interesting Dewey Redman compositions, and his own *Bop-Be. Silence* is

(Continued on page 118)



# WHY YOU OUGHT TO INVEST IN A FISHER SPEAKER SYSTEM RATHER THAN SOMEBODY ELSE'S.

Building a great speaker is something like building a great violin. Although there are many violin manufacturers, the design artistry and painstaking craftsmanship of the Stradivarius won it the reputation as the world's finest.

Making speakers, like making fine musical instruments, is something of an inexact science... even with today's computers. It still takes *artistry, craftsmanship, and most of all, experience* to produce a great sounding speaker.

Our new Studio Standard ST400 series speakers, manufactured at our modern speaker plant in Milroy, Pa., are the culmination of everything we've learned in producing hundreds of thousands of speakers. At the top of this new line is the ST461 — a speaker that critical listeners consistently rank among the two or three best they've ever heard.

The ST461 combines the staggering bass capability of the 15" Fisher model 15130 woofer, the flawless midrange of two 5" model 500 midrange drivers, and the ultra-high definition of the 3" model 350 horn tweeter. Plus a precision crossover network with adjustable midrange presence and treble brilliance,

and a resettable circuit breaker overload protector. All in a beautifully finished genuine walnut cabinet, at the reasonable price of \$350\*. Other ST400 series speakers start at \$120\*.

So, if you'd like to own the "state-of-the-art" in speakers, listen to Fisher's new ST400 series.

Fisher components are available at selected audio dealers or the audio department of your

favorite department store. For the name of your nearest dealer, call toll-free 1-800-528-6050, ext. 871 from anywhere in the U.S. (In Arizona, call toll-free 1-955-971C, ext. 871).

\*Manufacturer's suggested retail value. Actual selling price is determined solely by the individual Fisher dealer.

 **FISHER**  
The first name in high fidelity.



ST461



# THE NEXT VOICE YOU HEAR WILL BE HERBIE HANCOCK.

Now Herbie's singing with his voice as well as his keyboards. And the result is "Sunlight." It's a new album that shines with so much musical energy, you'll wonder why he's waited till now to make music with *everything* he's got.

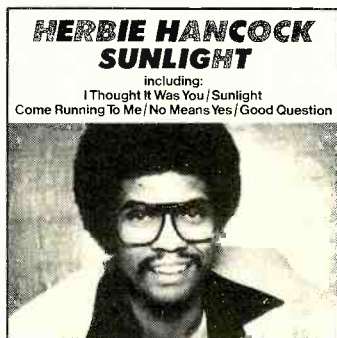

"SUNLIGHT," A VOCAL NEW DIRECTION IN MUSIC  
FROM HERBIE HANCOCK. ON COLUMBIA RECORDS AND TAPES.



"Columbia," are trademarks of CBS Inc. © 1978 CBS Inc.

CIRCLE NO. 11 ON READER SERVICE CARD

a beautiful dirge by Haden that I found myself returning to, but even more stunning is the sensitive, poetic reading given Alec Wilder's *Blackberry Winter*. Getting back to that cover, what we have here are fine gems in a tinplate setting (a brown paper bag would be an improvement). But good as the music is, there is also an ethical principle involved, and Jarrett has reason to be upset at this apparently high-handed treatment of his work. C.A.

**WEBSTER LEWIS: *Touch My Love*.** Webster Lewis (vocals, piano); instrumental accompaniment. *Hideaway: There's a Happy Feeling; Touch My Love; Seasons*; and three others. EPIC JE 35017 \$7.98, © JEA 35017 \$7.98, © JET 35017 \$7.98.

Performance: **Disappointing**  
Recording: **Very good**

Webster Lewis first came to my attention as a member of the Piano Choir, an ensemble of seven keyboard artists led by anchorman Stanley Cowell and given to spectacular group improvisations. Having already identified Lewis with a rather innovative approach to jazz, I was somewhat disappointed by this, his debut album as a leader, since he has opted for the safe terrain of soul-jazz fusion. Though "Touch My Love" is highly appealing easy listening, there is nothing at all venturesome about it. There is a touch of Lonnie Liston Smith in the airy melodies of *Hideaway* and Coleridge-Taylor Perkinson's *Seasons*, a bit of black-church hand-clapping and foot-stomping on *Believe in Yourself*, and an element of introspection on Lewis' composition *Loving*. Overall, it's pleasant but unexciting; Lewis seldom shows us what he can do with a piano in terms of introducing and developing musical ideas. I am certain there is more to him than this. P.G.

**JOHN McLAUGHLIN: *Electric Guitarist*.** John McLaughlin (guitar); David Sanborn (alto saxophone); Jerry Goodman (violin); Chick Corea (piano, mini-Moog); Carlos Santana (guitar); Stanley Clarke (acoustic bass); Billy Cobham, Tony Williams, Jack DeJohnette (drums). *Phenomenon; Compulsion; My Foolish Heart; Friendship; Every Tear from Every Eye*; and three others. COLUMBIA JC 35326 \$7.98, © JCA 35326 \$7.98, © JCT 35326 \$7.98.

Performance: **Back to basics, sort of**  
Recording: **Very good**

Not only has John McLaughlin abandoned his guru, he has also given his back-up group, Shakti, the slip, at least for this album (I hope forever). Well, gurmaania went out with love beads anyway, and that ragapop sound Shakti was dishing up is equally passé. What we have now is more like the John McLaughlin we started out with, the one we heard on such Miles Davis albums as "In a Silent Way" and "Bitches' Brew" or with the Tony Williams Lifetime group.

"Electric Guitarist" has one solo track—Victor Young's *My Foolish Heart*, played so straight as to be boring—and six McLaughlin compositions each featuring a different group. It's an unbalanced menu, but it is by far the best McLaughlin has served up for some time. *Do You Hear the Voices That You Left Behind?*, dedicated to John Coltrane, has the former Mahavishnu swinging wonderfully with a strong rhythm section composed of Chick Corea, Stanley Clarke (on acoustic



bass), and Jack DeJohnette; *Phenomenon: Compulsion* is an effective duet with drummer Billy Cobham; and *New York on My Mind* contains a good input from violinist Jerry Goodman.

Not bad, considering the path McLaughlin had been taking of late, but not really very good either, considering the direction he was taking in 1968, when he came to this country from England. With all the talent involved in this album, I think we have a right to expect something on a considerably higher level than what a good rock band can furnish. We aren't getting it this time. C.A.

**RECORDING OF SPECIAL MERIT**

**BUTCH MILES: *Miles and Miles of Swing* . . .** Butch Miles (drums); Marky Markowitz (flugelhorn); Scott Hamilton, Al Cohn (tenor saxophones); John Bunch (piano); Milt Hinton (bass). *Cherokee; Sweet Lorraine; Broadway; The King*; and three others. FAMOUS DOOR HL 117 \$8 (available from Harry Lim Productions, 40-08 155th Street, Flushing, N.Y. 11354).

Performance: **Light 'n' lively swing**  
Recording: **Very good**

Butch Miles was called Charles J. Thornton, Jr. in 1953 when, at the age of nine, he began playing the snare drum. Since January 1975, he has propelled the Count Basie band with the kind of relaxed drive that organization requires, and now he has made his recording debut as a leader. "Miles and Miles of Swing . . ." is what has come to be a typical Famous Door album: unpretentious, timeless, small-band swing played by a mixture of veterans and tradition-oriented newcomers and recorded with infinite care. To extol the virtues of each individual musician here would be both space-consuming and redundant; they are all men whose playing encompasses such vital qualities as imagination, taste, technique, and the ability to swing. Every track is a delight from beginning to end, and it's good to hear that this kind of music can still be played with the kind of freshness that fills these grooves. Miles has already recorded his second album (with Carmen Leggio, Russell Procope, and Waymon Reed). It's something to look forward to. C.A.

**LONNIE LISTON SMITH: *Loveland*.** Lonnie Liston Smith (electronic and acoustic keyboards); the Cosmic Echoes (instrumentals). *Sunburst; Bright Moments; We Can Dream*; and five others. COLUMBIA JC 35332 \$7.98, © JCA 35332 \$7.98, © JCT 35332 \$7.98.

Performance: **Faceless**  
Recording: **Good**

When Lonnie Liston Smith first started the Cosmic Echoes in 1973, I was impressed enough to feature the group (in its more exciting, embryonic stage with Norman Connors and Stanley Clarke) on a weekly television show that I was producing and hosting at the time. Since then, however, Smith (as well as Connors and Clarke) has had considerable success playing the sort of fringe music that is displayed on this album. I have never understood the popularity of this music; it often sounds like a very average rock band drowning its shortcomings in electronically generated loudness. Smith is capable of better. C.A.

(Continued overleaf)



At ESS, technology means more than trying to repackaging a 50-year-old conventional loudspeaker design under a glamorous new name. Even the best conventional driver *pushes* air on a one-to-one ratio; it moves only as fast as the cone's movements. Only ESS's Heil air-motion transformer *squeezes* air, accelerating it to five times the speed of its own motions.

Free of the distortion and sonic limitations of sluggish conventional designs, Heil-generated sound is unparalleled in dispersion, transient response, dynamic range and musical detail. ESS makes 11 superb Heil-equipped loudspeaker systems, all characterized by a decided feel of excellence. Audition a pair today. See if you're not convinced.

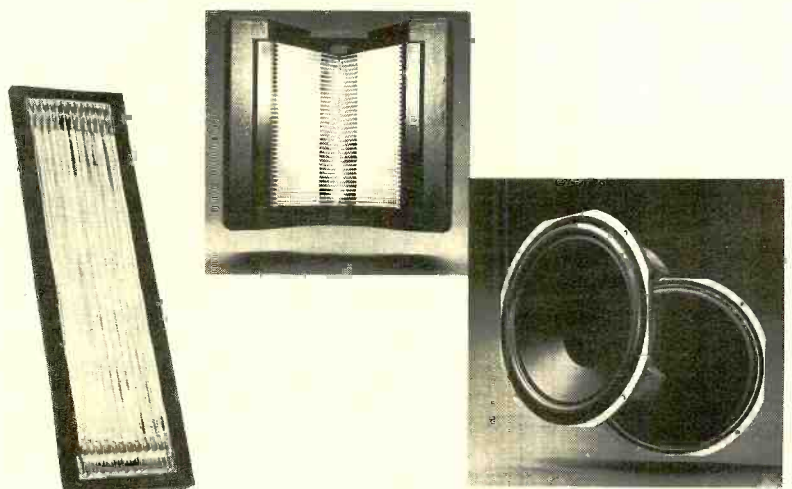

sound as clear as light **ESS**  
9613 Oates Drive, Sacramento, CA 95827



**BEN WEBSTER:** *Ben Webster at the NuWay Club.* Ben Webster (tenor saxophone); Charlie McLean (piano); Jimmy Cannady (guitar); John Dailey (bass); Ray White (drums). *Dancing on the Ceiling; Indiana; Owl; I Remember You;* and three others. JAZZ GUILD ® 1011 \$7.98 (from Jazz Guild, P.O. Box 194, Plainview, N.Y. 11803).

Performance: **Fat and facile**  
Recording: **Good, clean mono remote**

**BEN WEBSTER:** *Did You Call?* Ben Webster (tenor saxophone); Tete Montoliu (piano); Eric Peter (bass); Peer Wyboris (drums). *Sweet Georgia Brown; My Nephew Bent; Barcelona Shout; The Man I Love;* and four others. NESSA N-8 \$5.98 (from Flying Fish Records, 1304 W. Schubert, Chicago, Ill. 60614).

Performance: **Somewhat labored**  
Recording: **Very good**

Ben Webster came from Kansas City, Missouri, worked his way up through the ranks of some of the finest big bands, and firmly established himself as a man to be reckoned with when he joined Duke Ellington in 1935. He was with Ellington, though not continuously, until 1943, and again, briefly, in 1948. In the late Forties he became a part of Norman Granz's Jazz at the Philharmonic stable, and in late 1964 he moved to Europe, taking up residence first in Amsterdam, then in Copenhagen. His warm style and rich tone were in the Coleman Hawkins/Chu Berry tradition, but his playing could also exhibit a certain harshness, especially in his later years.

These two albums were made fourteen

years apart and under vastly different circumstances. The Jazz Guild set was recorded in 1958 at the NuWay, a club in Hempstead, Long Island. Webster made the recording himself on a Wollensak portable, and it is amazingly clear and well-balanced; it also happens to be superb from a musical standpoint. Obviously quite at home in this intimate setting, Webster flows through familiar musical territory with characteristic ease, imagination, and authority—in stark contrast to his performances on the Nessa album, which was recorded for a Spanish label in 1972, just ten months before his death. Backed by a rhythm section led by the blind Spanish pianist Tete Montoliu (who has made more satisfying records), Webster sounds uncomfortable here. His tone is harsh, his playing fragmented, and one gets the feeling that he just wanted to get the whole thing over with. *The Man I Love*, a tune the two albums have in common, illustrates the sad deterioration that had taken place between 1958 and 1972—a deterioration that makes it unfair to put all the blame on Montoliu's trio. The NuWay house band, led by guitarist Jimmy Cannady, was not a model rhythm section, but it could relate to Ben Webster's music, and the rapport that comes through on the Jazz Guild album is totally missing on the Nessa set.

C.A.

#### RECORDING OF SPECIAL MERIT

**THE WRITERS.** The Writers (vocals and instrumentals); other musicians. *Hey Babe; Tahiti Breakfast; Touch Me;* and three others.

COLUMBIA JC 35297 \$7.98, ® JCA 35297 \$7.98, © JCT 35297 \$7.98.

Performance: **Top-drawer**  
Recording: **Disco bright**

This set represents a bid for glory on the part of several talented musicians who have been hiding their lights under other people's bushels. Led by percussionist Ralph MacDonald, they rank among the cream of studio musicians and composers. Along with MacDonald, the group includes guitarists Hugh McCracken and Jeff Mironov, keyboardist Jerry Peters, bassist Anthony Jackson, and vocalist Frank Floyd, with percussionist/composer Harvey Mason sitting in as an official guest.

Though the cover of the album cries out for some recognition of them as individuals (there should be pictures, bios, quoted tidbits from each), they can easily rest on the laurels their group efforts merit. Being well-versed in all the techniques and styles that have worked for others, they here employ them in their own behalf without seeming imitative of anybody. Their greatest assets are instrumental mastery and a thorough understanding of how various sounds can be meshed to create rich textures, all presented with an unflaggingly energetic thrust. And they are just as adept at playing sweetly, as their rendition of Mason's lovely *Touch Me* attests. Special honors are due MacDonald for his imaginative application of the syndrum, which parallels work on his recently issued "The Path," and McCracken for his gut-tugging, blues harmonica solos on *La La La, La, La La La*.

P.G.

# They Speak For Themselves.



**Ultralinear®**



# The Newsweek vs. Time showdown.

(You win either way.)

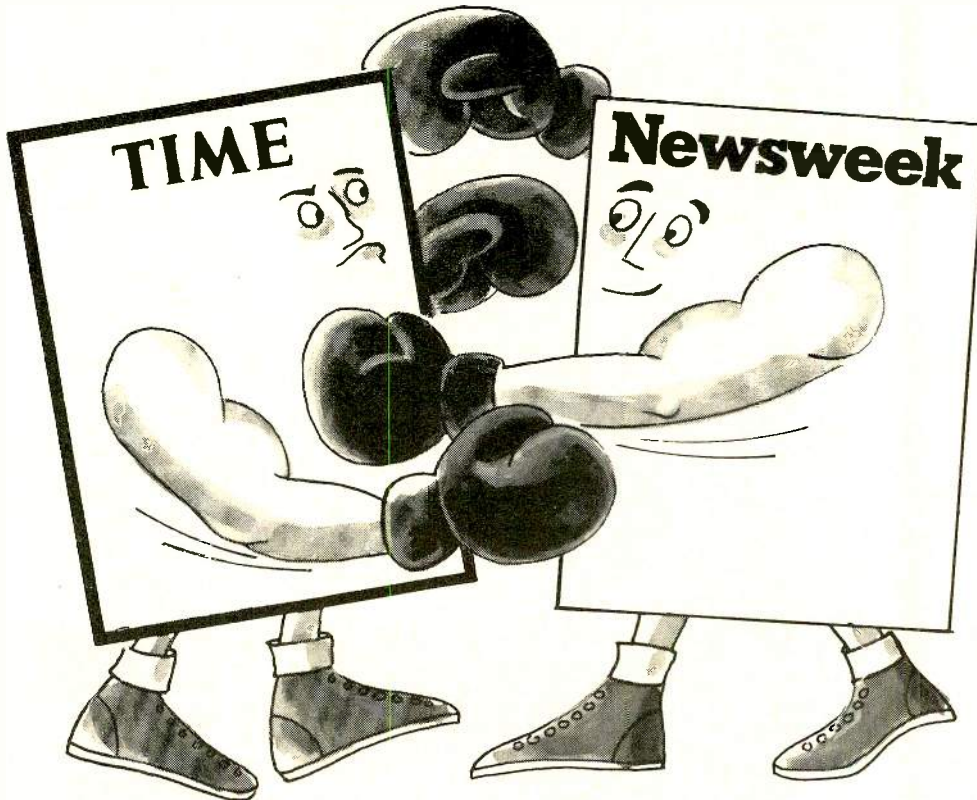

We're sticking our necks out.

If we're right, we're going to win a lot of friends for Newsweek. If we're wrong, the winner might be TIME.

What we propose to do is this. We'll enroll you as a subscriber to Newsweek at a 43% savings. You'll pay 43% less than the newsstand price. If, after reading Newsweek, you are disappointed, we're willing to send your name to TIME and tell them to give you their best offer.

Each week Newsweek plunges you behind the scenes to add substance to the news.

We clarify what's happening in the nation and world in a way that's understandable to you personally.

We tell you what everyone's talking about in entertainment and the arts.

We put the spotlight on the frenetic happenings of the sports arena.

We put you in touch with what's new in science, medicine, education... developments in the worlds of business and finance.

As a reader of Newsweek, the world is more fascinating to you. And you are more fascinating to the world.

Try being a Newsweek subscriber. We're betting you'll like it so much—TIME will have to look elsewhere for your name.

## Try Newsweek at 43% savings, then decide.

**Newsweek**<sup>®</sup> The Newsweek Building  
Livingston, N.J. 07039

**YES.** Please send me a subscription to Newsweek for the term checked below. I get the lowest price available to the general public and save 43¢ a week off the newsstand price of \$1.00 a copy. If I'm not delighted I'll write "cancel" on the bill and, if I wish, tell you to turn my name over to TIME for their best offer.

**23 weeks for \$12.99**       **46 weeks for \$25.98**  
(Save \$10 off the cover price.)      (Save \$20 off the cover price.)

Name \_\_\_\_\_

Address \_\_\_\_\_

City \_\_\_\_\_

State \_\_\_\_\_ Zip \_\_\_\_\_

51052846

Good Only in the 50 States of the U.S.A.

## Try the Newsweek difference





Michael Seidel

□ Singer-songwriter **ALBERTA HUNTER** took time out between her shows at the Cookery in New York to celebrate her eighty-third birthday by cutting a cake for some of her friends and colleagues. They are (left to right) her accompanist Gerald Cook, ragtimer Eubie Blake, bass player Al Hall, cabaret artists Bobby Short and Jimmie Daniels, STEREO REVIEW contributing

editor Chris Albertson, and vaudeville dancer and comedian Boots Marshall. When Miss Hunter declined a photographer's request to pose kissing Eubie Blake, the nonagenarian composer said, "Alberta, you haven't kissed me for forty years. Is it my breath?" Miss Hunter's latest album will be out shortly on the Columbia label.

# POP ROTOGRAVURE

By Rick Mitz

□ When **JUDY COLLINS** threw a party after her last concert at New York's Carnegie Hall, simply *everybody* came—except one close friend who sent Judy a telegram of congratulations. It was delivered not by hand but by mouth by two members of the Singing Telegram Company. Shown above is a very sur-

prised Judy Collins, who had thought all the singing was over for that night. But tonight, and for many nights to come, you can hear her singing on her latest album, "So Early in the Spring" (Elektra 8E6002). Rumors that she will include that singing telegram on her next album are completely unfounded.



Gayle Burns



Waring Abbott



Arista Records

□ So far, punk chic has included such happy fashion favorites as spikes around wrists and shiny black leather with zillions of zippers, the whole topped off by a safety pin through the nose. Well, Stiff recording artist **IAN DURY** [his latest musical offering is "New Boots and Panties!!" (STF 0002)] has gone a step further. He missed his British homeland so much on a recent U.S. tour that he had the Union Jack permanently engraved on his lower front teeth—a three-color, four-span job. Dury has a penchant for singing with the microphone *in* his mouth. We don't yet know what effect his new bridgework will have on that habit, but it sure as hell canceled him out for any toothpaste ads.

□ Peaches Record Store in Atlanta has picked up where Grauman's Chinese left off: they have visiting rock stars shake hands with a slab of cement for the delectation of posterity. **LOU REED**, an amiable sort, agreed to do it while he was in town to promote his new album, "Street Hassle" (Arista AB4169). But when the store left the monument outside overnight to dry, some determined fan carted it off. A dirty, underhanded trick.



□ A lot of people sit in their bedrooms at night and dream of making a hit record. **PETER BROWN** actually did it—made a hit record in his bedroom, that is. The song, *Do You Wanna Get Funky with Me*, was the first 12-inch single

ever to go gold. Brown is shown here where it all began—back home in his bedroom in a Chicago suburb. And now that he's got his own L.P., "A Fantasy Love Affair" (Drive 104), maybe he can afford a slightly larger studio.

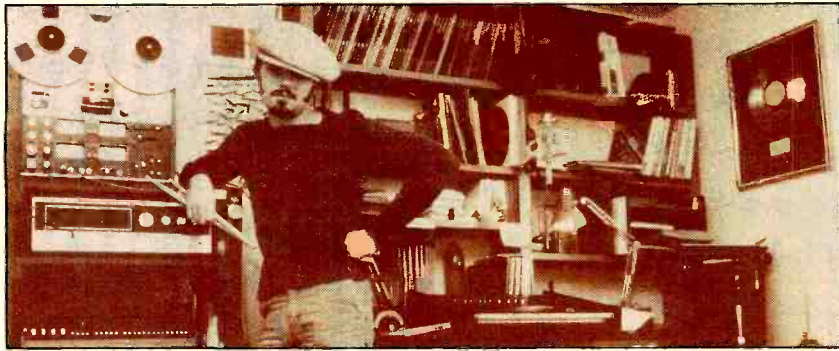

UPI

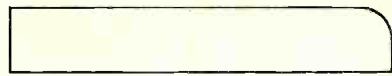

□ **ART GARFUNKEL** is a very fussy man. First, he ripped up negatives, sent for his approval, that he didn't like for a *Circus* magazine cover. The magazine was very mad. Then, at a gala party celebrating his latest L.P., "Watermark" (Columbia JC 34975), Garfunkel barred any photographers from attending. And so, not shown having a swell time at Art's party in the non-existent photograph above are (from left) Paul Simon and Shelley Duvall, James Taylor and Carly Simon, Dan Hill (seated next to unidentified woman), *Saturday Night Live*'s Loren Michaels and Dan Akroyd, songwriter Sammy Cahn and *STEREO REVIEW*'s own Paulette Weiss.

Countrysee Attractions



□ He comes from a religious family and used to be a truck driver. He sings *Love Me Tender* and *I'm So Lonesome I Could Cry*. His name is Presley—**DUKE PRESLEY**. He's the latest in a series of Elvis impersonators, but his last name is the real thing. His manager, "Colonel" Gary Emerson, told *STEREO REVIEW* that Duke had wanted to do some non-Elvis material on his debut album "Duke Presley" (Slade 040678), but "people are expecting him to do Elvis' stuff, and so he will. They want to make comparisons." That figures—just look at these two photos (Elvis is on the right).



RCA Records

□ A high-school student in Fairview, Pennsylvania, became an avid **STEVE MARTIN** fan after seeing the comedian in concert, so she went off to see all those movies she'd heard he made. Result was that she dashed off an angry letter to Warner Brothers complaining that she had seen several films starring Martin and Lewis, but that Steve Martin wasn't in one of them. Well, she'll soon be able to see Steve in two films: *Sgt. Pepper's Lonely Hearts Club Band* and his own *Easy Money*. Until then, she'll have to settle for his Grammy-award-winning album, "Let's Get Small" (Warner Bros. BSK 3090).



Photo collage by Larry Brill



Howard Bloom Organization

□ "He's the man who inspired me to write!" **MELANIE** told *STEREO REVIEW* when we asked her what all the excitement was about. The singer-songwriter met the inspiring Kurt Vonnegut, Jr. (left), along with poet Melvin Van Peebles and playwright Paddy Chayefsky (seated), at a party recently for the Frederick Douglas Writers Workshop. "I wish someone had told me he was going to be there," said Melanie of Kurt. "I'd have spent two days preparing something to say." She could, of course, have given him a sample of what he inspired—her new L.P., "Phonogenic: Not Just Another Pretty Face" (MCA 3033).

□ **VICKI BRITTON**, popular Dallas singer, was having some casual publicity photos taken one day with her cuddly puppy, Behre, when (as you can very well see) the attack-trained dog lunged at the photographer. While he was recovering from arm, back, and neck wounds, Britton offered him a job as head of what she calls her "graphic design department." He accepted. No suit. Vicki has just released her first album on Pidgeon Records, "Vicki Britton Live," and critics might be well advised to adore it.



Bruce Trinch





# CLASSICAL DISCS AND TAPES

Reviewed by RICHARD FREED • DAVID HALL • GEORGE JELLINEK • PAUL KRESH  
STODDARD LINCOLN • ERIC SALZMAN

**J. S. BACH:** *Concerto for Two Violins and Orchestra in D Minor; Violin Concerto No. 1, in A Minor* (See MENDELSSOHN)

## RECORDING OF SPECIAL MERIT

**BARTÓK:** *Sonata for Two Pianos and Percussion*. **STRAVINSKY:** *Concerto for Two Pianos; Sonata for Two Pianos*. Alfons and Aloys Kontarsky (pianos); Christoph Caskel and Heinz König (percussion). DEUTSCHE GRAMMOPHON 2530 964 \$8.98.

Performance: **On top of it**  
Recording: **Strong**

The Stravinsky works and the Bartók are, without a doubt, the cornerstones of the twentieth-century repertoire for two pianos. These performers—the Kontarsky brothers as well as the percussionists—have been best known over the years as avant-garde specialists, but they are equally on top of this more traditional modern music. They dig in with strength and conviction. This is not particularly subtle or inward playing, but it is solid and exciting—no small virtues in music with mostly clangorous color and rhythmic drive. Only the cool Stravinsky sonata, a late work composed in light tonal shades, escapes them a bit. On the other hand, their performance of the Bartók sonata, full of ice and fire, is as fine as any yet recorded of this twentieth-century masterpiece.

E.S.

### Explanation of symbols:

- Ⓜ = reel-to-reel stereo tape
- Ⓢ = eight-track stereo cartridge
- Ⓒ = stereo cassette
- = quadraphonic disc
- Ⓡ = reel-to-reel quadraphonic tape
- Ⓢ = eight-track quadraphonic tape

Monophonic recordings are indicated by the symbol Ⓜ

The first listing is the one reviewed; other formats, if available, follow it.

**BEETHOVEN:** *Piano Concerto No. 5, in E-flat Major, Op. 73 ("Emperor")*. Charles Rosen (piano); Symphonica of London, Wyn Morris cond. PETERS PLE 024 \$6.98.

Performance: **Brilliantly analytic**  
Recording: **Excellent**

Charles Rosen's notes for this disc and for his *Odyssey* album of Bach's last keyboard works suggest his interpretive preoccupations. In the latter, he speaks of the modern piano as a "medium through which the music's purity may shine transparently," while in the former he says that Beethoven's solo-piano flourish following the opening *tutti* chord of the *Emperor* Concerto is made up of "the simple elements of music nakedly displayed." It is the elemental aspect of music as music that seems to me to lie at the heart of Rosen's reading of the *Emperor* Concerto. It is utterly Classical, yet on a big scale. There is no attempt whatever to bring out the proto-Lisztian characteristics of the work that are sought by so many others. Conductor Wyn Morris, who has made something of a specialty of taking fresh looks at "warhorse" classics, is clearly at one with Rosen in this approach. Their performance is a genuinely close musical collaboration comparable with, say, that of Walter Gieseking and Bruno Walter in their pre-World War II recording of the *Emperor* with the Vienna Philharmonic—but with totally different results.

I don't think we will ever hear this concerto more clearly articulated in pianistic detail, orchestral texture, and tonal architecture than it is here. It is singularly illuminating, and the disc is well worth acquiring by any close student of the music. What is lacking, for me at least, is tonal warmth on the part of the soloist. Whether this is the fault of the piano itself, I cannot say. The recording as such is excellent. Morris' London players are heard to fine advantage, especially the wind section, which here receives a measure of the prominence it enjoyed in the orchestras of Beethoven's day. In short, if it's a Classical *Emperor* chiseled in gleaming marble that you're after, this recording is definitely the best example to date.

D.H.

## RECORDING OF SPECIAL MERIT

**BOCCHERINI:** *String Quintet No. 15, in F Major (G. 279); String Quintet No. 77, in D Major (G. 341, "Del Fandango"), with Pastorale from Quintet No. 6, in D Major (G. 270); String Quintet No. 60, in C Major (G. 324, "La Musica Notturna delle Strade di Madrid")*. Quintetto Boccherini. HNH 4048 \$7.98.

Performance: **Idiomatic**  
Recording: **Very good**

Few of Boccherini's ten-dozen-odd cello quintets have been available on records since the early Sixties, when Angel deleted its six mono discs of them played deliciously by a "Quintetto Boccherini," a group apparently formed by members of the Virtuosi di Roma. The ensemble so labeled on this new HNH release is a different one except for violist Luigi Sagrati, who participated in some but not all of the Angel recordings. He and his new associates—violinists Montserrat Cervera and Claudio Buccarella, cellists Marco Scano and Pietro Stella—seem even more idiomatically persuasive than the earlier group, and they have chosen an especially meaty assortment of works.

The fandango of G. 341 and the final movement of G. 324, known as *Il Ritirata di Madrid*, are the most familiar portions of this program, since Boccherini used each of them in at least two other settings. The F Major Quintet (Op. 13, No. 3, in Boccherini's original labeling) is one of the most attractive of the quintets without special devices or subtleties. The happy combination of spirit and polish shown in these performances leaves nothing to be desired—except several more such discs. The recording itself (by Ensayo, I believe, though its origin is not stated) is very good indeed, and Peter Eliot Stone's engaging annotations tell us everything we might want to know about the background, content, and codification of these works.

R.F.

## RECORDING OF SPECIAL MERIT

**BRAHMS:** *Piano Quartets: No. 1, in G Minor, Op. 25; No. 2, in A Major, Op. 26; No. 3, in C*



**Minor, Op. 60.** Alexander Schneider (violin); Walter Trampler (viola); Leslie Parnas (cello); Stephanie Brown (piano). VANGUARD VSD 71221/2 two discs \$15.96.

Performance: **Old-time, warmhearted**  
Recording: **Blended sound**

You can pick plenty of nits out of these performances, but the exercise, however hygienic, will add little to the sum total of human happiness. This is big, warmhearted Brahms the way he used to be, and if you don't love it don't come complaining to me! Alexander Schneider has long upheld an ideal of string playing that has mostly vanished elsewhere: good but intense feeling, the long phrase, a warm blend of sound, blurred rhythmic edges, fluid form based on the big thematic lines, internal sensibility as the final measure of all things. He is joined in this by two more of the finest string players around, Walter Trampler and Leslie Parnas, and a talented young pianist by the name of Stephanie Brown. The most impressive demonstration of this style comes in the relatively unfamiliar C Minor Quartet. Unlike Nos. 1 and 2, which are lyric, autumnal, almost leisurely, No. 3 is tight, intense, dramatic, and tragic; it makes a powerful impression. The other performances are likable, but this one is compelling. E.S.

**BRITTEN: A Birthday Hansel, Op. 92; Canticle V, The Death of Saint Narcissus, Op. 89; Suite for Harp, Op. 83; Second Lute Song from Gloriana, Op. 53; Two Scottish Folk Songs.** Peter Pears (tenor); Osian Ellis (harp). LONDON/RICHMOND SR-33257 \$3.98.

Performance: **Definitive**  
Recording: **Excellent**

This is an intriguing collection of mostly very late works in which Britten showed his fascination with the harp, both on its own and in combination with the voice of Peter Pears, for whom he composed so many major works over a period of more than three decades. Also reflected here is Britten's abiding interest in folk materials, not only in the two Scottish settings (*O Can Ye Sew Cushions?* and *Ca' the Yowes*) but also in the Harp Suite, the last of whose five brief movements is based on an old Welsh hymn as "a compliment to the dedicatee," who performs the work here. *A Birthday Hansel*, composed for the Queen Mother's seventy-fifth birthday in 1975, comprises settings of six Burns poems. Like *Ca' the Yowes*, they are familiar in folk-song settings, but Britten has provided wholly original music; the new setting of *Afton Water* ("Flow gently, sweet Afton"), may give you a bit of a jolt at first, but it does fit, and very snugly indeed. *Canticle V*, with a text by T. S. Eliot, was introduced earlier in 1975. The lute-song setting of Essex's "Happy were he could finish forth his fate" from *Gloriana* is earlier than the other pieces on the albums, having been composed as part of the festive work for the coronation of Elizabeth II in 1953. The performances here are, of course, definitive, and the recording, while close-up in focus, is generally excellent. The release of this material on London's budget label is an unexpected kindness that may encourage investigation by listeners who might not otherwise be attracted to it. R.F.

**DEBUSSY: Le Martyre de Saint Sebastien; Symphonic Fragments; Two Fanfares. Printemps.** Orchestre de Paris, Daniel Barenboim

cond. DEUTSCHE GRAMMOPHON 2530 879 \$8.98. © 3300 879 \$8.98.

Performance: **Good**  
Recording: **Good**

Spring was a favorite subject for Debussy. The relatively little-known *Printemps* recorded here began as a chorus-and-orchestration composition written in 1887 while Debussy was in Rome on his Prix de Rome stipend. Fittingly, it was inspired by Botticelli's *Primavera*. A score for voice and piano duet was published in 1904, and this was reorchestrated—the original version having been destroyed in a fire. Debussy claimed—by Henri Büsser in 1913. Büsser's symphonic suite is the version that is occasionally performed and recorded today. The organic blossoming forth of natural things held great meaning for Debussy; it was, in fact, the basis of his artistic credo. We can hear the germ of that in this work, but only the germ.

However, whatever the shortcomings of *Printemps*, it is a work of charm and spirit compared with the morbid and really decadent music Debussy composed for D'Annunzio's impeccably pretentious *fin-de-siècle* dance-drama. *The Martyrdom of Saint Sebas-*

*tian*. As with *Printemps*, the version here is a symphonic suite made from a voices-and-orchestra original (this time by André Caplet). The score has never held its own musically even with the voices, and in this purely orchestral version it is the ultimate formless movie-music psychodrama. It is very difficult to evaluate the performance of music like this: maybe it could have been done more tightly and convincingly than Barenboim does it here, but I'm not sure. E.S.

**DOHNÁNYI: Variations on a Nursery Tune, Op. 25; Capriccio in F Minor, Op. 28** (see Best of the Month, page 90)

#### RECORDING OF SPECIAL MERIT

**DVOŘÁK: String Quartet in E-flat Major, Op. 51; String Quartet in A-flat Major, Op. 105.** Gabrieli Quartet. LONDON STS 15399 \$3.98.

Performance: **Exquisite**  
Recording: **Excellent**

The Dvořák quartets are so close to the great main line of chamber music—Haydn, Schubert, Brahms—and so gracious and appealing in their own right that it is surprising that they



Judd Concert Bureau

## Serkin's 75th Birthday Concert

**RUDOLPH SERKIN** celebrated his seventy-fifth birthday on December 15, 1977, with a solo recital in Carnegie Hall; the event was broadcast on public television, and now Columbia has released the recording. In these performances of music by Haydn, Mozart, Beethoven, and Schubert, Serkin's genius burns with something like Walter Pater's hard, gem-like flame. He neither asks for quarter nor gives any. His is the ultimate in Central European classical style: stern, correct, inward, never showy, but nevertheless

of a very deep intensity and feeling. What makes this combination of qualities possible is his wonderful gift for phrasing. Everything is subordinate to the phrase or else grows out of it; like an arch, the great, classical phrase bridges the gap between feeling and structure.

Serkin's technique—exposed here by the live-performance situation—has never been astonishing, but it seems to have actually improved a bit in recent years. Now and again the Beethoven provokes some struggle; otherwise there are only a few passages that are "hard" in the other sense—that is, gritty, glassy. But that is already part of the style. High up on the mountain one expects to find rocks, crags, midsummer snow and ice—and a profusion of wildflowers; there's also some mist at times, but when it clears the view is stupendous.

**T**HE recording is a splendid example of the modern technique of making a live, concert-hall performance sound exactly like a studio take; audience reaction is, mercifully, kept to a minimum. The album includes an elegant booklet with photographs, extensive notes by, among others, Irving Kolodin, and a discography of Columbia recordings by Serkin—of which there are more than 120, beginning with the early Forties collaborations with Adolph Busch and including previous recordings of both the Beethoven and Schubert sonatas here. Now I wonder how this is going to look (and sound) on a video disc. . . .

—Eric Salzman

**RUDOLPH SERKIN: On Television—The 75th Birthday Concert at Carnegie Hall.** Haydn: *Sonata in E-flat Major (Hob. 49)*. Mozart: *Rondo in A Minor (K. 511)*. Beethoven: *Sonata in E-flat Major, Op. 81a ("Les Adieux")*. Schubert: *Sonata in B-flat Major, Op. Posth. (D. 960)*. Rudolph Serkin (piano). COLUMBIA M2 34596 two discs \$15.98.



# Introducing The Budget-Priced



## SERAPHIM

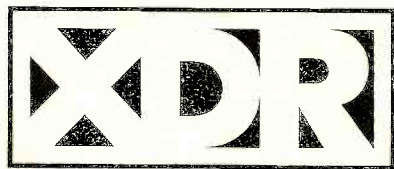

### Cassette

We introduced budget-priced Seraphim 12½ years ago.

Now we answer another need. To provide the classical listener a top quality cassette tape at the lowest possible price.

We introduce the SERAPHIM low-priced cassette . . .

Distinctively packaged cassette tapes made to the same exacting technical standards as the higher priced XDR Angel series.

\$4.98\*, the suggested retail price.

For this debut release we have selected 50 of the label's all-time best selling performances. Choose from this representation of titles:

#### MULTIPLE CASSETTE ALBUMS

4X3G-6081 **Saint-Saëns: Piano Concertos** (Ciccolini)  
4X3G-6092 **The Art of Courty Love** (Munrow)  
4X2G-6099 **Puccini: La Bohème** (De los Angeles)  
4X2G-6108 **Bellini: La Sonnambula** (Callas)

#### SINGLE CASSETTE ALBUMS

4XG-60045 **Dvořák: "New World" Symphony** (Giulini)  
4XG-60069 **Beethoven: Concerto No. 5** (Gieseking)  
4XG-60079 **Beethoven: Symphony No. 9** (Cluytens)  
4XG-60136 **Dvořák: Concerto in B Minor** (Rostropovich)  
4XG-60144 **Vivaldi: The Four Seasons** (Auriacombe)  
4XG-60175 **Holst: The Planets** (Stokowski)  
4XG-60176 **Tchaikovsky: The Nutcracker-Suite** (Boult)  
4XG-60185 **Music of Delius** (Beecham)  
4XG-60199 **Michael Rabin-In Memoriam**  
4XG-60229 **Stravinsky: The Firebird-Suite** (Stokowski)  
4XG-60236 **Orff: Carmina Burana** (Stokowski)  
4XG-60237 **Bachmaninoff: Concerto No. 2** (Pennario)  
4XG-60253 **Debussy: Piano Music** (Ciccolini)  
4XG-60265 **Brahms: Violin Concerto in D** (Milstein)  
4XG-60276 **Handel: Water Music-Suite** (Sargent)  
4XG-60283 **R. Strauss: Also Sprach Zarathustra** (Kempe)  
4XG-60290 **Spain!** (Dragon)

© Capitol Records, Inc. XDR TM Capitol Records, Inc.

\*Price optional with dealer

aren't better known. Opus 51 maintains a perfect balance between Viennese *Gemütlichkeit* (and formal grace) and Slavic soul (and bounce). Opus 105, begun during Dvořák's last days in America, is both a more deeply felt work and a more original one. It could bear repeated hearings very well, for it is music of some depth and richness. The Gabrieli Quartet's playing ought to hold up equally well. These English musicians have the feeling and exuberance to work the spell of this engaging music. E.S.

**DVOŘÁK: Symphony No. 9, in E Minor ("From the New World").** Chicago Symphony Orchestra, Carlo Maria Giulini cond. DEUTSCHE GRAMMOPHON 2530 881 \$8.98, © 3300 881 \$8.98.

Performance: **Glowing**  
Recording: **Very fine**

With more than two dozen versions currently available, there is a *New World* Symphony recording for virtually every interpretive and aural predilection. Like his 1962 reading, still available on Seraphim, Carlo Maria Giulini's new one is of the "non-Slavonic" variety, with an emphasis on the music's lyrical content and sheer beauty of sound and with careful attention to structural and dynamic proportion. The first-movement repeat is correctly observed.

The distinctive attraction here is the superb orchestral playing—with sound to match. There is little of the fierceness that Kubelik or Karajan bring to this music, what with the moderate tempos chosen for the two final movements, but there is much exquisite detail to be heard (in the slow movement and scherzo especially). The overall poetic approach to the score recommends this disc on its own terms. D.H.

**GIARDINI: Quartet in D Major for Oboe and Strings, Op. 25, No. 3** (see MOZART)

**GRIEG: Lyric Pieces, Books I-X** (see *Best of the Month*, page 91)

**HAYDN: Divertimento for Oboe and Strings** (see MOZART)

**HAYDN: The Creation.** Lucia Popp (soprano), Gabriel; Helena Döse (soprano), Eve; Werner Hollweg (tenor), Uriel; Benjamin Luxon (baritone), Adam; Kurt Moll (bass), Raphael; Brighton Festival Chorus; Royal Philharmonic Orchestra, Antal Dorati cond. LONDON OSA 12108 two discs \$13.96, © 5 12108 \$13.96.

Performance: **Easygoing**  
Recording: **Good**

Like Herbert von Karajan's 1969 Deutsche Grammophon recording, Antal Dorati's new performance of *The Creation* is sung in German, but the approach of Dorati and the London producers is decidedly more intimate in scale and more easygoing as to tempo and dramatic emphasis. Those who want a tautly dramatic *The Creation* realized on a monumental level should stick with Karajan. Those who take a particular pleasure in being made aware of the gentler and more picturesque details of the score may find Dorati and his forces more to their taste.

Dorati's recording has, in Lucia Popp, a marvelously radiant soprano as Gabriel, and tenor Werner Hollweg is a clear-voiced Uriel.

Kurt Moll is a Sarastro-voiced Raphael—suitably imposing for the most part, but occasionally, as in the vocal trio toward the end of Part II, verging on cuteness. Helene Döse and Benjamin Luxon do creditably enough as Adam and Eve in Part III. The Brighton choristers do well enough too, but they are no match in body and sharpness of attack for Karajan's Wiener Singverein. Dorati's Royal Philharmonic players are in good form, notably in the solo wind department, and the harpsichord work in the recitatives is much more imaginative than in the DG album. London's sound is well focused on the soloists and orchestra, a mite spread out where the chorus is concerned. D.H.

**HAYDN: L'Isola Disabitata.** Norma Lerer (mezzo-soprano), Costanza; Linda Zoghby (soprano), Silvia; Luigi Alva (tenor), Gernan-



LUCIA POPP  
A marvelously radiant Gabriel

do: Renato Bruson (baritone), Enrico. Orchestre de Chambre de Lausanne, Antal Dorati cond. PHILIPS 6700 119 two discs \$17.96.

Performance: **Good**  
Recording: **Excellent**

Our knowledge of Haydn's considerable operatic output continues to grow thanks to the admirable Philips series under Antal Dorati. The latest in the sequence is *L'Isola Disabitata* (1779), a relatively brief opera in two scenes. Its story is both simple and far-fetched. Husband, wife, and wife's young sister are forced by storm to seek shelter on a desert island. Husband is abducted by pirates. Oblivious of that event, wife and sister believe they have been shamefully abandoned and live a life of primitive loneliness à la Robinson Crusoe (1719) for thirteen years. Freed at last, husband turns up with friend, who falls in love with sister. Husband and wife are reconciled, and, since friend happens to be a baritone, nothing stands in the way of a happy finale for four jubilant voices. All this was set forth by Pietro Metastasio in skillful and elegant rhymes, though it can hardly be called a "play."

The Haydn score is full of isolated pleasures. The orchestral writing is superb, embellished by masterly woodwind details and solos for violin and cello. The handling of the voices per se is on a similar level of skill, but the overall design reveals a serious lack of



theatrical sense: after a promising overture we get nearly twenty minutes of *recitativo acompagnato* before the first aria. The arias, of reasonable length and variety, are frequently very beautiful. So is the final ensemble, though it is inordinately long.

The singing here is quite good. The two ladies are satisfactory, and Renato Bruson, one of the best Italian baritones around, makes one wish he could be heard more frequently on records. Luigi Alva's elegant style remains admirable despite the growing menace of fraying tones. Dorati's leadership exemplifies his well-documented sympathy with this repertoire; it is zestful, effectively paced, and attentive to Haydn's inventive orchestration. The Lausanne Chamber Orchestra plays with precision and tonal polish, though the exposed solos fall somewhat short of virtuoso caliber. The recorded sound is excellent, the notes informative. *G.J.*

**LISZT: Hungarian Fantasia; Mephisto Waltz No. 1, Op. 110, No. 2** (see Best of the Month, page 90)

**LISZT: Mephisto Waltz No. 1; Hungarian Rhapsody No. 11, in A Minor; Hungarian Rhapsody No. 14, in F Minor; Funerailles; Au Bord d'une Source; Die Loreley.** SCHUBERT/LISZT: *Liebesbotschaft*. Misha Dichter (piano). PHILIPS 9500 401 \$8.98, © 7300 639 \$8.98.

Performance: **Magnificently controlled**  
Recording: **Generally good**

There is a mixed bag of Liszt repertoire here, which displays richly varied facets of composer and pianist alike. The immediate impression one gets from the *Mephisto Waltz*—the piano version of the first of the Lenau *Faust* episodes—is that Misha Dichter has everything under total control. He can cut loose with the most blinding digital dexterity and dynamics, yet also—as in the central section—bring to bear a most telling poetic sensibility. One has only to lean back and enjoy the music for its own sake. It is fascinating, for example, to hear how Liszt made the song arrangements from Schubert and his own *Loreley* into miniature tone-poems. As in *Au Bord d'une Source*, Dichter takes full advantage of the opportunity to wax poetic in his personal yet carefully disciplined fashion. The two Hungarian rhapsodies, the relatively unfamiliar No. 11 and the very well-known No. 14 (*Mohacs Field*) add a fine element of sentiment and razzle-dazzle to the recital. Only the great *Funerailles* is something of a disappointment, not so much because of any deficiencies in Dichter's execution, but because the recording fails to capture to the fullest effect the funeral knell of the opening pages. Garrick Ohlsson's Angel disc (5-37125) spells out the difference. *D.H.*

**MENDELSSOHN: Violin Concerto in E Minor, Op. 64. TCHAIKOVSKY: Violin Concerto in D Major, Op. 35.** Henryk Szeryng (violin); Concertgebouw Orchestra, Amsterdam. Bernard Haitink cond. PHILIPS 9500 321 \$8.98.

Performance: **Tchaikovsky very good**  
Recording: **Excellent**

**MENDELSSOHN: Violin Concerto in E Minor, Op. 64.** Stoika Milanova (violin); TVR Symphony Orchestra, Sofia. Vassil Stefanov (Continued on page 132)

**ADS 810  
AR 11  
ESS amt 10b  
INFINITY QUANTUM 5  
YAMAHA NS 690 II**

# There's only one way to decide which of these fine speaker systems you'd prefer. Compare them with the Ditton 44.

This array of speaker systems should give you an interesting experience in evaluation and selection. Except for their price range (about \$300), they have little in common. That is, with respect to size, shape, speaker complement and—to some extent—engineering approach.

Of course, all speakers should pursue the same goal: to be accurate, precise and faithful to the program material. And for a goodly number of music lovers, each of these speakers has come acceptably close to that goal. Which makes each of them a worthy challenger to the Ditton 44.

One fact about the Ditton 44 we can give you right now. It combines both high efficiency and unusually high power-handling capacity. As little as five watts brings it to realistic listening levels. As much as fifty watts are easily handled. And you'll find the listening level uncomfortably high long before the Ditton 44 is in danger of being overdriven.

The specialists we've selected to be Celestion dealers have critically-designed listening rooms that allow all components to be evaluated accurately and fairly. This, of course, is especially important when it comes to speakers.

These conditions make it very likely that you will be highly satisfied when you listen to the speaker of your choice in your own listening environment. Even more so, we believe, if it should be the Ditton 44.

**The Ditton 44 by Celestion**  
An hermetically sealed three-way system employing a 1" dome super tweeter functioning from the 5 kHz crossover point to well beyond audibility, a 6" cone midrange that functions down to 500 Hz and a 12" bass transducer that is operational down to 30 Hz. Overall frequency response is 30 Hz to 40 kHz. Available in walnut or teak finish. 30" h x 14½" w x 10" d.

**Celestion**  
Loudspeakers for the perfectionist



**Celestion Industries, Inc.**  
Kuniholm Drive, Holliston, MA 01746  
In Canada: ROCELCO Inc.





# SOUND machine

## EVERYTHING IN SOUND EQUIPMENT

2836 Kennedy Boulevard • Jersey City, New Jersey 07306  
New Jersey 201/963-6300 New York 212/349-7070

CALL TOLL FREE

800-526-6070 N.J. RES. CALL DIRECT  
FREE PRICE QUOTES & INFORMATION

We carry everything in stereo, audio, color & black & white TV's, C.B.'s, scanners, radar detectors, computer games, phone answering equipment, calculators, tapes, accessories, etc.



## GUARANTEED LOWEST PRICES!

OUR PRICES ARE SO LOW  
MANUFACTURERS WILL NOT  
ALLOW US TO  
ADVERTISE THEM.

Call or write to us for our  
BRAND NEW CATALOGUE

We deliver anywhere in the U.S.A. Charge it by phone on BACVISA or DINERS. C.O.D. orders accepted. All merchandise in factory sealed cartons. Guaranteed lowest prices.

CIRCLE NO. 48 ON READER SERVICE CARD

## SPEAKER INFORMATION KIT.



Get 70 pages of speaker facts in three fact-packed publications.

Speakerlab's Speaker Operating Manual covers everything you need to know to get the best performance out of any loudspeaker, including placement, wire gauges and allowable lengths, amp overloads, room acoustics, L-pad adjustments and impedances.

Our 54-page color catalog covers enclosures, designing your own speakers and driver principles as well as our line of nine easy-to-build speaker kits ranging from a miniature two-way system only ten inches high to a massive all-horn corner system.

"How To Hook Up Your System" spends twelve pages of text and diagrams really explaining system hookup. From where to place your electronics for maximum cooling to the intricacies of installing a cartridge, from eliminating hum to proper record care.

Get all three for just a dollar from the folks who take speakers and speaker information seriously...



Here's a buck! I can really use 70 pages of speaker information from the world's largest manufacturer of speaker kits. Dept. SR-M

name \_\_\_\_\_

address \_\_\_\_\_

city \_\_\_\_\_

state \_\_\_\_\_

zip \_\_\_\_\_



Falla in a Spanish garden with Wanda Landowska

## Falla's Epic "Atlántida"

WHEN I first met Manuel de Falla, in Paris in May 1930, he had been at work on *Atlántida* for some three years. When I saw him for the last time, at his rural retreat in Alta Gracia de Córdoba, Argentina, in the summer of 1945, *Atlántida* remained unfinished. In November of the following year, a few days before his seventieth birthday, Falla died, leaving to a puzzled posterity the immense torso and many unfinished fragments of the "scenic cantata" that was to have been the crowning achievement of his creative career. Instead, it became a problem and a source of controversy. Should only those portions completed by Falla, plus those fully sketched but lacking the definitive instrumentation, be edited for publication and performance? Or should an attempt be made to reconstruct the whole from the plethora of fragmentary sketches (particularly in Part II)? Falla's heirs and executors favored the latter procedure, and for the formidable task of reconstruction they chose Falla's closest musical associate, the Spanish composer Ernesto Halfter. Now a recording of *Atlántida* as "realized and completed" by Halfter has been released by Angel. Before evaluating this realization, we should consider the genesis of *Atlántida*, in which memory, desire, and coincidence all played a part.

Although Falla was born and raised in the Andalusian seaport of Cadiz and lived for much of his life in Granada, he also developed strong ties with Catalonia, the birthplace of his mother. He knew and admired its cultural heritage, including the great literary tradition of the Catalan language. In 1926, when Falla himself was fifty years old, the city of Bar-

celona celebrated the fiftieth anniversary of the publication of the epic poem *L'Atlántida* by the Catalan poet Jacint Verdaguer. This event immediately registered with Falla, who for some time had cherished the ambition of writing a large vocal-symphonic work on a Hispanic subject that would combine mythology, religion, and patriotism—more specifically, the discovery of America by Columbus under the patronage of Queen Isabella. He saw no discrepancy in using the Catalan language for such a purpose.

The title of Verdaguer's poem refers to the mythical subcontinent Atlantis, whose monarch (in Verdaguer's retelling) was the mighty Atlas. Because of the inordinate greed and ambition of the inhabitants of Atlantis, God caused a great cataclysm whereby it disappeared into the bottom of the ocean. Only that part which became known as Spain was saved from the catastrophe, in order to fulfill its destiny of discovering the New World. Many other themes, too numerous to mention here, are interwoven in this symbolic epic. The final message, consistent with Falla's own deep-rooted convictions, is essentially religious—that is, Christian and Catholic.

FALLA was prevented from completing *Atlántida* by ill health, aggravated by the distress of the Spanish Civil War (as a consequence of which he settled in Argentina in 1939). He had originally planned the work as a "scenic cantata" in collaboration with the Catalan artist José María Sert, who was to provide visual projections to illustrate the themes and episodes. Sert's death in 1945 was a severe blow to Falla, and the next year he wrote



to a friend. "Now I am only concerned with the music, without thinking of the production visually..." That, obviously, must also be the situation of listeners who have their first experience of this remarkable and controversial work through the splendid new Angel recording.

What is—or, rather, has been—"controversial" about *Atlántida* is the authenticity of Halffter's "reconstruction" of Falla's unfinished opus. The version heard on the Angel recording is actually a revision of Halffter's previous one, which was originally performed in concert in Barcelona in 1961 and "scenically" at La Scala in Milan in 1962. My own view is that Halffter's revised version should be regarded and accepted as definitive—with the proviso that it be clearly identified as the work of two composers: Falla/Halffter.

Musically, to appreciate the style of *Atlántida* one should be familiar with Falla's last two important completed works, *Master Peter's Puppet Show* (1919-1922) and the Harpsichord Concerto (1923-1926). In both of these works he turned to archaic elements of early Hispanic music, including the folk tradition. In the first he uses a narrator to describe and comment on the action, as he does in *Atlántida*, and in the second there are modal melodies derived from both secular and religious sources, some going back as far as the eleventh and twelfth centuries.

**T**HE producers of this first recording are to be commended for an impressive achievement that should stand as a landmark of twentieth-century music. The recording was made in the Teatro Real of Madrid with the cooperation of the Artistic and Cultural Foundation of the Spanish Ministry of Education and Science. This indicates, among other things, full official acceptance of the Catalan language, which had been banned by the Franco regime.

Besides mastering the difficulties of an unfamiliar language, the choruses and all the principals perform their parts admirably. In the absence of a tenor with three heads and a basso range, the role of Geryon, the three-headed monster of mythology, is sung by two tenors and a bass. Led by Rafael Frühbeck de Burgos, the performance as a whole is in keeping with the symbolic grandeur and religious fervor of Falla's composition. The accompanying booklet gives the full text in Catalan, an English translation, a synopsis of the story, and important documentation by Enrique Franco and Ernesto Halffter.

—Gilbert Chase

**FALLA/HALFFTER:** *Atlántida*. Enriqueta Tarrés (soprano), Queen Isabella; Anna Ricci (mezzo-soprano), Queen Pyrene; Vicente Sardinero (baritone), Narrator; Eduardo Giménez (tenor), Archangel; others. Children's Chorus of Our Lady of Remembrance; Spanish National Chorus; Spanish National Orchestra, Rafael Frühbeck de Burgos cond. ANGEL □ SBLX-3582 two discs \$16.98.

Scholar/critic **Gilbert Chase**, who is currently teaching at the University of Texas at Austin, is the author of the recognized classic study *The Music of Spain*, which is still in print as a Dover paperback (\$3.50).

# Q • Where should you start in your search for better sound?

## A • At the beginning. With a new Audio-Technica Dual Magnet™ stereo phono cartridge.

Our AT12XE, for instance. Tracking smoothly at 1 to 1-3/4 grams, depending on your record player. Delivers smooth, peak-free response from 15 Hz to 28,000 Hz (better than most speakers available). With a minimum 24 dB of honest stereo separation at important mid frequencies, and 13 dB minimum separation even at the standard high-frequency 10 kHz test point. At just \$65 suggested list price, it's an outstanding value in these days of inflated prices.

Audio-Technica cartridges have been widely-acclaimed for their great sound, and for good reason. Our unique, patented\* Dual Magnet construction provides a separate magnetic system for each stereo channel. A concept that insures excellent stereo separation, while lowering magnet mass. And the AT12XE features a tiny 0.3 x 0.7-mil nude-mounted elliptical diamond stylus on a thin-wall cantilever to further reduce moving mass where it counts. Each cartridge is individually

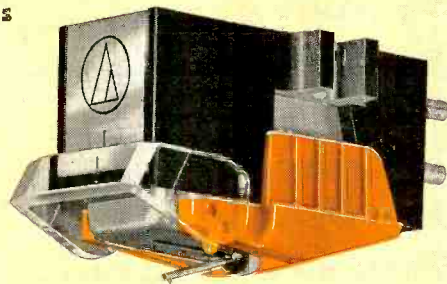

assembled and tested to meet or exceed our rigid performance standards. As a result, the AT12XE is one of the great bargains of modern technology... and a significant head start toward more beautiful sound.

Listen carefully at your Audio-Technica dealer's today.

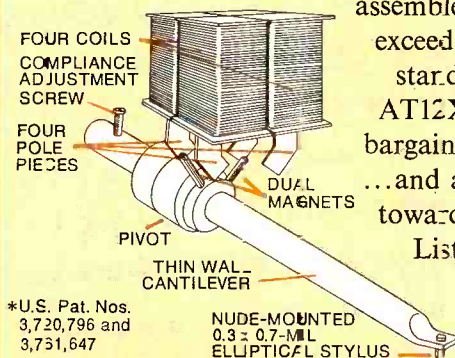

**audio-technica**  
INNOVATION □ PRECISION □ INTEGRITY

AUDIO-TECHNICA U.S., INC., Dept. 88F, 33 Shawwassee Avenue, Fairlawn, Ohio 43131  
In Canada: Superior Electronics, Inc.

CIRCLE NO. 8 ON READER SERVICE CARD





The composer in his student days

## Shostakovich's Satiric Opera "The Nose"

**N**IKOLAI GOGOL'S *The Nose*, written in 1833, is the wildly improbable story of a certain Major Platon Kuzmich Kovalyov who loses and regains his nose. It was set to music almost a century later by the young Dmitri Shostakovich, then at the height of his powers, in a brash, intense, biting style. In the early years of the Soviet Union, a revolutionary ferment maintained itself in the arts; *The Nose* was right at home in the artistic atmosphere of Leningrad in 1930. A few years later, the Stalinist crackdown—initiated by the dictator's visit to another Shostakovich opera—hit Shostakovich heavily and sent *The Nose* into a long eclipse. The work was revived with success in the West in the 1960's and in Russia in 1974, a few months before the composer's death.

It has lost none of its bite. The musical style of the young Shostakovich is fierce, relentless, almost savage in its intensity, and *The Nose* is possibly his most outrageously grotesque work, more startling in many ways than the now-familiar shockers of Schoen-

berg, Varèse, Stravinsky, or Ives. On the occasion of the first performance, the composer made the somewhat surprising claim that the satire is all in the text and that the music is not humorous. On the face of it, this seems absurd; the music is a farrago of grotesquerie and parody. Yet, in a way, the claim is comprehensible, for Shostakovich has here raised musical parody to an epic level. *The Nose* is very close to Central European expressionism, and in its combination of short, surrealist scenes, its aggressive use of song-speech, its intensity of expression, and its view of conventional society gone mad (a nineteenth-century view reinterpreted in modernistic terms), it resembles nothing so much as Berg's *Wozzeck*!

*The Nose* is so closely wedded to its Russian text that an authentic Russian production is virtually a necessity for proper appreciation. Well, the new Columbia/Melodiya release is certainly that. This superb performance and recording has spirit in the sense of style and of *esprit*. The grotesque is truly raised to the epic level.

**A**LAS, though, the Columbia packaging shortchanges the work and its potential English-language public. There is neither libretto nor translation, only a woefully inadequate summary. It is not even possible to sort out all the singers and their vocal categories—hence they are not so listed below. What can be said is that the quality of the singing is high, although, as usual in Russian recordings, the men are far more impressive than the women. Particularly notable is the high male falsetto singing by (I believe) two or more of those startling Russian tenors. And Gennady Rozhdestvensky's direction is perfect in revealing that wonderfully mad, youthful, iconoclastic side of the Russian character that official Russian art has long tried to suppress.

—Eric Salzman

**SHOSTAKOVICH: *The Nose*.** Eduard Akimov, Major Kovalyov; Valery Byelich, the Barber; Nina Sasulova, Barber's Wife; Boris Tarkhov, Police Inspector; Boris Druzhinin, Ivan; Alexander Lomonosov, the Nose; Valery Solovianov, Clerk; Liliانا Gavriluk, Noblewoman; Ashot Sarkisov, Doctor; Alexander Braim, Yaryzhkin; Liudmilla Sapegina, Madame Podtochina; Liudmilla Ukolova, Her Daughter; other soloists. Chorus and Orchestra of the Moscow Chamber Opera. Gennady Rozhdestvensky cond. COLUMBIA/MELODIYA M2 34582 two discs \$15.98.

cond. J. S. BACH: *Concerto for Two Violins and Orchestra in D Minor (BWV 1043)*; *Violin Concerto No. 1, in A Minor (BWV 1041)*. Stoika Milanova, Georgi Badev (violins); Sofia Soloists Chamber Ensemble, Vassil Kazandjiev cond. MONITOR MCS 2156 \$3.98.

Performance: **More zest than refinement**  
Recording: **Reasonably good**

I am not wholly enamored of either of these latest recordings of the Mendelssohn Violin Concerto. The tempos in the first movement on Henryk Szeryng's disc are not appreciably different from those on his 1965 Mercury re-

plenty of drive and intensity, but in terms of stylistic address she is significantly overshadowed by her more seasoned recorded competitors. Sofia's TVR Symphony may not be the Concertgebouw Orchestra's equal, but conductor Vassil Stefanov and his players give Milanova decent support in the Mendelssohn. The accompanying ensemble in the Bach is quite capable also, but I hear no evidence of a continuo instrument. The recording quality on both sides of the Monitor disc is good, if not quite up to the current state of the art.

The Tchaikovsky concerto fares much the best of the offerings on these two discs. Szeryng's mastery of the solo role in this music shows to particular advantage in the slow movement. Haitink, too, seems to respond more to this score, bringing a fine delicacy to the finale, especially in the coda. The sonics throughout the Philips recording definitely are state-of-the-art. *D.H.*

**MOZART: *Così Fan Tutte*.** Kiri Te Kanawa (soprano), Fiordiligi; Frederica von Stade (mezzo-soprano), Dorabella; Teresa Stratas (soprano), Despina; Philippe Huttenlocher (baritone), Guglielmo; David Rendall (tenor), Ferrando; Jules Bastin (bass), Don Alfonso. Chorus of the Opéra du Rhin; Luciano Sgrizzi (harpsichord); Strasbourg Philharmonic Orchestra, Alain Lombard cond. RCA FRL3-2629 three discs \$23.94. © FRK3-2629 \$23.94.

Performance: **Good**  
Recording: **Good**

For a distinctly non-box-office opera, *Così Fan Tutte* is astonishingly well represented in the record catalogs. It is a pleasure to report yet another worthy arrival in this Erato-licensed RCA set, though it offers no serious threat to the previous versions. One of its main attractions has to do with economy: it is on three discs, but it is the most "complete" among the three-disc versions, omitting only the duettino "*Al fato dan legge*" and the tenor aria "*Ah, lo veggio*" in addition to minor cuts in dialogue. Each record side yields around thirty minutes of music, which is quite generous, but it may account for the not particularly spacious though thoroughly decent sound.

Alain Lombard conducts this gem of an opera in a generally lively and flexible manner, though in some instances ("*Un'aura amorosa*," for one) his tempos drag a bit. He secures precise ensemble work and imparts warmth to the proceedings, and, while the Strasbourg Philharmonic is not a really luscious-sounding ensemble, their playing is enjoyable, enhanced by good solo wind contributions. I am surprised, however, that such a fine harpsichordist as Luciano Sgrizzi was not asked to make his contributions somewhat more imaginative.

As for the cast, all the excellence seems to be on the feminine side. Kiri Te Kanawa cannot be said to relish the fiendish vocal writing Mozart contrived for Fiordiligi, but she sings the part with abundant musicality and tones of creamy richness through most of the range. Frederica von Stade's light-timbred mezzo does not provide sufficient contrast between the sisters, but no fault can be found with her singing. Teresa Stratas, on the other hand, sounds firmer in tone and more mature in character than most Despinas. Yet she does not lose the light touch. Her characterization is enjoyable, though the Notary impersona-

tioning with Antal Dorati, but Dorati had a noticeably lighter hand with the orchestral accompaniment than Bernard Haitink does here. In the last movement, both the solo playing and the accompaniment offered more sparkle on the earlier disc.

Though I prefer the more volatile approach of Bulgarian virtuoso Stoika Milanova—whose recording of the two Prokofiev concertos for Monitor was definitely memorable—to Szeryng's coolness, her Mendelssohn has more animal vitality than romantic insight. Likewise, her Bach playing (she takes the *second* violin part in the Double Concerto) has



tion is overdone. The men are less impressive. David Rendall discloses an agreeable and malleable light tenor that is not always fully centered, Philippe Huttenlocher is a competent, somewhat colorless Guglielmo, and Jules Bastin is a Don Alfonso of insufficient vocal weight and a dry timbre. He captures the character's elegance, but he sounds uncomfortable in the upper range.

If price is a factor, I can recommend this set with the above reservations. Otherwise, my recommendation goes to Solti's (London) or Leinsdorf's (RCA), both complete on four discs, or to the beautifully performed but considerably cut Böhm version (Angel). G.J.

**MOZART: Piano Concerto No. 9, in E-flat Major (K. 271); Piano Concerto No. 21, in C Major (K. 467).** Murray Perahia (piano); English Chamber Orchestra, Murray Perahia cond. COLUMBIA M 34562 \$7.98, © MT 34562 \$7.98.

Performance: **Distinguished No. 9**  
Recording: **Good**

Murray Perahia's innate musicality, in combination with a pianistic fluency that goes "like oil" (to use Mozart's own words), makes for an exceptionally distinguished performance of the first of Mozart's mature piano concertos, K. 271 in E-flat. The slow movement is a model of proper nuance and phrasing, and the gauging of the tempo contrast between the main body of the finale and its menuetto interlude is accomplished with unerring skill.

Less successful is the performance of the bigger-scale C Major Concerto, now inevitably associated with the film *Elvira Madigan*. The treatment of the opening movement has none of the Beethovenian sweep implicit in the music, and the cadenza (Perahia's own?) seems overelaborate to me. The slow movement passes muster all right, but the finale seems to have more simple facility than Mozartian nervous tension and volatility. The recording itself may contribute to this impression, for whereas the openness and transparency of Columbia's sound work splendidly for K. 271, greater orchestral presence is needed in K. 467. D.H.

**MOZART: Quartets for Flute and Strings; No. 1, in D Major (K. 285); No. 2, in G Major (K. 285a); No. 3, in C Major (K. 285b); No. 4, in A Major (K. 298).** Paula Robison (flute); members of the Tokyo String Quartet. VANGUARD VSD-71228 \$7.98.

Performance: **Gorgeous strings**  
Recording: **Excellent**

The four flute quartets may be among the least important of Mozart's works, but they are delicious nonetheless, and they have certainly fared well on records. In this newest recording, the Tokyo Quartet players are really glorious, and Paula Robison's playing is always on a high level. Since there are a half-dozen similar discs from which to choose, though, my enthusiasm for this entry is less than it might have been otherwise. Robison's wide vibrato, feathery texture, and occasional crudities (such as the jarring little bleats evidently meant to liven up the end of K. 298) get in the way of my enjoyment—a personal reaction, to be sure. Those who find the elegant version by William Bennett and the Grumiaux Trio (Philips 6500 034) too brisk and the one by Rampal and his all-star associates (Co-

lumbia M 30233) too muscular are referred to Michel Debost and the Trio à Cordes Français on Seraphim S-6024. That budget-price disc is a real bargain, for Debost has a rich, ripe tone and fine ideas on phrasing: the hitch is that his string companions are no match for the Tokyo team and are not helped by the recording. The cello is simply inaudible some of the time, while Sadao Harada on Vanguard is always beautifully in the picture. My own first choice would be the Philips, which seems to be the best combination of flute, strings, and sound, but Debost is the handsomest flute among recordings of these works, and the Tokyo players are surely the handsomest strings. The Vanguard has excellent sound and fine annotation by Harris Goldsmith. R.F.

**MOZART: Quartet in F Major for Oboe and Strings (K. 370); Adagio and Rondo for Glass Harmonica, Flute, Oboe, Viola, and Cello (K. 617); Quintet in C Minor for Oboe and Strings (K. 406).** Heinz Holliger (oboe); Bruno Hoffman (glass harmonica); Aurèle Nicolet (flute); Herman Krebbers (violin); Karl Schouten, Judith de Munk-Gerö (violas); Jean Decroos (cello). PHILIPS 9500 397 \$8.98, © 7300 607 \$8.98.

Performance: **First-rate**  
Recording: **Sparkling**

**MOZART: Quartet in F Major for Oboe and Strings (K. 370). HAYDN: Divertimento for Oboe and Strings. GIARDINI: Quartet in D Major for Oboe and Strings, Op. 25, No. 3.**

# 800-638-6666

Over 40 brands of  
Home and Car Stereo

If you want the lowest possible  
price plus the fastest delivery  
you can't afford to pass us by!

**PIONEER**  
SX980



80 watts RMS per channel  
Call or Write for price.

**Sansui**  
9090DB



125 watts RMS per channel  
\$436

**marantz**

HD-880



Call or Write for price.

4 speakers,  
12" woofer

**PIONEER**  
CT-F8282

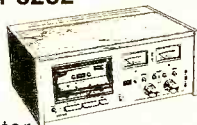

2 motor  
Cassette Deck \$280

1245XS



Changer, complete with Shure V-15III  
\$190

**marantz**

5030B



3 Head  
Cassette Deck  
Call or Write for price.

**PIONEER**  
SA-9500II

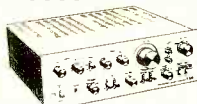

80 watts RMS per channel  
\$302

**AKAI**  
CS-702DII



Front load  
Cassette Deck \$140

**Garrard**  
DD-75



Semi-auto.  
Direct Drive \$134



discount  
sound

301-881-8890 800-638-6666

5618 RANDOLPH RD., ROCKVILLE, MD. 20852 All orders shipped immediately • Phone orders accepted • Use your BankAmericard or Master Charge • Call or write for price quotes on all the top audio brands • Write for free catalog • All merchandise in factory sealed cartons with full manufacturer's warranty.



# Hi-Fi Buys

ON **PIONEER SONY**  
Technics **marantz**  
by Panasonic We sound better.  
AND OTHER FAMOUS BRANDS



**SONY STR-6800SD**  
80 watts per channel, minimum RMS  
of 8 ohms from 20Hz to 20kHz with  
no more than 0.15% THD



**PIONEER HI-FI 100**



The SL-23 F.G. Servo  
Belt-Drive Turntable  
by Technics ...



**MARANTZ MODEL 2325**  
125 watts rms per channel,  
with no more than 0.1% thd  
at 8 ohms **\$456**



**THE PIONEER SUPER TUNERS**

CASSETTE WITH FM STEREO  
SUPER TUNER  
Phase-Lock Loop Multiplier Demodulator  
LOW NOISE SWITCH

Automatic Level  
Control System  
Matrix  
Stereo-Be-Bop & Treble

Save on other famous brands. Quotations answered same day. Write or call for free catalog. All units factory sealed. Full manufacturer's warranty.

**PHONE TO ORDER BY C.D., BANKAMERICARD, MASTER CHARGE**

For shipment within 48 hours send money order or certified check. Two week delay on personal checks. 20% deposit requested on C.O.D. shipments. Shipping cost is collected C.O.D. unless paid in advance.



1362 HOLTON LANE  
LANGLEY PARK, MD. 20783  
**(301) 434-5330**

CIRCLE NO. 23 ON READER SERVICE CARD

## J&R BLANK TAPES & ACCESSORIES AT WHOLESALE PRICES!

### BLANK TAPES

**CASSETTE TAPES**  
Ampeg Grandmaster C-90 ..... 2.79  
BASF Studio C-90 ..... 2.39  
BASF Professional  
II or III C-90 ..... 2.99  
Maxell UD XL I or II C-60 ..... 2.47  
Maxell UD XL I or II C-90 ..... 3.47  
Maxell UD C-90 ..... 2.84  
Memorex C-90 3 pk ..... 5.99 for 3  
Scotch C-90 3 pk ..... 4.99 for 3  
Scotch Master II or III C-90 ..... 3.29  
Sony Ferricrome C-90 ..... 3.22

**REEL-TO-REEL**  
Scotch 207 1800 ft ..... 4.99  
Scotch 212 1800 ft ..... 3.79  
TDK L 1800 1800 ft ..... 4.64

Write for our SUPER low prices on other Maxell Tapes not listed.  
Minimum Order 12 Tapes - 100% Guaranteed

### CARTRIDGES

**audio-technica**  
AT 20 SLA ..... 120.00  
AT 15 SA ..... 78.00  
AT 14 SA ..... 45.00  
AT 12 SA ..... 29.00  
AT 10 ..... 12.00

#### STANTON

881S ..... 72.50  
881EE-S ..... 55.00  
881EE ..... 42.50  
680E ..... 20.80  
500EE ..... 14.40

#### EMPIRE

2000Z ..... 60.00  
2000 ..... 30.00  
2000E III ..... 16.25  
2000E II ..... 15.00

**SHURE**  
V15 Type IV ..... 90.00  
V15 III ..... 63.50  
M95ED ..... 26.50  
M91ED ..... 21.00

#### PICKERING

XSV 3000 ..... 42.95  
XV 15 1200E ..... 34.40  
XV 15 625E ..... 19.18  
XV 15 400E ..... 16.35

### HEADPHONES

**audio-technica**  
AT 701 ..... 26.40  
AT 702 ..... 38.40  
AT 703 ..... 51.20  
AT 705 ..... 63.90  
AT 706 ..... 95.88

#### SENNHEISER

HD 400 ..... 24.99  
HD 414X ..... 39.97  
HD 424X ..... 59.95

#### KOSS

Pro 4AA (new) ..... 37.05  
HVI ..... 26.97  
HVIA ..... 32.97  
HVILC ..... 36.97  
K6LC ..... 20.97  
TECH VFR ..... 48.00  
Phase II ..... 51.00

**HOW TO ORDER:** For shipment within 48 hours, send money order or certified check. Two weeks delay on personal checks. Please add \$2.50 per order for shipping & handling. (\$5.50 for orders outside U.S.). N.Y.S. residents add tax. No C.O.D.'s. All merchandise 100% guaranteed, brand new & factory fresh.



33 Park Row, Dept. SR, N.Y.C. 10038  
**(212) 732-8600—Write For Free Catalog.**

CIRCLE NO. 28 ON READER SERVICE CARD

Pierre W. Feit (oboe); Slovenian String Trio.  
PETERS INTERNATIONAL PLE 023 \$6.78.

Performance: **Supple**  
Recording: **Shrill**

The new Philips Mozart album has four things in its favor: Mozart's music, Holliger's performance, and two musical curiosities. The first is obvious and need not be discussed. As for Heinz Holliger, I have heard much of his Vivaldi but none of his Classical playing. His work in Baroque music has given him a mastery of clear articulation. Combine this with a sensitivity of nuance and his usual elegant phrasing and one might imagine that his reading of the Mozart Oboe Quartet is not to be equaled. It is not. But the performance is soloist-directed. The same goes for the Quintet in C Minor. Here we have a curiosity, for Mozart himself arranged his C Minor Serenade (K. 388) as a string quintet and this version simply substitutes an oboe for the first violin. I have always found the sound of all-woodwind ensembles rather much; the version for string quintet, on the other hand, is simply too homogenized for the music. The combination here of strings with oboe seems to give us the best of both worlds, and I recommend it.

As for the Adagio and Rondo for Glass Harmonica (Bruno Hoffmann must be given credit for devoting his life to this bizarre instrument), the sound is haunting and the writing a miracle. Unfortunately, however, the glass harmonica is musically impossible because of its sluggish attack and a cold, unyielding tone color that refuses to blend with other instruments. The result is frustrating, to say the least, but the work is part of the Mozart catalog, and here it is for the curious.

Turning to the Peters album, we find that Pierre Feit has come up with a delightful Haydn divertimento and a graceful work by Felice Giardini (one of the many Italian expatriates who worked in London during the last decade of the eighteenth century) that serve as strong companions to the Mozart quartet. Feit's playing is characterized by vigor and suppleness, and it is a pleasure to hear,

though the recorded sound here is somewhat shrill. The ensemble playing with the Slovenian Trio is especially good. Much more than Holliger, Feit plays as a member of a quartet rather than as a soloist, which, of course, results in a better balance. **S.L.**

**MOZART: String Quartet No. 22, in B-flat Major (K. 589); String Quartet No. 23, in F Major (K. 590).** Alban Berg Quartet. TELEFUNKEN 6.42042 \$7.98.

Performance: **Splendid outer movements**  
Recording: **Good**

Last April I was enthusiastic about the Alban Berg Quartet's recordings of the two Mozart quartets immediately preceding this final pair (K. 499 and K. 575, both in D Major, Telefunken 6.41999), even though the group's "sinewy, taut approach," with its "solidity, firm rhythms, fine balance, and overall depth," seemed a little short on charm. These two new performances are in a similar vein, and they are similarly attractive except in the slow movements—which, to put it plainly, are disappointing. In place of the "unforced warmth of heart" I noted in the inner movements on the previous disc, there is here a distressingly tentative quality; the lovely Larghetto of K. 589, in particular, is off-putting because of choppy handling, which makes it seem directionless and without any sense of flow. Splendid as the outer movements are in both works and handsome as the recording itself is, the similar coupling by the Guarneri Quartet (RCA LSC-2888) seems a safer bet. **R.F.**

**PROKOFIEV: Romeo and Juliet, Op. 64 (excerpts).** Los Angeles Philharmonic Orchestra, Erich Leinsdorf cond. SHEFFIELD LAB LAB-8 \$14.00.

Performance: **Razor-sharp**  
Recording: **A model of clarity**

As in the Wagner program issued on Sheffield LAB-7 (reviewed in the July issue), Leinsdorf and the Los Angeles Philharmonic have a go,

"Y'know, I told the wife . . . if we ever got the cleaning contract here. . . ."

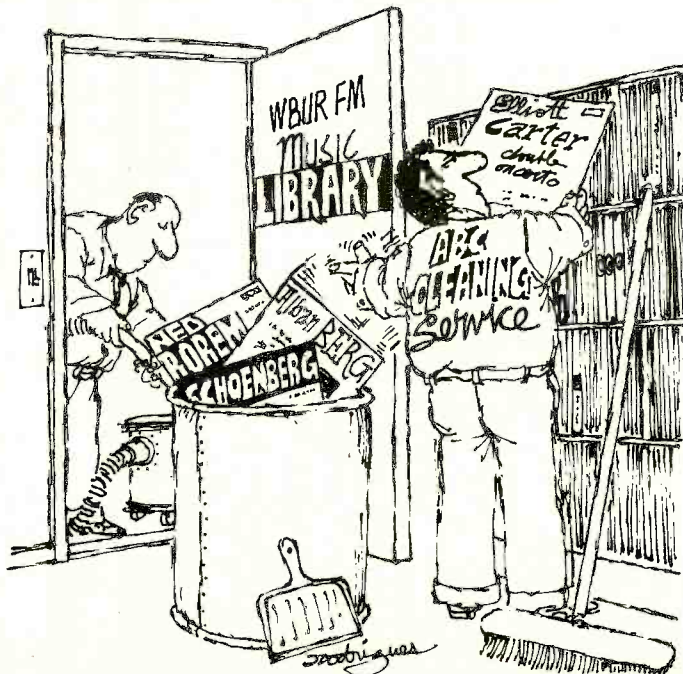



in this equally handsome package, at repertoire associated with the conductor's Boston years a decade back—in this instance, a well-put-together string of highlights from Prokofiev's major ballet masterpiece. There are some fifteen excerpts in all, including such well-known ones as the Dance of the Knights, the powerful Act II Introduction, the Death of Tybalt, Romeo and Juliet's Farewell, and the final scenes at the Capulet tomb. Also as with the Wagner release, Sheffield's direct-to-disc recording displays a striking immediacy of impact and brilliant clarity throughout the entire audible spectrum. The Los Angeles players respond with a will to the challenge posed by the no-editing technique, coming through with performances full of verve, snap, and, where called for, great tonal richness (Juliet the Young Girl and Romeo and Juliet's Farewell are among the most notable instances). At least in my pressing, side two yielded a somewhat more full-bodied sound and more immediacy of transient impact, especially in the Act III Introduction and the Farewell scene. The latter, by the way, is prime audio-demonstration material!

D.H.

**RECORDING OF SPECIAL MERIT**

**PUCCHINI: Suor Angelica.** Katia Ricciarelli (soprano), Suor Angelica; Fiorenza Cossotto (mezzo-soprano), the Princess; Maria Grazia Allegri (mezzo-soprano), the Abbess, the Mistress of the Novices; Anna di Stasio (mezzo-soprano), the Sister Monitor; Rosanna Lippi (soprano), Sister Genevieve, a Novice; others. Polyphonic Chorus of Rome; Orchestra of the National Academy of Santa Cecilia, Bruno Bartoletti cond. RCA ARL1-2712 \$7.98, ©ARK1-2712 \$7.98.

Performance: **Very good**  
Recording: **Good**

Recorded a few years ago for RCA's Italian branch, this *Suor Angelica* now completes Puccini's *Il Trittico* for that label in the U.S. as well. It is a first-rate account of the opera, paced by outstanding performances of the two leading characters. Katia Ricciarelli was still at the outset of her career at the time of the recording; her portrayal is touching and deeply felt, though without the pathos that makes Renata Scotto's *Angelica* (Columbia M 34505) truly heartrending. Vocally, on the other hand, she is exquisite throughout, triumphing over the pitfalls of the aria "*Senza mamma*." Fiorenza Cossotto is magnificent in the role of the Princess: the icy implacability of the character is captured without compromising tonal beauty.

Except for Anna di Stasio's fine contribution, the smaller roles are done adequately, no more. The chorus is good, and so is the overall sound, though the orchestra should have been given more presence. Bruno Bartoletti leads a clean, idiomatic performance. I find some of his tempos a shade too brisk, but not enough to dilute the opera's impact. I recommend this as at least the equal of the other two stereo versions in the catalog. G.J.

**PURCELL: Fantasias for Violas.** Ulsamer Collegium. DEUTSCHE GRAMMOPHON ARCHIV 2533 366 \$8.98.

Performance: **Spiritual**  
Recording: **Golden**

Filled with contrapuntal artifice that would have stood Bach's hair on end, Purcell's Fan-

**TOLL FREE 800-356-9514**

**PIONEER**



Under Dash  
Cassette Deck  
**KP-66G**

**PIONEER**

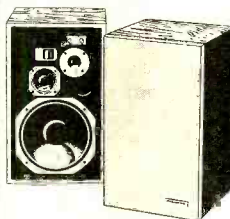

12" 4-Way  
SPEAKER  
SYSTEM  
**HPM 100**

**SHARP**



Computer  
Cassette Deck  
**RT-3388**

- Home and Car Stereo
- Over 60 Brands Stocked and Discounted
- Write or Phone for Free Price Sheet
- All Equipment in Factory Sealed Cartons
- MASTER CHARGE and VISA Accepted by Phone

**WDS**  
ISCONSIN DISCOUNT  
**STEREO**

For The Lowest Prices  
Call Toll Free

800-356-9514  
608-271-6889

2517 whalen lane madison, wisconsin 53713

CIRCLE NO. 60 ON READER SERVICE CARD

**FREE**

**McIntosh CATALOG  
and FM DIRECTORY**

Get all the newest and latest information on the new McIntosh Solid State equipment in the McIntosh catalog. In addition you will receive an FM station directory that covers all of North America.

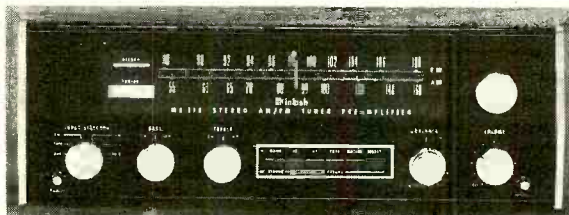

**MX 113**

**FM/FM STEREO - AM TUNER AND PREAMPLIFIER**

**SEND  
TODAY!**

McIntosh Laboratory, Inc.  
East Side Station P.O. Box 96  
Binghamton, N.Y. 13904  
Dept. SR

NAME \_\_\_\_\_

ADDRESS \_\_\_\_\_

CITY \_\_\_\_\_ STATE \_\_\_\_\_ ZIP \_\_\_\_\_

If you are in a hurry for your catalog please send the coupon to McIntosh.  
For non rush service send the *Reader Service Card* to the magazine.

CIRCLE NO. 35 ON READER SERVICE CARD



cies (or Fantasias) are cut of such sublime musical fabric that one can compare them only to the late quartets of Beethoven. As the quartet culminates in Beethoven, so the "fancy" culminates in Purcell. The Ulsamer Collegium, a consort whose complement ranges from three to seven viols, makes these fancies sound mellow and clear. The players, however, treat their early instruments more like cellos than viols. They manage to impose an unwanted vibrato in the slow sections and play with a constant legato rather than availing themselves of the articulation that the music needs. Nonetheless, the music is of such high quality and the overall sound and ensemble so good that it is still a pleasure to hear this album. S.L.

**SCHUBERT/LISZT: *Liebeshotschaft* (see LISZT)**

**SHOSTAKOVICH: *String Quartet No. 4, Op. 83; String Quartet No. 12, Op. 133* (see *Best of the Month*, page 89)**

**STRAVINSKY: *Concerto for Two Pianos; Sonata for Two Pianos* (see BARTÓK)**

**STRAVINSKY: *Petrouchka (1947 Version)*. Chicago Symphony Orchestra, James Levine cond. RCA ARL1-2615 \$7.98, © ARS1-2615 \$7.98, © ARK1-2615 \$7.98.**

Performance: **Crisp**  
Recording: **Good**

While most recent recordings of *Petrouchka* have favored the luxuriant 1911 scoring,

James Levine, like the composer himself, has chosen the leaner, more linear 1947 one.

Stravinsky's own recorded realization for Columbia was on the "cool" side. Levine's is, if anything, even cooler. To my ears it comes off as almost a "concerto for orchestra" rather than as music originally intended for the stage. RCA's recording and Levine's own definition of line, texture, and rhythm make every last detail audible, and on those terms the disc is a brilliant success. But I would have enjoyed just a bit more theater atmosphere. D.H.

#### RECORDINGS OF SPECIAL MERIT

**TCHAIKOVSKY: *Violin Concerto in D Major, Op. 35; Valse-Scherzo, Op. 34*. Boris Belkin (violin); New Philharmonic Orchestra, Vladimir Ashkenazy cond. LONDON CS 7076 \$7.98, © CS 5 7076 \$7.95.**

Performance: **Graceful**  
Recording: **Splendid**

**TCHAIKOVSKY: *Violin Concerto in D Major, Op. 35*. Itzhak Perlman (violin); London Symphony Orchestra, Alfred Wallenstein cond. *Andante Cantabile; Marche Slave, Op. 31*. London Philharmonic Orchestra, Massimo Freccia cond. QUINTESSENCE PMC-7056 \$3.98.**

Performance: **Crackling**  
Recording: **All just fine**

Two more diverse ways of dealing with the Tchaikovsky Violin Concerto can scarcely be imagined than those represented in these re-

leases. Violinist Boris Belkin and Vladimir Ashkenazy come up with a wholly convincing reading in a lyrical, rubato style that casts quite a different light on the music than the more customary fire-eating approach that the eighteen-year-old Itzhak Perlman took in this performance recorded in 1964 (just after he won the Leventritt award). I find both treatments equally valid, though if I had to choose one to add to those I already have (by Heifetz and others), it would certainly be the Belkin/Ashkenazy collaboration, simply because it is an unusual interpretation of this much-abused masterpiece. They bring a kind of romantic, *Eugene Onegin* aura to the music, especially in the first movement, which is played with great soul and violinistic brilliance and has a sweep to the polonaise-like ritornellos that truly does evoke *Onegin*. The slow movement is a gem; Belkin's violin tone is sweet yet strong, and the New Philharmonic wind players are ravishing in their obbligato commentary on the melody. The initial pace of the finale (played, incidentally, without the usual small cuts) is blistering, but Belkin brings it off, fireworks and all, in fine style. Similarly, he makes the filler *Valse-Scherzo* seem mere child's play, even the dazzling cadenza near the end.

The Quintessence disc is also something special, and not only for Perlman's crackling performance of the Violin Concerto (in which he is ably partnered by Alfred Wallenstein). The sleeper here is an outstandingly fine recording of Massimo Freccia's reading of that venerable warhorse *Marche Slave*. He takes a fresh look at the score, and the cymbal and

## A NEW PREAMP FOR THAT DISCERNING PERFECTIONIST WHO CAN APPRECIATE THE DIFFERENCE.



The new Phase 3000 Series Two was designed for that discerning music-lover who has a passion for accurate sound, an eye for elegant, yet functional design, a feel for craftsmanship, and an unfailing determination to maximize return on investment.

The Phase 3000 incorporates the latest technological advancements in preamp design. Transient overloading that plagues preamps has been virtually eliminated, whether amplitude, frequency, or slew induced. Now you can enjoy the flexibility, performance and features that are priced substantially higher in other equipment.

#### CMOS LOGIC MEMORY SYSTEM

Most preamps use dated mechanical switching devices that force signals to travel long, noisy, circuitous routes from

the inputs, to the front panel, then back to the outputs. *Ours doesn't.* The Phase 3000 uses CMOS-digital logic to energize switching relays located where they belong, at the input jacks. This shortens critical signal paths. Noise, hum, and the "crosstalk" that's characteristic of mechanical switching is virtually eliminated.

#### PHONOCARTRIDGE FLEXIBILITY

The two independent RIAA Phono Stages eliminate all low-level switching. As a result, noise is reduced to theoretical limits.

Phono 1 is designed for moving-magnet cartridges and has three selectable capacitance values.

Phono 2 is used with moving-coil cartridges and has three selectable resistance values. The expensive outboard head amp usually required for a moving-coil cartridge is already built into the 3000.

#### WANT MORE?

A listening session with a pair of headphones will convince you just how much of a difference a true headphone amp makes. Turn the 3000 around, and see how easy it is to patch in your noise reduction unit.

Two complete tape circuits allow you to copy between decks while listening to another source.

But we've done enough talking. If you're serious about state-of-the-art performance it's time for you to do some listening. See your Phase dealer.

*Phase Linear*  
THE POWERFUL DIFFERENCE

Phase Linear Corporation, 20121 48th Avenue West, Lynnwood, Washington 98036  
MADE IN USA. DISTRIBUTED IN CANADA BY H. ROY GRAY LTD. AND IN AUSTRALIA BY MEGASOUND PTY. LTD.



bass-drum sounds are some of the best I've heard in quite some time. (The violins may seem a bit steely, but a slight mid-range cut should take care of that.) The *Andante Cantabile* (from the String Quartet No. 1, Op. 11), also conducted by Freccia, is as tasteful and lovely as ever. At the price, you can't go wrong with this disc. *D.H.*

**TCHAIKOVSKY: *Violin Concerto in D Major, Op. 35*** (see MENDELSSOHN)

**VAUGHAN WILLIAMS: *Concerto in A Minor for Oboe and Orchestra; The Lark Ascending, Romance for Violin and Orchestra.*** Neil Black (oboe); Pinchas Zukerman (violin); English Chamber Orchestra. Daniel Barenboim cond. ***Concerto in F Minor for Bass Tuba and Orchestra.*** Arnold Jacobs (tuba); Chicago Symphony Orchestra, Daniel Barenboim cond. DEUTSCHE GRAMMOPHON 2530 906 \$8.98, © 3300 906 \$8.98.

Performance: **Good to outstanding**  
Recording: **Excellent**

The main repertoire attraction here is the Oboe Concerto, which has not been readily available in recorded form in the U.S. for far too long, and then not in stereo. (There is another recent recording—British EMI ASD 3127, with John Williams as soloist and Paavo Berglund conducting the Bournemouth Symphony—available as a special import in some shops, but it is not generally distributed here the way Deutsche Grammophon releases are.) It is regrettable that the beautiful recording of the work by Leon Goossens, for whom it was written, with Walter Susskind conducting, has never turned up on Seraphim, but Neil Black and Daniel Barenboim do a fine job with it nonetheless, and they benefit, of course, from DG's excellent sound. Arnold Jacobs, the longtime tuba player of the Chicago Symphony, does well by the remarkably lyrical Tuba Concerto, too. But the prize performance in this assortment is that of *The Lark Ascending*, which Zukerman projects with almost heartbreaking eloquence and conviction. This work turns up in various other Vaughan Williams collections, and this very performance, in fact, is available on a record of twentieth-century English music issued by DG two or three years ago (2530 505, © 3300 505). Questions of duplication aside, however, this is an attractive package: Barenboim's conducting is consistently sensitive throughout the three works, and the soloists' playing ranges from very good to surpassingly fine. The handsome album cover, by the way, carries a reproduction of a painting by Winston Churchill. *R.F.*

**VERDI: *Il Trovatore.*** Franco Bonisoli (tenor), Manrico; Leontyne Price (soprano), Leonora; Elena Obraztsova (mezzo-soprano), Azucena; Piero Cappuccilli (baritone), Il Conte di Luna; Ruggero Raimondi (bass), Ferrando; Maria Venuti (mezzo-soprano), Ines; Horst Nitsche (tenor), Ruiz; Martin Egel (bass), Old Gypsy. Chorus of the Deutsche Oper, Berlin; Berlin Philharmonic Orchestra, Herbert von Karajan cond. ANGEL □ SCLX-3855 three discs \$24.98, © 4X3X-3855 \$21.98.

Performance: **Karajan's show**  
Recording: **Very good**

As I recall eleven complete recordings of Verdi's *Il Trovatore*, from the Pertile/Sabajno set

AUGUST 1978



## The First Speaker System Thoroughly Engineered to Sound Right In a Car.

Advent, maker of this country's most popular and imitated home speaker, has developed the first

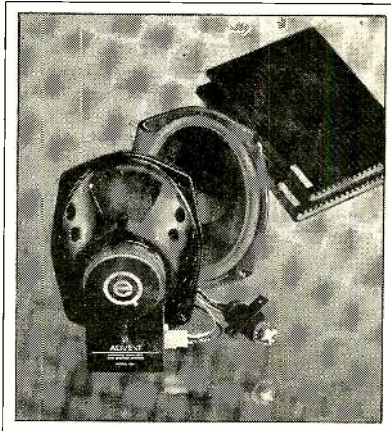

*The Advent EQ-1 Powered,  
Equalized Car Speaker System.*

speaker system fully designed to sound best under car listening conditions. The Advent EQ-1 system consists of a stereo pair of 6x9" dual-cone speakers with built-in power amplifiers that are frequency-equalized to produce balanced sound inside a car. They connect to any car stereo configuration, and, for \$180\*, give you the kind of sound you've never heard before on the road.

For more information, and a list of Advent dealers, please send in this ad.

Name \_\_\_\_\_

Address \_\_\_\_\_

City \_\_\_\_\_

State \_\_\_\_\_ Zip \_\_\_\_\_

\*Suggested price, subject to change without notice.

### Advent Corporation

195 Albany Street, Cambridge, Massachusetts 02139

SR-8/78

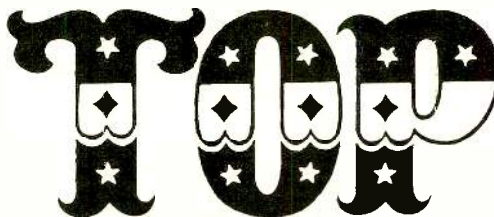

## DISCOUNT AUDIO

1150 N. Powis Rd.  
West Chicago, IL 60185

### YOUR NATIONAL HEADQUARTERS FOR NAME BRAND ELECTRONICS BY MAIL

• RECEIVERS • SPEAKERS • COMPACTS

• MULTI-  
MILLION  
\$\$\$  
INVENTORY

FULL  
MANUFACTURER  
GUARANTEE  
APPLIES  
TO ALL SALES!

ALL ORDERS  
Shipped In  
Factory-Sealed  
Cartons—  
Most Within  
24 Hours!

• TUNERS • AMPLIFIERS • AUTOMOTIVE

TOP DISCOUNT  
AUDIO

1150 N. Powis Rd.  
West Chicago, IL 60185  
(312) 293-1825

We Honor VISA and  
MASTERCARD  
By Phone or Mail

Call or Write for the LOWEST PRICES Anywhere!

Send catalog \_\_\_\_\_

MR.  
MS.

(First) (Initial) (Last) (Date)

(Number and Street)

(City) (State) (Zip code)

• TAPE DECKS • CHANGERS • CARTRIDGES • HEADPHONES •

CIRCLE NO. 58 ON READER SERVICE CARD



**8 IMPORTANT REASONS WHY MORE PEOPLE BUY TOP QUALITY EQUIPMENT FROM INTERNATIONAL HI-FI THAN ANY OTHER MAIL ORDER COMPANY**

**MORE THAN 80,000 CUSTOMERS NATIONWIDE**

1. Guaranteed lowest price . . . you pay same price many dealers pay.
2. No-risk, no-deposit . . . phone orders shipped C.O.D. or Credit Card.
3. Same day shipping when ordered by 1 p.m.
4. Seven audio advisors provide professional help for the inexperienced buyer.
5. Fully insured shipments plus full manufacturers' warranty.
6. Exclusive "no lemon" guarantee.
7. Fully staffed customer service department.
8. Over 70 top name brands . . . equipment most mail order and discount dealers can't supply.



**CALL NOW**  
**(301) 488-9600**  
**Mon.-Fri. 9-9, Sat. 9-4**

Write for: • Brochure with prices and lines  
 • Tips on buying by mail



**International Hi-Fi Distributors**

Moravia Center  
 Industrial Park, Dept. S8  
 Baltimore, Maryland 21206

CIRCLE NO. 27 ON READER SERVICE CARD

**Sound Reproduction  
 A PIONEER IN  
 MAIL ORDER**

**SEND FOR  
 CATALOG  
 TODAY ON**



**Technics  
 AND OVER 40 OTHER FAMOUS  
 BRAND AUDIO COMPONENTS  
 AT LOW DISCOUNT PRICES.**

**marantz**



**MARANTZ 2325 AM-FM Stereo Receiver**  
 with built-in Dolby Decoder/Encoder,  
 Dolby FM, 125 W. Min RMS/Ch. 20-20,000  
 Hz. 0.06% THD.  
 LIST \$800.00 **448<sup>00</sup>**

**Technics SL-1900**

**A fully-automatic  
 direct drive  
 turntable**

**I.C. CONTROLLED**



**SOUND  
 REPRODUCTION INC.**

**460 CENTRAL AVENUE  
 East Orange, New Jersey 07018  
 (201) 673-0600**

**Closed Every Monday Till Labor Day**

CIRCLE NO. 51 ON READER SERVICE CARD

of 1928 to the Pavarotti/Bonyng edition of 1977, the one that surpasses all others in its strength of musical leadership is Angel 3554 (1956), starring Maria Callas and conducted by Herbert von Karajan. It is in mono, however. Now, after twenty-two years, Karajan has recorded the opera in stereo. His music-making powers are as awesome as ever, but this time the singers are not in his class.

There are many elements that raise Karajan's interpretation of this much-abused opera above the others. Lucidity is one: Karajan's control and his sense of balances are unerring, and no one can clarify the multifold contrapuntal goings-on (in the finale of Act II and in Act III, Scene 1, in particular) with his kind of firmness and transparency. He also gets some orchestral details into focus and achieves sensitively graded dynamics that make the most familiar passages shine with freshness. One could argue that some of the tempo choices are slower than ideal, but Karajan makes them work. The *allegro brillante* closing portion of the Act IV Leonora-Luna duet, for instance, gets off with insufficient sparkle, but a stirring effect is achieved by accelerating the last eighteen measures or so. This is somewhat unorthodox, but I find Karajan's way refreshing. As usual, he gets superb playing from the Berliners; the brass is nothing short of magnificent.

But can *Il Trovatore* ever be regarded as a "conductor's opera"? The 1952 RCA set indifferently conducted by Renato Cellini but boasting Milanov, Bjoerling, and Warren in their prime may have settled the issue for thousands of opera lovers once and for all! This new set, while it has moments of beautiful singing, is on the whole far from what a first-rate performance ought to be. In her third portrayal of a role that has brought her much glory on stage, Leontyne Price can still produce a radiant tone above the staff. Her "*Tacea la notte*" is spun with a seamless legato, and her "*D'amor sull'ali*" (Act IV) is nearly as impressive. In the fast-moving "*Dital' amor*," however, she sounds uncomfortable, and the speed causes her intonation to falter. Miss Price may be heard in better form on RCA 6194 (Mehta conducting), but her portrayal here is still one of distinction. I cannot say the same for Elena Obraztsova's Azucena. Her best singing occurs in the fourth act. Earlier, she reveals a commanding presence and a fiery temperament, but there is also a wide vibrato that makes the inexact pitch of her "*Stride la vampa*" unacceptable.

Piero Cappuccilli is a solid, reliable baritone in the good Italian tradition. He never really disappoints, but neither does he contribute anything to the role of Luna that Warren, Merrill, Bastianini, or Milnes (his recorded counterparts) have overlooked. Ruggero Raimondi is a first-rate Ferrando; his narrative, expertly guided by Karajan, is cleanly articulated and delivered with rare feeling and sensitivity. The interpreters of Ines and Ruiz, on the other hand, are barely adequate. Inadequate is the word for Franco Bonisolli's Troubadour: it is robustly but unappealingly sung, with weakly sustained notes in the crucial E-G area and flatness in "*Ah si, ben mio*."

The opera is presented here uncut. The exaggerated pianissimos would not work in an opera house, but the engineering is excellent. As a performance, however, I recommend it only as a documentation of Karajan's art. G.J.

(Continued on page 146)



## The New 1978 Basic Repertoire

STEREO REVIEW again presents the annual revision of the Basic Repertoire. In pamphlet form, it includes 1978 disc and tape recommendations for 173 standard musical works. For your copy, send 50¢ in coin, plus a stamped, self-addressed No. 10 envelope (9½ x 4¼ in.), to Esther Maldonado, STEREO REVIEW, 1 Park Avenue, New York, N.Y. 10016.

## PLANNING TO MOVE?

Let us know 8 weeks in advance so that you won't miss a single issue of **STEREO REVIEW**.

Attach old label where indicated and print new address in space provided. Also include your mailing label whenever you write concerning your subscription. It helps us serve you promptly.

**Write to:** P.O. Box 2771, Boulder, CO 80322,  
 giving the following information:

Change address only  Extend my subscription

**ENTER NEW SUBSCRIPTION**

1 year \$9.98  Payment enclosed  
 Allow 30-60 days for (1 extra BONUS issue)  
 delivery.  Bill me later

NEW ADDRESS HERE

0419

Name \_\_\_\_\_ please print

Address \_\_\_\_\_ Apt. \_\_\_\_\_

City \_\_\_\_\_

State \_\_\_\_\_ Zip \_\_\_\_\_

Additional postage on foreign orders: add \$1 a year for Canada, \$5 a year for all other countries outside the U.S. and its possessions. Cash only on foreign orders, payable in U.S. currency.

**AFFIX OLD LABEL**

If you have no label handy, print OLD address here.

Name \_\_\_\_\_ please print

Address \_\_\_\_\_

City \_\_\_\_\_

State \_\_\_\_\_ Zip \_\_\_\_\_



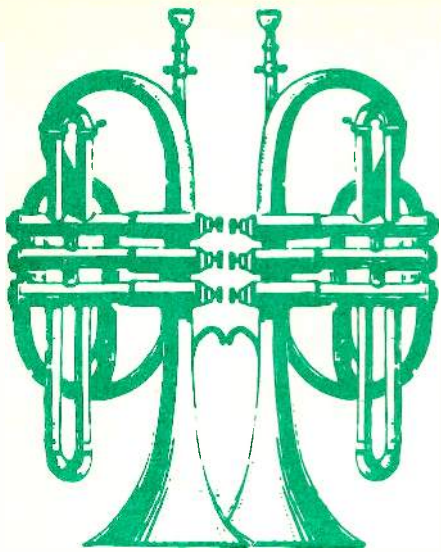

## FREE INFORMATION SERVICE

Here's an easy way for you to get manufacturer's information about products advertised or mentioned editorially in this issue. Just follow the directions below...and the literature will be sent to you free of charge from the manufacturer.

**a** Tear out one of the perforated postage-free cards. Please print or type your name and address where indicated. Use only one card per person.

**b** Circle the numbers on the card that correspond to the key numbers at the bottom of the advertisement or editorial mention that interests you. (Key numbers for *advertised products* also appear in the Advertisers' Index.)

**c** Simply mail the card. One card per person is all that is necessary. No postage is required.

**d** This address is for our "Free Information Service" only. All other inquiries are to be directed to, Stereo Review, One Park Ave., New York, N.Y. 10016.

## FREE INFORMATION SERVICE

1	2	3	4	5	6	7	8	9	10	11	12	13	14	15
16	17	18	19	20	21	22	23	24	25	26	27	28	29	30
31	32	33	34	35	36	37	38	39	40	41	42	43	44	45
46	47	48	49	50	51	52	53	54	55	56	57	58	59	60
61	62	63	64	65	66	67	68	69	70	71	72	73	74	75
76	77	78	79	80	81	82	83	84	85	86	87	88	89	90
91	92	93	94	95	96	97	98	99	100	101	102	103	104	105
106	107	108	109	110	111	112	113	114	115	116	117	118	119	120
121	122	123	124	125	126	127	128	129	130	131	132	133	134	135
136	137	138	139	140	141	142	143	144	145	146	147	148	149	150
151	152	153	154	155	156	157	158	159	160					

4  Please send me 12 issues of Stereo Review for \$4.99 and bill me.

PLEASE PRINT—Use only one card per person.

SR8783

NAME \_\_\_\_\_

ADDRESS \_\_\_\_\_

CITY \_\_\_\_\_ STATE \_\_\_\_\_ ZIP CODE \_\_\_\_\_

(Zip Code must be included to insure delivery.) (Void after Oct. 31, 1978)

1	2	3	4	5	6	7	8	9	10	11	12	13	14	15
16	17	18	19	20	21	22	23	24	25	26	27	28	29	30
31	32	33	34	35	36	37	38	39	40	41	42	43	44	45
46	47	48	49	50	51	52	53	54	55	56	57	58	59	60
61	62	63	64	65	66	67	68	69	70	71	72	73	74	75
76	77	78	79	80	81	82	83	84	85	86	87	88	89	90
91	92	93	94	95	96	97	98	99	100	101	102	103	104	105
106	107	108	109	110	111	112	113	114	115	116	117	118	119	120
121	122	123	124	125	126	127	128	129	130	131	132	133	134	135
136	137	138	139	140	141	142	143	144	145	146	147	148	149	150
151	152	153	154	155	156	157	158	159	160					

4  Please send me 12 issues of Stereo Review for \$4.99 and bill me.

PLEASE PRINT—Use only one card per person.

SR8782

NAME \_\_\_\_\_

ADDRESS \_\_\_\_\_

CITY \_\_\_\_\_ STATE \_\_\_\_\_ ZIP CODE \_\_\_\_\_

(Zip Code must be included to insure delivery.) (Void after Oct. 31, 1978)

1	2	3	4	5	6	7	8	9	10	11	12	13	14	15
16	17	18	19	20	21	22	23	24	25	26	27	28	29	30
31	32	33	34	35	36	37	38	39	40	41	42	43	44	45
46	47	48	49	50	51	52	53	54	55	56	57	58	59	60
61	62	63	64	65	66	67	68	69	70	71	72	73	74	75
76	77	78	79	80	81	82	83	84	85	86	87	88	89	90
91	92	93	94	95	96	97	98	99	100	101	102	103	104	105
106	107	108	109	110	111	112	113	114	115	116	117	118	119	120
121	122	123	124	125	126	127	128	129	130	131	132	133	134	135
136	137	138	139	140	141	142	143	144	145	146	147	148	149	150
151	152	153	154	155	156	157	158	159	160					

4  Please send me 12 issues of Stereo Review for \$4.99 and bill me.

PLEASE PRINT—Use only one card per person.

SR8781

NAME \_\_\_\_\_

ADDRESS \_\_\_\_\_

CITY \_\_\_\_\_ STATE \_\_\_\_\_ ZIP CODE \_\_\_\_\_

(Zip Code must be included to insure delivery.) (Void after Oct. 31, 1978)



FIRST CLASS

PERMIT NO. 217  
CLINTON, IOWA

BUSINESS REPLY MAIL

NO POSTAGE NECESSARY IF MAILED IN THE UNITED STATES

POSTAGE WILL BE PAID BY—

Stereo Review

P.O. BOX 2908  
CLINTON, IOWA 52732

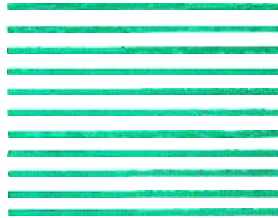

FIRST CLASS

PERMIT NO. 217  
CLINTON, IOWA

BUSINESS REPLY MAIL

NO POSTAGE NECESSARY IF MAILED IN THE UNITED STATES

POSTAGE WILL BE PAID BY—

Stereo Review

P.O. BOX 2908  
CLINTON, IOWA 52732

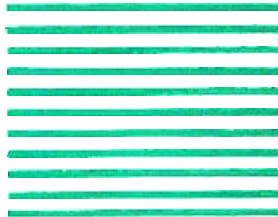

FIRST CLASS

PERMIT NO. 217  
CLINTON, IOWA

BUSINESS REPLY MAIL

NO POSTAGE NECESSARY IF MAILED IN THE UNITED STATES

POSTAGE WILL BE PAID BY—

Stereo Review

P.O. BOX 2908  
CLINTON, IOWA 52732



An important set of recordings created to help you expand your understanding of music

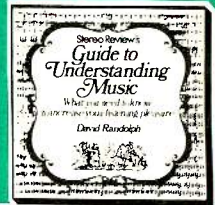

This unique four-disc album is interesting, easy to comprehend, and instructive. It is the first project of its kind to approach the understanding of music through its basic elements: rhythm . . . melody . . . harmony . . . texture.

Written and narrated exclusively for Stereo Review by David Randolph, Music Director of the Masterwork Music and Art Foundation, this fascinating set of stereo records will help you become a more sophisticated, more knowledgeable listener.

In the GUIDE TO UNDERSTANDING MUSIC, David Randolph first discusses, by means of recorded narration, how the composer uses and unifies all the basic musical elements. After each musical point is made in the narration, a musical demonstration of the point under discussion is provided. Thus you become a part of the creative musical process by listening, by understanding, by seeing how music's "raw materials" are employed by composers and performers to attain their highest level of expressivity and communication through musical form.

FOUR STEREO RECORDS

**Record I—The Elements of Music:** 1. Rhythm. 2. Melody 3. Harmony 4. Texture.

**Record II—Sense and Sensation in Music:** (The Instruments of the Orchestra)—How Music is Unified.

**Record III—Form in Music—Words and Music.**

**Record IV—Can Music Tell a Story or Paint a Picture?—The Interpretation of Music.**

OVER 200 MUSICAL EXAMPLES which have been carefully chosen from among thousands of recordings by major record companies as the best illustrations of musical points made in the recorded narration. In addition, supplementary musical demonstrations were specially recorded for this album.

BOOKLET ENCLOSED. The accompanying booklet is a valuable complement to the album. It presents David Randolph's straightforward professional approach to music, and shares the insights and understanding of his many years of experience in bringing music to listeners . . . as well as advice on how you can make the best use of the album.

If you already have some knowledge of music, the Guide to Understanding Music can expand and enrich that knowledge. If you've always wanted to understand music but have been discouraged because it looked too difficult and time-consuming, the Guide to Understanding Music can show you how easily and quickly you can make yourself at home with any music.

This exclusive four-disc recording is just . . .

\$21.98 Postpaid

for all four 33 1/2 rpm stereo longplay records, a price made possible by the availability of the consultative and production facilities of Stereo Review and its staff. Under ordinary auspices, a work of this nature and importance would cost much more.

HERE'S HOW TO ORDER

CASH: Mail your order along with your name, address and remittance in the amount of \$21.98. (Outside U.S.A. \$26.98). Residents of CA, CO, DC, FL, IL, MI, MO, NY STATE, TX, and VT add applicable sales tax

CHARGE: To your American Express, VISA, MasterCard or Diners Club account! Mail your order name, address, credit card # and expiration date (Master Charge customers include 4-digit Interbank # above your name). Be sure your signature is on your order. You will be billed at \$21.98.

ORDER FROM:  
GUIDE TO UNDERSTANDING MUSIC,  
P.O. BOX 278, PRATT STATION,  
BROOKLYN, N.Y. 11205



# THE NEW Stereo Review SRT14

## STEREO TEST RECORD

The editors and technical staff of Stereo Review present the most comprehensive, accurate and easy-to-use test record ever developed.

Here, at last, is a record that contains everything you need to get the fullest, most realistic reproduction from your stereo equipment.

Whether you've spent thousands on your stereo system or have a more modest setup, the SRT14 is an indispensable tool for helping you realize the full potential of your equipment.

Best of all, you don't have to be an electronics engineer to use it. You can actually perform a complete stereo-system checkup by ear alone.

### A test lab in a record jacket

Employing the most advanced recording, mastering, and pressing techniques, the Stereo Review SRT14 is produced to strict laboratory standards. Engraved in its grooves are a series of precisely recorded test tones, frequency sweeps, and random-noise signals that enable you to accurately analyze and check your stereo system for:

- Frequency response.
- Stereo separation.
- Cartridge tracking.
- Channel balance.
- Hum and noise, including turntable rumble
- Wow and flutter
- Optimum speaker placement, and more . . . much more.

And you can do it all without any instruments . . . by ear alone.

### Step-by-step instructions

Included with the SRT14 is a detailed instruction manual complete with charts, tables, and diagrams. This takes you step by step through the testing process. It explains the significance of each test. It tells you what to listen for. It clearly describes any aberrations in system response. And it details corrective procedures.

### For professionals too

The usefulness of the SRT14 is not confined to the nontechnical listener. Included on the record are a series of tests that call for the use of sophisticated measuring instruments, such as oscilloscopes, chart recorders, and distortion analyzers. These tests permit the advanced audiophile and professional to make precise measurements of transient response, recorded signal velocity, anti-skating compensation, IM distortion, and a host of other performance characteristics.

### SRT14 record contents

**FREQUENCY-RESPONSE TEST, LEFT AND RIGHT CHANNELS.** Consists of half-octave warble tones that permit testing and adjustment of frequency response of a sound system over the full audio range.

**STEREO SEPARATION.** Indicates the amount of signal leakage from one channel into another using warble tones from 400 to 12,800 Hz.

**PHONO-CARTRIDGE TRACKING, HIGH FREQUENCY.** Consists of a two-tone test signal (16,000 and 16,300 Hz) that repeatedly swoops to a high level and returns to a fixed low level. The level and quality of an audible "difference tone" indicates mistracking.

**PHONO-CARTRIDGE TRACKING, LOW FREQUENCY.** A single 300-Hz tone recorded with similar swoops indicates mistracking as an increase in harmonic distortion.

**CHANNEL BALANCE.** Separate random-phase noise sources for the two channels permit balancing not only of overall channel levels, but also of the individual tweeters and mid-range drivers in the speaker systems.

**PHASE TEST, SPEAKERS AND PHONO-CARTRIDGE.** A low-frequency warble tone is recorded alternately in and out of phase several times to establish correct interchannel phasing.



**NOISE TEST.** A very low-level recording of a piano provides a reference playback level by which the low-frequency noise of a sound system playing an unmodulated groove can be judged.

**RECORD-PLAYER FLUTTER TEST.** A passage of piano music is recorded three times with increasing amounts of flutter. The degree to which the record-player's flutter "masks" the recorded flutter indicates its relative severity.

**FREQUENCY-RESPONSE SWEEP, 10,000 TO 40,000 HZ.** The frequency response and channel separation of a phono cartridge at ultrasonic frequencies can be measured with a voltmeter or other appropriate instrument to give an indication of the cartridge's suitability for CD reproduction.

**FREQUENCY-RESPONSE SWEEP, 500 TO 20,000 HZ.** Similarly, the cartridge's response and separation over the range of important audible frequencies can be measured.

**SQUARE-WAVE TEST.** The high-frequency response, phase shift, and resonant characteristics of a phono cartridge can be evaluated quickly by viewing the reproduced waveform of an RIAA-equalized 500-Hz square wave on an oscilloscope.

**TONE-BURST TEST.** Tone bursts sweeping from 500 to 20,000 Hz give an indication of a phono cartridge's transient response when the reproduced signal is viewed on the oscilloscope.

**INTERMODULATION-DISTORTION TEST.** A phono cartridge's intermodulation distortion can be measured directly using a standard IM meter designed to analyze an SMPTE signal.

**ANTISKATING TEST.** A specially designed test signal permits adjustment of skating compensation for best reproduction of critical high-level recorded passages.

**1,000-HZ REFERENCE TONES.** Four tones whose recorded velocities increase by 3-dB steps can be used to determine (by the comparison method) the recorded signal velocity on a disc recording.

**FLUTTER AND SPEED TEST.** A 3,150-Hz tone recorded with great speed-accuracy and stability provides a signal for use with a flutter meter or frequency counter.

**STEREO-SPREAD TEST.** A series of recorded gun shots provide a guide to optimum speaker placement for the most subjective satisfying stereo image.

### The final step

Start getting the most out of your stereo system. Make the SRT14 your next record purchase. Just complete the coupon and mail it along with your remittance . . . today!

Test Record, Dept. 30013, P.O. Box 278, Pratt Station, Brooklyn, NY 11205

Please send \_\_\_\_\_ SRT14 (Stereo) Test Records @ \$7.95 each (\$9.95 outside U.S.A.).

Enclosed is \$\_\_\_\_\_ Residents of CA, CO, DC, FL, IL, MI, MO, NY STATE, TX and VT add applicable sales tax.

CHARGE:  American Express  Master Charge  
 VISA  Diners Club

Account # \_\_\_\_\_ Exp. Date \_\_\_\_\_

Master Charge Interbank # \_\_\_\_\_ (4 #'s over your name)

Signature \_\_\_\_\_

Print Name \_\_\_\_\_

Address \_\_\_\_\_

City \_\_\_\_\_ State \_\_\_\_\_ Zip \_\_\_\_\_



## Prokofiev's Film Music: Two New Recordings



Culver Pictures

WHAT appears to be the first four-channel recording of Sergei Prokofiev's *Alexander Nevsky* cantata—derived from his music for the justly celebrated Sergei Eisenstein film—has been released on the Candide label, and to my very pleasant surprise both the performance and the sound quality stand up to the finest imaginable competition on full-price labels.

Having myself been involved in producing recordings with less than celebrated orchestras, I am well aware that a challenge of the sort represented by *Nevsky* can get the performers tremendously charged up, which I assume is part of the explanation for the remarkable results achieved here by mezzo Claudine Carlson and the St. Louis Symphony Orchestra and Chorus with Leonard Slatkin conducting. Another large element in the success is the production work of Marc Aubort and Joanna Nickrenz, whose previous work for Vox in St. Louis and Minneapolis was formidable. It is clear that they took particular care to achieve something of an aural parallel in the recording to Eisenstein's camera tracking in the film—for example, the immense down-river vista that accompanies the "Song about Alexander Nevsky" and the violent cross-cutting in the "Battle on the Ice." Of course, the full impact can be experienced only in properly decoded quadrasonic playback of the QS recording.

THE orchestral presence here is full-bodied and shows up the most minute details of line and color. The chorus, singing in Russian, is slightly further back in perspective, yet amply present, and in four-channel playback the placement gives the sound a "wide-screen" quality. A most pleasing aspect of the performance is a balance of male to female voices that very nearly approximates that in Russian choirs. While Yevgeny Svetlanov's Melodiya/Angel disc may be a shade more idiomatic in style, the sonics are by no means in a class with those accorded Slatkin and his forces. The gut-shaking bass transients in the "Cru-

saders in Pskov" and the "Battle on the Ice" climaxes provide ample testimony to this superiority. And I must add that Carlson's richly throaty mezzo-soprano most affectingly conveys the message of Prokofiev's nobly elegiac "Field of the Dead." All told, this is a very fine performance and an altogether outstanding production.

—David Hall

PROKOFIEV worked on his score for Sergei Eisenstein's projected three-part motion-picture epic *Ivan the Terrible* from 1942 to 1945. Only two parts of the film were fully realized; Eisenstein's death in 1946 left the trilogy uncompleted. Unlike the film score of *Alexander Nevsky*, which Prokofiev fashioned into an effective concert cantata, the music for *Ivan the Terrible* was left untouched by the composer. After his death, it was Abram Stasevich, conductor for the film, who arranged it in the form of an oratorio and subsequently recorded it, a performance that was briefly available here as Melodiya/Angel SRB-4103.

The work makes an admirable tapestry. Really a series of episodes covering many years of the fearsome monarch's reign, it is held together by a narrator who alternately fills in the historical background and voices Ivan's own passionate pronouncements. The music

something of an  
aural parallel to the  
"Battle on the Ice"

at times recalls the epic style of the composer's Fifth Symphony (written in the same period) in its dramatic sweep and bold, brassy proclamations. But equally effective is the

choral writing—the splendid coronation scene and picturesque evocations of conspiracies, bloody deeds, and savage battles. This is a brilliantly conceived and highly exciting score.

IN Angel's new quadrasonic recording of *Ivan*, Boris Morgunov declaims the text in a vivid melodramatic style that seems just right in approach, particularly to the listener familiar with the film. There are three contralto solos (two with chorus), which Irina Arkhipova sings with her customary opulence. Baritone Anatoly Mokrenko has only one number, a boisterous drinking song, and he sings it with lively gusto and adequate vocal resources. But the real hero is conductor Riccardo Muti, who fuses all the elements into an irresistible whole. The chorus sounds inspired, the orchestra plays with razor-sharp precision and transparent clarity, and dramatic momentum is sustained throughout. The four-channel SQ-encoded recording captures all this with considerable success.

On the fourth side of the set, Muti leads the orchestra in the same exemplary fashion in Prokofiev's rarely heard *Sinfonietta* (originally Opus 5, later revised in 1929 to become Opus 48). This is a concise, five-movement work in the sardonic spirit of the *Classical* Symphony, with a constant rhythmic animation and a certain harmonic quirkiness that keep it stimulating. Altogether, the release adds up to a package of pleasing discoveries.

—George Jellinek

PROKOFIEV: *Alexander Nevsky*, Op. 78. Claudine Carlson (mezzo-soprano); St. Louis Symphony Orchestra and Chorus, Leonard Slatkin cond. CANDIDE □ QCE 31098 \$4.98.

PROKOFIEV: *Ivan the Terrible*, Op. 116; *Sinfonietta*, Op. 5/48. Boris Morgunov (narrator); Irina Arkhipova (mezzo-soprano); Anatoly Mokrenko (baritone); the Ambrosian Chorus; Philharmonia Orchestra, Riccardo Muti cond. ANGEL □ SB-3851 two discs \$15.98.



SAVE MONEY!
SAVE TIME!
SAVE FREIGHT!

Phone Now!
312
664-0020

illinois audio
12 East Delaware Place, Chicago 60611



PIONEER TAPE DECKS - SAVE LOTS OF \$\$\$

Table listing Pioneer Reel-to-Reel Decks and Cassette Decks with prices.



RECEIVERS-TUNERS-AMPLIFIERS-ELECTRONICS

Table listing Pioneer Receivers and Separates with prices.

Table listing Sansui Stereo Equipment with prices.

Table listing Marantz Stereo Equipment with prices.

Table listing Kenwood Electronics with prices.

Sherwood - New Certified Performance Units

JVC - Call or Write Us For These Prices

Technics Electronics - Best Prices!

Table listing Dynaco Electronics with prices.

Table listing Sony Electronics with prices.



TURNTABLES-CHANGERS-COMplete PACKAGES

Table listing Dual Changers & Turntables-Complete Packages.

Table listing B-I-C Automatic Turntables.

Table listing Garrard Automatic Turntables.

Table listing Empire Professional Turntable.

Table listing Sony Turntables with Base and Covers.

Table listing Marantz Turntables - Good Deals!

Table listing Philips Turntable.

Table listing Technics Turntable - Bargains!

Table listing Sansui Turntables with Bases & Covers.

Table listing Pioneer Turntables Bases & Covers Included.

NOTE: THE USE OF "LIST" PRICE ON THIS SHEET IS FOR COMPARISON PURPOSES ONLY...



LOUDSPEAKER SYSTEMS-WRITE FOR OTHERS NOW

Table listing Pioneer Loudspeaker Systems - Best Buys!

Table listing B-I-C Venturi Loudspeaker System Deals.

Table listing Sansui Loudspeaker Systems - New Models.

Table listing Dynaco Loudspeaker Systems - Big Deal!

Table listing Marantz Loudspeaker Super Systems.

Table listing Technics Loudspeaker Systems.

Table listing Altec Loudspeaker Systems.

Looking for something that's not listed? Fill in coupon and send it to us...

Form for requesting products not listed, including name, address, and city.

Call if you have questions: 312-664-0020

Table listing Teac Tape Decks - Best Sellers.

Table listing Dual Cassette Decks - New Models!

Table listing Kenwood Cassette Decks - Better Values Now!

Table listing Marantz Cassette Decks - Best Values Ever!

Table listing Sansui Cassette Decks - Best Selling Models!

Table listing Akai Tape Decks - Super Deals and Prices!

Table listing Cassette Decks.

Form for requesting products not listed, including name, address, and city.

ABOUT ORDERING: ALL MERCHANDISE SHIPPED FROM OUR WAREHOUSE IN FACTORY SEALED CARTONS (DOUBLE PACKED WHERE NECESSARY) AND INCLUDES FULL MANUFACTURERS WARRANTIES TO ORDER...



# STEREO REVIEW MARKET PLACE

**REGULAR CLASSIFIED: COMMERCIAL RATES:** For firms or individuals offering commercial products or services, \$2.25 per word. Minimum order \$33.75. **EXPAND-AD® CLASSIFIED RATE:** \$3.40 per word. Minimum \$51.00. Frequency discount: 5% for 6 months; 10% for 12 months paid in advance. **PERSONAL RATE:** For individuals with a personal item to buy or sell, \$1.35 per word. No minimum! **DISPLAY CLASSIFIED:** 1" by one col., \$280.00. 2" by one col., \$560.00. Col. width 2-1/4". Advertiser to supply film positives. Please write or phone for frequency rates. **COLOR:** Color avail for all classified ad styles at earned rate plus additional 25%. Color choice Publisher's option & subject to availability. Publisher reserves right to run ad in black if color not available on classified pages. In such cases color charge will be refunded or credited. **GENERAL INFORMATION:** Ad copy must be typewritten or clearly printed. Payment must accompany copy except when ads are to be billed on credit cards — American Express, Diners Club, Master Charge, VISA — or when ads are placed by accredited advertising agencies. First word in all ads set in caps. All copy subject to publisher's approval. All advertisers using P.O. Boxes in their addresses MUST supply publisher with permanent address and telephone number before ad can be run. Ads are not acknowledged. They will appear in the first issue to go to press after closing date. Closing Date: 5th of the 2nd month preceding cover date (for example, March issue closes January 5th). Send order and remittance to: Classified Advertising, **STEREO REVIEW**, One Park Avenue, New York, New York 10016. For inquiries contact: Gladys Mathieu at (212) 725-3926.

## EQUIPMENT

WRITE FOR quotation on any Hi-Fi components: Sound Reproduction Inc., 460 Central Avenue, East Orange, N.J. 07018. 201-673-0600.

WRITE FOR DISCOUNT PRICES on your choice of components. District Sound, Inc., 2316 R.I. Ave., Wash., D.C. 20018. (202) 832-1900.

### STEREO TV

The TE-200 TELEADAPTER EASILY CONNECTS TO ANY TV & STEREO SYSTEM. Using our coupling and matrix circuit, the adapter takes a low impedance output from the television and delivers two HIGH IMPEDANCE CHANNELS OF SIMULATED STEREO to drive any amplifier. Frequency response is maintained so you can hear the tinkle of bells or booming bass sounds as it happens on TV. With service warranty and hookup instructions \$21.95 ppd. Guaranteed to make your TV 100% more enjoyable.

TE-300 UHF-VHF TV Hi-Fi Audio Tuner for the best TV sound. Solid state, mono and simulated stereo outputs - use with any amplifier. Anodized front panel - simulated walnut case. Dare to be 100% entertained. \$199.95 ppd. SEND CHECK M.O. MASTERCARD or BANKAMERICARD NO and Expiration date TO: RHOADES NATIONAL CORP. DEPT. A BOX 817, HENDERSONVILLE, TENNESSEE 37075 (615) 824-1735

NAME \_\_\_\_\_  
 ADDRESS \_\_\_\_\_  
 CITY \_\_\_\_\_ STATE \_\_\_\_\_ ZIP \_\_\_\_\_

#SEND COMPLETE CATALOG

DIAMOND NEEDLES and STEREO CARTRIDGES at DISCOUNT PRICES for SHURE, PICKERING, STANTON, EMPIRE, GRADO and ADC. Send for free catalog. LYLE CARTRIDGES, Dept. S., Box 69, Kensington Station, Brooklyn, New York 11218. For Fast Service call Toll Free 800-221-0906.

SAVE UP TO 69% on over 100 top brand audio components from Carston Studios, New England's Audio Supermarket, one of the oldest mail order firms (Est. 1952) and certainly one of the most reliable. All orders shipped from stocked warehouse. Send for price quote and price list. Carston Studios, Old Brookfield Rd., Danbury, Conn. 06810.

PROFESSIONAL HI-FI COURSE—Instructors include Len Feldman, Julian Hirsch, Larry Klein and Larry Zide. Home study course also available. Send \$2.00 for full color AUDIO PRIMER and full information on joining Society Audio Consultants (SAC), 49 E 34th St., Dept. SR, New York, New York 10016.

PERFORMANCE ENTHUSIASTS PREFER DYNAKITS. Before Purchase You Owe Yourself Our Quote. Mainline IIr, 971 Fronheiser, Johnston, PA 15902.

### SMALL WONDER

You can get a virtual wall of sound out of two-element high-fidelity stereo speakers only ten inches high. With 1" dome tweeter and 6" woofer, the Speakerlab Point One outperforms the



expensive, imported miniature systems yet only costs \$55 each. Because you assemble it in less than an hour with only a tube of special adhesive. See it in our 34-page color catalog/manual of kits, raw speakers and accessories. Send \$0x to

**Speakerlab®**  
 Dept. SR-S,  
 735 N. Northlake Way  
 Seattle, WA 98103

SANSUI and PICKERING! BELOW mail order prices! Send to: GSH Super Savings, P.O. Box 86, Eden, N.C. 27288.

LOWEST PRICES on stereo-esoteric components & tapes!!! Over 150 brands. Audio Unlimited, 401 Reynolds Circle # 12-B, San Jose, CA 95112. (408) 289-8875.

NEEDLE IN A HAYSTACK specializes in stereo styli and cartridges, accessories, special albums. All major brands and many hard-to-find replacements available. Free catalog. Dept. S, P.O. Box 17436, Washington, D.C. 20041.

BARCLAY STEREO COMPONENTS for those who appreciate fine music: Audio Research, Crown, RTR, IMF, EMT, Dennon, Luxman, KEF, Nakamichi, Magnaplanar. Request free catalog — 233 East Lancaster Avenue, Wynnewood, PA 19096. (215) 667-3048.

CANADIAN Discount Catalog. Name brand stereo and 4-channel gear. Ecto-3, 521 5th Ave., NYC 10017.

**SHURE**

**KOSS**

**BIC-TEAC**

**ADC**

**TDK**

**SONY**

**AKAI**

AND OVER 40 OTHERS

### BUY HI-FI COMPONENTS THE MODERN WAY

## PHONE & MAIL

Call TOLL FREE or write for LOW PRICES  
 IN CALIFORNIA    NATIONWIDE  
 800/472-1783    800/854-7769

Approved by phone  
**MCK SALES**  
 111 S. COLLEGE AVE, PO BOX 5000  
 CLAREMONT CA 91711

## A SINGER'S DREAM!

**REMOVES VOCAL FROM MOST STEREO DISCS**

The Thompson Vocal Eliminator can actually remove most of all of a solo vocalist from a standard stereo record and yet leave the background music virtually untouched! Not an equalizer! We can prove it works over the phone. Write for a brochure and demo record below. COST: \$195.00

## ECHO Ambiance

We do it BETTER for LESS

Whether your interest is in using ambiance for a concert hall effect or as an echo chamber for studio recording use, we manufacture a broad line of sophisticated analog delay Echo and Reverberation devices at prices which only direct sales make possible. Prices range from \$159 to \$495.

Write for a brochure and demo record. Include \$1 to cover costs (refundable with order).

Write to: **LT Sound**, Dept. SR, P.O. Box 1061,  
 Decatur, GA 30031 (404) 284-5155

LOWEST PRICES and Biggest Mail Order Business in California: California Natural Sound, P.O. Box 99147, San Francisco, Calif. 94109.

### Lambda Series II by SpeakerKit, Ltd.

Woofers with butyl surrounds. Transmission lines. Open dome midrange and tweeters. Infra-woofers and ultra-tweeters. Accurate sound at a reasonable price. Send 25¢ for Series II catalog and manual.

**SpeakerKit** Box 12S, Menomonie, WI 54751

## STEREO COMPONENT Video Tape Equipment

**AKAI • B-i-C • Harman Kardon  
 Phase Linear • ALTEC • Kenwood •  
 TEAC • Marantz • Sony • Technics •  
 Sanyo • JVC • JBL • Pioneer • Dual •  
 RCA** Photographic Equipment Too!

**TO ORDER CALL TOLL FREE  
 (800) 421-8537**

## Henny's

**CAMERA • HI-FI • VIDEO**

516 W. 8th St. Downtown L.A., Ca. 90014 Tel. 488-0341

**HOLD IT! DON'T BUY a component rack until you've seen the best coming next month from Custom Sound.**

DYNAKITS — LOW PRICES, fast service. DEW Audio (formerly Underground HiFi), #Pinewood, Hampstead, N.H. 03841.

DISKO MIX-MASTER IV outstanding performance, professional specs. Two phono inputs: tape, MIC inpts plus cueing. Literature available. Berkshire Audio, P.O. Box 35, Great Neck, NY 11021.

BRITISH HI-FI? We can supply all brands at keenest prices. Mail for free quote. Audimex International Ltd., 16 Charlotte Street, Bristol, BS1 5PP England.

HORNS-WOOFERS-MIDS-TWEETERS at tremendous OEM savings. Altec, Electro-Voice, Pioneer, Peerless, Phillips, Polydax and many others. Dozens of hard to find items used in major manufacturers most expensive systems. Huge selection of crossover network components, automobile systems, and musical instrument loudspeakers. Send for FREE catalog. Sherman Research Corp., Audio Sales Div., Dept. SR, 9144 King Arthur Dr., Dallas, TX 75247.

WRITE OR CALL for quotes on Hi-Fi equipment: Stereo & Stuff, PO Box 671, Storm Lake, Iowa 50588. (712) 732-5329.

**AUDIO BARGAINS—FREE LIST.** Stamp please. Stereo Cost Cutters, Box 8014 (SR788), Canton, Ohio 44711.

### BUILD YOUR OWN SPEAKERS

**SAVE  
50 TO 75%**

Send for FREE 40 page Catalog/Manual  
 Speaker Kits • Components • Crossovers  
**ACUSTA CRAFT**  
 Dept. SR P.O. Box 12030  
 Shawnee Mission, Ks. 66212

### Get QUALITY HI-FI with PROFESSIONAL ADVICE call the Pros at Audio Concepts

Franchised Dealers For:  
**JBL, AR, TECHNICS PRO, GREAT AMERICAN SOUND, MICRO SEIKI, BOSE, DAHLQUIST, AVID, ADS/NAKAMICHI, KOSS, MAXELL, DISCWASHER, MXR, YAMAHA, ONKYO, OPTONICA, SATY-ADC, ACCUTHASE, PHASE LINEAR, TANDBERG, AKG, DBX, WIN LABS, SONUS, MICRO ACOUSTICS, HARMAN KARDON, DUAL, OTHERS.**

Call or write us. IT'S WORTH IT!  
 Free freight on most items. Master Charge approved by phone.

## AUDIO CONCEPTS

1127 W. Huntington Dr., Arcadia, CA 91006  
 (213) 445-0710

## TAPE AND RECORDERS

GOLDEN AGE RADIO—Your best source for radio tapes. Free catalog. Box 25215-TA, Portland, Oregon 97225.

OPERA CLASSICAL MUSIC Open Reels. Rare mostly live free catalog. K. Lohan Tapes, P.O. 298, Mastic Beach, N.Y. 11951.

TDK, BASF, Memorex, Maxell, cassettes, reels, 8-tracks. Lowest prices, new guaranteed. S&S Audio, P.O. Box 56039, Harwood Heights, Ill. 60656.

SCOTCH RECORDING TAPE, exclusively, all new, lowest prices. TAPE CENTER, Box 4305, Washington, D.C. 20012.

RADIO'S GOLDEN DAYS on tape. Reel, Cassette, Cartridge catalog. Radio Memories, Box 2297, Newport News, VA 23602.

1930-1962 RADIO PROGRAMS. Beats Television!! Tapes, \$1.00 Hour! Established esteemed dealer. Informative 200 page catalog, \$1.25. AM Treasures, Box 192SR, Babylon, N.Y. 11702.



EVERYTHING ON OPEN REEL! Stereo, Quadraphonic. Catalogue \$1.00. Barclay-Crocker, Room 1470S, 11 Broadway, New York 10004.

RADIO RERUNS best source for radio shows, remotes, chronologies, jazz, personalities. Box 724-SR, Redmond, WA 98052.

HISTORICAL OPERA DISC & TAPE — Magnificent quality, speedy service. Greatest live performances of past 50 years. Reel, cassette, disc. Free catalog. Historical Recording Enterprises, Box 12, Kew Gardens, N.Y. 11415.

LIVE OPERA TAPES (REELS) — CASSETTES. Unbelievable treasure since 1926. Over 4,000 selections. Free DELUXE Catalog: Mr. Tape, Box 138, Murray Hill Station, N.Y. 10016.

BASF TAPE: All widths 40-55% off. All tapes guaranteed. INTERGALACTIC, 1043 Kirks, Troy, Michigan 48084.

8600' NEW L/N Scotch or Ampex tape, 10-1/2" metal reel 5 for \$38.00. 24 page booklet on tape editing 80 cents. Sound, POB 88338, Atlanta, GA 30338.

RECORDING TAPE — Outstanding Values. Cassettes, 8-Tracks, Open Reels, Accessories. New, fully guaranteed. Free Catalog. Write: Magne House, 2015-A, 17th Street, San Francisco, CA 94103.

YESTERDAY'S RADIO ON TAPE. Reels-Cassettes. Quality Sound. Reliable Service. Catalog \$1.00 refundable with first order. ADVENTURES, Box 4822-S, Inglewood, California 90302.

LIVE OPERA TAPES ON REEL. Quality casts, Sound-coded. Reasonable. Free catalogue. Fann, 330 W. 56th, 4A, New York, NY 10019.

SAVE \$\$\$ on Blank Cassettes. First line state-of-the-art quality guaranteed. No minimum. Easy ordering. Fast, free shipping. Sample C-46, \$1.00. Larksong, Box 641, Point Area, CA 95468.

VIENNESE LIGHT MUSIC SOCIETY — Waltzes, Polkas, Overtures on imported Dolby cassettes. Most non-Schwann. K.C. Company, Box 793, Augusta, Maine 04330.

LIVE OPERA TAPES, CASSETTES. Incredible selection since 1930's. Personal, quick service, bonuses. Magnificent free catalogue. LIVE OPERA, Box 3141, Steinway Station, L.I.C., N.Y. 11103.

40,000 OLD RADIO SHOWS on Tape, Jazz/Big Band remotes. Country/Western, discographies, anthologies, chronologies. Send \$2 for huge catalog (refundable). McCoy's Recording, Box 1069S, Richland, Washington 99352.

CLASSICAL CASSETTES. FREE Catalog. Stereo-Dolby. Quality Guaranteed. Credit cards accepted. EKR Classics, GPO Box 1977SG, New York, N.Y. 10001.

AMPEX GRAND MASTER C-90 Tape Cassettes. Professional Studio Quality. Factory Sealed. \$3.00 each. Minimum order ten tapes. Add \$2.49 Shipping & Handling and 5% Texas tax. Discount Tapes, Box 35493, Dallas, TX 75235.

PARANOID ABOUT SPECS? Prove or disprove playback performance cassette or record player with surprising new technique developed by Emory Cook. Test cassette or record, instructions \$3.95 (Connecticut residents add tax). COOK LABORATORIES, INC., 375 Ely Avenue, Norwalk, CT 06854.

SAVE up to 80% BY MAIL on: SCOTCH, TDK, BASF, MAXELL, MEMOREX, CAPITOL MUSIC TAPE, CERTRON (over 180 different reel & cassette tapes to choose from); top brand recorders; America's largest collection of taping accessories, too. Same day service. **FREE catalog.**

America's Recording Tape Specialists

## SAXITONE TAPE SALES

1776b Columbia Rd., Washington, D.C. 20009  
(202) 462-0800

### BLANK TAPE SALE

MAXELL RECORDING PROJECTS. We carry the complete line of Maxell products. Write or call for prices.

TDK: SA-C60	..... \$1.97	Ampex: Grandmaster-C60	..... \$2.29
TDK: SA-C90	..... 2.87	Ampex: Grandmaster-C90	..... 3.19
TDK: AD-C90	..... 2.39	BASF: Studio or CRD <sup>2</sup> -C90	..... 2.49
Scotch: Master I-C90	..... 2.79	BASF: Prof. I-C90	..... 2.69
Scotch: Master II or III-C90	..... 3.24	BASF: Prof. II or III-C90	..... 2.79

Minimum order 12 pieces. All tapes can be assorted. PA add sales tax. Shipping \$2.50 per order. Or write for complete catalog. (412) 283-8621.  
**Tape World, 220 Spring St., Butler, PA 16001**

## RECORDS

SHOW ALBUMS. Rare, Out-of-Print LP's. 64 pg. list. \$1.00. Bakers Wife cast LP \$9.95. Broadway/Hollywood Recordings, Georgetown, Conn. 06829.

PROTECT your LP's—Poly sleeves for jackets 9 cents; Round Bottom Inner Sleeves 8 cents; Square Bottom 6 cents; Poly lined paper 15 cents; white jackets 35 cents. Postage \$1.50. Record House, Hillburn, N.Y. 10931.

COLLECTORS' Soundtracks. Mint. List 50 cents (refundable). Jemm's, P.O. Box 157, Glenview, Ill. 60025.

OLDIES oldies, 45rpm. Also current hits. Free Catalog. Cor-ny's Record Shop, Box 166HF, Mason, Ohio 45040.

CLASSICAL RECORDINGS for collectors. Bi-monthly lists. Collections bought, ARS MUSICA, 13 Dante St., Larchmont, N.Y. 10538.

PROTECT YOUR ALBUMS. White cardboard replacement jackets 35 cents. Plastic lined sleeves 15 cents. Postage \$1.25. Opera Boxes, 78 Sleeves. Free Catalog. CABCO 400-1, Box 8212, Columbus, Ohio 43201.

THOUSANDS of like new LPs and prerecorded tapes catalogue \$1.50. Records, Hillburn, New York 10931.

## NOTICE: Record Raters Wanted

(No experience required) Each month you will receive nationally released albums to rate **There is no extra charge for the LP's you receive** — all you pay is a small membership fee which covers all costs of the LP's including postage and handling. In return for your opinion you will build a substantial album collection — first come basis. For application write

**E.A.R.S. INC.**  
Box 10245 Dept. SR  
5521 Center St. Milwaukee, WI 53210  
"Guaranteed" © 1975 E.A.R.S., Inc.

DAYBREAK EXPRESS RECORDS Jazz imports from Europe and Japan. CBS-Sony, Trio-Whynot-Eastwind. Free Catalog. Write: P.O. Box 582, Cathedral St. Station, New York, N.Y. 10025.

FILM — STAGE SOUNDTRACKS! Monthly Listings! Many rarities. Over 1,000 listings! AJLSR, Box 557342, Miami, Fla. 33155.

RARE ORIGINAL RECORDS, all kinds, mostly mint. 5000 list \$2.00, refundable. Carl, Box 828, Princeton, NC 27569.

WORLD'S LARGEST, computerized catalogue of rare records. 18,000 entries. Classical, showbiz, popular, jazz, comedy, spoken. \$2.00 refundable. RoundSound West, P.O. Box 2248, Leucadia, CA 92024.

FREE

## PSYCHIC MUSIC RECORD CATALOG

and Free "MEDITATING WITH MUSIC INSTRUCTIONS." Explore your inner mind through music. A thrilling psychic experience! No obligation. Clip this ad and send to:

**BURCHETTE BROTHERS, Dept. RS**  
1632 Tarleton St., P.O. Box 1363  
Spring Valley, CA 92077

RECORD COLLECTORS: YOU SHOULD be reading my well detailed and easy to read auction list now. Send stamp for list. C.A. Burke, 432 So. "B" St., Lompoc, CA 93436.

JAPANESE STYLE UNERS and everything else in record and tape protection. Free catalog. Quasi-Rational Products, Box 171, Prospect Heights, IL 60070.

CLASSICAL LP AUCTION. Send 50¢ — SASE. List, 1955 Carmen, L.A., CA 90068.

RARE JAZZ/POP VOCAL LP's Sold by Auction. Free Lists. Leon Leavitt, P.O. Box 38395, Los Angeles, CA 90038.

DIRECT MASTERED RECORDS — Free Catalog — Phone — Write (805) 773-1855. The Essentials, 761 Shell Beach Rd., Shell Beach, CA 93449.

BLINDNESS COMPELS SALE of ten thousand classical and semi-classical records in excellent condition. No lists. Clarence I. Cohn, 250 Brevoort Lane, Rye, NY 10580. (914) 698-0456.

**TUBES**

TV and Radio Tubes 36 cents. Free 48 page color catalog. Cornnell, 4215-H University, San Diego, California 92105.

**INSTRUCTION**

HOW TO WRITE A SONG AND GET IT PUBLISHED, a booklet written by a professional musician, can get anyone started in the lucrative song writing business. Send \$2.00 to: Marva Enterprises, P.O. Box 307, Hardy, AR 72542. Request Publication #711.

**MUSICAL INSTRUMENTS**

UP TO 60% DISCOUNT. Name brand instruments Catalog. Freeport Music, 114 Q. Mahan St., W. Babylon, N.Y. 11704.

**WANTED**

GOLD, silver, platinum, mercury, tantalum wanted. Highest prices paid by refinery. Ores assayed. Free circular. Mercury Terminal, Norwood, MA 02062.

**HYPNOTISM**

FREE Hypnotism, Self-Hypnosis, Sleep Learning Catalog! Drawer H400, Ruidoso, New Mexico 88345.

**RUBBER STAMPS**

RUBBER ADDRESS STAMPS, BUSINESS CARDS. Free Catalog — Fast Service. Jackson's, Brownsville Road-E-101, Mt. Vernon, Ill. 62864.

**BUSINESS OPPORTUNITIES**

I MADE \$40,000.00 Year by mail order! Helped others make money! Free Proof. Torrey, Box 318-NN, Ypsilanti, Michigan 48197.

STEREO REPRESENTATIVES NEEDED!!! Lowest Possible Prices!! Over 100 Brands!!! Krasco-Rep, 998 Orange Ave., West Haven, Conn. 06516.

GET RICH!! Secret law erases debt. Free report exposes millionaire \$\$ secrets. Blueprints, No. DD8, 453 W 256, NYC 10471.

### CLASSIFIED ADVERTISING ORDER FORM

1	2	3
4	5	6
7	8	9
10	11	12
13	14	15
16	17	18
19	20	21
22	23	24
25	26	27
28	29	30

SIGNATURE \_\_\_\_\_

PRINT NAME \_\_\_\_\_

ADDRESS \_\_\_\_\_

CITY \_\_\_\_\_ STATE \_\_\_\_\_ ZIP \_\_\_\_\_ SR-878

Please refer to heading on first page of this section for complete data concerning terms, frequency discounts, closing dates, etc. **WORD COUNT: 15 WORD MINIMUM.** Include name and address.

Words \_\_\_\_\_

\$2.25 (Commercial Rate)  
\$3.40 (Expand-Ad Rate)  
\$1.35 (Personal Rate)

Insertions \_\_\_\_\_

ENCLOSED IS \$ \_\_\_\_\_

CHARGE: You will be billed monthly.

American Express     Master Charge

Visa                       Diners Club

Account # \_\_\_\_\_

Expiration Date \_\_\_\_\_

Master Charge Interbank # (4 digits above name) \_\_\_\_\_



NEW LUXURY Car without cost. Free Details! Codex-ZZ, Box 6073, Toledo, Ohio 43614.

MAKE BIG MONEY in spare time selling: Tubes, Antennas, Speakers, Test Equipment, Lite Bulbs, Hi-Fi, etc. No investment. Free information: Allied Sales, Pimento, IN 47866. (812) 495-6555.

MILLIONS IN MAIL! Free Secrets. Transworld-17, Box 6226, Toledo, Ohio 43614.

AUDIOPHILES WANTED!! Put your knowledge to use, earn an excellent spare time income. We need campus Dealers to sell name brand stereo equipment at substantial discounts in your area. No investment necessary. For information and application please write: ABCO, Dept SR, 1201 East Main Street, Meriden, Conn. 06450. Cali (203) 238-7979.

\$650 WEEKLY for beginners!! Free report: Mailorder Consultants MDD8, 453 W. 256, Bronx, NY 10471.

HI-FI ENTHUSIASTS WANTED!! Earn more than just spare money in your spare time. We need campus representatives to sell name brand stereo components at discount prices in your area. High commission, no investment required. Serious inquiries only, please. Contact: Mail Order Dept. K&L Sound Services Co., 75 No. Beacon St., Watertown, Mass. 02172. (617) 926-6100.

REPRESENTATIVES increase your profits! Make \$\$\$! DEUTSCHE Radiowerke offers high quality IMPORTED Headphones, SPEAKERS, Microphones. 6311 Yucca Street, Hollywood, California 90028.

COLLEGE DEALERS — WRITE for details on college program. Fast shipments, low prices, excellent profit. Sound Reproduction, 460 Central Ave., East Orange, N.J. 07018.

## MOVIE FILMS

16mm SOUND Features, Shorts, New, Used for Sale. Free Catalog. National Cinema, 333 W. 57th St., N.Y., N.Y. 10019.

## EDUCATIONAL OPPORTUNITIES

LEARN WHILE ASLEEP. Hypnotize! Astonishing details, strange catalog free! Autosuggestion, Box 24-ZD, Olympia, Washington, 98507.

## EMPLOYMENT INFORMATION

ROCKY MOUNTAIN JOBS!! Colorado, Idaho, Montana, Wyoming! Free details . . . Intermountain-W, 3506 Birch, Cheyenne, Wyoming 82001.

## SERVICES

WRITING, RESEARCH, EDITING. All disciplines. Original! Professional Team. Confidential. Reasonable. Superior literary facilities. Writers Unlimited, Box 4391, Washington, D.C. 20012. (202) 723-1715. Mastercharge — VISA accepted.

STOP! Before you buy any component check what is available from a number of companies. Send today for a package of manufacturers literature. Loudspeakers \$4.00, Turntable & Cartridges \$3.00. Other Hi-Fi categories, write or call for price. Information Exchange Co., P.O. Box 308, Concordville, PA 19331, (215) 459-5020, Mastercharge accepted.

## MAGAZINES AND BOOKS

HAD IT WITH MCINTOSH'S FREE FM LIST? Let the FM Atlas and Station Directory help you enjoy more FM stations at home or on the go. \$3.95. FM Atlas, Adolph, MN 55701.

## FOR SALE

MUSIC LOVERS — Music is Unique! So are the gifts in our catalog. Free Catalog and special offer. Musical Mart, Dept-A, Box 385, Cloverdale, Ind. 46120.

McINTOSH 6100 \$550.00, SONY 854-4S \$1000.00. J. Durand, Old Albany, Rd., Greenfield, Mass. 01301.

## PERSONALS

MAKE FRIENDS WORLDWIDE through international correspondence. Illustrated brochure free. Hermes-Verlag, Box 110660/Z, D-1000 Berlin 11, Germany.

## MISCELLANEOUS

PERSONALIZED BOUTIQUE SUNGLASSES for guys and gals. Glamorous, tinted lenses. Details free. Products International, Box 8327, St. Louis, MO 63132.

## COLLECTIONS

**THE MASTERSINGERS OF THE SAN ANTONIO SYMPHONY. Verdi: Ave Maria, from Quattro Pezzi Sacri. Lotti: Crucifixus II. Gretchaninoff: Nunc Dimittis. Corigliano: Psalm 8. Wolf: Six Sacred Songs. Byrd: Ave Verum Corpus. Rubbra: Infant Holy. Thompson: Alleluia.** Mastersingers of the San Antonio Symphony, Roger Melone cond. TEL-ARC 5026 \$7.98.

Performance: **Fine**  
Recording: **Spacious**

Of special interest here are the Wolf songs, which are not otherwise available on disc, and John Corigliano's Psalm setting, the latter as intense and gripping in its smaller-proportioned way as the fantastic Clarinet Concerto introduced in New York last winter. The Corigliano is the only piece on the disc with instrumental accompaniment—for which the listener is unprepared since there is no mention of the organ or its performer on the label or liner. There are no texts, either, a more serious omission, especially in the case of the Wolf pieces, all of whose texts are by Eichendorff. The singing, though, is invariably fine—this appears to be a first-rate little chorus—and the sound is suitably spacious.

R.F.

## RECORDING OF SPECIAL MERIT

**DAVID MUNROW: Monteverdi's Contemporaries. Mainerio: Ten Dances. Guami: Canzona à 8. Lappi: La Negrona. Prioli: Canzona Prima à 12. Porta: Corda Deo Dabimus. Busatti: Surrexit Pastor Bonus. Donati: In Te, Domine Speravi. D'India: Isti Sunt Duae Ollivae. Grandi: O Vos Omnes; O Beate Benedicte.** Early Music Consort of London, David Munrow cond. ANGEL □ S-37524 \$6.98.

Performance: **Top-drawer**  
Recording: **Excellent**

This record contains some of the most interesting music ever recorded by the Early Music Consort of London under David Munrow's direction. It is a fascinating sampler of Monteverdi's contemporaries, a group of composers who certainly gave the master a run for his money. The first side is devoted to instrumental music; especially delightful are the Mainerio dances, in which we are treated to such enticing old instruments as the xylophone (yes, it's authentic), the mandora, and the cittern. The canzonas by Guami and Prioli are scored for various multiple groups, which engage in arresting dialogues between consorts of recorders, strings, brass, and reeds.

More unusual are the motets on the second side, which are scored for vocal solo or duet with continuo accompaniment and variously instrumented *sinfonie*. The instrumental performances are crisp and vital, the vocal performances sensitive to word coloration and beautifully phrased. Countertenor James Bowman is in particularly fine form; the highlight of the record is his reading of Busatti's *Surrexit Pastor*, in which florid alleluias contrast with that strange brand of chromaticism only an early seventeenth-century Italian composer could create. Bowman holds these elements together convincingly, and his rich voice is perfect for the work.

S.L.

**JESSYE NORMAN: French Songs. Duparc: La Vie Antérieure; Phidylé; Chanson Triste;**

*L'Invitation au Voyage. Ravel: Deux Mélodies Hébraïques; L'Énigme Éternelle; Kadisch. Poulenc: Voyage à Paris; Montparnasse; Les Chemins de l'Amour; La Grenouillère. Satie: La Statue de Bronze; Daphnéo; Le Chapelier; Je Te Veux.* Jessye Norman (soprano); Dalton Baldwin (piano). PHILIPS 9500 356 \$8.98.

Performance: **Not ideal**  
Recording: **Excellent**

Despite her frequent demonstrations of remarkable vocal gifts, Jessye Norman still hasn't realized her potential as a performer. Hers is a voice of rare velvety richness with a contralto-like opulence in the bottom range. It is well equalized only up to a point, however, because the top notes lack tonal sheen. And, while her control of dynamics is impressive in the region where the voice itself glows, that too becomes unpredictable in the higher range. Moreover, her intonation is also subject to minor but damaging lapses, a phenomenon particularly apparent here in *La Vie Antérieure*. The recital is intelligently programmed, and there are several songs that present no vocal challenges to the artist. She is not yet the interpreter who can take us inside these songs with the elasticity, penetration, and textual illumination of a Teyte or a Tourel, but she does have a beautiful vocal instrument going for her. It is more suitable for the pathos of *Kadisch* or the sensuous lyricism of *Les Chemins de l'Amour* than for the ephemeral lightness of Satie and Poulenc, but it goes a long way toward giving listening pleasure. Dalton Baldwin's exemplary piano support and Philips' topnotch engineering are also helpful.

G.J.

## RECORDING OF SPECIAL MERIT

**BORIS SHTOKOLOV: Recital. Dargomyzhsky: Russalka: Aria of the Miller. Tchaikovsky: Eugene Onegin: Gremin's Aria. Rachmaninoff: Cavatina of Aleko. Boris Shtokolov (bass); Orchestra of the Bolshoi Theater, Fuat Mansurov cond. Glinka: A Life for the Tsar: Susanin's Aria. Rimsky-Korsakov: Sadko: Song of the Viking Guest. Moussorgsky: Boris Godounov: Act II. Boris Shtokolov (bass); Karina Slovtsova (soprano); Vladimir Ulyanov (tenor); others. Orchestra of the Leningrad Kirov Theater, Sergei Eltsin cond. COLUMBIA/MELODIYA M 34569 \$7.98.**

Performance: **Outstanding**  
Recording: **Good**

Boris Shtokolov, leading bass of the Leningrad Kirov Theater, was introduced to America about ten years ago by way of a superb recorded recital (Melodiya/Angel S-40038, now deleted). I recall raving about it in these pages, urging one and all to acquire that fabulous disc. Those who chose to ignore my wise counsel are now offered a second chance to make the singer's acquaintance; in fact, this Columbia release duplicates two selections (Glinka and Rimsky-Korsakov) from that bygone recital, though the performances, like the rest here, are evidently more recent.

Shtokolov is now forty-eight, and his voice has lost some of its youthful bloom, but it is still powerful, splendidly resonant, and beautifully equalized in what is generally regarded as the bass-baritone range. His low notes are "negotiated" rather than fully projected, but there is abundant skill at his disposal to conceal such relatively minor shortcomings. Nor



does he lack dramatic qualities, even though he disdains the histrionic devices of the Chaliapin school: Aleko's agony is conveyed with moving passion, and the aria of Dargomyzhsky's Miller (unheard on records since the time of Kipnis) rings out with an infectious gusto. In general, Shtokolov lets the expressive power of his voice rule over the music, and it works magnificently.

The entire second side is devoted to Act II of *Boris Godounov*, including the dialogues with the children and Shuisky, the great Monologue, and the Clock Scene. It is given in a mysterious edition that omits a great deal and adds material I've never heard in other versions. In addition to considerable textual changes, the orchestral writing varies from both Moussorgsky's original and the familiar Rimsky-Korsakov edition. This must be the Kirov's preferred way of presenting the opera, but the annotations should have made that clear. The assisting artists are entirely undistinguished, but Shtokolov excels as usual. The orchestral accompaniments are vital, if a shade unrefined in terms of ensemble sound, and the overall engineering is effective. *G.J.*

#### NEW LABELS

For comments on the first releases on the new "mid-price" labels from Deutsche Grammophon (Privilege) and Philips (Festivo), see "Going on Record," page 62.

#### RECORDING OF SPECIAL MERIT

**MARTIAL SINGHER.** *An Album of French Songs.* Duparc: *Phidylé; Le Manoir de Rosamonde; Chanson Triste; La Vie Antérieure.* Ravel: *Chants Populaires; Nicolette.* De Lara: *Rondel de l'Adieu.* Chausson: *Le Colibri, Op. 2, No. 7; Les Papillons, Op. 2, No. 3; Le Temps des Lilas, from Op. 19.* Britten: *Five French Folk-song Arrangements.* Martial Singher (baritone); Dorothy Angwin (piano). 1750 ARCH 1766 \$6.98.

Performance: **Stylish**  
Recording: **Good**

Martial Singher was seventy-two when he recorded this collection. His voice is not the opulent instrument it once was, but it is rather remarkable all the same, and the even more remarkable taste and integrity that have always distinguished his work are reflected here in the choice of material as well as his handling of it. The bittersweet *Rondel de l'Adieu* of Isidore de Lara (1858-1935) is an intriguing discovery, as are the Britten folk-song arrangements, but it is more to the point that none of the familiar or unfamiliar songs on the album could have a more persuasive champion. To hear *La Vie Antérieure* interpreted as it is here is a pointed lesson in style from a profound musician whose medium happens to be the voice. Dorothy Angwin is an able collaborator, the sound is good, and full texts and translations are provided. *R.F.*

#### RECORDING OF SPECIAL MERIT

**TAPIOLA CHILDREN'S CHOIR.** Sallinen: *Älä Tuule Tyttö Tuuli; Sympaati; En Minä Meryttä Kiitä; Balladi.* Johansson: *Pater Noster.* Britten: *Old Abram Brown.* Mellnäs:

*Aglepta.* J. S. Bach: *Mass in G Major; Domine Deus.* Pergolesi: *Stabat Mater; Final Chorus.* Trad.: *Oh, Peter Go Ring Them Bells; Go, Tell It on the Mountain.* Panula: *Are You Sleeping?* Kabalevsky: *Italaulu.* Bárdos: *Dana Dana.* Kodály: *Italaulu.* Sinikka Koivisto (soprano); Olli Pohjola (flute); Kaija Harjanne (piano); Tapiola Children's Choir, Erkki Pohjola cond. DEUTSCHE GRAMMOPHON 2530 812 \$8.98.

Performance: **Choice**  
Recording: **Excellent**

The Tapiola Children's Choir is Finland's answer to the Vienna Choir Boys. The children who make up this group are not professionals but school kids who attend classes all week in Tapiola, actually a part of the city of Espoo (about six miles west of Helsinki). Once a week they get together to rehearse, and they are terrific! They have made themselves such a reputation by now that they have been seen and heard internationally on television and radio, most notably on a television show for UNICEF (for which they were conducted by Danny Kaye). They have also made five records so far, and on this latest one there isn't a single cliché. Instead, there are remarkable settings of Finnish folk poems by the Finnish composer Aulis Sallinen; a *Pater Noster* by another Finn, Bengt Johansson, employing sound clusters as well as spoken passages combined with a deliberately archaic style to breathtaking effect; a canon by Benjamin Britten; choruses from the religious music of J. S. Bach and Pergolesi; lullabies by Kodály and Kabalevsky; and even two Afro-American spirituals, which gain in charm from the Finnish accents. A particularly startling selection is *Aglepta* by the Swedish composer Arne Mellnäs. It is based on the text of a magic verse (actually nonsense language): "*Aglaria pidhol garia ananus quepta.*" Say it to an enemy and you totally confound him. Mellnäs contrasts a conventional melody with shrieks, phonetic effects, cries, and whispers, and the result is hair-raising. No texts are included with the album, which is a shame. *P.K.*

**VIENNA WIND SOLOISTS.** Ibert: *Trois Pièces Brèves.* Janáček: *Mládi (Youth).* Hindemith: *Kleine Kammermusik, Op. 24, No. 2.* Ligeti: *Ten Pieces for Wind Quintet.* Horst Hajek (bass clarinet in Janáček); Vienna Wind Soloists. LONDON STS 15419 \$3.98.

Performance: **Bright**  
Recording: **Very good**

This is a handsome collection offering twentieth-century classics for wind quintet by Hindemith and Ibert, a contemporaneous sextet by Janáček now attaining similar status, and a ten-year-old work by Ligeti that is surprisingly appealing in its imaginative use of color and texture. The players, presumably members of the Vienna Philharmonic, all sound fine individually, and they seem to be accustomed to performing together—though not, perhaps, in all of these particular works. The opening allegro of the Ibert is rather too brisk for the ingratiatingly saucy effect I prefer, and the Hindemith suffers from a technical lapse or two as well as a certain stiffness. In general, though, these are more than agreeable performances, very well recorded; the bright, well-judged presentation of the Janáček, the strongest part of the package, is especially welcome. The annotation is concise but comprehensive and helpful. *R.F.*

## STEREO REVIEW ADVERTISERS' INDEX AUGUST 1978

READER SERVICE NO.	ADVERTISER	PAGE NUMBER
2	A A L Speakers	32
	ADS	15
	Advent Corporation	137
	Akai America, Ltd.	13
3	Allison Acoustics	36
4	Altec Corp./Sound Products Division	27
5	Angel/EMI Records	128
6	Audio Discount Warehouse Sales	100
7	Audio Dynamics—Cartridge	26
8	Audio Technica U.S., Inc.	131
	Audio Technica U.S., Inc.	59
9	Ball Corporation	11
	Bose Corporation	106, 107
10	BSR (USA), Ltd.—Accutrac	21
11	CBS Records	118
12	Celestion Industries, Inc.	129
13	Century Records	93
	Crown International	103
14	Cruzan Rum	143
	Design Acoustics	14
	Discount Music Club	33
16	Discount Sound	133
	Discwasher	4
50	Dual	47
17	Electro-Voice, Inc.	110
18	Emanation Sound	38
21	Empire Scientific Corp.	2
19	Epicure Products, Inc.	63
	ESS, Inc.	119
	Fisher Corp.	117
22	Heublein/Smirnoff Vodka	53
23	Hi-Fi Buys	134
26	Hitachi	49
24	Illinois Audio	143
25	Infinity Systems, Inc.	113
27	International Hi-Fi Dist.	138
	Jack Daniels	99
28	J & R Music World	134
	JBL	50, 51
29	Jensen Sound Laboratories	28, 29
30	JVC America	111
	Kenwood Electronics	7
	Kool Cigarettes	54, 55
31	Koss Corporation	Cover 4
32	Lafayette Radio Electronics	109
	Lux Audio of America, Ltd.	37
	Marantz, Inc.	148, Cover 3
33	Maxell Corp. of America	88
34	Mazda	105
35	McIntosh Laboratory, Inc.	135
36	Mamorex Corporation	31
37	Mitsubishi	16, 17
38	Ohm Acoustics Corp.	102
	Phase Linear	136
39	Pioneer Electronics of America	82
	Radio Shack	39
40	RTR Speakers	72
41	S A E	97
42	Sansui Electronics Corp.	115
43	Sanyo	9
	Seagrams Distillers	25
53	Sharp Electronics	23
45	Shure Brothers	34, 35
46	Sonic Research, Inc.	30
47	Sony Corporation of America	43
49	Soundcraftsmen	12
48	Sound Machine	130
51	Sound Reproduction Inc.	138
	Speakerlab	130
52	Spectro Acoustics, Inc.	96
44	Stanton Magnetics	61
54	Stereo Corporation of America	116
	Stereo Discounters	116
55	Synergistics	71
56	TDK Electronics	19
57	Technics by Panasonic	56
58	Top Discount Audio	137
61	UltraInear	120
50	United Audio	47
1	U.S. Pioneer	Cover 2, 1
	Visonik of America	87
60	Wisconsin Discount Stereo	135
	Yamaha International Corp.	45



# 17 MARANTZ COMPONENTS WHATEVER THE MIX IT'S ALWAYS

Now there's a Marantz component system for everyone! From our most affordable to our finest—with 223 systems priced in between—Marantz delivers the same top Marantz quality and the same stunning Marantz look. There's never a compromise! And with so many systems to choose from, you'll be able to find the exact match for your listening requirements and budget.

## A MARANTZ EXCLUSIVE: MIXED SYSTEMS THAT REALLY MATCH.

From the least expensive to the most expensive, all Marantz Pre-Amps, Power Amps, Console Amps, Tuners and Front-Load Cassette Decks feature the same front panel size, the same striking cosmetics, the same top quality design philosophy. So whatever component combination you choose, you'll have a perfect match. Only with Marantz.

## BRINGING IT ALL TOGETHER.

Once you have selected a system, only one question



*The RM-3700 STACK RACK contains three Marantz components on fixed-positioned shelves, an accessory shelf and divided record compartment behind its full-length smoked-glass door. The Marantz system shown includes the 6170Q Turntable, 2110 Tuner, 1180DC Integrated Amplifier, 5010B Cassette Deck and Design Series 930 Speakers.*

remains: Where do you put it? With a Marantz STACK RACK you can bring it all together—with style. The RM-3100 "Professional" STACK RACK (at right) will accommodate up to four Marantz components equipped with optional rack handle adaptors. Or you may prefer the RM-3700 "Decorator" STACK RACK (above) which encloses three Marantz components behind its full-length smoked glass door. A perfect fit in either rack, your entire system will be at your fingertips.

## BUILD NOW. ADD LATER.

Once you see and hear what Marantz components have to offer by way of more performance per dollar, striking appearance and unheard of flexibility, you'll be sold. You'll have a perfectly matched system tailored to your specific needs from as little as \$650\* to \$2100.\* And don't hesitate when you want to upgrade any part of your system. Any Marantz component you upgrade to will match what you already have.

## MIX AND MATCH BY MARANTZ—IT'S ALL FOR YOU.

17 separate components from Marantz. Designed to mix and match into 225 different systems to give you unprecedented flexibility. Whoever you are, Marantz has the perfect system for you.

*The three unit Marantz system shown at right includes the 2100 Tuner, 1090 Integrated Amplifier and the 5000 Cassette Deck with 6270Q Turntable. The four unit Marantz system shown at the far right includes the 2130 Tuner, 3650 Pre-amplifier, 5030B Cassette Deck and the 300DC Amplifier with a 6370Q Turntable.*

25<sup>th</sup> Anniversary **marantz**®



**225 MARANTZ SYSTEMS.  
S A MATCH - FROM \$650\* TO \$2100\*.**





# Our theory sounds fantastic.



©1977 Koss Corp.

In an industry where trial and error methods are common, the Koss Theory of loudspeaker design may seem out of place. But once you hear the unmatched Sound of Koss in the new CM 1020 loudspeaker, you'll know our computerized theory helped make the optimum 3 bandpass speaker a reality.

The Koss Theory eliminates the guesswork in speaker design by selecting parameters for the best possible performance. That's why every part of the CM 1020 works superbly both alone and as part of the whole.

The dual ports, for example, enhance the woofer's front sound waves and dampen excessive woofer movement. There are two ports instead of one because two allow for improved cabinet tuning and greater structural stability. This added stability keeps the cabinet walls from beginning to flex causing unwanted sound-waves.

The port-augmented 10-inch woofer is a special de-

sign that provides a 3 dB gain in electrical efficiency and a 3 dB down point of 31 Hz while offering maximally flat response over the low bandpass. To capture all the presence and musical energy from 300 Hz to 3.5 kHz, the CM 1020 features a performance synthesized 4½-inch midrange driver. Handling the high bandpass is a 1-inch dome tweeter linked to a unique acoustic transformer. This Koss tweeter produces the highest energy output and lowest distortion of any 1-inch direct radiator tweeter on the market. Finally, to unite all these outstanding elements, Koss developed a unique, seamless crossover network.

Though we've tried to describe the superiority of the Koss CM 1020, nothing can match the thrill of a live performance. Ask your Audio Dealer for a demonstration, or write to Fred Forbes c/o the Koss Corporation for a free brochure of Koss CM loudspeakers. After experiencing the CM 1020, you'll agree: hearing is believing.

## **KOSS**® CM 1020 SPEAKER SYSTEM hearing is believing™

**KOSS CORPORATION**, 4129 N. Port Washington Ave., Milwaukee, Wisconsin 53212  
Koss International/London, Dublin, Paris, Frankfurt • Amsterdam • Koss Limited/Ontario • Koss K.K./Tokyo

CIRCLE NO. 31 ON READER SERVICE CARD