

# Stereo Review®

14276

SEPTEMBER 1976 • ONE DOLLAR

## REPORT: THE '76 CONSUMER ELECTRONICS SHOW

- **RECEIVERS:** higher powers and lower costs
- **AMPLIFIERS:** the year of the medium-size super-power unit
- **TUNERS:** among others, a tuning system with a computer memory
- **PHONO CARTRIDGES:** one model weighed in at a mere gram
- **RECORD PLAYERS:** direct drive moves to the fore
- **TAPE EQUIPMENT:** the Elcaset, a brand-new cartridge format
- **SPEAKERS:** coherent phase and electrodynamic film diaphragms are still trends

AND \* \* \* \* \*

- **DISCOmania**
- **The Great American Symphony**

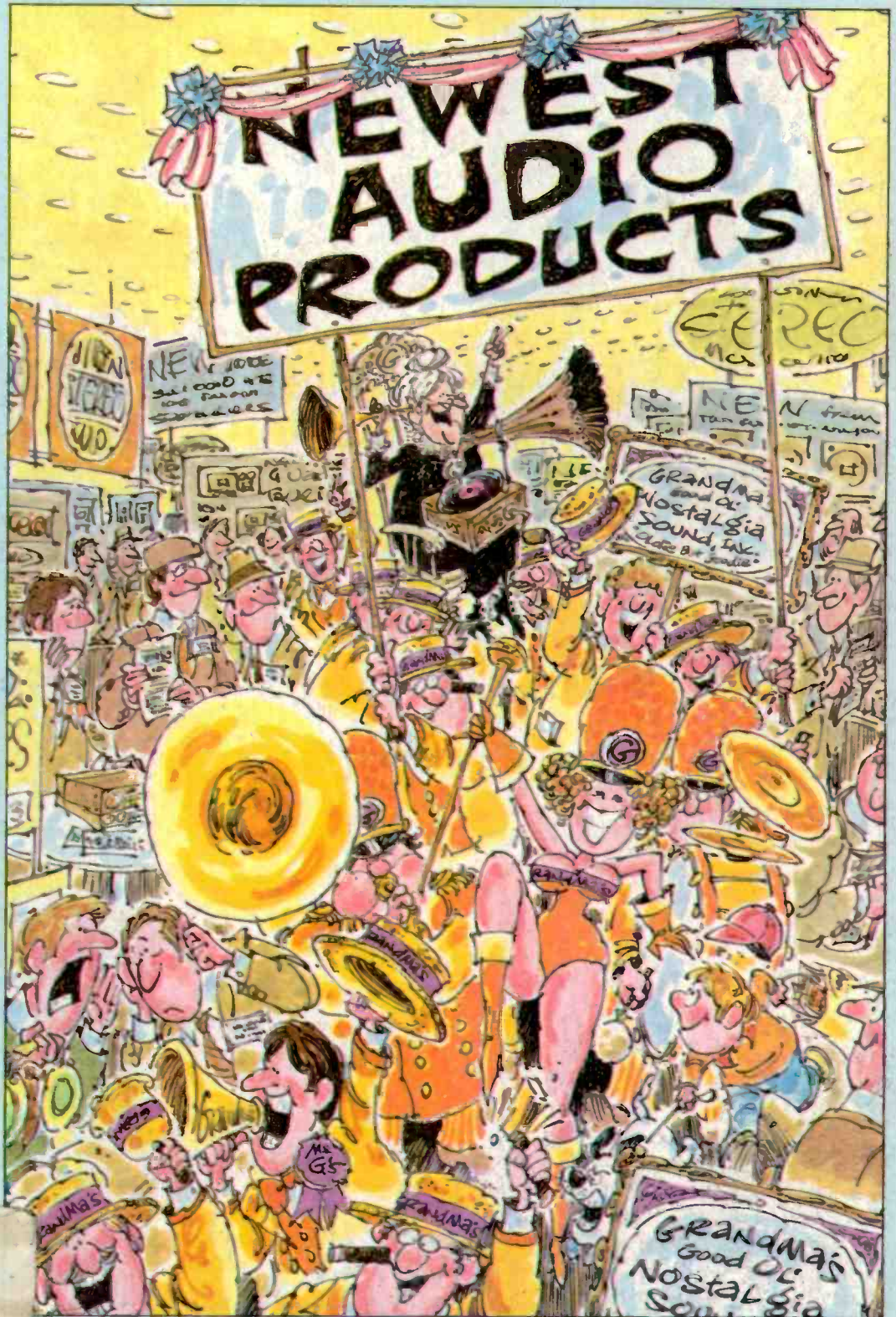

5T0256 VXR 89006093 741J MAY77  
JEFF YOKRACKA  
3990 GRANDBURY CIR  
ST LOUIS MO 63123  
69





# A COMPARISON THAT'S NO COMPARISON.

	PIONEER SX-1250	MARANTZ 2325	KENWOOD KR-9400	SANSUI 9090
POWER, MIN. RMS. 20 TO 20,000 HZ.	160W+160W	125W+125W	120W+120W	110W+110W
TOTAL HARMONIC DISTORTION	0.1%	0.15%	0.1%	0.2%
PHONO OVER- LOAD LEVEL	500 mV	100 mV	210 mV	200 mV
INPUT: PHONO/AUX/MIC	2/1/2	1/1/no	2/1/mixing	1/1/mixing
TAPE MON/DUPL	2/yes	2/yes	2/yes	2/yes
TONE	Twin Tone	Bass-Mid- Treble	Bass-Mid- Treble	Bass-Mid- Treble
TONE DEFEAT	Yes	Yes	Yes	Yes
SPEAKERS	A.B.C	A.B	A.B.C	A.B.C
FM SENSITIVITY (IHF '58)	1.5 $\mu$ V	1.8 $\mu$ V	1.7 $\mu$ V	1.7 $\mu$ V
SELECTIVITY	90 dB	80 dB	80 dB	85 dB
CAPTURE RATIO	1.0 dB	1.25 dB	1.3 dB	1.5 dB

One look at the new Pioneer SX-1250, and even the most partisan engineers at Marantz, Kenwood, Sansui or any other receiver company will have to face the facts.

There isn't another stereo receiver in the world today that comes close to it. And there isn't likely to be one for some time to come.

In effect, these makers of high-performance receivers have already conceded the superiority of the SX-1250. Just by publishing the specifications of their own top models.

As the chart shows, when our best is compared with their best there's no comparison.

### 160 WATTS PER CHANNEL: AT LEAST 28% MORE POWERFUL THAN THE REST.

In accordance with Federal Trade Commission regulations, the power output of the SX-1250 is rated at 160 watts per channel minimum RMS at 8 ohms from 20 to 20,000 Hz, with no more than 0.1% total harmonic distortion.

That's 35 to 50 watts better than the cream of the competition. Which isn't just something to impress your friends with. Unlike the usual 5-watt and 10-watt "improvements," a difference of 35 watts or more is clearly audible.

And, for critical listening, no amount of power is too much. You need all you can buy.

To maintain this huge power output, the SX-1250 has a power supply section unlike any other receiver's.

A large toroidal-core transformer with split windings and four giant 22,000-microfarad electrolytic capacitors supply the left and right channels independently. That means each channel can deliver maximum undistorted power at the bass frequencies. Without robbing the other channel.

When you switch on the SX-1250, this power supply can generate an inrush current of as much as 200 amperes. Unlike other high-power receivers, the SX-1250 is equipped with a power relay controlled by a sophisticated protection circuit, so that its transistors and your speakers are fully guarded from this onslaught.

### PREAMP SECTION CAN'T BE OVERLOADED.

Perhaps the most remarkable feature of the preamplifier circuit in the SX-1250 is the unheard-of phono overload level of half a volt (500 mV).

That means there's no magnetic cartridge in the world that can drive the preamp to the point where it sounds strained or hard. And that's the downfall of more than a few expensive units.

The equalization for the RIAA recording curve is accurate within  $\pm 0.2$  dB, a figure unsurpassed by the costliest separate preamplifiers.

### THE CLEANEST FM RECEPTION THERE IS.

Turn the tuning knob of the SX-1250, and you'll know at once that the AM/FM tuner section is special. The tuning mechanism feels astonishingly smooth, precise and solid.

The FM front end has extremely high sensitivity, but that alone would be no great achievement. Sensitivity means very little unless it's accompanied by highly effective rejection of spurious signals.

The SX-1250 is capable of receiving weak FM stations cleanly because its front end meets both requirements without the slightest compromise. Thanks, among other things, to three dual-gate MOSFET's and a five-gang variable capacitor.

On FM stereo, the multiplex design usually has the greatest effect on sound quality. The SX-1250 achieves

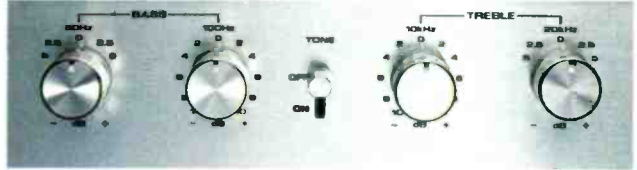

*Twin tone-control system with step-type settings, permitting 3025 possible combinations.*

its tremendous channel separation (50 dB at 1000 Hz) and extremely low distortion with the latest phase-locked-loop circuitry. Not the standard IC chip.

Overall FM distortion, mono or stereo, doesn't exceed 0.3% at any frequency below 6000 Hz. Other receiver makers don't even like to talk about that.

### AND TWO MORE RECEIVERS NOT FAR BEHIND.

Just because the Pioneer SX-1250 is in a class by itself, it would be normal to assume that in the class just below it the pecking order remains the same.

Not so.

Simultaneously with the SX-1250, we're introducing the SX-1050 and the SX-950. They're rated at 120 and 85 watts, respectively, per channel (under the same conditions as the SX-1250) and their design is very similar.

In the case of the SX-1050, you have to take off the cover to distinguish it from its bigger brother.

So you have to come to Pioneer not only for the world's best.

You also have to come to us for the next best.

U.S. Pioneer Electronics Corp., 75 Oxford Drive, Moonachie, New Jersey 07074



*Click-stop volume control calibrated in decibels, with left/right tracking within 0.5 dB.*



**PIONEER®**

Anyone can hear the difference.

CIRCLE NO. 1 ON READER SERVICE CARD



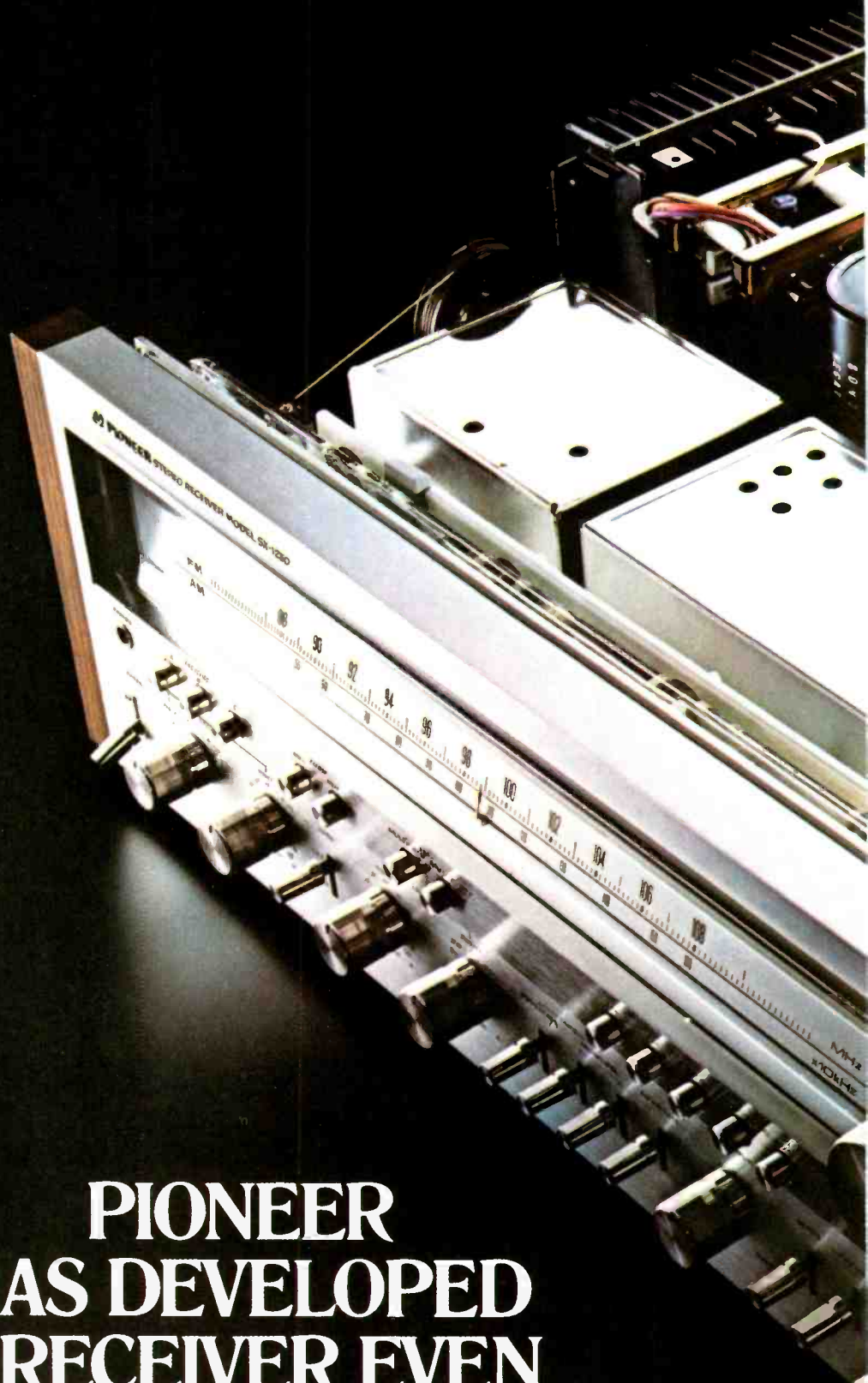

**PIONEER  
HAS DEVELOPED  
A RECEIVER EVEN  
MARANTZ, KENWOOD AND  
SANSUI WILL HAVE TO  
ADMIT IS THE BEST.**



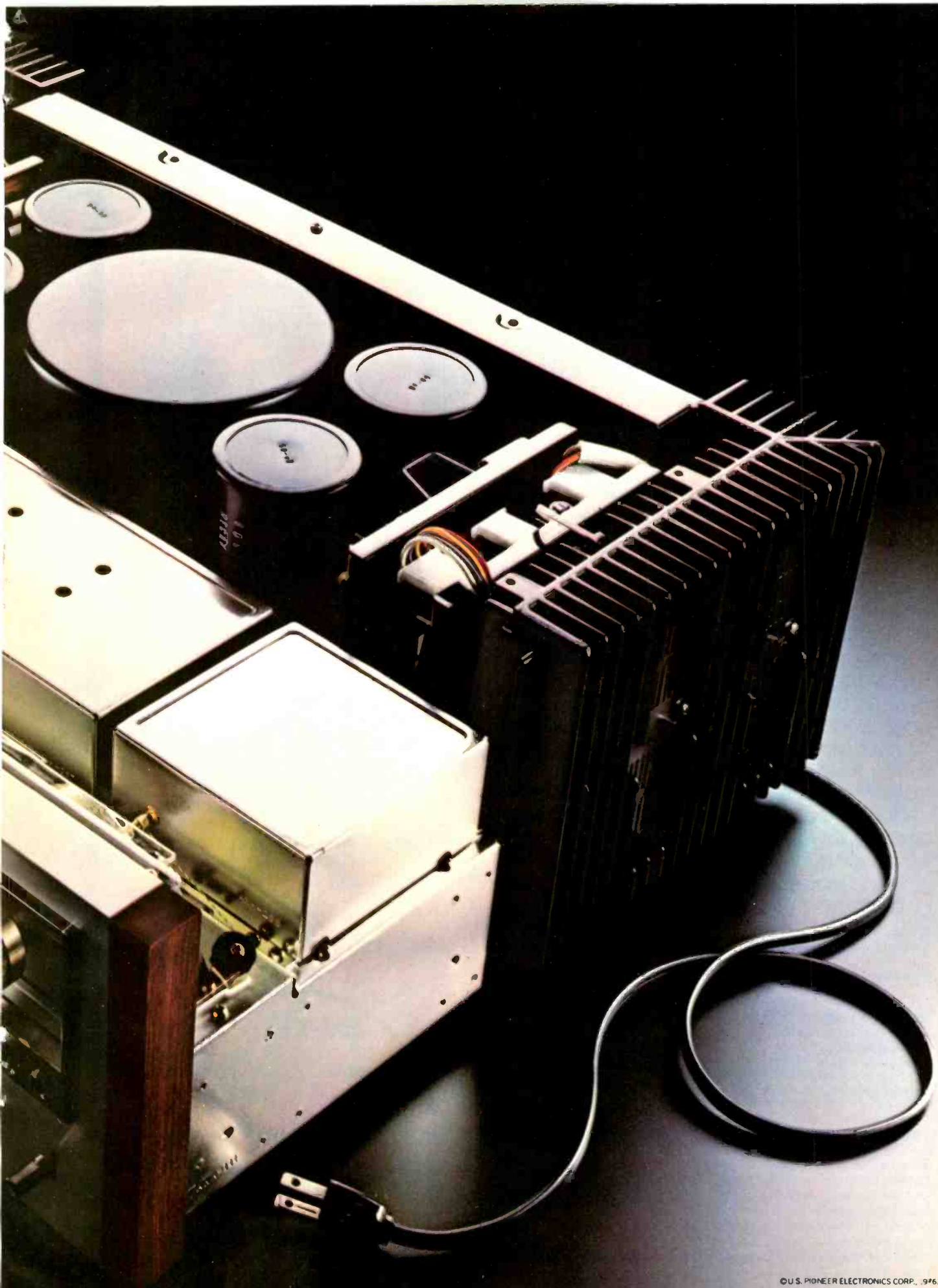



# Blueprint for Flat Frequency Response

In the graph below, frequency response was measured using the CBS 100 Test Record, which sweeps from 20-20,000 Hz. The vertical tracking force was set at one gram. Nominal system capacitance was calibrated to be 300 picofarads and the standard 47K ohm resistance was maintained throughout testing. The upper curves represent the frequency response of the right (red) and left (green) channels. The distance between the upper and lower curves represents separation between the channels in decibels. The inset oscilloscope photo exhibits the cartridge's response to a recorded 1000 Hz square wave indicating its resonant and transient response.

Smooth, flat response from 20-20,000 Hz is the most distinct advantage of Empire's new stereo cartridge, the 2000Z.

The extreme accuracy of its reproduction allows you the luxury of fine-tuning your audio system exactly the way you want it. With the 2000Z, you can exaggerate highs, accentuate lows or leave it flat. You can make your own adjustments without being tied to the dips and peaks characteristic of most other cartridges.

For a great many people, this alone is reason for owning the Z. However, we engineered this cartridge to give you more. And it does. Tight channel balance, wide separation, low tracking force and excellent tracking ability combine to give you total performance.

See for yourself in the specifications below, then go to your audio dealer for a demonstration you won't soon forget.

The Empire 2000Z.

Already your system sounds better.

**Frequency Response**—20 to 20K Hz  $\pm$  1 db using CBS 100 test record  
**Recommended Tracking Force**— $\frac{3}{4}$  to 1 $\frac{1}{4}$  grams  
(specification given using 1 gram VTF)

**Separation**—20 db 20 Hz to 500 Hz  
 30 db 500 Hz to 15K Hz  
 25 db 15K Hz to 20K Hz

**I.M. Distortion**—(RCA 12-5-105) less than .08% .2KHz to 20KHz @ 3.54 cm/sec

**Stylus**—0.2 x 0.7 mil diamond

**Effective Tip Mass**—0.2 mg

**Compliance**—lateral 30 X 10<sup>-6</sup> cm/dyne  
 vertical 30 X 10<sup>-6</sup> cm/dyne

**Tracking Ability**—0.9 grams for 38 cm per sec @ 1000 Hz  
 0.8 grams for 30 cm per sec @ 400 Hz

**Channel Balance**—within  $\frac{3}{4}$  db @ 1 kHz

**Tracking Angle**—20°

**Recommended Load**—47 K Ohms

**Nominal Total System Capacitance** required 300 pF

**Output**—3mv @ 3.5 cm per sec using CBS 100 test record

**D.C. Resistance**—1100 Ohms

**Inductance**—675 mH

**Number and Type of Poles**—16 Laminations in a 4 pole configuration

**Number of Coils**—4 (1 pair/channel—hum cancelling)

**Number of Magnets**—3 positioned to eliminate microphonics

**Type of Cartridge**—Fully shielded, moving iron

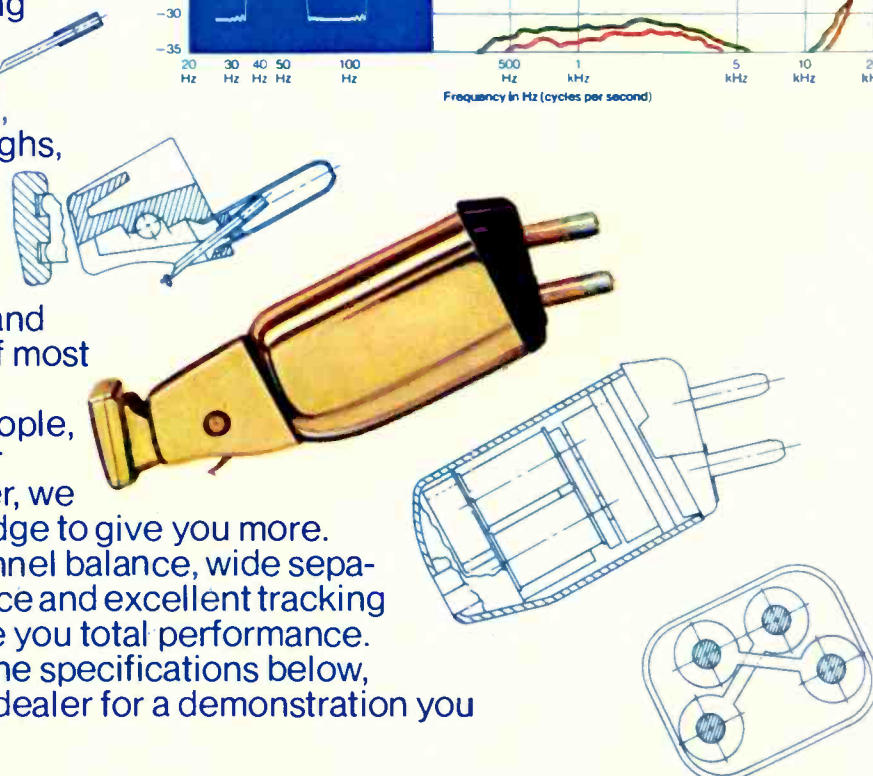
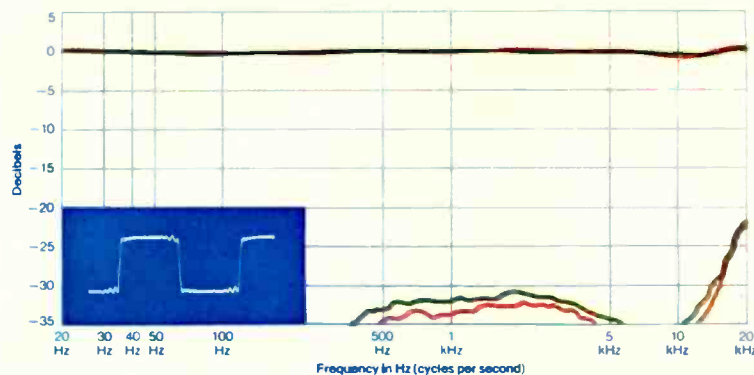

For a free "How to Get the Most Out of Your Records" brochure write: Empire Scientific Corp., Garden City, N.Y. 11530.

CIRCLE NO. 21 ON READER SERVICE CARD



FORMERLY HI-FI/STEREO REVIEW

# Stereo Review®

SEPTEMBER 1976 • VOLUME 37 • NUMBER 3

## The Equipment

<b>NEW PRODUCTS</b> <i>A roundup of the latest in high-fidelity equipment</i> .....	14
<b>AUDIO QUESTIONS AND ANSWERS</b> <i>Advice on readers' technical problems</i> .....	LARRY KLEIN ..... 22
<b>AUDIO BASICS</b> <i>Glossary of Technical Terms—28</i> .....	RALPH HODGES ..... 25
<b>TAPE HORIZONS</b> <i>Record vs. Playback</i> .....	CRAIG STARK ..... 30
<b>EQUIPMENT TEST REPORTS</b> <i>Hirsch-Houck Laboratory test results on the Sony TC-880-2 stereo tape deck, ADC Accutrac 4000 record player, Tannoy Cheviot speaker system, and Tandberg TR-2075 AM/stereo FM receiver</i> .....	JULIAN D. HIRSCH ..... 35
<b>A PREVIEW OF NEXT YEAR'S SOUND EQUIPMENT</b> <i>The audio future looks practical, promising, and big</i> .....	RALPH HODGES ..... 64

## The Music

<b>WHAT IS THIS THING CALLED DISCO?</b> <i>The first epidemic of dance mania since the Twist</i> .....	CLIFFORD TERRY ..... 74
<b>THE GREAT AMERICAN SYMPHONY</b> <i>"The sound of this music is now part of our tonal subconscious"</i> .....	ERIC SALZMAN ..... 78

## The Reviews

<b>BEST RECORDINGS OF THE MONTH</b> <i>Vocal: Carlo Bergonzi sings Verdi arias; Jan DeGaetani sings Ives songs; Southside Johnny's "I Don't Want to Go Home"</i> <i>Operatic: Giuseppe Verdi's Il Corsaro</i> <i>Jazz: The L.A. Four</i> .....	85
<b>POPULAR DISCS AND TAPES</b> .....	90
<i>The Runaways: Punk Rock</i> .....	STEVE SIMELS ..... 91
<i>Kelly Garrett: Vocal Abundance</i> .....	PETER REILLY ..... 100
<i>Harry Nilsson: Still Workin' on It</i> .....	NOEL COPPAGE ..... 108
<b>CLASSICAL DISCS AND TAPES</b> .....	116
<i>The Bicentennial Corner: American Music from the Founding Years</i> .....	STODDARD LINCOLN ..... 117
<i>Lesser Known Britten</i> .....	RICHARD FREED ..... 120
<i>New American Music in Cross Section</i> .....	CHRISTOPHER ROUSE ..... 126

## The Regulars

<b>EDITORIALLY SPEAKING</b> .....	WILLIAM ANDERSON ..... 4
<b>LETTERS TO THE EDITOR</b> .....	6
<b>TECHNICAL TALK</b> .....	JULIAN D. HIRSCH ..... 34
<b>THE OPERA FILE</b> .....	WILLIAM LIVINGSTONE ..... 52
<b>GOING ON RECORD</b> .....	JAMES GOODFRIEND ..... 54
<b>THE SIMELS REPORT</b> .....	STEVE SIMELS ..... 56
<b>THE BASIC REPERTOIRE</b> .....	MARTIN BOOKSPAN ..... 60
<b>CHOOSING SIDES</b> .....	IRVING KOLODIN ..... 114
<b>ADVERTISERS' INDEX</b> .....	136

COVER: Paul Coker, Jr.

COPYRIGHT © 1976 BY ZIFF-DAVIS PUBLISHING COMPANY. All rights reserved. Stereo Review, September 1976, Volume 37, Number 3. Published monthly by Ziff-Davis Publishing Company; Editorial and Executive Offices at One Park Avenue, New York, N.Y. 10016; Telephone: 212 725-3500. Hershel B. Sarbin, President; Furman Hebb, Executive Vice President; John R. Emery, Senior Financial Vice President and Treasurer; Charles B. Seton, Secretary. Also the publishers of Boating, Car and Driver, Cycle, Flying, Modern Bride, Popular Electronics, Popular Photography, and Skiing. One-year subscription rate for U.S., \$7.98; U.S. possessions and Canada, \$9.98. All other countries, one-year subscription rate \$10.98, cash orders only, payable in U.S. currency. Second-class postage paid at New York, N.Y. and at additional mailing offices. Authorized as second-class mail by the Post Office Department, Ottawa, Canada, and for payment of postage in cash. SUBSCRIPTION SERVICE: Forms 3579 and all subscription correspondence should be addressed to Stereo Review, Circulation Department, P.O. Box 2771, Boulder, Colorado 80302. Please allow at least eight weeks for change of address. Include your old address, as well as new—enclosing if possible an address label from a recent issue. Material in this publication may not be reproduced in any form without permission. Requests for permission should be directed to Jerry Schneider, Rights and Permissions, Ziff-Davis Publishing Company, One Park Avenue, New York, New York 10016.



# Editorially Speaking

By William Anderson



## CEREMONIAL MUSIC

I WOULD like to assure younger readers (and TV watchers) that political conventions were not always the cut-and-dried, wall-to-wall yawns the Democratic muster turned out to be this year (I am writing this in mid-July, before the opening of the rather more dramatically promising Republican show). No, it used to be that these quadrennial get-togethers were riots of rumpus and razzle-dazzle, heady with excitement, rife with surprises, and accompanied by enough unclassifiable foofaraw to last a lifetime.

We have in late years so perfected the spreading out of political energies through the mechanism of the primaries, however, that such concentrated orgies of decision-making have very likely slipped into history (the Ford-Reagan head-to-head can be regarded as a freakish last hurrah). Future conventions will probably be, like the 1976 Democratic one, matters of form, ceremonial affirmations of conclusions already arrived at elsewhere. That, of course, is no reason not to take them seriously, for there appears to be some basic

human need for ritual pomp and ceremonial circumstance that will be satisfied.

There was, in fact, at least one note of the requisite high ritual seriousness struck on the Democratic program, one that filled our human needs admirably: the opening ceremony was a Trooping of the Colors, a fine thing for this Bicentennial (or any other) year, done to the tune of Aaron Copland's *Fanfare for the Common Man*, the right piece at the right time if ever there was one. It may have sounded a little like the *Wrong Note Rag* (perhaps it's a bit hard for a band to adjust to the Copland harmonies after Sousa), but no matter; it had its effect. The crowd hushed, moved out of the aisles and into their seats, and for a moment you could actually believe something of consequence was going on.

It would be nice if the master (or mistress) of ceremonies responsible for choosing this apt bit of repertoire were to stand up and be counted, for we evidently need him (or her) in the White House, someone with a finely developed ceremonial sense to prevent a recur-

rence of the kind of programming that marked the "entertainment" portion of President Ford's Evening with the Queen. The TV documentation of the event was rather badly bungled by PBS's ill-prepared or sketchily briefed commentators, and it was also sabotaged technically, either by the rain or an inexperienced camera crew. And sabotaged, sad to say, at the wrong time, for I would much rather have watched Julia Child dissect Chef Haller's roast veal than sit through Bob Hope's appalling monologue, with its potty jokes about Lincoln's stove-pipe hat. Is that any kind of dish to set before a Queen? The Captain and Tenille, moreover, are a lovable pair of fine musicians, but they simply didn't measure up to the ceremonial needs of the occasion. Julia, bless her outspoken heart, put the finger of a fine hostess on the fiasco and characterized it for what it was: *ni kulturny*.

What, then, *should* the entertainment have been? So glad you asked, for I just happen to have a little program right here, one that is thoroughly American, Bicentennial, musical, and above all, for this occasion, *ceremonial*. It starts with a few piano rags of Scott Joplin (get Joshua Rifkin, William Bolcom, Max Morath, or Marvin Hamlisch), continues with a brace of songs by Stephen Foster (Jan DeGaetani) and a group of Gottschalk pieces (Ivan Davis), and concludes with a selection of American sentimental songs (Robert White). For an encore, tenor White would sing (tender flattery!) a lied or two by the Queen's great-grandfather Prince Albert.

If you (or anyone down at the White House) would like to check out just how this would have sounded, go right ahead: it's all (except for Albert) in the current record catalog (the labels are, respectively, Nonesuch, Nonesuch, London, and RCA), and I couldn't wish you a more delight-filled musical evening. You will pay particular attention, I hope, to the last item on the list, the just-released "When You and I Were Young Maggie" (RCA ARL1-1698). Besides the title song, it includes *Beautiful Dreamer*, *Mother o' Mine*, *Smilin' Through*, and several others that will let you know what a *real* tug at the heartstrings feels like.

## Stereo Review

**PUBLISHER**  
EDGAR W. HOPPER

**EDITOR**  
WILLIAM ANDERSON

**MANAGING EDITOR**  
WILLIAM LIVINGSTONE

**EDITORIAL COORDINATOR**  
LOUISE GOOCH BOUNDAS

**MUSIC EDITOR**  
JAMES GOODFRIEND

**TECHNICAL EDITOR**  
LARRY KLEIN

**ART DIRECTOR**  
BORYS PATCHOWSKY

**ASSOCIATE TECHNICAL EDITOR**  
RALPH HODGES

**POPULAR MUSIC EDITOR**  
STEVE SIMELS

**ASSISTANT MUSIC EDITOR**  
VIVIANNE WINTERRY GOODMAN

**PRODUCTION EDITOR**  
PAULETTE WEISS

**LONDON EDITOR**  
HENRY PLEASANTS

### CONTRIBUTING EDITORS

CHRIS ALBERTSON  
MARTIN BOOKSPAN  
NOEL COPPAGE  
RICHARD FREED  
DAVID HALL  
ROY HEMMING  
JULIAN D. HIRSCH  
GEORGE JELLINEK  
IGOR KIPNIS  
IRVING KOLODIN

PAUL KRESH  
STODDARD LINCOLN  
J MARKS-HIGHWATER  
LINCOLN PERRY  
PETER REILLY  
CHARLES RODRIGUES  
ERIC SALZMAN  
CRAIG STARK  
JOEL VANCE

**ADVERTISING DIRECTOR**  
JAMES J. SULLIVAN

**ADVERTISING SERVICE MANAGER**  
LINDA BLUM

**EXECUTIVE ASSISTANT**  
PEGI McEENEANEY

**ASSOCIATE PUBLISHER**  
STANLEY NEUFELD

Editorial and Executive Offices  
Ziff-Davis Publishing Company  
One Park Avenue, New York, New York 10016  
212 725-3500  
Eastern Advertising Manager: Richard J. Halpern  
Midwestern Office: The Pattis Group  
4761 West Touhy Ave., Lincolnwood, Illinois 60464  
312 679-1100  
Arnold S. Hoffman  
Western Office  
9025 Wilshire Boulevard  
Beverly Hills, California 90211  
213 273-8050; 272-1161  
Western Advertising Manager: Bud Dean

Japan: James Yagi  
Oji Palace Aoyama, 6-25, Minami Aoyama  
6-Chome, Minato-ku, Tokyo, Japan  
Telephone: 407-1930/6821, 582-2851

Circulation Office  
P.O. Box 2771, Boulder, Colorado 80302

EDITORIAL CONTRIBUTIONS must be accompanied by return postage and will be handled with reasonable care; however, publisher assumes no responsibility for the return or safety of art work, photography, or manuscripts.

Member Audit Bureau of Circulations



ZIFF-DAVIS PUBLISHING COMPANY  
Hershel B. Sarbin, President  
Furman Hebb, Executive Vice President  
John R. Emery, Senior Vice President-Finance/Treasurer  
Phillip T. Heffernan, Senior Vice President, Marketing  
Edward D. Muhfeld, Senior Vice President, Sports Div.  
Philip Sine, Senior Vice President  
Frank Pomerantz, Vice President, Creative Services  
Arthur W. Butzow, Vice President, Production  
Lawrence Sporn, Vice President, Circulation  
George Morrissey, Vice President  
Sydney H. Rogers, Vice President  
Sidney Holtz, Vice President  
Al Traina, Vice President  
Philip Korsant, Vice President  
Charles B. Seton, Secretary  
Edgar W. Hopper, Vice President, Electronics Div.

William Ziff, Chairman  
W. Bradford Briggs, Vice Chairman



# Skeptics Agree!

Reprinted from

## ELECTRONICS ENGINEERING TIMES

January 27, 1975 "Keep Your Records Clean"

"Up to now, I've had to wash records as dirty as these in a sink, with the attendant risks of mishandling. The Discwasher got rid of all the dirt and fingerprints in one easy operation, far more effective than any other record-cleaning tool I have come across. For simply dusting records, it is also very effective and does not leave that line of dust across the disc when you pick it up from the surface. At \$15.00 it's not cheap, but if you care for your records, it's worth it."

Reprinted from

## STEREO

Winter, 1975

"We were frankly at a loss as to how to test the 'performance' of the Discwasher System... Each time we examined the residue that adhered to the surface of the Discwasher brush, and each time

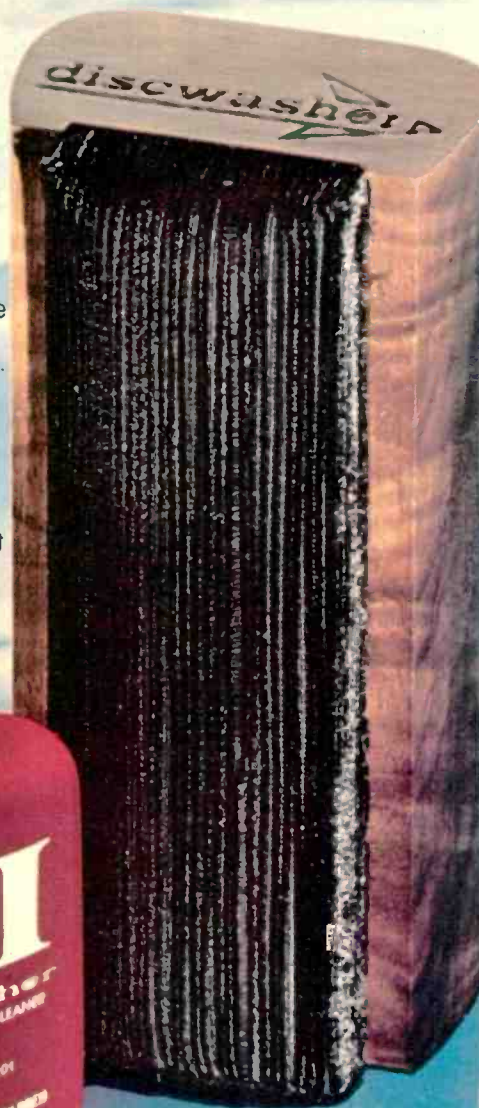

we were amazed at the amount of debris that this combination of brush and fluid was able to remove. It was frightening to realize that our stylus had been grinding away at these minute particles and globules for so long—but that seems to be the irrefutable case."

Reprinted from

## HIGH FIDELITY MAGAZINE

December, 1974—(Danish) "Testing"

"Discwasher D-II has been tried out on many different records in many different conditions..."

"All the other record cleaning devices used did not give results. Discwasher D-II not only cleaned the records but brought them back to their original state of high quality."

"On the grounds of the fantastic results, which can come about by using the Discwasher D-II, many will ask the question, 'IS IT WORTH 128 KRONER?'... But it does exactly what it says it does and this is where all of the others fail."

"It pays for itself, and is highly recommended."

Reprinted from

## AUDIO

May, 1976

"For the daily care of records, to wit, the ounce of prevention that can assure your records of reasonable longevity and noise-free plays, the Discwasher with D-II solution and the Zerostat should do the best job of keeping your records clean with a minimum of noise problem."

Reprinted from

## STEREO SOUND

Summer, 1975 (Japan) Page 303

K. Yamanaka, "This is the record cleaner. It is really effective. We can now listen to our old records with new discoveries."

# discwasher

A DIVISION OF DISCWASHER GROUP

COLUMBIA, MO 65201





# FREE

## details . . . A DIFFERENT KIND OF RECORD CLUB

You can now own every record or tape that you may ever want . . . at tremendous savings and with no continuing purchase obligations. You can get valuable free dividend certificates, you can get quick service and all the 100% iron-clad guarantees you want.

Now you can stop price increases that leave you with less music for your record and tape budget. You can guarantee yourself more music for less money through membership in Discount Music Club.

Look at these benefits:

### TREMENDOUS SAVINGS

on every record and tape in print—no "agree-to-purchase" obligations of any kind.

**DISCOUNTS OF 43% TO 73%** off mfg. suggested list . . . special catalog features hundreds of titles and artists.

### ALL LABELS AVAILABLE

including most imports through special custom ordering service. If we don't stock it we'll get it for you.

### SCHWANN CATALOG

lists thousands of titles; classical, pop, jazz, ballet, opera, musical shows, folk, rock, vocal, instrumental, country, etc.

### DISCOUNT DIVIDEND CERTIFICATES

Dividend Gifts—Every shipment carries a dividend gift or dividend certificate. Certificates redeemable immediately for extra discounts.

### NEWSLETTERS

happenings in the world of music; concerts, critiques, new releases . . . special super-sale listings at discounts of up to 73%.

### DISCOUNT ACCESSORY GUIDE

Diamond needles, cloths, tape cleaners, etc. Discount Music Club is your complete one stop music and accessory buying service.

### QUICK SERVICE

same day shipping on many orders . . . rarely later than the next several days. Partial shipments always made in the event of unforeseen delay . . . all at no extra cost to you.

### 100% IRON-CLAD GUARANTEES

on all products and services. Everything is guaranteed factory fresh and free of defects or damages of any sort. Your total satisfaction is unconditionally guaranteed.

Discount Music Club is a no-obligation membership club that guarantees tremendous discounts on all stereo records and tapes and lets you buy what you want . . . when you want . . . or not at all if you choose.

These are just a few of the money-saving reasons to write for free details. You can't lose so why not fill out and mail the coupon below for immediate information.

**dmc** DISCOUNT MUSIC CLUB, INC. DEPT. 9-96  
650 Main Street, New Rochelle, N.Y. 10801

NAME

ADDRESS

CITY

STATE

ZIP

CIRCLE NO. 2 ON READER SERVICE CARD

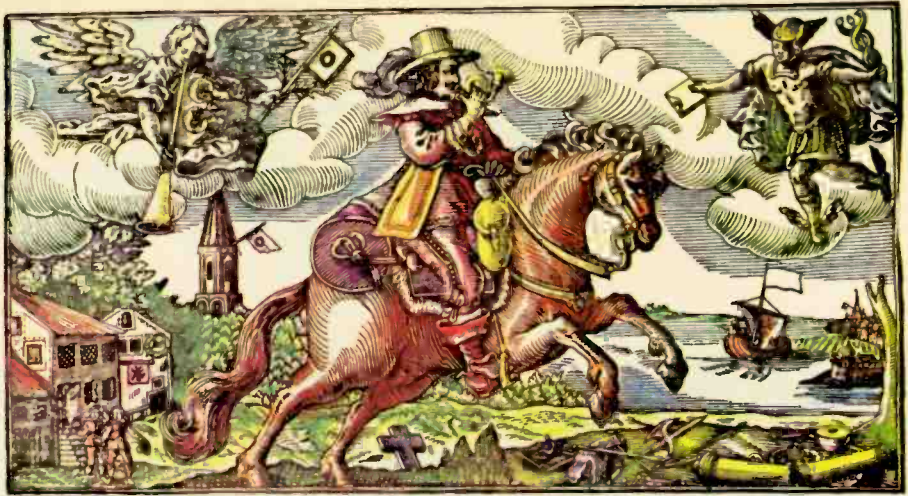

## LETTERS TO THE EDITOR

### Calendar of American Composers

● Congratulations on your excellent "Calendar of American Music" in the July issue. We outside the U.S.A. marvel at (or are jealous of) the supremacy of American technology and human endeavour, and justly so, for the pictorial contribution of the Moravian Music Foundation makes it even more emphatic. Benjamin Franklin would have been very proud, if he were alive in 1795, that his kite experiment was so ably applied. But I am a bit puzzled. I was under the impression that the double wall receptacle didn't appear until late in 1796.

LEO SCHWARTZ  
Toronto, Can.

● You left out John Denver.

WALTER HILKER  
Los Angeles, Calif.

● A splendid feature for the July Bicentennial issue—except you overlooked one giant and one major talent: Rachmaninoff and Castelnuovo-Tedesco. Both died as U.S. citizens.

JOHN KIFFIN  
San Francisco, Calif.

● Many thanks for including Charlie Parker, etc., in James Goodfriend's primarily long-haired American Music Calendar featured in the July issue. Long live American music, the greatest in the world! With all the Bicentennial commotion, isn't it strange that the liberal American composers of the 1930's (Earl Robinson, Roy Harris, and others), who dealt with American themes, are still ignored?

ANDY POLON  
New York, N.Y.

### The Van Vleck Synthesizer

● Thank you for printing one of the many pieces of evidence that Pennsylvania's Lehigh Valley has long been 'way out there with the avant-garde. Bishop Van Vleck's instrument in the picture on page 64 of July STEREO REVIEW is a fully polyphonic synthesizer (built for the Moravian Schantz family) using circuitry copied by Maurice Martenot and others over a century later.

JAMES D. CRAIG  
Allentown, Pa.

● A strange thing happened on the way from Bethlehem, Pennsylvania, in 1795 to page 64

of the July 1976 issue of STEREO REVIEW. The illustration of the birthday greeting given to Moravian Bishop Jacob van Vleck has acquired a highly modern touch—an electric cord and outlet!

Is this truly the first electronic harpsichord? Have the Moravian historians been suppressing knowledge? Since we know that Benjamin Franklin visited the Moravians in Bethlehem, is it just possible that he conducted his electrical experiments there and to a degree heretofore not known?

A color reproduction of this greeting can be found on the cover of the Columbia album ML 5688, "Arias, Anthems, and Chorales of the American Moravians, Volume 2."

THEODORE W. RIPPER  
Decatur, Ill.

● Now we know there is nothing new under the sun. Can we really credit Bishop Jacob van Vleck for the invention of the electric organ, or only for the electric cord and plug?

JAMES D. ANDERSON  
Kane, Pa.

● While it is generally taken for granted in this year of patriotic sentiment that Benjamin Franklin discovered static electricity, don't you think it somewhat absurd that Moravian Bishop Jacob van Vleck should be playing an electric organ in 1795?

GENE ZAGORSKY  
Setauket, N.Y.

● Do you intend to tell us the story behind that 1795 electric piano, *please*?

PAUL A. ALTER  
Pittsburgh, Pa.

● Is Jacob van Vleck *really* playing a very early synthesizer, or has one of the Patchowsky gang played with the illustration? Seriously, I just wanted you to know that *someone* noticed. I work on a magazine that goes to about 23,000 boys, and I once did something similar to a photo. We got *one* letter—and the photo was on the cover!

DAVID ALLEN CONDON  
Roselle, Ill.

*Well, we didn't get 23,000 letters, but we got more than enough to make us very proud of our wide-awake readers. We're sorry there wasn't room for them all.*



### Horses Don't Sing

● After reading Chris Albertson's article "A Word About Jazz" in the July issue, I am confused. Mr. Albertson states that Big Bill Broonzy, in referring to the blues, made the remark: "It's all folk music, 'cause horses don't sing." The first chapter of Leonard Feather's *The Book of Jazz* opens with very nearly the same words, but gives Louis Armstrong credit for saying them. Who actually made the statement?

MARGIE METHVIN  
West Monroe, La.

*Mr. Albertson replies: I am aware of the quote attributed to Louis Armstrong in Mr. Feather's book, but I have been unable to trace the source. However, Broonzy's statement can be heard—straight from the horse's mouth, so to speak—on a 1956 radio interview with Studs Terkel, issued on a Folkways album (FS 3864). Incidentally, I am guilty of relying on my memory; the actual quote is, "You hear people talking about folk songs. You hear people talking about the blues, like it's something else. It's all folk songs. You never hear horses sing 'em." I know this doesn't really answer the question, but it confirms that Broonzy did make the statement. Perhaps Leonard Feather, too, relied on fickle memory.*

### Elvis

● Your July article on Elvis was really appreciated in this corner, and I am sure by all his fans. He is the soundtrack of my adolescence. You are so right—it just wouldn't have been the same without him.

MONICA KELLY  
Larchmont, N. Y.

● I think Elvis Presley is a Big Farce in this art we call "pop music." Sure, he revolutionized the music scene—I only wish he was good at it. I've always thought a person should be good in his own field of endeavor. A fine example might be Les Paul.

LARRY DE PAOLI  
Elkhorn, Wis.

### Just Deserts

● I enjoyed the pictures of prize-winning musicians in "Just Deserts" in your August issue. One who was not mentioned was conductor Arthur Fiedler, who was awarded the honorary degree of Doctor of Humane Letters by Dartmouth College last June. According to Dartmouth's citation, Fiedler, who has recorded everything from the Beatles to Beethoven, has recorded more pieces than any other conductor and has sold fifty million records.

GRAHAM CHRISTOPHER  
New York, N.Y.

### Late Beethoven

● I'm pretty sure my ears hear differently from Irving Kolodin's, inasmuch as he (in his July column) feels that the Guarneri's glib reading of Beethoven's *Grosse Fuge* is somehow to be preferred to the technically astonishing version by the Fine Arts Quartet in their set of the late quartets. (Apart from Michael Steinberg's unsigned notes, it's the only good thing about their venture.)

But, however differently we hear, it is a pity that Mr. Kolodin did not audition or re-audition the Yale Quartet's Vanguard box, for their *Grosse Fuge* technically surpasses even the Fine Arts'. One listen-through with the  
(Continued on page 10)

# Is it live, or is it Memorex?



The amplified voice  
of Ella Fitzgerald can shatter  
a glass. And anything Ella  
can do, Memorex cassette tape  
with MF<sub>2</sub> Oxide can do.

If you record your own music,  
Memorex can make all  
the difference in the world.

**MEMOREX** Recording Tape.  
Is it live, or is it Memorex?

©1976, Memorex Corporation, Santa Clara, California 95052







# The Micro Seiki DDX-1000.

## The Problem.

Any cartridge is subject ultimately to your personal taste. That's why so many serious audiophiles own and regularly use more than one cartridge. But changing cartridges is really a major undertaking. Not any more.

## The Solution.

The Micro Seiki DDX-1000. It will accept up to three high quality tonearms. No matter how cultivated and diversified your musical tastes are, the DDX-1000 will let you discern the subtlety of interplay between disc and cartridge, cartridge and tonearm.

A direct drive DC servo controlled motor drives the large, balance-tested platter at near perfect speed. Wow and flutter is an unprecedented 0.025%. Additionally, the neon strobe lamp is driven by an independent built-in 45Hz oscillator with a frequency fluctuation of less than 0.03%.

A unique 3-point aluminum alloy supporting frame and special shock mounting provide optimum stability. The two-layer absorber system (consisting of cushion rubber and insulator balls with built-in springs) eliminates any possibility of acoustic feedback. The completely isolated power supply/control unit eliminates hum and electrical noise. And micro-switches provide fast, exact operational control. The signal-to-noise ratio is greater than 63 dB.

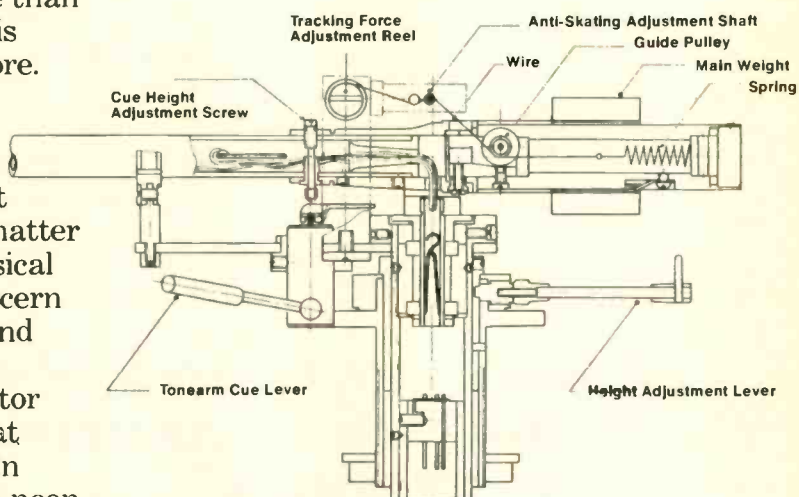
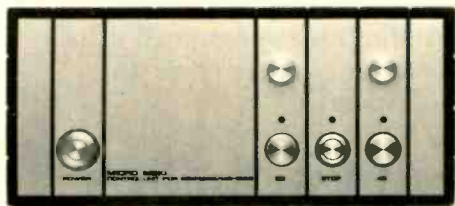

## The MA-505.

Pictured is the Micro Seiki MA-505\*, the first audiophile quality dynamic balance tonearm. Since it does not depend on gravity to maintain the proper tracking force, it will compensate better for surface and groove irregularities present in many mass produced discs. In addition, the stylus pressure may be adjusted while the disc is playing to assure the best possible reproduction.

\*Not included with DDX-1000. Supplied without cartridge.

**The DDX-1000 and MA-505. Creative design. Superior execution. The complete turntable system for the most critically demanding audiophile.**

## MICRO SEIKI

Distributed by TEAC Corporation of America, 7733 Telegraph Road, Montebello, California 90640 © TEAC 1976



score will show that it's a sizzling, pellucid, incredibly accurately played rendition.

DAVID MORAN  
Boston, Mass.

*A book could easily be written about the various available recordings of the Beethoven quartets, but its opinions would be no more likely to please every palate than a column as short as Mr. Kolodin's. How gratifying, then, that these masterpieces are so well represented in the catalog, permitting us to hear so many opinions on the subject, to have so much—and so various—evidence on which to base our own. For more on this fascinating subject of catalog duplications and their uses see Music Editor Goodfriend's column this month.*

#### Basic Library of American Music

● Concerning Bernard Jacobson's Basic Library of American Music in the July issue, I would rather see Virgil Thomson represented by his collaboration with Gertrude Stein, *Four Saints in Three Acts*, than by his film scores. (If you can't find the disc in stores, twisting RCA's arm should loosen one of the remaining copies of LM-2756.)

I also think *Time Cycle*, rather than *Baroque Variations*, would have better represented Lukas Foss. Perhaps Odyssey could do Foss Freaks a favor by putting the orchestral and chamber versions on one disc. In the meantime, Columbia Special Products can still supply the former.

Leon Kirchner and George Rochberg should be in there somewhere, as should Ruth Crawford Seeger's string quartet and the Odyssey album of Ned Rorem's songs. Perhaps a case could also be made for John Col-

trane's *Ascension*, almost forgotten now; although it may fall more into the influential than listened-to category, it stood jazz musicians on their ear in the mid-Sixties.

GIL GROSS  
Glenwood, N.J.

● I feel Bernard Jacobson has shortchanged your readers by omitting (at least) two of the most important and inspiring symphonies written in America, by Americans, which eloquently embody this country's most treasured ideals and idiosyncracies. One is Samuel Barber's First Symphony, a work worthy in its courage, straightforwardness, and sensual beauty to be a kind of symphonic National Anthem. The other is Charles Ives' masterpiece, the Symphony No. 4, which, incidentally, strongly recalls the Barber First in the climactic moments of its third movement. I hope that you can somehow convey to your readers the immeasurable value of these works—particularly those of Samuel Barber, whose overt romanticism seems either to scare off or to embarrass some critics.

ALEX SEGAL  
Santa Monica, Calif.

#### The Bandmaster and the Cannoneers

● Having participated in many hours of committee meetings that resulted in, among other things, the selection of material used in the Department of Defense recording project "Broad Stripes/Bright Stars," I feel I must set to rest one myth that David Hall perpetuates in his July review: "... I don't care for the updating of Sousa's famous *U.S. Field Artillery March*." John Philip Sousa did not compose *The Caissons Go Rolling Along*;

Brigadier General Edmund Gruber did in 1908. In 1918, Sousa blatantly swiped it (he served in the Marines and the Navy, you know) and a copyright battle ensued.

In 1956, the Army, casting wide for an official song to do battle with *Anchors Aweigh* and *The Marines Hymn*, held a worldwide contest, and some real doozies were entered. When the dust settled, the Field Artillery had given up their tune to all the other Army branches, and, with new words by Dr. Harold Arberg, *The Army Goes Rolling Along* was adapted and adopted. It's still a touchy subject with the descendants of General Gruber and with all red-legged cannoneers—but Sousa it's not.

MAJ. ALLEN C. CROWELL, JR.  
Fort Myer, Va.

*David Hall replies: Sousa's orchestral arrangement of Edmund L. Gruber's The Caissons Go Rolling Along (written by the latter, then a lieutenant, in 1908 for the Field Artillery in the Philippines) was published on January 22, 1918, with the military band arrangement following on February 26, 1918—in both instances without credit to Gruber.*

*The first authorized publication under Gruber's name appeared in 1921, and it was Sigmund Spaeth (on page 26 of A History of Popular Music in America, Random House, 1948) who was among the first to set the record straight, noting that Sousa had done his version for a New York Hippodrome benefit for Liberty Loan bonds. Perhaps the most detailed account of the misattribution is to be found on page 156 of James J. Fuld's The Book of World Famous Music (Crown Publishing Co., rev. ed. 1971).*

## A "noteworthy example of intelligent engineering"<sup>1</sup> that "transcends the commonplace"<sup>2</sup> and "is, simply, a great speaker system."<sup>3</sup>



We couldn't have said it better ourselves.

In our time, the vented, equalized Interface:A has received a small deluge of complimentary reviews from high fidelity magazines. Including the one you're reading.

<sup>1</sup>The *Stereo Review* test, 3/74. "Interface:A can deliver a level of undistorted bass far superior to any other speaker its size we have tested."

<sup>2</sup>The *High Fidelity* test, 2/74. "... unusually flat (plus or minus 1 $\frac{3}{4}$  dB from 63 Hz to 15 mHz!) in the omnidirectional measurement."



<sup>3</sup>The *Stereo & Hi-Fi Times* test, 4/75. "... clarity of the bass is most impressive."

The *FM Guide* test, 4/75. "... we measured sound pressure levels of 110 dB during the very loud passages ... the systems handled such musical moments with ease."

The *Sound* test, 2/76. "The on-axis position results in an exceptional curve which is — by speaker standards — virtually flat from 100 Hz out to 20 kHz."

The reviewers are convinced. Maybe you should be too. We've published a book with these sparkling reviews reprinted in full. For a copy, write us or see your E-V dealer.

### Interface:A™

Electro-Voice, Inc. a Gulton company  
616 Cecil St., Dept. 964F, Buchanan, Mich.  
49107



Most standard publications, including such recent ones as Julius Mattfeld's *Variety Music Cavalcade* (Prentice Hall, 1962) and James R. Smart's discography *The Sousa Band (U.S. Govt. Printing Office, 1970)*, as well as most recordings (it is correctly attributed on the label of the Dept. of Defense album) attribute the work to Sousa, though it was Gruber who wrote both words and music.

And according to Sousa authority Paul E. Bierley, in his *John Philip Sousa. A Descriptive Catalog of His Works* (University of Illinois Press, 1973), the song was thought to be old, perhaps of Civil War origin, at the time the March King adapted it for the 306th Field Artillery. The copyright battle (1942) did not involve Sousa, as Maj. Crowell's letter seems to imply, but two rival music publishers, and the court ruled that over thirty years of public use of the song without objection from the composer constituted "abandonment."

My opinion of the "updating" (by the U.S. Army Band's Col. Samuel R. Loboda) still stands, however. The misattribution of authorship is, I hope, understandable, given the situation in the standard reference works. I am grateful to have been prodded by Major Crowell into doing the back-checking which has made me a little smarter.

#### Wayward Wayfarer

● I was quite amazed to find in the July Best of the Month section that George Jellinek referred to "Dietrich Fischer-Dieskau's second recorded interpretation of Mahler's *Wayfarer Songs*." I presently have two recordings of these songs performed by Fischer-Dieskau in my collection, neither of which is Deutsche Grammophon 2530 630. If the latter is a new

recording, it must be a *third* interpretation. (My recordings are Angel 35522 with the Philharmonia Orchestra under Wilhelm Furtwängler, and Deutsche Grammophon 2530 190 with the Bavarian Radio Orchestra under Rafael Kubelik. The latter was the final side of the Mahler Symphony No. 5 recording.)

Does Mr. Jellinek mean this is the second interpretation in stereo, the second under Maestro Kubelik, or what? Or is this, like the Martin work on the reverse of the new recording, a repressing of the earlier Fischer-Dieskau/Kubelik collaboration? The mono Angel recording should certainly not be discounted since, in my opinion, it is the finest, most sensitive interpretation of the Mahler *Songs of a Wayfarer* that has yet appeared on record.

R. W. SCHULTZ  
Chicago, Ill.

*Music Editor James Goodfriend replies: We apologize for the confusion. The performance of the Wayfarer Songs is the same one as was previously released on the final side of the Symphony No. 5 recording. Thus, both sides of this new record are reissues—but the only clue on the record is a miniscule copyright notice (P) on the jacket which gives the date of original release.*

#### Simulcast

● Apropos "Music & TV" in June, all along I have noted (with Noel Coppage) that video appeared to be self-sufficient even with *indifferent* sound—until I heard Van Cliburn and the New York Symphony Orchestra simulcast over Channel 13 and WQXR in New York. Stereo via FM did lend better quality to the concert, as proved when I observed that the

man with the timpani was beating the skins without any sounds whatsoever coming over my TV's three-inch loudspeaker while the bass was coming on like gangbusters through my stereo speakers. But the truly astonishing improvement occurred when the program was heard synthesized over SQ quad. The soloist, picked up with a single microphone and fed as a center (mono) sound, naturally came out center front. In subdued light, we no longer were in a living room, but truly at a concert hall looking at the performers through a pair of binoculars and experiencing all the excitement of a real-life concert.

It's a pity that in subsequent simulcasts the audio was nearly monophonic, not allowing the quadraphonic simulation to take place properly. More work is needed to ascertain if similar improvement would be obtained with other TV fare, but certainly as far as concert-hall broadcasting is concerned, TV and hi-fi quadraphony go hand in hand.

BENJAMIN B. BAUER  
CBS Technology Center  
Stamford, Conn.

#### Music & TV

● Considering how many records, tapes, and stereo components are sold annually, I was surprised to read the statement in Noel Coppage's June article, "Music & TV," that, according to *TV Guide*, most people would give up all other entertainment sources in favor of television. For the record (no pun), I'll keep my stereo system and records, for better or worse, and forsake television. As for everyone else, well, they can have Cher's armpits.

FRANCIS PIVAR  
New Kensington, Pa.

## We'd be nuts not to publicize these reviews.



Put yourself in our place. You've designed what you believe is an exceptional speaker system—the vented, equalized Interface:B. And then the reviewers agree. That really makes it all worthwhile.

The *Stereo Review* test, 4/76. "It retains virtually all the features and fine acoustic qualities of the Interface:A." "The dispersion of the highs was excellent—easily as good as we have ever heard from a forward facing cone driver and rivaling that of most dome radiators." "The bass was true and powerful when the program material called for it." "The



efficiency of the Interface:B was relatively high for a small enclosure..."

The *High Fidelity* test, 4/76. "The peak level sound produced (114 dB) bespeaks good dynamic range." "...we found that fundamental bass tones remain audible to about 38 Hz. High frequencies are there up to about 17.5 kHz and are well dispersed, remaining audible to about 45 degrees of axis." It produces a well blended sound..." "It is capable of making a modest audio system rise to new heights—and, at quite an attractive price."

We've published a book with these excellent reviews reprinted in full. For a copy, write us or see your E-V dealer.

### Interface: B™

Electro-Voice, Inc. a Gulton company  
616 Cecil St., Dept. 964F, Buchanan, Mich.  
49107



# New Products the latest in high-fidelity equipment and accessories

## Fisher CA-2300 Integrated Stereo Amplifier

The line of "Studio-Standard" components from Fisher continues with the Model CA-2300, an integrated stereo amplifier rated at 35 watts per channel continuous at 8 ohms, 20 to 20,000 Hz, with a maximum of 0.15 per cent total harmonic distortion. Intermodulation distortion is 0.2 per cent or less. Controls consist of knobs for bass and treble (defeatable by means of a pushbutton), volume, balance, mode (with positions for normal and reversed stereo, mono, or either channel), input source (phono 1 and 2, tuner, auxiliary 1 and 2), and switching of two pairs of speakers, which can be played separately or together or turned off completely. There is also a tape selector for monitoring from two tape decks and dubbing from either one to the other. Pushbuttons are provided to switch low- and high-frequency filters, audio muting, and loudness compensation. There is a front-panel stereo-headphone jack.

The CA-2300 is said to have been designed using a minimum of negative feedback. Signal-to-noise ratios are 65 dB for the phono inputs and 90 dB for high-level inputs. The bass



and treble controls have ranges of  $\pm 10$  dB at 100 and 10,000 Hz, respectively. In the rear are three a.c. convenience outlets (two switched), as well as preamplifier-section outputs and power-amplifier inputs normally connected internally by a slide switch. Overall size of the amplifier is 16½ x 5¾ x 13½ inches; it weighs about 22½ pounds. Price: \$279.95.

Circle 115 on reader service card

## ESS amt-10b Speaker System

The amt-10b is the latest ESS product in the bookshelf format to incorporate the Heil air-motion-transformer high-frequency driver. A two-way system with a crossover frequency of 1,500 Hz, it incorporates a 10-inch woofer with a cone fabricated of Bextrene, a compound of polystyrene and rubber. The Heil device, operating above 1,500 Hz, is a refinement of previous configurations; it has a narrower magnetic gap, thicker conductors, and shallower diaphragm pleats. The driver can be rotated 90 degrees within the enclosure to retain the same dispersion characteristics when the speaker system is mounted on its side.

The amt-10b has a ported enclosure designed to present a high acoustical resistance

to the woofer. Frequency response is 50 to 22,000 Hz  $\pm 3$  dB. The dispersion of the Heil driver is 120 degrees in the lateral plane, 40 degrees in the vertical. Power-handling capability is 40 watts continuous program material, 350 watts peak. With a nominal impedance of 4 ohms, the system is said to provide a sound-pressure level of 82 dB at a distance of 15 feet with 1 watt of drive. A continuously variable control adjusts the output of the Heil

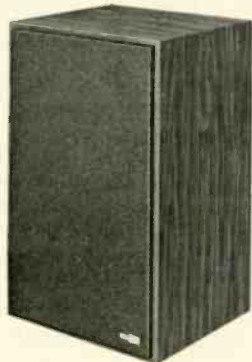

driver over a wide range. The amt-10b is finished in walnut with a brown fabric grille. Dimensions: 24 x 14 x 14 inches. Price: \$286.

Circle 116 on reader service card

## Rotel Model RT-1024 AM/Stereo FM Tuner

The RT-1024 de luxe tuner from Rotel has built-in Dolby B-type noise reduction that can be used for FM or external sources, two switch-selectable operating levels for FM interstation-noise muting, and an integral headphone amplifier with its own independent volume control. The imposing front panel of the RT-1024 has a linear tuning dial beneath which are four meters for signal-strength and channel-center tuning, Dolby-level calibration, and multipath indication (this last is activated only when the MULTIPATH switch is on). The Dolby controls occupy their own subsection on the panel and include all the necessary facilities for decoding Dolbyized FM broadcasts as well as for calibrating the Dolby circuits to any external tape machine. The FM interstation-noise muting can be set for a threshold of 30 or 10 microvolts or can be disabled altogether.

The RT-1024's function selector has positions for AM, automatic switching between stereo FM and mono, and stereo or mono only. There is also an output-level control that works independently of the headphone volume knob and a switchable HI-BLEND function that mixes the two stereo channels somewhat at high frequencies to reduce noise.

The IHF FM sensitivity of the RT-1024 is 9.3 dBf (1.6 microvolts) in mono and 14.5 dBf (2.9 microvolts) in stereo. Corresponding figures for 50-dB quieting sensitivity are 11.2 dBf (2 microvolts) and 36 dBf (34.5 mi-

crovolts). The ultimate signal-to-noise ratio is 75 dB for mono and 70 dB for stereo. Capture ratio is 1 dB, alternate-channel selectivity is



80 dB, and spurious-response and image rejection are both 110 dB. AM suppression is 55 dB and i.f. rejection is 120 dB. The FM frequency response is 30 to 15,000 Hz  $\pm 1$  dB, with stereo separation of at least 35 dB across that range. Distortion at 1,000 Hz is 0.2 per cent in mono and 0.35 per cent in stereo.

The RT-1024's front panel is equipped with heavy grab handles and is slotted for standard rack mounting. In the rear are 75- and 300-ohm antenna terminals and an AM ferrite-rod antenna, plus all necessary inputs and outputs, including connections for tape decks. The tuner's overall dimensions are 19 x 7 x 16 inches. Price: \$569.95.

Circle 117 on reader service card

## Shure M24H Phono Cartridge

The new M24H is Shure's first phono cartridge specifically intended for the reproduction of CD-4 four-channel discs as well as for matrixed four-channel and conventional stereo discs. According to the manufacturer, one of the important requirements for a good CD-4 cartridge is a flat frequency response over the audio range together with an elevated response between 20,000 and 45,000 Hz—the frequency range of the CD-4 carrier. The typical response of the M24H, properly loaded, is within about  $\pm 2$  dB up to 20,000 Hz, rising to about +4 dB near 30,000 Hz, the center of the carrier.

The M24H employs a newly designed 0.3 x 0.7-mil hyperbolic diamond tip intended to



track at forces ranging from 1 to 1½ grams. Very low effective stylus mass is said to result in tracking ability that almost equals that of the Shure V-15 Type III. The M24H also uses the laminated electromagnetic structure of the Type III to minimize signal loss. The output of the M24H is 3 millivolts per channel for a recorded velocity of 3.54 centimeters per second. Stereo separation is at least 22 dB at 1,000 Hz. The optimum load for CD-4 use is

(Continued on page 18)



# "I TESTED OUR NEW FM CAR RADIO IN A HOLE."

by Steve Tillack

I never thought I'd get sentimental over a mule, but if it wasn't for Sugar's cool head and sure foot, I wouldn't be here today.

This little adventure actually started when Pioneer began wondering what would happen if they designed an FM car stereo to high fidelity standards.



Well, they turned their engineers loose on the project and now, after two years of research and testing, the Supertuners are here. Four of them. With built-in cassette or 8-track.

They have a 1.8 dB capture ratio to grab elusive signals. 12 dB useable sensitivity for less noise. Muting to cut out that garbage between stations. And a local/distance switch to pick up what you do want and block out what you don't want.

With something this special, you gotta dream up a special test. So we took a Supertuner to a place where reception is really rotten.

The Grand Canyon.

Right on the rim, 65 miles from the nearest FM station, Supertuner sounded like it does in a showroom.

The other models we brought along were rattling off

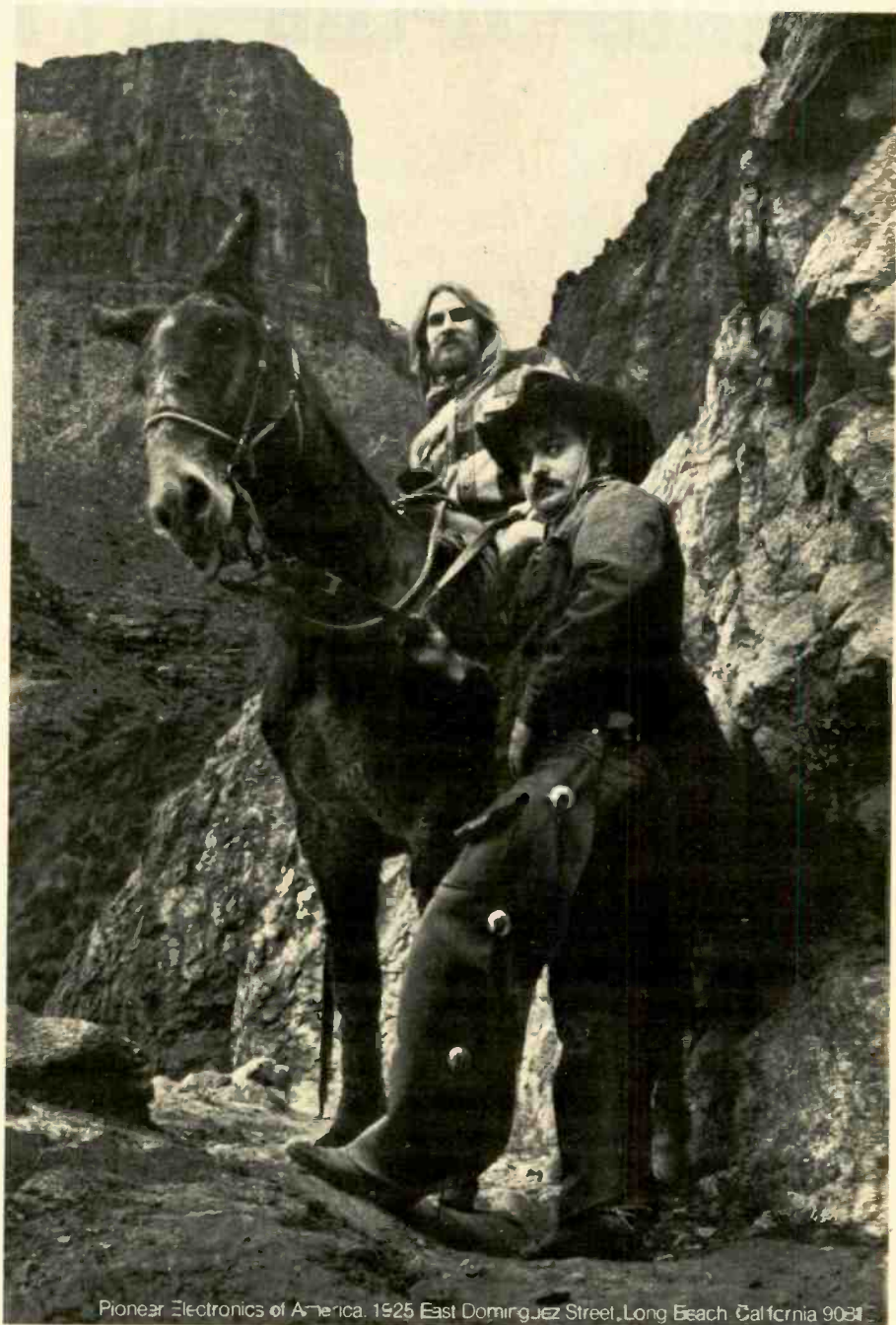

Pioneer Electronics of America, 1925 East Dominguez Street, Long Beach, California 90801

static and background noise.

Even at 75 feet below the rim, Supertuner was still sounding great.

I can't give you test results for other spots along the trail because we ran into a blizzard with 50 mile-an-hour winds and I figured it was curtains for all of us.

Now I'm absolutely convinced of two things.

Supertuner by Pioneer is the best line of car radios ever built.

And a sure-footed mule is man's best friend.

**THE PIONEER  
SUPER-TUNERS**



# Phase Linear starts where state-of-the-art leaves off.

We build products with state-of-the-art specifications. But we don't stop there. Specifications are important to us, but equally vital is the achievement of *obviously audible improvements* in the reproduction of music with every separate component we make. This is the driving force behind Phase Linear, the single-minded philosophy that has produced so many innovative features, advanced circuitry and ultimately, products with more dynamic range and bigger, more lifelike sound than any comparably priced components available on the market today. Our Research Department, headed by Robert Carver, is staffed by imaginative design engineers deeply concerned with the entire spectrum of musical reproduction. Many more new products are in the wings; in the meantime, we invite you to review the present Phase Linear line and read what the critics have said. Then ask your dealer for a demonstration, and draw your own conclusions.

## **The Phase Linear 700B Stereo Amplifier**

Has established performance and power standards unequalled by any other amplifier on the market...regardless of price.

*"the lowest distortion, in spite of its enormous power capability, was on the Phase Linear 700..."* Hirsch-Houck Labs in STEREO REVIEW.

*"Hum and noise figures were also well below anything we have encountered before."* C. G. McProud in AUDIO.

*"...in terms of sheer power it is the most impressive we have tested."* HIGH FIDELITY.

## **The Phase Linear 400 Stereo Amplifier**

Hailed internationally as the undisputed "best buy" among all the "super amps" available today.

*"We were utterly flabbergasted when we discovered the amplifier, which sounded dramatically cleaner and more revealing, turned out to be, when we removed our blindfold status, the Phase 400... No other amplifier... ever even tied the Phase 400 for naturalness, clarity, and lack of distortion!"* SOUND ADVICE, 225 Kearny St., San Francisco.

*"... a superb amplifier, furnishing the essential qualities of the Model 700 at a much lower price."* Hirsch-Houck Labs in STEREO REVIEW.

*"Harmonic distortion proved to be almost unmeasurable on this amplifier."* STEREO & HI-FI TIMES.

## **The Phase Linear 200 Stereo Amplifier**

The newest addition to our amplifier line incorporates all we have learned to date

about power amplifier design. The 200 has not been reviewed, but with its advanced LED metering system, sophisticated protection circuits and excellent performance specifications, we are optimistic!

## **The Phase Linear 4000 Stereo Preamp**

The model 4000 illustrates our philosophy of delivering far more than state-of-the-art specifications. It offers revolutionary features that make music sound better by providing greater dynamic range and a quiet background.

*"... a combination of noise reduction and dynamic-range-expansion circuits whose sophistication far surpasses anything previously available on the audio consumer level... even without the assistance of its special noise reducing systems, it would rank as one of the quietest units we have ever encountered... makes any program played through it sound better than through any other preamplifier we have ever used... a most impressive technical achievement."* Hirsch-Houck Labs in STEREO REVIEW.

## **The Phase Linear 2000 Stereo Preamp**

Beyond efficient handling characteristics and excellent specifications, the 2000 is capable of reproducing more of the music on your recordings. Its ability to reproduce ambient signals is a function found on no other preamplifier.

*"Super in the listening as it is smooth in the handling... The extra flexibility in the tone controls delivers worthwhile options. We find the ambience recovery feature a decided plus."* HIGH FIDELITY.

## **The Phase Linear 1000**

A noise reduction and dynamic-range-expansion system designed to eliminate noise from all sources (records, tapes, FM, etc.) and restore the music we hear at home to its original dynamic range.

*"... for any already top-quality music system, we doubt a \$350 expenditure in any other component could match the audible improvement made possible by the Phase Linear 1000."* Hirsch-Houck Labs in STEREO REVIEW.

*"In theory, the circuit (AutoCorrelator) can make the distinction and reduce the level of the noise component while reproducing the signal component unaltered. In practice, its ability to do so is far from absolute, yet audibly greater (to my ears) from that of any other noise-remover on the market."* Robert Long, in HIGH FIDELITY.

**To be released soon—**

## **The Phase Linear 5000 FM Tuner**

Loaded with innovations, the 5000 will feature circuitry capable of increasing the dynamic range of broadcast signals up to 9 dB! It will do more than just reproduce a mediocre broadcast perfectly; it will make FM signals sound virtually as good as recorded signals. This feature alone makes the Phase Linear 5000 FM Tuner worth waiting for!

**Phase Linear Corporation**, 20121 48th Avenue West, Lynnwood, Washington, 98036. Manufactured in the U.S.A., Distributed in Canada by H. Roy Gray, Ltd.

# Phase Linear



Phase Linear 2000 Preamplifier • Phase Linear 200 Power Amplifier • Phase Linear 5000 Tuner • Phase Linear 1000 Noise Reduction System • Phase Linear 4000 Preamplifier • Phase Linear 700B Power Amplifier • Phase Linear 400 Power Amplifier • Phase Linear Corporation, Lynnwood, Washington, U.S.A.



# New Products

the latest in high-fidelity equipment and accessories

100,000 ohms in parallel with a capacitance of 100 picofarads. The weight of the cartridge is 5.8 grams. Price: \$74.95.

Circle 118 on reader service card

## Sansui Model 9090 AM/Stereo FM Receiver

One of the leading models in Sansui's line of high-power receivers, the 9090 is rated for a continuous power output of 110 watts per channel into 8 ohms, 20 to 20,000 Hz, with no



more than 0.2 per cent harmonic or intermodulation distortion. Hum and noise are 80 dB below rated output for the high-level inputs, 70 dB below rated output for the phono inputs. Frequency response at 1 watt output is 10 to 30,000 Hz  $\pm 1$  dB, while the frequency response of the phono section matches the RIAA characteristic within  $\pm 0.5$  dB from 30 to 15,000 Hz.

In FM performance, the 9090 has a usable sensitivity of 1.7 microvolts and a 50-dB quieting sensitivity of 3 microvolts. The ultimate signal-to-noise ratio in mono exceeds 70 dB. Capture ratio is better than 1.5 dB, alternate-channel selectivity better than 85 dB, and image, i.f., and spurious-response rejection exceed 75, 100, and 90 dB, respectively. The frequency response of the FM section is 30 to 15,000 Hz  $+0.5$ ,  $-2$  dB, and stereo separation is over 40 dB at 1,000 Hz.

The major controls of the Sansui 9090 are volume and balance (concentrically mounted) and tone controls, of which there are three: bass, treble, and mid-range. The mid-range control has a range of  $\pm 5$  dB centered at 1,500 Hz, while the bass and treble controls can be switched to take effect at 300 or 150 Hz (bass) and 1,500 or 3,000 Hz (treble). The controls can also be separately switched out of the circuit. A selector performs tape-monitor switching for two tape decks and also facilitates dubbing from either one to the other. The source selector has positions for phono, auxiliary high-level source, AM, FM, and "Dolby FM Adaptor," which enables a B-type Dolby processor connected to the appropriate rear-panel jacks of the 9090 to act on incoming Dolbyized FM signals. This selector position introduces the correct 25-microsecond de-emphasis for Dolbyized broadcasts. The receiver also accepts a microphone input via a front-panel phone jack; an adjacent level control enables the microphone signal to be mixed in with whatever program the receiver is handling. Finally,

there are switches for loudness compensation and mono/stereo mode, two stereo-headphone jacks, and a speaker selector that chooses between three pairs of speakers (individually or in combinations of two) or silences all speakers for headphone listening.

In the tuning-dial area of the 9090 are push-buttons for low- and high-frequency filters, audio muting for brief listening interruptions, an optional external signal processor (Dolby unit, equalizer, or four-channel adapter), FM interstation-noise muting, and high-frequency blend for stereo FM. A final button converts the signal-strength tuning meter into a multipath indicator. There are also meters for FM channel center and for audio output; they are calibrated in watts (referred to an 8-ohm speaker load) for each channel. To protect loudspeakers from turn-on surges and amplifier failure there is an audio-output relay. When this acts to disconnect the speakers, a light-emitting diode indicator beneath the tuning meters flashes off and on. The dimensions of the Sansui 9090 are about 21 $\frac{1}{4}$  x 7 $\frac{1}{4}$  x 15 $\frac{3}{4}$  inches. Approximate price: \$750.

Circle 119 on reader service card

## Rectilinear 2 Speaker System

The new Rectilinear 2 extends the company's Contemporary Laboratory Series to three models, of which the 2 is the smallest. It is a two-way system, incorporating a 10-inch air-suspension woofer and two 1 $\frac{1}{2}$ -inch cone tweeters, which has a nominal impedance of 8 ohms and a resonance of 45 Hz. As with the other systems in this series, no crossover networks as such are employed in the Model 2. The woofer is permitted to operate right up to its natural rolloff point somewhat above 2,500 Hz. A high-pass filter serves to restrict the tweeters to frequencies above 2,500 Hz.

Frequency response of the Rectilinear 2 is



35 to 18,000 Hz  $\pm 3$  dB. The minimum power requirement of the speaker is 20 watts continuous, but it can be used with amplifiers capable of continuous outputs up to 100 watts per channel. The system is fused to protect the drivers. The cabinet has dimensions of

23 $\frac{1}{2}$  x 13 x 12 inches. It is constructed of high-density fiber material and finished in walnut-simulating plastic. The grille is of black acoustically transparent cloth. Price: \$139.

Circle 120 on reader service card

## SAE 2200 Stereo Power Amplifier

The new SAE 2200 is rated at 100 watts per channel continuous into 4 or 8 ohms over the full audio range, with a maximum of 0.05 per cent harmonic or intermodulation distortion. Frequency response at rated power is 20 to 20,000 Hz  $\pm 0.25$  dB, and the signal-to-noise ratio exceeds 100 dB. The circuit design of the amplifier is fully complementary throughout, and the amplifier has a slew rate of 40 volts per microsecond. Protection circuits include thermal sensors, current-limiting devices to protect the output stage, and an audio relay that breaks the connection to the speaker systems in the case of potentially destructive low-frequency disturbances.

Prominent on the amplifier's front panel is an LED power-output indicator display consisting of 15 LED's per channel calibrated in



3-dB steps from 0 to 200 watts. The panel is black anodized with a brushed finish; there are rack handles on either side. Dimensions are 19 x 5 $\frac{1}{4}$  x 8 $\frac{1}{2}$  inches; the amplifier weighs 28 pounds. Price: \$450.

Circle 121 on reader service card

## Radio Guide to Classical Music

*Musica* is a paperbound publication that attempts to list all the AM and FM radio stations in the continental U.S. that regularly program classical music. The listings are alphabetical by state and city or town. They include the call letters and broadcast frequencies of the stations, the days and times of regularly scheduled broadcasts, and usually some indication of the coverage radius of the stations in miles. An expanded edition of *Musica* with more than 750 listings is now available postpaid for \$3 from: *Musica*, Box 1266 (r), Edison, New Jersey 08817.

PUBLISHER'S NOTICE: Recent fluctuations in the value of the dollar will have an effect on the price of merchandise imported into this country. So, please be aware that the prices quoted in this issue may be subject to change.

# INNER BEAUTY

Brilliant new engineering for a bright new sound:  
KENWOOD RECEIVERS FOR '76



KENWOOD introduces a new receiver line for '76—six high performance new models, created in the KENWOOD tradition of engineering excellence. The beauty of 'original-performance' reproduction starts deep inside each new model. Big new power ratings enhance performance right down the line, but power alone is not the whole story. KENWOOD engineers have carefully concentrated on total performance, with a host of technical refinements: Direct-coupled output stages with pure complementary symmetry for better bass response and crisp transient response. New distortion-cutting circuitry in the all-important preamp for increased signal-to-noise ratio. Advanced new tuner design for greater sensitivity, better capture ratio, and full stereo separation throughout the frequency range. Plus KENWOOD's new uncluttered internal layout that minimizes wiring to maintain optimum signal-to-noise performance. Six new receivers—with an inner beauty all their own—are waiting for you at your nearest KENWOOD Dealer.



**KENWOOD**

15777 S. Broadway, Gardena, CA 90248 72-02 Fifty-first Ave., Woodside, N. Y. 11377 In Canada: Magnasonic Canada, Ltd.

CIRCLE NO. 19 ON READER SERVICE CARD



This is about as simply and as clearly as we can describe this latest achievement by Dual engineers. We could also describe the CS721 as the ultimate expression of the principles that determine the performance of tonearms and drive systems in record playback.

The tonearm is straight-line tubular from pivot to tonearm head, for lowest effective mass and greatest rigidity. It is centered with a true, four-point

gimbal in which the tonearm masses pivot at the intersection of both axes. This ensures dynamic balance throughout play, and turntable level is not critical.

# The new Dual CS721. It represents everything Dual has learned about turntables.

Every initial tonearm setting has a special touch of precision.

Stylus overhang is adjustable for optimum horizontal tracking angle. Balance is vernier-adjustable. Stylus force is applied around the vertical pivot and remains perpendicular to the record even if the turntable is not level. Anti-skating is calibrated separately for all three stylus types and is self-compensating for groove diameter.

In addition to these refinements, the CS721 tonearm has an innovation to be found on no other integrated tonearm: Vertical Tonearm Control. A vernier height adjustment over an 8mm range allows this tonearm to parallel the record with cartridges of any depth and without the use of spacers. Thus, accurate vertical tracking is assured, and the effective mass of the tonearm is kept at a minimum. Another benefit: changing cartridges is much easier.

The CS721 direct-drive system is the most advanced today for record playback. It features all all-electronic, low speed, brushless, DC motor with Hall-effect feedback control and a regulated power supply. The motor's field coil design is unique. Two overlapping coil layers, each with eight coreless bifilar-wound coils, achieve a gapless rotating magnetic field. This eliminates the successive pulses of magnetic flux typical of all other motor designs.

Although the CS721 is Dual's most expensive model, it is hardly the most expensive turntable available today. When you make comparisons, as we believe you should, you may even consider the CS721 underpriced. Not to mention the even less expensive direct-drive CS704, with the same tonearm and drive system but with semi-automatic start and stop.

With either model, you will enjoy the advanced precision performance of the quietest turntable ever made.



**United Audio Products**

120 So. Columbus Ave., Mt. Vernon, N.Y. 10553

Exclusive U.S. Distribution Agency for Dual

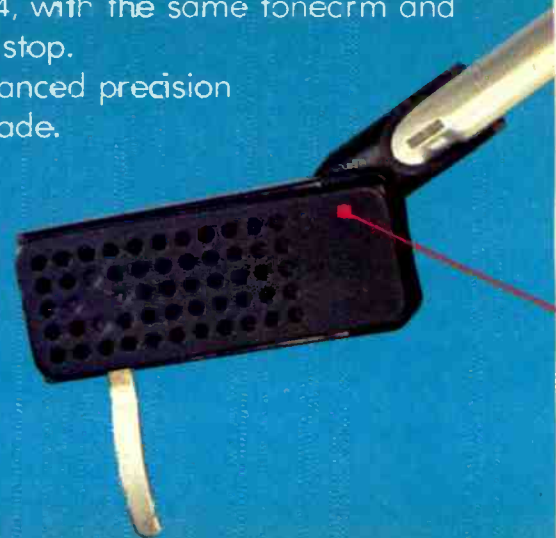



True, four-point gimbal centers and pivots intersect at one horizontal and vertical axis. Tonearm is dynamically balanced in all planes. The four needle point pivots are first hardened, then honed, a process which produces microscopically smooth surfaces.

Cueing descent speed can be set from slow to rapid, and tonearm cueing height is adjustable. Result: complete control of stylus setdown via cue-control.

Vertical Tonearm Control sets and locks tonearm height at any point over a 7.8mm range. Tonearm thus exactly parallels the record with any size cartridge. Result: accurate vertical tracking without the added mass of cartridge spacers.

Straight-line tubular tonearm provides maximum torsional rigidity and lowest effective mass. With the same effective tonearm length and tangential tracking error any other shape must either sacrifice rigidity or increase mass.

Rigid three-point suspension locks cartridge holder to tonearm head in identical position each time it is removed and replaced. Together with adjustable stylus overhang, this assures that correct vertical and horizontal tracking angle will be maintained.

The unique counterbalance contains two mechanical anti-resonance filters. These are separately tuned to absorb energy in the resonance-frequency ranges of the tonearm/cartridge system and chassis to minimize acoustical feedback.

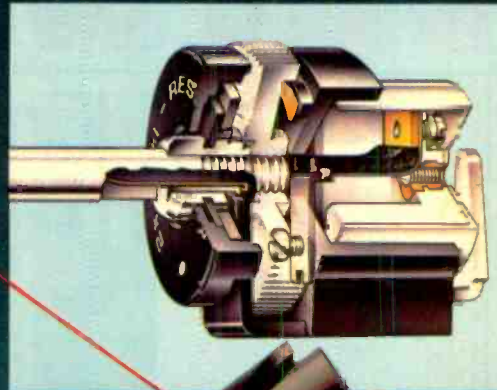

Stylus pressure is applied via a long coiled spring centered around the vertical pivot. Pressure is always maintained perpendicular to the record even if the turntable is not level.

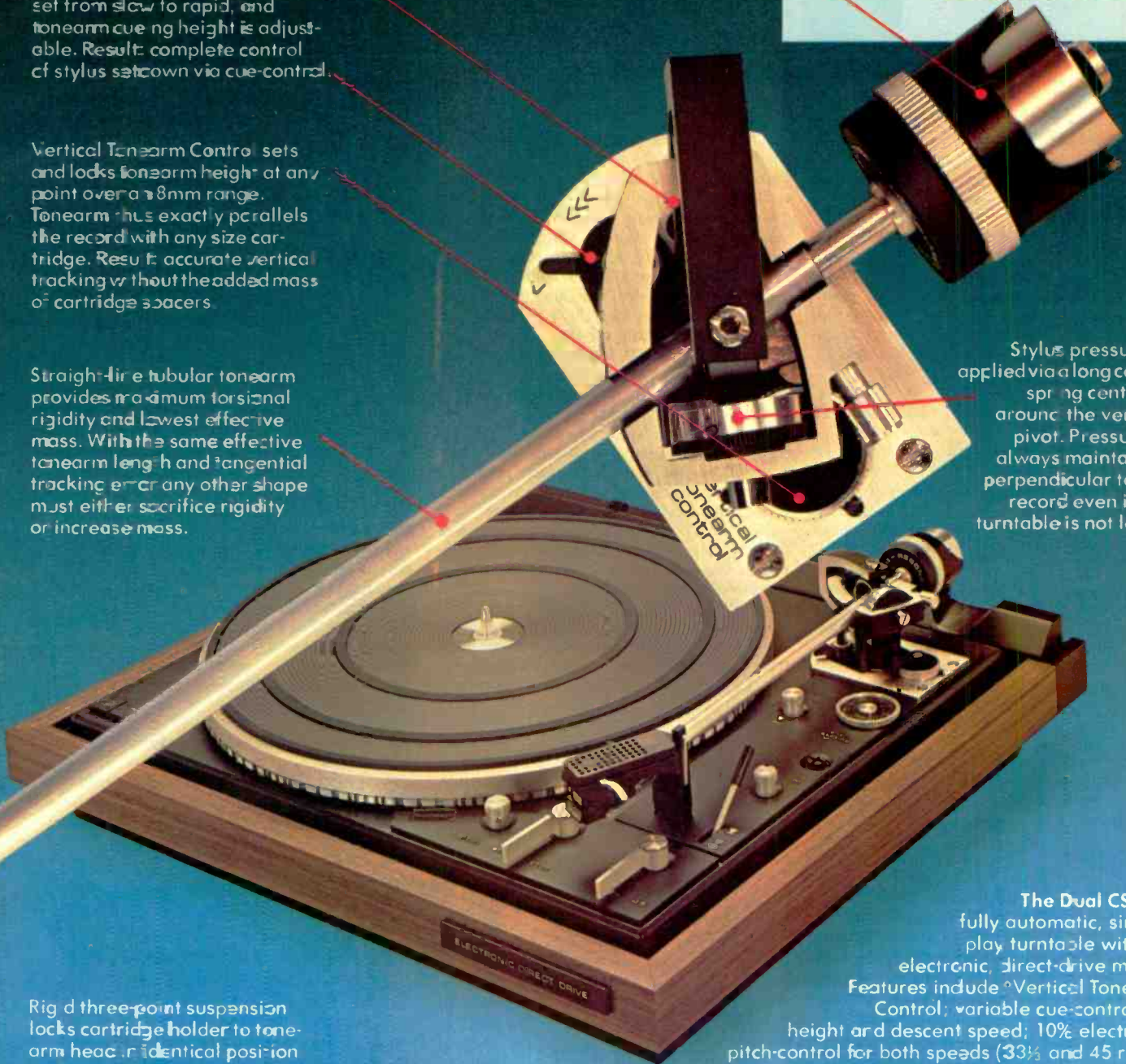

**The Dual CS721:** fully automatic, single-play turntable with an electronic, direct-drive motor. Features include Vertical Tonearm Control; variable cue-control lift height and descent speed; 10% electronic pitch-control for both speeds (33 $\frac{1}{3}$  and 45 rpm); illuminated strobe; dynamically-balanced 12" platter; cue-control viscous-damped in both directions; continuous-repeat. Price: less than \$400, including base and dust cover. **Dual CS704:** similar, except semi-automatic. Ingenious mechanical sensor locates lead-in groove of 12" and 7" records; tonearm lifts and motor shuts off automatically at end of play. Less than \$310, including base and dust cover.

Fully-automatic, single-play/multi-play Duals: 1225, less than \$140; 1226, less than \$170; 1228, less than \$200; 1249, less than \$280. Semi-automatic, single-play Duals: 502, less than \$160; 510, less than \$200.

CIRCLE NO. 50 ON READER SERVICE CARD



# Audio Q. and A.

By Larry Klein

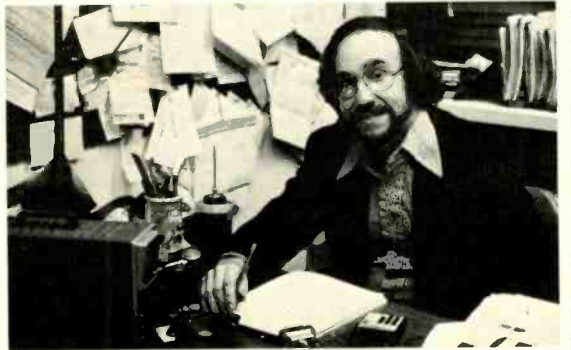

## Disco Speaker Burnout

**Q.** I've been involved in setting up a disco-theque sound system and have run into a weird problem. I'm using six speakers per channel, each rated to withstand 50 watts continuous power and perhaps five or six times that much "integrated program" material. These are fed by a 150-watt-per-channel power amplifier driven by my disco mixer. My problem is speaker burnout. I don't understand why this happens, since each speaker, even under the loudest playing conditions, should be getting no more than about 25 watts.

RICHARD SHANE  
Portland, Ore.

**A.** Would you believe that your difficulties probably arise from too little amplifier power rather than too much? Given the practices of most discos, I suspect that your amplifier is being run at its clipping level most of the time. And when driven really heavily, any amplifier's output probably resembles a series of square waves more than the original jagged musical waveform. (Such clipping is shown on the left side of the accompanying scope photo; normal unclipped waveforms are visible on the right.) This has two consequences, apart from the audible distortion incurred. First, the power delivered by a clipped sine wave can be significantly higher than that of a pure sine wave of the same amplitude. The effective voltage of a sine wave is 0.707 per cent of its peak voltage (see accompanying drawing) while the effective and peak voltages of a square wave are exactly the same. The effective voltage does the work and provides the basis for a power measurement. The 120 volts a.c. available from the wall socket is the effective (not peak) voltage of the 60-Hz waveform. Insofar as the audio waveform is "hard clipped" or substantially overdriven, it begins to resemble a square wave, and its power content changes. A perfect sine wave representing, say, 50 watts of power applied to the speaker, if converted into a perfect square wave of the same amplitude, would present 100 watts to the speaker. Of course, in conventional music we seldom encounter a perfect sine wave and never produce a perfect square wave however hard the amplifier is clipped. But the relationships discussed are valid. Oddly enough, you don't particularly hear the extra power produced by clipping, except possibly as distortion, since the actual amplitude of the signal is not, in fact, higher.

Aside from its potential for pushing the amplifier into delivering excessive power into your speakers, the clipping has additional potential for making trouble. If you have ever compared the sound of a lower-frequency square wave and a sine wave, you'll hear a harsh buzzy quality in the square wave. The buzz is the sound of all those additional high-order odd harmonics that give the square wave its shape. Say you clip a 1,000-Hz sine wave. It now is putting out very strong signals at 3,000, 5,000, 7,000, 9,000 Hz—and higher. The odds are that your tweeters are going to run into trouble since, in addition to their normal musical load, they also must cope with large amounts of spurious energy produced by the clipping. So you not only have more power than you want fed to your speakers, but a lot of it is applied right in the area where they are most prone to overload damage.

How does switching to a higher-power amplifier help? The main thing is that the clipping is avoided. Since the waveform now has a reasonable ratio of high to low amplitudes (as shown on the right side of the scope photo), the amplifier can paradoxically play louder (and cleaner) while providing a lower long-term-average amount of power to your speakers. To put it another way, your speakers will

Sine-wave amplitude *B* represents the maximum clean power available from a given amplifier. If driven beyond its rated power into clipping, the squared-off waveform defined by the shadowed areas (*C*) results. Substantial additional power would be delivered to the speakers because of the higher effective-volt-

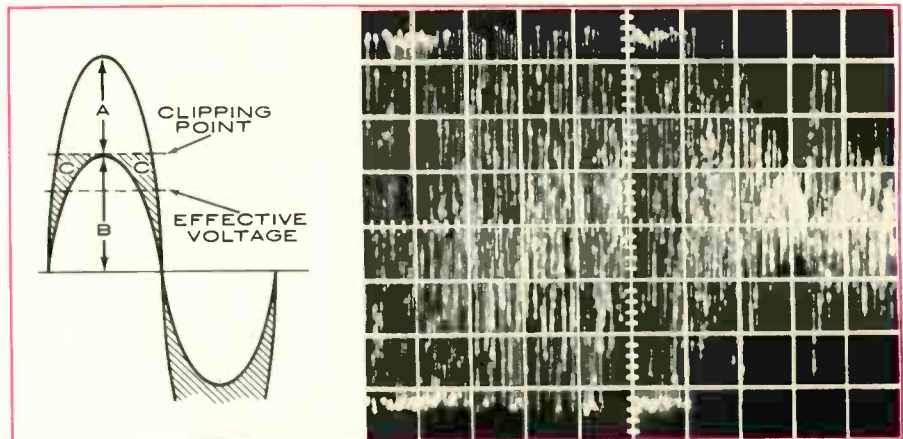

"run cooler," even though the amplifier may be driving them to a louder level than before.

Incidentally, my answer is not based simply on theory. A friend who does disco installations has told me that he solved several chronic burnout problems by replacing the original amplifiers with units that had double the power available.

## Magnetic Speaker Fluid

**Q.** I've been hearing rumors about a performance-enhancing magnetic fluid that is used in some new speakers. Does it exist, how does it work, and how does it help loudspeaker performance?

TERRY O'KANE  
Detroit, Mich.

**A.** Yes it exists, and several companies are producing the substance, under various names, the most common of which is ferrofluid. For quite some time speaker manufacturers have been using silicone grease in voice-coil gaps. Its purpose is to facilitate the transfer of heat from the voice coil to the surrounding metal parts to enhance the unit's power-handling capability. (Silicone grease is used in mounting power transistors for the same reason.) Someone apparently had the bright idea of floating magnetic particles in a similar substance, which would not only provide the heat transfer, but might also act to concentrate the available magnetic flux right where it is needed. Although sensitivity was improved by only a decibel or so, the magnetic fluid does serve to stabilize voice-coil behavior in that it damps the resonances of the voice-coil assembly and, oddly enough, helps keep it centered. It seems that the fluid offers far more resistance to radial (side) movement than to edge-on axial movement. As a matter of fact, the magnetic fluid was so effective in keeping a voice coil in axial alignment that at least one manufacturer found that he could eliminate the usual voice-coil support (the spider) in the cone mid-range and tweeter drivers produced by his company. So, although the magnetic fluid did not bring about the expected large improvement in sensitivity, its other advantages appear to be substantial enough that more and more manufacturers will probably be using it over the next few years.

age level and also because the clipping results in compression of the dynamic range. If adequate power were available from the amplifier (it would have to be almost quadrupled in the example shown), the waveform, instead of being clipped, would have amplitude *A* plus *B*. High power provides headroom for peaks.



# I didn't always smoke Winston Longs.

I was looking for a longer cigarette. But I also wanted taste. Only Winston Longs give me both. Winston Longs have the length I like, and all the real taste I want. If a cigarette doesn't have taste, it doesn't have anything. For me, Winston Longs are for real.

Warning: The Surgeon General Has Determined That Cigarette Smoking Is Dangerous to Your Health.

18 mg. "tar", 1.2 mg. nicotine av. per cigarette, FTC Report APR '76.



# Introducing the world's most powerful receiver. 165 watts per channel.

## With the world's least distortion. Only 0.08% THD.\*

The Technics SA-5760. More power and less distortion than any other receiver in the world at rated power. And that's just for starters.

The SA-5760 also has the reserve power you need to float through complex musical passages without distortion, clipping or instability. Because we use single-packaged dual transistors in the differential amplifier stage of each channel. Along with high capacitance filtering and a bridged rectifier. There's also direct coupling and heavy power supply regulation. So transient bursts in one channel remain isolated from the other.

And you'll hear your records precisely the way they were recorded. Thanks to "current mirror loading"—a radically new circuit found in the SA-5760's phono pre-amp. The results are an unsurpassed S/N ratio of 78dB. And a frequency response that's accurate to within  $\pm 0.2$  dB of the ideal RIAA curve.

On FM, the signal being broadcast will be the signal you'll hear because we use flat group delay filters in the SA-5760's tuner section. As well as a Phase Locked Loop IC. So you'll also receive 38dB of stereo separation at 10kHz and 45dB at 1kHz. As well as inaudible distortion and a

frequency response that actually exceeds the response of FM broadcasts.

The SA-5760's controls are as sophisticated as its circuitry. Like a 26-step true attenuator click-stop volume control. Negative feedback tone controls with turnover selector. Two-way tape-to-tape dubbing. A truly linear signal-strength tuning meter for AM and FM that works the way other meters don't: accurately. And all the other refinements you'd expect from the world's most powerful receiver.

And to complement the SA-5760, Technics has five other new stereo receivers. All with excellent power. Outstanding performance. Sophisticated circuitry. And all at a good price. The concept is simple. The execution is precise. The performance is outstanding. The name is Technics.

\* 165 watts per channel, minimum RMS, into 8 ohms from 20Hz to 20kHz with no more than 0.08% THD [total harmonic distortion].

# Technics

by Panasonic



CIRCLE NO. 38 ON READER SERVICE CARD

# Audio Basics

By Ralph Hodges



## GLOSSARY OF TECHNICAL TERMS—28

● **Power bandwidth**, up until a short time ago, was defined by the Institute of High Fidelity as the frequency range (or *band*) over which an amplifier could deliver at least *one half* its rated power output without exceeding its rated distortion. The rated power output was customarily based on a measurement made at 1,000 Hz—a frequency at which most audio amplifiers are capable of their greatest output. With the recent (1975) promulgation of the FTC rule on amplifier-power advertising, power bandwidth was redefined to mean the frequency range over which *full* rated power is available and made a required part of any amplifier-power specification.

● **Power-handling capacity**, a term usually used in reference to speaker systems or headphones, rates these devices for the maximum electrical signal input they can tolerate before distortion or even damage occurs. A typical power-handling specification might read "100 watts program material, 40 watts continuous," reflecting the fact that short-duration high-power peaks (typical of program material) can be withstood better than continuous signals lasting an appreciable amount of time. A truly complete power-handling specification would indicate the *maximum time periods* over which various power levels can be tolerated as well as the *frequencies of the signals*, since the various drivers in a speaker system will almost always have different power-handling capabilities.

Many people interpret power-handling capacity as an indication of the largest amplifier that can be used with a given speaker system. In fact, however, amplifiers capable of several times the speaker's rating can usually be used safely as long as excessive sound levels are avoided and the speaker is fused according to the manufacturer's instructions.

● **Power response**, when used in connection with amplifiers, is essentially equivalent to *power bandwidth*. When used in reference to speaker systems, it means the uniformity (or lack of same) of the system's *total* sound-power output (in all directions) over its usable frequency range. (This is in contrast to *frequency response*, which is a measure of sound-pressure uniformity with frequency, usually at some specific angle from the speaker system.)

Many authorities believe the power response of a speaker system is a much better indicator of the way it will sound in a normal room than the on-axis frequency response. This is because the speaker will typically be operated in an acoustically reflective environment that will ultimately cause its *total* integrated output to impinge on the listener, rather than just the energy that is radiated straight ahead or in any other single direction. When it appears in manufacturers' literature (which is rarely), a power-response specification takes the same general form as frequency response: 20 to 20,000 Hz  $\pm$  X dB, for example.

● **Power supply** is the part of an amplifier or other electronic component that provides the d.c. voltages required for the component to operate. The usual power supply consists of a power transformer, a rectifier, and several filter capacitors (the British call them "smoothing" and "reservoir" capacitors, which is somewhat more descriptive of their function), plus some resistors and possibly some regulating circuits. In an amplifier intended to drive loudspeakers the power supply is usually responsible for a significant fraction of the unit's weight, and its capacity and other characteristics will have a large influence on power-output capability.

● **Preamplifier**, as a separate audio component, functions essentially as a control center for an audio system as well as a gain and equalization amplifier for a magnetic phono cartridge. Its usual internal make-up consists of the phono-input stage (necessary to equalize the output of the cartridge and boost it to a level comparable to that of other components such as tuners and tape decks), a tone-control and filter section, and an output stage. On its front panel are found volume, balance, and tone controls, switching for input selection, tape monitoring, high- and low-frequency filters, and other features such as loudness compensation, audio muting, etc. In order to drive loudspeakers, a preamplifier must be used with a separate *power* amplifier, which may have few controls of its own or none.

The phono-input and control stages of integrated amplifiers and receivers are also properly referred to as *preamplifier sections*, as are the recording and playback amplifiers in tape decks.

● **Pre-echo** is the name for that faint, mysterious wisp of music that sometimes precedes the start of the actual music on a disc by about half a second. Pre-echo is generally thought to occur during the cutting of a disc, when the stresses set up by the inscribing of the first modulated groove work their way back through the lacquer material to lightly modulate the preceding "silent" groove. Increasing the spaces between grooves usually serves to diminish or eliminate pre-echo.

● **Pre-emphasis** is another name for the *equalization* applied to a signal to be recorded or broadcast in order to improve the ultimate signal-to-noise ratio. Currently the term is most frequently used to refer to FM-radio equalization, in which case pre-emphasis is the high-frequency boost the audio signal undergoes just before being broadcast by the station. On the receiving end, the tuner incorporates *de-emphasis* circuits that restore the original frequency balance and simultaneously reduce any noise that has intruded during transmission.

For many years FM in the U.S. has had an FCC-mandated pre-emphasis characteristic, usually specified by its time constant of 75 microseconds. However, shortly after the beginning of Dolbyized FM broadcasts the FCC permitted the use of the less extreme pre-emphasis characteristic of 25 microseconds provided by an FM Dolby encoder and used by those stations broadcasting a Dolbyized FM signal. The new characteristic recognized that the Dolby system's noise reduction would eliminate much of the original need for pre-emphasis, and at the same time it permitted Dolbyized stations to use a wider dynamic range and/or a higher overall modulation level in their broadcasts. The pre-emphasis also eliminated most of the audible effects of Dolby's high-frequency boost. The new characteristic requires a corresponding 25-microsecond de-emphasis circuit at the receiver—but only if you wish to use Dolby decoding. A 75-25 microsecond switch is being built into many modern tuners and receivers.

● **Printed circuits**, which began appearing in audio electronics during the 1950's, have greatly reduced the cost and complexity of equipment manufacture. The typical printed circuit is a thin phenolic or fiberglass board with the electronic circuit etched on one side in the form of a metal-foil pattern. The leads of resistors, capacitors, and other circuit elements are inserted (from the opposite side) into tiny holes that pass through the board and are soldered to the appropriate places on the foil pattern, eliminating the need for tedious point-to-point connections with hook-up wire.

While less than ideal for vacuum-tube designs, printed circuits have come into their own with transistors, since the tiny transistors are usually soldered directly to the board as if they were resistors or capacitors. The boards are frequently called "cards" when they have a row of contact areas that enable them to be plugged into a special type of socket.

● **Psychoacoustics** is a broad term for the study of acoustic phenomena as they are perceived by human beings rather than by laboratory instruments. It concerns itself with a wide and ever-expanding range of topics, including the perception of pitch, loudness, and direction, the sense of acoustic space, the effects of phase, and to some extent the physiology of the human hearing apparatus.



9090



# How much

*Sansui*



5050



6060





**power  
do you really need?**



7070



8080



# Sansui has the answer.

Power is, of course, one of the most important characteristics in the quality of a receiver. But it is only one of them. There is also the tuner section which should offer especially high sensitivity and selectivity, and a great stereo separation. And the Sansui 9090 does: sensitivity of 9.8 dBf (1.7  $\mu$ V); selectivity of better than 85dB; stereo separation of



better than 40 dB at 1 kHz, and also a wide linear dial for both AM and FM tuning. Equally important are the capabilities and features of the pre-amplifier and control sections. Such as; triple tone controls, extremely accurate RIAA phono pre-amplifier with wide overload capability, many versatile inputs and outputs, microphone mixing control for blending mic signals with any other source, tone defeat switch, capability of handling three speaker systems, a



7-position tape copy switch, and a Dolby\* 25  $\mu$ sec de-emphasis. Of all receivers available today only in the Sansui 9090 and 8080 will you find all of these desirable elements.

\*fm, Dolby Labs

And when you select a receiver, look for well-designed protection circuits to protect your amplifier and speakers, and a solidly designed power supply capable of continually delivering the total power, undistorted. With the Sansui 9090, which delivers an ample 110 watts per channel into 8 ohms, min. RMS, from 20 Hz to 20 kHz with no more than 0.2 percent THD, you get both of these. The 9090, 8080 and 7070 also feature twin power meters for monitoring output, which few other manufacturers offer.

The other models in this outstanding new line of stereo receivers share many of the same fine characteristics as the top of the line models.

So remember. Your receiver is the heart of your high fidelity system. If you listen to a 9090 or any one of the fine



receivers in this Sansui series, you will quickly know that you are listening to the best receivers available today.

Go to your nearest franchised Sansui dealer today. He will make certain that you buy the receiver that matches your needs, your likes, and your budget. Sansui has the answer.

\*Approximate nationally advertised value. The actual retail price will be set by the individual dealer at his option.

The 9090 is a superior value at less than \$750.\* If the 9090 is more than you need ask for the 8080 with 80 watts per channel, min RMS, both channels into 8 ohms, from 20 Hz to 20 kHz with no more than 0.2% total harmonic distortion at less than \$650.\* Or the 7070 with 60 watts per channel, min RMS, both channels into 8 ohms, from 20 to 20,000 Hz with no more than 0.3% total harmonic distortion at less than \$520.\* Or the 6060 with 40 watts per channel, min RMS, both channels into 8 ohms, from 20 to 20,000 Hz with no more than 0.4% total harmonic distortion at less than \$420.\* Or the 5050 with 30 watts per channel, min RMS, both channels into 8 ohms, from 20 to 20,000 Hz with no more than 0.5% total harmonic distortion at less than \$320.\* 9090 in walnut veneer. All other cabinets in simulated walnut grain.

**Sansui. A whole new world of music.**



**SANSUI ELECTRONICS CORP.**

Woodside, New York 11377 • Gardena, California 90247

SANSUI ELECTRIC CO., LTD., Tokyo, Japan

SANSUI AUDIO EUROPE S.A., Antwerp, Belgium

In Canada: Electronic Distributors

CIRCLE NO 52 ON READER SERVICE CARD





**is it worth to you ?**



7070



8080

# FAT SOUND FOUND

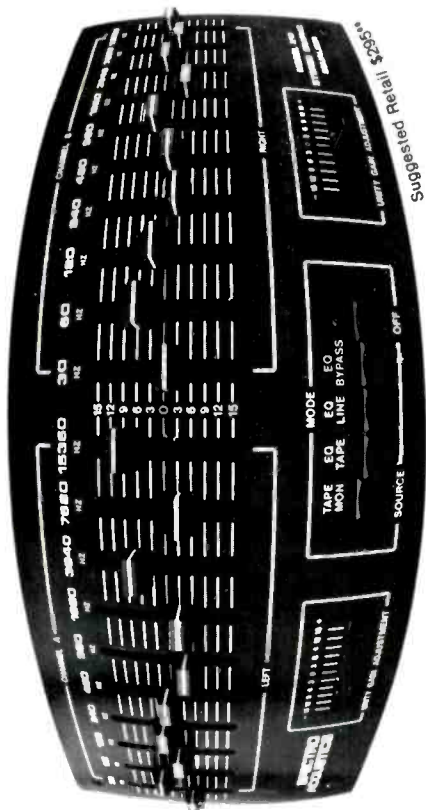

## SPECTRO ACOUSTICS MODEL 210

### GRAPHIC EQUALIZER

The Model 210 can be used to "fatten up" your sound quality for the ultimate in definition and clarity. Room, speaker and recorded material variations can often "gobble up" or over-emphasize certain audio frequencies. Authoritative tight bass, open highs, brassy horns and smooth solos are all in their place with the 210's individual octave energy controls... all without adding any audible noise or distortion. To wit:

- Less than 0.01% IM distortion
- Over 100 dB dynamic range
- 600 ohm outputs drive any system
- Free five year service contract

PLUS long throw silicone dampened controls for better accuracy, gyrator synthesized inductors for ultra-low distortion, full switching facilities for EQ line/tape/bypass and tape monitor, as well as full range unity gain level adjustments. The 210R Rack Mount version is also available.

### SPECTRO ACOUSTICS, INC.

1309 E. Spokane [509] 545-1829  
Pasco, Washington 99301

CIRCLE NO. 57 ON READER SERVICE CARD

## Tape Horizons

By Craig  
Stark



### RECORD VS. PLAYBACK

**I**n my last column I pointed out that only those magnetized oxide particles that lie close to the tape surface facing the head can contribute significantly to the playback of very-high-frequency ("short-wavelength") signals. By contrast, the low-frequency (long-wavelength) signals employ the whole thickness of the oxide layer. One of the obvious consequences of this fact is that it gives support (at least in *theory*) to the concept of "dual-coated" tape, in which a very thin outer layer of magnetic material (say, CrO<sub>2</sub>) especially suited to short-wavelength signals is laid over a much thicker layer whose conventional magnetic material is more responsive to relatively long wavelengths. Another consequence is more related to this continuing survey of just *how* recorders work, however, for it has to do with the difference in requirements (for optimum performance) between record and playback heads.

We have seen that for playback applications the overriding design objective must be to keep the head's gap length very short (narrow)—specifically, less than half the wavelength of the highest frequency of interest. In practical terms, this requirement is met for 7½-ips operation by a playback head whose gap length is in the order of 100 microinches, for at this speed the signal wavelength of even a 20,000-Hz tone is moderately long: 375 microinches. For cassettes, whose slower speed makes the wavelength of a 15,000-Hz tone only 125 microinches, a playback head gap of less than 50 microinches is indicated.

When a head is to be used for recording, however, the design objective changes. Recording takes place at (or, to be more accurate, *slightly* beyond) the trailing edge of the head's pole structure, so the relationship between signal wavelength and gap length becomes irrelevant. What is important in this application is the head's ability to direct the

magnetic flux generated within it out into the tape's oxide layer. The magnetic lines of force that simply flow across the space between the two pole pieces and never get into the tape (which is what happens when the poles are very close to each other) are mostly wasted. To be useful, the gap in the head core must constitute a kind of transfer zone in which the magnetic energy can flow outward from one pole piece, through the tape's oxide layer (where it magnetizes the particles), and then back through the other pole piece, completing the circuit.

With conventional head construction it has been found that a record head can penetrate a depth of oxide roughly equivalent to its gap length. It *may* push just a bit deeper, but it is not wise to count on more than about one and a half times the gap length. To put some practical figures to this, we can begin by noting that open-reel tape usually has an oxide coating whose thickness is about 500 microinches. Good "record-only" heads have 500-microinch gaps; indeed, in some laboratory and professional recorders 700- or even 1,000-microinch gaps are employed. Cassette tape is coated to a typical thickness of about 200 microinches, and where a cassette deck offers a separate record head it is likely to have a gap something like 200 microinches (5 microns).

A single record-playback head, then, represents a compromise. For cassettes the usual length is 60 to 80 microinches, which is long enough to adversely affect playback of the very high frequencies, but not long enough to put as much signal onto the tape as it can accept.

There are electrical and physical things that can be done to cause narrow-gap record heads to provide a field that will penetrate the tape-oxide to a greater depth, but to date such special heads have appeared in only a few models. These may be more common in the next generation of machines.





## The TL-3 won't replace your speaker systems, but it will give them some rest.

If you're a typical music lover, you've invested several hundreds of dollars—perhaps thousands—in your component system. Plus a lot of time and thought. But you can't always use that system at its best.

### Some speaker problems solved by headphones

Not everyone in the house wants to hear what you want to hear. Or when. Or that loud. So from time to time, you miss the impact of the full dynamic range that only high level listening can achieve.

Even when you're alone, you may not always be satisfied. The room acoustics may be tricky, or the seating arrangement not quite right for critical listening.

If you recognize any of these situations, chances are you've been doing all your listening via speakers. Which means you've never experienced headphones at their best.

### Provide unique listening experiences

Headphones do more than merely solve some speaker problems. They provide a unique listening experience of their own. They bring you into more intimate contact with the music. They achieve wider frequency response, with more brilliant highs. In fact, some experienced audiophiles believe that headphones come closer to the ideal than speakers.

### The TL-3 wins most auditions

If we've stimulated or rekindled your interest in headphones, keep these thoughts in mind the next time you visit your audio dealer. When you're there, you should audition our lightweight trans-linear TL-3. Rather than attempt to describe the "shimmering highs" and "thundering bass" achieved by its Mylar\* driver, we'll just mention what most music lovers (including audio specialists) have experienced with this remarkable phone. When they compare it with any other phone, at any price, they prefer the TL-3.

They like its sound, especially its full bass response. They like its foam-cushion comfort. And its modest price (\$40) is a pleasant surprise. It's very little to pay for so much additional pleasure that your speakers alone can never give you.

\*Mylar is a registered DuPont trademark.

 **SUPEREX**  
PRODUCTS WITH A DIFFERENCE

151 Ludlow St., Yonkers, N.Y. 10705  
In Canada: Paco Electronics Ltd., Montreal



# 10 sound reasons to buy our new receiver. Plus its sound.



Sony's new, more powerful STR-6800SD receiver should get a warm reception. Because it not only looks different from other receivers, it is different.

It has some features found in more expensive separate components—and other features found nowhere else at all.

**1. The most-used controls all in one place.**

Electronically, it would have been convenient for us to scatter the level control, tuning knob and input and tape selectors all over our receiver. Instead we grouped them in the upper right-hand corner—so they're convenient for you.

**2. A dial pointer that doubles in length when it's close to a station.** Together with the signal strength meter and the center channel meter, this Sony innovation constitutes a system that helps you tune faster and more accurately.

**3. A muting switch—great if the phone rings.**

Flick it down and volume drops. Flick it back up and volume goes back up to where it was. And this muting switch is right where it should be—right next to the level control.

**4. A stepped level control to keep both channels equal.**

It guarantees unprecedented accuracy—to within 1/2 db instead of 1 db. And it guarantees it over the whole volume range instead of just in mid-volume.

**5. MOS FET front end electronics unitized tuning.**

The 4-gang tuning section and all its associated electronic parts are mounted on one sub-assembly. So

temperature differences don't affect these circuits—the receiver tunes the same whether it's cold or warmed up. And, with MOS FET, the receiver has a very wide dynamic range.

**6. Dolby noise reduction system.**

As more and more stations broadcast in Dolby, you can really use a Dolby system. And ours has a definite advantage: instead of being an optional extra, it's built in—operated from the front panel.

**7. Phase locked loop.** It gives you greater stereo separation and less distortion.





**8. LEC (low emitter concentration) transistor.** This piece of advanced design in the preamp phono stage assures you tight RIAA equalization plus low noise, low distortion and a wide dynamic range. It's a Sony exclusive.

**9. An acoustic compensator for easy control of highs, lows and middles.** A conventional loudness control only lets you boost bass. Our acoustic compensator has three positions: For true

loudness compensation, for bass boost and for mid-range presence.

**10. Sony's most powerful receiver.** It delivers 80 watts minimum RMS continuous power per channel at 8 ohms from 20 Hz to 20,000 Hz with no more than 0.15% total harmonic distortion. It has a direct-coupled power amplifier with true complementary symmetry output stages.

**And more.** To these specifications (remember we state them conservatively), add Sony's proven reliability. And you get a receiver that produces a sound that'll make you understand why you have ears.

That's the STR-6800SC at \$600. Or, for less power and a few less features—but no loss of fidelity—the STR-5800SD at \$500 and the STR-480CSD at \$400 (all suggested retail prices).

A sound investment.



**SONY**



# Technical Talk

By Julian D. Hirsch



● **SPECTRUM ANALYSIS:** The spectrum analyzer, relatively unknown to the audio world a few years ago, has now become almost a household word—at least in households like mine. It is an instrument that measures the distribution and strength of individual signal or noise-energy frequencies over a given range—in this case the audio-frequency band or a fraction of it. The results of the analysis are usually displayed on a screen of the oscilloscope type, with the horizontal axis corresponding to frequency and the vertical axis to amplitude or level. The frequency band is scanned automatically and usually repeatedly.

In audio work, the so-called “real-time” analyzer has been widely used for determining the frequency response of auditoriums and studios since it responds almost instantaneously to signal inputs at any frequency in its operating range and gives a constant indication of the changes in spectral distribution as they are adjusted by the equalizer. However, its very fast response, paradoxically, makes it useless for precise, detailed measurement of complex signals. This is the result of a fundamental “trade-off” between scanning rate and frequency resolution, or the ability to separate and examine signals of nearly the same frequency. In order to cover the ten octaves or so of the audible frequency range at reasonable cost, the resolution of a real-time analyzer is limited to  $\frac{1}{3}$  or, at best,  $\frac{1}{10}$  octave (some very sophisticated instruments, using computer techniques, can get around this limitation, but their high cost rules them out for most audio applications).

The types of measurements usually made on audio-system components require a high-resolution analyzer, which must be of the “scanning” type. Instead of “looking” at all frequencies simultaneously, it examines only a very narrow band of frequencies at any given time, covering a wide range by slowly scanning through it. The key word is

“slowly,” since very highly resolved measurements, able to separate frequency intervals as narrow as 1 Hz, may take many minutes. However, when set up to sacrifice resolution, a scanning analyzer can cover the entire audio range in a second or so, giving a display that approximates that of a real-time analyzer.

We have recently added a Hewlett-Packard 3580A, one of the most advanced scanning low-frequency spectrum analyzers, to the Hirsch-Houck Laboratories’ test facilities. As it is applied to our test program, we expect to obtain much more accurate and definitive information on the technical performance of the products we test. The 5- to 50,000-Hz coverage of the analyzer, combined with a maximum resolution of 1 Hz, will enable us to quantify many measurements that formerly had to be expressed in relatively inexact terms.

What can we do with the spectrum analyzer that was not possible with more conventional test instruments? The ability to display, and measure accurately, very low-level signal components in the presence of much larger unrelated or unwanted signals is the principal advantage of this instrument. This means that an audio distortion measurement no longer need be limited by extraneous noise or hum, which often makes it difficult to measure amplifier distortion at low frequencies where such disturbance cannot be filtered from the signal. Furthermore,

the analyzer can measure distortion levels as low as  $-90$  dB (0.003 per cent), rivaling the best conventional “null-type” distortion meters.

Most meters give a total harmonic distortion (THD) reading, which lumps together all harmonics plus any hum or noise present in the signal. Some measurement standards, such as the latest IHF tuner standard, call for this type of test, although it can be misleading if significant amounts of hum or noise are present. The spectrum analyzer separates these signals into their components. For example, we may find a second-harmonic level of  $-62$  dB and a third-harmonic level of  $-66$  dB, etc., in an amplifier output. For easier correlation with more familiar measurement data, we usually combine these readings and convert the result to a percentage value that is nearly equivalent to a THD measurement (although it still excludes hum and noise). In the example given, the THD would be 0.095 per cent.

In FM-tuner measurements, the exclusion of 19-kHz pilot-carrier leakage from the distortion reading greatly improves the measurement accuracy on the better tuners, whose distortion may be at the same very low level as the inaudible pilot-carrier leakage. For most tuner measurements, however, the major advantage of the spectrum analyzer is its speed. In two 1-second scans we can obtain accurate readings of channel separation, distortion, and pilot-carrier leakage that previously had to be measured separately over a period of minutes.

A spectrum analyzer is almost a necessity for accurate measurement of tape-recorder distortion. Modulation noise and flutter prevent a THD meter from giving valid readings at distortion levels below about 1 per cent, but they have negligible effect on the spectrum-analyzer readings. The same advantage exists in loudspeaker measurements, where ambient room-noise levels or system hum can affect low-level harmonic-dis-

---

## Tested This Month

•

Sony TC-880-2 Stereo Tape Deck  
ADC Accutrac 4000 Record Player  
Tannoy Cheviot Speaker System  
Tandberg TR-2075 AM/FM Receiver

---



ortion measurements. With the spectrum analyzer, we can determine the true distortion of a speaker or headphones (including various forms of intermodulation distortion) even in the presence of relatively high noise levels.

The narrow measurement bandwidth of the spectrum analyzer is able to exclude noise to almost any desired degree (limited largely by the time we are willing to devote to the measurement). Combined with its almost incredible sensitivity (a signal of 100 nanovolts, or 0.1 microvolt, can produce a full-screen deflection on the display), this gives us a measurement capability limited only by our imagination and patience.

A typical measurement made possible only by this instrument is a frequency analysis of turntable rumble, to supplement the single weighted measurement that we will continue to use for purposes of correlation with manufacturers' ratings. A slow scan from 5 to 100 Hz, for example, will reveal the relative proportions of any rumble-frequency components in that range; from these we can infer the possible audible effects. Similarly, a spectrum analysis of the output of a flutter meter will show the frequency dis-

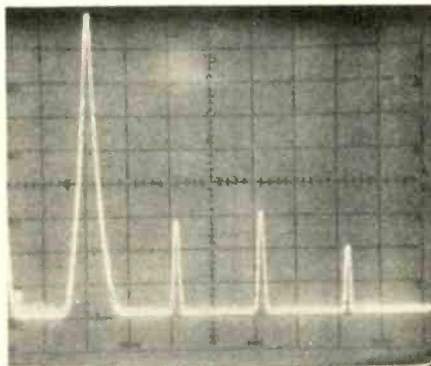

The spectrum analyzer displays the second, third, and fourth harmonics (the three peaks at the right) present in a "pure" sine wave. The amplitudes are a very low -62, -59, and -70 dB. Equivalent total harmonic distortion (as read on a meter) measured 0.014 per cent.

tribution of the wow and flutter from a turntable or tape recorder, providing another level of data beyond the single-value meter reading.

The scanning spectrum analyzer has

another unique feature, although we will rarely make use of it. It supplies an output signal, of constant amplitude, whose frequency is synchronized to the input "window" of the analyzer. By driving a speaker or amplifier with this signal and examining its output on the analyzer it is possible to make frequency-response measurements over a nearly unlimited dynamic range without noise- or hum-induced error.

In most of our response measurements it is more convenient to use the General Radio Graphic Recorder, which draws a response curve on a paper chart (spectrum-analyzer oscilloscope screens must be photographed to obtain a permanent record). Since our tests are made at a sufficiently high signal level to overcome any noise problems, this capability of the spectrum analyzer is of limited use in our work (although it is invaluable for certain types of filter-response measurements). In sum, the addition of the Hewlett-Packard 3580A spectrum analyzer to our laboratory will make it possible for us to learn much more about the detailed performance of most products we test and to do so in a fraction of the time required by previous methods.

## Equipment Test Reports

By Hirsch-Houck Laboratories

### Sony TC-880-2 Stereo Tape Deck



● THE new Sony TC-880-2 open-reel tape deck has several features found in no other home machine. It also has an extremely high level of performance, and it is one of the most

expensive tape recorders ever manufactured for home or nonprofessional use.

The TC-880-2 is basically a two-channel, half-track machine with an additional quarter-

track playback head. Reels up to 10½ inches in diameter can be used on the standard ¼-inch-diameter reel shafts or with the NAB hub adapters furnished with the deck. The three-motor transport features a direct-drive capstan motor that is servo-controlled in a manner similar to that used for direct-drive record-player turntables. Actually, a dual-capstan drive system is used, maintaining a constant and controlled tension on the tape as it passes over the heads. The second capstan has a heavy flywheel that is belt-driven from the direct-drive motor. The index counter is a true running-time indicator, reading in minutes and seconds for 15-ips operation. At the recorder's second speed of 7½ ips, the counter's time indications must be doubled.

The TC-880-2 has Sony's "Syncro-Trak" synchronous recording system. Either track of the recording head can be used for playback while recording on the other track. This permits the user to add later material with both tracks in synchronism. For each channel, there is a three-position REC MODE lever switch to select play, record, or synchronous operation. A light above each switch indicates its status. Two TAPE SELECT switches provide a choice of normal or high bias levels and three recording-equalization characteristics,

marked NORMAL, SPECIAL, and FcCr. The instruction manual recommends settings for most popular tapes. As the markings suggest, the TC-880-2 is compatible with Sony's new open-reel Ferrichrome tape, with which it delivers its maximum performance.

The recording-level controls, marked REC ATT, are step-type switches with 2-dB steps of attenuation for the first 34 dB, two larger steps to -50 dB, and a fully OFF position. The playback-level adjustment (PB ATT) is a step switch used in combination with a separate concentric, continuously adjustable FINE control. The attenuation settings correspond to those of the REC ATT switches, and the FINE vernier provides smooth control between steps and also permits channel levels to be balanced.

A PB HEAD switch connects the playback circuits to the output of either the half-track or quarter-track head. The headphone jack, driven by its own amplifier, has a separate level control. The recording inputs can be switched between LINE and MIC sources by a toggle switch, and a MIC ATT introduces either 15 or 30 dB of attenuation into the microphone inputs to prevent overload when recording high-level sounds. Dual low-impedance microphone inputs are provided, as are standard 1/4-inch jacks on the front panel for unbalanced microphones and Cannon-type connectors in the rear for balanced-line sources. The line inputs and outputs, in the rear, are through standard phono jacks.

The special meters of the Sony TC-880-2 are one of its most useful features, giving the user more information about program levels than any others we have seen. They are light-beam galvanometers in which the usual needle pointer is replaced by a narrow beam of light reflected from a mirror on the moving meter coil. Each channel has a horizontal scale about 4 inches long, calibrated from -40 to +15 dB. A narrow white light-beam "pointer" moves along the scale as the program level varies, changing color to red when it exceeds 0 dB. A switch to the left of the meters selects their three operating modes. The VU position gives the ballistic response of a true VU meter (which follows the general program level but normally indicates about 10 dB less than the maximum peak levels). In the PEAK position the meters are fast-acting peak indicators with a response rise time of 1 millisecond and a decay time of 1 second. For all practical purposes, this mode shows the true maximum instantaneous peak program level. Finally, in the PEAK HOLD position, the meters lock in the highest peak readings attained during any operating interval. This can be used to predetermine the maximum peak level of any program so that any necessary recording-level adjustments can be made with complete assurance that the final recording will not exceed the desired level at any time.

Above the electronic section of the TC-880-2 are the transport controls. A push-button power switch at the left is flanked by two toggle switches that adjust tape tension for either 7- or 10 1/2-inch reels and set the tape speed to either 7 1/2 or 15 ips. A small knob, when pulled out slightly, supplies a vernier SPEED TUNING capability (in playback only) over a range of several per cent. Wherever the knob is set, pushing it in returns the machine to its correct, factory-set speed.

A group of square pushbuttons operates the transport through a logic system and electromechanical solenoids. They can be used in any sequence without damage to the tape.

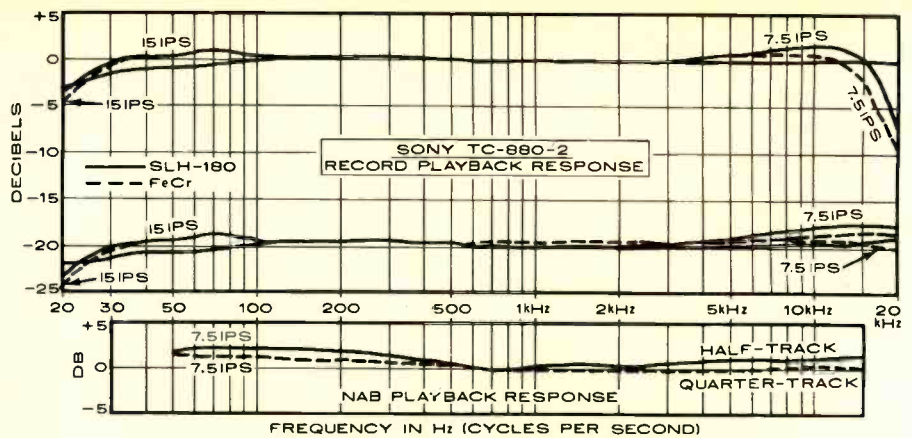

At 1,000 (left) and 5,000 Hz (right) the Sony TC-880-2 exhibits the remarkable ability to record and reproduce a square wave almost perfectly.

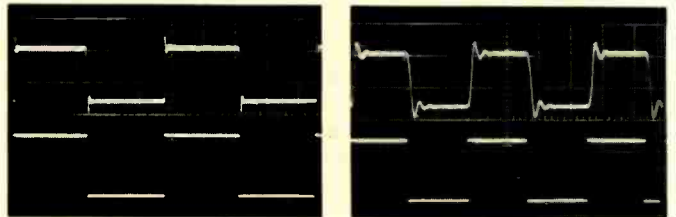

Each button lights when its function is selected. If either of the REC MODE switches is set to REC, the red circle on the recording-safety button flashes as a warning that the machine is ready to go into a recording mode. It is possible to make a "flying-start" recording, directly from the playback mode, by pressing the record and play buttons at the desired point. The PAUSE button is joined by a line on the control panel to the STOP button. This indicates that when the tape is stopped, pressing the PAUSE button releases the tape lifters so that the tape is in contact with the heads and the reels can be cued manually to any specific point on a recording.

Sony has designed the TC-880-2 to minimize the electrical phase shifts that make it impossible for most tape machines to record and play a reasonable facsimile of a square wave (and, by inference, other complex waveforms). According to Sony, the phase compensation in the recorder's playback amplifiers provides a more natural quality on live recordings, especially if they have been re-recorded several times in the Syncro-Trak mode, which can compound phase errors with each re-recording.

Another practical benefit of the phase compensator is that SQ or other matrixed quadraphonic programs can be recorded and played back (through a suitable decoder) without serious degradation of their directional properties. In addition to the electronic phase compensation within each channel, the gaps of the "Ferric and Ferrite" heads have been designed to minimize phase shift between the channels.

The Sony TC-880-2 is a rather large recorder, 18 1/2 inches wide, 20 1/4 inches high, and 10 1/2 inches deep. It weighs an impressive 80 pounds in its walnut-finish wooden case, which fortunately is fitted with sturdy carry-handles. Price: \$2,495.

● **Laboratory Measurements.** The 7 1/2-ips playback frequency response of the TC-880-2 was measured with the Ampex quarter-track test tape through the recorder's quarter-track

head. It was flat within  $\pm 0.5$  dB from 150 to 15,000 Hz, rising gently to +1.5 dB at 50 Hz. The response to an Ampex full-track test tape through the half-track head was quite similar. The headphone listening volume was more than adequate even when high-impedance phones were used.

For overall record-playback frequency-response measurements we used Sony PR-150 as the "normal" tape, Sony SLH-180 as the "special," and the new Sony Ferrichrome as the FeCr tape. We achieved the following rather impressive results (at a -20-dB recording level,  $\pm 2$ -dB tolerance): PR-150 tape at 7 1/2 ips, 20 to 20,700 Hz; at 15 ips, 20 to 36,500 Hz. With SLH-180 tape, response at 7 1/2 ips was 20 to 26,000 Hz; at 15 ips, 23 to 40,000 Hz. The FeCr tape at 7 1/2 ips gave 20 to 28,500 Hz; at 15 ips, 20 to 40,000 (!) Hz (our upper measurement limit is 40,000 Hz; the response may, in truth, have gone even higher). All our response measurements comfortably surpassed the manufacturer's ratings.

Remarkable as these frequency-response figures are, they are overshadowed by the recorder's freedom from tape or head saturation, which usually causes a loss in high-frequency response at high recording levels. Only at 7 1/2 ips was the 0-dB recording-level response curve significantly different from the -20-dB curve within the audible range. At 15 ips there was no detectable compression at 0 dB until we exceeded 25,000 to 30,000 Hz, regardless of the tape used. Although any good open-reel recorder, especially at 15 ips, is relatively free of high-frequency tape saturation, we hardly expected to find a bandwidth exceeding 40,000 Hz and essentially independent of recording level. To say we were impressed would be putting it mildly.

Recalling Sony's emphasis on linear phase response, we recorded and played back square waves at 1,000 and 5,000 Hz. The effectiveness of the phase compensation of this recorder can be judged from the accompanying scope photographs. With the MONITOR switch set to SOURCE, a small overshoot

(Continued on page 38)



# If our tape sounds bad on your hi-fi system you need a better hi-fi system.



Maxell tapes are the best way to see just how good or bad your hi-fi system is. Because Maxell tapes are made to stricter standards than many hi-fi systems.

To begin with, only the highest quality materials go into Maxell tapes. The finest polyester, screws, hubs and pressure pads.

Every batch of magnetic oxide we use gets run through an electron microscope. If every particle isn't perfect, the sound you hear won't be either.

Since even a little speck of dust can make a difference in what you

hear, no one gets into our plant until they've been washed, dressed in a special dust free uniform, even vacuumed.

The fact that we're such fanatics about making Maxell tapes pays off for you in the enjoyment of superior sound. And in the Maxell guarantee.

Which says if you ever have a problem with any Maxell tape, send it back and we'll send you a new one. No questions asked.

Naturally, a product this good doesn't come cheap. In fact, a single reel of our best tape costs more than

many inexpensive tape recorders.

So if you don't have a good hi-fi system, save yourself some money and buy cheaper tapes.



## Maxell. The tape that's too good for most equipment.

Maxell Corporation of America, 130 West Commercial Ave., Moonachie, N.J. 07074

CIRCLE NO. 37 ON READER SERVICE CARD



and a cycle or two of ringing, caused by the recording amplifier or the line-output amplifier, could be seen on the square wave. However, when we introduced the tape and heads into the signal path by switching to TAPE, the change in waveform was very small. The ringing on the 5,000-Hz square-wave output was at about 50,000 Hz, and the preservation of the rise and fall times of the waveform was consistent with an effective frequency response of about 50,000 Hz together with a linear phase-shift characteristic (constant time delay). At low audio frequencies the phase difference between the two channels was a few degrees, increasing to 30 degrees at 10,000 Hz, 50 degrees at 20,000 Hz, and 90 degrees at 33,000 Hz. This, too, is exceptional performance for a tape recorder.

An input of 38 millivolts (mV) at the LINE inputs, or 0.075 mV at the MIC inputs, was needed for a 0-dB recording level. The playback output was between 0.38 and 0.43 volt, depending on the tape. The microphone inputs overloaded at a very good 200-mV input. The overload point could be increased to 1 volt or 6.3 volts by using the MIC ATT switch.

The playback distortion from a 0-dB recording level at 1,000 Hz (7½ ips) was 0.56 per cent with the SLH-180, 2 per cent with PR-150, and 0.4 per cent with FeCr tape. The 3 per cent distortion level was reached at about +8 dB. The unweighted signal-to-noise ratios (S/N) referred to that level were, respectively, 60.2, 62, and 63.2 dB with PR-150, SLH-180, and FeCr tapes. With IEC "A" weighting these figures were improved to 65.5, 68, and 70.3 dB. Through the MIC inputs the noise at maximum gain increased by 13.5 dB.

At 15 ips, the respective playback distortions were 1, 0.6, and 0.32 per cent at 0 dB. The 3 per cent distortion levels were +5, +6, and +7 with PR-150, SLH-180, and FeCr. The S/N at 15 ips measured 53, 56.5, and 59 dB unweighted for the three tapes, and 61, 65.5, and 67 dB with "A" weighting.

The wow and flutter (unweighted rms) in a combined record-playback measurement were the lowest we have ever seen from a tape recorder, and may well represent the limitations of our test equipment. The wow reading of 0.015 per cent was absolutely unwavering (an unusual event in itself), and we would consider the flutter of this machine to be essentially zero. The reading was identical for



both tape speeds. The speeds themselves were as accurate as could be measured within the  $\pm 1$ -count ambiguity of our frequency counter. The playback-speed vernier had a range of about  $\pm 5$  per cent at 7½ ips and  $\pm 10$  per cent at 15 ips. In the fast speeds a 1,800-foot reel of tape was moved from end to end in 2 minutes.

In its PEAK mode, the movement of the meter light bar appeared to be virtually instantaneous, with no overshoot and with a slow decay that let it follow the crest of the program. In PEAK HOLD the maximum reading was retained for many minutes (switching to one of the other modes restored normal operation). When we drove the recorder with 0-dB tone bursts at a rate of once per second, a 100-millisecond burst gave a meter reading of -7 dB in the VU mode and +0.5 dB in PEAK (relative to the steady-state reading). Shortening the burst to 10 milliseconds gave a -21-dB VU reading, while the PEAK indicator read -1 dB.

● **Comment.** The performance and features of the Sony TC-880-2 set it apart from almost every other high-quality home recorder we have seen. For example, it is definitely *not* (and does not pretend to be) a "professional" recorder, though it is certainly capable of professional-level performance and more. The linear phase response and wide frequency range of the TC-880-2 make it suitable for recording and playing back quadrasonic

material in matrixed form. We confirmed this by taping SQ records with strong directional effects and playing back through a full-logic decoder. The directionality was affected only slightly by the record-playback process. Although Sony makes no claims in this regard, we also tried copying a CD-4 record and playing the tape back through a demodulator, but the phase-shift and time-delay characteristics of the recorder were not compatible with the exacting requirements of the CD-4 technique. We did obtain a good stereo playback, and the demodulator's CD-4 light turned on, but there was no front-to-back separation.

With the TC-880-2, the operator knows exactly where he stands with respect to program levels and the recorder's dynamic range. The meters, which must be used to be appreciated, are even better than the LED lights used on some machines—they are nearly as fast, and they give accurate quantitative information. It is a comforting thought to realize that no signal reading less than about +8 or +9 dB will be distorted or have its frequency content (or waveshape) altered even if it extends into the ultrasonic range. Of course, unless you use the finest microphones, this will not be a matter of concern.

Mechanically, this machine is a gem. Its precision and operating "feel" are consistent with the finest home electronic equipment (as we have mentioned in recent reviews, some de luxe audio components are currently setting new standards of excellence for their light, positive control action).

Finally, congratulations to Sony for something which the TC-880-2 does *not* do. It is, without doubt, mechanically the quietest tape deck we have used. Sony's measurements indicate an acoustic noise level of 30 dB in its vicinity, but this would be measurable only in an anechoic chamber. Suffice it to say that the TC-880-2 cannot be heard in operation except by pressing one's ear against the rear of the cabinet to detect the faint hum of the slow-turning direct-drive capstan motor. At 7½ ips we generally could not hear even that minuscule sound! With the tape stopped, only the softly lit meters give a clue that the machine is on. Of course, the solenoids operate with an audible "clunk," but that is to be expected. For many, \$2,500 probably seems like a lot of money for a tape recorder. On the other hand, the Sony TC-880-2 looks to us like a lot of recorder for the money.

Circle 105 on reader service card

The dual-capstan drive system of the Sony 880-2 is arranged symmetrically around the head assembly. The unusual speed-tuning control is located just below the left-hand pinch roller. The index counter just below the right pinch roller gives actual running times in minutes and seconds.



(Continued on page 42)



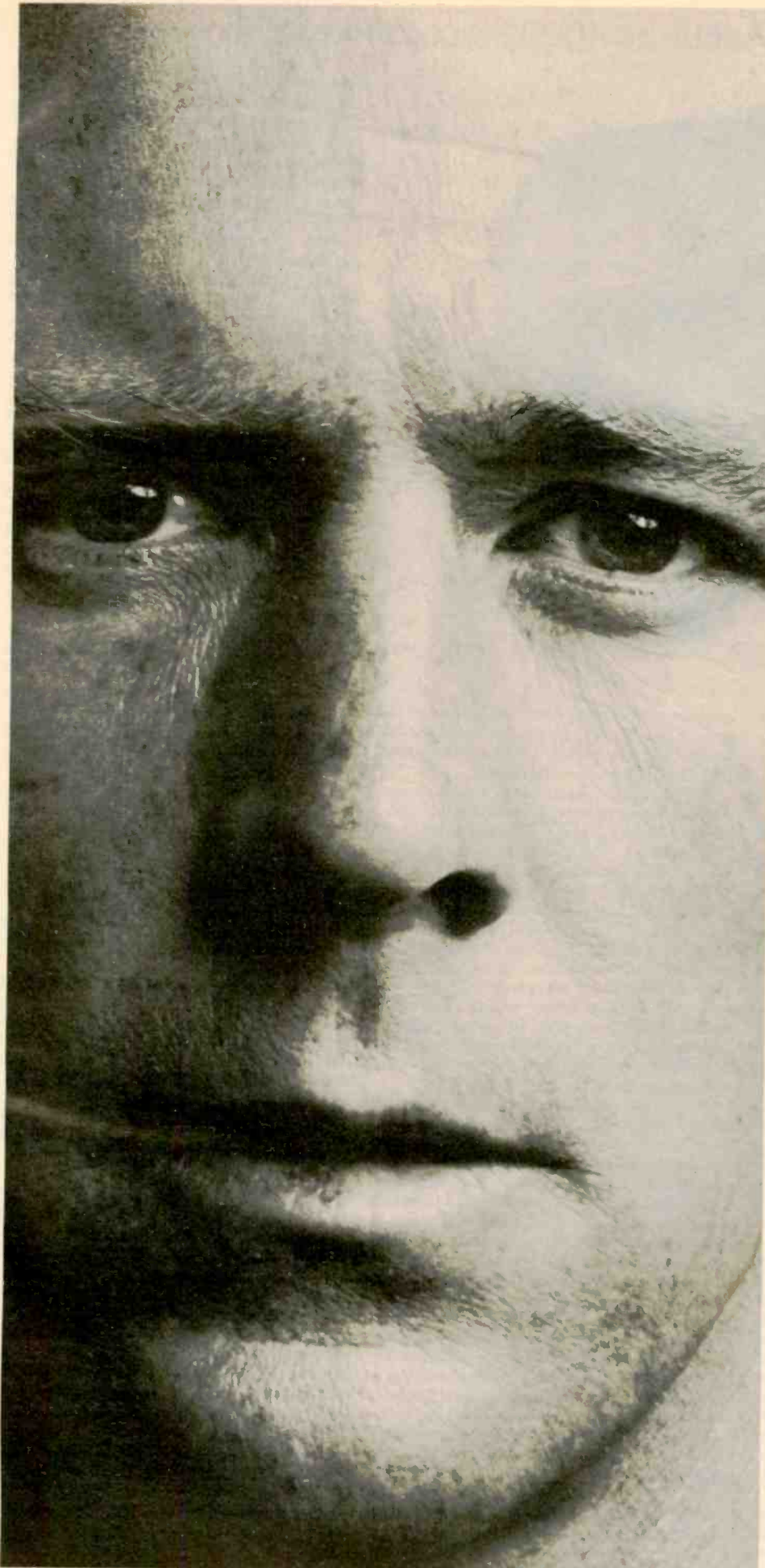

# The Great American Male

Understanding lover and patient father. Tough businessman, dedicated friend and O.K. boss . . .

Today a man must lead many lives even as he tries to shape his own. But the fact is, measuring up can mean losing a lot of yourself along the way.

Can you survive the hazards of being a man long enough to become yourself?

It's a question that more and more men — and women — are confronting today. In family life and the business world. In growing and in changing.

For nearly 5 million people, *Psychology Today* is one valuable and vital place to look. Because *Psychology Today* goes to the real source — human behavior — to search for answers, to question the paradox of being a *whole human being* in this volatile existence called modern society.

Why, for example, do some men instantly communicate in a relationship while others flounder from one encounter to another? Why has psychotherapy become a working part of American business and divorce suddenly as common as marriage? And how can some people climb to the very top of their field and others make a habit of defeat?

*Psychology Today* digs to discover . . . and then puts together today's most unusual mix of insight and ideas. It's an enlightening, provocative journey. Into the sexuality of children, into the gripping fear of "old age", into the locker room and through the corporate structure — not to find formulas of manhood or womankind, but to discover the nature of human experience.

Right now, you can explore *Psychology Today* for a full year — at the lowest price offered anywhere. Only \$7 (regular rate is \$12.) A \$5 savings! (And you have to be totally satisfied or your money back.) It's our way of reaching you — someone who is not alone in looking for answers.

**psychology today**

## ADC Accutrac 4000 Record Player



● AMONG the myriad "new" high-fidelity products announced each year, only a very few are *really* new in the sense that nothing like them has been available previously. The ADC Accutrac 4000 programmable record player is a new product in every sense. We will undoubtedly see other turntables with similar features eventually, but for the present the Accutrac 4000 is truly unique.

Its novelty does not lie in its basic record-playing functions, since the Accutrac 4000 is a combination of a good direct-drive, two-speed (33 $\frac{1}{3}$  and 45 rpm) turntable, a well-made conventional pivoted tone arm, and a cartridge essentially the same as the well known ADC XLM MkII. It is an excellent integrated record player, but not significantly different in its listening quality from any of a dozen other top-ranking record players.

However, the engineers at BSR (the parent company of ADC) have wedded the record player to a microprocessor system, essentially a compact special-purpose computer based on LSI (large-scale integration) integrated circuits, and this little computer can be programmed to "remember" a large number of instructions and to execute them upon command at a later time.

BSR's goal was to make a record player that could seek out and play any pre-selected track on a record containing more than one "band" of recorded material. This category includes not only virtually every popular recording, but a number of classical discs as well. Surveying the available records, they determined that none contained more than thirteen bands, and this is reflected in the row of calculator-like buttons numbered from 1 to 13 on its control panel (another button, marked ALL, is used to play a record in the normal manner, from beginning to end).

Operationally, the Accutrac 4000 is programmed by pressing, in the desired sequence, any or all of the track-selection buttons. A total of twenty-four commands can be

programmed, so that some tracks can be repeated, or if ALL is pressed twenty-four times, the entire record will play twenty-four times before the unit shuts down!

Accepting, for the moment, that the computer circuits can be programmed in this manner, how does the player distinguish one band from another? BSR's solution to the problem was beautifully simple and direct. Within the special cartridge body is an infrared light source that shines down on the record surface. On the opposite side of the cartridge is a tiny photocell that also scans the record. The grooved areas of a disc scatter the light, reflecting little to the photocell. The ungrooved areas between bands, however, reflect the infra-red beam to the cell, sending an electrical signal to the computer and informing it when the pickup is moving from one band to the next.

In operation, the arm is moved above the record surface by a servomotor, and the scanning system sends impulses to the computer that are compared with the instructions stored in its memory. For example, if track three has been selected, the computer sends a signal to the servomotor to stop the arm scan when it has counted three return signals. The arm pauses over the record for a couple of seconds, sensing any record eccentricity so that it can "zero in" on the center of the ungrooved section, and then lowers gently to the surface to play the selected track. After the track has been played, the next ungrooved band sends a signal to lift the arm and return it to its rest position outside the turntable diameter, from where it begins the next scan in accordance with its programmed instructions. After all the selected tracks have been played, the arm remains at rest and the motor shuts off.

All the controls of the ADC Accutrac 4000 are located on a sloping panel extending in front of the turntable proper, where they are accessible when the plastic cover is lowered.

Four small knobs turn on the power, adjust the speed separately for the two operating speeds (the stroboscope marks on the side of the platter are lit by a neon lamp through a prism), and adjust the sensitivity of the sensor system. The latter control is needed to compensate for unusually narrow ungrooved bands, or for extremely heavily modulated sections of a record that may reflect light to the photocell.

Two pairs of buttons select the operating speed and the indexing diameter (for 7- and 12-inch records). When power is first applied, the programmer is set for playing 33 $\frac{1}{3}$  rpm, 12-inch records, but this can be changed by pressing the appropriate buttons. When any one of the track-selector buttons is pressed, the motor turns on, but further operation is initiated by one of the five control buttons.

Normally, PLAY is pressed next, initiating the programmed operating cycle. Pressing REPEAT causes the track being played at that time to be replayed at its conclusion, after which the Accutrac continues with its original program. A REJECT button instantly stops play on the track in progress and the machine moves on to the next instruction in the program. If REPEAT and REJECT are pressed in sequence, the machine stops playing and returns to the beginning of the same band. The CLEAR button cancels all instructions and shuts off the player, CUE lifts the tone arm, and a second touch lowers it to the same spot.

In addition, the ADC Accutrac 4000 can be fully controlled from a remote listening position, using a wireless ultrasonic transmitter resembling a pocket calculator (its nineteen buttons duplicate those on the panel of the Accutrac 4000). A small spherical "receiver" connected to the Accutrac 4000 by a 12-foot cable can be placed anywhere in the room. When the transmitter is aimed at the receiver and one of its buttons is pressed, a red light on the receiver flashes to acknowledge that the command has been received and entered into the control computer.

The ADC LMA-1 cartridge (an XLM Mk II with the optical sensing components built into its body) tracks at forces between  $\frac{3}{4}$  and 1 $\frac{1}{2}$  grams, with 1 gram being the recommended value. The stylus is a 0.3 x 0.7-mil elliptical diamond, and it is replaceable by the user. The overall dimensions of the ADC Accutrac 4000, with the cover down, are 18 $\frac{1}{2}$  inches wide, 17 $\frac{3}{8}$  inches deep, and 6 inches high. It weighs 20 pounds, 4 ounces. Price: \$499.95.

● **Laboratory Measurements.** The turntable of the Accutrac 4000 had the superior performance we have come to expect from top-quality direct-drive units. Its unweighted rumble of -42 dB (-44 dB with vertical components canceled) was one of the lowest we have ever measured, and with ARLL weighting it was an excellent -62 dB. Wow and flutter were each 0.04 per cent. The speeds, which were not affected by extreme line voltage changes, could be varied over a range of approximately +2.6 to -2 per cent.

When the tracking-force dial on the arm was set to 1 gram, the actual force was 1.05 grams. The anti-skating dial had to be set to between 3 and 4 grams to give optimum correction at the 1-gram force. The tracking error of the arm was 1 degree per inch at a 2.5-inch radius, but was less than 0.5 degree per inch

(Continued on page 44)



# Sleeper!

The Realistic® STA-90 Will Change Your Ideas About Who's #1 in Hi-Fi Features, Value and Style!

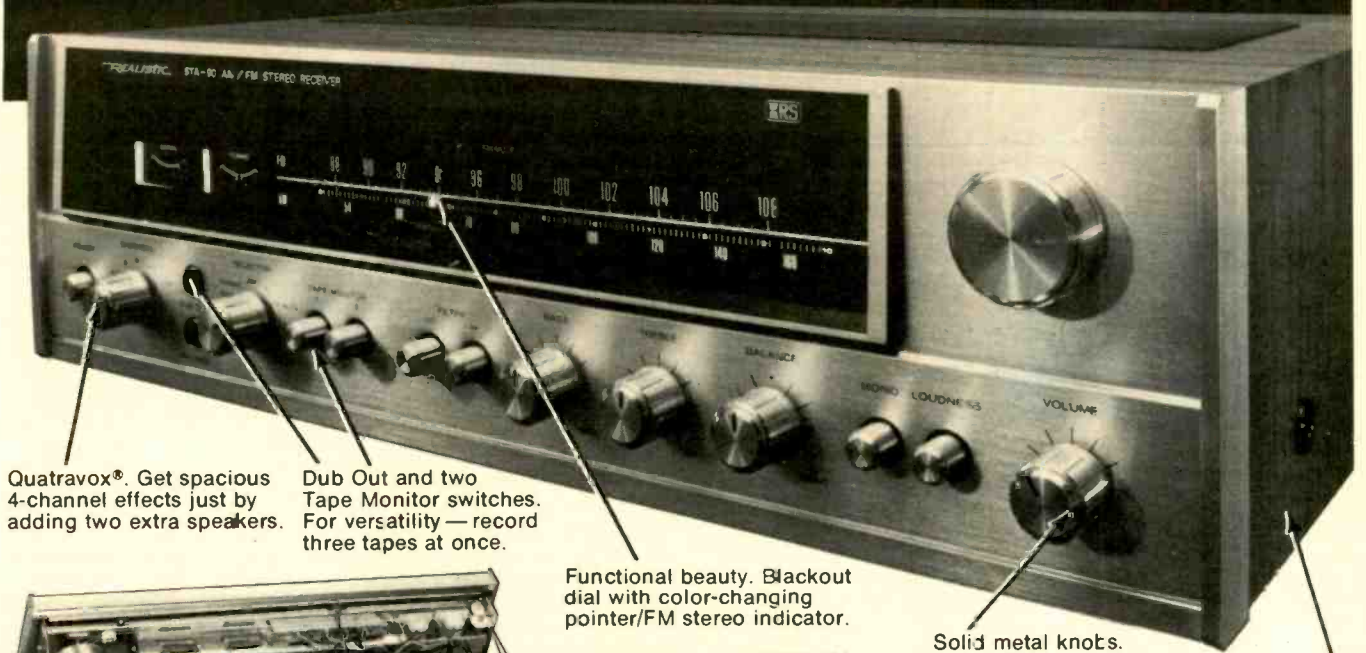

Quatravox®. Get spacious 4-channel effects just by adding two extra speakers.

Dub Out and two Tape Monitor switches. For versatility — record three tapes at once.

Functional beauty. Blackout dial with color-changing pointer/FM stereo indicator.

Solid metal knobs.

Walnut veneer case.

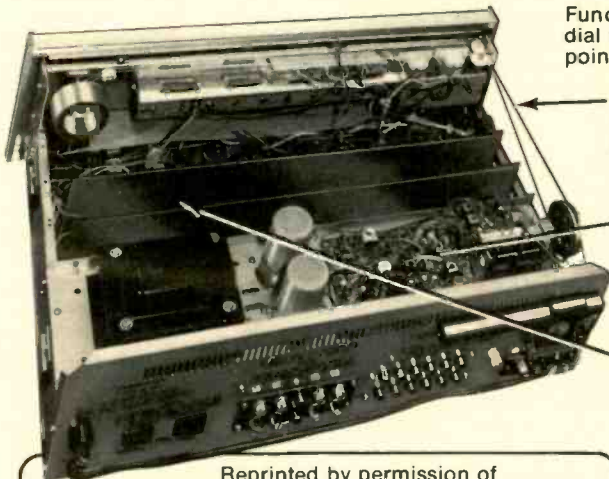

Dual-Gate MOSFET FM. Gets weak stations and still resists overload. Superior to FET designs.

Phase-locked loop FM stereo demodulator. For wider channel separation, almost zero distortion.

Direct-coupled amplifiers for powerful bass even at 20 Hz. 45 watts per channel, minimum RMS at 8 ohms from 20-20,000 Hz, with no more than 0.5% total harmonic distortion.

Amplifier Specs	
Power Bandwidth:	17-35,000 Hz
Response:	20-20,000 Hz ± 2 dB
IM Distortion:	0.3% at 30W
Phono Overload:	150 mV
Hum and Noise (dB):	
Phono 1,	-60
Aux 1,	-75
FM Tuner Specs	
Sensitivity:	2.0 μV IHF
S/N Ratio:	65 dB
Separation:	35 dB at 1 kHz
Total Harmonic Dist.:	0.8%
Capture Ratio:	2 dB
Selectivity:	70 dB

Reprinted by permission of Stereo Review Magazine, March, 1976 issue.  
**"The total harmonic distortion (THD) was less than 0.025 per cent from under 1 watt to 50 watts output, reaching 0.46 per cent at 55 watts."**



SOLD ONLY WHERE YOU SEE THIS SIGN:

# Radio Shack®

A TANDY CORPORATION COMPANY  
 OVER 5000 LOCATIONS • 50 STATES • 9 COUNTRIES

Only 359.95 at participating stores and dealers. Prices may vary at individual stores. U.L. listed. Ask for 31-2063. See what a Sleeper Looks like — today!

CIRCLE NO. 48 ON READER SERVICE CARD



over the rest of the record-playing surface.

The output of the cartridge was 3.8 millivolts at a velocity of 3.54 cm per second. With the CBS STR100 record, frequency response was flat within  $\pm 0.5$  dB up to 8,000 Hz, rising smoothly at higher frequencies to +6 dB at 20,000 Hz. Channel separation was excellent, about 30 dB through the mid-range and still 10 to 15 dB at 20,000 Hz. The low-frequency resonance of the arm and cartridge was at 8 Hz with an amplitude of 10 dB. The vertical stylus angle was 28 degrees, somewhat higher than the industry standard of 20 degrees, but not a serious discrepancy given the variability in the recording process.

The high-frequency tracking distortion of the cartridge, tested with the very high velocities of the Shure TTR-103 tone-burst record, was slightly higher than we have measured on some other top-ranking cartridges. However, it was negligible up to a 20-cm-per-second velocity, which will rarely be exceeded

everything on the Shure "Audio Obstacle Course Era III" record).

What about its unique automatic features? They work exactly as stated, practically to perfection, with a smoothness and positive quality that borders on the eerie. The instruction manual alerts the user to the few possible areas of difficulty, which we confirmed in our tests, but the suggested cures also proved to be 100 per cent effective. For example, anything that interferes with the reflection of the infra-red light source to the photocell can upset the track-location process. Transparent or translucent records cannot be used successfully (though they can be played conventionally by pressing the ALL button). We found one or two bizarrely over-recorded selections that the sensor insisted on interpreting as ungrooved portions of the record, and some records whose variable thickness in the lead-in-groove portion caused the system to overlook the ungrooved beginning of the record, result-

at any time (against a slight drag from the arm-drive clutch when the pickup is in its raised position).

The remote-control feature proved to be much more practical than we had expected. The ability to halt play and resume it from across the room, and to perform all other record-playing functions (except putting the disc on the platter and removing it) by remote control has advantages we came to appreciate after acquiring some familiarity with the unit. At dinner it was a genuine delight.

The big question to the audio consumer is: do the special non-audible features of the Accutrac 4000 justify a \$500 investment, or is this just another "gimmick"? In our view, the Accutrac automation is *not* gimmicky or frivolous. Even if you play only classical records from the beginning to the end of each side, the Accutrac 4000 will treat them more gently than the most skilled human operator, and with none of the limitations, real or imagined,

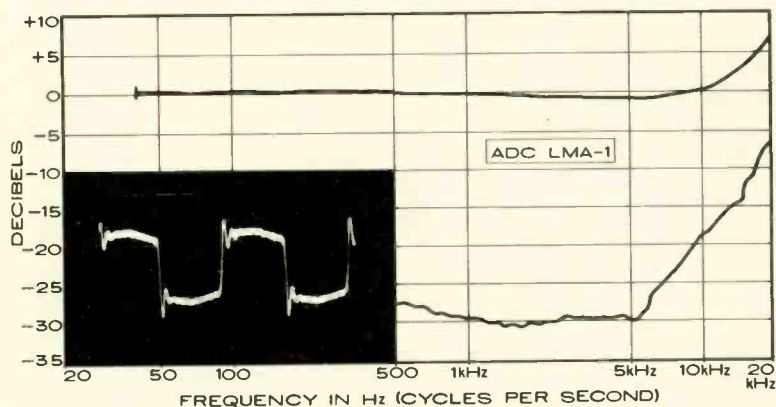

In the graph at left, the upper curve represents the smoothed, averaged frequency response of the cartridge's right and left channels: the distance (calibrated in decibels) between it and the lower curve represents the separation between the two channels. The inset oscilloscope photo shows the cartridge's response to a recorded 1,000-Hz square wave, which gives an indication of resonances and overall frequency response. At right is the cartridge's response to the intermodulation-distortion (IM) and 10.8-kHz tone-burst test bands of the TTR-102

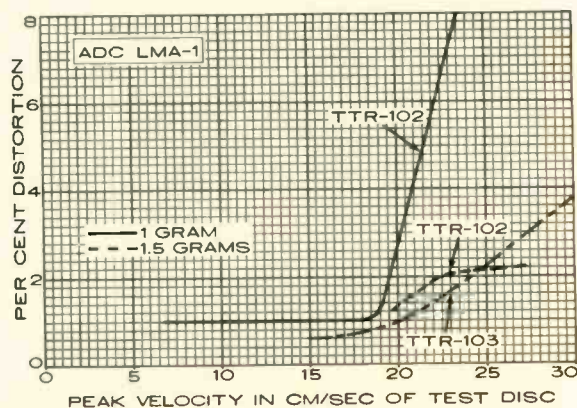

and TTR-103 test records. These high velocities provide a severe test of a phono cartridge's performance. The intermodulation-distortion (IM) readings for any given cartridge can vary widely, depending on the particular IM test record used. The actual distortion figure measured is not as important as the maximum velocity the cartridge is able to track before a sudden and radical increase in distortion takes place. There are very few commercial phonograph discs that embody musical audio signals with recorded velocities any higher than about 15 cm/sec.

ed while playing normal discs. The more conventional TTR-102 IM test record revealed very low distortion levels of about 1 per cent up to 18 cm per second, increasing rapidly to 15 per cent at 27 cm per second. This tracking ability should be adequate for the vast majority of records; for the most difficult recordings, increasing the tracking force to 1.5 grams reduces the distortion to a very low 2 per cent even at the maximum velocity of 27 cm per second.

The searching cycle which the arm goes through each time it looks for the next track requires about 7 seconds, most of which is spent waiting over the ungrooved portion before beginning its descent. The actual cueing descent requires about 2 or 3 seconds, and it is totally free of lateral drift. The cartridge outputs are muted at all times when the stylus is not on the record surface.

● **Comment.** As a record player—turntable, arm, and cartridge—the ADC Accutrac 4000 is obviously one of the best, and its performance needs little comment. Although it sounds very good at 1 gram, some people might find 1.5 grams preferable (at that force it tracks

ing in a one-band error in the playback sequence. These limitations, as we have stated, are clearly presented in the instruction manual. Otherwise, the system seemed to be infallible, able to sense "dead" bands so narrow that we could hardly see them with the unaided eye. Under low-humidity conditions, the plastic cover, as ADC warns, can easily acquire a static charge, and it is so close to the tone arm in playing position that it can literally lift the arm from the record. A wipe with a damp cloth removes the charge from the cover, and refraining from rubbing or brushing its surface reduces the possibility of its acquiring a new charge.

The entire record-player portion of the Accutrac 4000 is mounted on a separate heavy wooden board isolated from the base by springs. This does reduce the sensitivity to acoustic feedback somewhat as compared with more conventionally sprung units, but it does not totally eliminate it. Since the tone arm is never handled in normal operation, the rather springy nature of the mount causes no operational difficulties. Incidentally, the arm has a conventional finger lift, and it can be moved manually to any portion of the record

of a record changer. And, as we have stated, remote control is a definite convenience.

We prefer to look at the economics of the matter in this way. An equivalent record player with a superb direct-drive turntable, a very good arm, and one of the most respected phono cartridges would certainly sell for about \$400 on a list-price basis (of course, if your heart is set on any other cartridge, the Accutrac 4000 is probably not for you). For an extra \$100, one obtains the remarkable programmability of the Accutrac 4000 (and "remarkable" will seem like a strong understatement to anyone who has used it or seen it in action), plus full remote-control capability. That, we think, is a bargain by any standards. If \$500 is still too much for your budget, we understand that ADC will shortly announce lower-price Accutrac players using belt-drive turntables and without the remote-control feature. No matter what you may think of the concept, it is clear that computer technology has entered the high-fidelity field, and things may never be the same again.

Circle 106 on reader service card

(Continued on page 46)

STEREO REVIEW





## KLH Research Ten Column Bookshelf Loudspeakers: For people who care more about music than money.

You are looking at three pairs of truly unusual loudspeakers. From left to right, they are the CB-10, CB-8, and the CB-6. What makes them so unusual is that each pair is capable of reproducing an amount and quality of sound that has heretofore been impossible to achieve from such modest sized devices. They are efficient and can be driven effectively by any reasonable power source (the CB-6 and CB-8 need as little as 8 watts per channel; the CB-10 will do quite nicely with as little as 10 watts per side). Yet all three pairs have the ability to handle as much as 100 watts RMS per channel! Their performance is perhaps best characterized as uncommonly open and airy,

with notably good bass response. Indeed, the CB-8 and CB-10 use our famous Megaflex Woofer™; the CB-6 has a "special six"—a new woofer that is easily among the best used in today's smaller loudspeakers. The CB-6, the smallest of the series, delivers about a third of an octave less bottom than the CB-8; the CB-8 about a third of an octave less than the CB-10. But all three models share exceptional smoothness and perfect musical balance. They also share something else. They are incredibly *inexpensive*.

Which can be a problem. Unfortunately there's a sizeable number of people who believe that if a speaker

doesn't cost a lot of money, it can't deliver a lot of sound. But if you trust your ears more than your checkbook, we suggest you listen to our CB loudspeakers soon. We think you'll love them *and* their sensible prices a lot.

For more technical information, visit your KLH Research Ten dealer. Or write to KLH Research & Development Corp., 30 Cross St., Cambridge, Mass. 02139. (Distributed in Canada by The Pringle Group, 30 Scarsdale Road, Don Mills, Ontario, Canada.)



KLH Research Ten Division  
KLH Research & Development Corp.  
30 Cross St., Cambridge, Mass. 02139

# Tannoy Cheviot Speaker System

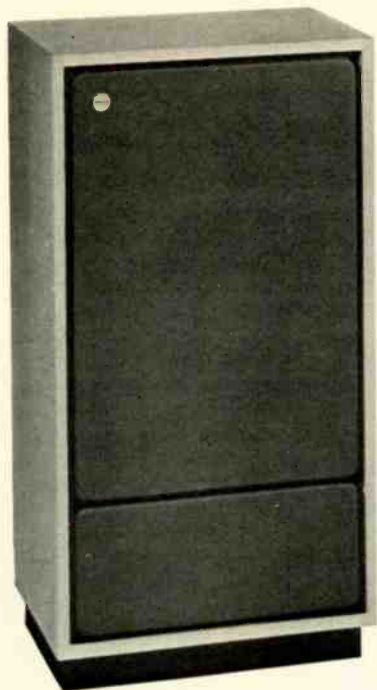

● TANNÖY (a British firm now a part of Harman International) has been manufacturing coaxial high-fidelity speakers for more than a quarter of a century, spanning virtually the entire history of the high-fidelity component industry. Although the Tannoy drivers have been modified and improved over the years, their general physical form is unchanged, and it remains unique to Tannoy. The tweeter assembly is a part of the woofer magnet structure, the high-frequency horn flaring out as it passes through the woofer pole-piece and voice-coil system and opening to the room through the acoustically transparent woofer dust cap.

Tannoy makes three basic coaxial systems using bass drivers with nominal cone diameters of 10, 12, and 15 inches. They are now available installed in handsomely finished and styled wooden cabinets, both "bookshelf" and floor mounting. The Cheviot, the smallest Tannoy free-standing system, is based on their HPD315A (12-inch) driver system. The cabinet is 33 inches high x 17½ inches wide x 10¼ inches deep, and the system weighs about 55 pounds. It is available in walnut or ash finishes with a choice of blue or brown grille.

The crossover between woofer and tweeter takes place at 1,000 Hz with 12-dB-per-octave slopes. The crossover network is physically separate from the driver. Behind the separately removable lower grille section are two high-frequency balance controls with distinctly different characteristics. The ENERGY con-

trol has a shelved response and adjusts the output of the tweeter uniformly for all frequencies above 1,000 Hz. It is a five-position switch, with the center setting marked LEVEL. The ROLL-OFF control attenuates the output progressively at frequencies above 5,000 Hz. In addition to a LEVEL position, it has three steps of attenuation.

The Tannoy Cheviot is rated to handle up to 60 watts of program and has a nominal 8-ohm impedance. The woofer has a rated free-air resonance of 20 Hz and operates in a ducted-port enclosure. The rated frequency response of the system is 40 to 20,000 Hz  $\pm$  4 dB. Price: \$345.

● **Laboratory Measurements.** The frequency response of the Tannoy Cheviot was measured with both controls set to their LEVEL positions. The response, as measured in the listening area some 12 to 15 feet from the speaker, was very smooth and flat over most of the audio range, varying only  $\pm$  2.5 dB from 120 to 16,500 Hz. There was a "bump" of about 4 dB centered at 90 Hz and a smooth roll-off to -5 dB at 40 Hz. Separate close-miked measurements at the woofer cone and the port opening showed that the contribution of the port was dominant below about 40 Hz. The ENERGY and ROLL-OFF controls had the claimed effects, with the former varying the output above 1,000 Hz by +2 to -3 dB about its LEVEL setting and the latter giving three levels of attenuation, in steps of 2 to 3 dB, at frequencies above 5,000 Hz.

The bass distortion was measured at a distance of 1 meter from the woofer cone at a constant sound-pressure level (SPL) of 90 dB. This procedure, heretofore not practicable because low distortion levels were masked by ambient noise, was made possible by the use of our newly acquired Hewlett-Packard 3580A spectrum analyzer. The predominantly second-harmonic distortion was very low, under 0.8 per cent from 100 Hz down to about 55 Hz, increasing rapidly to 1.8 per cent at 50 Hz and 6.5 per cent at 40 Hz.

The system impedance rating of 8 ohms is technically correct, since the minimum impedance above the bass resonance (which reached more than 40 ohms at 58 Hz) was about 8 ohms in the vicinity of 100 Hz. However, the impedance over most of the audio range was between 10 and 30 ohms. Our efficiency measurements, with the speaker driven at 1 watt into a nominal 8-ohm load and using an octave of random noise centered at 1,000 Hz, showed the Cheviot to be somewhat more efficient than most speakers, developing a 91.5-dB SPL at a distance of 1 meter from the grille. Since the actual impedance at that frequency was about 16 ohms, the speaker was probably receiving only about 0.5 watt, and it is therefore about 3 dB more efficient than the measurement shows. The

*(Continued on page 48)*

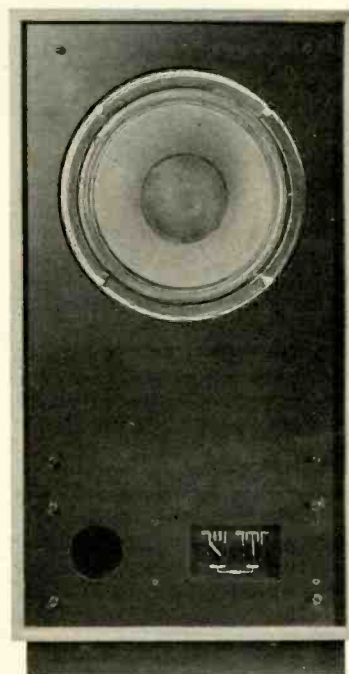

*The tweeter of the Tannoy Cheviot is invisible, being hidden by the acoustically transparent dust cap in the center of the woofer cone.*

*The tone-burst response of the Tannoy Cheviot at (left to right) 100, 1,000, and 6,000 Hz. The upper traces are the input signals.*

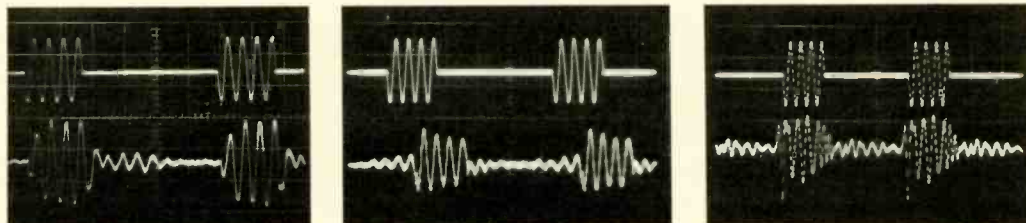



# Odd Couple.

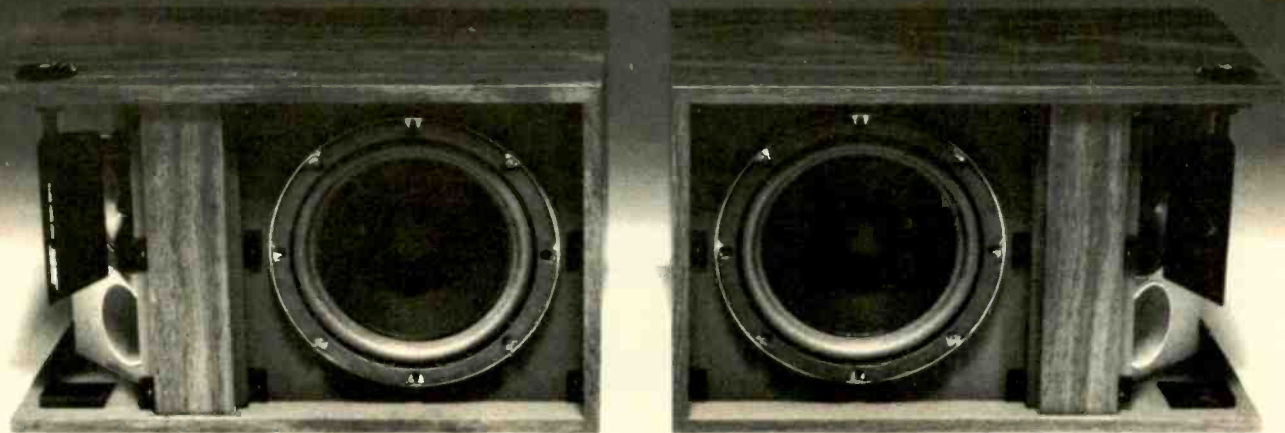

This is a pair of Bose Model 301 Direct/Reflecting® bookshelf speakers with their grilles removed.

What's odd about them might not be immediately obvious, but it's very significant. Unlike most pairs of speakers, they're not identical. Instead, the left-hand speaker is a mirror image of the right-hand speaker.

Bose goes to the extra trouble and expense of making the two speakers of the pair you buy different to provide the proper proportion of reflected and direct sound at high frequencies, a feature unique among bookshelf speakers.

To accomplish this, each speaker is of an "asymmetrical"

design. As a result, a pair of Model 301s has woofers pointing straight ahead and tweeters angled outward. A large proportion of the high frequency energy is reflected off the side walls and then into the center of the listening room, rather than being aimed directly at the listener. As in a live performance, the listener is surrounded with a balance of reflected and direct sound. This is the same principle used in the Bose 501 and in the legendary Bose 901® Direct/Reflecting speaker system. The result is extraordinarily open, natural, and spacious sound.

In addition, the Model 301 Dual Frequency Crossover™ network causes the woofer and tweeter to operate simultaneously for more than an octave, providing exceptionally smooth midrange response and an open spatial quality.

With the unique Direct Energy Control, the Model 301 provides excellent performance in a wide variety of rooms, including small apartments and dormitory rooms. And it is truly small enough to fit in a bookshelf.

These features make the Model 301 an unusual speaker with unusually fine performance. Its suggested retail price—less than \$100 per speaker—makes it an extraordinary value.

You already know the Model 301 looks different from other bookshelf speakers. Now visit a Bose dealer and hear how different it sounds.

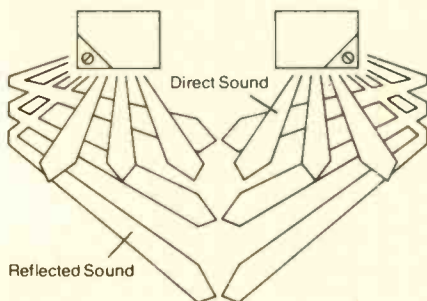
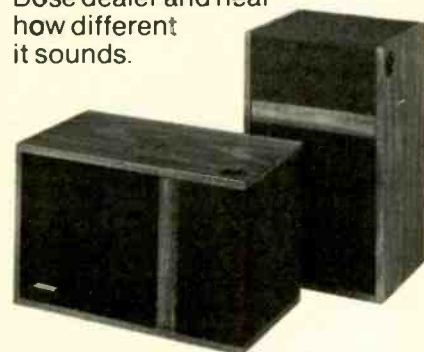

## **BOSE**®

The Mountain  
Framingham, Mass. 01701

Patents issued and pending.

For a full-color brochure on the Model 301, write: Bose, Dept. SR 9, The Mountain, Framingham, Mass. 01701.

tone-burst output of the speaker showed some evidence of ringing at many frequencies, but certainly not to an audible or objectionable degree.

● **Comment.** In our simulated "live-vs.-recorded" test, the best results were obtained with slightly reduced settings of the ENERGY and ROLL-OFF controls, which were varied according to the program material. The upper middles and highs were reproduced very ac-

curately, but we could hear a lower-mid-range coloration, or warmth, that prevented the Cheviot from successfully imitating the "live" sound.

In general listening, we preferred to keep the controls at their LEVEL settings, for this helped to balance the warmth which we attribute to the increased output in the 90-Hz region. Since the response of any speaker in this frequency range is strongly influenced by room dimensions and speaker placement, the

Cheviot might sound quite different in another environment.

Overall, we would describe the sound of the Tannoy Cheviot as completely smooth and musical, with some tendency toward bottom-end warmth. It is not what one would call an "accurate" reproducer in the clinical sense, but it is as easy to listen to as it is to look at—a remark that is meant entirely as a compliment!

Circle 107 on reader service card

## Tandberg TR-2075 AM/Stereo FM Receiver



● THE new Tandberg TR-2075 is a full-featured, medium-to-high-power receiver with a number of innovative operating and circuit-design features. It is rated to deliver 75 watts per channel to 8-ohm loads from 20 to 20,000 Hz with no more than 0.15 per cent total harmonic or intermodulation distortion. In its external styling, the TR-2075 bears a family resemblance to the lower-power Tandberg receivers, but there are also some significant differences.

The Scandinavian influence is apparent in the front-panel layout and styling. A full-width, satin-finish aluminum band just below the center of the panel carries all the normal operating controls. A deep blue "blackout" dial window spans the front just above the

control section, with an aluminum accent strip at the very top. At the right of the dial area are the tuning knob and a cluster of four small pushbuttons. These switch the FM tuner from stereo to mono (it also switches automatically when the signal strength drops below a preset threshold level), activate the FM interstation-noise muting circuit, change the FM de-emphasis from 75 to 25 microseconds (for FM decoding with an external Dolby unit), and dim the panel lighting.

When power is applied by pressing the large square ON-OFF button, the AM and FM dial scales and two large meters are illuminated in blue (the center-channel FM tuning meter lights only when FM is selected). The tip of the dial pointer is lit in red, as is the FM

STEREO indication above the FM scale when a stereo broadcast is received.

To the right of the power pushbutton are six similar control pushbuttons which select FM, AM, PHONO 1, PHONO 2, TAPE 1 MON, and TAPE 2 MON. There is no high-level AUX input as such, but one of the tape-recorder inputs can be used for this purpose. Continuing across the panel, we come to the VOLUME, BALANCE, BASS, MIDRANGE, and TREBLE tone controls, and the SPEAKERS selector. The tone controls have concentric sections for independent adjustment of the left and right channels. The SPEAKERS switch connects any one of three pairs of speakers or two combinations of two pairs as well as silencing all speakers for headphone listening.

On a black strip across the bottom of the panel are a number of small pushbutton controls as well as two headphone jacks and an output jack for a third tape deck. One button converts the tuner signal-strength meter to an output meter (calibrated from 0 to 25 volts) which responds to the peak level in the channel carrying the stronger signal at any moment. This provides a rough indication of the audio-power output (a table in the very complete instruction manual relates the meter reading to power delivered to speaker loads)

(Continued on page 50)

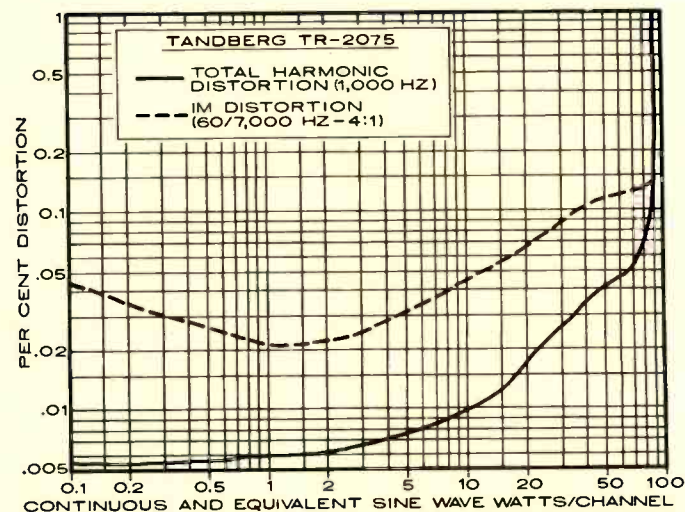
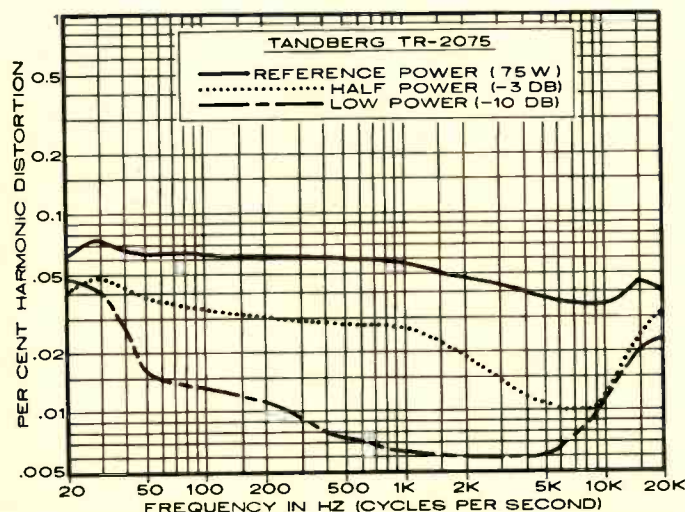



# New from Motorola... the hot cassettes with the hot button



Model TC876AX.  
In dash AM/FM Stereo Radio with Stereo Cassette and push button tuning. Optional overlays available to fit most domestic cars.



**POW-R-BOOST® makes dynamite sound a blast and a half!**

Model TC877AX.  
In dash AM/FM Stereo Radio with Stereo Cassette. Designed to fit compacts, imported and domestic.

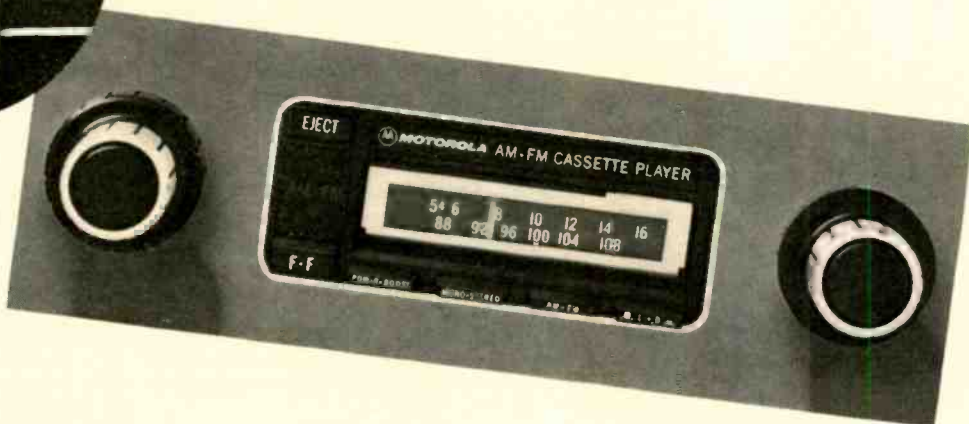

If you want the stereo cassette for your car that has everything, check out one of these new Motorolas.

Each is a complete entertainment center with AM/FM Stereo Radio and each has POW-R-BOOST®. Hit this hot button and it boosts the sound level and enhances the highs. Makes dynamite sound a blast and a half!

And that's just the beginning. You name it and Motorola's got it... fast forward with mute and cuing... slide bar switching for AM/FM... cartridge activated tape/radio switch. Why settle for just a stereo cassette when Motorola gives you one in a complete entertainment center.

See and hear the new cassettes at your nearest Motorola dealer.

## Limited One Year Warranty

Motorola warrants that it will correct product defects during the first year following your purchase... you merely have to take your record of purchase and your Motorola car stereo to one of our authorized stations.

There are thousands of Motorola authorized warranty stations covering all 50 states to help keep your Motorola sound on wheels sounding just right.

Complete warranty details are packed with each unit. Ask your Motorola dealer to show them to you and read them carefully.



**MOTOROLA®**  
SOMETHING ELSE in sound on wheels

CIRCLE NO. 44 ON READER SERVICE CARD

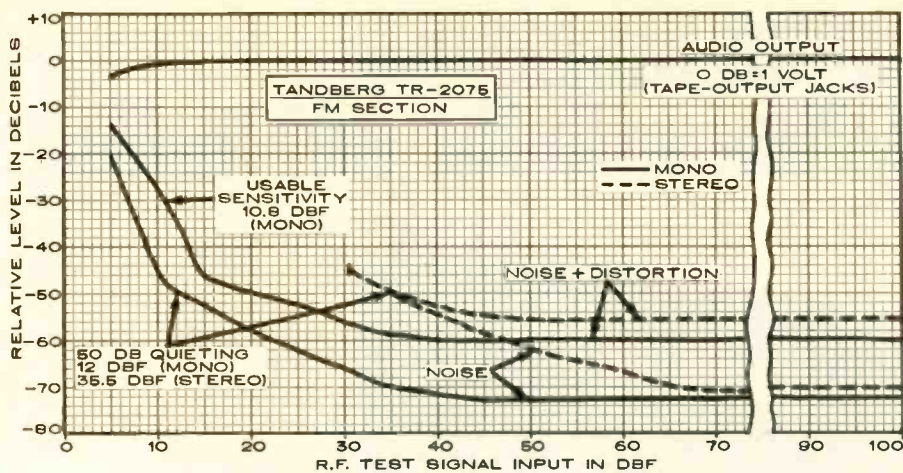

4, 8, or 16 ohms). Two buttons interconnect the tape decks from either one to the other without disturbing the normal program playing through the receiver. Other buttons switch in loudness compensation, play either channel through both outputs, combine them for L + R (mono) through both outputs, or provide normal stereo operation.

Three filter buttons connect the LOW filter (12 dB per octave below 70 Hz), HIGH 1 filter (12 dB per octave above 8,000 Hz), or HIGH 2 filter (6 dB per octave above 8,000 Hz). When both HIGH filter buttons are pressed, the filter slope becomes 18 dB per octave above 8,000 Hz. The final button next to the TAPE 3 output jack, labeled PREAMP REC, transfers the TAPE 3 output feed to a point after the volume, balance, and tone controls. It also reduces speaker volume by 20 dB and can be used as an "audio-muting" switch. Pressing any of the eighteen principal pushbutton controls turns on a small red LED above it. The bright red dots of light can be seen anywhere in the room and clearly identify the operating mode of the receiver.

On the rear apron the numerous inputs and outputs are logically grouped and explicitly labeled (including the input sensitivity and impedance specifications). The speaker outputs and antenna inputs use thumbscrew binding posts which have been designed to grip the wires in a positive manner. The separate preamplifier outputs and main amplifier inputs are joined by removable jumper links. The phono 2 input sensitivity is fixed at 3 millivolts (mV), and a knob next to the phono 1 input adjusts its sensitivity from 2.2 to 10 mV. Each set of tape-recorder inputs has its own level control, covering a range of 0.15 to 0.6 volt. In addition, each of the phono and tape input circuits has its own DIN socket. The

AM ferrite-rod antenna is hinged and pivots through a 270-degree angle (around to the side of the receiver if necessary). One of the three a.c. convenience outlets is switched.

The most unusual circuit feature of the Tandberg TR-2075 is its voltage-controlled-diode FM tuning. The tuning knob adjusts a potentiometer which varies the d.c. voltage applied to four separate pairs of diodes in the antenna, r.f.-amplifier, mixer, and local-oscillator stages (the AM tuner has a conventional mechanical variable capacitor). This approach to FM tuning, though not new (Tandberg has used it in other receivers), gives the designer considerable flexibility in his mechanical layout. In the case of the TR-2075, this is apparent in its remarkably serviceable physical construction, consisting mostly of rigid aluminum extrusions. The entire tuner section (including the tuning mechanism and dial) can be swung upward, or even lifted clear of the receiver, for complete access to all of its parts and those below it without interrupting normal operation. The power transformer is toroidally wound, an expensive type of construction that results in small size and a very low radiated hum field. The receiver is supplied in a wooden housing formed of separate side panels and a top plate. The overall dimensions are 20 1/4 inches wide x 13 3/4 inches deep x 6 inches high; the unit weighs 27.2 pounds. Price: \$1,099.

● **Laboratory Measurements.** The FM tuner section of the Tandberg TR-2075 had an IHF usable sensitivity of 10.8 dBf (1.9  $\mu$ V) in mono and 31 dBf (20  $\mu$ V) in stereo, the latter being determined by the automatic stereo/mono switching threshold. The steep limiting curve produced a 50-dB signal-to-noise ratio (S/N) with 12 dBf (2.2  $\mu$ V) input in mono

and 35.5 dBf (33  $\mu$ V) in stereo. The respective distortion levels were 1.6 and 0.32 per cent. Ultimate quieting at 65 dBf (1,000  $\mu$ V) was 72.5 dB in mono and 70 dB in stereo, and the distortion at that input level was respectively 0.1 and 0.17 per cent in the two modes.

The stereo FM distortion was also measured with modulating frequencies of 100, 1,000, and 6,000 Hz using 100 per cent modulation by a difference (L - R) signal as required by the new IHF tuner-measurement standard. The distortion was about 0.2 per cent at the middle and high frequencies and 0.5 per cent at 100 Hz.

The stereo frequency response on FM was unusually flat, within  $\pm 0.5$  dB from 30 to 15,000 Hz. In spite of the lack of any rolloff at the highest frequencies, the 19-kHz pilot-carrier component in the audio was a very low -80 dB. Channel separation was between 45 and 48 dB over most of the audio range, decreasing below 300 Hz to a minimum of 23 dB at 30 Hz (it remained an excellent 41 dB at 15,000 Hz, however).

The capture ratio was 1.5 dB and AM rejection was 66 dB at 65 dBf input. Image rejection was 69 dB and alternate-channel selectivity was 76 dB. The new adjacent-channel selectivity test, as expected, provided a much lower number than the alternate-channel figure, averaging 6.5 dB. The FM-muting threshold was between 2.5 and 5  $\mu$ V (13 to 19 dBf), while the transition between mono and stereo took place over an input range of 7 to 18  $\mu$ V (22 to 30 dBf). As a stereo signal became weaker, the receiver changed to mono at the lower level, and did not return to stereo until the input had been raised to the upper figure. The AM frequency response was very restricted, with the -6-dB response frequencies being 85 and 1,800 Hz. We are told that this bandwidth restriction is intentional, designed for the narrower channel spacings and limited AM bandwidth used in Europe.

The audio amplifiers of the TR-2075 clipped at 91 watts per channel when both channels were driven into 8-ohm loads at 1,000 Hz. The power at clipping into 4 ohms was 123 watts; into 16 ohms it was 58 watts. The 1,000-Hz total harmonic distortion (THD) was close to our lower measurement limits, reading less than 0.007 per cent from 0.1 watt to more than 10 watts and increasing smoothly to 0.056 per cent at the rated 75 watts and to 0.11 per cent at 90 watts. The intermodulation distortion (IM) was between 0.02 and 0.05 per cent up to 9 watts, 0.17 per cent at 75 watts, and about the same at 90 watts.

At the rated 75-watt output, the THD was very low—between 0.04 and 0.06 per cent from 20 to 3,500 Hz and 0.035 to 0.045 per cent from 5,000 to 20,000 Hz. The distortion was even lower at reduced power outputs, typically 0.01 per cent or less at any practical listening level over the full audio band. The calibration of the output meter scale was typically within 15 per cent of the actual power (based on 8-ohm loads), making it a perfectly adequate monitor of average listening levels.

The high-level input sensitivity, measured through the TAPE 1 inputs, could be adjusted from 53 to 200 mV for a 10-watt reference output. The hum level was a very low -82 dB referred to 10 watts. The PHONO 2 sensitivity was 1.2 mV (PHONO 1 could be adjusted from 0.76 to 3.7 mV), with a 75.5-dB S/N figure. Phono overload occurred at 76 mV through PHONO 2 and from 38 to 175 mV through PHONO 1, depending on its sensitivity setting. The high-level tape input overloaded at very safe

All inputs and tape-deck connectors on the TR-2075 are duplicated by DIN connectors. Note that most of the inputs are equipped with sensitivity controls immediately adjacent to the jacks.

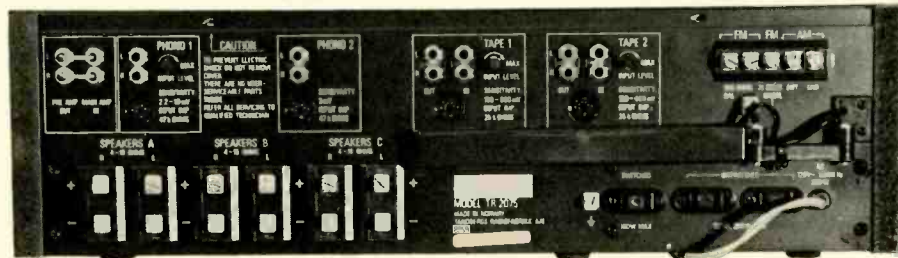



levels of 2.4 to 9.1 volts, depending on its sensitivity setting.

The tone controls had the usual characteristics of a sliding bass-turnover frequency and a treble response hinged at about 1,000 Hz. The mid-range tone control affected a very broad range of frequencies centered at 1,200 to 1,500 Hz, with a maximum control range of about  $\pm 7$  dB. The filters, with their 12-dB-per-octave slopes and well-chosen cut-off frequencies, provided very effective noise and rumble reduction with a minimum loss of program content. The  $-3$ -dB response frequencies were 55 Hz for the low filter and 10,000 Hz for the high filter. The loudness compensation was moderate and boosted both low and high frequencies.

The extended RIAA phono equalization was accurate within  $\pm 0.5$  dB from 20 to 20,000 Hz. When it was measured through the inductance of a phono-cartridge coil, the phono response dropped very slightly at high frequencies to about  $-2$  dB at 10,000 Hz before returning to its correct level at 20,000 Hz.

● **Comment.** Performance on the test bench showed the Tandberg TR-2075 to be a thoroughly excellent receiver both in its FM and audio sections (especially the latter, which, except for its power-output rating, could match some of the most highly regarded "super amplifiers"). We would expect no less from a top-of-the-line product bearing the Tandberg name. Nevertheless, we put the unit through extended use tests before arriving at our final appraisal of this expensive and ingeniously designed product.

Unless you have used a large number of stereo receivers, you might not appreciate the smoothness and positive action of the TR-2075's controls and their total lack of unexpected behavior or undesirable side effects. For example, when changing from one program source to another there is a slight delay before the new program is heard. This audio-muting system effectively eliminates all switching transients and enhances the luxurious "feel" of the receiver. Similarly, the FM interstation muting is positive and noise-free, with just enough time delay to make possible a silent spin across the dial. The calibration of the linear FM dial scale met the  $\pm 200$ -kHz accuracy specification, and we experienced no ambiguity in setting the tuner to any desired channel.

The TR-2075's tape-handling versatility, of course, is to be expected from a manufacturer noted for tape-recording products. And, perhaps needless to say, the FM and audio sound quality of the TR-2075 was also first-rate. The real question—the "bottom line" so to speak—in an overall evaluation of the TR-2075 concerns its price. This is an expensive receiver by any standard. From the manufacturer's standpoint, it is self-evident that the overall construction and general level of engineering excellence of the receiver justify its price. However, anyone price-shopping competitive units will be aware that there are a number of less expensive receivers available whose measured performance, in one or more respects, is equivalent to that of the TR-2075. It comes down to a question of personal taste and specific requirements. From the viewpoint of its potential owners, the higher price tag of the TR-2075 is doubtless justified by its rugged construction, exceptional operating smoothness, flexibility, handsome styling, and superb performance.

Circle 108 on reader service card

# The Sound Shaper. Because all rooms are not created equal.



You can own the finest component system and still be getting inferior sound.

Because unless you happen to have an acoustically perfect listening room, your system and space probably don't match. Hard walls, soft carpets, glass tables, even the size of a room can change sounds.

So ADC developed the new ADC 500 Sound Shaper Frequency Equalizer.

By adjusting the twelve frequency levels you can actually shape your sound to fit the shape of the room, and compensate for spaces and textures that interfere with sound. You can even tinker with the sound just for the fun of it: bring up a singer, lose a violin, actually re-mix your recording.

The new ADC 500 Sound Shaper can get your system into great shape.

ADC

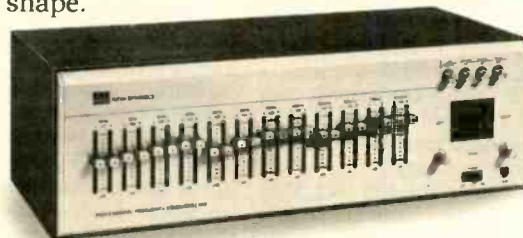

## The Sound Shaper

ADC Professional Products Group. A division of BSR (USA) Ltd., Route 303, Blauvelt, N.Y. 10913



# The Opera File

By William Livingstone



## THE FRENCH REVIVAL

A CENTURY ago, when this country was celebrating its first hundred years of independence, the Centennial gifts to the United States from France were two statues by Frédéric Auguste Bartholdi, the one of Lafayette that stands in Union Square in New York and the Statue of Liberty in the harbor. In addition, during the Centennial festivities in 1876, Jacques Offenbach came over to conduct concerts and performances of his operettas in Philadelphia and New York, where he was billed as "the operatic Puck."

France's generous Bicentennial gifts this year include a visit from the Paris Opera, which will perform in Washington and New York in September. When that tour was first announced, I entertained visions of Lalo's *Le Roi d'Ys*, Massenet's *Sapho*, Chabrier's *Le Roi Malgré Lui*, Fauré's *Pénélope*, and other works rarely sung outside France. But the repertoire that was finally selected by our visitors consists of Mozart's *The Marriage of Figaro*, Verdi's *Otello*, Gounod's *Faust*, and concert presentations (in Washington only) of Berlioz's *Requiem* and *Damnation of Faust*.

Speaking to the musical press corps in New York, Rolf Liebermann, the director of the Paris Opera, said, "We are an international company, we perform the international repertoire, and we decided to bring three productions representative of what we do regularly in Paris. Although these three operas are well known in the United States, our productions are contemporary interpretations that will give Americans an opportunity to see these masterpieces in a new light. For example, Giorgio Strehler's production of *The Marriage of Figaro* stresses the revolutionary content of the Beaumarchais play on which Mozart based his opera, and this makes it particularly appropriate for the Bicentennial. Our production of *Faust* is moved up to Gounod's own time, the beginning of the Industrial Revolution in the nineteenth century."

I'm a bit skeptical about some of that. Rudolf Bing gave us just such a *Faust* at the Met in 1953, and we were stuck with it for more than a decade. But the Paris Opera is one of the world's greatest companies, and even if they want to sing *Yankee Doodle*, they will be most welcome, particularly since Sir Georg Solti will conduct most of the performances, and we have far too few opportunities to hear him conduct opera in this country.

Happily for those of us who love French opera and operetta, our own opera houses and record companies are having a French revival right now. Massenet's *Thais*, for example, has been popping up all over the country—New Orleans, Baltimore, and Seattle—and Beverly Sills and Sherrill Milnes will open the San Francisco Opera season in *Thais* in Sep-



Beverly (you'd better believe it) Sills in the role of Massenet's *Thais*

tember. The Portland Opera is reviving Massenet's *Werther*, and the New York City Opera will have a new production of Offenbach's *La Belle Hélène*. One quarter of the Met's repertoire for 1976-1977 will be French—revivals of *Faust* and *Samson et Dalila* and new productions of Meyerbeer's *Le Prophète*, Massenet's *Esclarmonde*, and Poulenc's *Les Dialogues des Carmélites*.

Record companies are similarly active in the French repertoire. Angel is releasing a complete *Thais* with Sills, Milnes, and Nicolai Gedda, conducted by Lorin Maazel. Still glowing from its success with Massenet's *Navarraise* last year, Columbia is about to release his *Le Cid* with Grace Bumbry and Pla-

cido Domingo, conducted by Eve Queler, and Charpentier's *Louise* with Ileana Cotrubas, Domingo, Gabriel Bacquier, and Michel Sénéchal, conducted by Georges Prêtre. Columbia has already recorded Offenbach's *La Grande Duchesse de Gêrolstein* with Régine Crespin and Mady Mesplé, conducted by Michel Plasson, and plans to record *Le Prophète* and Thomas' *Mignon*. Deutsche Grammophon is said to be planning a recording of Meyerbeer's *L'Africaine*.

London Records will soon release a new recording of Bizet's *Carmen* with Tatiana Troyanos, Kiri Te Kanawa, Domingo, and José Van Dam, conducted by Solti. To coincide with the Met premiere of *Esclarmonde* in November, London will release a recording with the Met cast: Joan Sutherland, Huguette Tourangeau, and Giacomo Aragall, conducted by Richard Bonyngue. Sutherland and Bonyngue are working on Massenet's *Le Roi de Lahore* for Vancouver and will probably record that in time.

And Connoisseur Society is beginning to release a series of French operettas with Mady Mesplé. The first of these, Planquette's *The Chimes of Normandy* (*Les Cloches de Cornéville*), is so melodious and so charming that I can hardly wait for more.

BEFORE you get involved with these French rarities, you might survey your collection to be sure you have recordings of those few French operas that are never out of the international repertoire for long, and if I may put in my *quat' sous*, I'd like to make a few recommendations. *Carmen* is a must, and if you don't have it, you may want to wait for the new London version before making a choice.

You'll need Offenbach's *Tales of Hoffmann*. There are things to enjoy in all four available versions, including the rather campy movie soundtrack sung in English, and all four have their drawbacks. Although I have a lingering fondness for the Angel set with Gedda and three sopranos as his various loves, conducted by André Cluytens, my choice would be the London set with Sutherland and Domingo. Its only drawback is the strange edition Bonyngue chose to perform.

Massenet's *Manon* is pure enchantment from beginning to end—for me at least. The title role is especially well suited to Beverly Sills' voice and temperament, and her ABC recording of *Manon* is possibly her very best. But, for its more idiomatic style, I prefer the mono set on Seraphim conducted by Pierre Monteux. Victoria de los Angeles and Henri Legay, a tenor little known in this country, make the young lovers irresistible. This one is high on my personal list of great recordings of the century.

And that leaves *Faust*, one of the great operas of all time. A succession of beautiful arias and ensembles, it is an example of French lyric theater at its most effective. Alas, *Faust* is seldom performed with much style or conviction these days. Conviction is not lacking, however, in the Angel recording with Gedda, De los Angeles, and Boris Christoff. The chorus and orchestra of the Paris Opera are conducted by Cluytens, who gives the work its proper Gallic flavor and sense of drama. Recorded in Paris in 1958, the set shows its age sonically, but the overall performance is excellent. If you have no recordings of French opera, I suggest you start with this one. And then make some room on your shelves; as the French revival continues, I predict that you'll need it.



The Beogram<sup>®</sup> 4002. If music in your home is important to you, it should begin here.

The Beogram 4002 is a fully automatic turntable which exhibits a level of creativity and engineering skill unequalled in the field of audio components. Its tangential tracking permits the record to be played back in exactly the same manner that the master disc was cut. Electronic logic circuits, activated by a single light touch on the control panel, automatically select the record size and correct

speed, cue the stylus, and turn off the unit when the selection is finished. Furnished with Bang & Olufsen's finest cartridge, in itself an acknowledged masterpiece of audio engineering.

Request our product brochure and the name of your local Bang & Olufsen dealer. For our detailed, full color catalog, please enclose one dollar to cover postage and handling (available free at your local Bang & Olufsen dealer).

Rarely has technology  
served music so well.



Bang & Olufsen

Bang & Olufsen of America, Inc., Dept. 12D, 515 Busse Road, Elk Grove Village, Illinois 60007

CIRCLE NO. 15 ON READER SERVICE CARD



# Going on Record

By James Goodfriend



## THE CASE FOR MULTIPLICITY

A FRIEND of mine owns seventeen (at last count) recordings of Schumann's *Kinderszenen*. No, he is not the same man who when asked if he liked pancakes admitted that he had trunks full of them. He has a definite reason for owning seventeen recordings of the *Kinderszenen*, just as he does for owning multiple recordings of Haydn symphonies, Mozart piano concertos, Schubert lieder, Bach organ pieces, and many other works of the standard and not-so-standard repertoire. The reason is that they are all different.

*Kinderszenen*, as Schumann left it to us, is no more than a series of notes and indications—not actually music, but a set of directions for producing music. Every pianist who plays it, therefore, is giving us his idea of what Schumann had in mind, and it is reasonably safe to say that no two pianists have the same conception of what that was. It might be different if technology had allowed Schumann to leave us a recording of the work rather than a score (perhaps played by wife Clara, since Robert himself had already permanently maimed his right hand), but more likely it would not. For what is really responsible for the variety of interpretations of *Kinderszenen*—and particularly for the variety of fine ones—is not so much a deficiency of musical notation as the richness of possibility of the work itself.

There are, within the limitations defined by Schumann's score, a lot of different ways of playing *Kinderszenen*, some more effective, more beautiful, than others, perhaps, but

none of them "definitive." For each approach to the music sets up its own series of problems—those of tempo relationships, dynamic relationships, phrasings, accentuations, and the thousand expressive devices for which we have only such generic names as *rubato*. The interpreter chooses his problems and then attempts to solve them—and all the time, mind you, he is playing Schumann's *Kinderszenen*. A resolution of the problems presents a more or less satisfactory rendering of the piece on its own terms, but it is frequently the setting of the problems that decides how interesting this performance is going to be, even if it is not totally successful.

It is rare that a pianist will play a piece twice exactly the same way, though it does happen. It is almost unheard of that two pianists will play a piece—at least a piece so full of variegated possibilities as *Kinderszenen*—the same way. And thus recordings tend to contradict one of the basic elements of such music, for their infinite repeatability forces us to hear the same thing each time. We do not hear Schumann's *Kinderszenen*, but we hear pianist X's interpretation of the piece at one particular time and under one particular set of circumstances. If we hear that one performance enough times, the work becomes frozen for us, no longer a fluid and fecund thing, but permanently molded. This is not the best way to know music.

Granted, there have been (and are) certain composers who envision a work as played

only one way—or two: the right way and the wrong way. Such composers go to extreme lengths of notation to try to insure that a given performance will conform in the greatest degree to what they want, or they essentially bypass notation and give us instead a completely realized tape recording of the music to insure that there will be no variation between their intentions and what we hear. Granted, also, there are certain pieces of music—many of them, in fact—that to an extent "play themselves," and the variation from one performance to another is inconsequential, provided whatever directions the composer has left with the score are not actually violated. This is not necessarily inferior music, but it is music in which the options are already chosen and spelled out, or music that has intrinsically few options.

That still leaves us with a great deal of music, much of it generally recognized as some of the greatest we possess. This is music whose essence lies not only in its grouping of notes but in the range of possibilities it provides, music whose performance forever denies us the absolute certainty of what lies ahead. Reduced to the bare notes and playing indications, the same things "happen" each time the music is played, but *how* they happen can sometimes be the source of a great deal of surprise.

We cannot really get to know such music through unvarying listening to a single recording, no matter how many critics have praised that recording, no matter how much we may have come to love and cherish it. In fact, though it is less satisfying, we can probably get to know such music better through two more or less adequate recordings, or even one good and one mediocre recording, than through a single masterly one. Even bad performances tell us something about the music, since the dissatisfaction induced by a performance that doesn't work makes us search our minds to find those elements that *will* make it work; in so doing we discover possibilities in the music whose existence we did not notice before because they were all fulfilled. Enough of that sort of practice and we can listen even to a recording of a completely unfamiliar piece of music, hear that it does not come off, and *not* automatically say that the composition is to blame.

Most people who buy classical records today do *not* buy multiple recordings of a single work; in fact, they go through agonies to avoid duplication of repertoire. They compensate for the limitations of a single performance by buying another performance of something else. So they avoid the trap of too great a familiarity with one performance of a work simply by not hearing the work itself all that much. They become familiar with more and more repertoire and their knowledge of music tends to be broad rather than deep. It is one of the pleasanter traps of record collecting, and I have, to an extent, fallen into it myself.

But even the most rational plans can become muddled. Some works we *have* to hear more than others; some works we find that we own in two, three, five, or seventeen different performances, in spite of attempts to do otherwise. It would hardly constitute scientific proof, but going through our record shelves and finding multiple recordings of this work or that might just indicate which music each of us believes, perhaps unconsciously, to be the greatest masterpieces. At any rate, it might be worth thinking about.





# SOME OF THE HEAVIEST EQUIPMENT IN THE BUSINESS.

The next time you're looking at tape decks, pick up any piece of Akai equipment. They're heavy.

The motor, the drive system, the flywheel. Akai makes them big. As big and as strong as we possibly can. So they'll perform for you.

The Akai GX-630DSS is a good example. Pound for pound and dollar for dollar, it's one of our heaviest. It's driven by a big, heavy-duty AC servo capstan motor plus 2 eddy current motors for fast forward and rewind. It features Akai's Quadra-Sync® for

multiple track synchronization when recording. It offers complete versatility for mixing. And pitch control. It's got just about everything. For the guy who wants to do just about everything.

Our GX-650C stereo tape deck has just about everything, too. Closed loop dual capstan drive. One AC servo capstan motor plus 2 eddy current motors. Sound on sound. 3 speeds. It's got it.

That's the kind of equipment you can expect from Akai. Strong because we're heavy. Heavy because we're strong. Akai. Pick one up.



**AKAI™**  
**COMIN' ON STRONG!**

Akai reel-to-reel tape decks from \$299.95 to \$1,495.00 suggested retail value. Akai America Ltd. 2139 East Del Amo Blvd. Compton, California 90220.



# The Simels Report

By Steve Simels



## HE LOST ME (AGAIN) AT THE MOVIES

AUTHOR Truman Capote once opined that rock singers are really actors. Well, I haven't seen him in *Murder by Death* yet, so I can't comment on whether writers, too, are really actors, but the theory strikes me as yet another instance of an intellectual's misunderstanding the rock-and-roll process. Certainly, on the basis of Tony Bennett's stuporously horrific emoting in *The Oscar* (the definitive Great Bad Film), we know that pop singers, at least, aren't actors. And too, it may be significant that there haven't been many good movies starring rockers—lots of drive-in trash, yes, but not many with real substance. If pressed, I might be able to come up with half a dozen or so worthwhile efforts: Richard Lester's Beatles flicks; Tony Richardson's *Ned Kelly*, oddly underrated, perhaps because of Mick Jagger's rather too effete performance; my hero Sam Peckinpah's *Pat Garrett and Billy the Kid*, which has really splendid work by Dylan and Kristoffer-son and succeeds despite MGM's arbitrary cutting (after taking the film out of Peckinpah's hands, the studio excised a lot of exposition and a frame story, giving it an unintended but fascinatingly surreal narrative flow); and *Having a Wild Weekend* with the Dave Clark Five (directed by John Boorman of *Deliverance* fame), which, from a 1976 vantage point, surprisingly turns out to have been the most artful of the Swinging London flicks. And, of course, there's Nicholas Roeg's *fin de siècle* masterpiece *Performance*, which leads us neatly to the reason for the preceding ramble, namely David Bowie's film debut, masterminded by Roeg, as *The Man Who Fell to Earth*.

Long-time readers of this column will be well aware of my general coolness toward Mr. Bowie's music; although I haven't discussed it at length, I am just as cool about his dilettante approach to science fiction. The Ziggy Stardust conceit (or "The Homo from Aldebaran," as Lester Bangs has aptly dubbed it) in particular put me off. Despite the trendy Anthony Burgess trappings Bowie tried to disguise it with, the concept was at heart hardly above the level of Flash Gordon—and nowhere near as charming. Bowie's adaptation of sci-fi ideas struck me then (and still does) as at least as cynical and superficial as his dabbings with heavy metal and disco. Nonetheless, I've been a fan of Roeg's ever

since the days when he was photographing Vincent Price/Roger Corman adaptations of Poe, and I went into *The Man* with considerable expectations, despite my aversion to its star.

As it turned out, the film is not very good—in fact, it's one of the most curious, eccentric, and wrongheaded in recent memory—but somehow its posturings are so singlemindedly bonkers that it winds up almost endearing. But be warned: there are still stretches so tedious and silly that the audience I saw it with groaned audibly and often.



CANDY CLARK AND DAVID BOWIE  
*Love in a hot climate*

First of all, the whole thing makes almost no sense. For the opening forty minutes or so you can go along with the gag—a setup for a metaphysical shaggy dog story such as *2001*—but the Walter Tevis novel the film was based on has been so badly and pointlessly adapted that there is nothing left of it in the end but a series of plot holes big enough to drive a truck through. Why, for example, does the alien played by Bowie arrive on Earth in a \$19.95 pea-green Sears hooded parka? Why, if he has learned Earth language from television, does he (a) speak English with (b) a British ac-

cent? Has he been receiving only the BBC? Why does this super being, with powers and abilities far beyond those of mortal men, etc., move to New Mexico to live in connubial bliss with a truck-stop girl straight out of *Nashville*? Why, since he has come to Earth in search of water (his home planet is in the throes of a devastating drought), does he attempt to return home with nary a mention of taking back any of the precious fluid?

Ultimately, of course, none of this is germane, because the film isn't about an alien, or anything in the story sense, for that matter. It's about how a particular pop star sees himself. The entire thing has been conceived solely to explore Bowie's foppish narcissism, to indulge his very original but footless confusion of the homosexual and the extraterrestrial. If Bowie were just a little bit more interesting a figure, this might have worked; *Performance*, after all, was also concerned with a pop star's self-image. But of course it was about other things as well, and Mick Jagger had the good sense to relegate himself to a supporting role; that wouldn't do for David, obviously.

As to whether David can act—well, maybe you'd better ask Truman about that. I will say that although his performance is almost completely wooden, it does have a certain spastic otherworldliness about it, that he does make a convincing "alien" at times. On the other hand, everyone else in the film, including such real actors as Rip Torn and Buck Henry, is amateurishly terrible, perhaps in synergistic response to the black hole of Bowie's performance. Visually, the film is just as striking as one would expect of a Roeg product, but perhaps because the material is so thin, his directorial tricks (the flash forwards, the lengthy and explicit sex scenes) appear, for the first time, to be simply that—tricks. There is none of the disquieting eroticism of that love scene between Donald Sutherland and Julie Christie in his *Don't Look Now*, none of the ominous, hallucinatory foreshadowings that characterize that film as well as *Performance*. David's roll in the hay with Candy Clark, despite Roeg's directorial leering, comes off as basically neuter. In fact, perhaps the only scene with any real emotional jolt is the one where David sheds his human disguise (revealing himself as being without genitals), and Clark, though appalled and terrified, attempts and fails (naturally) to make love to him. And the music, which was so brilliantly utilized in *Performance*, is no help at all here. Bowie's own score was unaccountably scrapped (a mistake, for his brand of mechanistic android rock just might have clarified things or at least contributed an atmosphere) and replaced with an incredibly lame one by John Phillips, a parodistic c-&-w affair that only makes one wonder what we ever saw in the Mamas and the Papas.

As I suggested earlier, however, *The Man Who Fell to Earth* works so hard at being silly that eventually you can't help liking it a little in spite of yourself. And so I recommend it—at least if it hits the dollar theaters in your neighborhood. For myself, I'm now wrestling with a dilemma: since it has unaccountably garnered some good reviews, do I want it to be successful enough that Bowie will get out of rock-and-roll entirely (something I've been hoping for four years now) and start cranking out more films as dumb as this one? I'll say this for David: he's managed to muddle my priorities.



# NAVY. IT'S NOT JUST A JOB, IT'S AN ADVENTURE.



If you're just looking for a job, you can probably take your pick of thousands. But if you're also looking for adventure, the field suddenly narrows. To the Navy.

In the Navy, a job means more than a good paycheck. It means the opportunity to see places like Italy, Spain, Morocco, Hong Kong, the Philippines and Hawaii. It means working on some of the most advanced technical equipment devised by man. It means doing a job that really counts, with guys who count on you to do it.

The Navy has more than sixty career fields we can train you in. We'll help you continue your education, and you'll earn thirty vacation days with pay, a year. Your Navy recruiter can tell you more. Speak to him or call toll free 800-841-8000. (In Georgia, 800-342-5855.) Navy. It's not just a job, it's an adventure.

# NAVY

Capt. H. C. Atwood, Jr., U. S. Navy Q466  
NAVY OPPORTUNITY INFORMATION CENTER  
P.O. Box 2000, Pelham Manor, N.Y. 10803

- Send me more information on Navy opportunities. (G)  
 Call me. (G)

NAME \_\_\_\_\_  
First (Please Print) Last

ADDRESS \_\_\_\_\_

CITY \_\_\_\_\_ STATE \_\_\_\_\_ ZIP \_\_\_\_\_

BIRTH DATE \_\_\_\_\_ Last Grade Completed \_\_\_\_\_

PHONE \_\_\_\_\_  
(Area Code)

SR 9/6



# New. Diverse. Consistent.

The instruments in this advertisement are new and diverse. They are also selective, deliberately. This is consistent with our attitude — to make components only where we feel we have something to contribute. Then, to give them the finest expression of which we are capable.

Our 330c stereo receiver is the most recent in a series that opened the world of true high fidelity to the music lover with a modest budget. Its predecessor, the 330B, earned extraordinary reviews and recommendations from the leading magazines and the most respected consumer organizations. Nevertheless, when improvement was practical, we replaced it.

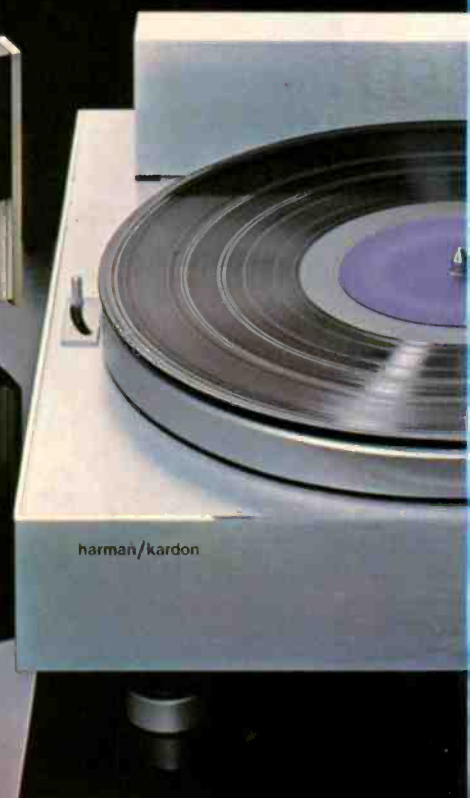



The 330c has increased power, tighter phase linearity and wider bandwidth than its immediate predecessor. Yet it is offered at virtually the same price as the original 330, introduced seven years ago.

In its review of the HK1000 stereo cassette deck, *High Fidelity* said, "The HK1000 is the best so far . . . A superb achievement."

We've gone beyond it.

With the HK2000.

Performance specifications of the HK2000 are impressive. For example, wow and flutter: 0.07% (NAB) WRMS. The HK2000 is so sensitive to low frequencies that a subsonic filter has been incorporated which can be used to remove unwanted signals from warped records. But just as in all

Harman Kardon amplifiers and receivers, wide band design in the HK2000 produces sound quality that transcends its impressive specifications.

When we introduced our straight line tracking turntable, the ST-7, it was recognized at once as the definitive way of playing records. Precisely as the master was recorded. Without tracking error. Without skating.

The ST-7 was designed for the music lover who had to have the very best—and could afford it.

The ST-6 now joins the ST-7. Straight line tracking, with the demonstrable benefits it offers, is now available to a wider audience—without compromising performance.

The two turntables are virtually identical in appearance and operating capability. They use the same tonearm and straight line tracking mechanism. They are both belt driven and use the same platter and support bearing. Yet the ST-6 is available for little more than the cost of a deluxe record player of conventional design.

We'd like to tell you more about our new instruments and, equally important, about the point of view they represent. Write to us directly—without impersonal reply cards or coupons. We'll respond in kind with full information.

Harman Kardon, 55 Ames Court, Plainview, New York 11803.



**harman/kardon**



# A preview of

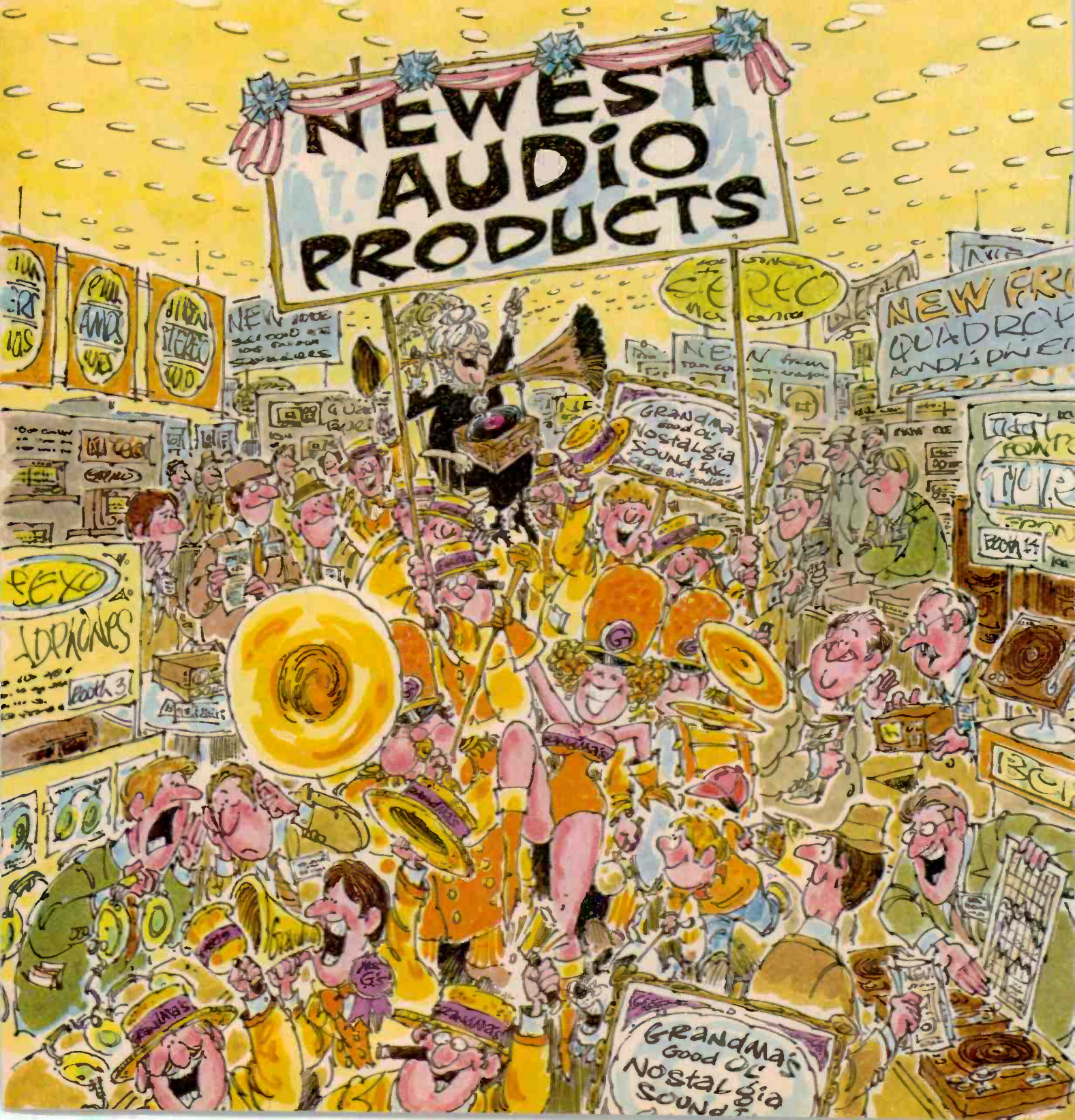



# next year's sound equipment

By Associate Technical Editor Ralph Hodges

**W**ITH a snip and a flourish the ribbon barring the entrance to Chicago's gargantuan McCormick Place exhibition center was cut on June 13, 1976, and over 40,000 "reps" and dealers, visiting dignitaries, the press, and a few other general hangers-on streamed in to confront this year's Consumer Electronics Show. As we've explained in years past, the summer CES is "the big one" for most peo-

ple involved in the audio/hi-fi trade. It is the setting for dealer/manufacture forums, for displaying innovative prototypes to see if they will fly (and if the dealers will buy), and for extended sales meetings to tout the virtues of the new products that will grace the dealers' display shelves this fall and winter.

When the curtain was finally rung down on the show three days later, everyone seemed to agree that it had been

practical, promising, and above all *big*. This same show, or most of its contents, is now wending its way to you via the pipelines that service audio retailers throughout the country. Without further ado, let's take a look at the products that evoked nodding approval, quiet rapture, and even a few gasps of amazement from those of us that gathered in Chicago during those four clammy June days.

## RECEIVERS

It was truly a show of abundance for stereo receivers this year, with a lot of the activity focused on what is called "filling out the line." Sansui built downward, adding the 7070 (60 watts per channel), the 6060 (40 watts), and the 5050 (30 watts) to support the larger 9090 and 8080 models that head this series. Technics by Panasonic built upward, crowning the stereo receiver line begun last year with the 165-watt-per-channel SA-5760, plus five other models descending down to a low 12 watts per channel. And H. H. Scott built out in *all* directions, introducing five new units (\$240 to \$550) that represent something of a departure from the company's previous spartan styling and encompass a power range from 75 to 15 watts per channel. Just before the show, Pioneer announced five new receivers, all in the mold of the 160-watt-per-channel SX-1250 but ranging from 15 to 65 watts in power and from \$200 to \$500 in price. (The model numbers run from SX-450 to SX-850 in steps of 100.) Another Pioneer development was the QX-949A, an improved version of the QX-949 four-channel receiver, now with full-logic SQ decoding and a redesigned CD-4 demodulator. And Panasonic stepped in with the new RA-6100, available with built-in eight-track recorder as the RA-6600.

**S**HERWOOD boosted the top of its line this year with the 100-watt-per-channel S-9910, augmented by the 60-watt S-7910 and the FM-only S-8910. The S-9910 features an innovative new FM detector circuit. Tandberg added the TR 2055 (55 watts per channel) to its 2000 series, and Akai added the AA-1010 (14 watts per channel) to its 1000 series. Other manufacturers with single entries included Yamaha, with the 25-watt-per-channel CR-450 in the now-classic Yamaha styling, and (of all companies) Advent, which

presented its first product of this type, the Model 300 (about \$260). The rating of 15 watts per channel may not seem too exciting, but the receiver incorporates the results of much investigation into circuit design. Furthermore, an internal modification sets the Model 300 up to operate from a 12-volt storage battery for mobile use.

Sony's introductions included three receivers in the medium-price range (\$400 to \$600), the STR-4800SD, 5800SD, and 6800SD. Toshiba revealed surprising depth by appearing with five models from 7 to 50 watts per channel, all with a deep waist-level incision in the front panels meant to suggest stacked separate tuners and amplifiers. Nikko brought forth a 68-watt-per-channel instrument, the STA 9095, for just over \$500, and Harman-Kardon unveiled a handsome successor to its pre-existing small receiver. The new unit is called the 330C, and it has been increased in power to 20 watts per channel with no price increase over its \$220 predecessor. Lafayette announced five new models, ranging from \$200 to \$600, with the 90-watt-per-channel LR-9090 representing a new high-power point for the company. Miida checked in with two new receivers, the 3140 and the smaller 3125, while GTE (the name under which new Sylvania components will be marketed) displayed a prototype of the Model 2600, providing 80 watts per channel and scheduled for autumn introduction. Fisher displayed its ample line of nine Studio-Standard receivers priced from about \$230 to \$1,000, and Marantz once again exhibited its seven stereo receivers and five four-channel units (Fisher also retains several of its four-channel units from years past). JVC's new receiver line, introduced in the spring, remains the same.

A formality any new receiver or tuner has to undergo before market introduction is a

quick check by the FCC to determine that it does not radiate excessive r.f. energy from its local oscillator circuit. However, with such multitudes of new products, the FCC has fallen behind in its work, and at show time several manufacturers were still awaiting the necessary certification. Among those left in the lurch by the FCC's schedule was the show's most powerful receiver, the Rotel RX-1603 (180 watts per channel), which has adopted the pleasing masculine styling of recent Rotel products and which should cost about \$1,000 when available (an unusual feature: the power-amplifier section can be unbolted and separated from the rest of the unit when installation space is limited). Kenwood was similarly delayed in presenting a new deluxe receiver and tuner, but the company's prestigious line of six recently introduced stereo receivers stood it in good stead meanwhile.

Among the show's claimants to serious innovation was the 75-watt-per-channel SR/903 receiver (\$500) from Hitachi. The 903 employs what Hitachi calls Class E power amplifiers. Two groups of output transistors per channel are used; one group handles low-level signals while the second group "switches in" for high-level information. The idea is not entirely new, but the execution is; it should result in lower operating temperatures, a worthwhile increase in the "music-power" capabilities of the amplifier, and certain attractive economies in the power supply and heat sink.

**T**HERE were more than a few newcomers to be found in McCormick Place this year. Aiwa, now in the hands of a new U.S. distributor, is staging a comeback with some very handsome receiver designs. Planar is a Canadian brand about to enter this country with the SR 2100, rated at 65 watts per channel. And way out there across the Pacific is a sleeping giant known as Korea, soon to be soliciting your attention with products bearing such exotic brand names as Inkel and Daewoo (Electown). (Continued overleaf)



# NEWEST AUDIO PRODUCTS



Pioneer SX-450 Receiver



Yamaha CR-450 Receiver



Advert 300 Receiver



Sony STR-3800SD Receiver



Hitachi SR-903 Receiver



Nakamichi 62C Power Amplifier



Yamaha B-2 Power Amplifier



Luxman 5C50 Preamplifier

## AMPLIFIERS

If you were expecting to read about myriads of *big* super-power amplifiers in this space you are a little late. All of those were introduced last year, practically by the dozens. This was the year of the *medium-size* (if you will) super-power amplifier such as the Audionics PZ3 and the Nakamichi 620, each rated at 100 watts per channel. Both are interesting and innovative. The Nakamichi output circuit is said to operate essentially in the Class B (as opposed to the usual Class AB) mode. Class B, while highly efficient, is shunned by most designers because of distortion problems. However, special control circuits for the output-stage bias have resulted in a *guaranteed* specification of less than 0.005 per cent distortion of any kind, under any conditions, up to a frequency of 10,000 Hz—the most ambitious figure I can recall being quoted for *any* audio component. The Audionics PZ3 also has bias-control circuits and offers specs that are nearly as good.

In addition, we encountered some new big power amplifiers that we had previously heard about but never actually seen, such as the Sultan basic stereo amplifier from Parenthian (100 watts per channel at 0.5 per cent THD) and its companion Model 24 preamplifier incorporating octave equalizers for each channel. We had also had a bit of advance word about the B-2 power amplifier from Yamaha (100 watts per channel at less than 0.08 per cent THD) and its companion, the low-silhouette C-2 stereo preamplifier. Like their predecessors, the B-1 and the C-1, the new components make heavy use of field-effect transistors right up to the output stage, where new complementary V-FET's are employed in the B-2. And the C-2 has a completely new facility for Yamaha: a high-sensitivity phono preamplifier to accept the output of a moving-coil cartridge directly without the need of a separate pre-preamplifier. Prices are \$850 (B-2) and \$650.

**A**NOTHER high-power entry, the Dynaco Mark VI, is a rack-mounting vacuum-tube mono power amplifier aimed at the professional as well as the consumer market. Its 120 watts puts it up there with the biggest of the tube units, although it is actually a super-power redesign of the elderly and respected Mark III. Luxman's amplifier introductions consisted of the 5M21 stereo power unit, resplendent in the company's tasteful styling, and the 5C50 stereo preamplifier, which is compact and low-silhouette. The power rating for the 5M21 is 100 watts per channel with less than 0.01 per cent harmonic distortion.

Something rather novel turned up from ESS: the new "Touch Control" Series Eclipse preamplifier and power amplifier. The Touch Control units are knobless, sliderless, and buttonless. Instead, flush-mounted contact plates perform most of the switching and also direct the preamplifier to shift up or down in volume at a steady rate. Tall vertical bars of light indicate the status of the switches and also serve as an output-level display for the power amplifier. (The amplifier, incidentally, is basically the re-

cently introduced Eclipse 500A; it provides 250 watts per channel.)

The sudden popularity of integrated amplifiers, while it puzzles some students of the marketplace a little, is certainly authentic and enduring. This year brought a very elaborate 120-watt-per-channel unit from Sherwood, the HP 2000, and a sister model, the HP 1000, at 60 watts per channel. The Marantz 1250, with an output rating of 125 watts per channel, has notably versatile switching for tape monitoring and dubbing that permits simultaneous processing of several program sources. Sansui has added four new integrated amplifiers to its 1976 line, ranging from the Model AU 7900 at 75 watts per channel to the AU 3900 at 22 watts per channel, with prices spanning \$400 to \$160. Sony now offers the 55-watt-per-channel TA-3650, which has the distinctive appearance that company has recently adopted for its electronics. And four new integrated amplifiers from Scott, ranging from Model A 406 to A 436 in steps of 10 and from well below \$200 to \$300, are genuine adornments, stylistically speaking, for that manufacturer's line.

**N**EW for Bozak this year is the 949 integrated amplifier, which reportedly combines the performance and essential features of the 909 preamplifier and the 65-watt-per-channel 939 power amplifier, both of which are also new.

At 130 watts per channel, the Kenwood 600 was the largest new integrated amplifier we saw at the show; it was accompanied by its smaller brother, the 500. Both have dual power supplies, separate for each channel. Rotel presented a 75-watt-per-channel addition, the RA-1312.

A new entry into this product category was a company called Clarion, which has equipped itself with three cleanly styled integrated amplifiers, the MA-7800, MA-7600, and MA-7400, ranging from just over 20 to about 45 watts per channel. Hitachi brought two new models, the 100-watt-per-channel HA/1100 and the smaller HA/610, and Nikko had one, the TRM 750 integrated amplifier, at 45 watts per channel.

Back in the world of power amplifiers, BGW presented a very slim unit, the Model 100 (\$319), designed to rack mount and to provide 40 watts per channel. The P-20 power amplifier (70 watts per channel) is the latest product from Kenonic. Altec showed an essentially professional product, the Model 1224A Electronic Crossover Bi-amplifier. As you might guess, the unit contains a two-way electronic crossover with a choice of 500-, 800-, or 1,500-Hz crossover points, plus a 60-watt bass amplifier and a 30-watt treble amplifier. Coincidentally, perhaps, Ace Audio turned up with an almost identical product, the 35 × 2 Bi-amp Electronic Crossover-Amplifier, available with a choice of nine crossover frequencies in total, and providing 35 watts each for bass and treble. The basic 35 × 2 is also available without the crossover as a conventional stereo power amplifier. Cerwin-Vega's 225-watt-per-channel A-1800



power amplifier can now be bought with output-level meters as the A-1800M. And the Quintessence line has gained some depth with the 150-watt-per-channel Power Amplifier II.

In the precinct of the exotic, a new company staked out a claim this year: Uesugi Laboratories, with a 20-watt Class-A power amplifier (employing what appears to be a single pentode transmitting tube for its output), a stereo preamplifier, and an electronic crossover, all of which employ vacuum tubes exclusively. Mark Levinson also announced a no-holds-barred Class-A power amplifier; details were few at show time, but the manufacturer suggested that the retail price might be in the neighborhood of \$100 per watt. Also in the exotic category are Jensens Stereo Shop's modifications of the Dynaco PAT-5 preamplifier and Stereo 400 power amplifier. They are not inexpensive, but they are said to add a final touch of refinement to products that are already excellent. Close by, Dunlap Clarke showed, along with its high-power amplifiers, a new preamplifier, the Model 10 (\$675), with separate phono preamplifiers for conventional and moving-coil cartridges. In another de-

velopment of note, Infinity Systems gave solemn assurances that its revolutionary Class-D DSP Switching Amplifier, which has been cropping up in these pages for several years now, will finally be available "in the immediate future." And Stax presented two new Class-A transistorized power amplifiers, the 50-watt-per-channel DA 80 and the 80-watt mono DA 80M. Both are priced at \$1,500.

To close, a glance at the British forces, which continue to gather strength at CES: Monogram Professional Audio had one of the largest stereo power amplifiers (100 watts per channel) that we have seen come from England, plus a preamplifier with eleven-band equalizer controls that the company calls the Room Acoustic Amplifier. The respected J. E. Sugden equipment made its first CES appearance, leading with the A48 integrated amplifier (45 watts per channel) and the Q51 four-channel decoder for SQ, QS, and BMX matrix systems, among others. Naim Audio was on hand with a 50-watt-per-channel power amplifier and a straightforward preamplifier. And there were many more as well, if only space permitted us to describe them here.

## TUNERS

In tuners this year, Sherwood managed to steal the show with the intriguing Micro/CPU 100 FM-only instrument. The first thing you note about the Model 100 is that it has not only a conventional-seeming tuning dial, but also an illuminated numerical frequency display and an alphabetical illuminated display of the station's call letters. This last display has all the letters of the alphabet plus some other symbols on tap. The user simply punches in the right combinations of letters for stations in his locality, and the tuner's memory holds onto them (it seems to us that he could also punch in any four-letter words he deemed appropriate for particular stations). Although the prominent tuning knob makes it appear mechanical, the tuning system is entirely electronic, and the tuner will scan the FM band for you automatically if you wish. Even the tuning dial is deceptive, using not a mechanical pointer but a dial-long row of LED's. Up to four stations can be preset to be recalled at the touch of a button. All in all, taken together with its advanced performance capabilities, the Micro/CPU 100 seems to offer a lot of innovation—even for a price of about \$2,000.

Another numerical-readout FM tuner was presented by Luxman, this one a frequency-synthesizing device. Designated the Model ST50, it also has a tuning dial in addition to the numerical frequency indicator. Presets for seven stations are provided, along with a pushbutton-activated scan mode. The Luxman tuner has built-in Dolby circuits for FM as well as a 400-Hz test-tone oscillator for Dolby calibration.

For about \$1,600 you can buy the Sequerra Model II, a unit with performance equivalent to that of the original Sequerra tuner but without the built-in oscilloscope display. The display will be made available as an op-

tion later on. The first tuners to be offered by Technics are the Models 8600 (about \$330) and 7600 (\$180). The 8600 has a built-in pink-noise generator plus a switch that cancels the de-emphasis circuits.

Of course, many of the manufacturers with new integrated amplifiers accompanied them with new AM/stereo FM tuners. H. H. Scott introduced two, the T-516 and the more elaborate T-526, at \$170 and \$250. Sansui unveiled three in the medium- to low-price range (\$230 to \$160) bearing the same model numbers—but with a "TU" prefix—as their corresponding integrated amplifiers. Sony came out with two, the Models ST-3950SD and ST-5950SD, both with Dolby noise-reduction circuits. Two more came from Hitachi, while the three new tuners from Clarion were set off by their distinctive styling. Rotel, meanwhile, showed a pair of new tuners, the RT-724 and the previously announced RT-1024.

Phase Linear now has an FM-only tuner, the Model 5000, with a built-in expander circuit whose characteristics are designed to undo the dynamic-range compression applied by many FM stations. The price will be roughly \$500.

**T**HE English firm Harrison-Chapman was another manufacturer with a numerical-readout tuner, the ST 200; its display functions for both FM and AM. It also has a scan function and five station presets for each of the two broadcast bands. The company also exhibited but did not announce a numerical-readout receiver with some similar features.

To close on a comforting note: Yamaha advises that the famed CT-7000 tuner is now optionally available, with a black front panel, as the CT-7000BL. The direct-drive YP-801 turntable from Yamaha also comes black upon request. *(Continued overleaf)*



Kenwood 60C  
Integrated Amplifier



NIKKO  
TRM-750 Integrated Amplifier



BGW Model 100 Power Amplifier



Kenosonic Accuphase P-20 Power Amplifier



Monogram  
Amplifier and Preamplifier



Sherwood  
Micro-CPU 100 Tuner



Luxman ST-50 Tuner



Scott T-526 Tuner and A-436  
Integrated Amplifier



# NEWEST AUDIO PRODUCTS



Garrard DC 75 Record Player



Dual CS 721 Record Player



Pioneer PL-530 Turntable



Sony EL-7 Elcase Deck

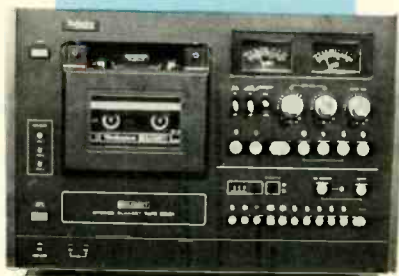

Technics Elcaset Deck

## PHONO CARTRIDGES

The AKG phono cartridges which were in the wings last year at last made an appearance at McCormick Place. As expected, there are five models ranging from the deluxe P8ES (individually calibrated) to the P6R, equipped with a 0.7-mil spherical stylus. All other models have elliptical (biradial) styli. A technical point stressed by AKG is the development of a suspension system ("Transversal Suspension") that keeps the pivot point of the stylus assembly coincident with the center of the suspension system under all playing conditions.

Other introductions of particular note were the first Shure cartridge designed for CD-4 use (see this month's New Products) and the new Silver Label series of Sonus cartridges consisting of the Model P for CD-4 and stereo reproduction and the Model E for stereo alone. The new series is designed to be more compatible with less-expensive tone arms than the costlier Red and Blue Label designs.

A new arrival from England is the Goldring G900 SE "micro mass" cartridge, a magnetic design that is said to weigh a mere gram. Drastic reductions in the mass of the moving system and of the coil assembly are

said to be responsible for the pickup's astonishing weight.

Pickering announced a new stylus shape, the "Stereohedron" tip, which evidently resembles a CD-4 stylus in certain key respects but is intended for stereo use. The first cartridge to be equipped with the tip is the XSV/3000. For its part, ADC introduced "pre-mounted" XLM MK II cartridges, the mounting being a low-mass cartridge shell with a bayonet connector of the type used in many high-quality arms.

The interest in moving-coil magnetic cartridges continues, with Superex now arranging to import the latest Satin cartridges from Japan. Aside from an innovative internal construction that in certain aspects resembles a cutting head, these pickups have unusually high output for moving-coil devices. They are rated at 3 millivolts per channel for a lateral recorded velocity of 5 centimeters per second, enabling them to feed a conventional phono preamplifier directly instead of through a step-up transformer or some specially designed gain stage. Two models are offered, the M-117E with elliptical stylus and the M-117X with Shibata stylus. The styli are user-replaceable.

## RECORD PLAYERS

If 1975 was the year of the manual turntable, 1977 will indisputably be the year of the direct-drive turntable. As if to prove this, the granddaddy of them all, the Technics SP-10, made a grand entrance at the show this year as the MK II, its new regalia consisting of a quartz-oscillator, phase-locked-loop speed control, a physically separate power supply, and a remote-control module.

Over the past year the ranks of direct-drive machines have swelled considerably, with Marantz, Sony, and Fisher, among others, making notable introductions. New appearances at CES were even more numerous. Garrard's DD75 manual is the first direct-drive machine for this manufacturer, featuring a photoelectric/solenoid arm lift at the end of the record and a handsome teak-finish base. Dual has a new top-of-the-line machine, the CS 721 (about \$400), which is a fully automatic single-play turntable with a tone arm that is adjustable in height to permit cartridge mounting without the use of spacers. A companion machine, the direct-drive 704 (under \$325), is similar except that automatic features are limited to an end-of-record arm lift. (A third Dual single-play model, the 502, is belt driven with an automatic arm lift.)

Pioneer's latest direct-drive entry, the PL-530 (about \$250), has a second motor to operate the automatically cycling tone arm and an unusual internal suspension system. And from Sansui comes the SR929 (\$430) with a direct-drive motor regulated by a quartz-crystal oscillator and a phase-locked-loop servo system. JVC's TT-101, the company's finest turntable, is supplied as an in-

verted-derby-shaped module without arm or base. On a ring corresponding to the brim of the derby are light-touch pushbuttons for on/off and speed selection, a numerical (!) LED speed indicator, and a line of LED's comprising a vernier indicator for fine speed adjustment. The machine is direct-drive, quartz-regulated, and phase-locked.

Kenwood's new direct-drive turntable is the KD-550 with tone arm, the KD-500 without. It is also phase-locked, and, like the Sansui unit described above, it has an inert base molded of a plastic-concrete compound that is said to resist feedback and vibration very effectively. Among Kenwood's very latest turntables, a line of four belt-drive machines, the two top models (KD-3055 and KD-2055) also employ this type of base.

Micro Seiki, which is now being distributed by Teac in the U.S., has at least four direct-drive models in its line of single-play turntables, along with three belt-drive machines. The top of the Micro Seiki line presents a startling, even wondrous appearance. A thick, highly polished platter spins in naked glory above a striking three-point support system. At the end of each support arm is a tone-arm station, and in the show unit a different make of tone arm occupied each station. These stations pivot to permit proper overhang adjustment of each arm.

Another Sony direct-drive model, the PS-3750, has the distinctive styling that has marked the Sony turntables of late. The least expensive direct-drive machine at the show was perhaps the Sanyo TP825D, with a suggested retail price of less than \$180.



The RT-4000 is Rotel's second direct-drive turntable, and Hitachi also showed two at McCormick Place, the PS/38 and the de luxe PS/48. Lafayette now has a direct-drive unit, the T-6000 (\$230), together with two new belt-drive machines at lower prices. And finally, the high-styled Gale turntable featured on our October 1975 cover was shown once again.

The busy-ness in the direct-drive camp did not markedly detract from activity in other turntable areas. Garrard, for example, had two more product introductions to make: a low-mass version of the tangentially tracking tone arm featured on the new GT55 belt-driven automatic turntable; and the more conventional idler-driven automatic, the 775M. B.I.C. hit its lowest price point yet with a belt-driven automatic turntable, the 920, at less than \$80 (the company also

previewed an advance sample of a new top-of-line, automated, remote-controlled turntable about which we are requested to say nothing more at the moment). The Marantz line has been graced with two new belt-drive single-play machines, the 6200 and the 6100, to augment that manufacturer's direct-drive models. The 6200 has fully automatic operating features.

The Empire 698, with its semi-transparent tone arm, was present at the show, as was the Yamaha YP-450, a new belt-drive manual in the moderate-price range (\$160). Another show unveiling was the Thorens TD 126C; it provides a number of operating features that are new for this Swiss company and is perhaps the only machine of its caliber still to offer three speeds: 33 $\frac{1}{3}$ , 45, and 78 rpm.

Five belt-drive units are reportedly brand

new in the Lenco line, with the top model, the L-90, featuring Lenco's IC electronics for automatic arm lift and shut-off at the end of a record. Philips showed some prototypes of yet-to-be-announced belt-drive single-play machines, while Connoisseur revealed the final version of the BD3 single-play machine which was only a prototype last year (note that the BD3 also has a 78-rpm speed). Goldring, known in the U.S. for its phono cartridges, has now presented us with a turntable as well, the CK2 manual. The new BSR belt-driven automatics, led by the Model 200 BAX, will all come equipped with ADC magnetic phono cartridges. And a handsome new import from England, the Ariston RD11E belt-drive manual, is distinguished by a metal-finish platter with two narrow rubber rings for record support and an unusually good rumble specification.

## TAPE EQUIPMENT

The pre-eminent event on the CES tape scene was of course the first public showing of the Elcaset cartridge format. Briefly, the Elcaset, comparable in size to a paperback book, was a joint development of Matsushita (Technics), Sony, and Teac. Although bearing a rough resemblance to the Philips cassette, it is considerably more complex in construction and uses  $\frac{1}{4}$ -inch tape operating at a speed of 3 $\frac{3}{4}$  ips. The most novel characteristic of the Elcaset is that the tape does not remain inside the plastic shell when in use. Instead, the tape machine draws it out to form a wide loop, and there—under the influence of the machine's own tape-guidance system instead of guides built into the plastic shell—it is passed across the tape heads for recording and/or playback.

There were three Elcaset tape decks presented at the show: the Models EL-7 and EL-5 from Sony/Superscope and a large undesignated model from Technics. (A Teac prototype was also displayed, but with no immediate production plans announced.) Technics' machine had bias and equalization switching for low-noise/high-output, ferrichrome, and chromium-dioxide tape. It also had four direct-drive motors—two for the dual-capstan tape-drive system and two for tape spooling—and separate erase, record, and playback heads, as well as a fourth head for the narrow "control" tracks that are an optional feature of this format.

The de luxe Sony EL-7 had three motors, one of which drives a dual-capstan system, and separate erase, record, and playback heads. The EL-5 had a single motor and two heads. All the machines had Dolby B-type noise reduction circuits and generally lavish control features such as would be found on the most elaborate cassette decks. Interestingly, the Sony machines were set up for low-noise/high-output, ferrichrome, and an as-yet-unspecified third tape type. Specifications were available for the Sony machines: with the EL-7, frequency response was 25 to 22,000 Hz  $\pm 3$  dB with ferrichrome tape; wow and flutter were 0.04 per cent (weight-*ed*), and signal-to-noise ratio was 62 dB.

If the Elcaset left show-goers intrigued, the developments in cassette equipment left

them impressed. In the area of three-head cassette decks particularly, there was a veritable inundation. First mention should go to the long-awaited Teac 860, which has been appointed leader of Teac's new Esoteric Series. The 860's three-motor, dual-capstan transport uses closely spaced record and playback gaps to reduce record-playback alignment problems. The machine is solenoid operated and incorporates—uniquely—the dbx compander noise-reduction system as well as Dolby circuits.

**B**y contrast, the three-motor Tandberg TCD 330's record- and play-head gaps are more widely spaced, and an alignment meter and test-tone generator are used to set up optimum alignment of the record head for each cassette. Recording- and playback-level controls are straightforward in the Tandberg manner. The machine is solenoid operated, with switching for two tape types ("normal" and "special"), and Dolby circuits for both recording and playback to facilitate tape monitoring. Both the Tandberg and Teac machines are front loaders.

A third machine is the three-head Akai GXC-570D, again with solenoids, and again with closely spaced head gaps (Akai's glass and crystal-ferrite heads are used). There are three motors with a dual-capstan tape drive. Front-panel record-equalization pots are provided, and they can be set with the aid of the Dolby calibration-tone oscillator and the machine's meters.

With the Lenco C-2003 we go back to the widely spaced head gaps, together with solenoids, dual-capstan drive, and two motors, but this time in a horizontal top-loading format. Hitachi offers both top loading (D/3500) and front loading (the new D/800) in horizontally oriented machines. The D/800 has light-touch mechanical controls, two sets of Dolby circuits for tape monitoring, and an intriguing illuminated "flow chart" on the front panel which indicates which circuits are in the signal path.

For the two-head cassette decks, we have space only for highlights. From Sony/Superscope: four new decks altogether, two front loading and two top loading. All have Dolby

circuits and limiters to prevent tape overload. Model numbers, in order of price, are TC-118SD (top loading), TC-135SD (top), TC-186SD (front), and TC-206SD (front). From Marantz there is the relatively inexpensive 5020 front loader with Dolby circuits, large meters, and handsomely styled slider-type level controls.

Four more new models join Teac's standard line, all front loaders and all Dolby-circuit equipped. Also, Teac has rounded out the beginning of the Esoteric Series with a high-quality stereo portable recorder, the PC-10.

Nakamichi's new Model 350 is a recording version of the cassette player built for the ADS/Nakamichi mobile stereo system. It can be had with a carrying case or with a car-mounting bracket for use in place of its playback-only predecessor.

Dual's second cassette deck, the C919 (about \$450), is not an auto-reversing machine, but it does have line and microphone mixing and front-panel Dolby calibration controls. Yamaha's two new offerings are a second (less expensive—\$310) machine in the unusual black-wedge shape (the TC-800D) and a more conventionally styled (for Yamaha) front loader, the TC-511S. From Pioneer, two new decks in the \$300 to \$400 price range, both front loading and both with the transparent convex cassette-well cover that has become a Pioneer trademark. The more elaborate of the two, the CT-F8282, has two motors and a solenoid-switched transport. The less expensive CT-F7272 has automatic switching to chromium-dioxide bias and equalization. Kenwood's line of cassette decks has jumped from one to three models this year with the addition of the de luxe KX-920 and the KX-720. Both load from the top.

**F**INALLY, we'd like to call your attention to the new Dokorder MK-550 top loader and the MK-610 front loader; the Clarion MK-7800, with the same clean styling as this company's other new components; Uher's first cassette deck (as opposed to recorder with built-in speakers), the CG-362; the Lafayette RK-D200 front-loader and the top-loading RK-D100; the Lenco PAC-10 cassette changer accommodating up to ten cassettes; and, lastly, the Sanyo RD 8400, which records and plays both cassettes and eight-track cartridges and can be set up to





The overwhelming success of the TV show called *Soul Train* brought disco out of the closet, so to speak (above, Hamilton Bohannon gets down)

Le Jardin, for instance (one of New York's landmark discos, originally for gays only, and now defunct), and that was a Problem, Bobby ("D.J.") Gut-tadaro, one of the best known and most respected disc jockeys around and one of the major contributors to the success of Le Jardin, blames the growing apathy of the crowd, saying that the people were becoming less interested in the music and more interested in "socializing." For whatever reasons, things began to go downhill, and there was a definite need for something more.

This feeling was expressed by the flight of the hard-core discotheque-ees from Midtown to Greenwich Village. In short order, there were discos springing up all over the Village. There was a small catch, however: what had been very public places became very private (members and guests only). Snobbish as it was, it did the trick, and business picked up. Styles of dancing remained pretty much the same; people still did the Hustle, still danced (variously) Latin, together-but-alone, or simply alone. One remarkable innovation, though, was a dance called the Machine, the Hollywood, or the Madison (depending on which part of town you were from), one of the most amazing dances ever to be seen on God's Green Earth. The dancers would line themselves up in long phalanxes, all moving their feet in synchronism to a fairly complicated step, producing a truly remarkable experience not only for the dancers but for the spectators as well. The first time I saw it I had the feeling that the dance was nothing less

than a political statement for the feet, the disco crowd physically demonstrating its solidarity against what they thought of (then) as the "straight" world. Whatever else it is, it is certainly impressive.

Of course, the men who market popular music caught on quickly; they were by now well aware of what had been happening. No longer did the radio programmer make the hits, so it was the *disco* D.J. who was now being flooded with promotional copies of records to sift through, select, and play to death. (Incidentally, the technique of spinning a turntable, of mixing different songs into one continuous flow of music according to the mood of the crowds, had also become something of a minor art. The boys in the booth had become, like their radio equivalents, true professionals, and they knew how to make a dance floor *jump*.) Record companies began to set up special disco a-&-r departments to produce disco records and special disco promotion departments to persuade the disc jockeys to play them in the clubs. In some cases this has worked very well, selling records in great quantities. Suddenly, records by groups unknown outside disco circles began to be certified gold by the RIAA.

As word of the new dancing madness filtered up to the straights, business boomed at dancing schools offering instruction in the new steps. And some midtown discos opened at noon for lunch-hour dancing by office workers who could not stay up all night in the really hip discos, where the action begins in earnest only at midnight. The fad aspect of the disco phenomenon attracted the International Jet Set in much the way the Twist, Chubby Checker, and the Peppermint Lounge had in the Sixties. New York's *haut monde* in 1976 could dance to disco music in such elegant (and expensive) surroundings as Regine's, an Art Deco club in Delmonico's Hotel, or in some of the funkier clubs downtown. Disco music became the walk-on music at so many fashion shows that professional dancers were hired instead of the usual models to boogie down the runway displaying the latest clothes by such designers as Yves St. Laurent.

Today, there seems to be more interest nationwide in disco music than ever before, especially beyond the provincial boundaries of New York and Los Angeles (*Soul Train's* origin point)—a state of affairs that is a trifle ironic, for the quality of today's disco music increasingly seems to be of less importance than the fact that it is just *there*. A certain spark seems to have been lost in the shuffle (or was it the Hustle?).

There are still a lot of good songs coming from New York, L.A., Philly, and elsewhere, but more than ever the music's detractors, who have cried "formula" since the boom started, are in some ways being vindicated—as witness the current lamentable trend of taking old songs and shooting them up with a disco beat: *Brazil*, *How High the Moon*, *Baby Face*, the theme from *Exodus*, and yes, even the theme from *I Love Lucy*, now called *Disco Lucy*. This kind of low-rent, high-camp fodder could well signal the death of the music.

When I questioned him about a possible decline in the current disco output, Bobby D.J. was generally evasive. "Sure, there's garbage," he said, "but as long as there are people who like to dance there will always be disco." Bobby currently "tables" (that's *turntables*, of course) at Infinity, one of the "cheeker" (as we say in the Village) discos (members and guests only), and according to him there is virtually no difference in quality between the records he is spinning now and those he spun at Le Jardin a couple of years ago. What makes disco music viable *as music*, he maintains, is that "it's shown people that dance music isn't something that's just thrown together and put on a juke box." In general, I'd have to agree; the amount of sophistication and plain hard work that go into the production of a genuinely successful dance record is astonishing, and even though I am a bit disappointed with the quality of most of what I'm hearing now, there are still plenty of new records around that delight me. A few that come to mind as of this writing include Pat Lundy's *Day by Day*, Vicki Robinson's *Turn the Beat Around*; and the remake of the Supremes' *I Hear a Symphony* by Hank Crawford.

AND so the beat goes on. And on. And on. Disco will undoubtedly be with us for some time to come, and is, in fact, in the process of going International. The members of Atlantic's Average White Band, one of their hotter disco acts, are Scottish; one of the biggest hits of 1975, *Fly Robin Fly*, was by a German group (the Silver Convention) out of Munich, and it is possible that all this may eventually work its way back to Paris, where it began in the first place. But as to whether a Barry White or a Gloria Gaynor will ever be revered the way rhythm-and-blues or jazz greats like Chuck Berry and Ray Charles are today, or whether disco as a *music* will go the way of the Twist, only time will tell. In the meantime, you can, as that felicitously named Frisco disco has it, Dance Your Ass Off. □





### RECOMMENDED DISCO DISCS

- Donna Summer: "Love Trilogy," OASIS OCLP-5004.
- Roberta Kelly: "Trouble Taker," OASIS OCLP-5005.
- Gloria Gaynor: "Experience," MGM MG3-4397.
- Silver Convention: "Save Me," MIDLAND INTERNATIONAL BKL1-1129.
- Disco Tex and His Sex-o-Lettes, CHELSEA CHL-505.
- Vicki Sue Robinson: "Never Gonna Let You Go," RCA APL1-1256.
- Barry White: "Stone Gon'," 20TH CENTURY T-423.
- Jackson Five: "Moving Violation," MOTOWN E5RS-7570.
- LaBelle: "Nightbirds," EPIC KE 33075.
- First Choice: "So Let Us Entertain You," WARNER BROS. BS 2934.



Disco-hitters, clockwise above, are: the Jackson Five (Motown), LaBelle (RCA), the First Choice (Bell Records), Billy Paul (Philadelphia), the Main Ingredient (RCA), Gloria Gaynor (Polydor), the Spinners (Atlantic), Silver Convention (Midland International), and Barry White (20th Century).







# The Great American Symphony

By Eric Salzman

**B**ACK in the good, old, simpler days, literary people used to talk a great deal about The Great American Novel, the large-scale social epic in the form and tradition of the European nineteenth-century novel that would somehow epitomize the American experience. In the same vein, a whole generation of American composers set itself to write The Great American Symphony, a serious, American version of another great tradition, with impact and wide appeal. Did they succeed? Questions of virtue and ultimate value have yet to be answered, but what we do know is that the development of a distinctive American symphonic school was a major event in American cultural history and that the achievements of that school are up for substantial re-evaluation.

The parallels between the development of the novel and symphony are quite suggestive. Both forms were born in the eighteenth century and reached high points in the nineteenth; both are strongly connected with the rise of middle-class culture; and both forms were brought to America, where they had a late flowering. The novel fared better in nineteenth-century America with the writings of men like James Fenimore Cooper, Herman Melville, and Nathaniel Hawthorne; there are no symphonic works of comparable im-

portance. But the Great American Novel phenomenon really refers to all those turn-of-the-century social sagas, and it was just at that period that a real American consciousness began to emerge in art music. It was not The Symphony yet, but it *was* American.

The first American composers to take the question to heart were of the generation born in the 1860's and 1870's. Arthur Farwell, born in 1872, was perhaps the first strong spokesman for the "new and daring expressions of our own composers, sound-speech previously unheard"; he founded the Wa-Wan Press to publish new American music. Farwell's work and that of Henry F. B. Gilbert (1868-1928) used American Indian and black music as sources of inspiration. After the turn of the century, ragtime and other elements of pop music engaged the interest of composers searching for an indigenous American style. Besides Gilbert (*The Dance in the Place Congo* and *American Dances in Rag-time Rhythm*), perhaps the most outstanding was the more sophisticated John Alden Carpenter (*Adventures in a Perambulator* and *Krazy Kat*, both ballet scores).

**B**UT whatever their talents, virtually all of the composers of that time suffered greatly from certain facts of musical life. A truly American symphonic school was an impossibility in a situation where the orchestras and concert institutions were almost entirely made up of and controlled by artists with a thoroughly European (mostly Central European) classical orientation. The best that could be hoped for under these circumstances was a folk-music frosting on a Dvořákian, Brahmsian,

or—in the more advanced cases—Wagnerian or Debussyian cake.

Of course, if you didn't have any hope of getting much music performed and didn't even *try* to function in musical society, you might do something else: Charles Edward Ives went into the insurance business and wrote what he pleased on his own time. And Ives, unknown to Arthur Farwell—or to almost anyone else, for that matter—singlehandedly created that "daring speech-sound" in a completely American vein. Most of the other composers of that day could manage a bit of Americana in a suite or dance score; Ives actually created a real symphonic style. There are four numbered symphonies, two other works of full symphonic dimensions, and a series of shorter pieces for chamber or theater orchestra. In the Fourth Symphony, the *Holidays*, and *Three Places in New England*, Ives did in fact create The Great American Symphony—but nobody knew it. His personal melting pot, with its peppery mixture of dissonance, tradition, folk and popular music, Emersonian philosophy, and old-time high spirits, emerged outside the American musical establishment. Some of his music began to be performed in the Twenties and Thirties, but it did not really begin to have any important influence on the course of things until the Sixties. The American symphonic school, which was a development of the Twenties, Thirties, and Forties, was formed without any influence from the single composer who had already produced a really individual, American symphonic style before World War I. (Ives did influence such composers as Henry Cowell, Lou Harrison, and Hen-





The American symphonic movement produced a broad body of excellent, expressive, and poetic work that can stand beside any of the other achievements of American art.

ry Brant, but not in the symphonic direction.)

American cultural life changed radically after World War I, and the development of a new American music was an important part of that change. Prosperity, the jazz age, the influence of European modernism, a new self-consciousness and a specifically "American" awareness, the romance of the machine age, and the credo of Progress were the background for a flourishing musical life on all levels.

ONE big influence in the Twenties was, of course, jazz. But there was another. As the old, genteel musical culture, with its Central European biases, faded in importance, a strong French or (more accurately) Franco-Russian influence came to the fore. This might seem like trading one set of overseas influences for another, but there was an important difference. The Germanic sway had been confining, traditionalist, and academic. The French and Russian approach was modern, open to cross-currents, and closer to the vein of popular and folk influences still waiting to be mined. The long procession of returning American students of Nadia Boulanger (beginning with Aaron Copland) and the presence and, in varying degrees, the Americanization of such musicians as Edgard Varèse, Serge Koussevitsky, and Igor Stravinsky were major factors in our musical life. The new fascination with the sound of jazz and the free, rich, fluid, modal qualities of modern European harmony and rhythm encouraged American composers to experiment with the problems of mating popular sources to symphonic sound

and form. The most famous issue of this match was, of course, Gershwin's *Rhapsody in Blue* (slightly illegitimate, but all the more fascinating for that). The jazz works of Copland are of equal note: *Music for the Theater* and the Piano Concerto are the most important. Other composers went at it as well, most notably Louis Gruenberg (*The Daniel Jazz and Jazz Suite*).

Despite the success of individual works, there was to be no real jazz symphony, and the direct impact of the music was surprisingly short-lived. The really dominant note in American new music during the Twenties was avant-gardism. The work of Varèse, Ruggles, Cowell, Antheil, and others, although stylistically diverse, was all characterized by a devotion to new and advanced musical ideas. Most of these composers wrote for orchestra, using the large modern symphony as a clangorous or highly dissonant, heterogeneous color mass, but a great deal of their activity was concentrated in the field of chamber music. Was the new American music going to turn out to be something quite far removed from nationalism and popular sources? Many thought so. Varèse, who called his first large work in the new style *Amérique*, was consciously trying to capture something big and new that would express the dynamics of the burgeoning American civilization as he understood them. This association of new music with the machine age permeated musical thinking in the Twenties. Even Copland was not immune; his *Piano Variations* of 1930 is pure age-of-steel music, and he wrote orchestral music in this vein as well.

With the advent of the Great Depres-



sion, however, still further changes in musical and cultural life took place. The modernist tendencies of the Twenties gave way to new social concerns and, in one form or another, social realism was born. The old genteel audience was the social elite, but the public for modern music was the intellectual middle class. In the Thirties, composers became aware of and involved with the much larger audiences whose cultural interests were being formed by popular music, radio, and the movies. The challenge was to find or create a contemporary "serious" style that could reach a large or even a mass audience, one that had not been nourished by the classics or by intellectual modernism. For many, this movement—which was by no means restricted to America—had political significance; others adapted its ideas to nationalistic ends; still others merely swam with the tide. But a tide it was—within a few years it swept modernism aside and came to dominate American music until the Fifties and the re-emergence of modernism. (It dominated the other arts as well—see, for example, the paintings of Edward Hopper or of Thomas Hart Benton.)

The new Americanism of the Thirties was a conscious revival of nationalism and folklore (our lately current folk and folk-pop movements are heavily indebted to this earlier interest). The in-



# Symphony

The sound of this music, although at first somewhat trashed by movie-music imitators, is now part of our tonal subconscious; it is part of our heritage whether we realize it or not.

fusion of folk, jazz, and popular elements into "serious" music occurred first and principally in the theater, in modern dance, and in film music. Music written in these genres is not "pure" music, but it was symphonic and had an enormous impact. Here again we find the name of Copland in the forefront, most notably with his famous ballets *Billy the Kid*, *Rodeo*, and *Appalachian Spring* and a series of notable film scores as well. Copland wrote fewer purely symphonic works, but these were influential too; his Third Symphony of 1946 seems almost to be a symphonic summing up of the period.

While the importance of Copland is undeniable, the creation of a recognizably American symphonic style owes at least as much to Roy Harris, once rated as one of the country's leading composers and now only slowly coming back from a long period of neglect. Unlike his confreres, Harris was not much involved with folklore or with the theater and films; he put his principal creative energies into symphonic music. The Americanism of Harris' music is not really a function of a conscious use of Americana (his *Folksong* Symphony came somewhat later) but was built into his style from the very beginning: expansiveness, fluidity, and cross-rhythms; a very free melodic style; the use of ostinatos and block, polychordal harmonies built on triads, fourths, and fifths that give it that wide-open-spaces *American* sound we've come to know and love so well. These characteristics—they are also, to be sure, found in Copland and elsewhere—are developed with a real symphonic breadth in works like the Harris Third Symphony of 1938, perhaps the best candidate we have, after Ives, for the title of Great American Symphony.

Copland and Harris established a recognizably American symphonic idiom which has been much imitated. Their influence has extended not only to other concert composers but even to the popular field and—most particular-

ly—to the film industry, which has made the style all too common musical coin. But let us not confuse the originals with, or blame them for, the sins of their imitators; Harris' music, past and current, deserves a rehearing and re-evaluation on its merits as well as its historical importance.

Although the Copland/Harris style was pivotal, it by no means tells the whole story. Probably the most articulate and individual proponent of Americanism and the new simplicity in symphonic music was Virgil Thomson. Thomson, who spent formative years in Paris and was later music critic of the New York *Herald-Tribune*, turned to American sources in the Twenties with his *Symphony on a Hymn Tune*, in several collaborations with Gertrude Stein, and in four documentary film scores, notably *Louisiana Story* and *The Plow That Broke the Plains*. Thomson's starting point was the familiar triad harmony of American hymnody, and because of this his music has—in spite of (or perhaps because of) the composer's intellectual sophistication—a strong popular sensibility.

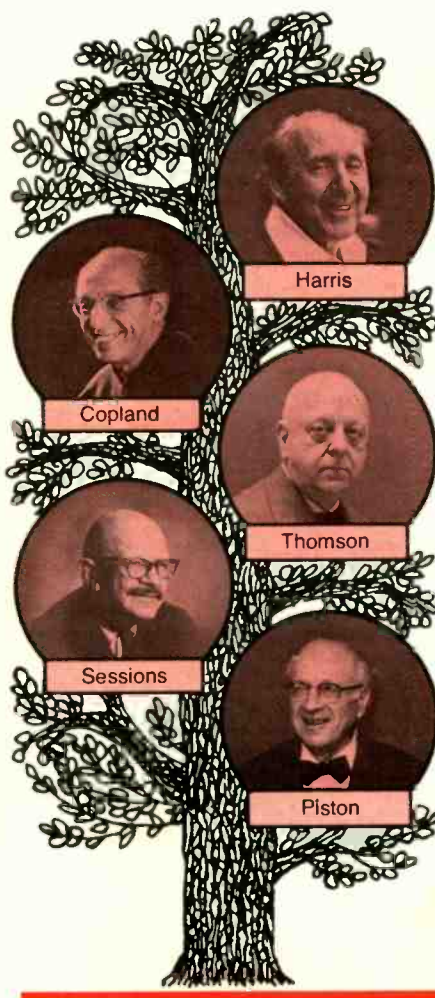

Henry Cowell was one of the few composers associated with the radical music of the Twenties who became identified with later populist symphonic movements. Cowell was deeply involved with folklore, not just from North America but from all over the world; in the Forties and later he produced a whole series of symphonies incorporating these elements.

It is remarkable how close the composers of this new American symphonic music were to each other in age. Thomson was born in 1896, Cowell in 1897, Harris in 1898, and Copland in 1900. Our picture of this era in American symphonic music can be rounded off with a mention of two other composers of virtually the same age: Roger Sessions (b. 1896) and Walter Piston (b.





1894). Both Sessions and Piston were university professors for many years; both started as neo-Classicists, and both retained strong traditional elements in their work. But while Piston remained the staunch Classicist, Sessions' work evolved into dissonance, expressionism, and ultimately a very intense, American form of twelve-tone symphonism. As we shall see, Sessions led the evolution of the American symphony from the open, tonal-modal forms of Harris to the introverted modern-traditionalism of its final phases.

As American music became more and more accepted in the concert hall, large symphonic forms became the dominant mode of American music. One branch of a by-now well-rooted tree might be represented by the kind of neo-Romanticism one finds in the work of Samuel Barber or, in a very different way, that of Howard Hanson, the least American of American symphonic composers. Unlike most of the composers discussed so far, Barber and Hanson are associated with conservatories. American conservatories have always been conservative, performer-oriented institutions and, on the whole, the most creative American composers have been self-taught, European-trained, or university products. However, beginning just before World

War II and continuing for almost two decades, conservatories and conservatory-trained composers came to occupy a central place in American music. This development was strongly associated with the development of a relatively conservative, non-folkloric symphonic style, and that style's leading composers are still among the big guns of American symphonic music: William Schuman (b. 1910), Vincent Persichetti (b. 1915), David Diamond (b. 1915), Norman Dello Joio (b. 1913), and Peter Mennin (b. 1923). The work of these composers is related, and they virtually form a school and a style: big, traditional symphonic forms; long, slow-developing melodic lines; polychordal harmonies with a certain spice; strong, pulsating rhythms; and broad, pungent orchestral color. Another Third Symphony—William Schuman's—is one fine example. Its movements—Passacaglia, Fugue, Chorale, and Toccata—are not (contrary to the titles) really neo-Classical at all but show an absorption of tradition into a distinctive, very secure contemporary symphonic vocabulary. Schuman has more than a bit of Americana in some of his music, but works like the Third Symphony are American in a more general way: in their scale, rhythmic and harmonic bite (distantly jazzy), and their brassy (literally and figuratively) confidence and optimism.

AFTER World War II, two strong directions in American symphonic music seemed apparent. One group of composers, including Roger Sessions and (to many people's surprise) Aaron Copland, moved strongly in the direction of chromaticism, atonality, an intense symphonic expressionism, and even twelve-tone theory. The other, under the influence of Stravinsky and, to a lesser degree, Hindemith (both were active in America), espoused a lively neo-Classicism. This group, including Arthur Berger, Ingolf Dahl, Irving Fine, and Lukas Foss, produced music full of elegance and wit—American most of all in its rhythmic vitality, otherwise related to international developments. This rather brief flowering of American neo-Classicism faded quickly and merged into the growing expressionist and twelve-tone movement.

The impact of expressionism and the twelve-tone method on American music would require a whole chapter of a book unto itself. Schoenberg's first American pupils were Adolf Weiss (who probably wrote the first American twelve-tone music) and Marc Blitzstein (who moved in a populist, anti-modernist direction in his music-theater works). But Carl Ruggles had already created a distinctive American expres-





# Symphony

The orchestra as an institution is a kind of economic anachronism which survives in this country on prestige and handouts.

sionism in his large-scale, dense symphonic works beginning after World War I, and Wallingford Riegger applied chromatic ideas to symphonic forms over several decades beginning in the Thirties. World War II brought a number of major Central European composers to this country—most notably Schoenberg himself, but also Ernst Křenek and Stefan Wolpe—and their influence was felt. In 1950, Ross Lee Finney, a student of Boulanger and also of Alban Berg, began to use tone rows in symphonic and chamber works; Sessions was doing the same by 1953. The infiltration of chromaticism and twelve-tone ideas, strongly resisted at first, became amazingly rapid; by the early Sixties one could say that the twelve-tone symphony had become the norm, the style of the mainstream of new American concert music. All of the previously mentioned neo-Classicalists incorporated these ideas into their work, and a whole new generation of composers (Ben Weber, Leon Kirchner, Hugo Weisgall, Andrew Imbrie, Milton Babbitt, Ben Weber—all but the last pupils of Sessions) had come up, and chromaticism was their natural mode of speech.

The latter-day twelve-tone symphony may seem a far cry from the simpler verities of a Roy Harris work of the Thirties, but there are more connecting links than might at first be apparent. The American symphony was never a static thing but a constantly evolving search for expression, and if we follow the steps of that evolution we will understand that the development had its own inner logic. The twelve-tone symphony is as much a part of the history of American art as the abstract expressionist painting which was its visual counterpart.

**W**E are not quite at the end of our story. The symphony in the traditional sense could not play much of a role in the revolutionary and avant-garde arts of the Sixties here. In Europe, where orchestras are state-supported, many of the younger composers did return to the symphony orchestra as a contem-

porary means of expression. This was much less true in the United States, where the orchestra was never as well acclimated. Nevertheless, the works of Varèse had a major revival, and composers like Stefan Wolpe and his pupil Ralph Shapey showed that it was still possible to use the orchestra in new ways as a medium for far-out styles. Even the two doyens of American new music, John Cage and Milton Babbitt, did some work for symphony orchestra. Elliott Carter, another outstanding figure to come to the fore in the Fifties and Sixties, evolved his complex style with some respect to the orchestra and the traditions of orchestral/symphonic writing. And there are a few younger composers—Gunther Schuller and Charles Wuorinen, for example—who have carried the twelve-tone idea as well as some of the basic principles of symphonic tradition down to today.

It would nevertheless be naïve to pretend that, in the sense in which we have been talking, The Great American Symphony is alive and well today. New music has had, for many years, a soloistic and chamber orientation and, more recently, has turned to mul-

ti-media, dance, and theater for inspiration and outlets. The orchestra as an institution is a kind of economic anachronism which (to put it bluntly) survives in this country on prestige and handouts. It was formed in the late eighteenth and nineteenth centuries for the music and the culture of another time and another place—for which it is, of course, still perfectly adapted. It has suffered the sea change to late twentieth-century America with more than its share of difficulties, and it is less well adapted here and now. The notion of using the Classical symphony orchestra and Classical/Romantic symphonic form as a means of reaching a wider and more popular audience—some such goal is perhaps the essential aim of The Great American Symphony—was a brave one, but, short of massive public support and a different public attitude toward classical music, it was bound to have its problems.

**S**TILL, it has had its successes too. Looked at with some perspective, it can be seen to be an essential part of a vital era in American music. The American symphonic movement produced a broad body of excellent, expressive, and poetic work that, at its best, can stand beside any of the other achievements of American art. Even if this music is still out of favor in the concert hall, we can appreciate it—all the more, perhaps—through our recorded museum-without-walls. I would go further and, amid a plethora of actual revivals and mere revival prophecies in other areas, predict that the best of this music too will be re-evaluated and heard again. Will it re-enter the mainstream of American musical life? In a way, it has never left. The sound of this music, although at first somewhat trashed by movie-music imitators, is now part of our tonal subconscious; it is part of our heritage whether we realize it or not. It has penetrated into folk, pop, and folk-rock—a bit of historical justice, since the folk and folk-rock movement traces its origins directly back to the folk revivals of the Thirties. The Seventies sometimes even *feel* like the Thirties, and some of the sound of recent new music owes something to the old American school (I'm thinking of some of the Soho group and of Michael Sahl, a composer of a lyric-popular American symphonic bent if ever there was one). But if The Great American Symphony comes back in a big way—in revivals or in the form of new works—something will have to have happened to the symphony orchestra and its audience. Unlikely, perhaps, but no bad thing: all that lovely music is still there waiting to be heard and re-understood. □

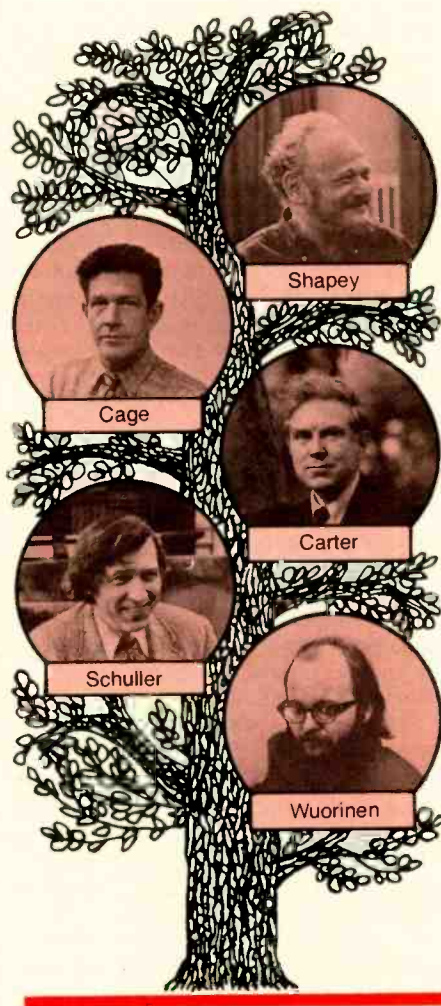



# The new Sherwood S7910: State-of-the-Art for under \$500.\*

In the past few years, good specifications have become a relative commonplace in the consumer electronics industry.

And, as the statistical gaps between comparably priced units lessened, other factors gained more importance. Most notably, design and the componentry that's used.

Nothing could suit us better. For twenty-three years, the strength of our reputation has rested primarily on the excellence of our engineering.

The new S7910\*\* is a case in point.

**With a power output of 60 watts per channel [minimum RMS at 8 ohms from 20-20,000 Hz] with no more than 0.1% Total Harmonic Distortion, the S7910 is clearly equipped to serve as the center point of the most progressive music systems.**

More to the point, though, is the componentry that permits this capability. The output devices are paralleled OCL direct-coupled. This configuration, combined with the high voltage and current ratings of the output devices, creates an extremely stable circuit. Additionally, the massive power transformer and twin 12,000  $\mu$ f filter capacitors, backed by a zener regulated secondary power supply, ensure the S7910's ability to perform well beyond the demands of normal use.

The S7910's IHF FM Sensitivity rating is 9.84 dBf [1.7  $\mu$ V]. That's one of the finest ratings attainable—and it can only be achieved through the utilization of superior componentry. 4-ganged tuning capacitors. Dual-Gate MOS FET's. Phase Lock Loop MPX. Ceramic FM IF Phase Linear Filters. And Sherwood's newly-developed digital detector, which introduces virtually no distortion to the signal and never requires alignment.

The front panel of the S7910 reflects every significant function of current hi-fidelity technology. And again, the componentry behind the faceplate is the finest available. [For example, the 3-stage Baxandall tone circuit employed for the Bass and Treble controls.] Other features, such as the Master Tone Defeat switch, switchable FM deemphasis and FM Stereo Only, and two front panel tape dubbing jacks, contribute to an operational versatility that is truly outstanding.

In every respect, the S7910 demonstrates the attention to detail, the on-going effort to refine existing solutions and discover better ones, that has characterized Sherwood throughout the years.

You might be able to find another receiver in this price range that offers similar specifications—on paper.

But you won't find a receiver that's been more meticulously designed, or more carefully produced.

At Sherwood, we approach the business of creating receivers like an art.

Because no approach brings you closer to reality.

**Sherwood Electronic Laboratories, Inc.  
4300 North California Avenue  
Chicago, Illinois 60618**

For a more complete description of Sherwood's unique approach to audio equipment engineering, write to the address above. We'll mail you a copy of our new brochure, "The anatomy of high performance design," along with detailed information about the new S7910.

 **SHERWOOD**  
Everything you hear is true.

\*The value shown is for informational purposes only. The actual resale price will be set by the individual Sherwood Dealer at his option. The cabinet shown is constructed of select plywood with a walnut veneer covering.

\*\*Model S8910 offers identical specifications and features, but is FM only.

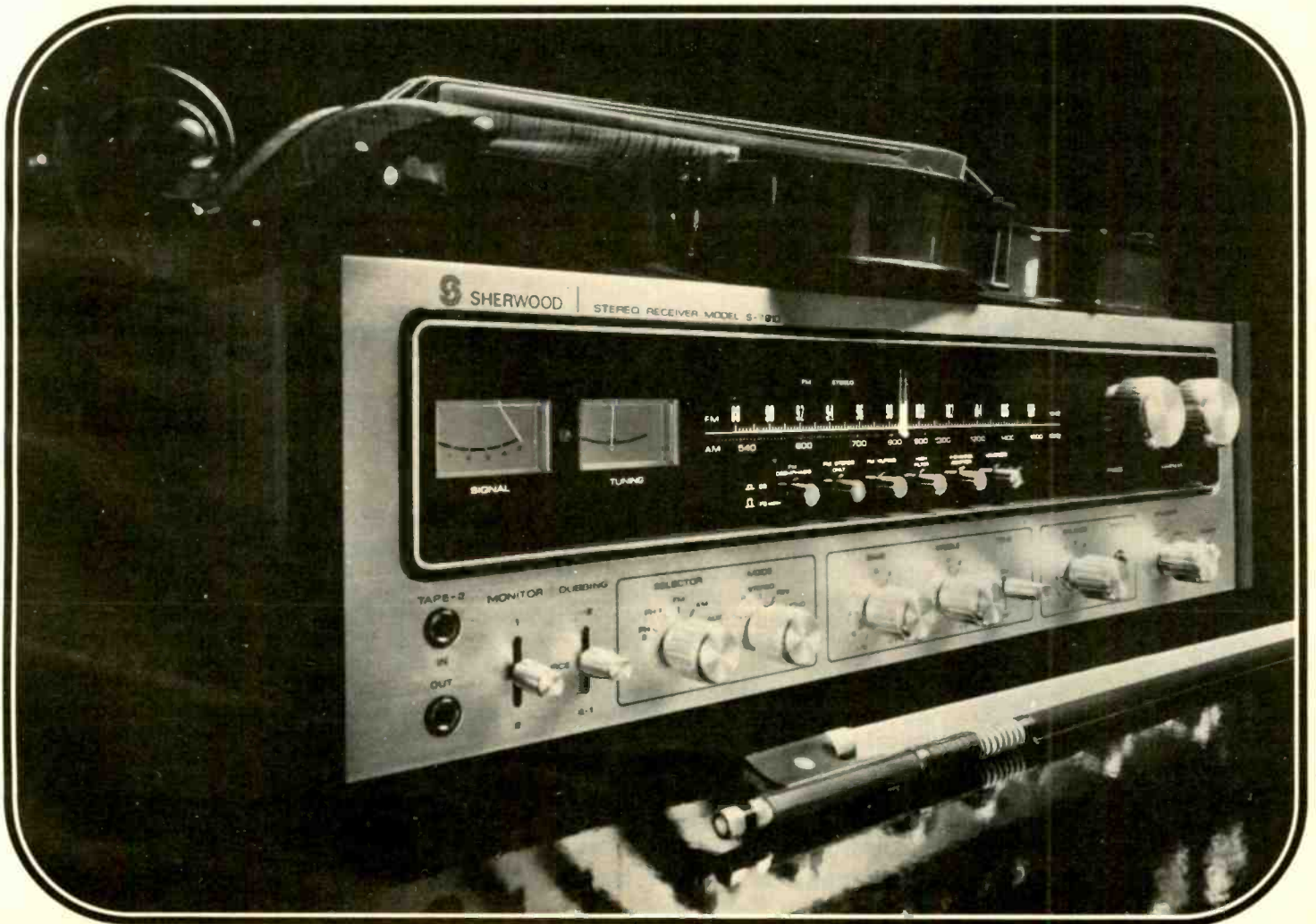



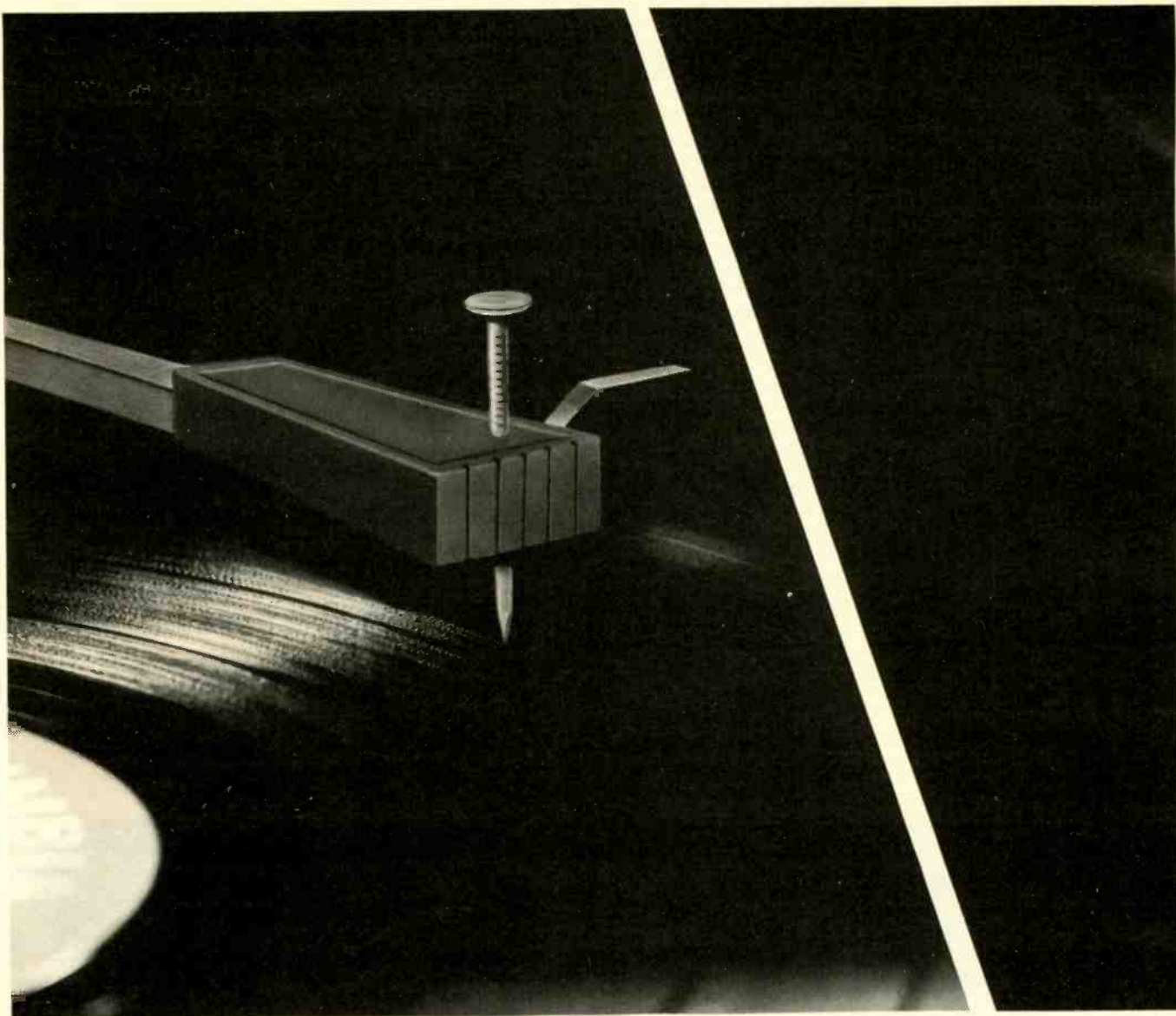

## This is no way to nail down a hi-fi bargain.

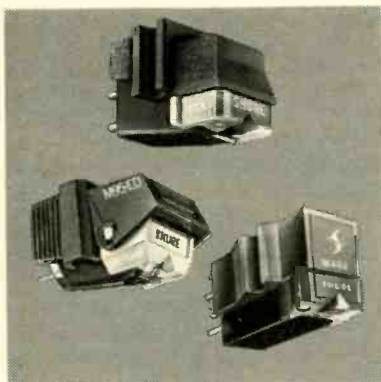

Some stores think that one of their cost-cutters in assembling a "bargain" stereo system is to install a run-of-the-mill, inexpensive cartridge. After all, who's going to notice a tiny cartridge when it's surrounded by powerful speakers and a dynamite turntable? Unfortunately, some shoppers are reluctant to insist on a better cartridge when buying one of these package specials. But *you* are made of sterner stuff! And if you insist on a Shure cartridge, "better" doesn't have to mean more expensive. Time and time again, consumer magazines have rated Shure cartridges the best in their price category. As the source of sound for the entire system, that tiny Shure cartridge and its critical stylus determine what you'll ultimately hear. And as bargains go, that's the best tip you'll hear today—or any day!

Shure Brothers Inc.  
222 Hartrey Ave., Evanston, IL 60204  
In Canada: A. C. Simmonds & Sons Limited



Manufacturers of high fidelity components, microphones, sound systems and related circuitry.

CIRCLE NO. 54 ON READER SERVICE CARD



# STEREO REVIEW'S SELECTION OF RECORDINGS OF SPECIAL MERIT BEST OF THE MONTH



RCA



CARLO BERGONZI: sound and style are inseparable

## Tenor Carlo Bergonzi Conducts a Resoundingly Triumphant Master Class for Verdians

**C**ARLO BERGONZI SINGS VERDI: Thirty-one Tenor Arias from *Oberto* (1839) to *Falstaff* (1893)—so reads the full title of a remarkable new three-disc set from Philips. The music ranges from simple cavatinas to elaborate scenes with choruses, and it includes arias—with or without recitatives, with or without cabalettas—that call for a full range of tenor voices, from the light lyric Fenton to the fully dramatic *Otello*, with the result that we are given a rare and fascinating overview of Verdi's musical development from the early Donizetti-like writing in *Oberto* and *Un Giorno di Regno* to the unmistakably individual sound of his later years. A project as ambitious as this, however desirable, is naturally subject to many pitfalls. Fortunately, since it was entrusted to Carlo Bergonzi, it is a resounding triumph.

There are tenors before the public today who surpass Bergonzi in sensuous

tonal beauty, and he was never noted for a powerful sound. But we must go all the way back to Tito Schipa to find his match in tonal refinement, elegance of phrasing, and innate musicianship. Like Schipa, he is a master of dynamic gradations, commanding so many shades above his pianissimo that he can create a fortissimo effect without actually resorting to loud singing. The floated *diminuendo* is another Bergonzi specialty, and if you wish to examine his handling of the phrases "*dove mortal non va*" (*I Lombardi*) and "*dell'immortal mio di*" (*Attila*) you will find this point clearly illustrated.

There is a dramatic *rightness* in Bergonzi's singing that is achieved without excessive stresses, intrusive aspirates, or other distortions of the vocal line, and he enunciates recitative passages clearly and meaningfully. Young Foscari's heartbreaking scene in his prison cell (*I Due Foscari*) is masterfully real-

ized, Corrado's Romance is filled with dejection (*Il Corsaro*), and Riccardo's "*Ma se m'è forza perdeti*" (*Un Ballo in Maschera*) simply rings with melancholy pathos.

Rodolfo Celletti makes some excellent points in his jacket annotations about Bergonzi's skill as a Verdi interpreter. A conscientious adherence to the composer's notations is one of the components: observed trills in "*Ah, sì, ben mio*," Verdi's seldom-followed though written-out cadenza at the end of "*Parmi veder le lagrime*" (*Rigoletto*), and the controversial *morendo* ending in "*Celeste Aida*." With Bergonzi, sound and style are inseparable; whatever he may lack in tonal richness he makes up for in refinement. The total achievement is surpassingly beautiful, a kind of "how-to" textbook for singers—and for teachers.

These are all new recordings: the excerpts from *Attila* and *I Masnadieri* are



taken from the complete sets already released by Philips, the others have been made expressly for the present collection. Not everything, to be sure, is flawless; Bergonzi is past fifty, and it would be foolish to pretend that he still has the full complement of lavish vocal gifts he displayed, say, ten years ago. The *Luisa Miller*, *La Forza del Destino*, and *Il Trovatore* scenes do not quite equal his earlier statements in the various complete sets. The two high C's in "Di quella pira" are very effortful, and other passages in the high register show signs of strain. On the other hand, he can now project a credible, contemplative, suffering Otello in a manner that would have been beyond the reach of his lighter timbre some years ago. But the reservations are few and the rewards are many in this exceptional survey. And Nello Santi, surely not a consistently satisfying conductor in previous endeavors, supports the singer with sensitive and judicious orchestral backgrounds. Occasionally, I think, the orchestral tone has been scaled down by the engineers to accord with the singer's modest dynamic range, but the overall sound is clear and well balanced, if not the richest imaginable.

It is my understanding that Philips, underestimating public interest, was originally reluctant to release this set domestically but was persuaded to do so by insistent inquiries. Evidently there are more connoisseurs of fine singing in this country than the industry suspects. They will find this album a treat.

George Jellinek

**CARLO BERGONZI SINGS VERDI.** *Ober- to: Ciel pietoso. Un Giorno di Regno: Pietoso al lungo pianto. I Lombardi: La mia letizia infondere. Ernani: Mercè, diletti amici . . . Come rugiada al cespite. I Due Fos- cari: Non maledirmi, o prode. Giovanna d'Arco: Sotto una guercia. Alzira: Irne lungi. Attila: Ella in poter del barbaro. . . Cara patria; Che non avrebbe il misero. Macbeth: Ah, la paterna mano. I Masnadieri: O mio castel paterno; Come splendido . . . Di ladroni attorniato. Il Corsaro: Eccomi prigionero . . . Al mio stanco cadavere. La Battaglia di Legnano: La pia materna mano. Luisa Miller: Quando le sere al placido. Rigoletto: Questa o quella; Ella mi fu rapita . . . Parmi veder le lagrime; La donna è mobile. Aroldo: Sotto il sol di Siria ardente. Il Trovatore: Ah si, ben mio; Di quella pira. La Traviata: De' miei bollenti spiriti. Simone Boccanegra: Sento avvampar nell'anima. I Vespri Siciliani: Giorno di pianto. Un Ballo in Maschera: Di' tu se fedele; Ma se m'è forza perderti. La Forza del Destino: Oh tu che in seno agli angeli. Don Carlo: Io la vidi. Aida: Celeste Aida. Otello: Dio! mi potevi scagliar; Niun mi tema. Falstaff: Dal labbro il canto.* Carlo Bergonzi (tenor); Ambrosian Singers; New Philharmonia Orchestra, Nello Santi cond. Royal Philharmonic Orchestra, Lamberto Gardelli cond. PHILIPS 6747 193 three discs \$23.94.



JAN DEGAETANI AND GILBERT KALISH

## Songs of Charles Ives: A Listening Experience One Is as Eager to Share as to Repeat

**M**EZZO-SOPRANO Jan DeGaetani and pianist Gilbert Kalish have recorded seventeen songs of Ives for Nonesuch. The very names of these performers by now carry an assurance of exceptional pleasure, but they can only hint at the depth of satisfaction to be found on the disc. Though the performances add up to a staggering display of virtuosity—there is such a range of characterization and of emotional level, and can anyone really enunciate intelligible words as rapidly as Miss DeGaetani does in the first part of *Memories*, let alone intersperse whistling?—it is the richness and variety of the songs themselves that are the most impressive elements of the whole.

Whether it is a poetic reverie such as *The Housatonic at Stockbridge*, the high-spirited *Circus Band*, the touchingly simple *A Christmas Carol*, the militant *Majority*, the spiritual-like *In the Mornin'*, or the perky, subminiature *Ann Street*, each song comes off with such utter conviction that all previous efforts are made to seem, to a greater or lesser degree, mere gropings toward the musical truth revealed here. Comparisons are, in any event, pointless. This is genuine inspiration, a listening experience that really cannot be described but which one is as eager to share as to repeat. It is one that offers, in the more familiar songs as well as in the lesser known ones, a real sense of discovery.

The collection is not only an econo-

mical one, but remarkably free of duplication problems. For example, there is only one song here which is sung by Helen Boatwright in her part of Columbia's five-disc Ives centenary package (M4-32504), though two others are presented therein in arrangements for chorus and orchestra. The recorded sound is first-rate, and if Mr. Kalish's Baldwin swamps Miss DeGaetani's voice now and then, well, it seems as right in this material as it is in the similar instances in the Ives violin sonatas. Nonesuch, with characteristic thoughtfulness, has embellished the release with an outstandingly good set of notes by Ives historian Vivian Perlis, and there is an insert with full texts of all the songs.

Richard Freed

**IVES: *The Housatonic at Stockbridge; Memories (A—Very Pleasant; B—Rather Sad); From "Paracelsus"; The Things Our Fathers Loved; Ann Street; The Innate; The Circus Band; In the Mornin'; Serenity; Majority; Thoreau; At the River; The Indians; The Cage; Like a Sick Eagle; A Christmas Carol; A Farewell to Land.*** Jan DeGaetani (mezzo-soprano); Gilbert Kalish (piano). NONESUCH H-71325 \$3.96.

## A Vigorous, Committed First Recording for Verdi's Neglected *Il Corsaro*

**H**ISTORY has not been kind to Verdi's *Il Corsaro*, though in all fairness it must be said that the composer wasn't either. He had been drawn to Byron's narrative poem *The Corsair* in 1846, after the completion of *Attila*, and he agreed to turn it into an opera for publisher Francesco Lucca. But Verdi's attention then turned to other matters, particularly to *Macbeth* and *I Masnadieri*. It was only after the premières of these two operas that he returned to the subject of *Il Corsaro*, and then only on Lucca's insistence and with considerably diminished enthusiasm. Francesco Piave was the librettist, work went rapidly, and the première took place at the Teatro Grande, Trieste, in 1848. It was not very successful, and after a few more productions in Milan, Venice, and some minor theaters, *Il Corsaro* sank into oblivion, not to be rescued for more than a century. Generations of Verdi biographers—Carlo Gatti and Francis Toye among them—





Southside Johnny  
(on vocal) and the  
Asbury Jukes  
in concert

dismissed the work as undeserving of serious consideration. Unlike them, Charles Osborne had the experience of seeing *Il Corsaro* performed, and he observed (in his *The Complete Operas of Verdi*, 1970) that "number by number, much of the music is immensely enjoyable."

In its first recording, *Il Corsaro* reaches us in the kind of vigorous, committed performance that points up the risk of making hasty judgments. This is, of course, by no means a significant opera in Verdi's output, despite some interesting anticipations of *Rigoletto* and *La Traviata* in the scoring, and yet it is certainly not without merit. Above all, it pulsates with the

full-blooded Verdian vigor that guarantees theatrical effectiveness, plot inconsistencies notwithstanding. But we can understand why, having discovered more vital dramatic substance in *Macbeth* (Shakespeare) and *I Masnadieri* (Schiller), Verdi had to feel lukewarm toward *The Corsair*, which was not a drama in the first place, but a narrative poem deficient in plot and not redeemed in any useful operatic way by the frequently dazzling but theatrically unyielding flights of Byron's poetry. Piave worked diligently against the odds, but the best he could do was to create a workable libretto. Transcending, as usual, the material he had to work with, Verdi wrote an opera whose momentum never flags and some of whose arias and ensembles approach the composer's best pre-*Rigoletto* level.

In the strong cast, tenor José Carreras is perhaps the most consistently pleasing singer. He portrays a noble outlaw, the social outcast so popular in Romantic literature (Ernani and Carlo Moor in *I Masnadieri* are other Verdian examples) with the proper melancholy spirit, and he sings admirably. This *Corsair* is loved, not too wisely, by two ladies: gentle, self-sacrificing Medora, interpreted by Jessye Norman, and exotic, fiery Gulnara, sung by Montserrat Caballé. Both possess lustrous voices and both have their luminous moments, though Miss Norman's florid technique is taxed somewhat by the writing and Miss Caballé finds the tessitura of the third-act duet too low. Baritone Mastromei is no tonal spell binder in his second-act aria, but he makes an appropriately mean-sounding villain. Three experienced British singers round out the competent cast.

Lamberto Gardelli's briskly paced, idiomatic leadership does full justice to the score, and the sound engineering

captures the excellent orchestral performance in rich detail. *Il Corsaro* unquestionably represents a temporary halt (or even a step backward) in Verdi's artistic development after *Attila*, *Macbeth*, and *I Masnadieri*, but it is eminently worth hearing—and surely no true Verdian would want to miss hearing it so well done.

At this writing, only four Verdi operas remain unrecorded: *Oberto* (1839), *I Due Foscari* (1844), *Alzira* (1845), and *Stiffelio/Aroldo* (1850/1857). The millennium is at hand. *George Jellinek*

**VERDI: *Il Corsaro*.** José Carreras (tenor), Corrado; Clifford Grant (bass), Giovanni; Jessye Norman (soprano), Medora; Montserrat Caballé (soprano), Gulnara; Gian-Piero Mastromei (baritone), Seid; John Noble (baritone), Selimo; Alexander Oliver (tenor), a slave. Ambrosian Singers; New Philharmonia Orchestra, Lamberto Gardelli cond. PHILIPS 6700 098 two discs \$15.96.

MONTSERRAT CABALLÉ AND JOSÉ CARRERAS



Mike Evans/Philips

## One You Can Bank On: Good Time Music from Southside Johnny and The Asbury Jukes

**B**UY two copies of "I Don't Want to Go Home" by Southside Johnny & the Asbury Jukes and put one in a bank vault; a long time from now you'll be happy you did, for it is some sweet kind of classic. Southside Johnny (Johnny Lyon) and the other members of this flexible and joyful band are all friends and/or former bandmates of Bruce Springsteen, who contributed



affectionate liner notes about the atmosphere and personalities of the Jersey Shore bar-band era of the late Sixties and early Seventies. The Asbury Jukes play a combination of dance rock, early r-&-b, and Memphis pop soul. But that is only a clinical description of their style, without heart. Johnny and the Jukes know what the function of music is: to please, to conjure, to seduce, to comfort, to bring dreams.

Johnny Lyon's furry, cozy vocals and the bright, light-handed expertise of the band (including a brass section, the Miami Horns) identify the group as one that is there for the *listener* and not, as is so often the case with rock bands, just there for themselves. The arrangements and delivery are loaded with good humor; it's a rare thing to hear a band that you suspect likes you as much as you like them.

"Miami Steve" Van Zandt, lead guitarist with Springsteen and co-director and co-arranger here with Lyon, has contributed three fine originals: the title tune, *Sweeter Than Honey*, and *How Come You Treat Me So Bad*. The last is especially delightful, a pastiche made up of Allen Toussaint's laid-back but syncopated comic songs for the wonderful Lee Dorsey, whose way with a lyric makes him the Jack Benny of Soul. Mr. Dorsey himself sings lead while keeping up a hilarious running patter with Johnny (sample line, almost obscured by the fade-out: "I'm gonna hit you so hard, when you wake up your clothes is gonna be out of style!").

Ronnie Spector, former lead singer with the Ronettes, shares vocals with Lyon on *You Mean So Much to Me*, a Springsteen original. There are also carefree versions of *Fannie Mae*, the Buster Brown blues-jump gem, Solomon Burke's *Got to Get You off My Mind*, Ray Charles' *I Choose to Sing the Blues*, Steve Cropper's *Broke Down Piece of Man*, plus the delicious (and slightly fealthy) *It Ain't the Meat (It's the Motion)*. All in all, this is *some* band. Let there be loud and prolonged cheers!

Joel Vance

**SOUTHSIDE JOHNNY & THE ASBURY JUKES:** *I Don't Want to Go Home*. Southside Johnny a/k/a John Lyon (lead vocals, harmonica); Kenny Pentifallo (drums, vocals); Kevin Kavanaugh (keyboards, vocals); Billy Rush (guitar); Alan Berger (bass); Carlo Novi (tenor sax); "Miami Steve" Van Zandt (guitar, vocals); other musicians. *I Don't Want to Go Home*; *Got to Get You off My Mind*; *How Come You Treat Me So Bad* (with Lee Dorsey vocal); *The Fever*; *Broke Down Piece of Man*; *Sweeter Than Honey*; *Fannie Mae*; *It Ain't the Meat (It's the Motion)*; *I Choose to Sing the Blues*; *You Mean So Much to Me* (with Ronnie Spector vocal). EPIC PE 34180 \$6.98, © PEA 34180 \$7.98.

## The L.A. Four: An Oasis in the Endless Desert of Electronic Aridity

**A**LTHOUGH I am well familiar with the L.A. Four's individual members, their just-released second album on the Concord Jazz label is my introduction to them as a group. And what a wonderful group it is—I mean, it really *works*, which is something that cannot be said for all all-star groups. Bud Shank, Laurindo Almeida, Ray Brown, and Shelly Manne have in common—besides their impressive track records—such attributes as a refined sense of dynamics, the ability to swing hard but softly, and the kind of artistic judgment that makes this one of the most aesthetically pleasing albums I have heard in a long time.

The program reflects that judgment, starting with Antonio Carlos Jobim's *Dindi* and bopping gently, to a prevailing Latin beat, through works by Shank, Gillespie, Bach (Carl Philipp Emanuel), Rollins, and on to the second movement of Joaquin Rodrigo's ubiquitous *Concierto de Aranjuez*. The last piece, so impeccably dressed up by Miles Davis and Gil Evans on the 1959 "Sketches of Spain" album, has been recorded by Laurindo Almeida twice before (with the Modern Jazz Quartet and with the Monte Carlo Opera Orchestra), but the present version—with Bud Shank's alto playing the orchestral parts—represents an altogether different translation. Shank and Almeida recorded two albums with this same instrumental combination for the World Pacific label almost twenty years ago, but, as good as their rapport was then, they work better together now. As the quartet's spokesman Ray Brown has it in the album's jacket notes, "the group seems to be shaping up to an original personality."

The highlight of this disc has to be Dizzy Gillespie's *Manteca*, in which Ray Brown and Shelly Manne carry on a memorable dialogue, but the album itself is a highlight, an oasis popping unexpectedly out of a seemingly endless desert of souped-up electronic aridity.

Chris Albertson

**THE L.A. FOUR:** *The L.A. 4*. Bud Shank (alto saxophone and flute); Laurindo Almeida (guitar); Ray Brown (bass); Shelly Manne (drums and percussion). *Dindi*; *Rainbows*, *Rondo Espressivo*; *Manteca*; *St. Thomas*; *Concierto de Aranjuez*. CONCORD JAZZ CJ-18 \$6.95 (available by mail from Concord Jazz, Inc., P.O. Box 845, Concord, Calif. 94522).



The L.A. Four, top to bottom: Laurindo Almeida, Ray Brown, Shelly Manne, and Bud Shank



# PART TWO: THE END OF THE DOUBLE STANDARD.

**In the frequency range where you find most music, our least expensive speaker offers virtually the same flat frequency response and freedom from distortion as our most expensive speaker.**

Until recently, you could consider the selection of speakers an act of faith.

Because of the lack of industry standards and the resulting confusion in the marketplace, the speaker buyer had to depend almost totally on personal taste and subjective evaluation.

But no longer.

At Yamaha, before we designed a new line of speakers that would equal the revolutionary standard of our electronic components, we first defined our goal:

High accuracy across the musical spectrum. One of the few objective criteria for rating speaker performance.

Then we proceeded to make all Yamaha speakers to a single revolutionary standard of accuracy:

A frequency response curve that varies by no more than  $\pm 3$  dB from 100 Hz to 15,000 Hz. With typically no more than 1% harmonic distortion.

But since the frequency range of all our speakers extends well below 60 Hz to beyond 15,000 Hz, why do we even bother mentioning this figure?

Because, with the exception of the very deepest rumblings of a pipe organ, all music is produced within this range. In fact, few if any commercially available stereo pressings have frequencies below 100 Hz and above 15,000 Hz.

Yamaha's success in achieving a single standard of accuracy in all our speakers is confirmed in the chart above.

Unlike the frequency response curves of other speaker manufacturers which indicate unnatural booming in the bass, added sparkle in the treble, and extreme loudness level variations of as much as 10 dB, Yamaha's frequency response curves show a relatively straight line, which indicates uncolored, natural sound.

#### Yamaha's musical heritage.

Yet, in spite of Yamaha's objectivity in design, the perception of sound remains subjective.

That's why Yamaha speakers aren't designed to meet objective standards alone, but to meet a higher standard: the ears of the people who make Yamaha's world-famous musical instruments.

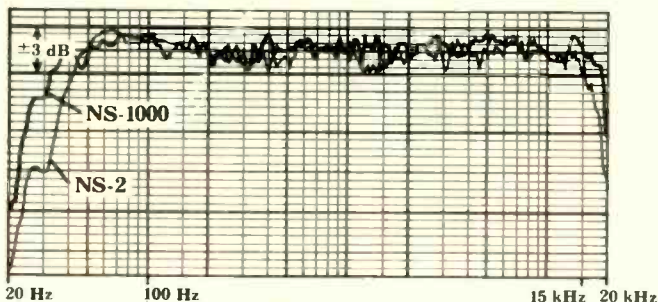

While many manufacturers offer accurate reproduction only in their top-end speakers, Yamaha brings you an extremely high degree of accuracy in all models throughout the line. The above curves, comparing the NS-1000 with the NS-2, were recorded under the following conditions: 1. **Equipment used** - Bruell & Kjaer (B&K) 4133 microphone, 1022 oscillator, 2113 spectrometer, and 2306 recorder. 2. **Input** - A "pink" noise source was used with an input level of 3 watts (significantly higher, more rigorous, and more closely corresponding to actual home listening levels than the commonly used industry standard of 1 watt). 3. **Measurement** - Each loudspeaker was placed in a "free field" (off the floor and no closer than 5 feet to any wall boundary in an average size listening room). A multiplicity of curves were taken at various points in the listening room and averaged, to produce the total energy curves pictured.

Since 1887, Yamaha has been making some of the finest musical instruments in the world. Pianos, organs, woodwinds, guitars, and brass.

With our musical instruments, we've defined the standard in the production of fine sound. And now, with our entire line of speakers and electronic components, we've utilized not only our studio engineers, but also our musical instrument designers to define the standard of music reproduction.

It's called Natural Sound. And it's totally unique to Yamaha.

#### Five different speakers, built to one standard.

Yamaha offers five different speaker models, ranging in price from \$1,350 a pair down to \$200 a pair.

At the top, the revolutionary beryllium dome NS-1000 Series, offering the ultimate in state-of-the-art performance. Following the NS-1000 are our

other three-way types: the NS-690, NS-670, and NS-3. Our least expensive, but still highly accurate, is the two-way NS-2.

Since each is built to the same high quality standard, you're probably wondering what those extra dollars are buying.

It's very simple.

To satisfy the most demanding audiophiles, those extra dollars buy extended response at the frequency extremes. Higher sound levels with equal or lower distortion. More power handling capacity. More tone controls to contour the tonal balance of the speakers with the characteristics of the room.

More specifically, on our model NS-670 and above, Yamaha offers die-cast speaker frame baskets to eliminate potential resonance. Luxurious wood enclosures (even rare ebony wood). Tangential-edge

suspension for midrange and tweeter domes to provide smooth response. Acoustic equalizers on tweeters to flatten frequency response and enhance dispersion. Diagonally edge-wound voice coils for greater diaphragm control and increased transient response. Plus thick felt lining inside the cabinetry to isolate rear sound waves for distortion-free bass response.

But regardless of how much you pay, every Yamaha speaker is built to the same essential construction criteria and tonal accuracy.

Proven acoustic suspension design. Dome drivers for better high frequency dispersion. Carefully matched crossover networks. And heavily reinforced, extremely rigid enclosures.

#### The End of the Double Standard.

The single standard of performance found throughout the entire line of Yamaha speakers is a demonstration of product integrity that no other manufacturer can claim.

But in the final analysis, only your ears can be the judge.

That's why we invite you to visit your Yamaha audio dealer soon. His knowledgeable salesmen and extensive demonstration facilities can save you time and trouble in selecting the speaker that's right for your budget. And right for your ears.



## YAMAHA

International Corp., P.O. Box 6600, Buena Park, Calif. 90620

CIRCLE NO. 61 ON READER SERVICE CARD





# POPULAR DISCS AND TAPES

Reviewed by CHRIS ALBERTSON • NOEL COPPAGE • PAUL KRESH • PETER REILLY • JOEL VANCE

## RECORDING OF SPECIAL MERIT

**ERIC ANDERSEN:** *Sweet Surprise*. Eric Andersen (vocals, guitar); instrumental accompaniment. *Lost in a Song; How It Goes; Dreams of Mexico; San Diego Serenade*; and four others. ARISTA AL 4075 \$6.98, © 8301-4075 H \$7.98.

Performance: **Very good**  
Recording: **Very good**

Experiencing Eric Andersen's voice for the first time has it all over the Binaca Blast, and I highly recommend it. What, exactly, he's up to these days is something else again. This second Arista album seems to back up suggestions in the first one about deromanticizing his sound. The thinking behind that may be that he reached the epitome of mellowness in the Columbia "Blue River" album and you can't top an epitome (although, of course, it would be unshowbusinesslike to think that way). Anyway, the songs are different these days, harder-edged or something, maybe evolutionary different and maybe jumped-ahead different, and the instrumental backing definitely is jumpier and fancier than would be ideal for a mellow fellow's style.

It's a *good* album, measured, as it should be, against the rest of the crop this month, but the supportive elements don't entice the voice to relax and feel at home the way it happened in "Blue River." The arrangements sometimes seem to be pulling the vocal instead of following it; they are disciplined and yet lively, but they attract too much attention. It is to

Andersen's credit that several songs—at least among the ones *he* wrote—still seem spiritually connected to the singing and leave it enough remnants of mellowness (as in the elegant *Love Will Meet Again*) to head off any out-and-out identity crises. Maybe Andersen is himself becoming less of a romantic these days, or trying to, which could indicate nothing more than a healthy interest in survival. Must get around to doing a similar job on me, one of these days. N.C.

**RUSS BALLARD:** *Winning*. Russ Ballard (vocals, guitar, keyboards); instrumental and vocal accompaniment. *Winning; Halloween; A Song for Gail (What Have We Got Her Into); Fakin' Love; Since You Been Gone*; and five others. EPIC PE 34093 \$6.98.

Performance: **Excellent**  
Recording: **Very good**

I'm not sure if Russ Ballard (formerly of Argent and producer of a Roger Daltrey solo album) sounds like himself or like an amalgam of British singers from Joe Cocker to Elton John, but this is a very well-made album with solid vocals, nail-on-the-head instrumental backup, and lively arrangements. Ballard is responsible for the songs, which are almost classy, and if he's also responsible for the arrangements he deserves extra credit. The title track is particularly good and *Cuckoo* is a bouncy standout. J.V.

**BOXER:** *Below the Belt*. Boxer (vocals and instrumentals). *Shooting Star; All the Time in the World; California Calling; Hip Kiss; More Than Meets the Eye*; and five others. VIRGIN PZ 34115 \$6.98, © PZA-34115 \$7.98.

Performance: **Okay**  
Recording: **Cloudy**

The personnel of Boxer have a lot of worthy credits behind them as members of successful British bands or as backing musicians for well-known singers: Sounds Incorporated (they were on the Beatles' "Sergeant Pepper" and *Lady Madonna* single), Eric Clapton, Jerry Lee Lewis, Little Richard, Jeff Beck, David Bowie, George Harrison, and Spooky Tooth. Now, since they had all that experience behind them I expected something better

than I got. Boxer is professional and energetic but lacking in imagination. They don't do anything wrong but they sure don't do anything really right. Just another rock-and-roll album. J.V.

## RECORDING OF SPECIAL MERIT

**ROY BUCHANAN:** *A Street Called Straight*. Roy Buchanan (guitar, vocals); vocal and instrumental accompaniment. *Running Out; Keep What You Got; Man on the Floor; Good God Have Mercy; Okay; Caruso*; and five others. ATLANTIC SD 18170 \$6.98, © TP-18170 \$7.98, © CS-18170 \$7.98.

Performance: **Excellent**  
Recording: **Evocative**

Back at the start of this decade, when Roy Buchanan was playing small clubs in the Baltimore/D.C. area, word started to spread that he was *the* guitarist, that as soon as he got a recording contract and started to tour . . . well, Eric Clapton and Jeff Beck and all those other lads could just pack up their axes and fade away. It didn't happen like that. Buchanan released several albums on Polydor, but they suffered from bad sequencing of performances and a lack of promotional punch on the label's part. Now that he's on Atlantic the promotional angle may change, and the sequence on this album is excellent.

Although a technical whiz comparable to Jimi Hendrix (his ability is demonstrated here in a version of Hendrix's *If Six Was Nine* followed by *Guitar Cadenza*, a piece of flashy faking abetted by studio tricks), Buchanan doesn't have the subtlety of Beck's solo ideas, and his playing of blues is loose and country-styled where Clapton's is urban and even Church of England formal.

What he does do better than almost anyone else is to play a kind of "lead rhythm," soloing in chord patterns or playing a dominating musical figure that establishes the mood for a song. On *Okay* he takes a wild, shimmering Hawaiian-blues solo while his band riffs terrifically. This is the cut you are likely to get stuck on, but there are other fine slices, including the eerie *Man on the Floor*, the bold *Running Out*, and *Caruso*, in which Buchanan—who knows he can't sing much—tells

### Explanation of symbols:

- Ⓜ = reel-to-reel stereo tape
- Ⓢ = eight-track stereo cartridge
- Ⓒ = stereo cassette
- Ⓛ = quadraphonic disc
- Ⓜ = reel-to-reel quadraphonic tape
- Ⓢ = eight-track quadraphonic tape

Monophonic recordings are indicated by the symbol Ⓜ

The first listing is the one reviewed; other formats, if available, follow it.



the listener to like it or lump it. You'll probably like it. J.V.

**GLEN CAMPBELL:** *Bloodline*. Glen Campbell (vocals and guitar); orchestra. *See You on Sunday; Baby Don't Be Givin' Me Up; Bloodline; The Bottom Line; Lay Me Down*; and five others. CAPITOL SW-11516 \$6.98, © 8XW 11516 \$7.98, © 4XW 11516 \$7.98.

Performance: **Boring**  
Recording: **Good**

Here's Glen Campbell sashaying through yet another album of pseudo c-&-w, this one so eggplant-slick that it makes his hair look ruffled by comparison. When he tries to be mournful, as he does in *Baby Don't Be Givin' Me Up*, he sounds only petulant, and when he goes dramatic, as unfortunately he does in *San Francisco Is a Lonely Town*, he sounds as uninvolved as a rural train conductor calling out stations. Campbell's self-confidence however, as with most bores, seems to remain impassively and completely intact. Whatever happened to his talent? P.R.

**KEITH CARRADINE:** *I'm Easy*. Keith Carradine (vocals, guitar); instrumental accompaniment. *High Sierra; Been Gone So Long; I'm Easy; The Soul Is Strong; I'll Be There*; and five others. ASYLUM 7E 1066 \$6.98.

Performance: **Boring**  
Recording: **Average**

While it's true that Keith Carradine singing *I'm Easy* was one of the better-sounding parts of the *Nashville* soundtrack, the catch is that that isn't saying much. But Carradine apparently takes himself seriously as a singer-songwriter. He is, unfortunately, about as mediocre at it as a man can get. His lyrics are in-corrugibly inane (and in this case so are the arrangements), his tunes are worn-down parts grafted together in tedious new—allegedly new—alignments, and his voice is like dried-out cornstalks rustling in the October wind, which (you could look it up) is tied with the sound of Esther Phillips as the least musical noise occurring in nature. It isn't exactly an unpleasant sound if you forget about music, and it doesn't commit grave technical errors—it just doesn't seem to go with melody. An actual musician *could* have made this recording, but he wouldn't have. N.C.

**HARRY CHAPIN:** *Greatest Stories Live*. Harry Chapin (vocals, guitar); Stephen Chapin (keyboards, vocals); Tom Chapin (guitar, banjo, vocals); John Wallace (bass); Mike Masters (cello); Doug Walker (guitar); Howie Fields (drums); other musicians. *Dreams Go By; W-O-L-D; Saturday Morning; Mr. Tanner; A Better Place to Be*; and nine others. ELEKTRA 7E-2009 two discs \$7.98, © ET-82009 \$9.97, © TC-52009 \$9.97.

Performance: **Well . . .**  
Recording: **Mostly very good**

Oh, it could be worse, I suppose. You can find a certain craftsmanship in Harry Chapin's work if you can shovel through the stuff he makes lyrics out of (some of it, at least, is merely corn, not a harmful substance) and appreciate how well the tunes are bridged or how slickly the soap-opera gimmicks fit together to make what he calls stories. But I feel for him; he does strain so to be somebody's answer to Tom T. Hall, and he is, by all accounts I get from people who know him, such a nice person . . . and he does write

“at best, three Lavernes and two Shirleys”



Lita Joan Jackie Sandy Cherie

## The Runaways: Punk Rock

I really wanted to like the Runaways' record for a variety of reasons, the most basic being that the Runaways are five nubile young girls (ages sixteen and seventeen, if you can believe the cover, and I do) who can't help but bring out a bit of the lecher in me; in the face of such ripe adolescent charms, any consideration of music ought to be almost irrelevant. Unfortunately, the music these kids make is for all intents irrelevant, and their record is just not very good. In a perverse sort of way, however, it is useful, because its flaws are illustrative of a lot of what is wrong with rock these days.

They play surprisingly well; simple as the music is, there are enough little Ritchie Blackmore amphetamine runs to demonstrate a fair degree of talent, and although their vocals are essentially faceless (if only they sang as they look, the way Ronnie Spector did!), their harmonies are cleanly and attractively executed. Unlike the Ramones, to whom the Runaways provide a slightly more sophisticated alternative, their problem lies not with how they play but with *what* they play—which is a number of things, primarily heavy metal. Now it is my unalterable conviction that most heavy metal is not very good rock-and-roll, first because it has little to do with the black roots that are the sources of rock's vitality (a debatable personal prejudice, I'll grant you), and second because heavy-metal rhythm sections are almost always painfully stiff. It takes real genius to get something of value out of this style, and only a handful of bands—the Who, the Yardbirds, the MC5, *perhaps* Led Zeppelin—have ever pulled it off. The rest—the Black Sabbath, Deep Purples, Uriah Heeps, and others—amount to a vast aural scrapheap.

The Runaways also play what certain critics who should know better have dubbed “punk rock,” which is a genre, style, what have you, that over the years has become increasingly annoying. The term was originally (and accurately) used to lump loosely together all sorts of bands and records. Mostly it

meant the music made by the various one-shot sensations of the Sixties who were blatantly imitative (the Shadows of Knight being a good example) but still managed to make good singles, although it was also broad enough to include the major groups these lower-echelon troops were looting. Later it was narrowed down to mean the sort of minimalist hard rock and juvenile-delinquent posturings of the early Stooges, and by now it has become thoroughly institutionalized. The New York underground scene is dominated by bands who want to be the Stooges, and the Runaways are the result of a similar impulse in L.A. Of course, it's all become so cut and dried by now that no punk rocker can avoid being a self-parody at inception.

The Runaways are a case in point; it doesn't *matter* whether they're as wasted and teen-snotty as they want us to believe. Even if they are for real, the pose is embarrassing. The fact that they're female, a novelty that just might have been expected to excuse the poker-faced tackiness of it all, simply isn't enough; at best, they come off as three Lavernes and two Shirleys. (It's significant, by the way, that Bruce Springsteen, who has the talent to make this kind of *West Side Story* romanticism work, is almost universally despised by the partisans of punk; the fact that he's good, by their peculiar logic, eliminates him. Mediocrity equals Sincerity.)

As I said, I really wanted to like this record, and at least three of these girls can have my unlisted phone number any time they want. But since their music can be appreciated only on the pop-sociological level, they'll have to leave it at home. —Steve (Humbert) Simels

**THE RUNAWAYS.** The Runaways (vocals and instrumentals). *Cherry Bomb; You Drive Me Wild; Is It Day or Night? Thunder; Rock and Roll; Lovers; American Nights; Blackmail; Secrets; Dead End Justice*. MERCURY SRM-1-1090 \$6.98, © MC8-1-1090 \$7.98, © MCR-1-1090 \$7.98.





Wakobu Asakura

**NELSON EDDY:**  
his heart forever shines  
on his Canadian  
Mountie's sleeve

such doggerel. He has a certain humor about him, some of which comes through better in a live album—although the business about the bananas is self-indulgent and should have been edited. But, unfortunately, he doesn't use Edgar A. Guest language strictly for put-on purposes. When I know he's serious, I keep getting the wrong effect by approximately 180 degrees—when, as he does here without warning, he speaks up for the Little People, for example, he manages to bring out the Mencken in me: all I can think of is a miasma of boobs putting "hey" in the middle of their sentences and slopping beer about. So it goes with me listening to Harry. But a live album is the best way for him to do the greatest hits bit, since he was going to do it anyway; he is affable on stage, and his brothers, Tom and Steve, do add something to the act. As I said, it could be worse—there could be underarm deodorant commercials every fifteen minutes, for example, and there aren't. *N.C.*

**DONOVAN:** *Slow Down World.* Donovan (vocals, harmonica, guitar); orchestra. *A Well Known Has-Been; Liberation Rag; Black Widow; Cryin' Shame;* and five others. EPIC PE 33945 \$6.98, © PEA 33945 \$7.98, © PET 33945 \$7.98.

Performance: **Disappointing and depressing**

Recording: **Good**

Donovan Leitch is in far from top form here. His songs and performances, which once had an airy, spun-silk, pastel lightness about them, now seem to hover like low-lying wisps of fog on a moor. His subjects are equally downbeat: *Cryin' Shame* ("Gold in the misery, sewer in the mind/Greed and corruption of every kind"), *Slow Down World* ("major problem ahead"), and the self-explanatory (but I hope not autobiographical) *A Well Known Has-Been*. What brought this turbid jag on I can't imagine, but it is as disappointing to me as the thought of learning that Puck is in group therapy. *P.R.*

**NELSON EDDY:** *The Artistry of Nelson Eddy.* Nelson Eddy (vocals); instrumental accom-

paniment. *Tonight We Love; The Lamp Is Low; My Reverie; 'Til the End of Time; Strange Music; Full Moon and Empty Arms;* and five others. EVEREST 3392 \$4.98.

Performance: **Murder**

Recording: **Good**

Nelson Eddy, the matinee idol whose songful, perpetual love affair with Jeanette MacDonald kept a whole generation of moviegoers in rapture, died not long ago, but before he did he put together this program of popular songs based on themes from the classics. Early in his career, Eddy actually sang the classics—in fact, he performed in dozens of operatic roles—but by the time Skitch Henderson got hold of him, that "glorious baritone" was completely frozen into the form recognized and adored by his admirers—the ringing climaxes, the fruity rubatos, the stilted operetta enunciation, the unbridled sentimentality. It is hard to decide, therefore, which element in this particular record is most irritating—the corruption of fragile music by Debussy and Ravel; the insipid distortion of lovely melodies by Grieg, Tchaikovsky, and Rachmaninoff; the incredible banality and vulgarity of the lyrics; the meretricious arrangements by Mr. Henderson; or the sound of Eddy himself, his heart forever shining on his Canadian Mountie's sleeve. Yet this album, icky as it may be, is sure to call forth many a matronly sigh for the good old days of *Rose Marie*, *Naughty Marietta*, and *Sweethearts*. May they never return! *P.K.*

**ENO:** *Another Green World.* Brian Eno (vocals, guitars, synthesizer, "synthetic percussion," etc.); Phil Collins (drums); Percy Jones (bass); John Cale (violas); other musicians. *Sky Saw; Over Fire Island; In Dark Trees; The Big Ship; I'll Come Running; Spirits Drifting;* and six others. ISLAND ILPS 9351 \$6.98, © Y81-9351 \$7.98.

Performance: **Another waste of time**

Recording: **Dense and foggy**

My response to this is on the order of, "Come on, Eno, get lost." It isn't fair, but you know how you feel on the third attempt to swat a fly,

when you are starting to flash on the law of diminishing returns? An album like this eludes analysis, since it is difficult to be analytical and yawn at the same time. Eno, again, comes off as one of those "creative" persons who talk a good game but don't actually *do* much; he plays a lot of automatic or "preset" instruments and sort of sings. Okay, other musicians can handle the hard parts, and they do—but then the songs are revealed as seventeen pastel shades of banal. They aren't good or bad, just precooked and flat. The production makes sure you don't hear many of the words, or exactly what the noise actually coming out of Eno's throat sounds like—so what's the point? Must be some kind of metaphysical angle to it, like the one behind the why of houseflies. *N.C.*

**FIREFALL.** Larry Burnett (vocals, guitar); Rick Roberts (vocals, guitar); Mark Andes (bass, vocals); Jock Bartley (lead guitar, vocals); Michael Clarke (drums). *It Doesn't Matter; Love Isn't All; Livin' Ain't Livin'; No Way Out; Dolphin's Lullaby; Cinderella;* and four others. ATLANTIC SD 18174 \$6.98, © TP-18174 \$7.98, © CS-18174 \$7.98.

Performance: **Weak script**

Recording: **Good**

Cases of terminal earnestness pop up now and then, and this could be one. A folk-rock band that doesn't seem to know such a thing as irony exists is theoretically capable, at this late date, of being good, I suppose, but it is a lot more likely to be taken as camp. Rick Roberts, the most familiar name here, has had at least one song (*Colorado*) pushed by people with big names, but you can't help comparing the ones he wrote here to *It Doesn't Matter*, which Stephen Stills and Chris Hillman helped him write. That one, the album's best, has a snap to it the others don't have. Larry Burnett's songs (except for *Cinderella*, which dares to be different, at least in a gimmicky sort of way) are generally a little more determinedly mundane than Roberts' are. Mostly, the material doesn't seem to want to be noticed—which of course means you'll find yourself thinking of nothing else. The band's way of playing is clean and flexible, and the vocals are good enough; you'd swear these chaps have more music in them than went into the making of these songs. *N.C.*

**DON HARRISON BAND.** Don Harrison (vocals, rhythm guitar, keyboards); Russell DaShiell (lead guitar, piano, vocals); Stu Cook (bass, piano, vocals); Doug Clifford (drums, vocals). *Sixteen Tons; Who I Really Am; Rock 'n' Roll Records; Fame and Fortune; Sometimes Loving You;* and five others. ATLANTIC SD 18171 \$6.98, © TP-18171 \$7.98, © CS-18171 \$7.98.

Performance: **Sturdy and sassy**

Recording: **Clean**

Here's a slugging quartet in which the basic slug is provided by bassist Stu Cook and drummer Doug Clifford, both formerly of Creedence Clearwater Revival. Lead singer Don Harrison and guitarist Russell DaShiell are relative newcomers, but they sound experienced. The band has had some action with their single of *Sixteen Tons* (yup, the old Tennessee Ernie Ford hit). The rest of the material is by Harrison, who's a strong singer, and DaShiell. Without ever being memorable, their songs are pretty good, and, like Cree-  
(Continued on page 94)



# THE FRONT ISN'T THE ONLY PLACE THIS DECK IS LOADED.

Front load design means you can stack this deck anywhere; you put your components together the way you want them; no more tail wagging the dog.

Cue and Review function lets you pick out your selection when you fast forward or rewind a tape.

Self locking pause control stops transport in play or record without canceling that mode.

Built-in Dolby-B noise reduction system helps eliminate tape noise without impairing overall frequency response.

Separate bias and EQ switches for standard and Chromium tapes.

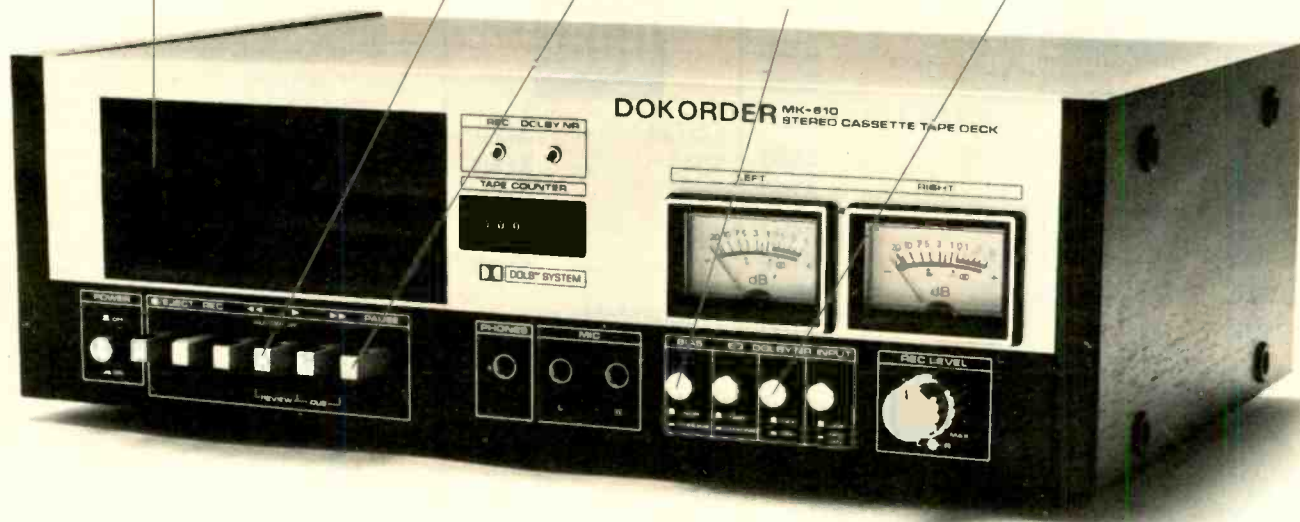

The MK-610 Front Loading  
Cassette Deck with Dolby.  
Suggested retail price  
\$249.95.

## DOKORDER

5430 Rosecrans Avenue Lawndale, CA 90260



dence Clearwater Revival, the Harrison outfit has a solid dance beat; their sound will make you get up and move. Enjoy, enjoy. J.V.

**RECORDING OF SPECIAL MERIT**

**ISLEY BROTHERS:** *Harvest for the World.* Isley Brothers (vocals); instrumental accompaniment. *Harvest for the World; People of Today; Who Loves You Better; (At Your Best) You Are Love;* and four others. T-NECK PZ 33809 \$6.98, © PZA 33809 \$7.98, © PZT 33809 \$7.98.

Performance: **Excellent**  
Recording: **Clean**

Good news bears repeating: Ronnie Isley is one of the best singers in the nation, in any

style, and certainly the pre-eminent black vocalist since the death of Otis Redding in 1967. There are three aspects to his remarkable singing: technique, range, and feeling. He makes use of the trick of bouncing from a lower note to a higher one, he is equally adept whether growling or crooning, and he performs with a fervor and tenderness that are genuine but nicely aged and tempered by years of professionalism.

The Isley Brothers' long and checkered career is now at its peak; they are more popular and have greater exposure than ever before in their twenty years of working. They have not made the business mistakes they did in former times, mistakes that interrupted their professional story and made it a tale of peaks and valleys. What marred their recent albums has



Spring Records

**MILLIE JACKSON**  
*A joyous, raucous, gutsy album*

been corrected: youngest brother Ernie's overkill Jimi Hendrix-style guitar has been muted (he now plays with the band), and the material, which historically was either pretty wonderful or pretty lousy, has been patched to a happy medium so that it's no worse than anyone else's and much better than most.

This album is basically a concert recital by Ronnie, and he is given full room to display his gifts. He is overdue to be credited as a master stylist of twentieth-century popular music. J.V.

**RECORDING OF SPECIAL MERIT**

**MAHALIA JACKSON:** *How I Got Over.* Mahalia Jackson (vocals); instrumental and vocal accompaniment. *How I Got Over; I Been Buked and I Been Scorned; Come On Children, Let's Sing; Out of the Depths;* and five others. COLUMBIA KC 34073 \$5.98.

Performance: **Mahalia lives**  
Recording: **Well blended**

Columbia has ransacked the archives and come up with a program of previously unreleased Mahalia Jackson items that should please her many admirers and maybe win her some new ones. When the deep-chested Mahalia hurled herself into a gospel number, especially in a real church before an assembly of active Baptist congregants, she could fuse the gospel style with her own magnificent voice and produce something thrilling indeed. A number of the church-song selections in this album were culled from a CBS film about the gospel singer called *Got to Tell It*. Others were put together from transcriptions of radio shows. As a result, Miss Jackson can be heard sometimes with her favorite accompanist, Mildred Falls, at the piano, sometimes with organist Ralph Jones or Edward Robinson backing her, at other times with the Jack Halloran Quartet. A particularly poignant stretch is *I Been Buked and I Been Scorned*, which was her memorial tribute in 1968 to Robert Kennedy. In the radio-show passages she often introduces a song with a few sentences of fervid religious prose. At times, as in her own gospel version of *Silent Night*, she gets so carried away by the emotion of the occasion that she tends to mix up the words a bit—but it really doesn't matter. Mahalia is here, in all her fervor and religious ecstasy, and she just gets to you. P.K.



**Try to beat our price!**

You can't with a stick. If you want the lowest possible prices on audio components *plus* the fastest delivery — you'll just have to shop Discount Sound.

**PIONEER**

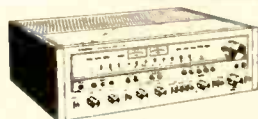

**AMPS & TUNERS**

- SA-9900 — \$495
- SA-9500 — \$330
- SA-8500 — \$264
- SA-7500 — \$198
- TX-9500 — \$264
- TX-7500 — \$165

**RECEIVERS**

- SX-1250 — \$590
- SX-1050 — \$475
- SX-950 — \$409
- SX-850 — \$352
- SX-750 — \$282
- SX-650 — \$211

**TAPE DECKS**

- RT-1020L — \$443
- CT-F9191 — \$307
- CT-F8282 — \$272
- CT-F7272 — \$218
- CT-5151 — \$184
- CT-F2121 — \$149

**TURNTABLES**

- PL-71 — \$198
- PL-530 — \$171
- PL-510 — \$136
- PL-117D — \$119
- PL-115D — \$91
- PL-112D — \$74

**marantz**



**TAPE DECKS**

- 5420 — \$290
- 5220 — \$256

**RECEIVERS**

- 2325 — \$578
- 2275 — \$471
- 2250B — \$367
- 2235B — \$295
- 2225 — \$250
- 2220B — \$223

**AMPS & TUNERS**

- 1250 — \$500
- 1150 — \$290
- 1070 — \$203
- 1040 — \$145
- 125 — \$246
- 112 — \$160



- CS721 — \$270
- 1249 — \$190
- 1228 — \$138
- 1226 — \$122
- 1225 — \$104

All turntable prices include walnut base and dust cover.



**discount sound**

301-881-8890

5618 RANDOLPH RD., ROCKVILLE, MD. 20852  
All orders shipped immediately • Phone orders accepted • Use your BankAmericard or Master Charge • Call or write for price quotes on all the top audio brands • Write for free catalog • All merchandise in factory sealed cartons with full manufacturer's warranty.



**MILLIE JACKSON: *Free and in Love*.** Millie Jackson (vocals); orchestra. *A House for Sale; Bad Risk; There You Are; I'm Free; Solitary Love Affair*; and four others. SPRING SP-1-6709 \$6.98, ⑧ 8T-1-6709 \$7.98, ③ CT-1-6709 \$7.98.

Performance: **Gutsy and fun**  
Recording: **Very good**

Millie Jackson is a lady with a lot of things on her mind, and when she decides to get them off said mind, she does so with all the subtlety of a house collapsing around you. Ms. Jackson's voice sounds like a buzz saw in the lower register and a fire alarm at the top; in between she can strike a mellow, gentler chord or two, as she proves in *Solitary Love Affair*, which has a slightly uneasy air of best-behavior about it. No matter; most of the album is a joyous, raucous, gutsy affair by a lady who obviously intends to get some fun out of life or damned well know the reason why not!  
P.R.

**DAVE LOGGINS: *Country Suite*.** Dave Loggins (vocals, guitar); Mike Noble (guitar); Kenny Malone (drums); Jack Williams (bass); other musicians. *Movin' to the Country; I'm Gonna Farm You Off My Mind; Wild Millie the Mountain Girl; The Weatherman; Lovin' Somebody on a Rainy Night; Goodbye Miss Sadness*; and five others. EPIC PE 33946 \$6.98, ⑧ PEA 33946 \$7.98, ③ PET 33946 \$7.98.

Performance: **Rough, but interesting**  
Recording: **Good**

Now here is a quirky little recording. Dave Loggins, who does seem to be a country boy—or at least to have a Southern accent—comes off preachy on the virtues of country living, out of character for a real rural fellow. Then there's the way he'll suggest irony and put-on tendencies one minute, as if he knows more than he's letting on here, and then the next minute appear to be sincerely delivering such a line as "I am a weatherman and I see rain in your eyes." I keep imagining a romantic country lane (not quite like the real ones I used to know, which came with the smell of cow manure as standard equipment), and the reply from, oh, let's call her Wanda June: "Why, that's real *poetical*, Homer Lee. That's the most poetical thang any feller ever said to me." So I can't really tell where Loggins' consciousness is; he seems a little more sophisticated than you can prove with the hard evidence. The album *sounds* pretty good, though. Loggins' vocals are emotionally toned-up and natural-sounding, and they do seem rustic; his voice may be more eloquent, is subtler, about country living than his pen is. The backing is essentially acoustic and generally effective, and the production is fairly good. It's just that some albums seem designed to leave you feeling mainly curious, and this must be one of those.  
N.C.

**TAJ MAHAL: *Satisfied 'n Tickled Too*.** Taj Mahal (vocals, guitar); vocal and instrumental accompaniment. *Satisfied 'n Tickled Too; New E-Z Rider Blues; Black Man Brown Man; Baby Love; Ain't Nobody's Business*; and four others. COLUMBIA PC 34103 \$6.98, ⑧ PCA-34103 \$7.98, ③ PCT-34103 \$7.98.

Performance: **Very good, but . . .**  
Recording: **Smooth**

I like Taj Mahal's catholic taste in music—folk, Caribbean, jazz, big-sound commercial

soul, blues. It makes for a variety of programming in his albums that you can always count on. But I also get the impression from Taj's work that he seems to be saying: "I don't *have* to do this, y'know; I *could* be doing something else"—that he's a Jack of all trades proud that he doesn't see a need to be master of one. This album is a case in point: there isn't a single outstanding cut on it. Everything here is good enough and displays Taj's proficiency, but until he decides to put his talent on the line and take risks I can enjoy his efforts but I'm not really interested in what he does next.  
J.V.

**STEVE MARRIOTT: *Marriott*.** Steve Marriott (vocals, guitar); Greg Ridley (bass, vocals); Ian Wallace (drums); Mickey Finn

(rhythm guitar); David Foster (keyboards); Mike Baird (drums); Red Rhodes (steel guitar); other musicians. *East Side Struttin'; Lookin' for a Love; Help Me Make It Through the Day; Star in My Life; You Don't Know Me*; and five others. A&M SP-4572 \$6.98, ⑧ 4572 \$7.98, ③ 4572 \$7.98.

Performance: **Stout, but green**  
Recording: **Average**

Steve Marriott of the late Humble Pie has combined a straight-ahead hard-rock side, with British studio musicians, and a somewhat more gimmicky, less lively "American side" to prove . . . well, I'm not sure what. That he can sing and play lead guitar, I suppose. His singing is adequate—he does seem willing to lose himself in the song—but I



## Looking for an ultimate standard of listening?

Many hi-fi enthusiasts bought a Crown DC-300A power amplifier because they were impressed by its performance specs, and by the quality of its "listening" performance. It was, for them, the "ultimate" amplifier.

Why not do what they did? Compare the specs for the Crown DC-300A with those of any other amplifier. Compare the clean,

pure DC-300A sound that comes from low-distortion circuitry and plenty of headroom. And especially compare the DC-300A with its smaller relatives, the Crown D-150A and D-60. Same clean, pure sound, less power, but maybe just what you need.

Use your own judgment. You could find your ultimate listening standard in Crown.

**DC-300A Stereo Amp**  
155 watts per channel min.  
RMS into 8 ohms  
(1-20,000 Hz), no more than .05% total harmonic distortion.

**D-150A Stereo Amp**  
80 watts per channel min.  
RMS into 8 ohms  
(1-20,000 Hz), no more than .05% total harmonic distortion.

**D-60 Stereo Amp**  
32 watts per channel min.  
RMS into 8 ohms  
(20-20,000 Hz), no more than .05% total harmonic distortion.

**Fast playback coupon** Send directly to Crown for fast info on amps.

When listening becomes an art,

Name \_\_\_\_\_

Address \_\_\_\_\_

City \_\_\_\_\_

State \_\_\_\_\_ Zip \_\_\_\_\_



**CROWN**

Box 1000, Elkhart IN 46514

SR-6

CIRCLE NO. 17 ON READER SERVICE CARD



# RTR arouses your inner ears

with the 240D  
Column System

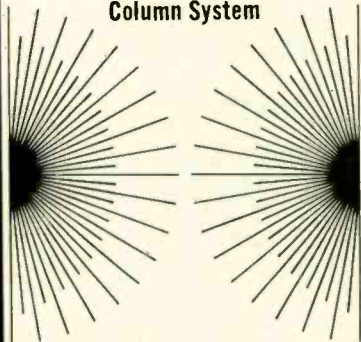

You know when a loudspeaker approaches concert hall experience. Every facet of your hearing responds: To open naturalness of live mid-range. To unfettered resonance of true bass. To crystalline definition of high frequency dispersion. You are aroused to reality.

RTR 240D Column System fulfills these audiophile aspirations in a lean and lovely format... an advanced restatement of the original RTR column concept. Experience the 240D at your franchised RTR dealer soon.

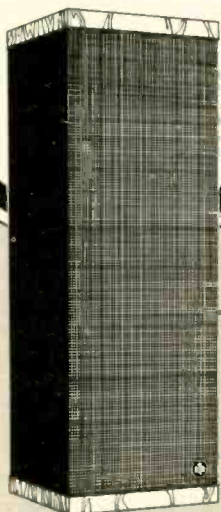

For dealer list and specifications, write RTR, Dept. HR, 8116 Deering Ave., Canoga Park, CA 91304.

CIRCLE NO. 49 ON READER SERVICE CARD

doubt whether the sound of it is distinctive enough to have him lollygagging at the summit with the Big Boys of rock very soon. One thing I noticed—and I don't recall noticing this about male singers before, although I'm sure it's true of several—is that he phrases like a girl singer (that seems to me neither good nor bad, in itself). He does play a lithe, active guitar and puts it through some good lines. *Help Me Make It Through the Day*, an all-out, beer-and-tears slow blues on the English side, is probably the most successful, most engrossing cut. Otherwise, it's an okay recording, but it seems to have an audible lack of seasoning in it. N.C.

## RECORDING OF SPECIAL MERIT

**IAN MATTHEWS:** *Go for Broke*. Ian Matthews (vocals, guitar); Ken Buttrey (drums); Norbert Putnam (bass); Steve Wood (keyboards); Joel Tepp (harp); other musicians. *Darkness, Darkness; I'll Be Gone; Brown Eyed Girl; Rhythm of the West; Groovin'; Lonely Hunter; Steamboat; A Fool Like You; Just One Look; When the Morning Comes*. COLUMBIA PC 34102 \$6.98, © PCA 34102 \$7.98.

Performance: **Striking**  
Recording: **Excellent**

Musical arrangements seem to come alive around Ian Matthews: you can almost *feel* the little gusts of human energy it takes to make the sounds—even the machine-made (synthesizer) ones—and if there's anything at all haunting in a melody, he'll drive it home. He has a smooth, technically very good singing voice, too, and it never sounded better than in "Go for Broke," this new disc for Columbia. Here he takes on well-known songs of more stylish singers—Jesse Colin Young (*Darkness, Darkness*) and Van Morrison (*Brown Eyed Girl*)—and makes of each a startling and thoroughly positive new adventure. Voice and instruments are so well integrated that one tends to experience the whole without analyzing the parts.

The special things about this album are all subtle, and the weaknesses (to me, the last two songs—an old rocker and a thing in Caribbean get-up) seem to be the result of gaddy song selection running afoul of an organic characteristic of Matthews'; he may be unfettered and experimental, but the style in which he operates best is still mellow-grandiose, and these choppy tunes clash with that. There's an elusive, almost airborne clarity about most of this, though, that's quite attractive. It's sleek and shining, but it isn't mechanical and it isn't unemotional. It's a pretty thing, like a gem of some kind. Some of us become quite attached to certain gems. N.C.

**C. W. McCall:** *Wilderness*. C. W. McCall (vocals); orchestra. *Wilderness; Crispy Critters; Jackson Hole; Four Wheel Cowboy; Columbine*; and seven others. POLYDOR PD-1-6069 \$6.98, © 8T-1-6069 \$7.98, © CT-1-6069 \$7.98.

Performance: **One very fine banjo**  
Recording: **Elaborate and very good**

This is one of those really dull albums, boringly sung but lavishly orchestrated and recorded. The songs, by McCall, Bill Fries, and Chip Davis, are all in that Earth Catalog vein of Super-Hips-Speaking-Plainly. But there is a banjo player here, Steve Hanson, who is extraordinarily good. He rips through *Telluride*

*Breakdown* like a bolt of lightning through a plate of farina. He appears briefly on other bands to make the miasma of pomposity even more apparent by his vibrant and colorful playing. Hanson's a natural winner; the album is a pretentious bummer. P.R.

**ROGER MCGUINN:** *Cardiff Rose*. Roger McGuinn (vocals, guitar); Mick Ronson (guitar, keyboards, accordion, autoharp, recorder); David Mansfield (guitar, violin, mandolin, organ); other musicians. *Take Me Away; Jolly Roger; Rock and Roll Time; Friend*; and five others. COLUMBIA PC 34154 \$6.98, © PCA 34154 \$7.98.

Performance: **Variable**  
Recording: **Variable**

I'm never able to decide how much of Roger McGuinn's success comes from position (as in *At the Right Hand of Dylan*, in the events



Columbia Records

IAN MATTHEWS  
*An elusive, airborne quality*

preceding this), how much from administrative skills (the man behind as well as in the Byrds, etc.), and how much from actual work on writing and performing. His most impressive work, as nearly as I can separate all this, comes in spurts. *Partners in Crime* is clever in how it gets your attention, being in the form of a letter to Dear Abbie (Hoffman), and its viewpoint seems an admirable mixture of detached irony and well-meaning compassion. Few of the other pieces here have such an individual signature on them; they just seem to be competently turned-out products from one who knows the market. Tuneful, though.

I'm not a great fan of McGuinn's solo singing, and here I can't take it through headphones—which may be strictly personal or may relate to Mick Ronson's production. Ronson's touch, sometimes heavy, sometimes light, sometimes refreshingly unpredictable, is almost as firm as McGuinn's. Aside from being a little busier than they need to be, the arrangements are pretty good, but Ronson seems similarly unpredictable with the engineering part of it; at times it is very clean and at other times (such as *Rock and Roll Time*) the upper bass seems to dominate it and the whole thing goes slightly tubby. I wonder how

STEREO REVIEW



this will sound compounded on those "Rock" speakers some McGuinn fans no doubt own. And I wonder if McGuinn's shaky voice may have been adjusted, by the production, to grate on my nerves more than it needs to. Anyway, I don't know much more than I did before I listened to it, but some of the time I spent, at least, wasn't wasted. N.C.

#### RECORDING OF SPECIAL MERIT

**THE NIGHTHAWKS:** *Open All Nite*. Mark Wenner (harmonica, vocals); Jim Thackery (guitar, vocals); Pete Ragusa (drums, vocals); Jan Zukowski (bass, vocals); Pinetop Perkins (piano). *Nine Below Zero*; *Help Me*; *Big Boss Man*; *Little by Little*; *That's Alright*; *Red Hot Mama*; and four others. ADELPHI AD 4105 \$6.95.

Performance: **Excellent**  
Recording: **Very good**

I was delighted to report on the first recording by the Nighthawks (March 1976), in my opinion one of the best things to come out of Washington, D.C., since George was inaugurated. This, the group's second LP, presents an all-blues program.

The Nighthawks' version of Elmore James' jump blues *Shake Your Money Maker*, a real winner, features the very tasteful guitar of Jim Thackery. White blues guitarists tend to play either too much (out of zeal) or not enough (owing to reverence). Thackery strikes a fine balance and, like all good musicians, leaves you wishing he'd played a bit more.

Mark Wenner is one of the few harmonica players who combine a knowledgeable love of the blues with an understanding of the potentialities of the harmonica as an instrument outside of the blues, folk, or country roles to which it is normally confined. He is equally creative as a solo or rhythm force. Few blues harmonica players, for example, could or would resist the temptation to make a show-piece out of Jimmy Reed's *Big Boss Man*. But Wenner doesn't solo on the little classic except to play a polite and firm homage to Reed's original choruses and ride the tune to a conclusion. Wenner's variations come in the delicious and subtle fills he plays behind the vocalist and lead instrument (he sets up Thackery's solo beautifully), so that the Nighthawks' remake can stand pretty close to the original on its own merits.

The group has built up an in-person reputation around the District of Columbia and in the Virginia-Carolinas area, and their second album is getting better distribution than the first; things are beginning to move for them, so keep an eye on them and an ear ready for them. J. V.

**ALAN PARSONS PROJECT:** *Tales of Mystery and the Imagination*. Orchestra and choir. *The Raven*; *The Cask of Amontillado*; *The Tell-Tale Heart*; and four others. 20TH CENTURY T-508 \$6.98, © 8-508 \$7.98.

Performance: **Labored**  
Recording: **Excellent**

The Alan Parsons Project consists of Parsons, who began as an assistant engineer on the Beatles' "Abbey Road" album and has since gone on to become a producer; Eric Woolfson, whose unfortunate idea it was to drub poor old Edgar Allan Poe's works into a rock fantasy; and arranger-conductor Andrew Powell. The three have collaborated here on

# dbx 128 tape copies sound better than your records



First, you play your favorite records, tapes or FM broadcasts through the expander section of our Model 128 to restore missing dynamics and reduce noise that's been robbing you of live performance realism.

Then, you preserve the dynamics of this vibrantly enhanced program by copying through the 128 noise reduction section to eliminate tape hiss normally added by copying.

Finally, you play back your taped copy through the decoder of your dbx 128 and hear music with more dynamic range and detail than you've ever heard before off any tape. Sound unbelievable? Well, it was until the dbx 128 came along. But now you can make dynamically enhanced copies that sound better than the originals, with no hiss build-up, on any open-reel, cartridge or cassette recorder.

To learn how, ask the dbxpert at your local dealer for a demonstration of the new dbx 128. For full product information and a list of demonstrating dbx 128 dealers, circle reader service number or contact:

# dbx

dbx, Incorporated, 296 Newton Street  
Waltham, Massachusetts 02154 • (617) 899-8090

CIRCLE NO. 18 ON READER SERVICE CARD



**"I've got a 60-minute  
recording studio  
in my pocket."**

**It's called the  
MICROCASSETTE®  
Pearlcorder-S®.**



A MICROCASSETTE recorder that's so unique, it's like having your own mini-studio in your pocket with remarkably good fidelity for music as well as voice. It's smaller than a checkbook (5¼" from top to bottom, slightly thicker than a pack of cards), and lightweight (12 ounces with batteries), but it's packed with studio precision and professional features:

- 60 minutes recording time.
- Capstan drive for constant tape speed, built-in electret condenser microphone, AC bias, record-warning light.
- All metal construction for years of dependable service.
- One-hand operation; instant loading.
- Fast forward and rapid rewind.
- Automatic level control.
- Connects to your stereo or full-size recorder with a Compacord, for both recording and playback.

The PearlCorder-S performs beautifully in an office, in your car, even on airplanes; and it's backed by the reputation of the Olympus Optical Co., Ltd., a company famous for fine cameras, medical and other precision scientific instruments.

The PearlCorder-S. Carry one. And have a studio with you.

Available at fine photographic, audio, and A-V dealers everywhere. Or write for our brochure, "Pocket Full of Miracles."

**OLYMPUS CORPORATION OF AMERICA**  
TWO NEVADA DRIVE, NEW HYDE PARK, NEW YORK 11040

60 minutes of sound in this  
actual-size MICROCASSETTE.®



CIRCLE NO. 46 ON READER SERVICE CARD



*Gram Parsons (lower left) and the Flying Burrito Brothers:  
getting some good old country songs out and noticed*

an album in which the engineering is trickily superb, but the pretension is so thick and the execution of the original idea of adapting some of Poe's most famous chestnuts is so sloppy and pointless that one might as well be listening to the Very Uncollected Thoughts of Sara Teasdale on the day she discovered speed. The songs at least have the virtue of brevity, but the flatulent "tone poem" that has been constructed around the title of *The Fall of the House of Usher* flows on and on like a river of treacle. At its best it sounds a bit like an old Korngold score for an Ida Lupino melodrama of the Forties; at its worst, well, the closest I can come is Ibert's *Escales* played backwards on a synthesizer. P.R.

**GRAM PARSONS/THE FLYING BURRITO BROTHERS: *Sleepless Nights*.** Gram Parsons (vocals, guitar); Emmylou Harris (vocals); Flying Burrito Brothers (vocals and instrumentals). *Brand New Heartache; Tonight the Bottle Let Me Down; Sing Me Back Home; Crazy Arms; Together Again; Green, Green Grass of Home*; and six others. A&M SP 4578 \$6.98, © 4578 \$7.98, © 4578 \$7.98.

Performance: **Good**  
Recording: **Good**

After his death, Gram Parsons (this is just about a *de facto* Parsons solo album) was all but canonized by the so-called rock press. I'm sure his attitudes were as laudable as they claim, and all that, and he had gotten some good country songs out and noticed where other people couldn't, but I wonder if *someone* in this relatively big world, besides me, was bothered by what he actually sounded like. I don't have perfect pitch, don't wince at every teeny little weirdness of harmonics, but it's a strain for me to listen to him, my ears, mind, the hearing process having to pull him back in tune all the time. Beyond that, to me he sounds like a dilettante—even though I agree he didn't have the attitudes of one. He sounds, here as elsewhere, too young and too middle-class to put across some of these old tobacco-stained, leather-faced country songs. One can get Merle Haggard and George Jones doing it so much more knowingly; their connection with the songs seems so much more clearly organic. Then again, maybe the smartest adaptation to The Market, if not the times,

is to phase out how organic you are, or seem.

Anyway, he's had some impact, and this is a dignified raid on the vaults that packages him as lead singer with the Burritos in nine songs and with Emmylou Harris' delicious vocal harmonies in *Brand New Heartache, Sleepless Nights, and The Angels Rejoiced Last Night*. Most of what bothers me about Parsons' solo singing does not apply in the Harris-duet cuts. When he sang with Harris, the important thing about his voice became the texture, a shift of emphasis that does wonders for my enjoyment of it—and of course Harris is shining and darting in there like a silver needle. These tracks are intriguing; the rest is slightly below-average middle-period Burritos—which, you must keep in mind, maintained a higher average than most bands of the sort. N.C.

**UTAH PHILLIPS: *Good Though*.** Utah Phillips (vocals); instrumental accompaniment. *Cannonball Blues; Queen of the Rails; Going Away; Frisco Road; Starlight on the Rails*; and eight others. PHILO 1004 \$5.98.

Performance: **A train without brakes**  
Recording: **Good**

Utah Phillips is an extremely bright fellow who is going to have to make up his mind one of these days whether he wants to be an entertainer or an educator. The act he puts on here, recorded at the Cafe Lena in Saratoga Springs, New York, where many a wandering minstrel has found a haven, is long and almost too rich for the blood. Utah, who has a kind of oppressive cowboy charm, the speaking voice of a radio announcer, and an evangelistic temperament, is a staple personality in the West at folk festivals and coffeehouses. Here he digs up his corniest jokes (the title, *Good Though*, is the punchline of one of them), tells stories, as raunchy as they are redolent of history, about the heyday of the railroads, box-car hobos, and wild, wild women, and sings innumerable railway songs.

The songs aren't bad and the singing isn't bad; neither are the stories; neither are the dubbed-in railroad sounds. There's just too much of a good thing, for Utah's way is to suffocate his audience in anecdotes and information and drive on as relentlessly as a loco-

(Continued on page 101)



# JVC builds in what other receivers leave out. A graphic equalizer.



The only way you can equal the realistic sound capability of JVC's modestly priced S300 stereo receiver, is by adding an expensive, but highly versatile graphic equalizer, to another receiver.

For the price of a conventional receiver in its price range, the S300 has built-in JVC's exclusive graphic equalizer system. With five zone controls to cover the entire musical range. While most high priced receivers offer bass and treble controls, and some include a third for midrange, none approach the precision and flexibility of the SEA graphic equalizer system developed and patented by JVC.

### 371,293 ways to hear better sound.

By adjusting the five detent tone controls covering the frequency range at 40Hz, 250Hz, 1,000Hz, 5,000Hz and 15,000Hz, you can create 371,293 different sounds. A feat never before achieved (with a stereo receiver) outside a professional recording studio. But, then, the S300 is a JVC professional.

### Get better performance from your components and listening room.

Why do you need such tremendous variations in tone? Quite simply, they help you to overcome the shortcomings of the acoustics in your listening room; they also can help you to compensate for the deficiencies in old or poor recordings.

Finally, they can do wonders for the frequency response of your speakers, and where you place them.

SEA is really quite easy to use. For example, the 40Hz switch reduces record hum or rumble, and it can add greater clarity to the ultra low bass of an organ.

The problem of booming speakers is simply handled with the 250Hz switch. And in the important midranges, the 1,000Hz control adds new dimension to the vocals of your favorite rock performers, while the 5,000Hz switch brings out the best in Jascha Heifetz. You can even reduce tape hiss and diminish the harsh sound of a phono cartridge at high frequencies, with the 15,000Hz control. Then, to double check any adjustment, SEA works with a tone cancellation switch which permits you to instantly compare your setting with a perfectly flat response.

### SEA adjusts the sound of your system to the size of your room.

You see, small rooms tend to emphasize high frequencies, while large ones accentuate the lows. But the ingenious SEA allows you to compensate for room size

and furnishings—so your system can perform the way it was meant to, wherever you are.

While most manufacturers reserve unique features for their top of the line model, JVC has included SEA in three of its receivers. The S300, the S400, and, of course, the top professional—the S600.

When you hear these receivers at your JVC dealer (call toll-free 800-221-7502 for his name), think of them as two components in one. In fact, it's like having all the benefits of a graphic equalizer . . . without buying one.

# JVC

JVC America, Inc.  
58-75 Queens Midtown Expressway,  
Maspeth, N.Y. 11378 (212) 476-8300



*“Remember this kid works one hundred feet up – without a net!”*

It has been claimed—by an expert, Helen Hayes—that the most “professional” of show-biz professionals are the acrobats. By the very nature of their work they never miss cues, never slacken their concentration, never use “personality” as a cop-out to cover sloppiness or lack of preparation. And they never, never give less than their all, an “all” they themselves have defined and refined

to join the slender ranks of those who can and do (Streisand, Lee, Fitzgerald, Ian, Baez—see, I needed only one hand to count) is a young singer named Kelly Garrett. Her new RCA album “Kelly” is one more proof of the old saw about there being only two grades of quality: the best . . . and the rest.

Kelly Garrett has a big, warm voice in perfect control, the ability to search out, and

of the talent she brings to them. In *Sittin’ in the Dark* she is able to create, out of what is basically a simple ballad (a girl having an affair with a married man), a whole range of complicated emotions, drawing a stark picture of a woman filled with resentment at having to sneak around “Tryin’ not to look like lovers . . .”, angry at herself for her own helplessness in the situation, and yet so deeply in love she’s almost past caring. It is as memorable in its way as the kaleidoscope of expressions that flitted across Lily Tomlin’s face in *Nashville* as she crossed over the line from complete self-possession to being possessed by Keith Carradine as he sang the insinuating *I’m Easy* to her. Garrett tells the story of *Sittin’ in the Dark* with all the intuitive, womanly skill of a Colette. Brilliant work.

Equally brilliant is her performance of *Keep Him Like He Is*, which she takes at a bright, easy gait, sliding from phrase to phrase with a style and polish only a topflight musician could manage. It’s in this song that the listener can best hear the sheer abundance of Garrett’s natural vocal equipment. It feels rather like driving a Mercedes at fifty-five miles an hour; you sail along serenely, secure in the knowledge that you can zap up to eighty-five at any moment and that the beautiful machine will respond effortlessly and smoothly without the least thump or clank from anywhere. It is this *depth* in her voice that makes Garrett something special among today’s singers. Whether or not it is being properly treated in the control room is something that only future albums will disclose. On this disc, only this one band seems to do her full justice.

**B**UT there are other, smaller delights here: her radiant intensity even in such a bummer as *I’m Gonna Make You Love Me*; her ability to swing along and eventually triumph over *Our Love Will Find a Way*, which has been gaudily overarranged into a Vegas set-piece; and her beautiful intonation and rich timbre on the title phrase of *If Only (He Would Make Love to Me)*, the kind of thing only a real pro can do, salvage something—anything—from any given piece of material.

Flawed though it is, Kelly Garrett’s new album conclusively proves that she’s the real thing. Too bad that it’s been such a long time between “real things” that many people will let this one slip by because of the bad song selections. Don’t be one of them. Listen to it and then drop Kelly a note about what you’d like to hear her sing. She can probably sing just about anything, so no need to make it easy. Remember, this kid works one hundred feet up—and without a net! —Peter Reilly

**KELLY GARRETT:** *Kelly*. Kelly Garrett (vocals); orchestra, Mike Melvoin arr. and cond. *I’m Gonna Make You Love Me; He’s So Fine; In a Quiet Way; Let Me Down Easy; Our Love Will Find a Way; If Only (He Would Make Love to Me); Keep Him Like He Is; Sittin’ in the Dark; He Moves Me; Leavin’ on Your Mind*. RCA APL1-1424 \$6.98, © APS1-1424 \$7.98.



## *Kelly Garrett: Vocal Abundance*

through years of practicing, learning, and performing. There is, of course, a very pragmatic reason for this: the ground tends to be just a bit unyielding whether you land on your feet, your fundament, or your head (besides, what can you do for an encore?), and the customers have little patience with a flyer who bounces foolishly up and down on a net when what they have paid to see is a display of coordinated courage.

Alas, there are all too few “acrobats” in any branch of the entertainment business today (even Evil Knievel pushed the panic button too soon), all too few performers who are not only prepared to lay it on the line each time out but who have the talent and the training to make it all work for themselves and for their audiences. Here’s big news, then: about

then act out, the meaning of a lyric (none of that syncopated “emoting” from a laundry list of stock “moves”), and a superb, instinctive musicianship. (Just how instinctive can be appreciated when you know that she once won a singing scholarship to an Ohio conservatory on the basis of a submitted tape. It was only after she was there as a student that the amazed faculty realized she had had absolute-ly no formal training.)

Unfortunately, all of that dynamite never really gets a chance to explode in this release because of the damping effect of a repertoire so poorly chosen that Garrett constantly has to goose it into a semblance of life. There are actually only two songs here (the Syreeta Wright-Stevie Wonder *Keep Him Like He Is* and Jack Carone’s *Sittin’ in the Dark*) worthy



motive you wish might occasionally run out of steam and stop. If you like facts for their own sake, though, such as how the train called Phoebe Snow got its name (no relation to the singer), and sad ballads about bums and buckaroos interlarded with lots of puns, Utah is your man. A text about a million words long, with additional stories about trains and the words of all the songs, is generously supplied, along with a request that you "either read these notes and then listen to the record or listen first and then read. Please don't try to do both at the same time." You can't—I tried.

P.K.

**MICHAEL PINDER:** *The Promise*. Michael Pinder (vocals and guitar); orchestra. *Free as a Dove; The Seed; The Promise; Carry On; Air*; and five others. THRESHOLD THS 18 \$6.98, © THS8-18 \$7.98, © THSS-18 \$7.98.

Performance: **Good**  
Recording: **Good**

Michael Pinder, of the Moody Blues, has written and arranged all of the songs here and come up with a competent, likable solo album debut. His voice isn't exactly anything to write home about, no matter where he lives, but his guitar playing is absolutely front-rank. The songs are the regulation high-class mush that passes for sentiment these days. *The Seed*, for example, has lyrics that sound as if they were lifted from a TM primer, and they are delivered as if Pinder were carefully reading a prescription over the phone to a non-English-speaking pharmacist. The arrangements, however, on this and on most of the other bands, are really beautifully done—transparent but lush, imaginative, and unstrained. It's something of a put-down, I guess, to rave about Pinder's arranging talent when he tries so hard in other creative directions, but that is about the only really striking area of this album. Better luck next time.

P.R.

**JOHNNY RIVERS:** *Wild Night*. Johnny Rivers (vocals, rhythm guitar); instrumental and vocal accompaniment. *Wild Night; Something You Got; Brown Eyed Handsome Man; Rain Song; Georgia Peach; Get It Up for Love*; and four others. UNITED ARTISTS UA-LA486-G \$6.98, © UA-EA486-H \$7.98, © UA-CA486-H \$7.98.

Performance: **Excellent**  
Recording: **Excellent**

Without ever consciously thinking about it before, I discover after listening to this album that I have been something of a Johnny Rivers fan ever since his 1964 version of *Memphis*. Rivers is an awfully good vocalist, and he usually sings quality stuff. About three years ago he came out with a dynamite version of the Huey "Piano" Smith oldie *Rockin' Pneumonia and the Boogie Woogie Flu*, and he has since had other hits based on material from the 1950-1964 rock era. But Rivers has not been deliberately nostalgic; he simply chooses to do good, sturdy tunes. I wish he had done the remake of Inez and Charlie Foxx's *Mockingbird*; it would have been superior to the comatose version by Mr. and Mrs. Carly Simon.

Rivers' performances on this current album are all strong and confident—ah, there's nothing like a pro—and the recorded sound is clean and well-balanced. The various tracks were made between 1973 and 1975. The stand-outs are *Something You Got*, *Georgia Peach*,

# What you don't know about effective tip mass won't hurt you, just your records.



You can find out what you don't know by contacting us for our comprehensive cartridge brochure.

## Bang & Olufsen

Bang & Olufsen of America, Inc., Dept. 12D  
515 Busse Road, Elk Grove Village 60007

CIRCLE NO. 14 ON READER SERVICE CARD

## READ WHAT THE EXPERTS SAY ABOUT HEATHKIT HI-FI:

“Once assembled, you can't tell the difference between the finished product and factory-assembled receivers costing at least \$150 more.” **Stereo, Fall, 1974**  
Heathkit AR-2020



Heathkit AR-2020  
AM/FM 4-Channel Receiver



Heathkit AR-29  
AM/FM Stereo Receiver

“On every count, the completed AR-29 either met or exceeded its published performance specifications—and did so with only the normal adjustments spelled out for the kit-builder.” **High Fidelity Test Reports, 1974**  
Heathkit AR-29

“The electrical performance of the Heath AA-1640 makes comment superfluous. In every respect it ranks with the finest high-power amplifiers on the market. We were constantly impressed with the conservatism of its construction and ratings.” **Stereo Review, May 1975**  
Heathkit AA-1640



Heathkit AA-1640  
Stereo Power Amplifier

**FREE** The world's largest catalog of electronic kits. More than 400 in all. Send for it today!



Heath Company, Dept. 40-21, Benton Harbor, MI 49022

HEATH Schlumberger		Heath Company, Dept. 40-21 Benton Harbor, MI 49022	
Please send my FREE Heathkit Catalog			
NAME _____			
ADDRESS _____			
CITY HF-301	STATE	ZIP	

CIRCLE NO. 25 ON READER SERVICE CARD



*Louisiana Man*, and *Rain Song*. Stick with Rivers, folks, he knows what he's doing. J.V.

**THE RUBETTES:** The Rubettes (vocals); instrumental accompaniment. *Sugar Baby Love*; *Foe Dee O Dee*; *Tonight*; *Juke Box Jive*; *Rock Is Dead*; *Judy Run Run*; and six others. MCA/STATE MCA-2193 \$6.98, © MCAT-2193 \$7.98.

Performance: **Pallid**  
Recording: **Okay**

A quintet of British singers who are pure Music Hall, with six singles hits to their credit in Olde Blimey, the Rubettes capitalize on what appears to be the continuing international nostalgia kick by taking every musical figure, gimmick, chord pattern, and vocal arrangement from every hit rock record from 1950 to 1966 and serving them up as a piping-hot casserole. But the Rubettes aren't satirists like Sha Na Na; they're more like the Swedish group Abba (*Waterloo*; *I Do, I Do*) with their homogenized emulations of sounds gone by. They don't have as much fun with their impersonations as Abba does, though. Slick, smooth, forgettable. J.V.

**SANTANA:** *Amigos*. Carlos Santana (guitar, percussion, vocals); vocal and instrumental accompaniment. *Dance Sister Dance*; *Take Me with You*; *Let Me*; *Gitano*; and three others. COLUMBIA PC 33576 \$6.98, © PCA-33576 \$7.98, © PCT-33576 \$7.98.

Performance: **No me gusta**  
Recording: **Good**

There are three positive things to be said for this Carlos Santana album: (1) it is not as presumptuous and offensive as his recent few; (2) he kept Alice Coltrane out of the studio; (3) he tries to sound more Spanish than he usually does. But, as usual, Santana and his crew give the impression that they're trying to sound like whoever is currently in favor as well as someone else: Chicago and Xavier Cugat, George Harrison and Perez Prado, the Mormon Tabernacle Choir and Vincent Lopez.

I'm not sure whether Santana's original intention was to fuse New York Latin music

(which is primarily Puerto Rican) with American jazz, pop, and soul into a style that would be rewarding to all, or whether, less talented than some of his Latin comperes, he simply set out to find a sound that would sell. J.V.

**JOHN SEBASTIAN:** *Welcome Back*. John Sebastian (vocals, guitar, harmonica); Richard Bell (keyboards); David Hungate (bass); other musicians. *Hideaway*; *She's Funny*; *You Go Your Way and I'll Go Mine*; *Don't Wanna Have to Do It*; and six others. REPRIS MS 2249 \$6.98, © M8 2249 \$7.98, © M5 2249 \$7.98.

Performance: **Good clean kiddy show**  
Recording: **Good, clean, etc.**

John Sebastian here turns to the equivalent of what, in my trade, is called "writing juveniles." He had, you'll recall, some connection with such adults-only characters as Fred Neil, so one might naturally react politically to Sebastian's writing the title song for *Welcome Back Kotter* and some of this other high-school stuff in here. I can't write juveniles myself, but somebody has got to do it, and maybe we ought to be grateful that we've got James A. Michener and Marvel Comics in our trade and that pop music has got Sebastian. He's a craftsman, anyway, a pro. This is a well-crafted, inconsequential, well-balanced, in-one-ear-and-out-the-other, well-engineered album. It has good spirits. Of course, it does sound a little funny on the turntable with no AM jock talking loud over part of it. N.C.

**JOHN DAVID SOUTHER:** *Black Rose*. John David Souther (vocals, guitar); Waddy Wachtel (guitar); Danny Kootch (guitar); Andrew Gold (piano); other musicians. *Banging My Head Against the Moon*; *If You Have Crying Eyes*; *Your Turn Now*; *Faithless Love*; *Baby Come Home*; and five others. ASYLUM 7E-1059 \$6.98, © ET8-1059 \$7.98, © TC5-1059 \$7.98.

Performance: **Slicked-up nicely**  
Recording: **Excellent**

This one is to phonograph records as Cher is to television—not a lot of body there to begin

with, but it can dress up. The arrangements have a patina a mosquito wouldn't dare try landing on, but the tunes range mostly between passable and tedious. So does Souther's singing; it's adequate but close to ordinary—he needs to have a catchy tune be the real focus of attention. His lyrics are promising but don't seem to put much of an edge on a song. In the reggae-arranged piece, *Banging My Head Against the Moon*, for example, there's "I'm gonna be lurking with intent to loom." Almost a good line, but also almost sophomoric. Then he likes to write those talky love songs that I've come to identify with young Southern California songwriters (Poco's got a bushel of them), and when you run all this through Peter Asher's high-gloss arrangements, it gives the impression of being a bad good album. Souther might be better off making good bad albums. *Faithless Love* seems to have what he wanted the whole album to have—it's neat, and of course splendidly done-up—but the rest of this one just doesn't have the stuff underneath. N.C.

**SOUTHSIDE JOHNNY & THE ASBURY JUKES:** *I Don't Want to Go Home* (see Best of the Month, page 87)

**STATUS QUO:** Status Quo (vocals and instrumentals). *Is There a Better Way*; *Mad About the Boy*; *Ring of a Change*; *Blue for You*; *That's a Fact*; and four others. CAPITOL ST-11509 \$6.98, © 8XT-11509 \$7.98, © 4XT-11509 \$7.98.

Performance: **Fair**  
Recording: **Good**

Status Quo is, I am told, very popular in England, and I am advised by the press material that accompanies this album that they should be treated with due respect and reverence. Their status over here has had its ups and downs. A 1967 hit, *Pictures of Matchstick Men*, was, so the band now says, unrepresentative of them. For a time they were hailed as purveyors of "heavy metal" (loud, three-chord) rock. But, so the band now says, that's not quite accurate either. They are, they declare, a dance outfit, and that is what they've always felt themselves to be. Or, as Popeye the Sailor Man might have expressed it: "I yam what I yam and that's all that I yam."

As a band, Status Quo is tight enough (after playing three-chord material for ten years you'd expect them to be), and their stuff is very bop-able, but dear God, how quickly it grows tiresome. A riff is not a tune. A riff is not a tune! A RIFF IS NOT A TUNE!!

They come closer to a melody on the slow *Blue for You* and the teasing *Ease Your Mind*, both revealing some personality and skill. But they make their living off the high-powered thumpa-thwacka stuff that keeps the kiddos dancing, so that after listening to this album for two minutes you need not listen to any more of it but merely be aware that it is still going on. J.V.

**STEPPENWOLF:** *Skullduggery*. Steppenwolf (vocals and instrumentals). *Skullduggery*; *Road Runner*; *Rock & Roll Song*; *Train of Thought*; *Life Is a Gamble*; and three others. Epic PE 34120 \$6.98, © PEA 34120 \$7.98.

Performance: **The usual**  
Recording: **Very good**

Disappointment is wired directly into Expectation, and somehow Steppenwolf, in either  
(Continued on page 104)

**JOHN SEBASTIAN:**  
the well-crafted,  
good-spirited  
product of a pro

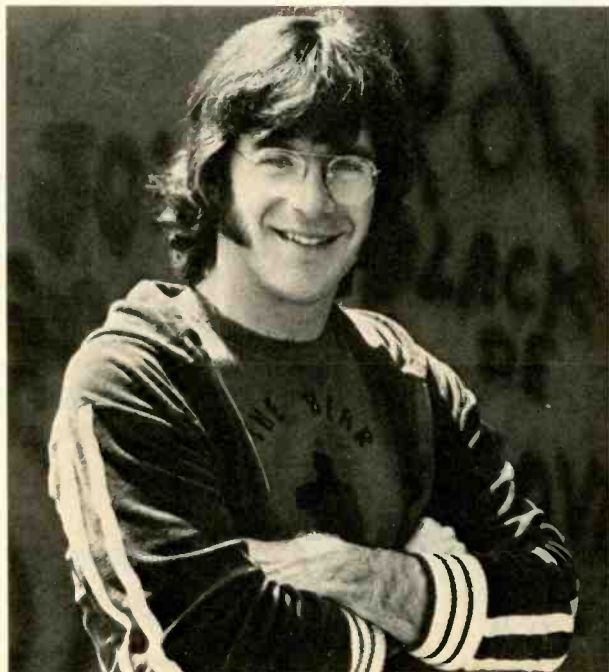

Warner Bros. Records



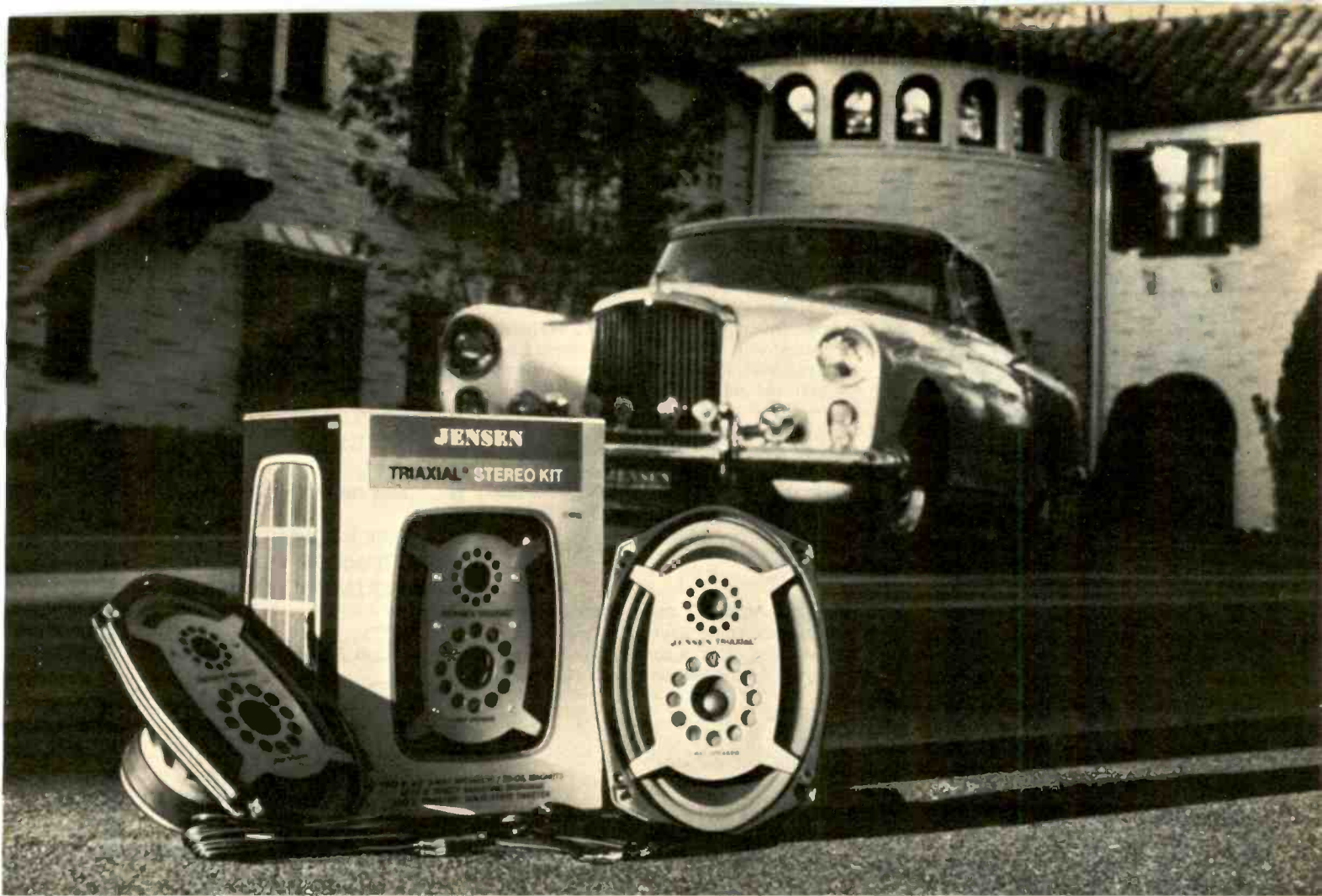

# Jensen's Triaxial<sup>®</sup> 3-Way Speaker... Quite simply, the most advanced car stereo speaker ever.

For the best sound ever in your car. The first car stereo speaker with a woofer, a tweeter and a midrange.

Identical in principle to the best home stereo speakers. Jensen's midrange picks up a whole range of tones lost to any other car speaker.

The result: warm, rich, full sounds you never expected to find in your car.

Only with Jensen's Triaxial<sup>®</sup>, the only 3-way car stereo speaker. For more information and the name of your nearest Jensen dealer, write Jensen Sound Laboratories, Dept. SR-96, 4310 Trans World Road, Schiller Park, Illinois 60176.

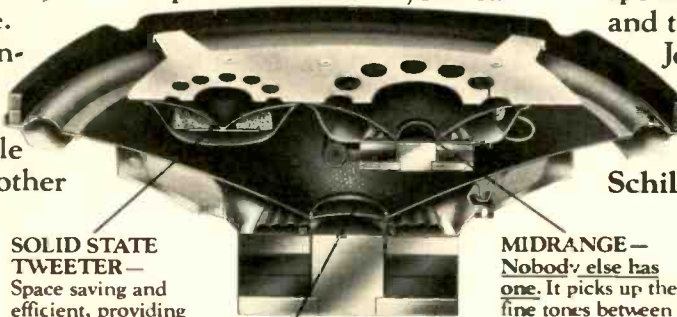

**SOLID STATE TWEETER** — Space saving and efficient, providing distortion-free high frequency response.

**WOOFER** — Designed to reproduce lower frequency tones just as you would hear them in person.

**MIDRANGE** — Nobody else has one. It picks up the fine tones between the high and low frequencies that other speakers miss.

\*"Triax" and "Triaxial" are registered trademarks identifying the 3-way car stereo speaker of Jensen Sound Laboratories, Division of Pmcpr, Inc.

**JENSEN**  
**SOUND LABORATORIES**  
Division of Pmcpr, Inc.

CIRCLE NO. 31 ON READER SERVICE CARD





# DOUBLE SAVINGS

FEATURING  
Technics by  
Panasonic



MODEL  
SL-1500

Mail order shopping is made easy the  
**AUDI-EXPO**  
way. Freight and insurance are already  
included in low Audio-Expo price.  
**THE PRICE YOU SEE IS THE  
PRICE YOU PAY!!**

**AUDI-EXPO**  
701 E. Gude Drive  
Rockville, Md. 20850  
301-340-7707  
SEND FOR PRICE QUOTES

CIRCLE NO. 13 ON READER SERVICE CARD

of its incarnations, has not been a big disappointment to me. It's a good B-grade band, and always was. Compare it to ridiculous posers like Iron Butterfly and Vanilla Fudge and Rare Earth, and notice which one is still alive and kicking. John Kay, the lead singer, does come within shouting distance, at least, of authenticating Steppenwolf's self-image; there is, one learns from interviews and whatnot, more to Kay than Steppenwolf's raw, simplistic format allows to come out, but one already knew there was. I do wonder, of course, listening to this ardently stylized, time-stood-still-in-'69 album, how these guys can keep doing the same sort of thing year after year and not seem more bored. But that seems almost an abstract concern: like, oh, like Jerry Murad and the Harmonicats, Steppenwolf's *comfortable*, stuck in a time warp, or at least they sound like it, and they're getting so relaxed and cozy in this latest one that I tend to settle back and reflect that, well, at least this seems a lot more *decent*, somehow, than being stuck a few notches back with Neil Sedaka.  
N.C.

**STEPHEN STILLS: *Illegal Stills*.** Stephen Stills (vocals, guitar, keyboards, bass); instrumental and vocal accompaniment. *Buyin' Time; The Loner; Stateline Blues; Midnight in Paris; No Me Niegus*, and five others. COLUMBIA PC 34148 \$6.98, © PCA 34148 \$7.98, © PCT 34148 \$7.98.

Performance: **Variable**  
Recording: **Good**

I used to shake my head in admiration and say of Stephen Stills: "Boy, that guy's really got something." This was the result, I fear, of hearing him occasionally over a period of several years at his occasional best: *For What It's Worth* with Buffalo Springfield; *Suite: Judy Blue Eyes* with Crosby, Stills and Nash; and Stills' solo *Love the One You're With*. Nowadays I shake my head and say: "Whatever he's got, I can't wait around until he comes up with it." Stills is a talented but woefully inconsistent man; what sustains him is facility and experience.

If you'd never heard Stills before and based your opinion on some of the dumb tunes and presentations on this album, you would never suspect he had ever done anything wonderful. From other songs here you *might* get the idea that there's hope for him after all, but from only two selections (Neil Young's *The Loner* and Stills' *Stateline Blues*, the latter done acoustically) would you feel that Stills was really going to amount to something. In all, it's not a very good score.  
J. V.

**DONNA SUMMER: *A Love Trilogy*.** Donna Summer (vocals); orchestra. *Could It Be Magic; Wasted; Come with Me*; and two others. OASIS OCLP 5004 \$6.98, © 5004 \$7.98, © 5004 \$7.98.

Performance: **Better than the material**  
Recording: **Heavy breathing**

Producers Giorgio Moroder and Pete Bellotte seem determined to keep Donna Summer at her gasping, panting, at-the-point-of-orgasm chores instead of letting her sing out in more conventional repertoire. *Prelude to Love*, for example, finds her once again chaise-longued and vibrating like a tuning fork while Moroder's arrangement pulsates around her like Leonore's Last Overture. It's too bad, because Summer really does have a big, flexible,  
(Continued on page 107)

# SAVE

TOP QUALITY GEAR  
LOWEST PRICES  
PROMPT DELIVERY  
SAVE ON FREIGHT  
SELECTION

ROYCE CB PANASONIC  
KENWOOD DYNACO  
PIONEER SANSUI  
DUAL BIC  
and more than 50 others

PLEASE REQUEST PRICE QUOTATIONS ON YOUR CHOICE OF QUALITY STEREO GEAR

## Component Discounters

DEPT. 917SR  
24020 ONEIDA  
OAK PARK, MICH. 48237  
313-559-1270



## Brand Name Audio Components

**BY MAIL**

Write Today for Our  
**FREE Audio Catalog**

DIXIE is one of the oldest and largest audio component mail order houses in the country. Our prices on brand name components are actually LOWER than "Discounters". See our new catalog or call us for a price quote. Everything shipped factory-sealed with full manufacturer's warranty.



Master Charge / BankAmericard honored on mail orders

**DIXIE HI-FI** SR-9  
2040 Thalbro Street Richmond, Va. 23230  
Phone: (804) 257-4241

Please rush me your FREE Audio Catalog and complete information. I understand there is no obligation.

Name \_\_\_\_\_  
Address \_\_\_\_\_  
City \_\_\_\_\_  
State \_\_\_\_\_ Zip \_\_\_\_\_



## big discounts

Hi-Fi COMPONENTS

**BOSE SAE UHER**  
**Technics YAMAHA BSR REVOX**  
**TEAC JBL Dual PIONEER**  
**THORENS KOSS TANDBERG**  
**marantz Celestion**  
**INFINITY DOKORDER**  
**Phase Linear SHURE CRAIG**  
**SUPERSCOPE harman kardon BIC Fisher**  
**SONY ElectroVoice PIONEER**  
**SHERWOOD Curv PICKERING**

**order toll free**  
**(800) 421-8537**

Except from Hawaii, Alaska, & California Daily & Saturday from 9:30 a.m. Pacific Time. For Price Information write or call (213) 488-0341.

All merchandise shipped promptly, fully insured and in fresh factory sealed cartons!

**Henny's**  
CAMERA HI-FI VIDEO  
516 W. 8th St. Downtown L.A., Ca. 90014 Tel. (213) 488-0341  
POMONA BRANCH: 1654 N. Indian Hill Blvd. Pomona, Ca. 91768 Tel. (909) 862-1276

CIRCLE NO. 62 ON READER SERVICE CARD  
STEREO REVIEW



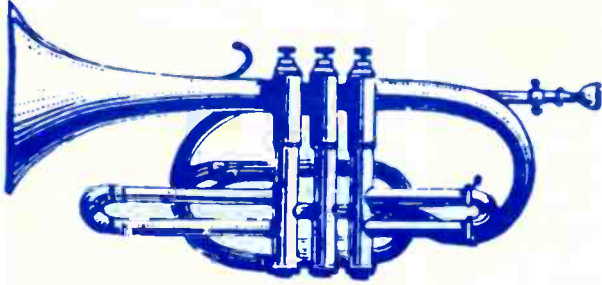

# FREE INFORMATION SERVICE

Here's an easy way for you to get manufacturer's information about products advertised or mentioned editorially in this issue. Just follow the directions below . . . and the literature will be sent to you free of charge.

- a** Tear out one of the perforated postage-free cards. Please print or type your name and address where indicated. Use only one card per person.
- b** Circle the numbers on the card that correspond to the key numbers at the bottom of the advertisement or editorial mention that interests you. (Key numbers for *advertised products* also appear in the Advertisers' Index.)
- c** Simply mail the card. One card per person is all that is necessary. No postage is required.
- d** This address is for our "Free Information Service" only. All other inquiries are to be directed to, Stereo Review, One Park Ave., New York, N.Y. 10016.

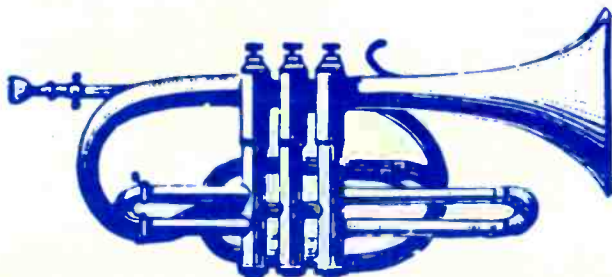

1	2	3	4	5	6	7	8	9	10	11	12	13	14	15
16	17	18	19	20	21	22	23	24	25	26	27	28	29	30
31	32	33	34	35	36	37	38	39	40	41	42	43	44	45
46	47	48	49	50	51	52	53	54	55	56	57	58	59	60
61	62	63	64	65	66	67	68	69	70	71	72	73	74	75
76	77	78	79	80	81	82	83	84	85	86	87	88	89	90
91	92	93	94	95	96	97	98	99	100	101	102	103	104	105
106	107	108	109	110	111	112	113	114	115	116	117	118	119	120
121	122	123	124	125	126	127	128	129	130	131	132	133	134	135
136	137	138	139	140	141	142	143	144	145	146	147	148	149	150
151	152	153	154	155	156	157	158	159	160					

Please send me 12 issues of Stereo Review for \$3.99 and bill me.   
 PLEASE PRINT—Use only one card per person.

SR9763

NAME \_\_\_\_\_

ADDRESS \_\_\_\_\_

CITY \_\_\_\_\_ STATE \_\_\_\_\_ ZIP CODE \_\_\_\_\_

(Zip Code must be included to insure delivery) (Void after Nov. 30, 1976)

1	2	3	4	5	6	7	8	9	10	11	12	13	14	15
16	17	18	19	20	21	22	23	24	25	26	27	28	29	30
31	32	33	34	35	36	37	38	39	40	41	42	43	44	45
46	47	48	49	50	51	52	53	54	55	56	57	58	59	60
61	62	63	64	65	66	67	68	69	70	71	72	73	74	75
76	77	78	79	80	81	82	83	84	85	86	87	88	89	90
91	92	93	94	95	96	97	98	99	100	101	102	103	104	105
106	107	108	109	110	111	112	113	114	115	116	117	118	119	120
121	122	123	124	125	126	127	128	129	130	131	132	133	134	135
136	137	138	139	140	141	142	143	144	145	146	147	148	149	150
151	152	153	154	155	156	157	158	159	160					

Please send me 12 issues of Stereo Review for \$3.99 and bill me.   
 PLEASE PRINT—Use only one card per person.

SR9762

NAME \_\_\_\_\_

ADDRESS \_\_\_\_\_

CITY \_\_\_\_\_ STATE \_\_\_\_\_ ZIP CODE \_\_\_\_\_

(Zip Code must be included to insure delivery) (Void after Nov. 30, 1976)

1	2	3	4	5	6	7	8	9	10	11	12	13	14	15
16	17	18	19	20	21	22	23	24	25	26	27	28	29	30
31	32	33	34	35	36	37	38	39	40	41	42	43	44	45
46	47	48	49	50	51	52	53	54	55	56	57	58	59	60
61	62	63	64	65	66	67	68	69	70	71	72	73	74	75
76	77	78	79	80	81	82	83	84	85	86	87	88	89	90
91	92	93	94	95	96	97	98	99	100	101	102	103	104	105
106	107	108	109	110	111	112	113	114	115	116	117	118	119	120
121	122	123	124	125	126	127	128	129	130	131	132	133	134	135
136	137	138	139	140	141	142	143	144	145	146	147	148	149	150
151	152	153	154	155	156	157	158	159	160					

Please send me 12 issues of Stereo Review for \$3.99 and bill me.   
 PLEASE PRINT—Use only one card per person.

SR9761

NAME \_\_\_\_\_

ADDRESS \_\_\_\_\_

CITY \_\_\_\_\_ STATE \_\_\_\_\_ ZIP CODE \_\_\_\_\_

(Zip Code must be included to insure delivery) (Void after Nov. 30, 1976)



# FREE INFORMATION SERVICE

(SEE REVERSE SIDE)

FIRST CLASS  
PERMIT NO. 217  
CLINTON, IOWA

BUSINESS REPLY MAIL

NO POSTAGE NECESSARY IF MAILED IN THE UNITED STATES

POSTAGE WILL BE PAID BY—

**Stereo Review**

P.O. BOX 2908  
CLINTON, IOWA 52732



FIRST CLASS  
PERMIT NO. 217  
CLINTON, IOWA

BUSINESS REPLY MAIL

NO POSTAGE NECESSARY IF MAILED IN THE UNITED STATES

POSTAGE WILL BE PAID BY—

**Stereo Review**

P.O. BOX 2908  
CLINTON, IOWA 52732



FIRST CLASS  
PERMIT NO. 217  
CLINTON, IOWA

BUSINESS REPLY MAIL

NO POSTAGE NECESSARY IF MAILED IN THE UNITED STATES

POSTAGE WILL BE PAID BY—

**Stereo Review**

P.O. BOX 2908  
CLINTON, IOWA 52732

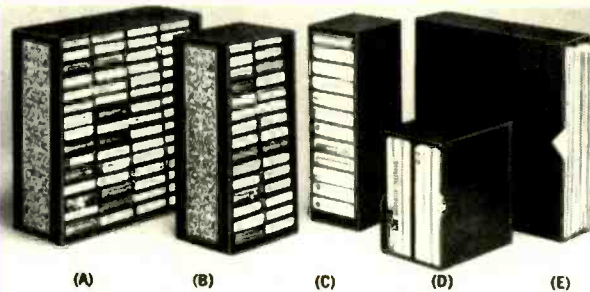

(A) (B) (C) (D) (E)

## A COMPLETE SET OF MATCHED STORAGE CASES

Here's the ideal solution to the problem of keeping all your records and tapes stored neatly, safely, conveniently and attractively. A complete set of matched storage cases, designed by the editors of STEREO REVIEW magazine, for your records and all your tapes: cassette, cartridge and 7" reel. Now you can keep them side-by-side on your bookshelf or cabinet, easy to identify and readily available.

These cases are sturdily constructed and covered in a handsome leatherette. The outer case is elegantly embossed in gold and comes in your choice of three popular decorator colors—black, brown and green—so that they lend themselves readily to the decor of any room.

STEREO REVIEW large capacity storage cases are just what you've been looking for—they're the ideal solution to keeping your records and tapes neatly stored for easy use.

- (A) 60-unit cassette case 13½" high x 12⅝" deep x 5½" wide. \$17.95 each; 3 for \$49.95.
- (B) 30-unit cassette case. 13½" high x 6½" deep x 5½" wide. \$12.95 each; 3 for \$34.95.
- (C) 12-unit 8-track cartridge case. 13¼" high x 6½" deep x 4½" wide. \$9.50 each; 3 for \$24.95.
- Units A, B and C have tilted compartments to prevent spillage and include pressure sensitive labels for titling.
- (D) 6-unit 7" reel case. 8" high x 7½" deep x 5" wide. Holds reels in original boxes. \$6.95 each; 3 for \$18.50.
- (E) 20-unit 12" record case. 13¼" high x 12½" deep x 3½" wide. Holds records in original jackets. \$7.50 each; 3 for \$19.95.

### HERE'S HOW TO ORDER

**CASH:** Mail your order along with your name, address and remittance in the amounts indicated above for the units being ordered. PRICES INCLUDE ALL POSTAGE AND HANDLING CHARGES. OUTSIDE U.S.A. ADD \$1 PER UNIT ORDERED. Residents of Calif., Col., Fla., Ill., Mich., Mo., N.Y. State, D.C. and Tex. add applicable sales tax.

**CHARGE:** Your American Express, BankAmericard, Master Charge or Diners Club account. Mail your order, name, address, credit card number and expiration date (Master Charge customers include four-digit Interbank #). Be sure your signature is on your order. You will be billed in the amounts indicated above.

Identify the type of case ordered and indicate your color choice for the back of the case—black, green or brown (sides in black only).

MAIL ORDERS TO ZIFF-DAVIS CONSUMER SERVICE DIVISION  
DEPT. SV. 595 BROADWAY, NEW YORK, N.Y. 10012





# Hi-Fi Buys

## ON PIONEER

AT WAREHOUSE TO YOU PRICES

### RECEIVERS

SX-1250	\$575
SX-1050	\$475
SX-950	\$409
SX-737	\$249
SX-636	\$215
SX-535	\$181
SX-434	\$142

### AMPS & TUNERS

SA-9900	\$495
SA-9500	\$330
SA-8500	\$264
SA-7500	\$198
TX-9500	\$264
TX-7500	\$165
TX-6500	\$123

### TURNABLES

PL71	\$198
PL530	\$170
PL510	\$136
PL117D	\$119
PL115D	\$91
PL112D	\$74

### DOLBY CASSETTE DECKS

CT-F9191	\$308
CT-F8282	\$272
CT-F7272	\$218
CT5151	\$184
CT4141A	\$164
CT-F2121	\$149

### SPEAKERS

HPM200	\$330	CS63DX	\$185
HPM100	\$165	CS99A	\$159
HPM60	\$124	CS700G	\$132
HPM40	\$83	CS500G	\$99

Save on other famous brands. Quotations answered same day. Write or call for free catalog. All units factory sealed. Full manufacturer's warranty. CB's also available at tremendous savings.

PHONE TO ORDER BY COD, BANKAMERICARD, MASTER CHARGE

For shipment within 48 hours send money order or certified check. Two week delay on personal checks. 20% deposit requested on C.O.D. shipments. \$1.25 handling fee on all orders. Shipping cost are collected C.O.D. unless paid in advance.



Hi-Fi Buys



1362 HOLTON LANE  
LANGLEY PARK, MD. 20783  
(301)434-5330

CIRCLE NO. 28 ON READER SERVICE CARD

stylish voice. The only time she's allowed to shake loose is in *Could It Be Magic*—where she proves, as she did in her previous album, that she has the basic credentials to be a serious and very good pop singer. Eventually, of course, she's going to get tired of being exploited. When that day arrives we're probably all in for a lot of good vertical entertainment.

P.R.

**MARTHA VELEZ:** *Escape from Babylon*. Martha Velez (vocals); orchestra. *Come On In; Disco Night; Money Man; There You Are*; and four others. SIRE SASD-7515 \$6.98, © 8147-7515-H \$7.98.

Performance: **Fair**  
Recording: **Obese**

These are lackluster performances by Martha Velez, who seems to have spent a great deal of time shopping through various musical styles and as yet hasn't made up her mind what it is she wants to buy. Mostly, she seems to think she might like a sort of reggae sound (*Money Man*), but then mild Latin rock (*Disco Night*) is nice too; but then again she also likes... well, you name it. The obese over-production, by Bob Marley, of all this scattered thinking is of scant help.

P.R.

**LOUDON WAINWRIGHT III:** *T-Shirt*. Loudon Wainwright III (vocals, guitar); instrumental accompaniment. *Bicentennial; Summer's Almost Over; Hollywood Hopeful; Reciprocity; At Both Ends; Wine with Dinner; Hey Packy*; and four others. ARISTA AL 4063 \$6.98, © 8301-4063 \$7.98, © 5301-4063 \$7.98.

Performance: **Very good**  
Recording: **Very good**

I have mixed feelings. If you compare his stuff to other albums coming out at a given time, any Loudon Wainwright album seems pretty good—but compared to what Wainwright is capable of, this one seems a bit watered down. It doesn't particularly seem to be trying to be more commercial (although he deserves to be more commercial); it's just milder than I want. At least it is between the moments of patented Wainwright acuity. It starts out with some of those, though: *Bicentennial*, all irony, has a wonderfully economic way of twisting the knife you didn't realize had been inserted. "You know we have our heroes," it says, "Washington and Lincoln... Including Audie Murphy... Including old Jack Ruby. Wasn't Jack wonderful?" *Prince Hal's Dirge* is an extraordinary costume piece. You can feel in it the rough wood of the tavern tables, hear the noises, see the dim, flickering light, sense the conflicting smells.

Some of the other pieces are subtle enough but, well, too mild. *Summer's Almost Over* can be taken to have secondary meanings, and anyway it does a good job of suggesting just how benign school-day concerns are going to seem one of these days. But the surface of it isn't quite satisfying; simplicity hasn't served it as well as it served *Bicentennial*. At *Both Ends* has some lines in it but, for Wainwright, seems mostly a noisy rocker to get the kids' attention. And so on. However, *California Prison Blues* (which he had to keep rewriting up to the last minute because of Patty Hearst's shifting status relative to the slammer), *Talking Big Apple '75*, and (for a few listens) *Wine with Dinner* give this album plenty of meat, compared to almost anyone else's album. And of course if you haven't

(Continued on page 109)

# PRICE WAR

AMERICA'S #1 VALUE LEADER

STEREO CORPORATION OF AMERICA



WRITE US NOW FOR LOWEST PRICE QUOTE

AUDIO DISCOUNTING STARTED IN NEW YORK & NOW WITH THE END OF FAIR-TRADE WE ARE SURE THAT NO ONE CAN BEAT OUR PRICES:

- We Discount Over 70 Major Brands
- Over 10 Years Of Reliable Service In The Mail Order Field
- Largest Inventory/Lowest Prices!

We Get The Best Deals From The Manufacturers. You Get The Best Deal From Us!

SHOP BY PHONE!

(212) 253-8888  
9-5 Mon. thru Sat.  
Use Your Charge Card

FREE

WRITE OR CALL FOR FREE Stereo Price Catalogue

STEREO CORPORATION OF AMERICA

S-R 1629 Flatbush Ave.  
Brooklyn N.Y. 11210  
Tel: (212) 253-8888

CIRCLE NO. 58 ON READER SERVICE CARD

# TOP Discount AUDIO

Your NATIONAL HEADQUARTERS

For Famous Brand Electronics By Mail

1150 N. Powis Rd., West Chicago, Ill. 60185 • (312) 293-1825

All Orders Shipped In Factory-Sealed Cartons

Write Or Call For The Lowest Prices Anywhere!

MILLION \$\$\$ INVENTORY

LOWEST PRICES ON

RECEIVERS    TURNABLES    TUNERS  
SPEAKERS    CHANGERS    CARTRIDGES  
TAPE DECKS    AMPLIFIERS    HEADPHONES  
CALCULATORS    COMPACTS    CAR AUDIO

Top Discount Audio West Chicago, Ill. 60185 (312) 293-1825

SR-9 We honor Master Charge and Bank Americard. Date \_\_\_\_\_ Please send me a quote on: \_\_\_\_\_

MR.  MS. (First) (Initial) (Last)  
(Number And Street)  
(City) (State) (Zip Code)

CIRCLE NO. 60 ON READER SERVICE CARD

# SAVE!

MONEY • TIME • FREIGHT

- QUALITY STEREO EQUIPMENT AT LOWEST PRICES.
- YOUR REQUEST FOR QUOTATION RETURNED SAME DAY.
- FACTORY SEALED CARTONS—GUARANTEED AND INSURED.
- SAVE ON NAME BRANDS LIKE:
  - A.D.C.                      KLH
  - A.R.                              SHURE
  - DYNACO                      KOSS
  - SONY                              FISHER

PIONEER AND MORE THAN 50 OTHERS BUY THE MODERN WAY BY MAIL—FROM

illinois audio

Department 217S  
12 East Delaware  
Chicago, Illinois 60611  
312-664-0020

CIRCLE NO. 29 ON READER SERVICE CARD



“Could be the garret is a lonelier place now than it used to be...”



RCA

## Nilsson: Still Workin' on It

THERE must be *some* good old American story that could be rewritten and doctored and made into a Nilsson Chronicle, one that would explain why Harry Nilsson can't seem to get off the dime, musically, and in motion again these days. One wants to try, say, the old disillusionment-with-success story in some form; one could have a good time imagining the protagonist (Harry, or, as Ringo says, 'Arry) railing at all those who led him to believe Happily Ever After meant something good—or, for that matter, anything at all. But it would be pretty tricky casting him in that one, almost a Faulknerian task. Nilsson had the hardscrabble beginnings of Faulkner's Snopeses, perhaps, but he never had their crudeness, and the aftermath of success didn't catch him—as it caught Flem Snopes—with too little class for his new station, or with too little sophistication for the roles higher up the socioeconomic rope, or any of that. Instead, what Harry appears to be doing musically these days is slumming, and a lot of his innate subtlety is going to waste in his current hangouts. Aristocracy-going-to-seed is the twist the story wants to take now, and for that you need not Snopeses but maybe Sartorises or Compsons.

Harry was *born* with a lot of class, I think, and seems to share a story—whatever that story is—with such figures as Marlon Brando and Orson Welles. He seems to toy with recording the way they toy with their dramatic roles nowadays, the Presence being continually too big for the vehicle. His newest RCA album, “. . . That's the Way It Is,” seems to covertly acknowledge that this is going on, and the music—the *material*—in it seems to relate to Harry's talent as the ridiculous stuff in *Missouri Breaks* relates to Brando's, or as the ridiculous stuff in *The Long Hot Summer*

related to Welles'. This is a curious state of affairs, for Harry Nilsson, as everyone knows, is a fine writer as well as a singer, and why couldn't he write his way out of this? But *Missouri Breaks* had the services of a fine writer too (Tom McGuane), and *Summer* was based on parts of a fine book by, as a matter of fact, William Faulkner.

THE thing that troubles the listener, of course—the same thing that troubles the viewer of the last dozen Brando movies—is that the protagonist's heart isn't in it; there is little meat in the subject for him and he seems to be going along and trying to amuse himself as best he can. And so we have here a strange, primal-scream treatment of Randy Newman's *Sail Away*. It may remind you of what a fine album “Nilsson Sings Newman” was, which Harry got his teeth into, or it may remind you of Harry's recent associations with John Lennon, another hardscrabble beginner who seems bent on a Compson-type middle age. You have a dragged-out joke, which Harry didn't write, about a tattooed lady; it's maybe half a cut above bathroom “humor,” and Flem Snopes probably would've liked it. You have the Nilsson virtuoso vocal treatment of a slow rhythm-and-blues number, *A Thousand Miles Away*, that may remind you of when this kind of thing was called race music (That's the Way It Was, and a lot of what was has been recycled into what *is*), but that is more likely a simple matter of goofing around in the studio. And so on. Harry has done very little writing for this, in fact; only two of the songs are his, and those are in collaboration with others. They are, like the rest, casual, though the one he wrote with Dr. John, *Daylight Has Caught Me*, is still pretty good. But there is a line he didn't write (in *Zombie Jam-*

*boree*) that seems altogether poignant for Harry Nilsson to be singing these days: “I don't give a damn . . . 'cause I've done that already.” Caring is out—it's been done. *That's* an interesting idea, and it may be relevant to the Seventies in spades. So give Harry good marks for a journalistic *feel* of some sort, but remember too that we listeners apparently have to do most of the work to make the album mean something.

That isn't quite how it's supposed to be. We're supposed to do *some* of it, but our ears have to be treated first. The way it's supposed to be is that Harry's supposed to be up in a garret somewhere coming up with stuff that we couldn't come up with ourselves and putting his own individual stamp on how it sounds. His razzle-dazzle in the studio is supposed to be *about* something; this is, after all, the one we used to call Nilsson(!). We don't one-name every Rockaday Johnny who comes along, and we'd feel better about albums like this if they were technically inferior but a little more earnest.

EXACTLY what's going on is impossible to know, of course, without knowing Nilsson extremely well personally. It could be, among other things, that the garret is a lonelier place now than it used to be. Back when he was publicly Nilsson, before everyone took to calling him Harry, he was, or seemed, above it all. Keeping his own counsel, I thought. His music wasn't rock; it wasn't anything you could categorize. He didn't seem to need to be identified with any particular in-group. Maybe we're now in a period when spies need to come in from the cold and artists need to come down from their garrets. The need for day-to-day ego feedback may be exacerbated by the general schlockiness of the Seventies—and of course with all that stroking and the associated identification with other persons and groups comes a threat to the individuality of one's work. Maybe Harry primarily needs time and circumstance in which to be a person, whereas Nilsson(!) needed primarily the solitude in which he could try to be an artist.

There must be a check built into this somewhere, nature being so full of safety valves, and perhaps it is boredom. I suspect that Harry, or maybe it's Nilsson(!) I'm talking about, won't tolerate much more boredom than he apparently endured in getting this project out of the way. And so he may climb back up there and consult himself again about doing something he cares about. The times and the part they play in all this could change, too. Times have been known to, and then some American stories do have this thing about upbeat endings. . . . —Noel Coppage

**HARRY NILSSON:** . . . *That's the Way It Is*. Harry Nilsson (vocals, keyboards); instrumental accompaniment. *That Is All*; *Just One Look/Baby I'm Yours*; *Moonshine Bandit*; *I Need You*; *A Thousand Miles Away*; *Sail Away*; *She Sits Down on Me*; *Daylight Has Caught Me*; *Zombie Jamboree*; *That Is All (reprise)*. RCA APL1-1119 \$6.98, © APS1-1119 \$7.98, © APK1-1119 \$7.98.



even discovered Wainwright yet, and don't do so soon, I'll take it personally. You wouldn't want to hurt an old folkie's feelings. N.C.

**BILL WRAY.** Bill Wray (vocals); orchestra. *Lover; I'm in Love; Takin' My Time; Sailin'; Tonight's the Night*; and four others. LEGEND MCA-2188 \$6.98, © T-2188 \$7.98.

Performance: **A bit embarrassing**  
Recording: **Fair**

Bill Wray writes and performs (sort of) all of his own material on this album. From the firmly mediocre beginning (*River City*) until the final turn of the screw seven bands later (*So Far from Home*), it is an exercise in the kind of galvanic sloppiness I thought had passed from the record industry when money got tight. An album that should simply be politely dismissed, ignored, and glossed over.

P.R.

## COLLECTIONS

**THE COMPLEAT DANCING MASTER.** Traditional airs compiled and arranged by Ashley Hutchings and John Kirkpatrick, with various readers and instrumentalists. AN-TILLES AN-7003 \$4.98.

Performance: **Interesting**  
Recording: **Very good**

This is an interesting, valiant, but largely unsuccessful attempt to fuse rock, dramatic readings from the classic literature, and antique musical forms into a palatable entertainment whole. Unfortunately, the result is a mostly confusing, highly erratic hash that never settles down to one consistently interesting point of view. The musical sections do have a certain arty chic that holds the attention for a while—until one begins to wonder why anyone would go to all this trouble simply to slide a few rock shadings into such a highly constricted form. The dramatic readings, by such well-known English actors as Michael Gough, Alec McCowen, and Sarah Badel, range from Dickens to Shakespeare to Chaucer, are uniformly plummy in diction, and are tinged with just enough echo chamber to make them sound "important" in an old-fashioned radio-drama sort of way. And yet, with all its pretentiousness, its scent of preciousness, and its "in" coyness, the album *does* have a certain donnish charm. P.R.

## RECORDING OF SPECIAL MERIT

**COWBOY SONGS.** Larry Hanks, Mark Ross, Lewis London, Mickey Clark, Sam Hinton, Saul Brody (vocals); instrumental accompaniment. *The Brazos River; Jesse James; Get Along Little Dogies; Red River Valley; Hell in Texas; Dreary Black Hills; Down in the Valley; Windy Bill*; and nine others. NATIONAL GEOGRAPHIC 07786 \$6.95 (from the National Geographic Society, Washington, D.C. 20036).

Performance: **Good**  
Recording: **Excellent**

Records of cowboy songs are not exactly the newest thing, and National Geographic would seem to be rustling in territory already staked out by other companies. But if we must have more records of cowboy songs, we couldn't get them in a better package than has been put together here, the first of four albums of the Society's "American Adventure Collection." First, there's the booklet, page after page

handsomely illustrated in full color with doggedly realistic paintings of cowboy life by Frank C. McCarthy. Then there's a text, one of those informative National Geographic texts, telling how it was for the hard-working cowpuncher who got the "tools and methods of his trade" from the Mexican *vaqueros* (hence, "buckaroos") and often put in an eighteen-hour working day. Then there are notes for all the songs, rich in facts about how the men would sing night-herding lullabies to soothe the cattle and prevent stampedes, how *The Streets of Laredo* can trace its ancestry back to Celtic origins, and what really happened to Billy the Kid (Sheriff Pat Garrett shot him dead after he escaped from the prison where he was being held on a murder rap). Finally there are the songs themselves, *Get Along Little Dogies* and *Red River Valley* and *Little Joe, the Wrangler*, along with a number of less familiar ballads like *Hell in Texas*, a no-holds-barred satirical stint about how it came to be so hot in the spade-shaped state, and *Trusty Lariat*, a spoof on the whole myth of the larger-than-life hero sitting tall in the saddle. Real cowboys often couldn't get jobs if they couldn't sing, but the group whose members take turns leading the songs in this collection could qualify with the best. There are seven soloists, and every one of them has a thorough grasp of the cowboy-song idiom and gets lively accompaniment from harmonica, guitar, fiddle, and banjo in various combinations—just as they were likely to have turned up around the campfire on the old Chisholm Trail. P.K.

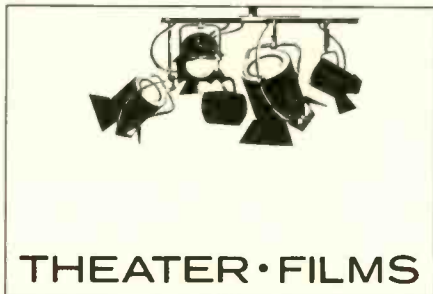

**COLE—A MUSICAL TRIBUTE TO COLE PORTER.** Elaine Stritch, Patricia Routledge, Ian Carmichael, Susannah McCorkle, the Mike Sammes Singers (vocals); orchestra. *Night and Day; I Get a Kick Out of You; You've Got That Thing; True Love; I'm in Love Again; In the Still of the Night; Brush Up Your Shakespeare*; and eight others. STANYAN SR 10136 \$6.98 (from Stanyan Record Co., 8440 Santa Monica Blvd., Los Angeles, Calif. 90069).

Performance: **You're the top, Carmichael**  
Recording: **Good**

This is an inglorious mess. Only one of the performers, Ian Carmichael, has any feel at all for the snap and wit of the Porter style, something he proves magnificently in *You've Got That Thing* ("That certain thing/That makes the birdies forget to sing . . .") and in the newly infamous *Miss Otis Regrets* (ah, Truman, you've gone too far at last). Carmichael is superb, and he deserves an album of his own for our delectation. Unfortunately, Elaine Stritch sounds totally spaced-out and all too obviously flat in *I Get a Kick Out of You* and in her three other numbers. Whatever

# The \$750 alternative.

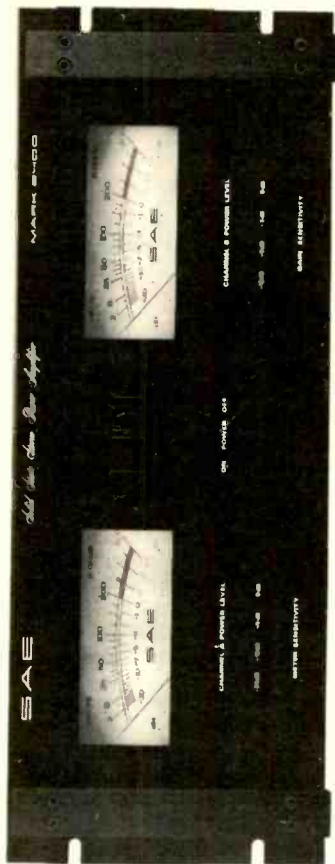

SAE 2400 Professional Dual-Channel Power Amplifier

- 200 Watts RMS, per channel, both channels driven into 4 or 8 Ohms from 20Hz to 20KHz at no more than 0.05% Total Harmonic Distortion.
  - 0.05% IM into 4 or 8 Ohms
  - (signal to noise) greater than 100dB
  - plug-in board modules
  - forced air cooling
  - only 11" deep
  - weighs less than 42 lbs.
  - superb construction using only the finest materials and component parts
  - available in black rack mount (as shown) or our traditional satin gold and black
- You'd have to look a long time to find a power amplifier that delivers this much value.



Scientific Audio Electronics, Inc. SR 9/76  
P.O. Box 60271, Terminal Annex  
Los Angeles, California 90060  
Please send me the reasons (including available literature) why the SAE 2400 Professional Amplifier is the "\$750 Alternative."

NAME \_\_\_\_\_  
ADDRESS \_\_\_\_\_  
CITY \_\_\_\_\_ STATE \_\_\_\_\_ ZIP \_\_\_\_\_

CIRCLE NO. 51 ON READER SERVICE CARD



er tough, wisecracking style she had in the past seems to have disappeared into a harsh, almost desperate aggressiveness.

Patricia Routledge and Susannah McCorkle are completely hopeless in dealing with the Porter subtleties—they sound like two barmaids walking through Bergdorf's on their lunch hour and trying to sound "chick" for the benefit of anyone who might overhear them. Oh well, Porter has and will survive this kind of mauling, and his own reaction to this album would probably have been one of grim amusement. P.R.

**REX (Richard Rodgers-Sheldon Harnick).** Original-cast recording (see *Choosing Sides*, page 114)

**TURNABOUT! (Forman Brown).** Original-cast recording. Elsa Lanchester, Forman Brown, Frances Osborne, Dorothy Neumann, Bill Buck, Harry Burnett (vocals); piano accompaniment. PELICAN LP 142 \$6.98 (from Pelican Records, P.O. Box 34732, Los Angeles, Calif. 90034).

Performance: **Good**  
Recording: **Good**

The Turnabout Theatre Revue was for years (1941 to 1956) an institution in Los Angeles, a city that never seemed to care too much for live entertainment of the traditional legit kind. Forman Brown's tiny, charming theater, however, with its company of clever comic actors who performed his material, did manage to survive as about the only place out there that had any of the snappy chic of what was then a multitude of supper clubs in New York (the Blue Angel, the Village Vanguard, Bon Soir, etc.). The fourteen numbers recorded here are supposedly representative of a "typical evening" at the Turnabout. Genteel, verging on the tatty, is about the best that can be said of this kind of material in 1976. Even Elsa Lanchester, a woman who even in casual conversation I generally find amusing, is only tee-hee-m'dear jokey in such things as *When a Lady Has a Piazza* or *If You Can't Get in the Corners*. Frances Osborne is still more of a drawing-room "card" in *Brunnhilde Rides Again*, and Harry Burnett sounds artily "wistful" in *Claribel the Great*, the saga of a man who is the back end of a stage horse. Brown himself is an interesting performer—a cross between the ghosts of Dwight Fiske and Clifton Webb. It's interesting historically, I suppose, but the album sounds today very much the way an Angela Thirkell novel reads—a bit precious, sometimes funny, but incredibly naïve. P.R.

#### RECORDING OF SPECIAL MERIT

**TUSCALOOSA'S CALLING ME (Bill Heyer-Hank Beebe).** Original-cast recording. Len Gochman, Patti Perkins, Renny Temple (vocals); Jeremy Harris (piano); Ted Sommer (drums); Dave Moore (bass). VANGUARD VSD 79376 \$6.98.

Performance: **Tonic**  
Recording: **Very good**

In *Tuscaloosa's Calling Me* . . . *But I'm Not Going* three bright and agile young people—Len Gochman, Renny Temple, and Patti Perkins—talk, sing, and prance their way through a musical review designed to raise the flagging spirits of besieged New Yorkers and make visitors feel glad they took the trip. Against constantly shifting backgrounds of

projected city scenes, the trio praises the town's virtues and twits its vices in a lively and ingenious mixture of skits, ballads, and patter songs reminiscent of the sort of thing that used to be done so well in night clubs like Plaza 9 and Upstairs at the Downstairs. When I got around to catching the show, this Valentine for the Big Apple had moved uptown from the Village Gate; Ms. Perkins was still in it, but Len Gochman had been replaced by Ted Prichard and Renny Temple by Chip Zien. Prichard and Zien were nimble enough, but Gochman and Temple are even more effervescent, and Perkins is a superb comic. Lucky, then, that it is their voices you hear on this original-cast recording, which offers ten of the best numbers out of the eighteen not invariably excellent ones to be seen on stage. (The jacket quotes a *New Yorker* review to the effect that *Central Park* is one of the loveliest songs, but that song is not included on the record.)

Since New Yorkers are not to be caught



Tuscaloosa's Gochman, Temple, and Perkins:  
An outright declaration of municipal love

praising their city in the kind of shameless Chamber-of-Commerce terms that might pass in, say, Los Angeles, the review backs into its romantic affair with the town by wry and circuitous routes. The opening number, for example, is a sardonic stinger in which the listener is assured that "nobody ever gets raped in Kansas City" or "strangled up in Boston." There's a skit where a cabbie is hard put to figure out where to take a thrill-seeking tourist who has already been "groped" at Radio City Music Hall and has had his worst fears about the metropolis reinforced through Johnny Carson ("That man is deep") routines. An entire ballad is given over to the glories of local delicatessen ("In Seattle never risk it/When they try to sell you brisquet"). *Everything You Hate Is Right Here* is an exercise for the indulgence of anti-New York hostilities reminiscent of the hate sessions in 1984, while *Fugue for a Menage à Trois* confirms the country folks' worst fears about city-dweller decadence. But all is not satire in *Tuscaloosa's Calling Me*. *Singles Bar* is a skit where the fun is tinged with pathos, *New York from the Air* is a shamelessly romantic ballad extolling the beauty of the town, and the title song is an outright declaration of municipal love. You don't have to have seen *Tuscaloosa's Calling Me* to enjoy the record. P.K.



**BEAVER HARRIS/THE 360 DEGREE MUSIC EXPERIENCE: From Rag Time to No Time.** Beaver Harris (drums, finger cymbals); two orchestras, including Doc Cheatham (trumpet), Herb Hall and Howard Johnson (reeds), Marshall Brown (valve trombone, euphonium), Dave Burrell (piano, Indonesian balaphone), Cecil McBee, Ron Carter and Jimmy Garrison (bass), and Bill Withlingham and Maxine Sullivan (vocals). *A. M. Rag; Round Trip (Parts 1 and 2)*; and three others. 360 LP 2001 \$6.98 (available by mail from 360 Records, 269 West 72nd Street, New York, N.Y. 10023).

Performance: **Something old, something new . . .**  
Recording: **Very good**

If the idea of Doc Cheatham and Herb Hall recording with Dave Burrell and Beaver Harris sounds as far out as Kate Smith doing back-ups for Gil Scott-Heron (don't worry, she hasn't as yet), it isn't. For one thing, no avant-garde player worth his salt finds it difficult to take a stylistic step backward, and as it happens the segments featuring Cheatham, Hall, Maxine Sullivan, and Marshall Brown (namely, side one) do not require *them* to take the more difficult step forward.

I suppose this is to be regarded as one work, but I find it hard to do so because what happens on side one is so totally different from side two, and—except for having in common the presence of Ron Carter and Beaver Harris—there seems to be no relationship. Side one features a sextet with a couple of vocals by Ms. Sullivan. Arranged by Brown, it starts off with *A. M. Rag*, written and played by Burrell, whose approach to ragtime is a deliberately stylized one; there is also a pleasant ballad written by Harris and sung by Maxine Sullivan—who sounds at least twenty years younger than she is—and a segment very reminiscent of the sort of thing John Kirby's band used to do (Ms. Sullivan was, incidentally, once Mrs. Kirby). Herb Hall plays well here, though he never fully measured up to his late brother, Edmond, and Doc Cheatham—in his seventies—amazingly continues to reflect the technique and musical thinking of a forty-year-old. It's a nice side, but I think just letting these musicians jam would have yielded better results.

Side two is more satisfying because it is more honest. Thirteen musicians, mostly percussionists, are featured. Dave Burrell's arrangements, which take full advantage of everyone present, have a great deal to do with the success of this album. Opening with a fine bass duet played by Cecil McBee and Ron Carter, who also engage in an interesting dialogue later on, *Round Trip* (the collective title of this side) is supposed to take us to the ragtime of the opening cut to the no time re-

(Continued on page 112)



# Some of the rather special adjectives the test labs have been using to describe LUX.

Unless this is the first high fidelity publication you have read, you know that equipment reviews are almost always favorable. We don't suggest that the reviews are inaccurate or that they don't reflect the editors' sincere judgments. Rather, we understand that the publications prefer to use their limited space for equipment that they can recommend to their readers.

Thus, the problem for the discerning reader is to distinguish between the adequate, the good and the truly superb. As of this date, four LUX products have been the subject of test reports in high fidelity magazines. Aside from confirming excellent specifications and exceptional sonic performance, the reviewers left little doubt as to which descriptive category they meant to apply.

For an apt example, the Hirsch-Houck report (in *Stereo Review*) on the Luxman L-100 concluded: "Obviously the performance and operating characteristics of the Luxman L-100 require the use of superlatives for an adequate description..."

Externally, internally and in respect to performance, (it) must be considered a simply beautiful product. The harmonic distortion (THD) at 1,000 Hz and 10 watts output was 0.0087 per cent and it remained at that figure up to the rated 110 watts..." (Our claimed THD at rated power, 20 to 20,000 Hz, is 0.08 per cent).

*Radio-Electronics* "heard a clarity and effortless power capability that is hard to describe in words but definitely is audible!"

*Audio* magazine's test of our T-310 tuner led

to this observation: "...most of our results were far superior to those claimed...distortion in mono and stereo was the lowest we have ever read for any tuner at any price." Also, "LUX's conservatism extends to some of the 'lesser' FM specs as well. We measured a capture ratio of 1.2 dB (1.5 dB claimed) and alternate channel selectivity turned out to be 76 dB (70 dB claimed) ...The (variable) AM muting feature has to be heard to be believed."

*High Fidelity* magazine's report was on the C-1000 preamplifier. They found "the performance... virtually impeccable. Clipping occurs at 13 volts. The data from the CBS Technology Center shows that, at a more reasonable 2 volts, THD is less than 0.0064% for all conditions, and intermodulation distortion is 0.002% or less." *High Fidelity's* conclusion: "It is more a Rolls-Royce than a Ferrari. But if you are a sybaritic audiophile with a budget to match, the C-1000 will pamper you as few preamps can."

*FM Guide* reported on the Luxman T-110 tuner, also with unequivocal conclusions: "...the FM purist's tuner... emphasis is totally on absolutely top FM performance... in most of our listening tests we were being limited by the quality of broadcast signals... without a doubt, the best performing tuner we have ever seen at this price."

If you would like to see and hear the equipment that prompted these superlatives from the reviewers, visit one of the select LUX dealers for a demonstration. Chances are the next superlatives you hear will be your own.



The Luxman  
C-1000.

The Luxman C-1000. "If you are a sybaritic audiophile with a budget to match, the C-1000 will pamper you as few preamps can." .....*High Fidelity*



The Luxman  
L-100.

The Luxman L-110. "It was obvious in most of our listening tests that we were being limited by the quality of broadcast signals and not by the capabilities of this superb tuner." .....*FM Guide*

The Luxman L-100. "Lux seems to have found some of the answers... about what makes one amplifier sound better than another" .....*Radio Electronics*

The Luxman T-310. "...a stunningly executed product that should appeal to the FM buff who seeks the finest FM reception." .....*Audio*



The Luxman  
T-110.



The Luxman  
T-310.

## LUX Audio of America, Ltd.

200 Aerial Way, Syosset, New York 11791  
In Canada: White Electronics Development Corp., Ontario



# Because good tracking isn't enough.



List Price: \$115.00

## The Micro-Acoustics 2002-e Cartridge.\*

No matter how much you hear about tracking ability, it can't tell you everything about cartridge performance. Because tracking ability only tells how well a stylus stays in the groove on loud passages, at low pressures. Transient ability is just as important. Without it, no cartridge can reproduce music with really lifelike clarity—because music is mostly transients.

The problem was, no cartridge offered both. So you had to choose between low record wear (tracking ability) and accurate reproduction (transient ability). Until now.

For the first time, superb transient and tracking ability are available in the same cartridge—the Micro-Acoustics 2002-e.

Designed by the world's leading manufacturer of record-mastering styli, with direct-coupled electrets and low-mass beryllium stylus bar that offer the most transparent sound your critical ears have ever heard. Tracking at only one gram.

But don't take our word for it. We've prepared a unique demonstration record to help you evaluate and compare cartridge transient and tracking ability. Just send \$3.50, and we'll mail you one postpaid. For free information, and the name of your nearest dealer, just write.

# ma<sup>®</sup>

Micro-Acoustics Corporation  
8 Westchester Plaza  
Elmsford, N.Y. 10523

\* Patent Pending. © 1975 Micro-Acoustics Corp.

CIRCLE NO. 42 ON READER SERVICE CARD

ferred to in the album title, but time is actually abandoned only briefly, returning at the end in the form of a Beaver Harris drum solo. Do I like the album? Yes. C.A.

**LEROY JENKINS: *For Players Only*.** Leroy Jenkins (violin); Jazz Composer's Orchestra, including Leo Smith (trumpet), Anthony Braxton and Dewey Redman (reeds), and David Holland and Sirone (bass). JCOA LP 1010 \$6.98 (from Jazz Composer's Orchestra Association, Inc., 6 West 95th Street, New York, N.Y. 10025).

Performance: **Free, but not easy**  
Recording: **Excellent remote**

The Jazz Composer's Orchestra Association commissioned Leroy Jenkins to write this work in 1974. It was first presented by the JCOA and WKCR-FM (the Columbia University station) in January 1975 at Columbia University's Wollman Auditorium during four workshop concerts, the third of which was recorded. Though the effect is lost on this stereo record, the concert was presented quadratically, clusters of musicians being placed in each corner of the square auditorium while Jenkins played and conducted from the middle. The effect was undoubtedly interesting to those present, but it is a far cry from, say, having trumpets on a balcony during a performance of the Verdi Requiem. *For Players Only* relies heavily on collective improvisation, which demands a certain intimacy made impossible by the placement employed here. I don't think it is my imagination that some passages of this performance are influenced by this lack of contact, but that may well be what composer Jenkins had in mind. Of course, the players heard each other (through an elaborately arranged p.a. system), but visual contact is almost as important.

There is confusion, there are weak moments, but the overall effect of *For Players Only* is generally good, and some passages are excellent. Though Jenkins dictated a certain structure, an order of events, motifs, this is essentially free-form music, and it would have been interesting to have on records what those who were present during each performance heard: a gradual development of this piece, one which obviously continued on the night following this recording. According to the album notes, "the piece meshed beautifully in the final evening's two consecutive performances." One wonders why JCOA decided to release this earlier one. C.A.

**THE L.A. FOUR** (see Best of the Month, page 88)

**PETER MAGADINI: *Polyrhythm*.** Peter Magadini (drums, percussion); Don Menza (flute, piccolo, soprano and tenor saxophones); George Duke (keyboards); Dave Young (electric bass). *The Modulator; Samba de Rollins; Midnight Bolero*; and three others. BRIKO BR 1000 \$6.98 (from Briko, P.O. Box 15075, Phoenix, Ariz. 85060).

Performance: **Very good**  
Recording: **Very good**

Annotator Bart Bull (if there is such a person) writes that "polyrhythms are relatively new to Western ears," which would indicate that the music of black Americans is relatively new to his ears. What is new here—to me, at least—are Peter Magadini and Don Menza, two fine musicians who surely could play their way out of Phoenix (where this album origi-

nates) and may well have done so already. George Duke, formerly of the late Cannonball Adderley's group, and bassist Dave Young, an erstwhile Oscar Peterson associate, fit nicely into the scheme of things, making this a very good album on a very young label from a very unlikely geographic location. By the time you get to Phoenix, though, Magadini and Menza will undoubtedly have moved on to more fertile jazz ground. C.A.

**MAHAVISHNU ORCHESTRA/JOHN McLAUGHLIN: *Inner Worlds*.** John McLaughlin (guitar, synthesizers, backing vocals); Mahavishnu Orchestra (vocals and instrumentals). *In My Life; Lotus Feet; Inner Worlds (Parts I and II)*; and seven others. COLUMBIA PC 33908 \$6.98, © PCA 33908 \$7.98, © PCT 33908 \$7.98,

Performance: **Stagnant**  
Recording: **Very good**

I have admired John McLaughlin as a musician ever since I first heard him play with Miles Davis, and I have enjoyed much of what he has done on his own since then, but this pseudo-spiritual waste of talent is positively sinful. Great as it is to hear McLaughlin play on a number like *In My Life*, I just can't see having to put up with all the surrounding nonsense. C.A.

**JACO PASTORIUS.** Jaco Pastorius (bass); various instrumental combinations, including Wayne Shorter (soprano saxophone), Hubert Laws (piccolo), Herbie Hancock (keyboards), Don Alias (congas and percussion), and Lenny White (drums). *Donna Lee; Opus Pocus; Continuum*; and seven others. EPIC PE-33949 \$6.98, © PEA-33949 \$7.98.

Performance: **Ho humdrum**  
Recording: **Very good**

I have come to the conclusion that there is some sort of master tape circulating in the record industry. Somewhere on its many tracks it contains the current gang of ins—Herbie Hancock, Wayne Shorter, McLaughlin, the Brecker brothers, etc.—located in such a way that the remix engineers can produce an almost infinite variety of combinations. A couple of tracks are left blank, of course, to add various leaders and soloists whose presence is designed to give the impression of a new recording.

Though we have heard it on other labels, this communal tape seems to be most frequently used by the Columbia/Epic people, who have used it as the basis for all the most recent Herbie Hancock albums. In this case, they have added Jaco Pastorius, a not-so-interesting bassist, as the leader, injected a tired vocal by soul team Sam and Dave, and tied the package with strings arranged by the very talented Michael Gibbs. Some of Hancock's work here sounds new, but there is little else that hasn't met the ear before. C.A.

**JOE VENUTI: *Joe Venuti and Zoot Sims*.** Joe Venuti (violin); Zoot Sims (tenor saxophone); Spiegel Wilcox (trombone); John Bunch (piano); Milt Hinton (bass); Bobby Rosengarden (drums). *Avalon; I Surrender Dear; Shine; Russian Lullaby*; and six others. CHIAROSCURO CR 142 \$6.98.

Performance: **Venutian**  
Recording: **Sloppy**

**JOE VENUTI/MARIAN McPARTLAND: *The Maestro and Friend*.** Joe Venuti (violin); Mari-





MIKE WOFFORD

Engaging melodies well worth listening to

an McPartland (piano). *Dinah*; *Stardust*; *C Jam Blues*; *Afterglow*; *How High the Moon*; and four others. HALCYON HAL-112 \$4.98 (from Halcyon Records, 302 Clinton Street, Bellmore, N.Y. 11710).

Performance: **Unflinching**  
Recording: **Very good**

Joe Venuti, who is older than the twentieth century, might have needed an introduction about five years ago when he was best known to jazz scholars and record collectors who knew his work from literally hundreds of recordings made in the Twenties and Thirties. However, the Seventies have seen a Venuti renaissance, and the recent outpouring of new releases by this old master has gained him new audiences throughout the world.

The two albums covered in this review are disparate in mood and texture. The Chiaroscuro set is Venuti's third for that label, and, like the other two, it teams him up with saxophonist Zoot Sims; they work well together, but a change of partners might be suggested for variety's sake. Drummer Bobby Rosen-garden is an awkward fly in this otherwise tasty soup, and trombonist Spiegel Wilcox—who appears to have been included (on one selection) more because he played with Jean Goldkette's band fifty years ago than because he plays well (he doesn't)—could also have been dispensed with. But Joe and Zoot swing, bassist Milt Hinton propels, and pianist John Bunch, though abominably recorded, keeps pace admirably.

Much more satisfactory is the set with pianist Marian McPartland. Recorded in Nice, France, in 1973, it has a certain character and charm. *C Jam Blues* is a spirited foot-stomper with a couple of rough edges, but the rapport is so marvelous that all simply has to be forgiven; ditto for *That's a Plenty*, which is followed by Marian McPartland's own composition *Afterglow*. Venuti and McPartland work beautifully together on such slow ballads as *Stardust*, and I looked forward to their collaboration on *Afterglow* (the highlight of Ms. McPartland's "Solo Concert at Haverford" album), but Venuti vanished five minutes and thirty-eight seconds before the conclusion of side two, a fact I can forgive only because

Marian McPartland renders a solo performance of devastating beauty.

Neither of these albums is my favorite of the new Venuti crop. Both have their merits and both have their flaws, but the Halcyon set definitely has the upper hand. C.A.

**MIKE WOFFORD:** *Scott Joplin: Interpretations '76*. Mike Wofford (piano); Chuck Dominicano (bass); Shelly Manne (drums). *A Real Slow Drag*; *Prelude to Act III*; *We're Goin' Around*; *Superstition*; and four others. FLYING DUTCHMAN BDL1-1372 \$6.98.

Performance: **More Wofford than Joplin**  
Recording: **Very good**

The album cover doesn't really make it clear, but the music of Scott Joplin here modernized by West Coast pianist Mike Wofford is all from the opera *Treemonisha*, which had its premiere in Atlanta in 1972, but was actually written some sixty-five years ago. We will never know what Joplin really had in mind, but the opera, as orchestrated by Gunther Schuller for the later Houston and New York performances, proved to be rather dull fare. Nevertheless, it contains some engaging melodies which translate nicely into a more modern musical language. This set is half solo piano, half trio, and all worth your listening time. Mike Wofford obviously likes what he is doing, and so do I. C.A.

#### RECORDING OF SPECIAL MERIT

**PHIL WOODS:** *The New Phil Woods Album*. Phil Woods (soprano and alto saxophones); the Phil Woods Quartet; brass and string accompaniment. *The Sun Suite*; *Gee*; *Chelsea Bridge/Johnny Hodges*; *Body and Soul*; and four others. RCA BGL1-1391 \$6.98, © BGS1-1391 \$7.98.

Performance: **Excellent**  
Recording: **Excellent**

Except for some excellent reissue programs, RCA Records barely seems to have given jazz a thought in recent years, but something is happening there now, and it's happening very nicely. As other labels churn out interchangeable albums of electronic gimmickry, RCA appears to have embarked on a project of recording jazz performers whose music will not go out the other ear. This is one such album.

A student of Lennie Tristano, the Manhattan School of Music, and Juilliard, Phil Woods—now forty-four—draws most of his inspiration from Charlie Parker, but his allegiance goes back to Pete Brown and Johnny Hodges. In recent years he has recorded for several small labels—including a disastrous flirt with electronics on a Testament album—but this album must be his crowning achievement to date. Woods arranged and orchestrated all but one tune himself, and it is he who dominates the album; his style is a pleasant blend of pre-Parker and post-Parker with a good measure of Woods added, and his technique is impeccable. Pianist Mike Melillo, bassist Steve Gilmore, and drummer Bill Goodwin, who complete the Phil Woods Quartet, are excellent, and they should not take seriously annotator Mort Goode's insulting remark: "The most interesting thing about The Quartet is that not one of them lives in New York." More interesting is their performance of such numbers as *Body and Soul* and *Mimi*, done without orchestral accoutrements. Keep it up, RCA, and you just might become number one again. C.A.

## Press comment:

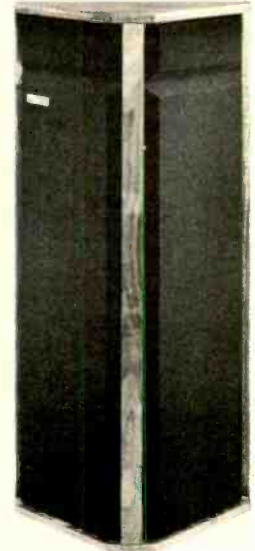

HIGH FIDELITY

April 1976

### "A Full Warranty"

"Allison Acoustics has implemented the first full warranty, as the word 'full' is defined under the recently enacted Magnuson-Moss Warranty Act, that we know of on a consumer audio product. The document begins: 'Allison Acoustics warrants that each of our loudspeaker systems will perform within  $\pm 2$  dB for five years from the date of original purchase.' It provides that the manufacturer will pay shipping both ways if it is necessary to return the equipment to the factory for warranty service. Abuse and damage resulting from unauthorized repair are among the few conditions omitted from coverage, and Roy Allison, president of the company, indicated in a clarifying letter to us that any reasonable doubt will be resolved in favor of the consumer. One provision of the new federal law is that a full warranty must be transferable with the ownership of the product, and that is fulfilled by Allison as well.

"Allison's letter concludes: 'The Magnuson-Moss Warranty Act gives the consumer some remedies against non-compliance that he did not have before and prohibits some deceptive practices in warranty statements. . . . It should be welcomed by every manufacturer who sincerely wishes to deal honestly and fairly with his customers.'

"Well said, Roy Allison. And congratulations to you and your company on apparently setting a precedent for the high fidelity industry."

*Descriptive literature on Allison loudspeakers, which includes technical specifications and a statement of warranty, is available on request.*

ALLISON ACOUSTICS INC.  
7 Tech Circle, Natick, Massachusetts 01760  
CIRCLE NO. 10 ON READER SERVICE CARD



# Choosing Sides

By Irving Kolodin



## REX: SEX, VEX, HEX

THE score for *Rex* was Richard Rodgers' forty-first for the musical theater; though the most recent, it may also, for the average theater-goer, be the least memorable. That is something we can regret without going quite as far as the *New York Times*' Clive Barnes did in his review, characterizing Rodgers as a great man of the musical theater with one hand while hoisting him high on the critical gibbet with the other. At any rate, *Rex* is dead after only forty-nine performances in New York, and though RCA's original-cast album (ABL1-1683) doesn't by any means mirror the whole score, it contains enough of what was strong about it to make one wonder why more wasn't done to correct what was weak.

The existence of a worm beneath the skin of this well-grown if somewhat unripe apple was apparent long before the Broadway opening in early April—as long before as February 20, indeed, when the production had its first showing in Wilmington, Delaware. Elaborate, complicated, with a multiplicity of scenes and a cast of principals to match, it had every ill-omened attribute of the classic out-of-town-opening fiasco. That was in itself something of a curiosity, given the vast experience of those involved: Richard Adler as producer, Sheldon Harnick (with many successes to his credit) as author of the lyrics to a book by Sherman Yellen, and, of course, Rodgers himself. Could it have been smoother, could it have been keener in its treatment of Henry VIII's catalog of fleshly passions? Perhaps so, given another group of collaborators. Lorenz Hart would have dealt more deftly with Henry's pre-Elizabethan enthusiasm for wiving and swiving—and for diving into any trencher his cooks could fill. Oscar Hammerstein II would have been worldlier about the royal urges, wiser about the surges and the purges. And both, certainly, could have accommodated Henry's yearning preoccupation with the subject of a son and heir without making it the underwhelming theme of the musical.

It was clear enough, on that Friday night in Wilmington, that the second of the two acts (a

dramatic division apparently now inviolable in the Broadway musical, though it suits this subject less well than it does some others) was the stronger. As Henry's life was winding down—with, finally, the reward of the son for whom he yearned and the disconcerting discovery that there might, after all, be more of his Tudor self in the female Elizabeth than in the male Edward—Rodgers' musical graph was rising higher. Henry's awareness of the passing days and his longing for an extension of them also inspired the touching imagery of Harnick's best lyric. Its cue was the presentation to Henry of a gift—a pear tree from Anjou—from his contemporary and rival Francis, King of France. Such a tree matures only after ten years, and Henry's longing to partake of its fruit was a kind of life (and death) wish, both admirably echoed in Rodgers' mu-



Tom Aldredge (*Will*) and Nicol Williamson (*Henry*): somewhat lacking in requisite royal volume

sic. It was, in fact, the warmest, most typically Rodgers-ish effort of the evening.

There were, of course, some changes made between the Wilmington and the Broadway openings, and to these the recorded version of *Rex* bears witness. Most, to judge from a comparison of the disc with the original printed program, were eliminations from the overlong, cluttered first act. But one addition is a

song titled *Why?* which gives still further voice to Henry's irritation at being denied—you guessed it—a son. This is probably what is called, in contemporary show-shop terms, "getting the message across." In other words, on the chance that the audience has been asleep the first two or three times the idea was presented, give it to them again.

Such redundancy is, first of all, insulting; it is also fallacious, as fallacious as the notion that a Broadway show cannot have a downbeat ending or even the suggestion of one. But the recorded *Rex* nevertheless comes to its end lamely with a reprise of the *Te Deum*, with which the original show, unlike the record, did not begin. Nor does the recording present *The Pears of Anjou* even in some other, slightly rearranged sequence. To avoid the possibility that it might even suggest an unhappy end, it is out, gone, eliminated. In similar circumstances Kurt Weill, say, might have been called on (though certainly not with Maxwell Anderson's compliance) to exchange his masterly *September Song* for something "happier" for Peter Stuyvesant to sing at the close of *Knickerbocker Holiday*. Something nice, perhaps, like "It's May in September/When all we remember/Is June will come again after December." This wouldn't make much sense for Peter Stuyvesant, but it is upbeat, and none of that nonsense about "the days dwindle down to a precious few." Is that the kind of thing you want to give middle-aged theater-goers to fret about on their night out?

In the kind of theatrical climate that prevails today, in which musicals are either flops or smash hits and nothing in between (*Pacific Overtures* might have been an intermediate exception, but it closed before the elapse of the year's run that would have proved it), it was probably easy to find an expert to snatch defeat from the jaws of even a potential victory by pontificating "You'll never make it with that downbeat number in there." What is diffi-

cult is to imagine why Rodgers, with all that productivity, all that prestige and those years of experience behind him, couldn't have insisted that so perfect a resolution of the story stay in.

If we should discover, in someone's memoirs to come, that the reason *The Pears of Anjou* was deleted was that Nicol Williamson couldn't handle the song on a night-to-night

"Peter Ustinov would have made a properly plump Henry VIII"



schedule, well, more's the pity, for Williamson was hardly a logical choice for the role in the first place. The idea of a tall, skinny Henry VIII was an absurdity from the outset, for if the character has any reality for American audiences at all, it is in the vividly memorable re-creation of Charles Laughton. Should it be contended that Laughton's Henry VIII dates to the Thirties and is now faded and gone, it will be patiently insisted that it is only as dated as the film's latest TV rerun. Peter Ustinov would have made a properly plump Henry VIII, and if the production was deemed to depend on a suitably serious, dramatic Henry, why not Rex Harrison? The show would then, at least, have had *one* authentic Rex.

Every so often in this recording (it is, on balance, not often enough) the surge and flow of a typically Rodgerish melody asserts itself: in *Away from You* (Act I) and in *From Afar* and *In Time* (Act II), two parts of a trinity left incomplete by the deletion of *The Pears*. Even so, good as the best of this score is, quality is compromised by the lack of suitably strong or stylish delivery: neither Nicol Williamson (he sings *Away from You* and *From Afar*) nor Penny Fuller (who, as Elizabeth, performs *In Time*), has the physical presence or the vocal sound to carry the music.

Taken all together, this *Rex* is a compound of sex, vex, and hex: Henry's sexual appetites are justified by his vexing insistence on fathering a son, and the hex is formed by the wives he had to run through (the hex symbol is six-sided, remember) before settling on the one (Catherine Parr) who would survive him. It would be my judgment that the enterprise was already fatally hexed by the effort to do too much, to overload the already rich subject of Henry VIII with the conventions of the "Broadway musical," producing, thereby, too much dance, too much spectacle, too much sentiment.

**I**n a theatrical season that has seen the abrupt demise of shows by two such luminaries of the musical theater as Richard Rodgers and Leonard Bernstein (not to mention their collaborators Sheldon Harnick and Alan Jay Lerner), one might wonder whether there is anything they have in common that might serve as a danger signal should any of them be contemplating another such try in the future. The one shared trait I can find is the idea of casting a principal performer in two or more parts. In *Rex* it was Penny Fuller, who played both Anne Boleyn and her daughter Elizabeth; in *1600 Pennsylvania Avenue* it was Patricia Routledge as a succession of First Ladies from Dolly Madison to Mrs. Rutherford B. Hayes, and Ken Howard as not only all her husbands but George Washington as well. We have the evidence of the RCA disc that Miss Fuller made an appealing Elizabeth, a less-appealing Anne. There is no such proof at hand for Howard and Routledge, for no record of *1600 Pennsylvania Avenue*, though it contained some of Bernstein's best recent theater music, is known to have been made. Dissimilar as the two projects were, both were unquestionably affected adversely by the harsh financial conditions governing success or failure in the Broadway theater today, as well as the narrow range of critical judgment represented by New York's few major newspapers. I would therefore be surprised if either Rodgers or Bernstein were to challenge the conditions of this market soon again. The risks lately just haven't been worth it.

# The Miida Stereo System

It delivers everything we promise.

We're sure! Because every promise we make is backed by test-proven facts.

Start with the Miida 3140 AM/FM Stereo Receiver. You get 43 watts per channel minimum RMS, both channels driven at 8 ohms, from 20Hz to 20kHz with no more than 0.4% total harmonic distortion.

Tie it into the Miida T3115 Direct Drive Turntable. It gives you such consistent rotation that wow, flutter and rumble are virtually eliminated.

To complete this remarkable system, connect a pair of Miida SP3150 4-way Speakers for a dynamically balanced stereo system that delivers sound with stunning brilliance and clarity.

Ask your dealer to show you a Miida Stereo System. It delivers everything we promise... and that's a fact.

For more information write to: Miida Electronics Inc., a subsidiary of Marubeni Corp., 205 Chubb Avenue, Lyndhurst, New Jersey 07071, (201) 933-9300.

**Miida 3140—AM/FM STEREO RECEIVER** Phase locked loop multiplex; IHF sensitivity: 2.0; Capture ratio: 1.5 dB; IF rejection: 70 dB

**Miida T3115—DIRECT DRIVE TURNTABLE** Stroboscope allows you to adjust speed with pinpoint accuracy; 2-speed adjustments; 13½" turntable; 6-pole electronic motor; S-shaped tone arm with anti-skate

**Miida SP3150—4-WAY SPEAKER SYSTEM** Overall frequency response: 25Hz to 22kHz ± 5 dB; Impedance: 8 ohms; Built-in crossover: 750Hz-1800 Hz, 7.5kHz, 12 kHz; Power handling capability 55 watts maximum music power



**Miida** ...the stereo specialist.





# CLASSICAL DISCS AND TAPES

Reviewed by RICHARD FREED • DAVID HALL • GEORGE JELLINEK • PAUL KRESH  
STODDARD LINCOLN • ERIC SALZMAN

## RECORDING OF SPECIAL MERIT

**J. S. BACH: Motets.** *Jesu, meine Freude* (BWV 227); *Fantasia sopra Jesu meine Freude* (BWV 713); *Vom Himmel hoch* (two settings, BWV 243 and BWV 701); *Freut euch und Jubiliert* (BWV 243); *Komm, Jesu, komm* (BWV 231); *Singet dem Herrn* (BWV 225); *Lobet den Herrn, alle Heiden* (BWV 230); *Der Geist hilft unsrer Schwachheit auf* (BWV 226); *Fürchte dich nicht* (BWV 228). David Lumsden (organ); Louis Halsey Singers, Louis Halsey cond. L'OISEAU-LYRE SOL 340-341 two discs \$13.96.

Performance: **Sumptuous**  
Recording: **Resonant**

Conceived more as concerti grossi than choral works, Bach's magnificent motets for double chorus are unique in the repertoire. The choral writing is brilliant in the extreme, and the fact that it is instrumental in its idiom presents formidable performance problems. The Louis Halsey Singers surmount all technical difficulties with flying colors. Their sound is a sumptuous one, and the clearly articulated coloratura passages produce a remarkable lucid texture not often found in performances of these works. Also exciting is the vital rhythmic concept Mr. Halsey brings to the music.

Perhaps the most interesting aspect of this album is the use of organ continuo to accompany the choruses. Although it is not specifically called for in the score, historical evidence seems to support its use, and the musi-

cal result in this performance proves the point. The organ is subordinate, but it is clearly heard because of David Lumsden's tasteful registration and excellent realization. Rather than muddying up the texture, as so often happens, the organ adds richness and luster to this fine reading, and it is also there to give us, as a bonus, some of Bach's keyboard transformations of chorale tunes. S.L.

**J. S. BACH: Sacred Songs from Schemellis Gesangbuch.** *Dir, Dir, Jehova, will ich singen; Ich steh an deiner Krippen hier; O Jesulein süß, o Jesulein mild; Der lieben Sonne Licht und Pracht; So gehst du nun, mein Jesu, hin; Gott, wie gross ist deine Güte; Liebster Herr Jesu, wo bleibst du so lange; Vergiss mein nicht, mein allerliebster Gott; So gibst du nun, mein Jesu, gute Nacht; Komm, süßter Tod; Eins ist not! Ach Herr, dies eine; Ihr Gestirn', ihr hohen Lüfte; Wo ist mein Schäflein, das ich liebe; Die bittere Leidenszeit beginnt abermal; Kommt, Seelen, dieser Tag muss heilig sein besungen; Es kostet viel, ein Christ zu sein; Die güldne Sonne, voll Freud und Wonne; Ich lass dich nicht, du musst mein Jesus bleiben; Brich entzwei, mein armes Herze; Gott lebet noch; Mein Jesu, was für Seelenweh; Ach, dass nicht die letzte Stunde; Kommt wieder aus der finstern Gruft; Steh ich bei meinem Gott.* *Sacred Songs from the Anna Magdalena Bach Notebook.* *Gib dich zufrieden und sei still; Wie wohl ist mir, o Freund der Seelen.* Elisabeth Speiser (soprano); Peter Schreier (tenor); Hedwig Bilgram (organ). DG ARCHIVE 2533 299 \$7.98.

Performance: **Inward**  
Recording: **Pure**

Bach set the devotional melodies from Schemelli's Song-Book of 1736 with the same loving care he lavished on his four-part choral settings. Elizabeth Speiser and Peter Schreier sing them simply and exquisitely. However beautiful they may be, though, a little goes a long way. There just isn't enough musical variety; Bach certainly never intended to have them ladled out in forty-minute quantities. Perhaps the organist should have added some introductions and interludes, thus breaking the monotony of one continuous sound for so

long a time. But, lacking that, the interested listener is simply advised to take the songs in small helpings, in which they will reveal all their loveliness and pathos. S.L.

## RECORDING OF SPECIAL MERIT

**J. S. BACH: Sonatas for Violin and Harpsichord** (BWV 1014-1019). Eduard Melkus (violin); Hugette Dreyfus (harpsichord). DG ARCHIVE 2708 032 two discs \$15.96.

Performance: **Very fine indeed**  
Recording: **Alive**

Having played these wonderful sonatas in public many times myself, I was completely appalled the first time I was forced to listen to somebody else perform them. What had happened to the remarkable three-part counterpoint so ingeniously divided among the harpsichordist's two hands and the violin? As a performer I saw it and heard it, but as a listener all I heard was a busy violin part with some sort of clatter in the background. And that is the problem of performing these sonatas: how to achieve equal balance among three voices, two of which are assigned to a prickly, dynamically static harpsichord and the third to a singing, dynamically alive violin.

Eduard Melkus and Hugette Dreyfus have solved this knotty problem by their choice of instruments and by returning to authentic Baroque articulation. Melkus' 1679 Amati has a sweet sound which, although not loud or forced, has character. He divides his phrases into small and clearly articulated groups that make room for the sound of the harpsichord. Miss Dreyfus commands a resonant Jean Bas harpsichord (1737) that has a ravishing tone, and, like her partner, she articulates clearly. Although at times the harpsichord perforce loses its equality with the violin, the nature of her instrument and the manner of her playing give it a presence that is musically satisfying. The resultant sound is, despite the minute articulations, that of a velvety legato, suave and sinuous. One only has to hear the canon of the inner slow movement of the Second Sonata to realize these artists' achievement. The two upper voices are perfectly matched, and the awkward bass line, which Bach marked *stac-*

### Explanation of symbols:

- Ⓜ = reel-to-reel stereo tape
- Ⓢ = eight-track stereo cartridge
- Ⓒ = stereo cassette
- Ⓛ = quadrasonic disc
- Ⓡ = reel-to-reel quadrasonic tape
- Ⓟ = eight-track quadrasonic tape

Monophonic recordings are indicated by the symbol Ⓜ

The first listing is the one reviewed; other formats, if available, follow it.



cato (a challenge Miss Dreyfus meets head on with beautiful results), offers the perfect support. It is these contrapuntal movements that come off best here.

Although Baroque slow movements are in general taken rather more quickly than Classical and Romantic ones, some of the Melkus-Dreyfus tempos—the first movements of Nos. 1 and 3, for example—seem a bit pressed, and the violin's detailed floritura is often crushed into an all too unrelenting beat. In these instances a more rhapsodic approach would help achieve the repose so needed in this music. On the other hand, the slow movements of No. 4 are stunning in their concept, and any team that can bring off the impossibly repetitious figuration of the first and third movements of No. 5 deserves high praise. Indeed, of all the recordings of these sonatas I have heard, I find this one the most rewarding musically. S.L.

#### RECORDING OF SPECIAL MERIT

**BEETHOVEN:** *Sonatas for Cello and Piano (complete); Seven Variations on "Bei Männern" and Twelve Variations on "Ein Mädchen oder Weibchen" from Mozart's "The Magic Flute"; Twelve Variations on a Theme from Handel's "Judas Maccabeus."* Jacqueline du Pré (cello); Daniel Barenboim (piano). ANGEL SCB-3823 three discs \$13.96.

Performance: **Wonderful**  
Recording: **Good BBC concert recordings**

These beautiful performances are drawn from two concerts given by Jacqueline du Pré and Daniel Barenboim at the Edinburgh Festival in 1970; they were recorded and broadcast by the BBC and are being released by Angel through an arrangement with the BBC record service. As live performances, they are astonishing; there is scarcely a patch or blemish. Yet these are hardly careful or held-back readings; they are rich and full-blown but never overwrought, a perfect blend of Beethovenian classicism and romanticism full of the presence of the live moment. There are other wonderful performances of these works in the catalog (the Rostropovich/Richter version especially), but the concert ambience of this set coupled with its musicality makes it something unique. E.S.

#### RECORDING OF SPECIAL MERIT

**BEETHOVEN:** *Sonata No. 23, in F Minor, Op. 57 ("Appassionata").* LISZT: *Sonata in B Minor.* Lazar Berman (piano). SAGA 5430 \$6.98.

Performance: **Assured**  
Recording: **Not bad**

With Berman now established as a pianist of international interest, elements of his past recording history have begun to creep into the catalogs. These two performances on the English Saga label are not Russian in origin but were actually recorded in England and released in 1959, shortly after Berman's first (and for many years, only) recital in that country in 1958. They were deleted from the catalog some time afterward as the artist was forgotten, and have now been restored to it just in time to coincide with the beginnings of an American distribution agreement between Saga and CMS/Desto, so the record is now available here for the first time.

While Beethoven usually suffers certain stylistic distortions in Russian performance

## The Bicentennial Corner



THE GREGG SMITH SINGERS: youthful and vigorous

## American Music from the Founding Years

"THE Founding Years," the first volume of a projected Vox series (Volume III, "The Great Sentimental Age," was released some time ago) designed to cover American music from the early seventeenth century to the present, is a real winner. Not only is the music strong and fresh, but it is also a revelation to hear the changing styles as the records proceed chronologically and from one geographical area to another. Most musicians have, of course, heard of the *Ainsworth Psalter* and the *Bay Psalm Book*, but to hear the actual music comes as a thrilling experience. The modal melodies are haunting, and the harmonizations, with their strong open intervals, occasional roughnesses, and telling cross-relations, have a curiously American ring to them, even though they were based on European models.

As usual, one is delighted with Billings and struck by the passion of Justin Morgan. In complete contrast to this primitive (in the best sense) a cappella music is the music of the Moravian church. The use of strings and horns, chorus, and soloists makes it apparent that Haydn and Gluck were not strangers to our shores even in the eighteenth century. The last two sides of the collection are devoted to the secular music of the American Revolution, to the graceful songs of Francis Hopkinson, various ballades, and some delightful music for vocal ensemble.

The Gregg Smith Singers are very fine indeed. Their sound is a youthful, vigorous one, and the soloists—I wish I could name them all here—sing with a simplicity and candor that fit the naive quality of the music. I wish too that the texts had been included, but the

diction is generally so good that most of the words come across with little difficulty.

Above all, the highest praise must be given Gregg Smith himself. It requires not only painstaking research to put together an album like this but also a sure sense of program building to keep up interest and variety for six sides.

This collection, then, is a must for those interested in early American music. And if you are one of those who have been assiduously party-pooping the Bicentennial celebration, I advise you to drop that attitude right now and enjoy a musical heritage that is just beginning to be explored. The rewards are great.

—Stoddard Lincoln

**AMERICA SINGS. Volume 1: The Founding Years (1620-1800).** Religious vocal music from *The Ainsworth Psalter; The Bay Psalm Book; Tuft's Introduction; Walter's Grounds and Rules; Lyon's Urania. Billings: Thus Saith the High, the Lofty One; As the Hart Panteth; Consonance. Swan: China. Morgan: Despair; Amanda; Montgomery. Brownson: Salisbury. Read: Russia. Ingalls: Northfield. Stevenson: Behold I Bring You Glad Tidings. Selby: O Be Joyful in the Lord. Dencke: O, Be Glad, Ye Daughters of His People. Herbst: God Was in Jesus. J. F. Peter: I Will Make an Everlasting Covenant; I Will Freely Sacrifice to Thee. Antes: How Beautiful upon the Mountains. S. Peter: O, There's a Sight That Rends My Heart; Look Ye, How My Servants Shall Be Feasting. Law: Bunker Hill. Anon.: Washington's March. Selby: Ode for the New Year. Van Hagen: Funeral Dirge on the Death of General Washington. Belknap: The Seasons. Read: Down Steers the Bass. Kelly: The Mischievous Bee; Last Week I Took a Wife. Lyon: Friendship. Hopkinson: A Toast; My Days Have Been So Wond'rous Free; Come Fair Rosina; My Love Is Gone to Sea; Beneath a Weeping Willow's Shade; Enraptur'd I Gaze; O'er the Hills Far Away; See, Down Maria's Blushing Cheek; My Gen'rous Heart Disdains; The Traveler Benighted and Lost. The Gregg Smith Singers and Chamber Orchestra, Gregg Smith cond. Vox SVBX 5350 three discs \$10.98.*



If You've  
Yet To Experience  
Angel Compatible  
Stereo/SQ Quad . . .  
Start with these.



**BERLIOZ: REQUIEM**  
Teor - City of Birmingham Orchestra & Chorus  
FREMAUX

SB-3814

**MUSIC OF JOHANN STRAUSS**  
On the Beautiful Blue Danube  
Emparor Waltz  
Overtures to "Die Fledermaus"  
& "The Gypsy Baron"  
Tritsch-Tretsch Polka  
Annens-Polka



BERLIN  
PHILHARMONIC  
ORCHESTRA  
KARAJAN

S-37144

Respighi  
**Ancient Airs and Dances**  
Los Angeles Chamber Orchestra  
MARRINER



**BOITO**  
Great Scenes from  
**MEFISTOFELE**  
TREIGLE - CABALLE  
DOMINGO  
London Symphony  
Orchestra  
RUDEL



S-37301

**IBERT ESCALES**  
Ouverture de fête  
Tropismes pour  
des amours  
imaginaires  
(first recording)  
Orchestra  
National de l'ORTF  
MARTINON



S-37159

**HAYDN**  
THE CELLO  
CONCERTOS  
D MAJOR  
& C MAJOR  
Rostropovich  
Academy of  
St. Martin-in-the-Fields  
BROWN



S-37194

S-37193



Complete Catalog of Angel Compatible/Stereo Quad Records Free from your dealer or Angel Records, 1750 N. Vine St., Los Angeles, CA 90028

—and Berman is no exception to this—the *Appassionata* seems to be one of the works that suffers least. This is not a slam-bang performance, although Berman's fabled virtuosity carries him grandly through passages where most pianists scramble frantically or fail in the attempt to balance highly unequal left- and right-hand parts. It is, rather, a thoughtful rendering, with an elastic quality that sometimes gives in places where one does not expect it to, and tightens elsewhere where one expects it to give. It does not have an overwhelming cumulative impact, nor does it reach the heights of lyricism in the slow movement, but it is sane and strong, and it is a pleasure to hear fingers that have the notes so surely and confidently in them. On points, it would have to be ranked among the best recordings of the work currently available.

Berman, of course, has recorded the Liszt sonata recently (Columbia/Melodiya M 33927), a performance as notable for its musical architecture as for its virtuosity. One might have expected this more youthful recording (he was twenty-eight) to be basically a technical showpiece, but what emerges from this record is one of the most poetic performances of the piece I have ever heard, with plenty of dynamic range and plenty of singing line. Really very impressive, and sounding much more like the work of a master of the old school than of a man in his twenties.

The recording is a trifle low in level (to accommodate the dynamic range) and slightly cloudy in overall quality, but it has bass and a pleasing, if obviously dated, sound. The pressing is not immaculate, but it's not bad by today's standards. *James Goodfriend*

**RECORDING OF SPECIAL MERIT**

**BERLIOZ: Harold in Italy, Op. 16.** Nobuko Imai (viola); London Symphony Orchestra, Colin Davis cond. PHILIPS 95(0) 026 \$7.98.

Performance: **Outstanding**  
Recording: **Excellent**

This is conductor Colin Davis' second recording of *Harold in Italy*, and, like the first, made in 1963 with Yehudi Menuhin and the Philharmonia Orchestra, it is an outstanding realization of Berlioz's unique masterpiece. The two recordings have their differences, however. The Menuhin reading was rather poetic and inner-directed, while the highly gifted Nobuko Imai's richer-toned playing and Davis' current approach to the music make for a more overtly dramatic and generally outer-directed view of Byron's hero amid the Italian mountain fastnesses. And in the new version, for the first time in my experience with recordings of *Harold in Italy*, the final brigands' orgy comes off with all the brilliance and panache that I believe Berlioz intended. Choosing between the older and the newer Davis readings in the other three movements comes down to a matter of taste and whether the marginally superior Philips recording is worth the extra \$1 investment. I'm holding on to both! *D.H.*

**RECORDING OF SPECIAL MERIT**

**BLOMDAHL: In the Hall of Mirrors.** Margareta Hallin (soprano); Barbro Ericson (contralto); Sven-Erik Vikström (tenor); Anders Näslund (baritone, narrator); Bengt Rundgren (bass); Swedish Radio Chorus and Stockholm Philharmonic Orchestra, Sixten Ehrling cond. Caprice Ⓜ CAP 1006 \$7.98 (from HNH Dis-

tributors Ltd., P.O. Box 222, Evanston, Ill. 60204).

Performance: **Marvelous**  
Recording: **Exceptionally good mono**

Oratorios with parts for speakers as well as singers have enjoyed a special popularity in Sweden; one example is Lars-Erik Larsson's so-called "lyric suite" *The God in Disguise*. Blomdahl described *In the Hall of Mirrors* as "a contemporary oratorio for speaker, soloists, chorus and large orchestra, but at the same time a succession of virtuoso symphonic variations, deriving their substance from the two whole-tone scales of the introductory bars." The work won the Fartein Valen prize for him in 1953 and since then has been regarded as one of the major creations in recent



Mike Evans/Photogram

**COLIN DAVIS, NOBUKO IMAI**  
*An outstanding Harold in Italy*

Swedish music. It is a setting of nine sonnets from *The Man Without a Way*, a 1942 cycle by Erik Lindegren (who later wrote the libretto for Blomdahl's "space opera" *Aniara*), dealing with the poignancy of the human condition as brought into flaming relief by the events of that time. It shares common elements with certain similarly motivated works by such composers as Tippett and Bernstein—the second section is marked "in modo di Slow Blues," and the fifth is a parody of boogie-woogie—yet *In the Hall of Mirrors* not only preceded many of these other works by nearly two decades but is in a musical language at once accessible and too distinctive to be mistaken for anyone else's. Blomdahl's use of both the vocal and instrumental forces is fascinating, delicate, and always original. If certain effects seem "obvious," they do not seem contrived, and their very obviousness emphasizes the note of urgency more effectively than something so "different" that the listener's response to it might be difficult or delayed. It will not be everybody's cup of tea, but it is something everyone ought to hear, and I cannot imagine a more expert or more vivid performance than the marvelous one preserved here.

If you are at all interested in this material, do not be put off by the recording's date (1966) or its being offered in mono. While it does seem more than strange that a major work of so important a composer would be recorded in mono as late as that, the sound hap-



pens to be so exceptionally good that one is hardly likely to be aware that anything is missing; there are, in fact, an impact and a realism here that few two- or four-channel offerings surpass. The packaging includes really distinguished annotation by Göran Bergendal as well as a full text in Swedish, English, and German. R.F.

**BRAHMS: Hungarian Dances** (see The Basic Repertoire, page 60)

**BRUCH: Kol Nidrei, Op. 47** (see DVORÁK)

**DOHNÁNYI: Variations on a Nursery Song, Op. 25; Suite in F-sharp Minor.** Béla Siki (piano); Seattle Symphony Orchestra, Milton Katims cond. TURNABOUT TV-S 34623 \$3.98.

Performance: **A bit breathless**  
Recording: **Very good**

**RECORDING OF SPECIAL MERIT**

**DOHNÁNYI: Variations on a Nursery Song, Op. 25. RACHMANINOFF: Rhapsody on a Theme of Paganini, Op. 43.** Christina Ortiz (piano); New Philharmonia Orchestra, Kazuhiro Koizumi cond. ANGEL □ S-37178 \$6.98.

Performance: **Fleet and fulfilling**  
Recording: **Excellent**

As composer, conductor, and pianist, Ernest von Dohnányi, born in Pressburg in 1877, was one of the leading figures in Hungarian musical life until 1949, when he came to America to teach music at Florida State University. By that time his most popular works, the Suite in F-sharp Minor and the Variations on a Nursery Song, were far behind him. When he died in 1960, he was regarded in some quarters as an old-fashioned nineteenth-century figure, in no way comparable to his compatriots Bartók and Kodály.

Old-fashioned Dohnányi's music may be, and shamelessly romantic too, but it abounds in charm and airy sparkle and beguiles the ear with the freshness of inspired melodic invention. The Suite, written in 1909 when the composer was thirty-two, is replete with felicitous elements. It has been out of the catalog for some time, and Katims' version on the Turnabout label, reflecting the work's high spirits in bright, clean sound, is therefore especially welcome.

The Variations on a Nursery Song (1913) is still available on the Angel label with the composer at the piano and Sir Adrian Boult conducting, but the sound on the old disc is not as alive as it might be in this witty work. The nimble fingers of Hungarian pianist Béla Siki tend to rush through the work's delights at too fast a pace, and the orchestra seems to be panting hard to keep up with him, although the playing is expert and the recorded sound quite good. But Cristina Ortiz turns in a more piquant and relaxed performance on Angel, with the Japanese conductor Kazuhiro Koizumi digging up more musical treasure in the score than Mr. Katims does. The backing here is still one more performance of the Rachmaninoff Rhapsody on a Theme of Paganini, of which there are too many on records already. Yet it must be said that the Russian work has probably never received a more dazzling treatment than it does here. The bargain Turnabout album, offering both the Suite and the Variations, is the more interesting buy, but the new Angel disc makes for more thrilling listening, particularly in SQ quadrasonic playback. P.K.

**RECORDING OF SPECIAL MERIT**

**DVORÁK: Romance in F Minor for Violin and Orchestra, Op. 11; Piano Concerto in G Minor, Op. 33; Mazurek in E Minor for Violin and Orchestra, Op. 49; Violin Concerto in A Minor, Op. 53; Silent Woods, Op. 68; Rondo in G Minor for Cello and Orchestra, Op. 94; Cello Concerto in B Minor, Op. 104.** Ruggiero Ricci (violin); Rudolf Firkušny (piano); Zora Nelsova (cello); Saint Louis Symphony Orchestra, Walter Susskind cond. VOX □ QSVBX 5135 three discs \$10.98.

Performance: **Very good to superb**  
Recording: **Very good to outstanding**

**DVORÁK: Violin Concerto in A Minor, Op. 53; Romance in F Minor, Op. 11.** Itzhak Perl-

man (violin); London Philharmonic Orchestra, Daniel Barenboim cond. ANGEL S-37069 \$6.98.

Performance: **Luscious**  
Recording: **Good**

**RECORDING OF SPECIAL MERIT**

**DVORÁK: Cello Concerto in B Minor, Op. 104.** Pablo Casals (cello); Czech Philharmonic Orchestra, George Szell cond. **BRUCH: Kol Nidrei, Op. 47.** Pablo Casals (cello); London Symphony Orchestra, Sir Landon Ronald cond. SERAPHIM Ⓜ 60240 \$3.98.

Performance: **Masterly**  
Recording: **Good 1937 vintage**

The Vox Box series has come up with another

# Soundcraftsmen THE PERFECT PRE-AMP

**FOR THE GREAT NEW SUPER-POWER AMPS!**  
For a SUPER-SYSTEM, match the 2217 with any of these TRUE "State-of-the-Art" amps —

• PHASE LINEAR • SAE • CROWN • DYNACO • AUDIO RESEARCH • CITATION •  
• ESS • MARANTZ • SONY • KENWOOD • BOSE • QUATRE • BGW •

**"FANTASTIC! I CAN HARDLY BELIEVE MY EARS... VERY VERSATILE & CLEAN-SOUNDING AND I REALLY LIKE THE SWITCHABLE PATCHING."**

**SPECIAL FEATURES**

- ALL PUSHBUTTONS INTERLOCKED to prevent inadvertent program destruction
- DISCRETE-OCTAVE EQUALIZATION CONTROL of ten octaves on each channel, ±12db each octave
- FULL-SPECTRUM LEVEL CONTROL for each channel
- AUTOMATIC CONTINUOUS MONITORING by light-emitting diodes for visual warning of overload in output circuits
- VISUAL ZERO-GAIN EQUALIZATION BALANCING on music, white noise or pink noise
- SELECTION OF TEST LITES on or off
- TAPE DUBBING BETWEEN TWO MACHINES, with optional simultaneous equalizing and monitoring
- DOUBLE-DUBBING into two recorders simultaneously
- SEPARATE SYSTEM-SELECTION enables full use of all other functions during the dubbing operation
- LINE OR TAPE equalization selector
- AUTOMATIC EQUALIZER-DEFEAT when line or tape equalizer is not in use
- FRONT PANEL TAPE input-output jacks for easy 2nd and 3rd tape recorder hookup access
- TAPE MONITORING of either tape at any time
- TWO stereo headphone jacks
- MONO SELECTOR for left, right or both channels to both outputs
- REVERSE-STEREO mode
- TWO lowlevel phono inputs
- FOUR independent phono preamps
- SIX A/C outlets, 4 switched, 2 unswitched
- ELECTRO-PLATED FERROUS CHASSIS — (eight sections) — provides optimum shielding to minimize magnetic field-coupling
- SINGLE-POINT system ground connector minimizes ground-loops
- TWO REGULATED power supplies

**Soundcraftsmen EQUALIZERS**

**NOW YOU CAN MAKE YOUR SYSTEM SOUND EXACTLY THE WAY YOU WANT IT TO SOUND!**  
In a few minutes, YOU can accurately "tune" the frequency response of YOUR stereo system and room environment to a **±2 db** All you need are YOUR OWN EARS and the Soundcraftsmen Equalizer (WITH ITS STEP-BY-STEP INSTRUCTION RECORD) to transform any stereo system and room environment into an acoustically perfect concert hall! Or, to provide any special, acoustical effects you desire! The Soundcraftsmen Equalizer enables YOU to instantly compensate for frequency response variations, IN SYSTEM AND ROOM.

**GUARANTEED to enhance and improve any fine system!**

Just plug 2 cables into your receiver's tape monitor jacks, and you are ready to enjoy a new experience in musical enjoyment!

**RP2212** (Includes Cabinet or Rack Mounts) \$369.50  
**RP2204** (Same as 2212, except no LED's) \$329.50  
**20-12A** (Same as 2212, except no LED's and Tape EQ thru rear panel patching) \$299.50

**Soundcraftsmen** • 1721 Newport Circle, Santa Ana, California 92705 Prices and specifications subject to change without notice.

**(CUSTOMER COMMENT CARDS ARE ON FILE AT SOUND-CRAFTSMEN)**

*"I really like the switchable patching... audio calms down... it is a great..."*

*"Fantastic unit! I'm glad my first audio calms down... it is a great..."*

*"Great! Fantastic! I am glad to see you must be kidding!"*

case list any suggested improvements, changes, or

**GUARANTEED SPECIFICATIONS**

**FREQ. RESPONSE** — Hi-level: ±1/2 db, 5 Hz to 100 kHz  
**FREQ. RESPONSE** — Phono: ±1/2 db, 20 Hz to 20 kHz  
**THD**: less than .05% at 1 volt (Typ. .01% at 1 volt)  
**IM**: less than .05% at 1 volt (Typ. .01% at 1 volt)  
**PHONO INPUT CAPABILITY**: 10mw  
**SIGNAL-TO-NOISE** — Hi level: 100 db below full output  
**SIGNAL-TO-NOISE** — Phono: 84 db below a 3mw input  
**SIGNAL-TO-NOISE** — Equalizer: 106 db @ full output  
**GAIN** — Phono: 63 db      90 db @ 2 v, RMS  
          Hi-level: 21 db      90 db @ 1 v, RMS  
**OUTPUT IMPEDANCE**: 600 ohms  
**EQUALIZER LEVEL**: Zero-gain controls for left and right continuously variable, for unity gain compensation  
**INDIVIDUAL OCTAVE CONTROL**: RANGE: Minimum: ±12 db (Typ. ±14 db); each octave centered at 30, 60, 120, 240, 480, 960, 1920, 3840, 7680, and 15,360 Hz  
**MAX. OUTPUT SIGNAL**: Variable master volume control allows adjustment of optimum output to match amplifier  
**GOLD SWITCHES**: All contacts are gold plated for low noise, long life, and resistance to oxidation and corrosion  
**CHICUT! ADAPTS**: Military grade G-10 glass epoxy  
**RESISTORS**: Low noise selected carbon film  
**CABINET SIZE**: 7 1/4" x 20" x 11 1/4" deep  
**SHIPPING WEIGHT**: 28 lbs.  
**MADE IN U.S.A.** Includes cabinet or rack mounts

**PE2217 — \$529.50**

**FREE!**

**THE "WHY'S AND HOW'S OF EQUALIZATION"**

An easy to understand explanation of the relationship of acoustics to your environment. This 6 page booklet also contains many unique ideas on "How the Soundcraftsmen Equalizer can measurably enhance your listening pleasure." "How typical room problems are eliminated by Equalization," and a "10-point self-rated Equalization Evaluation Check-List."



“beautifully characterized folk songs...”



Robert Dawson Studio

BERNADETTE GREEVY

## Lesser Known Britten

THREE discs of lesser-known works of Benjamin Britten, which our English cousins have been enjoying for the last three to nine years, have at last been issued here, and, to make up for the delay, London has released them all in its low-price Stereo Treasury Series. Represented on the six sides are various facets of Britten's chamber music and vocal production, including some which are more or less unique to this composer.

The string quartet is surely not such a category, but the record of Britten's two quartets, splendidly played by the Allegri Quartet (from whom we used to get some fine Haydn and Mozart on Westminster), is the most welcome of the three in this assortment. Both quartets are early works, No. 1 composed at the end of Britten's American sojourn in 1941 on commission from Elizabeth Sprague Coolidge and No. 2 in the summer of 1945 to commemorate the 250th anniversary of the death of Purcell. The Second Quartet, which concludes with a Purcellian *Chacony* longer than the two preceding movements combined, is more widely known than its predecessor, but it has not been available on records in this country since the briefly circulated Amadeus version on London's full-price label was retired about a decade ago. The Amadeus, I recall, showed a bit more subtlety and crispness, but the Allegri performance is first-rate by any standards—and it is available. The First Quartet, a more ingratiating work perhaps (but by no means slight), with “pre-echoes” of *Peter Grimes* here and there (most notably in the very opening and in the expressive slow movement), has been in circulation for years in the form of an ancient Galimir version now on the Counterpoint/Esoteric label in phony stereo. There is no contest in this case, the Allegri performance being sharper in every respect as well as benefiting from a more up-to-

date recording (1972): it is, in fact, one of the best-engineered string quartet records I have heard. Besides filling a gap in the Britten discography, this is a very distinguished addition to the general chamber-music catalog.

Most intriguing, and bubbling over with “uniqueness,” is the disc of choral and chamber works written for and performed by schoolboys. Britten composed his *Gemini Variations* (on a theme by Kodály) for a pair of gifted young twins he met in Budapest in 1964, Zoltán Jeney, a flutist, and his brother Gabriel, a violinist. Since both boys were also good pianists, Britten wrote a “Quartet for Two Players,” in the form of twelve variations and a fugue including various solos and duets for all their instruments. What is most remarkable is that the music has real substance and is far more than a mere stunt. (Some time after the recording was made in 1966, Britten composed three additional variations, to be played when there are four performers available instead of only two.) The 1962 setting of Psalm 150 is as original and exciting in its way as the one by Ives, and the early *Friday Afternoons* songs (all but No. 4 of the set of twelve composed in 1936) are clever, ingratiating, and fresh as paint. If this particular disc was intended to show that the world is *not* going to hell in a handbasket, it succeeds nobly.

**B**ERNADETTE GREEVY's 1970 recording of songs has to compete with memories of Maureen Forrester in *A Charm of Lullabies* (on Westminster) and Peter Pears in the folk-song arrangements (on the old London 10-incher with Britten at the piano). The Irish contralto seems less than fully attuned to the lullaby cycle, and in particular seems reluctant to sing softly when so directed. It is good to have the material available, though, and in the folk-song settings both Greevy and her accompanist, Paul Hamburger, with neither condescension nor self-consciousness, give beautifully characterized performances that could hardly be bettered. Texts are included with both vocal discs. —Richard Freed

**BRITTEN:** *String Quartet No. 1, in D Major, Op. 25; String Quartet No. 2, in C Major, Op. 36.* Allegri String Quartet. LONDON STS-15303 \$3.98.

**BRITTEN:** *Gemini Variations, Op. 73.* Zoltán Jeney (flute, piano); Gabriel Jeney (violin, piano). *Psalm 150, for Voices and Orchestra.* Boys of Downside School, Purley, Benjamin Britten cond. *Songs from Friday Afternoons, Op. 7.* Choir of Downside School; Viola Tunnard (piano); Benjamin Britten cond. LONDON STS-15173 \$3.98.

**BRITTEN:** *A Charm of Lullabies, Op. 41. Folk-Song Arrangements. There's None to Soothe; O Can Ye Sew Cushions?; O Waly, Waly; The Ash Grove; The Salley Gardens; The Trees They Grow So High; Come You Not from Newcastle?; Sweet Polly Oliver; The Bonny Earl o' Moray; Oliver Cromwell.* Bernadette Greevy (contralto); Paul Hamburger (piano). LONDON STS-15166 \$3.98.

winner in its package of the complete Dvořák output for solo instrument and orchestra. Although only the B Minor Cello Concerto is a top-drawer masterpiece, the early F Minor Romance and the fiery *Mazurek* are still glistening small gems, and the Violin Concerto certainly has its fine moments. Firkusny, long a champion of the oft-maligned Piano Concerto, manages to find and communicate more of its musical substance than I have heard from anyone else thus far.

Prague-born conductor Walter Susskind and his Saint Louis players perform with great dash and real Czech style, and the production staff has come up with a beautiful orchestral sound enhanced by ambient quadraphonics, with a soloist-orchestra balance that results in an integrated aural perspective rather than the “dual-focus” effect that mars all too many concerto recordings. This is Firkusny's third recording of the Piano Concerto, but his first to employ the original version with its rather dense writing for the solo instrument. Fortunately, the spacious recording does much to minimize the density in question and serves to bring out the very best in Firkusny's handsome treatment.

Ruggiero Ricci is in fine form throughout his solo assignments, delivering a really vivid reading of the *Mazurek* and going for maximum dramatic contrast in the Violin Concerto. In the Romance, however, his vibrato is a bit on the heavy side for my taste. Zara Nelsova, in both of the short pieces and in the Cello Concerto, chooses to stress the lyrical elements, emphasizing the dreamy sentiment in which the score abounds. The microphone placements here seem a bit closer than in the works with violin or piano.

The Itzhak Perlman/Daniel Barenboim collaboration in the Violin Concerto and the Romance matches temperaments and tempos perfectly to produce readings of fulsome sentiment. The solo-orchestral balance is clearly of the dual-perspective type, but not annoyingly so.

The 1937 Pablo Casals recording of the concerto, with George Szell and the Czech Philharmonic, is still the performance by which I judge all others. It is unmatched to this day in its intensity of phrase and transcendent luminosity of tone, even with forty-year-old sonics. The Seraphim disc represents the third long-play reincarnation of the Casals performance to be made available here. And, as a bonus, Seraphim has added Casals' beautiful reading of the Bruch *Kol Nidrei*. D.H.

**IVES:** *Songs* (see Best of the Month, page 86)

**LISZT:** *Sonata in B Minor* (see BEETHOVEN)

### RECORDINGS OF SPECIAL MERIT

**MENDELSSOHN:** *String Octet in E-flat Major, Op. 20; String Symphony No. 10, in B Minor; String Symphony No. 12, in G Minor.* I Musici. PHILIPS 6580.103 \$7.98.

**MENDELSSOHN:** *String Octet in E-flat Major, Op. 20.* **RIMSKY-KORSAKOV:** *Quintet in B-flat Major for Piano and Winds, Op. Posth.* Members of the Vienna Octet. LONDON STS-15308 \$3.98.

Performances: **Both excellent**  
Recordings: **Both very good**

Both of these versions of Mendelssohn's String Octet are very attractive, and both  
(Continued on page 122)



# How 2½ Million Smart Buyers Get Superior Quality CB and Hi-Fi Equipment at Lower Prices.



With The  
**FREE**  
Lafayette  
Catalog

You'll also find extraordinary values on the largest selection of electronic products in the world. The new 1977 LAFAYETTE catalog has 164 pages filled with thousands of the latest products and better electronic values for your home, car and business.

Select from hundreds of famous name brands in addition to top-rated LAFAYETTE products. Behind every product is our 56 years of experience, reliability and a money back guarantee of your satisfaction. Enjoy shop-at-home convenience and a variety of easy payment plans, too.

LAFAYETTE has provided consumers with leadership in electronics values since 1920 because we offer more for your money. You get superior quality products with extra features at lower prices. Whatever your needs, if its electronic, you'll find it in this catalog.

Smart buyers know that shopping around is the best way to get the best deal. Shop around in our new catalog and you'll see why so many people think so much of it. Before you buy anywhere else, check the LAFAYETTE catalog. Send for your FREE copy today. There's no obligation, and you'll get more for your money.

Mail the coupon below today.

- Citizens Band
  - Cameras
  - Calculators
  - Hobby Kits
  - Watches & Clocks
  - Test Equipment
  - Electronic Parts & Accessories
  - Musical Accessories
  - Security Systems
  - Power Tools
  - Stereo Components
  - Radios
  - Ham Gear
  - Scanners
  - TV Accessories
  - Books
  - Home & Office Communications Systems
  - Auto Accessories
  - Optics
  - Hardware
  - Antennas & Accessories
  - Microphones
  - Telephone Accessories
  - Tape Recorders, Decks & Players
  - Speaker Systems
  - Receivers
  - Turntables
  - Hi-Fi Systems
  - Phono Accessories
  - Cartridges
  - Headphones
  - Walkie-Talkies
- And much, much more.

**Lafayette**  
Radio Electronics & Shopping Centers

Lafayette Radio Electronics Corp.  
Dept. 24  
111 Jericho Turnpike, Syosset, New York 11791

Send my FREE catalog to:

Name \_\_\_\_\_

Street \_\_\_\_\_

City \_\_\_\_\_

State \_\_\_\_\_ Zip \_\_\_\_\_



present the work complete on a single side, with side two free for intriguing rarities. I have been enjoying I Musici's recording of the octet for the last eight or nine years on Philips 802.725LY; on that disc the finale was on side two, with Wolf's Italian Serenade and a Rossini sonata. The all-Mendelssohn coupling is probably a more attractive one (certainly less subject to duplication), and the reissued octet sounds even richer than before.

The Vienna Octet version, backed up by a really sparkling account of Rimsky's all but unknown quintet, is not a reissue, but a remake, and the new performance led by Anton Fietz is even more persuasive than the earlier one with Willi Boskovsky. The London sound is somewhat less robust than the Philips, befitting the somewhat more intimate approach of the Viennese performance. Neither version lacks vigor, and both are vividly effective in the famous scherzo; I Musici might be said to concentrate a bit more on brilliance, the Viennese to evince a bit more warmth of heart in their phrasing, but the differences either way are really very slight. Both versions are so appealing that coupling and price might very reasonably determine one's choice. R.F.

**MOZART: Mass in C Minor (K. 427, "The Great").** Carole Bogard (soprano); Ann Murray (mezzo-soprano); Richard Lewis (tenor); Michael Rippon (bass); Amor Artis Chorale; English Chamber Orchestra, Johannes Somary cond. VANGUARD VSD 71210 \$6.98.

**MOZART: Mass in C Minor (K. 427, "The Great").** Ileana Cotrubas (soprano); Kiri Te Kanawa (soprano); Werner Krenn (tenor);

Hans Sotin (bass); John Alldis Choir; New Philharmonia Orchestra, Raymond Leppard cond. SERAPHIM S-60257 \$3.98.

Performances: **Respectable**  
Recordings: **Average**

Here we have two respectable recordings of the Mozart C Minor Mass, both well done and well sung, but neither exciting and not much to choose between them. Leppard makes a richer sound and perhaps delves a mite deeper. He has a better-sounding orchestra, a plodding chorus, fine soloists, but not much sense of involvement. Somary achieves something more like an eighteenth-century sound—a bit more life and a bit more bite.

A couple of amusing footnotes: Leppard argues quite convincingly in his program notes that this Mass was not, as is usually assumed, connected with Mozart's marriage to Constanza Weber. And Vanguard prints the entire text of the Credo although Mozart set only the first half of it. E.S.

**MOZART: String Quartets Nos. 20-23.** Juilliard Quartet. COLUMBIA MG 33976 two discs \$7.98.

Performance: **No zing**  
Recording: **Good**

Do I detect a lack of conviction about these performances of the last quartets of Mozart? Simply doing one's duty is no way to do Mozart. Of course, the Juilliard Quartet is fluent, knowledgeable, well-balanced, and all the rest. But there's no zing here, and Mozart is one composer who always ought to (pardon the expression) zing out. E.S.

**ORFF: Trionfi: Carmina Burana; Catulli Carmina; Trionfo di Afrodite.** Milada Šubrtová (soprano); Jaroslav Tománek (tenor); Theodor Šrubař (baritone); Helena Tattermuschová (soprano); Ivo Židek (tenor); Marta Boháčová (soprano); Oldřich Lindauer (tenor); Karel Berman (bass); Czech Philharmonic Chorus; Prague Symphony Orchestra, Václav Smetáček cond. SUPRAPHON 1 12 1461/3 three discs \$20.94.

Performance: **Best in choral department**  
Recording: **Adequate to excellent**

**ORFF: Carmina Burana.** Sheila Armstrong (soprano); Gerald English (tenor); Thomas Allen (baritone); St. Clement Danes Grammar School Boys' Choir; London Symphony Orchestra and Chorus, André Previn cond. ANGELO S-37117 \$6.98.

Performance: **Lyrical in emphasis**  
Recording: **Very good**

Until Eugen Jochum or Herbert Kegel gets around to recording the *Trionfo di Afrodite*, this Supraphon album is likely to remain the only available stereo version of Carl Orff's complete trilogy on the power of love. Between the completion of the *Carmina Burana* (1936) and the concluding work of the *Trionfi* trilogy (1951) came Orff's *Der Mond, Die Kluge*, and the setting of the Hölderlin-Sophocles *Antigonae*. During this time, Orff was moving away from the relatively equal balance of music and word in *Carmina Burana* and toward the primacy of speech and ritual theater, with the musical element dominated by elemental rhythm and song-speech. Indeed, it is in the context of ritual theater and

the \$15 solution...



to hi-fi's most unrecognized problem.

The Problem: acoustic feedback  
The Solution: Netronics Acousti-Mount

Feedback may be the mysterious reason why your sound is muddy, your turntable rumbles, and in severe cases, you can't turn up the bass or volume controls without speaker howl. Designed specifically to accommodate today's line turntables, the Netronics Acousti-Mount sub-base platform suppresses acoustic feedback by effectively decoupling the entire turntable assembly from structure-borne vibration. A computer designed high-Q conical-spring suspension achieves a system resonance of approximately 4 Hz in both the horizontal and vertical planes. The apparent simplicity of the Acousti-Mount belies the sophistication of its design and the effectiveness — up to 30 dB! — of its isolation. The better your system, the more you may need Acousti-Mount.

Julian Hersh's test report: "We doubt that any other \$15 investment could make such an improvement in a record-playing system."

Please Send **ACOUSTI-MOUNTS** @ 15.00 (16 x 13 1/2) } Post Paid  
U.S. and foreign patents applied for. 17.50 (19 x 13 1/2)

Canadian residents add \$1.00 Conn. residents add 7% tax

Name \_\_\_\_\_

Address \_\_\_\_\_

City \_\_\_\_\_ Zip \_\_\_\_\_

Deluxe walnut grain vinyl finish. Money back if not delighted.

I am also interested in receiving information on your new turntable kits.

NETRONICS R&D LTD. ROUTE 6, BETHEL, CONN 06801  
CIRCLE NO. 45 ON READER SERVICE CARD



## CALENDAR OF CLASSICAL COMPOSERS

BACK by popular demand and updated from its original (1966) printing, Music Editor James Goodfriend's *Calendar of Classical Composers* is a listing of the most important composers from the year 1400 to the present, grouped according to the stylistic periods—Renaissance, Baroque, Classic, Romantic, etc.—in which they worked. This 12 x 24-inch aid, guide, and complement to your music listening is printed in color on heavy, nonreflecting stock suitable, as they say, for framing. A key to the calendar, consisting of capsule accounts of the principal stylistic characteristics of each musical period, is included. The whole will be sent rolled in a mailing tube to prevent creases: we pay postage. All you do is send 25¢ to:

Calendar of Classical Composers  
Stereo Review, 1 Park Avenue, New York, N.Y. 10016



primacy of the word that one must try to experience the work of Orff, and only after experiencing it from this aspect, I feel, does one have the right to render the verdict of "masterpiece" or "primitivistic kitsch" or something in between. One thing is sure, and that is that a knowledge and understanding of Orff's texts is as essential to the proper appreciation of the *Trionfi* as a thorough grounding in Shakespeare's *Henry IV* is for a true appreciation of Elgar's *Falstaff*. It is a major shortcoming of the Supraphon *Trionfi* album, therefore, that though the accompanying English, German, and French notes are excellent, there are no corresponding translations of the medieval German, Latin, and Greek texts of the works themselves.

As for the recorded performances, it should be noted that the *Carmina Burana* was originally available in this country on the Parliament label in 1962, while the *Catulli Carmina* was issued on Crossroads in 1967 and the *Trionfo di Afrodite* has been obtainable individually on Supraphon since 1970. All are distinguished by singing of exceptional power and rhythmic vitality from the Czech Philharmonic Chorus, especially in the tenor department. The work of the solo singers is considerably less distinguished; *Carmina Burana* suffers in particular from the wobbly baritone of Theodor Šrubař.

When I compared this *Catulli Carmina* performance with the superb Philips version conducted by Herbert Kegel, I concluded that the Czechs were presenting the tragedy of Catullus and Lesbia as a kind of "morality," while the Leipzig production sets forth an intensely poignant and deeply moving human drama.

The *Trionfo di Afrodite* here benefits from both the best recording and the most effective performance. Unlike the *Carmina Burana* panels and the *Catulli Carmina* drama, the *Trionfo di Afrodite* is a full-scale wedding ceremony in the ancient ritual sense. It has a text by Catullus and Sappho and is complete with processional, dialogues, and song between bride and groom, games and songs before the bridal chamber, and a final "epiphany of Aphrodite" climaxed by a torrent of orgiastic roars and screams from the chorus. The early pages are of less than prime interest, but things improve with the melismatic dialogue of bride and groom; by the time I got to the games and dances my listening interest was considerable, and it was steadily maintained to the end of this Orffian counterpart to Stravinsky's *Les Noces*.

All things considered, however, there are better versions of the first and second numbers of the trilogy, and I would wait for Jochum (Deutsche Grammophon) or Kegel (Philips) to come forth with versions of *Trionfi di Afrodite* which undoubtedly will include the all-important text with translation.

In yet another recording of *Carmina Burana*, this one from André Previn in Angel's SQ quadrasonic sound, the choral sound is of superior sonority and nicety of balance, the perspective of the excellent soloists relative to the choral-orchestral body unerringly judged, and the orchestral sound per se rich in fullness and detail. Gerald English sings the famous Roasted Swan vignette with somewhat more open voice than I have heard elsewhere, but with marvelous musicality, a quality that also distinguishes the work of baritone

Thomas Allen and soprano Sheila Armstrong. Perhaps the finest thing in the entire performance is the superb variety of nuance achieved by the male chorus throughout *In Taberna*. Previn eschews both the straitlaced motoric and anything that smacks of the "wow" technique, instead emphasizing the score's lyrical values. For my taste, the first half of the performance is on the tame side, but from *In Taberna* to the end, the reading is first-rate on all counts. If quadrasonics are essential to the would-be purchaser, Michael Tilson Thomas' version on Columbia still retains the edge in terms of sheer brash vividness, but Angel's more conservatively ambient view makes for an excellent and in some ways more natural listening experience. D.H.

**RACHMANINOFF:** *Rhapsody on a Theme of Paganini, Op. 43* (see DOHNÁNYI)

**RESPIGHI:** *Ancient Airs and Dances, Suites Nos. 1, 2, and 3*. Los Angeles Chamber Orchestra, Neville Marriner cond. ANGEL □ S-37301 \$6.98.

Performance: **Suave**  
Recording: **Very good, but . . .**

**RESPIGHI:** *The Birds; Trittico Botticelliano*. Prague Chamber Orchestra, "prepared for recording" by Josef Vlach (*Birds*) and Petr Škvor (*Trittico*). SUPRAPHON I 10 1769 \$6.98.

Performance: **Expansive**  
Recording: **Warm**

Marriner's disc of the *Ancient Airs and Dances*, one of the first recordings he has made in this country, is very handsome: the

# TWO WAYS TO CATCH THE WIND



Print size 3½ x 4½ in.

The Kodak Tele-Instamatic 608 camera lets you take pictures two ways without moving a step. Normal shots. And with just the flick of a finger—telephoto shots. It uses flipflash. And it's pocket-sized so it's easy to take along.

The Tele-Instamatic 608 camera carries a Full three-year Warranty. And it costs less than \$39 at your photo dealer's. For a few dollars more you can get a complete outfit with Kodak color film and flipflash.

Price is subject to change without notice.

**FOR THE FUN OF IT**



**Kodak Tele-Instamatic™ 608 camera** 

CIRCLE NO. 24 ON READER SERVICE CARD



# Sensible alternative.

The Uher CG 320 is unlike any other stereo cassette machine, even a Uher.

We built the CG 320 to be an exceptionally reliable two-motor machine with the performance and features to match the world's finest.

- Electronic tape flow indicator.
- Clutchless tape drive system.
- Self-contained stereo power stage.
- Internal loudspeakers—or use it as a deck.
- On-off automatic level control.
- Dynamic Noise Limiter (DNL).

### Plus

- Automatic EQ switching for chrome tape.
- 3-digit counter with memory circuitry.
- End of tape switch off.
- Optional power cable for 12-volt power supply.
- Easy-to-read level meter with gauged dB scale.

Two separate sliders for independent record level control of the two channels, two sliders for independent replay level control of each channel and a slider tone level control to assure optimum operating conditions. Low distortion and top specifications are the hallmark of this quality product.

The Uher CG 320 offers the high technical quality, versatility and design to suit truly demanding tastes.

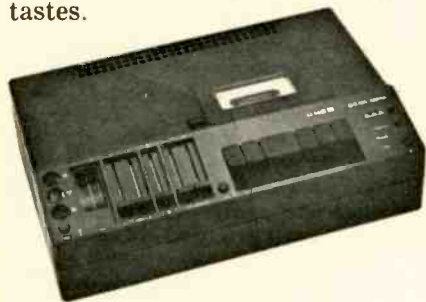

**UHER** of America Inc.

621 S. Hindry Avenue  
Inglewood, Calif. 90301

Please send me complete details on the CG 320, the sensible alternative to cassette tape recording and listening.

NAME \_\_\_\_\_

ADDRESS \_\_\_\_\_

CITY \_\_\_\_\_ STATE \_\_\_\_\_ ZIP \_\_\_\_\_

performances are characteristically suave, well balanced, and thoroughly enjoyable, and the fine acoustics of Pasadena's Ambassador Auditorium justify the acknowledgment on the labels. It must be said, though, that Antal Dorati, in his classic recording of these enchanting suites with the Philharmonia Hungarica (Mercury SRI 75009), shows a longer acquaintance with and deeper affection for the material. Moreover, those attracted to the Angel disc for quadruphony's sake should be warned that the rear channels will distort on the proper (SQ) setting on many systems. The explanation is complex, having to do with "variations in the SQ mix"; the corrective, in this case, seems to be to play the disc on the "Regular Matrix" or QS setting, even though it's supposed to be wrong.

The warm, full-bodied sonic frame Supraphon has provided enhances the rich string tone and expansive approach of the Prague Chamber Orchestra, but the expansiveness is overdone and the performances lack momentum—in *The Birds* more conspicuously than in the *Trittico*. I can take "The Hen" at the relaxed pace adopted by the Czechs, but the exquisite setting of "The Nightingale," which one wants to float on air, simply plods, and the final movement ("The Cuckoo") is rather heavy-footed, too. This recording of the *Trittico* is apparently the only one available now, but I have never felt this work to be one of Respighi's strongest anyway, and I would not recommend purchasing the disc just to have a recording of it. R.F.

**RIMSKY-KORSAKOV: Quintet in B-flat Major for Piano and Winds, Op. Posth.** (see MENDELSSOHN)

**SCHINDLER: String Sextet in Six Sections** (see THORNE)

**SCHUBERT: Piano Sonata in B-flat Major, Op. Posth. (D. 960).** Rudolf Serkin (piano). COLUMBIA M 33932 \$6.98.

**SCHUBERT: Piano Sonata in B-flat Major, Op. Posth. (D. 960).** Christoph Eschenbach (piano). DEUTSCHE GRAMMOPHON 2530 477 \$7.98.

Performances: **Serkin better**  
Recordings: **DG better**

All the grace, all the intensity, all the—yes—schmaltz is in Serkin's performance of Schubert's last, great sonata, and there is no reason why it should be otherwise.

Well, okay, not schmaltz. But this is a work of such strong and extended poetic feeling that it can, without intensity and passion in the performance, become thin and even boring. Schubert sonatas used to be quite rare in public performance, and with good reason; it is the rare pianist who can endow them with enough intensity to transcend their essential inwardness (otherwise they are better left on the living-room piano as music to be played for personal enjoyment). Serkin is such a pianist. Eschenbach is not yet the man; he plays it cool and straight and the music seldom comes to life. The day is long past when this music could interest us for its formal structure or as a historical artifact. We want to hear the expressive undertone of the poetry, and Serkin's reading is alive with basic humanistic qualities.

Both recordings are good. Serkin gets the mellow sound, but—as usual in American-German disc comparisons—the German rec-



Columbia Records

**RUDOLPH SERKIN**

*Not schmaltz, but passion in Schubert*

ord is noticeably superior in the sheer quality of its plastic. E.S.

**SCHUBERT: Die Zwillingsbrüder.** Kurt Moll (bass), Magistrate; Helen Donath (soprano), Lieschen; Nicolai Gedda (tenor), Anton; Dietrich Fischer-Dieskau (baritone), Franz, Friedrich Spiess; Hans-Joachim Gallus (bass), Official. Bavarian Radio Chorus and Orchestra, Wolfgang Sawallisch cond. EMI-ELECTROLA 065-28 833 \$7.98.

Performance: **Very good**  
Recording: **Very good**

Franz Schubert—immensely gifted, inexhaustibly productive, and invariably poor-sought success in the theater, thinking that it would assure him wealth and recognition. He never succeeded. Even allowing for the poverty of the librettos and the unresponsiveness of the audiences in the midst of Vienna's Rossini craze, it must be recognized that opera simply was not Schubert's medium. Perhaps the closest he came to success was when his *Die Zwillingsbrüder* (*The Twin Brothers*) received seven performances at Vienna's Kärntnertheater in 1820. Schubert's champion and friend, Johann Michael Vogl, sang the double role of the two brothers—one good, one bad—whose simultaneous sudden reappearance after an eighteen-year absence causes enough complications to sustain a one-act *Singspiel*.

But it is a naïve and unconvincing *Singspiel* that unfolds in the course of this well-produced and elegantly cast first recording, and even the uniformly fine singing and loving direction cannot make it effectively theatrical. There are ten arias, duets, and ensembles separated by spoken passages. One of them, a soprano aria (No. 3), is very attractive, with a clarinet interplay anticipating *Der Hirt auf dem Felsen*. Throughout, the orchestra writing is delicate and highly accomplished—after all, Schubert at twenty-three had already composed six symphonies—and the melodies are always engaging. Missing, however, is the dramatic flow, the knack of involving the listener in the plot. Still, it is an excellent performance of an *opera* by Schubert—and this description alone makes it almost irresistible.

G.J.

**STRAVINSKY: Petrouchka, Three Movements** (see TCHAIKOVSKY)



**STRAVINSKY: *Symphony of Psalms; Canticum Sacrum.*** Choir of Christ Church Cathedral, Oxford; Philip Jones Ensemble, Simon Preston cond. ARGO ZRG 799 \$6.98.

Performance: **Canticum comes to life**  
Recording: **Full**

This performance of the *Symphony of Psalms* is ornate and sumptuous where it ought to be bright and clear (because of the sonic effect of the massed choral and instrumental forces and the overwhelming acoustic). It is rather hurried and uninflected where it ought to be more measured and detailed (tempo and phrasing). As a result, the almost medieval beauty of the performance—for once, boys' voices are employed as the composer intended, and the performers and Preston's leadership are excellent—might be undervalued.

These accomplishments are put to better use in the *Canticum Sacrum*, a much more austere and modern/medieval work. The *Symphony of Psalms* was written in 1930 for the "glory of God" and the Boston Symphony; *Canticum*, which appeared a quarter of century later, was composed for the patron saint, the cathedral, and the city of St. Mark: Venice, Italy. In this strange composition, Stravinsky was consciously striving for the austerity and religious intensity of his last period, combining medievalism with twelve-tonery in a very distinct way. This combination, hard-edged and not often understood by classically trained conservatory musicians, is perfectly captured here and is really the highlight of the album. Not many people will buy a Stravinsky album for the *Canticum Sacrum*—as opposed to the far more appealing *Symphony of Psalms*—but that is where the real interest of the album lies, and it is no small accomplishment to have succeeded in bringing the late, gnarled Stravinsky back to life. E.S.

**TCHAIKOVSKY: *Fatum, Op. 77; The Tempest, Fantasia, Op. 18; The Storm, Overture, Op. 76; The Voyevode, Symphonic Ballad, Op. 78.*** Frankfort Radio Symphony Orchestra, Eliahu Inbal cond. PHILIPS 6500 467 \$7.98.

**TCHAIKOVSKY: *Fatum, Op. 77; The Tempest, Fantasia, Op. 18; Romeo and Juliet, Overture-Fantasia.*** National Symphony Orchestra of Washington, D.C., Antal Dorati cond. LONDON CS 6891 \$5.98.

Performances: **I like Inbal**  
Recordings: **I like Philips**

The recording industry works in mysterious ways: not long ago we had two first recordings, issued almost simultaneously, of Massenet's all-but-forgotten opera *La Navarraise*; now we have the same situation with two stereo premières of an even more obscure score by Tchaikovsky, the early symphonic poem *Fatum*. There is another rarity on the Philips disc, a very late orchestral piece based on an Adam Mickiewicz tale of jealousy and murder, *The Voyevode*. Both pieces are, for my taste at least, of more documentary than musical interest. If one heard *Fatum* without knowing the title, it could easily be mistaken for a discarded ballet score. The late opus number is explained by the fact that the score was published posthumously from the orchestral parts after Tchaikovsky had destroyed the original. *The Voyevode* I find even less interesting in musical substance, though more so in its orchestration, making use as it does of the celesta a year before the celebrated ex-

ploitation of that then novel instrument in the *Nutcracker* ballet.

The overture to Ostrovsky's *The Storm*, although a student work, has more points of interest, not the least being the use of thematic material that was later to find its way into the slow movement of the First Symphony. And *The Tempest*, if not the imperishable masterpiece that *Romeo and Juliet* became in its final revision, is a piece that has always found a warm spot in my heart. The opening and closing sea music is splendidly atmospheric, and the Ariel-Caliban episode abounds in fanciful touches.

The Dorati disc here (actually a companion disc to London CS 6841, which includes *The Voyevode, Francesca da Rimini, and Hamlet*) contains three sharply honed, but not particu-

larly impassioned readings, of which *Fatum* is the most convincing. The *Romeo*, unhappily, has none of the fiery temperament that marked Dorati's 1954 Mercury disc, while *The Tempest* suffers noticeably from a Constitution Hall acoustic that muffles the all-important brasses and emphasizes the low end of the orchestral spectrum to the detriment of presence in the violin section.

Happily, on the other hand, Eliahu Inbal and his orchestra have the benefit of well nigh flawless recorded sound—glowing, intense violins, stirringly "brassy" brass, rich but not obtrusive bass line and percussion, and expertly managed stereo pinpointing of the solo highlights. The readings all have a youthful ardor tempered by a fine feeling for line and

*(Continued on page 128)*

## KLIPSCHORN® X-3 LOUDSPEAKER, CIRCA 1942, IS STILL ALIVE AND REPRODUCING.

The Klipschorn you buy today will be doing the same in the 21st century.

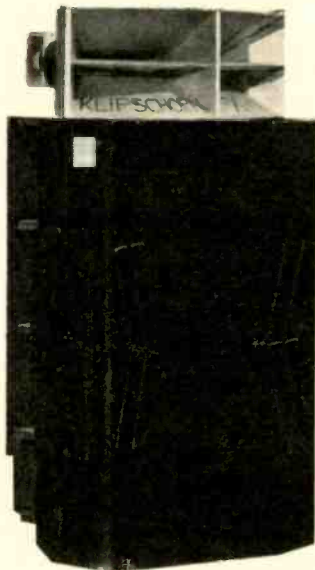

Paul W. Klipsch recalls building the first models:

*"The experimental corner woofer 'X-1' was made in the garage of an acquaintance of mine in Houston in March of 1940.*

*After I made the X-3, the original X-1 was stored in a barn behind my house in Hope; the termites ate it and it had to be burned. It was not a good speaker.*

*The X-3 was the prototype from which the K-3 KLIPSCHORN woofers evolved and is really KLIPSCHORN #1 since X-1 was an entirely different structure with a response limited to 200 Hz.*

*The X-3 is still in existence and in operating condition. X-3 was built entirely by me by hand — not a machine made cut. I whittled the thing out with a hand saw and wood rasp (1942)."*

By 1946 a few modifications were made and the KLIPSCHORN had acquired a Klipsch-designed high frequency horn. Then, with the addition of a tweeter the KLIPSCHORN emerged as virtually the same speaker that is produced today. And because the design is fundamental to the laws of acoustics it's an investment for a lifetime. This coupon will bring the latest information on the full line of Klipsch loudspeakers.



Plwood construction

### KLIPSCH AND ASSOCIATES, INC.

P.O. Box 688 S-9 Hope, Arkansas 71801

In Canada: Superior Electronics, Inc.

Please send me your latest brochure and list of dealers.

Name \_\_\_\_\_  
Address \_\_\_\_\_  
City \_\_\_\_\_ State \_\_\_\_\_ Zip \_\_\_\_\_



CIRCLE NO. 34 ON READER SERVICE CARD



FREDERICK RZEWSKI:  
worth keeping  
an eye on

## New American Music in Cross Section

THIS Bicentennial year has brought with it a not unexpected flurry of activity within the realm of new recordings of American music. There are those who will hypocritically group these endeavors with all the other crass, commercialistic manifestations of the “Buy-centennial,” but the fact is that all but a very few of such recordings, be they of Billings or Babbitt, have an extremely limited sales potential. Clearly the record companies don’t intend to net unheard-of profits from American serious music, even in 1976. Yet, all of us have pet recording projects we would be overjoyed to see accomplished this year, and I can’t help but beg for one or two things myself at this juncture—recordings of *Montezuma* (Sessions), *The Visitation* (Schuller), and an uncut *Four Saints in Three Acts* (Thomson). At the same time, however, it is important that we value what we’ve already been given from the record companies, and the efforts of Folkways Records in its four-volume New American Music series deserve special applause.

What Folkways, in association with the Creative Artists Public Service program (CAPS), has done is to offer something of a compendium of the diverse styles in which today’s younger American composers are working, and they have tried to represent as wide a cross-section of musical techniques and languages as they can, from “conservative” (Swanson) to “experimental” (Graves). Their inclusion of works by a number of black and women composers is also to be lauded. All but a few of the composers represented are in their thirties, and most of them are in some way connected with the musical life of New York State, a fact that leads me to wonder if Folkways plans further releases in this series that will give young composers in other parts of the country an opportunity to be heard.

Perhaps the most immediately impressive aspect of the New American Music discs is their representation of the return of American composers to a style in which such elements as drama and sensitivity hold sway over the musical product, the end result being a type of new romanticism in music over and against much of the impotent and stillborn offspring of the 1950’s. This fact is effectively brought home by the realization that not one composi-



Werner Berthold/Berlin

tion of the twenty-one presented could be reasonably placed within the realm of serial formalism, pseudo-formalism, or crypto-formalism. Many of today’s American composers are honestly trying to re-establish some sort of more direct communication with the larger listening public, shunning equally the extremes of Babbitt and of Cageyness. That is something well worth celebrating in this Bicentennial year.

THE reason for all this preliminary kudos to CAPS and Folkways is to lend general praise and encouragement to their (and similar) efforts. I am sorry to report, though, that the specific results on these records are often disappointing. Quite frankly, too much mediocre music by composers of limited abilities has been included, and even the works of some of the better composers represented fall short of the best these people can, and have, accomplished. Volume 2 is a case in point, containing as it does works by Lucia Dlugoszewski, Carman Moore, Philip Glass, and Stanley Silverman, all of whom have received a great deal of deservedly good press recently. Dlugoszewski’s *Angels of the Inmost Heaven* for five brass instruments is a dense, difficult, Varèse-oriented work of considerable power, yet it falls short of the theatrical and timbral depth of her *Space Is a Diamond*. Glass is represented by *Two Pages*, an austere work for electric organ and piano which contains all the trademarks of his hypnotic style but is nonetheless lacking in the elegance that usually typifies his work. Moore’s *Youth in a Merciful House* dates from its composer’s days at Juilliard, and it does indeed sound like a student piece—episodic and without anything unique to say. All of these musicians are capable of much more, and I am at a loss to understand why these particular works were chosen for release. Only Stanley Silverman’s chamber concerto for guitar entitled *Planh* is a real winner—a *planh* is a type of Provençal poetic lamentation, and Silverman achieves in this one-movement mini-concerto some moments of true beauty and sensitivity. *Planh* is Silverman at his best, and it is to be hoped he will continue to compose music of like poetry and atmosphere.

Volume 1 offers six jazz compositions of

varying persuasions—regrettably, there is an inordinate amount of pomposity here. Two of the pieces, Gil Evans’ *Bluefish* and Samuel Rivers’ *Shadows*, take appealing musical ideas and gestures and run them into the ground *ad nauseam*; their works would be vastly improved by some judicious pruning. The selections by Sunny Murray and Milford Graves, however, seem virtually irredeemable. Graves’ *Transmutations* is particularly annoying, for, though it stems from the fascinating world of late John Coltrane and earlier Pharoah Sanders, it lacks both the drama and discipline of those artists’ best work. The pretentiousness of much of the music here is matched only by the obnoxiousness of the accompanying program notes, which inform us that Murray’s *Encounter* “represents a broken road in the musical thoroughfare of lives” and that the Graves piece “depicts the constant changes taking place in life.” I thought that sort of nonsense would down some time ago. The most redeeming value of Volume 1 is the inclusion of two attractive pieces by Mary Lou Williams, *Zoning Fungus II* and a Gloria from one of Ms. Williams’ three jazz Masses. Here, for once, is music which refuses to posture as being something more than it is—this is simply good, down-to-earth jazz (rather more mainstream in orientation) that requires little or no explanation, just listening.

Volume 4, like Volume 1, centers around music of a particular genre, in this case works which in some sense involve electronics either in live or taped form. The most powerful selection here is *Conflict*, by one of the elder statesmen of electronic music, Vladimir Ussachevsky. The music, for tape alone, is almost visceral in its impact, yet, at the same time, understated. Ussachevsky achieves his goal not by the perhaps expected onslaught of sound but rather by a sense of control and restraint that renders the effect more sinister and evil than directly violent. *Conflict* is joined by pieces of Gordon Mumma, Noa Ain, Joel Chadabe, and Ann McMillan which, with the possible exception of McMillan’s somewhat unoriginal tape transformation of naturally produced (*Whale I*) and musically produced (*Carrefours*) sounds, all have something to recommend them. Ain’s composition is a tribute to violinist Yoko Matsua. Conceived entirely on tape, *Used to Call Me Sadness* consists of a juxtaposition of Matsua performing against an interview in which she speaks of her childhood, her marriage, and so forth. The effect was strangely moving despite the fact that I was able to understand only a few words of the interview.

FOR those interested in sampling just one of these four discs, let me recommend Volume 3, which begins with a stunning percussion ensemble piece by Talib Abdul Hakim. *Placements* presents a series of quasi-improvisatory solos over a foundation of repeating fragments that constantly interact with each other differently; this is static music in the best sense of the word, in some ways almost devotional in character. *Placements* is followed by



William Bolcom's *Whisper Moon*, which will present little new to those who know Bolcom's music: it combines quotes from late Romantic German classical music and pop songs of the Twenties and Thirties with Bolcom's own essentially Brand X style of atonality. Volume 3 also contains an enjoyable if somewhat traditional and tonally oriented trio for flute, clarinet, and piano by Howard Swanson, but the real treasure, not only on this record but of the entire series, is the set of three songs by Frederic Rzewski. About ten years ago Rzewski (pronounced CHEFF-skee) was composing conceptually based pieces, but in the later 1960's he became involved in the activist political movement with the result that he is now firmly entrenched in the politics of the left. In earlier works of this new period (such as the spellbinding *Les Moutons de Panurge*), the relationship between the music and the philosophy was not always clear, but in later pieces, such as *Attica* and the songs here recorded, the marriage is much more obvious. The three songs were not intended to be performed as a set, and their grouping here is admittedly arbitrary. The first, *Struggle*, comes from Rzewski's 1974 cantata of the same name. Langston Hughes' *God to a Hungry Child* furnishes the inspiration for the second song, a lullaby, while an essay by the Latin American revolutionary Otto René Castille supplies the words for the final song. All three are unified by a direct and unapologetic use of simple tonal procedures to stunning effect. The music is purposely not directed toward climaxes but rather remains basically unchanging in a hypnotic way, thus allowing the force of the texts to predominate. In other words, Rzewski is a leading practitioner of the new communication between composer and audience, and he is undoubtedly a gentleman worth keeping an eye on.

**W**ITHOUT access to scores, one can only assume that these composer-supervised performances are authentic. With the exception of the selections on Volume 4, most, if not all, of the recordings seem to have originated in the same studio, and they possess a generally dry, not always flattering acoustic. But despite these and other doubts already mentioned, a hearty bravo is due Folkways and CAPS for their courage in bringing this music to the public eye and ear; let us hope they will be able to continue the series in the coming months with, I trust, just a bit more discrimination in their choice of music.

—Christopher Rouse

**NEW AMERICAN MUSIC. Volume 1:** Evans: *Bluefish*. Graves: *Transmutations*. Williams: *Zoning Fungus II*; *Gloria*. Rivers: *Shadows*. Murray: *Evocations*. **Volume 2:** Dlugoszewski: *Angels of the Utmost Heavens*. Glass: *Two Pages*. Fulkerson: *Patterns No. 7*. Moore: *Youth in a Merciful House*. Silverman: *Planh*. **Volume 3:** Hakim: *Placements*. Bolcom: *Whisper Moon*. Swanson: *Trio for Flute, Clarinet and Piano*. Rzewski: *Three Songs—Struggle*; *God to a Hungry Child*; *Apolitical Intellectuals*. **Volume 4:** Ain: *Used to Call Me Sadness*. Chadabe: *Echoes*. McMillan: *Whale I*; *Carrefours*. Mumma: *Cybersonic Cantilevers*. Ussachevsky: *Conflict*. **FOLKWAYS FTS** 33901/2/3/4 four discs \$6.98 each.

**FREE**

# McIntosh CATALOG and FM DIRECTORY

Get all the newest and latest information on the new McIntosh Solid State equipment in the McIntosh catalog. In addition you will receive an FM station directory that covers all of North America.



## MX 113

FM/FM STEREO - AM TUNER AND PREAMPLIFIER

**SEND  
TODAY!**

McIntosh Laboratory, Inc.  
East Side Station P.O. Box 96  
Binghamton, N.Y. 13904  
Dept. SR

NAME \_\_\_\_\_

ADDRESS \_\_\_\_\_

CITY \_\_\_\_\_ STATE \_\_\_\_\_ ZIP \_\_\_\_\_

If you are in a hurry for your catalog please send the coupon to McIntosh...  
For non rush service send the *Reader Service Card* to the magazine.

CIRCLE NO. 39 ON READER SERVICE CARD

## WRITE FOR QUOTATION

FACTORY SEALED CARTONS  
FRANCHISED DISTRIBUTOR  
QUICK SHIPMENT

**WE GIVE  
DISCOUNTS  
ON HI-FI  
COMPONENTS**

**SOUND  
REPRODUCTION,  
INC.**

460 CENTRAL AVENUE  
East Orange, New Jersey 07018  
(201) 673-0600

CIRCLE NO. 55 ON READER SERVICE CARD

# BIG DISCOUNTS

**STEREO COMPONENTS**

Largest selection of top name brands... try us and see.

It's worth a call  
**(301) 488-9600**

**INTERNATIONAL  
HI-FI  
DISTRIBUTORS**

6330 Frankford Ave.  
Baltimore, Md. 21206

All mail answered within 24 hours

Phone Daily 9 AM to 9 PM  
Saturday 9 AM to 4 PM  
Phone (301) 488-9600

CIRCLE NO. 30 ON READER SERVICE CARD



**SPECIAL  
PRE-PUBLICATION  
OFFER FOR READERS  
OF STEREO REVIEW  
MAGAZINE**



**THE 1977  
STEREO DIRECTORY  
& BUYING GUIDE**

is scheduled to go on sale  
nationally October, 1976

This all-new edition will feature the latest information on stereo systems and components, including four-channel—more than 1500 products in all—listed by manufacturer, each with model number, complete specifications, descriptions and prices.

**YOU CAN RESERVE  
YOUR COPY NOW  
AT THE**

**SPECIAL  
PRE-PUBLICATION  
PRICE OF ONLY \$1.25,  
POSTPAID.**

This offer is being made to readers of STEREO REVIEW Magazine only. Regular price is \$1.95; mail order price \$2.25. Reserve your copy now by completing the Reservation Form and returning it promptly along with your remittance. STEREO DIRECTORY & BUYING GUIDE will be mailed to you from first-off-the-press copies when published.

**PRE-PUBLICATION RESERVATION FORM**  
Stereo Directory  
& Buying Guide  
Consumer Service Division  
595 Broadway, New York, N.Y. 10012

Enclosed is \$1.25.\* Please reserve my copy of the 1977 STEREO DIRECTORY & BUYING GUIDE to be mailed to me from first-off-the-press copies when published. SR96,

Print Name \_\_\_\_\_

Address \_\_\_\_\_

City \_\_\_\_\_

State \_\_\_\_\_

Zip \_\_\_\_\_

\*Residents of Cal., Col., Fla., Ill., Mich., Mo., N.Y. State, D.C. and Tex. add applicable sales tax.

structure. This pays off particularly well in *Fatum* and almost makes a convincing piece of it. If you are a real Tchaikovsky buff, the Philips disc is a worthwhile investment. D.H.

**TCHAIKOVSKY: Piano Concerto No. 1, in B-flat Minor, Op. 23.** STRAVINSKY: *Three Movements from Petrouchka*. Ilana Vered (piano); London Symphony Orchestra, Kazimierz Kord cond. LONDON SPC 21148 \$6.98, © 8-21148 \$7.98, © 5-21148 \$7.98.

Performance: **Brilliant**  
Recording: **Brilliant**

Ilana Vered uses her formidable keyboard prowess to give the Tchaikovsky concerto a treatment completely different from those of Berman, Richter, and Cliburn. Here is the good old knock-'em-in-the-aisles virtuoso style of the pre-Cliburn era, and on this level, Vered, with ample support from the London Symphony under Kazimierz Kord and London's Phase-4 recording staff, turns in a handsomely satisfying job. But the really spectacular part of this album is the pianist's stunning rendition of the *Russian Dance*. In *Petrouchka's Room*, and *Shrovetide Fair* episodes that Stravinsky arranged in 1921 for Artur Schnabel (what a shame Rubinstein himself never recorded it!). Miss Vered turns in a knockout job, as do the engineers, for the sound, I am happy to say, is vivid, brilliant, and entirely appropriate. D.H.

**RECORDING OF SPECIAL MERIT**

**TCHAIKOVSKY: Symphony No. 4, in F Minor, Op. 36.** New York Philharmonic, Leonard Bernstein cond. COLUMBIA □ XMQ 33886 \$7.98; XM 33886 \$6.98, © XMA 33886 \$7.98, © XMT 33886 \$7.98, □ QAX 33886 \$8.98.

Performance: **Glorious**  
Recording: **Superb**

**TCHAIKOVSKY: Symphony No. 5, in E Minor, Op. 64.** Chicago Symphony Orchestra, Sir Georg Solti cond. LONDON CS 6983 \$6.98.

**TCHAIKOVSKY: Symphony No. 5, in E Minor, Op. 64.** Concertgebouw Orchestra, Amsterdam, Bernard Haitink cond. PHILIPS 6500 922 \$7.98.

Performances: **Haitink cool, Solti hot**  
Recordings: **Philips has the edge**

Leonard Bernstein's new recorded realization of the Tchaikovsky Fourth takes a place, for

me, beside such extraordinary earlier documentations of the work as those by William Mengelberg and the Amsterdam Concertgebouw in the early 1930's, Kurt Sanderling with the Leningrad Philharmonic as recorded in Vienna in the middle 1950's, and Herbert von Karajan's 1966 Deutsche Grammophon reading. Even Karajan doesn't match Bernstein in the splendid menace achieved in the opening pages or the sense of insane panic that climaxes the first-movement development. And how beautifully Bernstein brings forth the bell strokes at the close of the slow movement! The famous *pizzicato* slow movement gets the razzle-dazzle treatment here, but through crackling rhythmic tension rather than fast pacing. As for the finale, it's not only a gloriously exuberant performance, but a humdinger of a test for any sound buff's playback system, quadraphonic or stereo.

The Columbia recording crew has wisely stayed away from any fancy stuff in its four-channel sonics, giving us here just a good big sound with enough ambient surround to produce the you-are-there feeling, together with the kind of presence that makes one almost feel the resin flying off the strings. A top job!

Performances of the Tchaikovsky Fifth, like the music itself, affect me variably. Because of the episodic nature of the finale, in particular, the Fifth is a hard piece to bring off, and the first movement, as well, presents problems of tempo relationships that the conductor must solve if the whole thing is not to fall apart.

I must say that Bernard Haitink's reading of the first movement aroused my anticipation of a truly superb reading on all counts. I don't think I've ever heard pacing and tempo relationships so justly and beautifully handled as in this new Philips disc, and all superbly played and recorded in the bargain. The middle movements, though, turned out less happily—stodgy in pace despite the elegant details of phrasing and counter-melodies. The finale comes off well under Haitink's baton but without the kind of excitement it needs to become credible in spite of it all.

In the Solti/Chicago performance, though, the middle movements make up the high points. Solti's pacing in both movements is absolutely ideal, making for truly balletic grace in the waltz and for just the right lyrical urgency in the famous slow movement. The Chicago Symphony's first-chair oboe deserves special praise for the exquisite tone and phrasing he brings to his obbligato passages early in that movement. Solti's handling

ILANA VERED: *vive la différence*



London Records



of the end movements is swift and sure, with lots of rhythmic excitement. These movements seem a bit short on lyrical soul, but here I think London's recording can be faulted to some extent; in the first movement, especially, I found the brass presence overshadowing that of the all-important violins.

So where do we stand with the Tchaikovsky Fifth in a roster of recordings currently numbering close to twenty? Despite minor reservations regarding the pacing of the slow movement, I'll stick with the DG Karajan version for now. *D.H.*

**THORNE:** *Six Set Pieces for Thirteen Players.*  
**SCHINDLER:** *String Sextet in Six Sections.*  
Contemporary Chamber Players of the University of Chicago, Ralph Shapey cond. Owl. ORLP-20 \$5.98.

Performance: **Lively**  
Recording: **Not lively**

The University of Chicago Contemporary Chamber Players directed by Ralph Shapey are among the few surviving long-term organizations devoted to new music—thanks largely to conductor-composer Ralph Shapey, a dynamic and much underrated presence on the contemporary scene. Shapey's own music and his musical taste gravitate toward the dynamic, and, as a result, he has escaped the creeping academicism that seems to have overtaken much collegiate music-making in America. The pieces recorded here are good cases in point. Francis Thorne's *Set Pieces* are so named for two reasons: because they use a twelve-tone row or set, but also because they have the character of a jazz set. This is modern music of a particularly limber sort, performer's music with a strong and immediate impact.

Alan Schindler, a pupil of Shapey at the University of Chicago, is a talented composer with an expressionist style that owes something to his teacher but also has strong individuality. His highly intense sextet, filled with agonizing quarter tones, makes a strong impression in Shapey's performance. The recordings are clear, but the Thorne in particular is on the dull side sonically. *E.S.*

**VERDI:** *Il Corsaro* (see Best of the Month, page 86)

**VERDI:** *Operatic Excerpts* (see Best of the Month, page 85)

#### COLLECTIONS

**CARLO BERGONZI:** *Verdi Recital* (see Best of the Month, page 85)

**CARMINA BURANA:** *Volume 1—Songs of Drinking and Eating; Songs of Unhappy Love. Bacche, bene venies; Virent prata hiemata; Nomen a sollempnibus; Alte clamat Epicurus; Vite perditae (two versions); Vacillantis trutine; In taberna quando sumus; Iste mundus furi-bundus; Axe Phebus aureo; Dulce solum natalis patrie; Procurans odium; Sic mea fata canendo solo; Ich was ein chint so wolgetan.* Clemencic Consort, René Clemencic cond. HARMONIA MUNDI HMU 335 \$7.98 (from HNH Distributors Ltd., P.O. Box 222, Evanston, Ill. 60204).

Performance: **Exotic**  
Recording: **Echoey**

To most of us "Carmina Burana" means Carl Orff's ever popular settings of medieval go-

## Saving the best for last.

The chances are good that when you first bought a stereo system, it was a "package" that included a receiver, 2 speakers, and a record player with cartridge. But how much time was spent selecting the cartridge? Most probably it was just a minor element of the package. Even if it had a famous name, it probably was not a truly first-rank model.

Yet the cartridge is more important than that. It can limit the ability of the entire hi-fi chain to properly reproduce your records. It can affect how many times you will enjoy your favorite records without noise and distortion. And it can determine whether you can play and enjoy the new four-channel CD-4 records.

Consider the advantages of adding an Audio-Technica AT15Sa to your present system. You start with response from 5 to 45,000 Hz. Ruler flat in the audio range for stereo, with extended response that assures excellent CD-4 playback if desired. Tracking is superb at all frequencies and distortion is extremely low. The sound is balanced, transparent, effortless. Stereo separation is outstanding, even at 10kHz and higher where others fall short. Our Dual Magnet design\* assures it.

And the AT15Sa has a genuine nude-mounted Shibata stylus. Which adds a host of advantages. Like longer record life. Better performance from many older, worn records. Exact tracing of high frequencies, especially at crowded inner grooves. And tracking capability—at a reasonable 1-2 grams—that outperforms and outlasts elliptical styli trying to track at less than a gram.

We're so certain that an AT15Sa will improve your present system that we'd like to challenge you. Take several of your favorite records to an Audio-Technica dealer. Have him compare the sound of your present cartridge (or any other) with the AT15Sa. Listen. We think you'll be impressed. And convinced.

\*T.M. Audio-Technica Dual Magnet cartridges protected by U.S. Patent Nos. 3,720,796 and 3,761,647.

**The AT15Sa.**  
**Very possibly the**  
**last phono**  
**cartridge**  
**you'll ever**  
**need.**



**audio-technica®**  
® INNOVATION □ PRECISION □ INTEGRITY

AUDIO-TECHNICA U.S., INC., Dept. 96F, 33 Shilawasse Ave., Fairlawn, Ohio 44131  
Available in Canada from Superior Electronics, Inc.



# The sand of music.



Bookshelf loudspeakers are devious rascals.

They'll sound one way in an anechoic chamber or an open room with few obstacles.

And quite another way when you get them in your home.

(The furniture, the carpeting, the drapes. All take their toll.)

But at Mitsubishi, we try especially hard to overcome these problems. And one of the things that helps us do it is an ordinary pile of sand.

Every Mitsubishi speaker system we make gets immersed in it. With only the front baffle and drivers protruding.

This creates an infinite baffle situation, which provides test data unobtainable in an anechoic chamber (where the sound radiates through 360°). Data that's helped us uncover additional parameters, to which we manufacture our loudspeakers for uncompromising consistency.

So when you're looking at loudspeakers, you might ask if they've gone through sand immersion, as well as the customary anechoic chamber.

Because our sand bath is one more thing it takes to guarantee really clean sound.



Melco Sales, Inc.  
3030 E. Victoria St.  
Compton, CA 90221

Gentlemen:

I, too, am very particular about speakers. Please send me a brochure and the name of my nearest dealer.

Name \_\_\_\_\_

Address \_\_\_\_\_

City \_\_\_\_\_

State \_\_\_\_\_ Zip \_\_\_\_\_

CIRCLE NO. 40 ON READER SERVICE CARD



HÅKAN HAGEGÅRD: youthful baritone



MIHÁLY SZÉKELY: imposing bass

liard poetry. This album purports to present these texts in their original musical settings. That is, of course, patently absurd, as the original notation consists of squiggles above the texts which are virtually undecipherable. Undaunted by such difficulties, however, René Clemencic offers a bold reconstruction. It is rather like giving a sculptor a tiny piece of the elbow of a lost statue from which he "reconstructs" a reclining nude on a cloud surrounded by myriad cupids and a lusty lover. This disc, then, is an evocation of medieval music that probably never existed. Nonetheless, Mr. Clemencic must be credited with imagination in his use of exotic ancient instruments, seductive percussion, and throaty voices declaiming in a style that ranges from singing to *Sprechstimme*. The results, if not historic, are intriguing. S.L.

#### RECORDING OF SPECIAL MERIT

**HÅKAN HAGEGÅRD: Opera Recital.** Leoncavallo: *Pagliacci: Prologue.* Gounod: *Faust: Avant de quitter ces lieux.* Verdi: *Rigoletto: Cortigiani, vil razza.* Don Carlos: *Per me giunto.* Werle: *Tintomara: Crispin's Monologue.* Tchaikovsky: *Pique Dame: Yeletsky's Aria.* Mozart: *Così Fan Tutte: Rivolgete a lui lo sguardo.* Wagner: *Tannhäuser: O, du mein holder Abendstern.* Gluck: *Iphigénie en Tauride: Dieux qui me poursuivez; Dieux protecteurs.* Håkan Hagegård (baritone); Royal Court Orchestra, Carlo Felice Cillario cond. CAPRICE CAP 1062 \$7.98 (from HNH Distributors Ltd., P.O. Box 222, Evanston, Ill. 60204).

Performance: **Good or better**  
Recording: **Good**

Håkan Hagegård of the Stockholm Royal Opera, the engaging Papageno in Ingmar Bergman's film version of *The Magic Flute*, is scheduled to make his U.S. opera debut as Rossini's Figaro in the forthcoming San Francisco Opera season. His record debut offers a varied and imaginative program, all selections in the original languages.

Hagegård is young and sounds youthful—which is not always advantageous, for he lacks the ideal vocal weight to make an effective Tonio and Rigoletto. Just the same, the overall impression is favorable. He is an intelligent and musically singer, at home in the various styles. He rarely forces his warm and malleable voice, sounds effortless in the top register, and knows how to spin an untroubled legato line. This latter attribute shines in an

exceptionally beautiful rendering of Wolfram's Song to the Evening Star. A combination of good singing and unusual repertoire makes this a worthy addition to a connoisseur's library. G.J.

#### RECORDING OF SPECIAL MERIT

**JOAN SUTHERLAND AND LUCIANO PAVAROTTI: Recital.** Donizetti: *Lucia di Lammermoor: Sulla tomba . . . Verranno a te.* L'Elisir d'Amore: *Chiedi all'aura lusinghiera.* La Fille du Régiment: *Depuis l'instant.* Verdi: *Rigoletto: È il sol dell'anima.* Bellini: *I Puritani: Fini . . . me lassa!* Joan Sutherland (soprano); Luciano Pavarotti (tenor); various orchestras, Richard Bonyngue cond. LONDON OS 26437 \$6.98.

Performance: **Meeting at the summit**  
Recording: **Excellent**

There is a feast of brilliant singing in this sequence of five scenes excerpted from recordings of that many complete operas. If this were a recital by lesser singers than Sutherland and Pavarotti, one could possibly raise minor objections to instances of unpolished orchestral execution, some rhythmic inaccuracies, or the far too inward Adina Joan Sutherland projects in the *Elisir* scene. Here, however, such reservations must be set aside in our enjoyment of this generous outpouring of lavish vocalism enriched by seasoned bel canto artistry. G.J.

**MIHÁLY SZÉKELY: Opera Recital.** Mozart: *Abduction from the Seraglio: Wer ein Liebchen hat gefunden; Ha! wie will ich triumphieren.* Don Giovanni: *Madamina. Die Zauberflöte: O Isis und Osiris; In diesen heiligen Hallen.* Haydn: *L'Infedeltà Delusa: Non v'e rimedio.* Rossini: *Il Barbiere di Siviglia: La calunnia.* Verdi: *Don Carlos: Ella giammai m'amo.* Simon Boccanegra: *Il lacerato spirito.* Borodin: *Prince Igor: How goes it, Prince?* R. Strauss: *Der Rosenkavalier: Finale, Act II.* Mihály Székely (bass); various orchestras; János Ferencsik, Lamberto Gardelli, Pál Varga, Vilmos Komor, other cond. HUNGAROTON SLPX 11444 \$6.98.

Performance: **Imposing**  
Recording: **Fairly good**

Mihály Székely's brief Metropolitan Opera association (1946-1949) ended when the stalwart basso returned to his native Hungary at the end of his last engagement and was not (Continued on page 132)





# If you haven't tried Skiing...you're missing the time of your life.

The time of your life can start anytime with skiing.

Maybe it begins when you take that first run and end it laughing. Or when you discover you and ski clothes were meant for each other.

It could start with a chair ride into a massive mountain world that leaves you breathless. Or when you realize you're in love with your skis and the places they take you.

If you're a late bloomer, the

time of your life could start when the ski day ends. And you share stories, hot drinks and a warm fire with friends.

Skiing. It's a lot more than snow. And it could be the time of your life, every time you go.

## SKIING

MAGAZINE

Ziff-Davis Publishing Company  
One Park Avenue  
New York, N.Y. 10016



**NIKKO** Circuit Breakers keep it happening.

16270 Raymer, Van Nuys, California 91406  
In Canada: Superior Electronics, Quebec, Canada



Who else but Nikko has a three-year parts and labor warranty?

Who cares? This Nikko 9095 receiver is the greatest.

The power amplifier delivers extended frequency response.

This capacitor keeps it happening with low distortion.

What are you doing after the party?

Listening to my Nikko 9095 all night long.

CIRCLE NO. 7 ON READER SERVICE CARD

allowed to leave again. He was free to accept foreign engagements after 1956, and in fact became Glyndebourne's resident Osmin, but by then his prime years were over. He died in 1963 after a brief illness at age sixty-two, active to the last.

There is a street named after him near the Budapest Opera House, of which he was a star member for nearly forty years. I grew up operatically in that house, and I saw Székely in all but two of the roles represented on this record—and in about thirty others. An imposing sight on stage, he knew how to make the most of his stature, whether for regal roles (King Philip, Khan Kontchak, Mephisto) or clowning ones (Osmin, Don Basilio). His spectacular strength was the *profondo* register. Where other bassos would be content to reach down into the low D-E-F region, Székely reveled in it, finding all kinds of sonorities and dynamic shadings down below. It was a velvety sound, unforgettable in its security and richness. (His low F in Sparafucile's exit line created a sensation at the Met.)

This Hungaroton release combines two 10-inch discs that have long been out of print. They were recorded in the early 1950's, and the sound, while acceptable, is not true stereo. All but two selections are sung in Hungarian, which will reduce the disc's sales appeal. And yet, Székely's Osmin, Fiesco, and Ochs will stand up to any—and that low register must be heard!

G.J.

**EDITH THALLAUG: Recital. Tchaikovsky: The Maid of Orleans; Adieu, forêts. Falla: La Vida Breve; Vivan los que rien. Verdi: Don Carlos; O don fatale. Rossini: The Barber of Seville; Una voce poco fa. Alnaes: Four Songs. Poulenc: Sanglots; Hôtel; La Reine de Coeur; C; Fêtes Galantes.** Edith Thallaug (mezzo-soprano); Jan Eyron (piano, in the songs); Stockholm Royal Court Orchestra, Carlo Felice Cillario cond. CAPRICE CAP 1107 \$7.98 (from HNH Distributors, P.O. Box 222, Evanston, Ill. 60204).

Performance: **Good to very good**  
Recording: **Good**

This Swedish import introduces us to Norwegian-born Edith Thallaug, a leading mezzo of the Stockholm Royal Opera since 1964. Aside from appearing in the principal mezzo roles there, she has also been heard in Moscow and at Glyndebourne. The liner notes (informative, multilingual, but clumsily organized) tell us that Miss Thallaug began as a song recitalist. Indeed, the song side of this debut recital is decidedly more successful than the operatic side. The four songs by Norway's Eyvind Alnaes (1872-1932), with their soaring Grieg-like Romantic utterance and sensuous colors, receive what seems to me an ideal interpretation. The Poulenc songs, which require a more subdued emotional approach, are also expertly done; in fact, they stand comparison with Régine Crespin's model versions of much the same repertoire (London OS 26043).

The operatic side also deserves praise for imagination and variety. But here Miss Thallaug's respectable achievements must be measured against such paragons as Arkhipova, Verrett, De Los Angeles, and Berganza, who have set extraordinary standards for these arias. Edith Thallaug sings them with a warm tone and good technique, but the renditions are in no sense extraordinary. The piano accompaniments are outstanding, but the orchestra could stand more refinement.

G.J.

Save Time Money Freight

Phillips GA 212  
semi-auto turntable . . . \$117.00

Discounts on all major brands of  
stereo equipment & accessories



Write for our price sheet  
and quote

**Michigan Audio Discounters, Ltd.**  
286 Wolverine Dr.  
Walled Lake, Mich. 48088  
313-474-4430

CIRCLE NO. 8 ON READER SERVICE CARD

## PLANNING TO MOVE?

Let us know 8 weeks in advance so that you won't miss a single issue of **STEREO REVIEW**. Attach old label where indicated and print new address in space provided. Also include your mailing label whenever you write concerning your subscription. It helps us serve you promptly.

Write to: P.O. Box 2771, Boulder, CO 80302, giving the following information:

Change address only     Extend my subscription

**ENTER NEW SUBSCRIPTION**

1 year \$7.98                       Payment enclosed (1 extra **BONUS** Issue)

Allow 30-60 days for delivery.                       Bill me later

AFFIX OLD LABEL

If you have no label handy, print OLD address here.

Name \_\_\_\_\_ please print

Address \_\_\_\_\_

City \_\_\_\_\_

State \_\_\_\_\_ Zip \_\_\_\_\_

NEW ADDRESS HERE    0287

Name \_\_\_\_\_ please print

Address \_\_\_\_\_

City \_\_\_\_\_

State \_\_\_\_\_ Zip \_\_\_\_\_

Additional postage per year: For Canada add \$2. For countries outside U.S. and Canada, add \$3—cash in U.S. currency only.



# Get yourself the big one!

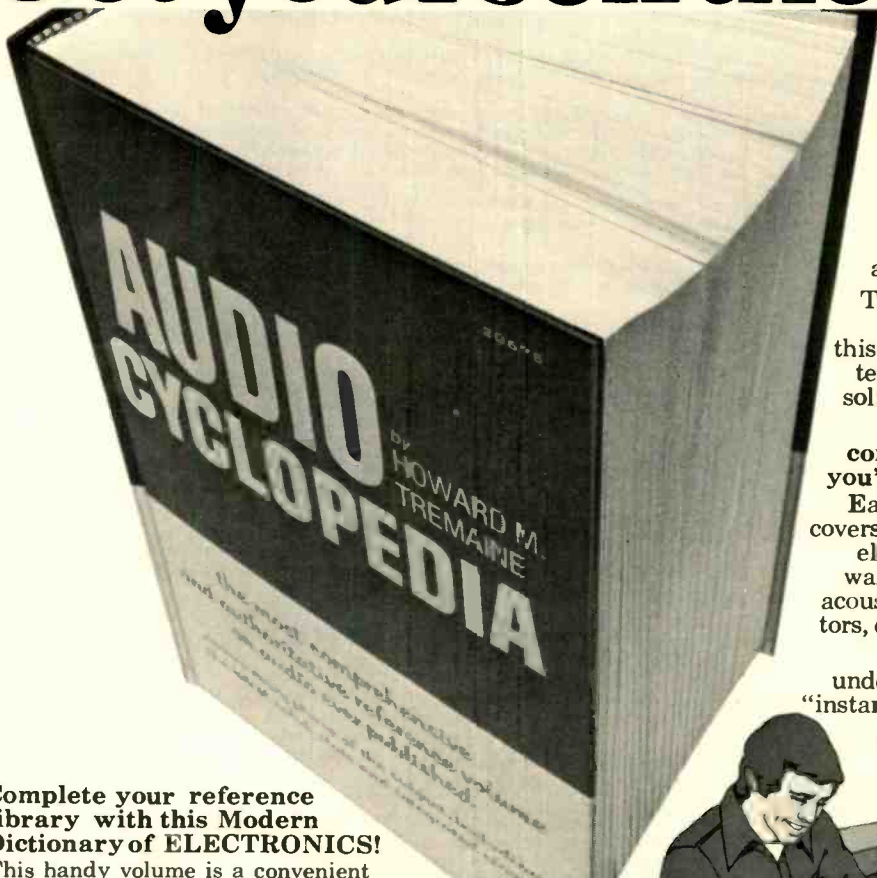

1,757 illustrated pages of detailed audio reference for the working technician... the student... the hi-fi buff!

Here's a comprehensive volume especially designed for the man or woman who has an understanding of electronics and an interest in audio technology.

The Audio Cyclopeda is the most authoritative reference book ever published on this subject. It includes every phase of audio technology—plus the latest information on solid-state and integrated circuits.

25 informative chapters... convenient format so you find what you're looking for... quickly... easily!

Each of the big, information-filled chapters covers in depth one of the major areas of audio electronics. You'll find anything you could want to know about everything—amplifiers, acoustics, meters, transformers, coils, transistors, diodes, filters... plus much, much more!

All information is presented in easy-to-understand, question-and-answer format. For "instant find," there's a unique index and reference system so the information you need is always at your fingertips.

Send for this complete reference library today for **\$34.00** just

## Complete your reference library with this Modern Dictionary of ELECTRONICS!

This handy volume is a convenient way for you to keep abreast of all the latest happenings in the ever-changing field of electronics. *Modern Dictionary of Electronics* gives you clear, concise definitions of 18,500 terms commonly in use today in the fields of communications, microelectronics, fiberoptics, semiconductors, reliability, computers and medical electronics.

It's yours for only **\$14.50**

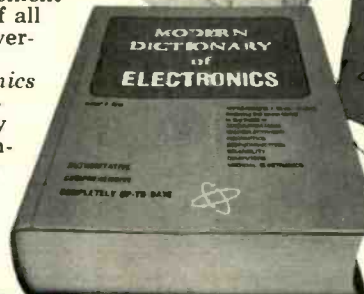

107R1

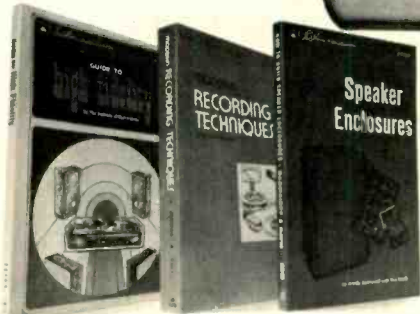

For more audio information... Take one or more of these handy paperback guides.

### Guide to High Fidelity

Here's a convenient guide to help you select a hi-fi system that not only meets your needs but fits your budget besides. If you ever plan to invest in any hi-fi equipment at all, this book is a *must*. Yours for a low **\$4.50**

### Modern Recording Techniques

Now, whether you're a would-be recording artist or an experienced engineer, you can find out all about the techniques that are being used today in pop recording. Learn how to cut your own records, and how to use equipment and controls creatively. Just **\$9.95**

### How To Build Speaker Enclosures

Here's *the* book to use if you want to build enclosures that give you realistic sound reproduction. Includes directions for enclosures to fit any application... any price range. Yours for a low **\$4.50**

## MAIL TODAY FOR 15-DAY FREE TRIAL

**YES** — send me the book(s) checked below to examine for 15 days free. If not completely satisfied, I may return my order and owe absolutely nothing. Otherwise, I will pay the amount on the invoice accompanying my book(s), including shipping and handling.

- Audio Cyclopeda** (20675) ..... \$34.00
- Modern Dictionary of Electronics** (20852) ..... \$14.50
- Modern Recording Techniques** (21037) . \$9.95
- Guide to High Fidelity** (21154) ..... \$4.50
- How to Build Speaker Enclosures** (20520) ..... \$4.50

Name \_\_\_\_\_ (PLEASE PRINT)

Address \_\_\_\_\_

City \_\_\_\_\_

State \_\_\_\_\_ Zip \_\_\_\_\_

Save shipping and handling costs. Full payment enclosed. (Plus sales tax, if any.)  
MAIL TO: Howard W. Sams & Co., Inc., 4300 W. 62nd Street  
Indianapolis, Indiana 46206

BD21



# STEREO REVIEW MARKET PLACE

**NON-DISPLAY CLASSIFIED: COMMERCIAL RATES:** For firms or individuals offering commercial products or services, \$1.90 per word (including name and address). Minimum order \$28.50. Payment must accompany copy except when ads are placed by accredited advertising agencies. Frequency discount: 5% for 6 months; 10% for 12 months paid in advance.

**READER RATE:** For individuals with a personal item to buy or sell. \$1.20 per word (including name and address). No minimum! Payment must accompany copy.

**DISPLAY CLASSIFIED:** One inch by one column, \$240.00. Two inches by one column, \$480.00. Column width 2-1/4". Advertiser to supply film positives. Please write or phone for frequency rates.

**GENERAL INFORMATION:** First word in all ads set in caps at no extra charge. All copy subject to publisher's approval. All advertisers using Post Office Boxes in their addresses MUST supply publisher with permanent address and telephone number before ad can be run. Ads are not acknowledged. They will appear in the first issue to go to press after closing date. Closing Date: 5th of the 2nd month preceding cover date (for example, March Issue closes January 5th). Send order and remittance to: Classified Advertising, STEREO REVIEW, One Park Avenue, New York, New York 10016, Attn. Hal Cymes.

## EQUIPMENT

WRITE for quotation on any HI-FI components: Sound Reproduction Inc., 460 Central Avenue, East Orange, N.J. 07018. 201-673-0600.

NO fair trade laws in D.C. Write for discount prices on your choice of components. District Sound, Inc., 2316 R.I. Ave. N.E., Wash., D.C. 20018. (202) 832-1900.

**Listen to TELEVISION IN STEREO**



The TE 200 TELEADAPTER EASILY CONNECTS TO ANY TV & STEREO SYSTEM. Using our exclusive anti-matrix circuit, teleadapters take a low impedance output from the television and delivers two HIGH IMPEDANCE CHANNELS OF SIMULATED STEREO, to drive any amplifier. Frequency response is maintained so you can hear the timbre of bells or booming bass sounds as it happens on TV. With service warranty and hookup instructions \$16.95 and guaranteed to make your TV 100% more enjoyable.

**OUR NEW TE 300 VHF UHF HI-FI TUNER IS NOW AVAILABLE.** A complete and self-contained 130 volt tuner, VHF UHF antenna connection. Recording and amp output jacks. Five year service warranty \$149.95 and from our factory.

**SEND CHECK MASTER CHARGE NO for TE 200 TE 300 or \$5.00 for C.O.D. TO RHODES NATIONAL CO DEPT SR**

P.O. BOX 817 HENDERSONVILLE, TENNESSEE 37075

NAME \_\_\_\_\_

ADDRESS \_\_\_\_\_

CITY \_\_\_\_\_ STATE \_\_\_\_\_ ZIP \_\_\_\_\_

**DIAMOND NEEDLES and STEREO CARTRIDGES at DISCOUNT PRICES for SHURE, PICKERING, STANTON, EMPIRE, GRADO and ADC.** Send for free catalog. LYLE CARTRIDGES, Dept. S, Box 69, Kensington Station, Brooklyn, New York 11218.

**ABSOLUTELY THE LOWEST PRICES** on name brand stereo components. Send for our free catalog to BOSTON AUDIO EXCHANGE, 472 Massachusetts Ave., Cambridge, Mass. 02139.

**DON'T PAY** the high mail order prices. Thieves Warehouse of Tampa, 1531 South Dale Mabry, Tampa, Florida 33609.

**CANADIAN Discount Catalog.** Name brand stereo and 4-channel gear. Etco-3, 521 5th Ave, NYC 10017.

**DON'T PAY** the high mail order prices. Thieves Warehouse of Sarasota, 6564 Gateway Avenue, Sarasota, Florida 33581.

**DON'T PAY** the high mail order prices. Thieves Warehouse of Ft. Walton Beach, 652-D Beal Parkway, N.W., Ft. Walton Beach, Florida 32548.

**CROSSOVERS**—Custom designed; fully tested; guaranteed quality. Free Brochure. Write: Crossovers, Box 458, Placentia, CA 92670.

**LOWEST PRICES** on many brands of stereo components — 4 day delivery, write for many day quotes. University Stereo Cooperative, 57 E. Ridgewood Avenue, Ridgewood, N.J. 07450.

**DON'T PAY** the high mail order prices. Thieves Warehouse of Mobile, 1770 Bellline Highway, Mobile, Alabama 36609.

**STEREO NEEDLES and CARTRIDGES**—ADC, Audio Technica, B&O, Emplre, Grado, Micro Acoustics, Pickering, Ortofon, Shure, Sonus, Stanton, Supex, BSR, G.E., RCA, Sony, Panasonic and others. For FREE CATALOG, write: NEEDLE IN A HAYSTACK, INC., P.O. Box 17436, Washington, D. C. 20041.

**DON'T PAY** the high mail order prices. Thieves Warehouse of Pensacola, 3731 Navy Boulevard, Pensacola, Florida 32507.

**DON'T PAY** the high mail order prices. Thieves Warehouse of Atlanta, 3164 Peachtree Road, N.E., Atlanta, Georgia 30303.

**DON'T PAY** the high mail order prices. Thieves Warehouse of Atlanta, 1030-3 Cherokee Road, Smyrna, Georgia 30080.

**DON'T PAY** the high mail order prices. Thieves Warehouse of Atlanta, 4166 Buford Highway, N.E., Atlanta, Georgia 30345.

**DON'T PAY** the high mail order prices. Thieves Warehouse of Atlanta, 4162 Jonesboro Road, Zayre Center, Forest Park, Georgia 30050.

**DON'T PAY** the high mail order prices. Thieves Warehouse of North Tampa, 1441 East Fletcher Avenue, Tampa, Florida 33612.

**DON'T PAY** the high mail order prices. Thieves Warehouse of Atlanta, 2769 Lakewood Avenue, S.W., Atlanta, Georgia 30315.

**DON'T PAY** the high mail order prices. Thieves Warehouse of Montgomery, 3286 Norman Bridge Road, Montgomery, Alabama 36105.

**DON'T PAY** the high mail order prices. Thieves Warehouse of St. Petersburg, 9151 Park Boulevard, North Largo, Florida 33037.

**SAVE ON SACRED COWS**—Bose, SAE, JBL, Thorens, Phillips. Over 50 top brands. Write for quotes. SOUTHBOUND SOUND, P.O. Box 52508, Atlanta, Georgia 30355.

**DON'T PAY** the high mail order prices. Thieves Warehouse of Panama City, 5220 West Highway 98, Suite D, Panama City, Florida 32401.

**DON'T PAY** the high mail order prices. Thieves Warehouse of Atlanta No. 6, Belvedere Plaza Shopping Center, 1203 Columbia Drive, Decatur, Georgia 30032.

**DON'T PAY** the high mail order prices. Thieves Warehouse of Knoxville, 5710 Kingston Pike, Knoxville, Tennessee 37919.

**DON'T PAY** the high mail order prices. Thieves Warehouse of Birmingham, 123 Roebuck Plaza Drive, Birmingham, Alabama 35206.

**DON'T PAY** the high mail order prices. Thieves Warehouse of Orlando, 1915 East Colonial Drive, Orlando, Florida 32803.

**DON'T PAY** the high mail order prices. Thieves Warehouse of Miami, 1756 S. W. 8th Street, No. 201, Miami, Florida 33135.

**DON'T PAY** the high mail order prices. Thieves Warehouse of Jacksonville, 1239 Arlington Road & Lone Star, Jacksonville, Florida 32211.

**"DUBIE CD-5 RECORDING SYSTEM IS A MUST FOR THE SERIOUS HOBBYIST"** or anyone owning two or more recorders. Dubie CD-5 allows you to be more creative in multiple taping, mixing, dubbing and editing. Available at Olson and Team Electronics stores for only \$59.95. Or write Dubie, Rt. 4, Box 98, Stigler, Okla. 74462.

**DON'T PAY** the high mail order prices. Thieves Warehouse of Jacksonville, 6078 Old St. Augustine Road, Jacksonville, Florida 32217.

**DON'T PAY** the high mail order prices. Thieves Warehouse of Clearwater, 1502 A Gulf To Bay Boulevard, Clearwater, Florida 33515.

**DON'T PAY** the high mail order prices. Thieves Warehouse of Birmingham, 103 South 18th Street, Birmingham, Alabama 35233.

**DON'T PAY** the high mail order prices. Thieves Warehouse of Mobile/Village Square, 301 South Craft Highway, Mobile, Alabama 36610.

**SAVE UP TO 69%** on over 100 top brand audio components from Carston Studios, New England's Audio Supermarket, one of the oldest mail order firms (Est. 1952) and certainly one of the most reliable. All orders shipped from stocked warehouse. Send for price quote and price list. Carston Studios, Old Brookfield Rd., Danbury, Conn. 06810.

**PROFESSIONAL HI-FI COURSE**—Instructors include Len Feldman, Julian Hirsch, Larry Klein, and Larry Zide. Home study course also available. Send \$1.00 for audio primer and full information on joining Society Audio Consultants (SAC), 49 E. 34th St., New York City 10016.

**PERFECTIONISTS PREFER DYNAKITS.** Before Purchase You Owe Yourself Our Quote. Mainline Ilr, 971 Fronheiser, Johnstown, PA 15902.

**NO GIMMICK!** Buy new components at 50% discounts using highly innovative purchasing methods. Fully legal. Request FREE information packet. Stereo Cost Cutters, Box 8014, Canton, Ohio 44711.

**FORMULA 4 PROFESSIONAL DAMPED TONE ARM** available through U.S. Audio Dealers. Literature \$1 Bill. Formula 4, 15 Heather Walk, Edgware, Middlesex, England.

**NO SACRED COWS.** Top Discounts on BOSE, Infinity, Hegeman, ADS, Dual, Dyna, Sansui, Sony, Marantz, Yamaha, SAE, Klipsch, B&O, Teac, McIntosh, Citation, others. Seriously Audio Sales, 2126 Faulkner, Atlanta, GA 30324. (404) 325-7353.

**DON'T PAY** the high mail order prices. Thieves Warehouse of Ft. Lauderdale, 3347 North Federal Highway, Ft. Lauderdale, Florida 33306.

**DON'T PAY** the high mail order prices. Thieves Warehouse of Pensacola No. 2, 3820 North 9th Avenue, Pensacola, Florida 32503.

**DON'T PAY** the high mail order prices. Thieves Warehouse of Hialeah, 6741 West 4th Avenue, Hialeah, Florida 33012.

**DON'T PAY** the high mail order prices. Thieves Warehouse of North Miami Beach, 1807 N.E. 164th Street, Miami Beach, Florida 33162.

**DON'T PAY** the high mail order prices. Thieves Warehouse of Tallahassee, 1119 Apalachee Parkway, Parkway Shopping Center, Tallahassee, Florida 32301.

**DON'T PAY** the high mail order prices. Thieves Warehouse of Plantation, 231 South State Road 7, Plantation, Florida 33317.

**SPEAKER Enclosures with Grill Boards—Raw Speakers—Details SASE.** Stereo Workbench, 214-A Montauk, New London, Conn. 06320.

**DYNACO Stereo 120** walnut cabinets, with VU meters. Literature? Geometrics, Box 612, Mexico, MO 65265.

**FANTASTIC DISCOUNTS** on Hi-Fi Components. Write for FREE catalog! Gochènou's Sound House, P.O. Box 86, Eden, N.C. 27288.

**DON'T PAY** the high mail order prices. Thieves Warehouse of Hollywood, 5719 Hollywood Boulevard, Hollywood, Florida 33021.

**DON'T PAY** the high mail order prices. Thieves Warehouse of Ridgewood, 25 Godwin Avenue, Ridgewood, New Jersey 07450.

**DON'T PAY** the high mail order prices. Thieves Warehouse of Gainesville, 434 N.W. 13th Street, Gainesville, Florida 32601.

**DON'T PAY** the high mail order prices. Thieves Warehouse of Fair Lawn, 34-09 Broadway, Fair Lawn, New Jersey 07410.

**DON'T PAY** the high mail order prices. Thieves Warehouse of Dumont, 78 Washington Avenue, Dumont, New Jersey 07628.

**DON'T PAY** the high mail order prices. Thieves Warehouse of Boca Raton, 499 N.E. 20th Street, Boca Raton, Florida 33431.

**DON'T PAY** the high mail order prices. Thieves Warehouse of Atlanta No. 7, 215 Copeland Road, Atlanta, Georgia 30342.

**DON'T PAY** the high mail order prices. Thieves Warehouse of Jacksonville No. 3, Cedar Hills Shopping Center, 3716 Blanding Blvd., Jacksonville, Florida 32210.

**ELEVEN Month Old Soundcraftsmen RP2212** Equalizer. Excellent, \$210.00. Ed Kirtley, (502) 781-8597, 843-8345.

**DYNAKITS, DYNASPEAKERS, SHURE, S.M.E.,** Lowest Prices, Assembled Kits, Perfectionist Modifications, Stereo 400 — \$350, A-25's — \$103/pair. Underground HiFi, 324A Broadwater Road, Arnold, MD 21012. (301) 647-0919.

## BUILD YOUR OWN SPEAKERS AND SAVE UP TO 50%



You can assemble your own high quality, multi-element stereo speakers in a few hours and save up to half the cost of comparable speakers. Send for our free 32-page catalogue of speaker kits, raw speakers and accessories.

**SPEAKERLAB**  
Dept. SR-7, 5500-35th N.E.  
Seattle, Washington 98105

**UNUSUAL Recorders & other 'Special' Equipment.** FREE Catalog: Garrison, L-99, 42-55 Golden Street, Flushing, N.Y. 11354.

**FRIED LOUDSPEAKERS (formerly IMF)** — including the Incredible Model H. Hear them at Underground HiFi Sales, 324a Broadwater Road, Arnold, MD 21012. (301) 647-0919.

## TAPE AND RECORDERS

**RENT 4-track open reel tapes**—free brochure. Stereo-Parti, P.O. Box 7, Fulton, California 95401.

**THRIFTIEST "Live"**—Operatic, Symphonic—Tapes & Cassettes, P.O. Box 1101, Woodhaven, New York 11421.

**OPERA TAPES**—Open Reel and Cassettes—Historical performances of past 40 years. Unbelievable treasures and rarities. Also LP records. Ed Rosen, 66-33 Saunders St., Rego Park, N.Y. 11374.

**SCOTCH new low noise tape 10-1/2"** metal 3600', 5 for \$35.00. Reels, POB 88338, Dunwoody, GA 30338.

**GOLDEN AGE RADIO**—your best source for radio tapes. Box 25215-T, Portland, Oregon 97225.

**OLD RADIO PROGRAMS** on tape. Thousands available. Six hours, \$8.00. Catalogue, 50 cents. Nostalgic Radio, Box 29-B, Peoria, IL 61601.



1930-1962 RADIO PROGRAMS. Reels, \$1.00 hour! Cassettes, \$1.00 show!... Mammoth Catalog, \$1.25. AM Treasures, Box 192SR, Babylon, New York 11702.

### CASSETTES / LABELS

Plain white cassette labels, Norelco cassette cleaners, famous brand cassettes. Send for open reel and cassette discount catalog.

	1-9	10-99	100	1000	10M
Cassette Labels		02	015		01.006
Norelco Cassette Cleaner	65	60	55	50	45

Plus Postage by Weight and Zone Minimum Order \$5.00

WE'VE GOT THE "SPIRIT", THE PRICES AND THE ADDRESS TO PROVE IT  
Saxitone's Bicentennial Tape Shoppe  
1776 Columbia Road, N.W., Washington, D.C. 20009



YESTERDAY'S RADIO PROGRAMS on Tape. Catalog \$1.00 refundable first order. REEL-CASSETTE. ADVENTURES, Box 4822-S, Inglewood, California 90302.

OPERA CLASSICAL MUSIC Open Reels. Rare mostly live free catalogue. K. Lohan Tapes, P.O. 298, Mastic Beach, N.Y. 11951.

TDK, BASF, Memorex, Maxell, cassettes, reels, 8-tracks. Lowest prices, new guaranteed. S&S Audio, P.O. Box 56039, Harwood Heights, Ill. 60656.

OLD RADIO PROGRAMS. Two Catalogs \$1.50, Cassettes \$1.59 hour, Reels four hours \$5.00. Nostalgia Sounds, 4151 Florence, Santa Susana, California 93063.

40,000 OLD RADIO SHOWS on Tape. Jazz/Big Band remotes, Country/Western, discographies, anthologies, chronologies. Send \$2 for huge catalog (refundable). McCoy's Recording, Box 1069S, Richland, Washington 99352.

SCOTCH RECORDING TAPE, exclusively, all new, lowest prices. TAPE CENTER, Box 4305, Washington, D.C. 20012.

PROFESSIONAL Scotch Brand, Dynarange series, low noise tape. Silicone lubricated polyester backing. 1200 ft. 1.5 mil on 7 inch reels. Supply limited. \$3.00. Crosby Enterprises, Box 976, Newbury Park, Calif. 91320.

JAZZ. Popular, Country Oldies! Rare collections on cassette. Free Lists! Tapes, Box 132 Little Falls, New York 13365.

BASF TAPE: New Stock. 40-55% Savings! Cassettes, Reels, GUARANTEED! Write Larry or Mike, INTERGALACTIC, 1047 Kirts, No. 134, Troy, Michigan 48084.

TAPES Classical singers, conductors, instrumentalists in live performance, opera. Emphasis on Superior sound. Open Reel only. Good Sound Associates, P.O. Box 489, Planetarium Station, New York, N.Y. 10024.

ORIGINAL OLDTIME RADIO broadcasts on quality tapes. Free catalogue. Carl R. Froelich, Route One, New Freedom, Pennsylvania 17349.

RARE BROADWAY Shows on tape including private and live recordings. Catalog \$1.00. David Hummel, 2820 South Memorial Highway, Traverse City, Michigan 49684.

### RECORDS

SHOW ALBUMS. Rare, Out-of-Print LP's. 52 pg. list. 50 cents. Broadway/Hollywood Recordings, Georgetown, Conn. 06829.

PROTECT your LP'S—Poly sleeves for jackets 8 cents; Round Bottom Poly Inner sleeves 7 cents; Poly lined paper 15 cents; white jackets 35 cents. Postage \$1.50. Record House, Hillburn, N.Y. 10931.

THOUSANDS like new LP's and prerecorded tapes. Catalogue \$1.50. Records. Hillburn, New York 10931.

COLLECTORS' Soundtracks. Mint. List 50 cents (refundable). Jemm's, P.O. Box 157, Glenview, Ill. 60025.

SOUNDTRACK RECORD ALBUMS—Mail Auction—Free List. Whalton, 2321D Hill, Redondo Beach, Calif. 90278.

QUADRAPHONIC RECORDS AND TAPES—World's largest selection — all labels, over 1000 titles — at discount prices! For your free illustrated quad catalog, write: SOUND CONCEPTS, Box 654-A, Peoria, IL 61601.

RECORD RATERS WANTED! Anyone qualifies. We ship you nationally released LP's to-rate. We pay postage and handling. You pay nothing for LP's. All you pay is small membership fee. Applicants accepted "first come basis." Write: E.A.R.S., Inc., Dept. SR, Box 10245, 5221 W. Center Street, Milwaukee, WI 53210.

OLDER JAZZ, Swing, LP's — lowest prices. Monthly lists. Soundtracks, Auctions! Records, Box 1138R, Whittier, Calif. 90609.

SOUNDTRACKS, ORIGINAL CASTS, PERSONALITIES — Free Newsletter/Auction. RTSR. 3700 Plaza, F211, Santa Ana, California 92704.

CASH for unwanted LP's and pre-recorded reel-to-reel tapes. TAPES, Hillburn PO, New York 10931.

HARD-TO-FIND Soundtracks, Shows, Nostalgia. Superb Imported, Domestic selections. Catalog \$1.00 (refundable). List Communications, P.O. Box 916-x, NYC 10023.

OLDIES oldies, 45rpm. Also current hits. Free Catalog. Corry's Record Shop, Box 166HG, Mason, Ohio 45040.

RARE RECORDS, 45's, 78's, 33's, Soundtracks, Original, Cast Personalities, all kinds, mostly mint, 5,000 record lists, \$2.00. Refundable. Dealers Welcomed. Gurley, Box A72, Princeton, N.C. 27569.

SELECT like-new Classical LP's. List. \$1.00 (refundable). Recycled Records, 5722 N. 20th St., Arlington, VA 22205.

CASH paid for quality used Classical LP's. Send List. Snead, 5722 N. 20th St., Arlington, VA 22205.

WHOLESALE ALBUMS—TAPES! Outstanding prices! All Titles! Save 50%-90%! Send stamp: MusiComp, 1611 Capitol, Des Moines, IA 50316.

OPERAS, Operettas, Operatic Recitals, Lieder, Chansons Scandinavian, Spanish vocals, piano, etc. Many rare items from private collection. SIERLE, 155 W. 95 St., NYC 10025.

SEARCHING? LP'S! DISContinued Records, 216 North Rose, Burbank, California 91505.

SHOW/MOVIE RECORDS. Collector selling cut-outs in excellent condition. Send for list. Box 423, Slukey, New York 13838



**Louisville Orchestra**  
First Edition Records

Now in Retail Stores! For Catalogue, write:

**The LOUISVILLE ORCHESTRA**  
333 W. Broadway, Louisville, KY 40202

FREE RECORD CATALOG—Pop, classics, jazz, shows, opera. Wide selection, low prices, prompt service. Write for latest catalog. Rose Records, 214 S. Wabash, Chicago, Ill. 60604.

### TUBES

TV and Radio Tubes 36 cents. Free 48 page color catalog. Cornell, 4215-H University, San Diego, California 92105.

### PLANS AND KITS

EXCLUSIVE U.S. Made, CBS Licensed SQ Decoder Kit. Full logic, wave matching and/or variable blend. SQ-1 (fixed blend), \$40.00. SQ-3 (variable blend), \$55.00. Knobs, cases not supplied. Regulated power supply available only with the decoder. \$5.00. Postpaid USA, Canada. Information available. Photolume Corporation, Dept. S-59, 118 East 28 Street, New York, N.Y. 10016.

TRON ARM MODIFICATION KIT. Improves transient response, reduces resonance. Eliminates high end ringing. Fits all. \$3.00 pp. G.K. Labs. 1138C Regina, Balto., MD 21227.

### INSTRUCTION

LEARN Electronics Organ Servicing at home. All makes, including transistors. Experimental kit—trouble-shooting. Accredited NHSC, Free Booklet. Niles Bryant School, 3631 Stockton, Dept. A. Sacramento, Calif. 95820.

RADIO BROADCASTING: High paying jobs, free records-tapes-equipment. Start your own station! Free booklet, "Radio!". Box 5516-RI, Walnut Creek, CA 94596.

### MUSICAL INSTRUMENTS

UP TO 60% DISCOUNT. Name brand instruments Catalog. Freeport Music, 114 Q. Mahan St., W. Babylon, N.Y. 11704.

### WANTED

GOLD, silver, platinum, mercury wanted. Highest prices paid by refinery. Ores assayed. Free circular. Mercury Terminal, Norwood, MA 02062.

### HYPNOTISM

FREE Hypnotism, Self-Hypnosis, Sleep Learning Catalog! Drawer H400. Ruidoso, New Mexico 88345.

SLEEP LEARNING: Hypnotic Method. 92% effective. Details free. ASR Foundation, Box 23429 EG, Fort Lauderdale, Florida 33307.

AMAZING self-hypnosis record releases fantastic mental power. Instant results! Free trial. Write: Forum (AA9), 333 North Michigan, Chicago 60601.

### RUBBER STAMPS

RUBBER address stamps. Free catalog. 45 type styles. Jackson's, Dept. K, Brownsville Rd., Mt. Vernon, Ill. 62864.

### SERVICES

PREWRITTEN RESEARCH, \$1.00 per page. Computerized Catalog, \$1.00. Academic/Business Writing. Professional. Confidential. Information Clearinghouse, Box 4391, Washington, D. C. 20012 (202) 723-1715.

### BUSINESS OPPORTUNITIES

I MADE \$40,000.00 Year by mailorder! Helped others make money! Free Proof. Torrey, Box 318-NN, Ypsilanti, Michigan 48197.

MAILORDER MILLIONAIRE helps beginners make \$500 weekly. Free report reveals secret plan! Executive (1K9), 333 North Michigan, Chicago 60601.

HI-FI ENTHUSIASTS WANTED!! Earn more than just spare money in your spare time. We need campus representatives to sell name brand stereo components at discount prices in your area. High commission, no investment required. Serious inquiries only, please. Contact: Alan Weisberg, K&L Sound Services Co., 75 No. Beacon St., Watertown, Mass. 02172. (617) 787-4073.

GET RICH with Secret Law that smashes debts and brings you \$500 to \$5 Million cash. Free report! Credit 4K9, 333 North Michigan, Chicago 60601.

FREE SECRET BOOK "2042 UNIQUE, Proven Enterprises." Fabulous "Little Knowns." Work Home! Haylings-B. Carlsbad, Calif. 92008.

STEREO REPRESENTATIVES NEEDED!!! Sell 100 brands!! Lowest Possible Prices!! Krasco, 623 Campbell Ave., West Haven, Conn. 06516.

COLLEGE STUDENTS—SOME CAMPUS REPS earn their entire tuition costs helping other students select high fidelity equipment. It's not hard. If you know enough about high fidelity components to mount a cartridge and hook up a pair of speakers, we'll supply the material. Nothing to Invest. The more you sell, the more you make. And it's fun. Call International Hi Fi, Baltimore, MD 21206 and ask for Mike Krizman (301) 488-9600 daily between 11 A.M. and 7 P.M.

CAMPUS REPRESENTATIVES Wanted to sell name brand hi-fi components at discount prices in spare time. Write: Sound Savings, 18506 N.E. 5th Ave., N. Miami Beach, Fla. 33179. (305) 652-7610.

\$2,000 MONTHLY by mailorder...evenings. Free Details. Alex C. Enterprises, 230 Rio Verde St., Daly City, CA 94014.

### EMPLOYMENT INFORMATION

AUSTRALIA—NEW ZEALAND WANT YOU!!! 50,000 Jobs! Paid Transportation! Latest Information and Forms. \$1.00. Autco, Box 3623-SR, Long Beach, California 90803.

OVERSEAS JOBS—Now Hiring, 103 Countries. All Occupations. High Pay, Free Transportation, Tax Benefits. Latest Computerized Reports—\$2.00. TRANSWORLD International Airport, Box 90802-SR, Los Angeles, California 90009.

### MOVIE FILMS

16mm SOUND Features, Shorts, New, Used for Sale. Free Catalog. National Cinema, 333 W. 57th St., N.Y., N.Y. 10019.

### EDUCATIONAL OPPORTUNITIES

LEARN WHILE ASLEEP. Hypnotize! Astonishing details, strange catalog free! Autosuggestion, Box 24-ZD, Olympia, Washington 98597.

### PUBLICATIONS

THE AUDIO AMATEUR—A quarterly publication for the serious audio constructor. Free prospectus. The Audio Amateur, Box 176Z, Peterborough, N.H. 03458.

STOKOWSKI DISCOGRAPHY 1917-1976 in production 175 pages. Order now \$6. Robert Gatewood, 108 Scotta, Warren, AR 71671.

BACK ISSUE MAGAZINES. 1890 to 1976. Free list. Send stamped envelope to Everybody's Bookshelf, Dept. ST, 317 West 6th, Los Angeles, CA 90014.

### PERSONALS

MAKE FRIENDS WORLDWIDE through international correspondence. Illustrated brochure free. Hermes-Verlag, Box 110660/Z, D-1000 Berlin 11, Germany.

### MISCELLANEOUS

WINEMAKERS. Free Illustrated catalog of yeasts, equipment. Semplex, Box 12276Q, Minneapolis, Minn. 55412.

STOP—Don't junk that television set! ASE manufactures the world's most complete line of television picture tubes. Over 2200 types. Two year factory warranty. Lowest prices. Send 50 cents. Allied Sales, Dept. 42, Pimento, IN 47866. Telephone: (812) 495-6555.



## Introducing the Staff . . .

When a personal opinion, particularly a publicly expressed one, grates on our nerves, one of the commoner responses is to ask, either under or at the top of our voices, just who that so-and-so thinks he or she is. The question is asked of STEREO REVIEW with respect to our regular contributors and staff many times each month, and in this column we endeavor to supply the answers. —Ed.



Contributing Editor

# Stoddard Lincoln

WHEN asked what his profession is, Stoddard Lincoln simply says that he is a musician. When asked what he *does* as a musician, he will usually (if caught in a rare serious mood) launch into a list of activities that resembles Leporello's Catalogue Aria. To boil it all down, he is a performer, a teacher, a musicologist (or *music historian*, as he prefers to be called), and a writer. When asked how he keeps it all up and together, he says he doesn't. It's an illusion.

As for how he got involved in music in the first place, Lincoln claims that it happened in high school as a result of sheer competitiveness. "When my brothers and sister were playing duets, I simply had to get in on the act."

Later came the war, the army, and an incident in which he was the unsung hero. "Slated to take part in the Normandy invasion, I managed to come down with chicken pox and caused the entire camp to be quarantined. Germ warfare being internationally outlawed, we could not join the festivities. Unfortunately, I recovered in time to make the Battle of the Bulge."

After World War II, Lincoln found himself at Juilliard studying piano first with Sascha Gorodnitzki and then with Muriel Kerr. This gained him a bachelor's degree, and he shifted to harpsichord after being knocked out by a Wanda Landowska recital, studying with both Fernando Valenti and Ralph Kirkpatrick.

Becoming interested in Restoration theater music, he wrote an article for *Musical Quarterly* which led to a scholarship at Columbia University. "Life was rough then. Although I had a scholarship, I had to play concerts to earn a living. Musicologists considered me a gypsy because I performed, and performers thought I had betrayed the cause by studying musicology." After getting a master's and all the points for the doctorate, Lincoln felt the urge to go to England, so he applied for and landed a Fulbright scholarship to Oxford. "I went there with the intention of giving up performance entirely, but the first thing that happened was that I was asked to give a concert; I was soon playing more than I ever had before. But I still had time for my research and ended up, by some quirk, with a Ph.D.<sup>2</sup> in English and musicology." While in England, Lincoln discovered the first full-length English opera (*Semele*, music by John Eccles, text by William Congreve) and gave it its world premiere. Returning to the States, he continued his concert activities and also accepted an appointment at Brooklyn College, where he continues on the music faculty as full professor.

While in England, Lincoln became interested in early pianos and acquired an 1827 Broadwood. He was also lucky enough, while doing research at California's Huntington Library, to find a reproduction of Mozart's piano. This led to concerts at Lincoln Center where he gave a series using the harpsichord, the "Mozart" piano, and the Broadwood, "an event from which I have really never recovered (nor has the audience, I'm sure)."

As for becoming a critic, "It all started when I was on sabbatical in London. I was working at the British Museum and house-sitting for Andrew Porter [now music critic with the *New Yorker*]. It seemed that I inherited some of his more modest critical duties with the London *Financial Times*, and it was this that ultimately landed me at STEREO REVIEW's front door. SR's editors liked what I had written for the *Financial Times*, and here I am."

Besides teaching, writing, and performing, Lincoln spends much of his free time at various research libraries here and abroad, working on a catalog of Restoration theater music. And in between all that, he edits rare keyboard music.

As for hobbies, there's not much time, but he enjoys cooking "tremendously," and often while waiting for something to braise, simmer, or rise manages to whip off a row or two of bargello. "Beyond that, when I have a review to write, I practice. When I have a concert, I write. I always take on more than I can manage, but somehow it all gets done. That and a few tickets to the opera, ballet, or theater and I'm a happy man." —*Drummond McInnis*

## STEREO REVIEW ADVERTISERS' INDEX SEPTEMBER 1976

READER SERVICE NO.	ADVERTISER	PAGE NUMBER
12	ADC, BSR Division	51
	Advent Corporation	12, 13
	Akai America	55
10	Allison Acoustics	113
11	Angel Records	118
13	Audio Expo	104
	Audio Technica, U.S., Inc.	129
14	Bang & Olufsen of America —Cartridge Division	101
15	Bang & Olufsen of America —Turntable Division	53
	Bose Corporation	47
	Brown & Williamson	133
	Component Discounters	104
17	Crown International	95
18	dbx, Inc.	97
2	Discount Music Club	6
22	Discount Sound	94
	Discwasher	5
	Dixie HiFidelity	104
23	Dokorder	93
50	Dual	20, 21, 137
24	Eastman Kodak	123
26, 27	Electro-Voice	10, 11
21, 99	Empire Scientific Corporation	2, 60
	Harman Kardon	62, 63
25	Heath Company	101
62	Henry's Camera	104
28	Hi Fi Buys	107
29	Illinois Audio	107
30	International Hi Fi Distributors	127
31	Jensen Sound Lab	103
32	JVC America	99
19	Kenwood Electronics	19
33	KLH Research & Development	45
34	Klipsch & Associates	125
20	Koss Electronics	Cover 4
36	Lafayette Radio Electronics	121
	Lux Audio of America	111
6	3 M Company	61
	Marantz	138 & Cover 3
37	Maxell	37
39	McIntosh Lab	127
3	Memorex	7
40	MGA	130
8	Michigan Audio Discounters	132
42	Micro-Acoustics Corporation	112
43	Miida	115
44	Motorola, Inc.	49
45	Netronics Research & Development	122
7	Nikko Electric of America	132
46	Olympus Corporation of America	98
4	Phase Linear	16, 17
41	Pickering & Company	73
47	Pioneer Electronics	15
48	Radio Shack	43
	R. J. Reynolds, Winston	23
49	RTR Industries	96
51	S.A.E.	109
	Howard Sams	133
52	Sansui Electronics Corporation	26-29
53	Sherwood	83
54	Shure Brothers	84
35	Sony Corporation of America	32, 33
55	Sound Reproduction	127
56	Soundcraftsmen	119
57	Spectro Acoustics	30
58	Stereo Corporation of America	107
59	Suporex	31
	Teac Corporation	8, 9, 58, 59
38	Technics by Panasonic	24
60	Top Discount Audio	107
	Uher of America	124
50	United Audio	20, 21, 137
5	U.S. Navy	57
1	U.S. Pioneer	Cover 2, 1
61	Yamaha International Corporation	89



With the Dual Auto/Reverse Deck, a C-90 cassette will play back for ninety uninterrupted minutes. You don't have to remove and flip the cassette for the second forty-five minutes unless you want to. Any cassette can also be set to play indefinitely until you shut it off. What's more, the Auto/Reverse Deck records in both directions. Mechanics and electronics reverse at the touch of a button. The record/playback head never moves, so there is no problem of misalignment, the bane of previous reversing decks.

## Now there are two cassette decks with Dual precision.

With the new Dual C919, you can take an especially creative approach to recording. Tape, disc or radio can be mixed with live material recorded via microphones.

Separate microphone and line-input level controls for each channel let you intermix all four inputs. There are also separate level controls for each headphone channel. Output level controls match the tape deck output to other program sources; there's no need to readjust volume settings when switching programs.

So much for convenience and versatility. What about performance? The C919 is too new for test reports, but it has the same motor, tape head and electronics as the Auto/Reverse Deck, which has been reviewed, such as in *Audio* magazine:

"...another outstanding example of the great strides in cassette deck technology in recent years. Wow and flutter was indeed extremely low, measuring 0.065% (WRMS)...total harmonic distortion during playback (at 1 kHz) of 1.4%, well below the 2.0% claimed by the manufacturer...The fast-wind mechanism...is about the fastest and smoothest we have encountered...We also checked a couple of C-120 cassettes and found that the Dual deck was able to handle them smoothly....A distinct feeling of quality...seems well worth the price!"

That's the caliber of performance you can expect with either Dual deck. All you have to decide is how much convenience and versatility you also want.

**United Audio Products**

120 So. Columbus Ave., Mt. Vernon, N.Y. 10553

Exclusive U.S. Distribution Agency for Dual

**Dual**

The Dual Auto/Reverse.



The Dual C919.



Additional features of the Dual cassette decks: Common to both models: Viscous-damped cassette eject, intermode switching, 60 second rewind for C-60 cassette, Dolby noise reduction system, professional VU-meter ballistics. Auto/Reverse only: Automatic bias switching, switchable ALC, Dolby oscillator and calibrators. Less than \$500.

C919 only: Memory stop, FM Dolby, three-way bias and equalization. Less than \$450.

\*Dolby is a trademark of Dolby Laboratories, Inc.

CIRCLE NO. 50 ON READER SERVICE CARD



# Marantz Stereo Cassette Decks..

1.

3-1/2-inch professional VU meters with peak LED overload and lighted function indicators. Exceptionally large, readable VU panel features special Light Emitting Diodes that illuminate when recorder is overdriven by a high level signal. Illuminated function indicators tell you at a glance which function is in operation.



Marantz 5420 Top Loading Deck with Dolby

(The enclosures for these units are constructed of plywood, finished in real walnut veneer).



# the decks that live up to their name.

2.

**Built-in Dolby<sup>®</sup> System that works with built-in mixing console; also permits external Dolby processing on other tape recorders.** Instantly switches for external Dolby encoding on reel-to-reel decks. Has 25 microsecond de-emphasis switch for FM Dolby. Works in conjunction with built-in mixer for Dolbyizing multiple input sources.



3.

**One button each for Normal, CrO2 and FeCr tapes automatically selects both bias and EQ.** Eliminates confusing combination adjustments of separate bias and EQ switches. Single control calibrates both bias and EQ automatically for best frequency response on any cassette tape.

4.

**Full 4-input mixing console with pan pot and master gain control.**

Four inputs—any combination of mic and line—are operated by four individual slide potentiometers plus one master gain control for fade-in/fade-out. Two pan pot controls permit inputs 3 and 4 to be assigned to either left, center or right stage. Can operate as a separate mixing panel for master-quality recordings with external tape recorders.

5.

**Built-in adjustable stand that changes the angle of the control panel from flat to 20 degrees.** Angles top loading decks for most suitable viewing and operation.

Marantz cassette decks have arrived. Performance and sophistication that surpasses every other deck on the market. Quality and technical excellence equalled only by Marantz receivers, components and speaker systems.

Top loading. Front loading. With Dolby. Without Dolby. \*\* The Marantz cassette deck line lets you select a model that exactly suits your needs. Five decks in all, with design features as exciting as their performance.

The Marantz 5420 top loading deck with Dolby for example, keeps wow and flutter down to 0.07%. Plus, it offers a wide frequency response (30 Hz to 17 kHz) and an exceptionally high signal-to-noise ratio (up to 60 dB).

Other outstanding features include **long-life ferrite heads, sophisticated DC servo drive systems** with total shut-off and **memory tape counters.**

See the complete Marantz line at your local Marantz dealer. Send for a free catalog.

**marantz.**  
We sound better.

Marantz 5120 Top Loading Deck with Dolby



Marantz 5220 Front Loading Deck with Dolby (Cabinet optional)

\*\*Not shown: Marantz 5400 Top Loading Deck without Dolby, and Marantz 5200 Front Loading Deck without Dolby.

\*Dolby System under license from Dolby Laboratories, Inc. © 1976 Marantz Co., Inc., a subsidiary of Superscope, Inc., 20525 Nordhoff St., Chatsworth, CA 91311. In Europe: Superscope Europe, S.A., Brussels, Belgium. In Canada: Superscope Canada Ltd., Ontario. In the Far East: Marantz Far East, Tokyo, Japan. Prices and models subject to change without notice. Consult the Yellow Pages for your nearest Marantz dealer.



# The famous Sound of Koss takes on a new look.



Koss K/135

Slipping into the beautiful Sound of Koss has always been an exciting experience for those who love music. And with the all new Koss K/125, K/135 and K/145 Stereophones, it's an even greater pleasure. Because not only are these new dynamic Koss Stereophones lighter and more comfortable, but they also reproduce the musical program material with greater accuracy than other dynamic phones in their price ranges.



Koss K/125

Indeed, everything from the lilting enchantment of a flute solo to the pulsating roll of a kettle drum will take on an unbelievable clarity and crispness.

But then, the superior performance of these new stereophones isn't all that they have to offer. Because Koss engineers gave the new Koss "K" series a distinctive low silhouette shape and slimline styling. They added the exclusive Koss Pneumalite® earcushions that seal out ambient noise and extend the bass range to below audibility. And they designed the new "K" series with wide, glove-soft, vinyl headbands for easy wearing comfort during long listening sessions.

All in all, the new Koss K/125, K/135 and K/145 Stereophones are in a class by themselves. Not just in terms of sound quality and superb styling, but in terms of price value as well. Write for a free full-color catalog, c/o Virginia Lamm. Or, ask your favorite Audio Specialist to show you the new look to the famous Sound of Koss. If the new look doesn't blow your mind, the sound will.



Koss K/145  
with volume/  
balance controls

 **KOSS**® stereophones  
from the people who invented Stereophones.

© Koss Corporation