

GUIDELINES FOR
SPEAKER PLACEMENT

14276

Stereo Review

AUGUST 1976 • ONE DOLLAR

SPECIAL SPEAKER ISSUE

Speaker anatomy * Tips for Buyers * Room Placement

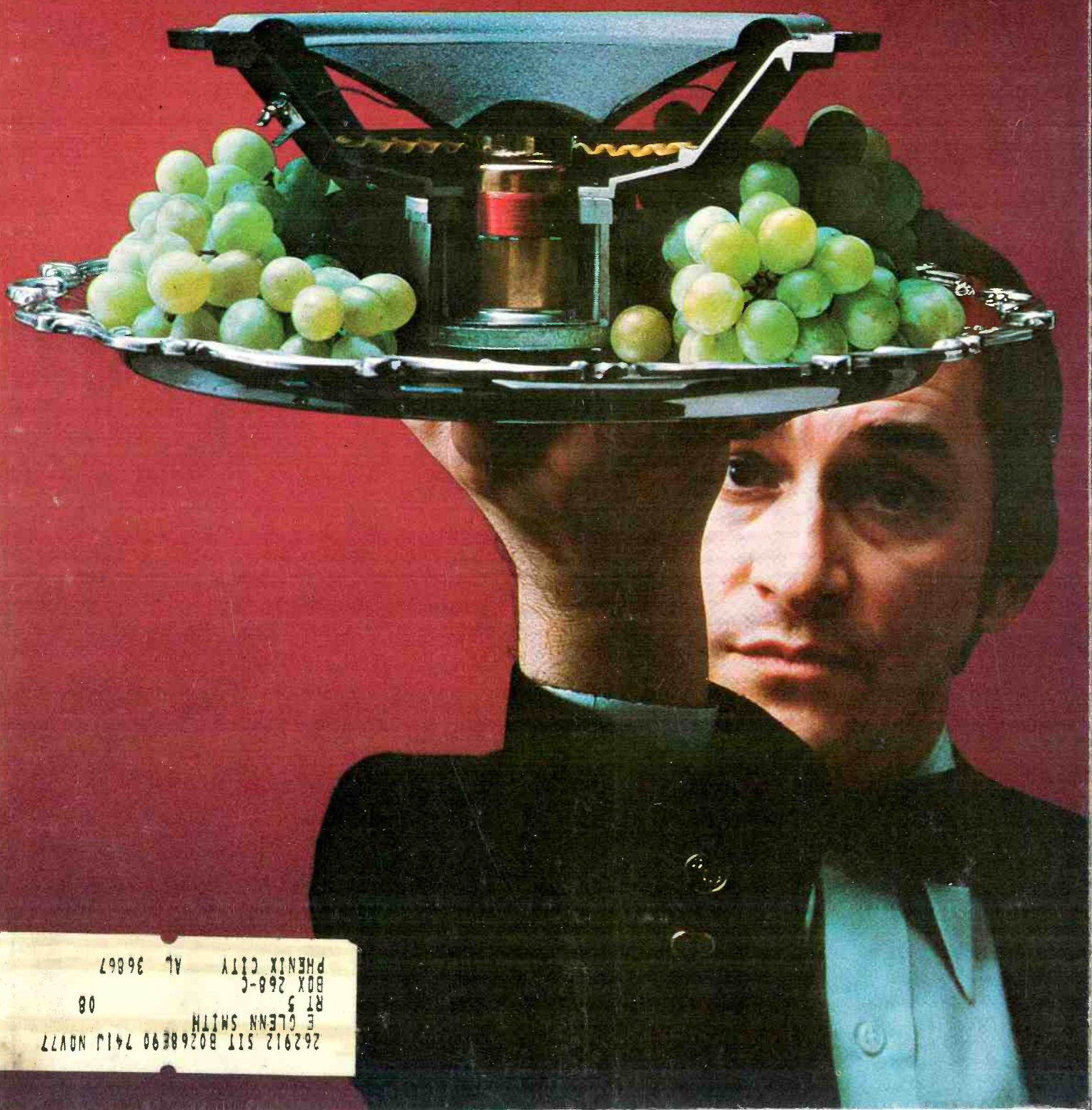

Pioneer has conquered the one big problem of high-priced turntables.



262912 SIT 80260090 741J NOV77
E GLENN SMITH
RT 5
BOX 268-C
PHENIX CITY AL 36867

The best way to judge the new Pioneer PL-510 turntable is to pretend it costs about \$100 more. Then see for yourself if it's worth that kind of money.

First, note the precision-machined look and feel of the PL-510.

The massive, die-cast, aluminum-alloy platter gives an immediate impression of quality. The strobe marks on the rim tell you that you don't have to worry about perfect accuracy of speed. The tone arm is made like a scientific instrument and seems to have practically no mass when you lift it off the arm rest. The controls are a sensuous delight to touch and are functionally grouped for one-handed operation.

But the most expensive feature of the PL-510 is hidden under the platter. Direct drive. With a brushless DC servo-controlled motor. The same as in the costliest turntables.

That's why the rumble level is down to -60 dB by the JIS standard. (This is considerably more stringent than the more commonly used DIN "B" standard, which would yield an even more impressive figure.) And that's why the wow and flutter remain below 0.03%. You can't get performance like that with idler

drive or even belt drive. The PL-510 is truly the inaudible component a turntable should be.

Vibrations due to external causes, such as heavy footsteps, are completely damped out by the PL-510's double-floating suspension. The base floats on rubber insulators inside the four feet. And the

turntable chassis floats on springs suspended from the top panel of the base. Stylus hopping and tone arm skittering become virtually impossible. (Even the turntable mat is made of a special vibration-absorbing material.)

But if all this won't persuade you to buy a high-priced turntable, even without the high price, Pioneer has three other new models for even less.

The PL-117D for under \$175*. The PL-115D for under \$125*. And the amazing PL-112D for under \$100*.

None of these has a rumble level above -50 dB (JIS). None of them has more wow and flutter than 0.07%.

So it seems that Pioneer has also conquered the one big problem of low-priced turntables.

The low performance.

U.S. Pioneer Electronics Corp.,
75 Oxford Drive, Moonachie,
New Jersey 07074.

Turntable:

- Direct drive
- Brushless DC servo-controlled motor
- 33 $\frac{1}{3}$ and 45 RPM speeds
- Strobe light
- Strobe-calibrated platter rim
- $\pm 2\%$ fine adjustment of speeds
- Double-floating system of suspension
- Turntable mat of high-internal-loss rubber
- One-handed operation of controls

Tone arm:

- Lightweight S-shaped tubular design
- Static balance
- Ball-bearing pivot with angular contact
- Anti-skating device
- Lateral balancer
- Direct-readout counterweight
- Viscous-damped cueing
- Lightweight plug-in headshell

The high price.

For under \$200*, you can now own the direct-drive PL-510.



 **PIONEER**

Anyone can hear the difference.

CIRCLE NO. 42 ON READER SERVICE CARD

*For informational purposes only. The actual resale prices will be set by the individual Pioneer dealer at his option.



DIRECT DRIVE SERVO MOTOR
PIONEER ELECTRONIC CORP.

CONTROL SYSTEM

GAIN ADJ.

SPEED

ARM-STOP/POWER/REPOSITION

OFF
ON-UP
DOWN

DIRECT DRIVE
STEREO TURNTABLE
PL-510



At TEAC, our fundamental mandate for any new product is performance and reliability. First and finally. Qualities that are measurable in terms of mechanical stability and inherent design integrity.

These are essentials. Because our technological resources established the cassette deck as a true high fidelity component. So we demand that a new product possess that measure of TEAC quality.

And that's what distinguishes the A-170. Compare it with other inexpensive cassette decks with Dolby, please. Just call (800) 447-4700* for the name of your nearest TEAC retailer. We think you'll agree it's a value you can rely on.

*In Illinois, call (800) 322-4400.

A-170

TEAC performance and reliability...

how can you really afford anything less?

TEAC.

The leader. Always has been.

TEAC Corporation of America / 7733 Telegraph Road, Montebello, Ca. 90640 ©TEAC 1975

Dolby is a trademark of Dolby Laboratories, Inc.

FORMERLY HI FI/STEREO REVIEW

Stereo Review®

AUGUST 1976 • VOLUME 37 • NUMBER 2

The Equipment

NEW PRODUCTS <i>A roundup of the latest in high-fidelity equipment</i>	10
AUDIO QUESTIONS AND ANSWERS <i>Advice on readers' technical problems</i>	LARRY KLEIN 14
AUDIO BASICS <i>Speakers: A Short Course</i>	RALPH HODGES 16
TAPE HORIZONS <i>Lost in Space</i>	CRAIG STARK 18
EQUIPMENT TEST REPORTS <i>Hirsch-Houck Laboratory test results on the McKay Dymek AM5 AM tuner and DA5 AM antenna, Sonus phono cartridges, Nikko 7075 AM/stereo FM receiver, and Dual 510 manual record player</i>	JULIAN D. HIRSCH 21
ANATOMY OF THE LOUDSPEAKER <i>A useful introduction to a multifaceted subject</i>	LARRY KLEIN 46
THE SPEAKER AND THE LISTENER <i>Where to put your speakers—and yourself—in the listening room</i>	ROY ALLISON 56

The Music

JUST DESERTS <i>Musicians harvest a bumper crop of prizes, degrees, and awards</i>	52
THE CAPTAIN AND TENNILLE <i>"... playing with the Beach Boys, you have to be as good as you can get"</i>	PENELOPE ROSS 62
ANTONIO DE ALMEIDA <i>The Yale man as globe-trotting symphony conductor</i>	ROY HEMMING 64

The Reviews

BEST RECORDINGS OF THE MONTH <i>Operatic: Gaetano Donizetti's Maria Stuarda</i> <i>Chamber: Shostakovich's valedictory quartets</i> <i>Vocal: Steve Goodman's "Words We Can Dance To," Warren Zevon's debut album, and the return of Sylvia Syms</i>	67
POPULAR DISCS AND TAPES	72
<i>Neil Sedaka: "Steppin' Out"</i>	PETER REILLY 73
<i>Steely Dan: "Royal Scam"</i>	STEPHEN HOLDEN 80
<i>Louis Armstrong and Earl Hines: the 1928 collaborations</i>	JOEL VANCE 88
CLASSICAL DISCS AND TAPES	92
<i>The Bicentennial Corner: American music for two pianos</i>	PAUL KRESH 93
<i>Alicia de Larrocha: "Mostly Mozart," Volume II</i>	GARRICK OHLSSON 96
<i>Has the Avant-garde Become the Establishment?</i>	ERIC SALZMAN 100

The Regulars

EDITORIALLY SPEAKING	WILLIAM ANDERSON 4
LETTERS TO THE EDITOR	6
TECHNICAL TALK	JULIAN D. HIRSCH 20
GOING ON RECORD	JAMES GOODFRIEND 37
THE SIMELS REPORT	STEVE SIMELS 38
THE OPERA FILE	WILLIAM LIVINGSTONE 42
THE BASIC REPERTOIRE	MARTIN BOOKSPAN 44
CHOOSING SIDES	IRVING KOLODIN 90
ADVERTISERS' INDEX	111

COVER: Design by Borys Patchowsky, photo by Bruce Pendleton

COPYRIGHT © 1976 BY ZIFF-DAVIS PUBLISHING COMPANY. All rights reserved. Stereo Review, August 1976, Volume 37, Number 2. Published monthly by Ziff-Davis Publishing Company; Editorial and Executive Offices at One Park Avenue, New York, N.Y. 10016; Telephone: 212 725-3500. Hershel B. Sarbin, President; Furman Hebb, Executive Vice President; John R. Emery, Senior Financial Vice President and Treasurer; Charles B. Seton, Secretary. Also the publishers of Boating, Car and Driver, Cycle, Flying, Modern Bride, Popular Electronics, Popular Photography, and Skiing. One-year subscription rate for U.S., \$7.98; U.S. possessions and Canada, \$9.98. All other countries, one-year subscription rate \$10.98, cash orders only, payable in U.S. currency. Second-class postage paid at New York, N.Y., and at additional mailing offices. Authorized as second-class mail by the Post Office Department, Ottawa, Canada, and for payment of postage in cash. SUBSCRIPTION SERVICE: Form 3579 and all subscription correspondence should be addressed to Stereo Review, Circulation Department, P.O. Box 2771, Boulder, Colorado 80302. Please allow at least eight weeks for change of address. Include your old address, as well as new—enclosing if possible an address label from a recent issue. Material in this publication may not be reproduced in any form without permission. Requests for permission should be directed to Jerry Schneider, Rights and Permissions, Ziff-Davis Publishing Company, One Park Avenue, New York, New York 10016.

Editorially Speaking

By William Anderson



ALICIA AND WOLFGANG

There are, it seems to me, two possibilities: either Clio, the Muse of history, has an off-beat sense of humor, or my mind has an unorthodox filing system. Just under two years ago, on this very page, Zeus' second daughter nodded over my shoulder as I brought together a rare cast of characters: W. A. Mozart, Alicia de Larrocha, and R. M. Nixon. The occasion was the eighth annual Mostly Mozart Festival then under way in New York's Avery Fisher Hall. Mme. De Larrocha, who had just recorded for London her "Mostly Mozart, Vol. I" album, was a soloist in the Festival, and I attended her concert the night of August 9, 1974, when the unadvertised intermission feature was the resignation speech of then-President Nixon. It was, Clio knows, an historic occasion I shall not soon forget. Isn't it odd, then, that just a few days ago, as I paused to enjoy the latest chapter in the continuing saga of our Congressional Casanovas and their scribbling doxies, there should appear on my desk an advance copy of Alicia de Larrocha's new London

disc "Mostly Mozart, Vol. II," together with an announcement of her four appearances this year in the phenomenally popular Festival. She will be playing in Tully Hall (Fisher Hall, as you know, is being remodeled this summer) the nights of August 3 and 5, and wouldn't it be funny if Clio could arrange to have Wayne Hays (as well as whatever other poor sinners may have joined him in the pillory by then) come on during one of the intermissions and . . .

The rustication of political rascals is important, necessary, and even, at times, curiously refreshing, but, selfish sensualist that I am, I'd much rather attend to Alicia and Wolfgang. Which is why, rather than dashing off an intemperate letter to the *Times* on the subject of Sex Among the Solons, I immediately began pestering the staff to come up with a Very Special Reviewer for the new London album. That VSR turned out to be very successful pianist Garrick Ohlsson, himself a Mostly Mozart performer in years past, and you will find his review on page 96.

One of the classic canards of music is the one about critics being failed performers. Mean, disappointed, and envious, they are said to derive the only pleasure their poor, crabbed lives will accommodate from tearing down their betters. Nonsense, of course, but *persistent* nonsense. It is therefore instructive to see what reviewer Ohlsson, a performer of proved accomplishment, has to say on the subject of De Larrocha, for it turns out to be very much what professional critics have been saying about her all along. And I would not be at all surprised to learn that sensitive listeners have been saying it as well. I am delighted, for example, to find that Ohlsson dwells so tellingly on that one characteristic of De Larrocha's playing—her rhythmic sense—that has always so impressed me. Whatever it is she plays, whether the Bach/Busoni *Chaconne* ("Mostly Mozart, Vol. I") or the Mozart *Fantasia in D Minor* ("MM, Vol. II"), she has an instinctive, distinctive flair for discovering and teasing out the dance element. This is as it should be, for when we reduce music down to its two essential kinds, vocal and dance, it can be seen that the percussive piano is more suited to the second than to the first, despite some pianists' noble efforts to perfect the "singing tone" and the "seamless legato." The vocal element in music is better served at the piano by concentrating on the phrasing of the melodic line. Properly done—as De Larrocha invariably does it—it sounds, even in non-vocal music, remarkably and satisfyingly like breathing.

The answer to the question "Why Mozart" posed to me by a friend recently is not a flip "Why not?", but that it is another example of the peculiar grace that seems to accompany everything this composer touches. Printing presses, hotel beds, and concert halls are so costly that they cannot be left unoccupied for long. Lincoln Center's management needed some kind of special small-orchestra programming to attract summer visitors. There were many suggestions, among them one for a "Mozart Festival." When it was observed that *all* Mozart might be a little heavy for summer fare, someone remarked, "Well, it could be *mostly* Mozart." And so it is.

Stereo Review

PUBLISHER
EDGAR W. HOPPER

EDITOR
WILLIAM ANDERSON

MANAGING EDITOR
WILLIAM LIVINGSTONE

EDITORIAL COORDINATOR
LOUISE GOOCH BOUNDAS

MUSIC EDITOR
JAMES GOODFRIEND

TECHNICAL EDITOR
LARRY KLEIN

ART DIRECTOR
BORYS PATCHOWSKY

ASSOCIATE TECHNICAL EDITOR
RALPH HODGES

POPULAR MUSIC EDITOR
STEVE SIMELS

ASSISTANT MUSIC EDITOR
VIVIANNE WINTERRY GOODMAN

PRODUCTION EDITOR
PAULETTE WEISS

LONDON EDITOR
HENRY PLEASANTS

CONTRIBUTING EDITORS

CHRIS ALBERTSON
MARTIN BOOKSPAN
NOEL COPPAGE
RICHARD FREED
DAVID HALL
ROY HEMMING
JULIAN D. HIRSCH
GEORGE JELLINEK
IGOR KIPNIS
IRVING KOLODIN

PAUL KRESH
STODDARD LINCOLN
J. MARKS-HIGHWATER
LINCOLN PERRY
PETER REILLY
CHARLES RODRIGUES
ERIC SALZMAN
CRAIG STARK
JOEL VANCE

ADVERTISING DIRECTOR
JAMES J. SULLIVAN

ADVERTISING SERVICE MANAGER
LINDA BLUM

EXECUTIVE ASSISTANT
PEGI McENEANEY

ASSOCIATE PUBLISHER
STANLEY NEUFELD

Editorial and Executive Offices
Ziff-Davis Publishing Company
One Park Avenue, New York, New York 10016
212 725-3500
Eastern Advertising Manager: Richard J. Halpern
Midwestern Office: The Pattis Group
4761 West Touhy Ave., Lincolnwood, Illinois 60646
312 679-1100
Arnold S. Hoffman
Western Office
9025 Wilshire Boulevard
Beverly Hills, California 90211
213 273-8050; 272-1161
Western Advertising Manager: Bud Dean

Japan: James Yagi
Oji Palace Aoyama, 6-25, Minami Aoyama
6-Chome, Minato-ku, Tokyo, Japan
Telephone: 407-1930/6821, 582-2851

Circulation Office
P.O. Box 2771, Boulder, Colorado 80302

EDITORIAL CONTRIBUTIONS must be accompanied by return postage and will be handled with reasonable care; however, publisher assumes no responsibility for the return or safety of art work, photography, or manuscripts.

Member Audit Bureau of Circulations



ZIFF-DAVIS PUBLISHING COMPANY
Hershel B. Sarbin, President
Furman Hebb, Executive Vice President
John R. Emery, Senior Vice President-Finance/Treasurer
Phillip T. Heffernan, Senior Vice President, Marketing
Edward D. Muhfeld, Senior Vice President, Sports Div.
Philip Sine, Senior Vice President
Frank Pomerantz, Vice President, Creative Services
Arthur W. Butzow, Vice President, Production
Lawrence Sporn, Vice President, Circulation
George Morrissey, Vice President
Sydney H. Rogers, Vice President
Sidney Holtz, Vice President
Al Traina, Vice President
Philip Korsant, Vice President
Charles B. Seton, Secretary
Edgar W. Hopper, Vice President, Electronics Div.
William Ziff, Chairman
W. Bradford Briggs, Vice Chairman

Blueprint for Flat Frequency Response

In the graph below, frequency response was measured using the CBS 100 Test Record, which sweeps from 20-20,000 Hz. The vertical tracking force was set at one gram. Nominal system capacitance was calibrated to be 300 picofarads and the standard 47K ohm resistance was maintained throughout testing. The upper curves represent the frequency response of the right (red) and left (green) channels. The distance between the upper and lower curves represents separation between the channels in decibels. The inset oscilloscope photo exhibits the cartridge's response to a recorded 1000 Hz square wave indicating its resonant and transient response.

Smooth, flat response from 20-20,000 Hz is the most distinct advantage of Empire's new stereo cartridge, the 2000Z.

The extreme accuracy of its reproduction allows you the luxury of fine-tuning your audio system exactly the way you want it. With the 2000Z, you can exaggerate highs, accentuate lows or leave it flat. You can make your own adjustments without being tied to the dips and peaks characteristic of most other cartridges.

For a great many people, this alone is reason for owning the Z. However, we engineered this cartridge to give you more. And it does. Tight channel balance, wide separation, low tracking force and excellent tracking ability combine to give you total performance.

See for yourself in the specifications below, then go to your audio dealer for a demonstration you won't soon forget.

The Empire 2000Z.

Already your system sounds better.

Frequency Response—20 to 20K Hz \pm 1 db using CBS 100 test record
Recommended Tracking Force— $\frac{3}{4}$ to 1 $\frac{1}{4}$ grams
 (specification given using 1 gram VTF)

Separation—20 db 20 Hz to 500 Hz
 30 db 500 Hz to 15K Hz
 25 db 15K Hz to 20K Hz

I.M. Distortion—(RCA 12-5-105) less than .08% .2KHz to 20KHz @ 3.54 cm/sec

Stylus—0.2 x 0.7 mil diamond

Effective Tip Mass—0.2 mg

Compliance—lateral 30×10^{-6} cm/dyne
 vertical 30×10^{-6} cm/dyne

Tracking Ability—0.9 grams for 38 cm per sec @ 1000 Hz
 0.8 grams for 30 cm per sec @ 400 Hz

Channel Balance—within $\frac{1}{2}$ db @ 1 kHz

Tracking Angle—20°

Recommended Load—47 K Ohms

Nominal Total System Capacitance required 300 pF

Output—3mv @ 3.5 cm per sec using CBS 100 test record

D.C. Resistance—1100 Ohms

Inductance—675 mH

Number and Type of Poles—16 Laminations in a 4 pole configuration

Number of Coils—4 (1 pair/channel—hum cancelling)

Number of Magnets—3 positioned to eliminate micropionics

Type of Cartridge—Fully shielded, moving iron

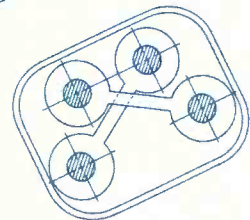
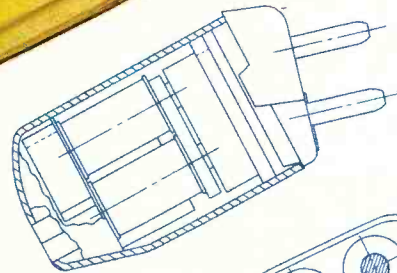
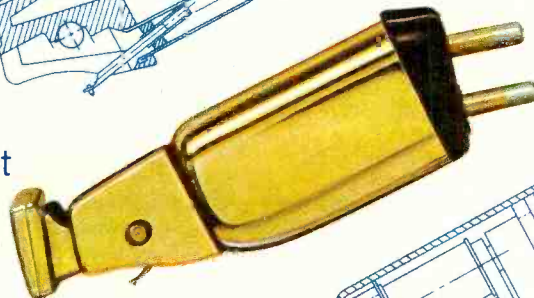
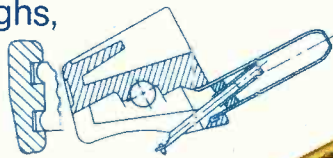
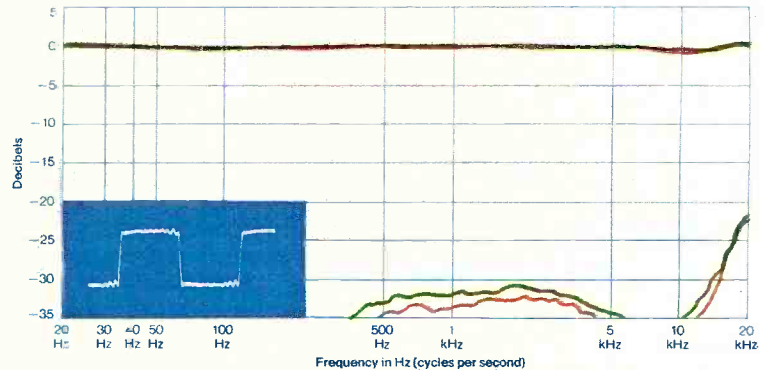



LETTERS TO THE EDITOR

TV and Music

● Noel Coppage's June article on the conflict between successful television and successful music was an accurate description of a phenomenon I have been aware of for some time. It was more than mere coincidence when John Denver began to delete songs such as Tom Paxton's *Jimmy Newman* from his concert program just as he was establishing a television image. In fact, his single most universally identified trademark ("far out") was introduced through TV-show small talk, his music aside.

And Gordon Lightfoot claims he seldom performs on television because of his concern with getting the sound right. However, he did appear on *Midnight Special* some time ago, and some of the nastier habits of television rendered his performance less than convincing. First of all, the audience roared into grateful applause not at the end of each song, but when the applause light flickered on—I assume this was the case because the clapping started during a relatively new song, which might have had another verse. Second, after station identification, the program returned to "... read my mind, Love," indiscreetly editing out not only the instrumental introduction but "If you could." Finally, Terry Clements' lead guitar work in *Sundown* was interrupted by a proclamation by Johnny Cash that his new TV special was to be aired the following week. And then a return to an audience wildly applauding a half-finished song.

My hypotheses are: (1) a musician can be made a victim of the TV cameras even when the lens cap is on; (2) television will permit, even of the best musicians, not a good musical performance but only a convenient television performance.

BOB McCANN
Columbus, Ohio

● I'd like to make a few comments about Noel Coppage's "Music and TV" (June). The "elitist" argument makes his concern irrelevant, because television is not a truly competitive medium for serious music consumption (it is inferior to records, scores, etc.). It would be unrealistic, lacking in aesthetic integrity, and unprogressive for a visual medium to assume leadership in an area in which it is already surpassed by other media. Besides, there is plenty of genuine musical seriousness

in movie film scores that are a great part of TV viewing, often directly competing with a variety show on another channel.

Mr. Coppage's argument is relevant at the cultural level but unfair at the media level. From the philosophical point of view, he has missed his target. From the psychological point of view, he is "kicking his dog" in a fit of "misplaced aggression." From the musical point of view, why bother with TV?

J. ROBERT HINES
Hoffman Estates, Ill.

The Editor replies: For a very simple reason: it is making a palpable bid to replace the other media, botching their jobs in the process. To take Mr. Hines' own example: is a hacked-up old movie (and its musical score) constantly interrupted by commercials the same thing as a real movie? Does the Midnight Special do as good a job with pop music as records and radio? Is the eleven o'clock news an adequate substitute for a newspaper or a news magazine? I am sure Mr. Hines will agree that if TV is going to invade the provinces of the other media, it has some responsibility to govern them passably well.

Hum Filter

● Thanks for a thoroughly enjoyable June issue. I really freaked out over the "Glenn Gould Hum Filter" in Charles Rodrigues' cartoon. I'm only sorry someone else beat me to it; the adaptive-recursive, orthogonal, dispersive-feedback digital filter I had in mind was probably too simple, in any case.

TERRY CONBOY
Redwood City, Calif.

Sexist Clean-up

● I was commenting this morning to my three female musician roommates that it's time to clean up our P.A. systems and my disco board. I went to the mailbox and my June STEREO REVIEW was awaiting me with an article called "Clean Up/Tune Up Your Audio System." I thought, what a coincidence, and rushed back to read your checklist. Much to my dismay and insult, the opening paragraph biasedly/sexistly implied that only MEN can clean/have the ability to clean their systems and/or are the only ones who have systems. I am an audio technician, a disc jockey, and a free-lance journalist and am, to say the least, angry. Articles such as this one

are discriminatory and detrimental to a percentage of your present readership. I realize that technology is "man-made," but let's not be ridiculous.

JACQUI MAC
Arlington, Mass.

Over 95 per cent of STEREO REVIEW's readers are male.

● Thanks for Craig Stark's article on "clean-ups" . . . and just when I needed it most!

LAWRENCE CHELSI
New York, N.Y.

How to Write an Opera

● Your June issue is really nice, especially Eric Salzman's piece on the origin of opera. A few of the points that were omitted are not too important, such as the choruses Andrea Gabrieli wrote for the revival of *Oedipus Tyrannus* by Giustiniani in 1585 at Vicenza, and the recording of Peri's *Euridice* on Orpheus OR 344-345.

But editions of the Greek tragedies that show which parts were sung prove that up to half of the classical tragedies were sung or intoned. In other words, they were operas just as much as the dialogue version of *Carmen*. Like Wagner, who consciously imitated them, the Athenian tragedians and comic writers were composers as well as dramatists. Mr. Salzman's qualified description of opera as deriving from ritual music can be extended by stating flatly that all music drama has a ritual origin. From the Osiris passion play at Memphis (2500 B.C.) to Euripides' *Bacchae* to the various versions of the Orpheus and Eurydice story around 1600, to Strauss' *Ariadne auf Naxos*, the ritual origin is evident. All comedy operas end with the wedding (or betrothal) of the hero and heroine, a typical sacred marriage ritual for the purpose of inducing spring fertility. Similarly, tragic operas end with the ritual sacrifice of the hero; often, the heroine is a victim too. Unless this ritual basis of tragic opera is understood, it is almost impossible to compose a successful tragic music drama today. (The tacked-on ritual ending of Stravinsky's *Rake's Progress* is an unfortunate example of misunderstanding this.)

The unique etching from James Goodfriend, showing Apollo slaying the "serpent" (or Pythia), is part of the archetypal ritual drama of the radiant spring hero (Siegfried, Tamino, Tristan, Idomeneo, etc.) slaying the winter monster so that spring can return.

PHILIP L. FORSTALL
Evanston, Ill.

The Basic Repertoires

● Martin Bookspan's "Basic Repertoire" column appears to have gone into reruns. I would prefer that updatings and reconsiderations be left to your annual pamphlet by Richard Freed, at least until certain seemingly obvious omissions are filled in. I welcome the start at a "Basic Chamber Repertoire"; my ideal would be to have four concurrent columns covering the basic orchestral, operatic, chamber music, and solo piano repertoires.

G. C. BANDEMER
Glenview, Ill.

The Editor replies: Mr. Bookspan's column has now been running in STEREO REVIEW for eighteen years, and we judge that because we have added a few new readers since that time (about 30 per cent are new each year), we must revisit the Basic Repertoire for their uses too.

"Reruns" from now on will occupy about half the columns, new items (both "obvious omissions" in the orchestral area and excursions into chamber, solo instrumental, and vocal repertoires) the other half. Four separate columns would be lovely, but this is not, alas, the best of all possible worlds. . . .

Opera Quiz

● I'm not an opera fan, but I am a Johnny Carson fan and I know the question that goes with the answer "Judith Blegan, Marilyn Horne, Beverly Sills, and Luciano Pavarotti" in the Editor's column in the June issue: "Name three American canaries and one Italian blimp."

CARLTON POWERS
New York, N.Y.

Lavarsi la bocca!

● Editor William Anderson was right in his June editorial—opera is a spectator sport, as proved by the fact that the Metropolitan Op-



era played Puccini at Yankee Stadium in one of its "parks concerts" this summer.

VITO D'AMATO
Brooklyn, N.Y.

Yes, and Anna Moffo was in the starting lineup. She was persuaded to pose in uniform for a Daily News photographer at a May press conference called to announce the June performance of *Madama Butterfly* (see photo above).

Speaker Testing

● Ours is an age oscillating between two false poles: the promotional hype and the pseudoscientific critic. It has become very unfashionable, even dangerous, to remark that the emperor is naked. All the more honor, then, to Julian Hirsch for blasting the "incredibly simple-minded approach to speaker evaluation" employed by that supposed paragon of scientific objectivity, Consumers Union (June). Too many Americans, disillusioned

AUGUST 1976

Is it live, or is it Memorex?



The amplified voice
of Ella Fitzgerald can shatter
a glass. And anything Ella
can do, Memorex cassette tape
with MRX₂ Oxide can do.

If you record your own music,
Memorex can make all
the difference in the world.

MEMOREX Recording Tape.
Is it live, or is it Memorex?

©1976, Memorex Corporation, Santa Clara, California 95052

CIRCLE NO. 24 ON READER SERVICE CARD

sioned by the poor quality of consumer products, have fallen into the opposite trap of believing everything the professional consumerist tells them. It cannot hurt the public to be told that Consumers Union is not an idol, is not infallible, and is capable of missing the whole point on occasion.

ROBERT M. STRIPPY
Evansville, Ind.

Steeleye

● In response to the hopes of Al Eibel and the prayers of the editorial commentator in the June Letters: *Don* was good. Steeleye Span toured this country, virtually unheralded, in the spring and summer of 1974. We had the pleasure of catching them at Penn State for a truly memorable concert. The tour cul-

minated in an appearance on television (*Don Kirshner's Rock Concert*) which, God willing, will be rerun soon.

J. W. GREEN
Carlisle, Pa.

● I'd like to share some information with the "Steeleye Spanatic" in the June Letters section. Thirteen Steeleye Span albums exist, not ten. Eight are English imports, four are on the American Chrysalis label, and one album is out of print in the U.S. but available in England. To help other Steeleye Spanatics, here is a list of their albums:

- "Folk Songs of Old England, Vol. 1," Tepee Records ARPS-3, mono (English)
- "Folk Songs of Old England, Vol. 2," Tepee Records ARPS-4, mono (English)

A new high performance additive for your car

The all-new Jensen stereo speaker kits won't help your car go faster. Or run better. What they will do is maximize the performance of your radio or 8-track in a way you never thought possible.

The next best thing to home speaker sound.

When our engineers designed these new Jensens, they incorporated all the things we know about making home speakers. That's why inside you'll find features like Flexair® woofer suspension and powerful Syntox-6® ceramic magnets. They combine to provide rich sound reproduction you won't find in any comparably priced car speaker.

Another Jensen first—true coaxial car speakers in 4", 5¼" and 6" x 9" sizes.

Jensen is the only company that offers a true coaxial speaker in three

compact sizes. Sweeter,™ our new space-saving solid state tweeter, is one of the reasons why. It allowed us to develop two revolutionary new models—the Jensen 4" and 5¼" coaxials. Together with our 6" x 9" model, they now make it possible for anyone to obtain home speaker sound quality in his car.

Ask your local Jensen dealer for a demonstration.

You won't know what you're missing until you hear these new Jensen car speakers perform for you.

For a free catalog, write Jensen Sound Laboratories, 4310 Trans World Road, Schiller Park, Illinois 60176.

JENSEN
SOUND LABORATORIES
Division of Pemcor, Inc. Schiller Park, Illinois 60176



© 1975 Jensen Sound Laboratories

CIRCLE NO. 18 ON READER SERVICE CARD

- "Summer Solstice," B&C Records CAS 1035 (English)
- "Hark! The Village Wait," RCA Victor SF 8113 (English)
- "Ten Man Mop or Mr. Reservoir Bitler Rides Again," Pegasus PEG-9 (English)
- "Individually and Collectively," Charisma CS-5 (English)
- "Pleased to See the King," B&C Records CAS 1029 (English)
- "Almanack," B&C Records CS 12 (English, greatest hits)
- "Below the Salt," Chrysalis CHR 1008 (U.S.)
- "Parcel of Rogues," Chrysalis CHR 1046 (U.S.)
- "Now We Are Six," Chrysalis CHR 1053 (U.S.)
- "Commoner's Crown," Chrysalis CHR 1071 (English)
- "All Around My Hat," Chrysalis CHR 1091 (U.S.)

The first three albums are by Tim Hart and Maddy Prior before they formed Steeleye Span. The first two are mono and were re-released in England on the Mooncrest label. "Commoner's Crown," one of their greatest albums, was released in England only.

RANDALL L. SMITH
Hot Springs, Ark.

Popular Music Editor Steve Simels replies: Unfortunately, due to the recent bankruptcy of B&C Records and their Mooncrest subsidiary, many of the albums Mr. Smith mentions will soon be unavailable. For the moment, the bulk of Steeleye's wonderful English catalog can still be obtained from my favorite importers, Jem Records, Import Record Service, P.O. Box 362, 3001 Hadley Road, South Plainfield, N.J. 07080. I particularly recommend "Hark! The Village Wait," their earliest dalliance with a rhythm section, and "Commoner's Crown," their most ambitious and successful album to date.

Glière Bargain

● In his review of the new release of Glière's Symphony No. 3 in the June issue, David Hall objects to "the short measure offered in this expensive two-record set—only an hour and fifteen minutes of music spread over four sides" and gives the list price as \$13.96. Actually, Columbia is offering this recording as a specially priced, two-LP set for \$7.98. Considering the spacious sonics and the fact that this is the first and only recording to present this mammoth symphony uncut, it is a veritable bargain!

PETER J. KAUFMAN
Philadelphia, Pa.

Claudine's Hit

● Steve Simels may have forgotten who did the original *Party Lights* when he wrote his review of Annie McLoone's "Fast Annie" (June). It was Claudine Clark, not Christine. That *Party Lights* was Claudine's only hit ever, back in 1962, was verified on a special radio program, broadcast on Casey Kasem's nationally syndicated *American Top 40* in April 1975, about artists who had only one hit on the charts and were never heard from again.

CHARLES E. EVERETT
Sag Harbor, N.Y.

Musical Snobbery

● In the May issue, Editor William Anderson says a central tenet of STEREO REVIEW's editorial policy is "the encouragement of catholicity and the discouragement of snob-bishness in musical taste." Then I turn to

page 55 and find the following statement of musical snobbery: "Perhaps the parallel decline of music and monarchy in our own time lends credence to Schiller's words (that 'the singer should accompany the king; both dwell on the heights of mankind')." Please spare us from the prophets of doom who are always complaining about the quality of contemporary works. More and better music is being created now than ever before, whether or not it suits the taste of Mr. Bakshian. I laud Mr. Anderson's comment, but I more than occasionally detect signs of musical snobbery in your pages.

FRED N. BREUKELMAN
Dover, Del.

Mr. Bakshian replies: I am surprised and flattered that Mr. Breukelman should have taken an essentially light piece so deadly seriously. Schiller was no snob, although occasionally a bit of a bore, and as for myself, I simply happen to believe that the system of royal patronage has, over the years, been the most productive in the realm of classical music, a belief that is mathematically illustrated by the fact that Italy and Germany, which were divided into dozens of small individual monarchies and principalities from the sixteenth through the mid-nineteenth centuries, contributed the single largest body of great and near-great classical composers. For all their faults, kings are easier to compose well for than are congresses, foundations, or committees, and the reason, I would submit, has a great deal to do with individuality and very little to do with snobbery.

Fiat Gobbledygook

● It has been my ambition for a long time to catch STEREO REVIEW in a grammatical error, and now I have: in the review of the Sansui 9090 stereo receiver in the June issue you say that the "approximate nationally advertised value is \$750." "Value" is like "worth," and it contains an element of relativity—what is "valued" at \$750 by one person may not be "worth" 75 cents to another. "Cost" and "price," however, are absolutes—a manufacturer gives his receiver a "price" of \$750, and that will be its "cost" when you buy it (unless you know a good discounter!). "Value" in this context is therefore a solecism and a tautology as well, for any possible fluctuations in price have already been covered by the word "approximately."

JOHN MACKENZIE
Richmond, Va.

The Editor replies: A nice unraveling of a knotty semantical problem, Mr. MacKenzie, reminding us of Oscar Wilde's definition of a cynic—one who knows the price of everything and the value of nothing. We tend rather toward the cynical side here, and find the word "value" pretentious and "inoperative" in the subject passage, rather more appropriate to the TV-spot vocabulary of a used-car salesman. It is not, however, the language of STEREO REVIEW or of Sansui, but of the regulation writers at the Federal Trade Commission. The national dialect shows every sign of turning shortly into an unmixed gobbledygook in which many fine (in both senses of the word) and useful verbal distinctions will have run into each other like water colors. When this results in watery and imprecise communication, a well-meaning but linguistically insensitive bureaucracy will have to take some of the credit.

The Sound Shaper. Because all rooms are not created equal.

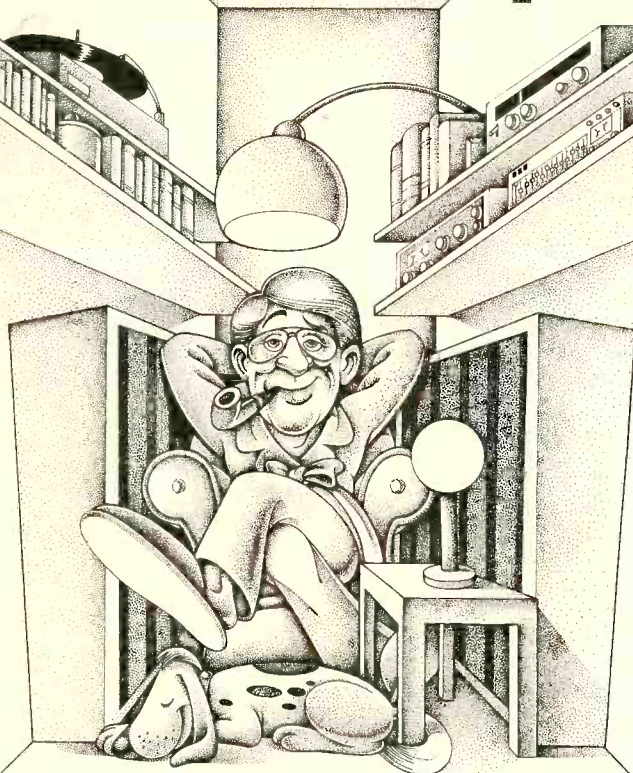

You can own the finest component system and still be getting inferior sound.

Because unless you happen to have an acoustically perfect listening room, your system and space probably don't match. Hard walls, soft carpets, glass tables, even the size of a room can change sounds.

So ADC developed the new ADC 500 Sound Shaper Frequency Equalizer.

By adjusting the twelve frequency levels you can actually shape your sound to fit the shape of the room, and compensate for spaces and textures that interfere with sound. You can even tinker with the sound just for the fun of it: bring up a singer, lose a violin, actually re-mix your recording.

The new ADC 500 Sound Shaper can get your system into great shape.

ADC

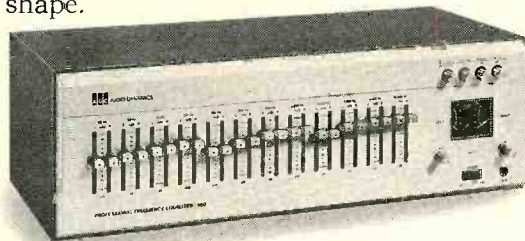

The Sound Shaper

ADC Professional Products Group. A division of BSR (USA) Ltd., Route 303, Blauvelt, N.Y. 10913

Accusound Model 100B Speaker System

The Accusound line of speaker systems, manufactured by Technisound, now consists of four models in bookshelf and floor-standing configurations. The 100B is representative of the larger bookshelf designs. Like its brethren, the Model 100B employs an internal acoustic labyrinth terminated by a passive radiator rather than an opening or port. The ac-

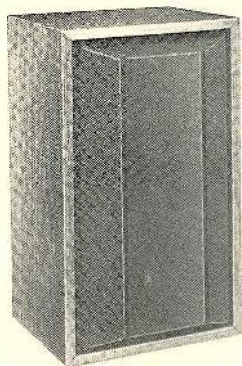

tive woofer itself is an 8-inch design mounted at the input end of the labyrinth; the passive radiator at the output has a 12-inch diaphragm. Frequencies above 1,400 Hz are provided by a 2-inch cone mid-range/tweeter that is mounted on a bracket several inches in front of the main mounting panel to enhance dispersion and reduce diffraction effects.

The power-handling capability of the 100B is 80 watts of continuous program material. Efficiency is said to be increased appreciably over that of sealed-box systems of comparable size. The system has a nominal impedance of 8 ohms. Dispersion, both horizontal and vertical, is said to be 145 degrees at 18,000 Hz. Dimensions of the 100B's wood veneer cabinet are 23 x 13 x 10½ inches. A sculpted fabric grille projects to accommodate the tweeter bracket. Price: \$140.

Circle 115 on reader service card

EPI Model 350 Speaker System

A new column speaker system, the Model 350, is the latest product from the EPI division of Epicure. The system's drivers are grouped into three modules, each consisting of a 1-inch inverted-dome tweeter and an 8-inch air-suspension woofer mounted on a different plane of the system's three radiating surfaces: the top and the two grille-covered sides. A 1,800-Hz crossover divides the frequencies going to the drivers, and a three-position switch adjusts the system's high-frequency output in 3-dB steps.

Frequency response of the Model 350 is 36 to 20,000 Hz (36 Hz is the -3-dB point on the response curve). The system has a nominal

impedance of 6 ohms, and it is recommended for use with amplifiers ranging in power from 38 to 125 watts per channel. The finish is oiled

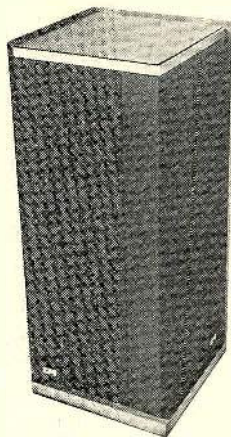

walnut with molded cloth grilles. The 350 measures 36½ x 15¼ x 13¼ inches and weighs 83 pounds. Price: \$399.95.

Circle 116 on reader service card

B.E.S. "Geostatic" Speaker Systems

Bertagni Electroacoustic Systems manufactures a line of loudspeakers with flat polystyrene-foam diaphragms activated by voice coils bonded to various points on their surface. The largest of these systems, the d120, is essentially a four-way design in two modules, the upper section incorporating one drive element for frequencies from 700 to 4,000 Hz, another that operates from 4,000 to 8,000 Hz, and a piezoelectric tweeter for the highest frequencies. The lower module con-

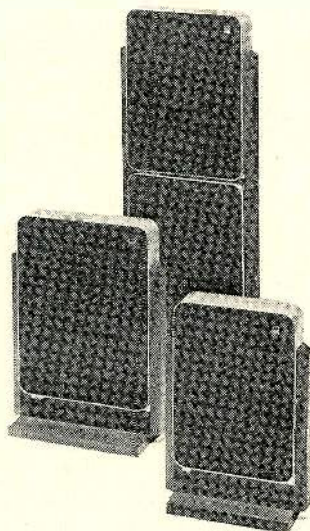

tains a single drive element for low frequencies. Overall response of the system is rated at 35 to 20,000 Hz ±2 dB. The nominal imped-

ance of the d120 is 4 ohms, and minimum recommended amplifier power is 25 watts per channel. The system has a power-handling capability of 100 watts continuous and is said to be usable with amplifiers rated up to 250 watts per channel. Two controls are provided to adjust mid-range and high-frequency levels.

Like the other B.E.S. systems, the d120 is a very shallow design (3¾ inches thick). It is framed in aluminum with dark grille cloth and supported by a solid oak cradle. Its frontal dimensions are 53¾ x 20¼ inches. Price: \$499. Other B.E.S. systems (shown) operate similarly and are priced as low as \$129.

Circle 117 on reader service card

JBL L166 Speaker System

The JBL L166 "Horizon" speaker system is constructed around a 12-inch high-compliance, low-resonance woofer, a 5-inch cone mid-range, and JBL's recently developed 066 dome tweeter. The 066 employs a phenolic diaphragm on which a thin film of aluminum has been vapor-deposited. Its voice coil is 1 inch in diameter, and it is said to have a dispersion of 150 degrees at 20,000 Hz. The system's crossover frequencies are 1,000 and 6,000 Hz. Recommended amplifier powers into its 8-ohm nominal impedance range from 10 to 150 watts per channel; power-handling capacity is rated at 75 watts "continuous program." Sensitivity for the L166 is 1 watt input for a sound-pressure output level of 76 dB measured at a distance of 15 feet. The sys-

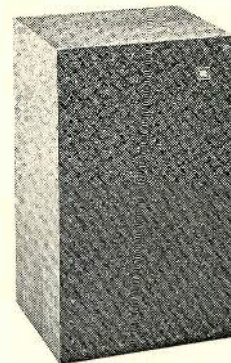

tem's cabinet is 23½ x 14¼ x 13 inches; it is finished in walnut veneers with a molded grille made of a new perforated, acoustically transparent plastic material. Price: \$375.

Circle 118 on reader service card

Onkyo Model TX-4500 AM/FM Stereo Receiver

A circuit called a "Quartz-Locked" tuning system is a prominent feature of the new On-

(Continued on page 12)



Bring home a legend.

When you go out to buy a stereo system, you'll be matching sophisticated, expensive components from a vast array of choices.

More important (because good music means a lot to you), you'll be selecting an important part of your personal environment.

So you don't want to be let down, not even a little bit. That's why the speakers you bring home should be Bose 901s.[®]

You'll be impressed with your new 901s as soon as you unpack them. They're much more compact than their performance, reputation, or price would lead you to believe, and they're beautifully crafted from fine materials.

By the time you have the system set up, you'll somehow be expecting something new and better in the music, something you've never been able to hear before.

You won't be disappointed.

You will hear an extraordinarily open, spacious sound that very effectively reproduces the feeling of a live, concert-hall performance, a sound that has been acclaimed by reviewers all over the world.

That unique sound is the result

of several interrelated technical developments.

First, the 901s are Direct/Reflecting[®] speakers. Sound reflects off the walls of the room, surrounding you with the correct proportions of reflected and direct sound, all frequencies in balance, almost everywhere in the room. In contrast, conventional direct-radiating speakers tend to beam high frequencies, limiting optimum listening area, and producing a sometimes harsh sound.

Second, the 901 has no conventional woofers or tweeters, just nine identical, 4½-inch, full-range drivers, acoustically coupled inside that very compact 901 cabinet. Coupling tends to cancel out, across all nine drivers, the small imperfections found in any speaker (ours included). The result is a smooth, life-like sound that's virtually free of distortion.

Third is the Active Equalizer, a compact electronic unit that automatically boosts power at frequencies that need a boost. This produces consistent sound output up and down the frequency range, with full, clear highs and solid, powerful lows.

The first time you listen to

your new 901s, you'll know you've brought home the right speakers. Years later you'll have the continued satisfaction of owning and using a product of uncompromising quality.

We invite you to go to a Bose dealer, listen, and compare the 901 to any other speaker, regardless of size or price. Then you'll begin to know why the Bose 901 has become something more than a loudspeaker system for thousands of music lovers all over the world.

For a full-color brochure on the 901 loudspeaker system, write: Bose, Dept. SR7, The Mountain, Framingham, Mass. 01701. Patents issued and pending.

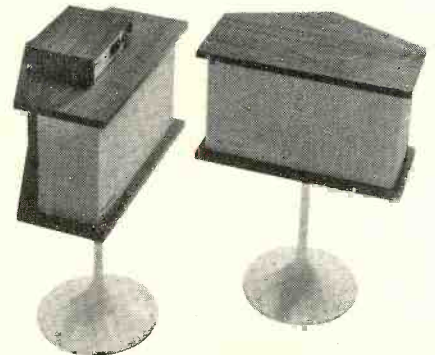

BOSE[®]

The Mountain
Framingham, Mass. 01701

"I've got a 60-minute recording studio in my pocket!"

It's called the MICROCASSETTE® PearlCorder-S®



A MICROCASSETTE recorder that's so unique, it's like having your own mini-studio in your pocket with remarkably good fidelity for music as well as voice. It's smaller than a checkbook (5¼" from top to bottom, slightly thicker than a pack of cards), and lightweight (12 ounces with batteries), but it's packed with studio precision and professional features:

- 60 minutes recording time.
- Capstan drive for constant tape speed, built-in electret condenser microphone, AC bias, record-warning light.
- All metal construction for years of dependable service.
- One-hand operation; instant loading.
- Fast forward and rapid rewind.
- Automatic level control.
- Connects to your stereo or full-size recorder with a Compicord, for both recording and playback.

The PearlCorder-S performs beautifully in an office, in your car, even on airplanes; and it's backed by the reputation of the Olympus Optical Co., Ltd., a company famous for fine cameras, medical and other precision scientific instruments.

The PearlCorder-S. Carry one. And have a studio with you.

Available at fine photographic, audio, and A-V dealers everywhere. Or write for our brochure, "Pocket Full of Miracles."

OLYMPUS CORPORATION OF AMERICA
TWO NEVADA DRIVE/NEW HYDE PARK, NEW YORK 11040

60 minutes of sound in this actual-size MICROCASSETTE.®



CIRCLE NO. 26 ON READER SERVICE CARD

New Products the latest in high-fidelity equipment and accessories

kyo TX-4500 stereo receiver. The circuit employs a highly stable quartz-crystal oscillator that functions as a reference for the 10.7-MHz i.f. frequency. It provides a correction signal as necessary to prevent drift from affecting the operation of the receiver's FM section. The Quartz-Locked system also simplifies tuning by locking onto a station even before the dial pointer has been correctly positioned. Then, when the tuning knob is released, the control circuits of the system are activated to maintain tuning.

Principal FM specifications for the TX-4500 include IHF sensitivities of 10.3 dBf or 1.8 microvolts (mono) and 19.2 dBf or 5 microvolts (stereo), and 50-dB quieting sensitivities of 17.2 dBf or 4 microvolts (mono) and 37.2 dBf or 40 microvolts (stereo). Capture ratio is 1.5 dB, and image, i.f., and spurious-response rejection are 70, 100, and 85 dB, respectively. Alternate-channel selectivity is 70 dB, and AM suppression is 50 dB. The FM



frequency response is 30 to 15,000 Hz ± 0.5 , -2 dB, with stereo separation 40 dB at 1,000 Hz and 30 dB from 30 to 10,000 Hz. Harmonic distortion is 0.2 per cent in mono and 0.4 per cent in stereo.

The power amplifiers of the TX-4500 are rated at a continuous output of 55 watts per channel, 20 to 20,000 Hz, into 8 ohms with 0.1 per cent total harmonic distortion. Intermodulation distortion is 0.3 per cent at rated output and 0.1 per cent at 1 watt. Signal-to-noise ratios are 65 dB for the phono inputs, 80 dB for high-level inputs. Frequency response of the phono inputs is within ± 0.3 dB of the RIAA characteristic, and the phono overload point is 200 millivolts at 1,000 Hz. The receiver has two sets of phono inputs, plus complete inputs and tape-monitoring and dubbing facilities for three tape decks. Up to three pairs of speakers are accommodated, playable alone or in combinations of two pairs.

The volume, tone, and balance controls are detented for precise resettability. Pushbuttons operate the various tape circuits and switch the high- and low-frequency filters, mono/stereo mode, loudness compensation, and FM interstation-noise muting. A final pushbutton is designed to connect an external Dolby noise-reduction unit into the signal path for Dolby FM decoding; the button also changes FM de-emphasis from 75 microseconds to the required 25 microseconds. Signal-strength and channel-center tuning meters are located to the left of the tuning dial; above the dial illuminated legends indicate the operation of the Quartz-Locked tuning system. The receiver is supplied with a cabinet clad in walnut-grain vinyl. Approximate di-

mensions are 21¼ x 6½ x 17 inches. Price: about \$450.

Circle 119 on reader service card

ADS/Nakamichi Mobile Stereo System

The combined effort of Analog & Digital Systems (ADS) and Nakamichi Research has resulted in a high-quality stereo cassette playback system that can be installed in a car, boat, or other vehicle and can be powered by a 12-volt storage battery or through an optional a.c. adapter. The three-piece ensemble (shown with a cigarette pack for size comparison) consists of two ADS 2002 miniature speaker systems with built-in power amplifiers and the Nakamichi 250 automobile cassette player.

The ADS 2002 is an acoustic-suspension speaker system measuring about 6¼ x 4¼ x 5 inches and incorporating a 4-inch woofer and a 1-inch dome tweeter. Frequency response is 55 to 22,000 Hz ± 5 dB, and the system has a maximum undistorted acoustical output of 104 dB at a distance of 1 meter. Within its black-anodized aluminum enclosure are separate power amplifiers for the tweeter and woofer. The former has a rated output of 5 watts continuous at 10,000 Hz into the 3-ohm impedance of the tweeter, with 0.1 per cent total harmonic distortion. A two-section amplifier is used for the woofer; it operates in a bridged configuration for increased power-output capability. Rated continuous power is 25 watts at 100 Hz into the woofer's 1.5-ohm impedance with 0.1 per cent distortion. The 2,500-Hz crossover point between woofer and tweeter is determined by two 12-dB-per-octave filters in the electronics. The amplifiers of the 2002 present an input impedance of 47,000 ohms with a sensitivity of 0.5 volt for rated output. The signal-to-noise ratio of the electronics is 90 dB.

The ADS 2002 is designed to be driven by the Nakamichi 250 cassette player, which incorporates the necessary volume, balance, and tone controls (this last is a single knob with a central "flat" position). Push keys select play, fast-forward, rewind, or stop/eject modes, and pushbuttons activate the built-in Dolby noise-reduction circuits and switch the playback equalization from standard to chromium-dioxide bias and frequency characteristics. Measured with a Nakamichi test tape, the frequency response of the playback-only deck is 40 to 17,000 Hz ± 3 dB, and the signal-to-noise ratio (chromium-dioxide equalization, Dolby circuits on) is 62 dB. Wow and flutter are rated at 0.13 per cent. The Model 250 provides power as well as drive signals to the 2002 speakers through an interconnecting cable.

The Nakamichi 250 is supplied with cable, mounting hardware, and an under-dash mounting bracket that provides maximum clearance for the cassette-loading well on the top of the unit. The bracket releases quickly to permit easy removal of the deck for securi-

ty or use elsewhere. Dimensions are 7¼ x 3½ x 9½ inches. Price of the 250 alone is \$275; the optional a.c. adapter costs \$30. The ADS 2002 speakers come with cables, mounting

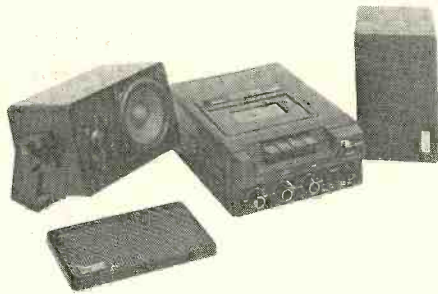

hardware, and quick-release swivel brackets. Price: approximately \$395 per pair.

Circle 120 on reader service card

SQ Four-channel Booklet

A twenty-two-page illustrated booklet titled "Spatial High Fidelity Through SQ Quadrasonic Recording and Broadcasting" has been specially prepared to answer questions about the "what" and "how" of quadrasonic broadcasting, recording, and home listening. It gives a concise, graphic description of the equipment and principles involved in CBS' SQ-matrix quadrasonic system. Included are sections on the encoding, recording, decoding, logic, and synthesizing systems that create and reproduce ambient and surround sound. Also covered is the simple conversion of a home stereo system to a quadrasonic system. Requests for the free booklet must include a long, stamped, self-addressed envelope and should be sent to Information Services Dept. SR, CBS Technology Center, 227 High Ridge Rd., Stamford, Conn. 06905.

Fuji Cassette Booklet

A free 26-page booklet available from Fuji Photo Film describes cassettes, their most effective use, and their numerous applications in non-technical, easy-to-understand language. Entitled "Cassette Tape and How to Make It Work for You," the publication describes the various types of cassette recorders and players and their features, the characteristics of good cassettes, plus professional and purely pleasurable uses for the cassette medium. The booklet concludes with a check list for cassette recording and a brief glossary of cassette terms. The booklet is approximately 3¾ x 8¾ inches and is printed in four colors on high-quality stock. Write: Audio Tape Division, Dept. SR, Fuji Photo Film U.S.A. Inc., Empire State Building, New York, N.Y. 10001.

PUBLISHER'S NOTICE: Recent fluctuations in the value of the dollar will have an effect on the price of merchandise imported into this country. So, please be aware that the prices quoted in this issue may be subject to change.



The only thing better than being there is being there again



Music. Record it right. On the only premium blank tape good enough to wear the name—The Music Tape™ by Capitol®. It's designed specifically to record music with wide frequency response, low noise and low distortion. Nobody knows music better than Capitol...

knows the subtle colors of treble, bass and mid-range.

Listen. Record. Listen. The Music Tape by Capitol takes you there again and again and again.

Capitol™



the music tape™
BLANK CASSETTES, CARTRIDGES & REEL TO REEL
BY CAPITOL®

records music

CAPITOL MAGNETIC PRODUCTS A DIVISION OF CAPITOL RECORDS, INC., HOLLYWOOD, CA

CIRCLE NO. 5 ON READER SERVICE CARD

Audio Q. and A.

By Larry Klein

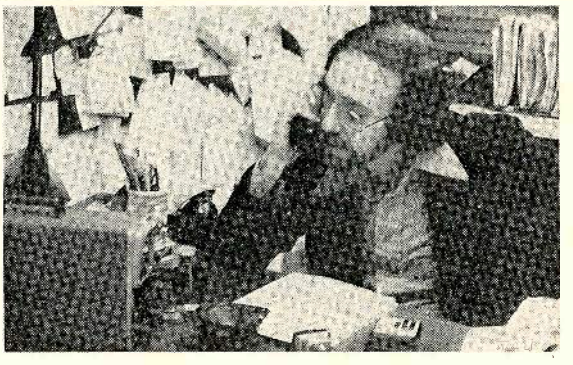

Speakers and Damping Factor

Q. What effect does the "damping factor" of a receiver or amplifier have on its performance? Is the damping factor greater if the receiver or amplifier has more power or a certain frequency response?

GRANT MAH
Oakland, Calif.

A. Of all the amplifier specifications, damping factor is probably the least understood and most worried about. Let's see if by enhancing the understanding, we can allay some of the anxiety. The damping factor of an amplifier refers only to the *source impedance* seen by a speaker at the amplifier's speaker-output terminals. This source impedance has nothing to do with the amplifier's ability to drive 4-, 8-, or 16-ohm loads, but refers only to how much effective "resistance" is in the output circuit of the amplifier.

Of what significance is this source impedance? If you were to put a single pulse of energy into a woofer, the woofer cone would be moved in or out depending upon the polarity of the signal. But whether or not it bounced about momentarily or overshot (went too far) at full excursion depends upon the damping of the system. After all, the cone is suspended on a springy compliance, and spring systems usually require some kind of mechanical damping to stabilize their performance. A low source impedance means that the speaker-cone movement will be provided with the required electrical damping.

A very high damping factor indicates that the source impedance is very low. However, for reasons having to do with the design of the speaker and speaker-output circuit, this is really of no significant advantage in terms of speaker performance. Here's why: a damping factor of, say, 20 means that an 8-ohm speaker will see a source impedance of 0.4 ohm. "Improving" the amplifier's damping factor to 200 would mean that the speaker would then see a 0.04-ohm source impedance. This turns out not to be a significant improvement because you have, in effect, the speaker's voice-coil resistance, the crossover network's resistance, plus the resistance of the wires (and possibly a fuse) between the amplifier and speaker. If these various elements total perhaps 6 ohms, then it's easy to see that any "improvement" that reduced the total series resistance from 6.4 ohms to 6.04 ohms would benefit an advertising copy writer more than it would an amplifier user. The consensus

among the experts on the matter seems to be that damping factors much above 20 or so, while they don't hurt amplifier/speaker performance, do nothing to improve it—as long as all other factors remain the same.

However, there is one little-appreciated aspect of the question that shouldn't be overlooked. It could well be that the damping factor of a given amplifier is very high at mid-frequencies (where it is rated), but it falls to very low values at low frequencies where it is most needed. This used to be true of many tube amplifiers (because of deficiencies in their output transformers), but it should never be a problem with modern transistor equipment (which doesn't have such transformers).

What effect does a lower-than-20 damping factor have? Certainly nothing very terrible; it could cause the speaker's impedance variations at low frequencies to become audible. The bass might go from "tight" to "fuller" to "mushy" depending upon where it was to start. Anyone who would like to simulate the effect of a very low damping factor can do so by temporarily installing a 10-ohm, 10-watt resistor in one side of a speaker line. Of course, the volume control will have to be turned up to compensate for the loss in the resistor, but what you hear would be what you would get with an amplifier damping factor of about 1. Under some conditions, and with some speakers, you might even like the results!

Hi-fi and RFI

Q. A so-called "ham" (radio amateur broadcaster) moved into a building about 100 feet away from mine, installed an enormous antenna on his roof, and is now transmitting Morse code and distorted voice signals into my hi-fi system. What are my rights in the matter? How do I get him to stop?

CHARLES GROSS
New York, N.Y.

A. It may come as something of a shock, but you have *no* rights in the matter, and you can't make him stop. The attitude of the Federal Communications Commission is that radio-frequency interference (RFI) problems caused by legal broadcasts from properly operating transmitting equipment is *not* the responsibility of the broadcaster; it is the responsibility of the owner of the interfered-with audio equipment to get his gear modified so that it will not respond to radio-frequency signals (the interfering ham will usually volunteer his help). And, as a matter of fact, a bill

has recently been introduced into the 94th Congress giving the FCC the right to regulate the manufacture and design of home-entertainment equipment to insure that it "includes protective components . . . which are capable of reducing interference to such equipment from radio-frequency energy."

In truth, most manufacturers of audio equipment are somewhat insensitive to RFI problems even if their equipment isn't. I also have a nearby ham intermittently CQing through my system, but long before that I was troubled by TV-signal sync buzz heard in my telephone answerer, portable cassette recorder, and phono preamp. It is self-evident that much of today's audio equipment is simply not designed to operate in a dense radio-frequency environment. And there is no question that the "airwaves" are daily getting ever more crowded with everything from the milliwatts of CB to the megawatts of radar.

It's the FCC's job to regulate the various broadcasting "services" to insure that their performance is not mutually conflicting. However, the intrusion of the FCC into non-broadcasting areas, whether or not sanctioned by Congress, makes me nervous for two main reasons. I have some literature from the FCC dealing with RFI elimination in amplifiers, and their remedial suggestions show little appreciation of audio design problems. For example, one recommended FCC fix is to solder disc capacitors across the phono-input jacks. This may or may not get rid of the RFI, but it will almost certainly cure most phono cartridges of any tendency to provide a flat frequency response.

The FCC is loaded with electronic technical experts, but I suspect that their public credentials and private concerns lie more in the radio-frequency than the audio-frequency area. (This may also help to account for the atrocious audio quality heard on the television, FM, and AM broadcast bands, but that's a subject we've covered elsewhere.) In any case, if the FCC gets involved in audio-circuit design, I suggest that vigilance be exercised by hi-fi manufacturers to prevent anti-RFI modifications that may affect audio quality from becoming legal requirements. A second concern is the question of increased component costs. True, there *are* low-cost or no-cost design changes that could be made in present-day equipment to minimize sensitivity to RFI; however, the stronger the r.f. field to be coped with, the more difficult the design task, and, likely, the more expensive the solution. Depending upon how immune from RFI the FCC demands the audio equipment be, audiophiles may or may not run into heavy additional costs. It is therefore vital that the audio industry monitor the FCC (assuming the Congressional bill becomes law) to insure that technical standards and economic good sense are maintained for the audio manufacturer as well as for the commercial, amateur, and CB broadcaster.

One further thought: I suspect that a ham who installs a large-beam antenna driven by a 1,000-watt transmitter (the legal limit) on the roof of an apartment house in a heavily populated metropolitan area is probably going to create RFI problems, at least for his nearest neighbors, even *after* anti-RFI modifications of their audio equipment. It would be fair, therefore, if the Congressional RFI bill had a rider on it that made some rules about the maximum r.f. field strength, etc., that those who broadcast as a hobby can impose on their neighbor's home electronic equipment.

TDK SA. WE DEFY ANYONE TO MATCH OUR VITAL STATISTICS.

Manufacturer	Brand	MAGAZINE A		MAGAZINE B	
		S/N Ratio Weighted in dB	Output @ 3% THD	S/N in dB (re: 3% THD)	THD at 0 dB (%)
TDK	SA	66.5	+4.2	66.0	0.9
AMPEX	20:20+	56.4	+1.9	—	—
FUJI	FX	60.0	+2.3	—	—
MAXELL	UD	—	—	58.5	1.1
MAXELL	UDXL	62.5	+2.7	—	—
NAKAMICHI	EX	60.0	+2.3	55.0	1.1
SCOTCH	CHROME	—	—	64.0	1.3
SCOTCH	CLASSIC	62.5	+2.0	—	—
SONY	FERRICHROME	64.0	+2.1	64.0	1.8

Decks used for tests: Magazine A-Pioneer CT-F9191 (cross-checked on DUAL 901, TEAC 450); Magazine B-NAKAMICHI 1000.

Two leading hi-fi magazines working independently tested a wide variety of cassettes. In both tests, TDK SA clearly outperformed the other premium priced cassettes.

The statistics speak for themselves. TDK SA provides a greater S/N ratio (66.5 dB weighted and 66.0 dB @ 3% THD), greater output sensitivity (+4.2 dB @ 3% THD), and less distortion (THD 0.9%) than these tapes.

When you convert these statistics into sound, TDK SA allows you to play back more of the original signal with less distortion and noise.

Put these facts and figures together and TDK SA adds up to the State of the Art because it provides greater dynamic range. This means cleaner, clearer, crisper recordings, plain and simple. Sound for sound, there isn't a cassette that can match its vital statistics.

Statistics may be the gospel of the audiophile, but the ultimate judge is your own ear. Record a piece of music with the tape you're using now. Then record that same music at the same levels using TDK SA. You'll hear why TDK SA defies anyone to match its sound.

Or its vital statistics.

TDK Electronics Corp., 755 Eastgate Boulevard, Garden City, New York 11530. Also available in Canada.

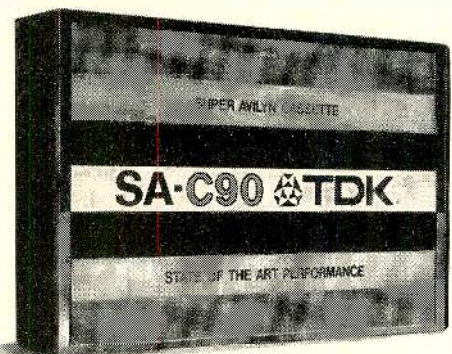

Wait till you hear what you've been missing.

By Ralph Hodges

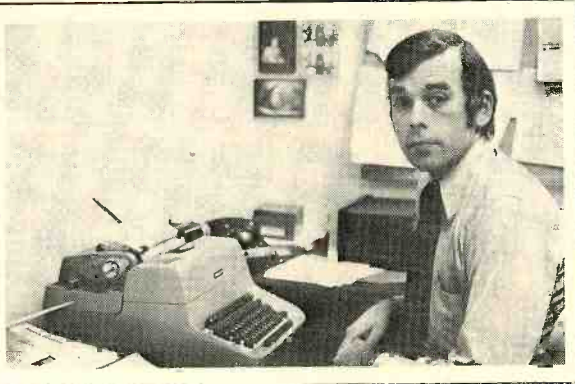

SPEAKERS: A SHORT COURSE

THERE is very likely no one—not even an established authority in the field—who has not run across an unfamiliar item of loud-speaker terminology from time to time. I recently encountered several while test-shopping local hi-fi stores. On investigation they turned out to be merely impressive names for some rather improbable concepts, but the ordinary consumer does not have my sources—or even inclination—for research into such matters, so how can he be expected to judge?

The best way to tell when you are being “handed a line”—because you’re at the mercy of an uninformed or unscrupulous salesman, or one who has the verbal talent for making a little sound like a lot—is to know *just enough* about speakers and speaker language to be able to detect the illogic in the seller’s argument. Below, in no particular order, I’ve listed a number of technical terms that appear regularly in ads and product literature, along with enough explanation to put them (I hope) in useful perspective. And just remember that a given feature can be the crowning glory of one speaker-system design and the limiting liability of another.

● **Voice coils.** Presently there are “high-temperature” voice coils, “edge-wound” voice coils, and “double-layer” and “triple-layer” voice coils, and it seems likely that there soon will be “bobbinless” voice coils. A high-temperature coil would seem to be a good choice where operating temperatures are likely to be high—perhaps because the electroacoustic

efficiency of the driver is low. Edge-wound voice coils are well suited to high-efficiency driver designs—but there are reasons why high-efficiency drivers may not be appropriate for certain speaker systems. As to coils of other types, the rule is essentially the same: application determines choice.

● **Dome-type tweeter.** Despite the glamour that surrounds this device, its main advantage is simply that the dome shape is structurally rigid, which means that the diaphragm is likelier to move as a unified whole instead of breaking up into sections that vibrate independently. This rigidity of shape is particularly important for so-called *soft-dome* tweeters, with diaphragms made of a rubberized material that has no inherent stiffness. However, if a suitably light, perfectly rigid material were available, the dome shape could be eliminated with no compromise in performance in almost every case.

Incidentally, depending on application, some speaker designers may not want an altogether rigid diaphragm, and so will turn to cone tweeters or other devices. The dispersion characteristics of a rigid diaphragm are gratifyingly predictable (one of its greatest assets), but that doesn’t mean that the designer can’t empirically determine that the generally less regular dispersion properties of some other diaphragm are suitable for his purposes.

● **Long-throw or long-excursion woofer.** A long-throw woofer is capable, when driven

with adequate amplifier power, of large linear in-and-out cone movements ranging up to perhaps half an inch or so. While this implies a correspondingly greater sound-output capability, it says little or nothing about efficiency (the amount of amplifier power needed to obtain that output) or even about linearity over the extended excursion range. Fact is, *most* high-quality speaker systems have long-throw woofers, whether specified as such or not. A prominent exception is the horn type of system, in which a long-throw design could not be particularly beneficial and is therefore not ordinarily used.

● **L-C (inductance-capacitance) crossover network.** It would be difficult to find a crossover network that is *not* made up of inductors and capacitors, except in those cases where only a capacitor is used because that is the type of crossover appropriate for the specific driver(s) involved. Factors such as crossover frequencies, slopes, and the types of inductor and capacitor used should generally be determined by the characteristics of the drivers and not according to some “ideal” of intrinsic crossover quality. This is not to belittle the art of crossover design, which can be scholarly, complex, and fruitful. But it is to say that no lay person is equipped to evaluate crossovers, and should not attempt to do so.

● **Vented or ported enclosure.** Vented enclosures (as opposed to “sealed-box” or “air-suspension” enclosures) have enjoyed a resurgence in popularity of late, probably because of the same appealing characteristic that kept them in vogue up through the 1950’s: efficiency. In a vented system the sound energy that the woofer develops *within* the enclosure is permitted to emerge (through the vent) to somewhat reinforce the direct radiation of the woofer. When the enclosure is properly “tuned,” the frequencies at which reinforcement takes place are precisely chosen and the frequency response of the overall system can thus be shaped to the designer’s liking.

The classic vented enclosure, the so-called “bass reflex,” offers about twice the efficiency of a comparable sealed-box system. But, as many manufacturers have demonstrated, a large variety of enclosure “tunings” are possible and some are sonically attractive. These newer tunings do not always have enhanced efficiency as an objective, however, so you cannot simply note that an enclosure has a hole in it and assume that large sound output will be available for small amplifier inputs. In a subject as complex as vented-enclosure design, you have to rely on the guidance of the manufacturer and published test reports to

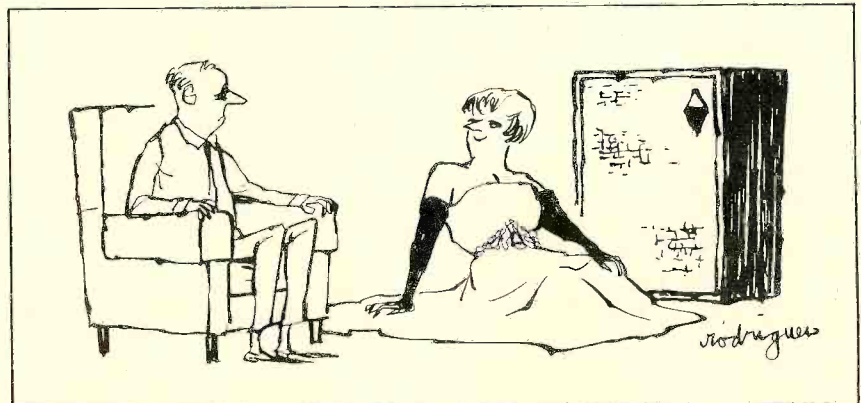

determine in each individual case what the objective was and how well it has been achieved.

● **Transmission line.** While the vast majority of vented enclosures are resonant devices, the transmission line is a vented enclosure that attempts to be totally *nonresonant*. The "line" is usually a highly absorbent duct intended to obliterate completely sound energy developed *within* the enclosure without significantly affecting the driver otherwise. This is, of course, an unrealizable goal in practical systems, but it is a perfectly valid *approach* to speaker design.

Efficiency is not one of the objectives of transmission-line systems. As a rule, their efficiency is on the order of what would be obtained with a sealed-box system using the same drivers. Other benefits provided depend entirely on the execution of the design. (Note: do not confuse transmission-line enclosures with the "wave-transmission-line" drivers sold by Ohm and Infinity. They are entirely different animals, although they have some similarities on the theoretical level.)

● **Horn-type enclosure.** Speaker systems employing horn enclosures for the woofer are offered by very few manufacturers nowadays, and they must of necessity be rather large (almost refrigerator size) to maintain output down to the lowest frequencies. They are, however, unparalleled in efficiency. Horn-type mid-ranges and tweeters are more common, but because of their high efficiency (their chief benefit) they can rarely be used at full strength with the less efficient woofers of small and medium-size speaker systems.

FINALLY, a few words about speaker specifications. The principal ones—frequency and power response, impedance, power-handling capability, minimum required power, and distortion—have already been discussed in some detail in these pages, and repetition here would be too lengthy for this "short course." But there are other specifications, not as thoroughly standardized, that inevitably enter into any serious discussion of loudspeakers. Prominent among them are factors having to do with time or phase delay, which comes about when a speaker system is measurably slower in delivering some frequencies to your ears than it is with others. This is a fairly esoteric area; the measurements involved are complex at the present state of technology, and their significance is controversial. For example, some authorities, backed by persuasive evidence, believe that the supposed advantages of a coherent-phase (nondelayed) speaker system can be heard only with coherent-phase program material, of which there is virtually none available on the commercial market. Others hold opposing views, and they have similarly impressive supporting data.

If your interest in speakers runs deep enough to take you into these waters, be aware that they are largely uncharted and that you will have to do your own navigating. Certainly, some of today's tenuous theories about loudspeaker performance may turn out to be tomorrow's established facts. However, don't be seduced by every new concept that comes along. The loudspeaker industry in particular has a long-standing penchant for taking fliers on technically intricate hypotheses based upon pure speculation or superficial testing. For every one that proves out there are at least twenty consummate myths.

The phono cartridge that doesn't compromise any modern record.

AT15Sa

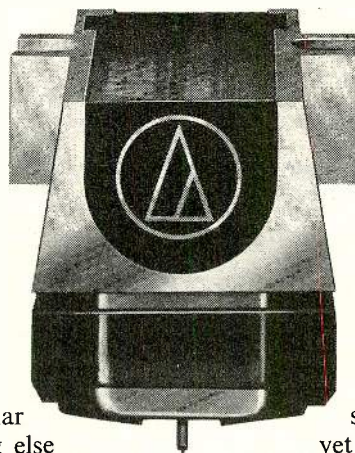

Choosing an AT15Sa can add more listening pleasure per dollar than almost anything else in your hi-fi system. First, because it is one of our UNIVERSAL phono cartridges. Ideally suited for *every* record of today: mono, stereo, matrix or discrete 4-channel. And look at what you get.

Uniform response from 5 to 45,000 Hz. Proof of audible performance is on an individually-run curve, packed with every cartridge.

Stereo separation is outstanding. Not only at 1 kHz (where everyone is pretty good) but also at 10 kHz and above (where others fail). It's a result of our exclusive Dual Magnet* design that uses an individual low-mass magnet for each side of the record groove. Logical, simple and *very* effective.

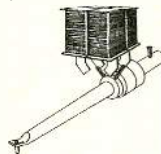

Now, add up the benefits of a *genuine* Shibata stylus. It's truly the stylus of the future, and a major improvement over any elliptical stylus. The AT15Sa can track the highest recorded frequencies with ease, works in

*TM. U.S. Patent Nos. 3,720,796 and 3,761,647.

any good tone arm or player at reasonable settings (1-2 grams), yet sharply reduces record wear. Even compared to ellipticals tracking at a *fraction* of a gram. Your records will last longer, sound better.



Stress analysis photos show concentrated high pressure with elliptical stylus (left), reduced pressure, less groove distortion with Shibata stylus (right).

The AT15Sa even helps improve the sound of old, worn records. Because the Shibata stylus uses parts of the groove wall probably untouched by other elliptical or spherical styli. And the AT15Sa Shibata stylus is mounted on a thin-wall *tapered* tube, using a nude *square*-shank mounting. The result is less mass and greater precision than with common round-shank styli. It all adds up to lower distortion and smoother response. Differences you can hear on every record you play.

Don't choose a cartridge by name or price alone. Listen. With all kinds of records. Then choose. The AT15Sa UNIVERSAL Audio-Technica cartridge. Anything less is a compromise.

audio-technica 
INNOVATION □ PRECISION □ INTEGRITY

AUDIO-TECHNICA U.S., INC., Dept. 86F, 33 Shiwasssee Ave., Fairlawn, Ohio 44313

FREE

details... A DIFFERENT KIND OF RECORD CLUB

You can now own every record or tape that you may ever want... at tremendous savings and with no continuing purchase obligations. You can get valuable free dividend certificates, you can get quick service and all the 100% iron-clad guarantees you want.

Now you can stop price increases that leave you with less music for your record and tape budget. You can guarantee yourself more music for less money through membership in Discount Music Club.

Look at these benefits:

TREMENDOUS SAVINGS

on every record and tape in print—no "agree-to-purchase" obligations of any kind.

DISCOUNTS OF 43% TO 73%

off mfg. suggested list... special catalog features hundreds of titles and artists.

ALL LABELS AVAILABLE

including most imports through special custom ordering service. If we don't stock it we'll get it for you.

SCHWANN CATALOG

lists thousands of titles; classical, pop, jazz, ballet, opera, musical shows, folk, rock, vocal, instrumental, country, etc.

DISCOUNT DIVIDEND CERTIFICATES

Dividend Gifts—Every shipment carries a dividend gift or dividend certificate. Certificates redeemable immediately for extra discounts.

NEWSLETTERS

happenings in the world of music; concerts, critiques, new releases... special super-sale listings at discounts of up to 73%.

DISCOUNT ACCESSORY GUIDE

Diamond needles, cloths, tape cleaners, etc. Discount Music Club is your complete one stop music and accessory buying service.

QUICK SERVICE

same day shipping on many orders... rarely later than the next several days. Partial shipments always made in the event of unforeseen delay... all at no extra cost to you.

100% IRON-CLAD GUARANTEES

on all products and services. Everything is guaranteed factory fresh and free of defects or damages of any sort. Your total satisfaction is unconditionally guaranteed.

Discount Music Club is a no-obligation membership club that guarantees tremendous discounts on all stereo records and tapes and lets you buy what you want... when you want... or not at all if you choose.

These are just a few of the money-saving reasons to write for free details. You can't lose so why not fill out and mail the coupon below for immediate information.

dmc DISCOUNT MUSIC CLUB, INC. DEPT. 9-86
650 Main Street, New Rochelle, N.Y. 10801

NAME

ADDRESS

CITY

STATE

ZIP

CIRCLE NO. 9 ON READER SERVICE CARD

Tape Horizons

By Craig Stark

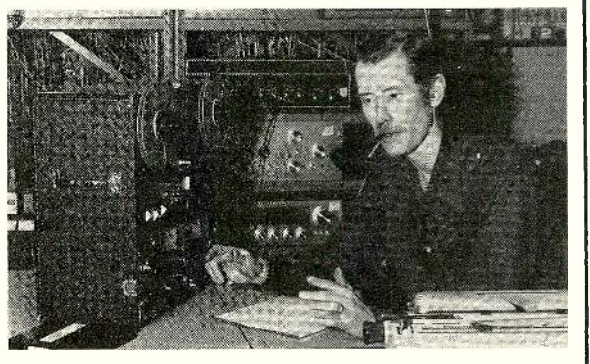

LOST IN SPACE

LAST month we saw how the length of the playback-head gap (the distance between its two parallel pole pieces, also called "gap width") could radically restrict your recorder's ability to reproduce the extreme treble frequencies. The key concept to review is that of *wavelength*, which is equal to velocity (inches of tape per second for recording purposes) divided by frequency: $\lambda = V/f$. At a given tape speed (V), then, the higher frequency (f) of the signal, the shorter is the length (λ) between each of its constituent waves. As these become so short as to approach the length of the playback-head gap, the head loses its ability to resolve them. For cassettes, this means that the optimum playback-head gap would be less than 50 millionths of an inch.

Gap losses are not the only wavelength troubles besetting the head as it plays back a recorded tape, however. Another is called "spacing loss," and, as its name implies, it arises because the head does not always make perfect contact with the moving tape. Large-scale, momentary spacing losses are self-descriptively named "drop-outs," and they are usually caused by tape defects. Less severe, but still serious, is the spacing loss that can be blamed on accumulated dirt or oxide/binder build-up on the head face, for this, too, pushes the tape surface away from the gap and causes high-frequency losses. But even with good tape and a clean head the contact is never perfect: given enough magnification, even a highly polished tape surface begins to look like a lunar landscape! And for best results, even 10 microinches of spacing may be too much.

Ten millionths of an inch doesn't seem like a lot of space, but the wavelength of the signals we want to reproduce can make it so. At 1 7/8 ips the wavelength of a 15,000-Hz tone is only 125 microinches, which turns a 10-microinch distance between the head gap and the tape surface

into a 4.4-dB loss. (The formula for this calculation, which is even more significant in what follows, is: loss in decibels = 54.6 times the distance divided by the wavelength). By comparison, the spacing loss under the same conditions at 50 Hz (where the wavelength is 37,500 microinches) is only about one hundredth of a decibel.

The spacing-loss formula above also gives us an insight into why it is that treble frequencies are often said to reside in a very thin layer at the surface of the tape. The average thickness of the oxide coating on a C-60 cassette is about 200 microinches. (Open-reel tapes have a thicker oxide layer, typically 500 microinches.) Now try to look at the oxide particles as the playback head "sees" them. Those particles right on the surface of the oxide coat can communicate their fields to the head with relatively little attenuation, whether they are magnetized at long or short wavelengths; little spacing loss is involved, even at 15,000 Hz. Those particles deepest in the coating, however, are located some 200 microinches from the gap. At this distance the spacing-loss formula gives an attenuation of 0.29 dB for a 50-Hz wavelength. But at 15,000 Hz the distance loss would be more than 87 dB! From this, then, it is clear that at the short wavelengths only those oxide particles within the immediate vicinity of the gap can make any significant contribution to the playback output. From the high-frequency viewpoint, most of the oxide coating might as well not be there at all. On the other hand, at long wavelengths (low frequencies) even deep-lying oxide particles, if magnetized (see next month!), can add importantly to the playback-signal voltage generated in the head. Since the overall output of a tape—which is going to determine its signal-to-noise ratio, all else being equal—depends on long-wavelength response, a thick oxide layer seems desirable. But even this has limits.

Four questions you must ask about any multiple-play turntable.

1. Does it perform as well as any single-play turntable?

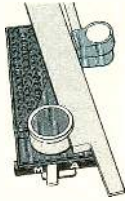

There are some who believe that a single-play turntable is somehow inherently better than a multiple-play unit. All right—the Z2000B *is* a single-play turntable. Its capacity to function as a multiple-play unit offers convenience with no compromise of performance. The *automatic* mechanism which gently indexes the arm, lifts it at the end of play, returns it to

the arm rest and shuts off the motor—is completely disengaged during record play. A 2-position control sets the proper vertical tracking angle for single or multiple play. The Z2000B can truly be called the automated, single-play turntable with multiple-play capability.

2. Does it have belt-drive and variable speed?

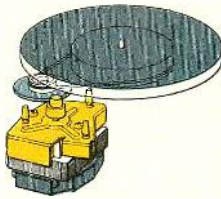

Garrard engineers have attained remarkable results by combining the world famous Synchro-Lab motor and an inventive belt/idler drive combination. A 5 lb., die-cast, dynamically balanced platter is rotated via a flexible belt. Not only are the tiniest fluctuations of speed smoothed out, but an extraordinary -64dB rumble is only one example of the im-

pressive specifications achieved. A variable speed control corrects out-of-pitch recordings and an illuminated stroboscope provides optical confirmation. The Z2000B combines all of these elements to achieve the main goal of Garrard engineering: superior performance at reasonable cost.

3. Does it handle records gently?

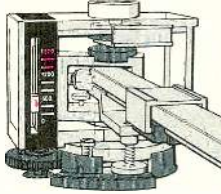

All responsible turntable manufacturers are concerned with protecting your records. With Garrard, it's an obsession. The Z2000B boasts an array of features designed solely to prolong the life of your records. In addition to the exclusive, articulated tonearm, it incorporates an exceptionally accurate magnetic anti-skating device. Cueing is viscous damped in

both directions. The ingenious built-in automatic record counter keeps track of how many LP sides the stylus has played. And unlike some of the highest priced changers that support records only at the center hole, the Z2000B supports them at the hole *and* edge, and the release mechanism operates at *both* points. Protection for your records indeed!

4. Does it eliminate tracking error?

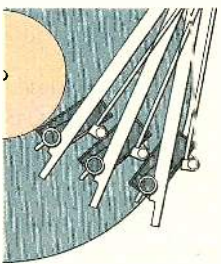

The grooves of a record are cut by a stylus that travels in a straight line. Conventional playback tonearms move in an arc. The difference between these two paths is called "tracking error." Simply stated, tracking error launches a cycle of distortion and record wear. In good design, the error is averaged over the record so that distortion is minimal. But such

compromise was unacceptable in the Z2000B. What Garrard engineers did about it was summed up by High Fidelity Magazine which described the Zero Tracking Error Tonearm as "...the best arm yet offered as an integral part of an automatic player." The Z2000B is the *only* automatic turntable in the world without tracking error.

The Garrard Z2000B. Yes. Yes. Yes. Yes.



\$229.95

Garrard
The Automatic Choice

For your free copy of the New Garrard Guide, write to Garrard, Division of Plessey Consumer Products, Dept. A, 100 Commercial St., Plainview, New York 11803

Technical Talk

By Julian D. Hirsch



● HOW TO JUDGE LOUDSPEAKERS:

Why do so many people shopping for their first good component system doubt their own ability to tell good sound reproduction from bad? I can only guess that, having been exposed for years to the miserable sounds produced by most TV receivers and portable phonographs, their critical judgment goes askew when first exposed to clean, wide-range sound. However, I am less concerned with the root causes of this situation than with trying to show how anyone can learn to tell a good speaker from a bad one and, further, how to identify the more common aberrations that affect the sound of many speaker systems.

In deference to those who “know what they like,” I will refrain from imposing my own standards of sound quality on others. But I am assuming that many others of my readers are genuinely confused by the claims and the counter-claims made for various speakers and are therefore looking for someone to guide them out of the sonic maze.

Buyers are often advised to attend live concerts and become familiar with their sound as part of the preparation for selecting speakers for a home music system. Such listening experience is always a good idea, even after your system is in operation, *but* do not expect to hear any close similarity between the sounds in the concert hall and those produced by your audio system, no matter how good or expensive it may be. The best you can hope for is a reasonably convincing illusion that the sounds you hear *could* have existed in some hypothetical hall.

Should you use the finest available demonstration records (or even master tapes, if you are lucky enough to have access to them) as a basis for judging speaker quality? They are useful for demonstrating some of the ultimate capabilities of speakers, but unless you plan to listen to this sort of material most of the time, it would be a mistake to base your speaker selection only on such

atypical program material. From time to time I play some of my best recorded programs just to see how they sound through some speaker under test. As a rule, the result reinforces my belief that the specific recording used has much more influence on the quality of the sound heard than does the speaker itself—but that is another, somewhat hassle-filled story (see the Hodges-Balgavis “Hot Platters” article in the April 1976 issue).

If you do most of your listening to FM radio or to ordinary commercial records and tapes (as I do), you should use these sources to assess a speaker's quality. Sometimes they will reveal weaknesses that might go undetected with more spectacular demonstration programs. For example, I am sensitive to the kind of mid-bass coloration that gives the male voice a heavy, unnatural quality. Few musical demo records will show this up, simply because there are no speaking voices on them. The voices of many male FM station announcers, however, make an ideal “test signal” for speaker mid-bass smoothness (say, from 80 to 200 Hz). Accurate reproduction of the voice is a severe test of a speaker's quality. Unfortunately, such accuracy is not necessarily related to the size, the price, or even some of the audio measurements usually applied to loudspeakers to judge their *musical* quality. You should be aware, however, that the voice quality

on some FM stations is already unnatural and therefore a poor tool with which to check a speaker.

What about the deep bass? It may come as a surprise to learn that it is a rare recording that contains much energy below 50 Hz. A speaker system capable of useful output at frequencies between 30 and 50 Hz is usually costly in dollars, bulk, weight, and/or the amplifier power required to drive it (though not in *all* these factors simultaneously, of course, since there can be a considerable trade-off between them). So, unless you are a pipe-organ or bass-drum aficionado, do not place too much emphasis on the low bass of a speaker system as compared with its all-important mid-range performance. (Incidentally, a great deal of what some people think of as “bass” is really at frequencies from 60 to 100 Hz, well within the capability of most small and inexpensive speaker systems. A uniform—“flat”—energy output in this frequency range is much more important than an additional octave of very low bass response.)

The mid-range (200 to 2,000 Hz, give or take a few hundred cycles) is the most important part of the frequency range simply because most of the fundamental frequency content (and quite a bit of the harmonic structure) of music falls within it. If it is reproduced unevenly, a variety of unpleasant colorations can be added to the sound. Nasality, boxiness, honkiness, and some other qualities not as easily described come to mind. To further complicate matters, almost every speaker system has one or two crossovers in this frequency range, and the possibilities for response aberrations from this source have been well publicized. However, aside from phase shifts in the crossover region, it is an indisputable fact that without a smooth middle a speaker cannot convincingly produce “natural” sound from *any* program.

Most of what we perceive as “highs” are in the frequency range of 2,000 to

Tested This Month

●
McKay Dymek AM Tuner
Sonus Phono Cartridges
Nikko 7075 AM/Stereo FM Receiver
Dual 510 Manual Turntable

10,000 Hz. This is the portion of the spectrum that is often eliminated by the neophyte's misusing his treble tone controls to convert a wide-range program to a reasonable facsimile of typical "AM quality" (apologies to the few, but ardent, boosters of AM as a high-quality medium—but I did say "typical"). Once more, smoothness is the quality to listen for in this range. A peak anywhere in the upper treble will impart a shrill and unpleasant quality to any program. A response "hole" is much less obvious unless it is unusually wide and deep. Sometimes the response is fairly smooth but slopes upward or downward as the frequency increases. It may not be heard as a high-frequency aberration per se, but altering the octave-to-octave balance of sound can give an impression either of thin bass or heavy, warm bass. Fortunately, this sort of response error is often correctible by tone controls (it is one of the few that are).

If the sound quality changes significantly as you walk back and forth in front of a speaker, it has inadequate dispersion. The speaker does not have to be

an "omni" to cover a normal listening area with a fairly uniform sound field, but it should have a reasonably constant output over an angle of at least 90 degrees facing into the room. Curves and measurements can be used to describe this property, but moving about and listening (to the high frequencies) yourself is the easiest and the best test.

Finally we come to the *extreme* highs, the frequencies that are absent from most available program material, and if present are often attenuated by the speaker itself. To me, frequencies above 10,000 Hz are the icing on the multilayer cake of high-fidelity music reproduction. The basic flavor and nutrition are in the cake itself and can be enjoyed and appreciated without the icing, but a little sweet plus-10-kHz topping certainly does add to enjoyment of the whole thing.

The sparkle and "liveness" contributed by the uppermost audible octave is easy to hear when it is added to or subtracted from the sound, but it is often not particularly obvious *without* that comparison, even to experienced listeners. It

is, further, interesting to note that the presence or absence of the highest frequencies can be detected by many people who, by standard audiology tests, have a considerable hearing loss in that frequency range.

Having gone through the frequency spectrum from end to end, I will now suggest that you avoid judging a speaker entirely on such a piecemeal basis. Instead, listen for overall balance, a sense of smoothness, and the absence of any special emphasis on a portion of the frequency range. A good speaker should not sound bassy, bright, dull, "forward," or thin. Ideally, it should be so neutral that the listener can forget it is there. Once in a while a good speaker may emit a floor-shaking thud or an airy transparent tinkle as a reminder of its capabilities and the content of the program, but most of the time you should be able to enjoy the sound without analyzing the process that created it. Leave that job to a spectrum analyzer. Your ears, with very little practice, can be more revealing than a laboratory full of instruments. Listen, and enjoy!

Equipment Test Reports

By Hirsch-Houck Laboratories

McKay Dymek AM5 AM Tuner and DA5 AM Antenna

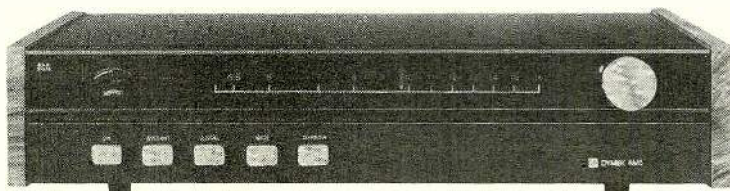

● To the high-fidelity enthusiast with a good FM tuner, the AM band seems like a quaint relic from the dark ages of broadcasting. Buzzes, whistles, and other strange sounds are overlaid on muffled, distorted programs whose upper frequency limit is probably no more than 2,000 or 3,000 Hz. The frequency range of AM broadcasts as heard from even some of the most expensive component receivers is abysmally narrow, as we have stated on more than one occasion. However, we are regularly taken to task by a few die-hard AM fans (they are frequently connected professionally with AM broadcast stations) who remind us that AM bandwidth is *not* limited by law to 5,000 or even 7,500 Hz (although few AM-tuner sections will reach even the lower of those frequencies).

Their point is well taken, but to verify it you will probably have to invest in a McKay Dymek AM5 tuner. Originally from New Zealand (where there was no FM) the McKay Dymek is a genuine high-fidelity AM tuner designed to extract the full performance avail-

able from the best AM stations. Across the top of its flat black panel is a tuning dial calibrated in 10-kHz intervals from 550 to 1,000 kHz and in 20-kHz intervals from 1,000 to 1,600 kHz. The dial scale is flanked by the tuning knob and a signal-strength meter. There are five large pushbuttons that control power, sensitivity (DISTANT and LOCAL), and bandwidth or selectivity (WIDE and NARROW).

On the rear apron are the audio-output jack and a level control, terminals for optional 150- or 600-ohm balanced-line outputs (many broadcast stations use the AM5 as an off-air monitor), and two sets of antenna connections. One pair uses screw terminals, and the other is a standard phono-pin jack. There are two a.c. outlets, one of them switched.

Although the McKay Dymek AM5 can be used "as is" with a good outside wire antenna, for best results it should be paired with the company's DA5 antenna. This is an "active" AM antenna using a 12-inch shielded ferrite rod in a swiveling and tilting housing and a tuned amplifier to boost the r.f. signals and

deliver them to the tuner at a 50-ohm impedance. The DA5 is styled much like the AM5, and it is about half its size. It has an on-off switch, a sensitivity control, and a tuning dial calibrated for the AM broadcast band. In its rear there is a 50-ohm antenna output and an input jack for an external antenna which is connected directly to the tuner when the DA5 is turned off.

The performance specifications of the McKay Dymek components are not easy for the audiophile to interpret, since no comparable tuner is available and there is no subjective frame of reference—for example, what does a sensitivity of 3 microvolts (μV) for a 10-dB signal-to-noise ratio (S/N) mean in *listening* terms? We can appreciate, however, that the audio-frequency response is down only 3 dB at 15 Hz and at 10,000 Hz in the WIDE mode, that the audio level changes less than 6 dB over an input-signal level variation from 10 to 10,000 μV , that the NARROW bandwidth is about one-third that of the WIDE mode, and that the distortion varies from 0.5 per cent at 30 per cent modulation to 1.5 per cent at 80 per cent modulation. Most of these AM specifications are normally left unstated by other AM/FM tuner manufacturers for good and obvious reasons.

The AM5 tuner is 17½ inches wide x 10½ inches deep x 4 inches high with its walnut side panels, and it weighs about 12 pounds. The DA5 antenna is 9 inches wide x 8½ inches

Introducing the world's most powerful receiver. 165 watts per channel.

With the world's least distortion. Only 0.08% THD.*

The Technics SA-5760. More power and less distortion than any other receiver in the world at rated power. And that's just for starters.

The SA-5760 also has the reserve power you need to float through complex musical passages without distortion, clipping or instability. Because we use single-packaged dual transistors in the differential amplifier stage of each channel. Along with high capacitance filtering and a bridged rectifier. There's also direct coupling and heavy power supply regulation. So transient bursts in one channel remain isolated from the other.

And you'll hear your records precisely the way they were recorded. Thanks to "current mirror loading"—a radically new circuit found in the SA-5760's phono pre-amp. The results are an unsurpassed S/N ratio of 78dB. And a frequency response that's accurate to within ± 0.2 dB of the ideal RIAA curve.

On FM, the signal being broadcast will be the signal you'll hear because we use flat group delay filters in the SA-5760's tuner section. As well as a Phase Locked Loop IC. So you'll also receive 38dB of stereo separation at 10kHz and 45dB at 1kHz. As well as inaudible distortion and a

frequency response that actually exceeds the response of FM broadcasts.

The SA-5760's controls are as sophisticated as its circuitry. Like a 26-step true attenuator click-stop volume control. Negative feedback tone controls with turnover selector. Two-way tape-to-tape dubbing. A truly linear signal-strength tuning meter for AM and FM that works the way other meters don't: accurately. And all the other refinements you'd expect from the world's most powerful receiver.

And to complement the SA-5760, Technics has five other new stereo receivers. All with excellent power. Outstanding performance. Sophisticated circuitry. And all at a good price. The concept is simple. The execution is precise. The performance is outstanding. The name is Technics.

* 165 watts per channel, minimum RMS, into 8 ohms from 20Hz to 20kHz with no more than 0.08% THD (total harmonic distortion).

Technics

by Panasonic



CIRCLE NO. 38 ON READER SERVICE CARD

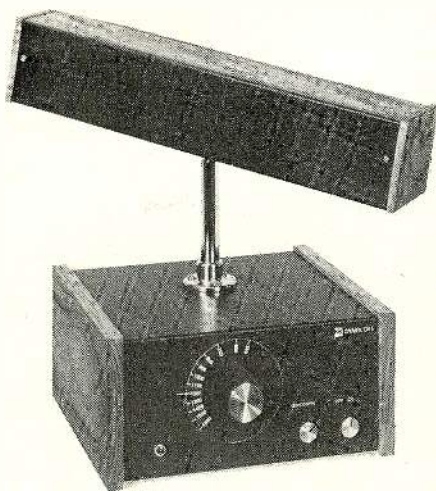

The DA5 active AM antenna.

deep x 4 inches high and weighs 6 pounds. Its antenna section is 14 inches wide and stands about 12 inches above the base of the tuning section, into which it plugs. Price: AM5 \$295; DA5 \$175. The AM8 (not tested) has the same AM performance as the AM5 and includes a 20-watt amplifier section plus a volume control and headphone jack. Price: \$320.

● **Laboratory Measurements.** The WIDE-mode frequency response of the McKay Dymek AM5 is about as close as one can come to conventional FM response within the limitations imposed by the spacing of the AM channels. It measured ± 0.5 dB from 20 to 8,000 Hz and dropped sharply at 10,000 Hz due to the action of an incredibly sharp "whistle filter" which cut interstation heterodyne squeals by 30 dB with virtually no effect on the program bandwidth. The response sloped off above 10,000 Hz to -6 dB at 11,000 Hz and to -16 dB at 15,000 Hz. In the NARROW mode, response was similarly flat, but it was down 3 dB at 5,000 Hz and dropped sharply above 7,000 Hz.

The audio output, with a 30 per cent modulated signal, increased by 7 dB as the input was increased from 10 to 10,000 μ V. The S/N—actually (S+N)/N—was an apparently unimpressive 15 dB at 10 μ V, reached 30 dB at 250 μ V, and was a constant 47 dB at 1,000 μ V and higher inputs. These values should not be compared too critically with the typical performance of an FM tuner, which is inherently very quiet at low signal levels. The signal meter, calibrated from 0 to 80 in arbitrary units, read 20 with a 10- μ V input and reached 60 at 300 μ V (it did not increase much beyond that point even with a 10,000- μ V input). In our suburban New York location, the meter read at least 60 on every signal we tuned in, and it was usually closer to 70.

The alternate-channel selectivity (which prevents interference from stations 20 kHz away from the tuned station) was about 35 dB in WIDE and in excess of 70 dB in NARROW. Stations only 10 kHz from the desired signal were attenuated about 6 dB in WIDE and 45 to 50 dB in NARROW. The DISTANT sensitivity mode was used for all measurements; the LOCAL switch setting reduced the sensitivity by 33 dB. Image rejection was unmeasurable with the available generator output but was greater than 75 dB. Unfortunately, AM distortion could not be measured due to test-equipment limitations.

● **Comment.** Our test data generally confirmed the manufacturer's specifications, with due allowance for differences in test equipment and methods. It clearly defines the McKay Dymek AM5 as a superb AM tuner that we would expect to be capable of high-fidelity performance to the extent allowed by the broadcast material. The real proof had to come in our listening tests, and these showed that, in this case at least, figures do *not* lie.

The most obvious difference between the sound quality from the AM5 and that from any other AM tuner (or tuner section) we have used was the absence of noise. There was no trace of the electrical noise, man-made or natural, that we have always associated with AM reception. In fact, the background noise between stations was lower than that of any FM tuner (with its muting off), and it was our impression that the effective S/N on received signals was also the equal of FM reception.

Fortunately, we were able to confirm our impressions by listening to a local classical-music station (WQXR) that carries the same programs on its AM and FM outlets. Switching between the audio-output signals from an FM tuner (set to mono) and the AM5, we found that the differences were very slight, actually comparable to those we have sometimes heard between different FM tuners. Much of the time no difference at all could be heard. To our surprise, the background noise on AM was at the same level as on FM; it was, in fact, usually the record or tape hiss originating in the station program material. When and if AM stereo becomes a commercial reality, we would expect the AM5 or its successor to be equally effective in the stereo mode.

At night, selective fading and co-channel interference prevent really high-fidelity reception from most stations. However, the DA5 antenna provided additional selectivity, since by orienting it correctly one could often eliminate or at least greatly reduce interference from far-off stations. On one occasion we were able to hear virtually interference-free programs from either of two distant stations, choosing between them merely by orienting the antenna.

We do have two small criticisms of the AM5, however. In the WIDE mode, since the meter reading varies negligibly over a considerable tuning range, tuning must be done by ear. This is a critical process if optimum results are to be obtained. In NARROW, the tuning is much less ambiguous (and the overall sound is still superior to just about any other AM tuner we have used). The second point concerns a small but noticeable frequency drift (at least in our sample), especially at the high-frequency end of the tuning range, during the first hour of operation.

In sum, we must admit to being convinced that AM, at its best, has the potential to be a true high-fidelity medium. However, to achieve this goal one must live fairly close to a station that broadcasts clean, wide-band sound and one must (for the present) use a McKay Dymek AM5/DA5 combination. We are told that millions of people in the United States, to say nothing of other countries, lack effective FM service. This remarkable tuner gives that audience an opportunity to enjoy the best possible radio reception, even if it is not always of high-fidelity quality.

Circle 105 on reader service card

(Continued on page 28)

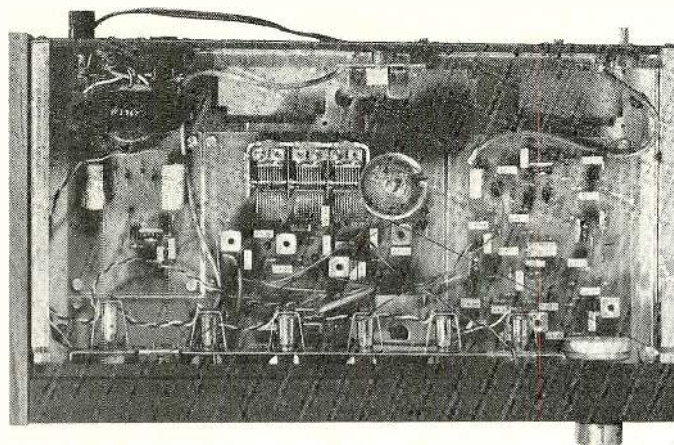

At left, the internal layout of the AM5 tuner from above. Below, the measured audio-frequency response of the tuner in its wide- and narrow-band modes.

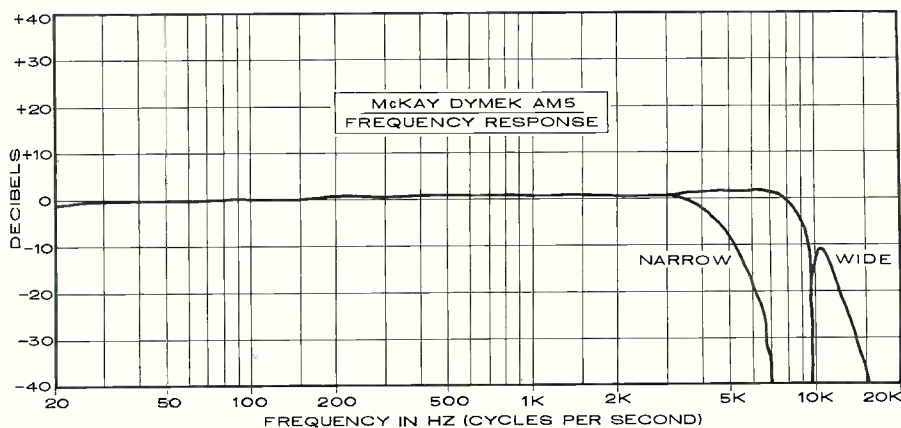

9090



How much



5050



6060



**power
do you really need?**



7070



8080

Sansui has the answer.

Power is an important element in high fidelity reproduction. But power alone doesn't make a receiver. Power is one of the many specs and features that should be considered in purchasing a receiver suited to your needs. Too much power can have damaging or detrimental side effects such as increased possibility of speaker distortion,

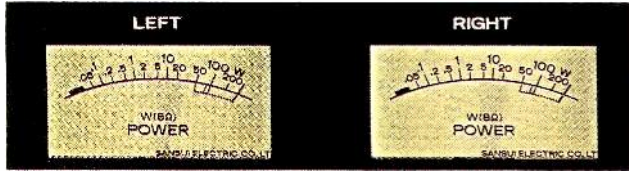

the creation of excess heat, overloaded or damaged speakers, and of course, the unnecessary cost of unused power. Not to mention the fact that speakers have maximum power ratings as well as recommended minimums. Have you checked yours?

Sansui, therefore, is proud to present a complete line of highest quality high fidelity stereo receivers with specs you can use and features you will love in a price

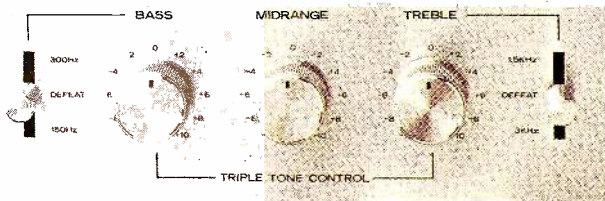

receiving Dolbyized broadcasts. From the medium priced and powered 7070, to the high end you will find Sansui's unique twin power meters calibrated into 8 ohms for monitoring power output, triple tone controls for midrange as well as bass and treble, tone defeat switch for instant flat response, and a seven position tape copy switch for two sources. Both the 9090 and 8080 are capable of handling three speaker systems for added musical pleasure.

Top of the line Model 9090 gives 110 watts per channel, min RMS, both channels into 8 ohms from 20 Hz to 20 kHz with no more than 0.2% total harmonic distortion. In addition: triple protection circuits including red to green LED power/protector indicator; precision RIAA equalized phono pre amp with wide overload capability; and an excellent

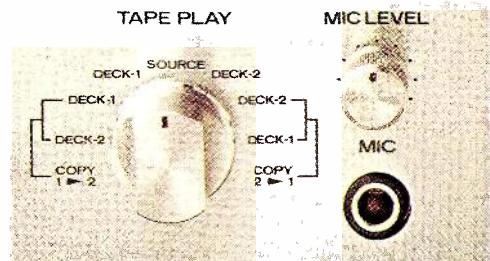

sensitivity of 9.8 dBf (1.7 μ V). Brushed anodized aluminum face plate, control knobs and buttons and a walnut veneer finished cabinet add to the elegant styling of this unit.

See and hear the Sansui 9090 or any of the other fine receivers in this complete series at your nearest franchised Sansui dealer.

* Approximate nationally advertised value. The actual retail price will be set by the individual dealer at his option.

and power range right for you. Look at what Sansui offers:

All five Sansui receivers have a special microphone mixing control for blending mic signals with any other source as well as a 25 μ sec de-emphasis for

The 9090 is a superior value at less than \$750.* If the 9090 is more than you need ask for the 8080 with 80 watts per channel, min RMS, both channels into 8 ohms, from 20 Hz to 20 kHz with no more than 0.2% total harmonic distortion at less than \$650.* Or the 7070 with 60 watts per channel, min RMS, both channels into 8 ohms, from 20 to 20,000 Hz with no more than 0.3% total harmonic distortion at less than \$520.* Or the 6060 with 40 watts per channel, min RMS, both channels into 8 ohms, from 20 to 20,000 Hz with no more than 0.4% total harmonic distortion at less than \$420.* Or the 5050 with 30 watts per channel, min RMS, both channels into 8 ohms, from 20 to 20,000 Hz with no more than 0.5% total harmonic distortion at less than \$320.* All four cabinets finished in simulated walnut grain.

Sansui. A whole new world of music.



SANSUI ELECTRONICS CORP.

Woodside, New York 11377 • Gardena, California 90247
SANSUI ELECTRIC CO., LTD., Tokyo, Japan
SANSUI AUDIO EUROPE S.A., Antwerp, Belgium
In Canada: Electronic Distributors

CIRCLE NO. 31 ON READER SERVICE CARD



is it worth to you?



7070



8080

Sonus Phono Cartridges (Blue and Red Labels)

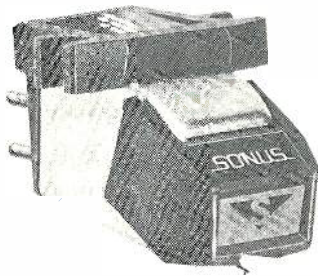

● SONIC RESEARCH, INC. may be a new name to many readers, but its principals bring years of experience in phono-cartridge design and manufacturing to the Sonus line of cartridges. The three initial Sonus products are identical except for their replaceable stylus assemblies, whose color coding identifies the cartridge model. At the top of the line is the Blue Label, fitted with a multiradial diamond tip for playing CD-4 as well as stereo and matrixed quadraphonic records. Next is the Red Label cartridge with an elliptical stylus intended for stereo and matrixed records only. The last is the Green Label, with a spherical stylus.

Except for their stylus dimensions and shapes, the cartridges carry the same specifications. The output voltage is 1 millivolt \pm 2 dB for a stylus velocity of 1 centimeter per second. For stereo applications, the recommended load is the usual 47,000 ohms in parallel with not more than 400 picofarads (pF). For CD-4 records, the Blue Label cartridge will normally be terminated by the 100,000-ohm input impedance of a CD-4 demodulator, and the shunt (tone-arm, cable, and preamplifier) capacitance should not exceed 250 pF. It should be noted that this is considerably higher than the 100-pF maximum usually specified for CD-4 cartridges, presumably because the coils of the Sonus cartridges have less inductance than most others. The rated tracking force is from $\frac{3}{4}$ to $1\frac{1}{4}$ grams, and the vertical tracking angle is the current standard of 20 degrees. These are high-compliance cartridges with a rating of 40×10^{-6} centimeters per dyne. The cartridge mass of 5 grams (not

to be confused with the stylus mass) is about as low as that of almost any magnetic cartridge we know.

The Sonus cartridge employs the moving-iron principle of transduction. Its magnetic transduction system has been designed for high efficiency and has been worked out to place the armature as close as possible to the record surface. This keeps the stylus-to-armature distance short, thus minimizing the possible effects of cantilever resonance on the performance of the cartridge. To the same end, the stylus tip is on the same axis as the armature and the pivot is at the dynamic center of rotation of the moving system. Prices: Blue Label, \$125 (available with individual calibration at \$185); Red Label, \$104; Green Label (not tested), \$88.

● **Laboratory Measurements.** We tested the Sonus Red Label and Blue Label cartridges in the tone arms of typical high-quality automatic turntables. The Red Label was loaded with 47,000 ohms and 250 pF and the Blue Label with 100,000 ohms and 150 pF.

Both cartridges tracked our high-velocity test records well at 1 gram, including the 60-micron level of the German High-Fidelity Institute record. At $1\frac{1}{4}$ grams they tracked the 70-micron level, which is a worthwhile increase in tracking ability and in our view justifies the use of $\frac{1}{4}$ -gram higher force (which was used for our other tests).

The output of the Red Label cartridge was 3.35 millivolts (mV) at a velocity of 3.54 centimeters per second (cm/sec). Playing the 400- and 4,000-Hz tones of the Shure TTR-102 record, it produced an intermodulation-distortion (IM) measurement of about 1 per cent up to 14 cm/sec. The increase in distortion at higher levels was moderate; it did not exceed 3 per cent until the very high velocity of 24 cm/sec was reached and it was only 6 per cent at the record's maximum of 27 cm/sec. The high-frequency tracking distortion, tested with the 10.8-kHz tone bursts of the Shure TTR-103 record, was also quite low, increasing smoothly from about 0.7 per cent at 15 cm/sec to 2.2 per cent at 30 cm/sec.

The cartridge frequency response with the

CBS STR 100 record was flat within ± 1 dB from 40 to 12,500 Hz, increasing by several decibels at 20,000 Hz. The channel separation was about 20 dB in the mid-range, 25 to 30 dB at 10,000 Hz, and close to 20 dB at 20,000 Hz. The low-frequency resonance in the tone arm used was at 5 to 6 Hz with an amplitude of 7 dB, confirming the high compliance of the stylus. The cartridge should probably be used in a low-mass tone arm to avoid problems when playing severely warped records (although we experienced no difficulties in this regard).

The Blue Label cartridge had slightly less output (2.4 mV at 3.54 cm/sec). Its tracking abilities seemed to be identical to those of the Red Label, and the $1\frac{1}{4}$ -gram force is also recommended for best results. The distortion measurements as well were very similar for both cartridges, and we suspect that one would find as much variation between two samples of the same model as between the two cartridges we tested. Both units had the rated 20-degree vertical stylus angle.

The Blue Label frequency response in the audio range was almost identical to that of the Red Label except for somewhat better channel separation at 20,000 Hz. We also measured response over the 1,000- to 50,000-Hz range with the JVC 1005 test record. It was flat within ± 1.5 dB up to 20,000 Hz, rose to a maximum of +10 to +11 dB at 32,000 Hz, and was still within 2 dB of the mid-range level at 50,000 Hz. The channel separation was 20 to 25 dB at 30,000 Hz and remained a strong 15 to 20 dB all the way to 50,000 Hz.

● **Comment.** A subjective check of the tracking ability of the two Sonus cartridges, using the Shure TTR-110 test record, indicated that the two were virtually identical when operated at $1\frac{1}{4}$ grams. There was a trace of mistracking on the highest level of the sibilance test with the Red Label, but the Blue Label was able to pass even that severe test. At 1 gram, the Blue Label was audibly superior, and only a slight mistracking of the maximum sibilance level kept it from earning a perfect score. The Red Label, on the other hand, sounded strained on most of the high-

(Continued on page 32)

In the graph at left, the upper curve represents the smoothed, averaged frequency response of the cartridge's right and left channels; the distance (calibrated in decibels) between it and the lower curve represents the separation between the two channels. The inset oscilloscope photo shows the cartridge's response to a recorded 1,000-Hz square wave, which gives an indication of resonances and overall frequency response. At right is the cartridge's response to the intermodulation-distortion (IM) and 10.8-kHz tone-burst test bands of the TTR-102 and TTR-103 test records. These high velocities provide a severe test of a phono cartridge's performance. The intermodulation-distortion (IM) readings for any given phono cartridge can vary widely depending on the particular test record used. The actual distortion figure measured is not as important as the maximum velocity the cartridge is able to track before a sudden and radical increase in distortion takes place. There are few commercial phonograph discs with recorded velocities exceeding about 15 cm/sec.

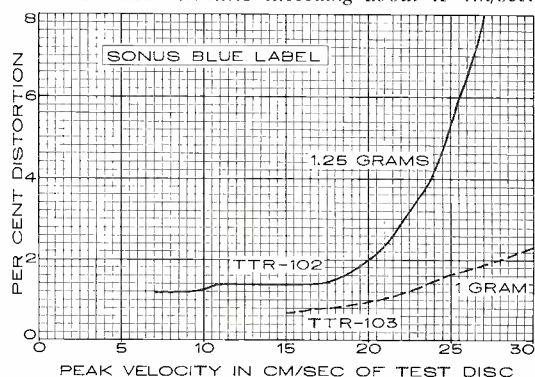
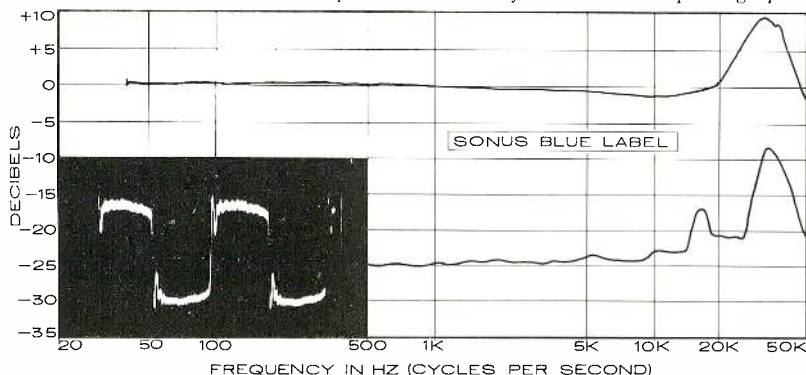

If you've got the salt, I've got the Sauza.

Nothing gets a good thing going better than Sauza Tequila. That's because Sauza is the Number One Tequila in all of Mexico. And that's because Sauza Tequila—Silver or Gold—does best all the things anybody would want Tequila to do.

Try it the classic down-Mexico way: in a shot glass, with salt and lime on the side. Or in a Margarita. Or in a Sunrise. Who knows where it will all lead?



You'll appreciate some things about Dual right away. Others will take years.

Unlike receivers and speakers, whose operating elements are completely concealed, much of what a turntable does—and how well it does it—can be easily evaluated on the dealer's shelf. The mechanical feel of the control levers, smoothness of tonearm movement and overall evidence of solidity and precision are excellent clues to the turntable's general performance.

For many consumers, their own sense of quality is all it takes to decide on a Dual. And considering the many years that Dual has been the first choice of audio experts, nothing more is really needed. However, we'd like you to know about the differences between Duals and other turntables that are not so readily apparent. The true measure of a turntable's quality and long-term reliability is not simply in its features, but is inherent in the materials used, the care in their manufacture and the quality control employed in assembly and testing.

As an example, consider the Dual tonearm. The same engineering approach is applied to all models: straight-line for maximum rigidity and lowest mass. Stylus force is set by a long coiled spring centered around the vertical pivot, and its accuracy is maintained independently of record warps or turntable level. Anti-skating, however, does change during play—automatically, to compensate for the inherent change in skating force that occurs as the stylus moves inward.

The tonearms of the five top Dual models pivot in

a four-point gyroscopic gimbal suspended within a rigid frame. Each gimbal is hand-assembled, and special gauges are used to measure lateral and vertical friction to assure that each will conform to Dual's stringent specifications. Only by such rigid quality control can tonearm calibration be set and maintained with the accuracy required by today's finest cartridges.

Every one of the component parts in Dual turntables is built with similar care and precision. For example, the rotor of every motor is dynamically balanced in all planes of motion. And the motor pulleys that drive the belts or idler wheels are individually machined and examined with precision instruments to assure perfect concentricity. Thus, the virtual absence of drive-system vibration, the primary source of rumble.

Despite all this precision and refinement, Dual turntables are designed to be rugged; they need not be babied, by you or anyone else in your family. Chances are your Dual will outlast all your other components, so you should carefully consider which of the three types of Dual you want: semi-automatic, single-play; fully automatic, single-play; automatic single-play with multi-play facility.

When you visit your United Audio dealer, don't be in a rush to decide, since you're likely to own your Dual a long, long time—and appreciate it more, play after play, day after day, year after year.



The Dual 1225.

Fully automatic, single-play/multi-play. Viscous damped cue-control, pitch-control, 10 3/4" platter. Less than \$140.00, less base. Dual 1226, with cast platter, rotating single-play spindle. Less than \$170.00. Dual 1228 with gimballed tonearm, synchronous motor, illuminated strobe, variable tracking angle. Less than \$200.00.



The Dual 1249.

Fully automatic, single-play/multi-play. Belt-drive, 12" dynamically-balanced platter. Less than \$280.00, less base. Full-size belt-drive models include: Dual 510, semi-automatic. Less than \$200.00. Dual 601, fully automatic. Less than \$250.00. (Dual CS601, with base and cover. Less than \$270.00.)



The Dual CS701.

Fully automatic start and stop, single-play. D.C. brushless, electronic direct-drive motor tuned anti-resonance filters. Electronic pitch-control (8%) for each speed, 3 3/4 and 45 rpm, with illuminated strobe. Less than \$400, including base and cover.

United Audio Products, 120 So. Columbus Ave., Mt. Vernon, N.Y. 10553

Exclusive U.S. Distribution Agency for Dual

Dual[®]

The Dual tonearm is centered within a four-point gyroscopic gimbal and pivots horizontally and vertically on identical sets of precision low-friction bearings. The metal used for the bearings is first hardened, then honed; a process which produces microscopically smooth surfaces. (Dual models with gimbal-mounted tonearms: 1228, 510, 601, 1249 and 701.)

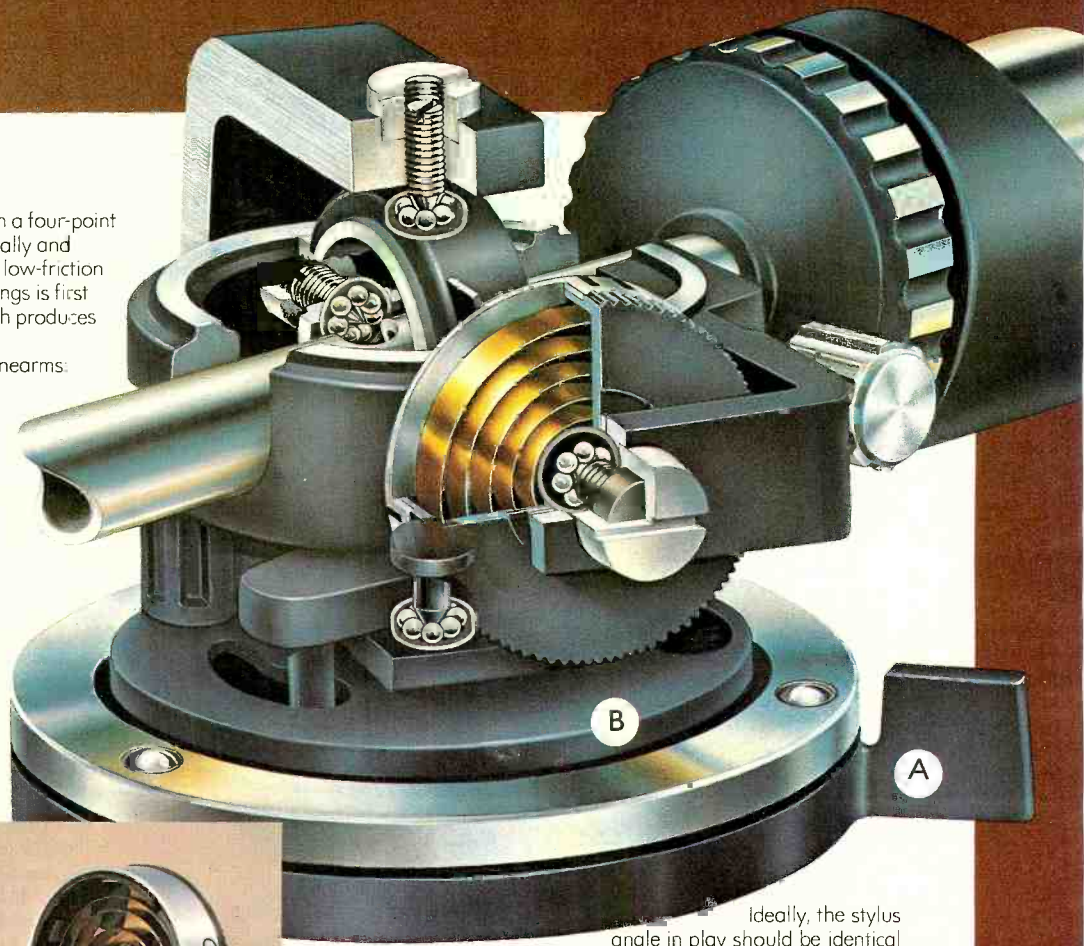

Ideally, the stylus angle in play should be identical to the angle used in cutting records. This is accomplished in the Dual 1249 by the Mode Selector (A) which moves the tonearm base (B) up or down according to the mode of play. In single-play the tonearm is parallel to the record; in multiple-play, parallel to the center of the stack.



Vario-pulley expands and contracts to vary speeds; belt is never distorted or twisted. Each Vario-pulley is precision-machined for perfect concentricity and balance. Drive belt is precision-ground to maintain speed constancy and eliminate weak spots.



Stylus pressure is applied by long coiled spring, centered around vertical pivot. This system applies stylus pressure perpendicular to record and thus maintains the pressure equally on both groove walls even if turntable is not perfectly level.

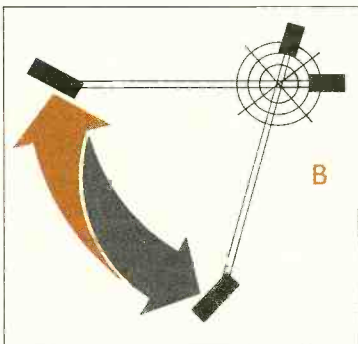
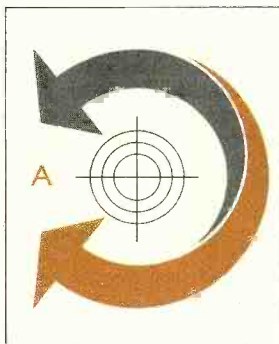

A) Dual's anti-skating system is located within the tonearm system. It applies the necessary counterforce around the pivot and directly opposite to the skating direction. B) The system also provides automatic compensation for the inherent change in skating force that occurs as the stylus moves toward the record center.



Multi-scale anti-skating provides accurate settings for all stylus types—conical, elliptical and CD-4—assuring perfectly balanced tracking pressure on record groove walls.

est-level portions of this record at a tracking force of 1 gram.

We doubt that anyone could tell these two cartridges apart in practice when they are playing stereo records (rather than test discs) at 1¼ grams. The sound is neutral and very well defined (the rising extreme top end is in most cases desirable in a phono cartridge, since very few speakers maintain their full response at those frequencies).

Playing CD-4 records with the Blue Label cartridge, we again confirmed that 1¼ grams

was necessary for distortion-free reproduction. However, at that force it delivered outstanding quality from our library of CD-4 records, the very worst of them sounding merely strained at those places where other CD-4 cartridges often break up. On most of the recent releases the sound was excellent in every respect.

Like many top-quality cartridges, the Sonus models are not cheap (although with discounting they might be quite competitive with other well-known cartridges). On the other

hand, their sound is as good as we have heard from comparable models tested recently, and often better. Even though the two cartridges sound alike, we can think of two reasons why the extra cost of the Blue Label might be justified, even if CD-4 playing is not contemplated: its tracking ability is slightly better, and (we assume) its multiradial stylus, like the Shibata and others designed for CD-4 reproduction, should produce less record wear than an elliptical stylus operated at the same force.

Circle 106 on reader service card

Nikko 7075 AM/Stereo FM Receiver

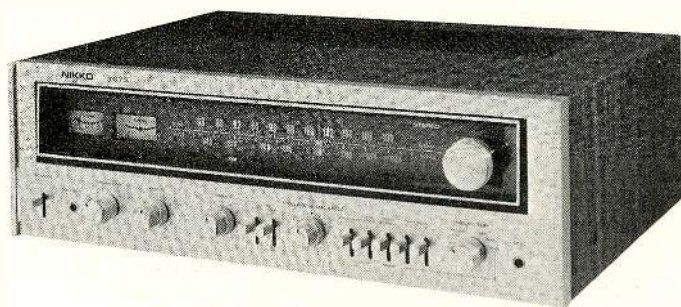

● THE Nikko 7075 AM/stereo FM receiver is rated to deliver 38 watts per channel into 8-ohm loads from 20 to 20,000 Hz with less than 0.5 per cent total harmonic distortion (THD). Its external styling is attractive and not unlike that of many other Japanese receivers. The front panel is finished in satin gold, with matching knobs and lever switches. The tuning dial scales and two tuning meters are behind a "blackout" area across the full width of the panel and are lit in blue when the receiver is on.

The tip of the plastic dial pointer is lit in yellow when either AM or FM reception is selected. A red STEREO legend is illuminated when a stereo FM broadcast is received. The large tuning knob operates a smooth flywheel mechanism. The other operating controls form a single row across the lower portion of the panel. Lever switches control POWER, LOW and HIGH audio filters, LOUDNESS COMPENSATION, FM MUTING, mode (stereo or

mono), and the TAPE MONITOR functions from either of two tape decks.

The input selector offers a choice of AM, FM, PHONO, MIC, AUX, and DUB. The last of these cross-connects two tape decks for copying from either one to the other, with monitoring capability from either deck.

A SPEAKERS switch connects either or both of two pairs of speakers or silences them for listening through headphones via the front-panel jack. The BASS and TREBLE tone controls are eleven-position detented potentiometers. The BALANCE control, which has a center detent, is operated by a ring around the VOLUME control. A MIC jack on the panel connects the output of a single microphone to both audio channels.

On the rear apron, a DIN socket duplicates the functions of one of the two sets of tape inputs and outputs. There are antenna terminals for 300- and 75-ohm FM antennas and a wire AM antenna in addition to the pivoting AM

ferrite-rod antenna. The preamplifier outputs and main-amplifier inputs are brought out separately and are normally joined by a slide switch. Nikko has chosen to mark these jacks as 2CH OUT and 4CH IN and the switch as a 4CH ADAPTOR control with 2CH and 4CH positions. Although this facility can indeed be used for conversion to four-channel operation (with an external quadraphonic decoder and back-channel amplifier), it is equally useful for connecting to an electronic crossover, equalizer, or other accessory.

Insulated spring clips are used for the speaker connections. A nice feature is the use of pushbutton-reset circuit breakers instead of fuses to protect the speaker outputs and the a.c. power line input. There are three a.c. convenience outlets, one of them switched. The Nikko 7075 is housed in a walnut-grain wooden cabinet measuring 19 inches wide x 16 inches deep x 6¾ inches high. The receiver weighs about 26.4 pounds. Price: \$399.95.

● **Laboratory Measurements.** The amplifiers of the Nikko 7075 did not become unduly warm during the standard preconditioning period. They delivered 48.5 watts per channel to 8-ohm loads at 1,000 Hz before the outputs clipped. The maximum 4-ohm output was 62.4 watts; into 16 ohms it was 32 watts. The 1,000-Hz THD was about 0.01 per cent from less than 1 watt to about 20 watts output; it was only 0.018 per cent at 40 watts and 0.035 per cent at 50 watts. The IM distortion was about 0.06 per cent from less than 50 mil-

(Continued on page 34)

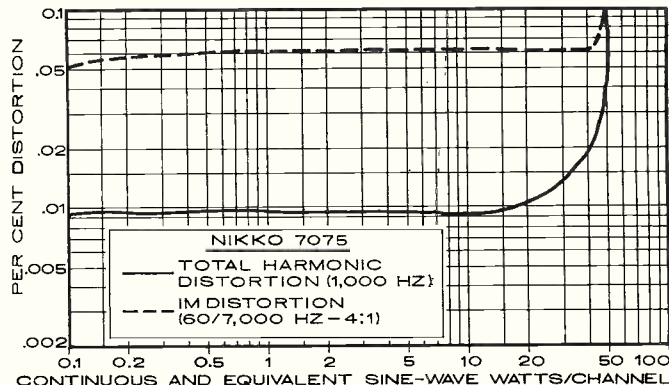
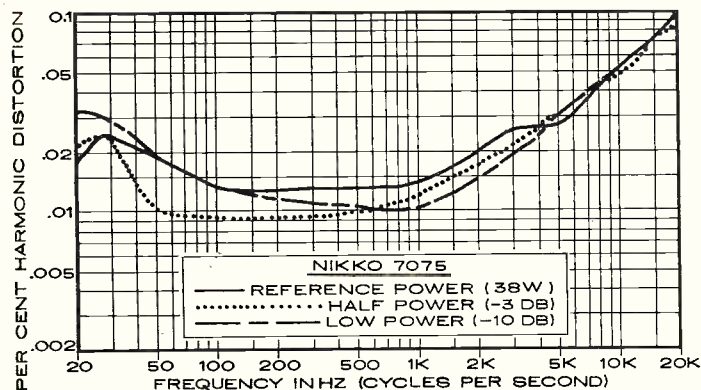

The High Profile Speaker From The Low Profile Company

With products like the new 15T, no company could keep a low profile for long—by any measure, it's a magnificent transducer system, with imposing proportions and classic lines that only hint at the performance within.

Its floor-facing cast frame woofer is loaded so effectively using 4th order Butterworth tuning plus linear phase delay elements that it can handle 1000 watt 32 Hz power surges with very little distortion!

Crossover to the 8" midrange occurs at a low 200 Hz, preventing extreme woofer excursions from intermodulating with the midrange. The result is sound that's as transparent and unstrained at full crescendo as at a whisper.

High frequencies are handled by our new "Superdhorn"—a unique design that combines the low coloration of a soft dome with the efficiency of a horn, making it possibly the most advanced moving coil tweeter ever.

The 15T's fourth driver, an adjustable rear-reflecting horn active above 2 kHz, adds a pleasingly spacious sound without compromising the transient reproduction of the carefully-phased primary radiators.

In the Cerwin-Vega tradition, the 15T is so efficient that a watt or two will drive it to a comfortable level, yet its 150 watt power rating gives it wider dynamic range than virtually any other home speaker.

Write us and we'll send you full details on the amazing 15T and our many other advanced audio products.



Cerwin-Vega
6945 Tujunga Ave., North Hollywood, CA 91605 (213) 769-4869
CIRCLE NO. 8 ON READER SERVICE CARD

liwatts to 45 watts output and 0.1 per cent at 50 watts.

At the rated output of 38 watts, and at levels down to one-tenth of that value, the THD was between 0.01 and 0.015 per cent from 100 to 1,000 Hz, increasing to 0.03 per cent at 20 Hz and to 0.1 per cent at 20,000 Hz. An 80-millivolt (mV) input at the AUX terminals, 1.7 mV at the PHONO jacks, or 1.3 mV at the MIC input was sufficient to develop a reference power output of 10 watts. The respective signal-to-noise (S/N) ratios were 82, 74, and 56.5 dB. The phono-overload level was a very good 140 mV and the microphone circuit overloaded at 120 mV.

The first two or three positions of tone control boost or cut had only a slight effect on the frequency response, but the more extreme settings had a very large effect. In fact, the maximum bass boost of 22.5 dB at 35 Hz was one of the largest we have ever measured, and it is far greater than would ever be used in practice.

The filter slopes were gradual—only 6 dB per octave—with the -3-dB response frequencies being 200 and 4,000 Hz. The LOW filter removed an undesirably large portion of the program content together with rumble or hum. The LOUDNESS compensation boosted the bass moderately and the treble slightly at low volume-control settings. The RIAA phono equalization was accurate within ± 0.5 dB from 40 to 20,000 Hz. There was a moderate amount of interaction with cartridge inductance, causing a downward-sloping frequency response when the phono input was measured through a typical cartridge coil. The loss was 1.5 dB at 15,000 Hz, and the output rose by 2 to 3 dB at 20,000 Hz. The microphone frequency response was down 6 dB at 77 and 7,700 Hz relative to the 1,000-Hz level.

The FM tuner section had an IHF usable sensitivity of 11 dBf or 2 microvolts (μ V) in mono and 18.5 dBf (4.6 μ V) in stereo. In mono, 50 dB of quieting was obtained with an input of 19.5 dBf (5.2 μ V) for 0.67 per cent THD. In stereo, it was at 36 dBf (34 μ V) with 0.47 per cent THD. The tuner distortion at a 65-dBf (1,000 μ V) input was 0.2 per cent in mono and 0.21 per cent in stereo. The S/N at that level was 70.6 dB in mono and 68.3 dB in stereo.

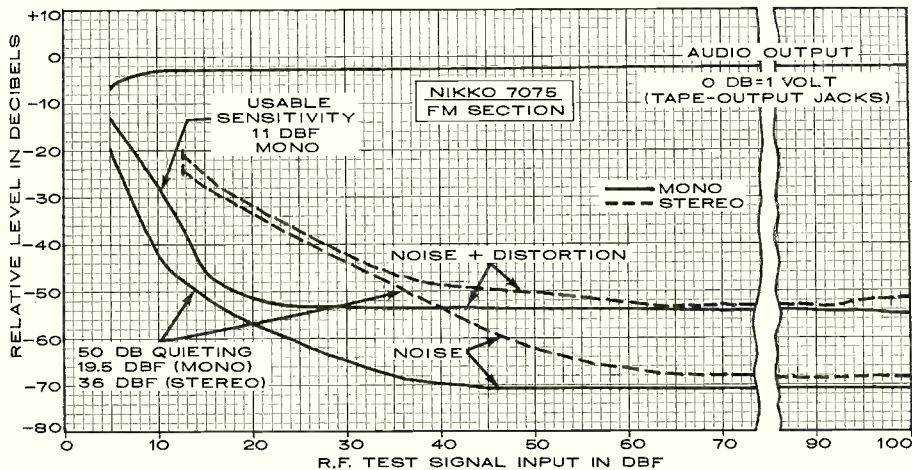

The FM frequency response was ± 1 dB from 30 to 13,000 Hz, down 3 dB at 15,000 Hz. The channel separation was very uniform—between 33 and 36.5 dB from 30 to 10,000 Hz and an excellent 30 dB at 15,000 Hz. Pilot-carrier leakage into the audio was 73 dB below full modulation. The AM frequency response was down 6 dB at 120 and 5,000 Hz.

The Nikko 7075 had very good FM interference-rejection characteristics, with alternate-channel selectivity of 75 dB and 86 dB of image rejection. In accordance with current IHF standards, we also measured the adjacent-channel selectivity (against a signal only 200 kHz removed from the desired frequency) and found it to be 5.4 dB. Although this is not an impressive figure, it does not really imply a weakness in the tuner. In fact, a high numerical adjacent-channel selectivity is almost impossible to obtain without severe compromise of the tuner's distortion and stereo-channel separation characteristics, and the performance of the Nikko 7075 in those categories is above reproach. The FM capture ratio of 1.6 dB and the AM rejection of 73 dB are both indicative of good performance potential under multipath reception conditions. The FM muting took place smoothly between 5.5 and 11 dBf (1 to 2 μ V) input, and the stereo switching threshold was at 12.5 dBf (2.3 μ V).

● **Comment.** The test results clearly show that the Nikko 7075 has an exceedingly good audio amplifier in combination with a first-rate FM tuner section. It would be difficult to surpass the low-distortion properties of the receiver in these two basic categories without moving into a much higher price range.

We were less impressed with the tone controls, principally because of the way they "came on" so strongly at the extreme settings, with almost no effect at intermediate settings. Anyone using the full bass boost could easily overdrive the unit's amplifier.

The real quality of the Nikko 7075 becomes evident in actual use. Its FM dial calibrations, in spite of the undesirably wide 2-MHz spacing between markings, was very accurate, so that we had no difficulty tuning to any desired frequency without the ambiguity that exists with an inaccurately calibrated dial (no matter how many markings it has). The muting operated without noise bursts and only a slight thump. The subjective FM background hiss was lower than we have heard on some comparable receivers operating from the same antenna system. All the controls worked smoothly and positively, and the receiver conveyed an unmistakable impression of solid, precise construction.

Circle 107 on reader service card



Dual 510 Manual Record Player

● THE Dual 510 is a two-speed (33 $\frac{1}{3}$ and 45 rpm) manual record player with an automatic shut-off and arm lift at the end of play. Its 12-inch, 3-pound cast-aluminum platter is belt-driven by an eight-pole, 900-rpm synchronous motor. The speed is changed by a lever on the motorboard that physically shifts the belt to a different drive-shaft diameter. A concentric vernier speed control with a nominal range of ± 3 per cent operates by expanding a section of the drive shaft, thus varying its effective diameter. The edge of the platter carries stroboscope markings, cast in relief, which are illuminated from below and can be seen while a record is being played.

Dual has designed the 510 for utmost simplicity of operation. The success of this effort can be appreciated from the fact that its only operating controls are the speed selector and a cueing lever. When the arm is on its rest, the cueing lever is in its "up" position. Picking up the arm by its conveniently shaped finger lift turns on the motor. When the arm has been placed over the desired point on the record, pushing the cueing lever to the rear lets the pickup descend slowly. It can, of course, be lifted at any time, and the action of the cueing system is smooth and damped in both directions of arm movement.

At the end of the record, the cueing device automatically lifts the arm and the motor shuts off. The arm must be returned manually to its rest, but this can be done by a simple lateral push on the arm since it is safely support-

arm base is the anti-skating dial with separate scales for conical, elliptical, and CD-4 styli.

Two types of mounting bases (wood and molded plastic with wood-grain finish) are available for the Dual 510, and there is a choice of low-profile or high-profile tinted plastic dust covers that will remain open at any angle. Mounted on the LB-19 base (plastic) and fitted with the DC-6 low profile cover, the Dual 510 is 16½ inches wide, 14¼ inches deep, and 6 inches high; it weighs 14½ pounds. Price: 510, under \$199.95; LB-19 base, under \$15.95; DC-6 dust cover, under \$13.95.

● **Laboratory Measurements.** At the 1-gram tracking force used in our tests, the calibration of the dial on the Dual 510 was exact. At settings of 2 and 3 grams, the actual force was within 0.05 gram of the indicated value.

At 33½ rpm, the vernier adjustment had a range of +3.4 to -4.2 per cent. When the 33½-rpm speed was set exactly, the 45-rpm speed was 0.8 per cent fast. The vernier control had a range of +1.25 to -1.5 per cent at 45 rpm. The speed was not affected by line-voltage shifts from 95 to 135 volts.

The combined wow and flutter measured 0.04 per cent (unweighted rms), and our spectrum analyzer revealed that the speed variation was predominantly in the vicinity of 5 Hz. The unweighted rumble was -32 dB including vertical components, and it was -35 dB with the vertical rumble cancelled out. With ARLL audibility weighting, the rumble was a very low -61.5 dB.

The anti-skating compensation was approximately correct when its dial was set to agree with the tracking-force dial. The tone-arm geometry was so good that tracking error was difficult to measure. Except at a 2.5-inch radius, where it was still a very good 0.4 degree per inch throughout. The capacitance of the arm wiring and the signal cables supplied was 165 picofarads per channel, but low-capacitance signal cables can easily be substituted for those supplied with the player if desired. The low-frequency arm resonance with a good high-compliance cartridge was at 7 Hz, amplitude 7 to 8 dB. The cueing device lowered the arm in 3 to 4 seconds with no outward drift.

The isolation from external vibration afforded by the spring suspension of the Dual 510 was average—approximately the same as we have measured on other Dual models as well as most competitive players. With normal precautions taken in installation, no difficulties should be experienced from acoustic feedback.

● **Comment.** At a time when cosmetic decoration and "gimmick" features abound in consumer products of all types, we find the simplicity of the Dual 510 to be most attractive. This moderately priced record player is exceptionally easy to use, and its basic simplicity should pay dividends in long, trouble-free service. The automatic indexing aid is highly effective and useful (although, if the arm is cued in the usual manner instead of being pushed laterally across the lift bar, one would never suspect its presence).

The measured performance of the Dual 510 speaks for itself, and obviously places this unit in the same class with a number of much more expensive products, including many of the direct-drive record players we have seen.

Circle 50 on reader service card

Introducing an evolutionary idea.

Great ideas never change radically.

Instead, they are constantly being refined to become more relevant with time.

So it has been with Empire turntables. Our latest model, 698, is no exception. Basically, it's still the uncomplicated, belt-driven turntable we've been making for 15 years. A classic.

What we're introducing is improved performance.

The lower mass tone arm, electronic cueing, quieting circuitry and automatic arm lift are all very new.

At Empire we make only one model turntable, the 698. With proper maintenance and care the chances are very good it will be the only one you'll ever need.

For more information write:
EMPIRE SCIENTIFIC CORP.
Garden City, New York 11530

The New Empire 698 Turntable



EMPIRE

Already your system sounds better.

CIRCLE NO. 99 ON READER SERVICE CARD

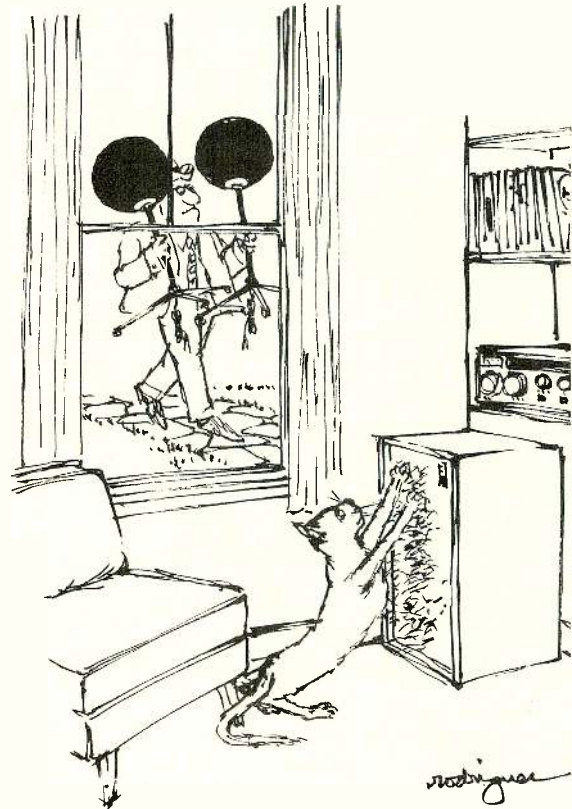

ed above the record. The 510 also features a uniquely simple yet effective arm-indexing device. When a small lever on the motorboard is set appropriately, a slight detent action can be felt at the lead-in diameters corresponding to 12- and 7-inch records when the arm is pushed horizontally. When the detent is felt, the cueing lever is merely flipped to the rear to begin playing. If the automatic indexing is not desired, it can be disabled by its control lever.

The tone arm of the Dual 510 resembles those of the company's other record players. It is a straight, low-mass aluminum tube whose offset head accepts a plastic cartridge-mounting plate. The gimbal pivot structure uses identical low-friction bearings for both vertical and horizontal arm motion. The counterweight has an elastically mounted section for damping arm resonance. Tracking force is applied by a dial on the side of the pivot structure; it is calibrated from 0 to 1.5 grams in 0.1-gram intervals and from 1.5 to 3 grams in 0.25-gram intervals. On the motorboard next to the

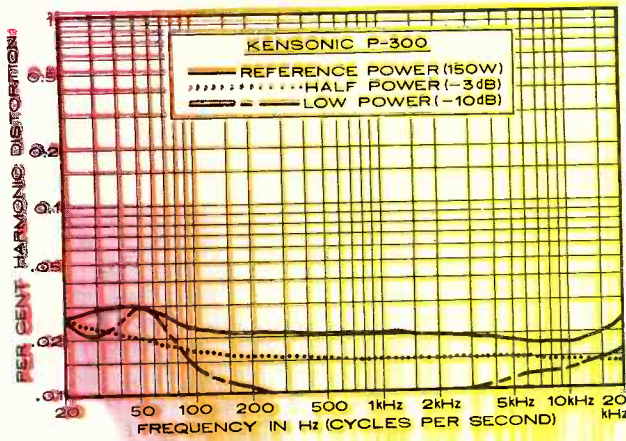

HARMONIC DISTORTION. "An input signal of 0.2 volt drove the amplifier to a reference 10-watt output at maximum gain. We could not measure the output noise, which was less than our minimum meter reading of 100 microvolts (roughly -100dB referenced to 10 watts)."

TOTAL HARMONIC/IM DISTORTION. "With regard to the sound quality of the two components, since they add neither noise nor distortion, there is little to be said."

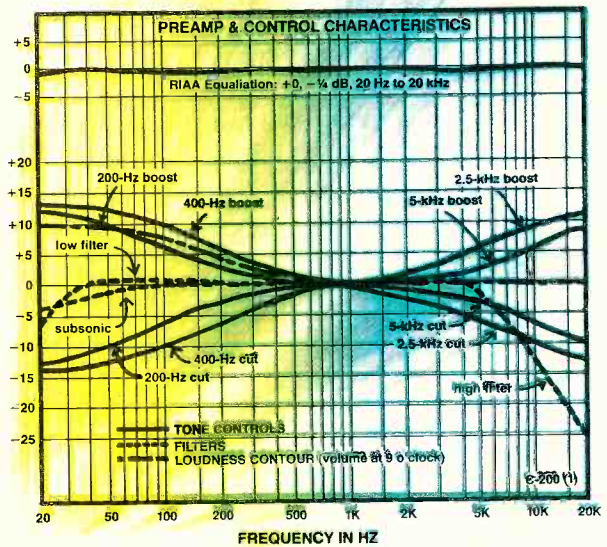
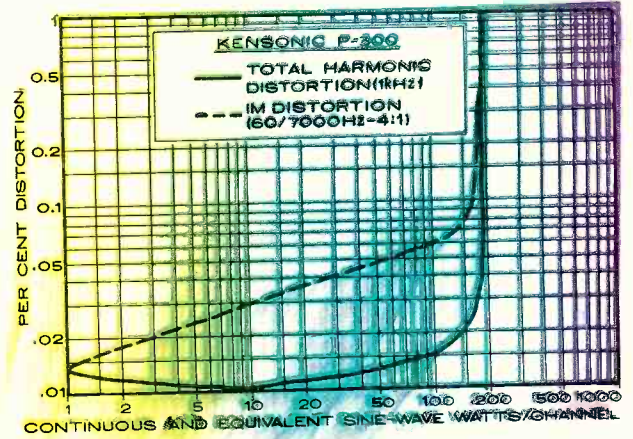

PREAMP & CONTROL CHARACTERISTICS. "The tone controls and filters are more effective than most."

"If you are looking for the proverbial 'straight wire with gain,' this combination meets all the requirements."

Hirsch-Houck Laboratories wrote that headline over a year ago. Since then, quite a number of independent laboratories have attested to the uncompromising quality of Accuphase.

We've assembled them for you in a free 36-page booklet. It's the second most informative way you can learn about these superb stereo components.

The best way is to audition them yourself. Then you'll understand why the critical acclaim has been as impressive as the product itself.

Accuphase

Going on Record

By James Goodfriend

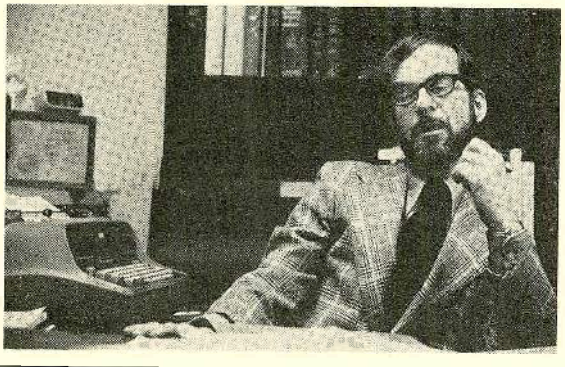

CROSSING OVER

THE classical rip-off has become so prevalent in American popular music that it might just as well be considered a subcategory of music rather than a mere aberration. Certain performers, of course, still try to take compositional credit for the music they have stolen—though Emerson, Lake and Palmer just *happened*, of course, to come up with the same notes, chords, and rhythms for their *Barbarian* as Béla Bartók did for his *Allegro Barbaro*. But at least as many others are generous enough to *share* the credit, feeling, perhaps, that the currently commercial names Bach, Fauré, and Pachelbel will add the same measure of “class” to their productions as the names Tchaikovsky, Rachmaninoff, and Chopin did to the songs of an earlier generation. It is a moot point, but obviously there is something here worth investigation.

Classical rip-offs have often enjoyed considerable commercial success and popularity in themselves, but no one has yet produced any evidence that they lead to any general interest in the music of those composers from whose works they derive. The only real beneficiaries of the appropriation are the rip-off artists themselves, for they get both the musical material and the “derived from the classics” aura at no cost. The original composer (whose work is invariably out of copyright) gets neither payment nor public interest, and the public itself gets only the single selection it pays for rather than any introduction to a new treasure trove of musical enjoyment. However much they might need both the material and the “class,” though, one would think that a monetary saving would be, for successful rock groups at least, a matter of little or no importance. If I am correct in that conjecture, then I have what may be an eminently practical and profitable (if slightly revolutionary) suggestion.

Why rip off only *dead* composers? As a matter of fact, if money is *not* the object, why rip off anybody at all? We have, on the one hand, a number of rock and other pop groups who command large audiences and possess ample money. We have, on the other hand, several hundred (at least) living, serious composers who command considerable critical approbation and prestige but very small audiences indeed, and who, were it not for foundations and universities, would hardly have even the proverbial pot. Why not bring the

two together? Let the rock groups *commission* the composers to write new works specifically for them. This would *add* new works to the repertoire, rather than subtracting old ones, which is the effect the rip-off process frequently has. It would give the groups the measure of intellectual prestige they desire, and put them, in company with cardinals, kings, dukes, and perspicacious classical performers, in the category of patrons of the arts rather than petty thieves. It would give the composers the hard cash many of them so sorely need and—perhaps more important—a *real audience to write for*. Granted, some of them would not be able to meet that challenge, but then perhaps they shouldn't be composing in the first place. It would also give audiences something to look forward to rather than backwards on.

The idea has its possibilities. Gershwin, after all, wrote a pretty good piece for Paul Whiteman back in the Twenties. Stravinsky wrote another for Woody Herman in the Forties. Nobody fox-trotted to *Rhapsody in Blue*, and the *Ebony Concerto* offered no opportuni-



ties for jazz improvisation, but that didn't keep the Whiteman Band from remaining a successful dance and (sometimes) jazz band, nor the Woody Herman Herd from being an ever-renewable fixture in the developing world of jazz. The *Rhapsody* and the *Concerto* were *other* things they could and did do, and they brought both organizations additional public interest and approval. So why not a piece by Ralph Shapey (who reportedly has begun composing again) for the Rolling Stones? And why shouldn't Elton John commission something from Michael Tippett? Would George Crumb write for Pink Floyd? John Cage for Alice Cooper? Lester Trimble for Chicago? Alan Hovhaness for Oregon? Leave the dead in peace. Support the living.



New World Records has just released its first ten discs of American music, a fact that would be of considerable interest to collectors were it not that the records, at least for now, are not available to be bought. New World Records is the company set up by the Rockefeller Foundation to produce a set of one hundred discs that would systematically and fairly survey the whole of American music, taking some of its material from the archives of commercial companies and newly recording the rest.

The set of records is to be donated to certain libraries and educational institutions and made available at cost to others. The option of purchase by private individuals has not yet been investigated. It is senseless, therefore, to *review* such records in a consumer magazine, but it would be equally silly to ignore them completely. Hence, this note.

The initial release includes a record of American art songs, impeccably selected from old 78's and annotated by Philip L. Miller, and one of experimental piano music by Cowell, Cage, Johnston, and Nancarrow, the first three brilliantly performed by Robert Miller, the last recorded from the composer's own player pianos. There is a newly recorded disc of “music of the American Revolution” which seems to me to involve some rather odd choices and omissions, and which places the fife and drum ensemble in an inexplicably resonant ambiance. Also, a quite interesting disc of “country ragtime music,” selected from old 78's, stretches the definition of ragtime far beyond what we are accustomed to today, perhaps even beyond the bounds of a useful category. Additional records include newly recorded ones of works by Charles Griffes, of American Indian music, of classical American marches by the Goldman Band, and of nineteenth-century American concert organ music. There is a record of bebop taken from commercial recordings of the Forties and early Fifties, and a composite, essentially complete, recording of Sissle and Blake's 1921 revue *Shuffle Along* ingeniously put together from a variety of separate 78-rpm discs featuring a variety of performers, including the composers.

The transfers from old recordings seem generally fine, and the new recordings, apart from such minor lapses as the one mentioned above, are also good. Annotations on these records are extensive, exhaustive of the subject matter, and even, sometimes, nicely written as well. The packaging, though, is institutional in the extreme (different type faces for different albums provide the only variety), tombstone dull, and just made for the library shelf where the albums are destined to rest.

The Simels Report

By Steve Simels



THE SURVIVING BEATLE—AND OTHERS

WENT into Paul McCartney's recent New York concert cynical and determined to have as bad a time as possible, but I came out almost ecstatic. In the sober light of day that still amazes me. After all, the Beatles were once the whole ball of wax for me, and though I certainly haven't given up on rock-and-roll since they disbanded, I think everyone pretty much accepts the fact that there's nobody else around now who can do what the Beatles did—exceed one's highest expectations with each new release. All the more distressing, therefore, for an unreconstructed Beatle-maniac like myself to have to contend with the bulk of Paulie's Seventies output. Yes, he's made some good singles, most notably *Junior's Farm*; yes, I like isolated cuts on "McCartney" and "Wildlife"; and yes, I even think that most of "Band on the Run" is quality stuff. But "Ram" drives me up a wall, and the bulk of what's on "Red Rose Speedway" and the last two albums is about as bland as you can get. And I'm not about to forgive him for giving domesticity a bad name either.

But in concert? Well, all I can say is that, confronted with that voice, with that effortless, superb musicianship, with all those half-remembered Liverpudlian Beatles mannerisms, I reverted to the most shameless of adoring teenagers—he's so goddamned *endearing* that you can forgive him anything. Quite apart from that, the simple truth is that Wings, as a performing unit, are about a zillion times better than their records lead you to believe. They made the most banal of McCartney's recent songs sound like the work of genius, and I suspect that this had less to do with my awe at seeing a real live Beatle on stage for the first time than with the fact that this is a very hot little band, and nostalgia certainly has nothing to do with that. They rock as hard as anybody (McCulloch and Laine play marvelously aggressive guitars, and the bass work is splendid) and they have one of the strongest lead singers in the business. In fact, I think that's what amazed me most: after a long and grueling tour, Paulie can still belt it out the way he does in the studio (which, if you've ever heard any of the live Beatles bootlegs, you know was not *always* the case).

A few observations in passing: the crowd was surprisingly young and very near hysteria

through most of the show (it really did look like Beatlemania at times, so eat your heart out, Bay City Rollers); Paul did his newer stuff almost exclusively (no one seemed to mind, although the reaction to *Yesterday* seemed to be the most enthusiastic of the evening—personally, I got chills); I have not sensed such downright *friendly* vibes at any rock event in recent memory; and I would not



LINDA AND PAUL
Giving domesticity a bad name?

hesitate to go see the show again (I'm almost annoyed that I couldn't go back for the second night). Still . . . given that Capitol's impending Beatles reissue plans are probably going to be hugely successful (what a pleasure it's going to be to hear *Got to Get You into My Life* on AM radio), and given that Paul has finally proved to his own satisfaction that he Still Has It, I live in the unfashionable, unrealistic hope that the time is now right for Our Boys to get together again, if only on a temporary, studio basis. Wings are wonderful (and I'm delighted that McCartney has had the honesty to just get out there and play), but *they aren't the Beatles*.

MOVING from the sublime to the ridiculous, I'd like to put my two cents in about the current media focus on the New York Rock Scene, which embarrassingly refuses to die. I'm getting fed up with opening rock magazines and being assaulted with reports about the latest avant-garage sensations appearing at C.B.G.B.'s (they are generally written by personal friends of the band members). I mean, I *like* Patti Smith, but by and large we've been treated to some truly trivial music and a barefaced hype so brazenly self-serving as to make one nostalgic for MGM's quaint "Bosstown Sound" promotion of the late Sixties. The New Liverpool indeed.

For those out-of-towners who are still curious, let me observe that the New York Dolls, who started the ball rolling, have gone from being an incompetent pastiche of the Stones to being a competent pastiche of the J. Geils Band, which is hardly progress; that Television has the single worst rhythm section in the history of rock-and-roll; that Talking Heads have nothing going for them but two guitarists who look, respectively, like Lou (yawn) Reed and a slightly plumper Marianne Faithful; and that the Ramones, who have actually wangled a record deal and were glimpsed recently embarrassing the hell out of everybody on a double bill with the superb Doctor Feelgood, make the 1969 Stooges sound like the Philadelphia Orchestra. My only consolation in all this is that the various writers and critics responsible for perpetrating this hoax on the folks are going to look pretty silly come Up-pace Morn, since the teenage audiences outside the Big Apple are unquestionably going to treat these bands to the same blank stare that so quickly withered the Dolls as a commercial venture.

I WOULD also, at this juncture, like to say God Bless the King Biscuit Flower Hour, and not merely because they have made it possible for a horde of enterprising bootleggers to immortalize some really high-quality rock performances. It's simply that, in an era when most "progressive" FM radio is so tightly playlisted, formulaic, and plain boring as to make the AM screamers of yore seem like an attractive alternative, and when rock-and-roll on television has degenerated into an endless succession of appearances by such noted rockers as Helen Reddy and Paul Anka, the Biscuit and its various spin-offs (the British Biscuit, their new interview show) provide just about the only reason for listening to anything but records these days. Their artist roster has been gratifyingly catholic (would you believe that their first show, four years ago, featured Bruce Springsteen?), the presentations are invariably faithful to the artists' intentions, and many of them have been superior to the live albums these same artists have released.

Finally, I would like to alert you to one of the marvels of the age: Keith Emerson, the man who made Wretched Excess a household phrase, has made a good record. He has recently released—as yet only in Britain, but that should change shortly—a version of Meade Lux Lewis' old boogie-woogie show-piece *Honky Tonk Train Blues* that is relatively faithful to the original (he adds a Forties swing band, which doesn't bother me), credits the composer (!), and, for once, puts his famous fingers to some meaningful musical use. Staunch ELP fans will undoubtedly detest it, but I urge the rest of you to *act now*.

The new Sherwood S7910: State-of-the-Art for under \$500.*

In the past few years, good specifications have become a relative commonplace in the consumer electronics industry.

And, as the statistical gaps between comparably priced units lessened, other factors gained more importance. Most notably, design and the componentry that's used.

Nothing could suit us better. For twenty-three years, the strength of our reputation has rested primarily on the excellence of our engineering.

The new S7910** is a case in point.

With a power output of 60 watts per channel [minimum RMS at 8 ohms from 20-20,000 Hz] with no more than 0.1% Total Harmonic Distortion, the S7910 is clearly equipped to serve as the center point of the most progressive music systems.

More to the point, though, is the componentry that permits this capability. The output devices are paralleled OCL direct-coupled. This configuration, combined with the high voltage and current ratings of the output devices, creates an extremely stable circuit. Additionally, the massive power transformer and twin 12,000 μ f filter capacitors, backed by a zener regulated secondary power supply, ensure the S7910's ability to perform well beyond the demands of normal use.

The S7910's IHF FM Sensitivity rating is 9.84 dBf [1.7 μ V]. That's one of the finest ratings attainable—and it can only be achieved through the utilization of superior componentry. 4-ganged tuning capacitors. Dual-Gate MOS FET's. Phase Lock Loop MPX. Ceramic FM IF Phase Linear Filters. And Sherwood's newly-developed digital detector, which introduces virtually no distortion to the signal and never requires alignment.

The front panel of the S7910 reflects every significant function of current hi-fidelity technology. And again, the componentry behind the faceplate is the finest available. [For example, the 3-stage Baxandall tone circuit employed for the Bass and Treble controls.] Other features, such as the Master Tone Defeat switch, switchable FM deemphasis and FM Stereo Only, and two front panel tape dubbing jacks, contribute to an operational versatility that is truly outstanding.

In every respect, the S7910 demonstrates the attention to detail, the on-going effort to refine existing solutions and discover better ones, that has characterized Sherwood throughout the years.

You might be able to find another receiver in this price range that offers similar specifications—on paper.

But you won't find a receiver that's been more meticulously designed, or more carefully produced.

At Sherwood, we approach the business of creating receivers like an art.

Because no approach brings you closer to reality.

**Sherwood Electronic Laboratories, Inc.
4300 North California Avenue
Chicago, Illinois 60618**

For a more complete description of Sherwood's unique approach to audio equipment engineering, write to the address above. We'll mail you a copy of our new brochure, "The anatomy of high performance design," along with detailed information about the new S7910.

 **SHERWOOD**
Everything you hear is true.

*The value shown is for informational purposes only. The actual resale price will be set by the individual Sherwood Dealer at his option. The cabinet shown is constructed of select plywood with a walnut veneer covering.

**Model S8910 offers identical specifications and features, but is FM only.

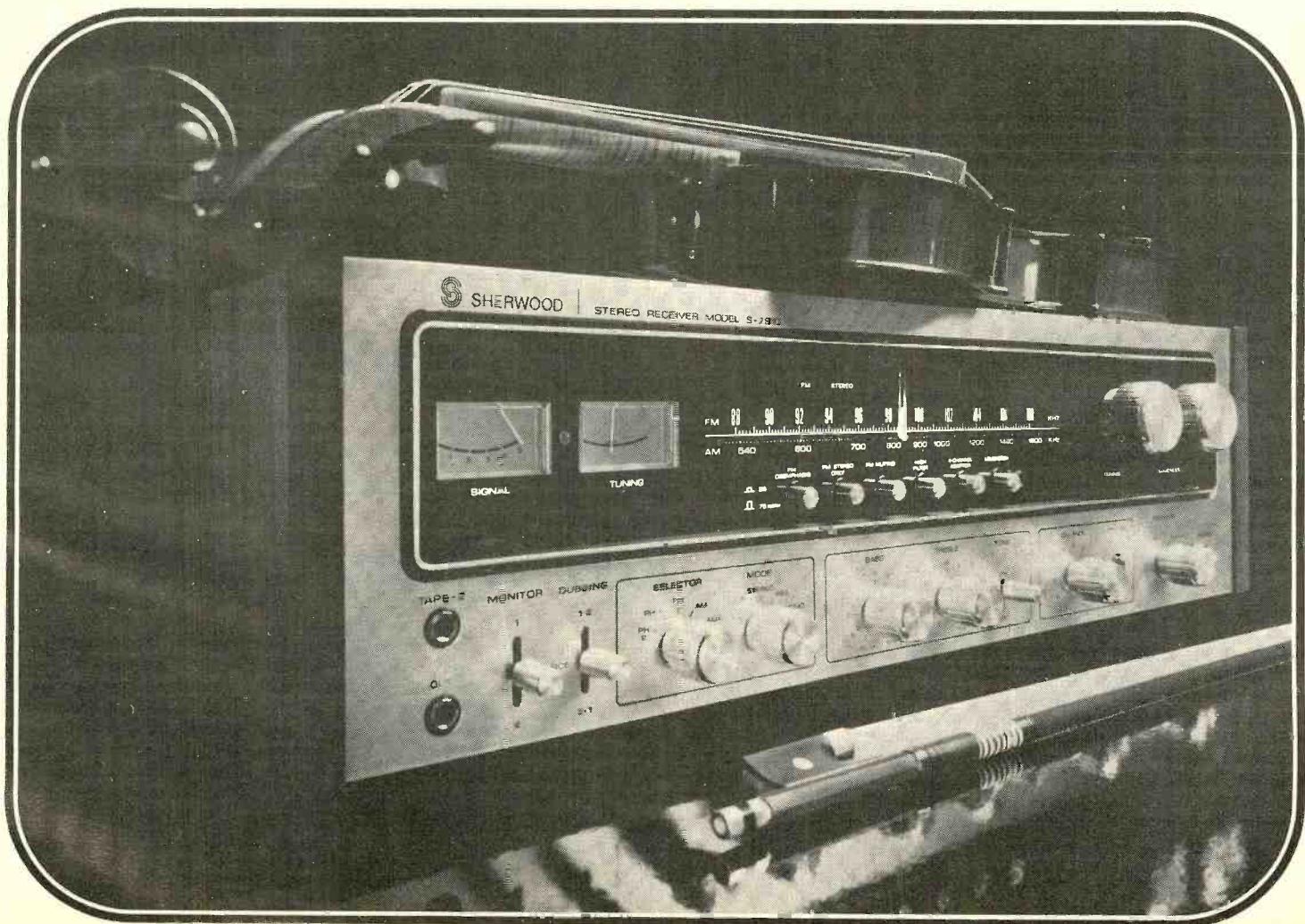

How to develop your

**TIME
LIFE
RECORDS**

presents GREAT MEN OF MUSIC

the world's great music played by the world's great performers

HAVEN'T YOU ALWAYS admired people who could listen to a few bars of classical music and say "That's Beethoven" . . . or "Tchaikovsky" . . . or "Mozart" — and be right just about every time?

The truth is, every great composer in history developed his own style . . . his own "voice" . . . and you can learn to recognize it — just as you can learn to tell a painting by Michelangelo from a painting by Van Gogh, without ever looking at the signature.

All you need to begin is a carefully chosen selection of masterworks by a composer . . . and some guidance as to what you should listen for that makes his style unique.

TIME-LIFE RECORDS has designed GREAT MEN OF MUSIC to provide you with *both* — along with some of the happiest hours of your listening life.

Each album in the GREAT MEN OF MUSIC series contains four 12-inch stereo LPs devoted to the works of a single great composer, interpreted by some of the foremost performers of our day. As you listen to the variety of musical forms in which a composer worked — symphonies, concertos, sonatas, operas, oratorios . . . as you follow the extensive notes provided in the accompanying booklets . . . as you compare one composer's works with another's . . . you will begin to recognize the very special characteristics that make each composer's work unique.

In a word, you'll develop your own ear

for music . . . and open up a whole new world of knowledge for yourself and your family.

A new depth of understanding awaits you

To introduce you to GREAT MEN OF MUSIC and this exciting new way to understand and enjoy music classics, TIME-LIFE RECORDS invites you to sample the first boxed collection in the series, *Tchaikovsky*, free for 10 days.

There you will discover how Tchaikovsky translated the torment that wrecked his personal life into glorious music . . . hear Tatyana's Letter Scene aria from *Eugene Onegin* and understand why it was dedicated to his mentor, Mme von Meck . . . experience the exquisite *Sleeping Beauty* ballet and see (on page 17 of the booklet) the room in Tchaikovsky's home at Klin where it was composed.

You will hear things in the music that perhaps you never heard before . . . the sinister and lugubrious harmonies Tchaikovsky used to depict the terror of the underworld in *Francesca da Rimini* . . . the simple folk song he heard a blind beggar sing at a fair in Kamenka, which he used as the principal theme in his *Piano Concerto No. 1*.

Once-in-a-lifetime performances

In addition, you'll be hearing some of the most memorable performances of our time. Great soloists like Heifetz, Van Cliburn, Leontyne Price. The celebrated Boston, Philadelphia, Chicago and Lon-

don symphony orchestras. World-renowned conductors such as Eugene Ormandy, Fritz Reiner, Pierre Monteux and Charles Munch.

And to broaden your enjoyment and understanding even further and enhance your book library as well, you will also receive the GOLDEN ENCYCLOPEDIA OF MUSIC at no extra cost with your Tchaikovsky album.

This handsome volume offers 720 pages of easy-to-acquire musical knowledge with more than 800 illustrations.

A startling value in all . . . Yours FREE for 10 days

By just mailing the coupon you will receive four records worth \$6.98 each—plus The Golden Encyclopedia retailing for \$17.95—a total value of \$45.87—for only \$17.95 plus shipping and handling. Or you can return the Encyclopedia and Tchaikovsky album within ten days and owe nothing.

If you decide to keep them, you will continue to receive future albums in the series — and explore the lives and works of Bach, Beethoven, Mozart, Brahms and other giants of music. A new album will arrive approximately every other month and each will come on the same 10-day free audition basis. You can cancel at any time and there is no obligation to accept any minimum number of albums.

Send for your free Tchaikovsky audition today—open up a whole new dimension of musical enjoyment. Send no money. Just mail the coupon.

TIME-LIFE RECORDS

Time & Life Building, Chicago, Ill. 60611

RLALE2

YES, I would like to audition TCHAIKOVSKY in the GREAT MEN OF MUSIC series. Please send this four-stereo-record album to me for 10 days' free examination. Also send The Golden Encyclopedia of Music to examine free for 10 days and to keep free if I purchase the Tchaikovsky album. If I decide to keep TCHAIKOVSKY, I will pay \$17.95 (\$18.95 in Canada) plus shipping and handling. I will then receive future albums (each containing four stereo 12-inch LP records) in the GREAT MEN OF MUSIC series, shipped an album at a time approximately every other month. Each album will be \$17.95 (\$18.95 in Canada) plus shipping and handling and will come on the same 10-day free-audition basis. There is no minimum number of albums that I must buy and I may cancel my subscription at any time simply by notifying you. If I do not choose to keep TCHAIKOVSKY and The Golden Encyclopedia of Music, I will return them in 10 days, my subscription for future albums will be cancelled and I will not be under any further obligation.

Name _____

Address _____ Apt. No. _____

City _____

State _____ Zip _____

Schools and libraries: Order Library-Style bindings from Silver Burdett Company, Morristown, New Jersey 07960. Eligible for Titles I, II funds.

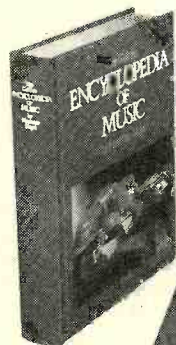

A Bonus Gift

The Golden Encyclopedia of Music

Covering musical terms, works, composers, performers, more. Lavishly illustrated. More than 1,000 musical examples. Yours as a gift when you accept TCHAIKOVSKY.

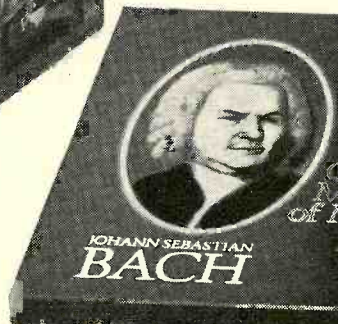
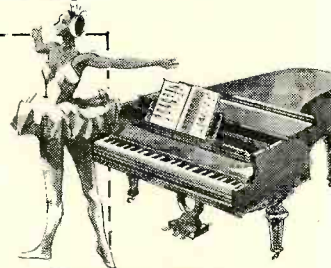

ear for great music

Step 1— Read

what makes the music of each composer truly great, through TIME-LIFE RECORDS unique picture-history technique. Read how each composer developed his style — what to listen for — how his life influenced his work.

Step 2— Listen

to the most acclaimed performances of great composers' works by the world's leading artists — performers like Heifetz, Van Cliburn, Leontyne Price — on superlative 12-inch LP stereo records.

Experience
the grandeur
of TCHAIKOVSKY
FREE for 10 days



The Opera File

By William Livingstone



OPERA ON THE TUBE

THE Public Broadcasting System's programming of opera on TV was rather spotty after WNET's opera-producing unit closed in 1973. But this year PBS brought opera back to home video screens with a very solid season in April, May, and June. The repertoire was well balanced between familiar classics and modern works, between new productions and repeats from earlier seasons. Except for *Carmen*, all were sung in English, and each opera was broadcast three times to make it available to the maximum number of viewers.

Good reviews, good ratings, and an overwhelming response from viewers (keep those cards and letters coming in!) have led PBS to schedule a similar season for next year. When Douglas Moore's *The Ballad of Baby Doe* was telecast live from the New York City Opera in April (part of Exxon's Great Performances series), it was seen in the New York viewing area, according to the ratings, by more people than had attended the NYC Opera's spring season. When you consider that PBS carried the show from coast to coast live and repeated it on tape twice within a week, you realize that the audience reached by opera on television is so enormous that this medium simply has to be taken seriously as a part of the musical life of the country.

I watched the opera series with considerable interest and pleasure and then talked with a couple of the men involved with it. The producer of *Baby Doe* and some of the other operas seen on PBS this year was David Griffiths. A pioneer in developing the "simulcast" system of broadcasting classical TV programs simultaneously in stereo on FM radio stations, he won a 1976 Emmy Award for the most outstanding classical program on television: Leonard Bernstein and the New York Philharmonic in the Great Performances series.

Griffiths was pleased with the success of the opera series and said, "I think *quality* is what the audiences for classical music want these days. The public has become very sophisticated in the media, and some of our earlier techniques were simply not acceptable. I like to think the tremendous increase in music programming on television is a result of our ability to deliver sound of high quality. I'm glad we're getting back into producing opera

for TV in America instead of just buying it from abroad, but it's so expensive that we have to do it on an exchange basis."

Filmed in London, two of the operas shown this year, Verdi's *La Traviata* and Wagner's *The Flying Dutchman*, were co-productions of the BBC and WNET in New York. The British baritone Norman Bailey starred in



DUTCHMAN NORMAN BAILEY
A model of the modern major opera star

both. This was a big *Dutchman* year for Bailey in the United States. He performed it with the opera companies of Hartford, Connecticut, and San Antonio, Texas, and in concert form with the Chicago Symphony under Sir Georg Solti. One of the concert performances was taped for future national radio broadcast in the Chicago Symphony series underwritten by Standard Oil of Indiana, and this summer Bailey recorded the *Dutchman* with Solti and the Chicago Symphony for London Records.

As befits the model of the modern major opera star, one who works in television, radio, and recordings as well as on stage, Bailey is keenly interested in the techniques of opera

in the electronic media. He explained that in the filming of *The Flying Dutchman* the singers did not prepare a separate soundtrack but sang while they were being photographed. "The orchestra was in another studio and we heard it through loudspeakers, which meant that the technicians had to be constantly alert to the possibility of feedback. I was not in England when it was shown there, but saw it here for the first time. I was aware of occasional shifts in the miking, but I was pleased with the balances."

BORN in Birmingham, England, Bailey received his musical training in South Africa and Vienna, where he made his professional debut with the Vienna Chamber Orchestra. He has sung with the principal companies in Austria, Germany, and Italy, and in London he appears both with the Royal Opera at Covent Garden, where opera is sung in the original language, and with the English National Opera, where all performances are in English. In New York he performs similar feats of bilingualism. Last season he sang Hans Sachs in *Die Meistersinger* in English at the NYC Opera, and in October he will make his Metropolitan debut in the same role in German.

And he has recorded Wagner in both English and German. He participated in the English National Opera's recording of the *Ring* in translation, two parts of which are now available. The *Siegfried* is imported by Peters International (619 West 54th Street, New York, N.Y. 10019), and *The Rhine Gold* has been released by Angel. *The Valkyrie*, already recorded, will also be released by Angel. For London Records Bailey has recorded, in addition to *Der Fliegende Holländer*, the role of Hans Sachs (in German) in a *Meistersinger* still awaiting release.

The New York Times critic pronounced Bailey's performance of the *Dutchman* in English on TV "a personal triumph," and he got excellent reviews for his concert performance with Solti in German. "Learning a role in two languages is not such a problem," he said. "The difficulty is that there are various translations. I sing the *Dutchman* in German and in two English translations. For real opera fans who are familiar with the repertoire, perhaps the original is better, but the translations help new audiences, particularly on television, to understand the work. And when we did the English *Ring* in London, even people who knew it quite well in German told me they were grateful for the English version because it brought them closer to the work."

While recognizing the documentary value of filming live opera performances, Bailey prefers that opera for TV be produced in studios. "It's like recording for stereo—in the studio the set is specifically designed for maximum effectiveness on television and for a variety of camera angles."

BAILEY is optimistic about the effect of TV opera. "To put opera on television in the correct perspective, it should not be considered a reduction of the stage into the box, but as an extension of records. I think the future of recordings is tied up with the video disc or tape, and in time we will go into stores not to buy a sound recording of opera, but a video recording, or at least we'll have the choice. In the past, instead of diminishing attendance at opera houses and concert halls, records have generated greater interest. I think opera on television will have the same effect and will build larger audiences."

PART TWO: THE END OF THE DOUBLE STANDARD.

In the frequency range where you find most music, our least expensive speaker offers virtually the same flat frequency response and freedom from distortion as our most expensive speaker.

Until recently, you could consider the selection of speakers an act of faith.

Because of the lack of industry standards and the resulting confusion in the marketplace, the speaker buyer had to depend almost totally on personal taste and subjective evaluation.

But no longer.

At Yamaha, before we designed a new line of speakers that would equal the revolutionary standard of our electronic components, we first defined our goal:

High accuracy across the musical spectrum. One of the few objective criteria for rating speaker performance.

Then we proceeded to make all Yamaha speakers to a single revolutionary standard of accuracy:

A frequency response curve that varies by no more than ± 3 dB from 100 Hz to 15,000 Hz. With typically no more than 1% harmonic distortion.

But since the frequency range of all our speakers extends well below 60 Hz to beyond 15,000 Hz, why do we even bother mentioning this figure?

Because, with the exception of the very deepest rumblings of a pipe organ, all music is produced within this range. In fact, few if any commercially available stereo pressings have frequencies below 100 Hz and above 15,000 Hz.

Yamaha's success in achieving a single standard of accuracy in all our speakers is confirmed in the chart above.

Unlike the frequency response curves of other speaker manufacturers which indicate unnatural booming in the bass, added sparkle in the treble, and extreme loudness level variations of as much as 10 dB, Yamaha's frequency response curves show a relatively straight line, which indicates uncolored, natural sound.

Yamaha's musical heritage.

Yet, in spite of Yamaha's objectivity in design, the perception of sound remains subjective.

That's why Yamaha speakers aren't designed to meet objective standards alone, but to meet a higher standard: the ears of the people who make Yamaha's world-famous musical instruments.

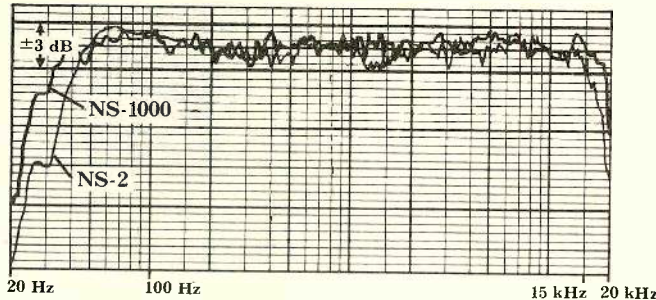

While many manufacturers offer accurate reproduction only in their top-end speakers, Yamaha brings you an extremely high degree of accuracy in all models throughout the line. The above curves, comparing the NS-1000 with the NS-2, were recorded under the following conditions: 1. **Equipment used**—Bruell & Kjaer (B&K) 4133 microphone, 1022 oscillator, 2113 spectrometer, and 2305 recorder. 2. **Input**—A "pink" noise source was used with an input level of 3 watts (significantly higher, more rigorous, and more closely corresponding to actual home listening levels than the commonly used industry standard of 1 watt). 3. **Measurement**—Each loudspeaker was placed in a "free field" (off the floor and no closer than 5 feet to any wall boundary in an average size listening room). A multiplicity of curves were taken at various points in the listening room and averaged, to produce the *total energy curves* pictured.

Since 1887, Yamaha has been making some of the finest musical instruments in the world. Pianos, organs, woodwinds, guitars, and brass.

With our musical instruments, we've defined the standard in the production of fine sound. And now, with our entire line of speakers and electronic components, we've utilized not only our studio engineers, but also our musical instrument designers to define the standard of music reproduction.

It's called Natural Sound. And it's totally unique to Yamaha.

Five different speakers, built to one standard.

Yamaha offers five different speaker models, ranging in price from \$1,350 a pair down to \$200 a pair.

At the top, the revolutionary beryllium dome NS-1000 Series, offering the ultimate in state-of-the-art performance. Following the NS-1000 are our

other three-way types: the NS-690, NS-670, and NS-3. Our least expensive, but still highly accurate, is the two-way NS-2.

Since each is built to the same high quality standard, you're probably wondering what those extra dollars are buying.

It's very simple.

To satisfy the most demanding audiophiles, those extra dollars buy extended response at the frequency extremes. Higher sound levels with equal or lower distortion. More power handling capacity. More tone controls to contour the tonal balance of the speakers with the characteristics of the room.

More specifically, on our model NS-670 and above, Yamaha offers die-cast speaker frame baskets to eliminate potential resonance. Luxurious wood enclosures (even rare ebony wood!). Tangential-edge

suspension for midrange and tweeter domes to provide smooth response. Acoustic equalizers on tweeters to flatten frequency response and enhance dispersion. Diagonally edge-wound voice coils for greater diaphragm control and increased transient response. Plus thick felt lining inside the cabinetry to isolate rear sound waves for distortion-free bass response.

But regardless of how much you pay, every Yamaha speaker is built to the same essential construction criteria and tonal accuracy.

Proven acoustic suspension design. Dome drivers for better high frequency dispersion. Carefully matched crossover networks. And heavily reinforced, extremely rigid enclosures.

The End of the Double Standard.

The single standard of performance found throughout the entire line of Yamaha speakers is a demonstration of product integrity that no other manufacturer can claim.

But in the final analysis, only your ears can be the judge.

That's why we invite you to visit your Yamaha audio dealer soon. His knowledgeable salesmen and extensive demonstration facilities can save you time and trouble in selecting the speaker that's right for your budget. And right for your ears.



 **YAMAHA**

International Corp., P.O. Box 6600, Buena Park, Calif. 90620

In a League

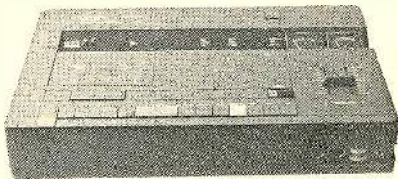

by itself.

When considering a precision three-head stereo cassette deck for off-the-tape monitoring, consider a Lenco C-2003.

How many tape decks in its league feature a direct-drive, two-capstan transport which fills existing state-of-the-art gaps in three-head cassette technology? Only the C-2003 and it retails for under \$700.

Some of the myriad features are:

- Dolby Noise Reduction system with separate IC Dolby decoders to eliminate recalibration.
- Logic controlled tape transport allows direct change of any function without touching "stop."
- Automatic tape selection for chrome tapes and manual settings for three additional types of tape.
- Motion sensing ends tape jamming; memory rewind and pitch control improve recording flexibility.
- Fully-illuminated indicator panel shows all functions as they are selected; even the cassette is lit.
- Technical specifications are without peer. What you would expect from one of Europe's most experienced audio manufacturers.

Discover how Lenco has developed a professional cassette deck which fills the big gap in modern design and advanced features. Write to us and we'll tell you everything about the C-2003.

Lenco

Uher of America Inc. 621 S. Hindry Ave.
Inglewood, Calif. 90301 (213) 649-3272

Please tell me everything about Lenco's 3-head stereo cassette deck, the C-2003.

Name _____

Street _____

City _____

State _____ Zip _____

- Send data on Lenco precision turntables.

The Basic Repertoire

By Martin Bookspan



CHOPIN'S WALTZES

IN 1830, at age twenty, Fryderyk Franciszek Chopin left his native Poland, never to return. He went first to Vienna, where he found the populace intoxicated with the rhythms and flavor of the waltz. "Among the numerous pleasures of Vienna," he wrote home, "the hotel evenings are famous. During supper, Strauss or Lanner play waltzes. . . . After every waltz they get huge applause; and if they play a Quodlibet, or jumble of opera, song, and dance, the hearers are so overjoyed that they don't know what to do with themselves."

In a later letter a note of derision creeps in. "Here, waltzes are called works! And Strauss and Lanner, who play them for dancing, are called Kapellmeister! This does not mean that everyone thinks like that; indeed, nearly everyone laughs about it; but only waltzes get printed."

These cynical words notwithstanding, Chopin himself had already caught the waltz contagion. His waltzes in E-flat Major (Op. 18) and A Minor (Op. 34, No. 2) date from his Viennese days. They are, however, more personal and more introspective than the style of waltz he heard all about him—particularly so in the case of the thoroughly Slavic A Minor Waltz, sometimes called *Valse Mélancolique*.

Once he settled in Paris in 1831, Chopin began to compose the urbane, elegant waltzes that so reflect the elegance of the life he loved. Refinement, luxury, and sophistication were the essence of the salons Chopin frequented; he changed his name to Frédéric François, and he was invariably dressed in one of his ten dark-blue tailcoats, with a wide necktie and a diamond stickpin, white gloves, and a flowing cloak.

Only eight of Chopin's waltzes were published during his lifetime, including the two from the Vienna period. Seven more appeared after his death, but he may have preferred that some of them, dating from his student years, should have been destroyed. At any rate, we possess nineteen of them today.

The sequence of Chopin waltzes contains several that are, in their various ways, very special. The Waltz in A-flat Major (Op. 34, No. 1), all grace and elegance, is said to have been Paderewski's favorite. The A-flat Major Waltz of Opus 42 is a brilliant virtuoso vehicle, and the three of Opus 64 are charming and chic; the D-flat Major Waltz of Opus 64 is

the familiar "Minute" Waltz, and the C-sharp Minor Waltz from the same set is dedicated to one of Chopin's wealthy patronesses in Paris, the Baroness de Rothschild.

Until recently, when one spoke of the Chopin waltzes one was referring to fourteen works: the Opus 18 *Grande Valse Brillante*; the three of Opus 34; the A-flat, Op. 42; the three of Opus 64; the two of Opus 69; the three of Opus 70; and the E Minor, Op. Posthumous. It is these fourteen that make up the Chopin waltz collections recorded by most pianists. Dinu Lipatti's performances remain, for me, the touchstone by which to measure all others. Lipatti brought a rare quality of personal identification and perception to his playing of them, along with an inimitable sense of spontaneity. Two mono recordings by Lipatti are extant: a studio recording dating from the late 1940's (Odyssey 32160057—avoid the electronic stereo reissue 32160058E) and one taken down at his last public appearance, at the Besançon Festival in September 1950 (included in Angel 3556, a two-disc album of the entire concert). Regrettable in the festival recording is the absence of the *Valse Brillante* in A-flat (Opus 34, No. 1); racked with the pain of his terminal illness, Lipatti no longer had the strength to play it.

OF pianists who have recorded the "traditional" set of fourteen waltzes in modern stereo, Rubinstein's is the one to have (RCA LSC 2726; cartridge ARS 1071; cassette ARK 1071). His playing has vitality and imagination, and the recorded sound, a product of RCA's Rome studios, is full-bodied. Other pianists have recorded the full nineteen Chopin waltzes, adding the five fairly early works that remained unpublished until relatively recently. Abbey Simon's (Turnabout 34580) is the account I would recommend from this group; his playing has an abandon that is quite appropriate, and the sound reproduction is rich.

The 1976 UPDATING OF THE BASIC REPERTOIRE is now available in convenient pamphlet form. Send 25¢ and a stamped, self-addressed No. 10 envelope (9½ x 4½ in.) to Esther Maldonado, Stereo Review, 1 Park Avenue, New York, N.Y. 10016 for your copy.

Not everyone can sell you a receiver that looks as good as this.

The RS4744 is the top stereo receiver in our line. And we think it looks good from any angle—value, performance and specs.

Audio magazine said "... we note that most receivers in this price range offer less power (usually 50 or fewer watts per channel) and don't have as many control features as this top-of-the-line entry from Sylvania."*

But, don't just take other people's word for it, check the specs out for yourself.

Power output of 60 Watts min. RMS per channel at 8 ohms from 20 Hz to 20 kHz with no more than 0.25% total harmonic distortion.

Three wide-range tone controls that let you tailor bass, mid-range and treble response to your speakers, room and ears.

Amplifier	Rating
Power, min. RMS, at 8 ohms, 20 Hz to 20 kHz	60 Watts
Total harmonic distortion at rated power output	0.25%
FM Tuner	Rating
Usable sensitivity (IHF) 300 ohms	1.8 μ V
50 dB quieting sensitivity	3.0 μ V
Signal/noise ratio 100% mod.	67 dB

Typical specifications

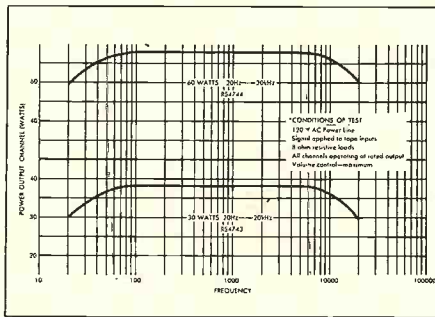

Power from 20 Hz—20 kHz

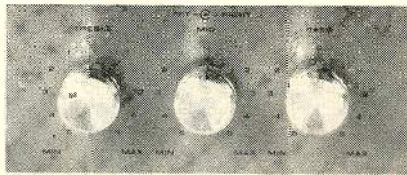

Active tone controls

Active high- and low-cut filters that have a sharp 12 dB/octave slope to reduce noise and rumble with minimum effect on music.

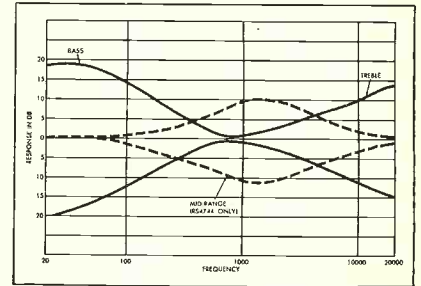

Tone control action

In the tuner section, you'll find features such as a phase-locked loop for long-term stability. An IHF sensitivity of 1.8 μ V and a 3.0 μ V level for 50 dB quieting.

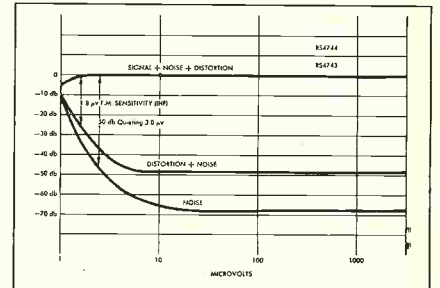

FM Quieting

And the front panel doesn't get by on just its good looks alone. Its functionally designed pushbutton bank puts a wide range of control capabilities right at your fingertips for mode selection, scratch and rumble filters, three-stage FM muting and loudness control.

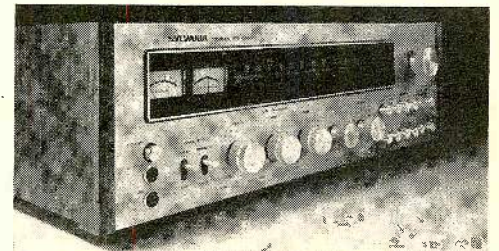

Functional design

Listen to the RS 4744 at your Sylvania dealer's today. You'll find its specs sound every bit as good as they look.

GTE SYLVANIA

*Reprinted by permission from Audio, February 1976

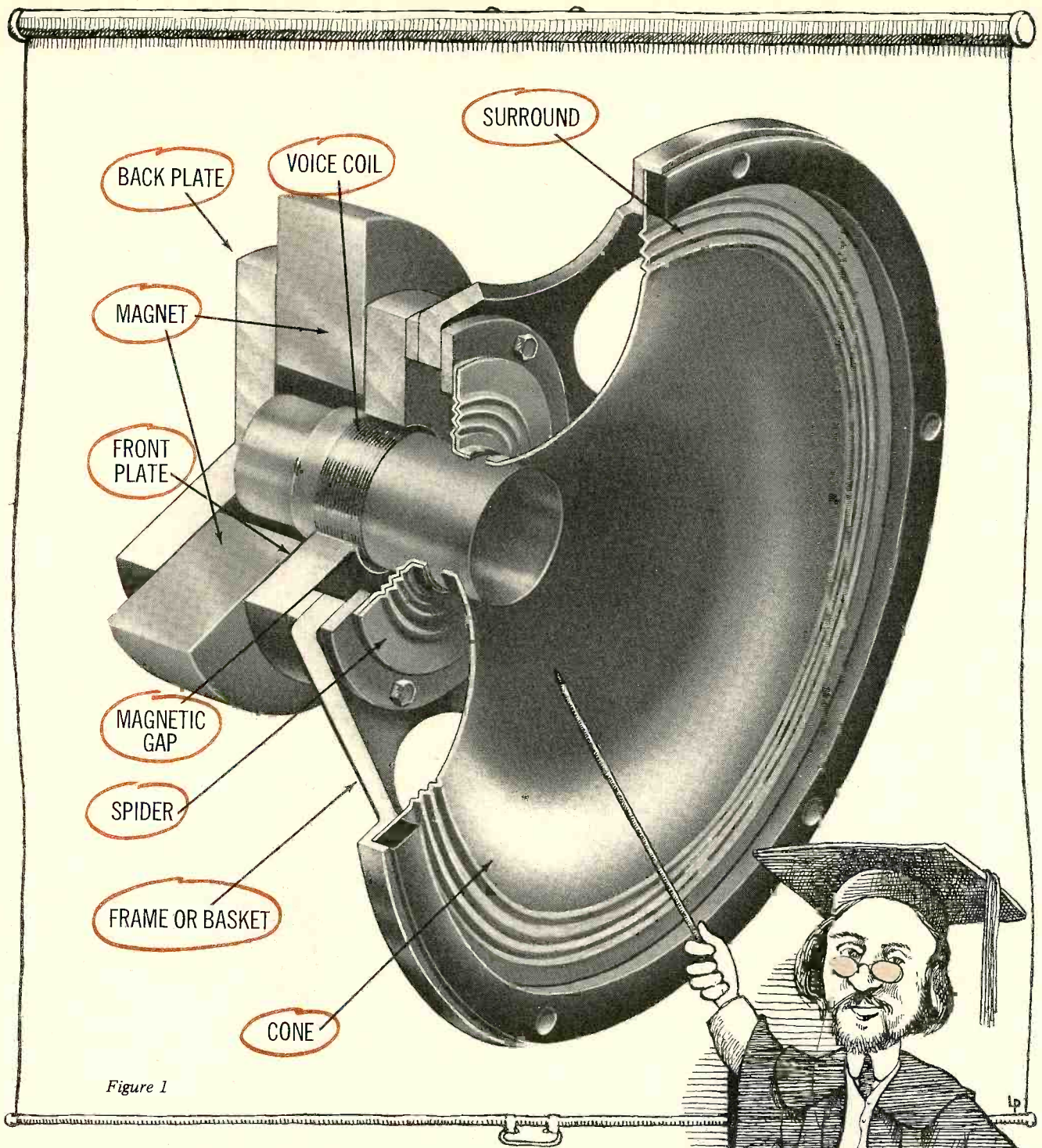
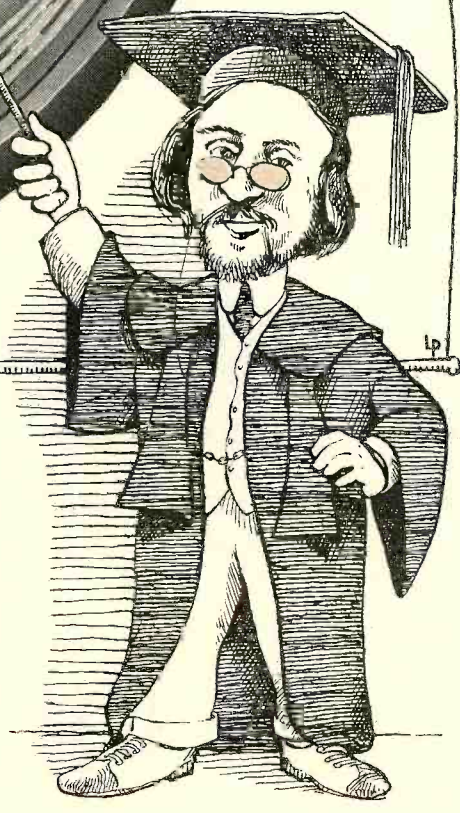

Figure 1

ANATOMY OF THE LOUDSPEAKER

By Technical Editor Larry Klein



WHEN an engineer is feeling particularly elegant and/or playful, or wants to impress a nontechnical acquaintance, he might refer to a loudspeaker as "an electroacoustical transducer." The meaning of "electroacoustic" is more or less self-evident; "transducer" signifies that the device in question converts one form of energy into another. So, although a speaker, like an amplifier, is driven by *electrical* energy, unlike an amplifier, it delivers *acoustical* energy. And insofar as it performs its task correctly, the sound that comes out of a speaker is a replica—in acoustic form—of the electrical audio signal that went into it.

Theoretically, the process is reversible: a microphone properly positioned in front of a speaker should convert the sound waves produced by the speaker back into the original electrical audio signal. Nothing, however, is that perfect or works that well in the world of electroacoustics. This is not to repeat in a roundabout way the old cliché about speakers being "the weakest link in the audio-reproduction chain," but simply to point out that loudspeaker design is a complex matter that eludes pat simplification. Anyone wishing to understand the problems of a speaker designer, however, has to know at the very least how a loudspeaker works. Readers should be warned, however, that the discussion following merely scratches the surface of a complicated, multifaceted subject.

Back to Basics

To begin at the beginning, we will first examine how a typical loudspeaker driver works and then look at some of its individual electromechanical elements to discover in what way they influence how *well* it works. The type of speaker driver we will be examining is the conventional "dynamic direct radiator," simply because it is found in perhaps 95 per cent of the systems on the market. (When we refer to a "speaker" we usually mean a speaker system which includes several drivers, a crossover network, and an enclosure. A "driver" refers to a *woofer*, a *tweeter*, or a *mid-range* unit that are part of a system.)

A loudspeaker, of course, is normally connected to an amplifier whose task is to provide the constantly varying voltage that represents the audio signal. The current flow produced by this voltage activates the electromagnetic mechanism of the driver, which in turn pushes and pulls a "cone" (also called a "diaphragm"), a structure

compounded of paper, fibers, and any number of other substances. The cone's purpose is, quite simply, to move air in exact response to changes in the waveform of an applied electrical audio signal.

The magnetic mechanism that produces speaker-cone movement is sometimes, at least among speaker designers, referred to as a "motor." The term is actually quite descriptive in respect to both its operating principle and its function. Motion is imparted to a speaker cone through the interaction of two magnets; one is a *permanent* magnet, the other an *electromagnet*. The permanent magnet is part of the large, heavy assembly clearly visible from the rear of an unmounted speaker. The electromagnet, commonly known as the *voice coil*, on the other hand, is buried deep within the mechanism—in

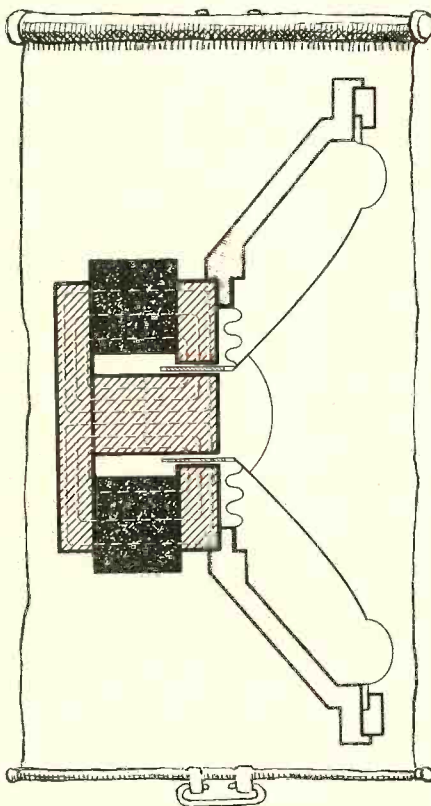

Figure 2. The fixed magnetic field (color) provided by the disc-shaped ceramic magnet is focused by the pole and top plate to impinge on the flexibly suspended voice coil.

most cases it can't be seen without disassembling the driver.

The cutaway view of a typical woofer in Figure 1 (and on the front cover of this issue as well) reveals the voice coil's location. When an audio electrical signal from the amplifier is fed into the speaker, it goes directly to the

voice coil through a pair of highly flexible leads (not shown). The variations in signal current produce an equivalently varying electromagnetic field around the voice coil: a positive-going part of the electrical audio waveform will produce a north-south magnetic field in one direction, and a negative-going waveform will produce a field in the other. In short, the magnetic field around the voice coil varies in both polarity and strength in exact correspondence to the audio signal.

Next, since it is a fact (first established back in the mid-eighteenth century) that magnetic likes repel and opposites attract, the *fixed* field of the permanent magnet, interacting with the *varying* polarity and strength of the voice coil, causes the loosely suspended voice coil to shuttle back and forth within the magnetic gap. The schematic diagram of a speaker's magnetic circuit (Figure 2) shows the relationship between the two magnetic forces. Since the voice coil is attached to the speaker cone, we are therefore at the source of the movement that pushes (or pulls) the cone that moves the air that produces the sound waves.

The voice coil cannot, of course, be permitted to flop about loosely within the magnetic gap; it must be held in precise side-to-side alignment while at the same time being free to move without restriction along its axis. The *spider* (see Figure 1) keeps the voice coil centered to prevent its rubbing against the sides of the magnetic gap, and it also returns the voice coil to a centered "rest" position when there is no audio signal. Finally, since the voice coil is already attached to the cone, the spider supports the inner rim of the cone as well.

The outer rim of the cone also requires support and some kind of seal to prevent air from leaking around the edge when the cone moves. Both of these functions (and several others) are performed by the *surround*, which may be made of corrugated paper, butyl or foam rubber, or other suitable materials. All of these elements are held together in turn by a metal frame or *basket*.

It should be clear that any spurious vibrations, floppiness, or cone movements that are not in direct response to voice-coil movement are going to introduce some aberration in the sound produced. So will any voice-coil movement that is not coupled accurately to the cone, and so will any electrical audio signal that is not accurately converted into equivalent voice-coil movement. There are, in fact, so *many* opportunities for the speaker's drive system to go wrong that it is a wonder any of them ever work well at all.

ANATOMY...

"A pressure variation that takes place slowly over an eight-hour period, too low a frequency to be heard, is usually called 'weather'."

Some of the potential problems that must be avoided (or compensated for) in driver design are:

- *flexing of the cone* at the point where it is driven by the voice coil,
- *spurious vibrations* set up within the cone material itself, and
- *inaccurate cone movement* resulting from limitations in its suspension or the uneven application of the magnetic field to the voice coil over the normal range of its excursion.

All these problems come under the general headings of "cone breakup" and "nonlinearity" (meaning that the output does not have a one-to-one analogous relationship to the input). The audible effects are large peaks and dips in the speaker's frequency response and a variety of distortions. The general solutions are to make the cone material as rigid and nonresonant as possible and to make sure that the magnetic field in the voice-coil gap impinges on an adequate and equivalent amount of the voice coil at all times. By making the voice-coil winding somewhat longer than the magnetic gap (Figure 2), the designer can ensure that a constant drive force is applied during the normal range of cone excursion, but this means a loss of efficiency unless a heavier (and hence more expensive) magnet is used.

The Box

You have probably noticed that speakers usually come in some sort of enclosure. Apart from such matters as aesthetic appearance and physical protection, there are good *acoustic* reasons for this. The main one relates to bass response. A woofer without an enclosure may push and pull at the air, but the results of its efforts—at least in the low bass—are nullified as they are produced. The reason is that while the forward-moving cone pushes air toward the listener, creating a high-pressure acoustic wave, it is simultaneously creating a low-pressure area in its rear. Thus the low-bass pressure wave from the front of the cone, instead of propagating into the room, rushes around the

cone to compensate for the lower-pressure area, and the bass never reaches the listener. When the cone moves inward, the same thing happens, except that the air rushes from the rear to the front.

Keep in mind that all "sound" is actually minute variations in air pressure above and below the normal barometric pressure. A variation in air pressure, however slight, that takes place 440 times a second is the musical pitch "A." (And a variation that takes place slowly over an eight-hour period, too low a frequency to be heard, is usually called "weather.") The ear is a highly sensitive mechanism for detecting rapid changes in air pressure, although we are seldom aware of it in just that way—except, perhaps, during plane takeoffs and elevator rides.

The frequency at which cancellation starts depends on the wavelengths involved. Wavelength is the distance between adjacent peaks of the generated air-pressure pulses that normally travel outward from the vibrating source at—appropriately—the speed of sound. For an unmounted 12-inch woofer, the wavelengths are such that the bass response starts to cancel at about 700 Hz and falls at the rate of 6 dB per octave below that frequency. Above 700 Hz or so, the wavelengths become short enough for the speaker cone to serve as its own baffle for the front-to-back flow of air.

Installing the speaker on a *baffle board* extends the front-to-back air-flow path lengths and therefore permits longer (lower-frequency) waves to be heard. If you wanted to use a baffle board instead of a box enclosure to get bass response down to 40 Hz, your woofer would theoretically have to be mounted in the center of a 200-square-foot panel. Possibly (!) for this reason,

speaker-system designers have ignored the virtues of the flat baffle and have chosen instead to install their drivers in various types of enclosures.

Building Better Boxes

The type of speaker housing used has a great influence on the performance of the bass reproducer, but tweeters and mid-range units require hardly any baffling at all. (Wavelength is the reason for this, of course: a tweeter operating in the frequency range above 5,000 Hz puts out waves shorter than three inches.) Two bass-enclosure approaches—*bass reflex* and *acoustic suspension*—have dominated the speaker field for many years. (There are others too: horns, transmission lines, infinite baffles, and more. Manufacturers employing any of these in their products are pleased to send literature explaining their particular advantages; we will confine our discussion here to the two most popular enclosure designs.)

The bass-reflex (BR) enclosure has also been known at times as the ducted port, distributed port, Helmholtz resonator, phase inverter, vented system, and probably several other names I've forgotten. Its operating principle was first discovered in the last quarter of the nineteenth century by German physicist Hermann Ludwig Ferdinand von Helmholtz. (This was, of course, long before speaker systems were invented.) Helmholtz found that he could construct a sharply tuned *acoustic* resonator (as opposed to a *mechanical* resonator such as a tuning fork) by using a hollow glass sphere with an opening in it. The pitch of the resonator could be shifted by changing its size or that of the opening—within limits, certainly,

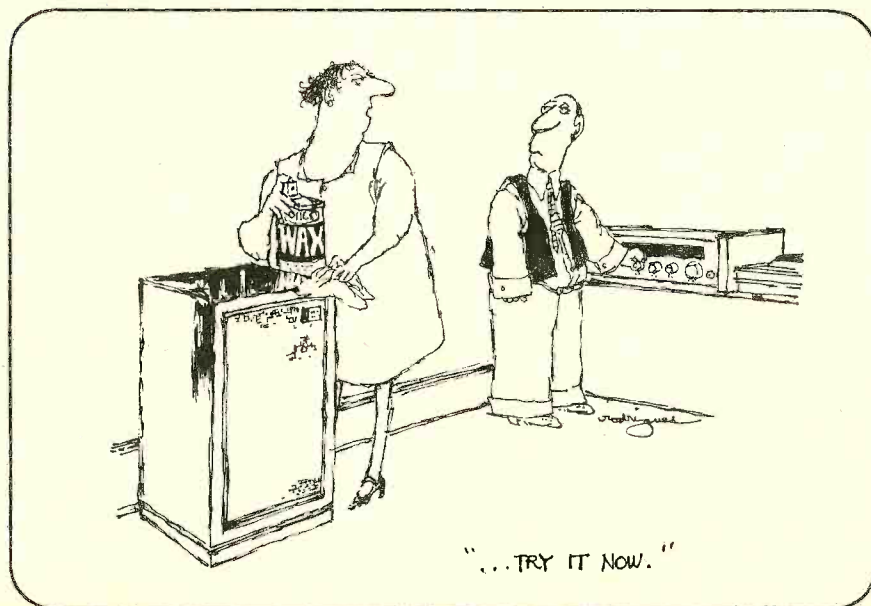

for too large a hole would simply swallow the sphere. If you blow across the mouth of a bottle and produce a tone, you have activated a genuine Helmholtz resonance. Hold onto that idea for a moment while we return to the speaker.

A loudspeaker driver also has a specific *mechanical* resonance frequency determined by the compliance (springiness) of its suspension and the mass (roughly, weight) of its moving parts. This is the frequency at which the cone prefers to vibrate, where its excursion is excessive, and its movement most uncontrolled. Also, for complicated acoustic reasons, this is also the point below which the speaker's bass-frequency response starts to fall off rapidly.

In 1932, a patent was awarded to A. L. Thuras, who had the bright idea of housing the *mechanically* resonant speaker in an *acoustically* resonant box (remember Helmholtz?) and adjusting the box's resonance to control the speaker's resonance. It worked in that it reduced the speaker's resonant peak and extended the bass response below that frequency, but over the years all the designs using the principle did not work as well as expected, for reasons that were not quite clear. The problem was that there were just too many variables involved. Bass-reflex design at that time was a hit-or-miss proposition that produced some good systems but others that were boomy, lacking in bass, too large, and so on.

In 1954, Acoustic Research introduced what was to become known as the *acoustic-suspension* system. It dealt with the same problems of bass cancellation and resonance as the bass-reflex designs, but in an entirely different way. First, a woofer with a *very* low resonance was designed. It was then installed in a very small (for those days) box. The air trapped inside the box acted (because of its relative incompressibility) to stiffen the suspension of the cone to the degree necessary to raise the speaker's in-box resonance to a selected frequency. Advantages of the technique are that (1) *air* suspension is far more linear than the problematical *mechanical* cone suspension, and (2) cone resonance can be completely controlled in respect to frequency placement and damping. The various electrical, acoustical, and mechanical parameters of the acoustic-suspension design were, in short, more manipulatable than those of other designs, and it became possible to obtain a very flat, clean, low-bass performance from a very small box.

But there was a price to be paid for all this: efficiency. For several reasons, the acoustic-suspension system needed

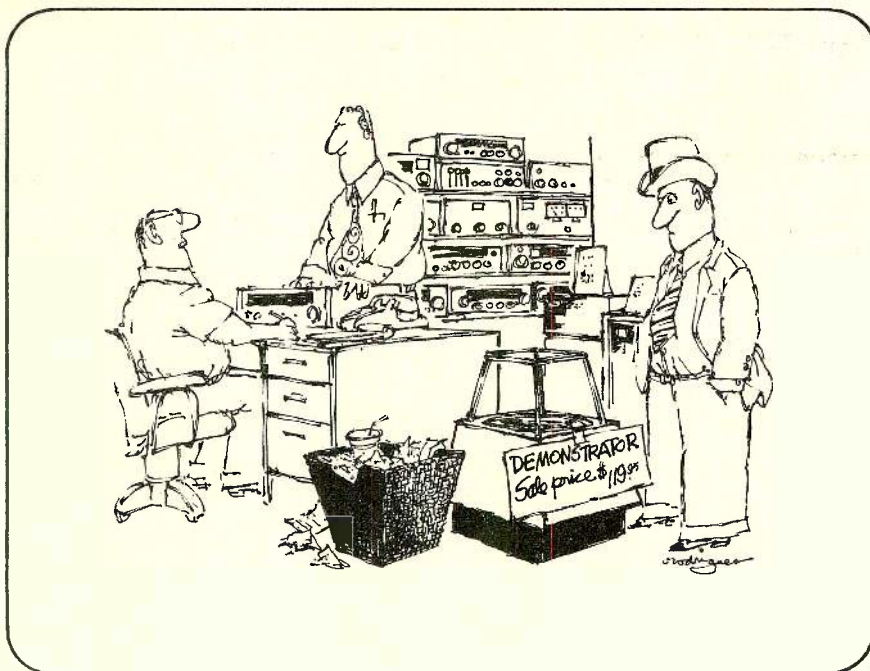

about twice the amplifier power a bass-reflex system would need for a given acoustic output. Even so, the virtues of the acoustic-suspension design were generally recognized and accepted over the course of the following decade, and the bass-reflex designs faded into the background except where high efficiency was a basic design requirement. And, of course, many other designs—horn, transmission line, infinite baffle—continued to coexist as well.

Perhaps five years ago, however, there came a hint of a design-trend reversal. The variables of the bass-reflex system suddenly became well enough understood that a designer could achieve almost any performance he desired. The man primarily responsible for the breakthrough was an Australian, A. N. Thiele, an expert not in speaker design but in complex electrical filter-network theory. It had long been accepted that the driver/enclosure interrelationships could be analyzed through electrical-circuit analogies. The cone mass could be represented by one group of circuit components, the enclosed air by another, the air mass by a third, and so forth. Such analogs had been used previously, but the difference between them and Thiele's was that his actually could be used to optimize the woofer design.

The Upper End

It has been observed by some audio cynics that speaker systems do not live by bass alone. And unfortunately, the

factors that make a woofer good for bass get in the way when it tries to reproduce the higher frequencies. The cone of a conventional woofer is simply too heavy and too large to reproduce the very high frequencies at a reasonable level or to disperse them evenly. For that reason, the audio signal fed to a speaker system is almost always divided among two or more drivers. In a two-way system these are the woofer (which we have already dealt with) and the tweeter; in a three-way system there is in addition a mid-range. The frequency point(s) at which the amplifier energy (audio signal) is evenly split between the two drivers—or any adjacent (in frequency) pair of drivers—is called the crossover frequency.

Why are some speaker systems two-way, others three-way, and some even four-way? The usual goal of a speaker designer is to provide as wide a frequency range as possible for a product of a given cost. Additional drivers and crossovers are added to provide the "extras," such as the ability to play *very* loud or have very wide dispersion or cover (with reasonable flatness) the entire audio range of 20 to 20,000 Hz. Perhaps any one (maybe two) of these "extras" could be achieved with a two-way system, but not all of them.

If you want a *very loud* loudspeaker system, it has to be able to accept and deliver lots of energy. And when an amplifier is pushing several hundred watts into a speaker system, it follows that the more drivers you divide those watts among, the better the chance each will survive—and play with reasonably low distortion. This is true

ANATOMY...

"A large woofer does not perform very well as a tweeter for the same reasons that kettledrums don't tinkle."

whether there are several drivers operating in the same part of the frequency band or there are crossovers that distribute different frequencies to a number of drivers. The word is Divide and Survive.

A large woofer does not perform very well as a tweeter for many of the same reasons that kettledrums don't tinkle. The larger the woofer, the lower must be the crossover to the mid-range/tweeter to avoid peakiness caused by the woofer cone's inability to follow the rapid movements of its voice coil. An 8-inch woofer can cross over to the tweeter at perhaps 2,000 Hz without running into problems. A 10-inch woofer prefers a crossover of 1,500 Hz or lower, and a 12-incher does best under 1,000 Hz.

It follows that the lower the woofer-to-tweeter crossover point, the more energy the high-frequency reproducer has to be able to accept. That means a certain ruggedness is required—except that for the very high frequencies we need a very lightweight and relatively fragile driver. We obviously can't have it both ways, so we have to install a mid-range unit that is rugged enough to work at the lower frequencies but still light enough to handle the higher ones properly. One might consider a mid-range unit either as a low-power woofer or as a high-power tweeter; several manufacturers make drivers that can serve either as woofers in smallish low-power systems or as mid-range units in larger, high-power systems.

The Higher Highs

The high-frequency reproducing end of the speaker has probably had more attention paid to it, and has generated more esoteric design efforts, than any other element in the system. It is enormously difficult to reproduce accurately sound waves of, say, 15,000 to 20,000 Hz for the same reasons a phono stylus finds it difficult to pick them up out of the record groove in the first place. The tweeter cone, like the phono stylus, must respond precisely to the driving force with neither too much nor too little excursion, and it must be free

of spurious vibrations. But the tweeter has even more problems:

- it must move enough air to be audible,
- it must disperse the sound over a wide area, and
- it must be able to handle enough drive signal to do the moving and the dispersing.

Various tweeter designs—the domes, the cones, the air-motion transformers, the electrostatics, the crystals, the transmission lines, the ionics—have all attacked the problem in different ways, with different degrees of success. That there is such diversity of design indicates how little designers see eye-to-eye in this frequency area.

Crossing Over

Hidden inside the speaker enclosure are the coils, capacitors, and resistors responsible for channeling the various bands of frequencies to the respective drivers. As we have seen, crossover points are chosen to provide each driver with that band of frequencies at which it works best. The crossover between woofer and mid-range will be made low enough that the woofer cone doesn't operate in its high-frequency-breakup area and will have reasonable dispersion—but it can't be *too* low, or the mid-range will be fed too much power and be forced into excessive excursion. The crossover between the mid-range and the tweeter must be chosen similarly: it must be low enough for the mid-range to avoid cone breakup and a ragged dispersion pattern, but it should not be so low that the tweeter is fed too much drive signal.

The crossover is also designed to

provide—in conjunction with the electrical and mechanical characteristics of the *specific* drivers—carefully chosen *slopes* at the crossover points. This is the reason you can't wire any old set of drivers into a crossover network, even if the crossover points are "correct," and hope to get best results.

A Final Word

In this fast tour through the wonderful world of speaker design, we have covered territory both familiar and previously unknown. You should by now have some notion of the lay of the land and be somewhat better able to evaluate the "advances," "breakthroughs," and "revolutions" in speakers that will come your way over the next decade. However, don't feel bad if you can't render instant judgment as to the technical validity of some given design approach. *Nobody* can! The difficulty is this: there are many equally valid ways to skin a cat—or design a speaker. Some designs are easier to manufacture, some use less expensive materials, and some produce a more reliable product. Some designs sound better in some areas, others sound better in others. And it is no more possible to tell how a speaker will sound from its specification sheet than to predict a politician's post-election performance from his campaign promises. What is the ideal or best speaker system? I really can't say. If someone presented me with a product that sounded as good as the best, and was half the size, and had twice the efficiency, and sold for, say, \$400 a pair, I would be inclined to judge it as "best"—but *you* might not. □

COMPUTER-ASSISTED SPEAKER DESIGN

EARLIER this year I visited Wharfedale's speaker plant in England and spent some time with a group of engineers who had perfected a computer program for speaker design based on the electrical analogs of A. N. Thiele. They asked me to supply two specifications to the computer; I decided on an enclosure size of 1 cubic foot (there was a slight delay while this was translated into liters) and a low-frequency response cutoff of 40 Hz (so the problem wouldn't be *too* easy). The speaker design program was called up, my two parameters were punched in, and the computer immediately began to type out forty-three (!) different ways of doing the job, depending on the other variables chosen. The printout went

into sufficient detail to spell out the gauge of wire to be used in the voice coil, the magnetic flux density in the gap—in fact, *every* physical or electrical variable that would have an effect on bass performance. It did not specify the precise color of the phenolic spider, but everything else was pinned down to a fare-thee-well. Half jokingly, I asked the \$64 question: Did the prototypes built following the computer design work as predicted? I've asked the same question of several designers who have used the Thiele "alignment" approach with and without computer assistance, and the answer (as it was in this case) has always been the same—an unequivocal yes!

—L.K.

The New AR-16

A Best Buy from Acoustic Research

The best kind of loudspeaker is one that plays back the music on the record or tape with the greatest degree of fidelity. The best value is the loudspeaker that comes closest to this ideal at the lowest cost. This is true whether it is the music of The Stones, Coltrane, or Stravinsky. What you want from the record is exactly what the musicians, composers, and engineers put there. Nothing more, nothing less.

Acoustic Research has been designing and manufacturing high fidelity loudspeakers based on this approach for over 20 years. It is against this background of experience that we make the statement that the AR-16 is the best buy we have ever offered the public.

Performance

For a price of \$115, the AR-16 offers a unique combination of uniform energy response and flat anechoic frequency response. A crossover network of much greater refinement than is found in other two-way speaker systems gives the AR-16 uniform radiation over almost as wide a frequency range and solid angle as the most expensive AR speakers.

The performance of the AR-16's 8 inch woofer has been improved to the level of most 10 inch acoustic suspension designs. With a system resonance frequency of 55 Hz and near-critical damping, usable

response has been extended to below 40 Hz, approximately the lowest note on the orchestral double-bass.

A new cabinet design eliminates audible diffraction effects by avoiding all unnecessary projections and allowing for the mounting of both drivers flush with the front surface.

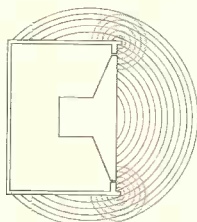

Cabinet diffraction effects, graphically illustrated above, are absent in the AR-16 because of the elimination of unnecessary moldings and projections.

These performance characteristics, rarely combined even in far more expensive speakers, are essential for the accurate reproduction of music under actual listening conditions and for maintaining proper tonal balance for listeners in various parts of a room.

Appearance

The special cabinet construction of the AR-16 has also made possible an attractive departure in appearance from conventional speakers. The oiled walnut wood



finish of the cabinet sides is continued on the front. An acoustically transparent foam grill, mounted in the center of the front baffle, is the only element that projects beyond the flush-mounted drivers. The AR-16 is also available in a vinyl finish for under \$100.

'Best-Buy' value

The AR-16 is an extremely accurate—and attractive—high fidelity reproducer. Its combination of price, performance, and styling place it at the point beyond which improvements are achieved only at disproportionately higher cost... exactly what value is all about.

Guarantee

The performance specifications of the AR-16, like those of the most expensive AR speakers, are guaranteed for five years.

For a complete description of the AR-16, fill out and mail the coupon today.



TELEDYNE
ACOUSTIC RESEARCH
10 American Drive
Norwood
Massachusetts 02062

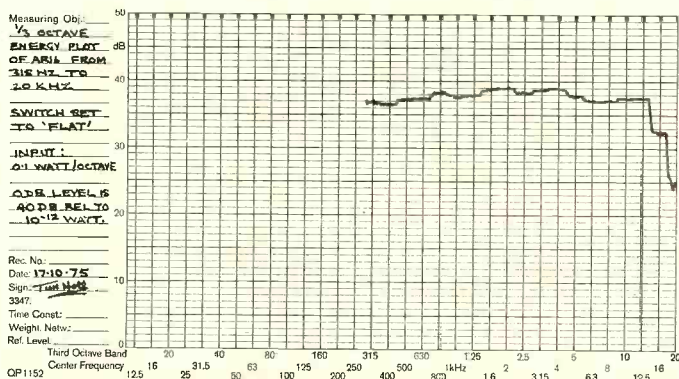
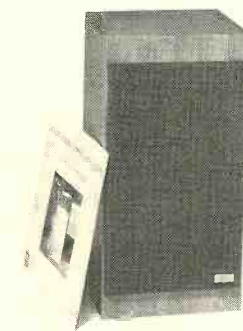

Energy response of the AR-16 speaker system. Woofer performance below 400 Hz (not shown above, owing to size limitations of reverberant chamber) is equivalent to that of most 10-inch acoustic suspension designs.

Please send me a complete description of the AR-16

Please send me the AR demonstration record 'The Sound of Musical Instruments' (check for \$5 enclosed)

Name _____

Address _____

SR8

JUST DESERTS: musicians harvest

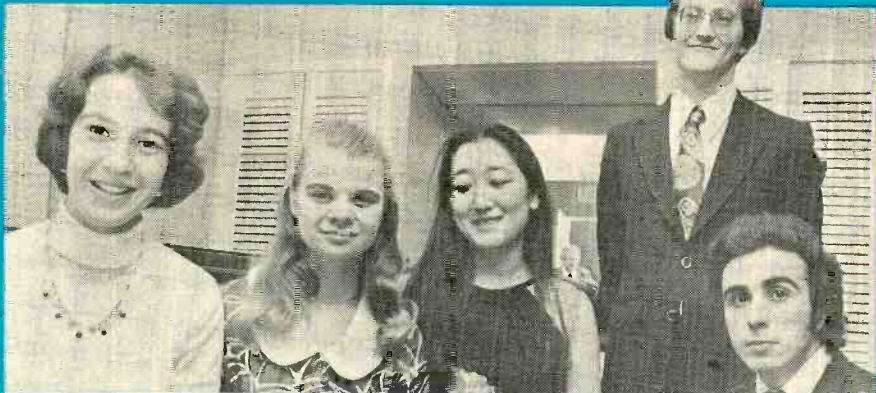

Cash prizes of \$1,000 each were awarded Levintritt Foundation finalists (l. to r.) Marian Hahn, Lydia Artymiw, Mitsuko Uchida, Steven De Groot, and Santiago Rodriguez. (There has been no first prize since Joseph Kalichstein's 1969 award.)

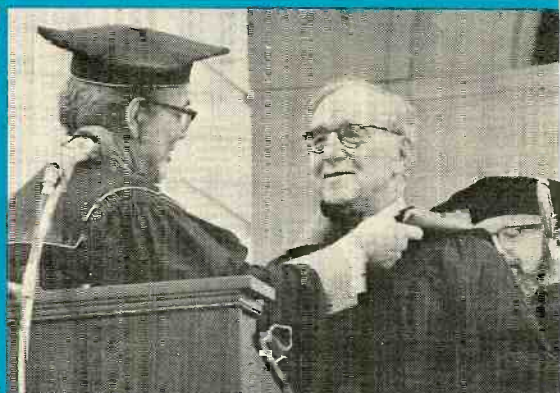

Union College, Schenectady, N.Y., made jazz clarinetist Benny Goodman an honorary Doctor of Fine Arts in May.

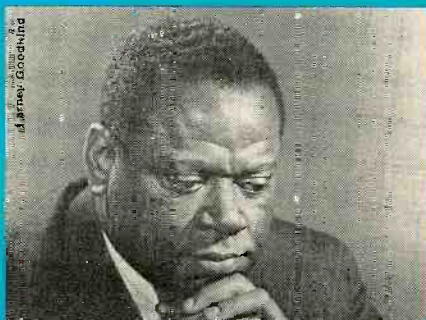

Phi Mu Alpha Sinfonia Fraternity named baritone William Warfield its American Man of Music for 1976.

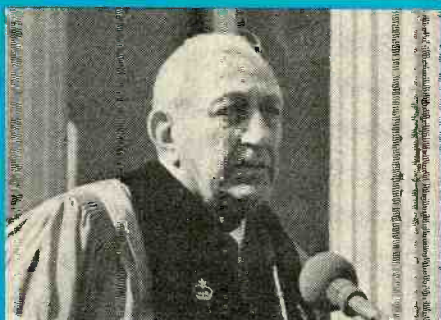

Russian cellist Gregor Piatigorsky received the degree of Doctor of Music from Columbia University.



Samuel Barber (chatting with William Schuman) received the National Institute of Arts and Letters' Gold Medal.



New York's association of Latin critics voted singer Nati Mistral's Town Hall concert the best of the year.



Conductor-composer José Serebrier received Columbia University's 1976 Ditson Conductor's Award.



Boston's Berklee College of Music made Newport Jazz Festival founder George Wein an honorary Doctor of Music.



New York's Adelphi University made Peter Goldmark, inventor of the LP, an honorary Doctor of Science.



Conductor Eugene Ormandy received a Doctorate of Humane Letters degree from Moravian College, Bethlehem, Pa.



The Catholic Actors Guild's George M. Cohan award went to famed chanteuse Hildegard, 70-plus and going strong.

a crop of prizes, awards, and degrees



Keith Carradine (with Burt and Angie Dickinson Bacharach) won an Oscar for his song *I'm Easy* from *Nashville*.



A Drama Critics Award, 9 Tonys, and 1 Pulitzer for *Chorus Line*: choreographer Bob Avian, co-author Jas. Kirkwood, producer Joe Papp, actress Donna McKechnie, director Michael Bennett, composer Marvin Hamlisch, lyricist Edward Kleban.



N.J. Governor Brendan Byrne proclaims Jerome Hines Day to celebrate the bass-baritone's 30th year with the Met.

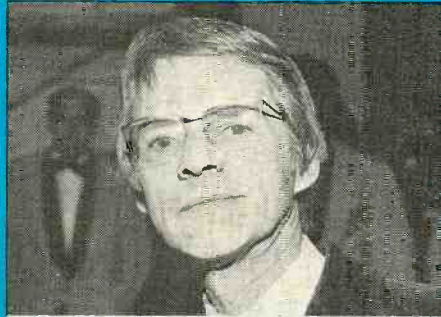

Composer Jack Beeson (*Lizzie Borden*) has been elected a member of the American Institute of Arts and Letters.

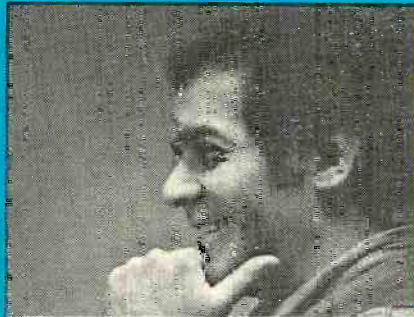

Composer-performer George Russell received a National Music Award for his work in the field of jazz theory.



Gunther Schuller was awarded the American Composers Alliance Laurel Leaf by prexy Nicholas Roussakis.

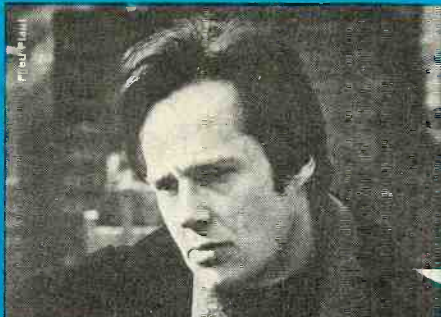

The 1976 Pulitzer Prize in Music went to composer Ned Rorem for his orchestral work *Air Music*.



Doctor of Humane Letters is what it says on the sheepskin the University of Nevada dropped on Frank Sinatra.



New York's Handel Medallion went to dancer Dame Margot Fonteyn, shown here with Mayor Abraham Beame.

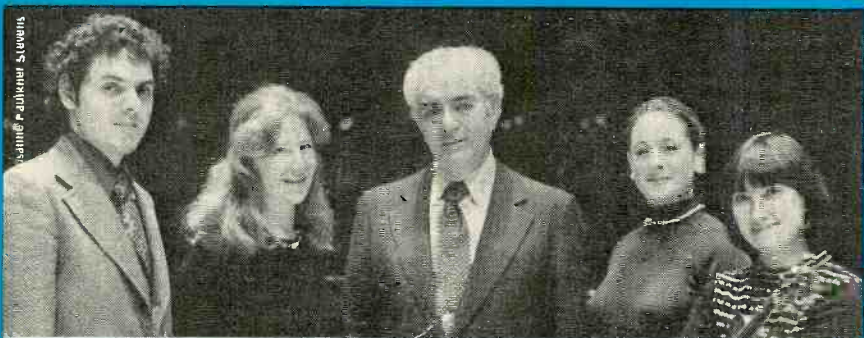

Avery Fisher Prizes (\$1,000 awards and debuts with the N.Y. Philharmonic) for young American pianists Paul Schenly and Ursula Oppens, harpist Heidi Lehwalder, and violinist Ani Kavafian (donor Fisher is at center).

10 sound reasons to buy our new receiver.

Plus its sound.



Sony's new, more powerful STR-6800SD receiver should get a warm reception. Because it not only looks different from other receivers—it is different.

It has some features found in more expensive separate components—and other features found nowhere else at all.

1. The most-used controls all in one place.

Electronically, it would have been convenient for us to scatter the level control, tuning knob and input and tape selectors all over our receiver. Instead we grouped them in the upper right-hand corner—so they're convenient for you.

2. A dial pointer that doubles in length when it's close to a station.

Together with the signal strength meter and the center channel meter, this Sony innovation constitutes a system that helps you tune faster and more accurately.

3. A muting switch—great if the phone rings.

Flick it down and volume drops. Flick it back up and volume goes back up to where it was. And this muting switch is right where it should be—right next to the level control.

4. A stepped level control to keep both channels equal.

It guarantees unprecedented accuracy—to within 1/2 db instead of 1 db. And it guarantees it over the whole volume range instead of just in mid-volume.

5. MOS FET front end electronics unitized tuning.

The 4-gang tuning section and all its associated electronic parts are mounted on one sub-assembly. So

temperature differences don't affect these circuits—the receiver tunes the same whether it's cold or warmed up. And with MOS FET, the receiver has a very wide dynamic range.

6. Dolby noise reduction system.

As more and more stations broadcast in Dolby, you can really use a Dolby system. And ours has a definite advantage: Instead of being an optional extra, it's built in—operated from the front panel.

7. Phase locked loop.

It gives you greater stereo separation and less distortion.



8. LEC (low emitter concentration) transistor. This piece of advanced design in the preamp phono stage assures you tight RIAA equalization plus low noise, low distortion and a wide dynamic range. It's a Sony exclusive.

9. An acoustic compensator for easy control of highs, lows and middles. A conventional loudness control only lets you boost bass. Our acoustic compensator has three positions. For true

loudness compensation, for bass boost and for mid-range presence.

10. Sony's most powerful receiver. It delivers 80 watts minimum RMS continuous power per channel at 8 ohms from 20 Hz to 20,000 Hz with no more than 0.15% total harmonic distortion. It has a direct-coupled power amplifier with true complementary symmetry output stages.

And more. To these specifications (remember, we state them conservatively) add Sony's proven reliability. And you get a receiver that produces a sound that'll make you understand why you have ears.

That's the STR-6800SD at \$500. Or, for less power and a few less features — but no loss of fidelity — the STR-5800SD at \$350 and the STR-4800SD at \$200 (all suggested retail prices).

A sound investment.



SONY

THE SPEAKER AND THE LISTENER

Where to position them within
the listening room—and why

By Roy Allison

Speaker designers, testers, and users have for many years argued about the proper acoustic environment in which to test loudspeaker systems. The central problem has always been the lack of correlation between the various response curves obtained in an anechoic test chamber, in a reverberant test chamber, and in a "normal" listening room. Although the curves obtained in the two test chambers are repeatable, and although when used together they do predict, to some degree, a system's performance in a normal room, the correlation is far from perfect. There is nothing inherently "wrong" with the chamber test

A NEWCOMER to high-fidelity sound reproduction soon discovers that the sound of a given speaker system is profoundly affected by the acoustical characteristics of the room in which it is being used. Not quite so evident, however, is the fact that there are also significant, audible changes in frequency balance as the position of the speaker—or of the listener—changes even slightly in the room.

The effects of all these variables have often been touched upon in a general way in articles dealing with room size, construction materials, and furnishings. Only recently, however, has it become possible to develop quantitative data on two important aspects of the complicated speaker/room/listener relationship. First, if a speaker system's position with respect to the nearest three room boundaries (two walls plus the floor or ceiling) is known, the room's effect on the speaker's acoustic power output can be predicted quite accurately. Second, at least a close approximation of the way room boundaries affect the sound field at various listener locations can also be calculated if we know the distance of the listener's head from the nearest three room surfaces.

When sound is fed into a room, it reflects successively from one room-

boundary surface to another. This effect is known as reverberation. In those areas that are only a small fraction of a wavelength away from such a boundary, the direct and reflected sound pressure are in phase, and therefore combine by simple addition. For an area close to any one room surface but not to others (such as the center of a large wall), the maximum increase in sound pressure above that measured in the middle of the room (assuming that sound energy is arriving at the boundary equally from all directions) is 3 dB. (Note that in all our examples we are assuming that the sound field is diffuse—that is, it reaches the boundary after having been reflected from all directions.)

If the listener moves farther away from the reflecting surface (or if the wavelength is decreased by making the frequency higher), the reflected sound energy will eventually arrive back at the observation point opposite in phase to the direct sound, causing the sound pressure at that point to be about 1 dB lower than it is in the middle of the room. This pressure minimum occurs at a distance of 0.35 wavelength from the boundary. Beyond that distance the effects of the boundary are minor. A speaker system's acoustic power output at low frequencies is in direct pro-

portion to the resistive load presented by the air surrounding it, and that load depends on the speaker's proximity to room boundaries. The measured effect of this loss on a speaker's power output is of precisely the same magnitude as the audible variation in sound pressure for listeners near room boundaries. There is, however, no dependence on a diffuse field in the room, because the speaker's output at low frequencies is omnidirectional.

Near the intersection of two room boundaries the additive reflections can increase the sound pressure by a factor of four, or a maximum of 6 dB. And the sound pressure at a location that is only a small fraction of a wavelength distant from a three-boundary intersection (two walls and a ceiling or floor) is increased nearly eight times by the multiple in-phase reflections, for a maximum boost of 9 dB. Thus the gain in sound pressure at very low frequencies is inversely proportional to the solid angle represented by nearby listening-room boundaries.

This proportionality does not, however, hold for the maximum reduction in sound pressure at the observation point which occurs when reflections are in phase opposition to the direct sound. At a single boundary (wall, floor, or ceiling) the sound pressure is

techniques, but they cannot take into account the random acoustic factors that are introduced when a speaker is placed in a real room with unknown damping qualities, unspecified dimensions, and at unpredictable distances from adjacent room surfaces. Under such circumstances, speakers with smooth, flat measured response curves can develop quite audible dips and peaks in their sound output; others may lose clarity or suffer from subtle, distorting coloration.

Most of us are aware of—and can deal reasonably well with—the damping effects of the room. Simply stated, the “softer” the rugs, drapes, and furniture, the

greater the high-frequency absorption and the less chance that the sound will be overly bright. Fortunately, most room furnishings provide acoustic absorption (damping) within the proper range. However, as many listeners have discovered to their dismay, improving room acoustics can involve a lot more than just proper damping.

Some sensitive and critical audiophiles have spent months moving their speaker systems about, checking the sonic effect of one randomly selected room location after another. They know what they are listening for, but they lack guidelines that will help them achieve it. Roy Allison,

who has been particularly concerned with room/speaker interface problems, has worked out, with the aid of a computer, the specific effects of the major speaker- and listener-position variables encountered in a conventional listening room. It should be obvious that all the random room factors have not been reduced to an easily applied formula, but the article that follows should enable you to eliminate at least one important and disturbing unknown from the complex speaker/room/listener equation.

Larry Kle
Technical Editor

reduced by 1 dB, as we have seen. But at a point approximately 0.3 wavelength distant from two intersecting room surfaces, the sound pressure reduction is 3 dB, and at about 0.3 wavelength distant from a three-boundary intersection the reduction is 11 dB!

This phenomenon has severe audible consequences. If a microphone (or a listener's head) is located close to and equidistant from a three-surface room corner, the sound pressure will vary over a range of 20 dB (+9 to -11 dB) as the audio signal frequency (and hence

the wavelength) changes, although the sound pressure in the middle of the room remains constant. Fortunately, the variation is less for locations off the line of symmetry from the corner, but it is still of considerable magnitude.

These relationships were first spelled out in several papers by scientists at the National Bureau of Standards. The mathematical operations required to plot a “response curve” for a particular speaker or listener location are tedious, but a large computer, properly programmed, can make short work of

the dreary calculations. The curves presented with this article were plotted from data supplied by such a computer. They are of two kinds: first, there are speaker power output vs. frequency curves showing how the calculated power output of a standard “ideal” speaker system changes as its position in the room is varied. Second, there are curves showing the additional influence of room boundaries on the sound heard by listeners sitting in typical positions in a room. In addition, there are a few curves showing the result of combining a speaker's response for a particular room location with a specific listener position.

The theoretical basis for predicting a listening room's influence on speaker acoustic-power output has been tested experimentally and found to be applicable to real home listening rooms and speaker systems. Therefore, the loud-speaker/room curves shown herein can be relied on completely. Somewhat less confidence should be placed in the listener-position curves, however, since they assume a totally diffuse sound field such as might occur in a concert hall, and the home listening room suffers from resonance modes (standing waves) which are directional and, in a small room, usually widely spaced in the low-frequency range. However,

Figure 1. Relative power output vs. frequency for a “standard” speaker system with a 50-Hz bass resonance. This is a normal anechoic performance for many current speaker systems.

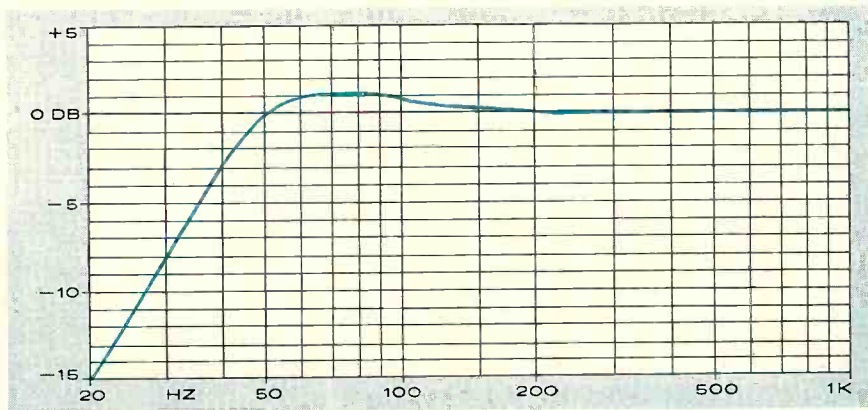

with the usual listener locations, the resonance modes tend to coincide with and reinforce the normal boundary effects at listener positions.

Speaker Position

To show how speaker output is affected by a real room, it is convenient to start with a "standard" or reference speaker. Figure 1 is a power-output vs. frequency curve (measured in an anechoic chamber; a near-field response measurement would yield the same curve) for a hypothetical "standard" speaker. The performance and the physical arrangement of the system are quite close to those of many high-price bookshelf units now on the market. This hypothetical system has a cabinet with dimensions of about 1 x 1 x 2 feet, and its woofer is mounted toward one end of the front panel. The system's normally damped bass resonance is at 50 Hz. (Although this hypothetical system is an acoustic-suspension type, the design principle is actually not relevant. The room effects to be shown would apply to any type of speaker system except those using bass corner horns; only the distance from the driver to the three nearest room boundaries is important.)

Suppose we take this standard speaker system into a home listening room and put it on a 32-inch-high table or shelf, with its back close to the wall. The center of the woofer will be 3.17 feet from one room boundary (the floor), and its average path length along the exterior surface of the cabinet to the rear wall will be about 1.67 feet. Figure 2 is a family of acoustic power-output curves obtained as the system is moved gradually away from the side wall, with its center at distances varying from 1 to 6 feet. It is evident that as the distance to the side wall is increased, the peak in output centered at 50 to 60 Hz decreases. In fact, the 6-foot side-wall spacing causes an output variation from normal of only about ± 3 or ± 4 dB. None of the curves looks exactly like the system's *anechoic* curve, however, and in most domestic rooms it would not of course be feasible to locate a stereo speaker six feet or so from the nearest side wall.

If we take the speaker off the shelf and put it on a 1-foot base or stand with the woofer end of the cabinet at the bottom, the woofer's center will be roughly 20 inches or 1.67 feet above the floor. Its average path length to a rear

wall remains 1.67 feet if the cabinet back is placed close to the wall. Adjusting the base location so as to vary the distance to the side wall, we obtain the family of curves shown in Figure 3. It is obvious that the bass peak here is greater than for the corresponding shelf positions. Also, the fact that the woofer remains at the same distance from two of the boundaries tends to "pull" the acoustic power dip toward a common frequency (200 Hz) for all the curves and to make its average severity greater than would be the case for unequal distances. It is rarely a good idea, therefore, to stand a speaker system on a short base.

The curves in Figure 4 are similar to those in Figure 3, except that the woofer end of the cabinet now rests on the floor. As a result, the 1.67-foot woofer-center distance of Figure 3 becomes 0.67 feet (8 inches), with a resulting improvement in overall smoothness. The suck-out at 200 Hz is now gone. A study of the three sets of curves shown so far does, in fact, suggest a useful rule of thumb for the installation of conventional speaker systems: *the more different the distances from the woofer to the three nearest room boundaries, the smoother the acoustic power-response curve will be.* That rule is verified in general by the set of curves shown in Figure 5. We have left the woofer end of the cabinet sitting on the floor but have moved the system forward so that the woofer is about three feet from the rear wall. Again, curves are shown for four different distances up to 6 feet from a side wall. The most irregular curves (aside from the 50- to 60-Hz bass peak) are those for which two dimensions coincide or are quite close.

Figure 6 shows the result of positioning the system on a pedestal somewhat away from the rear wall. The woofer is assumed to be 3 feet above the floor and 2 feet from the back wall, and the speaker is again moved varying distances away from a side wall. Some of the power curves are relatively smooth, particularly those at greater distances from the side wall. When two dimensions coincide, however, as at the 3-foot distance, there are larger variations. (It should be made clear that the same results would be obtained if we kept the woofer's center 2 feet above the floor—or 2 feet below the ceiling—and 3 feet from the rear wall. It is the *combination* of distances that matters.)

Next, if we install this standard speaker diagonally across a wall intersection, the distance from the center of the woofer to each wall will be about 1½ feet. Power response in this case is very uneven no matter how far the sys-

tem is raised above the floor, as Figure 7 shows. A corner is therefore *not* a good place to install any system *not specifically designed for it.*

Listener Location

In most domestic listening rooms there are fewer practical choices for locating the listener than for locating the speaker. For example, few audiophiles, however dedicated, would be comfortable sitting on a midwall shelf. Also, the height dimension is virtually constant since a seated listener's ears will hardly ever be less than 36 inches and never more than 42 inches above the floor. For our purposes, it is safe to assume a standard height of 1 meter

Figure 2. Power output vs. frequency curves for the standard speaker system of Figure 1 as measured in a typical listening room. The numbers on the charts show distances (in feet) from center of woofer to the floor, to the back wall, and to the nearest side wall. Curves are typical for the system placed on a table or a bookshelf 32 inches high with its back near a rear wall and at gradually increasing distances from a side wall.

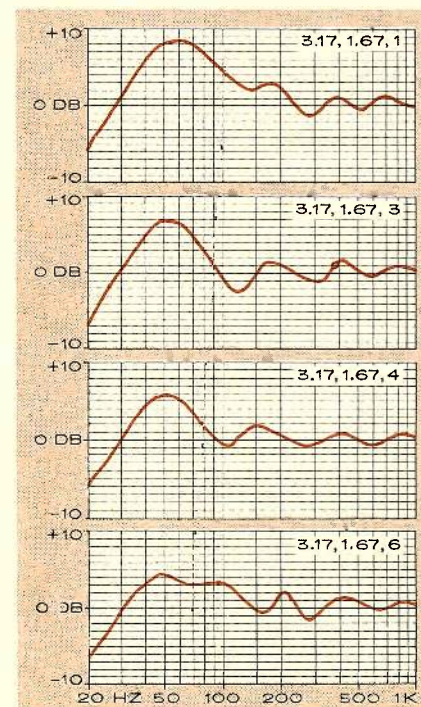
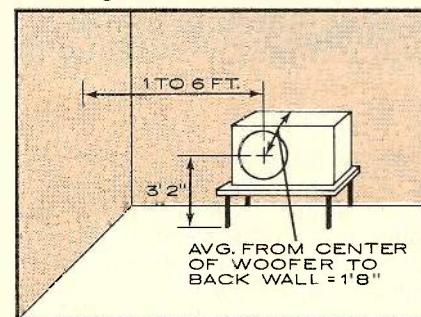

(3.3 feet). Sofas and chairs are usually placed close to or against one wall, and a seated listener's ears will therefore usually be 1.1 feet (13 or 14 inches) away from a wall. Figure 8 shows the calculated effect of the room boundaries on the sound pressure for listeners on a chair or sofa against one wall and at distances from 2 to 6 feet from an intersecting wall. The worst response is displayed, as expected, by the curve for the 3-foot side wall distance since it is nearly the same as the height dimension. Also as expected, the shape of the bass peak depends on the distance to the side wall.

Another common sofa arrangement is L-shaped, with the listener seated several feet away from the room wall

opposite the speakers. This in effect moves the listener toward the room center, placing him, say, 5½ feet or so from the rear wall. Figure 9 shows the room-boundary effects for listeners seated at distances from 2 to 7 feet from the nearest side wall. It is apparent that these curves are in general rougher than those for positions closer to a wall. The reason is that, with two of the distance dimensions fixed at 3.3 feet (listener height) and 5.5 feet (approximate rear-wall distance), there are not likely to be large differences in the three dimensions. However, the general shape of these curves is not necessarily bad, as we shall see.

The remaining common seating position is in a room corner. If a chair is

placed well into the corner, a seated listener's head will be about 1½ feet from each wall, with the result shown by the upper curve in Figure 10. Bad enough. But if a corner chair is used as part of a seating arrangement with a sofa along a wall, it will usually be situated well out from the corner. Then the unfortunate occupant of the chair may find that his head is about 3 feet distant from each wall. The distance to the floor is almost the same, and when all three dimensions nearly coincide, the result is awful, as can be seen from the middle curve in Figure 10. Minor adjustments in the chair's corner position can be of some help. The lower curve in Figure 10 is for a listener located 4 feet from one wall and 2½ feet from the other. It

Figure 3. The standard system placed on a base or low table about 1 foot high with the woofer end of the cabinet down, the back near the rear wall, and the distance to the side wall increasing in 1-foot increments.

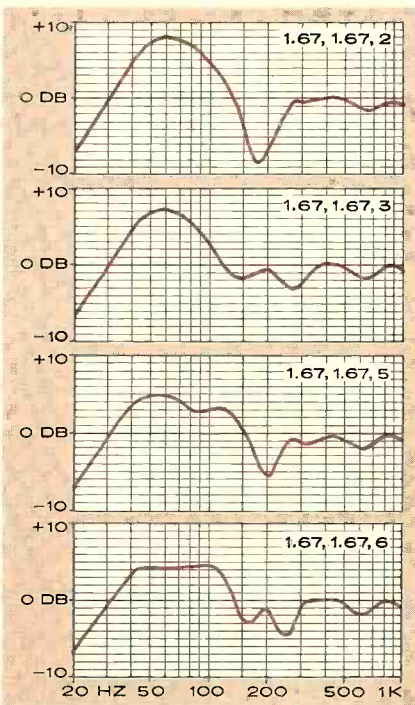
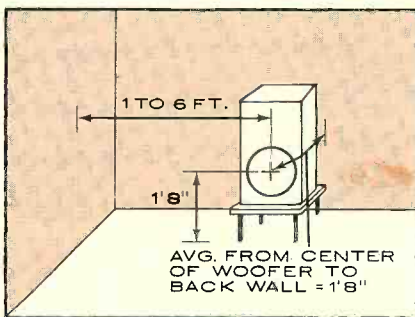

Figure 4. Response in a real room for the standard system with the woofer end of the cabinet on the floor, back close to the rear wall, and at 1-foot increments of distance from a side wall.

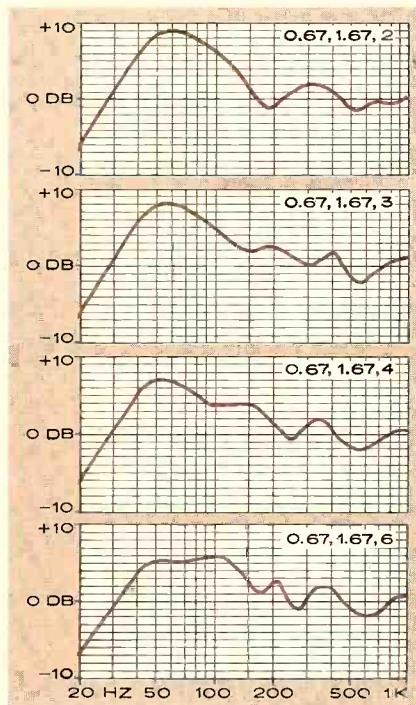
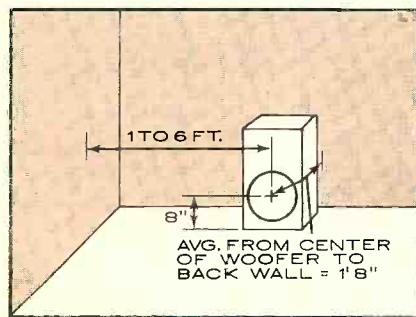
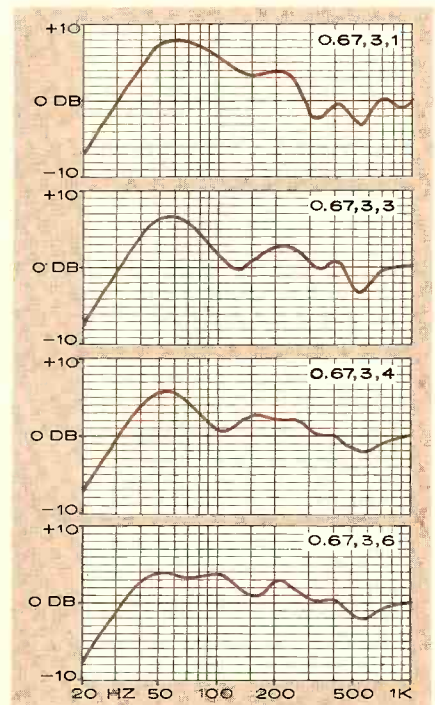
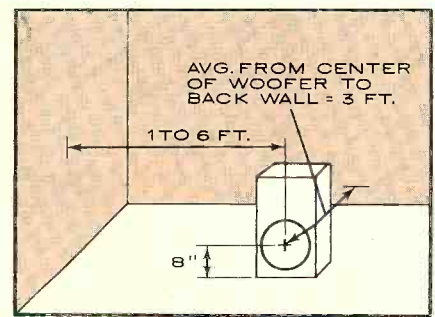

Figure 5. Real-room response of the standard system. Here the woofer end of the cabinet is on the floor and the distance to the rear wall is 3 feet. Response changes radically as the distance to a side wall is increased incrementally from 1 to 6 feet.



SPEAKER/LISTENER

can nevertheless be said that corner positions are no more desirable for listeners than they are for conventional box speakers.

Combining Positions

If the sound field were perfectly diffuse at low frequencies in your particular listening room (it isn't), and if the room's sound-absorption properties were the same at all frequencies, you could simply add the acoustic power-output curve of your ideal speaker in a given room position to whichever lis-

tening-position curve you select, and you would have a precise overall speaker/room/listener response curve. Naturally you would try to find complementary curves, so that the hills in the speaker-output curve would be canceled by valleys in the listening-position curve, and vice versa.

There are indeed a few combinations for which this works quite well. Figure 11, for example, shows a curve obtained by simple arithmetical addition of the values from the 4-foot speaker spacing curve, Figure 2, and the 7-foot listener-spacing curve, Figure 9. Note that these positions may or may not be practicable in your living room. The amount of bass rise shown is no cause for alarm; it may be about right to balance the bass that gets lost through normal flexing of the room walls.

Another fairly smooth combination, though with considerably more extreme bass, is that shown in Figure 12. This combines the 5-foot speaker-spacing curve of Figure 3 with the 6-foot listener-spacing curve of Figure 8. Combinations as smooth as these are rare, but they are worth looking for. A combination that might be established by room-decor considerations could produce a curve as bad as that shown in Figure 13, and there are many even worse combinations possible, as inspection of the other curves will prove.

As mentioned, much of the bass rise shown in these curves is not actually heard in most rooms (which is all to the good) because the room boundaries are not sufficiently stiff at low frequencies to retain it all. And, also as noted before, rooms of home-listening-room

Figure 6. The standard box's real-room response when the woofer is 3 feet above the floor, 2 feet from the rear wall (or vice versa), and at 1-foot increments of distance from the side wall.

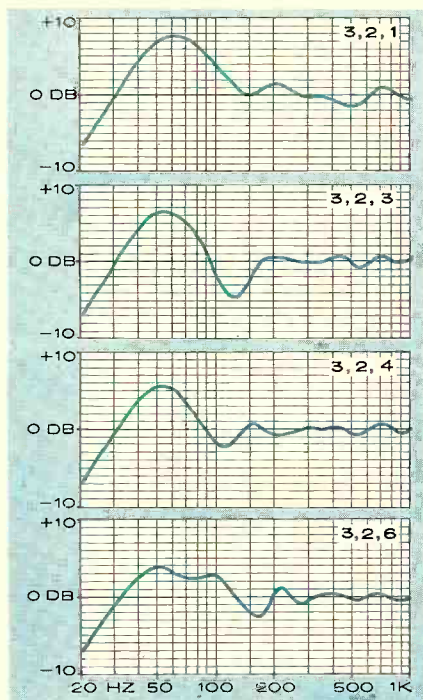
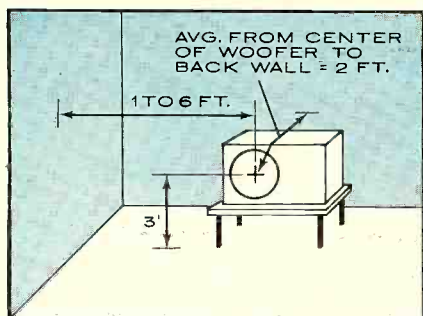

Figure 7. Cater-corner placement of the standard system produces the output curves shown for four distances of woofer center above the floor.

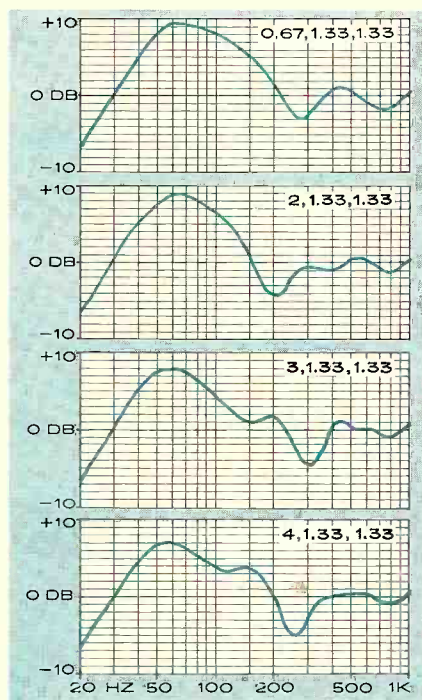
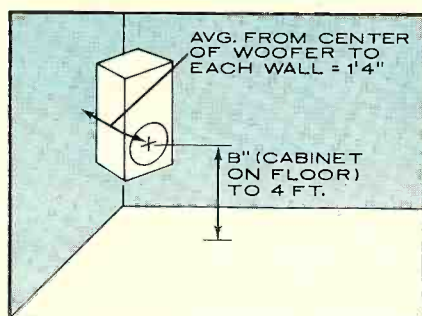
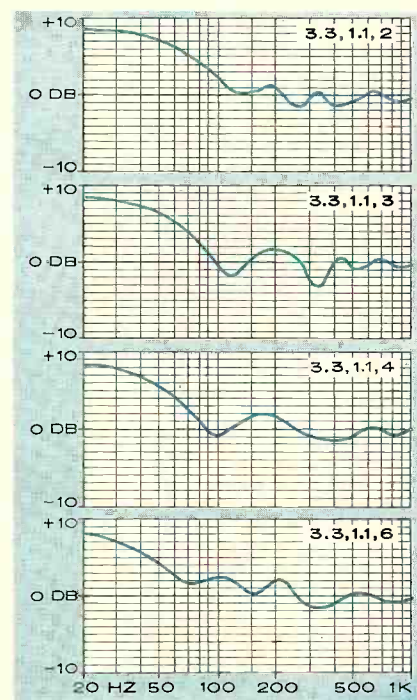
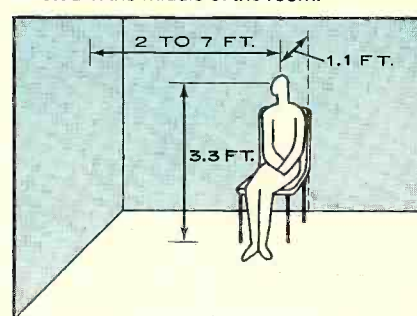
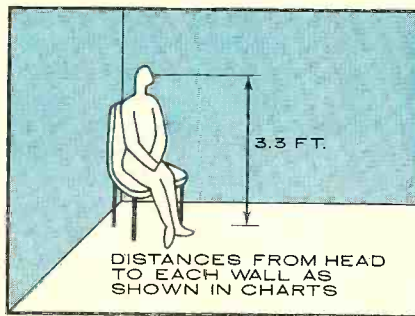
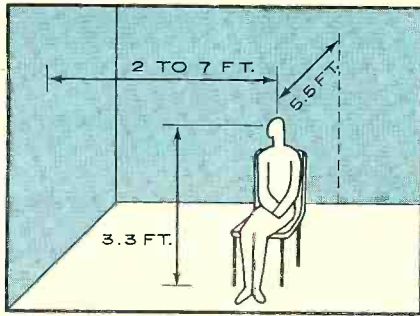

Figure 8. Room-boundary reflections also alter sound pressure at listener locations. Curves show boundary augmentation for a listener seated close to one wall and at various distances from another. Curves would represent sound pressure vs. frequency if a diffuse, uniform sound field existed in the middle of the room.





possible once we know how much boost and cut is needed and precisely where in the frequency range to apply it. But equalizers can also increase amplifier power requirements and speaker distortion. And, in any case, it certainly makes sense to optimize the acoustical situation physically *before* resorting to electronic correction.

It should be noted that *each* speaker system's performance in a stereo setup is determined individually by its position with respect to nearby room surfaces. To the extent that a pair of stereo speakers are producing the same material within the affected frequency range (this is most likely to be true in the bass region), it may be possible to achieve partial compensation of power-response aberrations by choosing appropriate differences in position for the two speaker systems. It can certainly be said that the most uniform power output will *not* be obtained from a pair of conventional stereo speaker systems if they are placed symmetrically in a room, for in such a situation *each* system will have the same aberrations.

WHAT all these investigations make clear, of course, is that we need speaker systems whose woofers will be uniformly loaded by a room throughout their assigned frequency range without being unduly influenced by their position in the room. It is perfectly feasible to design systems of that kind—some, in fact, are now being made. But until there are more of them available, we can help the standard speaker boxes provide better sound simply by being careful where we put them—and our listening selves. □

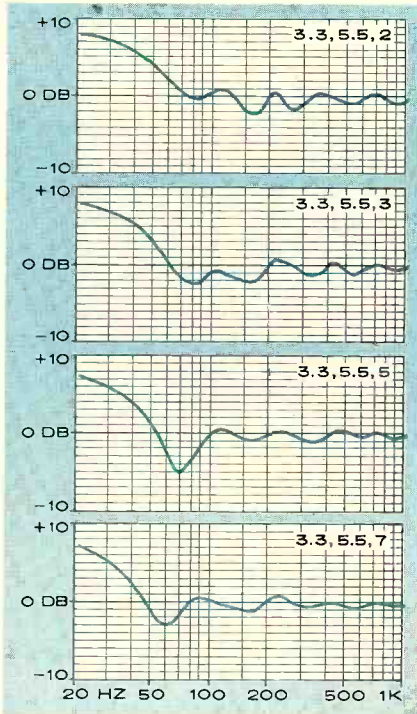

Figure 9. Boundary effects on sound pressure for a listener seated 5½ feet from one wall and at 1-foot increments between 2 and 7 feet from a side wall.

size do not provide diffuse sound fields at low frequencies. Since all loudspeakers are not as inherently flat as our reference standard, does this mean that the curves are useless or unreliable? Not at all. It means that if you use this information to establish the speaker and seating locations *you will be able to reduce the unknown variables significantly* and thereby improve your odds. Even if you ignore the listener-position curves and simply put your speakers where the curves show the room will treat them kindly, you can expect audible improvement.

As is evident, the worst aberrations occur well within the operating ranges of most woofers. Such peaks and dips *cannot* be removed by a speaker's balance adjustments or level controls, but only by changes in the speaker's position. True, some compensation by means of narrow-band equalizers is

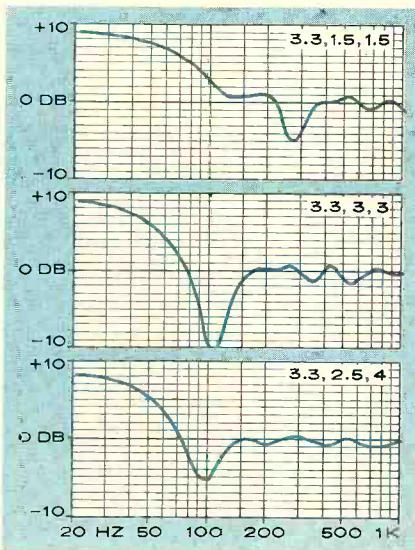

Figure 10. Effects of room-boundary reflections on the sound field for a listener seated close to a corner. Height is constant at 3.3 feet; other dimensions shown are distances to the nearby walls. Note huge variation when the three distances are nearly identical.

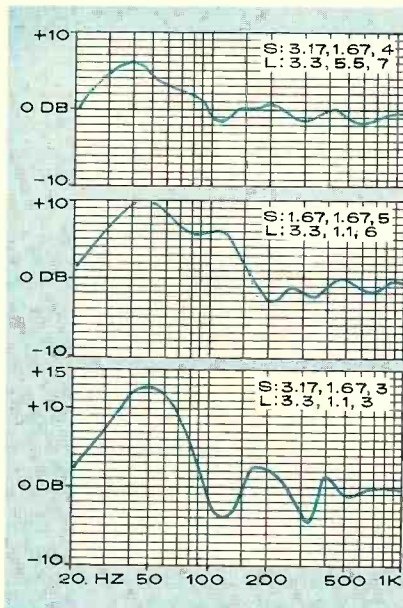

Figure 11. In some cases, a conventional speaker system can be so located that its power-output curve is complementary to the boundary augmentation at a given listener position. This room/listener curve is obtained by adding the power output of the standard box in position 3.17, 1.67, 4 (Figure 2) to the listener-position curve 3.3, 5.5, 7 (Figure 9). Bass rise shown would probably be beneficial (see text).

Figure 12. Another room/listener curve, relatively smooth but with strong bass. Speaker-output curve 1.67, 1.67, 5 of Figure 3 was added to listener-position curve 3.3, 1.1, 6 of Figure 8.

Figure 13. A room/listener curve that might be obtained by addition of random but typical speaker and listener-position curves. There are many worse combinations.

THE CAPTAIN AND TENNILLE

STORIES about the remarkable career of the Captain and Tennille usually contain the terms "fairy tale" and "fantasy come true." In its outline, their story indeed is that. Consider: in the fall of 1973 the Captain (Daryl Dragon) and his fiancée (now wife) Toni Tennille were earning their living playing small club dates around Los Angeles. They went into a studio to cut a demonstration record of a song Toni had written, *The Way That I Want to Touch You*.

When they couldn't interest any record company in their work, they decid-

But even in fairy stories, the hero (or heroine) doesn't spring out of nowhere and reach the happy ending without doing some hard preparatory work. The Captain and Tennille have impeccable musical credentials, and their experience and background are so impressive that the real surprise is that they couldn't find a record company to sign them in the first place. Daryl, son of the conductor Carmen Dragon, had been an arranger and keyboard player for the Beach Boys for seven years. (It was the Beach Boys who gave him his nickname, Captain Keyboards, in hon-



William R. Eastbrook

The sentiments may be sentimental, but they are real

By Penelope Ross

The Captain and Tennille, winners of this year's Grammy award for Record of the Year, are shown above with presenters Joan Baez and Stevie Wonder during the February telecast.

ed to spend \$500 to press copies themselves and send them to local disc jockeys. It was an unusual but hardly unique solution to a situation faced by other groups with local followings. The result was an L.A. Top Ten hit, and it generated enough interest to get them a record contract with A&M. The single they made for their new company, *Love Will Keep Us Together* (also the title of their debut album), blasted its way to number-one song in the country, was certified Gold by the RIAA (sales in excess of one million copies), and won a Grammy Award from the National Academy of Recording Arts and Sciences as Record of the Year. That single was the start of a solid, bright, new musical career.

or of the sailor's cap he habitually wears.) Toni Tennille, composer, actress, singer, and keyboard player, was *really* unique—she was (and to date still is) the *only* woman ever to play with the Beach Boys, touring with them as pianist and occasional back-up vocalist during 1972. She had also sung on Elton John's "Caribou" and worked with Bruce (I Write the Songs) Johnston after he left the Beach Boys to launch his solo career.

Prior to her entry into pop music, Toni and a collaborator had written *Mother Earth*, a musical revue about ecology, which got rave reviews at the South Coast Repertory Theater in Los Angeles. The reviews aroused the interest of other producers who wanted

to do the show. So Toni, who describes herself as "naïve at the time," signed with a producer in San Francisco—only to discover she had also signed away artistic control. "When he insisted on inserting unacceptable material, I left the show."

Now Toni reflects that her experience helped her to learn not to be so trusting in business. More important, *Mother Earth* was her introduction to Daryl Dragon. Or, as Daryl put it when asked if they had met on tour with the Beach Boys, "It wasn't an on-stage romance. It was an on-tape romance. I was approached to do arrangements for *Mother Earth* and asked to hear the music first. I was sent a tape of Toni singing the score and just followed that voice to San Francisco." Toni added, "It was really special that he liked my music. Daryl won't work unless he likes the music."

IT would seem that when the couple left the Beach Boys in early 1973 to form their own group (the two of them plus Chris Augustine on drums), there should have been some record-company interest in their music. But even without records they quickly worked up an impressive following in their club dates, a fact of which they are quite proud, since they both believe it is a direct outcome of their approach to performing.

Toni, who does most of the talking on stage and in interviews, explains: "It is our philosophy that every night we would do the best we could, no matter how many people were in the audience. That way, if anyone liked us and told his friends, they could be sure of seeing a good show, even if we were only playing to six people. We just took a chance on building our act that way. We started at the bottom in the San Fernando Valley, where we did four sets a night, six nights a week, and developed an audience. We had people sign cards if they were interested in knowing where we were playing next, and we ended with a list of two thousand fans who followed us!"

So why couldn't they get a record contract? Toni recalled: "It was the fall of 1973, and, if you remember, there was a vinyl shortage and companies just weren't signing new acts. We did send the record around, but we had no manager and just couldn't walk into offices with our demo." Even the Beach Boys, who had their own label, were unwilling to take a chance. "Daryl took the single to Carl Wilson, but they were going through some hard times with Flame, the only group they had signed, and the whole label seemed to be in trouble. Carl told us to come back to them if we ever got some action

on the record on our own. Dennis [Wilson] really liked it, and now he's one of our biggest fans. But at the time they weren't interested. I don't blame them. It was business."

In any case, the lack of interest in 1973 disappeared in 1974, along with the vinyl shortage, and they went to A&M, probably the ideal company for them and their music. Herb Alpert and Jerry Moss may well have been fascinated by the parallels between the couple's career approach and their own start in the music business. (Alpert couldn't get his band a recording deal either, so he and Moss pressed and distributed their own records, then took it one step further by starting their own label.) More important, the Captain and Tennille make A&M's kind of music—an up-tempo hybrid of rock and pop that is melodic enough to be middle-of-the-road but at the same time has enough emphasis on the beat to attract younger listeners.

In performance the Captain and Tennille display some really dazzling musicianship, together playing a total of eight keyboard instruments. Toni uses a grand piano, an electric piano, and a mini-Moog synthesizer on which she works bass lines, singing all the while. Daryl has chosen to stay in the background, playing clavinet, organ, vibes, and ARP and Moog synthesizers and leaving most of the spotlight, the talking, and all of the singing to his wife.

They seem to know how to heighten the innate differences between them to help the show. Toni is naturally voluble, filled with energy and Southern charm (she's a native of Montgomery, Alabama). In contrast to her effervescence, Daryl is dour and deadpan and says little. But he can still let loose with his own funny one-liners when he has the chance, most notably when he moves to the piano to give a demonstration of his great musical love, boogie-woogie in the Fats Domino tradition. Events sometimes conspire to make him more silent than he would like: "People always ask me why I don't talk more, and I would, but they keep forgetting to turn on my voice mike."

IN live performance, the Dragons do a wider range of material than they have yet recorded, moving from country to pop to rock. Although their melodies are generally simple—both their own and the numbers they do by other composers—their arrangements are intricate enough to keep the interest level high. It's an approach they may well have developed in their work with the Beach Boys.

Another trait they display on record also reflects the ideas of their old

group—keeping the music in the family. Their first album lists Louisa, Melissa, and Jane Tennille (Toni's sisters) as singing background harmonies. The four girls sang together as children and, as Toni says, "It's lucky we all have different vocal ranges so we can sing four-part harmonies." Then there is Daryl's brother Dennis, who engineered and mixed the album and who also played drums on one song. He didn't join them on the road, they said, "because Dennis gets a little excited drumming and it's hard to hold him down when he's playing with us."

SUCCESS has brought a few changes for the Captain and Tennille. They have already released a new album, "Song of Joy" (reviewed on page 00), and have a manager at last. He has booked them on major tours, opening for such disparate attractions as Mac

"when you're playing with the Beach Boys, you have to be as good as you can get."

Davis, Freddie Prinze, and the Beach Boys (which may give Daryl his chance to play *Help Me, Rhonda* once again). The venues are huge halls and arenas, which necessitated expanding their group: they added Melissa and Louisa Tennille as back-up singers, Melissa's husband Andy on percussion, and Gary Sims as guitarist and bass player. Daryl expressed some regret about abandoning their tightly knit trio, but observes that, "When you play huge halls, you need extra people. Especially when you're playing with the Beach Boys, you have to be as good as you can get."

Beyond that, Toni is trying to encourage Daryl to join her more in the spotlight and perhaps make his stage singing debut. "Daryl wrote an answer to *The Way That I Want to Touch You*, called *She Wrote This Song for Me*. When he sang it for his parents, they just sat there and cried, it was so beautiful." The sentiments may be sentimental, but they are real.

The Captain and Tennille seem to have hit on a formula that can please audiences and themselves as well. Daryl sums it up simply: "People want to hear happy music these days." It looks like the combination of "happy" and a high degree of professional polish will take them where they want to go. □

ANTONIO DE ALMEIDA

By Roy Hemming

Now that there are dozens of recordings of every Beethoven and Brahms symphony and practically every Ravel suite and Puccini opera in the catalog, it's not surprising that new recordings of such rarities as Massenet's *La Navarraise*, Halévy's *La Juive*, Schmitt's *La Tragédie de Salomé*, Lalo's Symphony in G Minor and *Rapsodie*, and an album of Rossini ballet music get special attention from reviewers and record collectors. Recent releases of each of these rarities have had one thing in common: all were conducted by Antonio de Almeida (he pronounces it *dal-may-dah*). At a time when most conductors seem determined to establish their reputations by recording complete sets of Beethoven, Mahler, or Tchaikovsky, De Almeida has been content to specialize in performing the unusual, the less familiar, and what he calls "the unfairly neglected."

I discussed this with him recently when the tall, handsome, silver-maned French conductor of Portuguese ancestry passed through New York with his family. "There are so many composers who've been totally eclipsed just because they're not commercial," he said. "It's a shame." Could he be specific? Without hesitation he started reeling off names: "Lalo, D'Indy, Chabrier, Dukas, Massenet, Martinů, Franz Schmidt. And in America, Howard Hanson, Samuel Barber, Roy Harris. There are many more."

De Almeida, forty-eight, has always been the sort of conductor willing to take chances where others won't, especially to explore the unknown and different. As one record-company executive put it to me: "The Bernsteins, Karajans, and other 'big names' are so busy jetting here, there, and everywhere that they don't have the time it takes to research neglected works, to supervise getting the parts in shape for performance, and all that. A conductor like De Almeida is not only willing to put in the time required, he *loves* doing it. And that is what makes him so special today."

The French government also feels he is someone special. This spring it awarded him the Legion of Honor for his contributions to French music. And in May he was named music director of both the Nice Opera and the Orchestre Philharmonique de Nice.

De Almeida first became interested in music when he was a teenager newly arrived in New York from France shortly after the outbreak of World War II. "When the Germans came into France, we managed to get out though the family was separated for about a year," he recounted. "My father was offered a job in Buenos Aires while my brothers and I were left in New York to go to school." That one year in New York had quite an influence on De Almeida. "I discovered jazz and started to teach myself to play the clarinet by listening to Benny Goodman and Artie Shaw records. Then I took up the saxophone and oboe. I had begun studying the piano earlier, when I was ten or eleven back in Paris, but I never played it terribly well. I still don't."

By the time De Almeida rejoined his family in Buenos Aires to finish his high school education there, he knew he loved music more than anything else. But neither he nor his family then considered it a future career for him. So, from the Argentine, he applied to the Massachusetts Institute of Technology for a chemistry scholarship—and won it. At M.I.T. he soon began spending far more time pursuing extracurricular musical activities than his science studies. He became a vice-president of the glee club and a clarinetist in the M.I.T. band. He also moonlighted as an oboist with the nearby Wellesley orchestra and as a horn player with the Tufts orchestra.

"One day," he said, "the other vice-president of the glee club and I got to talking about the fact that Harvard and other universities in the area had both a symphony orchestra and a jazz band as well as a glee club. We decided M.I.T. needed the same and that it was up to us to organize them. We tossed a coin,

and I got the job of organizing the symphony. I was disappointed at the time not to get the jazz band, but I plunged ahead. Looking back, I honestly think I would have moved very soon into symphonic music anyway, but this flip of the coin put me smack into it.

"By my sophomore year the orchestra was giving regular concerts, and I was convinced the scientific life was not for me. I transferred to Yale to major in musicology. I knew by then that I wanted to be a conductor, and I chose Yale because it didn't have a conducting course. I knew that if I went to a school with other conductors, I'd never get to conduct much," he says. "On the other hand, if I went to a school without a conducting course, I'd be the only conductor."

And that's exactly what happened. De Almeida formed the Yale Pocket Symphony and conducted it for two years. "It was a small chamber orchestra. We played works by Corelli and Mozart and did Handel's *Julius Caesar*. And we commissioned new works from young composers studying in Paul Hindemith's classes at Yale. We'd play in prep schools around Connecticut and New York if they'd pay our transportation and give us dinner, and they loved having an orchestra come and play for them.

"I learned more from Hindemith than from anyone else," De Almeida says warmly. "I studied with him every Saturday for four hours. I told him I didn't want to be a composer, that I had no talent at all for composition. He just smiled and said, 'That's all right, most of my regular students don't either.'"

With his Yale degree, plus two summers' training at Tanglewood, De Almeida set out to conquer the world's podiums. "But in those days youth was not 'in' as it is today," he said. "It's like saying you want to be the general of the army and nothing less, but who's going to give you their army to lead until you've won a battle or two? So I packed my suitcases and went back to Europe. I figured I'd just go around and

knock on everyone's door until someone gave me a chance to show what I could do."

The first one to give him that chance was Pedro de Freitas-Branco in Lisbon. "He was Ravel's favorite conductor," De Almeida said fondly. "But he didn't have any strong ambitions to conduct outside Portugal, so he never became very well-known internationally, except for a few Ravel recordings he made for Westminster in the early 1950's."

De Almeida's first Lisbon concerts got good reviews. Armed with those, plus a scratchy 78-rpm transcription of one of his concerts, he took off for Germany to try to land some more engagements. "Very slowly they came," he says. "I started in the small towns. In fact, in Bad-Hamburg when we rehearsed, the streets were virtually deserted because everyone was in the orchestra."

A major boost to De Almeida's career came from Sir Thomas Beecham.
(Continued overleaf)

Clive Berke, CAS

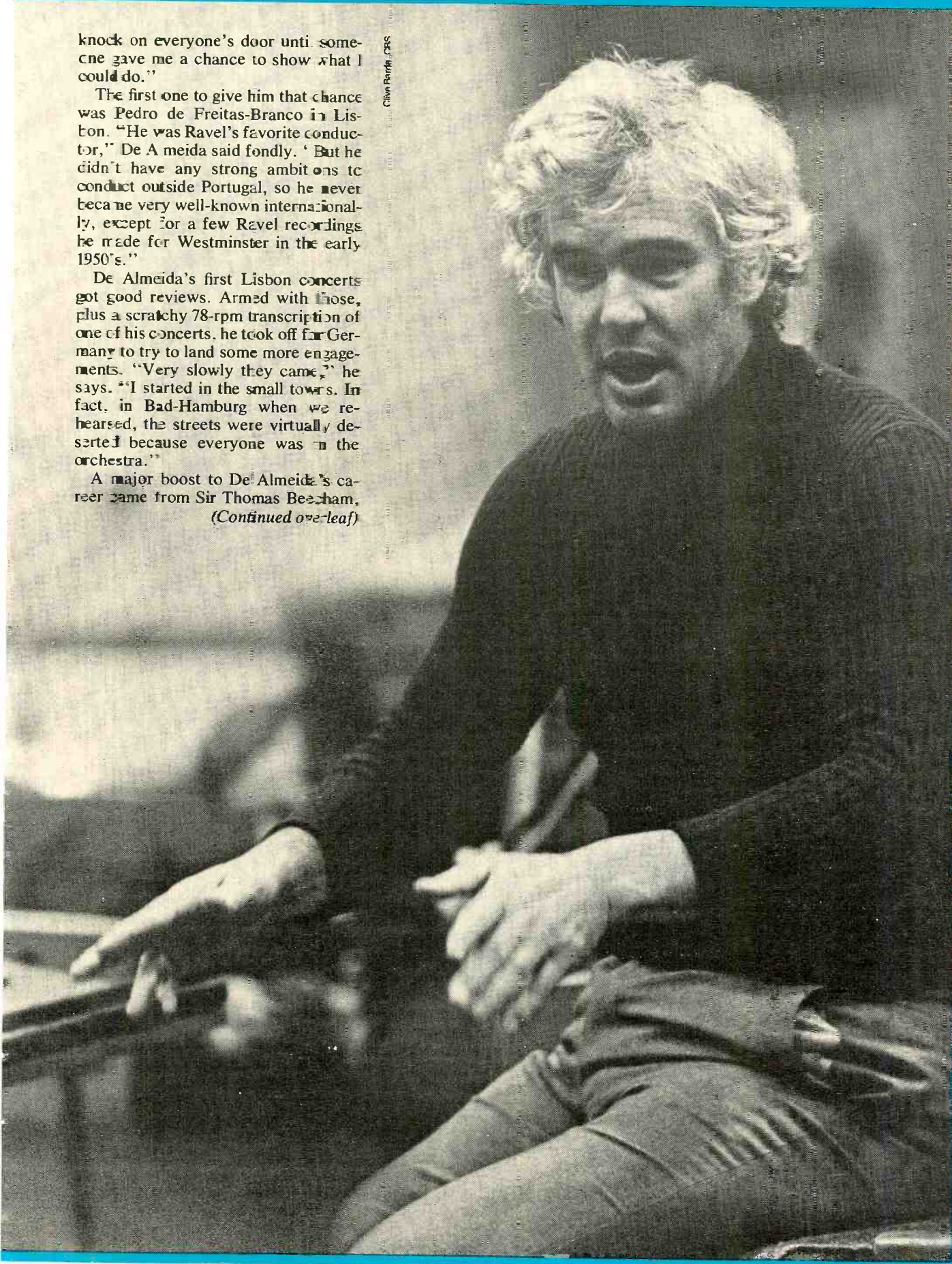

who invited him to make his London debut conducting the Royal Philharmonic (he has since conducted it often). "Also at about this time, the Portuguese radio wanted another major orchestra besides the one in Lisbon. I was asked to organize an orchestra in Oporto, in the north of Portugal. I did so, and conducted it for three years [1957-1960]. Beecham came to conduct it, and I acted as his interpreter. After the first rehearsal I asked him what he thought of the orchestra. 'Oh, absolutely delightful,' he said. 'Of course, it's fortunate I'm still totally deaf from yesterday's plane ride.'"

De Almeida's recording of the Lalo symphony, released this year by Philips, is not only its first in stereo but also the first since Beecham's mono version in the 1950's. While admitting that Beecham's recording is one of his favorites, De Almeida insists, "Mine is not a copy of his. I think it's silly that people say you should never listen to recordings because they'll influence you so that you wind up copying them. That's not so. You can listen to a Toscanini recording of a Beethoven symphony a hundred times and then go out and conduct it your own way. Unless you have no personality at all, it's impossible just to copy what some other conductor has done."

the Beethoven and Brahms symphonies I can't tell you how many times a month." De Almeida returned to the United States for several years, first to study with George Szell in Cleveland and then in 1968 to be the principal conductor of the Houston Symphony for two seasons.

While thus continuing a heavy workload in the standard repertoire, he found himself becoming more and more intrigued by the less familiar works he was asked to perform as a guest conductor at the Paris Opera, the Lisbon Opera, and the various radio symphonies. "There are fifteen full-time opera houses in France alone," he says, "so operas like Meyerbeer's *Les Huguenots* and Halévy's *La Juive* are performed, but outside of France these works are virtually unknown today."

Does he think the success of his Columbia recording of Massenet's *La Navarraise* last year will pave the way for the recording of other less-familiar French operas? "I certainly hope so," he answered. "Later this year I will record Ambroise Thomas' *Mignon* for Columbia. Many others deserve consideration. Massenet's *Le Jongleur de Notre-Dame* is just a title to most people nowadays, yet it may well be his masterpiece. His *Cinderella* is a delightful, frothy piece, and *Le Cid* is a

wrote an absolutely beautiful opera, *Le Roi Arthus*, which is filled with juicy French music no one ever gets to hear today. The Saint-Saëns operas are well written musically, but because of their librettos they don't stage well. But they would record well, and I'm sure people would enjoy listening to them at home."

In the 1960's De Almeida put in a lot of work and study preparing himself to record all the Haydn symphonies in H. C. Robbins Landon's "critical" editions approved by the Haydn Society, of which De Almeida became artistic director in 1968. "We began to record the series in 1969," he said, "with Robbins Landon himself as producer. We put together an orchestra of the finest solo players we could get, such as the great Roman flutist Gazzelloni, and we had a marvelous time during the sessions. I can honestly say we all played with a great deal of love for the music. But the Haydn Foundation couldn't get commercial backing for the project, and we ran out of money after completing only the Esterhazy and London symphonies—twenty-three in all."

A few years later, London Records signed Antal Dorati to record all the Haydn symphonies. That series was completed in 1974 and has won several international prizes. I asked De Almeida if he was miffed that his pioneering work was upstaged by the Dorati releases. "I don't have time to feel miffed," he replied. "I have other things to keep me busy and to look forward to. Naturally, I'm disappointed we couldn't complete the series, but I'm proud of those we recorded."

Philips Records has released two of the symphonies (Nos. 94 and 96) on a single disc as a sort of test to see how well it will go in this country, but a Philips spokesman was frank in saying it seems unlikely that the twenty-one other recorded symphonies would be released here, partly because of present import costs.

ONE other De Almeida project is also in limbo at present. "I've written the Offenbach 'Koechel'—a thematic catalog of all of Offenbach's works. But it hasn't been published. Frankly, it would be too expensive to do it the way I believe it should be done. I started it as a hobby. Wherever I was performing, I'd ask in the conservatory if they had any Offenbach manuscripts, and quite a few turned up. In Leningrad, for example, I discovered a piece for viola no one knew about outside Russia." From the gleam in De Almeida's eye, it was obvious that this lost viola piece means more to him than another fancy set of all the Beethoven or even the Haydn symphonies. □

Antonio de Almeida, named music director of the Nice Opera and of that city's Orchestre Philharmonique, is congratulated by Jacques Médecin, Mayor of Nice.



Margaret Carson

In 1960, following an engagement at the Stuttgart Opera in Germany, De Almeida was invited to become the principal conductor of the Stuttgart Philharmonic, a post he held for four seasons. "Despite its name, it's not a city orchestra," he pointed out. "It belongs to the whole state, so we played in many other cities besides Stuttgart. That gave me strength in the basic repertoire that I don't think many young conductors get today. We would play

fine work with all kinds of interesting contrasts. Then there are all of Gounod's neglected works—we know only *Faust* and perhaps *Mireille*, but he wrote quite a few others—and Lalo's *Le Roi d'Ys*, which no one but the Paris Opera seems to perform. Chabrier's *Le Roi Malgré Lui* is an absolute masterpiece, and I mean the whole opera, not just the overture and *Fête Polonoise* that we hear occasionally on concert programs. Chausson also

STEREO REVIEW'S SELECTION OF RECORDINGS OF SPECIAL MERIT BEST OF THE MONTH



"How the queen was decapitated" (from Blackwood's *La Mort de La Royne D'Escosse*, Paris 1589)

The Bel Canto Revival Flourishes: Donizetti's Operatic Tragedy *Maria Stuarda* Receives Its Second Recorded Realization

THE Queen of Naples did not like operas on certain subjects, and that may be why the censors in the city in 1834 forbade the presentation of Gaetano Donizetti's *Maria Stuarda*, in which a queen (an ancestress of the Neapolitan sovereign) is beheaded. The opera was ultimately performed, but, like most of Donizetti's works and those of other bel canto composers, it rested in oblivion for close to a century. Since its revival in Bergamo in 1958, however, it has become almost a repertoire staple in Italy, England, and the United States. Its current vigor is attested to by its representation on records in two excellent performances

ABC's 1972 release (ATS 20010/13) with Beverly Sills in the title role and now the new London set (OSA 13117) with Joan Sutherland.

Maria (Mary Stuart, Queen of Scots) does not appear in the musically uneventful first act of the opera, but from the moment she is first heard in the skillfully drawn scene at Fotheringay Park (Act II) she is a compelling central figure to the end. The role calls for dramatic projection of a wide range of emotions, with special emphasis on haughty royal anger (Act II) and noble pathos (Act III). There are dramatic nuances in Beverly Sills' interpretation not to be found in Joan Sutherland's

because of the latter's well-known difficulty in articulating words. On the other hand, Sills' fragile and occasionally impure tones cannot always carry the burden of her dramatic insights, while Sutherland's warm, rich, and well-focused tones themselves add expressiveness to her modest dramatic gifts. Oddly enough, this opera provides opportunities for display of the best qualities of both divas, so both fans and detractors can have a field day arguing over them. For myself, I am pleased to have both on records in this rewarding role.

The Elizabeth of the set, Huguette Tourangeau, is to me rather a strange singer. She has evident intelligence, a good technique, and a gift for bel canto phrasing, but there are also a disturbingly inward, veiled vocal production and a disconcerting gap separating her high and low registers. I do not find her an imperious enough queen here, but

then one must remember that she is facing not only a Mary Stuart but also a Joan Sutherland!

The role of Leicester is not a very substantial one from the musical or dramatic point of view, but Luciano Pavarotti's elegant and persuasive artistry scores impressively nonetheless in every one of his scenes. Roger Soyer is an excellent Talbot and James Morris a sonorous Cecil, though he must be on guard against a growing tendency to push his voice (an intrusive waver is already evident).

Richard Bonyge conducts with sea-

the London set that are of any substance, none of them too meaningful. They occur in the opening chorus, in the conclusion of the Leicester-Talbot duet (Act I, Scene 4), and in the conclusion of the Maria-Talbot scene (Act III, Scene 5).

London's engineering is a bit over-reverberant for my taste, and one could wish at times for more orchestral presence. I prefer the brighter sonics of the ABC set but can live very happily with the sound—and the singing—of the London also. *George Jellinek*

DONIZETTI: *Maria Stuarda*. Joan Sutherland (soprano), Maria Stuarda; Luciano Pavarotti (tenor), Leicester; Huguette Tourangeau (mezzo-soprano), Elisabetta; James Morris (bass), Cecil; Roger Soyer (bass), Talbot; Margreta Elkins (mezzo-soprano), Anna. Chorus and Orchestra of the Teatro Comunale, Bologna, Richard Bonyge cond. LONDON OSA 13117 three discs \$20.94.



DMITRI SHOSTAKOVICH (1906-1975)

soned mastery and his characteristic consideration for the singers. His tempos seem always just, though the great final ensemble ("*Deh tu di un umile andantino*") moves at a rather jaunty *andantino* as against the stately *andante* imposed by Aldo Ceccato in the ABC set (Donizetti's score marking is "*andante comodo*"). Given the uplifting tone of Mary's transfiguration in the face of death, however, the brisker tempo carries a certain conviction, and it sweeps along beautifully *musically*.

As Jeremy Commons points out in his excellent notes, there is no original autograph score for this opera, only several equally "authentic" versions that differ in various ways. Of the two complete recordings, ABC offers more music, but there are only three cuts in

Britain's Fitzwilliam Quartet Shines in Valedictory Works Of Shostakovich

ONE of the happiest developments of the last few years is the appearance of new chamber-music ensembles made up of very young and very gifted performers. To name three striking examples, we have in this country the Tokyo Quartet, distinguishing itself in the Viennese classics, the Cleveland Quartet, identified most closely with the Romantic literature, and the Concord Quartet, giving incandescent performances of new and recent music. The heartening phenomenon is similarly evident in Scandinavia and in Britain, where the Fitzwilliam Quartet, all of whose members are still in their twenties, has not only become a fine ensemble since its founding in 1969 but has achieved an altogether extraordinary authority in the string quartets of Shostakovich, perhaps still the most neglected single source of important works in this medium. The Fitzwilliam's debut disc for L'Oiseau-Lyre, comprising Shostakovich's Quartets Nos. 7, 13, and 14, is something absolutely not to be missed, even by collectors who may have the Borodin Quartet's Seraphim sets of Nos. 1-11 and/or the Melodiya/Angel disc of No. 13 played by the Beethoven Quartet (for whose late violist, Vadim

Borisovsky, that work was written).

Irving Kolodin explored the substance and significance of the Shostakovich quartets in these pages two years ago ("The Private Shostakovich," May 1974), when only Nos. 1-11 and No. 13 were known and available on records in this country, although the last two quartets, Nos. 14 and 15, had been completed and introduced in the U.S.S.R. by then. Quartets Nos. 13, 14, and 15 received their English premières at the hands of the Fitzwilliam Quartet, whose members met Shostakovich and formed a personal bond with him when he came to York for their performance of No. 13 in 1972. They also made the première recordings of Nos. 14 and 15, and Alan George (the Fitzwilliam's violist and founder) suggests, in his annotation for the debut record, that all of these valedictory quartets reflect, in one way or another, the composer's preoccupation with death.

Quartet No. 14, here recorded for the first time, is the last of the four quartets Shostakovich dedicated to the respective members of the Beethoven Quartet, this one to Sergei Shirinsky, the cellist. All three of the works on this disc are in tripartite layout—Nos. 7 and 14 fast-slow-fast, No. 13 the opposite. And Nos. 13 and 14 do seem to support Alan George's contention: the former is an intense, tragic work, the latter relatively tranquil and serene but with deep undercurrents. Dedicated in 1960 to Shostakovich's first wife, who died six years earlier, No. 7 is actually an elegiac work, but, as Irving Kolodin noted, it relates "less to the agony of separation than to a remembrance of the joy in their life together. . . ." Alan George tells us that "the composer himself had a special affection for it, and was anxious for us to play it to him when he was with us."

One imagines Shostakovich must have been more than pleased with what he heard, for the performances of all three works on this disc are expert, committed, and compelling. The recording quality is absolutely first-rate, the pressings exemplary, and Nos. 7 and 13 together on a single thirty-two-minute side constitute a bonus beyond what can be reckoned in minutes per dollar. I now look forward impatiently to the forthcoming Fitzwilliam disc of Nos. 8 and 15, and I hope that No. 12 also will in time materialize from the same source. *Richard Freed*

SHOSTAKOVICH: *String Quartet No. 7, in F-sharp Minor, Op. 108; String Quartet No. 13, in B-flat Minor, Op. 138; String Quartet No. 14, in F-sharp Major, Op. 142.* Fitzwilliam Quartet. L'OISEAU-LYRE DSLO-9 \$6.98.

Another Visit to Steve Goodman's Wonderful Musical Department Store

"CREATIVITY" is one of the more sadly corrupted words just now, for which we can blame, among others, (1) businessmen who think it is just another label they can buy and put on themselves, and (2) very young or

Burgh), Goodman takes a style—country swing, Caribbean, whatever—and does it right, does it with jaunty clarity. He has a sure feel for which musicians to rely upon for what, and he seems to follow no known rules for this: would you have thought, for instance, of hiring Raun MacKinnon to sing back-up on a schlocky old rocker like *Tossin' and Turnin'*? I wouldn't even have thought of playing it in the first place.

Goodman has done more writing for this album than he did for the last; the results are clear and economical, and they seem to represent his funny brand of skepticism pretty well. I thought *Roving Cowboy* (another song delivered unto Goodman from Mike Smith) and Goodman's own *Unemployed* were especially good on side one, and that everything after the first (merely all right) tune on side two was just super. The ending finds him creating furiously with his head, hands, guitar, and an old song called *The Story of Love*. Steve Goodman, artistically at least, is on a winning streak.

Noel Coppage

STEVE GOODMAN: *Words We Can Dance To*. Steve Goodman (vocals, guitar); Steve Burgh (guitar); Steve Mosley (drums); Saul Broudy (harmonica); Jeff Gutcheon (piano); other musicians. *Roving Cowboy*; *Tossin' and Turnin'*; *Unemployed*; *Between the Lines*; *Old Fashioned*; *Can't Go Back*; *Banana Republics*; *Death of a Salesman*; *That's What Friends Are For*; *The Story of Love*. ASYLUM 7E-1061 \$6.98, © ET8-1061 \$7.98, © TC5-1061 \$7.98.

Warren Zevon: New Contender in the Cracked Sensibility Sweepstakes

I've got something to get off my chest. As much as I respect and admire professional oddballs like Randy Newman and Loudon Wainwright, I've never been able to get much pleasure out of listening to them, probably because of their attitudes toward music. Both seem to view it as a basically functional message carrier: Loudon, the old folkie, has never progressed beyond a kind of talking-blues primitivism, while Randy, as splendidly crafted as his stuff is, is just cerebral enough to be fatally cold. Since as writers they're primarily in it for the big (verbal) yocks, neither sees his music, be it kindergarten-simple or conservatory-com-

plex, as having to do much beyond keeping out of the way. Which is fine for their purposes, I suppose, but it doesn't do much to advance the art of songwriting.

So now we have the debut of an L.A. weirdo named Warren Zevon, a similarly cracked sensibility who has surrounded himself with a slew of Famous Names I have been on record for some time as not caring for—and I have to confess I am totally bonkers about it. Why? Because despite his style (deadpan humor) and his subject matter (pithy dissections of the seamy under-

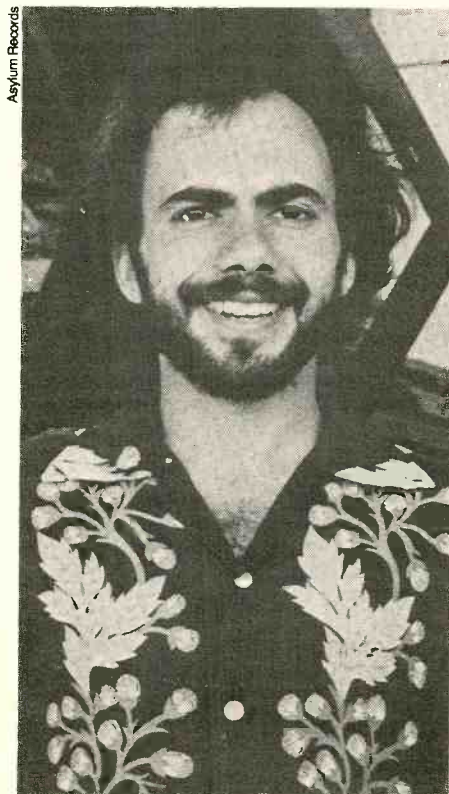

STEVE GOODMAN: *creative*



WARREN ZEVON: *cohesive*

very naïve persons who find the word a handy tool with which to rationalize away their lack of discipline. Steve Goodman, it seems to me, is really trucking these days with what we used to mean by the word, using tools and materials he has bothered to learn the workings of, using hands and mind to make something that did not exist before.

Goodman's new "Words We Can Dance To" for Asylum is in some ways a more satisfying album than the excellent "Jessie's Jig" that preceded it. Again, you feel as if you've been set down in a department store of musical styles, and again you just know this is not one of your run-of-the-strip low-overhead marts. Producing himself (with a little help from guitarist Steve

belly of California-America), he has made a rock-and-roll album that is as musically rich as anything I've heard in geological epochs. What does he sound like? Oh, nothing special—just a grittier Jackson Browne (Jackson produced, by the way), the Eagles without the cloying sentimentality, English art-rockers of the Eno school without the avant-garde pretensions, Newman if he had been weaned on the Beatles rather than Hollywood film music, and Wainwright if he had been born into the lower middle class, just to scratch the surface. The sheer song-to-song variety of style and substance Zevon presents is amazing enough, but he also manages somehow to give it all a believable cohesiveness.

This album has gotten me so excited

that I'm tempted to go out on a limb here and announce that Zevon is the most interesting artist to come out of pop music since Bruce Springsteen, or something equally hyperbolic. But I'm going to restrain myself, if only because I'm not sure that L.A. lowlife is the kind of subject matter that can sustain him (to say nothing of Dory Previn) for more than an album or two. Still, some of the best tracks, *Frank and Jesse James* or *Mama Couldn't Be Persuaded*, treat situations more abstract and fictional than his Hollywood songs (my favorite: *Desperados Under the Eaves*, a wryly pessimistic number with a wonderful Dvořákian string ar-

SYLVIA SYMS:
she comes on slow
and easy, but she's
a heartbreaker



Atlantic Records

range), and they suggest an enormous and still untapped potential. So I'm simply going to say that this is a great, great record, lyrically brilliant and funny, at times breathtakingly sung and performed, that manages to rock almost nonstop. I've asked you to do this before, but you really *should* trust me on this one. *Steve Simels*

WARREN ZEVON. Warren Zevon (piano, guitar, vocals); Waddy Wachtel (guitar); Bob Glaub (bass); Larry Zack (drums); Bobby Keyes (saxophone); Phil Everly, J.D. Souther, Jackson Browne, Carl Wilson, Bonnie Raitt, Stevie Nicks (harmony vocals); other musicians. *Frank and Jesse James*; *Mama Couldn't Be Persuaded*; *Backs Turned Looking Down the Path*; *Hasten Down the Wind*; *Poor Poor Pitiful Me*; *The French Inhaler*; *Mohammed's Radio*; *I'll Sleep When I'm Dead*; *Carmelita*; *Join Me in L.A.*; *Desperados Under the Eaves*. ASYLUM 7E-1060 \$6.98.

Sylvia Syms: A Smile to Light Up The World, a Voice To Break Your Heart

WHO is Sylvia? They call her the "singer's singer." Judy Garland once had her sing *On Second Thought*, a very sad song by Cy Coleman and Carolyn Leigh, sixteen times in succession at a New Year's Eve party. Benny Carter wrote *Lonely Woman* for her. Paul Anka wrote *The Long*

Lonely Season for her, and he coaxed her out of the audience in the middle of a Las Vegas appearance to introduce it. Whitney Balliett, in a long New Yorker article in 1974, called her "indomitable and masterly," observing that students of the American popular song regard her as "the premiere female singer" and the "counterpart of Frank Sinatra and Tony Bennett."

Sylvia Syms has a round and shining face, a smile to light up the world, and a voice to break your heart. She has been covering the night-club circuit for some thirty years. She turned up on Broadway in *Diamond Lil* with Mae West, played Bloody Mary in *South Pacific*, was one of the long succession of road-company leads in *Hello, Dolly*. But ill luck has pursued this woman with the haunting throb in her voice, and except for a hit album she recorded for Decca in 1956, she entered a long

eclipse. Ill-fated love affairs, an operation, an automobile accident kept her out of view. Recently, however, sightings of Sylvia have been reported at the Newport Jazz Festival, at a fund-raising concert in the Palace Theatre, and at Barney Josephson's Cookery in Greenwich Village, where the food is indifferent but the jazz first-rate. And now she has come back to Atlantic, where she made her first album many years ago, to record after a hiatus of two decades.

The results are delicious, causing Rex Reed to compare her, in his shamelessly adoration liner notes, to vanilla ice cream, another of his passions. "I'd marry her," he concludes, "but she doesn't do windows." Most of the time Sylvia, who comes on slow and easy and is most at home with an old-fashioned torch song, seems out to break the listener's heart, and she is expert at it, especially in the tearful ballads written for her—*On Second Thought* and *The Long Lonely Season*. She dives into the dustbin of forgotten tunes to retrieve James Shelton's *I'm the Girl* (from a 1949 revue) to project a moving portrait of a female doomed to serve as second choice and midnight comforter for a man who's in love with somebody else.

When she applies the same sleepy tempos to such usually hurried upbeat numbers as *I Get a Kick Out of You*, *Honeysuckle Rose*, and *Mountain Greenery*, the results are enchanting. She also has a few surprise arrows in her quiver—*Pink Taffeta Sample Size 10*, for example, a Cy Coleman item jettisoned from the score of *Sweet Charity* during a Philadelphia tryout (it shouldn't have been). The way Sylvia puts over this tragicomic ballad about the daughter of a traveling dress salesman who sends her the dress of her dreams for her birthday, it sounds like a piece that could have stopped the show rather than hold it up.

Now that she's back among us, it is to be hoped that Sylvia Syms will stay awhile. She claims to have coveted a singer's career from the days when she used to sing Rodgers and Hart songs in her baby carriage. It may well be that now, as the great wheel of popular taste has spun full circle, her time has finally come. *Paul Kresh*

SYLVIA SYMS: *Sylvia Syms, Lovingly*. Sylvia Syms (vocals); instrumental accompaniment, Dick Hyman arr. and cond. *Sky-lark*; *I Get a Kick Out of You*; *On Second Thought*; *I Didn't Know About You*; *Honeysuckle Rose*; *Pink Taffeta Sample Size 10*; *The Long Lonely Season*; *My Shining Hour*; *I'm the Girl*; *Mountain Greenery*; *Lonely Woman*; *I'll See You Again*. ATLANTIC SD 18177 \$6.98, © TP 18177 \$7.98, © CS 18177 \$7.98.

THE TAPE THAT'S TOO GOOD FOR MOST EQUIPMENT.

Maxell tapes are not cheap.

In fact, a single reel of our most expensive tape costs more than many inexpensive tape recorders.

Our tape is expensive because it's designed specifically to get the most out of good high fidelity components. And unfortunately, there's not much to get out of most inexpensive tape recorders.

So it makes no sense to invest in Maxell unless you have equipment that can put it to good use.

And since even a little speck of dust can put a dropout in tape, no one gets into our manufacturing area until he's been washed, dressed in a special dust-free uniform and vacuumed.

(Yes, vacuumed.)

Unlike most tape-makers, we don't test our tape every now and then. We test every inch of every Maxell tape.

Which is why every Maxell tape you buy sounds exactly the same. From end to end. Tape to tape. Year to year. Wherever you buy it.

And Delrin rollers. Because nothing sticks to them.

A lot of companies weld their cassettes together. We use screws. Screws are more expensive. But they also make for a stronger cassette.

Our tape comes with a better guarantee than your tape recorder.

Nothing is guaranteed to last forever. Nothing we know of, except our tape.

So our guarantee is simplicity itself: anytime you ever have a prob-

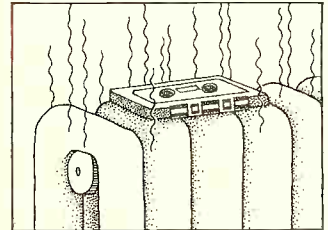

Our guarantee even covers acts of negligence.

Give our tape a fair hearing.

You can hear just how good Maxell tape sounds at your nearby audio dealer.

(Chances are, it's what he uses to demonstrate his best tape decks.)

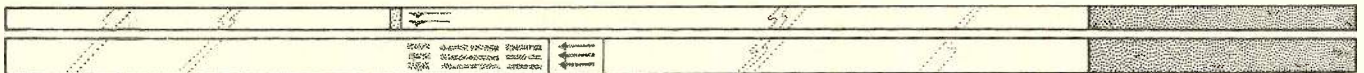

No other tape starts off by cleaning off your tape recorder.

No other tape sounds as good as ours because no other tape is made as carefully as ours.

For example, every batch of magnetic oxide we use gets run through an electron microscope before we use it. This reveals the exact size and proportions of individual particles of oxide. Because if they're not perfect, the tape won't sound perfect.



Every employee, vacuumed.

We clean off the crud other tapes leave behind.

After all the work we put into our tape, we're not about to let it go to waste on a dirty tape recorder head. So we put non-abrasive head cleaning leader on all our cassettes and reel-to-reel tapes. Which is something no other tape company bothers to do.

Our cassettes are put together as carefully as our tape.

Other companies are willing to use wax paper and plastic rollers in their cassettes. We're not. We use carbon-impregnated material.

lem with any Maxell cassette, 8-track or reel-to-reel tape, you can send it back and get a new one.

You may be surprised to hear how much more music good equipment can produce when it's equipped with good tape.



Maxell Corporation of America, 130 West Commercial Ave., Moonachie, New Jersey 07074

CIRCLE NO. 20 ON READER SERVICE CARD



POPULAR DISCS AND TAPES

Reviewed by CHRIS ALBERTSON • NOEL COPPAGE • PAUL KRESH • PETER REILLY • JOEL VANCE

AMERICA: *Hideaway*. America (vocals and instrumentals); David Dickey (bass); Willie Leacox (drums); George Martin (piano). *Lovely Night; Amber Cascades; Don't Let It Get You Down; Watership Down; She's Beside You; She's a Liar; Letter*; and five others. WARNER BROS. BS 2932 \$6.98, © M8-2932 \$7.98, © M5-2932 \$7.98.

Performance: **Soft and hazy**
Recording: **Very good**

America the group, unlike America the country, seems to have outlasted its critics. Partly it's the problem of what to say after you've said, "Why bother?" I don't think the group has improved all that much; it's just been accepted in some kind of default situation. It's there, like television. It has hooked up with George Martin, who does a nice job on the production, but it still seems to me Martin's basic gentleness would bounce better off a group with some grit in it, as the Beatles had. What America does, of course, is fashion hit singles regularly; this has been mostly a matter of coming up with a catchy enough tune. They never do a *bad* job of singing it, so the performance will be no problem . . . and neither will it aspire to be anything special. Or so it still seems to me. This is one of those albums that people talk throughout the "listening" of and then say, "That wasn't bad, was it?" Well, no. I guess not. It didn't jump off the turntable and get me. N.C.

HOYT AXTON: *Fearless*. Hoyt Axton (vocals and guitar); orchestra. *Jealous Man; Paid in*

Advance; The Devil; An Old Greyhound; and eight others. A&M SP-4571 \$6.98, © 4571 \$7.98, © 4571 \$7.98.

Performance: **Good**
Recording: **Good**

One of the cleverest and glossiest of the tale-spinning c-&-w old pros, Hoyt Axton here serves up another collection of his songs with all the assurance and vividness of a Somerset Maugham telling an after-dinner story. *Idol of the Band* is a brief, worldly-in-its-way *conte* about a super-groupie; *Jealous Man* is an ugly little story about a man setting himself up for murder; and *An Old Greyhound* is one of those road songs about a driver's love for his bus. It's all extremely well done, facile, and entertaining—though it's also more than a bit too programmed and contrived. The bummer here, however, is Axton's stumbling run-through of Dylan's *Lay, Lady, Lay*. He's way over his head, and the muted feeling, deep but only half articulated in the lyric, ferments into sour-mash self-pity in his performance. But when he stays safely in his own slick groove Hoyt Axton is pretty good. P.R.

JIM CAPALDI: *Short Cut Draw Blood*. Jim Capaldi (vocals, percussion); instrumental accompaniment. *Goodbye Love; It's All Up to You; Love Hurts; Johnny Too Bad; Short Cut Draw Blood; Living on a Marble*; and three others. ISLAND ILPS 9336 \$6.98.

Performance: **Feeble**
Recording: **Good**

A few years ago I reviewed a Traffic record and found that the title of one of the songs, (*Sometimes I Feel So*) *Uninspired*, defined the entire album. Former Traffic member Jim Capaldi should have titled this solo foray "(I Am Consistently) Listless."

There is some lively sax playing by Ray Allen which is all too brief, and the band tries to get things going now and then, but Capaldi's vocals are so tepid and his approach so wobbly that you get the impression that (a) he is bored; (b) he is suffering from a glandular defect; (c) this is the first time he's heard the songs—which is really weird, since he wrote most of them; (d) he doesn't know what he's doing; and (e) he wouldn't make any changes

even if he did know. To cite only one instance: the Boudleaux Bryant song *Love Hurts* is taken at a semi-perky tempo which is totally inappropriate to the intent of the tune—it is a *tearjerker*. But Capaldi sings it so lamely that you are likely to say, "If that's all it hurts, I'll make a special point out of falling in love with the wrong person bright and early tomorrow morning." J.V.

RECORDING OF SPECIAL MERIT

CAPTAIN & TENNILLE: *Song of Joy*. Daryl Dragon and Toni Tennille (instrumentals and vocals); orchestra. *Shop Around; Muskrat Love; 1954 Boogie Blues; Mind Your Love; Butterscotch Castle*; and six others. A&M SP-4570 \$6.98.

Performance: **Good**
Recording: **Very good**

This is a good act getting slicker and better all the time. The Captain (Daryl Dragon) is a veritable whiz at a variety of keyboards, and Toni Tennille hangs right in there with a vital, earthy vocal style. But she's perhaps a little too earthy this time out; she seems to have been listening to too many Bessie Smith records, with the result that she sounds a bit forced and melodramatic. The duo's best effort here is the Neil Sedaka *Lonely Night*, a right-on commercial number given a right-on commercial performance, and *1954 Boogie Blues* is another glossy piece that they serve with wit and style. It's obvious that they are both people of taste and elegance—otherwise, they would not own such gorgeous bulldogs as Elizabeth and Broderick, pictured in all their rotund glory on the back cover. P.R.

JOHNNY CASH: *Strawberry Cake*. Johnny Cash and the Carter Family (vocals); instrumental accompaniment. *Doin' My Time; I Still Miss Someone; I Got Stripes; Church in the Wildwood; Lonesome Valley*; and five others. COLUMBIA KC 34088 \$5.98, © CA-34088 \$6.98, © CT-34088 \$6.98.

Performance: **Creditable**
Recording: **Excellent**

Johnny Cash can be an overbearing bore and a mawkish purveyor of homilies that are the

Explanation of symbols:

- Ⓜ = reel-to-reel stereo tape
- Ⓢ = eight-track stereo cartridge
- Ⓒ = stereo cassette
- Ⓛ = quadraphonic disc
- Ⓡ = reel-to-reel quadraphonic tape
- Ⓟ = eight-track quadraphonic tape

Monophonic recordings are indicated by the symbol Ⓜ

The first listing is the one reviewed; other formats, if available, follow it.

philosophical equivalent of junk food, but he's neither boring nor mawkish on this record put together from the tapes of a London appearance at the Palladium. Here, with his wife June and members of her caroling family, he keeps the audience entertained with jaunty patter and a series of lively ballads lustily sung. There are wistful items like *I Still Miss Someone*; a prisoner's song, *I Got Stripes*; songs with a folk character delivered pure and straight to a lively beat—the railroad song *Rock Island Line*, for example—and a homage to American Indians called *Navajo*. Especially rousing is the title song, a generous portion of wish fulfillment inspired by a bum Cash encountered outside the Plaza Hotel in New York where a wagon of de luxe desserts was on display. A ballad created specifically for the London show, *Victoria Station*, turns out to be a fairly dog-eared piece of merchandise, and some of the intros are a little on the sticky side, but, in all, Johnny Cash comes across as a vital and expert supplier of populist sentiments and serenades. P.K.

DAVID CASSIDY: *Home Is Where the Heart Is*. David Cassidy (vocals); orchestra. *On Fire; January; A Fool in Love; Run and Hide; Bedtime*; and five others. RCA APL1-1309 \$6.98, © APS1-1309 \$7.98, © APK1-1309 \$7.98.

Performance: **Promising**
Recording: **Good**

Ex-teenybopper sex-symbol superstar David Cassidy is back in a very well-produced (by Cassidy and Bruce Johnston) album that probably would never have made it to release if he hadn't been who he used to be. Neither his writing nor his performing skill has yet jelled to the point where he seems more than promising here—with one bright exception, the totally engaging and professional *Take This Heart*, which is a really good job on all counts. But promising he definitely is. No matter how much production gloss has been applied here, it is still all varnish on what is an as-yet-to-be-developed adult talent. His performances are secure and controlled, but they wander aimlessly. So do his songs; *Breakin' Down Again* starts off strongly but then winds down to a meander, and *Damned If This Ain't Love* has the kernel of a good idea that goes precisely nowhere. Still, this album should convince almost anyone that Cassidy does have talent and that with a lot more work and a lot less production gimmickry he's sure to make a very fine album one of these days. If you don't believe me, just give a long listen to *Take This Heart*. P.R.

MIKE DOUGLAS: *Sings It All*. Mike Douglas (vocals); orchestra, Richard Rome arr. and cond. *If; My Mother's Eyes; Dancin' Again; Philadelphia*; and four others. ATLANTIC SD 18168 \$6.98.

Performance: **Professional**
Recording: **Good**

Long before Mike Douglas took to chatting with Hedy and Bette and Gore and Sonny to the delight and edification of millions of housewives on his hugely successful syndicated talk show, he was a vocalist with the old Kay Kyser Orchestra. Unfortunately, he seems to consider that a Golden Time in his life, so much so that he insists on opening each show with a song or two no matter how much, say, Cloris or Norman is champing at the bit in the Green Room. Since all is rela-

“a pro in the art of mass communication”

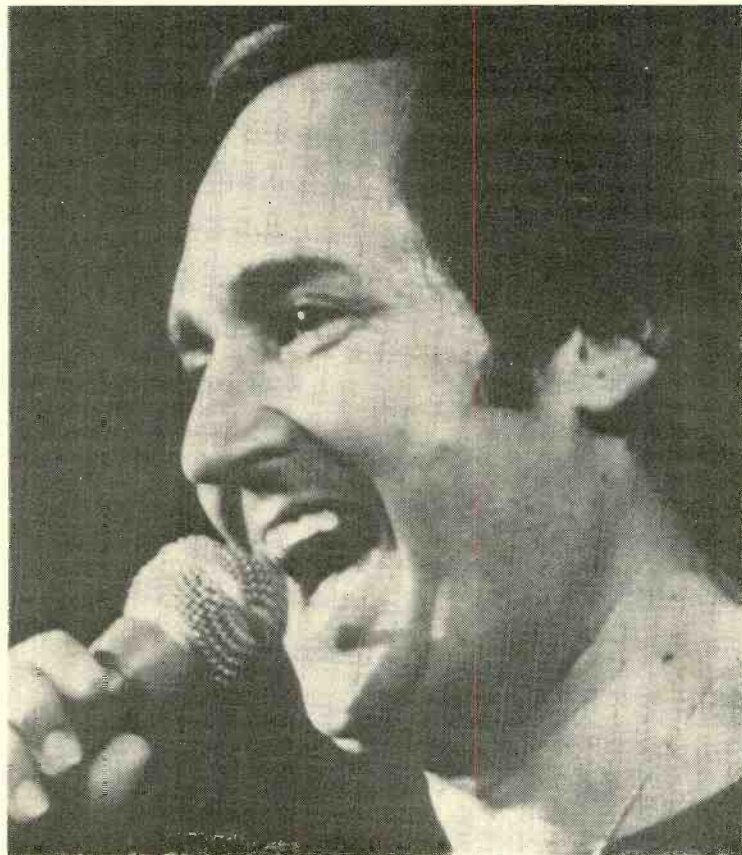

MCA/ROCKET

“Steppin’ Out” With Neil Sedaka

As a friend of mine said, as Neil Sedaka's new Rocket release “Steppin’ Out” was playing, “Y’know, I like Sedaka. He’s like mellow, y’know, and his music doesn’t like threaten me like, y’know, James Taylor’s does.” (From the number of “likes” and “y’knows” I guess y’know that this friend is in his early twenties and that Sedaka’s work during the Fifties is mostly unknown to him.)

Well, I have to confess that Sedaka does threaten me as a reviewer. Up until this last year or so, he represented to me the nadir of cynical, exploitative pop music ground out by the yard for the very young or the very dull-witted. But of late I’ve moved beyond that automatic response and I’m beginning to appreciate just what a complete pro he is in the fine art of mass communication. Along with his contemporary and peer Paul Anka, he has the seemingly natural ability to seize upon whatever is the popular mood of the moment and then expand or define it in a very slick but often surprisingly graceful and apt way.

True, much of his work is trite—the music can be banal (*Cardboard California*) and the lyrics (#1 with a Heartache) can sound as refried as an S. J. Perelman parody of himself. But the fact remains that when all is right, as it so often is (such really good pop songs as *Here We Are Falling in Love Again*, *Summer Nights*, and *Steppin’ Out*), he’s impressive in a way that perhaps no one else but Anka currently is. The threat to me, of course, is that in twenty years I’ll be writing this kind of piece about (ugh!) Tony Orlando and Dawn or (say it isn’t so!) the Osmonds. But of course I won’t, because they are mere entertainers and Sedaka is a creator. There may be a little quibbling on that last point as to just what the level of creativity is, but I’ll leave that to the pop musicologists. I just thought you’d like to know for now that “Steppin’ Out” is well worth listening to, and I’m sure most people will be greatly entertained. Beyond that, it’s up to you to decide What It All Means. Y’know? —Peter Reilly

NEIL SEDAKA: *Steppin’ Out*. Neil Sedaka (vocals, piano); other musicians. *Sing Me; You Gotta Make Your Own Sunshine; #1 with a Heartache; Steppin’ Out; Love in the Shadows; Cardboard California; Here We Are Falling in Love Again; I Let You Walk Away; Good Times, Good Music, Good Friends; Perfect Strangers; Bad and Beautiful; Summer Nights*. ROCKET PIG-2195 \$6.98, © PIGT-2195 \$7.98, © PIGC-2195 \$7.98.

tive, he is not as good as Dinah, he is better than Merv, and he is a sensation compared to Carson—which is to say that actually he is a passably professional meat-grinder singer, long on the eye-winking “charm” that devastates the moms and grannies and woefully short on the ability to differentiate one lyric and its message from another. He glides through this very plushly produced album, containing such bits of cuteness as *Smile, Smile, Smile* and the lumpy halvah of *My Mother's Eyes*, with all the executive *élan* of a rich man playing golf: umpteen caddies plus golf cart, portable bar, and selected minions carefully holding back their best shots so that there won't be any post-game embarrassment about who wins. Every once in a while he does have a distressing tendency to sound like good old Fabian, particularly in Paul Williams' *Loneliness*. But since his fans probably haven't caught up with Fabian yet, I can't hear any reason why they won't love it. P.R.

THE EAGLES: *Their Greatest Hits, 1971-1975*. The Eagles (vocals and instrumentals). *Take It Easy; Witchy Woman; Lyin' Eyes; Already Gone; Desperado*; and five others. ASYLUM 7E-1052 \$6.98, © TP-1052 \$7.98, © CS-1052 \$7.98.

Performance: **Standard procedures illuminated**
Recording: **Mostly very good**

This seems to demonstrate that, at their most commercial, the Eagles exercise a conservative, formula-following streak. They do make music occasionally that isn't this homogenized and/or predigested, but that's on “normal” albums, not on juke boxes or in places like this. Here there are competent treatments of mostly pleasant-sounding songs that you don't have to follow very closely; you get the idea very early that the main thing is you won't be *offended*—the Eagles, in making hits, don't simultaneously make enemies the way some people do by being arch about one thing or another. A few other bands would have breathed more excitement into the better songs (say *Take It Easy*), but then a lot of other bands would have sunk miserably with such mundane ones as *Best of My Love*. Matter of fact, the *Eagles* almost managed to offend me with that one. But not quite. An Eagles hit proceeds according to plan, gets *The Treatment*, and the treatment always works reasonably well; an Eagles hit has a sound of its own . . . except that it shares it with all the *other* Eagles hits. N.C.

DONNA FARGO: *On the Move*. Donna Fargo (vocals); Pig Robbins (piano); David Briggs (electric keyboards, harpsichord); Grady Martin (guitar); Ken Buttrey (drums); other musicians. *Mr. Doodles; Song with No Music; Southern Lady; Patches; Country Girl; One of God's Children*; and four others. WARNER BROS. BS 2926 \$6.98, © M8-2926 \$7.98, © M5-2926 \$7.98.

Performance: **Getting there**
Recording: **Very good**

Donna Fargo seems to have put some verve into this first effort on a new label, and it is one of her better albums. It is dramatic and sentimental; she uses the ringing chorus, the hallelujah ending, to good effect, and she shifts her songwriting viewpoint around more effectively than she's been doing lately. The woman behind these songs seems more nearly three-dimensional than the happiest girl in the

whole U.S.A. I have a couple of small complaints, though. There's a curious lack of intensity in the way she sings *Sing for My Supper*, a good Fargo song that Marti Brown recorded first and now seems to own. And there's too much pop-string sweetening for my taste through the arrangements, and there are these little left-handed ways Fargo has of patronizing the audience. *Mr. Doodles*, for example, would be a pretty effective treatment of absence making the heart grow fonder if it were not pinned to that oafish and oft-repeated nickname. Attempted cuteness ought to be a misdemeanor in certain cases. She keeps that sort of thing down, though, in this outing, and she keeps her own spirit from seeming so disgustingly *up* all the time, so it's listenable, pardner, it's listenable. N.C.

J. GEILS BAND: *Blow Your Face Out*. J. Geils Band (vocals and instrumentals). *Southside Shuffle; Back to Get Ya; Shoot Your Shot; Musta Got Lost; Where Did Our Love Go; Wait*; and twelve others. ATLANTIC SD 2-507 two discs \$7.98, © TP2-507 \$9.98, © CS2-507 \$9.98.

Performance: **Rerun**
Recording: **Variable**

I am all the more disappointed in the J. Geils Band now because I used to think they were artists; now I realize they're not artists but entertainers. Good entertainers, yes. A creative band, no. This double-disc live set, recorded on the group's safe home ground in Boston, displays charm and chug—but a live album in almost any case is something released when the performer or the label doesn't know what else to do. J. Geils' last few studio albums have shown that they've already done just about everything they *can* do. For what was once a very exciting band this is a sad state of affairs. J.V.

GENESIS: *A Trick of the Tail*. Genesis (vocals and instrumentals). *Dance on a Volcano; En-*

tangled; Squonk; Mad Man Moon; Ripples; and three others. ARCO SD 36-129 \$6.98, © TP-36-129 \$7.98, © CS-36-129 \$7.98.

Performance: **Toned down a bit**
Recording: **Good**

If you subscribe to the dictum “Do what you do do well,” you'll want to give Genesis reasonably high marks for this. The songwriting is smoother; the old erratic way with meter is damped down, and the matching of lyric and melody is more sensible. And the performing involves fewer of the old excesses; Peter Gabriel seems to be gone, and drummer Phil Collins does most of the lead singing, and that helps—Gabriel was getting to be a pain. The electric-keyboard pomp has been toned down somewhat, too. But, gee whiz, I don't know. You may want to subscribe to some other dictum; it may be reasonable to question whether some things need to be done at all. This business of trying to James Joyce the popular song, for one. Trying to appear deep without actually being deep seems to make Genesis appear silly more often than not. And there are all these tinfoil allegories: the image, say, of someone dancing on the lava flowing out of a volcano is somehow supposed to enlighten you, but neither the language nor the music ever comes to grips with what's so enlightening about it. Still, the extremes have been lopped off, and this does have tuneful moments. It's just that I keep thinking about the other side of the subject, specifically of what Will Rogers said about Cal Coolidge: “He wasn't a bad President. He didn't *do* nothin'—but that was what we wanted done.” N.C.

THE STEVE GIBBONS BAND: *Any Road Up*. The Steve Gibbons Band (vocals and instrumentals). *Take Me Home; Johnny Cool; Roll-in'; Spark of Love; Speed Kills*; and four others. MCA MCA-2187 \$6.98, © MCAT-2187 \$7.98.

Performance: **Refreshingly predictable**
Recording: **Clean**

Steve Gibbons and his gang are from Birmingham, about which Gibbons says, “It's like the Detroit of Britain . . . all speed and machinery.” So is the music of the Steve Gibbons Band. It is cold-blooded but has a certain integrity: it just will not resort to cheap tricks. (*Melody Maker* calls it “menacing,” but I have a feeling that *Melody Maker* has to call some rock band “menacing” every month or so or suffer terrible hyperbole-withdrawal symptoms.) It is so straightforward about hard rock that it almost seems to be doing something *new* at times, though of course it is not: Gibbons' vocals give the band a signature; they're good, solid, rock-band vocals and even manage to suggest a little something beyond image. The imagination behind it all seems fairly humdrum, though. It's a good workaday group, a good enough antidote to the Barry Manilows of this world, and if you don't mind the reserve it has built up around itself, the invisible shield—that cold-bloodedness—that protects the band from the likes of you, you'll find it useful, if only for helping you remember what rock was like before it got hokey. N.C.

GOLDEN EARRING: *To the Hilt*. Golden Earring (vocals and instrumentals). *Why Me?; Facedancer; To the Hilt; Nomad; Sleep Walk-in'; Latin Lightning; Violins*. MCA-2183 (Continued on page 76)

STEVE GIBBONS
Good, solid, rock-band vocals



MCA Records

The Beogram[®] 4002. If music in your home is important to you, it should begin here.

The Beogram 4002 is a fully automatic turntable which exhibits a level of creativity and engineering skill unequalled in the field of audio components. Its tangential tracking permits the record to be played back in exactly the same manner that the master disc was cut. Electronic logic circuits, activated by a single light

touch on the control panel, automatically select the record size and correct speed, cue the stylus, and turn off the unit when the selection is finished. Furnished with Bang & Olufsen's finest cartridge, in itself an acknowledged masterpiece of audio engineering.

A full color brochure presenting all of Bang & Olufsen's audio components is available upon request.

Rarely has technology
served music so well.

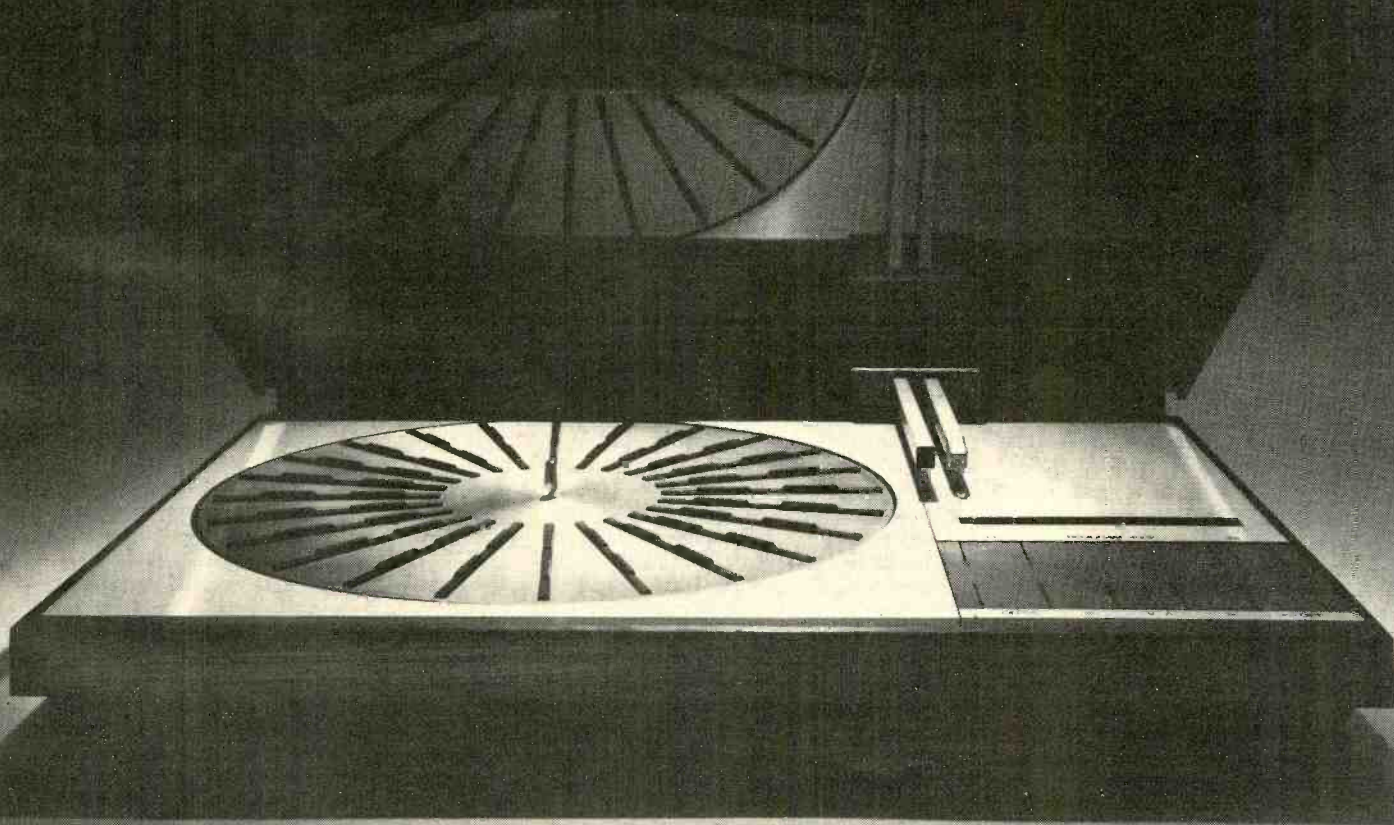

Bang & Olufsen

Bang & Olufsen of America, Inc., 515 Busse Road, Elk Grove Village, Illinois 60007



BEN E. KING:
lightweight,
effortless blues

Atlantic Records

instrumental accompaniment. *The Black-hats' Fight Song; Train A-Travelin'; The Death of Emmett Till; The Jews-Whore Marie Saunders; It's Alright Ma;* and seventeen others. XTRA (D) 1157 two discs \$15.96 (from HNH Distributors, P.O. Box 222, Evanston, Ill. 60204).

Performance: **Too bitter**
Recording: **Excellent**

Bettina Jonic is a Yugoslavia-born, Los Angeles-raised opera singer who performs "The Bitter Mirror" as a one-woman recital of twenty-two songs by Bertolt Brecht and Bob Dylan. Dylan and Brecht? Well, why not? They share a point of view, the mirror they both hold up to life is a terrifying one, they both use the lyrics of their songs as weapons of social protest. And the prospect of hearing Dylan's songs separated from his familiar nasal snarl would seem intriguing. As the album goes its gloomy way, however, one begins to have second thoughts.

Jonic's is a strong soprano, but her relentlessly mannered way of interrupting her own rhythm time and again, like a powerful car held up by a traffic light, is increasingly wearing. There is passion in her treatments of Dylan's denunciations of war, his melancholy *North Country Blues*, his laments over rootless and downtrodden and exploited people. *Blowin' in the Wind*, as Jonic sings it, even when drenched in a heavy orchestral sauce, stands up as an authentic angry ballad likely to endure. But adding Brecht finally lays the listener low. How many misfortunes, horror tales, and hard-luck stories is it possible to absorb in a single concert? Moreover, a Brecht song with music by Kurt Weill is an emotional experience; a Brecht song with an anemic setting by Hans Eisler is simply depressing. Too much, too somber, too slow. Too bad. P.K.

BEN E. KING: *I Had a Love*. Ben E. King (vocals); orchestra. *I Betcha Didn't Know That; Everybody Plays the Fool; No Danger Ahead; We Got Love;* and five others. ATLANTIC SD 18169 \$6.98, © TP-18169 \$7.98, © CS-18169 \$7.98.

Performance: **Good**
Recording: **Good**

This is lightweight, effortless performing by Ben E. King in a collection of one-beat, one-idea blues. *Everybody Plays the Fool*, for example, runs on for well over five minutes, and after it's over the feeling is that of having been on a synocopated treadmill. I did have a fine time, nonetheless, with *I Betcha Didn't Know That*—a song that somehow benefits from the sameness of projection and performance. The rest of the album, however, left me rather aimlessly finger-snapping into very thin air. P.R.

KINGFISH. Bob Weir (vocals, guitar); Dave Torbert (vocals, bass); Matthew Kelly (vocals, guitar, harmonica); Chris Herold (drums); Robby Hoddinott (lead guitar). *Lazy Lightnin'; Supplication; Wild Northland; Asia Minor; Home to Dixie; Jump for Joy; Good-bye Yer Honor;* and four others. UNITED ARTISTS/ROUND RX-LA564-G \$6.98, © RX-EA564-H \$7.98.

Performance: **Dull but fidgety**
Recording: **Good**

This reminded me of the old tuning-up joke about the trouble with cutting records on the
(Continued on page 78)

\$6.98, © MCAT-2183 \$7.98, © MCAC-2183 \$7.98.

Performance: **Pompous**
Recording: **Good**

If you hear a group playing blues-rock patterns and moaning overblown lyrics, you can safely assume they are trying to be Significant; you can further assume, with the utmost safety, that they are not. If you hear, in your professional capacity as a reviewer for the best of all possible music magazines, fifty to sixty albums of this type during the year, you are liable to mutter into a long glass filled with comforting liquids: "Maybe, with training, I could become a tractor-trailer driver." Someday—and this is wishful thinking—so might the members of Golden Earring. J.V.

STEVE GOODMAN: *Words We Can Dance To* (see Best of the Month, page 69)

LINDA HOPKINS: *Me and Bessie*. Linda Hopkins (vocals); instrumental accompaniment. *Romance in the Dark; Fare Thee Well; Trouble;* and ten others. COLUMBIA PC 34032 \$6.98. © PCA 34032 \$7.98.

Performance: **Mockery**
Recording: **Very good**

Side one of this record has hardly gone a revolution before Miss Hopkins states "I ain't Bessie," which has to be the superfluous remark of the year. Actually, when she first got on the Bessie Smith bandwagon a couple of years ago, Miss Hopkins was going around saying that she believed she was Bessie, and it is clear that her gratuitous denial has been designed by her puppeteers to evoke an "oh but you really are" response. The truth of the matter is that Linda Hopkins is a second-rate gospel singer who can't hold a candle to any number of women whose voices rise soulfully in black churches around the country.

The album takes its title and music from Miss Hopkins' current Broadway show, which purports to be some sort of musical biography of the late Bessie Smith, but actually

comes no closer to Bessie than Diana Ross did to Billie Holiday. As one who has written a biography of Bessie, and being the writer originally approached to script Miss Hopkins' show (I turned it down), I felt I had to be particularly careful lest my personal involvement should prejudice my opinion. Accordingly, I listened to this record about ten times, becoming more and more convinced that my opinion would have been the same had my only association with Bessie Smith been the experience of listening to her on records.

Bessie was without a doubt the greatest blues singer who ever lived, and any singer who thinks he or she can even approximate Bessie Smith's mastery of the blues has to be suffering delusions of grandeur. Even Dinah Washington, who (unlike Miss Hopkins) was herself a blues singer, never pretended to be a reincarnation of Bessie when she recorded an album of songs associated with her. Linda Hopkins has gone as far as claiming that Bessie Smith materialized before her on a San Francisco stage, lent her that famous voice and smiled. If Bessie ever really heard what Miss Hopkins is doing, the final curtain would promptly ring down on *Me and Bessie*.

Accompanied by the most horrendous band and with atrocious arrangements by John Allen, Linda Hopkins spews out the lyrics to such songs as *Preachin' the Blues* and *Put It Right Here*, totally failing to grasp their humor, and with timing so bad that one begins to wonder if she ever really listened to Bessie's records. Her gospel version of *Nobody Knows You When You're Down and Out* is passable, but she turns the wonderful *Gimme a Pigfoot* into a pleaser for the Disneyland straw-hat-and-stripped-jacket crowd. And *After You've Gone*—which Bessie turned into a majestic personal statement—will simply make you cringe. Forget this artless bit of exploitation and listen to Bessie Smith's own records. They are, in a word, ermine to Miss Hopkins' alleycat. C.A.

BETTINA JONIC: *The Bitter Mirror—Songs by Dylan and Brecht*. Bettina Jonic (vocals);

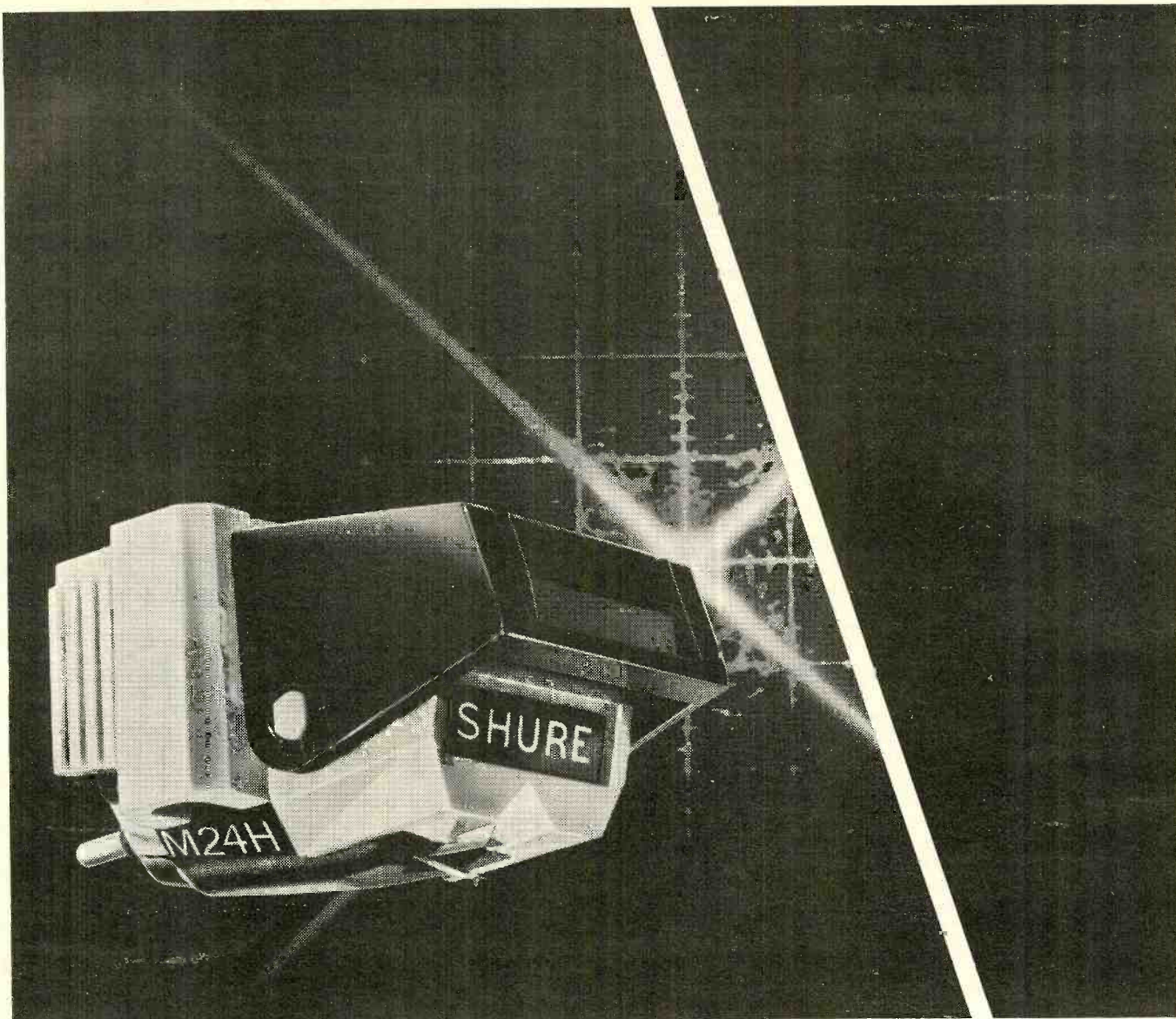

Uncompromised stereo/quadrphony —Undeniably Shure.



The new Shure M24H Cartridge offers audiophiles the best of both worlds: It is the only cartridge on the market that does not compromise stereo reproduction to add discrete quadriphonic capability. It eliminates the need to change cartridges every time you change record formats! This remarkable performance is achieved at only 1 to 1½ grams tracking force—comparable to that of some of the most expensive conventional stereo cartridges. Other M24H features include the lowest effective stylus mass (0.39 mg) in quadrphony, a hyperbolic stylus tip design, an exclusive “Dynetic® X” exotic high-energy magnetic assembly, and a rising frequency response in the supersonic carrier band frequencies that is optimized for both stereo and quadriphonic re-creation. If you are considering adding CD-4 capability, but intend to continue playing your stereo library, this is the ONE cartridge for you.

Shure Brothers Inc.
222 Hartrey Ave., Evanston, IL 60204
In Canada: A. C. Simmonds & Sons Limited



Manufacturers of high fidelity components, microphones, sound systems and related circuitry.

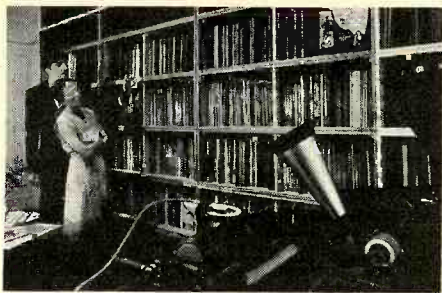

No matter how young or old the recording, the Institute of the American Musical, Inc. relies on Stanton for playback.

Speaking of problems, how would you like to be faced with the need to accurately reproduce the sound from Edison Diamond Discs, Pathés and Aeolian-Vocalions? That's just what the Institute is faced with — and that's precisely why they turned to Stanton cartridges.

The Institute collection consists of approximately 35,000 recordings, from just about every American theatre or film musical since the Berliners of the 1890's through to the latest stereo and quadraphonic recordings. They have original, historic machines to play the old recordings, but the arms are heavy and the old styli insensitive and somewhat worn. Furthermore, the acoustic playback does not permit them to filter the surface noise or tape these rare records.

Miles Kreuger, President of the Institute, discussed his problem with other famed and experienced archivists. They all agreed that the Stanton calibrated 681 Series was the answer. Naturally, it is the 681 Triple-E for critical listening and taping with more recent discs; the special 681 stylus for LP's; and, for some old 78's, a 681 cartridge, especially wired for vertical response (with a 1 mil stylus).

Today, scholars, authors and researchers, can get perfect to adequate reproduction of any of the material in the collection. The work of the Institute is important work . . . Stanton is proud to be an integral part of it.

Whether your usage involves archives, recording, broadcasting or home entertainment, your choice should be the choice of the professionals . . . the Stanton 681 Triple-E.

Write today for further information to:
Stanton Magnetics, Terminal Drive,
Plainview, N. Y. 11803.



CIRCLE NO. 44 ON READER SERVICE CARD

Oral Roberts label—the holes keep healing up. Had to gouge it out with a Bic pen, but the sound on the Grateful Dead's label is better than it needs to be to cover what this band does. Kingfish, which seems to be headed by Dead member Bob Weir, sounds like the Dead in one of its sleepwalking modes. Dynamics are compressed, soloists seem confused about the difference between tasteful and dull, the wah-wah pedal is leaned on like a crutch, and the pause is used so casually that it ceases to mean anything . . . except you do get the feeling, after a while, that everything comes to a full stop after every note. Ah, well, the songs are pitifully stale to start with. Wait'll you hear the fake Jamaican arrangement of *Bye and Bye*. Holy mackerel dere, Kingfish. N.C.

KISS: *Destroyer*. Kiss (vocals and instrumentals). *Detroit Rock City; King of the Night Time World; God of Thunder; Flaming Youth; Beth*; and four others. CASABLANCA NBLP 7025 \$6.98, © 7025 \$7.98, © 7025 \$7.98.

Performance: **Ridiculous**
Recording: **Thick**

This seems worth talking about only to the extent that it shows that not only can a "successful" act be illiterate and silly, but it doesn't even have to keep its affectations up to date. At first you hope it's a put-on (I still hope that piece in the *Village Voice* about the intellectual ramifications of Kiss' work was an attempted put-on), but then when you find nothing clever or funny or even interesting about it, you stop hoping for anything. "I feel up-tight on a Saturday night" seems to be Kiss' depth where lyrics are concerned, and the playing is of the Black Sabbath bash-crash sort; you must know at least five pathetic little garage bands that can do it. The theatrical part is just warmed over Bowie-Cooper-Peter Gabriel. But selling something everyone is tired of buying, or says he is tired of buying, does make a point of some sort, I suppose. Ah, America, you really miss P. T. Barnum, don't you? N.C.

NILS LOFGREN: *Cry Tough*. Nils Lofgren (guitar, vocals); instrumental and vocal accompaniment. *Cry Tough; It's Not a Crime; Incidentally . . . It's Over; For Your Love; Share a Little*; and four others. A&M SP-4573 \$6.98, © 4573 \$7.98, © 4573 \$7.98.

Performance: **Good, but . . .**
Recording: **Very good**

I've got mixed feelings about Nils Lofgren. He's got talent, all right; his guitar work and singing are quite effective, and his original material, especially *Mud in Your Eye* and *Jail-bait*, are as good as we get nowadays in blues-based rock. But something's missing in Lofgren's music.

At times "Cry Tough" is reminiscent of a Rick Derringer album—polite neo-punk-style rock. Now, Rick is fine as far as he goes, but on the basis of what Lofgren does here I think he can and should go further. Maybe he's been hanging out with rock for too long and ought to look for other musical forms; his Prisoner-of-Rock-and-Roll stance is good on paper, but in many ways it's a trap, an easy way to avoid making the personal statement I suspect he's capable of. J.V.

BOB MARLEY & THE WAILERS: *Rastaman Vibration*. Bob Marley and the Wailers (vo-

cal and instrumentals). *Positive Vibration; Roots, Rock, Reggae; Johnny Was; Cry to Me; Want More; Crazy Baldhead*; and four others. ISLAND ILPS 9383 \$6.98, © Y81-9383 \$7.98, © ZC1-9383 \$7.98.

Performance: **Good**
Recording: **Good**

I want to say a word, Mon, about the loneliness of the long-distance critic. I feel a definite pressure to fake liking reggae, of which Bob Marley and the Wailers are just about the epitome, more than I really do. It looks as if it would be comforting, being of a mind about this with the people who say they like reggae so much, for they include many bright, attractive ones. There may have been a time when I could have faked it pretty well, but times change and they apparently change us, and I just don't think I could bring it off now. What really happens is I find reggae diverting for a



BOB MARLEY
The epitome of reggae

few minutes and then I find it boring for the remaining minutes. In effect, I guess, I like it the way it comes from the Yankees who went down to Jamaica and—well, as they say, ripped it off. I like it done one song per album, that is; I really don't see much fun in all this hopping up and down and needle-moving I always wind up doing when I have to deal with a whole album of it.

Marley and his group, in particular, have charm—*anyone* can see that (although the Mighty Sparrow was slyer with the lyrics)—but let me put it this way: in a movie about a related kind of folk-hero in the U.S., how many times do you really need to see the hayseed-who-comes-out-on-top shuffle his feet and say "Shucks"? I mean, there really isn't much here to take with more than a grain of salt except the *beat*, when you come down to it, and I don't think some of us bright, attractive ones are that simple, however much at times we wish we were. So I see this infatuation with reggae as at best lackadaisical and short-term and at worst unreal, so that's how I call it. Man—er, Mon, you don't know what lonesome is, etc. N.C.

WILLIE NELSON: *The Sound in Your Mind.* Willie Nelson (vocals, guitar); Bobbie Nelson (piano); Paul English (drums); Jody Payne (guitar); Bee Spears (bass); Mickey Raphael (harmonica); other musicians. *That Lucky Old Sun; If You've Got the Money I've Got the Time; A Penny for Your Thoughts; Thanks Again; Amazing Grace; Funny How Time Slips Away; Crazy; Night Life;* and four others. COLUMBIA KC 34092 \$5.98, © CA-34092 \$6.98, © CT-34092 \$6.98.

Performance: **Cruising speed**
Recording: **Lackadaisical**

The singer and the band do a lot that's worth hearing here, but it's a time-marking album for Willie Nelson, with no new pronouncements to speak of. Where dredging up the old and familiar *Blue Eyes Crying in the Rain* worked spectacularly in "Red Headed Stranger"—he actually got people to listen to it in spite of how well they already knew it—the excavation of *Lucky Old Sun* doesn't quite make it. Nor does *If You've Got the Money, etc.*, which has been done to death. The program does pick up from there, though, and the new versions of some of Nelson's old songs are worth a listen. Bobbie Nelson (now who could that be?) at the piano has some nice-sized holes to fill and does some tasty filling, and Paul English conducts a clinic on how to play drums behind a country singer—at least behind a gentle, sophisticated, country-jazz Texas redneck-hippie who seems to be in some mellow and admirable forties. The production is distracting, though, having a slightly hard sound and positioning what I'd like in the middle over toward the right. Nelson is a

good buddy of Texas football coach Darrell Royal, so maybe this is supposed to sound like a single wing formation. N.C.

OLIVIA NEWTON-JOHN: *Come On Over.* Olivia Newton-John (vocals); orchestra. *Jolene; Pony Ride; It'll Be Me; Greensleeves; Smile for Me; Come On Over;* and six others. MCA MCA-2186 \$6.98, © MCAT-2186 \$7.98, © MCAC-2186 \$7.98.

Performance: **"Well, hello there . . ."**
Recording: **Good**

Olivia Newton-John looks improbably lovely and chaste in the cover photo on her newest album. On the record itself she still sounds as demure as she looks. Even when she does such things as her own version of *Greensleeves* or the steamier *Wrap Me in Your Arms*, it is with all of the sylvan innocence of a maiden skinny-dipping in a mountain waterfall. Well, you go be Young Werther if you like; all this album *really* does is bring out the Dirty Old Man in me. Miss Newton-John turns me on. Unfortunately, though, her recordings have nothing to do with it. P.R.

CARROLL O'CONNOR: *For Old P.F.A.R.T.S.* Carroll O'Connor (vocals); instrumental accompaniment. *I Love to Dance; Dream a Little Dream of Me; Glad to Be Unhappy; Hold My Hand; Bei Mir Bist Du Schoen;* and six others. AUDIO FIDELITY AFSD 6276 \$6.98.

Performance: **Won't bring back the dip**
Recording: **Very good**

When last heard from on record, Carroll

O'Connor was teaming up with Edit' for a nostalgic evening of songs da way dey used to be. The album showed that both O'Connor and Jean Stapleton have better singing voices than we had been led to believe from the prologue to their TV series, but not much else. O'Connor is back alone this time, playing a nostalgic slob longing for the love songs and dance tunes of the good old days. (The acronym in the tasteless title is explained as standing for "People Favoring a Return to Sentiment.") He still sings well, but maybe not well enough. The program starts off amusingly, with the dance-tune-happy O'Connor murmuring into his partner's ear remarks like "C'mon Zelda—while we're waitin' for the pressed duck" and "I may just dip here"—expounding fervidly on what a dip was and why the discontinuation of dipping dealt a mortal blow to ballroom dancing. His meat-handed way with lovely period pieces like *Dream a Little Dream of Me* and *Glad to Be Unhappy*, however, whether intended or not, wreck the songs and set the program adrift in a limbo where the listener can no longer be sure when O'Connor is kidding and when he's just not equal to the singing assignment. There are a few bright moments, as when the portrayer of the anti-Semitic Archie sings *Bei Mir Bist Du Schoen* in Yiddish, and when he offers a medley of tangos which he says must be danced "when you're miffed wit one anudder." But by the time the record is over you begin to wish they'd bring the check already and let you drop off this visiting bore from whatever town at his hotel. P.K.

(Continued on page 81)

The Advent Loudspeaker.

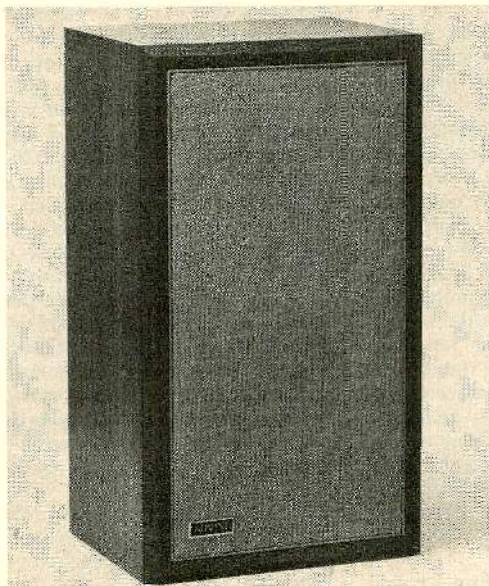

For the last three years, surveys by the hi-fi magazines have been indicating that the Advent Loudspeaker is this country's best-selling speaker.

We think you'll have no trouble hearing why. It covers the full ten-octave audible range of music, and it offers the highest level of speaker performance for a fraction of the usual price.*

It's well worth listening to at the nearest Advent dealer.

Advent Corporation, 195 Albany Street,
Cambridge, Massachusetts 02139

Please send information on the Advent
Loudspeaker and a list of dealers.

Name _____

Address _____

City _____

State _____ Zip _____

Advent Corporation, 195 Albany Street, Cambridge, Massachusetts 02139.

*The suggested retail price of the Advent Loudspeaker, subject to change without notice, ranges from \$121 to \$149, depending on cabinet finish and how far it has been shipped. The cabinet shown is finished in genuine walnut veneer.

“... the only outrageous thing about the group is its name...”



Steely Dan: “Royal Scam”

STEELY DAN is the most anti-romantic rock band in the land. Remarkably, in a field in which formula cynicism usually counts for little unless it enters astride some memorably outrageous gimmick, the only outrageous thing about the group is its name (from William Burroughs' novel *Naked Lunch*, in which a couple christens the family dildo Steely Dan). The music they make is cool, almost middle-of-the-road jazz-pop, and their lyrics are mostly wisecracks that occasionally slip from the cryptic into the arcane.

Where a group like the Eagles regularly promotes the Los Angeles Lifestyle with a devoted Chamber of Commerce slickness, Steely Dan invariably deflates that image in songs filled with ennui and tinged with vague menace. Their lyrics are couched in the language of what used to be called the Hipster, which is no accident: their name connects them to Burroughs' sexual nihilism and their repetitive, stylized, pop-jazz sound connects them to his obsession with heroin. The apocalypse Steely Dan continually conjures up is therefore not the dramatic purging into health so many L.A. writers dream about, but simply an extension of the joyless banality they see in the present, junk music for a junk culture.

The band's architects, Donald Fagen and Walter Becker, are New Yorkers transplanted to Los Angeles, and that may account for the bebop-in-the-smog ambiance of their songs. Fagen and Becker write almost all the group's material, and Fagen handles the lead vocals. Their concert career aborted because of persistent personnel changes, they are now primarily a recording band; it is safe to say that Fagen and Becker are Steely Dan, for the only other recurring character in their little saga is producer Gary Katz.

From the beginning, the musical turf they staked out has been rather narrow—almost all of Becker and Fagen's tunes revolve around a

single modal idea—and they have worked it over so intensively during the course of five albums that the strain is beginning to show. Their melodies are slinky, sarcastic, accusatory, and underpinned by Latin rhythms whose somewhat sleazy nature is not always balanced by a saving sophistication. Understated as they are, however, Steely Dan have still managed to make infectiously commercial sounds. Their first hit, *Do It Again*, was so hypnotically listenable that almost everyone managed to overlook its horribly bleak lyric, and their second, *Reelin' in the Years*, revealed in sheer spitefulness beneath a surface of embattled joviality.

With “Royal Scam,” their new album, Steely Dan's ironical stance seems to have become self-conscious, their musical formula in clear need of some kind of overhaul. No tune has the throbbing hook of *Do It Again*; no lyric trips as skillfully between innocence and devilishness as their biggest hit, *Rikki Don't Lose That Number*; and certainly nothing is as relentlessly agonized as *Dirty Work*, perhaps the finest song from their debut album. The most successful pieces on “Scam” are harsh, rueful vignettes about criminal and sexual deceit. *Kid Charlemagne*, the best of the lot, is the story of a legendary San Francisco drug chemist who is on the run, unable to adjust to a nonpsychedelic environment. Its lyric has the marvelous slangy looseness that characterizes Becker and Fagen at their best: “Clean this mess up/Or we'll all end up in jail/Those test-tubes and the scale/Just get them all out of here/Is there gas in the car/I think the people down the hall know who you are.”

While *Charlemagne*, *Sign In Stranger*, and the less memorable *Don't Take Me Alive* all concern themselves with crime, sexual duplicity is the theme of the album's other first-rate songs, *Haitian Divorce* and *Everything*

You Did. *Divorce* sneers at the jet-set histrionics of “Babs and Clean Willy,” a couple who separate after a lovers' spat. The wife goes to Haiti, has an affair, and, after a “tearful reunion” in the States, has a “semi-mojo” baby. *Everything You Did*, which is set to an almost jaunty tune, puts us down in the middle of a domestic battle occasioned by the wife's flagrant infidelity. In the course of the husband's furious interrogation, he orders her to “Turn up the Eagles/The neighbors are listening,” a pointedly witty (because far from accidental) Steely Dan interjection.

But nothing on the rest of the album approaches that level of incisiveness. *Green Earrings* is hopelessly obscure. *The Fez* is modest aural exotica. *The Caves of Altamira* is a striving, almost-successful song about art, but its stark desperation just isn't sharp enough to permit it to wound. The album's title song also works too hard. In this strange fable about immigrants to the United States stuck at the bottom of the heap but still writing home about being “paid in gold just to babble,” the band's signature cynicism reveals its affectation most clearly.

It seems to me that, while their writing is never less than intelligent and craftsmanlike, Fagen and Becker are out of their depth when they attempt anything large-scale; they are persuasive only when their eye for detail and nuance supplies them with pins to prick small but pretentious balloons. And that, of course, is no negligible talent. —Stephen Holden

STEELY DAN: *Royal Scam*. Walter Becker (bass); Donald Fagen (keyboards, vocals); other musicians. *Kid Charlemagne*; *Caves of Altamira*; *Don't Take Me Alive*; *Sign In Stranger*; *The Fez*; *Green Earrings*; *Haitian Divorce*; *Everything You Did*; *The Royal Scam*. ABC D931 \$6.98, © 8022 931H \$7.98, © 5022 931H \$7.98.

LEON AND MARY RUSSELL: *Wedding Album*. Leon and Mary Russell (vocals); instrumental accompaniment. *Rainbow in Your Eyes; Like a Dream Come True; Fantasy; Satisfy You; You Are on My Mind; Lavender Blue (Dilly Dilly)*; and four others. PARADISE PA 2943 \$6.98, © M8-2943 \$7.98, © M5-2943 \$7.98.

Performance: **Poor**
Recording: **Very good**

I'm always suspicious of people who make their weddings too public, especially in the entertainment business. And, predictably, Leon Russell's collection of songs about how sweet it is to be in love (what else is new?) with his new bride shows his talent to be working at half-power. I wish Russell and Mary all the best, but, felicitations out of the way, the songs in this album are boneless, Russell's singing makes too much use of his Oklahoma accent, the lady does not sing as much as she caterwauls, and they both ought to be embarrassed about their Boston Pops treatment of *Lavender Blue (Dilly Dilly)*, a dumb song if there ever was one. People in love should sometimes keep their hearts open and their mouths shut. J.V.

RECORDING OF SPECIAL MERIT

SEALS & CROFTS: *Get Closer*. Jim Seals (vocals, guitar); Dash Crofts (vocals, mandolin); David Paitch (keyboards); Louie Shelton (guitar); other musicians. *Sweet Green Fields; Get Closer; Red Long Ago; Goodbye Old Buddies*; and four others. WARNER BROS. BS 2907 \$6.98, © M8-2907 \$7.98, © M5-2907 \$7.98.

Performance: **Trustworthy, loyal . . .**
Recording: **Very good**

Seals and Crofts—well, I think we keep them around like pets; it has to do with their being perceived as not dangerous and as having created for themselves a style that stands out and yet is something a person could live with. Among the pets, take your dogs: dogs in general don't have much style, but one's own pet dog in particular always seems to, and it's a fine and necessary thing, and a great thing as

SEALS AND CROFTS
Nobody else does it quite their way



Warner Bros. Records

long as it doesn't get on your nerves. Seals and Crofts don't seem to get on too many people's nerves—not even on mine much when they do their AM radio-hit number, the patently annoying title song. They write like kindly, absent-minded small-town preachers, not too long on vocabulary, but there's no question about the dedication. Maybe it's not terribly relevant, maybe it's even a bit fog-brained, but still it is pleasant and nobody else does it quite that way. And of course the way they sound is similarly unique and compatible. This latest album, while it is a little looser and considerably less puffed up about spirituality than most, does come right on over and lick your hand. The old sound is right there, the old vague areas are still right where they should be in the songs, the mandolin comes in just so, the harmonies grate on each other just so—and you're going to enjoy it the way we radio kids used to enjoy waiting to hear Jack Benny say "Well!" What more useful goal, really, could there have been, time and place considered, for this album? N.C.

SYLVIA SYMS: *Sylvia Syms, Lovingly* (see Best of the Month, page 70)

RICHARD AND LINDA THOMPSON: *Pour Down Like Silver*. Richard Thompson (vocals, guitar); Linda Thompson (vocals); Pat Donaldson (bass); Dave Mattacks (drums); other musicians. *Night Comes In; Jet Plane in a Rocking Chair; Hard Luck Stories; For Shame of Doing Wrong*; and three others. ISLAND ILPS 9348 \$6.98.

Performance: **Good**
Recording: **Very good**

This impresses me less than the other Richard and Linda Thompson album I have. (A third and earlier one, reportedly very good, was released only in England.) One of the difficulties here is the impression it makes of being stuck, melodically, in a rather tight area; tunes keep turning the same tricks, taking off on the same tack, and at least one sounds very much like something Sandy Denny, a former associate of Richard's, would write. Another problem with the material is that it seldom takes advantage of Linda's vocal specialties. For

FRAZIER
YOUR SOUND
OUR SOUND

Listen to Frazier loudspeakers . . . you'll hear your kind of sound. Sound that flows like silk . . . sparkles like diamonds. Sound that's as crisp as a fine autumn day. It's our sound; crystal clear qualities that come only after years of making fine loudspeakers . . . sound that comes

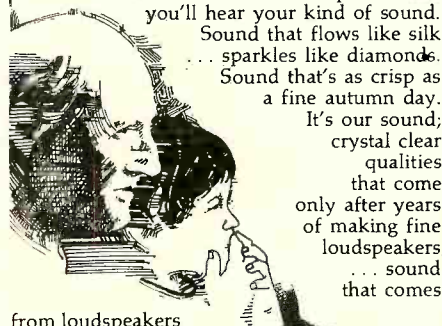

from loudspeakers where pride of craftsmanship is the by-word . . . superlative sound that is only Frazier.

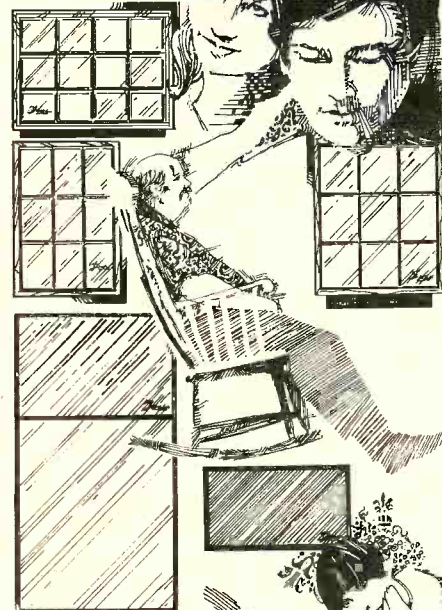

There is truly a Frazier loudspeaker for every person.

From our fantastic Super Midget at under \$60 to our elegant ELEVEN at \$1,200, you're sure to find a Frazier loudspeaker that is perfect for you.

FRAZIER
INCORPORATED

1930 Valley View Lane
Dallas, Texas 75234
Phone 214-241-3441

CIRCLE NO. 12 ON READER SERVICE CARD

The \$750 alternative.

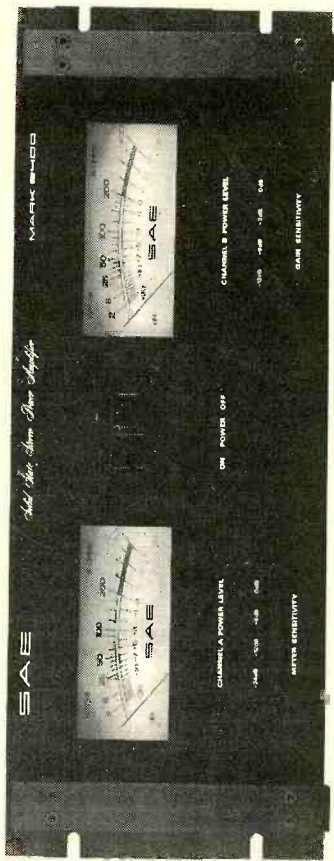

SAE 2400 Professional Dual-Channel Power Amplifier

- 200 Watts RMS, per channel, both channels driven into 4 or 8 Ohms from 20Hz to 20KHz at no more than 0.05% Total Harmonic Distortion.
 - 0.05% IM into 4 or 8 Ohms
 - (signal to noise) greater than 100dB
 - plug-in board modules
 - forced air cooling
 - only 11" deep
 - weighs less than 42 lbs.
 - superb construction using only the finest materials and component parts
 - available in black rack mount (as shown) or our traditional satin gold and black
- You'd have to look a long time to find a power amplifier that delivers this much value.



Scientific Audio Electronics, Inc. SR 8/76
 P.O. Box 60271, Terminal Annex
 Los Angeles, California 90060
 Please send me the reasons (including available literature) why the SAE 2400 Professional Amplifier is the "\$750 Alternative."

NAME _____
 ADDRESS _____
 CITY _____ STATE _____ ZIP _____

CIRCLE NO. 30 ON READER SERVICE CARD

Shame of Doing Wrong, for example, is a pleasant tune, but the construction of the melody, or something, has her spending most of her time with it near the bottom of her range, which isn't where she's strongest. The Thompsons' penchant for tinkering with sound leads them this time to a recurring button-accordion/concertina backwash. It's a nice enough sound, played well by John Kirkpatrick, but a little of it goes a long way. Aside from that, the performances are of a high caliber—the ensemble sound jells beautifully in *Jet Plane in a Rocking Chair* (a typical Richard Thompson title), the most impressive selection. All the songs are good enough to be in albums—it's just that I question the judgment involved in putting them all in the same album. N.C.

WING AND A PRAYER: *Babyface*. Wing and a Prayer Fife and Drum Corps (vocals and instrumentals). *Eleanor Rigby*; *Charleston*; *Those Were the Days*; *I Hear a Symphony*; and three others. WING & A PRAYER HS 3025 \$6.98, © TP 3025 \$7.98, © CS 3025 \$7.98.

Performance: **Unbelievable**
 Recording: **Good**

It is such disasters as this that make record reviewing a hazardous occupation for those of us with nervous conditions. A miscellaneous collection of instrumentalists and singers meet head-on here to perform a series of "hits" in a manner that sounds like Muzak gone berserk. Before I bit the dust I think I heard them run through a "Medley" of such traffic stoppers as *Toot Toot Tootsie!*, *Swanee*, and *Blue Skies*; it felt like being trapped in some demonic elevator in the World Trade Center—riding up and down, up and down. It is enough to give you the willies, and I got them. Brrr. P.R.

JESSE COLIN YOUNG: *On the Road*. Jesse Colin Young (vocals, guitar); vocal and instrumental accompaniment. *Sunlight*; *Walkin' Off the Blues*; *Peace Song*; *Miss Hesitation*; *Have You Seen My Baby*; *Corinna*; and three others. WARNER BROS. BS 2913 \$6.98.

Performance: **Good, but . . .**
 Recording: **Excellent**

Things start off well on this "live" album. The first two tracks are very satisfying: *Sunshine* is a pretty song about a woman who backs up her man, and *Walkin' Off the Blues* features scintillating Dixie jazz clarinet by reedman Jim Rothermel. Alas, things go downhill after that. *Peace Song* is one of those dreary paeans to the obvious. "We've got to stop killing each other," Young sings. Sure; what else is new?

Miss Hesitation—which uses the chorus from W. C. Handy's *Hesitation Blues* without crediting Handy as composer—is an excuse for a grab-bag of rhymes; Young has shyly introduced the song as dealing with what would happen if all his sexual fantasies came true. Rather mild fantasies, lad . . . ahem, well, no matter. As for the rest, Cab Calloway's 1931 version of the old blues *Corinna* is better than Young's, and Ringo Starr's 1974 version of Randy Newman's *Have You Seen My Baby* is likewise superior to this one.

The problem is that Young has a fine, high tenor voice that is perfect for ditties like *Sunshine* and for mild blues. But when he tries to get funky he sounds like a kid imitating King Kong. Can't someone advise him about types of material to stay away from? Some time in

the very early Sixties I heard Young's "The Soul of a City Boy" album. It contains his wonderful version of *Black-Eyed Susie*. I quickly learned it on the guitar and still play it today. But *Susie* was the only standout on that album. This has been true of every Young set I've heard since then: one gem, maybe two, and the rest paste. J.V.

WARREN ZEVON (see *Best of the Month*, page 69)

COLLECTIONS

THE OUTLAWS: *Wanted*. Waylon Jennings (vocals, guitar); Willie Nelson (vocals, guitar); Jessi Colter (vocals, piano); Tompall Glaser (vocals, guitar); instrumental accompaniment. Jennings: *My Heroes Have Always Been Cowboys*; *Honky Tonk Heroes*. Colter: *I'm Lookin' for Blue Eyes*; *You Mean to Say*. Nelson: *Me and Paul*; *Yesterday's Wine*. Glaser: *T for Texas*; *Put Another Log on the Fire*. Jennings-Colter: *Suspicious Minds*. Jennings-Nelson: *Good-Hearted Woman*; *Heaven or Hell*. RCA APL1-1321 \$6.98, © APS1-1321 \$7.98, © APK1-1321 \$7.98.

Performance: **Shuffling**
 Recording: **Erratic mix**

There's a big enough body of talent here to go bear hunting with a willow switch, but this sampler doesn't satisfy the way it should; it is rushed, I think, and a little slapdash. Waylon Jennings got of dominates it, which would be fine with me except that the songs he chooses to do are all pretty much alike, and the band backing him sounds like it's sealed up inside a barrel, except for the bass, which is outside with Jennings and plenty loud. The sound behind Willie Nelson is considerably clearer, and the songs he chooses complement each other better and relax with the album's thematics. But then there is Tompall Glaser, a fine singer, a natural, who seems to have given song selection even less of a lick and more of a promise than Waylon did, and to have managed to sound slightly distracted singing. Jessi could keep her tunes, I guess, although I do wish female c-&-w singers with such nice voices didn't have such a narrow range of songs to choose from.

If there is one central problem with the album, I suppose it is that the evocation of the theme got a little too self-conscious; people got to playing outlaw a little too much like the way Kirk Douglas would play it. These four are honorable outlaws, Robin Hoods of the country-and-the-west, in real life; or at least they—particularly Jennings and Glaser—were, their crime being rubbing the Nashville Sound hierarchy the wrong way. But now they stand exonerated in the eyes of enlightened people everywhere, even within the Nashville establishment, and if their record sales still aren't what they deserve to be, they are exerting considerable and far-reaching influence on the new musicians coming along. Nelson is the real head of the whole Austin thing, and Jennings' cult is even bigger, more broadly based, and more fanatical. They are a source of vitality to country and to pop in general. Here they seem distracted by the trappings of the role of the outlaw, and, for some reason, in a hurry to boot, and so they lay it on a little thick. Still, of course, this is a place to hear four fine—and four still basically bulldog-honest—voices at work. N.C.

(Continued overleaf)



RECORDING OF SPECIAL MERIT

TOSHIKO AKIYOSHI/LEW TABACKIN BIG BAND: *Long Yellow Road*. Toshiko Akiyoshi (piano); Lew Tabackin (flute, piccolo, tenor saxophone); orchestra. *Children in the Temple Ground; Since Perry/Yet Another Tear; Opus Number Zero*; and three others. RCA JPL1-1350 \$6.98.

Performance: **Superb**
Recording: **Excellent**

Very few big bands impress me these days, but the Toshiko Akiyoshi/Lew Tabackin Big Band is so fine that some of the bands that have impressed me must now take a back seat. Ms. Akiyoshi (now Mrs. Tabackin, formerly Mrs. Charlie Mariano) is responsible for all the arrangements and most of the compositions, and mere words cannot describe the splendor of it all. Born in Manchuria forty-seven years ago, Toshiko studied classical piano before moving to Japan with her family

in 1946. She became involved with jazz the following year and was recognized as Japan's leading jazz pianist by the mid-Fifties, when she enrolled at the Berklee School of Music. During her twenty years in this country, Toshiko has made numerous recordings, but none as outstanding as this album, which surely must establish her as one of our leading arrangers.

This album also deserves top honors for performance. Toshiko's arrangements are not always easy to play, but the band has caught her considerable spirit, and the music flows effortlessly. There are superb solos, most notably by trumpeter Don Rader and Lew Tabackin himself. Tabackin has a steady job, buried in the Doc Severinsen orchestra on the *Tonight Show*, but his talent is considerably

greater than that of his boss. Just listen to his tenor on *Since Perry/Yet Another Tear*, a medley of two of his own compositions that ends this album on notes so mellow they conjure up memories of Hawkins, Webster, and Byas. More! More!
C.A.

COUNT BASIE/ZOOT SIMS: *Basie and Zoot*. Zoot Sims (tenor saxophone); Count Basie (piano, organ); John Heard (bass); Louis Bellson (drums). *Hardav; Honeysuckle Rose; I Surrender, Dear; Captain Bligh*; and four others. PABLO 2310-745 \$7.98, © S10-745 \$7.98.

Performance: **Lightly swinging**
Recording: **Very good**

To say that Count Basie and Zoot Sims are capable of generating tremendous swing is to



TOSHIKO AKIYOSHI & LEW TABACKIN: mere words cannot describe the splendor of it all

RCA Records

What's a tweeter doing on the back of our cabinet?



You want accurate reproduction. Whether you like to sit right in front of the grillcloth or across the room in an easy chair.

Most speakers can't do both jobs. Either they produce hot spots up front or high frequencies are dulled further away or off axis.

The trick is to give you flat response with uniform dispersion wherever you sit. E-V engineers were smart enough to do just that. They designed Interface:A with two tweeters — one facing forward, one backward.

Our front tweeter produces flat response to nearly 18,000 Hz,



pure joy on axis and up close. And, our rear tweeter gradually reaches full output at about 8,000 Hz and continues on up. The energy it adds into the room lets you hear full frequency response everywhere without overemphasis in front.

Another neat trick. Interface:A can sit anywhere and the rear tweeter still does its job. Even 2 inches from a wall. It's unlike position-sensitive speakers which dictate where they have to be placed.

You probably haven't seen or heard anything quite like the Interface:A, but your E-V dealer can solve that one. It's a system you'll want to examine closely. Backward and forward.

Interface: A

Electro-Voice, Inc. a Gulston company
616 Cecil St., Dept. 864F, Buchanan, Mich.
49107

SAVE!

MONEY • TIME • FREIGHT

- ▶ QUALITY STEREO EQUIPMENT AT LOWEST PRICES.
- ▶ YOUR REQUEST FOR QUOTATION RETURNED SAME DAY.
- ▶ FACTORY SEALED CARTONS—GUARANTEED AND INSURED.
- ▶ SAVE ON NAME BRANDS LIKE:

A.D.C.	KLH
A.R.	SHURE
DYNACO	KOSS
SONY	FISHER

PIONEER
AND MORE THAN 50 OTHERS
BUY THE MODERN WAY
BY MAIL—FROM

illinois audio

Department 217S
12 East Delaware
Chicago, Illinois 60611
312-664-0020

CIRCLE NO. 16 ON READER SERVICE CARD

understate a well-known fact, and to say that this collection of three blues and five standards does not add proof would be to make an absurd statement. It's a beautiful, tasteful, jazzy album throughout. C.A.

PAUL BLEY, BILL CONNORS, AND JIMMY GIUFFRE: *Quiet Song*. Jimmy Giuffre (reeds); Paul Bley (keyboards); Bill Connors (guitar). *Solo; Duet; Play Blue; Goodbye*; and six others. IMPROVISING ARTISTS 373839 \$6.98.

Performance: **Keenly sensitive**
Recording: **Excellent**

This is a collection of ten pieces that range in time from fifty-two seconds to close to ten minutes. Except for Gordon Jenkins' *Goodbye*, the pieces are original compositions by Giuffre, Bley, and Connors, three highly sensitive improvisational artists who share a common wavelength. Jimmy Giuffre and Paul Bley have been associated with jazz for many years now, but the music they are now playing transcends what originally brought them to our attention; like their recent individual albums, this one is richly melodic and so intense in the moods it conjures up that the listener might easily feel guilty of invasion of privacy. But go ahead—eavesdrop. C.A.

TED CURSON: *Tears for Dolphy*. Ted Curson (trumpet, piccolo trumpet); Bill Barron (clarinet, tenor saxophone); Herb Bushler (bass); Dick Berk (drums). *Kassim; 7/4 Funny Time; Reava's Waltz*; and three others. ARISTA/FREEDOM AL 1021 \$6.98.

Performance: **Beautiful**
Recording: **Very good**

If Philadelphia-born trumpeter Ted Curson is unknown to today's younger generation of jazz listeners, and I suspect he is, blame it on an attitude toward black improvisational music that forces some of our finest players to seek abroad the recognition they deserve at home. And if you are among those who have hitherto missed the sound of Curson's horns, I can think of no better way to rectify that situation than to listen to this superb 1964 album. Ted Curson has worked under the leadership of such men as Max Roach, Cecil Taylor, and Charles Mingus, and his own groups—on and off records—have included such heavyweights as Booker Erwin, Roy Haynes, Danny Richmond, and Eric Dolphy. Yet I have seen him having personally to rent the Village Vanguard in order to be heard in his own country. For more than ten years, most of Curson's musical activity has taken place in Europe, but, unlike many of his colleagues, he has maintained his residence here, popping in and out of the country, hoping to find enough work to keep him here, but having to return to Europe each time. A couple of years ago, Atlantic recorded a Curson album, but it remains unreleased.

This album took twelve years to reach the American market. It was recorded in Paris and released on the European Fontana label by producer Alan Bates, whose leasing agreement with Arista now, finally, makes it available here. The music is as fresh as it was then, with extraordinary performances by Curson and his long-time associate Bill Barron. Two of the compositions are Barron's, the rest Curson's, and all are of more than passing interest. I don't know what Arista's policy regarding the discontinuance of albums is, but I

(Continued on page 87)

PRICE WAR

AMERICA'S #1 VALUE LEADER

STEREO CORPORATION OF AMERICA

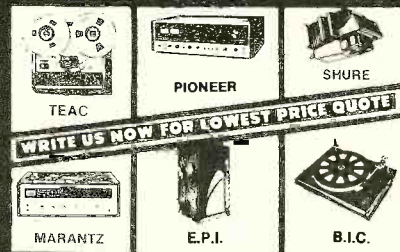

WRITE US NOW FOR LOWEST PRICE QUOTE

AUDIO DISCOUNTING STARTED IN NEW YORK & NOW WITH THE END OF FAIR-TRADE WE ARE SURE THAT NO ONE CAN BEAT OUR PRICES:

- We Discount Over 70 Major Brands
- Over 10 Years Of Reliable Service In The Mail Order Field
- Largest Inventory/Lowest Prices!

We Get The Best Deals From The Manufacturers. You Get The Best Deal From Us!

SHOP BY PHONE!

(212) 253-8888
9-5 Mon. thru Sat.
Use Your Charge Card

FREE

WRITE OR CALL
FREE
Stereo Price
Catalogue

STEREO CORPORATION OF AMERICA

S-R 1629 Flatbush Ave.
Brooklyn N.Y. 11210
Tel: (212) 253-8888

CIRCLE NO. 36 ON READER SERVICE CARD

SAVE ON

Brand Name Audio Components

BY MAIL

Write Today for Our
FREE Audio Catalog

DIXIE is one of the oldest and largest audio component mail order houses in the country. Our prices on brand name components are actually LOWER than "Discounters". See our new catalog or call us for a price quote. Everything shipped factory-sealed with full manufacturer's warranty.

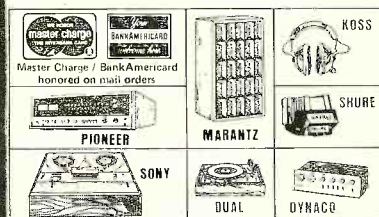

DIXIE HI-FI

SR-8

2040 Thalbro Street Richmond, Va. 23230
Phone: (804) 257-4241

Please rush me your FREE Audio Catalog and complete information. I understand there is no obligation.

Name _____
Address _____
City _____
State _____ Zip _____

Hi-Fi Buys

ON PIONEER

AT WAREHOUSE TO YOU PRICES

RECEIVERS		AMPS & TUNERS	
SX-1250	\$590	SA-9900	\$495
SX-1050	\$475	SA-9500	\$330
SX-950	\$409	SA-8500	\$264
SX-737	\$249	SA-7500	\$198
SX-636	\$215	TX-9500	\$264
SX-535	\$181	TX-7500	\$165
SX-434	\$142	TX-6500	\$123

TURNABLES DOLBY CASSETTE DECKS

PL71	\$198	CT-F9191	\$308
PL530	\$170	CT-F8282	\$272
PL510	\$136	CT-F7272	\$218
PL117D	\$119	CT5151	\$184
PL115D	\$91	CT4141A	\$164
PL112D	\$74	CT-F2121	\$149

SPEAKERS

HPM200	\$330	CS63DX	\$185
HPM100	\$165	CS99A	\$159
HPM60	\$124	CS700G	\$132
HPM40	\$83	CS500G	\$99

Save on other famous brands. Quotations answered same day. Write or call for free catalog. All units factory sealed. Full manufacturer's warranty. CB's also available at tremendous savings.

MAIL AND PHONE ORDERS FILLED!

For shipment within 48 hours send money order or certified check. Two week delay on personal checks. 20% deposit requested on C.O.D. shipments. \$1.25 handling fee on all orders. Shipping cost are collected C.O.D. unless paid in advance.

Hi-Fi Buys

1362 HOLTON LANE
LANGLEY PARK, MD. 20783
(301)434-5330

CIRCLE NO. 15 ON READER SERVICE CARD



DOUBLE SAVINGS

FEATURING
Technics by
Panasonic



MODEL
SL-1500

Mail order shopping is made easy the
AUDIO EXPO
way. Freight and insurance are already
included in low Audio-Expo price.
**THE PRICE YOU SEE IS THE
PRICE YOU PAY!!**

AUDIO EXPO
5509 Connecticut Ave.
Washington, D.C. 20015
202-966-1640
SEND FOR PRICE QUOTES

CIRCLE NO. 4 ON READER SERVICE CARD

DISCOUNTS

WASH. D.C.
HAS NO FAIR
TRADE
LAWS!

ON STEREO COMPONENTS

PLEASE REQUEST
Prices for your choice of
Changers, Receivers, Tape
Recorders, Speakers, etc.

PROMPT DELIVERY
IN FACTORY
SEALED
CARTONS.

DISTRICT SOUND INC.

2316 Rhode Island Ave. N.E.
Washington, D.C. 20018
202-832-1900

CIRCLE NO. 10 ON READER SERVICE CARD

strongly advise you to grab "Tears for Dolphy" before there is any chance of its disappearing from the catalog. C.A.

RECORDING OF SPECIAL MERIT

GIL EVANS: *There Comes a Time*. Gil Evans (keyboards); orchestra and soloists, including Marvin Peterson (trumpet, vocals), Dave Sanborn (alto saxophone), Billy Harper and George Adams (tenor saxophones), Ryo Kawasaki (guitar), and Herb Bushler (bass). *King Porter Stomp*; *The Meaning of the Blues*; *Makes Her Move*; *Anita's Dance*; and three others. RCA APL1-1057 \$6.98, © APS1-1057 \$7.98, © APK1-1057 \$7.98.

Performance: **Exciting**
Recording: **Excellent**

Gil Evans' importance as an arranger was first widely recognized as the Forties came to an end, and he ushered in the cool through a classic series of Capitol sessions under the leadership of Miles Davis. His subsequent collaborations with Davis—in the late Fifties—crowned his earlier achievements, but possibly did more to further the career of Miles Davis than his own; such is often the arranger's lot, a particularly sad example being Benny Goodman's overshadowing of Fletcher Henderson. Nevertheless, Evans has continued to thrive, creating exciting, innovative sounds that make most big-band arrangers' works sound like New Year's Eve at the Waldorf Astoria.

As I have said before, when Gil Evans borrows from the past, it is from his own past. He does just that with *King Porter Stomp*, which begins this album. Evans originally recorded the famous Jelly Roll Morton tune for the World Pacific label in 1958, a performance that featured the late Cannonball Adderley as soloist. That version has recently been reissued on Blue Note, and it is as interesting today as it was then. Here we are treated to basically the same arrangement with Dave Sanborn playing the alto solo; it, too, is exciting—though slightly hampered by heavy reverb—and would appear to have been included as an opener to remind us of the Evans of old, because everything that follows reflects more recent trends.

The principal soloists, besides Sanborn, are trumpeter Marvin Peterson (who also injects a couple of less pleasing, though not obnoxious, vocals), tenor men Billy Harper and George Adams, guitarist Ryo Kawasaki, and bassist Herb Bushler. Their individual work is uniformly meritorious and skillfully enhanced by Evans' characteristically rich, dramatic arrangements that often have the orchestra lurking menacingly but beautifully in the background. This is another wonderful excursion into your head by a man who doesn't know the meaning of the word cliché. C.A.

HAMPTON HAWES: *Live at the Montmartre*. Hampton Hawes (piano); Henry Franklin (bass); Michael Carvin (drums). *South Hampton*; *The Camel*; *Little Miss Laurie*; and two others. ARISTA/FREEDOM AL 1020 \$6.98.

Performance: **Curiously refreshing**
Recording: **Good**

Pianist Hampton Hawes sounded very interesting to me back in the Fifties when he was recording for the Contemporary label on the West Coast, but his life story—published in a 1972 biography—was more interesting by far

(Continued on page 89)

BIG DISCOUNTS

STEREO COMPONENTS

Largest selection of top name brands... try us and see...

It's worth a call
(301) 488-9600

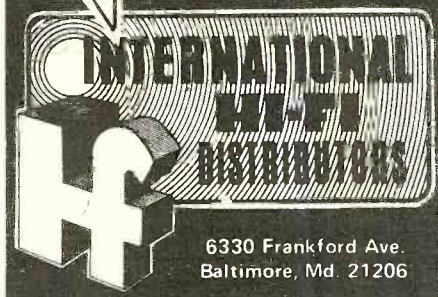

6330 Frankford Ave.
Baltimore, Md. 21206

All mail answered within 24 hours
Phone Daily 9 AM to 9 PM
Saturday 9 AM to 4 PM
Phone (301) 488-9600

CIRCLE NO. 17 ON READER SERVICE CARD

OUR
NAME WON'T
FOOL YOU ...

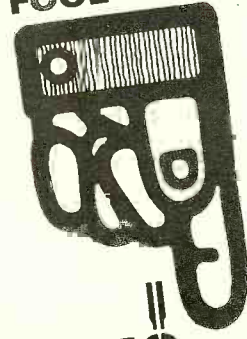

STEREO DISCOUNTERS

Our volume buying power enables us to pass our discount prices on to you. Send for your Free Hi-Fi and CB Catalog ... or call for a price quote on our "Super Service" line ...

301-252-6880

Name _____ SR
Address _____
City _____ State _____ Zip _____
STEREO DISCOUNTERS
7A Aylesbury Rd.
Timonium, Md. 21093

CIRCLE NO. 37 ON READER SERVICE CARD

“...a treasure... the civilized person will have to own a copy.”

The 1928 Collaborations of Louis Armstrong and Earl Hines



Delmark Records

Audio Fidelity Records

At the time they were first released, the 1928 performances of Louis Armstrong and Earl Hines had a pole-axe effect on musicians because of the harmonic and rhythmic ideas they illustrated. That was the year Armstrong abandoned his sentimental loyalty to New Orleans jazz (based on his love and respect for Joe “King” Oliver, whom Louis always regarded as a father and teacher) and finally accepted the sweet and scary responsibility for his gargantuan talent and technique. A new Smithsonian double-disc package collects all the Armstrong-Hines collaborations of 1928, after which time Hines spent eleven years in distinguished limbo as the leader of the Grand Terrace Band in Chicago while Armstrong went on to national, international, and immortal fame.

One selection in the Smithsonian collection, *Chicago Breakdown*, is from May 1927; the month before that, Armstrong and Hines were on a pick-up date with Johnny Dodds’ Black Bottom Stompers (Dodds was the original clarinetist in Armstrong’s original Hot Five) at which four sides were done. Those earlier sides are not included, though, since this set draws exclusively from the Columbia archives while the Dodds dates belong to MCA (née Decca-Vocalion-Brunswick) and are not very distinguished anyway.

Armstrong’s grandeur and bravura are everywhere evident in the collection, though on certain tunes he doesn’t seem quite comfortable (he became comfortable with them in short order). Hines, by contrast, seems entirely at ease. Perhaps Armstrong had trouble settling in because he realized that he had no reference or precedent for what he was doing, for his talent or for his style, except himself. In some of the performances you can hear him falling back on sheer lung power, playing harder than he had to, as if to convince himself that everything was going to turn out all right a hundred years from then. He may also have been bothered by his acquaintanceship

with Bix Beiderbecke. Louis and Bix had a furtive but deep adoration and respect for each other, but each seemed to sense that jazz was going to split into two roads based on what the two of them were doing. Louis was able to handle the pressures of genius and Bix wasn’t.

Whatever jazz trumpet is now, or may remain, is owing to Louis and Bix. Jazz piano is greatly in the debt of Earl Hines. His “trumpet-style” playing is legendary as to its origins. Because of his friendship with Armstrong, it is most often assumed that Hines got his attack and solo ideas from Louis. But, as Stanley Dance pointed out in his profile of Hines in the January 1974 issue of this magazine, Hines’ unique concept of piano playing came from the cornet of Joe Smith, whose style was tender and intimate, as well as from Hines’ own early and frustrated career as a trumpeter before he met Louis.

HINES was the first jazz pianist who released his left hand from time-keeping guard duty; his artistic motto might be, “I know where the rhythm is—don’t worry about it.” He thus freed his left hand to join his right in explorations that found whole new voices for the piano. Throughout his career, when he has played in a combo or a band he has been content to let somebody else worry about the immediate responsibilities of rhythm and beat, as most of these sides with the wonderful Zutty Singleton on drums show.

Hines’ “trumpet style”—giving obvious rhythmic considerations low priority while employing both hands to make autonomous solo statements—is actually a compliment to the listener, and a deliberate one. He has always respected his audience, and he believes that, since his listeners always know where things are supposed to be, a departure won’t throw them. It’s also interesting to note, when speaking of Hines’ style, that he was at one time an amateur boxer, and that his jabbing,

probing right hand on piano is like that of a sparring fighter. His approach to the rhythm in a tune can be compared to a boxer who moves well in the ring. It wouldn’t be inappropriate, therefore, to call him the Jack Johnson or the Muhammad Ali of the piano.

Although nearly everything in the Smithsonian set has been reissued before, the performances are brought together in chronological order for the first time. The mono reprocessing is absolutely first-rate, and the annotations are extensive if a bit ponderous; one has to dig for the information. Overall, the set is a treasure, and the civilized person will simply have to own a copy. —Joel Vance

LOUIS ARMSTRONG AND EARL HINES, 1928. Louis Armstrong (trumpet, vocals); Earl Hines (piano); other vocalists and instrumentalists. Louis Armstrong and His Hot Seven: *Chicago Breakdown*. Lillie Delk Christian with Louis Armstrong and His Hot Four: *Baby*; *I Must Have That Man*; *Sweethearts on Parade*; *Too Busy*; *You’re a Real Sweetheart*; *Last Night I Dreamed You Kissed Me*. Louis Armstrong and His Hot Five: *Fireworks*; *Skip the Gutter*; *A Monday Date*; *Don’t Jive Me*; *West End Blues*; *Sugar Foot Strut*; *Two Deuces*; *Squeeze Me*; *Knee Drops*. Carroll Dickerson’s Savoyagers: *Symphonic Touches*; *Savoyager’s Stomp*. Louis Armstrong and His Orchestra: *No (No, Papa, No)*; *Basin Street Blues*; *Muggles*. Louis Armstrong (with Earl Hines, piano): *Weather Bird*. Earl Hines: *Caution Blues*; *I Ain’t Got Nobody*; *Fifty-Seven Varieties*; *A Monday Date*. Louis Armstrong and His Savoy Ballroom Five: *No One Else but You*; *Beau Koo Jack*; *Save It, Pretty Mama*; *Heah Me Talkin’ to Ya*; *St. James’ Infirmary*; *Tonight Like This*. SMITHSONIAN COLLECTION © R 002 \$9.00, \$8.00 to Smithsonian Associates (from Smithsonian Museum Shops or by mail from the Smithsonian Collection, P.O. Box 5734, Terre Haute, Ind. 47802).

than any of his more recent recordings. Bitten by the electric bug, Hawes is drowning in the stagnant waters that also engulf Herbie Hancock, but this album, recorded in 1971 at Copenhagen's Montmartre Jazzhus, captures Hampton Hawes just before he plugged in. The drummer, Michael Carvin, is a bit overpowering, but I am willing to put up with that because this is the closest Hawes has come to fulfilling the promises I thought he was making on the old Contemporary records. Not much thought went into the technical aspect of this recording, however. C.A.

WOODY HERMAN: *King Cobra*. Woody Herman and the Thundering Herd (vocals and instrumentals). *King Cobra*; *Jazzman*; *Come Rain or Come Shine*; *Lake Taco*; and three others. FANTASY F-9499 \$6.98.

Performance: **Good**
Recording: **Very Good**

I don't think Woody Herman—now sixty-three—ever again will have a Herd that thunders like the one that stomped out *Apple Honey* and *Northwest Passage* some thirty years ago, but as long as he continues to employ fine musicians (and he does) he will always have something of interest to offer. I still fail to hear anything that might characterize this as a Herman band, but the veteran bandleader deserves credit for having a band at all in these economically shaky days and for giving us such soloists as trombonist Jim Pugh and flugelhornist Dennis Dotson. Despite its better moments, though, this album and others like it are beginning to suggest that big-band jazz really went out with Ellington. C.A.

RECORDING OF SPECIAL MERIT

HELEN HUMES: *The Incomparable Helen Humes*. Helen Humes (vocals); instrumental accompaniment. *Contact Me Poppa*; *I Can't Give You Anything but Love*; *Let the Good Times Roll*; and five others. JAZZOLGY J-55 \$5.98.

Performance: **Lives up to its title**
Recording: **Very good**

Helen Humes is one of those old-fashioned blues singers whose wicked way with a bent note and a double-entendre used to make listeners glad they had ears. Brought back out of retirement in Kentucky for this assignment in the Jazzology crusade to resurrect "authentic" jazz, she sounds like a wholesome version of Billie Holiday, whom, as a matter of fact, she replaced in the old Count Basie Band. Whether she is singing about the virtues of fidelity in *Old-Fashioned Love*, exhorting her man to drive her like a car in *Contact Me Poppa*, or evoking the poignancy of yesteryear's sweetest ballads in *I Cover the Waterfront*, Helen Humes comes over as a better in the best tradition. Even her own slightly shapeless song, *Million Dollar Secret*, containing specific instructions on how to get the most out of a very old man or a very young one, sounds inspired the way she puts it over, and her *St. Louis Blues* compares favorably with anyone's. Worth getting. P.K.

RECORDING OF SPECIAL MERIT

KENNY WHEELER: *Gnu High*. Kenny Wheeler (flugel horn); Keith Jarrett (piano);

Dave Holland (bass); Jack DeJohnette (drums). *Heyoke*; *Smatter*; *Gnu Suite*. ECM ECM-1069 \$6.98, © 8F-1069 \$7.98, © CF-1069 \$7.98.

Performance: **Quintessential quartet**
Recording: **Excellent**

Canadian-born Kenny Wheeler has lived in England since 1952 and has become one of that country's leading exponents of what we soon are going to have to stop referring to as "the new music." Except for an obscure 1971 album on the Incus label, this is his first record as a leader, but Americans have had the opportunity to make his acquaintance through two excellent Anthony Braxton sets ("New York, Fall 1974" and "Five Pieces, 1975," both on Arista). Here Wheeler teams up with Dave Holland of Braxton's quartet to lead a foursome rounded out by pianist Keith Jarrett and drummer Jack DeJohnette, two formidable players in the international new-music league.

The session is something of a departure from the usual ECM offerings, for it is a blowing session of sorts. Wheeler's playing is reminiscent of Miles Davis in his pre-electric days; the tone is a bit fuller, but that ethereal lyricism is there, blending perfectly with Jarrett's mellifluous style. Holland and DeJohnette are superb, too, their contribution by far transcending mere rhythmic support. This is a quartet I hope we hear more from, and I hope they continue to record on ECM, for part of the beauty of this album is the technical sound. It isn't often that one comes across an album as nearly perfect from cover to end groove as this one is. C.A.



BACK by popular demand and updated from its original (1966) printing, Music Editor James Goodfriend's *Calendar of Classical Composers* is a listing of the most important composers from the year 1400 to the present, grouped according to the stylistic periods—Renaissance, Baroque, Classic, Romantic, etc.—in which they worked. This 12 x 24-inch aid, guide, and complement to your music listening is printed in color on heavy, nonreflecting stock suitable, as they say, for framing. A key to the calendar, consisting of capsule accounts of the principal stylistic characteristics of each musical period, is included. The whole will be sent rolled in a mailing tube to prevent creases: we pay postage. All you do is send 25¢ to:

Calendar of Classical Composers
Stereo Review, 1 Park Avenue, New York, N.Y. 10016

HEAR WHAT YOUR RECEIVER SHOULD SOUND LIKE!

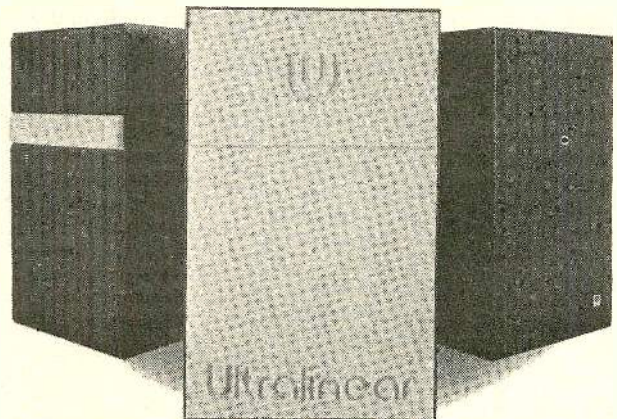

It should sound solid, whether you have a Marantz, Pioneer, Kenwood—or any other model. And it will sound its best when you listen to a pair of ULTRALINEAR Speakers. Ultralinear will deliver those clear, clean highs and full lows, as well as being smooth in the midrange. Ultralinear manufactures a complete line of efficient, full-range speakers. Speakers that will enhance your receiver. Listen to a pair of Ultralinear. Trust your ears. Then you'll trust us.

Ultralinear

HEAR WHAT YOUR RECEIVER SHOULD SOUND LIKE!

CIRCLE NO. 40 ON READER SERVICE CARD

Choosing Sides

By Irving Kolodin



THE SINGULAR FRENCH SYMPHONY

In a nineteenth-century world apparently filled with Russian, Czech, German, and eventually even English, Finnish, and Danish symphonists, the French tended to produce composers who wrote only "a" symphony among their many other works. Only three French composers (Saint-Saëns with three, Gounod and D'Indy with two each) persevered beyond the publication of a Symphony No. 1. Even Lalo, who wrote three, published only one.

This line of thought is induced by the recent recorded appearance of four such "singular" works: Bizet's C Major (Klavier KS 546), Lalo's G Minor (Philips 6500 927), Chausson's B-flat Major (London STS 15294), and Dukas' C Major (London CS 6995). Each has qualities that suggest a second, third, or fourth from the same hand might have added much of value to the symphonic repertoire, but, for a variety of reasons, the composers were attracted to other matters, and each left only a single symphony, souvenirs of a flirtation with the form rather than tokens of a lasting attraction.

In the case of Bizet, his C Major Symphony (written in 1855, when he was a student of seventeen) was quite literally shelved because it was considered too close a copy of Gounod's D Major, a work with which the young man was well acquainted. The C Major might still be lying untouched on a shelf in the library of the Paris Conservatoire had not D. C. Parker, the first English biographer of Bizet, come upon it and recommended it to Felix Weingartner, who had become director of the Basel Conservatory in the late Twenties. Weingartner performed it in Basel, for the first time ever, in 1935—eighty years after it was written. Unfortunately, Weingartner did not also make the first recording—it would have been a piquant pleasure to have the long-deferred delight of the Bizet One from the baton of the man who made the first recording of the Beethoven Nine.

The honor went instead, a few years later, to Walter Goehr, whose spirited effort (RCA Victor set 721, issued in January 1941) made

friends for the work wherever it was heard. Goehr's recording was the first of many (the number is now approaching twenty), of which the latest, by the City of Birmingham Symphony under Louis Frémaux (not to be confused with Louis de Froment) is one of the best. The success of the Bizet C Major has



prompted some to the belief that the long-forgotten Gounod work it "imitated" should be even better. Logical, but untrue. The Gounod symphony lacks the kind of animation that makes the Bizet work so successful and which prompted George Balanchine to produce the briskly beautiful choreography in his 1947 treatment of the work for the Paris Opéra Ballet.

Had his contemporaries been more perceptive would there be more Bizet symphonies? Probably not. It was Bizet's own judgment

that he was "not built for the symphony," and his later work titled *Roma* (it is coupled with the C Major on the Frémaux disc) tends to support this self-analysis. An episodic *envoi de Rome* first performed as a *Fantaisie Symphonique* in 1869, *Roma* was extensively revised but not published in Bizet's lifetime. When it was, posthumously, the publisher gave it the designation of *Suite de Concert No. 3* instead of "Symphony" (perhaps thinking of it as a successor to the *L'Arlésienne* and *La Jolie Fille de Perth* suites). Whatever pangs *Roma* represented to Bizet, it offers to the listener not much more than cuddlesome tunes and attractive instrumentation—in themselves, of course, worthy of acquaintance. At one point in the piece Bizet seems to have encountered the same brigands Berlioz met up with in his *Harold en Italie*. But, after all, isn't that what one goes to Italy for, to learn history? Frémaux discourses both works in a way evocative of both his own personality and that of Bizet.

THE best of the lesser-known French symphonies is, for my taste, Edouard Lalo's in G Minor. It is all but unknown in this country, but for those not previously acquainted with it, suffice it to say that what enduring imprimatur it enjoys was accorded by Sir Thomas Beecham, who chose it as a disc-mate for his Bizet C Major (now on Seraphim 60192), apparently not at all bothered by the fact that Lalo had the "misfortune" to have written the perennially popular and much overplayed violin concerto called *Symphonie Espagnole*. According to Kate Hevner Mueller's *Twenty-Seven Major American Symphonies*, which documents the programs those organizations performed over nearly a century and a half (1842-1969), the only performances of the Lalo G Minor ever given in this country were by the New York Philharmonic in 1932. The enterprising culprit in each case was, of course, Sir Thomas.

The general impression among other conductors is—or appears to be—that all of Lalo must be like the facile, appealing, well-written, but finally superficial work for which he is best known. The G Minor Symphony also is several of these things, but it is emphatically *not* superficial, as Antonio de Almeida too makes thoroughly apparent in his recording with the National Opera Orchestra of Monte Carlo. The best of its movements is, unquestionably, the soulfully singing Adagio, which would, I am sure, be welcomed by American symphony orchestra audiences regularly exposed to works by contemporaries not half the equal of Lalo in talent. Almeida's steadily ripening gifts are also applied here to a pair of other orchestral works by Lalo: the pleasantly Griegish pastiche called *Rapsodie Norvégienne* (originally the *Fantaisie Norvégienne* for violin and orchestra) and the overture to *Le Roi d'Ys*.

THE other two symphonies in this "singular" selection have a curious connection in time and circumstance. Both are in three movements, and both were written in the aftermath of one of the major happenings in the history of the French symphony: the first performance of the Franck Symphony in D Mi-

Bizet himself judged that he was "not built for the symphony."

nor (also in three movements) on February 18, 1889. Chausson, who would have come by the inclination naturally (he was a favorite student of Franck), tried to resist the temptation to compose in the same mold. Dukas, who had no connection with the man sometimes called the "Belgian Bach" (Franck was born in Liège, but he came to Paris in his early teens), did not.

The perpetual but incompletely fulfilled promise of Chausson, who died in 1899 at the age of forty-four from something as innocuous as an accident while cycling, is one of the tragedies of French music. Certainly a composer who could write such fine and distinguished music as the Concerto in D Major for Violin, Piano, and String Quartet or the marvelous *Poème de l'Amour et de la Mer* (of which Victoria de los Angeles has made the most recent and best recording, Angel 36897) was capable of adding magnificence to the catalog of French symphonic music.

Unquestionably, Chausson had such talent. Perhaps, though, he was not "built for the symphony" either, but for something akin to such a musical sport as d'Indy's *Symphony on a French Mountain Air*, a combination piano concerto/symphony. Chausson agonized about how he should proceed with his symphony following the surging first movement and the melodically motivated Adagio. Should he try to evolve a scherzo which would defer the dilemma of "beginning that terrible finale"? In the end, he decided simply to eliminate the scherzo without resolving the dilemma. The superb performance by the late Ernest Ansermet and L'Orchestre de la Suisse Romande (reissued in London's Stereo Treasury Series, STS-15294) gives Chausson every bit of the conviction to which he is entitled, but the overside version of Franck's *Les Eolides* tends to point the finger of resemblance more than politeness ought to permit.

THE Dukas C Major, in a powerfully compelling performance by Walter Weller (with whose conducting work I have no previous acquaintance) and the London Philharmonic, is so much the product of a man with a predisposition to orchestral writing that the sum of its parts *should* add up to more than they do. It was Debussy, writing to novelist Pierre Louÿs on February 9, 1897, who reported that "The symphony of Dukas . . . was disappointing. It shrank to nothing and was like a mixture of Beethoven and Charpentier." As in the Chausson, the Franckian three movements of motto theme, cyclical recurrence, and eventual affirmation act less as a means of access to individuality than as an invitation to a new kind of conformity.

But who is to say that the energy with which Dukas cultivated his garden did not bear fruit? What form the fruit took was nothing less than the tangy, tasteful *L'Apprenti Sorcier* (included on this disc), a product of the same year (1897) as the first performance of the symphony. Dukas may not have been a symphonist, but writing "a" symphony decidedly furthered his career. In the C Major Symphony, Dukas is apprentice to the sorcerer Franck; in *L'Apprenti*, Goethe's apprentice is in turn subservient to the new orchestral sorcerer, Dukas. If this Frenchman could not work successfully with the German discipline of the symphony, he could, through the exercise of native wit and ingenuity, convert another kind of German expression into something that well deserves the French appellation *jeu d'esprit*.

AIMEZ-VOUS BRAHMS?

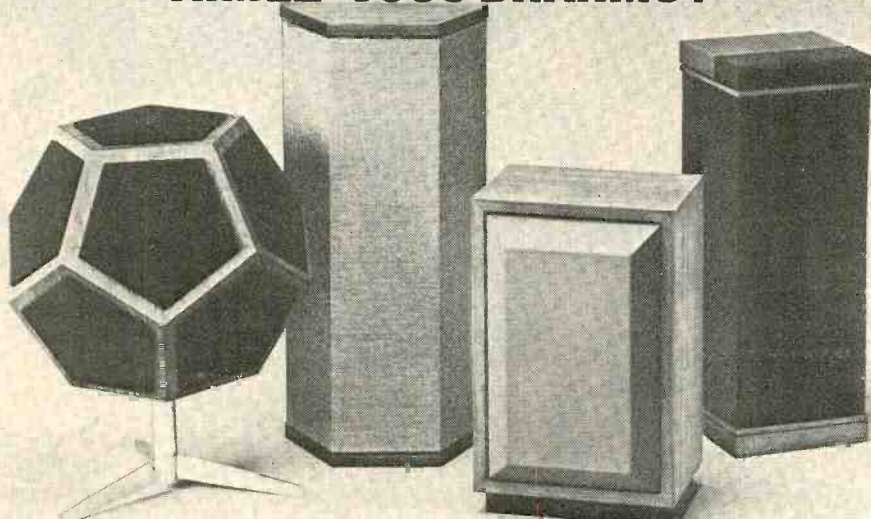

If you do (love Brahms, that is) try him played through one of our loudspeakers. Since we at Design Acoustics begin with the premise that a fine speaker system must do much more than reproduce the louder segments of a musical program, you'll hear the master's meticulous detailing, his subtleties of timbre, perhaps as you never before have. It's just this sort of program material that presents the greatest challenge to a speaker. A fine way to test the superior accuracy Design Acoustics builds into each model.

Not that our performance falls down

when you turn up the volume. Design Acoustics speakers can shout as clearly as they whisper. When the Brahms quintet is over, turn on The Rolling Stones. You'll hear.

Want to know what the critics think of our speakers and where you can audition them? Just send us your name and address. It could open up whole new worlds.



Design Acoustics, Inc.
2909 Oregon Court
Torrance, CA 90503
(213) 320-4981

CIRCLE NO. 8 ON READER SERVICE CARD

It's almost time...

**EXCITING NEW
56th ANNIVERSARY
EDITION**

Available at Your Nearby
Radio Shack September 1st

to get your new Radio Shack catalog at one of our 4200 stores!

Hi-Fi • CB • Phonos • Radios
Recorders • Tapes • Public Address
Intercoms • Alarm Systems • Tubes
Books • Calculators • Batteries
Auto Ignition • Kits • Antennas
Parts • Test Instruments • More

See what's *really* new in electronics for home, car, work, school. Our exclusive nationally advertised brands: Realistic, Micronta, Science Fair, Archer, others. Make it a "must" to come in for your copy of the most popular catalog in electronics!

FREE

1977 EDITION
Over 2000 Items
164 Pages of Exclusives
Beautiful Full Color

Radio Shack®

A TANDY COMPANY

SAVE! OUR PRICES ARE WITHIN 1% OF OUR JULY, 1975 PRICES!

CIRCLE NO. 28 ON READER SERVICE CARD



CLASSICAL DISCS AND TAPES

Reviewed by RICHARD FREED • DAVID HALL • GEORGE JELLINEK • PAUL KRESH
STODDARD LINCOLN • ERIC SALZMAN

RECORDING OF SPECIAL MERIT

J. S. BACH: *Suite No. 3, in C Major, for Unaccompanied Cello (BWV 1009)*. **KODÁLY:** *Sonata for Unaccompanied Cello, Op. 8*. Frans Helmerson (cello). Bis LP-25 \$7.98 (from HNH Distributors Ltd., P.O. Box 222, Evanston, Ill. 60204).

Performance: **Superb**
Recording: **A little over-reverberant**

While a set of all six Bach cello suites may be a convenient way to acquire the music, we are not likely to hear more than one of them in a given recital program, and the coupling offered here makes beautiful sense. Beautiful is the word for Helmerson's playing, too; equally stylish in Bach and Kodály, equally committed, and with as much freedom from superficiality as from technical problems. In short, not just fine cello-playing but musicianship on the highest level, lacking only a certain lightness of touch that might have made the Bach even more appealing. This is not a serious shortcoming, and it is noticeable, I think, only because of the excessive reverberation that tends to make the cello sound a bit larger than life now and then; neither Bach nor Kodály nor Helmerson needs this, but some listeners will find it less obtrusive than others. It is less conspicuous in the Kodály, of which there is not a more persuasive account on records now, and the pressing itself is as flawless as Helmerson's playing. R.F.

Explanation of symbols:

- Ⓜ = reel-to-reel stereo tape
- Ⓢ = eight-track stereo cartridge
- ⓐ = stereo cassette
- = quadraphonic disc
- Ⓡ = reel-to-reel quadraphonic tape
- ⓑ = eight-track quadraphonic tape

Monophonic recordings are indicated by the symbol Ⓜ

The first listing is the one reviewed; other formats, if available, follow it.

BIZET: *Symphony in C Major* (see Choosing Sides, page 90)

BRAHMS: *Variations on a Theme of Haydn, Op. 56a* (see ELGAR)

RECORDING OF SPECIAL MERIT

CARTER: *Double Concerto for Harpsichord and Piano with Two Chamber Orchestras*. Paul Jacobs (harpsichord); Gilbert Kalish (piano); Contemporary Chamber Ensemble, Arthur Weisberg cond. *Duo for Violin and Piano*. Paul Zukofsky (violin); Gilbert Kalish (piano). NONESUCH H-71314 \$3.98.

Performance: **The best**
Recording: **The best**

Elliott Carter's music is like the stern and rock-bound coast of New England—harsh, full of character, and often, in its way, extraordinarily beautiful. Like that coast, it is quite typically American. Though Carter's music has connections with modern European work, it has transcendental qualities that go back to New England origins. Carter is a native New Yorker, but he is closest in spirit, I think, to such a composer as Carl Ruggles; indeed, Ruggles, Varèse, and Ives are perhaps his real predecessors.

These two "duets" are separated by a period of thirteen years. The Double Concerto, written in 1959-1961, surrounds two highly characteristic solo keyboards with chamber sound and a wash of percussion. The Duo for Violin and Piano of 1973-1974 typically uses the differences between these very different string instruments as the starting point. Carter's starting point is a kind of dramatization of the special qualities of the instruments.

The particular virtues of this recording are the quality of the playing—the performers are closely identified with new music in general and Carter in particular—the recording, and the disc itself. These somewhat rarefied Nonesuch productions give the finest possible presentation of difficult new music. E.S.

CHAUSSON: *Symphony in B-flat Major* (see Choosing Sides, page 90)

CHOPIN: *Twenty-four Preludes, Op. 28*. Maurizio Pollini (piano). DEUTSCHE GRAMMOPHON 2530 550 \$7.98, © 3300 550 \$7.98.

Performance: **Peaks and valleys**
Recording: **Excellent**

Pollini's performance of the G Major Prelude (No. 3) is sheer magic, and there are more than a few such realizations in his sequence. The level is not as consistent, however, as in his account of the Chopin Études on an earlier DG disc (2530 291); in the Preludes Pollini seems to respond far more sympathetically to the brighter, more energetic pieces than to those with a brooding or legato character. The playing itself is never less than superb, and DG's engineer, Klaus Hiemann, has captured the piano sound outstandingly well, but one is left with the feeling that there is more to these pieces—or, at least, to many of them—than Pollini suggests. I still feel that Claudio Arrau finds more of their poetic substance than any other pianist currently represented by a recording of them. R.F.

CHOPIN: *Waltzes* (see The Basic Repertoire, page 44)

CROFT: *A Hymn on Divine Musick; By Purging Streams; Harpsichord Suites in C Minor, E Minor, E-flat Major, and C Minor; Violin Sonatas in G Minor and B Minor*. Honor Shepard (soprano); Marjorie Lavers (violin); Michael Dobson (oboe); Jane Ryan (viola da gamba); Robert Elliott (harpsichord). ORYX 1730 \$6.98.

Performance: **Good**
Recording: **Good**

This interesting disc should dispel the misbelief that there was no English music between the death of Purcell and the arrival of Handel. While William Croft cannot be considered a major composer, he is representative of many fine "little masters" who were writing in England at the turn of the eighteenth century, and his music, if not inspired, is serious, well crafted, and certainly worthy of revival today.

The performances are all good and reveal

the composer's intentions very well. Especially fine is Miss Lavers' reading of the excellent violin sonatas. Like her colleagues, however, she could enhance the music with more ornamentation. Mr. Elliott's solo harpichord playing is rather square and occasionally muddy because of thick registration, but his continuo playing is strong and his realizations marvelously imaginative. Despite the quibbles, we must thank these artists for sharing their devotion to William Croft with us. He is well worth it. *S.L.*

DONIZETTI: *Maria Stuarda* (see Best of the Month, page 67)

DUKAS: *Symphony in C Major* (see Choosing Sides, page 90)

DVOŘÁK: *Piano Concerto in G Minor, Op. 33.* Justus Frantz (piano); New York Philharmonic, Leonard Bernstein cond. COLUMBIA M 33889 \$6.98.

Performance: **Sumptuous**
Recording: **Likewise**

Rudolf Firkusny has done more than anyone else to keep this work in the repertoire, but Justus Frantz has also made two recordings of it (his earlier one was released here less than two years ago by the Musical Heritage Society). Frantz plays Dvořák's original version in both recordings, and he plays it with a great deal of understanding and conviction as well as skill; as one would expect, the orchestral sound is more sumptuous, the phrasing more

exquisitely molded, in the newer one with Bernstein. The slow movement is perhaps a little over-romanticized (a very slow Andante here), but it is so gorgeous—the solo horn in particular—that I cannot really object to it. If pressed to make a choice, though, I would stay with the recent Vox recording by Firkusny and Walter Susskind (in □ QSVBX-5135, with all of Dvořák's concerted works). But that New York horn is something! *R.F.*

RECORDING OF SPECIAL MERIT

DVOŘÁK: *Piano Trio No. 4, in E Minor, Op. 90* ("Dumky"). **SMETANA:** *Piano Trio in G Minor, Op. 15.* Yuval Piano Trio. DEUTSCHE GRAMMOPHON 2530 594 \$7.98.

Performance: **Impassioned**
Recording: **Very good**

The Israeli players of the Yuval Trio light into these masterworks of the Czech chamber literature with tremendous zest, but they do not in any way slight the poetic tenderness of the slow writing that furnishes the high points of both Smetana's youthful piece (composed after the death of his four-year-old daughter) and Dvořák's glowingly mature six-movement work based on the Slavonic ballad form of the *dumka*. By no means the least outstanding feature of this disc is the excellence of DG's recording—a flawless amalgam of brilliance, body, and warm acoustic ambience. I recommend this disc for both knowledgeable chamber-music enthusiasts and those just getting into the medium. *D.H.*

DVOŘÁK: *Symphony No. 9, in E Minor, Op. 95* ("From the New World"); *Carnival Overture, Op. 92.* San Francisco Symphony Orchestra, Seiji Ozawa cond. PHILIPS 9500.001 \$7.98, © 7300.419 \$7.98.

Performance: **Tepid**
Recording: **Dullish**

Ozawa's approach to both of these well-loved works is unexpectedly sedate. His pacing is fine, but there is an element of restraint throughout both performances, as if the exuberance in the scores were a provocation to be resisted at all cost. There is some beautiful playing, especially from the strings in the very sober reading of the symphony's slow movement, but the brasses are quite undistinguished in their rapid passages in the finale, and the overall effect, tepid at best, is not helped by the close-up but dullish sound. The first-movement repeat is taken by Ozawa, as it is in three or four other recordings of the *New World*, among them Kertész's London Symphony remake (London CS-6527 or Vox SVBX-5139), which is still my choice. *R.F.*

ELGAR: *Enigma Variations, Op. 36.* **BRAHMS:** *Variations on a Theme of Haydn, Op. 56a.* London Symphony Orchestra, Eugen Jochum cond. DEUTSCHE GRAMMOPHON 2530586 \$7.98.

Performance: **Lovingly detailed**
Recording: **Good**

ELGAR: *Enigma Variations, Op. 36; Falstaff, Symphonic Study, Op. 68.* New Philharmonia

The Bicentennial Corner

WHEN it comes to two-piano teams, there are few in the business who can compete with the immaculate keyboard work of Arthur Whittmore and Jack Lowe, and they are at their most engaging in a new album from Personal Touch Productions called "American Sampler"—some of it familiar, some not so familiar, and all of it perfectly timed for the you-know-what.

Here is Charles Ives' deceptively easy-sounding *Variations on "America"* (originally for organ), with its intricate innovations and rhythmic surprises. Here also, in the purity of its original piano setting, is American impressionism in the guise of Charles T. Griffes' exquisite *The White Peacock*. Louis Moreau Gottschalk is represented at his witty best with *The Banjo* in a marvelous two-piano arrangement by the duo. A Scott Joplin perennial and attractive excerpts from two of Morton Gould's most popular concert works follow, along with a period-evoking *Party Rag* Gould composed recently for a TV movie about F. Scott Fitzgerald's Hollywood days. All these roll forth effortlessly and at just the right tempos from the two keyboards.

More of a challenge are the passages from Copland's *Billy the Kid*—which, it seems, was presented with a two-piano accompaniment when the cowboy ballet was introduced in 1938. The pacing here is perhaps a bit slow, and I miss the outdoorsy ring of the Copland



ARTHUR WHITTEMORE AND JACK LOWE

A Two-piano Sampler of American Music

orchestra, but the strengths of *Billy* remain manifest. A dreamy *pas de deux* from Barber's melodic ballet *Souvenirs* follows; after that, the attempts to be inclusive rather mar the program, although they don't spoil it. Adding Richard Rodgers' *Lover*, the country-music piece *Honey*, a spiritual, a sentimental Civil War ballad, and the whole of *The Stars and Stripes Forever* brings matters down to a rather pedestrian level at the close. Still, the crisp playing rescues even *Lorena*, despite interpolations of phrases out of *Dixie* and the *Battle Hymn of the Republic*, from turning into shameless slop. And I guess you could always turn the thing off after *Souvenirs*.

—Paul Kresh

AMERICAN SAMPLER. Ives: *Variations on "America."* Griffes: *The White Peacock.* Gottschalk: *The Banjo.* Joplin: *The Easy Winners.* Gould: *Party Rag. Interplay: Blues. Latin-American Symphonette: Guaracha.* Copland: *Billy the Kid: The Open Prairie; Celebration Dance; Billy's Demise; The Open Prairie Again.* Barber: *Souvenirs: Pas de Deux.* Rodgers: *Lover.* Russell: *Honey.* Anon.: *Sometimes I Feel Like a Motherless Child; Lorena.* Sousa: *The Stars and Stripes Forever.* Arthur Whittmore and Jack Lowe (pianos). PERSONAL TOUCH 88WL \$8.00 (from Personal Touch, Inc., 10 Columbus Circle, New York, N.Y. 10019).

INTRODUCING ONE MORE GREAT REASON TO OWN SENNHEISER HEADPHONES: UNDER \$30.

Our new HD-400's incorporate everything that's made Sennheiser the premier headphones in the ears of discriminating audiophiles:

Wide response. Unusual smoothness. Superior transient ability. And extremely lightweight, rugged construction.

They sound so good, they've been compared with the finest loudspeakers. And deliver such a vastly improved sound from most amplifiers and receivers that people are actually buying Sennheiser headphones instead of trading up to a more expensive system.

It's entirely practical, too.

Because their unique Open-Aire® design lets you enjoy your music with more comfort and less listener fatigue than any other style of headphone... in fact, it's easy to forget you've got them on.

Your dealer has the new Model HD-400 now. But don't confuse it with imitations or 'look-alikes'.

They may have our great sounding new price tag, but not our great Sennheiser sound.

SENNHEISER

10 West 37th Street, New York 10018 (212) 239-0190
Manufacturing Plant: Bissendorf/Hannover, West Germany

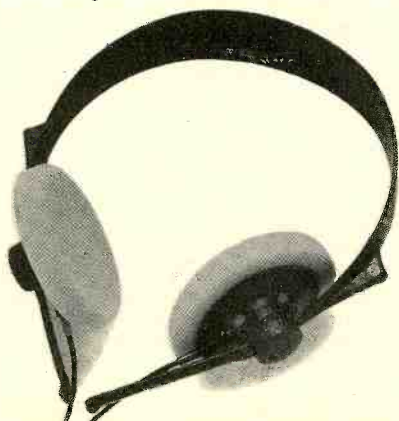

CIRCLE NO. 32 ON READER SERVICE CARD

Orchestra, Andrew Davis cond. LYRITA SRCS 77 \$7.98.

Performance: **Extrovert Enigma, brilliant Falstaff**

Recording: **Excellent**

Over the years, the *Enigma* Variations have fared singularly well in recorded performance, and that this highly individual and lovingly detailed reading by Jochum can reveal new dimensions and unsuspected detail speaks eloquently both for Jochum's sensitive musicianship and for the music itself. It is in the lyrical variations, Nos. 5, 6, 10, and 12, that Jochum is at his most revelatory. I would question, however, the almost static quality in his treatment of the celebrated *Nimrod* episode (Variation No. 9). The familiar Brahms variations are traversed with special attention to details of line and nuance, but here, as in the *Enigma*, my own taste favors more momentum throughout than we get here. The London Symphony players, solo desks especially, do their work gloriously and are accorded clean and bright sound.

Young Andrew Davis goes at the *Enigma* with superb spirit and urgency, but he lacks the more probing expressive touch of his elders. In *Falstaff*, however, he and the New Philharmonia do themselves proud in a reading of wonderful bite and dramatic power backed by playing of flawless virtuosity. I have not heard the work come to life in this fashion since the 78-rpm recording by Elgar himself, which I grew up with. The Lyrita recording I find to be a superior job in every department, meeting its match only in the Haitink version of the *Enigma*, which remains musically and sonically the one I prefer. *D.H.*

RECORDING OF SPECIAL MERIT

FALLA: *The Three-Cornered Hat*. Jan DeGaetani (mezzo-soprano); chorus; New York Philharmonic, Pierre Boulez cond. ***Harpsichord Concerto*.** Igor Kipnis (harpsichord); Paige Brook (flute); Harold Gomberg (oboe); Stanley Drucker (clarinet); Eliot Chap (violin); Lorne Munroe (cello); Pierre Boulez cond. COLUMBIA □ MQ 33970 \$7.98, M 33970 \$6.98.

Performance: **Penetrating**
Recording: **SQ sumptuous, two-channel dry**

Boulez may be somewhat less successful with Falla's ballet masterwork than with those of Stravinsky and Ravel—he is, I think, less fluid and flexible in this music than Ansermet or Frühbeck—but his is an intriguing reading even so. It is one that makes a strong case for the "symphonic" status of the work, missing none of the subtlety in the score and little of the wit. The Philharmonic's playing is top-notch throughout, and Jan DeGaetani's contribution is characteristically excellent. The Harpsichord Concerto, moreover, is no mere filler, but reason in itself for acquiring this disc. This still neglected piece is also a genuine masterwork, and has never had so penetrating and communicative a performance on records as it receives at the hands of Igor Kipnis and the Philharmonic's splendid soloists under Boulez. The two-channel edition struck me as dryish, tending toward downright harshness in spots. The SQ disc is sumptuously open, projecting an altogether more appealing impression of the orchestral performance; it is worth the extra dollar, whether you play it back in four channels or in two. *R.F.*

FAURÉ: *Requiem, Op. 48; Pavane, Op. 50*. Elly Ameling (soprano); Bernard Kruijsen (baritone); Daniel Chorzempa (organ); Netherlands Radio Chorus; Rotterdam Philharmonic Orchestra, Jean Fournet cond. PHILIPS 6500.968 \$7.98, © 7300 417 \$7.98.

Performance: **Very good**
Recording: **Good**

Fournet has the measure of this music and is abetted by first-rate associates in his affectionate and well-recorded presentation. I prefer this version of the *Requiem* to Daniel Barenboim's (Angel □ S-37077) because of its superior choral work and better balance in the aural perspective (though the organ is very close-up) as well as the greater conviction in Fournet's more straightforward approach. Barenboim's disc, though, includes the only current recording of the *Pavane* with its optional choral part; Fournet conducts the version for orchestra alone, and is a little squarish in this piece. Beautifully as Fournet's Elly Ameling and Barenboim's Sheila Armstrong sing the *Pie Jesu*, however, neither makes that section as touching as a boy soprano can, and there are excellent versions on Seraphim and Musical Heritage Society that feature all-male personnel. *R.F.*

RECORDING OF SPECIAL MERIT

FUX: *Harpeggio e Fuga in G Major; Parthie in G Minor; Sonata Septima; Capriccio in G Minor; Ciaccona in D Major*. Michael Thomas (clavichord). ORYX 1716 \$6.98.

Performance: **Sensitive**
Recording: **Very good**

From the seventeenth century until the present, music students have learned (like it or not) species counterpoint according to the precepts of Johann Joseph Fux. Because of this we have unfortunately forgotten that he was far more than a dry theorist and almost entirely neglected the fact that he was a vital and daring composer. As demonstrated by the music in this album, he was an original composer with a penchant for high-flown lyricism and poetry.

Perhaps the most difficult instrument to capture in recordings is the clavichord, which is so soft that the performer is virtually the only one who can hear it. It is extremely sensitive and responsive to the most minute nuance of expression, but it is a performer's instrument. The untutored listener is perforce tempted to turn the volume up and be faced with a sound that embodies the vulgarities of an electric guitar. The instrument has been recorded superbly here, however, and in order to get the full impact you should play a record that you know at a modest volume level and then, without changing a single dial, play this record. It will be almost unbearably soft, but so is the clavichord. Only then will you be able to hear the true clavichord sound and Mr. Thomas' beautiful performance of this very special music. *S.L.*

RECORDING OF SPECIAL MERIT

HAYDN: *La Fedeltà Premiata*. Lucia Valentini (contralto); Celia; Tonny Landy (tenor); Fileno; Frederica von Stade (mezzo-soprano); Amaranta; Alan Titus (baritone); Conte Perrucchetto; Ileana Cotrubas (soprano); Nerina; Luigi Alva (tenor); Lindoro; Maurizio Mazzieri (baritone); Melibeo; Kari Lövaas (soprano); Diana. Chorus of the Radio

Suisse Romande; Lausanne Chamber Orchestra, Antal Dorati cond. PHILIPS 6707 028 four discs \$31.92.

Performance: **Extremely good**
Recording: **Clear**

Perhaps one of the reasons Haydn's operas are virtually unknown is that they were written for such special local conditions and singers that even the composer during his lifetime discouraged their performance outside of Esterháza. Certainly Haydn had one of the most musically sophisticated audiences that ever existed, and one look at the vocal writing instructs us that he had singers who commanded a range and agility that confound the modern singer whose technique and audience admits of no falsetto. Even more perplexing to today's audience are the librettos. Haydn had no Da Ponte to bring warmth and humanity to



JOHANN JOSEPH FUX (1660-1741)
Far more than a dry theorist

the giddy nymphs and shepherds who dash about in a series of interlocking intrigues of such abandon and complexity that even the most serious student of erotic social behaviour would cry out for Ariadne's thread or at least a homing pigeon.

The libretto to *La Fedeltà Premiata* (not to be confused with *L'Infedeltà Delusa*, as it was even at Esterháza) is no exception. Nerina is in love with Lindoro who at first returns her love then shifts it to Celia (whose real name is, for some never-disclosed reason, Fillide) who, in turn, loves Fileno. To add to the confusion, Count Perrucchetto pursues them all and is eventually snared by Amaranta whose initial penchant was for Melibeo. The latter is a priest of Diana and it is his unpleasant duty to sacrifice a pair of faithful lovers to that goddess' blood-thirsty serpent who dwells in a nearby lake. Thus nobody is really admitting anything. All of this, which takes place in *secco* recitative during the hunting season amidst grottos, groves, and glades, is eventually worked out. But one wonders if even Haydn really knew what was going on as he composed his exquisite music.

Despite this arcadian chaos, Haydn seized on the emotional reality of each artificially created situation and turned in a score that ranges from sheer comedy to deeply felt love and rage. The hunt, which pervades the entire opera, is set in the Sinfonia which is more famous as the finale of Symphony No. 73, *La*

Chasse. One fine aria follows another, but the greatest concentration of them is found in the second act. Here Perrucchetto's *buffo* hunting aria "*Di questo audace ferro*" is followed by Fileno's moving decision to end his life ("*Bastano i piante*") and Celia's discovery of that fact ("*Ah come il me palpita nel seno*"). Also fine is Aramanta's "*Dell' amor mio fedele*," in which she decides to risk her life in order to rescue the seemingly unfaithful Perrucchetto. These are full-blown dramatic scenes that would grace the concert stage as well as many of Mozart's concert arias.

Haydn's finest writing, however, is found in the finales of the second and third acts. Cast in complex tonal structures that look forward to the next century, each character maintains his own individuality as the music ranges a wide gamut of emotions. Thus the music overcomes the libretto in the hands of a master.

The performance is basically an excellent one. All of the singers have fine voices, good techniques, and a sense of musicianship that makes the ensembles a joy to hear. The cruelty of Haydn's wide range is especially noticeable in the parts of Celia and Fileno, taken by Lucia Valentini and Tonny Landy, respectively. The former does not have the high register and the latter lacks the low notes. Judicious rewriting, some of it by Haydn himself, has helped to alleviate this problem, but certain contours that give rise to difficulties are unavoidable. Alan Titus as Perrucchetto lacks the boom needed by a true *buffo*, but his style is superb and he brings the part off very well indeed. Perhaps the finest singing in the album is offered by Frederica von Stade, whose warm voice easily reflects the wide emotional range of her part. If dazzling brilliance and passion are somewhat lacking in this performance, possibly because of the artificialities of the libretto and the difficulties of identifying with the characters, it is amply made up for by solidity and evenness of performance. Above all, Haydn has come off well. Let us hope that we may hear more of his operas in the future. S.L.

RECORDING OF SPECIAL MERIT

HAYDN: Symphony No. 6, in D Major ("Le Matin"); Symphony No. 7, in C Major ("Le Midi"); Symphony No. 8, in G Major ("Le Soir"). Prague Chamber Orchestra, Bernhard Klee cond. DEUTSCHE GRAMMOPHON 2530 591 \$7.98.

Performance: **Elegant**
Recording: **Excellent**

Everything about these performances exudes an air of healthy elegance. They are fastidious, highly polished, by no means staid, but filled with regard for the substance of these intriguing *concertante* works while making the most of the opportunities Haydn provided for the various solo players to distinguish themselves. The Prague Chamber Orchestra, always a stylish group even when playing without a conductor, has never sounded better: one infers that Bernhard Klee's approach—anything but iron-fisted—was one of providing encouragement and letting his players breathe, rather than imposing a rigidly restricted view. František Pošta's playing of the violone merits special mention, and it matters little that cellist Bohumil Bayer announces most of his solo entries with a grunt. What is somewhat distressing is that turnover comes

(Continued on page 97)

The new league of **KEY** **INSTRUMENTALISTS**

Mozart from DANIEL BARENBOIM.



MOZART
THE LATE PIANO
CONCERTOS
Nos. 21, 22, 23, 24, 25, 26, 27 &
Concert Rondo in D
BARENBOIM
English Chamber Orchestra

SDC-3830
The accomplished work of "an artist who plays like a master twice his age." D. Henahan, N. Y. Times.

Rachmaninoff from AGUSTIN ANIEVAS



RACHMANINOFF
THE COMPLETE PRELUDES
Three Nocturnes - Polka de W.R.
ANIEVAS

SB-3805
He is "in the front rank of the extraordinarily gifted pianists of his generation—in line to inherit the mantles of Serkin, Rubinstein and Horowitz."

And from CRISTINA ORTIZ.



RACHMANINOFF
Rhapsody on a Theme of Paganini
DOHNANYI
Variations on a Nursery Song
ORTIZ
New Philharmonia Orchestra
Kozumi

S-37178
Her "finely balanced touch produces tone of special luster, while her perceptions in the music give it welcome flair." P. Hume, The Washington Post.

Chopin from GARRICK OHLSSON.



CHOPIN
PIANO CONCERTO
NO. 1
KRAKOWIAK
OHLSSON
CHOPIN: CONCERTO NO 2
IN F MINOR
FANTASY ON POLISH
NATIONAL AIRS
OHLSSON
Polish Radio National Symphony
Micki Mulik

S-37179
S-37180
He "faces the prospect of seeing his name etched in the musical archives beside Liszt, Rachmaninoff, and Busoni, as one of the great pianists of history." The Wall Street Journal.

Mussorgsky from MICHEL BEROFF.



MUSSORGSKY
PICTURES AT AN EXHIBITION
(long version for piano)
Scherzo in B flat
Turkish March
BEROFF

S-37223
One of the outstanding artists of his generation—"he is a phenomenon—his virtuosity, which includes a breathtaking command of keyboard sonority, is stunning." Music and Musicians.

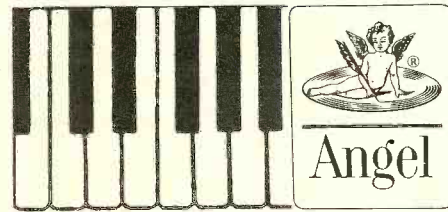

CIRCLE NO. 2 ON READER SERVICE CARD

"No music delights the mind or the senses more than Mozart's."



Herbert Breslin

Mostly Mozart, All Alicia

It seems that Alicia de Larrocha has inherited the distinction previously enjoyed by Sergei Rachmaninoff—that of having the widest spectrum of admirers of any pianist currently active. On my own tours I hear the name of Rachmaninoff from the lips of people who are not at all regular concert-goers. At the same time it is well known that his greatest colleagues spoke of him only with awe and respect. Happily, we now have much the same situation with Alicia de Larrocha. There are those who ordinarily wouldn't attend a "classical" concert but feel drawn in a mysterious way to her performances nonetheless. And, at the other end of the scale, even her mightiest colleagues speak of her playing with a mixture of respect and love.

Her unique position might be called unusual only if one insists that the highest development of musical sensitivity is, or ought to be, separate from the basic impulses of song and dance. These are the natural sources of our musical heritage, and Alicia de Larrocha's artistry is so closely allied—or even elemen-

tally tied—to them that it doesn't take a philosopher to figure out why her playing, with its non-neurotic vitality, is so deeply satisfying both to the novice and to the experienced musician.

Her repertoire seems to range as widely as her popularity. First, she was known for her definitive performances of the Spanish composers. Branching out from there, she surprised and delighted us with her interpretations of composers as disparate as Bach and Ravel. I believe she is probably the only pianist who has given in one New York season an all-Albéniz recital, an all-Beethoven recital, and one devoted to Bach and Mozart. This range of repertoire would not mean so much if it weren't for her ability not only to grasp but to personalize the essence of the differing styles without distortion. Needless to say, her impeccable and elegant pianism is no hindrance to her extraordinary communicative abilities.

Understandably, she has made a special niche for herself as a Mozart player. The per-

fect equilibrium of his music and its operatic wealth of characterization find a ready response in her infectious rhythmic sense and her multicolored tone. She suggests that difficult-to-achieve balance of vibrant serenity and slightly naughty humor—it is so easy to err on one side or the other—and she incorporates Mozart's tragic undertones without excessive underlining. No music delights the mind or the senses more, and the same can be said of this pianist.

But, surprisingly, in her newest London recording, "Mostly Mozart, Volume Two," released on the tenth anniversary of the Mostly Mozart Festival at Lincoln Center, the single greatest delight for me is not one of the Mozart pieces but the Haydn F Minor Variations. Miss De Larrocha's superb technique allows her to orchestrate the work so that each voice emerges as if with a mind of its own—and all of them conversing in the most lucid possible discourse. The exalted coda is realized with an unforced tragic weight, which is all the more effective after the almost giddy F Major sections preceding it. Sometimes one wants to giggle—that irrepressible humor again—but a dark, steadily deepening intensification of the musical subject comes as a reminder that the work as a whole is aimed in a different direction altogether.

In the Mozart Fantasy, the poised elegance of De Larrocha's phrasing emphasizes the poignancy of a dark-hued and somber piece. Throughout this record I find myself delighted time and again by the beautifully balanced phrasing, the careful but unemphatic voicing, and always the most wonderful rhythmic sense. It is perhaps this last that gives me the greatest joy in her playing. It is a constant, revitalizing force which enables me, for one, to listen with untiring interest. This is no less true in Miss De Larrocha's playing of the two Mozart sonatas. These also boast a great variety of very effective staccato touches, which are not only wonderful in themselves but serve to set off the sensuous beauty of the cantabile melodies to great effect. And how is it that De Larrocha can consistently taper her phrases dynamically and rhythmically without ever becoming mannered and without chopping a whole movement into sections in the process?

On the test pressing I received for review the quality of the piano sound was especially good in the Haydn Variations and the Mozart Fantasy. The sonatas sounded, to my ears, somewhat less distinct in ambiance, as if they stemmed from a different set of recording sessions. And one more thing: dare I suggest to London's a-&-r department that Alicia de Larrocha be signed immediately to record at least a half-dozen Mozart concertos?

—Garrick Ohlsson

ALICIA DE LARROCHA: *Mostly Mozart, Volume II. Haydn: Andante and Variations in F Minor. Mozart: Fantasia in D Minor (K. 397); Sonata in D Major (K. 311); Sonata in C Major (K. 330).* Alicia de Larrocha (piano). LONDON CS 7008 \$6.98.

between the recitativo and the adagio proper which constitute the slow movement of No. 7. In Antal Dorati's six-disc set of Symphonies Nos. 1-19 it is No. 6 that is split for turnover. That set, I think, is really indispensable: Dorati's performances, as beautifully played and recorded as Klee's, are a bit longer on charm and, incidentally, allow the harpsichord to be heard. But in its own right the new DG is a distinguished release, and anyone interested in a single disc of this trilogy could hardly do better.

R.F.

KODÁLY: Sonata for Unaccompanied Cello, Op. 8 (see BACH)

LALO: Symphony in G Minor (see Choosing Sides, page 90)

MAHLER: Symphony No. 2, in C Minor ("Resurrection"). Ileana Cotrubas (soprano); Christa Ludwig (mezzo-soprano); Vienna Philharmonic Orchestra, Zubin Mehta cond. LONDON CSA 2242 two discs \$13.96.

Performance: **Good to superb**
Recording: **Very good**

If it weren't for what I consider an erratic treatment of the heroic-tragic opening movement, I would rate Zubin Mehta's exceptionally well-recorded realization of Mahler's vast symphonic fresco very near the top of the ten recorded versions currently listed in *Schwann-1*. Mehta really holds my interest throughout the lilting *Ländler* movement—which is too often sloughed off as a kind of make-weight intermezzo—by paying minute attention to details of line, balance, and nuance without being over-fussy and losing the pulse. The scherzo comes across with a splendidly sinister urgency, and the enormous finale has all the sweep and grandeur one could ask for, being surpassed only by Leonard Bernstein's incredible Ely Cathedral recording for Columbia (which has other drawbacks). Likewise, Christa Ludwig's singing of the rapt *Urlicht* movement is surpassed for me only by that of Janet Baker in the Bernstein album.

The first movement is the problematic one here, and a comparison with Leopold Stokowski's version is instructive. In contrast to Mehta, Stokowski keeps the basic pulse unwaveringly through its twenty-three-minute course without sacrificing—or exaggerating, for that matter—one iota of the music's dramatic impact.

On the other hand, the sound in this recording is one of the London engineering staff's very best achievements in Vienna's Sofiensaal. Compared with the Solti recording of a decade ago, there is less emphasis, in terms of microphone placement, on minute detailing of each instrumental voice and choir, and more attention to the total tapestry of sound in both its linear and vertical aspects. The result is a most convincing sense of spatial depth and breadth with no loss whatever of essential musical detail. The handling of acoustic perspective of choir relative to orchestra in the finale is one of the high points of this recording. I'm not going to discard this one, but I'm afraid I will have to turn to one of the other available recordings for a reasonably satisfying opening movement.

D.H.

RECORDING OF SPECIAL MERIT

MOZART: Symphony No. 35, in D Major (K. 385, "Haffner"); Overture, The Marriage of

Figaro (K. 492); Overture, The Magic Flute (K. 620); Overture, Don Giovanni (K. 527). Mostly Mozart Festival Orchestra, Antonia Brico cond. COLUMBIA M 33888 \$6.98.

Performance: **Just right**
Recording: **Excellent**

Somewhere, in the best of all possible worlds, there is that place where achievement and success are measured by ability and accomplishment alone. There are people who think that the world of classical music must be such a place; that, being "purer" than commercial music, its standards must be based more strictly on merit. Of course, this is a romantic idea. Take the case of Antonia Brico, one of the first American conductors to obtain a substantial European reputation. In the 1930's no

one doubted that she had a great career ahead of her. But World War II cut off European musical life, and the United States, hardly ready to accept any native conductorial talent, let alone a woman, was simply not interested. Dr. Brico became a respected and loved music teacher in Denver, Colorado.

The story would have ended right there but for the efforts of one of Dr. Brico's pupils, a certain Judy Collins. With Jill Godmillow, Ms. Collins made a much-acclaimed film about the teacher and, quite literally, brought about the rediscovery of Antonia Brico. The musical turning point was an engagement at the 1975 Mostly Mozart Festival, a regular summer fixture at Lincoln Center in New York. This popular event, which features some of the best New York musicians,

Better Than Any Pusher

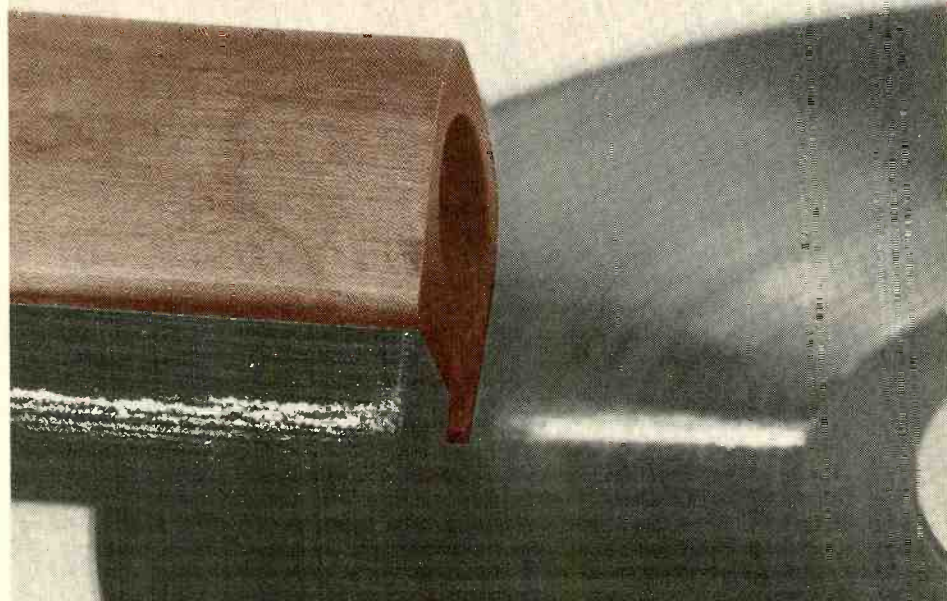

No matter how fine the fibers or how soft the "plush"—everything other than the Discwasher system is a pusher.

Pushers only line up dirt and microdust into an even line of contamination. Run your pusher off the record at a tangent—and you spread these particles into a tangent line. And microdust becomes permanently welded into vinyl by a tracking stylus.

Only the Discwasher system has the patented micro-tipped fibers which are directional—slanted—to pick up, hold and thus remove particles from your discs. These same directional fibers also remove fluid and solubilized contaminants by capillary action.

The superior record cleaner—better than any pusher.

 **DISCWASHER, INC.** • 909 UNIVERSITY • COLUMBIA, MO 65201

RTR ignites your receiver

with the HPR-12 Magnum music system

Fiery reproduction capabilities are buried within many contemporary lower-powered amps and receivers. Only mating with ordinary speakers keeps them from delivering blazing performance.

Now RTR ignites average components with the HPR-12 Magnum. From the Helmholtz driven passive radiator to the 12" woofer and piezo-electric tweeter, this speaker complements components to deliver 100 watts of pure, powerful music.

Plug into a pair at your RTR franchised dealer. Listen to the fireworks!

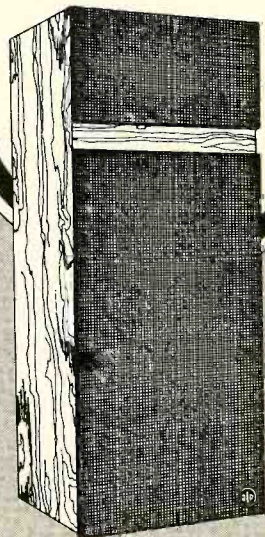

For dealer list and specifications, write RTR, Dept. SR, 8116 Deering Ave. Canoga Park, CA 91304.

CIRCLE NO. 29 ON READER SERVICE CARD



Columbia Masterworks

ANTONIA BRICO: no pseudo-eighteenth-century tiptoeing through the tulips here

proved an excellent showcase for Dr. Brico's talents, and other engagements as well as this recording followed in short order.

Make no mistake, this story is no media hype around a celebrated pop name. Judy Collins, who has always taken musical matters with the seriousness of any classical musician, acted out of the deepest affection and respect for an artist who has obviously suffered in her career for being a woman. And certainly one cannot imagine a worthier candidate for this kind of attention than Antonia Brico. I think the recorded evidence stands on its own. This is, to put it simply, excellent Mozart—incisive, crystalline, architectural. The orchestra—drawn from the top New York free-lance players—could constitute the nucleus of another New York Philharmonic. Players of this quality can often devastate a duffer or lead a lesser talent around by the nose. Not here. Dr. Brico's style and strong leadership are everywhere in evidence. No pseudo-eighteenth-century tip-toeing through the tulips here; this is good strong stuff and highly recommended strictly on its musical merits.

E.S.

PROKOFIEV: Piano Sonata No. 8, in B-flat Major, Op. 84; Visions Fugitives, Op. 22, Nos. 1, 3, 5, 7, 8, 10, 11, and 17. Emil Gilels (piano). COLUMBIA/MELODIYA M 33824 \$6.98.

RECORDING OF SPECIAL MERIT

PROKOFIEV: Piano Sonata No. 8, in B-flat Major, Op. 84. **RACHMANINOFF: Six Moments Musicaux, Op. 16.** Lazar Berman (piano). DEUTSCHE GRAMMOPHON 2530 678 \$7.98, © 3300 678 \$7.98.

Performances: **Berman electric**
Gilels contemplative

Recordings: **Both good**

The Prokofiev Eighth Sonata was written between 1939 and 1944—that is, during World War II—and it was premiered in 1944 in Moscow by Emil Gilels. It belies the image of late Prokofiev as a populist knuckling under to the Stalinist requirement to make Soviet music ultra-accessible to the people. The style of this music is basically simple, but, far from being the popular romanticism that is often associated with late Prokofiev, the Eighth Sonata

has a dramatic intensity and inner workings that make it one of his best compositions of any period.

Even though Gilels was the original performer of this work and his recording emanates from Mother Russia, I think most people will be grabbed by Lazar Berman's electric reading. Where Gilels is soft and contemplative, Berman plays out a line of remarkable tension that keeps one's attention riveted through the gentle but uneasy lyricism that dominates the sonata. This line carries right through the faster and more dramatic music, so that a larger whole is created. It is a strong achievement. I don't know whether Gilels is closer to the composer's intention, but I do know that Berman succeeds in keeping me involved while Gilels does not.

The pairings are worth a mention. *Visions Fugitives* is some of that early twentieth-century music that one often reads about but rarely hears (occasionally one or two of these turn up in printed collections). They are short, aphoristic—contemporary with World War I and early Webern!—and modernistic in feeling but also surprisingly varied and poetic. This selection adds an element of major interest to the Gilels disc. The other end of the Russian spectrum is represented by the Rachmaninoff *Moments Musicaux*, written in 1896 in a full-blown late-Romantic style and perfectly played by Berman with just the right mixture of style and soul.

E.S.

RECORDING OF SPECIAL MERIT

RACHMANINOFF: Piano Concerto No. 3, in D Minor, Op. 30. Vladimir Ashkenazy (piano); Philadelphia Orchestra, Eugene Ormandy cond. RCA ARL1-1324 \$6.98.

Performance: **Dazzling**
Recording: **Very Good**

Ashkenazy's third go-around at recording this most formidable and complex of Rachmaninoff concertos is his most successful yet. It holds a decided edge over his very fine 1972 realization with André Previn and the London Symphony and takes the full measure of the somewhat more flamboyant and brilliantly recorded Melodiya/Angel issue with Yevgeny Mogilevsky and Kiril Kondrashin.

The decisive factor here is superior record-

ing and superior orchestral accompaniment. Ashkenazy's solo work has always been dazzling and beguiling, but in RCA's new recording you can hear ever so much more nicety of detail, not only from Ashkenazy but from the orchestra. Where the orchestra in the London album sounds a mite distant, here everything is in close focus and beautifully integrated balance—and the closely textured writing that Rachmaninoff incorporated into his end movements *demand*s close-up microphonic treatment in order to make proper aural impact. It is not the big splashy climaxes that make this piece, but rather the cunning tonal weave, which must be revealed in all its intricate detail—as it is here.

I would not dispense with my earlier Ashkenazy recording of this music, nor with the Mogilevsky either, but as a means of getting deeper yet into Rachmaninoff's accomplishment I would certainly add this new one to my collection. *D.H.*

RACHMANINOFF: *Six Moments Musicaux, Op. 16* (see PROKOFIEV)

RECORDING OF SPECIAL MERIT

ROSSINI: *Six Sonatas for String Orchestra; Variations in C Minor for Clarinet and Small Orchestra; Serenade in E-flat Major for Small Orchestra.* Jacques Lancelot (clarinet); I Solisti Veneti, Claudio Scimone cond. RCA AGL2-1339 two discs \$9.96.

Performance: **Sparkling**
Recording: **Bright and clear**

These lightweight, melodious early works from the witty pen of Rossini make delightful listening if your mind requires elegant diversion. Even if it doesn't, they still make a charming effect. The performance sparkles and the string playing is truly virtuoso, especially the naughty double-bass solos that the impish composer had a way of throwing in. The jacket notes are also excellent—I wrote them myself. *S.L.*

SHOSTAKOVICH: *String Quartets Nos. 7, 13, and 14* (see Best of the Month, page 68)

SMETANA: *Piano Trio in G Minor, Op. 15* (see DVORÁK)

R. STRAUSS: *Thus Spake Zarathustra, Op. 30; Till Eulenspiegel, Op. 28; Don Juan, Op. 20.* Chicago Symphony Orchestra. Sir Georg Solti cond. LONDON CS-6978 \$6.98, ® 8-6978 \$7.98, © 5-6978 \$7.98.

Performance: **Super-virtuoso**
Recording: **Excellent**

There is really no reason for a work performed in thirty to thirty-four minutes to be spread over two full sides, as is the case with every other stereo version of *Zarathustra* listed in the current Schwann catalog, but this is the first recording of this work fully contained on a single side since the old Rodzinski mono disc made with the Chicago Symphony twenty-eight years ago. If the sound quality suffers in London's presentation, it is undetectable to the naked ear; the Chicago strings luxuriate here in a warm, rich sonic frame. A bigger surprise than the generous format, perhaps, is Solti's approach in this work: it is not impetuous and supercharged, but curiously autumnal, with the climaxes somewhat restrained and a seamless continuity felt throughout the thirty and one-half minutes. It is, in a word,

almost a chamber-music approach, contrasted with the grandeur in those of Karajan, Ormandy, Reiner, *et al.*; if Solti's sunrise is less blinding than theirs, it may have been scaled down deliberately to avoid the almost inevitable sense of anticlimax that follows.

Solti's *Till*, a glorious blend of super-virtuosity and mellowness, belongs at or near the very top of the list of outstanding recordings of the piece. So does his superbly proportioned *Don Juan*, which now seems even more convincing than when it was first issued two or three years ago. The disc is a bargain in the truest sense, though I suspect most listeners will prefer the greater excitement of some of the two-sided *Zarathustras*. *R.F.*

RECORDING OF SPECIAL MERIT

TELEMANN: *Twelve Fantasies for Flute.* Jean-Pierre Rampal (flute). ODYSSEY Y 33200 \$3.98.

Performance: **Flawless**
Recording: **Silvery**

The very thought of two sides of unaccompanied flute performance of what *could* be formula writing by Telemann is appalling. But this is not formula Telemann—each fantasy is cast in a different mold and has its own individual effect. The set is a tour de force, revealing an ingenious composer working with a severely limited idiom and making the very most of it. Due credit must be given Rampal. Thanks to his superb technique and ability to color his tone in many subtle ways, one soon forgets that he is hearing *only* the flute and begins to revel in Telemann's strong melodies and artful harmony and counterpoint. *S.L.*

ISAO TOMITA: *Firebird; Prelude to the Afternoon of a Faun; A Night on Bare [sic] Mountain.* Isao Tomita (various synthesizers). RCA ARL1-1312 \$7.98.

Performance: **Interesting**
Recording: **Complex and beautifully done**

For what this is, an album of concert-hall chestnuts electronically re-created by Isao Tomita, it is an impressive and immaculately carried-out piece of work. By means of various synthesizers Tomita has reproduced (well, almost) the famous Stravinsky *Firebird* without using a single conventional musical instrument. Just what this proves I'm not at all sure. That it *can* be done is, of course, interesting and at times weirdly lovely, but then again so are silk flowers and *trompe-l'oeil* paintings. Beauty is in the eye of the beholder or the ear of the listener, I guess. The Debussy and the Moussorgsky are as meticulously and stylishly done as the Stravinsky—yet, somehow, I can't refrain from asking, "What's it all about, Isao?" —*Peter Reilly*

VIVALDI: *Concertos for Violin, Strings, and Continuo, Opp. 11 and 12 (complete).* Salvatore Accardo (violin); I Musici. PHILIPS 6747 189 three discs \$23.94.

Performance: **Exciting**
Recording: **Loud and clear**

This is Vivaldi at his wildest, whipping us with exciting rhythms, startling us with novel textures, and astonishing us with brilliant virtuosity. We are also seduced by these rich, chromatic harmonies and moved by these sinuous melodies. Bring to that kind of music razor-sharp performances by superb string
(Continued on page 102)



In a class by itself.

The Phase Linear 400 Power Amplifier has only one serious competitor when it comes to advanced design, superior performance, made-one-at-a-time craftsmanship, proven reliability, elegant appearance . . . and incomparable value. And that's the Phase Linear 700B. Hear them both at your dealer soon.

Phase Linear 400

THE POWERFUL DIFFERENCE

201 watts per channel, min. RMS at 8 ohms from 20 Hz-20 kHz with no more than .25% total harmonic distortion.

PHASE LINEAR CORPORATION
20121 - 48th Avenue S.W.
Lynnwood, Washington 98036
CIRCLE NO. 27 ON READER SERVICE CARD

“all the virtues—and the defects—of a do-good organization...”

Has the Avant-garde Become the Establishment?



CHARLES DODGE

CURTIS O. B. CURTIS-SMITH

ROBERT POLLACK

As the better-known record companies—Bicentennial or no—quietly cut back on or simply cut out American music (with a few notable and honorable exceptions such as Elektra’s Nonesuch and Atlantic’s Finnadar lines), Composers Recordings, Inc., more familiarly known as CRI, has taken an increasingly important position in making American music available on records and keeping it there.

CRI has all the virtues—and the defects—of an established, institutionalized do-good organization. It is, surprisingly, not a non-profit organization, and its means of support have always been a little mysterious. But it is, in effect, a semi-public type of company with an idealistic commitment. Most of its recordings are foundation-subsidized; one way or another, its decisions are panel or board decisions, and panels and boards are, by definition, long, hard, and made of wood. Decision by committee may be a fine principle, but in artistic matters it can be the quick way to middle-of-the-roadness, mediocrity, and lack of imagination. These have, in fact, been CRI’s besetting problems. Endless outpourings of all sorts of new music (much of it run-of-the-mill) arranged in omnibus albums of three and four composers with varying qualities of performances and recordings and unimaginative production may represent some higher social good, but in practice it has been confusing, boring, and slow to sell. CRI’s mission should be equivalent to that of a good contemporary museum like New York’s Whitney or Buffalo’s Albright-Knox or Minneapolis’ Walker. In fact, recordings of the omnibus sort seem to be made largely for the back files of college music libraries.

Recently, however, CRI has been slowly but surely changing its tune. Once a bastion of conservatism, it has moved strongly into the avant-garde (of course, ironically and amusingly, one could point out that the avant-garde is now the new-music Establishment and that CRI’s new policies prove it). And it has tended to limit the focus of each recording, giving individuals—including younger talents—clearer exposure.

Some of the trends—in American music and in CRI’s success in showing it off—can be

gleaned from a selection of the company’s recent releases ranging from the reissue of the old New Music Quartet’s Columbia recording of Wallingford Riegger’s excellent Second Quartet (matched with effective string-and-keyboard pieces by Donald Harris and Lawrence Moss) to a pack of keyboard works by younger composers, the odd “synthesized speech music” of Charles Dodge, and the instrumental-and-tape music of Richard Felciano. Felciano, born in 1930, is a composer respected inside the music community but not too well known outside. The cross-influences of electronics, Eastern music, new European music, and a fluid American instrumental technique produce a kind of “gestural” approach which amalgamates diverse sources effectively in his work.

The Charles Dodge album is more unusual. The “music” consists entirely of computer-synthesized speech sounds built on poems of Mark Strand. The computer does not compose but, on a set of instructions, puts pseudo-human sounds directly down on tape. The result is to speech as Red Dye No. 2 is to food. Remember HAL’s computer rendition of *Daisy, Daisy in 2001?* This was no Kubrick fantasy but an actual early attempt at computer voice synthesis recorded on disc years ago by RCA. Well, the words may be better and the tunes more original, but in the matter of expressive quality this medium does not seem to have advanced much beyond the pioneering efforts of HAL.

Robert Morris (born in England in 1943 but brought up and educated here) and Curtis O. B. Curtis-Smith (b. 1941) are among the younger composers represented here. Curtis-Smith has come up with something rather original and striking: the use of bows to play on the piano strings. In his *Inventions*, these bows are used (along with a wine bottle, a guitar pick, and hard rubber mutes) to match up the piano sounds—which sound nothing like a piano usually sounds—with a violin. In one invention, a violin with a flat bridge is used so that all four strings can be sounded at once by the violinist while the pianist gets up from the keyboard to turn the pegs of the violin, thus producing all manner of sliding effects. Sonically ingenious.

The *Bridgeforms* of Robert Pollack (b. 1946) is, like Robert Morris’ *Phrases*, serialistic piano music of the dry sort. And, like Morris, Alfred Nieman, whose sonata is paired with the Pollack work, was born in England. There the similarity ends; Nieman has remained in England working in relative obscurity, and his sonata is a big, long, original, introverted work in a neo-expressionistic vein. It is ironic that Nieman’s first appearance on records should be on an American composers’ label.

Miriam Gideon and Hugo Weisgall are two older composers noted for their work with the human voice. Their fluent, autumnal, elegaic settings—beautifully done but rather depressing—are distinguished by outstanding performances by four of the finest vocalists who work in new as well as old music. These recent CRI recordings are almost all characterized by outstanding performing talent and (with the exception of the English tape of the Nieman) by recording that is much better than most new music gets.

Of the two two-composers-to-a-side omnibus records, more interest attaches to the disc of new vocal music written by the four Naumburg winners. The other disc contains instrumental music; Erb’s brass-and-piano work is an amusing bit of sonic wit, but the remaining pieces are the work of three very serious composers of the type that used to be called long-hair. The vocal music attracts not just because of the use of texts, and not just because the singers (particularly Bethany Beardslee in J. K. Randall’s delicate, Webernesque setting of e. e. cummings) are the very best, but because the music itself is closer to home. The instrumental abstraction of the other music is too far away from essentials. The human voice is an essential.

But alas, we find that, with some exceptions, instrumental music holds sway today even to the point of influencing vocal music. There is much of value in the instrumental and the vocal music recorded here, but most of it seems peripheral, far away—not at all escapist, but part of an elite dream of culture, born in another time and place, and now preserved by universities and foundations. The

new CRI is doing everything right, and continuing to do good, but, contrary to the conventional view, doing good is not always doing well.
—Eric Salzman

WALLINGFORD RIEGGER: *String Quartet No. 2.* New Music Quartet. **DONALD HARRIS:** *Fantasy for Violin and Piano.* Paul Zukofsky (violin); Gilbert Kalish (piano). **LAWRENCE MOSS:** *Elegy.* Paul Zukofsky, Romuald Teco (violins); Jean Dupouy (viola). *Timepiece.* Paul Zukofsky (violin); Gilbert Kalish (piano); Raymond Des Roches (percussion). CRI SD 307 \$6.95.

RICHARD FELCIANO: *Crasis.* Ensemble and tape, Richard Felciano cond. *Spectra.* Nancy Turetzky (contrabass). *Gravities.* Milton and Peggy Salkind (piano, four hands). *Chöd.* Philadelphia Composers' Forum, Joel Thome cond. CRI SD 349 \$6.95.

CHARLES DODGE: *In Celebration; Speech Songs; The Story of Our Lives.* Synthesized voice music realized at the Columbia University Center for Computing Activities, Nevis Laboratories, Bell Telephone Laboratories. CRI SD 348 \$6.95.

ROBERT MORRIS: *Phases.* William Albright, Robert Morris (pianos). **CURTIS O. B. CURTIS-SMITH:** *Five Sonorous Inventions.* Gerald Fischbach (violin); C. Curtis-Smith (piano). CRI SD 346 \$6.95.

ROBERT POLLACK: *Bridgeforms.* Robert Pollack (piano). **ALFRED NIEMAN:** *Sonata No. 2.* Alberto Portugheis (piano). CRI SD 333 \$6.95.

MIRIAM GIDEON: *Questions on Nature.* Jan DeGaetani (mezzo-soprano); Philip West (oboe); Samuel Lipman (piano); Barry Je-kofsky (percussion). *The Condemned Play-ground.* Phyllis Bryn-Julson (soprano); Constantine Cassolas (tenor); Felix Galimir, Jack Shapiro (violins); Michael Tolomeo (viola); Fortunato Arico (cello); Paul Dunkel (flute); Alexander Heller (bassoon); Fritz Jahoda cond. **HUGO WEISGALL:** *End of Summer.* Charles Bressler (tenor); New York Chamber Soloists. CRI SD 343 \$6.95.

ROBERT ERICKSON: *End of the Mime.* New Music Choral Ensemble, Kenneth Gaburo cond. **JOHN FERRITTO:** *Oggi.* Neva Pilgrim (mezzo-soprano); Allen Blustine (clarinet); Ursula Oppens (piano). **J. K. RANDALL:** *Improvisation.* Bethany Beardslee (soprano); Allen Blustine (clarinet); Ronald Anderson (trumpet); Thomas James (piano); Albert Regni (saxophone); Stanley Silverman (guitar); David Gilbert cond. **JEAN EICHELBERGER IVEY:** *Hera, Hung from the Sky.* Elaine Bonazzi (mezzo-soprano); Notes from the Underground, Andrew Thomas cond. CRI SD 325 \$6.95.

LESLIE BASSETT: *Sextet.* John Graham (viola); Gilbert Kalish (piano); Concord String Quartet. **DONALD ERB:** *Three Pieces for Brass Quintet and Piano.* James Smolko (piano); New York Brass Quintet, Matthias Bamert cond. **GEORGE EDWARDS:** *Kreuz und Quer.* Boston Musica Viva, Richard Pittman cond. **ROBERT MACDOUGALL:** *Anacoluthon: A Confluence.* Contemporary Music Ensemble, Arthur Weisberg cond. CRI SD 323 \$6.95.

Could the ultimate system be all Crown?



It depends on how you define "ultimate." But Crown may be the only top-quality, state-of-the-art manufacturer whose components could build a complete, ultimate hi-fi system.

For instance: A CX-824 tape deck, world-renowned for reliable performance. Connected to an IC-150A pre-amp. With the signal amplified by a DC-300A power amp, proved in many thousands of hours of professional use. Output controlled, monitored and switched by an OC-150. Possibly a VFX-2 for personal control of crossover points. And sound faithfully reproduced by ES-212 electrostatic speakers.

All Crown. We think that system would be somebody's ultimate. Certainly ours. Maybe yours.

Write us today for the name of your nearest Crown dealer. He'll talk to you — ultimately.

 **CROWN**
Box 1000, Elkhart IN 46514

When listening becomes an art,

CIRCLE NO. 7 ON READER SERVICE CARD

Save **Time**

Phillips GA 212
semi-auto turntable . . . \$117.00

Discounts on all major brands of
stereo equipment & accessories

Write for our price sheet
and quote

Michigan Audio Discounters, Ltd.
286 Wolverine Dr.
Walled Lake, Mich. 48088
313-474-4430

Money **Freight**

CIRCLE NO. 25 ON READER SERVICE CARD

**Build
your own
speakers
and save
up to**

50%

When you buy a Speakerlab kit, you get about twice as much for your money as you do with ready-built models. Suddenly you can afford exponential horn/drivers, 12" butyl woofers, sturdy 1 1/4" walnut veneer enclosures, high-grade acoustic fiberglass, L-pads and all the other goodies you only find on speakers costing \$500-\$1000 each.

For a free, 32-page catalog and speaker-building manual, send in the coupon below. Please print clearly because it's actually your return mailing label in disguise.

MAIL TO Dept. SR6, 5500 35th N.E., Seattle, 98105

ZIP

STATE

CITY

ADDRESS

NAME

SR8

TOP Discount AUDIO

Your NATIONAL HEADQUARTERS
For Famous Brand Electronics By Mail

1150 N. Powis Rd., West Chicago, Ill. 60185 • (312) 293-1825
All Orders Shipped In Factory-Sealed Cartons

Write Or Call For The Lowest Prices Anywhere!

MILLION \$\$\$ INVENTORY

LOWEST PRICES ON

RECEIVERS	TURNTABLES	TUNERS
SPEAKERS	CHANGERS	CARTRIDGES
TAPE DECKS	AMPLIFIERS	HEADPHONES
CALCULATORS	COMPACTS	CAR AUDIO

Top Discount Audio 1150 N. Powis Rd. West Chicago, Ill. 60185 (312) 293-1825

SR-8 We honor Master Charge and Bank Americard. Date _____

Please send me a quote on: _____

MR. MS. (First) (Initial) (Last)

(Number And Street) (City) (State) (Zip Code)

CIRCLE NO. 39 ON READER SERVICE CARD

SAVE

TOP QUALITY GEAR
 LOWEST PRICES
 PROMPT DELIVERY
 SAVE ON FREIGHT
 SELECTION

ROYCE CB PANASONIC
 KENWOOD DYNACO
 PIONEER SANSUI
 DUAL BIC
 and more than 50 others

PLEASE REQUEST PRICE QUOTATIONS ON YOUR CHOICE OF QUALITY STEREO GEAR

Component Discounters

DEPT. 817SR
 24020 ONEIDA
 OAK PARK, MICH. 48237
 313-559-1270

players and the pyrotechnics of Salvatore Accardo's fiddling, and you are in for a Baroque thriller. Beware! The discs are recorded at a very high volume level, so start with a soft setting of that dial. And if you are dogged enough to listen to all twelve concertos at one sitting, be prepared to spend an hour recuperating from the utter exhaustion your system will suffer. S.L.

WALDTEUFEL: *The Skaters' Waltz; Mon Rêve; Toujours ou Jamais; The Grenadiers; España; Dolores; Pomone.* National Philharmonic Orchestra, Douglas Gamley cond. LONDON CS 6899 \$6.98.

Performance: **Hard on the ankles**
 Recording: **Spectacular**

Charles Emile Waldteufel, whose real name was Levy and who was born in Strasbourg in 1837, published his first waltzes at his own expense, and they were so successful that he went on to write hundreds of them. Unlike the waltzes of the Strauss family, which conjure up pictures of couples twirling in sumptuous nineteenth-century ballrooms, the works of Waldteufel tend to suggest images of a Parisian skating rink. Not only *The Skater's Waltz, Les Patineurs* (not the *Les Patineurs* of the Ashton ballet, which is based on pieces by Meyerbeer), but practically everything Waldteufel put down on paper has that round-the-rink quality. Sometimes the flavor is military, as in *The Grenadiers*, or French-accented Spanish, as in the waltz adaptation of Chabrier's *España*, but the inevitable association is with ladies in long cloaks and muffs, the blades of their skates gliding over the ice—sometimes, musically speaking, rather thin ice. The seven waltzes heard here are all attractive compositions, performed with a reliable, if relentless, oompah beat and brilliantly recorded, with deep bass tones and crisp highs. If I owned a skating rink, I would certainly not want to be without it. P.K.

WUORINEN: *String Trio; Bearbeitungen uber das Glogauer Liederbuch.* Members of Speculum Musicae. *Grand Bamboula for String Orchestra.* The Light Fantastic Players, Daniel Shulman cond. NONESUCH H-71319 \$3.96.

Performance: **Excellent**
 Recording: **Excellent**

Charles Wuorinen, like Elliott Carter a Nonesuch favorite, is one of the most prestigious of the "younger" generation of American composers. He is a serious, unglamorous artist of extraordinary capabilities whose music often suffers from academicism of an advanced variety. The trio, a major work of the late Sixties, has a marvelous opening and closing, but its dogged earnestness loses me about halfway through it. The arrangements from the late-fifteenth-century Glogauer Liederbuch (the German title is pure affectation) are charming. The *Grand Bamboula* of 1971 is an ingenious and nearly successful attempt by Wuorinen to adapt his systematic approach to composition to a lighter style. It is the best work on the record, although one keeps waiting—in vain, of course—for the music to let go. I recall criticizing years ago the wildness of Wuorinen's youthful compositions; now I wish he would put some of the wildness back in. The performances and recordings are superb, but I should mention that Wuorinen's album notes are unspeakably pretentious and arrogant in tone. The music deserves better. E.S.

COLLECTIONS

JANET BAKER: *Scottish Folk Songs Arranged by Haydn and Beethoven.* Haydn (arr.): *The Brisk Young Lad; O Bonny Lass; The White Cockade; John Anderson; The Ploughman; Duncan Gray; My Boy Tammy;* and ten others. Beethoven (arr.): *Polly Stewart; The Sweetest Lad Was Jamie; Faithful Johnnie; Cease Your Funning; Bonny Laddie, Highland Laddie.* Janet Baker (mezzo-soprano); Yehudi Menuhin (violin); George Malcolm (harpsichord, piano); Ross Pople (cello). ANGEL □ S-37172 \$6.98.

Performance: **Excellent**
 Recording: **Very good**

The seventeen Haydn arrangements on this disc come from a collection published by Londoner William Napier in 1792. According



JANET BAKER
A paragon of triumphant technique

to the liner notes of Ronald Kinloch Anderson, Napier was rescued from insolvency as a result of Haydn's generosity and the success of this collection. The five Beethoven arrangements come from the collections published by George Thomson of Edinburgh, a folk-song enthusiast who also published Haydn arrangements.

Dame Janet can do no wrong. She invests these simple songs with the virtually limitless range of her artistry without compromising their charm and spontaneity. To cite but one example, in the tender "O can ye sew cushions" she is a paragon of triumphant technique, performing miraculously yet hiding all traces of effort from the listener. Through all kinds of dynamic shadings, sustained pianissimos, and exquisite trills and grace notes, the music flows with the naturalness of breathing.

The Haydn arrangements are very simple, requiring little from the instrumentalists. The Beethoven pieces are more elaborately laid out, but they too keep the vocal line pretty much exposed and unencumbered. The Messrs. Menuhin and Malcolm perform their self-effacing tasks faultlessly. This is unpretentious music elegantly played and easy to enjoy. My only criticism relates to the excessive surface noise on my review copy. G.J.

(Continued on page 106)

READERS' BONANZA!



Get up to **50% off** on your choice of these outstanding publications.

Take a good look at these popular magazines. Then take a look at the prices below. Bonanza! You may select as many as four of these titles at our special introductory rates—up to 50% off! Use the attached card to order or write to: Magazines at Discount, P.O. Box 2703, Boulder, Colorado 80302.

HERE'S WHAT YOU SAVE:

- APARTMENT LIFE - 9 ISSUES. YOU PAY ONLY \$4.97**
(Regular rate: \$7.46)
- BUSINESS WEEK - 1 YEAR. YOU PAY \$21.50 (Reg. rate)**
(Newsstand rate: \$51.00)
- CAR & DRIVER - 1 YEAR. YOU PAY ONLY \$3.99**
(Regular rate: \$7.98)
- CYCLE - 1 YEAR. YOU PAY ONLY \$3.99**
(Regular rate: \$7.98)
- ESQUIRE - 8 ISSUES. YOU PAY ONLY \$6.00**
(Newsstand rate: \$12.00)
- FAMILY HANDYMAN - 1 YEAR (9 ISSUES). YOU PAY ONLY \$6.98**
(Regular rate: \$8.55)
- MONEYSWORTH - 1 YEAR (26 ISSUES). YOU PAY ONLY \$3.88**
(Regular rate: \$5.00)
- NEWSWEEK - 25 ISSUES. YOU PAY ONLY \$12.50**
(Newsstand rate: \$25.00)
- PLAYBOY - 1 YEAR. YOU PAY ONLY \$10.00**
(Newsstand rate: \$16.00)
- POPULAR ELECTRONICS - 1 YEAR. YOU PAY ONLY \$6.99**
(Regular rate: \$9.98)
- POPULAR PHOTOGRAPHY - 1 YEAR. YOU PAY ONLY \$4.49**
(Regular rate: \$8.98)
- PSYCHOLOGY TODAY - 1 YEAR. YOU PAY ONLY \$6.00**
(Regular rate: \$12.00)
- ROLLING STONE - 1 YEAR (26 ISSUES). YOU PAY ONLY \$7.00**
(Regular rate: \$14.00)
- STEREO REVIEW - 1 YEAR. YOU PAY ONLY \$3.99**
(Regular rate: \$7.98)
- TIME - 25 ISSUES. YOU PAY ONLY \$12.50**
(Newsstand rate: \$25.00)
- TV GUIDE - 32 ISSUES. YOU PAY ONLY \$7.39**
(Lowest available rate)

If card is missing, write to: Magazines at Discount, a division of Ziff-Davis Publishing Co., P.O. Box 2703, Boulder, Colorado, 80302.

RECORDING OF SPECIAL MERIT

TERESA BERGANZA: *Canciones Españolas.* *Anchieta: Con amores, la mi madre. Torre: Pámpano Verde. Esteve: Alma, sintamos! Granados: La Maja Dolorosa; El Majo Discreto; El Tra La Lá y El Punteado; El Majo Timido. Turina: Saeta; El Fantasma; Cantares. Guridi: Three Canciones Castellanas. Montsalvatge: Five Canciones Negras.* Teresa Berganza (mezzo-soprano); Felix Lavilla (piano). DEUTSCHE GRAMMOPHON 2530 598 \$7.98.

Performance: **Outstanding**
Recording: **Excellent**

For nearly two decades now, Teresa Berganza has been enjoying a triumphant career while her American appearances have been few and far between. A recital disc like this

TERESA KUBIAK:
a fine vocalist
with an effective
top range



one points up how much we have been missing! This recording is a follow-up to the Spanish mezzo's earlier, guitar-accompanied disc of early Spanish songs (DG 2530 504). Two of the present recital's entries are also pre-Baroque; the beautiful dirge-like *Alma, sintamos!* might have been written by Sarti, Giordani, or another eighteenth-century Italian contemporary of Catalonian Pablo Esteve.

Omitting the nineteenth-century song literature (because, unfortunately, there really wasn't any . . .), Miss Berganza offers the best among the twentieth-century exponents. Some of the Granados-Turina-Guridi material was also on her early London disc (25726), but that is long deleted and the new versions could not be more welcome. The singing is sumptuous, delivered with immaculate taste and just the right dash of temperament. The Montsalvatge songs, with their African-tinged lyrics and piquant musical idiom, are in a class by themselves. They include, of course, the irresistibly haunting *Cancion de Cuna* (*Cradle Song for a Negro Infant*), and also the remarkable *Cuando Mi Madre*, which gives us the Spanish view on the loss of Cuba to the Yanquis, as well as the war-chant "Yambambo, Yambambé!"

In sum, this is a collection of refreshingly unconventional songs performed by a fabulous singer. I would have preferred guitar

accompaniment for the early songs, but Felix Lavilla certainly knows his business—including how to contrive guitar effects on the piano. In any case, his support for the singer (Sra. Lavilla) is admirable. Engineering and surfaces are exceptionally fine. The liner notes contain translations in three languages of the Spanish text. Unfortunately, the English is poor. G.J.

BENGT ERICSON, ROLF LA FLEUR: *Music for Lute and Gamba.* *Ortiz: Recercada Primera; Quinta Pars; Recercada Segunda. Morley: Lamento; Fancy. Dowland: Resolution. Rauh/Newsidler: Ach Elslein. Ballard: Prélude; Allemande; Courante; Rocantins. Robinson: The Queenes Good Night. Abel: Sonata in G Major. De Caix d'Hervelois: Suite in A Major.* Bengt Ericson (viola da gamba); Rolf la Fleur (lute). BIS LP-22 \$7.98 (from

HNH Distributors, P.O. Box 222, Evanston, Ill. 60204).

Performance: **Aristocratic**
Recording: **Clear and bright**

Although a figured bass may be realized by any instrument capable of playing chords, most Baroque performances make use of harpsichord and cello. It is therefore a pleasurable change to hear a lute fill this important role. When coupled with the dulcet sounds of the viola da gamba, the sonorities are indeed ravishing. We enter here into that rare world of two musicians playing for themselves, and the fact that it is recorded and that we are able to hear it is sheer luck on our part. Most of the music on this disc was conceived for this sort of duo, and it receives a beautiful performance. This recording, then, is very special. It is intimate to an extreme and offers perhaps a unique glimpse of what early musicians cheered their souls with in private. S.L.

TERESA WOJTASZEK KUBIAK: *Opera Arias.* *Puccini: Madama Butterfly: Un bel di vedremo. Manon Lescaut: Sola, perduta, abbandonata. Verdi: The Masked Ball: Ma dall'arido stelo. Dvořák: Rusalka: O lovely moon. Tchaikovsky: Pique Dame: Lisa's Aria from Act III. Moniuszko: Halka: Aria from Act II. Wagner: Lohengrin: Einsam in triben*

Tagen. Teresa Wojtaszek Kubiak (soprano); Lodz Philharmonic Orchestra, Henryk Czyz cond. MUZA SX 1144 \$6.98.

Performance: **Mostly good**
Recording: **Good**

This appears to be the first recorded appearance of Teresa Kubiak (as she is known in the United States), who has distinguished herself in a number of roles at the Metropolitan. It comes as an import from her native Poland, part of a series called "Famous Polish Singers." Miss Kubiak is a fine vocalist with a bright, youthful-sounding timbre, clean intonation, and freely produced top notes—the top, in fact, is her most effective range. She sings all selections of her varied program in the original languages. The three Slavic arias are affectingly done, and the pretty excerpt from the Polish national opera *Halka*, rarely found on records, is most welcome.

Less successful are the Italian arias, not because they are in any way vocally objectionable, but because there is an air of tentativeness and a lack of true involvement about them—they do not go much beyond accurately rendered musical notes. The uninspired orchestral playing, rather unnecessarily exposed in the lengthy introduction to *The Masked Ball* aria, does not help matters. This is a qualified success, then, but the three un-hackneyed excerpts are welcome. The Muza surfaces are excellent. G.J.

ELENA OBRAZTSOVA: *Operatic Recital.* *Tchaikovsky: The Maid of Orleans: Joan's Aria. Moussorgsky: Khovantchina: Marfa's Prophecy. Rimsky-Korsakov: The Tsar's Bride: Lyubasha's Aria. Kashchei, the Deathless: The night descends. Saint-Saëns: Samson et Dalila: Mon coeur s'ouvre à ta voix; Amour, viens aider. Donizetti: La Favorita: O mio Fernando. Verdi: Don Carlos: O don fatale.* Elena Obraztsova (mezzo-soprano); Orchestra of the Bolshoi Theater, Boris Khaikin and Odyssei Dimitriadis cond. COLUMBIA/MELODY M 33931 \$6.98.

Performance: **Fine artist not quite at her best**
Recording: **Average**

Elena Obraztsova did indeed have a tempestuous success with the Bolshoi in New York, as Robert Jacobson relates in his informative annotations, but this debut recital is not representative of her most impressive achievements. For one thing, the recordings are not new—this sequence has been in the Russian Melodiya catalog for several years. They attest to many of the mezzo's fine qualities: her creamy and sensuous voice, impressive range, and considerable dramatic qualities. Her vibrato, however, is too prominent too often, and there are pitch uncertainties. In none of the eight selections does she turn in an inferior performance, but, except for the darkly evocative scene from the unfamiliar *Kaschei, the Deathless*, nowhere does she attain true distinction, either. The orchestral backgrounds are effective, but the recorded sound is unexciting. G.J.

RECORDINGS OF SPECIAL MERIT

ROCCO DANCE MUSIC. C. P. E. Bach: Two Minuets (Wq. 189); Five Polonaises (Wq. 190). Rameau: Seven Dances from "Zoroastre." Starzer: Ten Dances from "Diane et Endimione," "Roger et Bradamante," and "Gli
(Continued on page 108)

INNER BEAUTY

Brilliant new engineering for a bright new sound:
KENWOOD RECEIVERS FOR '76



KENWOOD introduces an all-new receiver line for '76 — six high performance new models, created in the KENWOOD tradition of engineering excellence. The beauty of 'original-performance' reproduction starts deep inside each new model. Big new power ratings enhance performance right down the line, but power alone is not the whole story. KENWOOD engineers have carefully concentrated on total performance, with a host of technical refinements: Direct-coupled output stages with pure complementary symmetry for better bass response and crisp transient response. New distortion-cutting circuitry in the all-important preamp for increased signal-to-noise ratio. Advanced new tuner design for greater sensitivity, better capture ratio, and full stereo separation throughout the frequency range. Plus KENWOOD's new uncluttered internal layout that minimizes wiring to maintain optimum signal-to-noise performance. Six new receivers — with an inner beauty all their own — are waiting for you at your nearest KENWOOD Dealer.



KENWOOD

15777 S. Broadway, Gardena, CA 90248 72-02 Fifty-first Ave., Woodside, N.Y. 11377 In Canada: Magnasonic Canada, Ltd.

CIRCLE NO. 19 ON READER SERVICE CARD

FREE

McIntosh CATALOG and FM DIRECTORY

Get all the newest and latest information on the new McIntosh Solid State equipment in the McIntosh catalog. In addition you will receive an FM station directory that covers all of North America.

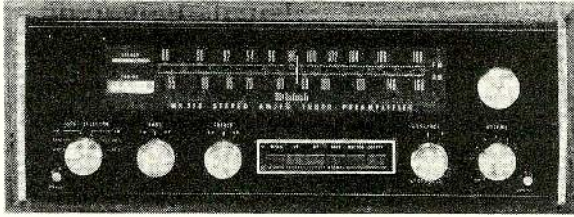

MX 113

FM/FM STEREO - AM TUNER AND PREAMPLIFIER

**SEND
TODAY!**

McIntosh Laboratory, Inc.
East Side Station P.O. Box 96
Binghamton, N.Y. 13904
Dept. SR

NAME _____
ADDRESS _____
CITY _____ STATE _____ ZIP _____

If you are in a hurry for your catalog please send the coupon to McIntosh..
For non rush service send the *Reader Service Card* to the magazine.

CIRCLE NO. 23 ON READER SERVICE CARD



The New Basic Repertoire

STEREO REVIEW again presents the annual revision of the Basic Repertoire. In pamphlet form, it includes 1976 disc and tape recommendations for 175 standard musical works. For your copy, send 25¢ in coin, plus a stamped, self-addressed No. 10 envelope (9½ x 4½ in.), to Esther Maldonado, STEREO REVIEW, 1 Park Avenue, New York, N.Y. 10016.

PLANNING TO MOVE?

Let us know 8 weeks in advance so that you won't miss a single issue of STEREO REVIEW.

Attach old label where indicated and print new address in space provided. Also include your mailing label whenever you write concerning your subscription. It helps us serve you promptly.

Write to: P.O. Box 2771, Boulder, CO 80302, giving the following information:

Change address only Extend my subscription

ENTER NEW SUBSCRIPTION

1 year \$7.98 Payment enclosed (1 extra BONUS issue)
Allow 30-60 days for delivery. Bill me later

NEW ADDRESS HERE ⁰²⁸⁶

Name _____ please print

Address _____

City _____

State _____ Zip _____

Additional postage per year: For Canada add \$2. For countries outside U.S. and Canada, add \$3--cash in U.S. currency only.

AFFIX OLD LABEL

If you have no label handy, print OLD address here.

Name _____ please print

Address _____

City _____

State _____ Zip _____

Orazi e Gli Curiazi. Ensemble Eduard Melkus, Eduard Melkus cond. DEUTSCHE GRAMMOPHON ARCHIV 2533 303 \$7.98.

Performance: **Suave**
Recording: **Lively**

VIENNESE DANCE MUSIC FROM THE CLASSICAL PERIOD. Eybler: *Polonaise.* Haydn: *Two Minuets.* Gluck: *Ballet from "Orpheus and Euridice"; Allegretto from "Don Juan."* Mozart: *Six Ländler (K. 606); Five Contradances (K. 609).* Wranitzky: *Ten German Dances; Quodlibet.* Beethoven: *Four Contradances (WoO 14).* Salieri: *Minuet.* Ensemble Eduard Melkus, Eduard Melkus cond. DEUTSCHE GRAMMOPHON ARCHIV 2533 182 \$7.98.

Performance: **Sophisticated**
Recording: **Delicate**

For the devotee of Terpsichore, here is a feast that will straighten the spine and make the toes twinkle. The music is contagious and the sounds produced by the Ensemble Melkus are delicious. The dances of the Rococo period are delicately scored and evoke the elegance of eighteenth-century court and theater. Taking up more lusty and exotic instruments such as the bagpipes, xylophone, psaltery, and panpipes, the Melkus Ensemble demonstrates what happened to dancing when the Viennese bourgeoisie took it up in the dance hall; it is sheer delight to hear Haydn, Mozart, and Beethoven let their hair down. This charming collection will dispel your gloom and cheer your heart before (and after) a bout with the heavy Romantics. S.L.

RENATA SCOTTO: Songs by Rossini, Bellini, Donizetti, Verdi. Donizetti: *Ne ornerà la bruna chioma; Una lagrima; La mère et l'enfant; La corrispondenza amorosa.* Bellini: *Dolente immagine di fille mia; Per pietà, bell'idol mio; Vaga luna, che inargentì; Malinconia, ninfa gentile.* Verdi: *Lo spazzacamino; Brindisi; Stornello.* Rossini: *Giovanna d'Arco (Cantata); La Danza.* Renata Scotto (soprano); Walter Baracchi (piano). RCA AGL1-1341 \$4.98.

Performance: **Imperfect, but stimulating**
Recording: **Good**

There are several treasures to be discovered here beneath the deceptive familiarity of the surface. Rossini's lengthy *Giovanna d'Arco* is a complex dramatic *scena* composed in 1832, during his "retirement" in Paris. The similarly constructed though shorter *Ne ornerà la bruna chioma* was written by Donizetti nine years later, also in Paris. The same composer's equally unfamiliar *Una lagrima*, a prayer with a Verdian dramatic sweep, dates from the same time. Even the better-known short pieces on this record (originally released by RCA Italiana some five years ago) are elusive enough to be welcomed on this occasion.

The emotional compass of such a repertoire is considerable, but Renata Scotto deals with the challenge intelligently and with the alert and discriminating response that has characterized her recent work. Vocally she is somewhat uneven: there are some acidulous high notes and minor lapses of intonation. On the other hand, her phrasing is always expert, the inflections are telling, and the emotional input for each song seems unerringly right.

The piano accompaniments are acceptable or better, and the sound is good. Robert Jacobson's annotations help in placing this unusual repertoire in its historical context. G.J.

STEREO REVIEW MARKET PLACE

NON-DISPLAY CLASSIFIED: COMMERCIAL RATES: For firms or individuals offering commercial products or services, \$1.90 per word (including name and address). Minimum order \$28.50. Payment must accompany copy except when ads are placed by accredited advertising agencies. Frequency discount: 5% for 6 months; 10% for 12 months paid in advance.

READER RATE: For individuals with a personal item to buy or sell. \$1.20 per word (including name and address). No minimum! Payment must accompany copy. **DISPLAY CLASSIFIED:** One inch by one column, \$240.00. Two inches by one column, \$480.00. Column width 2-1/4". Advertiser to supply film positives. Please write or phone for frequency rates.

GENERAL INFORMATION: First word in all ads set in caps at no extra charge. All copy subject to publisher's approval. All advertisers using Post Office Boxes in their addresses MUST supply publisher with permanent address and telephone number before ad can be run. Ads are not acknowledged. They will appear in the first issue to go to press after closing date. Closing Date: 5th of the 2nd month preceding cover date (for example, March issue closes January 5th). Send order and remittance to: Classified Advertising, STEREO REVIEW, One Park Avenue, New York, New York 10016, Attn. Hal Cymes.

FOR SALE

ACOUSTIC FEEDBACK? Vardensity damping material reduces distortion due to feedback in disc playback... for 300+ cu. in. of Acoustic Feedback Insulation and brochure send \$5.00 to: Stephen Heimlich 5584 Pleasant View Dr., Milford, Ohio 45150.

HEWLETT-PACKARD Distortion Analyzer 333A never used. (913) 267-2395.

EQUIPMENT

WRITE for quotation on any Hi-Fi components: Sound Reproduction Inc., 460 Central Avenue, East Orange, N.J. 07018. 201-673-0600.

NO fair trade laws in D.C. Write for discount prices on your choice of components. District Sound, Inc., 2316 R.I. Ave, N.E., Wash., D.C. 20018. (202) 832-1900.

Listen to TELEVISION IN STEREO



The TE 200 TELEDAPTER EASILY CONNECTS TO ANY TV & STEREO SYSTEM. Using our coupling and matrix circuit, teledapter takes a low impedance output from the television and delivers two HIGH IMPEDANCE CHANNELS OF SIMULATED STEREO to drive any amplifier. Frequency response is maintained so you can hear the tinkle of bells or booming bass sounds as it happens on TV. With service warranty and hookup instructions. \$16.95 post. Guaranteed to make your TV 100% more enjoyable.

OUR NEW TE 300 VHF UHF HI FI TUNER IS NOW AVAILABLE. A complete and self contained 110 volt tuner. VHF UHF antenna connection. Recording and amp output jacks. Five year service warranty \$149.95 post. From our factory.

SEND CHECK MASTER CHARGE NO for TE 200 TE 300 or \$5.00 for C.O.D. TO RHODES NATIONAL CO DEPT SR P.O. BOX 817 HENDERSONVILLE, TENNESSEE 37075

NAME _____

ADDRESS _____

CITY _____ STATE _____ ZIP _____

SEND COMPLETE CATALOG

DIAMOND NEEDLES and STEREO CARTRIDGES at DISCOUNT PRICES for SHURE, PICKERING, STANTON, EMPIRE, GRADO and ADC. Send for free catalog. LYLE CARTRIDGES, Dept. S, Box 69, Kensington Station, Brooklyn, New York 11218.

ABSOLUTELY THE LOWEST PRICES on name brand stereo components. Send for our free catalog to BOSTON AUDIO EXCHANGE, 1589 Commonwealth Avenue, Brighton, Massachusetts 02135.

DON'T PAY the high mail order prices. Thieves Warehouse of Tampa, 1531 South Dale Mabry, Tampa, Florida 33609.

CANADIAN Discount Catalog. Name brand stereo and 4-channel gear. Etco-3, 521 5th Ave, NYC 10017.

DON'T PAY the high mail order prices. Thieves Warehouse of Sarasota, 6564 Gateway Avenue, Sarasota, Florida 33581.

DON'T PAY the high mail order prices. Thieves Warehouse of Ft. Walton Beach, 652-D Beal Parkway, N.W., Ft. Walton Beach, Florida 32548.

CROSSOVERS—Custom designed; fully tested; guaranteed quality. Free Brochure. Write: Crossovers, Box 458, Placentia, CA 92670.

LOWEST PRICES on many brands of stereo components — 4 day delivery, write for same day quotes. University Stereo Cooperative, 57 E. Ridgewood Avenue, Ridgewood, N.J. 07450.

DON'T PAY the high mail order prices. Thieves Warehouse of Mobile, 1770 Beltline Highway, Mobile, Alabama 36609.

STEREO NEEDLES and CARTRIDGES—ADC, Audio Technica, B&O, Empire, Grado, Micro Acoustics, Pickering, Ortofon, Shure, Sonus, Stanton, Supex, BSR, G.E., RCA, Sony, Panasonic and others. For FREE CATALOG, write: NEEDLE IN A HAYSTACK, INC., P.O. Box 17436, Washington, D. C. 20041.

DON'T PAY the high mail order prices. Thieves Warehouse of Pensacola, 3731 Navy Boulevard, Pensacola, Florida 32507.

DON'T PAY the high mail order prices. Thieves Warehouse of Atlanta, 3164 Peachtree Road, N.E., Atlanta, Georgia 30303.

DON'T PAY the high mail order prices. Thieves Warehouse of Atlanta, 2769 Lakewood Avenue, S.W., Atlanta, Georgia 30315.

DON'T PAY the high mail order prices. Thieves Warehouse of Montgomery, 3386 Norman Bridge Road, Montgomery, Alabama 36105.

DON'T PAY the high mail order prices. Thieves Warehouse of St. Petersburg, 9151 Park Boulevard, North Largo, Florida.

SAVE ON SACRED COWS—Bose, SAE, JBL, Thorens, Philips. Over 50 top brands. Write for quotes. SOUTHBOUND SOUND, P.O. Box 52508, Atlanta, Georgia 30355.

DON'T PAY the high mail order prices. Thieves Warehouse of Panama City, 5220 West Highway 98, Suite D, Panama City, Florida 32401.

DON'T PAY the high mail order prices. Thieves Warehouse of Atlanta No. 6, Belvedere Plaza Shopping Center, 1203 Columbia Drive, Decatur, Georgia 30032.

DON'T PAY the high mail order prices. Thieves Warehouse of Knoxville, 5710 Kingston Pike, Knoxville, Tennessee 37919.

DON'T PAY the high mail order prices. Thieves Warehouse of Birmingham, 123 Raebuck Plaza Drive, Birmingham, Alabama 35206.

DON'T PAY the high mail order prices. Thieves Warehouse of Orlando, 1915 East Colonial Drive, Orlando, Florida 32803.

DON'T PAY the high mail order prices. Thieves Warehouse of Miami, 1756 S. W. 8th Street, No. 201, Miami, Florida 33135.

DON'T PAY the high mail order prices. Thieves Warehouse of Jacksonville, 1239 Arlington Road & Lone Star, Jacksonville, Florida 32211.

"DUBIE CD-5 RECORDING SYSTEM IS A MUST FOR THE SERIOUS HOBBYIST" or anyone owning two or more recorders. Dubie CD-5 allows you to be more creative in multiple taping, mixing, dubbing and editing. Available at Olson and Team Electronics stores for only \$59.95. Or write Dubie, Rt. 4, Box 98, Stigler, Okla. 74462.

DON'T PAY the high mail order prices. Thieves Warehouse of Jacksonville, 6078 Old St. Augustine Road, Jacksonville, Florida 32217.

DON'T PAY the high mail order prices. Thieves Warehouse of Clearwater, 1502 A Gulf To Bay Boulevard, Clearwater, Florida 33515.

DON'T PAY the high mail order prices. Thieves Warehouse of Birmingham, 103 South 18th Street, Birmingham, Alabama 35233.

DON'T PAY the high mail order prices. Thieves Warehouse of Mobile/Village Square, 301 South Craft Highway, Mobile, Alabama 36610.

DYNAKITX, DYNASPEAKERS—lowest prices, fastest service, large inventory. Underground HiFi Sales, 324a Broadwater Road, Arnold, MD 21012. (301) 647-0919.

SAVE UP TO 69% on over 100 top brand audio components from Carston Studios, New England's Audio Supermarket, one of the oldest mail order firms (Est. 1952) and certainly one of the most reliable. All orders shipped from stocked warehouse. Send for price quote and price list. Carston Studios, Old Brookfield Rd., Danbury, Conn. 06810.

PROFESSIONAL HI-FI COURSE—Instructors include Len Feldman, Julian Hirsch, Larry Klein, and Larry Zide. Home study course also available. Send \$1.00 for audio primer and full information on joining Society Audio Consultants (SAC), 393 5th Ave., New York City 10016.

PERFECTIONISTS PREFER DYNAKITS. Before Purchase You Owe Yourself Our Quote. Mainline Iir, 971 Fronheiser, Johnstown, PA 15902.

NO GIMMICK! Buy new components at 50% discounts using highly innovative purchasing methods. Fully legal. Request FREE information packet. Stereo Cost Cutters, Box 8014, Canton, Ohio 44711.

FORMULA 4 PROFESSIONAL DAMPED TONE ARM available through U.S. Audio Dealers. Literature \$1 Bill. Formula 4, 15 Heather Walk, Edgware, Middlesex, England. **NO SACRED COWS.** Top Discounts on BOSE, Infinity, Hegeman, ADS, Dual, Dyna, Sansui, Sony, Marantz, Yamaha, SAE, Klipsch, B&O, Teac, McIntosh, Citation, others. Seriously Audic Sales, 2126 Faulkner, Atlanta, GA 30324. (404) 325-7353.

DON'T PAY the high mail order prices. Thieves Warehouse of Ft. Lauderdale, 3347 North Federal Highway, Ft. Lauderdale, Florida 33306.

DON'T PAY the high mail order prices. Thieves Warehouse of Pensacola No. 2, 3820 North 9th Avenue, Pensacola, Florida 32503.

DON'T PAY the high mail order prices. Thieves Warehouse of North Miami Beach, 1807 N.E. 164th Street, Miami Beach, Florida 33162.

DON'T PAY the high mail order prices. Thieves Warehouse of Tallahassee, 1119 Apalachee Parkway, Parkway Shopping Center, Tallahassee, Florida 32301.

DON'T PAY the high mail order prices. Thieves Warehouse of Plantation, 231 South State Road 7, Plantation, Florida 33317.

DON'T PAY the high mail order prices. Thieves Warehouse of Jacksonville No. 2, 6078 Old St. Augustine Road, Jacksonville, Florida 32217.

DON'T PAY the high mail order prices. Thieves Warehouse of Atlanta, 1030-3 Cherokee Road, Smyrna, Georgia 30080.

DON'T PAY the high mail order prices. Thieves Warehouse of Atlanta, 4166 Buford Highway, N.E., Atlanta, Georgia 30345.

DON'T PAY the high mail order prices. Thieves Warehouse of Atlanta, 4162 Jonesboro Road, Zayre Center, Forest Park, Georgia 30050.

DON'T PAY the high mail order prices. Thieves Warehouse of North Tampa, 1441 East Fletcher Avenue, Tampa, Florida 33612.

CLASSIC Decca Tonearm on precision Linn-Sondek Turntable, Remote Control Cueing. Two Decca London export cartridges. Mint, \$350.00. Richard Bearoff, 159 Charles St., King Manor, Bridgeport, PA 19405.

SPEAKER Enclosures with Grill Boards—Raw Speakers—Details SASE. Stereo Workbench, 214-A Montauk, New London, Conn. 06320.

DYNACO Stereo 120 walnut cabinets, with VU meters. Literature? Geometrics, Box 612, Mexico, MO 65265.

BUY HI-FI COMPONENTS THE MODERN WAY:

PHONE & MAIL

Call TOLL FREE or write for LOW PRICES

Nationwide **800/854-7769**

California **800/472-1783**

Approved by Phone

MCK SALES

250 N THOMAS, PO BOX 2100
POMONA CA 91766

FANTASTIC DISCOUNTS on Hi-Fi Components. Write for FREE catalog! Gochenour's Sound House, P.O. Box 86, Eden, N.C. 27288.

DON'T PAY the high mail order prices. Thieves Warehouse of Hollywood, 5719 Hollywood Boulevard, Hollywood, Florida 33021.

DON'T PAY the high mail order prices. Thieves Warehouse of Ridgewood, 25 Godwin Avenue, Ridgewood, New Jersey 07450.

DON'T PAY the high mail order prices. Thieves Warehouse of Gainesville, 434 N.W. 13th Street, Gainesville, Florida 32601.

DON'T PAY the high mail order prices. Thieves Warehouse of Boca Raton, 499 N.E. 20th Street, Boca Raton, Florida 33431.

DON'T PAY the high mail order prices. Thieves Warehouse of Atlanta No. 7, 215 Copeland Road, Atlanta, Georgia 30342.

DON'T PAY the high mail order prices. Thieves Warehouse of Jacksonville No. 3, Cedar Hills Shopping Center, 3716 Blanding Blvd., Jacksonville, Florida 32210.

DON'T PAY the high mail order prices. Thieves Warehouse of Hialeah, 6741 West 4th Avenue, Hialeah, Florida 33012.

DON'T PAY the high mail order prices. Thieves Warehouse of Fair Lawn, 34-09 Broadway, Fair Lawn, New Jersey 07410.

DON'T PAY the high mail order prices. Thieves Warehouse of Dumont, 78 Washington Avenue, Dumont, New Jersey 07628.

TUBES

TV and Radio Tubes 36 cents. Free 48 page color catalog. Cornell, 4215-H University, San Diego, California 92105.

PLANS AND KITS

EXCLUSIVE U.S. Made, CBS Licensed SQ Decoder Kit. Full logic, wave matching and/or variable blend. SQ-1 (fixed blend), \$40.00. SQ-3 (variable blend), \$55.00. Knobs, cases not supplied. Regulated power supply available only with the decoder, \$5.00. Postpaid USA, Canada. Information available. Photolum Corporation, Dept. S-58, 118 East 28 Street, New York, N.Y. 10016.

INSTRUCTION

LEARN Electronics Organ Servicing at home. All makes, including transistors. Experimental kit—trouble-shooting. Accredited NHSC, Free Booklet. Niles Bryant School, 3631 Stockton, Dept. A, Sacramento, Calif. 95820.

RADIO BROADCASTING: High paying jobs, free records-tapes-equipment. Start your own station! Free booklet, "Radio!". Box 5516-RH, Walnut Creek, CA 94596.

MUSICAL INSTRUMENTS

UP TO 60% DISCOUNT. Name brand instruments Catalog. Freeport Music, 114 H. Mahan St., W. Babylon, N.Y. 11704.

WANTED

GOLD, silver, platinum, mercury wanted. Highest prices paid by refinery. Ores assayed. Free circular. Mercury Terminal, Norwood, MA 02062.

RECORDS

SHOW ALBUMS, Rare, Out-of-Print LP's. 52 pg. list. 50 cents. Broadway/Hollywood Recordings, Georgetown, Conn. 06829.

PROTECT your LP'S—Poly sleeves for jackets 8 cents; Round Bottom Poly Inner sleeves 7 cents; Poly lined paper 15 cents; white jackets 35 cents. Postage \$1.50. Record House, Hillburn, N.Y. 10931.

THOUSANDS like new LP's and prerecorded tapes. Catalogue \$1.50. Records, Hillburn, New York 10931.

COLLECTORS' Soundtracks. Mint. List 50 cents (refundable). Jemm's, P.O. Box 157, Glenview, Ill. 60025.

SOUNDTRACK RECORD ALBUMS—Mail Auction—Free List. Whalon, 2321D Hill, Redondo Beach, Calif. 90278.

QUADRAPHONIC RECORDS AND TAPES—World's largest selection—all labels, over 1000 titles—at discount prices! For your free illustrated quad catalog, write: SOUND CONCEPTS, Box 654-A, Peoria, IL 61601.

RECORD RATERS WANTED! Anyone qualifies. We ship you nationally released LP's to rate. We pay postage and handling. You pay nothing for LP's. All you pay is small membership fee. Applicants accepted "first come basis." Write: E.A.R.S., Inc., Dept. SR, Box 10245, 5221 W. Center Street, Milwaukee, WI 53210.

OLDER JAZZ, Swing, LP's—lowest prices. Monthly lists. Soundtracks, Auctions! Records, Box 1138R, Whittier, Calif. 90609.

SOUNDTRACKS, ORIGINAL CASTS, PERSONALITIES—Free Newsletter/Auction. RTSR, 3700 Plaza, F211, Santa Ana, California 92704.

CASH for unwanted LP's and pre-recorded reel-to-reel tapes. TAPES, Hillburn PO, New York 10931.

HARD-TO-FIND Soundtracks, Shows; Nostalgia. Superb Imported, Domestic selections. Catalog \$1.00 (refundable). List Communications, P.O. Box 916-x, NYC 10023.

AUGUST Jazz LP Sale featuring Atlantic, Flying Dutchman, Impulse, Muse; Cutout LP-Tape, Rock, Oldies Catalogs \$2. NERT, Box 268SR, Lawrence, Mass. 01842.

ROCK 'n' ROLL—Jazz, Blues, Folk and more LP's and tapes: by mail. Many imports. Fast Service—Low Prices. Free Catalog. AIRBORNE, Dept. SR, 9093 Comprint Ct., Gaithersburg, MD 20760.

OLDIES oldies, 45rpm. Also current hits. Free Catalog. Cor-ny's Record Shop, Box 166HF, Mason, Ohio 45040.

RARE RECORDS, 45's, 78's, 33's, Soundtracks, Original, Cast Personalities, all kinds, mostly mint. 5,000 record lists, \$2.00. Refundable. Dealers Welcomed. Gurley, Box A72, Princeton, N.C. 27569.

1950's PRIVATE COLLECTION. 45's original Rock & Roll, Pop, Classical, Semi-Classical, X-Party records, Promotional copies. Send \$2.00. 45's, P.O. Box 493, Land O'Lakes, Fla. 33539.

RARE Jazz and Popular LP's sold by auction. Leon Leavitt, 824-1/4 North Las Palmas, Los Angeles, CA 90038.

RUBBER STAMPS

RUBBER address stamps. Free catalog. 45 type styles. Jackson's, Dept. K, Brownsville Rd., Mt. Vernon, Ill. 62864.

TAPE AND RECORDERS

RENT 4-track open reel tapes—free brochure. Stereo-Part, P.O. Box 7, Fulton, California 95401.

THRIFTIEST "Live"—Operatic, Symphonic—Tapes & Cassettes. P.O. Box 1101, Woodhaven, New York 11421.

OPERA TAPES—Open Reel and Cassettes—Historical performances of past 40 years. Unbelievable treasures and rarities. Also LP records. Ed Rosen, 66-33 Saunders St., Rego Park, N.Y. 11374.

SCOTCH new low noise tape 10-1/2" metal 3600', 5 for \$35.00. Reels, POB 88338, Dunwoody, GA 30338.

GOLDEN AGE RADIO—your best source for radio tapes. Box 25215-T, Portland, Oregon 97225.

OLD RADIO PROGRAMS on tape. Thousands available. Six hours, \$8.00. Catalogue, 50 cents. Nostalgic Radio, Box 29-B, Peoria, IL 61601.

1930-1962 RADIO PROGRAMS. Reels, \$1.00 hour! Cassettes, \$1.00 show!...Mammoth Catalog, \$1.25. AM Treasures, Box 192SR, Babylon, New York 11702.

RARE OPERA, symphonic music on open reel tape. American, European broadcasts. Live Tapes. Historic performances. Free catalogue. Underhill, Bellport, N.Y. 11713.

CASSETTES / LABELS

Plain white cassette labels, Norelco cassette cleaners, famous brand cassettes. Send for open reel and cassette discount catalog. 1-9 10-99 100 100010M
Cassette Labels .02 .015 .01006
Norelco Cassette Cleaner .65 .60 .55 .50 .45
Plus Postage by Weight and Zone Minimum Order \$5.00

OPEN REEL STEREO TAPE BUYERS!

At Last! An open reel catalog, including titles, songs, etc. of 95 long play, 2-3 hour albums by American Airlines or Ampex 4-track stereo tapes. Send \$1.00 — and we will also mail you a 140-page Harrison Stereo Tape Guide — so you'll get both for \$1.00 — and this \$1.00 is refundable on your first \$10.00 purchase of open reel stereo tapes at our 20% discount.

WE'VE GOT THE "SPIRIT", THE PRICES
AND THE ADDRESS TO PROVE IT
Saxitone's Bicentennial Tape Shoppe

1776 Columbia Road N.W., Washington, D.C. 20009

YESTERDAY'S RADIO PROGRAMS on Tape. Catalog \$1.00 refundable first order. Reel-Cassette. ADVENTURES, Box 4822-S, Inglewood, California 90302.

OPERA CLASSICAL MUSIC Open Reels. Rare mostly live free catalogue. K. Lohan Tapes, P.O. 298, Mastic Beach, N.Y. 11951.

TDK, BASF, Memorex, Maxell, cassettes, reels, 8-tracks. Lowest prices, new guaranteed. S&S Audio, P. O. Box 56039, Harwood Heights, Ill. 60656.

TAPE WORLD deals exclusively in tapes so we must give you the lowest possible prices. Save 30-40% on TDK, FUJIGI, BASF, AMPEX, MAXELL and others. Tape World International, Box 231, Butler, PA 16001.

SONAR'S OPEN REEL TAPES. Duped one-to-one from master. Quad, stereo; 1/4, 1/2 track; 7-1/2, 15 IPS; 7", 10-1/2" reels. Highest quality anywhere! Send for catalog. Sonar Records, P.O. Box 455S, Kingsbridge Sta., Bronx, N.Y. 10463.

THRILLING Live Opera Tapes. Enormous Free Catalogue. Live Opera, P.O. Box 3141, Steinway Station, L.I.C., N.Y. 11103.

OLD RADIO SHOWS. Most have original commercials. Low as \$1.87 per hour. Catalog \$1.00. Phantom Empire, 2500 Pennington, Houston, Texas 77093.

40,000 OLD RADIO SHOWS on Tape. Jazz/Big Band remotes, Country/Western, discographies, anthologies, chronologies. Send \$2 for huge catalog (refundable). McCoy's Recording, Box 10695S, Richland, Washington 99352.

MANY Superb Operatic Tapes. Bargain Prices. Complete Operas, Recitals, Galas. Free Catalog From J. A. George, Box 601, STEREO REVIEW, Classified, 1 Park Ave., NYC 10016.

OLD RADIO PROGRAMS. Two Catalogs \$1.50, Cassettes \$1.59 hour, Reels four hours \$5.00. Nostalgia Sounds, 4151 Florence, Santa Susana, California 93063.

BUSINESS OPPORTUNITIES

I MADE \$40,000.00 Year by mailorder! Helped others make money! Free Proof. Torrey, Box 318-NN, Ypsilanti, Michigan 48197.

MAILORDER MILLIONAIRE helps beginners make \$500 weekly. Free report reveals secret plan! Executive (1KB), 333 North Michigan, Chicago 60601.

HI-FI ENTHUSIASTS WANTED!! Earn more than just spare money in your spare time. We need campus representatives to sell name brand stereo components at discount prices in your area. High commission, no investment required. Serious inquiries only, please. Contact: Alan Weisberg, K&L Sound Services Co., 75 No. Beacon St., Watertown, Mass. 02172. (617) 787-4073.

GET RICH with Secret Law that smashes debts and brings you \$500 to \$5 Million cash. Free report! Credit 4K8, 333 North Michigan, Chicago 60601.

FREE SECRET BOOK "2042 Unique, Proven Enterprises." Fabulous "Little Knowns." Work Home! Haylings-B, Carlsbad, Calif. 92008.

EMPLOYMENT INFORMATION

AUSTRALIA—NEW ZEALAND WANT YOU!!! 50,000 Jobs! Paid Transportation! Latest Information and Forms. \$1.00. Austco, Box 3623-SR, Long Beach, California 90803.

OVERSEAS JOBS—Now Hiring, 103 Countries. All Occupations, High Pay, Free Transportation, Tax Benefits. Latest Computerized Reports—\$2.00. TRANSWORL, International Airport, Box 90802-SR, Los Angeles, California 90009.

MOVIE FILMS

16mm SOUND Features, Shorts, New, Used for Sale. Free Catalog. National Cinema, 333 W. 57th St., N.Y., N.Y. 10019.

EDUCATIONAL OPPORTUNITIES

LEARN WHILE ASLEEP. Hypnotize! Astonishing details, strange catalog free! Autosuggestion, Box 24-ZD, Olympia, Washington 98597.

SERVICES

PREWRITTEN RESEARCH, \$1.00 per page. Computerized Catalog, \$1.00. Academic/Business Writing. Professional. Confidential. Information Clearinghouse, Box 4391, Washington, D. C. 20012 (202) 723-1715.

PUBLICATIONS

THE AUDIO AMATEUR—A quarterly publication for the serious audio constructor. Free prospectus. The Audio Amateur, Box 176Z, Peterborough, N.H. 03458.

CB SLANG DICTIONARY — Most complete CB Dictionary Handbook available. Hundreds of slang terms plus part 95 mandatory FCC rules. Great gift. Order Now. Send \$5.00 to: Communication Books, Inc., Dept. SR, Box 10198, Milwaukee, WI 53210.

FREE SAMPLE! World's only audiophile's classified newsletter. AUDIO MART, Box 821, Stratford, Connecticut 06497. SUBSCRIBE: \$5/12 issues.

PERSONALS

MAKE FRIENDS WORLDWIDE through international correspondence. Illustrated brochure free. Hermes, Berlin 11, Box 110660/ZD, Germany.

HYPNOTISM

FREE Hypnotism, Self-Hypnosis, Sleep Learning Catalog! Drawer H400, Ruidoso, New Mexico 88345.

SLEEP LEARNING. Hypnotic Method. 92% effective. Details free. ASR Foundation, Box 23429 EG, Fort Lauderdale, Florida 33307.

AMAZING self-hypnosis record releases fantastic mental power. Instant results! Free trial. Write: Forum (AA8), 333 North Michigan, Chicago 60601.

MISCELLANEOUS

WINEMAKERS. Free illustrated catalog of yeasts, equipment. Semplex, Box 12276Q, Minneapolis, Minn. 55412.

CORVAIR PARTS—1800 different Corvair parts stocked. Big Catalog—\$1.50. Clark's Corvair Parts, Shelburne Falls, MA 01370.

Introducing the Staff . . .

When a personal opinion, particularly a publicly expressed one, grates on our nerves, one of the commoner responses is to ask, either under or at the top of our voices, just who that so-and-so thinks he or she is. The question is asked of STEREO REVIEW with respect to our regular contributors and staff many times each month, and in this column we endeavor to supply the answers. —Ed.



Art Director

Borys Patchowsky

A double-windowed office at STEREO REVIEW, overgrown with a minor jungle, is inhabited by my husband, Borys Patchowsky. No, he is not the resident horticulturist, just someone who can't say no to an orphaned plant. In the daylight filtering through this jungle, Borys designs covers, lays out pages, chooses type faces, and confers with photographers and illustrators. He is the art director, you see, and is responsible for the way the magazine looks.

This quiet, reasonable professional who never seems to raise his voice does not at all resemble the man I met one black night several years ago at the end of a pier. While awaiting some friends, I noticed a seventy-foot sailboat heading for the dock. She was under power with only three people on deck, one at the wheel and two enjoying cocktails in the bow. From nowhere there came a man with a thundering voice: "Get the hell out of there or do something." The two in the bow vanished and the thunderer ordered me to "make fast." At the same time he threw an enormous hawser at me. I couldn't decide

whether to attempt to "make fast" or run for safety. I did not run, and though I would not have believed it then, I eventually married that brawny bellower.

Sailing is only one of Borys' many interests. He skis with the gusto of one who learned before he can remember, and he fences like a misplaced musketeer. Sports, however, have been only a minor distraction. Since he is the son of a Ukrainian poet and the brother of an artist and a musician, he has been more preoccupied with the arts. According to his family, Borys has been painting and drawing since early childhood, but it was not until he went to school that he discovered his aptitude for commercial art (he found that with a little retouching a dormitory food-ration ticket could be used again).

Migrating from country to country in Europe during World War II must have suited Borys' gypsy nature, for he managed not only to piece together his primary and secondary education but also to acquire several languages as well. Can you imagine reading *The Adventures of Huckleberry Finn* in Ukrainian?

AFTER the war he came to the United States, and tackling college here was made more interesting by having to learn English. It was difficult, but he made headway by reading "escape fiction." He entered college with the lowest admissible scores because the only questions on the entrance exams he could unscramble were the mathematical ones. Equipped with equal amounts of intellect and stubbornness, he eventually acquired a degree in art from City College of New York, his sixth language, and a Phi Beta Kappa key. His diverse European-American education has given him a double-barreled view of life, and consequently discussions with him on any subject are never dull.

I find his powers of concentration as an artist both beautiful and exasperating. With Mozart for accompaniment and a woodcut or etching to make, Borys requires neither food, drink, nor sleep for a phenomenal length of time. One of the few things that can distract him from his own creative work is collecting that of others. Although the prints, paintings, and drawings seem to be of primary interest to him, it's the books that take up the major part of our living space. He has promised not to bring any more home, but why, where there used to be two, do there now seem to be four? Can books propagate?

In his travels Borys may have missed a few tourist sites, but very few bookstores or print galleries from here to Istanbul have escaped his scrutiny. Like hunters who seldom look at their trophies, he seems more interested in tracking down a prize piece of art than in the ultimate acquisition. In the course of collecting he has developed an enviable skill in restoring damaged prints, and this has brought him gradually back to doing his own work as a printmaker.

He insists that I have him wrapped around my finger—something I find impossible to believe. And he seems quite determined not to let me find out which one it is. —Joan E. Patchowsky

STEREO REVIEW ADVERTISERS' INDEX AUGUST 1976

READER SERVICE NO.	ADVERTISER	PAGE NUMBER
	Accuphase, Division of Teac	36
1	Acoustic Research	51
3	ADC, Division of BSR	9
	Advent	79
2	Angel Records	95
4	Audio Expo	87
	Audio Technica, U.S., Inc.	17
	Bang & Olufsen of America	75
	Bose Corporation	11
5	Capitol Magnetic Devices	13
6	Cerwin-Vega	33
	Component Discounters	102
7	Crown International	101
8	Design Acoustics	91
9	Discount Music Club	18
	Discwasher	97
10	District Sound	87
	Dixie HiFidelity	84
50	Dual	30, 31
11	Electro-Voice	83
21, 99	Empire Scientific Corporation	5, 35
12	Frazier, Inc.	81
14	Garrard	19
13	GTE Sylvania, Entertainment Division	45
15	Hi Fi Buys	84
16	Illinois Audio	84
17	International Hi Fi Distributors	87
18	Jensen Sound Lab	8
19	Kenwood Electronics	107
22	Koss Electronics	Cover 4
	Marantz	112, Cover 3
20	Maxell Corporation	71
23	McIntosh Laboratory	108
24	Memorex	7
25	Michigan Audio Discounters	101
26	Olympus	12
27	Phase Linear	99
28	Radio Shack	91
29	RTR Industries	98
30	S.A.E.	82
31	Sansui Electronics Corporation	24-27
32	Sennheiser	94
33	Sherwood	39
34	Shure Brothers	77
35	Sony Corporation of America	54, 55
	Speakerlab	101
44	Stanton Magnetics	78
36	Stereo Corporation of America	84
37	Stereo Discounters	87
	TDK Electronics	15
	Teac Corporation	2
38	Technics by Panasonic	22
	Tequila Sauza	29
	Time-Life Records	40, 41
39	Top Discount Audio	102
	Uher of America	44
40	Ultralinear	89
50	United Audio	30, 31
42	U.S. Pioneer	Cover 2, 1
43	Yamaha International Corporation	43

“Marantz offers—in one speaker—both air suspension and ported design. It’s the ultimate in flexibility—and quality.”

**February, 1976:
Marantz engineers invited
audio experts to comment on the new
Marantz High Definition Speaker Systems.
The following remarks were taken
from that taped discussion:**

“It’s one thing to design an acoustic air suspension system that will have low distortion. And it’s another to design a ported system for high efficiency. But here, in one unit, Marantz offers the audiophile the best of both worlds.”

“It’s incredible. Marantz calls it Vari-Q*. Pull out the high density acoustic foam plug and the system becomes a tuned port reflex. Push it back in and the port is absolutely sealed and the speaker becomes air suspension.”

“It doesn’t matter what kind of music the listener is into, either. Air suspension with the plug in is great for full orchestra, because it damps better and doesn’t peak the lower frequencies. But when you listen to rock, pull the plug and you increase the low end efficiency. It pumps up the lows at about 75 Hz and really delivers that low end oomph.”



HD-88

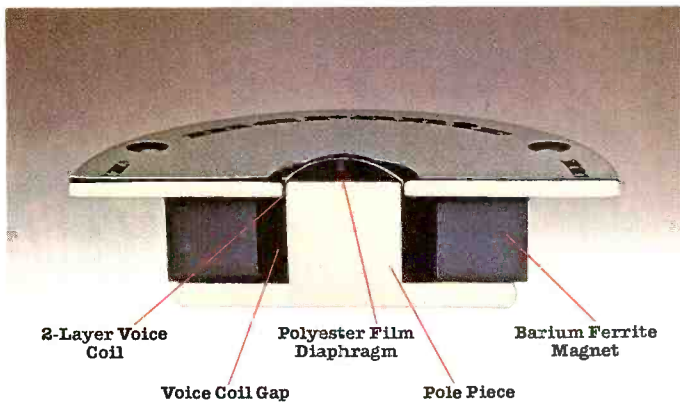

Linear Polyester Film Dome Tweeter

“Another tremendous feature is the **linear polyester film domes** on the tweeters. The dome shape disperses high frequencies over a much wider area. And because the polyester film is so lightweight, it’s more efficient.

It takes less power to do the same job. And they’re practically indestructible. And higher efficiency means greater distortion-free accuracy in reproducing high-frequency transients.”

We call them High Definition Speaker Systems. You’ll call them the ultimate in flexibility and listening excitement. Five models in all (three with Vari-Q) ranging from the bookshelf-sized HD-44 with frequency response from 45 Hz to 18 kHz (± 3 dB – all controls set flat) and power handling capacity of 60 Watts – to the super-powerful HD-88 with frequency response from 25 Hz to 25 kHz (± 3 dB – all controls set flat) and power handling capacity of 300 Watts. Marantz High Definition Speaker Systems start as low as \$89.95.** Experience the professionals’ choice today at your Marantz dealer. He’s in the Yellow Pages.

marantz®
We sound better.

