

Hi Fi/Stereo Review

NOVEMBER 1963 • 50 CENTS

ESSENTIALS OF AN OPERA COLLECTION * TIPS ON
RECORD CARE * AN INTERVIEW WITH JOAN BAEZ



You'll find it only in these all-in-one Fisher integrated stereo receivers.



The Fisher 400
(FM only), \$329.50†

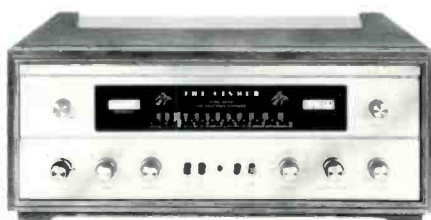

The Fisher 500-C
(FM only), \$389.50†



The Fisher 800-C
(AM and FM), \$449.50†

STEREOPHONIC high fidelity is as simple as connecting the two speakers of your choice to any of the superb Fisher all-in-one integrated receivers illustrated.

Each Fisher receiver consists of an FM (or AM/FM) tuner, an FM Multiplex converter, a stereo control-preamplifier and a stereo power amplifier — all on a single, compact chassis. And each of these sections is just as ruggedly built, reliable, and free from overheating as though it were built as a separate component! Never before have you seen so much amplifier power, such high tuner sensitivity, so many advanced control features, and such a fine degree of overall engineering sophistication on any single chassis, much less one only 17½"

wide, 5¾" high and 13½" deep.

The 500-C and 800-C each have STEREO BEAM††, the exclusive Fisher development that automatically signals the presence of Multiplex, and switches to it. The 400 has the exclusive STEREO BEAM††† indicator, which shows whether or not an FM station is broadcasting in stereo.

These are just a few of the reasons why Fisher integrated receivers outsell all other components in the world today... why they are the biggest-selling components in the history of the audio industry.

Perfectly matched to Fisher stereo receivers are the six different Fisher loudspeaker models available today. The famous KS-1 is the world's first slim-

line in kit form while the KS-2 is the most advanced 3-way slim-line speaker system available in any form at anywhere near the price. (Both the KS-1 and the KS-2 are available, if you prefer, factory-assembled.)

An original Fisher design, the Free Piston speaker, is found in Fisher's XP-1A and XP-2A loudspeaker systems... specifically designed for flawless sound reproduction with amplifiers providing 10 watts of power or more.

The famous XP-4A also features the Free Piston speaker, but is equally well known for utilizing the world's first 'basketless' woofer. This low frequency driver employs no metal frame of its own but is supported directly by the walls of

† IN UNFINISHED WALNUT, \$64.50. FACTORY-ASSEMBLED, IN SANDED AND FINISHED BIRCH, \$84.50. IN OILED WALNUT, \$89.50. †† SLIGHTLY LESS IN SANDED, UNSTAINED

Look for this calibre of Stereo Multiplex tuner, control-preamplifier, and power amplifier on a single chassis.

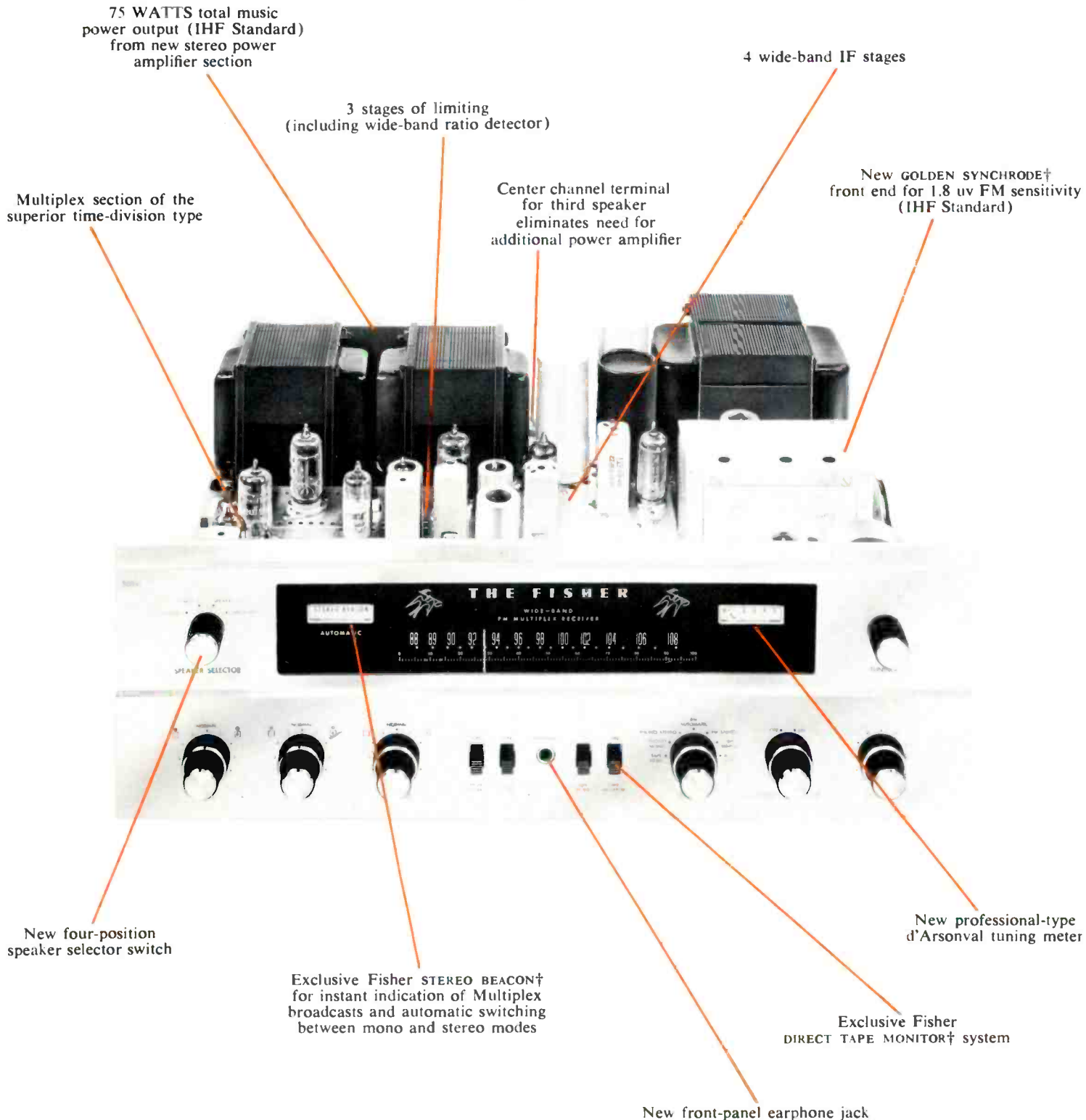

How to own a superb stereophonic high fidelity sound system:

**Mail this coupon.
Turn this page.**

\$1.00 VALUE! ONLY 25¢! Please send me the new 1963 edition of The Fisher Handbook, a comprehensively illustrated 44-page component catalogue and guide to custom stereo. I enclose 25¢, double-wrapped, to cover cost of handling and mailing.



FISHER RADIO CORPORATION
21-37 44th Drive, Long Island City 1, N. Y.

NAME _____

STREET _____

CITY _____ ZONE _____

STATE _____

021101/10

Foreign residents write to: Fisher Radio International, Inc., Long Island City 1, N. Y.
Canadian residents write to: Tri-Tel Associates, Ltd., Willowdale, Ont.

And connect it to a pair of any of these 3-way Fisher speaker systems.



The Fisher KS-1
\$59.50*



The Fisher XP-2A
\$84.50**



The Fisher KS-2
\$89.50***

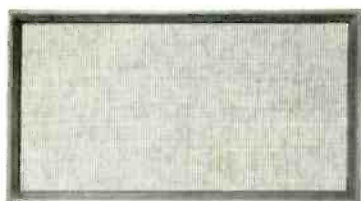

The Fisher XP-1A
\$129.50**

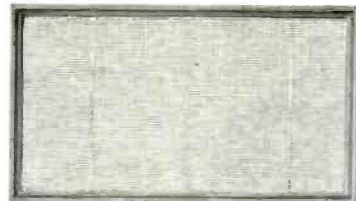

The Fisher XP-4A
\$199.50

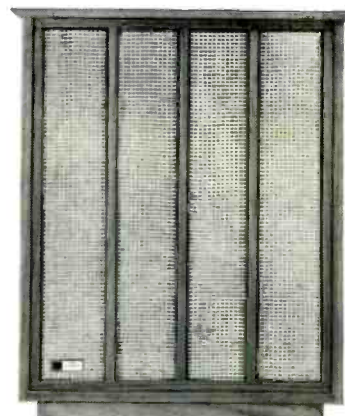

The Fisher XP-10
\$249.50

the 2½-cubic-foot enclosure itself. Reflections and resonances normally originating at the back of the woofer cone are eliminated. Bass coloration is absorbed by liberal use of AcoustiGlas packing.

The XP-4A also features the revolutionary hemispherical soft-dome tweeter. It creates a smooth response and makes for the widest possible dispersion angle of highs within and beyond the range of human hearing. It is the predecessor of the world's first "soft" dome tweeter originally found in the XP-10 Console; a major breakthrough in the reproduction of higher frequencies. A cotton diaphragm is actually bonded to the voice coil. The cone being driven on its periphery, rather than its center, reproduces

highs with virtually no breakup. There are no resonances throughout its range.

This XP-10 is the newest Fisher speaker, specifically designed to reproduce sound favorably comparable to that which is produced by those speakers in the category known as "very large, very expensive," without being either.

Like the XP-4A, the XP-10 uses a voice coil wound on pure electrolytic copper. This makes damping linear throughout the woofer's range, resulting in extraordinary transient response and a startling degree of bass definition.

Its components are entirely hand made, extraordinarily 'balanced' to contribute to the much sought after "single-speaker" sound desired by multi-speaker

designers, and matched to within ± 1 db to insure balanced stereo response when used in pairs.

There you have it. The stereo system of your choice can be as simple as the three Fisher units of your choice. One Fisher receiver. Two Fisher speakers. There's a demonstration awaiting you at your Fisher dealer's showroom.

In striking contrast to the industry-wide standard of 90 days, the Fisher Warranty is extended to all tubes, diodes, and parts for a period of one year from date of purchase.

Foreign residents write to Fisher Radio International, Inc., Long Island City 1, N. Y. Canadian residents write to Tri-Tel Assoc., Ltd., Willowdale, Ont.

BIRCH-AN UNFINISHED WALNUT, \$94.50. FACTORY ASSEMBLED, IN FINISHED BIRCH, \$114.50; IN OILED WALNUT, \$119.50. CABINET IN WALNUT OR MAHOGANY, \$24.95. ALL PRICES SLIGHTLY HIGHER IN THE FAR WEST. PAT. PEND.

WHAT'S THE BEST THING ABOUT A GARRARD AUTOMATIC TURNTABLE?

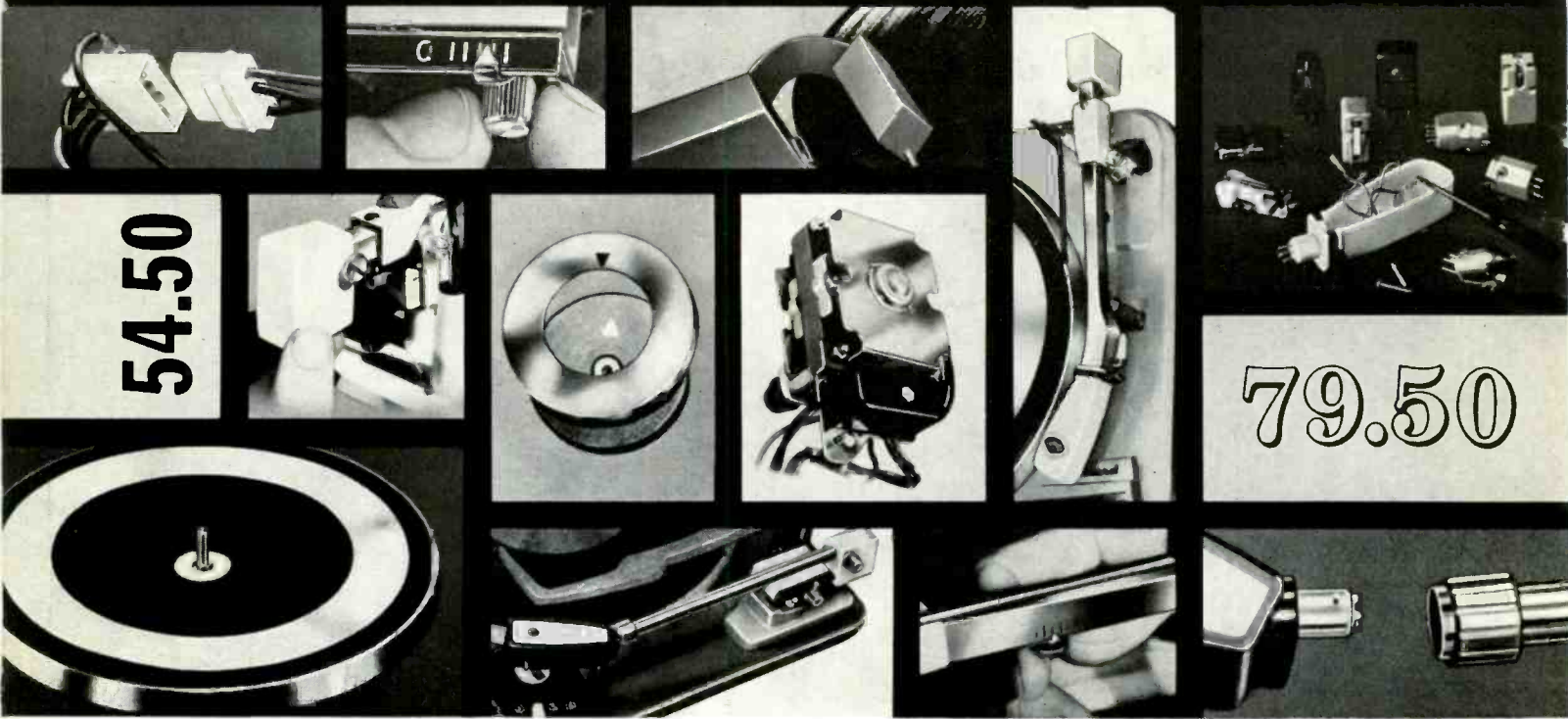

TYPE A
\$79.50



AT6
\$54.50

It could be the tone arm—dynamically balanced...counterweight adjusted...tracking even professional cartridges flawlessly for flawless reproduction. It could be the turntable...over sized, heavy, and balanced. It could be the motor...Laboratory Series®...on speed...double-shielded against hum, and free from rumble. It could be the automatic feature...at your service when you want it...foolproof, incomparably gentle to records. It could be *any* of these...precision components that you would previously have expected to select individually and have mounted together. Now, in the Automatic Turntable, Garrard has combined and integrated them for you. But we don't think any of these are the best thing about a Garrard Automatic Turntable. Most people realize after they own a Garrard, that the most important advantage it offers stems from a 50 year fund of engineering experience and a glorious tradition of craftsmanship...supported by superior manufacturing and quality-control techniques, and the industry's most comprehensive spare parts and authorized nationwide service network. These practical factors result in the enduring satisfaction which Garrard owners enjoy. Every time you play your Garrard, the pleasure and the pride you will derive from owning this magnificent mechanism will increase. We think *this* is the best thing about a Garrard Automatic Turntable!

There is a Garrard for every high fidelity system. Type A \$79.50, AT6 \$54.50, Autoslim \$39.50. For Comparator Guide, write: Dept. GS-123, Garrard Sales Corp., Port Washington, New York.

Garrard
World's Finest



HiFi/Stereo Review

NOVEMBER 1963 • VOLUME 11 • NUMBER 5

THE MUSIC

- 25** THE BASIC REPERTOIRE
Brahms' Double Concerto.....MARTIN BOOKSPAN
- 33** RICHARD TAUBER AND VIENNA
A nostalgic memoir of a singer and his city.....HANS H. FANTEL
- 38** A TALK WITH JOAN BAEZ
The mistress of American folk song grants an interview....NAT HENTOFF
- 45** ESSENTIALS OF AN OPERA LIBRARY
Twenty-one provocative recommendations.....GEORGE JELLINEK
- 55** BEST OF THE MONTH
Reviews of outstanding new releases

THE EQUIPMENT

- 22** BEGINNERS ONLY
Distortion—Part III.....HANS H. FANTEL
- 29** TECHNICAL TALK
*Lab reports on the Bell RT 360 tape recorder
and the Fisher Model 400 stereo receiver*.....JULIAN D. HIRSCH
- 43** DISTORTION—AND WHAT YOU CAN DO ABOUT IT
Some simple solutions to a pesky problem.....HERMAN BURSTEIN
- 50** RECORD WEAR AND CARE
An expert gives the lowdown on dirty records.....JOHN MILDER
- 54** SOUND AND THE QUERY
Answers to your hi-fi technical questions.....LARRY KLEIN

THE REVIEWS

- 61** CLASSICAL
- 111** JAZZ
- 121** STEREO TAPE
- 129** ENTERTAINMENT

THE REGULARS

- 4** EDITORIALY SPEAKING
- 8** LETTERS TO THE EDITOR
- 16** JUST LOOKING
- 150** ADVERTISERS' INDEX; PRODUCT INDEX

COVER: DETAIL FROM "A CONCERT" BY LORENZO COSTA (1480-1535), FORMERLY ATTRIBUTED TO ERCOLE ROBERTI; NATIONAL GALLERY, LONDON

Copyright © 1963 by Ziff-Davis Publishing Company. All rights reserved. HI-FI/STEREO REVIEW, November 1963, Volume 11, Number 5. Published monthly by Ziff-Davis Publishing Company at 431 South Wabash Ave., Chicago, Illinois 60605. Subscription rates: one year United States and possessions \$5.00; Canada and Pan-American Union Countries \$5.50; other foreign countries \$6.00. Second-class postage paid at Chicago, Illinois and at additional mailing offices. Authorized as second class mail by the Post Office Department, Ottawa, Canada, and for payment of postage in cash.

HiFi/Stereo Review

PUBLISHER
PHILLIP T. HEFFERNAN

EDITOR
FURMAN HEBB

MANAGING EDITOR
WILLIAM ANDERSON

MUSIC EDITOR
ROBERT OFFERGELD

TECHNICAL EDITOR
LARRY KLEIN

ART EDITOR
BORYS PATCHOWSKY

ASSOCIATE EDITOR
ROBERT S. CLARK

PRODUCTION EDITOR
MEL SCHINASI

CONTRIBUTING EDITORS

CHRISTIE BARTER
MARTIN BOOKSPAN
HANS H. FANTEL
WILLIAM FLANAGAN
STANLEY GREEN
JOE GOLDBERG
DAVID HALL
NAT HENTOFF
JULIAN D. HIRSCH
GEORGE JELLINEK
IGOR KIPNIS
PAUL KRESH

**ADVERTISING
SALES MANAGER**
LAWRENCE SPORN

**ADVERTISING
SERVICE MANAGER**
ARDYS C. MORAN

ZIFF-DAVIS PUBLISHING COMPANY

Editorial and Executive Offices (212 Oregon 9-7200)
One Park Avenue, New York, New York 10016
William B. Ziff, Chairman of the Board (1946-1953)
William Ziff, President
W. Bradford Briggs, Executive Vice President
Hershel B. Sarbin,
Vice President and General Manager
M. T. Birmingham, Jr.,
Vice President and Treasurer
Robert P. Breeding, Circulation Director
Stanley R. Greenfield, Vice President
Phillip T. Heffernan, Vice President
Midwestern & Circulation Office (312 Wabash 2-4911)
434 South Wabash Avenue, Chicago, Illinois 60605
Advertising: Jerry Sweeney
Western Office (213 Chestview 4-0265)
9023 Wilshire Blvd., Beverly Hills, Calif. 90211
Western Advertising Manager: Bud Dean
Foreign Advertising Representative
D. A. Goodall Ltd., London, England
SUBSCRIPTION SERVICE: All subscription correspondence should be addressed to HiFi/Stereo Review, Circulation Department, 434 South Wabash Avenue, Chicago, Illinois 60605. Please allow at least six weeks for change of address. Include your old address, as well as new—enclosing if possible an address label from a recent issue.
EDITORIAL CONTRIBUTIONS must be accompanied by return postage and will be handled with reasonable care; however, publisher assumes no responsibility for return or safety of art work, photographs, or manuscripts.

Member Audit Bureau of Circulations



EDITORIALLY SPEAKING

by FURMAN HEBB

THE SIGNS of fall are all around us. Leaves are turning, cool air is sweeping down from Canada, and our concert halls are again reverberating to the sonorities of Mahler, Beethoven, Bruckner, and the other heavyweights who were thoughtfully tucked away for the summer. For us, the arrival of fall is also heralded by the New York High Fidelity Show, held this year in September, which annually kicks off the hi-fi season. And with the national economy moving ahead slowly but apparently surely, most of the hi-fi manufacturers I met at the Show were already beginning to glow with unaccustomed optimism over the prospects of 1963-1964.

Along with this atmosphere of optimism, or perhaps because of it, has come a proliferation of high-price hi-fi units, which were prominently dotted throughout the New York Show. Of these, the majority were transistor amplifiers, produced variously for reasons of performance, for prestige, or for the marketing advantages that accrue to the magical cadences of *trans-si-lor*. Of course, it was not only the transistorized amplifiers that were expensive. Every category of playback equipment had its luxury models for those who want the ultimate and are willing to pay for it.

But at the same time that prices have been pushing upward at one end of the scale, a healthy phenomenon has been taking place at the other end. In the past six months, several of the old-line prestige manufacturers have been making equipment for the low-price market. These manufacturers are so eager to break into this lucrative area that some claim their units are priced essentially as loss-leaders. If this is in fact the case, it means better values for the consumer.

There has also been a multiplication of models in the medium-price range. Never before has the hi-fi buyer had such a wide choice of equipment so well balanced as to cost and quality. Of course it could be said, and with some justification, that there are simply too many models, that the diversity is too confusing, that we have too much of a good thing. But it seems to me that this admittedly complex picture is also a healthy one, for it enables each listener, no matter what his price range, to choose equipment that is precisely right for his tastes and for his pocketbook. True, the task of selection is not simple, but it can and should be rewarding.

Coming Next Month in HiFi/STEREO REVIEW

RICHARD WAGNER: TWILIGHT OF A GOD
by Frederic Grunfeld

RECOMMENDED RECORDS FOR CHILDREN
by Herbert Mitgang

THE DECLINE OF THE POPULAR SONG
by Gene Lees

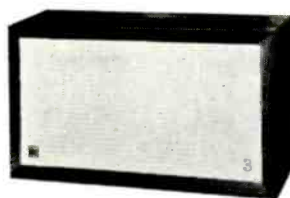

AR-3 REPORT FROM LONDON: R. L. West writes in the March, 1963 *Hi-Fi News*, "This is the first time in his life that the reviewer has ever heard 20 c/s from a commercial loudspeaker. Feeling is perhaps a better word. Above 25 c/s it [*the AR-3*] will take enough power to make really impressive organ pedal tone without obvious harmonic generation.

"... the most outstanding feature is its lack of bass — on all the occasions when there shouldn't be any! The reviewer sees why they have been raved about in their homeland."

MUSIC EDITOR'S EVALUATION OF THE AR-3: Robert C. Marsh writes in a recent issue of the *Chicago Sun-Times*, "If you want maximum music from compact speakers and will pay the price in power, the AR-3 is the obvious answer." (The AR-3's acoustic suspension design *requires* a small enclosure, without which it could not produce its clean bass.)

DIZZY GILLESPIE ON THE AR-2a: Charles Graham reports in the January, 1963 *Jazz*, "Dizzy chose Acoustic Research AR-2a loudspeakers... on the evidence of the bass fiddle beat of his own recordings. In addition he said it was important to him to get extremely clean middle- and high-frequency sounds."

AR-3 speakers are \$203 to \$225, depending on finish. The AR-2a, a lower-cost version of the same acoustic suspension design, is \$109 to \$128. The 5-year AR speaker guarantee covers parts, labor, and reimbursement of any freight charges to the factory.

A catalog and list of AR dealers in your area will be sent on request.

ACOUSTIC RESEARCH, INC., 24 Thorndike Street, Cambridge 41, Massachusetts



**BOTH
POLYESTER
BASE**

BUT ONLY ONE IS MYLAR® . . .

When tapes of Du Pont MYLAR* polyester film first appeared on the home-recording scene, they brought a standard of performance that was unknown before. Naturally enough, the people who wanted assurance of tape that wouldn't break, tape that kept precious per-

formances for years in all climatic conditions, couldn't risk using other tapes. MYLAR was preferred for top-quality tapes. ■ Now, other polyester films are beginning to appear. They are not all the same; MYLAR is a polyester film, but other polyester films are not MYLAR. In the

*Du Pont's registered trademark for its polyester film.

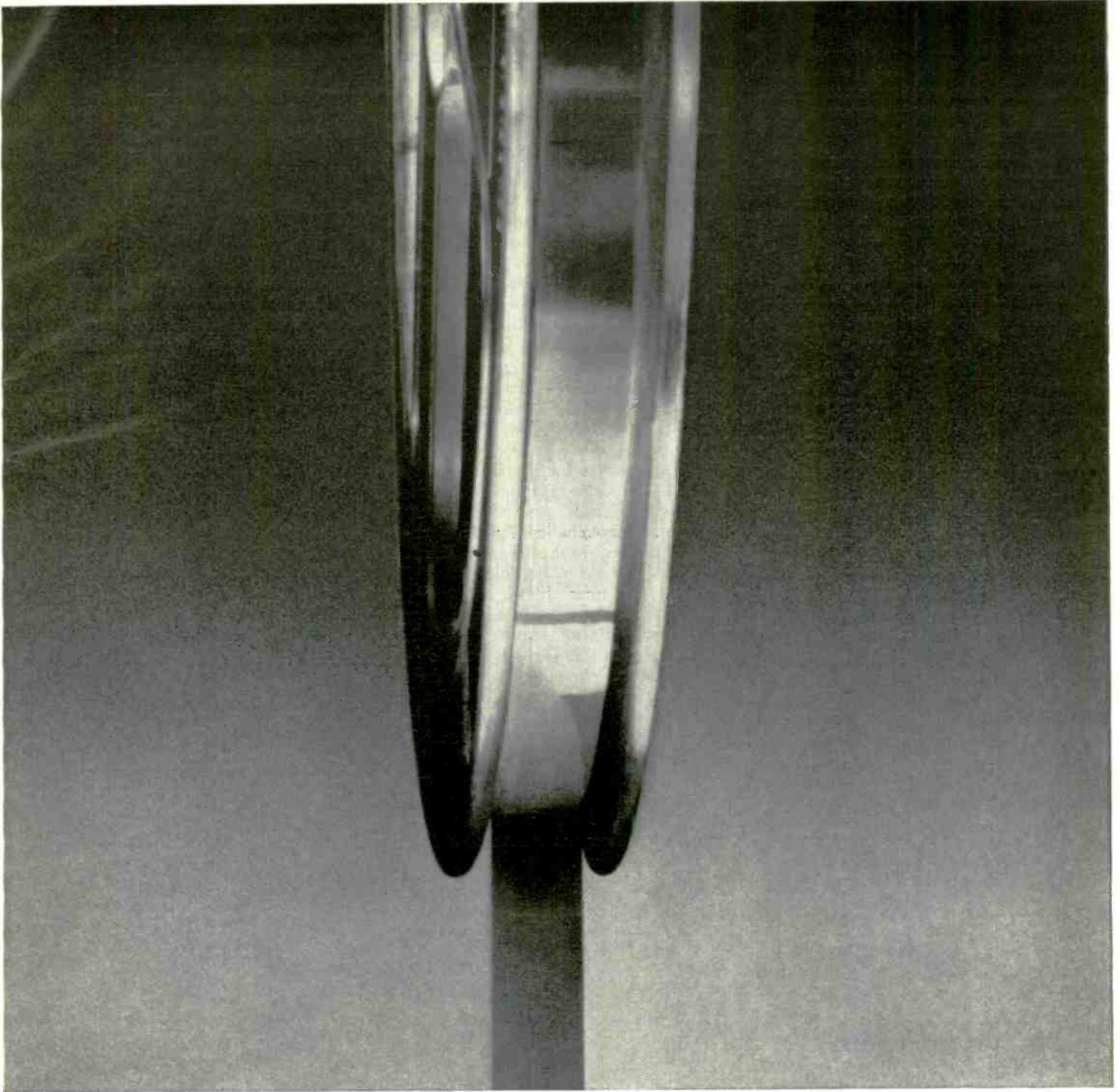

PROVEN IN USE

past you could be sure you were getting MYLAR when you bought a box of magnetic tape marked "polyester". Today you cannot. ■ There's only one way to be sure you're getting the MYLAR you've come to depend on for proven premium performance.

PICK THE BOX WITH THIS TRADEMARK
NOVEMBER 1963 CIRCLE NO. 43 ON READER SERVICE CARD



BETTER THINGS FOR BETTER LIVING . . . THROUGH CHEMISTRY

only **DUPONT** makes

MYLAR[®]
POLYESTER FILM



ALTEC SOUND TALK

WHY ALTEC DROPPED "HI FI" IN FAVOR OF "PLAYBACK"

There was a time when the term "hi fi" commanded an awed respect; but today its application can be virtually meaningless. So misleading, in fact, that the Federal Trade Commission is attempting to establish a binding definition of "high fidelity"—one on which the FTC can issue a ruling that will protect the buying public against the increasing horde of inferior products that are being advertised as "hi fi."

But a simple, workable definition that would adequately classify truly dedicated high fidelity components is not easy to come by. On request, the EIA composed a definition which was so loose that we understand the FTC found it entirely unacceptable and have now turned to other industry bodies for suggestions in the hopes that someone can come up with an industry solution that can be used to clearly identify those products that are capable of music reproduction above the ordinary.

WHAT'S THE ANSWER?

For Altec, the solution was so obvious we're rather embarrassed that we hadn't thought of it before. We simply dropped "hi fi" and replaced it with the original generic term for all Altec recording studio equipment... **PLAYBACK**.

PLAYBACK is the one definition that cannot be compromised or falsely exploited. For **PLAYBACK** is the term used in the recording industry to designate the studio sound reproducing equipment relied on by conductors, performing artists and recording engineers to accurately compare the realism of a recording with the live rendition.

Only *genuine* **PLAYBACK** components have been able to meet or surpass these critical demands.

THE ASSURANCE OF PROFESSIONAL ACCEPTANCE

Since the beginning of modern sound reproduction, **PLAYBACK** has been directly associated with Altec Lansing. For Altec, and only Altec, sells 80% of its products to the professional usage market. This is your assurance that any Altec component you choose for your home is of genuine studio **PLAYBACK** quality. You need only ask yourself this: Who should be better judge of audio components than the user whose living depends on them?

The more you think about it, the more you'll appreciate why Altec dropped the term "high fidelity" and has returned to its original genre. "Hi fi" is a matter of personal interpretation. **PLAYBACK** is a matter of *fact*.

Altec Lansing Corporation
Anaheim, California

© 1963 ALD
CIRCLE NO. 5 ON READER SERVICE CARD

LETTERS TO THE EDITOR

Picaresque Clancys

● In my review of Peg and Bobby Clancy's "Songs from Ireland" (September), my word for the Clancy Brothers in America was not, as the printer had it, "picturesque"—an adjective I haven't used for twenty years—but "picaresque," which has the virtue of meaning something.

NAT HENTOFF
New York, N. Y.

Music Criticism

● I would guess that a common reaction among readers of Frederic Grunfeld's article "Music Criticism: Where Words Fail" (August) was "Yes, but." Anyone who has read music criticism is bound to feel that, the general relevance of Mr. Grunfeld's indictment notwithstanding, *somebody* has been gravely wronged. My nominations for Mr. Grunfeld's apologies are the American Virgil Thomson and the British novelist and critic W. J. Turner.

For the most part the musical review is the lowly stepchild of the prose art, hastily conceived, ill-formed, more journalism than criticism, and often the most subjective journalism at that. But Thomson's reviews for the New York *Herald Tribune* during the 1940's are trenchant and lively capsule essays that still make enlightening reading. We search our newspapers in vain today for the insight and felicity of expression of this paragraph, taken from the collection entitled *The Musical Scene*:

Beecham alone of the great conductors, as Nikisch did before him, collaborates with an orchestra rather than conquers it. As a result his orchestra always sounds like an ensemble of skilled musicians rather than like a Panzer division on the march. This particular attitude toward music-making places him at once as the survivor of a vanished epoch and the hope of the next. He is the obvious rallying-point for all those musicians, young and old, who have had enough of musical Caesarism.

And time after time, Thomson, with startling accuracy, put his finger on just what matters about a musical work or a performer:

[*Der Rosenkavalier*] does not bother me and does not amuse me. I can take a cat nap here and there without seeming to miss anything, because when I wake up the music is always doing exactly what it was when I dropped off.

Mr. [Artur] Schnabel does not admit, or plays as if he did not admit, any differ-

ence between the expressive functions of melody and of passage work. The neutral material of music—scales, arpeggiated basses, accompanying figures, ostinato chordal backgrounds, formal cadences—he plays as if they were an intense communication, as if they were . . . as important as the main thematic material.

Few of W. J. Turner's works have been published in this country, but many will recognize his *Mozart: the Man and the Works*, in Anchor's paperback series. His *Berlioz* is equally distinguished for scholarship, profundity, and wit. Turner is a delight to read—a gift that, if it dominates, can injure serious discourse, but one that is most welcome if it accompanies the higher rhetorical virtues. He never uses the critical language Mr. Grunfeld deplores as being able to "camouflage the fact that nothing is being said." His straightforward prose—these examples are from *Music and Life*—illuminates his perceptions while it entertains his audience:

I do not think . . . that the role of music is to express lamentations for children sunk in the *Lusitania*. Such a lament for strings by an English composer has been much praised, but I can find no merit in it. To me it is only a quiet, unaggressive noise, from which I gather that the composer

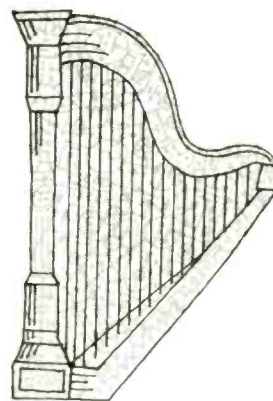

felt sad, and, for the moment, gentle. That is to say, it merely conveys information and expresses grief just as tears do, and is simply a roundabout way of the composer coming on to the platform, ejaculating *Lusitania*, with a sob, snivelling into a handkerchief, and retiring.

The whole of modern opera, with its subordination of music to drama, the music being a growling commentary on the drama instead of being the drama itself, is a bastard production due more to Wagner's theories and the incapacity of his followers than to his practice.

(Continued on page 12)

One-year subscriptions to **HIFI/STEREO REVIEW** may be purchased in Australian pounds (2/15/12); Belgian francs (310); Danish kroner (33); English pounds (2/4/6); French francs (31); Dutch guilders (22); Indian rupees (31); Italian lire (3,000); Japanese yen (2,100); Norwegian kroner (45); Philippine pesos (25); South African rand (4.50); Swedish kroner (33); Swiss francs (27); or West German marks (25). Ziff-Davis Publishing Company also publishes **Popular Photography**, **Popular Electronics**, **Electronics World**, **Popular Boating**, **Car and Driver**, **Flying**, **Modern Bride**, **Amazing**, and **Fantastic**.

HIFI/STEREO REVIEW

Records at Cost!

through our Special Membership Plan

- no "agree to purchase"
- freedom of selection
- prompt service
- periodic specials
- free Schwann catalog
- 100% guarantee

BUILD YOUR RECORD LIBRARY INEXPENSIVELY, QUICKLY, CONVENIENTLY NO "AGREE TO PURCHASE" OBLIGATION — CHOOSE RECORDS YOU WANT

THE CITADEL RECORD CLUB is a unique kind of membership club that entitles its members to purchase singles, hi-fi and stereo albums at cost; all categories of music are available including classical, popular, jazz, show hits, folk, children's records etc. Prices never vary from our published price list. There are never any "list price" purchases through Citadel.

CITADEL RECORD CLUB MEMBERSHIP — the complete record service for you and your family. Whether your music interests are classical, popular, jazz, show hits, folk — whether you prefer one label or a variety of labels and artists . . . all are available through Citadel.



CITADEL MEMBERSHIP — THE PROVEN METHOD OF RECORD BUYING USED BY THOUSANDS OF SATISFIED CLUB MEMBERS BECAUSE...

- **YOU DECIDE ON YOUR PURCHASES** — You are not obligated to purchase any particular quantity of records. Buy as few or as many records as you want, when you want them . . . the choice is always yours. Citadel has no "agree to purchase" requirement of any kind.
- **YOU HAVE COMPLETE FREEDOM OF SELECTION** — Virtually any record or album by any artist on any label is available including ABC, Angel, Atlantic, Audio Fidelity, Bach Guild, Blue Note, Caedmon, Capitol, Columbia, Command, Decca, DGG, Dot, Epic, Folkways, Impulse, Kapp, Liberty, London, Mercury, MGM, Pacific Jazz, Period, Philips, Prestige, RCA, Riverside, Roulette, Spoken Arts, United Artists, Vanguard, Verve, Warner Brothers, Westminster, and hundreds of others as well as most imports. Again, the choice is completely up to you. Citadel has no "pre-selected" list of recordings for you to choose from. We do not limit your choice in any way.
- **PROMPT SERVICE** — Many orders are shipped the same day received, rarely later than the next several days. In the event of a delay, partial shipments are made and your order completed as soon as the record is available and, of course, without any additional cost to you.
- **PERIODIC SPECIALS** — Periodically you receive a list of hit albums from all categories of music at prices up to 55% off list. The selections depend on those special purchases we have been able to make. Again, you are under no obligation to purchase any of these selections.
- **FREE! SCHWANN RECORD CATALOG** — With your membership you receive this quick reference to over 25,000 albums. This easy-to-use catalog contains separate sections for classical, popular, ballet, opera, musical shows, folk music, jazz, etc., and lists a separate section for all new releases. You are not restricted to this catalog; it is simply a handy guide.
- **100% GUARANTEE** — All records Citadel supplies to members are guaranteed factory fresh and free of defects or damages of any sort. If a damaged or defective record does get through our inspection, we shall immediately replace it with a perfect copy.

Special! BONUS BENEFITS MAKE YOUR CITADEL MEMBERSHIP THE MOST VALUABLE CLUB YOU EVER JOINED

- **DIAMOND NEEDLES**  A complete selection of 100% guaranteed, precision engineered diamond needles is available for virtually all cartridges. A clearly pictured, easy-to-follow order form is sent to you along with your catalog.
- **GIFT CERTIFICATE SERVICE**  A great help in solving your gift-giving problems to friends and relatives for birthdays, anniversaries, holidays or any special occasions.
- **OPTIONAL PRE-RECORDED TAPE DIVISION MEMBERSHIP**  Many Citadel members collect both LP's and pre-recorded stereo tapes. As an added service we have made all stereo tapes available. Details on attached card.

Membership dues is \$3.00 a year . . . a nominal amount if you reflect for a moment on the record purchases you have made within the past year and the prices you have paid. AS A CITADEL MEMBER BUYING RECORDS AT COST, YOUR DUES WILL BE PAID FOR WITH VIRTUALLY THE FIRST PURCHASE YOU MAKE THROUGH THE CLUB. Additional savings quickly mount up, permitting you to buy many more albums on your record budget. Special bonus benefits make your membership an ever increasing asset as you now have a complete record source to serve your needs.

May we suggest that you give Citadel Record Club an opportunity of proving its value to you. You enter no obligations, take no risks . . . simply complete the attached card, mail, and upon receipt we shall immediately forward all club membership material to you. We cordially invite you to join thousands of other satisfied Citadel members who are purchasing their records at cost price through their Citadel Club membership.

SATISFACTION GUARANTEED Try membership in Citadel Record Club for 30 days. If at the end of that time you are not satisfied in every respect, simply request your membership dues back and it will be immediately refunded, no questions asked.

CITADEL RECORD CLUB

545 FIFTH AVENUE

NEW YORK, N. Y. 10017

There's no smoke
like a pipe



-no pipe like
KAYWOODIE

PIPES AND SETS
\$5.95 TO \$2,500.



Super Grain, Apple, \$7.95

Large pipe above: Straight Grain, Billiard, \$100.

New Kaywoodie Butane Lighter

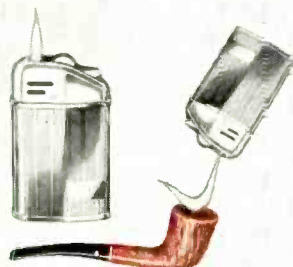

Specially designed for pipes as well as cigarettes. Upright for formal flame. Tilt for large soft flame that won't scorch your pipe. Only \$5.95 with free miniature Butane Injecto-Refuel cartridge. Table model \$14.95. Guaranteed for life.

KAYWOODIE

Send 25¢ for 48-page catalog and sample of new imported Kaywoodie Tobacco. Tells how to smoke a pipe; shows all shapes and styles. Kaywoodie Pipes, Inc., New York 22, Department Z31.
CIRCLE NO. 83 ON READER SERVICE CARD
12

(Continued from page 8)

I feel certain that Mr. Grunfeld, after passing a few hours at getting to know Thomson and Turner—if he does not already—would agree that they belong with Berlioz and Schumann and Shaw in the scarce company of estimable music critics.

DAVID TOLAND
Boston, Mass.

● How refreshing it is, in a world filled with people taking themselves so seriously, to find someone still able to refrain from doing so. Frederic Grunfeld accomplishes beautifully the all-but-impossible task of sustaining the authentic note of the laughing philosopher throughout his amusing article "Music Criticism: Where Words Fail." But I wonder how many of your serious-minded readers took him seriously.

MCKIM DAINGERFIELD
New York, N. Y.

Several.

Shostakovich's Fourth

● I agree with David Hall's judgment (in his review leading off July's "Best of the Month" selections) that the Shostakovich Fourth Symphony is definitely one of that composer's finest works. Yet I am appalled that perhaps his greatest symphony, the Eighth, has not yet found its way to discs. Considering Ormandy's magnificent reading of the Fourth (MS 6459, ML 5859), and Columbia's beautiful recording, this seems to be the team for the task.

HAROLD BROWN
Broadview, Ill.

Haydn by the Schneiders

● Readers of B. H. Haggin's article "Essentials of a Chamber Music Library" in your June issue may be interested to know that most of the Schneider Quartet's performances of Haydn quartets on Haydn Society recordings, cited by Mr. Haggin as "the ones to hunt for and acquire," have been reissued by The Record Hunter of New York.

Since these reissues are the exclusive property of The Record Hunter, and no other store carries them, and since they are not listed in the Schwann catalog, it is a fair assumption that most prospective buyers will not know they are in circulation again.

ROBERT HOWLAND
Chicago, Illinois

Haydn Society pressings of many of these quartets, including the complete Opp. 33, 50, 51, 76, and 77, are indeed available from The Record Hunter, 507 Fifth Avenue, New York 10017. The price is \$4.98 each postpaid. A minimum mail order of four is required.

Satisfied Customer

● I must convey to you my satisfaction with Larry Klein's August article "Three Speaker Enclosures." I have just completed the construction of two of the larger bass-reflex enclosures. After my initial listening sessions with the units, I can say only one thing about the results: I am immensely pleased with their tonal quality. Three cheers for Mr. Klein.

DONALD REEFE
Boca Raton, Fla.

Flanagan on Richter

● In the September issue William Flanagan, in his review of Gary Graffman's Columbia disc "Russian Piano Music" (MS 6444, ML 5844), concedes that Graffman is "not yet . . . the master that Richter is," but continues, "Graffman illustrates large powerful forms . . . whereas Richter subordinates all to a

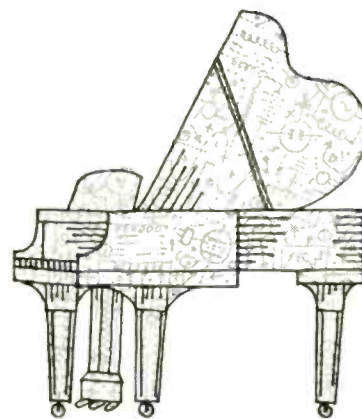

dominating personal lyricism." Mr. Flanagan apparently believes that Graffman is presenting the "real" Prokofiev but Richter is giving us a saccharine second-hand version.

I would like to remind Mr. Flanagan that for perhaps fifteen years, until Prokofiev's death in 1953, Richter was a close personal friend of the composer and his chosen interpreter as well. Furthermore, Prokofiev was a great admirer of Richter's pianism. The "war sonatas"—with the exception of the Eighth, written for Gilels—were written with Richter in mind: it was Richter Prokofiev chose to play them at their premieres. And Prokofiev also dedicated his great Ninth Sonata to Richter.

I also differ with Mr. Flanagan's finding that "personal lyricism" is alien to Prokofiev's music. When did Mr. Flanagan last listen to the violin concertos, the Second Violin Sonata, the Fifth and Seventh Symphonies, and so forth?

As for the rest of the review of Graffman's disc, if Mr. Flanagan finds Graffman's performance of the Rachmaninoff works superb, he should listen to that composer's G Minor Prelude as played by Richter on the two-disc set recorded at Carnegie Hall (Columbia M2L 282).

(Continued on page 14)

HIFI/STEREO REVIEW

CIRCLE NO. 69 ON READER SERVICE CARD →

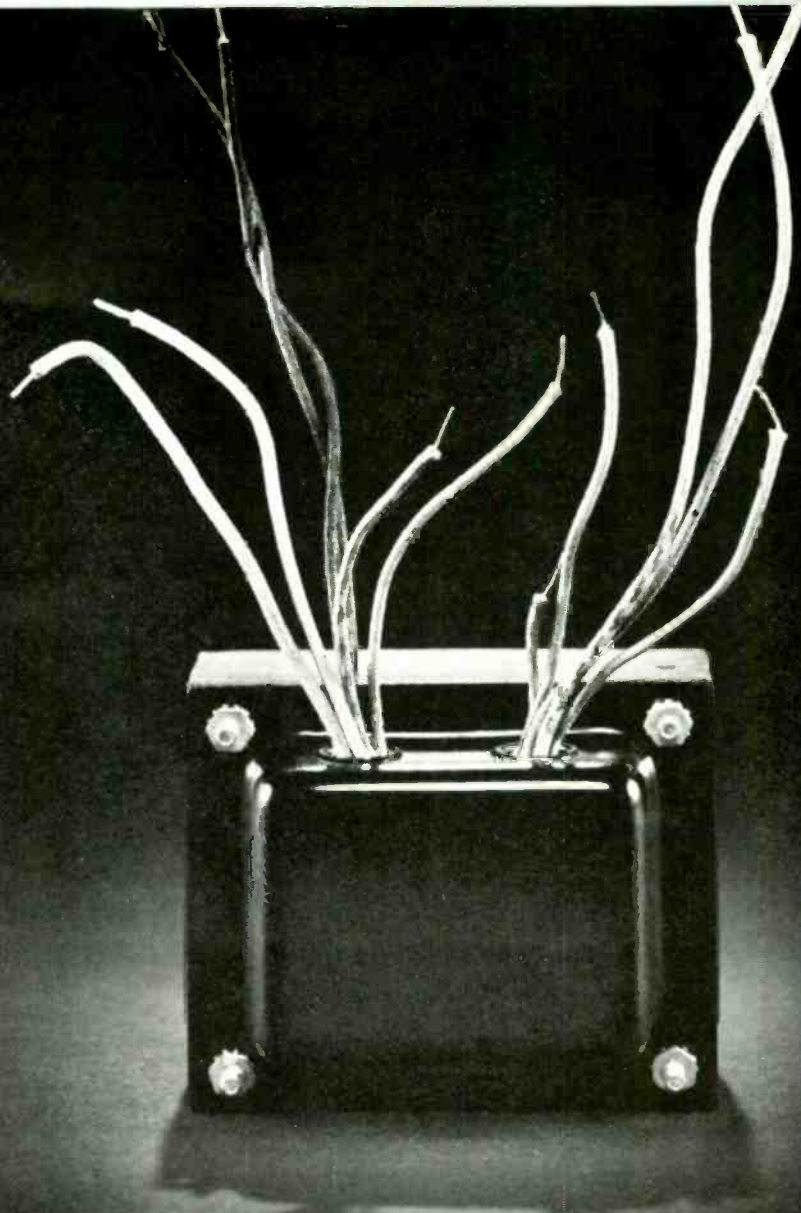

EXTRAVAGANCE?

Scott uses heavy, oversized output transformers on their amplifiers and tuner/amplifiers. Most manufacturers settle for lightweights, as little as half the iron found in Scott equipment. Is this extravagance?

Scott feels the extra dollars put into jumbo output transformers is an absolute necessity! Just listen to the solid, clean bass response you get from all Scott amplifiers and tuner/amplifiers. To obtain this kind of bass you need power and lots of it in the vital low frequency range. And to get this extra power you must have big, heavy, oversized transformers like the ones you find on all Scott amplifiers (even the budget-priced Model 200B.)

Scott never economizes on performance or reliability. That's why

you find big transformers, conservatively rated components, and electrolytic aluminum chassis (for coolest operation and low hum) on all Scott equipment. With Scott equipment you make an investment in years of trouble-free listening enjoyment.

Scott extravagances can be found in the powerful 80-watt 299D and the modestly priced 48-watt 222D, as well as the previously mentioned 200B. They can be found on all Scott Kits. Visit your favorite hi-fi dealer for a demonstration or circle the number below on the information card bound into the magazine, and

Scott will mail you complete information on all their quality products.



299D 80-watt Stereo Amplifier \$229.95

Prices slightly higher west of Rockies



H. H. SCOTT, INC., 111 POWDERMILL RD., MAYNARD, MASS.

Export: Morhan Exporting Corp., 458 Broadway, New York, N. Y. • Canada: Atlas Radio Corp., 50 Wingold Avenue, Toronto.

NEW!

GRADO TRACER BEAM

STEREO CARTRIDGES

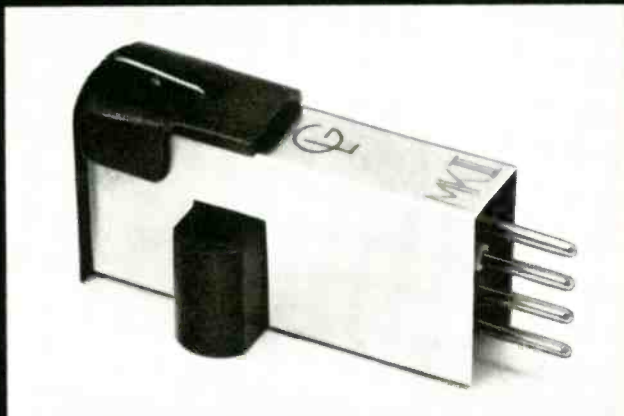

THE GRADO TRACER BEAM STEREO CARTRIDGES MEET ALL OF THESE REQUIREMENTS!

Eliminate inner groove distortion.

Eliminate completely "Shattering," and buzzing during playback.

Play both stereo and monaural records.

Be completely non-critical to installation problem and still perform superbly.

Track in a good tone at 1 gram or less (not just make sound but trace with low distortion!)

Work in all record changers and automatic turntables at up to 6 grams.

Have 1M distortion of no more than 2% at the highest recorded levels and maintain 1% or less 1M distortion for normal recorded levels.

Have a high frequency response to at least 24,000 CPS or better.

Have a FLAT frequency response down to 10 CPS.

STYLUS ASSEMBLY REPLACEABLE BY CONSUMER!

TRACER BEAM MK II STEREO CARTRIDGE \$49.50
TRACER BEAM MK III STEREO CARTRIDGE \$37.50
TRACER BEAM MK IV STEREO CARTRIDGE \$27.50

For further information please write:

GRADO LABORATORIES, INC. 4614 Seventh Ave., B'klyn 20, N.Y.

(Continued from page 12)

or by Josef Hofmann on the disc made from the recording of his 1937 recital. Graffman may have assimilated "values foreign to the limited culture that produced Richter," but I do not think that Graffman has assimilated those "limited" old-world values common to a school of piano playing that began with Anton Rubinstein, continued with Hofmann and Rachmaninoff, and presently finds its greatest exponent in Sviatoslav Richter.

I should add that this is also the culture that produced Serge Prokofiev.

M. STEPHEN WIGLER
Garden City, N. Y.

Mr. Flanagan replies: "Mr. Wigler's letter deserves, I fear, the classic rejoinder, 'You said it, I didn't.' For nowhere in my review of the record in question did I say that Richter's performances were either 'saccharine' or 'second-hand.' Furthermore, in my use of the phrase 'personal lyricism,' I was referring to Richter's performing style, not to Prokofiev's compositional style. In point of fact, Mr. Wigler is forming his own conclusion when he assumes my review even suggests that one performance is better than the other.

"But I think that the point of my review remains valid, and I do not feel that it is affected either by Mr. Wigler's roll-call of Russian greats or by his chronicle of the Richter-Prokofiev relationship. For twentieth-century Russian musical culture has indeed been 'limited' by party dogma: as a matter of fact, dogma has anathematized the spirit of experiment, innovation, and aesthetic re-evaluation that characterized Paris in the middle 1920's, where, to a large degree, modern music was born. To this spirit Prokofiev was fully, excitedly, and impressionably exposed prior to his return to the—I repeat—limited culture of the Soviet Union.

"That Graffman has grown up as a child of the century I describe here is as obvious as it is that Richter has not. Certainly, Graffman's playing specifically reflects our century's characteristic reaction to certain stylistic excesses of nineteenth-century Romanticism, as indeed does much of Prokofiev's sophisticated, carefully contoured, bittersweet, acidic lyricism. These aspects of Prokofiev's music are the ones that identify him as a twentieth-century composer—which, his conservatism granted, he unquestionably was in every way, party jargon to the contrary. And I think not even Mr. Wigler would deny that these qualities are more apparent in Graffman's approach than in Richter's. Whether their being so makes Graffman the better interpreter of this composer's music is a pointless judgment that, in my review, I carefully avoided making."

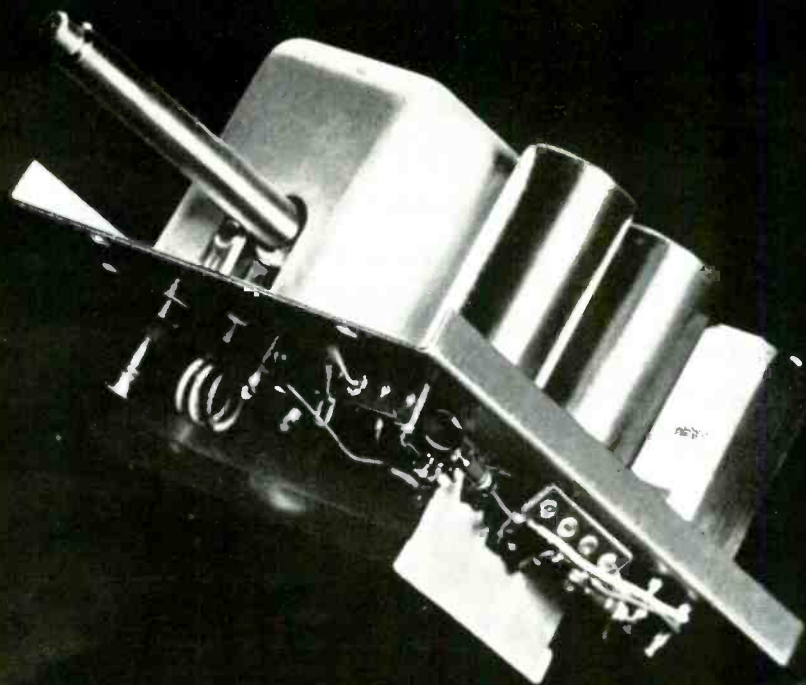

EXTRAVAGANCE?

Is it an extravagance to silver-plate the critical Radio Frequency circuit (front-end) of an FM tuner? Scott doesn't think so . . . and neither do the editors of the leading hi-fi magazines.

For example . . . Audio reporting on the Scott 4310, said, "Without question, this tuner is one of the finest extant. It pulled in more stations, loud and clear, than any other tuner we have tested. The record now stands at 40 stations."*

What makes Scott tuners pull in more stations, loud and clear, than any other tuners? Is it the exclusive Scott Time-Switching multiplex circuitry . . . the Scott Wide-Band design? Partly.

It is also the fact that Scott, and only Scott, goes to the extra expense and trouble of silver plating Radio Frequency circuits. Silver is a far better conductor of electricity than steel or aluminum, the materials commonly used by most tuner manufacturers. With this greater conductivity the tiny signal received by the tuner

(often just a few microvolts), is not subject to signal losses or the addition of noise. As a result, Scott tuners can receive many more stations, cleanly, and without distortion.

Scott tuners are used in the most critical professional applications. It was a Scott tuner that was selected by Bell Laboratories for the famous Telstar Tests. Most broadcasting stations use Scott tuners for monitoring their own broadcasts and for relay applications. These professionals recognize the advantages of Scott's scrupulous attention to details like the silver-plated front end . . . details that make Scott the ideal choice for enjoying FM stereo in your home as well.

Scott tuners are available in all price ranges, in factory assembled or in kit form. Prices start at \$119.95.

Write today for complete details.

*Audio, September 1963.



350 C FM Stereo Tuner \$224.95

Prices slightly higher west of Rockies



SCOTT®

H. H. SCOTT, INC., 111 POWDERMILL RD., MAYNARD, MASS.

Export: Merhan Exporting Corp., 458 Broadway, New York, N. Y. • Canada: Atlas Radio Corp., 50 Wingold Avenue, Toronto.



JUST LOOKING

... at the best in new hi-fi components

Mated to Perfection!
THORENS
NEW STEREO TURNTABLE
WITH INTEGRATED ARM



THORENS TD-135

COMPLETE WITH INTEGRATED ARM

For the first time, Thorens — in the new TD-135 — offers a *component-quality* arm and turntable mated with a precision that insures you perfect sound . . . always . . . with a minimum of installation effort on your part.

There's no compromise whatever with quality such as you usually find in integrated turntable and arm units. THORENS TD-135 is Swiss-precision crafted throughout . . . true component high fidelity all the way. You get: A precision turntable featuring 4 speeds, all adjustable, with an 8-pound non-magnetic table . . . plus a completely new, advanced tone arm that's so good we also sell it separately (see below) for use with *any* turntable of your choice. Exceeds NAB specs for wow, rumble and flutter. Has same belt-plus-idler drive as famous TD-124. Shuts off automatically at end of record. Many, many more features than we can detail.

\$125 net



THORENS BTD-12S
12" PROFESSIONAL TONE ARM

Identical arm included with TD-135, but sold as separate unit. Less than 0.5" inch tracking error. Built-in cueing device. All adjustments: vertical height; calibrated gram-force; stylus positioning slide; balancing counter-weight. Unique vertical pivot keeps stylus vertical for any height adjustment. Resonance well below audible frequencies. Interchangeable 4-pin cartridge shells. Mounted on board for THORENS TD-124, TD-121 turntables.

\$50.00 net

See and hear the THORENS TD-135 and ALL the members of the "TD" family of fine turntables at your franchised dealer's today; there's one for every budget! For additional information, write us direct.



THORENS DIVISION
ELPA MARKETING INDUSTRIES, Inc.
New Hyde Park, N. Y.

CIRCLE NO. 26 ON READER SERVICE CARD
16

● **Audio Dynamics** adds the ADC-12 speaker system to its line. This system, like its larger counterparts the ADC-14, ADC-16, and ADC-18, features a rigid rectangular foam-diaphragm woofer with



a nine-pound ceramic magnet. A high-compliance double surround of molded cloth supports the foam radiator. High frequencies are handled by a specially designed tweeter with a 1/2-inch voice coil and Mylar diaphragm. The 23 1/2 x 13 x 11 3/4-inch speaker cabinet is of oiled walnut and can be mounted either vertically or horizontally. Frequency response is 38 to 20,000 cps, and impedance is 8 to 16 ohms. The ADC-12 can be driven by an amplifier rated as low as 10 watts (rms) per channel. Price: \$139.50.

circle 184 on reader service card

● **Burgess** is marketing a new test tape for the home tape recorder. Designed to check out a tape recorder for maximum record and playback efficiency without additional test equipment, the test tape includes recorded step-by-step explanations that instruct the recordist how to check his recorder for fidelity, balance, timing accuracy, and frequency response. Such techniques as sound-on-sound, splicing, and editing are also explained. Price, including a 1200-foot reel of blank Burgess tape: \$8.

● **Elpa** is now marketing two new record-cleaning devices designed by Cecil Watts and imported from England. The Parastat dislodges dirt from record



grooves, and deposits an antistatic solution on the disc. Price: \$15. A lower-cost record-cleaning unit, the Preener, is also available. Price: \$3.

● **Inter-Mark** introduces the Cipher VII, a new stereo tape recorder that includes heavy-duty detachable speaker systems. The unit features three-speed operation, two VU meters, individual volume and tone controls for each channel, automatic tape shut-off, and facilities for sound-on-sound recording and stereo-earphone connection. Jacks are also provided for radio, phonograph, and microphone, as well as for external speakers and amplifiers. Frequency response is 35

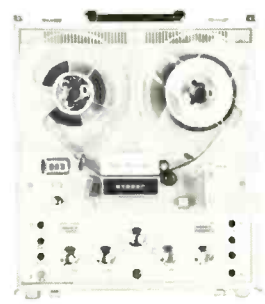

to 15,000 cps at 7 1/2 ips, and signal-to-noise ratio is greater than 50 db. Wow and flutter are 0.2 per cent at 7 1/2 ips, and distortion is less than 2 per cent. Price: \$274.95.

circle 185 on reader service card

● **3M's** new tape reel is threaded by merely laying the tape between the flanges near the hub. As the reel spins, the tape winds automatically around the hub. The self-threading reel has solid



flanges, and comes equipped with a snap-closure collar that makes the combination a dust-proof self-storing unit. Each set includes pressure-sensitive adhesive labels for both reel and collar. The new reel, valued by the company at \$1.50, will be offered initially for 39 cents with each purchase of three 7-inch reels of Scotch recording tape.

● **Omega's** new Model 1800 Laboratory Series solid-state integrated stereo amplifier has a power rating of 35 watts
(Continued on page 18)

HIFI/STEREO REVIEW

CIRCLE NO. 69 ON READER SERVICE CARD →

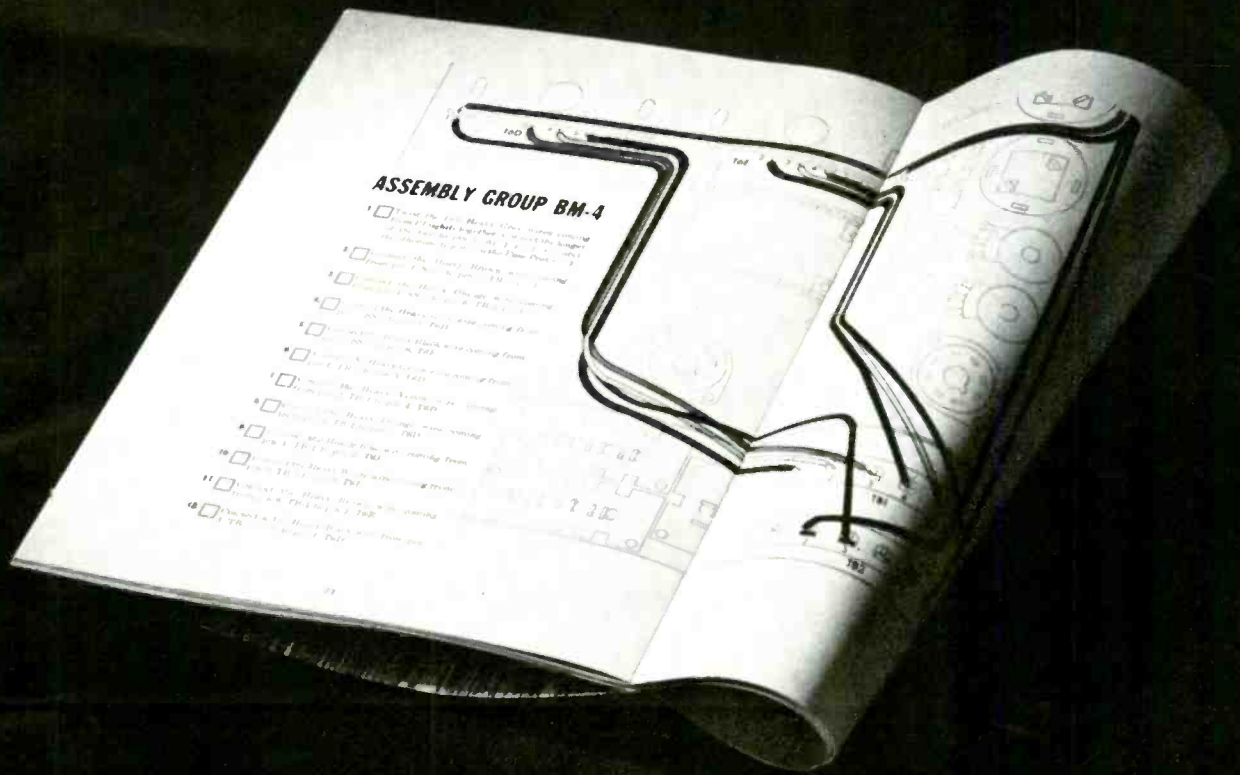

EXTRAVAGANCE?

Printing an instruction book in natural color is a tremendously costly process. All other kit manufacturers print their instruction books in black and white. If black and white is good enough for everybody else why must Scott spend so much extra for color?

As Popular Electronics puts it, "the exclusive Scott full color instruction book eliminates just about the last possible chance of wiring errors . . ." Every part is shown in natural color and in its proper position. All you have to do is look at the picture and you instantly know where each part goes. Only a few parts are shown in each colored pictorial to avoid confusion. A separate Part-Chart is provided for each pictorial. The components are mounted on the Part-Charts in the exact order used. Sounds simple? It is simple. So simple that thousands of people who never built kits before,

are proudly listening to superb Scott stereo components they built themselves.

Thanks to the instruction books and the unique Scott Ez-A-Line method you can build tuner kits as easily as amplifier kits and you don't need any laboratory test equipment.

Extravagant? No, sir—Essential as far as Scott is concerned. The proof of our reasoning is this typical review of Scott kits: "The Scott instruction books should be a model for the industry . . . the finest in the kit field." American Record Guide.

Only the finest is good enough for Scott, and for you, too. Write for information on the complete line of Scott-Kit tuners and amplifiers. Use reader service number below.



LK-72 80-watt Stereo Amplifier Kit \$164.95

Prices slightly higher west of Rockies

Export: Morhan Exporting Corp., 458 Broadway, New York, N. Y. • Canada: Atlas Radio Corp., 50 Wingold Avenue, Toronto.



H. H. SCOTT, INC., 111 POWDERMILL RD., MAYNARD, MASS.

(Continued from page 16)



There's *no end* to your listening pleasure with Concertone *double Reverse-O-Matic*®

Now, there is literally no end to the unattended playing time you can enjoy. Concertone, who doubled your listening pleasure with exclusive Reverse-O-Matic, now presents *Double Reverse-O-Matic* in the dramatic 505 Imperial Series. This exclusive automatic playback feature plays 4-track stereo tapes from end to end, reverses, and plays the other 2 stereo tracks as it rewinds... then automatically "takes it from the top" again to repeat the cycle. For a full evening of uninterrupted listening, the Concertone 505 Imperial is your instrument. Create your own personal programming... then let it play to your perpetual pleasure. All the fine craftsmanship and features you expect of Concertone. Stainless steel faceplate for extra beauty. Learn all the exciting details of this magnificent new recorder. Write for complete information today.

CONCERTONE 510



Instant monitoring... the Concertone 510. Unmatched recording flexibility in one compact unit. The 510 incorporates all the features of the 505 plus twin speakers and sound-directing panels which provide instant monitoring of the recorded signal. Luxurious ebony naugahyde carrying case. Stainless steel panel. Exclusive Reverse-O-Matic feature.

CONCERTONE 400 COSMOPOLITAN

For people on the go... it's the Cosmopolitan—Combination Tape Recorder with AM Radio. A versatile companion and co-worker for business or pleasure travels. 5" reel capacity. Push-button operation. Amazing fidelity. Remote mike. Foot-pedal control. This all-transistorized recorder has big recorder features in miniature form.

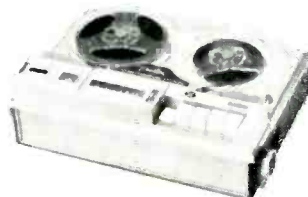

per channel for stereo and 70 watts mono, with distortion less than 0.5 per cent. Frequency response is 18 to 20,000 cps ± 0.2 db at full power output. Hum and noise is rated 75 db below full output at 10 mv sensitivity. Controls include bass, treble, mode, volume, balance, blend, loudness, scratch filter, rumble filter, phasing switch, and a tape-monitor switch.

The matching Model 1850 Laboratory Series solid-state stereo tuner is designed for extreme sensitivity and minimum noise susceptibility for fringe-area reception. IIF sensitivity is 1.6 mv with 0.3

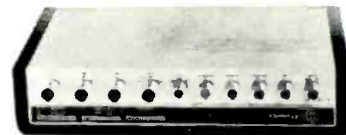

per cent maximum distortion. Stereo channel separation is 36 db, and frequency response is 15 to 30,000 cps ± 0.5 db. Controls include an interstation-noise suppressor, stereo-noise filter to minimize hiss under marginal conditions, and a local-distant switch to give optimum reception of either weak or strong signals. Other facilities include automatic frequency control, a stepped output-level control, and a stereo-broadcast indicator. Each unit is furnished with a complete test report. The Model 1800 amplifier and the Model 1850 tuner are each priced at \$349.50.

circle 186 on reader service card

● **University's Model CLC** is a speaker system engineered for outdoor and indoor public-address applications requiring high-fidelity reproduction. Replacing the University Model BLC, the CLC offers superior bass, smoother response, and modern styling. It can be installed with a screwdriver and features a U-bracket mounting to permit vertical



or horizontal installation. Weatherproof marine paint and its physical design make the CLC completely immune to rain, snow, and humidity. Frequency response is 55 to 14,000 cps, and power rating is 30 watts. Diameter is 22 $\frac{3}{4}$ inches and depth is 12 $\frac{11}{16}$ inches. Price: \$69.95.

circle 187 on reader service card

for further information write:



AMERICAN CONCERTONE, INC.
A DIVISION OF ASTRO-SCIENCE CORP.
9449 W. JEFFERSON BLVD. • CULVER CITY • CALIF.

Export: J. D. Marshall International, 170 W. Washington, Chicago, Illinois

“Brings
out sound
from records
that more
expensive
cartridges
do not”

Preston McGraw
United Press
International Hi-Fi
equipment reviewer

the incomparable

SHURE SERIES M33

Stereo Dynetic®

HIGH FIDELITY PHONOGRAPH CARTRIDGES

NOT HOW MUCH? BUT HOW GOOD?

According to United Press' Preston McGraw, the Shure series M33 cartridges are "so good that a hard-shelled listener might suspect Shure engineers of not knowing what they had when they hung a price tag on them."

We knew, all right, Mr. McGraw. It's just that we don't believe the best sounding cartridge need be the most expensive. The new Series M33, after all, was developed by the same team of engineers who developed the redoubtable Shure M3D series... the world's first truly high fidelity stereo cartridge. Numerically, Shure has made more highest-quality stereo cartridges than any other manufacturer—and they're used by more critics and independent hi-fi authorities than any other. Chronologically, Shure had a two year head start on the others. In short, Shure has learned how to make these critical components in the kind of quantities that result in lower prices.

THE SOUND OF SPECIFICATIONS

Again quoting Mr. McGraw: "Professional engineers are largely impressed by specifications, and the specifications of the M33 (except for compliance) are not unprecedented. But the way it sounds is something else again. The M33 puts flesh and bones on specifications. It brings out sound from records that more expensive cartridges do not."

He's right. To begin with, Shure specifications (as published) are not theoretical laboratory figures, or mere claims... they are actual production standards. 20 to 20,000 cps. response may appear average. But what the bare specifications don't show is that the M33 series goes right through the audible spectrum without a hint of the break-up prevalent in most other cartridges. Also, it is remarkably free from disconcerting peaking at this frequency or that. Result: absolutely smooth, transparent, natural sound re-creation. (Incidentally, where would you find a record that goes from 20 to 20,000 cps. with genuine music on it?)

Separation is over 22.5 db. at 1000 cps. Much more than necessary, really. Again, the separation figure doesn't show that the M33's separation is excellent throughout the audible spectrum. No cross-talk between channels. Even when an oboe plays.

And the matter of compliance: 22×10^{-9} cm. per dyne for the M33-5.

Now there's a specification! According to Mr. McGraw, the Shure stylus feels like a "loose tooth." And so it should. The incredible compliance of the M33-5 gives it the ability to respond instantly to the manifold and hyper-complex undulations of the record groove.

Superior sound is one outcome of the superb compliance.

Another is the ability to track the record at low force. The M33-5 will track at forces as low as any other cartridge on the market today.

SPECIFICATIONS	M33-5	M33-7
Channel Separation (at 1000 cps)	Over 22.5 db	Over 22.5 db
Frequency Response	20 to 20,000 cps	20 to 20,000 cps
Output Voltage (per channel, at 1000 cps)	6 mv	6 mv
Recommended Load Impedance (per channel)	47,000 ohms	47,000 ohms
Compliance; Vertical & Lateral	22.0×10^{-9} cent. per dyne	20.0×10^{-9} cent. per dyne
Tracking Force	$\frac{1}{4}$ to 1.5 grams	1.5 to 3 grams
Inductance	600 millihenrys	600 millihenrys
D.C. Resistance	750 ohms	750 ohms
Stylus:	.0005" diamond	.0007" diamond
Terminals	4 terminal. (Furnished with adapters for 3-terminal stereo or monaural use.)	
Mounting Centers	Fits Standard $\frac{1}{2}$ "	

One other item: if your tracking force is 4 to 6 grams, the even lower cost M77 Stereo Dynetic will deliver the best sound you can possibly get from your cartridge-arm combination.

THE ULTIMATE TEST

Give a listen. In fact, compare the Shure M33 series with any other cartridge, regardless of price, in A-B tests (we do it all the time). If you are not impressed with the distinct difference and greater naturalness of the Shure, don't buy it. That's punishment enough for us.

PRICES:

Why spend more than you must? M33-5 and M33-7 net for \$36.50 The M77 is only \$27.50

If you insist on Shure when you buy, you can demand more from the rest of your system when you play... write for literature, or still better, hear them at your high fidelity showroom: Shure Brothers, Inc., 222 Hartrey Avenue, Evanston, Illinois.

Manufactured under U.S. Patents 3,055,988; 3,077,521; 3,077,522;
D193,006; D193,934; other patents pending

portable
perfection
for
hi-fi fans



From Denmark comes this aristocrat of portables. Superb AM-FM-Shortwave performance with all the features you can imagine in a high quality portable: one full watt push-pull output and a 5" x 7" speaker, flywheel tuning with slide-rule dial, full range independent tone controls, pushbutton band selection, tuning meter and battery indicator, loudspeaker-earphone output and separate tuner output, plus plug-in connection for an auto antenna and accessory mounting bracket for over-the-road hi-fi.

Write for detailed specifications and test reports.



By appointment
to the Royal Danish Court

DYNACO

DYNACO, INC.
3912 Powelton Ave., Phila. 4, Pa.

CIRCLE NO. 44 ON READER SERVICE CARD

22

**BEGINNERS
ONLY**

by HANS H. FANTEL

DISTORTION – PART III

MY RECENT columns on distortion have dealt chiefly with harmonic and intermodulation distortion, the two types most commonly included in specifications for high-fidelity components. But components are subject to other forms of sonic misbehavior that are rarely stated on data sheets because they are too elusive for direct measurement. One such culprit is called transient distortion.

Transients are sounds that reach a high loudness level very quickly and then diminish just as quickly. Drum beats and other percussion sounds are good examples, as is the sound of plucked or struck instruments, such as guitars, cymbals, and pianos.

Transients present a problem to amplifiers and speakers because they represent pulses of voltage and current that build up suddenly to high levels. In the engineer's language, such sounds (and their electrical analogs in the amplifier) have a "steep wavefront." These steep wavefronts pose a stiff challenge, because the circuits within the amplifier must be capable of almost instantaneous—and controlled—response, and the speaker cone must respond without inertial delay. And when the brief sound pulse is past, the equipment must immediately return to the resting state without oscillation or bounce. Poor transient response distorts the steep vertical wavefronts, rounding the sharp edges, and sometimes causes what is known as "shock-excited oscillation." Aurally, such distortion is especially noticeable during percussive passages, but it can also cast a pall over the whole texture of the sound, beclouding orchestral transparency.

Unfortunately, there is no mathematically exact way of measuring the transient characteristics of amplifiers and speakers. Some amplifier manufacturers show photographs of oscilloscope square-wave patterns in their product specifications. The square wave is used as a test signal because its vertical sides represent the steepest possible wavefront. Speaker manufacturers assess the transient response of their products by similar methods, feeding pulsed tone-bursts of a fraction-of-a-second duration into the speaker. The speaker's output, picked up by a microphone and displayed on an oscilloscope screen, provides clues to the behavior of the cone when it is responding to a signal containing sudden starts and stops.

The trouble with these attempted measurements of transient distortion is that the waveforms encountered in music are somewhat more varied and complex than the fairly simple waveforms used as test signals. Consequently, no one-to-one relationship exists between test performance and musical performance: the data are indicative, not conclusive. In the end, the critical ear, listening for clarity of orchestral texture and equal coverage of the audible spectrum, remains the most useful test instrument in this elusive area.

• • •

A word of gratitude to the many readers of this column who have asked me if I have written a book on high fidelity. Thanks to their encouragement, I now have. It has just been published under the title *ABC's of Hi-Fi and Stereo* by Howard W. Sams & Co., 4300 West 62nd Street, Indianapolis 6, Indiana, and can be ordered from the publisher for \$1.95 postpaid.

All the music-

**In the
most compact
instrument
yet**

the KLH Model Fifteen

If you've been reluctant to surrender your living room to an elaborate component system or a massive console, your KLH dealer has a thrilling surprise waiting for you. It looks not unlike a small table phonograph, but that's where the resemblance ends. Its sound is the sound of a high quality component system, because the KLH Model Fifteen is a high quality component system with the air squeezed out — the culmination of four years of development aimed at bringing you full, uncompromised stereophonic performance in an incredibly compact instrument.

Three great KLH innovations — each a major advance in its own right — have made the Model Fifteen possible:

- (1) A new KLH-designed, solid state, stereophonic amplifier with an output of 15 watts music power. Beyond the obvious advantages of long, trouble-free service, freedom from heat and noise, etc., a good transistor amplifier, in its ability to handle and recover from peak loads, is equal to tube amplifiers with twice its power (and delivers sound quality to match).
- (2) Revolutionary new full-range KLH speakers (2 in each enclosure) with the highest ratio of magnet power to cone weight ever built into a speaker. These amazing speakers account for the smooth natural sound and freedom from distortion of the Model Fifteen, as well as for its wide frequency range.
- (3) Frequency Contouring. The output curve of the amplifier is shaped to match precisely the low frequency requirements of the long-excursion speakers, to provide a bass performance you have never heard before in a system of this size.



The Model Fifteen is much more than just a compact high quality stereo phonograph. It is a complete stereophonic music center which will accept all other music sources you may wish to add. In addition to its powerful solid state amplifier and the new full-range speakers, the Model Fifteen features a Garrard AT-6 4-speed record changer and a Pickering 380C magnetic pickup, with diamond stylus. Controls are provided for Volume, Balance, Bass (15 db cut or boost), Treble (15 db cut or boost), Mono or Stereo Mode, and Phono or Auxiliary. The speaker enclosures can be separated up to 48 feet with the cables supplied — farther if you wish. Inputs are installed to give you the same flawless performance with a tuner or tape recorder. Outputs are provided for a tape recorder and earphones.

Nothing with such sound quality was ever so compact and convenient before. Or so modestly priced.

**compact
phonograph
system* \$259**

*Control Center available separately in late October.....\$179



KLH RESEARCH AND DEVELOPMENT CORPORATION
30 CROSS STREET, CAMBRIDGE 39, MASSACHUSETTS



interior by Yixzi, Beverly Hills

Captured by Concord: Sound Devotion.

Musical moments will live a lifetime with the Concord 550. Designed for the connoisseur of sound, it incorporates all the quality features so vital to professional tape recording and play back.

TRANSISTORIZED... Transistorized pre-amplifiers of the Concord 550 assure greatest operation reliability together with freedom from heat, noise and hum.

It offers all push button controls, three speeds, sound-on-sound recording, two VU meters, and 6" speakers which can be separated for full stereo effect.

The Concord 550 is the ideal recorder for operation thru the amplifier and speakers of a high fidelity music system, or as a completely self-contained stereo system.



for Connoisseurs of Sound

CONCORD 550

CONCORD  ELECTRONICS CORPORATION

809 No. Cahuenga Blvd., Dept. F, Los Angeles 38, Calif. / In Canada: Regal Industries Ltd., Montreal and Toronto

Recording from multiplex tuners is perfect with the transistor Model 550.

Priced less than \$320*

Concord 550 tape deck version of Model 550 especially fitted for easy custom installation.

Priced less than \$230*

CONCORD 220—Hi fidelity monaural recorder with push button controls, 3 speeds, sync flutterless drive motor, dual channel indicator, cue and edit buttons, and sync accessory for movie sound.

Priced less than \$150*

CONCORD 880—Finest 4-track stereo recording and play back. Professional 3-head design, sound-on-sound recording, 10 watt amplifier, computerized channel indicator, dual cathode follower, low impedance outputs. Two VU meters, three speeds, push button operation.

Priced less than \$400*

*Prices slightly higher in Canada.





BRAHMS' *Double Concerto*

Fiddler Joseph Joachim (1831-1907) shown in a 1905 caricature by Vanity Fair's Spy, has been credited with the "discovery" of Brahms, and played in the premiere performance of the Concerto.

BRAHMS spent three consecutive summers during the late 1880's vacationing in the small Swiss town of Thun. Something about its atmosphere and environment served as a powerful stimulus to his creative impulse. During these years Brahms composed some of his most heartfelt and personal works, among them the violin and piano sonatas in A Major (called the "Thun" Sonata) and in D Minor; the F Major Cello and Piano Sonata; and the C Minor Trio for Violin, Cello, and Piano.

Why this outpouring of music for the violin? One answer, unquestionably, lies in the friendship, renewed at this time, between Brahms and Joseph Joachim, the distinguished violinist and conductor. A decade earlier these two had been on close terms. Brahms composed his Violin Concerto for Joachim, and the latter was the soloist when the concerto was given its premiere, the composer conducting, at a New Year's Day concert in Leipzig in 1879. But in the intervening years Joachim became embroiled in a bitter divorce proceeding. A letter from Brahms that completely refuted some of

Joachim's charges against his wife was introduced in court, and opened a gulf between the two friends that was years in the bridging. Finally, by 1886, Joachim and Brahms were reconciled.

The following summer in Thun, Brahms composed a strange hybrid of a work—a concerto for violin, cello, and orchestra. Brahms himself conducted the premiere of the piece in Cologne in October, 1887; the soloists were Joachim and another friend of Brahms, a cellist named Hausmann. When the music was published the following year, Brahms presented the score to Joachim. On it was the inscription: "To him for whom it was written."

About a year and a half after the world premiere, the Double Concerto, as it has come to be called, was introduced to the United States at a concert in New York conducted by Theodore Thomas. The cello soloist on this occasion, a musician of uncommon artistry, was to become one of America's most successful composers of operettas—Victor Herbert.

(Continued overleaf)



The Franchescatti-Fournier-Walter version of Brahms' Double Concerto on the Columbia label is elegant and polished. Also on Columbia (Walter again conductor) is a highly personal treatment by Stern and Rose. For dynamic excitement and tension, however, the Victor version with Heifetz, Feuermann, and Ormandy is still available.

The Double Concerto was to be Brahms' last orchestral score. During the final decade of his life, Brahms composed some chamber music and some songs, and the autumnal quality of these works is a characteristic of the Double Concerto too.

The concerto is in three movements, and the writing for the two solo instruments is a matched discourse of perfect fusion. The opening allegro is a dramatic movement rich in lyrical warmth. Brahms' biographer, Walter Niemann, describes the andante slow movement as "a great ballad, steeped in the rich, mysterious tone of a northern evening atmosphere." The concluding vivace non troppo is a jolly rondo with a Hungarian flavor.

The need for two soloists of matched artistic temperaments makes the Double Concerto still rather infrequently encountered in our concert halls. In the world of recorded music, however, the Double Concerto is a perennial favorite. A recent issue of the Schwann catalog listed a baker's dozen of available recordings. Two are reissues of recordings released many years ago. The pioneer version by Jacques Thibaud and Pablo Casals, with Alfred Cortot conducting the Barcelona Symphony Orchestra, is currently available as one of Angel's Great Recordings of the Century (COLH 75). The performance by Jascha Heifetz and Emanuel Feuermann, with Eugene Ormandy conducting the Philadelphia Orchestra, is in the RCA Victor Treasury series (LCT 1016). Both, of course, are available on monophonic discs only. The Cortot-Thibaud-Casals team brought a strong feeling of dedication and perceptive musicianship to everything it played, but I have always found the performance of the Double Concerto overintellectualized and more than a little antiseptic; and the sound, of course, is now antique. The Heifetz-Feuermann collaboration is altogether a different matter. Both artists were at their blazing best at the time of the recording (circa 1941), and the performance throws off sparks of artistic excitement. Ormandy and the orchestra are superb, and the sound is on the whole acceptable.

Five of the remaining recordings exist in stereo as well as mono versions: Francescatti and Fournier, with Bruno Walter conducting (Columbia MS 6158, ML

5493); Heifetz and Piatigorsky, with Alfred Wallenstein conducting (RCA Victor LDS/LD 2513); David Oistrakh and Pierre Fournier, with Alceo Galliera conducting (Angel S 35353); Oistrakh again, and Sergei Knushevitzky with Kurt Eliasberg conducting (Period SHO 2336, SHO 336); and Wolfgang Schneiderhan and Janos Starker with the late Ferenc Fricsay conducting (Deutsche Grammophon 138753, 18753).

Of these five, the Francescatti-Fournier-Walter version is my unhesitating recommendation. The two soloists are perfectly matched. They bring to the music an elegance and polish that are extremely winning, and Walter's rather broad tempos permit the noble assurance and grandeur of the score to emerge. The recorded sound is first-rate, with rich resonance and fine stereo placement.

The Heifetz-Piatigorsky performance is the exact antithesis of the one by Francescatti and Fournier. Here everything is very hectic and rushed, and there are ragged bits of ensemble, orchestral as well as solo. And the sound, too, has an unpleasant pinched, wiry quality. Chalk this one up to an off day for all hands.

The three remaining stereo performances lack vitality. The two in which Oistrakh participates are surprisingly inhibited—one wonders what a more assertive conductor might have accomplished in each case. The Schneiderhan-Starker version plods on heavy feet, and the recorded sound is the distant sort all too often encountered on the DGG label.

Two other performances are worth mentioning. One is the Toscanini-NBC Symphony Orchestra performance with Mischa Mischakoff and Frank Miller as the soloists (RCA Victor LM 2178). It is a spectacular failure, foursquare and unmercifully driven in the playing, cramped and confined in sound. The other is a beautifully Romantic, highly personal treatment by Isaac Stern and Leonard Rose, with Bruno Walter conducting the New York Philharmonic (Columbia ML 5076).

In sum, then, either of the two performances conducted by Bruno Walter is recommended—with the newer one the choice for stereophiles. And the old Heifetz-Feuermann version still has the most dynamic excitement and tension.



What went on in room 433 at the New York Hi-Fi Show?

The first solid state receiver...Bogen's RT1000 a superb instrument accorded the most enthusiastic response

The response was twofold. People responded to the Bogen technology which produced the FM-Stereo and FM/AM RT1000. And they responded to the understated elegance of design, to the hushed gold front panel. The RT1000 responded with pure performance. In high fidelity, transistors have just one reason for being . . . to make a component perform better. We knew the RT1000 was a milestone. Now all who saw and heard it in room 433 know it, too.

Here are but a few reasons why: 100 watts of exceptionally clean power (50 per channel). Distortion is practically extinct since transistors replace a major source, *output transformers*. The RT1000 is actually hum-free.

Cool. That's a good word for the RT1000. Transistors reduce heat markedly. That does away with enclosure vents ordinarily needed to cool the chassis.

Let's talk tuner, FM-Stereo and FM/AM that is. Separation, selectivity and sensitivity approach professional perfection. Flywheel tuning that sweeps the dial as effortlessly as moving your fingers. An FM-Stereo switch position automatically lights the Stereo Minder Indicator when mono transmission changes to stereo.

Summing up the responses, "there has never been a sound quite like it . . . clean, cool, pure performance." Check your own responses. Let us send you free, detailed literature on the RT1000 all-transistor receiver. Just mail the coupon below.



LEAR SIEGLER, INC.  BOGEN COMMUNICATIONS DIVISION R-11
PARAMUS, NEW JERSEY

Please send me literature on the RT1000 and a catalog of all the 1963 Bogen Components.

Name

Address

City State

BOGEN

should Sherwood increase its prices by 20%



the superlative new S-8000 III FM stereo receiver priced at \$349.50



Years ago, Sherwood high-fidelity tuners and amplifiers were evaluated by two highly-respected, totally-impartial research companies as either the finest designed or the best valued on the market. ■ Although we were pleased by such endorsements of pure quality in design and performance, the really significant fact was that *other leading components carried higher price tags.* ■ *Subsequent Sherwood components have received ratings indicating features and performance equal or superior to brands carrying price tags at least 20% higher.* ■ A current example of Sherwood design superiority is our new S-8000 III receiver. Sensitivity is rated at 1.8 microvolts. Capture effect is an outstanding 2.4 db. ■ No other FM receiver can claim the 80-watt music-power rating of the S-8000 III, and only one other (priced \$50 higher) offers the professional D'Arsonval zero-center tuning meter that's standard with Sherwood. ■ We still believe that our old-fashioned policy of superior engineering and realistic prices is best for both you and Sherwood.

SOME OF THE S-8000 III FEATURES THAT MAKE THE DIFFERENCE

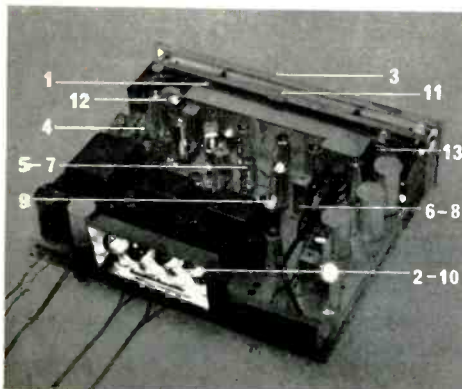

1. Zero-center tuning
2. 80-watt music power
3. Complete stereo control center
4. 1.8 μ v. (IHF) sensitivity
5. Wide-band 3-mc. gated beam limiter
6. 1-mc. band pass balanced ratio detector
7. 2.4db. capture effect
8. 1/3% distortion at 100% modulation
9. Interchannel hush
10. Long-life Novar output tubes
11. 8-inch professional-type tuning scale
12. Silk-smooth flywheel tuning
13. Positive stereo broadcast identification

For your free copy of our complete catalog, write Dept. R-11
SHERWOOD ELECTRONIC LABORATORIES, INC.
4300 North California Ave. Chicago 18, Illinois

Sherwood
HIGH FIDELITY

STEREO RECEIVERS ■ TUNERS ■ AMPLIFIERS ■ STEREO INDICATOR LIGHTS ■ SPEAKER SYSTEMS ■ CONTEMPORARY CABINETRY

CIRCLE NO. 70 ON READER SERVICE CARD

HIFI/STEREO REVIEW



TECHNICAL TALK

by JULIAN D. HIRSCH



● **TESTING PHILOSOPHY:** Equipment test reports, such as those I write for *HiFi/STEREO REVIEW*, are like icebergs. Only a small fraction of the vast amount of detailed information I accumulate during my tests appears in the published reports. Limited space is of course one of the major reasons for this. The test data compiled on a fairly complex piece of equipment such as the Fisher Model 400 stereo receiver described this month are voluminous. I take some four hundred separate measurements on such a receiver, covering the various equalization characteristics, power output *vs.* frequency, distortion, sensitivity, crosstalk, and many other items that might not be familiar to the average audiophile.

Most of these secondary measurements are not mentioned in the text of my report. If I commented on every measurement I made, some reports might easily run to five or six printed pages, and yet the average reader would gain little, if any, added useful information about the equipment under test. As an example, consider the question of tracking between the two sections of the ganged volume controls used on most stereo amplifiers. If changing the volume of one channel by a given amount does not equally affect the other channel, the apparent sound source will shift from one speaker to the other as volume is varied. I therefore compare the gains of the two channels as the volume control is varied over its useful range. If the channels remain within one or two decibels of each other, no comment is needed. After all, this is expected from any good amplifier. If the tracking error is excessive, however, this is reported in the text.

Many measurements are devoted to verifying the manufacturer's ratings of such characteristics as hum, gain, etc. These, too, are generally not mentioned unless they are in some way out of the ordinary. I try to avoid repetition of the manufacturer's catalog information in my reports, but obviously some of it is useful in describing the features of a product with which the reader is not familiar.

There are some tests I formerly made that I now

omit or abbreviate. My decision to eliminate them was based on the conviction that they are of minor significance, or that they might mislead rather than inform. Tone-control curves are an example. A plot of maximum cut-and-boost frequency-response curves *looks* nice, but is quite meaningless. Only slightly more informative is a family of curves taken at different control settings. This at least gives an indication of whether the tone-control characteristics hinge at a fixed frequency or whether the transition frequencies themselves are varied (the preferred type, in my opinion). But taking such a family of curves is time-consuming, and I do not believe it yields any information that would be useful in judging the performance of an amplifier. Personally, I have little use for tone controls, and have rarely operated mine in any position but "flat." Rarely can deficiencies in reproduction—whatever the cause—be corrected by tone controls without consequent side effects.

ANOTHER unimportant performance specification is damping factor. A number of years ago, this was a popular subject in high-fidelity circles, and reams were written to prove the desirability of damping factors ranging from negative infinity to positive infinity (this is not as much an exaggeration as it might seem). Recently, this subject seems to have lost its appeal. As far as I am concerned, any damping factor greater than about 10 (in a tube amplifier) is as good as any other. Since any reasonably good amplifier meets this requirement, therefore, I no longer measure damping factor.

Incidentally, I repeat most measurements on the second channel of a stereo component. This doubles the required laboratory time, but gives me a better idea of how well the performance of a component is likely to be duplicated from unit to unit. Also, if something appears to be amiss in one channel, I can, through comparison, determine if it is a design fault or merely a defective component.

One measurement I make on every piece of electrically operated equipment (and one I seldom men-

REVIEWED THIS MONTH

Bell RT 360 Tape Recorder ●

Fisher Model 400 Stereo Receiver

tion) is power-line leakage. If the leakage current from the chassis to an external ground is not greater than about one milliamperere, I make no mention of it. If it is as much as two or three milliamperes, an unpleasant shock can result, and I feel this should be mentioned.

However, the old adage about one picture being worth ten thousand words is still true. Starting with the reports in this issue, some data will be presented graphically. Key points will of course continue to be mentioned in the text as an aid in the interpretation of the graphs.

In future columns, I expect to go into considerable detail on the specific measurement procedures I use. There are many pitfalls in measurement, as well as some tricks of the trade that have been insufficiently publicized, and I hope to shed some light on these.

BELL RT 360 TAPE RECORDER



● COPYING RECORDED TAPES onto blank tape normally requires two tape recorders, or at least one playback deck and a recorder. Since both units must be of equivalent quality for a good copy, the setup can be expensive. However, by means of ingenious accessory "outboard" reel-drive motors, the new Bell RT-360 recorder makes it possible to copy tape on a single machine. Since the RT-360 is in all respects a high-quality home recorder, with all the operating flexibility one could desire, it should be of considerable interest to tape enthusiasts.

The RT-360 is a two-speed ($3\frac{3}{4}$ and $7\frac{1}{2}$ ips), four-track machine that bears a strong family resemblance to earlier Bell recorders, with its piano-key control buttons, three-motor transport, and electro-dynamic braking. It has separate recording and playback amplifiers and separate recording and playback heads. All controls are in pairs, including two illuminated VU meters that function on both recording and playback. There are inputs for microphones, magnetic cartridge, and high-level sources. The playback-preamplifier outputs can drive an external amplifier. Since these outputs are at a rather high impedance, the lengths of interconnecting cable should be kept as short as possible to avoid high-frequency losses.

Like many other modern recorders, the Bell RT-360 is capable of making monophonic sound-on-sound recordings. With the accessory "outboard" reel-drive kit, the RT-360 can make sound-on-sound recordings in stereo. To my knowledge, no other currently available home machine can do this. In addition, a special-effects switch permits controlled echo to be introduced by

rerecording a portion of each channel's output through its own input. Another effect is Duo-Sound, in which a portion of each channel's output is delayed and recorded on the other channel. This is intended to produce a pseudo-stereo effect on mono recordings; however, I did not find it particularly effective.

The tape-transport controls require considerable pressure to operate, but they work well and handle the tape gently. My chief criticism of the mechanism is that the RECORD switches do not disengage automatically when the tape is stopped or rewound. In spite of the red warning lights, it is possible to erase a recording accidentally.

The RT-360 is furnished in a portable case with a dual 8-watt playback amplifier and two detachable speakers with six-foot extension wires. There are outputs for driving external speakers and stereo headphones.

The accessory motor kit, Model DK-1, consists of two reel-motor assemblies that are powered by the recorder and fasten to the sides of its case. All standard-size reels, including $10\frac{1}{2}$ -inch NAB reels, can be accommodated. To make tape copies or stereo sound-on-sound recordings, the original tape is placed on the regular reel hubs and threaded over the playback head, bypassing the record and erase heads. The blank tape is placed on the outboard reel hubs and threaded over the record and erase heads, bypassing the playback head. Both tapes run between the capstan and pressure roller. The program on the original tape is then played back and recorded onto the fresh tape, with both tapes in exact synchronism since they are driven by the same capstan.

This simple but clever system worked perfectly. The tape copies I made sounded as good as the originals. To confirm this, I copied one of my standard alignment tapes and measured the recorder's response with it. Between 40 and 13,000 cps the response was exactly the same as with the original tape, with a slight fall-off beyond those limits.

The $7\frac{1}{2}$ -ips playback response averaged ± 2.5 db from 50 to 1,500 cps, rising smoothly to +7 db at 15,000 cps. Any amplifier's treble controls should be able to flatten out this response quite adequately. The over-all record-playback response was a very flat ± 2

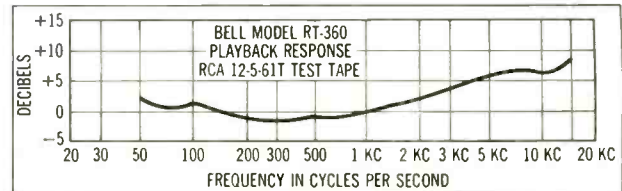
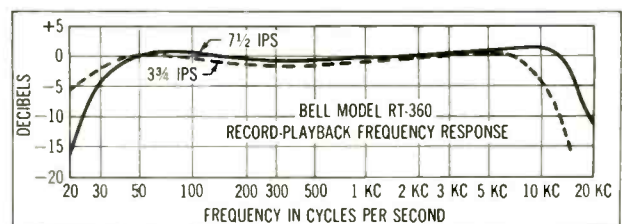

db from about 35 to 17,000 cps at 7½ ips, and about 5 db down at 10,000 cps at 3¾ ips. These figures place the Bell among the better home recorders I have tested.

Wow and flutter were 0.08 per cent and 0.31 per cent at 7½ ips, and 0.06 per cent and 0.2 per cent at 3¾ ips. The flutter, although slightly higher than in some other comparably priced machines, was not audible. Signal-to-noise ratio was 47.5 db.

The playback amplifiers, which delivered 6.5 watts per channel (8 watts with only one channel driven) were quite adequate for their purpose. Their distortion levels and limited low-frequency power capabilities were well suited for driving the pair of 6 x 9-inch oval speakers supplied with the recorder. Equalization on the magnetic-phonograph inputs was almost nonexistent, and gain was rather low for most magnetic cartridges.

All things considered, the Bell RT-360 is a well-constructed tape recorder that can do justice to almost any home requirement. With the Model DK-1 motor kit, it is an ideal machine for making tape copies and special-effects recordings.

The Bell RT-360 is priced at \$449.95. The DK-1 motor kit is \$49.95.

FISHER MODEL 400 STEREO RECEIVER



● THE NEW MODEL 400 is the lowest-price stereo receiver in the Fisher line. It comprises a stereo FM tuner, stereo control center, and two 30-watt (music-power) amplifiers on a single chassis.

The Model 400's styling and control facilities are similar to those of other Fisher audio components. Its two treble controls and the two bass controls are mounted concentrically, with a slip-clutch arrangement to permit individual adjustment. There is a single ganged volume control and a separate balance control to adjust relative channel gain. Four slide switches control a scratch filter, tape-monitoring, loudness-compensation, and speaker shut-off when using stereo headphones (for which there is a convenient front-panel jack). The function selector has positions labeled TAPE-HEAD, PHONO MONO, PHONO STEREO, FM STEREO, FM STEREO FILTER, FM MONO, and AUX-TAPE. The bar-type tuning eye also functions as a stereo indicator for FM reception, closing in the presence of the stereo pilot carrier when the receiver is set for stereo reception. Unfortunately, the scale illumination is so dim that it is easy to forget that the receiver is on when it is set to phono or tape.

As an FM tuner, the measured IHF sensitivity of the Fisher 400 was almost exactly its rated 1.8 micro-

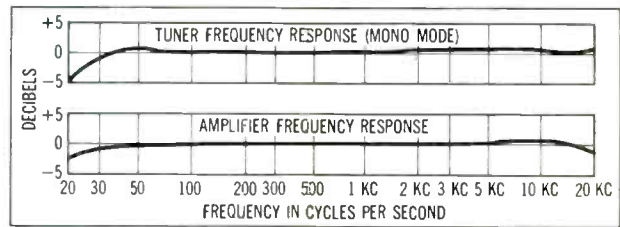
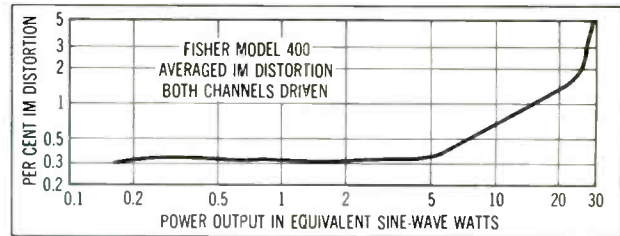

volts. Its excellent, very steep limiting curve insures that any signal stronger than 5 microvolts is fully limited. Harmonic distortion measured 0.85 per cent at 100 per cent modulation. No AFC is provided, but drift was negligible, and tuning was easy and non-critical.

In the stereo FM mode, channel separation averaged better than 30 db up to 9,000 cps, reducing at higher frequencies. The tuner's frequency response was almost perfectly flat on mono, and in stereo was down about 5 db at 15,000 cps. The tuner and stereo multiplex sections appear to be identical to those in the higher-price Fisher receivers.

Amplifier frequency response was ± 2.5 db from 20 to 20,000 cps. The phono and tape-playback equalizations were very accurate down to 30 cps. The 1,000-cps continuous-power output was 25 watts per channel at 1 per cent distortion with both channels operating (as rated). At 30 cps the available power was 15 to 20 watts per channel. A reduction in power output occurred at high frequencies, with 13 watts available at 15,000 cps and 4 to 5 watts at 20,000 cps. Internodulation distortion was about 0.3 per cent at listening levels, 1 per cent at 16 watts, and 2 per cent at 25 watts (per channel), with both channels operating.

In listening tests, the Fisher 400 performed as well as its measurements would suggest. It met all the requirements of a high-quality instrument, with an exceptionally sensitive stereo FM tuner and a good-quality 50-watt amplification system. Possibly its only limitation would be in driving low-efficiency speakers, or in other applications that call for high undistorted outputs at the frequency extremes. For the vast majority of high-fidelity installations, however, it should serve admirably.

The Model 400 receiver has many of the operating and performance features of Fisher's higher-power receivers, and at a lower price: \$329.50.

For additional product information, use the reader service card. Circle number 188 for the Bell RT 360 tape recorder, and number 189 for the Fisher Model 400 stereo receiver.

TUNER SECTION: In the kit, the two most critical sections—the front end and the IF strip—are supplied prewired and pre-aligned; and a high quality circuit board and pre-aligned coils are provided for the stereo demodulator circuit. The IF strip has 4 amplifier-limiter stages and a wideband ratio detector for perfect limiting and flat frequency response. Sensitive bar-type electron-ray tuning indicator pinpoints the center of each broadcast channel for lowest distortion, and also serves as the stereo program indicator.

Antenna input: 300 ohms balanced IHFM usable sensitivity: 3 μ v (30 db quieting), 1.5 μ v for 20 db quieting Sensitivity for phase locking (synchronization) in stereo: 3 μ v Full limiting sensitivity: 10 μ v IF bandwidth: 280 kc at 6 db points Ratio detector bandwidth: 1 mc peak-to-peak separation Audio bandwidth at FM detector: flat to 53 kc IHFM signal-to-noise ratio: 55 db IHFM harmonic distortion: 0.6% Stereo harmonic distortion: less than 1.5% IHFM capture ratio: 3 db Channel separation: 30 db.

AMPLIFIER SECTION: High quality Baxandall bass and treble controls do not interact or affect loudness, permit boost or cut at extremes of range without affecting mid-range. Balance control is infinitely variable, permitting complete fade of either channel. Blend control is variable from switch-out, for maximum separation, to full blend. Tape Monitor switch permits off-the-tape monitoring with the Eico RP100 Stereo Tape Recorder.

Power: 36 watts IHFM music, 28 watts continuous (total) IM distort on (each channel): 2% at 14 watts, 0.7% at 5 watts, 0.2% at 1 watt Harmonic distortion (each channel): 0.6% at 10 watts, 40 cps to 10 kc; 0.2% at 1 watt, 30 cps to 20 kc IHFM power bandwidth at rated continuous power, 1% harmonic distort on: 30 cps to 20 kc Frequency response \pm 1 db, 15 cps to 40 kc Speaker output: 8, 16 ohms Inputs: Magnetic phono or adapted ceramic phono, tuner, tape auxiliary Sensitivity: 2.3 mv phono 250 mv others Noise: -65 db at 10 mv, mag phono; -80 db others.

New Eico Classic 2536 Stereo FM Receiver

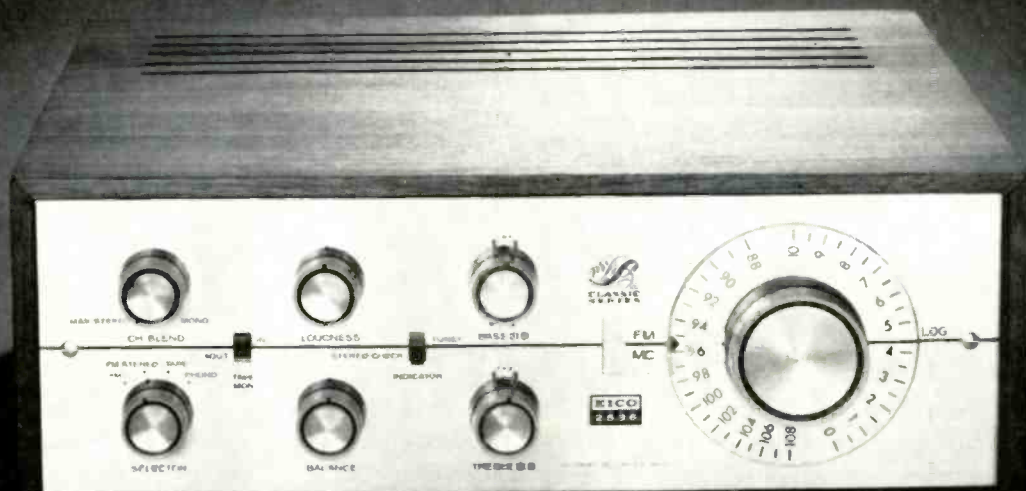

Now... every other stereo receiver seems overpriced

Take a superb stereo tuner, guaranteed stable under all conditions, and sensitive enough to give full stereo separation even on weak, fringe-area signals...

Add a virtually distortion-free 36-watt stereo amplifier with remarkable overload and transient characteristics...

Mount them on one chassis—effectively separated for the performance benefits of components plus the convenience of a single compact unit... Price this combination at \$209.95 factory-wired, and at \$154.95 in a new kit pack that makes building a delightful experience—and what do you have? The Classic 2536 Stereo Receiver, star of the new Eico Classic Series, and a component that matches or surpasses the performance of components selling at substantially higher prices. How? Simple. It's pure performance. Stripped of everything but the finest basic circuitry. Examine the specifications yourself. Compare them with those of more expensive units. Listen to the 2536—then to higher priced units. Can you see or hear a difference worth paying for?

If you're interested in building a fine stereo receiver, take a long look at our new kit pack, too. Note the logical, orderly arrangement of parts. How easily it sets up for work. How easily it closes down between work sessions—with no loose parts to go astray. Thumb through the 2-color Construction Manual. Ever see such graphic diagrams? Every step is clear and unmistakable—and no diagram shows more than 20 steps. Another thing the diagrams show you: how simple the wiring is. No tricky frills; no clutter; no confusion, even around switches and controls. Plenty of space to work in. And Eico has eliminated the most tedious part by pre-mounting jacks, sockets, terminal boards, and transformers.

Does any other kit give you more building ease, or assurance of success than the Eico Classic? See it at your hi-fi dealer. Optional Walnut Cabinet WE-73, \$19.95, Metal Cover E-12, \$7.50. Write for catalog. Eico Electronic Instrument Co., Inc., 3300 Northern Blvd., L. I. C. 1, N. Y. Export: Roburn Agencies Inc., 431 Greenwich Street, New York 13, New York.





*An affectionate account of the love affair
between the great Viennese tenor
and the city of his dreams*

Richard Tauber and Vienna

by Hans H. Fantel

ON THE block where I lived in Vienna in the 1930's, the principal attraction for teen-age boys was an enormous Mercedes touring car. It was usually parked not far from my parents' house, and with its rakish stance and its sharply pointed radiator, this towering vehicle looked rather like a misplaced ship stranded among the chestnut trees and curlicued villas of Hietzing, Vienna's garden district. Brass fittings and lanterns protruding from the sea-blue hull confirmed this nautical impression, and the open front with its massive oak steering wheel and outboard gearshift seemed more like a captain's bridge than a chauffeur's seat. What made the extravagant car even more attractive to my adolescent curiosity was the knowledge that it belonged to our illustrious neighbor, Vienna's reigning idol, the tenor Richard Tauber.

Often in the late afternoon I would dawdle near his gate, pretending to fix my bicycle or even to be look-

ing for an escaped turtle, just to catch a glimpse of Tauber being driven off to the theater. It was a sight to reward anyone's patience. Monocle clamped in one eye, head crowned by a black silk topper, the ensemble superbly framed in astrakhan, and glittering ebony cane swinging, Tauber would ascend the three running-board steps of his car like a victorious admiral boarding his flagship. Once aloft he would perch himself next to the driver for an open-air progress in many ways more splendid than anything that might follow it at the theater. In the street, people would greet him warmly from all sides and Tauber would lift his top hat or wave his cane in convivial acknowledgment. Even the Vienna police were his fans, and since these were the days before automatic traffic lights, they briskly cleared the street-crossings at his quasi-royal approach.

The popular accolade and Tauber's graceful response were expressions of a love affair between the

Tauber

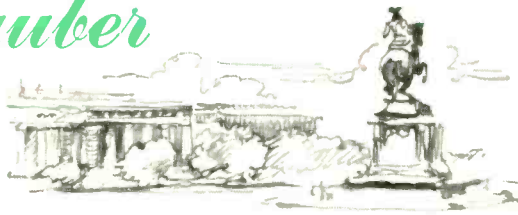

singer and his city—a serious and requited passion engendered in about equal parts by Viennese music and the political history of a disastrous era. During the drab interlude that followed the collapse of the Austrian empire, when Vienna was like a bankrupt baroness wearing her jewelled heirlooms in defiance of poverty, Tauber symbolized to the man in the street a lingering dream of the aristocratic life: nights of white tie and tails, invitations to one *Schloss* or another, the sporty deshabillé of expensive open cars. Naturally, none of this had ever been within reach of the average Austrian. But with an empire gone, and Vienna the threadbare capital of a politically impotent remnant, the visible glory of Tauber served to revitalize a national fantasy of ease and elegance. Tauber was the dashing Count Danilo of *The Merry Widow*, the exuberant Herr von Eisenstein of *Die Fledermaus*, and he was saluted as no less than a symbol of national survival.

CERTAIN aspects of Vienna's infatuation with Tauber might nevertheless cause wonder. A city almost pathologically addicted to physical beauty had chosen as its glamour symbol a conspicuously ugly man. His short, stocky figure testified to his fondness for the *Schlagobers* and other calorific gaieties of Vienna's famous five-meals-a-day routine. His wide face with its flat nose was the antithesis of the romantic stereotype, and the asymmetry of his mouth, almost grotesquely exaggerated when singing, inspired the saying that to enjoy Tauber's voice one had to look away from his face. But his bearing and his manner made audiences forget all this. With a single gesture he was able to instill a conviction that grace and *savoir-faire* are inherent and invincible in the human species. The same magic marked his vocal style. His lighthearted and elegant phrasing somehow lent credibility to the dream world of Viennese operetta, in which champagne always bubbled and love always triumphed.

Born in 1891 into a family of actors in the upper-Austrian city of Linz, Tauber was naturally inclined toward the stage, and the early discovery of his musicality and his vocal talent headed him inevitably for opera. His rise through the provincial theaters of Germany and Austria was rapid, and by the early 1920's he had conquered the heights: the State Operas in Vienna and Berlin.

But even in music-obsessed Austria a first-rate singer isn't automatically a national idol. Like other men

at the presumed top of their professions, Tauber may well have felt that there was no further place for him to go. It was sheer happenstance that propelled him beyond the limits of operatic fame.

One evening in 1923, Tauber went by chance to the Theater an der Wien, an ivory-and-gold gem that saw the premieres of Mozart's *Magic Flute* and Beethoven's *Fidelio* but later became the lively hub of Viennese operetta. Here Tauber responded to Lehár's *Frasquita* with an enthusiasm that may be incomprehensible to those who remember this work as a bubbly bit of musical soda pop. But in the lilting sweetness of Lehár's melodies Tauber sensed something deeply sympathetic to his own musical temperament. And at a later meeting, the popular composer was stunned when Tauber, the leading opera tenor, asked his permission to sing in a Lehár operetta.

For Lehár, too, the meeting was a turning point. Lehár had been world-famous since 1905, when he had written *The Merry Widow*; but his later works—he was now in his fifties—lacked the freshness of inspiration that had made *The Merry Widow* a masterpiece. It was in fact Tauber who rejuvenated the aging composer's pen. Lehár responded to the challenge by developing a style of composition precisely tailored to Tauber's ardent voice and debonair manner. A new musical genre was born: the "Tauber Song."

Its popular effect was unprecedented. Far beyond the confines of the theater, the Lehár-Tauber vocal champagne drenched the landscape. Electric sound reproduction had been invented a few years earlier, and Tauber was among the first to attain omnipresence through the phonograph. His voice poured from the huge flat-baffle loudspeakers hung in the Heurigen gar-



dens where the Viennese spent long evenings sampling the new wine. At the outskirts of the city it rang from the ornate merry-go-rounds whose wheezy mechanical organs, chronically broken down, had been replaced by record players. To the ears of an impressionable boy, the voice and the city seemed one, and I particularly recall one instance of Tauber's ubiquity. In Vienna's great park, the Prater, coffeehouse gardens proliferate with their wrought-iron tables spread over graveled acres beneath ancient trees. Walking one day in a borderline area between adjacent coffeehouses, I actually heard records of Tauber in triplicate, in three different Lehár songs, in three different keys, in three different cafés.

Not merely Tauber's voice but his personal traits confirmed Vienna's self-image of itself, profligate in the pursuit of transitory beauty. He could not bear ugliness in any form. It frightened him as it does a child, and possibly that was the secret of this ugly man's radiant elegance. Perhaps it was also a spur to his fabled generosity—the misfortune of others striking him as a kind of ugliness, driving him to an excess of altruism. He seldom gave less than a thousand dollars to any person approaching him in behalf of a charity, usually by taking cash from his wallet. Friends in need often received many times that amount, and Tauber would never admit to being the anonymous benefactor.

This prodigality, however, was not ostentatious; it was more a childlike joy in being able to spread abundance. Florists in the major European cities had standing orders to send flowers to his friends at regular intervals. And when the first intercontinental telephone links were established in the late 1920's, his telephone

bills became fantastic. "He'd call up a friend in Australia as casually as you or I would call New Jersey," recalls Maurice Feldman, once Tauber's New York press agent. "Whenever he happened to think of someone he liked—anywhere in the world—he would almost automatically pick up the phone. It was like a reflex. And afterward he'd send a present."

A GENEROSITY so grandiose and so genial was made for popular legend, and as the legend grew, so did Viennese affection. But neither Tauber's legend nor his voice could alone account for the impact of the Tauber Songs, for the special fascination that turned the city's sentimental surrender into a kind of unending operetta marriage. Perhaps the secret of the spell cast by vocal idols is not any particular emanation from the personality, but rather the ability of the spell-binder to respond symbolically to the forces latent and unexpressed in the human situation around him.

That this was true for Tauber I realized much later, in another country, and through a very different singer. During the early war years, I once watched a group of teen-agers playing Sinatra records in a Kansas City drug store. I noted in their faces a familiar kind of enthrallment, the same type of expression I had seen years earlier among the patrons of a Viennese garden café when a Tauber Song poured from a chestnut tree wired for sound. The era, the place, and the music were all vastly different, but I saw the same abstracted gaze of self-forgetfulness, as if the song had tapped some inner dream. The dream in the case of Sinatra was a sensual reverie, sketching with an insinuating tenderness the vague outline of romantic love. This, too, was the secret of the Tauber Song, but while



At left, Richard Tauber attired as the dashing Count Danilo; at left above, Tauber with Jarmila Novotna and Franz Lehár at the premiere of Lehár's *Giuditta*; at right, Tauber as he appeared in the role of Franz Schubert in the 1934 film *Blossom Time*.

Tauber

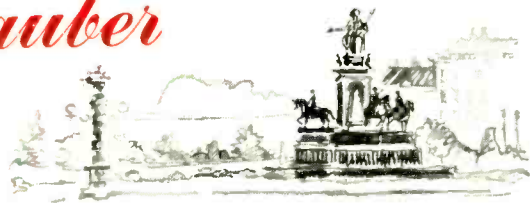

Sinatra sweetened adolescent hope, Tauber sweetened adult disillusion.

The music Lehár wrote for Tauber spoke an amorous language previously unheard in the realm of popular song. Combining buoyant melodic transports with disconsolate minor cadences, the music sang not of love's young dream but of adult ambivalence. The sexuality it projected was a sophisticated longing, hopeful in spite of disenchantment. The romance was more than faintly bitter: these were in fact love songs for a broken city. Few of the songs ever crossed the language barriers beyond *Mittel-Europa*. But two, less melancholy than most, swept the world: *Yours Is My Heart Alone* and *Vienna, City of My Dreams*. Courageous tenors, braving comparison with Tauber, still sing them as encores.

UNLIKE other singers who have switched from opera to operetta, Tauber did not lose his standing as an operatic artist, but capably managed to make the best of both worlds, alternating Tamino, Don Ottavio, Lt. Pinkerton, Rodolfo, and other of his celebrated operatic roles with prolonged stints in Lehár productions. To a critic who complained that Tauber, the great Mozart singer, had lowered himself by singing operettas, Tauber replied indignantly: "I'm not singing operetta, I'm singing Lehár!"

Ultimately, it was Tauber's belief in the merit of Lehár's music that opened to this composer the doors of Vienna's musical Elysium. Lehár's last work, *Giuditta*, was staged at the State Opera with a cast that included Tauber and a young soprano, Jarmila Novotna, who later became a great favorite at the Met. The premiere of *Giuditta* was one of the last occasions to glitter with all the nostalgic pomp that Vienna could still muster—one that remains in my memory as a divide between two eras. Women with tiaras, dignitaries with benedaled sashes across gleaming shirt fronts, arrived in carriages drawn by four plumed horses. But another age was heralded by the primitive box-like microphones that hung over the stage and carried the performance across Europe. Few knew it then, but the linked transmitters that spread Tauber's voice to an audience of unprecedented size that night were soon to carry a harsher voice—one that in fact separated the singer from his city and ended the romantic illusions that kept Vienna living in its past.

It was largely through the medium of network radio

that Adolf Hitler was able to fascinate Europe to the point of political paralysis. Tauber, although a life-long Catholic, was partly of Jewish descent. And in Germany, where his popularity had been almost as great as in Austria, he was branded as a "Jewish perverter of Germanic purity" and a "cultural Bolshevik." His assets in the German banks were confiscated.

After Tauber's expulsion from Germany, the Viennese took him even closer to their hearts. He also appeared frequently in London, both in opera and in lighter works, and his concert tours took him across the world. The loss of his fortune failed to daunt his high spirits, alter his style, or lessen his generosity. He still lived high, but he lived out of pocket. The man who could not bear ugliness was unable to believe that he himself might someday suffer need, or that misfortune might strike him personally. This incurable optimism nearly placed him in the hands of the Nazis.

In March, 1938, Hitler's armies were at the Austrian border. But Tauber, who had been singing in Italy, was determined to return to Vienna. He simply could not comprehend that he was now "racially inferior." When he laughed off the telephoned warnings of his wife, who was then vacationing on the Riviera, Mrs. Tauber raced in her car to Milan, intercepting her husband as he was about to board the train for Vienna. They returned to their hotel to hear the radioed news that the Nazis were in Austria.

In Vienna, Tauber's remaining property was now confiscated by the new government. His recordings

Tauber's wife Diana, in a 1936 painting by Cathleen Mann.



NEW YORK PUBLIC LIBRARY



NEW YORK PUBLIC LIBRARY

In 1933, Tauber posed for this portrait by Edward Steichen.

were publicly smashed at Nazi rallies, and even owning a Tauber record made one politically suspect. Tauber never quite recovered from the grief of losing the country whose spirit had so deeply entered into his art, but outwardly his success continued. He traveled more than ever, singing in London, New York, Los Angeles, in South Africa and Australia. He sold out Carnegie Hall in a lieder recital for which scalpers charged \$25 a seat. He sang at the White House for President and Mrs. Roosevelt (and this he held to be the greatest honor of his career).

Yet, without his city, Tauber seemed somehow diminished. His friend, the actor Basil Rathbone, commented: "Richard was still a child, and the world about him had grown up harshly, crudely, and cruelly. Man was in the process of destroying himself, and like a bird, Richard was singing to them, trying to remind them of their lost happiness."

But Tauber, even in exile, was never without that sort of lightly ironic gallantry that is as Viennese as the jokes in *Fledermaus*. When one of Hitler's haphazardly guided missiles almost hit a London theater where he was singing, he kept the audience in good heart by remarking dryly, "That bomb was off key," and resumed the interrupted phrase.

With similar spirit, he fought a personal struggle against failing health, and he probably never knew that from the first it was a lost battle. In 1946, a chest condition forced his withdrawal from a somewhat altered version of Lehár's *Land of Smiles* (which ran in New York under the title *Yours Is My Heart*). He fully

expected to return to the show, but his condition worsened and without him the show soon folded. X-rays revealed that Tauber had cancer, and that one lung would have to be removed. Convinced that the truth would be psychologically disastrous for him, Mrs. Tauber and the physicians told him that the operation was for the removal of an abscess.

It was at that time that the Vienna State Opera, barely reorganized from the disruption of the war, made its first guest appearance in London. Tauber was invited to sing once more his famous role of Don Ottavio in *Don Giovanni*, reunited with his Viennese colleagues. The doctors protested, but Tauber was adamant: "I must and I shall sing in this performance. Nothing on earth will prevent me from doing that. After that you can do with me what you like."

And so, on September 27, 1947, London heard a now legendary performance of *Don Giovanni* that (in the words of Tauber's wife) "to those few who knew Richard's true condition will forever remain a miracle. There he was, striding confidently across the stage, and the first few notes, sung in that perfect legato, began to cast their magic spell over an audience which was utterly unaware of the tragedy that was pending. Nor is it possible to fathom the incredible strength of will which he needed to go on with the performance. His delivery was easy, his phrasing without flaw; altogether, it seemed Richard Tauber at his best. All the technicalities in the annals of an experienced singer would fail to explain it without paying high tribute to the exceptional physical and mental courage required." And for one night, it was as if the singer and his city were once more united.

Five days later, Tauber was again hospitalized. Characteristically, during his final weeks he made plans for extended concert tours. On January 7, 1948, he died in his sleep after assuring his wife that he felt much better.

IT IS now twenty-six years since Tauber last sang in Vienna, but his recordings still work a kind of magic there, even for those too young to have heard him in person. There remains a firm bond between Tauber and the city whose lighthearted and sensuous mythology he propagated with so much vitality and art. The songs that Lehár wrote for him still melt on the Viennese air, and from the windows of the record shops along the Kärntnerstrasse and the Graben, Tauber's picture still greets the Viennese with that jaunty and indomitable smile I remember so well.

Hans H. Fantel, known to readers of HiFi/STEREO REVIEW for his monthly "Beginners Only" column, left his native Vienna in 1940 and has been a citizen of this country for over twenty years. In spirit, however, he will evermore remain Viennese.



A TALK WITH JOAN BAEZ

By NAT HENTOFF

THE PUBLICITY-SHY FOLK-SONGSTRESS TELLS WHY SHE CONTINUES TO SPURN THE GOLDEN APPLES OF SUCCESS

IN THE four years since her rise to renown at the 1959 Newport Folk Festival, twenty-two-year-old Joan Baez has contrived to remain, despite her enormous popularity, unyieldingly herself. A shy and slender girl of Irish-Scottish-Mexican descent, she has steadfastly refused to capitalize on her success, to make concessions to commercialism, or to work more than five weeks at a stretch. She also avoids interviews, as she does all the other ritual observances that are usually made mandatory by fame.

However, shortly after the 1963 Newport Folk Festival—at which Miss Baez and her friend Bob Dylan were the undisputed stars—I managed to visit the elusive singer during one of her brief stays in New York. She was living at a friend's apartment on the upper West Side. It was evening, and the room in which we sat overlooked the Hudson River. Outside all was serene, and, perhaps because she was in friendly surroundings, Miss Baez was more relaxed than at any of our previous meetings. Her dark hair was worn, as always, long and straight.

I asked her if she still intended to work only a small portion of each year. "Yes," she said, "I don't do more than thirty concerts—part of them in the spring and part in the late summer and fall. I will not work night clubs for the obvious reasons: the noise and the fact that many people don't come to those places primarily to listen.

"At first," she continued, "I was reluctant to work frequently because I was afraid of the commercial scene, afraid of being caught up in it. I was being offered golden apples, and my fear was that I'd get to want them, above everything else. Now that I've seen what those golden apples do to people, I know I don't want them. Therefore, the main reason I insist on spending much of my time at home on the southern California coast is that I need to keep part of my life for myself. During a tour, I hear too much about myself. At each concert, I'm surrounded by hundreds of people who regard me as some sort of symbol, some kind of goddess. A number of them actually ask for hairs from my head. Yes, they really *do*. So I have to get away and go home to California where I can just be me again."

Even while she's working, Miss Baez tries to remain by herself as much as she can. Often, before a concert, she will demand that she be left absolutely alone for twenty minutes or more. "I started doing that in Santa Monica a couple of years ago," she explained. "Outside the hall, there were huge signs with my name on them, and there seemed to be millions of stage hands, along with a lot of people ooh-ing and ah-ing, sending flowers, and jumping up and down. I knew I couldn't sing anything right unless I had a chance to meditate."

All is not adulation for Miss Baez, however. There are folk-music critics, performers, and listeners who charge that she reveals insufficient knowledge of the singing styles and historical traditions of the songs she chooses to perform.

"They may be right," Miss Baez acknowledged, "and sometimes I do wonder about where a certain song came from and what it means beyond what the lyrics say. Yet this aspect of folk music has always been so secondary with me. It's as if there were a mysterious string in me. If something I hear plucks that string, then I'll sing that song. It can be funny or serious, or it can be in another language. I can't analyze what qualities a song must have to do that to me. The whole process must be instinctual. And I have to admit that when people talk about the history of a song, I usually get somewhat bored."

Miss Baez frowned. "Maybe some performers have to talk about backgrounds and the like so that they'll feel strongly enough about it to sing it. Some audiences, too, have to know enough about a song to get to the point at which they care about hearing it. But that's not the way I approach folk music."

"Yet," I said to Miss Baez, "the way you sing—your use of vibrato, for one example—indicates a more conscious sense of musical purpose than you admit to."

She laughed. "No, it didn't happen that way at all. Take the vibrato. When I was in the eighth grade, I was jealous of a girl who had a fine vibrato. My voice at the time was straight as a pin. I *forced* it to wiggle up and down until the vibrato came out by itself. But I didn't do it primarily for aesthetic reasons. You see, I like to sing, and all this stuff has happened *to* me. I haven't tried to plan any of it." [Continued overleaf]

BAEZ INTERVIEW

Miss Baez laughed again, this time in self-deprecation. "I do admit it would be nice to be able to breathe when I'm singing. It'd be much easier if I knew how to breathe, and I'd probably sound better, too. I don't know how to sing properly. I know I could improve my work, but the idea of training my voice doesn't appeal to me. Once, I did stay for two weeks in a speech class at Boston University, and I remember what the instructor said about having to relax certain parts of the throat before you sing. Every once in a while, before a concert, I do what he said to do. But as long as I can sing this well, I don't think I'll ever take lessons. I suppose I'm afraid that if I do start studying, I'll find out I'm really not that good to begin with."

She paused and pursed her lips. "I do feel kind of bad about being so bloody ignorant—because I'm that way about everything. I have a primitive way of going about everything. I can't force myself to do something in which I'm not really interested." I suggested that, in describing her behavior, she was describing also how a great part of our folk music began—out of spontaneity of feeling. She brightened, seemed to fondle the concept briefly, and then let it go.

"Perhaps so," she said, still vaguely displeased with herself. "Fundamentally," she added, with an edge of exasperation, "I'm lazy. Once, for instance, I bought all the bound volumes of *Sing Out*, the folk-music quarterly, to learn more about folk material. But I never looked at them. Another time, I subscribed to the *Christian Science Monitor* to keep up with the news, and I didn't read more than three issues of the paper all year. I'm not professing that this is the way to be, and maybe you shouldn't print it because some kid will think it's smart to be like me. I expect I'll get over it, either through an effort on my part or as the result of some internal change I won't even know is taking place. I do judge myself more harshly than most other people do. I know I should have a larger repertoire, for one thing, and the reason I haven't learned more songs has nothing to do with the so-called pressures of success. It's just my own laziness."

Miss Baez added that when she does add to her repertoire, it's usually by accident. "I hear a song somewhere and like it. Less often, much less often, I select something from what people send me. I don't read music very well, although I can muddle it out. Actually, the only song I've ever learned entirely from the written page was Malvina Reynolds' *What Have They Done to the Rain?* And that was because the words are so startlingly good. Otherwise, I learn from records. Or best of all, when I'm traveling, I may meet

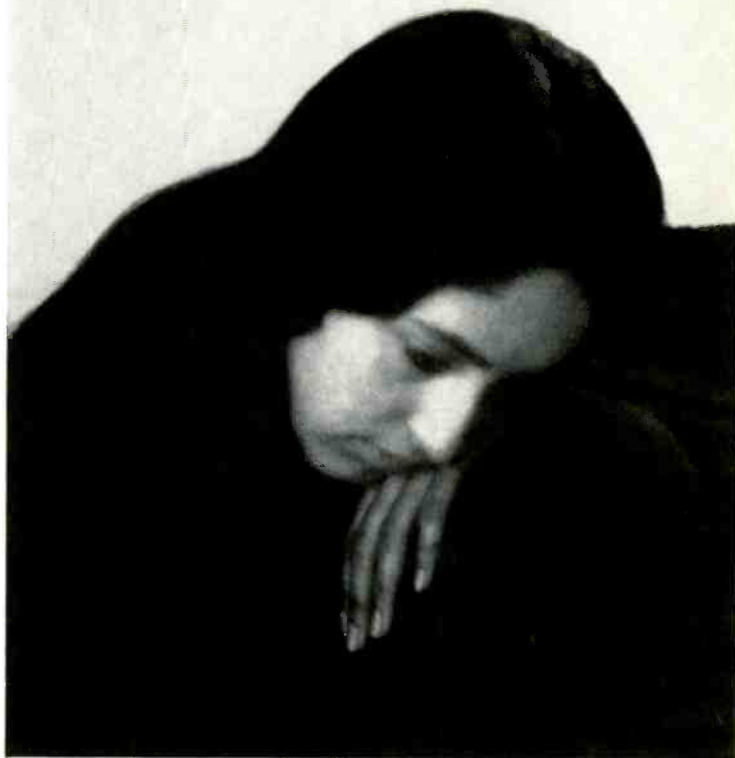

"... It's as if there were a mysterious string in me."

people who know some songs that I like and then they teach them to me."

I asked her to what extent she is able to identify with her material. "To a greater or lesser degree," she began, "I have to identify with all the songs I use. But a foreign language is different. Even though I've read a translation of the lyrics, nothing goes through my head when I'm singing in another language except 'What a beautiful sound the words have!' When the lyrics are in English, I do identify with some songs more than with others. *Mary Hamilton*, for one.

"When I first began to sing that ballad," Miss Baez recalled, "I'd actually be shocked by the clapping when I was through. I'd gone so far off during the performance. Now, that seldom happens any more. When I started singing in public, I wanted to deny there were people there. I felt there was something bad in singing for an audience and making money. Now I can accept the audiences. I don't push them away. Even stupid audiences—and I've had some dillies. In those cases, however, I look around trying to find a face I can sing to. That's why I have the lights on during my performances. I look for what I call the *Catcher in the Rye* faces. I can sing to *them*. I can't explain exactly what kind of face that is. It's just somebody who looks

as if he understands what's happening. Once in a while, I can't find a *Catcher in the Rye* face, and then I imagine one. If I don't love *someone* out there, I can't sing."

Among the things Miss Baez decidedly does not love is appearing on television. "They're about to videotape a concert I'm doing in Hartford for pay-TV," she said. "That's ideal, because I don't even have to think about being on television." She is generally suspicious of attempts to program folk music on television. Too high a percentage, she feels, is grossly commercialized, and there are often far too many irrelevant distractions—from coy sets to rigid camera directions—that heighten her self-consciousness.

During the past year, Miss Baez has insisted on one absolute condition for any television appearance—that Pete Seeger be hired for it, too. Miss Baez admires Seeger as a person and as a folk performer, and she is incensed over his apparent blacklisting by television networks. "Now," Miss Baez smiled acidly, "they seldom offer me a show. They know I'll ask for Pete."

A program Miss Baez finds particularly distasteful because of its heavy use of commercial folk singers is ABC-TV's *Hootenanny* series. "I'll admit," she said, "that if they had asked me for that show and had also taken Pete, it would have been a very painful victory."

Musing about blacklisting, Miss Baez's voice suddenly sharpened and her gestures became vehement. "I cannot understand why city folk singers agree to appear on programs which refuse to hire performers for reasons that don't concern music. I don't expect the country people to know what it's all about. I can't blame Mother Maybelle Carter, for instance, for going on *Hootenanny*. But it's disgusting that there are city singers—including some who don't need the bread and the exposure—who perform on those programs. They should know what it's all about."

Calm again, Miss Baez speculated about the future of the current folk boom. "I expect the commercial groups like Peter, Paul and Mary and the Kingston Trio will come and go while performers such as Bob Dylan and Pete Seeger will stay."

I asked Miss Baez if she felt better disposed toward Peter, Paul and Mary since they had recorded songs of social conscience—*If I Had a Hammer* and Bob Dylan's *Blowin' in the Wind*. "Anybody," she said scornfully, "can record *Blowin' in the Wind*. It's the easiest thing in the world. No network would ban Peter, Paul and Mary for anything they do. They get away with the easy ones. They enable the network guys to say, 'That's a gas. It's real great, you people

"If something I hear plucks that string, then I'll sing that song. It can be funny or serious. The whole process must be instinctual."

PHOTOS BY DICK ROWAN



talking up like that.' But if they were a little more outspoken, they'd be off the air."

Miss Baez looked out the window at the lights of the Palisades Amusement Park across the river. "I'm struck, to use my own case, with how easy it is for me to sing *Oh, Freedom*. Man, I've been free all my life. Nobody ever turned me away from anywhere. At the worst, I've experienced a little prejudice because

BAEZ INTERVIEW

I look like a beatnik or a Mexican. It's like the time I was singing at a peace demonstration in front of a San Francisco post office. A woman came up and said to me, 'It must take such courage to do what you're doing, dear.' It doesn't take any courage. *I've* never been threatened."

To what extent, I wondered, was the accelerating interest of the young in folk music involved with the fact that the city singers' repertoire is more and more concerned with civil rights, The Bomb, and other root issues of the decade. "As long," said Miss Baez, "as there is a need for people to speak out on these issues, young people will be attracted to the kind of folk songs you mention. Folk music is the ideal way to get these feelings out. It's not too far above anybody's head and it's not really beneath anybody. Anyone—from little children to old people—can understand it. If a folk song is good, it contains something basic and true."

MISS BAEZ demands more from a song, however, than her agreement with its message. She has little respect for most of the growing quantity of topical folk songs. "The majority of those 'protest' songs are stupid. They're without beauty. By contrast, there are Bob Dylan's songs. They're powerful as poetry and they're powerful as music. Most of the others are powerful as neither. Their writers are just trying desperately to say something, but they don't know how to say it. But Bob is expressing what all these kids want to say. And I love his singing! Oh, my God, the boy can sing! He can be so terribly moving. I've never heard anyone like him. When he starts singing a song like *A Hard Rain's A-Gonna Fall*, I cry and have to leave the room."

Miss Baez has already added three of Bob Dylan's songs to her repertoire and is learning more. She considers his future limitless. "Oh, he has some idiosyncrasies," she says, "but he'll grow out of them." I asked Miss Baez if she ever volunteers any advice to Dylan. She smiled. "I try to slip some in. I know I hate getting advice, and he's not the type who eats it up. But essentially, what I try to tell him is not to listen to anybody but himself. Oh, if Jesus walked in, I'd say listen to Him. But certainly not to most other people. You yourself have to know where you want to go."

Aside from her conviction that Dylan will become increasingly important, Miss Baez declined any opinions about the future of folk music. "It seems to me," she said, "that the question doesn't mean too much. You can't predict what's going to happen. And even if you could, so what? What should be important is what's happening now."

Turning to a specific question about her own development, I read to Miss Baez John Cohen's comment about her in a recent issue of *Sing Out*: "On her recordings, one only hears the sad and mournful side, but Joan is full of life and jokes, and enough craziness to fill a looney-house. She can really swing with gospel songs and rock-and-roll pop sounds. She has an uncanny ability to mimic any kind of music within her reach, and this she generally does with sympathy, not with ridicule. One can only ask why these aspects of her have not been revealed."

Miss Baez grinned. "I don't know the answer to that. I do horse around a lot, and when I'm low in energy or sick, I do give what I call 'light' concerts. I crack jokes, tell stories, and maybe sing some parodies. I enjoy that sort of concert, but it's not as meaningful to me as the more serious performances. There is an awful lot of the clown in me. But I do have tremendous respect for folk music, and some of it can move me to tears because it's so real. I suppose, therefore, that I find it especially difficult to do anything funny on a record because I think that anything that you want to be enduring should be beautiful."

Beauty, I noted, is a recurrent motive in her talk about singing. "Yes," she said, "I do feel there has to be beauty of one kind or another in all kinds of folk music. It depends on your definition, of course. I think of a rural folk singer—Doc Watson's mother—whose voice might not seem beautiful to some people. But her voice has a straightness, an honesty, a purity. On the other hand, a voice may have all the tone quality and all the vibrato you could ask for, and yet it'll sound so bland that it has no beauty at all. There are so many of those!"

Miss Baez was about to leave for an appointment to hear several of Bob Dylan's newest songs. She stopped at the door to pick up a line of thought with which the interview had begun—her refusal to give all her time to performing. "It's not a firm decision," she said. "Nothing is, with me. I may go either way. I may perform all year 'round, or I may quit altogether." The latter possibility seemed to be slight as she continued: "Suppose we knew we had just so long a time before everything was all over. You could spend the rest of your days waiting for the end of the world, or you could spend the time doing something beautiful. For some, it might be opera or painting. For me, it's singing. I'd like to do as beautiful a job as I can, and at the same time try to do something to keep The Bomb from falling. In folk music, I can do both."

Nat Hentoff, a world-recognized authority on folk music and jazz, is HiFi/STEREO REVIEW's senior critic in these fields.

DISTORTION AND WHAT YOU CAN DO ABOUT IT

THE AUTHOR PINPOINTS ELEVEN COMMON CAUSES
OF DISTORTION AND SUGGESTS WAYS TO
PREVENT OR ELIMINATE THEM

By HERMAN BURSTEIN

MANUFACTURERS of high-fidelity components spend an enormous amount of research time and money in the battle against various types of distortion. But the user also has a part to play in this struggle. The following tips concern distortion-producing factors that *you* can do something about.

- When connecting leads to the screw terminals of the power amplifier or speaker, take care that a stray strand of wire does not cause a partial short circuit between the terminals. Since such a short circuit usually does not cut off the sound entirely, but results in low volume and distortion, it can be difficult to track down.

- Make sure that your amplifier can handle the power requirements of your speaker system(s), because some excellent speakers are also remarkably inefficient. Thus, for the same acoustic output, one speaker might require 10 or even 20 times as much audio power as another. A low-efficiency speaker calls for a high-power amplifier—perhaps 30 watts or more per channel—if you want loud, clean sound. Check the speaker manufacturer's recommendations as to power-amplifier specifications.

A few manufacturers are vague about how much

power is required by their speakers. If you like the sound of a speaker that seems to have low efficiency (and this includes a number of the new slim-line types), listen to it at high volume with an amplifier of the same power rating as yours. Then switch to a higher-power amplifier and check for any improvement in sound, particularly in the bass frequencies. Also check the amplifier specifications for the amount of power available at the frequency extremes. Although one amplifier rated at 30 watts may be able to develop its rated power at low distortion all the way from 20 to 20,000 cycles, a second amplifier rated at 30 watts may live up to its rating at 1,000 cycles and then degenerate into a 10-watter below 50 cps.

- Respect the *maximum* power rating of your speaker, since speakers, as well as power amplifiers, break up into distortion when driven too hard. Although a speaker may be able to handle, say, 30 watts without damage to its voice coil or suspension, this doesn't necessarily mean it can do so on a distortion-free basis. It may be beyond the capability of your speaker to reproduce the 32-foot stop of an organ both cleanly and at a life-like level.

(Continued overleaf)

DISTORTION

- When using multiple-speaker setups having odd impedances that do not match the amplifier's output impedances, minimum distortion results when the total impedance of the speaker line is lower—rather than higher—than the amplifier connection. For example, in a test involving an amplifier of moderate power, I have measured 2 per cent IM (intermodulation distortion) at 10 watts output when a 16-ohm load was connected to the 16-ohm amplifier tap. But when the 16-ohm load was connected to the 4-ohm tap, the IM soared to 34 per cent at the same power output. On the other hand, connecting a 4-ohm load to the 16-ohm tap resulted in no significant increase in the amount of measured distortion.

- Keep tabs on the operating time of the output tubes of your power amplifier, since their performance gradually deteriorates with use. For minimum distortion, replace them periodically, even though they are still working and test okay on a tube checker. If you use your hi-fi system almost daily, replacement about every year, or at least every two years, is suggested. A frequent check of the rectifier tubes in the tuner and amplifier is also recommended.

- When you are replacing a faulty output tube in a power amplifier, also replace the other tube of the pair (output tubes are always used in pairs in high-fidelity amplifiers). The reason for this is that, for minimum distortion, the two tubes should have nearly identical electrical characteristics, and the old tube is hardly likely to match the new one. In fact, it is a good idea to install a matched pair of tubes.

- The adjustment controls on your amplifier should be checked regularly, especially the bias control (which governs the amount of current drawn by the output tubes) and the balance control (which enables the output tubes to draw equal amounts of current). If your amplifier incorporates a meter or some other self-checking device, you can make these adjustments yourself. Otherwise, you will need an external meter or the services of an audio technician. For minimum distortion, particularly at high operating levels, these controls should be set precisely as directed in the manufacturer's instructions. Check the adjustments at least once a year, or whenever output tubes or rectifier tubes are replaced. The hum control should be readjusted whenever a preamplifier tube is replaced.

- Keep your components cool by providing good ventilation. Overheating is one of the main reasons resistors, capacitors, and other components change characteristics or otherwise deteriorate, with resultant distortion. If the components are placed in a cabinet, bookshelf, or other closed space, allow at least 4 inches

above each component for air flow. Don't stack components directly on top of each other, particularly on top of a power amplifier. If proper ventilation is a problem, install a low-noise fan (such as the Rotron Whisper Fan) in the enclosure, connected to a switched outlet of your preamplifier so that the fan works only when the equipment is turned on.

- If your system plays at a high volume when the gain control of your preamplifier or integrated amplifier is turned to about 10 or 11 o'clock, your cartridge, tuner, or other signal source may be supplying too much signal and driving the input stages of your amplifier into overload. This situation is most likely to occur when you are using some combination of old, new, and foreign-made equipment. There are several possible solutions to the problem. If the preamplifier has an input-level control at the input jack, adjust it for proper level. Make certain that the phono leads are plugged into the correct jacks, since a number of preamplifiers provide a choice of inputs for high- and low-output magnetic cartridges. If you are using a ceramic cartridge, be sure you are using the correct adaptor and have it plugged into the correct input.

- Always use a stylus that has a tip of the correct radius for your records. A 0.5-mil stylus is fine for LP records made in the past four or five years, but it is likely to be too small for the grooves of older LP's. To be safe, use a 0.7-mil or 1-mil stylus when playing older LP's. A 3-mil or 2.5-mil stylus should be used on 78-rpm records. Of course, a 3-mil (or 2.5-mil) stylus is much too large for microgroove records, and, similarly, a 1-mil stylus is not suitable for stereo records.

- When taping, it is important to record at a high level in order to obtain the best possible signal-to-noise ratio. However, even a slight increase past the maximum permissible recording level indicated by the magic-eye or VU meter may produce a large increase in distortion. If your recordings suffer from distortion in the loud passages, the indicator may be miscalibrated and is not giving you adequate warning against overrecording. A competent technician can check this and make the necessary adjustment.

If the indicator is a VU meter, the fault may be yours in failing to interpret the reading correctly. VU meters cannot faithfully follow the sharp, sudden rises in signal level that are commonly encountered in speech and music. That is, the meter reading may be lower than the actual peak of the audio signal. While the tape recorder manufacturer usually (not always) calibrates the meter with a compensating safety factor, the margin of safety may be inadequate on program material with high-level transients. It is up to you to make the necessary allowances in setting the recording level.

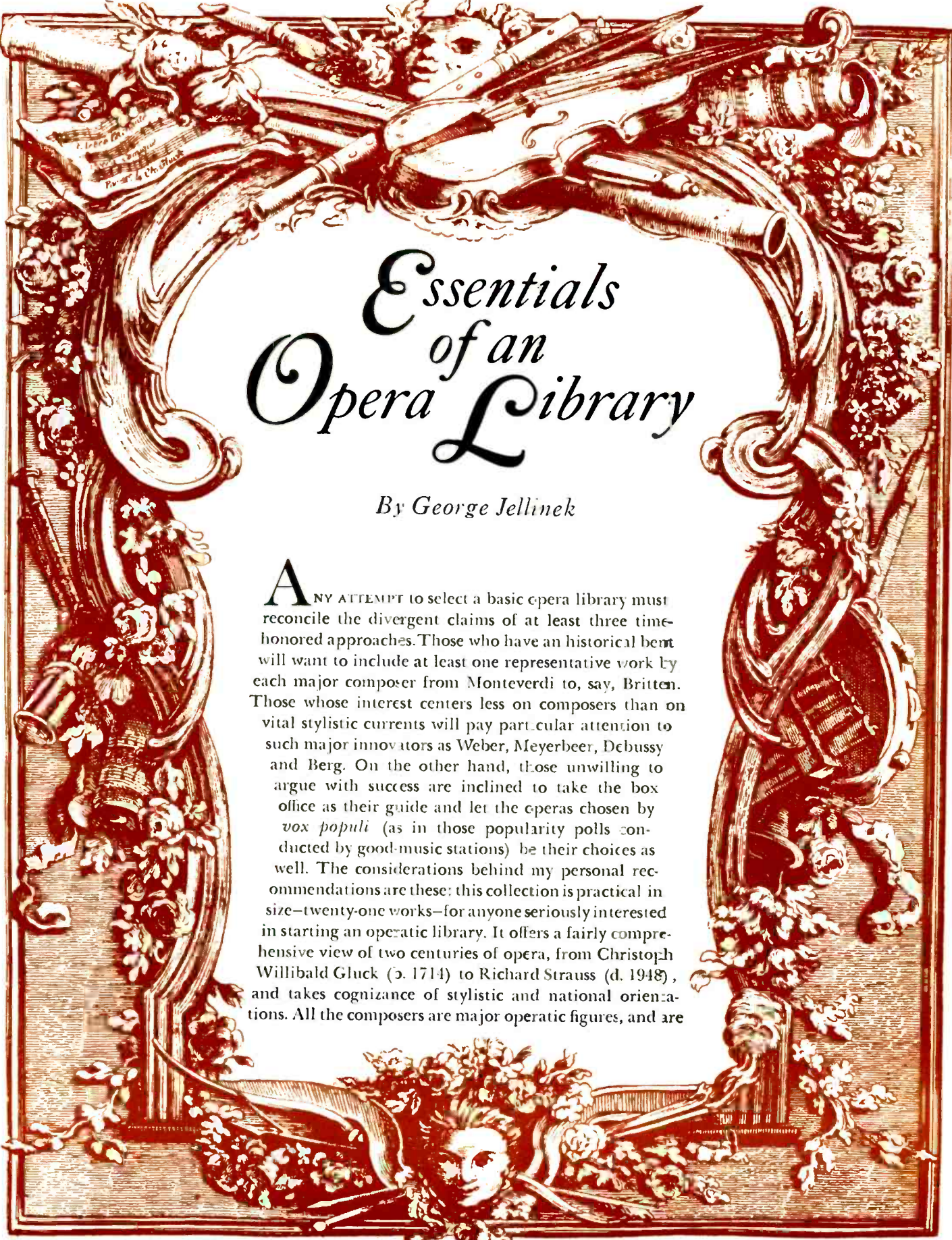

Essentials of an Opera Library

By George Jellinek

ANY ATTEMPT to select a basic opera library must reconcile the divergent claims of at least three time-honored approaches. Those who have an historical bent will want to include at least one representative work by each major composer from Monteverdi to, say, Britten. Those whose interest centers less on composers than on vital stylistic currents will pay particular attention to such major innovators as Weber, Meyerbeer, Debussy and Berg. On the other hand, those unwilling to argue with success are inclined to take the box office as their guide and let the operas chosen by *vox populi* (as in those popularity polls conducted by good-music stations) be their choices as well. The considerations behind my personal recommendations are these: this collection is practical in size—twenty-one works—for anyone seriously interested in starting an operatic library. It offers a fairly comprehensive view of two centuries of opera, from Christoph Willibald Gluck (c. 1714) to Richard Strauss (d. 1948), and takes cognizance of stylistic and national orientations. All the composers are major operatic figures, and are

Opera

Lenari Bellini, a dashing Figaro of the 1830's, sings "Se vuol ballare."



represented by their most significant works. Finally, this is a *recorded* library, which means that in some instances the availability or the absence of outstanding recordings dictates the choice.

GLUCK: *Orphée et Eurydice*. Nicolai Gedda, Janine Micheau, Liliane Bertin: Paris Conservatory Orchestra, Louis de Froment cond. ANGEL 3569 two 12-inch discs \$9.96.

Gluck, who turned the static, almost moribund form of *opera seria* into works of theatrical effectiveness, achieved his creative peak in *Orfeo ed Euridice* (1762). On the whole, I much prefer the Italian version to the later French edition (1774), which requires that the role of Orphée (written for male alto but sung by a contralto in the Italian version) be sung by a tenor in an uncomfortably high tessitura. Unfortunately, no satisfactory complete recording of the Italian version exists. (Toscanini's superlative reading of Act II on RCA Victor LVT 1041 is, of course, a model for all time of dramatic urgency, rhythmic vitality, and total control.) There is room for a new *Orfeo*, preferably with Simionato or Berganza in the title role, and Moffo or Tucci as Euridice. Until then, since the omission of this glorious score from a basic opera library would be unpardonable, Angel's satisfying version of the French edition is the logical choice.

MOZART: *Le Nozze di Figaro*. Giorgio Tozzi, Roberta Peters, Lisa della Casa, George London, Fernando Corena: Vienna Philharmonic Orchestra, Erich Leinsdorf cond. RCA VICTOR LSC 6408 four 12-inch discs \$23.92, LM 6408 \$19.92.

MOZART: *Don Giovanni*. Cesare Siepi, Suzanne Danco, Lisa della Casa, Hilde Gueden, Fernando Corena, Anton Dermota: Vienna Philharmonic Orchestra, Josef Krips cond. LONDON OSA 1401 four 12-inch discs \$23.92, A 4406 \$19.92.

Gluck was opera's great revolutionary, but the artistic powers that created *Le Nozze di Figaro* (1786) and *Don Giovanni* (1787) would probably have achieved the same matchless results even without Gluck's inno-

ventions. Espousing no theories, propounding no philosophies, Mozart relied solely on his genius, and he simply could do no wrong. He could transform even an indifferent libretto into workable opera, but when he had Da Ponte for a collaborator, as he did for *Figaro* and *Don Giovanni*, his creations became unsurpassed peaks of the operatic art. Unforgettable character portrayals, quicksilver action, a perfect fusion of musical and dramatic elements, and inspired sequences of scenes that add up to a totality even more miraculous—there you have a capsule description, admittedly an inadequate one, of these operas. Both are handsomely served on records—so generously, in fact, that alternate performances should be mentioned for each opera. For *Figaro*, listeners who may feel Leinsdorf's vital and precise reading is too tightly controlled may prefer having London OSA 1402/A 4407, in which Erich Kleiber's more relaxed and caressing treatment of the score brings out the best in a cast headed by Siepi as Figaro and Gueden as Susanna. And for *Don Giovanni*, the all-around superiority of the London set is challenged by Angel 3605 with a performance in which conductor Giulini highlights the dramatic tension and romantic elements most persuasively, and Joan Sutherland, Elisabeth Schwarzkopf, and Graziella Sciutti form a feminine trio of uncommon strength.

BELLINI: *Norma*. Maria Callas, Christa Ludwig, Franco Corelli, Nicola Zaccaria; Chorus and Orchestra of La Scala, Tullio Serafin cond. ANGEL S 3615 three 12-inch discs \$17.94, 3615 \$14.94.

ROSSINI: *The Barber of Seville*. Roberta Peters, Cesare Valletti, Robert Merrill, Giorgio Tozzi, Fernando Corena; Metropolitan Orchestra Chorus and Orchestra, Erich Leinsdorf cond. RCA VICTOR LSC 6143 three 12-inch discs \$17.94, LM 6143 \$14.94.

The age of bel canto—in which dramatic elements, orchestration, harmony, and plausibility of staging were secondary to vocal writing of the most demanding kind—reached its peak in the works of Rossini, Bellini, and Donizetti. Rossini's *The Barber of Seville* (1816) is, in Verdi's words, "for verve, declamation, and abundance of musical ideas the finest of all comic operas." Bellini, although less stimulating as a dramatist and completely unadventurous in his treatment of the orchestra, was a uniquely gifted melodist. In *Norma* (1831), his graceful, melancholy melodies are allied to expressions of power and passion. Unlike *The Barber*, which can survive almost any treatment, *Norma* should not be performed unless a singer capable of coping with its cruelly difficult title part is available. Maria Callas is, of course, a *Norma* in the grand tradition, and her portrayal alone would make the Angel set treasurable. Fortunately, she is surrounded by an excellent cast, and supported by an authoritative conductor. Angel also has a strong *Barber*, with brilliant characterizations by Maria Callas and Tito Gobbi, but only RCA Victor offers the uncut score of this delightful opera. For this reason, and for the over-all excellence of the performance, I recommend the RCA version.

VERDI: *La Traviata*. Anna Moffo, Richard Tucker, Robert Merrill; Chorus and Orchestra of Rome Opera, Fernando Previtali cond. RCA VICTOR LSC 6154 three 12-inch discs \$17.94, LM 6154 \$14.94.

VERDI: *La Forza del Destino*. Renata Tebaldi, Mario del Monaco, Ettore Bastianini, Cesare Siepi, Giulietta Simionato; Chorus and Orchestra of Santa Cecilia, Francesco Molinari-Pradelli cond. LONDON OSA 1405 four 12-inch discs \$23.92, A 4408 \$19.92.

VERDI: *Aida*. Zinka Milanov, Fedora Barbieri, Jussi Bjoerling, Leonard Warren, Boris Christoff; Chorus and Orchestra of Rome Opera, Jonel Perlea cond. RCA VICTOR LM 6122 three 12-inch discs \$14.94.

VERDI: *Otello*. Renata Tebaldi, Mario del Monaco, Aldo Protti; Vienna Philharmonic Orchestra, Herbert von Karajan cond. LONDON OSA 1324 three 12-inch discs \$17.94, A 4352 \$14.94.

Bel canto was Verdi's cradle, but Verdi became bel canto's doom. His bolder, more muscular expression gradually overpowered the gently flowing, embroidered melodies of the old style. For twelve years and through fifteen early operas this stern genius labored in the thickets of a febrile Romanticism. With *Rigoletto* (1853), he found direction and individual strength in the Romantic idiom, and Italian opera took the first step toward its greatest glory. Although *Rigoletto*, the rightful representative of early Verdi in a basic opera library, is passed over here in favor of *La Traviata* (1853), it is only because no really satisfying version of the former exists on records today. By contrast, of the eight recorded *Traviatas* in the catalog, seven have notable merits. Of these, the most satisfying is the RCA Victor set. Anna Moffo's Violetta is deeply moving and exquisitely sung, and Tucker's Alfredo displays exceptional vocal strength.

Antonio Tamburini as Don Giovanni in an 1841 Paris production.



NEW YORK PUBLIC LIBRARY

Eyebrows may be raised at the inclusion here of *La Forza del Destino* (1862). The work has a rather preposterous story, to be sure, and an uneven score. But nowhere do we find a better example of Verdi's inexhaustible melodic invention, of the bold and reckless profusion of his ideas. This is an opera in which, paradoxically, the excesses are impressive and the faults are treasurable. The London set, a near-definitive performance, offers a triumphant documentation of turbulent, middle-period Verdi.

Ten years later came *Aida* (1872), the first fruit of Verdi's final miraculous creativity. *Aida* is a piece of clearly contrived theatricalism in which, nevertheless, every measure rings convincingly true. The record companies, realizing that this is a score to be recorded with lavish artistry or not at all, have paid *Aida* an often spectacular attention. Two stereo sets offer some magnificent singing, but one (RCA Victor LSC 6158) suffers from the eccentricities of its conductor, the other (London OSA 1313) from an overabundance of technical gimmicks. So my choice is an earlier RCA production, conducted with power but without ostentation by Jonel Perlea, and sung with never-to-be-forgotten vocal art by Zinka Milanov, Jussi Bjoerling, and Leonard Warren.

Otello (1887) is the summit of Italian opera: perfect music set to a perfect text. Although Toscanini's galvanic reading on RCA Victor LM 6107 is matchless, this set suffers from the inadequacies of Ramon Vinay in the crucial title role. The choice, then, must go to London's new stereo edition. Captured in powerful sonics and conducted with vitality, it is sung by the most accomplished Otello and Desdemona of our times.

WAGNER: *Tristan und Isolde*. Kirsten Flagstad, Blanche Thebom, Ludwig Suthaus, Dietrich Fischer-Dieskau, Josef Greindl; Philharmonia Orchestra, Wilhelm Furtwängler cond. ANGEL 3588 five 12-inch discs \$24.90.

WAGNER: *Die Meistersinger von Nürnberg*. Ferdinand Frantz, Elisabeth Grummer, Rudolf Schock, Gottlob Frick, Gustav Neidlinger; Berlin Philharmonic Orchestra, Rudolf Kempe cond. ANGEL 3572 five 12-inch discs \$24.90.

In *Otello*, without any fanfare or theorizing, Verdi achieved a perfect blend of music and speech, an aim that Wagner pursued steadily, heroically—and for the most part without success. But in *Tristan und Isolde* (1859) Wagner achieved, by means of an uninterrupted musical continuity, a dramatic intensity of surpassing mastery. Indeed, the score's most remarkable quality is its surging, ebbing, continuous flow. The decade-old Angel *Tristan* is a true classic, superior to its stereo rival (London OSA 1502) in every element except orchestral sonics. In creating a gorgeous orchestral setting, however, London's engineers virtually bury the vocal line, including—and this takes some doing—Birgit Nilsson's soaring soprano.

Die Meistersinger (1867) shows us Wagner's human side. There are no gods here, no superhuman heroes, no

Opera

Marie Célestine Laurence Gulli-Marie was the first Carmen (and the first Mignon as well).



BETTMANN ARCHIVE

visionary knights, but real people, a credible story, comic situations, and a delightfully evocative atmosphere. Wagner's happy inspiration is beautifully served by Angel's Berlin recording, in which all the principal roles are perfectly cast, the orchestra and chorus are superb, and the sound, though not stereo, is all one could ask for.

BIZET: *Carmen*. Victoria de los Angeles, Nicolai Gedda, Janine Micheau, Ernest Blanc, Xavier Depraz; Radiodiffusion Orchestra, Sir Thomas Beecham cond. ANGEL S 3613 three 12-inch discs \$17.94, 3613 \$14.94.

MASSENET: *Manon*. Victoria de los Angeles, Henri Legay, Michel Dens, Jean Borthayre; Orchestra of the Opera Comique, Pierre Monteux cond. CAPITOL GDR 7171 four 12-inch discs \$14.94.

During the first hundred years covered by this survey, the most significant French operas were written by *étrangers*: Gluck, Cherubini, Rossini, and Meyerbeer. With Gounod's *Faust*, the golden age of French Romantic opera began, culminating in two masterpieces, both in their own ways expressive of the best Gallic qualities: *Carmen* (1875) and *Manon* (1884). Even the regrettable current decline of French opera seems to have had no effect on these two operas' enduring popularity. As for their recorded representation, we are fortunate in having classic interpretations by two great conductors. Thanks to Sir Thomas Beecham, we can enjoy the richness and sparkle of Bizet's orchestration that legions of unfeeling perfunctory conductors managed to conceal from us. Pierre Monteux's *Manon* is a similar amalgam of elegance, discipline, and obvious affection for the opera's charm and poetic qualities. Both sets are blessed by the presence of Victoria de los Angeles, in enchanting voice and equally convincing in the two dissimilar characterizations. Her colleagues are not her peers, but Beecham and Monteux bring out the best in them.

MOUSSORGSKY: *Boris Godounov*. Boris Christoff, Evelyn Lear, Dimitr Ouzounov, John Lanigan, Anton Diakov; Chorus of the National Opera House, Sofia; Paris Conservatoire Orchestra, André Cluytens cond. ANGEL S 3633 four 12-inch discs \$23.92, 3633 \$19.92.

Here we enter a different world. Throbbing Italian melodies, Wagnerian tonal sensuousness, and elegant Gallic wit are left far behind. Moussorgsky strikes with a crude, elemental power, with massed sonorities and unique harmonic color—unique even in Rimsky-Korsakov's dressed-up orchestration—and with his direct, unspectacular, yet intensely moving declamation. *Boris Godounov* (1874) is more than the most significant Russian opera: it is echoed in the choruses of Puccini's *Turandot*, in the song-speech of Debussy's *Pelléas et Mélisande*, and extends even to the vocal writing of Francis Poulenc. The able cast and superlative chorus in Angel's new stereo recording bring this powerful score stunningly to life. At its head stands the brilliant and magnetic Boris Christoff, with magnificent interpretations of the three roles of Boris, Pimen, and Varlaam.

MASCAGNI: *Cavalleria Rusticana*. Maria Callas, Giuseppe di Stefano, Rolando Panerai; La Scala Chorus and Orchestra, Tullio Serafin cond. ANGEL 3509 two 12-inch discs (three sides) \$7.98.

LEONCAVALLO: *I Pagliacci*. Franco Corelli, Lucine Amara, Tito Gobbi, Mario Zanasi; La Scala Chorus and Orchestra, Lovro von Matatic cond. ANGEL S 3618 two 12-inch discs \$11.96, 3816 \$9.96.

Seventy years of modern civilization have taken the shock value out of these Siamese twins of *verismo*, but their popularity remains undiminished. After all the criticisms

Léon Bakst's costume design for a Polish nobleman in Boris.



NEW YORK PUBLIC LIBRARY

have been enumerated, the operas' lack of intellectual depth duly deplored, and their raw emotionalism put into proper perspective, one fact remains: no one has equalled Mascagni and Leoncavallo in expressing in music a "slice of life" passionately, credibly, and tersely. Both of the stereo versions of *Cavalleria Rusticana* (1891) are inferior to the mono set of Angel 3509, in which Maria Callas is a strikingly drawn Santuzza and Giuseppe di Stefano is a light-voiced but intensely moving Turiddu. *Pagliacci* (1892) has fared better in stereo, and Franco Corelli's thrilling Canio, Tito Gobbi's memorable Tonio, and Lovro von Matacic's vigorous and disciplined leadership make Angel 3618 the preferred choice. (The classic Canio of Beniamino Gigli in a 1934 performance is preserved on Electrola 80476/77, and should be heard by anyone who values operatic excellence.)

PUCCHINI: *La Bobème*. Renata Tebaldi, Carlo Bergonzi. Gianni d'Angelo. Ettore Bastianini, Cesare Siepi. Orchestra of Santa Cecilia Rome. Tullio Serafin cond. LONDON OSA 1208 two 12-inch discs \$11.96, A 4236 \$9.96.

PUCCHINI: *Tosca*. Maria Callas, Giuseppe di Stefano, Tito Gobbi; La Scala Orchestra, Victor de Sabata cond. ANGEL 3508 two 12-inch discs \$9.96.

PUCCHINI: *Turandot*. Birgit Nilsson, Renata Tebaldi, Jussi Bjoerling, Giorgio Tozzi; Rome Opera Chorus and Orchestra, Erich Leinsdorf cond. RCA VICTOR LSC 6149 three 12-inch discs \$17.94, LM 6149 \$14.94.

"Three Puccini operas for a basic library? Nonsense!" will be one reaction to the above. "What? No *Butterfly*?" will be another. At any rate, the rapturous *La Bobème* (1896), the vibrantly melodramatic *Tosca* (1900), and the savagely colorful *Turandot* (1924) afford a comprehensive study of Italy's most accomplished operatic master since Verdi. Puccini worked in a narrower expressive spectrum than did Verdi, but within it he was an absolute master. He possessed an unerring dramatic sense and an uncanny—and vastly underrated—command of orchestral resources that have contributed much to our modern concept of opera. The unfinished *Turandot*, Puccini's masterpiece despite its flaws, was the last opera to enter the international repertoire. The next link in the broken chain is nowhere yet in sight.

Arturo Toscanini, who conducted *La Bobème's* premiere in 1896, lends his tremendous authority to RCA Victor LM 6006, a 1946 performance transferred to long-playing recordings. But the sound is a severe handicap, and the singing is surpassed by that of the exceptionally fine cast of the London stereo set. This is a somewhat reluctant recommendation, however, for London's engineering renders the orchestra excessively dominant. As for the recorded *Toscas*, Angel's 1953 performance, one of the outstanding operatic recordings of all time, is virtually definitive, despite its ten-year-old sonics. In *Turandot*, RCA Victor's Birgit Nilsson and Jussi Bjoerling are only two of many reasons why the Victor set is recommended.



NEW YORK PUBLIC LIBRARY

Costume sketch of Baron Ochs for the original production of *Der Rosenkavalier*, Adolf Fürstner, designer.

STRAUSS: *Elektra*. Inge Borkh, Marianne Schech, Jean Madeira, Dietrich Fischer-Dieskau; Saxon State Orchestra. Karl Böhm cond. DEUTSCHE GRAMMOPHON 138690/1 two 12-inch discs \$13.96, 18690/1 \$11.96.

STRAUSS: *Der Rosenkavalier*. Elisabeth Schwarzkopf, Teresa Stich-Randall, Christa Ludwig. Otto Edelmann; Philharmonia Orchestra. Herbert von Karajan cond. ANGEL S 3563 four 12-inch discs \$23.92, 3563 \$19.92.

In his daring *Elektra* (1909), Richard Strauss exploited every known resource of orchestral and vocal writing, bringing operatic means to a boundary he himself was unwilling to cross in his ensuing works for the stage. Retracing his steps in 1911, he composed *Der Rosenkavalier*, which he unwisely called his "Mozartian opera"—his lack of Mozart's sense of proportion is nowhere exhibited more startlingly. Although in *Der Rosenkavalier* lightness and sophistication are at constant odds with overblown sonorities and long-windedness, the score is gorgeously written, and the delightfully drawn characters are given exquisite music to sing. While the performance on London A 4404, beautifully conducted by Erich Kleiber, is a brilliant one, the captivating Marschallin of Elisabeth Schwarzkopf on Angel 3563 is wholly irresistible.

With regard to *Elektra*, there can be no dispute: the singing on DGG's recording mirrors the score's seething passions, conductor Karl Böhm's authority is unexcelled, and the recorded sound captures to perfection the furious glory of Strauss' sonorities.

George Jellinek has been HiFi/STEREO REVIEW's regular monthly reviewer of opera and vocal recordings for the past five years.

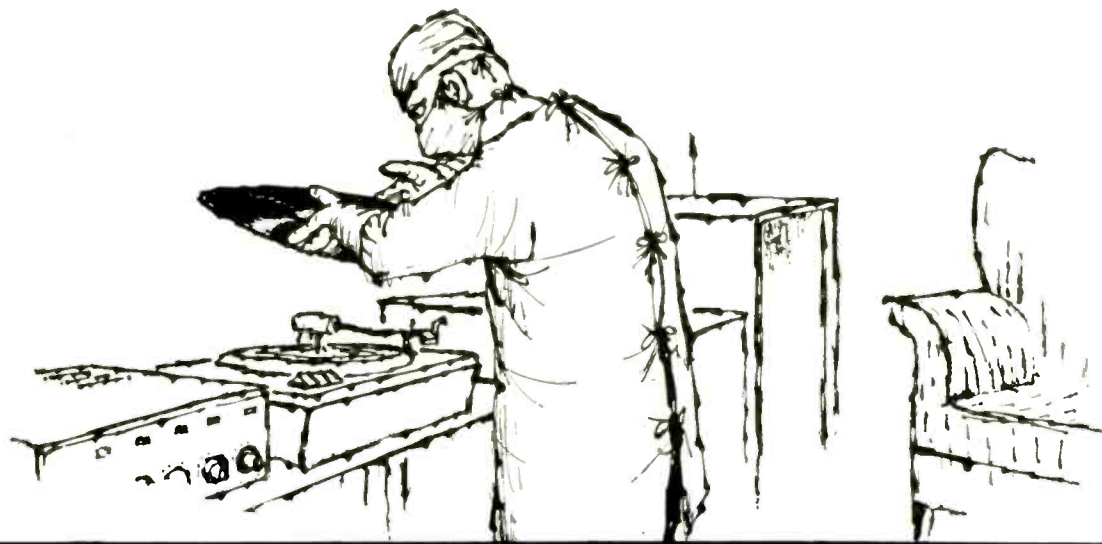

RECORD WEAR AND CARE

SOME PRACTICAL HINTS ON HANDLING AND STORING YOUR DISCS,
PLUS A GUIDE TO THE MOST EFFECTIVE RECORD-CLEANING DEVICES

By **JOHN MILDER**

ACCORDING to a report published a few years ago by the Library of Congress, the long-playing record is a durable product, capable of lasting a lifetime. For most of us, however, the microgroove disc is one of the most delicate, potentially short-lived products ever put on the market.

Until recently, the most common cause of record damage was a worn stylus. It is still true that a worn, chisel-shaped stylus can do tremendous damage to a record in a single playing, but the problem of stylus wear is no longer what it once was. The new, high-compliance, low-mass stylus assemblies that track at forces of two grams and below have just about eliminated the problem for the owner of component hi-fi equipment. No one seems to have worn out one of the new styli yet, and their life expectancy seems to be at least five years. An additional consideration is that several new cartridges employ styli that retract into the body of a cartridge at forces greater than two or three grams, thereby reducing the chances of chipping a diamond stylus by dropping a tone arm. All in all, it seems that the inspection of a stylus under a microscope every few months is now necessary only for owners of older equipment.

Far more dangerous to records than worn styli is accidental damage to the stylus shank, which can cause the stylus tip to contact the record groove at an improper angle. Many cartridge manufacturers, par-

ticularly those who make cartridges with quick-change stylus assemblies, will repair or replace a distorted or damaged shank for significantly less than the cost of a complete new stylus assembly. If a stylus is damaged beyond repair, you should buy the manufacturer's own replacement stylus. "Bargain" styli are seldom really bargains, since they usually fail to meet specifications for everything from compliance to stylus-tip size.

If you own one of today's high-compliance cartridges, the most important consideration for extended record life is setting stylus force at the right value. This does *not* mean finding the lowest force at which a stylus will stay in record grooves. As the tracking forces of arms and cartridges have been lowered in the past few years, the advantages of ultralight tracking have been well publicized. But as things now stand, too light a force is probably more destructive to grooves than one that is too heavy. If a stylus is in perfect contact with the groove walls, the only result of slightly excessive tracking force is that the walls are deformed slightly as the stylus passes. But the normal elasticity of vinyl causes the groove wall to spring back into shape almost immediately—providing the groove is not replayed several times in a few minutes. (When operated too far above their maximum specified forces, however, the stylus assemblies in many current cartridges will collapse—immediately or after a few hours of playing—and possibly suffer damage.)

At too light a force, however, contact between the stylus and the groove becomes intermittent, and the stylus begins to bounce back and force between the groove walls. The result may be destruction of the high-frequency modulations in the groove and the resultant addition of a harsh quality to the over-all sound.

It is possible to determine the tracking force by ear. One way is to listen to a heavily modulated passage and to adjust the stylus force upward from the lowest recommended value until the loud passages are distortion-free. A better method, though, is to use the HiFi/STEREO REVIEW Model 211 test record, which has two separate bands for setting tracking pressure. Once you have found the correct force, check it periodically with a reliable device such as the Garrard SPG 3 or the Acoustic Research stylus-pressure gauge.

ONCE your record-playing equipment is set up correctly, the main considerations then become your records and how to handle them. The first question to be decided is simply where to keep your records when they are not on the turntable. With proper storage, records should have a shelf life of a century or two without showing any signs of deterioration. Improper storage, on the other hand, can cause warpage overnight or serious groove damage in a matter of weeks.

There is no question that records should be shelved vertically—standing at a perfect 90 degrees. Stacking large numbers of records on top of each other leads both to warpage and possibly to damaged record surfaces (since dust, vinyl particles, and even the creases in an inner record sleeve are pressed into them). Storing records slightly off the vertical, as in a partially filled record compartment, tends to cause warpage. The solution advocated by most authorities is a compartmented cabinet or shelf arrangement, in which each compartment is designed to contain no more than about twenty records. Many commercial cabinets meet these simple requirements (several mail-order houses offer modular cabinets, some in kit form, for expanding record collections), and they are also easy to build. The only additional requirement is that the compartments in use be kept comfortably full; pieces of corrugated cardboard the same size as record jackets are handy for filling in empty spaces, and are preferable to wedges that exert unequal pressure on record surfaces.

As long as you select a storage location that is away from sunlight and other sources of heat, keeping your records in good condition becomes mainly a matter of habit. Most records are damaged between the time they are played and the time they are returned to storage. Whatever the reasons for it—such as the need to get to bed after a long evening—it is not a good idea to leave records lying around—or stacked on a record changer—overnight.

Habit is also the key to the proper handling and cleaning of records. In some households, record-playing is as involved a ritual as the opening of a bottle of vintage wine, but it no longer has to be. If you are worried about handling ultralight arms and cartridges (the danger is more to the cartridge than to the record), you can check the semi-automatic or viscous-damped tone arms supplied by AR, Bogen, Empire, Shure-SME, Thorens, Weathers, and others. If you already own a tone arm, you can easily install one of the raising and lowering devices such as the Ortofon Hi-Jack or the Lafayette Radio Model MS-785.

In the case of record changers, a precaution against groove-skating is to level the unit carefully when you install it. And as for handling records on the way to or from a turntable, a short training session can teach all members of a household (including children) to handle LP's only at their rims and labels—to avoid both scratches and oily finger marks. Those same oily fingertips also should not habitually be “played” on your stylus in an effort to dislodge accumulated dust. Not only might the stylus assembly be distorted, but the transients thus generated may damage your speakers. A handy substitute for your fingertip in this case is the kind of stylus brush sold by Robins as the Kleen-needle and by Audiotex simply as “stylus brush” (30-004). Both of these little items have adhesive bases for mounting directly on your record player, and the stylus assembly can be cleaned merely by moving the tone arm across the brush. On record changers, the brush can be set up to clean your stylus automatically.

ALTHOUGH it is not necessary to carry the business of cleaning LP's to extreme lengths, some type of consistent routine is needed. Dust and grit not only add annoying pops and clicks to the reproduced sound, but eventually, through abrasion, damage both grooves and styli. Keeping records free of dust is unquestionably the biggest concern in preserving an LP collection.

What makes dust such a pernicious problem is the charge of static electricity on the surfaces of a disc. An incredible amount of airborne dust can be attracted to the record surface during a single playing. Briefly, the problem is that vinyl is a natural insulator that accumulates a static charge when rubbed against just about anything (including record sleeves and cleaning cloths). A conductive material that permits leakage of electrons would solve the problem, and some record companies make discs with such a substance in the vinyl mix. But no material has proved perfect in this respect, and many manufacturers insist that standard, nonconductive materials make the best-sounding and most durable records. For the most part, therefore, the battle against static electricity is still left to the listener.

(Continued overleaf)

RECORD WEAR

Of the parade of antistatic and cleaning devices that have been marketed since the inception of the long-playing record, a majority have either not worked, had unwanted side-effects, or actually aggravated the problems. Most chemical sprays, for instance, lose their effectiveness as soon as they dry—usually leaving hardened deposits in grooves to clog a stylus tip or to mask high-frequency modulations. Liquids that are viscous enough to avoid immediate evaporation also become ineffective after a while; but before they do, they may thoroughly gum up the stylus assembly. As for the antistatic cloths sold or given away by record stores, many dry out almost immediately; as soon as they do, their application to a record simply adds to the static charge.

BUT a number of effective and safe products are on the market. The oldest and one of the best is the Dust Bug, once marketed by ESL but now handled by Elpa. Invented by Cecil Watts, a British authority on record care, the Dust Bug combines a nylon brush and a plush pad on a lucite arm that pivots (like a tone arm) to follow record grooves; the arm's pivot assembly attaches with a rubber suction cup to any convenient point on a turntable's mounting board. As it tracks the grooves of a record, the brush turns up dust and grit, and the plush pad collects the loosened debris during the next revolution. The Dust Bug's antistatic action, which is intended to last only temporarily, is supplied by a sparing application of a refined ethylene glycol solution to the pad, and little or no residue is left to harden either in the grooves or on the stylus tip. The Dust Bug's effectiveness is unquestionable, but the listener must be willing to handle a second "arm" at the beginning and end of a record. Elpa plans to market a changer version of the Dust Bug in the near future, designed to clip on the tone arm.

Another Watts invention, the Preener, is a cylindrical device that is wide enough to cover a record from rim to label. Inside the cylinder is a removable wick that is moistened with ordinary tap water to release an antistatic solution through the outer pad. The surface of the cylinder is made of a soft, sheared material that seems to penetrate to the bottom of record grooves fairly effectively, and applying the Preener to the surface of a disc (as it makes two or three revolutions on a turntable) cleans the record well enough that a subsequent cleaning with the Dust Bug does not turn up much dust. The Preener is very convenient to use, but applying it to a record for more than the suggested two or three revolutions seems to place a static charge on the *opposite* side of the record.

Audio Dynamics' Hush Brush is also a brush-pad combination, but with two added features. The brush and pad, both the width of a standard record radius, are attached to an equally wide plastic handle that serves as a reservoir for the antistatic fluid supplied with the Hush Brush. When the brush is tilted down to clean a record (the cleaning again takes place while the record rotates a few times), the pad receives a measured application of the antistatic fluid from the reservoir. The brush itself consists of 1,800 bristles that are designed to reach to the bottom of microgrooves. The result is excellent cleaning of both surface and grooves. The use of the fluid is a must: without it, the Hush Brush also tends to create a static charge on the opposite side of the record.

Grado Laboratories offers a cleaning gadget called the Dustat. Consisting of a soft pad on a transverse rod that can be swung into place over a record's surface, the Dustat is a novel approach to the static problem. It relies on the contact between pad and record to build up a static charge on the pad, which in turn attracts the dust from the record surface. This reversal of the usual antistatic procedure works effectively, and the Dustat is relatively convenient to use. It does not remove the static charge, however, and the record must be put back into its jacket immediately after playing to avoid the accumulation of a new layer of dust.

Several record-care products use radioactive materials to neutralize static charges. Some, like the Audiotex Stat-Elim, are pellets that clip onto a tone arm and neutralize the charge on the record surface as the arm moves across a disc. However, while very effective, these gadgets still require some provision for removal of the loosened dust. The Dust Bug works very well with an ionizing gadget clipped onto it and then no longer requires application of its antistatic

"You mean you left this lying flat since ten this morning?"





CARTOONS BY RODRIGUES

*"The stylus looks okay,
but did you know someone
in your house has
chicken pox?"*

liquid. Another product, the Staticmaster, combines a strip of radioactive polonium with a soft brush of jaguar hair for simultaneous cleaning and antistatic action.

Although all the radioactive devices discussed radiate relatively harmless alpha particles and are completely safe in normal use, precautions are in order. Any of the devices may attract the notice of inquisitive children, particularly the berry-like appearance of the jewels. The manufacturers warn of potential harm from direct contact with the radioactive materials themselves. Any radiating pellet should be epoxy-glued in place, and the Staticmaster brush should be kept where prying hands can not get to it.

ALL of the products mentioned here are designed for use with reasonably new records, and they may not be able to clean older discs that have dust partially imbedded in the grooves. For the time being, at least, the only effective technique for cleaning older records is an old-fashioned washing. From my own experience, I would suggest the following procedure for records that have been made unlistenable by dust and grit: using a few drops of a mild detergent (such as liquid Ivory or Lux) in lukewarm water, bathe the records individually for a minute or so, agitating them to loosen the accumulated grit. After rinsing (and a bit of manual spin-dry action), dry with a soft, lint-free cloth, following the spiral of the grooves. This procedure will not yield records that sound brand-new, but it can make them more listenable, removing a surprising amount of extraneous noise. A precaution, however, is to check each record label in advance with a wet cloth to see if its dye will run. If so, keep the label dry. This cleaning procedure—not as laborious as it sounds—may be made unnecessary by a new product from Cecil Watts, the manual Parastat (not to be confused with Mr. Watts' larger and more expensive gadget used in

some British record stores for permanent de-staticizing). According to advance publicity, the new Parastat will handle old as well as new microgroove records.

Although almost all the troubles records are heir to can now be overcome easily, one major problem still remains: the warped record. Because of stresses applied during manufacture, shipping, and storage, a certain percentage of discs are warped before they reach a turntable. If you can not find a sufficiently flat pressing of a particular record, the best answer is a tone arm that will track the normal slow warp with the least amount of audible wow. Unless the warp in a record is both so severe and so abrupt as to make it unplayable with a good tone arm, avoid any home remedies for flattening it. Most of these techniques—such as clamping a record between heavy sheets of plate glass, slowly heating it in an oven, and then cooling—may simply produce a new warp. And excessive heating can cause groove deformation. If you have a record that is unplayably warped, you might try flattening it, but try all other measures first—including a search for a new copy of the record.

Ultimately, the condition of any record collection depends on its owner's attitude toward it. If you consider records expendable, they will tend to become dog-eared fairly quickly. But in those households where records have a way of becoming documents, an old-favorite recording of a symphony often occupies a turntable while a newer, stereo version rests undisturbed on the shelf. If you suspect that some of your records will become documents, and you treat them as such, you will find that a record is not as fragile as is sometimes thought.

John Milder has written numerous previous HiFi/STEREO REVIEW articles; the most recent were two in the August issue.

S&Q

SOUND AND THE QUERY

PRACTICAL POINTERS ON THE INSTALLATION AND MAINTENANCE OF HOME MUSIC SYSTEMS

BY LARRY KLEIN

Oil on Troubled Equipment

Q. How often should I oil my record player and my tape recorder?

PETER DiSALVO
Denver, Colo.

A. You will probably be better off if you don't. Unless the instruction manual that came with your equipment tells you exactly when, where, and what grade of oil to use, you run the risk of damaging the rubber parts in the drive system. The cost of repairing such damage would probably be greater than the cost of repairing any wear that might occur because of lack of lubricant. Most equipment is made with sealed bearings that have permanent lubricants.

Basic Level Setting

Q. My stereo power amplifier has a level control at each input. Is there an optimum setting for these level controls?

BETTY GREEN
Downington, Pa.

A. In general, level controls on a basic amplifier should be set to the full-gain position. However, if excessive noise comes through with the preamplifier's volume control turned down, reduce the basic amplifier's input controls until the noise lessens or until you can't get enough volume from the system. In any case, the level control on the basic amplifier should not be turned down more than one-third of its total rotation. If noise from the preamplifier is still audible with the basic's controls turned down, the preamplifier is probably in need of servicing.

Disc Color

Q. Is there any particular reason that most records are black? Is the vinyl used in the occasional red or orange record of different quality from that used in the black?

STANLEY KOSTER
Minneapolis, Minn.

A. Most records are black because black records have long-standing customer acceptance. Aside from this, an opaque record conceals struc-

tural flaws in the record that, although not audible, might be objectionable to consumers.

I've also been told that the carbon black used as the coloring agent increases the record's conductivity and thus helps leak off static-electricity charges. But whether black, red, orange, or tutti-frutti, the vinyl used in all good records is of the same quality.

Stereo Blend Control

Q. I am using two separate mono systems for stereo reproduction, and I'm quite pleased with the results. However, I would like to add a blend control. Is there any easy way to do this without extensive rewiring?

CHARLES MARGOLIS
Culver City, Calif.

A. Considering your setup, the best place to add a blend control would be across the speaker leads, as shown in the diagram. The control should be connected from the 4-, 8-, or 16-ohm output terminal of one amplifier to the equivalent terminal on the

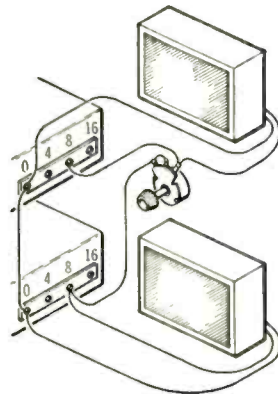

other amplifier. It may also be necessary to add a connecting wire between the two common ("0") output terminals of the amplifiers. If your main speakers are 4-ohm types, use a 100-ohm, 2-watt wirewound control; for 8- or 16-ohm speakers, use a 200-ohm control.

In the control's minimum-resistance position, both channels will be paralleled, and monophonic reproduction will result; at the maximum-resistance

position, the control is, in effect, out of the circuit. In-between settings will provide the desired degree of blend.

Multiplex-Ready

Q. I've noticed that tape-recorder advertisements frequently use the phrase "multiplex-ready." Does this mean that older recorders can not be used to tape stereo FM programs?

S. J. NEIDTICH
San Bernardino, Calif.

A. When the specifications of a tape recorder state that it is "multiplex ready," they usually mean that some provision has been made in the tape recorder to prevent interaction between the recorder's internal recording bias oscillator and the 19-kc signal (or its harmonics) that accompanies all FM stereo broadcasts. It is difficult to predict whether any given tuner and tape recorder will have difficulty in recording. The determining factors are the degree to which the 19-kc signal is suppressed at the output of the tuner, whether the tape recorder has a 19-kc filter built in, and the frequency of the oscillator in the tape recorder. When purchasing a new recorder or stereo tuner, make sure it operates with your present equipment without producing whistles or overload.

Speaker Specs

Q. Do frequency-response specifications for speakers mean anything? My catalogs list a \$3.95 tweeter that seems to have the same specifications as a \$25 model.

ARTHUR CHARLES
Los Angeles, Calif.

A. Unless the response is expressed as plus or minus so many decibels from the lowest to the highest frequency covered, it is meaningless. Furthermore, frequency response is not the whole story—it isn't even necessarily the most important part of the story. Other characteristics such as distortion, transient response, damping, and dispersion are more important to the listener. It is unfortunate that these factors are rarely detailed in specification sheets and in catalogs.

Because the number of queries we receive each month is greater than we can reply to individually, only those questions selected for this column can be answered. Sorry!

BEST OF THE MONTH



CLASSICAL

A REVELATORY READING OF BERLIOZ' *HAROLD IN ITALY*

Yehudi Menuhin and Colin Davis provide a marvelous blend of gusto and sensitivity

HECTOR BERLIOZ' symphony with viola obbligato, *Harold in Italy*, is a score by this remarkable composer that I have always placed in the second rank among his creations—at least in relation to such masterpieces as the *Symphonie fantastique*, the Requiem, or *L'Enfance du Christ*. But this astounding recorded performance,



BERLIOZ IN ITALY
(An 1831 Roman portrait by Signol)

featuring the eminent violinist Yehudi Menuhin playing the viola and England's most promising young conductor, Colin Davis, has compelled serious second thought on my part.

If Mr. Davis can, in the next few years, accomplish consistently with the monumental classic, Romantic, and modern symphonic repertoire what he has done here, there will be no question of his succession to the mantle of the late Sir Thomas Beecham; for it is Sir Thomas in peak form who comes to mind as one listens to this disc, and it was Sir Thomas, with William Primrose, who in 1952 made the only other wholly convincing recorded version of this music.

Thanks to Menuhin's powerful personality as a performer and to his unerring musicianship, Berlioz' Byron-inspired protagonist emerges on this disc as a poignant personage in his own right, taking part in a meaningful dialogue with the orchestra as it evokes his experiences in the Italian Alps, his viewing of the pilgrims' procession, his memories of the Abruzzi mountaineer serenading a girl, and his recollection of the brigands' orgy. Colin Davis, like Menuhin a positive and gifted interpreter, carries his players into the spirit of the situation with a marvelous blend of gusto and coloristic sensitivity. (Continued overleaf)



Yet he does not neglect a loving attention to a classically proportioned phrasing of melodic line and to a balancing of contrapuntal voices within the orchestral fabric, most notably in the Pilgrims' March. The essence of a perfect Berlioz performance, as expounded in the past by Monteux, Beecham, and the almost forgotten Sir Hamilton Harty, is to be found here: ardor of expression combined with a Gluck-like purity in setting forth the melodic line. It is only this approach that can save the brigands' orgy from becoming—as it usually does—a meaningless uproar. The high spot of this movement, however, is its introduction, wherein the soloist and orchestra recall in dialogue (as in Beethoven's Ninth) themes from the previous movements. Here the rapport between Menuhin and Davis is a joy to hear. Then there is the often troublesome stumbling block midway in the Pilgrims' March, where the solo viola is restricted to playing arpeggio figurations while the orchestral winds intone a chorale. Menuhin, with the most artful kind of tonal coloring, endows this episode with an intense aura of communicative conviction; this is no less than an interpretive miracle.

Performances of this caliber are all too seldom encountered. In my opinion, this revelatory reading will surely take its place among the Great Recordings of the Century a generation hence. I hope, by the way, that this will not be the last of Menuhin's disc appearances as viola soloist. It would be good to hear what he would do with, for example, the Walton Concerto or the Bloch Viola Suite.

David Hall

© BERLIOZ: *Harold in Italy*, Op. 16. Yehudi Menuhin (viola); Philharmonia Orchestra, Colin Davis cond. ANGEL S 36123 \$5.98, 36123* \$4.98.

A SONIC TRIUMPH: VON KARAJAN'S *TOSCA*

Leontyne Price is sensuous and powerful in the title role

TEN YEARS AGO, Angel released a recording of *Tosca* (with Maria Callas, Giuseppe di Stefano, and Tito Gobbi, Victor de Sabata conducting) that established a standard no subsequent productions have quite been able to match. Now, however, in RCA Victor's new version with Leontyne Price, Giuseppe di Stefano, and Giuseppe Taddei, with Herbert von Karajan conducting, we have, for the first time, a recorded performance to challenge Angel's supremacy.

As noted, Giuseppe di Stefano sings Cavaradossi in both the old Angel and the new RCA Victor sets. Even without the ringing freedom and soaring, liquid ease with which he completely dominated the role's vocal challenges ten years ago, this is still one of the tenor's best performances in years. Perhaps it was von Karajan's influence, or perhaps he was inspired by his two impeccably musical colleagues, but the fact is that this Cavaradossi is dramatically convincing and vocally imposing.

The Tosca of Leontyne Price fulfills all expectations. The dark beauty of her voice, and the sensuous and passionate coloration that is its distinguishing characteristic, make her a superb interpreter of the role. She is most impressive—in fact, incomparable—in those moments when the vocal challenges are greatest. There is still a measure of fussy self-consciousness in her first scenes, but she nevertheless gives us an intelligent and powerful characterization bathed in streams of glorious sound.

Giuseppe Taddei's voice, full and sonorous in mid-range, loses body and becomes hollow at the top. It is used so skillfully, however, that—except when he is pitted against full orchestra—these limitations are hardly evident. What is more important, Taddei's characterization is completely absorbing: his Scarpia is a brutal, sinister, oily and calculating figure, a monster with intelligence and courtly manners. Fernando Corena makes rather more of his scene as the sacristan than he should—an old story with this gifted but irrepressible artist.

In no other recording of *Tosca* has the orchestra been heard with the richness, power, and clarity of texture revealed here. The playing of the Vienna Philharmonic is a triumph of tone, discipline, and expressiveness, but along with the Karajan insights, we also get a share of the Karajan tempo eccentricities. The solemnity of the *Te Deum* is, I think, overdone; Act II is not quite as excitedly paced as De Sabata's; and the pre-execution scene in Act III is allowed to sag perceptibly.

One small miscalculation should also be pointed out: toward the end of Act II, when Tosca has convinced herself that Scarpia is dead, she utters the words "*È morto.*" The score at this point clearly indicates a pause after the one-measure rest before Tosca announces "*Or gli perdono*" ("Now I forgive him"). Callas, needless to say, makes the most of this pause; Price pronounces the two lines with hardly a breath between them. It sounds ineffective and is un-

convincing—but the fault is the conductor's.

Except for the rather overclangorous *Te Deum*, this is an extremely well-balanced performance from the technical point of view. Alongside its stunning sonorities, clarity, and extended dynamic range, Angel 3508 tends to sound rather faded (for stubborn me, however, the Angel set still remains an unsurpassed performance). But I have the highest admiration for the accomplishment here. *George Jellinek*

RCA VICTOR



The original poster for *Tosca*, designed by Hohenstein in 1899 for the world premiere of the opera in Rome.

© M Puccini: *Tosca*. Leontyne Price (soprano), Tosca; Giuseppe di Stefano (tenor), Cavaradossi; Giuseppe Taddei (baritone), Scarpia; Carlo Cava (bass), Angelotti; Fernando Corena (bass), sacristan; Piero de Palma (tenor), Spoletta; Leonardo Monreale (bass), Sciarrone; Alfredo Mariotti (bas.), jailer; Herbert Weiss (boy soprano), shepherd. Vienna Philharmonic Orchestra, Herbert von Karajan cond. RCA Victor LDS 7022 two 12-inch discs \$12.96, LD 7022 \$10.96.

COLLECTOR HOROWITZ COLLECTED

*Personal magic and completed
perspectives in a rich pianistic sampler*

EVEN AMONG its luxurious companions in RCA Victor's Soria series, "The Horowitz Collection" is something very special indeed. Astutely edited, it of course contains pianistic marvels and to spare. But it chiefly exploits, as does no other piano collection available, the un-intimidated catholicity of a supremely imaginative virtuoso: one who obviously delights in giving us magical performances of the long unplayed, the formerly overplayed, and the downright unplayable. Prokofiev with terse exactitude has called Vladimir Horowitz "the miraculous pianist." If we suppose, as I think we must, that in the eye of God all miracles are the same size, it is sheer pleonasm or worse to speak of greater miracles or smaller ones. Yet I am less astonished at what Horowitz does here with muscular works like the Prokofiev and Barber sonatas than at the radiant life he confers on less-than-heavy-weight scores commonly neglected in our time. It is good to be reminded again of the elegance and dazzling *esprit-de-chandelier* of old Czerny; the Beethovenish power and intellectual force of Clementi; the unflawed shapeliness of Mendelssohn's lyricism. And I don't suppose there is another musico-literary showstopper in existence to compare with the Saint-Saëns-Liszt-Horowitz *Danse macabre*.

It is one of the great and provocative mysteries of music that different eras hear the same music—even down to the same performances of it—with radically different ears. These performances were recorded between 1942 and 1955, and I have now had the instructive experience of playing them for several listeners who well remember their own past impressions of the earlier Horowitz. Yes, we all sagely agreed, here were the old breathtaking velocities, the hyperhuman energies. Et cetera. But what we hadn't been so sage about—what in fact we had completely disremembered—was the all-enveloping warmth: the lambent heat and glow of the pianist's deeply personal communicativeness.

It seems unthinkable that we were not aware of it at the time—I am sure that privately we were. But for certain fashionable reasons we

were disturbed by it, and we consequently tended for a time to discount it. To be explicit, I think we were already somewhat chilled by a poker-faced generation of pianists who were academically brainwashed to give us the pianistic letter of the text but little of its spirit. A cold literalness was (and in many circles still is) considered primary evidence of intellectual integrity, and the poetic suggestibility which is the *sine qua non* of the Romantic literature was habitually denounced as a major felony—something between grand larceny and outright forgery.

Luckily, Mr. Horowitz's aesthetic vision was larger and longer than ours. He is not only unafraid of sentiment; he roundly proclaims that sentiment is the very engine of Romanticism's larger utterance. The record catalogs still list a number of those clinically pure *architectural* structures so dispassionately erected by pianists and conductors suffering from the Corbusier syndrome, but unless I am much mistaken, they are fast being found (like the neat apartment houses they so unhappily resemble) unfit for human habitation. Meanwhile, "The Horowitz Collection" may be recommended for thawing out and reorienting a generation loftily swindled into thinking that great music is only a *machine pour écouter*.

The album's title makes play with Mr. Horowitz's distinction in an extra-musical pursuit; its accompanying brochure, lavishly produced by the Swiss art-publishing house of Skira, contains tipped-on plates in superb color of the pianist's art collection (we are shown Manet, Picasso, Rouault, and Degas). A thoughtful interpretive essay—on the relation of the Horowitz phenomenon to artistic taste in general and to Romanticism in particular—is by the pianist's long-time friend Samuel Chotzinoff. The brochure also contains excellent photographs of the pianist chez Horowitz, hospitably posed among his fastidiously chosen objets d'art. Happily, this nothing-if-not-expensive enterprise is executed on a level of taste that precludes mere snobbishness, even if its glimpsed domiciliary grandeurs recall (as they were no doubt intended to) the quasi-imperial social ambience of the more exalted virtuosos of the Romantic era. At any rate, the album is worthy of the musical aristocracy inside it, and I don't doubt that it will be found under many a connoisseur's Christmas tree.

A word about the sound: you will be unable to indulge, with these recordings, the fantasy that you are in the same room with Mr. Horowitz's piano, and there are occasional slight distortions

in a Chopin *Grande Polonaise Brillante* that seems to be just too heroic in scale for 1945 engineering. But if what we have here is vintage sound, it is certainly the best of its years, and the velvety bouquet is pure Horowitz, unmistakable and unfaded.

Robert Offergeld

© VLADIMIR HOROWITZ: *The Horowitz Collection*. Works by Czerny, Mozart, Clementi, Schumann, Mendelssohn, Chopin, Scriabin, Barber, Prokofiev, Moszkowski, Saint-Saëns-Liszt-Horowitz. Vladimir Horowitz (piano). RCA VICTOR LD 7021 two twelve-inch discs \$11.96.

A NEW FOLK STAR IN ASCENDANCE

*Bob Dylan's second album
may be the year's best*

THE MOST VITAL force on the folk-music scene currently is a young man of twenty-two named Bob Dylan, who, in the black corduroy cap that is his trademark, looks perhaps like a vulnerable, underfed version of the early Bing Crosby. Moreover, it is not precisely correct to call Dylan a folksinger, for he writes most of his folk-like material himself. He is, however, a sort of back-country one-man band, accompanying himself on the guitar and playing one of a battery of harmonicas (he calls them "harps") slung, by means of a metal holder, around his neck.

On his first recording (Columbia CS 8579/CL 1779), which attracted considerable attention, Dylan seemed undecided whether he wanted to be Blind Lemon Jefferson or Woody Guthrie when he grew up. Now, on "The Free-wheelin' Bob Dylan," his second disc for Columbia and one far superior to his first, he has plumped for Guthrie's social-protest style, and it is beginning to appear that Dylan's music will become as much a rallying point for this era as Guthrie's was for his.

Dylan's subjects are The Bomb and racial discrimination, and he can be unforgettably poetic on either. His *Blowin' in the Wind* has become the protest song of the younger generation. (Predictably, it has already become far more popular in Peter, Paul and Mary's scrubbed and sugary commercial version than in Dylan's own.) His *Hard Rain's A-Gonna Fall*, about impending nuclear war, is a set of images of cumulative horror. Dylan can make mistakes, too, but they are

mostly the mistakes of youth. He can be as embarrassingly naïve (in *Masters of War*, for instance) as Guthrie was when singing about the trade unions he wanted so badly. At other times, the same simplicity of vision makes him direct and profound.

A belief that white people should not kill black people or that one country should not obliterate another does not, of course, make a man an artist automatically: there are many untalented bores on the side of the angels. Dylan, however, has presence, and although he is indebted to his idol Guthrie, his style is his own. He sounds completely artless, except on a number such as *One More Chance*—so excessively mannered that all the craft that has gone into the piece begins to show. Folksingers place great value on “authenticity,” and Dylan’s use of his hoarse, wounding, affectingly ugly voice is nearly a capsule definition of that term. He can hardly play the guitar at all, and on those numbers in which Bruce Langhorne substitutes for him on the instrument, the difference is immeasurable.

Dylan has limitations and affectations (as with Guthrie, his dropped final g’s are a kind of reverse snobbery), but these are negligible when compared to the power of his personality. He has a superb sense of timing and a mocking wit, both brilliantly displayed on *Talking World War III Blues*. At times, this wit is turned simultaneously inward on himself and outward toward the whole folk-music business—as when he sings (in *Bob Dylan’s Blues*) “Go ’way from my door and my window, too.” He is fond of using paradox, as he does in the masterful juxtaposition of charming tune and words of dreadful import called *Oxford Town*. But his most unusual quality is the ability, both in writing and in performing, to create a song that is strikingly of the present and at the same time seen through the film of memory, a mythic quality similar to that which distinguishes the motion pictures of John Ford. This comes through most forcefully when Dylan deals with personal matters—*Bob Dylan’s Dream* and *Girl from the North Country* are lovely gems of stabbing nostalgia. The range of emotion, performance style, and subject matter in this one album is astonishing, particularly for one so young. The album stays with the listener, different numbers demanding to be played again, depending on one’s mood.

It is unfortunate that Columbia decided not to include two of Dylan’s better numbers in this set: a talking blues about the John Birch Society and a song about fallout shelters, *Let Me Die in*

My Footsteps. But the selections here nonetheless form a portrait of a diverse and fascinating young man who would be one of our finest folk performers even if he didn’t write, and who would certainly be our finest writer of contemporary folk material even if he couldn’t sing. Since he does both so well, it is gratifying, but not surprising, to see that he has made what will probably be the folk-music record of the year.

Joe Goldberg

© © BOB DYLAN: *The Freewheelin’ Bob Dylan*. Bob Dylan (vocals, harmonica, and guitar), with Bruce Langhorne, George Barnes, or Howie Collins (guitar), Dick Wellstood (piano), Gene Ramey or Leonard Gaskin (bass), Herbie Lovelle (drums). *Blowin’ in the Wind: Bob Dylan’s Blues: I Shall Be Free; Down the Highway: Corrina, Corrina*: and eight others. COLUMBIA CS 8786 \$4.98, CL 1986* \$3.98.

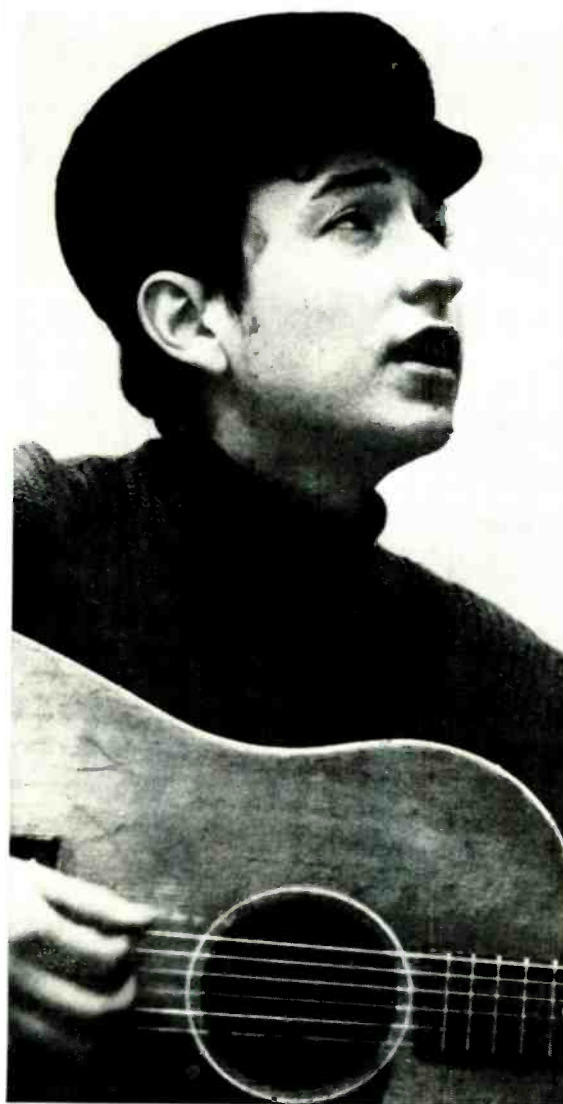

COLUMBIA RECORDS

BOB DYLAN

A voice hoarse and affectingly ugly

The JBL Energizer/Transducer raises audio reproduction to a degree of perfection and precision never before available to the home listener. You hear music re-created in all its detail, rich and splendid, life size, without hum or distortion. The Energizer/Transducer sets new standards for fully controlled bass, completely realistic mid-range, immaculate highs, and transient reproduction without equal.

An Energizer/Transducer has its own source of power: the Energizer. The Energizer is exactly matched to the specific loudspeaker-and-enclosure system in which it is used. Energizer and transducer are engineered as a unit. Given a flat, pure signal from a preamplifier, the Energizer/Transducer delivers sound that is perfectly flat and pure — an exact replica

NOW! ALL ARE AVAILABLE SELF- ENERGIZED

— with exactly the right amount of damping at all frequencies. No other home high fidelity equipment can give you these results.

The JBL Energizer is a stereophonic all-solid-state device of scientific-instrument quality. Devoid of microphonics, generating negligible heat, it can be mounted within an acoustical enclosure. All JBL loudspeaker systems are available as Energizer/Transducers. The JBL loudspeaker system you now own can be made into an Energizer/Transducer. When ordering your matched Energizer, you need only provide your Audio Specialist with the complete model number of your system. Write for your free copy of the new Energizer/Transducer six-page brochure.

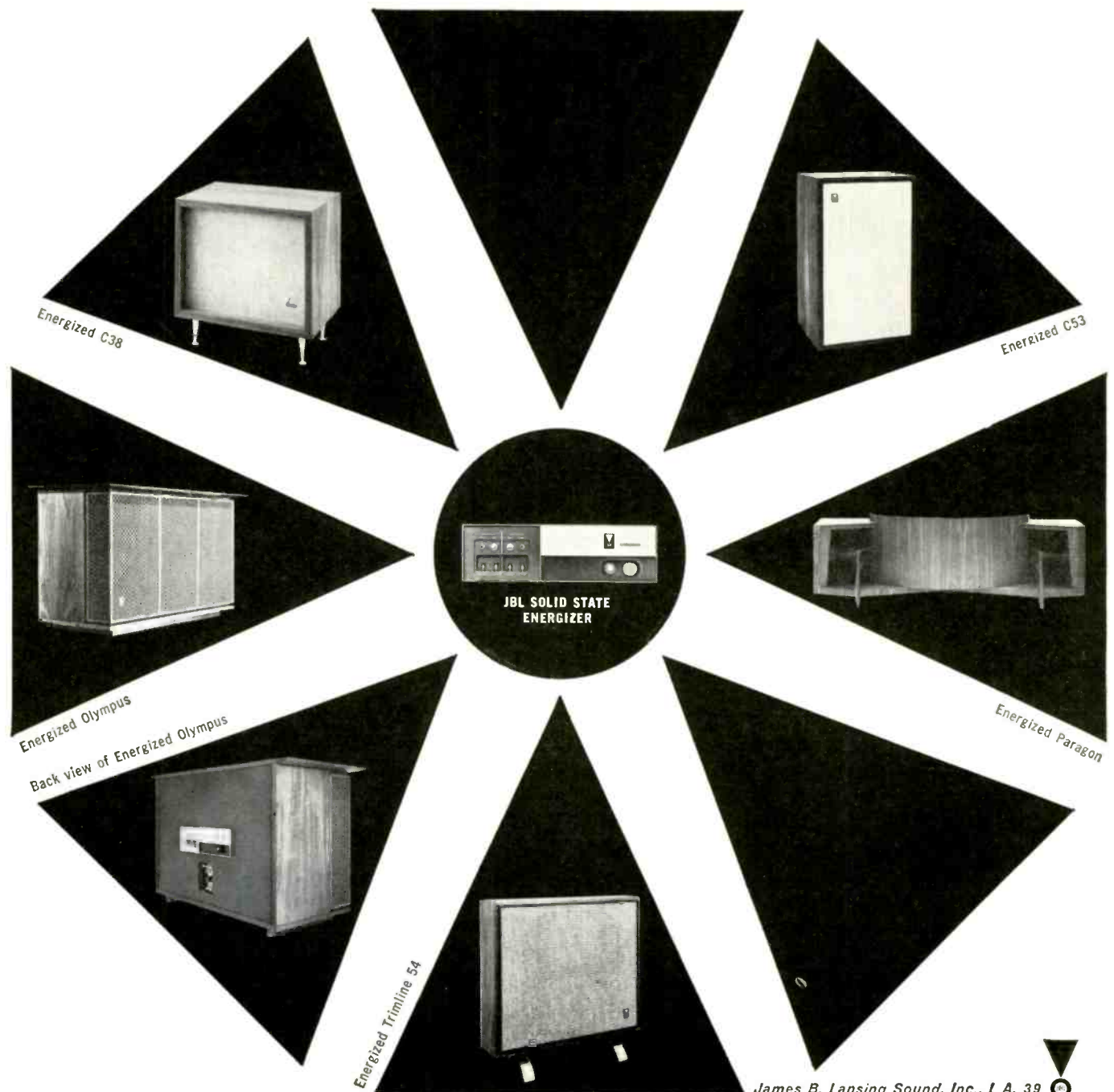

James B. Lansing Sound, Inc., L.A. 39



HIFI/STEREO REVIEW'S CHOICE OF THE LATEST RECORDINGS

CLASSICAL

Reviewed by WILLIAM FLANAGAN • DAVID HALL • GEORGE JELLINEK • IGOR KIPNIS

Ⓢ Ⓜ BACH: *Harpsichord Concerto, No. 3, in D Major (S. 1054); Concerto, in F Major, for Oboe, Strings, and Continuo (S. 1053)*. Edith Picht-Axenfeld (harpsichord); Helmut Winschermann (oboe); Deutsche Bachsolisten, Helmut Winschermann cond. CANTATE 057701 \$6.98, 047701* \$5.98.

RECORDING OF SPECIAL MERIT

Ⓢ Ⓜ BACH: *Harpsichord Concerto, No. 7, in G Minor (S. 1058); Concerto, in D Minor, for Oboe, Violin, Strings, and Continuo (S. 1060)*. George Malcolm (harpsichord); Georg Friedrich Hendel (violin); Helmut Winschermann (oboe); Deutsche Bachsolisten, Helmut Winschermann cond. CANTATE 057702 \$6.98, 047702* \$4.98.

Interest: Bach concerto arrangements
Performance: First-class
Recording: Vivid
Stereo Quality: Fine

The two of these four concertos that are for harpsichord are Bach's own arrangements of earlier works—that is, the two violin concertos. The well-known and often-recorded D Minor Concerto for oboe and violin is a reconstruction of what was most likely the original version, now lost, of the C Minor double harpsichord concerto (S. 1060).

The least familiar piece, and a first recording in this form, is the F Major Concerto for oboe, which turns out to be the same music that Bach used for the second Harpsichord Concerto (S. 1053) and the Cantatas Nos. 49 and 169. In this case, the reconstruction (published in 1955) is by the late oboist Hermann Tötcher, who believed that the material as we know it was originally used by Bach in Cöthen for a now-lost oboe concerto. In many ways, it is more effective for oboe than for harpsichord, though the

lengthy passages of sixteenth notes and absence of opportunities for breathing pose great difficulties for the wind soloist. The stylish and musically expressive performances of this concerto and the oboe and violin concerto are most enjoyable.

The harpsichord concertos are likewise sympathetically executed. Miss Picht-Axenfeld pulls the rhythms about a bit, but her spirit is admirable. George Malcolm's performance is even more thrilling here than in his well-remembered recording of the G Minor Concerto on



DEUTSCHE GRAMMOPHON

KARL RICHTER

Inspired pacing of Bach vocal works

HMV 78's during the late Forties. The German Bach Soloists, a small, expertly trained chamber ensemble, many of whose members are familiar to American collectors through the Deutsche Grammophon Archive series, provide virtually ideal accompaniments under their talented oboist-conductor. The recording, made in connection with (but not at, as Cantate's publicity release implies) a series of concerts in Germany by this group, is warm, vivid, and brilliant. Considering the very high quality of these

performances, it is perhaps ungenerous to mention the abominably poor English translations of the program notes. *I. K.*

RECORDING OF SPECIAL MERIT

Ⓢ Ⓜ BACH: *Magnificat in D Major; Cantata No. 78, "Jesu, der du meine Seele."* Maria Stader (soprano), Ursula Buckel (soprano), Hertha Töpfer (contralto), Ernst Haefliger (tenor), John van Kesteren (tenor), Dietrich Fischer-Dieskau (baritone), Kieth Engen (bass); Munich Bach Choir, Munich Bach Orchestra, Ensemble of Soloists of the Bach Ansbach Festival, Karl Richter cond. DEUTSCHE GRAMMOPHON ARCHIVE ARC 73197 \$6.98, 3197* \$5.98.

Interest: Great Bach performances
Performance: Superb
Recording: Excellent
Stereo Quality: Excellent

Once a year, at least, a Bach recording is issued that stands among the very best releases of that twelve-month period. Such, for example, was the 1962 Mass in B Minor, conducted for Deutsche Grammophon Archive by Karl Richter. Now these same forces have come up with another disc of such high quality that it must be recommended with the same enthusiasm.

The *Magnificat*, presently available in eight other performances, has never been recorded with a group of first-rate soloists such as these, and most of the other versions, good as they are, do not reveal the clarity of either the choral writing or the instrumental accompaniment. Richter's interpretation is highly charged in the choruses, and the excitement of these sections is in sharp contrast to the wonderfully contemplative mood of most of the arias and of the alto-tenor duet.

The Cantata No. 78, written for the fourteenth Sunday after Trinity, is not unfamiliar to collectors, although its last recording dates from 1954 (Bach Guild 537, with Teresa Stich-Randall and others). Its merry duet for soprano and alto is certainly one of the most delightful moments in all of Bach's vocal writing. Here, again, the performance is exceptional: the chorus sings with re-

Explanation of symbols:

- Ⓜ = monophonic recording
- Ⓢ = stereophonic recording
- * = mono or stereo version not received for review

markable precision, the vocalists are uniformly excellent, the instrumental soloists—including the artist on the audible organ continuo—are stunning, and Richter's pacing is truly inspired. The sound on both sides is remarkably vivid, with a realistic stereo spread. *I. K.*

© BACH: *Suite No. 3, in C Major, for Cello Solo; Suite No. 4, in E-flat Major, for Cello Solo.* Pierre Fournier (cello). DEUTSCHE GRAMMOPHON ARCHIVE ARC 73187 \$6.98, 3187* \$5.98.

Interest: Volume Two of complete set
Performance: Mostly praiseworthy
Recording: First-class
Stereo Quality: Good

As with the first two unaccompanied cello suites, recorded on Archive 73186/3186 by Fournier, these in the second installment are for the most part beautifully played. The interpretations are



ROBERT DOISNEAU

GEORGES PRÊTRE AND GILBERT BÉCAUD
An eclectic opera, an exciting performance

warm and sensitive, and the intonation, barring a few minor difficulties in the fourth suite, is superb. Fournier's rhythmic vitality and understanding of the dance structure of the movements are praiseworthy. But the performances might have been even better if there had been less long-line phrasing and more attention to the correct performance of the ornaments. The reproduction is expert. *I. K.*

© BÉCAUD: *Opéra d'Aran.* Rosanna Carteri (soprano), Maureen; Agnès Disney (mezzo-soprano), Mara; Alvino Misciano (tenor), Angelo; Peter Gottlieb (baritone), Mickey; Frank Schooten (bass), Sean; others. Chœurs du Conservatoire and Orchestre de la Société des Concerts du Conservatoire Paris, Georges Prêtre cond. ANGEL S 3637 three 12-inch discs \$17.94, 3637 \$14.94.

Interest: New French opera
Performance: Capable
Recording: Very good
Stereo Quality: Effective

For a popular singer to be a conservatory-trained composer is unusual. But France's Gilbert Bécaud, in addition to this, also had the courage, the perseverance—and the means—to stage his *Opéra d'Aran* last fall in an elaborate production at the Théâtre des Champs-Élysées in Paris. The opera had an uninterrupted run of more than two months, rather pleasing the public and annoying the critics no end. Angel's recording with the original cast offers an explanation for both reactions.

Anyone looking for a significant milestone in the development of contemporary opera had better look elsewhere. Musically, Bécaud has nothing new to say, nor did he, I suspect, ever harbor such ambitions. His idiom is eclectic in the extreme, combining the harmonic styles of Bizet and Franck with occasional flavorings of Mascagni—all peppered with touches of instrumentation reminiscent of the better cinema scores. Occasionally, his devices are a bit obvious, but they are skillfully and effectively used.

Bécaud found strong operatic stuff in this tale of tragic love in Aran, the bleak islands of fisher folk off the west coast of Ireland. His music captures the mood of the story, which hovers between illusion and realism, and carries the action to its conclusion with dramatic force. Bécaud may be France's answer to Gian Carlo Menotti—strong, if somewhat derivative, melodic gifts are at work here, and a vivid sense of the theater. I would not presume to predict the opera's fate, but whether or not it endures, the recording holds one's interest.

Every one of the singers is a capable artist, and although there are no outstanding individual contributions, the principals do work with strength and conviction within the frame of an effective ensemble. Conductor Georges Prêtre extracts the last measure of excitement from the score, and the engineering—lively presence and effective stereo—is first-rate. *G. J.*

RECORDING OF SPECIAL MERIT

© BEETHOVEN: *Piano Concertos: No. 1, in C Major, Op. 15; No. 2, in B-flat, Op. 19; No. 3, in C Minor, Op. 37; No. 4, in G Major, Op. 58; No. 5, in E-flat, Op. 73 ("Emperor").* Artur Schnabel (piano); London Symphony Orchestra, Sir Malcolm Sargent cond. (No. 1); Philharmonia Orchestra, Issay Dobrowen cond. (Nos. 2, 3, 4); Philharmonia Orchestra, Alceo Galliera cond. (No. 5). ANGEL GRE 4006 five 12-inch discs \$29.90.

(Continued on page 66)

HIFI/STEREO REVIEW

CIRCLE NO. 22 ON READER SERVICE CARD →

THE SOUND OF GENIUS



ML 5456/MS 6128*



ML 5491/MS 6156*



ML 5367/MS 6049*



ML 5766/MS 6366*



ML 5643/MS 6243*

ON COLUMBIA MASTERWORKS



*Stereo

©COLUMBIA MARCAS REG. PRINTED IN U.S.A.

**A YEAR'S SILENCE...
TO PREPARE FOR THE
GREATEST CHALLENGE**

When Rudolf Serkin stopped concertizing for a year to re-study a composer he had already mastered, it was a measure of the depth of his dedication to music. As a result of that year, this great artist has achieved complete identification with Beethoven's piano music. His new record of the "Appassionata," "Moonlight" and "Pathétique" sonatas—the first fruit of his re-study and planned recording of all the thirty-two sonatas—personifies Rudolf Serkin, the musician and humanist.

It is this same spirit of dedication that pervades the Marlboro Music School and Festival he founded in Vermont. At Marlboro there is no thought of financial rewards—only music-making in its finest and most joyous state. "Marlboro could happen only in America," said Mr. Serkin. And now America has returned the compliment by awarding him the highest civilian peacetime honor, The Presidential Medal of Freedom. The citation reads, to those "who contribute significantly to the quality of American life."

**RUDOLF SERKIN
ON COLUMBIA
MASTERWORKS**



ML 5881/MS 6481*

ANOTHER REASON WHY HEATHKIT

SOLID-STATE* STEREO

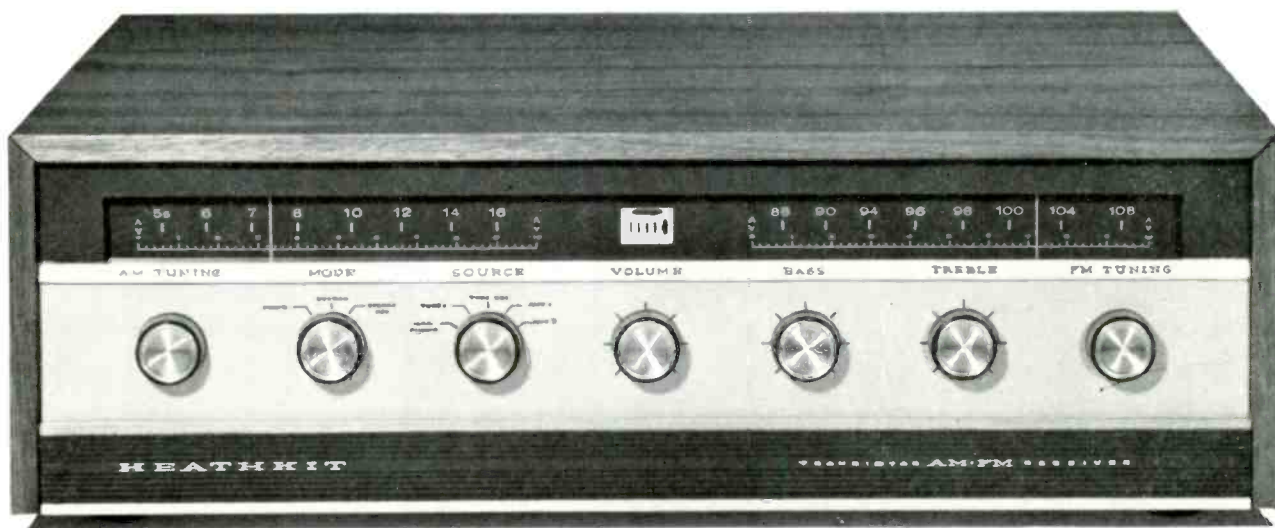

NEW! AR-13 STEREO RECEIVER...only \$195⁰⁰

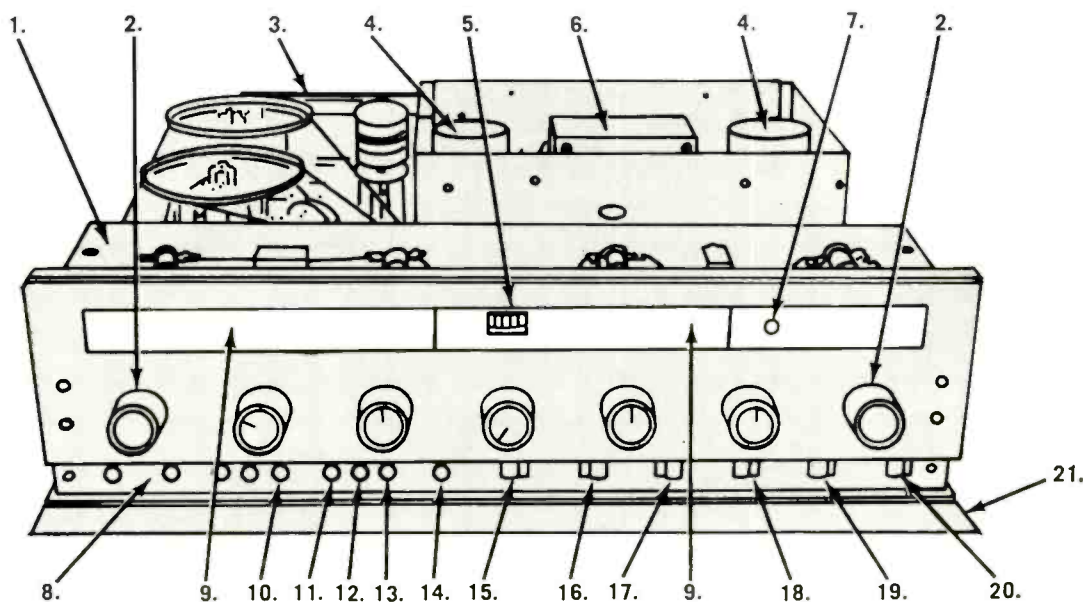

- | | |
|---|-------------------------------|
| 1. Preassembled FM Front End | 12. Stereo Separation Control |
| 2. Individual AM and FM Tuning | 13. FM Squelch Control |
| 3. AM Rod Antenna | 14. Level Balance Control |
| 4. Regulated & Electronic Filtered Power Supply | 15. Phase Adjust Switch |
| 5. Tuning Meter | 16. AFC Switch |
| 6. Transformer Operated Power Supply | 17. Local-Distance Switch |
| 7. Stereo Indicator Light | 18. SCA Filter Switch |
| 8. Input Level Controls | 19. Noise Filter Switch |
| 9. Illuminated Slide Rule Dials | 20. Speaker Phase Switch |
| 10. Phase Adjust Control | 21. Hinged Lower Front Panel |
| 11. Converter Balance Control | (conceals secondary controls) |

* 43 Transistor, 16 Diode Circuitry

LEADS IN TRANSISTOR STEREO

TUNER-AMPLIFIER

by Heathkit

FIRST IN KIT FORM!

ALL-TRANSISTOR AM-FM & FM STEREO TUNER PLUS
ALL-TRANSISTOR 40-WATT STEREO AMPLIFIER—ALL
IN ONE SMART WALNUT CABINET FOR JUST \$195.00

Now in time for Christmas giving, Christmas listening! Two 20-watt power amplifiers...two separate preamplifiers...plus wide-band AM, FM, and FM Stereo...all beautifully housed in this one, compact Heathkit All-Transistor Stereo Receiver. For Heathkit this means another first! For you it means experiencing the uncompromising realism of "transistor sound" in a handsomely styled receiver that *won't* overheat...just the coolest, fastest, most "hum-free" operation possible! Just the purest, most "solid sound" possible! This is the why of transistor stereo. This is why you should move up to the new AR-13 Receiver. And the traditional Heathkit economy makes this advanced performer easy to own...just \$195.00

All the electronics you need for a complete music system are "Heath-Engineered" into this handsome unit...just add two speakers and a phonograph or tape recorder! And there's plenty of advanced features to match the advanced performance of the AR-13. You'll like the way this unit *automatically* switches to stereo, thus eliminating any manual operation. In addition the automatic stereo indicator light silently signals when stereo is being received. For versatility there's three stereo inputs (mag. phono and two auxiliary) plus two filtered tape recorder outputs for direct "off-the-air" beat-

free stereo recording. Dual-tandem controls provide simultaneous adjustment of volume, bass, and treble of both channels. Balancing of both channels is accomplished by a separate control. The AM tuner features a high-gain RF stage and high-Q rod antenna.

Other quality features include a local-distance switch to prevent overloading in strong signal areas; a squelch control to eliminate between-station noise; AFC for drift-free reception; heavy die-cast flywheel for accurate, effortless tuning; pin-point tuning meter; and external antenna terminals for long-distance reception. For added convenience the secondary controls are "out-of-the-way" under the hinged lower front panel to prevent accidental system changes.

Building the AR-13 is quick and easy with the pre-assembled FM "front-end" and 3-stage AM-FM I.F. strip, plus circuit board construction. Styled in Heathkit's new low-silhouette design, the beautiful walnut cabinet accented with the extruded gold-anodized aluminum front panel makes the AR-13 a handsome addition to any home decor. This Christmas, move up to the better listening of "transistor sound" with the new AR-13 Stereo Receiver...another example of superb Heathkit quality at unmatched savings.

Kit AR-13, 30 lbs., no money dn., \$19 mo. . . . \$195.00

SPECIFICATIONS—Amplifier: Power output per channel (Heath Rating): 20 watts/8 ohm load, 13.5 watts/16 ohm load, 9 watts/4 ohm load. (IHFM Music Power Output): 33 watts/8 ohm load, 18 watts/16 ohm load, 16 watts/4 ohm load @ 0.7% THD, 1 KC. **Power response:** ±1 db from 15 cps to 30 KC @ rated output; ±3 db from 10 cps to 60 KC @ rated output. **Harmonic distortion (at rated output):** Less than 1% @ 20 cps; less than 0.3% @ 1 KC; less than 1% @ 20 KC. **Intermodulation distortion (at rated output):** Less than 1%, 60 & 6,000 cps signal mixed 4:1. **Hum & noise:** Mag. phono, 50 db below rated output; Aux. inputs, 65 db below rated output. **Channel separation:** 40 db @ 20 KC, 60 db @ 1 KC, 40 db @ 20 cps. **Input sensitivity (for 20 watts output per channel, 8 ohm load):** Mag. phono, 6 MV; Aux. 1, .25 v; Aux. 2, .25 v. **Input impedance:** Mag phono, 35 K ohm; Aux. 1, 100 K ohm; Aux. 2, 100 K ohm. **Outputs:** 4, 8, & 16 ohm and low impedance tape recorder outputs. **Controls:** 5-position Selector; 3-position Mode: Dual Tandem Volume; Bass & Treble Controls; Balance

Control; Phase Switch; Input Level Controls (all inputs except Aux. 2); Push-Pull ON/OFF Switch. **FM: Tuning range:** 88 mc to 108 mc. **IF frequency:** 10.7 mc. **Antenna:** 300 ohm balanced (internal for local reception). **Quieting sensitivity:** 2½ uv for 20 db of quieting, 3½ uv for 30 db of quieting. **Bandwidth:** 250 KC @ 6 db down (full quieting). **Image rejection:** 30 db. **IF rejection:** 70 db. **AM suppression:** 33 db. **Harmonic distortion:** Less than 1%. **Multiplex:** bandpass: ±½ db, 50 to 53,000 cps. **Channel separation:** 30 db, 50 to 2,000 cps; 25 db @ 10 KC. **19 KC suppression:** 50 db down, from output @ 1 KC. **38 KC suppression:** 45 db down, from output @ 1 KC. **SCA rejection:** 30 db. **AM: tuning range:** 535 to 1620 KC. **IF frequency:** 455 kc. **Sensitivity:** 1400 KC: 3.5 uv; 1000 KC: 5 uv; 500 KC: 10 uv—standard IRE dummy antenna. **Bandwidth:** 8 KC @ 6 db down. **Image rejection:** 30 db @ 600 KC. **IF rejection:** 45 db @ 600 KC. **Harmonic distortion:** Less than 1%. **Overall dimensions:** 17" L x 5½" H x 14¼" D.



HEATHKIT-1964

NEW! FREE 1964 HEATHKIT CATALOG. See the latest new products in Heathkit's wide, wonderful line. Over 250 do-it-yourself kits for stereo/hi-fi, marine, TV, electronic organs, amateur radio, test instruments, educational, and home and hobby items that will save you up to 50%. Send for your free copy today!



HEATH COMPANY Benton Harbor 40M1chigan 49023

- Enclosed is \$195.00, plus postage. Please send Model No. AR-13.
- Please send Free Copy of New 1964 Catalog.

Name _____

Address _____

City _____ State _____

What do you hear from your FM?

Just as much as your FM
antenna lets you hear!

That's a fact.

The antenna built into your FM receiver can pull in only very close stations. And it may not do that with always complete clarity. If you'd like to tune in more (and more distant) FM stations clearly, you definitely need a high gain outdoor FM antenna. Kitchen table model or expensive stereo rig, the story's the same.

FM stereo, in fact, is a *weaker* signal than monaural FM; it "cries for" an antenna. A directional antenna, too, for clean FM stereo reception, since your built-in antenna pulls in signals from *all* directions and may lose your stereo effect.

Inexpensive, lasting solution! The totally new RCA 500 FM antenna just developed by experts with long, long electronics experience. This 8-element yagi-type antenna receives 88 to 108 MC, has a VSWR of 1.25:1 and a flat-frequency response across the entire band with an average 8 db gain. Acute directivity removes interference.

Your RCA dealer will happily explain in words of one syllable what better things you'll hear from your FM with an RCA 500 FM antenna.

Listen!

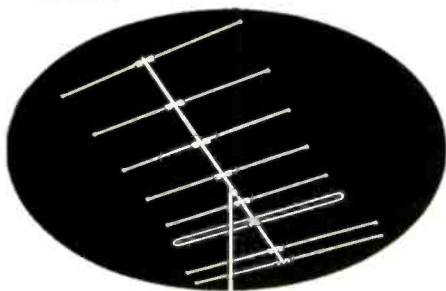

RCA Parts and Accessories



The Most Trusted Name
in Sound

CIRCLE NO. 50 ON READER SERVICE CARD
66

Interest: Classic Schnabel
Performance: Eloquent
Recording: Shows its age

From the 1930's until his death in 1951, Artur Schnabel was, by near-universal consent, *the* interpreter of the Beethoven piano-music literature—not because of any exceptional virtuosity or polish he brought to the works, but rather because of his remarkable ability to weld the formal and expressive elements of Beethoven's music into a superbly eloquent expression. This was most notably true in the slow movements, their apogee being the Schnabel readings of the late sonatas. (Parenthetically, I have never subscribed to the cultist view of Schnabel as a Beethoven specialist. I find his Schubert performances even better than the best of his Beethoven, and his Mozart concertos very nearly on a par with his best.)

Schnabel recorded the last two Beethoven concertos three times during his lifetime: in 1932-1933 with Sir Malcolm Sargent, in 1943 with Frederick Stock and the Chicago Symphony, and in 1946-1947 with the Philharmonia Orchestra under Dobrowen and Galliera. Numbers 2 and 3 were recorded first in 1935 and 1933, respectively, with Sargent and the London Philharmonic, and again in 1946-1947 with Dobrowen and the Philharmonia; No. 1 was done with Sargent in 1932, and never remade later. RCA Victor issued the entire Sargent series in one album in 1955, and the Dobrowen-Philharmonia collaboration with Schnabel in the Fourth Concerto as part of its LCT series in 1954.

What we have in this five-disc Angel Great Recordings of the Century album is the 1932 Sargent version of No. 1, and the 1946-1947 Philharmonia versions of the others, No. 3 being available commercially for the first time: because of a minor blemish in the solo part, the recording was never released until now.

Almost everything on these Angel records reveals Schnabel in his best and most characteristic vein. In the C Major Concerto, he underlines virility and exuberance. The B-flat, believed to have been written earlier, and scored for a smaller orchestra, is treated as chamber music, and is played in taut, brilliant fashion. The C Minor Concerto was, together with the G Major, the finest achievement of Schnabel's Thirties series with Sir Malcolm Sargent, but though the slow movement in this Forties performance with Dobrowen fully matches the earlier one in poignant eloquence, and the Rondo moves with as much brio as ever, the first movement seems lacking in force and cohesion. The 1933 performance with Sargent still remains the model of its kind.

The G Major Concerto was always a Schnabel specialty, and one has only to

listen to the opening measures for solo piano to appreciate the special qualities that Schnabel could bring to this wonderful music. They are all present in abundant measure here. Of the "Emperor," it is enough to say that there are a number of more brilliant performances on discs—both past and present—but very few that approach the tonal beauty Schnabel brings to the slow movement, let alone the verve of the finale as he plays it.

The sonic qualities of this Great Recordings reissue prohibit my unreserved recommendation. In their 78-rpm form, none of these recordings was the very best of its period. It is an unfortunate fact that, although the British EMI engineers were doing some of their finest recording just before and during World War II, in the years immediately after they seemed to have turned to experi-



RCA VICTOR RECORDS

ARTUR SCHNABEL
Doyen of Beethoven interpreters

mentation with dead studios instead of reverberant, warm-toned halls. Only the small-scale B-flat Concerto can stand this acoustic treatment; and of the Philharmonia series, only the recording of the "Emperor" seems to have a barely sufficient amount of sonic space around its tonal fabric. Furthermore, all the recordings lack tonal body, even by mid-Forties standards, and the piano sound verges on the tinny. Therefore, anyone contemplating shelling out \$29.90 for this set should be prepared to give his tone controls a workout if he expects to get good sound from these discs. I cannot escape the conclusion that, contrary to the usual results of the transfers in the Great Recordings catalog, these reissues—done in Paris in 1956—are less than an unqualified success. I note that Schwann still lists the 10-inch German
(Continued on page 68)

SOLID-STATE STEREO

BY HEATHKIT®



New! Deluxe All-Transistor, All-Mode Stereo Tuner & Matching 70-Watt Amplifier

Instantaneous bursts of power as the music demands...clean, uncompromising "solid" sound...cooler, faster, "hum-free" operation...this is the exciting performance of Heathkit's new deluxe all-transistor twosome. Add luxurious deluxe styling, plenty of deluxe features, plus "Heath-Engineered" quality, and you have the neatest, most advanced tuner and amplifier in the industry today! You'll enjoy deluxe extras like the unique "push-to-turn-off/on" switch, the concealed secondary controls to prevent accidental system changes, the automatic switch-to-stereo feature of the tuner, and the prebuilt, prewired encapsulated component modules in the amplifier for quick, easy assembly. You'll enjoy high fidelity AM-FM-FM Stereo reception, plus a full 70 watts of continuous power, 100 watts music power at all frequencies from 13 to 25,000 cps. You'll enjoy handsome matched tan, vinyl-clad steel cabinet styling with polished aluminum trim and soft refracted lighting...complements any decor! Both units are easy to build...easy to own! These are reasons you should move up to this all-transistor twosome from Heathkit now!

Kit AJ-43, Tuner, 18 lbs., no money dn., \$11 mo. \$119.95
 Kit AA-21, Amplifier, 29 lbs., no money dn., \$13 mo. \$139.95

AJ-43 All-Mode All-Transistor Stereo Tuner, 18 lbs., \$11 mo. \$119.95

AA-21 70-Watt All-Transistor Stereo Amplifier, 29 lbs., \$13 mo. \$139.95

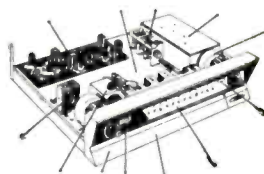

THE LATEST IN FEATURES

- 25 transistors, 9 diodes • Built-in circuitry • Automatic Stereo Indicator • Automatic Stereo switching to eliminate manual switching to receive stereo • Built-in Automatic Frequency Control and Automatic Gain Control • Adjustable FM Squelch • Stereo phase control • Filtered stereo tape recorder • Built-in AM & FM antennas • Separate AM & FM tuning meters • Lighted slide-rule dial • Flywheel tuning • Regulated power supply • Factory assembled FM tuning unit and 4-stage IF circuit board • Concealed controls behind hinged lower front panel.

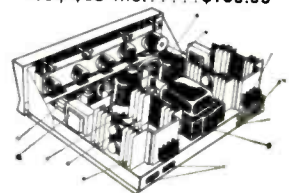

THE LATEST IN FEATURES

- Eight Germanium Power Output Transistors mounted on four finned heat sinks • Output circuit breakers • Power amplifier circuit boards containing four transistors and six diodes • Two driver transformers • Two preamplifier circuit boards contain six epoxy-sealed component modules and ten transistors • Two Germanium driver transistors plus two electronic filter transistors • Filter condensers and four power supply diodes • Output terminal boards • Input jacks • Tape recorder output • Power transformer • AC outlets.



HEATH COMPANY, Benton Harbor 40, Michigan 49023

Enclosed is \$_____, plus postage. Please send Model No. _____

Please send FREE copy of New 1964 Catalog.

Name _____

Address _____

City _____ State _____ Zip No. _____



NEW! FREE 1964 HEATHKIT CATALOG
 See the newest products in Heathkit's wide exciting line. Over 250 do-it-yourself kits for stereo/hi-fi, marine, TV, electronic organ, amateur radio, test instruments, educational and home & hobby items that will save you up to 50%. Send for your free copy today!

Electrola pressings of these same performances, presumably transferred from German rather than French pressings. Unfortunately, I have not had an opportunity to compare, but I would be curious to know if the technicians on the east side of the Rhine have done any better than their French counterparts.

D. H.

RECORDING OF SPECIAL MERIT

© ④ BEETHOVEN: *Trios for Piano, Violin, and Cello: Op. 70, No. 1 ("Ghost"), in D Major; Op. 70, No. 2, in E-flat Major.* Alma Trio: Adolph

Baller (piano), Maurice Wilk (violin), Gabor Rejto (cello). DECCA DL 710064 \$5.98, 10064* \$4.98.

Interest: Middle-period Beethoven
Performance: First-rate
Recording: Good
Stereo Quality: Lifelike

Since the only available alternates (both with Casals) of the two Op. 70 trios are neither paired on the same disc nor fully satisfying technically, this release is most welcome. It is excellent all the way: the rapport between these admirable musicians could hardly be better. Their play-

ing, a model of clarity, accuracy, and singing tone, strikes a happy medium between overrefinement and excessive muscularity. Decca's engineering is worthy of their effort. Except for the inherently troublesome "Ghost" passages, where the low piano ramblings tend to muddiness, the balances are excellent, the stereo placement vivid and natural. All concerned deserve to be complimented, with the exception of the annotator who, having lifted most of his material verbatim, should at least have credited his source—Alec Robertson's essay in the anthology *Chamber Music*, a Pelican edition. G. J.

BORODIN: *Polovtsian Dances* (see RAVEL).

© ④ BRAHMS: *Piano Quintet, in F Minor, Op. 34.* Leon Fleisher (piano); Juilliard String Quartet. Epic BC 1265 \$5.98, LC 3865* \$4.98.

Interest: Chamber classic
Performance: Twentieth-century Romanticism
Recording: Well-balanced
Stereo Quality: Excellent

Anti-Romantic tendencies in the interpretation of music during the last few decades have proved particularly strong, as a glance at the current recording and concert situation shows. Not only have the chamber works of such masters as Brahms, Schumann, and Sibelius declined in popularity—their orchestral works seem somewhat immune—but when such works are played, the bloom seems to be off the Romantic spirit, and a cerebral approach, keyed by efficiency, hypercontrolled emotion, and technical brilliance, takes its place. The chamber works of Beethoven and Mozart come and go in the record catalog, but those of Brahms appear more and more sporadically. The F Minor Piano Quintet, a magnificent composition, has for the last several years had only a couple of recordings. Luckily, both of them are warm and impassioned. Concerning this new version, the first in stereo, I have nothing but praise for the players as superlative instrumentalists, but their interpretation has as much warmth as a digital computer. Nothing can be added to this description except to observe that all of the i's are dotted and the t's crossed, the rapport among the players is remarkable, the performance is technically immaculate, and I couldn't wait to get back to the versions by Curzon and the Budapest Quartet on Columbia ML 4336 and Richter and the Borodin Quartet on a now-deleted MK release. Epic's stereo placement is extremely good, as is their adroit balancing of the instruments, but the pressing has a bit

(Continued on page 70)

VANGUARD

Current and Choice Recordings for the Connoisseur

CLASSICAL



HANDEL: *Samson—Complete Oratorio*

Jan Peerce, Phyllis Curtin, and other soloists; Utah Symphony Orchestra and Chorus; Maurice Abravanel, conductor. *A Bach Guild Special Release — 3 discs boxed for price of 2.* Text and notes.

*BG-648/50

HAYDN: *The Sturm und Drang Symphonies*

No. 44, *Trauersymphonie* & No. 45, *Farewell*. *VRS-1106
No. 46 in B major & No. 47 in G major. *VRS-1107
No. 48, *Maria Theresia* & No. 49, *La Passione*. *VRS-1108
Antonio Janigro conducting the Symphony Orchestra of Radio Zagreb.

MAHLER: *Des Knaben Wunderhorn*

Maureen Forrester, contralto; Heinz Rehfuss, bass-baritone; Symphony Orchestra conducted by Felix Prohaska. *VRS-1113

GOTTSCHALK: *Symphony — A Night in the Tropics*

GOTTSCHALK-KAY: Grand Tarentelle for piano and orch. GOULD: Latin American Symphonette. Maurice Abravanel conducting the Utah Symphony Orchestra; Reid Nibley, piano. *VRS-1103

FOLK



JOAN BAEZ IN CONCERT, PART 2

*VRS-9113

JAN PEERCE SINGS YIDDISH FOLK SONGS

*VRS-9122

THE WEAVERS: REUNION AT CARNEGIE HALL, 1963

*VRS-9130

IAN & SYLVIA "FOUR STRONG WINDS"

*VRS-9133

JOHN HAMMOND

*VRS-9132

CLARA WARD AT THE VILLAGE GATE

*VRS-9135

Choice Recent Releases



PURCELL: *Come Ye Sons of Art, and 2 Anthems.* Deller Consort. *BG-635

"A stunning new version." *Saturday Review*
SONGS OF THE AUVERGNE, arr. Canteloube (NETANIA DAVRATH, soprano)
Vol. 1—VRS-9085
Vol. 2—VRS-9120

"Enchanting . . . voice and orchestra form a bewitching and irresistible blend . . . recording is flawless."
Hi Fi/Stereo

HONEGGER: King David, with MILHAUD: *Creation of the World.* Utah Symphony Orchestra and Chorus; Abravanel, conductor. *VRS-1090/1
"Resounding performance of a masterpiece." *N. Y. Herald Tribune*
THE VIRTUOSO TRUMPET, Vol. 2. Haydn's Trumpet Concerto & Concertos for 1 to 6 trumpets. Wobisch & I Solisti di Zagreb; Janigro, conductor. *BG-641
"Finest of its kind . . . sonically thrilling."
High Fidelity on Vol. 1

RICHTER IN PARIS. *VRS-1102
". . . miraculous."
St. Louis Post-Dispatch

*Also on stereo

SOLID-STATE STEREO

BY HEATHKIT



NEW! Low-Cost All-Transistor, All Mode Stereo Tuner and Matching 40-Watt Stereo Amplifier

Cooler, faster operation . . . lower power consumption . . . longer life . . . and the clean, quick realism of "transistor sound." You'll enjoy all this and more with Heathkit's newest All-Transistor Stereo "Twins." Compact, low-silhouette styling magnificently fashioned in rich walnut cabinets neatly fits this handsome pair into a "proud place" in any hi-fi stereo system. Add to this extruded brushed gold-anodized aluminum front panels that serve practically to conceal secondary controls and decoratively to enhance over-all beauty. The AA-22 Amplifier provides 40 watts of continuous power at ± 1 db from 15 to 30,000 cps with no fading, no faltering . . . just pure solid sound! The AJ-33 Tuner offers selection of AM, FM, or FM Stereo to please any listening preference. Check both unit's features and discover why Heathkit leads in Transistor Stereo. The price? A great value, you'll agree . . . \$99.95 each!

AA-22 40-watt Transistor Stereo Amplifier, 14 lbs. \$10 mo. \$99.95

AJ-33 Transistor AM-FM-FM Stereo Tuner, 14 lbs. \$10 mo. \$99.95

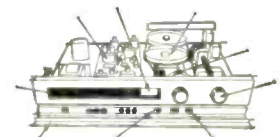
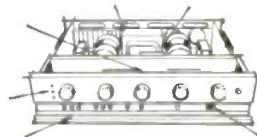

- 40 watts of power (20 per channel)
- 5 stereo inputs
- Speaker phase switch
- Miniature indicator light for each position on mode switch
- Transformerless output circuits
- Brushed gold-anodized aluminum front panel conceals secondary controls
- Walnut cabinetry

- Stereo phase control
- Automatic stereo indicator
- AFC and AGC
- Filtered stereo tape recorder outputs
- Built-in stereo demodulator
- Tuning meter
- Flywheel tuning
- Slide-rule dial
- Prealigned FM tuner and circuit board construction
- Brushed gold-anodized aluminum front panel conceals secondary controls
- Walnut cabinet



HEATH COMPANY Benton Harbor 4C Michigan 49023

- Enclosed is \$ _____, plus postage. Please send model No. _____
- Please send Free Copy of New 1964 Catalog.

Name _____

Address _____

City _____ State _____

HEATHKIT-1964



NEW! FREE 1964 HEATHKIT CATALOG

See the latest new products in Heathkit's wide, wonderful line. Over 250 do-it-yourself kits for stereo/hi-fi, marine, TV, electronic organs, amateur radio, test instruments, educational, and home and hobby items that will save you up to 50%. Send for your free copy today!

real FM
authorities
agree . . .



for the best seat in the house . . .
you need a **FINCO**® AWARD WINNING
FM ANTENNA

Guarantee yourself the best seat in the house for
tonight's FM concert . . . install a fidelity-phased
FINCO FM antenna.

THE FINNEY COMPANY
Bedford, Ohio
Dept. H.D.

of an edge, and the side-ends suffer from
constriction. I. K.

© ® CHOPIN: *51 Mazurkas* (Op. 6, 7, 17, 21, 30, 33, 41, 50, 56, 59, 63, 67, 68); *Notre Temps* No. 2, "À Emile Gailard"; *Polonaises*: No. 8, in D Minor, Op. 71, No. 1; No. 10, in F Minor, Op. 71, No. 3; No. 11, in G-sharp Minor, Op. Posth. (1822). CHOPIN-LISZT: *My Joys; The Maiden's Wish*. Alexander Brailowsky (piano). COLUMBIA M3S 685* three 12-inch discs \$17.94, M3L 285 \$14.94.

Interest: Brailowsky's Chopin
Performance: Flavorful, but one-sided
Recording: Very good

One of the most amazing aspects of the Chopin mazurkas is that they can be interpreted in so many different ways. Alexander Brailowsky, continuing his projected complete recording of that composer's works, emphasizes the rhythmic qualities, which, of course, is quite proper. He makes the most of the unwritten pause before the third beat, and his verve in the earlier sets of mazurkas is entirely refreshing.

The later, mature pieces, however, often transcend their dance origin (Op. 50, No. 3, for example), and here one feels the pianist's approach to be too one-sided, too unexpressive of the emotional scope of this music. These are dances, to be sure, but they are also miniature tone poems that express all the facets of Chopin's world, from the aristocratic atmosphere of the Paris salons in which he played to the nostalgic memories of his beloved homeland. There is relatively little smoothness, subtlety of nuance, shading of tone, or elegance in Brailowsky's playing of these works; yet one cannot help admiring the pianist's folk-inspired spirit and rhythmic drive, even though the effect, especially in difficult technical passages, inclines toward choppiness. If there is not as much variety or color in his interpretations as one hears from, say, Rubinstein, there is by no means a lack of flavor. The extra pieces on the sixth side, particularly the early polonaises, are a pleasant bonus, but one would have preferred to have the remaining mazurkas in their stead: there are fifty-eight altogether, not including variants of several. The sound, though slightly variable, is very good, but my copy had poor surfaces. I. K.

© ® GIBBONS: *First Service: Te Deum; Benedictus; Magnificat; Nunc Dimittis*. MONTEVERDI: *Messa a 4 Voci da Cappella*. Helen Keaney (organ); Judith Davidoff (gamba); The Old North Singers (Christ Church Boston), John Fesperman cond. CAMBRIDGE CRS 1415 \$5.98, CRM 415 \$4.98.

(Continued on page 76)

**NEW LOOK...
NEW SOUND...
NEW VALUE...
NEW HEATHKIT
SPEAKER
LINE**



**Need A High-Efficiency, High Fidelity Speaker
For A Particular Music System Job?**

...You'll Find It In Heath's Exclusive New Line!

Whether you want an advanced-engineered, professional-performing speaker for your custom music system, or need to replace a radio or TV speaker, you'll find it in this exciting new Heathkit line. Specially designed to meet Heath's exacting specifications, each speaker has been carefully crafted to perform a particular job. And regardless of which speaker you choose, each has a ceramic annular ring magnet for high efficiency and superior performance, plus polarized speaker terminals for proper phasing. All speakers except the least expensive in each size, have rugged, die-cast metal frames for life-long, trouble-free performance. In addition, each speaker is handsomely styled in a richly warm two-tone cinnamon and light tan motif, and carries a full one-year guarantee. Prices range from \$4.95 to \$49.95 . . . truly superb performance at unmatched savings! Send for your free Heathkit Catalog now, and select the proper Heathkit speaker to fulfill your needs!

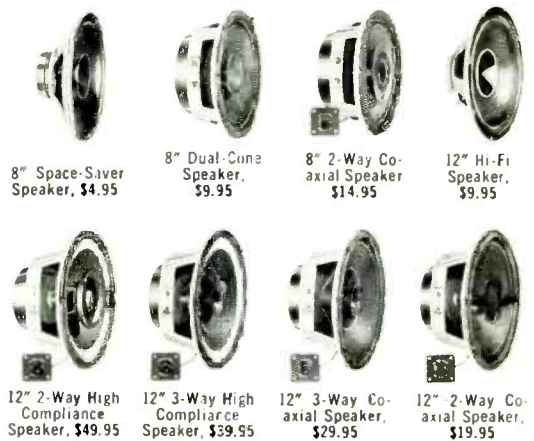

8" Space-Saver Speaker, \$4.95

8" Dual-Cone Speaker, \$9.95

8" 2-Way Co-axial Speaker, \$14.95

12" Hi-Fi Speaker, \$9.95

12" 2-Way High Compliance Speaker, \$49.95

12" 3-Way High Compliance Speaker, \$39.95

12" 3-Way Co-axial Speaker, \$29.95

12" 2-Way Co-axial Speaker, \$19.95



HEATH COMPANY

Benton Harbor 40, Michigan 49023

Please send Free copy of new 1964 catalog.

Name _____

Address _____

City _____ State _____ Zip Code _____

HEATHKIT-1964

**NEW! FREE
1964 HEATHKIT CATALOG**

See the latest new products in Heathkit's wide, wonderful line. Over 250 do-it-yourself kits for stereo/hi-fi, marine, TV, electronic organ, amateur radio, test instruments, educational, home and hobby that will save you up to 50%. Send for your free copy today!

TOSCANINI, SCHUBERT, AND THE PHILADELPHIA

AFTER TWO DECADES, A MAGNIFICENT RECORDING OF THE MAESTRO AND THE PHILADELPHIA ORCHESTRA HAS BEEN RELEASED FOR THE FIRST TIME

by David Hall

TWENTY years ago, when I was on the NBC staff writing Ben Grauer's script material for the Toscanini-NBC Symphony broadcasts, the Maestro's son Walter came into the office one day with a hefty package under one arm. He said, "David, I'd like you to try out these test records at home and tell me whether you think they are good enough to be released commercially."

The package in question contained the Tchaikovsky *Pathétique* Symphony, Debussy's *La Mer*, and the Schubert "Great" C Major Symphony, all recently recorded by Arturo Toscanini with the Philadelphia Orchestra—a dream combination. I was also informed that the Mendelssohn *Midsummer Night's Dream* music had also been recorded as part of the Philadelphia series. With trembling anticipation the records were taken home, and one side after the other of the 78-rpm shellac discs was sampled on the best playback equipment available at the time. The performances were all miracles of fiery eloquence and flawless elegance; but as side succeeded side on the turntable, it was clear that something was drastically wrong with the sound. The familiar Philadelphia tonal sheen was missing, and the sharpness of the Toscanini attacks seemed curiously blunted. It was as though the performances had been miked through a blanket. Clearly, the Toscanini-Philadelphia records could not possibly be released in this condition; it was enough to make the angels weep.

The records were returned to Walter Toscanini the next day, and he told me substantially the tale that was later recounted by Charles O'Connell, RCA Victor's musical director at the time, in his book, *The Other Side of the Record*. The records had been faultily processed, and since the original masters were on wax rather than on acetate or on today's tape, there seemed no choice but resignation to the loss of this unique documentation of Toscanini's interpretive art with what was then one of the three greatest orchestras in the world.

Walter Toscanini, however, seems to have been endowed with a measure of his illustrious father's stubbornness, and during the middle 1950's the basement of the Toscanini mansion in the River-

dale section of New York City was turned into a combined Toscanini archive and recording laboratory, with the immensely gifted and patient John Corbett serving as the chief engineer. Here have been gathered together not only every commercial disc ever made by the Maestro, but every available broadcast aircheck, including the unforgettable Beethoven



RCA VICTOR

ARTURO TOSCANINI
His Schubert C Major rescued

Ninth Symphony performed during Toscanini's final season with the New York Philharmonic (Elisabeth Rethberg and Friedrich Schorr were among the soloists), and even the embossed film recordings of the pre-Anschluss Salzburg Festival opera performances, among them *Die Meistersinger*. Out of this laboratory have come most of the tapes for RCA Victor's commercial discs processed from airchecks of NBC Symphony broadcasts, as well as the tapes for the rebroadcasts from the Toscanini-NBC Symphony era that have been played over good-music radio stations throughout the country over the past year.

Of all the challenges presented John Corbett and Walter Toscanini, in terms of bringing the art of Arturo Toscanini to life in a form sonically acceptable to today's stereo-hi-fi-conditioned ear, none was more formidable than that posed by the 1941 Philadelphia Orchestra record-

ings. The metal matrices were obtained, and the engineers claim that some 750 hours of work were required before they could come up with a workable master tape—and speaking as one who spent a good deal of time in the early LP days "de-ticking" and splicing tapes transferred from 78-rpm matrices, I can well believe it. Even when one has worked out a satisfactory equalization process for transferring a 78-rpm original to tape, there remains the vast and tedious problem of noise-removal—not merely surface noise (which must be minimized, but not at the expense of the music), but the bit-by-bit removal of the myriad ticks and pops found in most 78-rpm masters.

Of the accomplishment represented in this RCA Victor Soria series issue of the "Great" Schubert C Major Symphony with Toscanini and the Philadelphia Orchestra, I can only say that it is a triumph, not merely of technology, but more especially of the most painstaking kind of hand craftsmanship. The musical performance as such is an ideal representation of Arturo Toscanini's interpretation of Schubert's greatest orchestral masterpiece. The reading is tautly dynamic, but seems to have in it more sweetness and less overwhelming fierceness than the currently available NBC performance from the 1950's. This is due in no small measure to the exquisite playing of the Philadelphia woodwinds, but possibly it is due as well to the inevitably more restricted dynamic range imposed by the recording techniques of 1941. Even so, the recording as a whole is a remarkably honest account of Toscanini's interpretation of the acoustics of the Philadelphia Academy of Music, and of the Philadelphia Orchestra as it sounded then.

Perhaps it is too much to hope we may hear the remainder of those Toscanini-Philadelphia Orchestra recordings, but hope we shall until news from Riverdale tells us otherwise, for the sound of this Schubert C Major is most surely cause for great optimism.

© SCHUBERT: *Symphony No. 9, in C Major ("The Great")*. Philadelphia Orchestra, Arturo Toscanini cond. RCA Victor LD 2663 \$5.98.



Who says you can't afford an organ this Christmas?

**This New Feature-Packed 1964 Model Of The HEATHKIT
2 Keyboard "Transistor" Organ Costs Just \$349.95 ...
AND YOU CAN BUILD IT!**



What a delightful surprise on Christmas morning! And there's endless hours of fun, relaxation, education and achievement ahead for the whole family with Heathkit's 1964 version of the famous Thomas Organ. You'll be saving big money too, by easily building it yourself! No experience necessary! And you're assured long, faithful performance with the full 5-year warranty on tone generators. Can't play a note? Learn quickly and easily with a complete 48-lesson self-teacher course on 4 LP records (GDA-232-2) that's valued at \$50 . . . it's yours for only \$19.95! Like to hear it perform? Send 50c to the address below, and ask for demonstration record GDA-232-5. Plan now to give your family the exciting dimension of live music with the 1964 Heathkit Electronic Organ this Christmas!

Kit GD-232R, Organ, 160 lbs., no money dn., \$23 mo. **\$349.95**

GDA-232-1, Matching walnut bench, 16 lbs., no money dn., \$5 mo. **\$24.95**

Attention Heathkit Organ Owners! Add Variable Repeat Percussion to your Heathkit Organ with the easy-to-install kit.

GDA-232-4, 1 lb. only **\$9.95**

COMPARE THESE FEATURES WITH UNITS COSTING TWICE AS MUCH!

* **10 True Organ Voices**; Trombone, Reed, Flute, Oboe, Cornet, Violin, Saxophone, Horn, Viola, Diapason * **New! Variable Repeat Percussion**; produces effects of banjo, marimba, mandolin, balalaika, etc. * **Variable Bass Pedal Volume Control** * **Manual Balance Control**; adjusts volume of keyboards in any degree for solo work * **Variable Vibrato** * **Standard Expression Pedal**; adjusts volume from soft to full * **13-Note Heel & Toe Bass Pedals** * **Two Over-Hanging Keyboards**; each with 37 notes, range C thru C * **Beautiful Walnut Cabinet**; modern styling, hand-rubbed, hand-crafted * **20-Watt Peak-Power Amplifier & Speaker** * **Compact Size**; 34½" H x 39¾" W x 21½" D * **Transistorized**; for longer life, better tone, trouble-free operation.



HEATHKIT-1964

NEW! FREE 1964 HEATHKIT CATALOG
See all the latest products in Heathkit's exciting line. Over 250 do-it-yourself electronic kits in all . . . by far the world's largest line! There's something for every interest . . . stereo/hi-fi . . . marine . . . amateur radio . . . test and lab . . . television . . . home . . . and hobby. Send for your free copy today, and learn how you can save up to 50%.

- Enclosed is \$349.95, plus postage, please send my Heathkit Electronic Organ, model no. GD-232R.
- Enclosed is \$24.95, plus postage, please send matching walnut bench, model no. GDA-232-1.
- Please send my free copy of the new 1964 catalog.

HEATH COMPANY, Benton Harbor 40, Michigan 49023

Name _____ (please print)

Address _____

City _____ Zone _____ State _____

ALABAMA
BIRMINGHAM
Ack Radio Supply Co.
3101 4th Avenue, So.

ARIZONA
PHOENIX
Audio Specialists
333 E. Camelback
Bruces World of Sound
2711 E. Indian Sch. Rd.
Electronic Center, Inc.
3400 E. Thomas Rd.
High Fidelity Sound
Systems
1809 E. McDowell
TUCSON
The Sound Shop
4659 E. Broadway

ARKANSAS
LITTLE ROCK
Moses
505 Main

CALIFORNIA
ANAHEIM
Allied World of Music
912-916 S. Euclid
Henry Radio
931 N. Euclid Avenue
Stereo Mart
979 S. Los Angeles St.

AZUSA
Rancho Sound Co.
18532 E. Alhambra
BAKERSFIELD
Milligan's Audio Visual
217 S. Chester
BERKELEY
Thos Tenney Hi Fi Shop
2984 College Avenue

BURBANK
Audio Mart
921 W. Magnolia Blvd.
BURLINGAME
Foremans
1409 Burlingame Ave.
CASTRO VALLEY
Calbar Custom
Electronics
3223 Castro Valley Blvd.

CULVER CITY
Electronic Trading Post
4364 Sepulveda Blvd.
Hi-Fi Matic Company
5554 Sepulveda Blvd.
FRESNO
Stephenson-Bradford
Music Co.
624 W. Olive

FULLERTON
Pacific Recorders
1532 W. Commonwealth
GARDENA
Stereo Hi-Fi Center
13996 S. Crenshaw
GARDEN GROVE
State Electronics
13225 Harbor Blvd.

GLENDALE
Medico Electric Labs
1111 E. Chevy Chase Dr.
Radio Lab
806 S. Central
COLETA
Electronic Components
of Oxnard
(Formerly Dow Elec-
tronics)
1505 S. Oxnard Blvd.

HOLLYWOOD
Franklin Electronics
of California
5945 Gregory Avenue
INGLEWOOD
Newark Electronics Co.
4747 W. Century Blvd.
Olson Electronics
of Inglewood
4642 W. Century Blvd.

LA CANADA
Audio Corner
655 Foothill Blvd.
LANCASTER
Loewen and Sons
755 Lancaster Blvd.
LIVERMORE
Calbar Custom
Electronics
2184 First Street

LONG BEACH
Scott Audio Company
266 Alamitos
LOS ALTOS
Audio Center
293 State Street
LOS ANGELES
Beverly Electronics Co.
8413 Beverly Blvd.
Crenshaw Hi-Fi Center
107 Santa Barbara Pl.

Electronic Components
of Westwood
2008-18 Westwood Blvd.
Henry Radio
11240 W. Olympic Blvd.
Hi-Fi Corner
7901 Melrose Avenue
Hi-Fi Corner
669 N. Fairfax
Magnetic Recorders Co.
7140 Melrose Avenue

Ralke Company
849 N. Highland Ave.
MENLO PARK
McDaniel's Hi-Fi
935 El Camino Real
NORTH HOLLYWOOD
Chesney Stereo Center
11335 Camarillo
Olson Electronics of
N. Hollywood
5356 Lankershim Blvd.

OAKLAND
True Recordings Co.
3883 Piedmont Avenue
ORANGE
Fidelity Sound
238 South Glassell
PALM SPRINGS
Pal Barbara Music
121 S. Palm Canyon Rd.

PALO ALTO
Mardix
2103 El Camino Real
PASADENA
Electronic Components
of Pasadena
(Formerly Dow Radio)
1759 E. Colorado Blvd.
High Fidelity House
563 S. Fair Oaks
Stereo Mart
3205 E. Foothill Blvd.

REDONDO BEACH
Griffey Electronics
235 N. Pac. Cst. HiWay
RIVERSIDE
Audio Designers
4100 Merrill Street
SACRAMENTO
Industrial Sound &
Telephone
2001 El Camino Ave.
McCurry Camera Stores
8th and Eye Street
McCurry Camera Stores
Country Club Center
McCurry Camera Stores
Southgate Center

SAN BERNARDINO
George Barns & Son
3358 N. "E" Street
SAN DIEGO
Electronic Equipment
Distributors
3686 El Cajon Blvd.
High Fidelity House
1635 University Ave.
Recording Center
3941 5th Avenue
Telrad Electronics
3453 University Ave.
Wrights House of Hi-Fi
5140 El Cajon Blvd.

SAN FRANCISCO
Lakeshore Hi-Fi
222 W. Portal Avenue
Skinner Hirsch & Kaye
229 Kearny Street
Zack Electronics
1424 Market Street
SAN MATEO
Foreman's
111 East Fourth Ave.
Foreman's
202 Hillsdale Mall

SAN PEDRO
Bowers Music
810 South Gaffey
SAN RAFAEL
Catania Sound
1541 Fourth Street
SANTA ANA
Campbells Photo-Audio
Center
2122 N. Main Street
Hi-Fidelity Associates
1812 N. Main Street

SANTA BARBARA
Audio Center
3321 State Street
Electronic Components
of Santa Barbara
(Formerly Dow Elec-
tronics)
5857 Hollister Avenue
Westen's, Inc.
800 State Street
SANTA MARIA
Electronic Components
of Santa Maria
(Formerly Dow Elec-
tronics)
222 W. Main

TUJUNGA
Woodall Cameras
7165 Foothill Blvd.
VISTA
T.V. Craftsmen
516-518 E. Vista Way
WALNUT CREEK
Stevenson Electronics
1531 Locust Street
WHITTIER
Oxbow Electronics
15914 E. Whittier Blvd.
WEST LOS ANGELES
Bel Air Camera
933 Westwood Blvd.

COLORADO
BOULDER
House of Music
1779 29th Cross Roads,
North
COLORADO SPRINGS
Dick Jurgens High
Fidelity and Sound
530 South Tejon
DENVER
Burststein-Applebee Co.
1237 16th Street
Davis Audio-Visual, Inc.
2149 South Grape St.
Electric Accessories Co.
1620 Blake Street
Electric Accessories Co.
262 Fillmore Street
Empire Stereo & Hi-Fi
Center
1100 Broadway
Gramophone Shop
2904 E. 3rd Avenue
Howard Sound Corp.
843 Broadway

IDAHO
IDAHO FALLS
Hart's Inc.
633 Safstrom Drive
ILLINOIS
AURORA
Cook's Hi-Fi
47 Fox Street
CHAMPAIGN
Radio Doctor's Hi-Fi
811 W. Springfield
CHICAGO
Allied Radio Corp.
100 N. Western Ave.
Allied Radio Corp.
2025 West 95th St.
Allied Radio Corp.
921 North Rush St.
Educational Specialists
915 W. Wilson Ave.
Freid's
3801 W. 26th
Musicraft
48 E. Oak Street
Newark Electronics Corp
223 West Madison
Ralph's Hi-Fi
5310 W. North Ave.
Schwartz Bros.
8533 S. Cottage Grove

EVANSTON
Allied Radio Corp.
602 Davis Street
OAK PARK
Allied Radio Corp.
7055 W. North Ave.
INDIANA
INDIANAPOLIS
Pearson Platters
Devington Center

IOWA
WATERLOO
Farnsworth Electronics
201-205 E. Mullan Ave.
KANSAS
DODGE CITY
Dodge Music
203 First Avenue

KENTUCKY
LOUISVILLE
Gatchel's
431 W. Walnut St.
LOUISIANA
BATON ROUGE
Ogden Park Record
Shop
618 N. 3rd
LA FAYETTE
"Prof" Erny's Music
1508 S. College
SHREVEPORT
Keelmay Sales Co.
2530 Linwood Avenue

MARYLAND
BALTIMORE
Hi-Fi Shop
320 W. Baltimore St.
High Fidelity House
5123 Roland Avenue
BETHESDA
Audio Center
4962 Fairmount Ave.
SILVER SPRINGS
Federated Purchasers
1310 Apple Avenue
TOWSON
Hi-Fi Shop
Towson Plaza

Lloyd's Hi-Fi Shop
410 S. Colorado Blvd.
Sound in the Round
562 S. Broadway

CONNECTICUT
HARTFORD
Stereo Shop Inc.
229 Asylum Street

NEW HAVEN
David Dean Smith
262 Elm Street

DELAWARE
WILMINGTON
Radio Electric Service
Co. of Delaware
3rd and Tainall Street

DISTRICT OF COLUMBIA
WASHINGTON, D.C.
Custom Hi-Fi
1811 Columbia Rd. N.W.
Electronic Wholesalers
2345 Sherman Ave. N.W.
Kitt Music Company
1330 G Street, N.W.
Shrader Sound
2803 M Street, N.W.

FLORIDA
FT. LAUDERDALE
High Fidelity Associates
1620 N. Federal Hwy.
MIAMI
Electronic Wholesalers
9390 N.W. 27th Ave.
Flagler Radio Co.
1068 West Flagler St.
High Fidelity Associates
3180 Biscayne Blvd.
High Fidelity Associates
3396 Coral Way
Sound Box
11503 S. Dixie Hwy.

PENSACOLA
Grice Electronics
300 E. Wright Street
TAMPA
Viviano Stereo Center
1538 S. Dale Mabry

MASSACHUSETTS
BOSTON
De Mambro Radio
1095 Commonwealth
Avenue
CAMBRIDGE
Minute Man Radio
28 Boylston Street
HOLYOKE
Del Padre Audio
270 High Street
NORTHAMPTON
Del Padre Audio
28 Main Street
SPRINGFIELD
Del Padre Audio
999 Worthington St.
Soundco Electronics
147 Dwight Street
WELLESLEY
Music Box
58 Central Avenue

MICHIGAN
ANN ARBOR
The Music Center
304 S. Thayer Street
DEARBORN
Almas Hi-Fi Stereo
15031 Michigan Ave.
DETROIT
Almas Hi-Fi Stereo
7104 W. 7 Mile Road
High Fidelity Workshop
16400 W. 7 Mile Road
Lobby Hobby
17300 Woodward Ave.
Newark Ferguson
Electronics
20700 Hubbell Avenue
Pecar Electronics
11011 Moran

EAST LANSING
Tape Recording Ind.
1101 E. Grand River
GRAND RAPIDS
Audio Distributors
2342 S. Division Ave.
Electronic Sound
2249 S. Division
MINNESOTA
MINNEAPOLIS
Audio King
913 West Lake Street

MISSOURI
KANSAS CITY
Burststein-Applebee Co.
1012 McGee Street
Burststein-Applebee Co.
301 East 55th Street
Improved Method's
Corporation
8325 Wornall Road
McGee Radio Co.
1901 McGee Street
ST. LOUIS
Aeolian Co. of Missouri
1004 Olive Street
Aeolian Co. of Missouri
39 Crestwood Plaza
Aeolian Co. of Missouri
7754 Forsyth Blvd.
Van Sickle Radio-
Electronics, Inc.
1113 Pine Street

NEBRASKA
OMAHA
J B Electronics
Hi-Fi Stereo Plaza
1618 Cass Street
NEVADA
LAS VEGAS
Garehime Music
115 N. 3rd Street
RENO
Art Rempel Sound
Supply Co.
460 S. Wells Avenue

NEW JERSEY
ALLENTOWN
Federated Purchasers
1113 Hamilton Street
CAMDEN
Radio Electric Service
Co. of Penn.
30 Market Street
CLARK
Scholl Electronics
1113 Raritan Road
CRANFORD
Stuart's Audio
8 Alden Street

JERSEY CITY
Massa Sales & Service
434 Central Avenue
LYNDHURST
A Custom Stereo Center
530 Riverside Avenue
MENLO PARK
Bamberger's
Parsonage Rd.
MONMOUTH
Bamberger's
Eatontown Shopping Ctr.
MONTCLAIR
Perdue Radio Company
10 South Park Street
MORRISTOWN
Paramount-Morristown
TV & Radio Sales
33 South Street
NEWARK
Bamberger's
131 Market St.
Lafayette Radio
Electronics
24 Central Avenue
Sound Reproduction
34 New Street

NEW BRUNSWICK
BOSTON
28 Easton Avenue
PARAMUS
Bamberger's
Garden State Plaza
Gem Electronics
385 Route 17
PLAINFIELD
Lafayette Radio
Electronics
139 W. 2nd Street
SHREWSBURY
Federated Purchasers
483 Broad Street
SPRINGFIELD
Federated Purchasers
U.S. Route 22
Gem Electronics
Route #22
TOTOWA BOROUGH
Sim-orama Sound
Service
572 Union Blvd.
TRENTON
House of Hi-Fi
961 Princeton Avenue
WESTFIELD
Stuart's Audio
17 Elm Street

NEW MEXICO
ALBUQUERQUE
Sound By Hi-Fi House
3011 Monte Vista
Bldg., N.E.
LAS CRUCES
Mannie's TV
802 S. Solano
NEW YORK
BRONX
Gem Electronics
565 East Fordham Road
Lafayette Radio
Electronics
542 East Fordham Road
BROOKLYN
The Audio Exchange
1065 Flatbush Avenue
Gem Electronics
59 Willoughby Street
BUFFALO
FM Sound Equipment
1241 Main Street
Purchase Radio &
Hi-Fi Corp.
(Lafayette Radio
Associate Store)
747 Main Street
FARMINGDALE, L.I.
Gem Electronics
34 Hempstead Turnpike
FOREST HILLS
Gem Electronics
101-10 Queens Blvd.
HUNTINGTON STA., L.I.
Rite Electronics
1946 New York Avenue
JAMAICA, L.I.
The Audio Exchange
153-21 Hillside Avenue
Lafayette Radio
Electronics
165 08 Liberty Avenue
MANHASSSET
The Audio Exchange
451 Plurderon Road
NEW YORK
Audio Unlimited
715 2nd Avenue
Carston Studios
125 East 88th Street
Consolidated
Radio Sales
768 Amsterdam Avenue
G. Schirmer
4 East 49th Street
Gem Electronics
202 East 44th Street
Harvey Radio Co.
103 West 43rd Street
Harvey Radio Co.
1123 6th Avenue
Hi-Fidelity Center
1797 First Ave.
(at 93rd St.)
Leonaro Radio Inc.
69 Cortland Street
Leonard Radio
1163 Avenue of the Americas
Lyric High Fidelity
Center
1221 Lexington Avenue

NEW BRUNSWICK
Macy
Herald Square
Packard Electronics
Corporation
33 Union Square West
Rabsons-57 Street Inc.
119 West 57th Street
Sonocraft
115 W. 45th Street
Terminal Hudson
Electronics Inc.
48 West 48th Street
Terminal Hudson
Electronics Inc.
212 Fulton Street
ROCHESTER
Craig Audio Labs
139 North Union Street
SYOSSET, L.I.
Lafayette Radio
Electronics
111 Jericho Turnpike
TUCKAHOE
Boynton Studio's
295 Main Street
WHITE PLAINS
The Audio Exchange
203 Mamaroneck Ave.
YONKERS
Gem Electronics
1937 Central Avenue

OHIO
AKRON
Olson Electronics, Inc.
69 West State Street
CINCINNATI
Customcrafters Audio
2259 Gilbert Avenue
Stenberg's
633 Walnut Street
CLEVELAND
Audio Craft Company
2815 Prospect Avenue
Olson Electronics
of Cleveland
2020 Euclid Avenue
Olson Electronics
-Southland
6813 Pearl Road
COLUMBUS
Electronic Supply
814 West 3rd Avenue
Jimmy Rea's
479 West Rich Street
Palmer Electronics
1589 W. Fifth Avenue
DAYTON
Custom Electronics
1918 South Brown St.
Klop's Music Shop
323 Salem Avenue
FAIRBORN
Custom Electronics
419 West Dayton Drive
KENT
Dayho Electronics
411 Longmere
SPRINGFIELD
Gene Tavener
32 E. Harding
YOUNGSTOWN
Hi-Fi Center
2802 Market Street

OKLAHOMA
NORMAN
Thomson Sound
315 W. Boyd
OKLAHOMA CITY
Audio Specialties
2608 N. Pennsylvania
Larsen Music Co.
314 Park Avenue
TULSA
Sound Unlimited
3745 S. Peoria
OREGON
EUGENE
Oregon Typewriter
& Recorder
1111 Willamette Street
PORTLAND
High Fidelity Unlimited
2816 S.W. Sam
Jackson Park Road
Oregon Typewriter
& Recorder
500 S.W. 5th Avenue
Oregon Typewriter
& Recorder
1061 Lloyds Center

PENNSYLVANIA
PHILADELPHIA
Radio Electric Service
Co. of Penn.
701 Arch Street
SWARTHMORE
Hi-Fi Studio
8 Park Avenue
WILLOW GROVE
Radio Electric Service
Co. of Penn.
29 York Road
RHODE ISLAND
CRANSTON
Sound-orama
758 Reservoir Avenue
TENNESSEE
KNOXVILLE
McClung Appliances
310 Georgia Street, N.E.
MEMPHIS
W & W Distributing Co.
644-46 Madison Avenue
TEXAS
AUSTIN
High Fidelity
1610 Lavaca
BEAUMONT
Brook Audio
2293 Calder
DALLAS
Ernstoms
4356 Lovers Lane
Hillcrest High Fidelity
6309 Hillcrest
Home Music Associates
4518 N. Central
Expressway
EL PASO
The Howell Company
2815 Pershing Drive
FT. WORTH
Audio Associates
4802 Camp Bowie
HOUSTON
Audio Center
1424 Westheimer
Busacker Electronic
Systems
1216 West Clay
Hi-Fi Kilt Shop
2326 Bissonnet
Sound Equipment Co.
2506 Crawford Street
Sound Equipment Co.
3727 Westheimer
LAREDO
Cowl's Music Center
1212 Hidalgo
MIDLAND
May-Duncan Music
219 N. Main
Midland Camera Co.
317 N. Colorado
SAN ANGELO
Accurate Sound
15 N. Tyler
SAN ANTONIO
Bill Case Sound
3522 Broadway
Sterling Electronics
3903 San Pedro
Vandergrift Audio Co.
6740 San Pedro
UTAH
OGDEN
Hi-Fi Shop
2323 Washington Blvd.
SALT LAKE CITY
Clark Music
28 East 1st South
George F. Webb Sales
937 E. 33rd South St.
House of Music
156 South Main
WASHINGTON
BURien
Hess Recorder Co.
Stereo Center
650 S.W. 152nd Street
LYNNWOOD
Cascade Electronic
Supply
P.O. Building
RICHLAND
20th Century Sales
260 Williams Blvd.
SEATTLE
Electricraft
1408 6th Ave.
SPOKANE
20th Century Sales
W 1021 First Avenue
TACOMA
Paulson's
1101 South K Street
Paulson's
6111 100th S.W.
WISCONSIN
MILWAUKEE
Allied Radio Corporation
3555 S. 27th Street
Allied Radio Corporation
5314 N. Ft. Washington Road
Flanner and Hafsoos
2500 N. 108th Street
Hi-Fi Center
4236 W. Capitol Drive
Photoart Visual Service
840 N. Plankinton Ave.
Wack Sales Co.
3131 W. North Avenue
RACINE
Edward's Sound
856 Washington

Here's where to
see and hear the new
Amplex Fine Line F-44.





What new recorder is virtually custom-built?

AMPEX F-44

The F-44 is a brand new 4-track stereo recorder from Ampex. It's Ampex through and through. And there's this, too: at every stage of manufacture Ampex tunes, adjusts and aligns each F-44 to obtain its maximum performance — far beyond minimum specifications. Thus, no two F-44s are quite alike. Each is virtually a custom-built recorder. Each performs to the utmost of its capabilities. And each gives you the best possible sounds today — and for many years to come. As an F-44 owner, you'll receive from Ampex a record of the individual performance specifications of your own F-44. This record shows the frequency

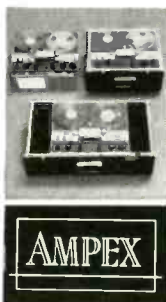

response curve, the signal-to-noise ratio, the flutter and wow, and the crosstalk rejection measurement. And it is signed by the Ampex engineers who tuned and adjusted your recorder. The new Ampex Fine Line F-44 also features a new special design hysteresis motor for smooth, quiet, accurate operation; an easy-to-read point-to-point record level meter for each channel; multiple sound-on-sound capability; new simplified controls; and the Ampex one year warranty. See and hear the new F-44 at your local Ampex dealer (listed opposite). Brochure? Write: Ampex Corporation, Redwood City, Calif. Worldwide sales and service.

CANTATE

GERMAN BACH SOLOISTS

Direction: HELMUT WINSCHERMANN
Exclusively on CANTATE—First recordings:

JOHANN SEBASTIAN BACH

Concerto in F for Oboe, Strings, and Continuo, BWV 1053
Concerto in D for Harpsichord, Strings, and Continuo, BWV 1054
Soloists: H. Wanschermann, Oboe; E. Picht-Axenfeld, Harpsichord
047 701 mono—057 701 stereo

Concerto in g for Harpsichord, Strings, and Continuo, BWV 1058
Concerto in d for Oboe, Violin, Strings, and Continuo, BWV 1060
Soloists: G. Malcolm, Harpsichord; H. Wanschermann, Oboe; G. F. Hendel, Violin
047 702 mono—057 702 stereo

GEORG PHILIPP TELEMANN

Overture in C—Concerto in B flat for Oboe, and Strings—Concerto in E for Oboe d'amore, Flute, and Viola d'amore
Soloists: H. Wanschermann, Oboe d'amore; H. J. Moehring, Flute; G. Lemmen, Viola d'amore;
047 703 mono—057 703 stereo

Send for descriptive catalog

CANTATE

P.O. Box 193
Greensburg, Pa.

CIRCLE NO. 20 ON READER SERVICE CARD

Free valuable Handbook

"11 ways to really improve
your Hi-Fi listening"

An authoritative study on
the uses of earphones.

For the first time a comprehensive compilation of data on one of the newest and most efficient methods of Hi-Fi listening issued by
NEW MODEL SUPEREX

The only stereo/phones containing woofers, tweeters and miniaturized crossover networks built in each phone... full 20-20,000 cps range; 8-16 ohms impedance. For true stereo or monaural listening without muddling, interference from room noises or conventional background sounds. ST-M \$29.95



SUPEREX stereo/phones

3-S Radford Place • Yonkers, N. Y.

Please send me "Your Free Handbook"

Name _____

Address _____ City _____ State _____

Interest: Seventeenth-century sacred works

Performance: Competent

Recording: Very good

Stereo Quality: Satisfactory

Monteverdi's declamatory and dramatic Mass, first published in 1651 after the composer's death, and the four canticles from Orlando Gibbons' Anglican *Short Service*, sung here a capella, are performed by the eighteen-voice mixed choir of Christ Church, known as "Old North," of Boston. The chorus is a good one, though an all-male choir, such as that of King's College at Cambridge University, would provide a more intense sound for the English repertoire. John Feserman differentiates between the styles of the impassioned Monteverdi and the more objective Tudor pieces, but the Mass suffers somewhat from blurred phrases, fast pacing, and a generally apparent lack of understanding of Monteverdi's high neo-classical style. The recording in both mono and stereo is full, but the review discs were not entirely free of surface faults.

I. K.

⑤ ⑥ GILBERT AND SULLIVAN:

Patience. John Shaw (baritone), Colonel Calverley; Trevor Anthony (bass), Major Murgatroyd; Alexander Young (tenor), the Duke; John Cameron (baritone), Archibald Grosvenor; George Baker (baritone), Bunthorne; Monica Sinclair (mezzo-soprano), Lady Jane; Marjorie Thomas (contralto), Lady Angela; Elsie Morison (soprano), Patience. Glyndebourne Festival Chorus and Pro Arte Orchestra, Sir Malcolm Sargent cond. ANGEL S 3635 two 12-inch discs \$11.96, 3635 \$9.96.

Interest: Abridged Savoy gem

Performance: Excellent

Recording: Tops

Stereo Quality: Vivid

With this *Patience*, Angel has regrettably missed a great opportunity. The D'Oyly Carte version (London OSA 1217) is complete, with all of Gilbert's arch and vitriolic text properly preserved. In contrast, Angel furnishes only the musical portions. Why this has to be is something of a puzzle—London's example proves that the entire opera could easily have been included on the four 12-inch sides. A pity, for the performance is excellent. Sir Malcolm Sargent's reading, a shade more deliberately paced and more elegantly executed than Godfrey's for London, delivers the last ounce of charm in Sullivan's music while preserving all of its rollicking gusto. And although *Patience* is one of the best D'Oyly Carte recorded efforts, that venerable organization does not supply matches for the robust Colonel of John Shaw, the luscious-toned Jane of Monica Sinclair, and

the radiant Mabel of Elsie Morison. That incredible septuagenarian, the indestructible George Baker, is, however, outdone by London's John Reed. Baker's portrayal of the sly and mercurial Bunthorne is virtually flawless, but his voice has worn thin, and he cannot convincingly suggest youthfulness.

Sumptuous sound and effective stereo add to the enticements of what could have been an exceptionally brilliant achievement. But listeners anticipating the wit and charm of this opera in its totality are likely to find here considerably less than they bargained for. G. J.

⑤ ⑥ HANDEL: *Musick for the Royal Fireworks*. Walter Holy, Helmut Finke, Ingus Schmidt (clarinos); Archive orchestra of ancient wind instruments, August Wenzinger cond. *Concerto a due Cori, No. 2, in F Major; Concerto a due Cori, No. 3, in F Major*. Helmut Hucke and Ingo Goritzki (oboes); Gustav Neu-



SIR ARTHUR SULLIVAN
In an 1874 caricature by Spy

decker, Edmund Stegner, Umberto Bac-celli, and Peter Steidle (horns); Eduard Müller and Valerie Kägi (harpsichords); Concert Ensemble of the Schola Cantorum Basiliensis, August Wenzinger cond. DEUTSCHE GRAMMOPHON ARCHIVE ARC 73146 \$6.98, 3146* \$5.98.

Interest: Accent on authenticity

Performance: Uninvigorating

Recording: Very satisfactory

Stereo Quality: Only adequate

This is the second recording of the *Royal Fireworks Music* to claim to use the original band scoring with instruments of the time, or reconstructions. Unlike the Vox fiasco, this performance sounds very

(Continued on page 78)

GENUINE PLAYBACK EQUIPMENT

A DISTINCT STEP-UP FROM HIGH FIDELITY

Genuine studio **PLAYBACK** equipment is as superior to conventional "hi fi" components as these components are superior to typical package "hi fi." The reason: **PLAYBACK** equipment is what the conductors, artists and recording engineers rely on in the studio to accurately compare the realism of a recording with the live rendition.

In professional audio, where no compromise with performance and reliability is tolerated, only genuine **PLAYBACK** equipment is deemed acceptable. Altec Lansing is synonymous with **PLAYBACK**, because major professional users—studios, concert halls, theatres—have used Altec equipment predominantly since the beginning of modern sound technology.

The Altec 605A "Duplex"® is an outstanding example of such studio equipment and has been judged the finest single-frame speaker in existence. It is the ultimate refinement of Altec's original 604 which had served as the **PLAYBACK** standard since the birth of long play records.

One hearing will quickly demonstrate why the 605A "Duplex" is supreme. These specifications will explain some of the reasons: The 605A is a 15", two-way speaker system employing a true multicell horn for perfect dispersion of high frequencies throughout the entire audio range. Its guaranteed frequency response is 20-22,000 cycles. The Altec 605A "Duplex" is so free of distortion and false coloration that other speakers sound shrill and constricted by comparison. That's why leading Capitol recording stars such as Judy Garland, Peggy Lee, Nat King Cole and Vic Damone can rely on the "Duplex" in studio **PLAYBACK** for evaluation of their work before the recording is "wrapped-up."

WIDE VARIETY OF WIDE-RANGE SPEAKERS

The 605A is priced at \$168.00 including dividing network. At 35 pounds, it is the "heavyweight" of the line. Two other "Duplex" **PLAYBACK** speakers of exceptional quality are also available. The 602C is a 15" two-way speaker which provides outstanding performance at the modest cost of \$132.00. For those who want genuine **PLAYBACK** sound in comparatively small space, Altec's two-way 601C is the ideal answer at \$108.00.

For "starter" systems on a budget, consider Altec full-range, single voice-coil "Biflex"® speakers: the 15" 415C and the 12" 412C. And, for speakers throughout the home, there's the remarkably smooth 8" 755C "pancake," a popular utility monitor in the broadcast and recording field for many years.

AUDIO'S MOST IMPORTANT FORMULA

Whatever you invest in your system, put major emphasis on the speakers. The speakers are the voice of your system and here, a compromise is most audibly apparent. If, for various reasons, you must compromise with overall quality, it is best not to do so in speaker selection but elsewhere in the audio system. Naturally, you will be assured best results by a stereo system made-up entirely of components of homogeneous quality such as offered by genuine Altec **PLAYBACK** speakers, amplifiers, and tuners.

Hear Altec speakers, speaker systems and other **PLAYBACK** components at your nearest Altec Distributor's (see your Yellow Pages). And while you're there, be sure to ask for your courtesy copy of "PLAYBACK and Speech Input Equipment for Recording and Broadcast Studios." Although prepared specifically for the recording and broadcast industry, it provides the obvious answers to better home listening as well. Or, for your free copy, write Dept. SR-11.



Interior of Columbia Records' Studio A in Hollywood showing CBS-built cabinets housing Altec 605A "Duplex" Loudspeakers for professional **PLAYBACK**.

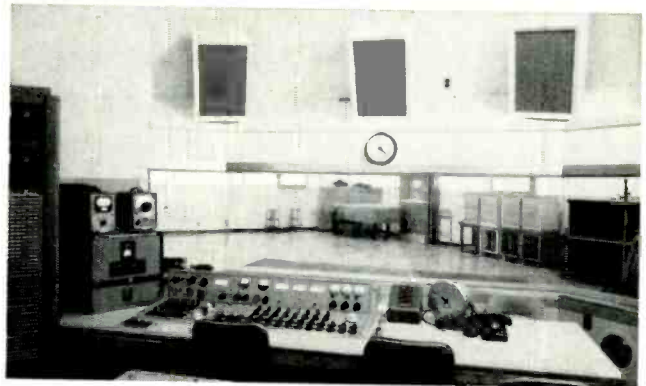

Monitoring with Altec "Duplex" speakers in Capitol's Control Room. More than 70 Altec "Duplex" speakers are used for various **PLAYBACK** purposes throughout Capitol Records' recording facilities.



©1963 ALTEC LANSING CORPORATION

**ALTEC LANSING
CORPORATION**

LTV A Subsidiary of
Ling-Temco-Vought, Inc.
ANAHEIM, CALIFORNIA



Do you want good movies of your family's hobbies, travels, and activities? Do you want a movie camera that looks good, is easy to use, and provides dependable, trouble-free operation? Then see the new line of 8mm movie cameras from Honeywell Elmo!

There are three of these superb instruments from which to choose—the Zoom 82 (shown here with the accessory Battery Operated Zoom Grip which allows you to zoom in and out without running film through the camera) at \$189.50; the Zoom 81 at \$169.50, and the compact Pocketauto 80 at just \$99.50.

Built by the Elmo Company, Japan's most respected maker of movie products, these fine new cameras are constructed to extremely high standards and are backed by Honeywell's guarantee and full factory service facilities. Ask your Authorized Dealer for a demonstration soon!

For detailed literature, write to John Thornton (209), Honeywell, Denver 10, Colorado.

Honeywell
PHOTOGRAPHIC PRODUCTS

good, both in the quality of the playing and the sonorities of the old instruments. The clarinos are modern reproductions of the Baroque high trumpet, which looked like a coiled snake, and are far less piercing than their present-day counterparts. Stylistically this is an admirable performance, but the conducting seems a bit square and Teutonic. Tempos are fast, and there is neither the nobility nor the British heartiness that characterizes the Mackerras recording (Vanguard 5046/630). The latter, using a larger band of modern instruments, not only gives more body to the music (the *Gentleman's Magazine* of 1749 reported that one hundred musicians played for the first public hearing), but also has sharper rhythmic outlines and clearer phrasing. The Vanguard coupling includes the same concerto for two wind choirs as here, but the Archive producers, following the latest scholarship, separate the music into two concertos and add two movements missing in the other version. The playing is again exceedingly skillful, although the same reservations apply. The recording is very clean, but, program notes to the contrary, does not make enough of the possibilities of stereo separation in the two concertos—again, Vanguard's is much more effective. In sum, very good Handelian style, but not nearly as imposing, invigorating, and idiomatically British a performance as the equally stylish Mackerras interpretation.

I. K.

HAYDN: *Duo in B-flat Major for Two Violins* (see SPOHR).

RECORDING OF SPECIAL MERIT

© HAYDN: *Feldparthien: Divertimento in G; Divertimento in F; Divertimento in C; Divertimento in F; Divertimento in C. March for the Prince of Wales* (1792). Wind Ensemble of the Vienna Volksoper, Wilhelm Sommer cond. AMADEO AVRS 6208 \$5.95.

Interest: Haydn for wind band
Performance: Diverting and delightful
Recording: Warm

Except for the engaging *March for the Prince of Wales*, written in London in 1792, the majority of the pieces in this unusual collection date from the early 1760's, when Haydn was Kapellmeister to Count Morzin, and shortly after, when he began his long service to the Esterházy. This disc gives a nicely varied sampling of the popular *Feldparthien*—wind-band music that might perhaps be looked on today as eighteenth-century Muzak. True, this is not profound stuff, but it brims with charm, and any wind-ensemble enthusiast (I myself became an addict on Mozart's Serenades Nos. 10, (Continued on page 80)



NEW ALL-TRANSISTOR FOR **PLAYBACK** PERFECTION

Transistors have changed the idea that old-fashioned vacuum-tube amplifiers could not be appreciably improved. First proof of what transistors could really do came to us five years ago when we applied solid state circuitry to specialized amplifiers for the telephone industry, the military, and other commercial and professional users. This early experience taught us that transistors had a revolution in store for future amplifier development; it was only a matter of time and a great deal of experimentation before we could make a more truly perfect amplifier available for studio **PLAYBACK** and serious home use.

Three years ago, at a time when most amplifiers were of the vacuum-tube type, we marketed our first all-transistor power amplifier for **PLAYBACK** applications. Today, the 351B model is credited as the most advanced single-channel amplifier of its type in the professional field. Shortly after the 351, we introduced the now famous 708A "Astro"—the only all-in-one stereo center with all-transistor power output stages. Now, after five years of actual production experience with solid state circuitry, we take pride in introducing the 360A all-transistor stereo pre/power amplifier... for **PLAYBACK** perfection.

WANT TO HEAR THE SOUND OF **PLAYBACK** PERFECTION?

That question contains a strong claim, but one that we have seen substantiated time and again during the many listening tests performed on the new solid-state Altec 360A Royale II stereo amplifier/preamplifier. In fact, the difference in perfection between this unit and even the finest vacuum tube amplifier is amazingly apparent. The lowest frequencies are unbelievably solid and life-like; snare drums sound like snare drums, an organ is an organ (you almost look for the pipes). Transient distortion, background hiss, and microphonics are conspicuous by their absence. Hum is so completely inaudible, even at loudest volumes, that we conclude there just isn't any. The highs are crisp, clean, transparent; for the first time, you hear a piccolo in complete purity because the amplifier does not contain, and does not need, a built-in bass boost for the lower end.

In short, the 360A is so far more perfect than the finest tube amplifier, we predict that others will hastily experiment and a rash of transistorized amplifiers will follow. But at Altec, experimentation is over! Five years of transistor amplifier production have literally put the 360A five years ahead of the home music field.

But no amount of words on paper can relate the somewhat startling audio revelation we had when we first listened to the 360A. The sound of perfection is not easy to describe. May we suggest a trip to your nearest Altec Distributor for a personal evaluation of this thing we call "transistor sound" (or perfection if you will).

NEW IN APPEARANCE, TOO!

The 360A is the first "keyboard" amplifier. Named for its unique musical-instrument type front panel keyboard control arrangement, the 360A offers operating convenience at one central front panel location, eliminating the universal objection to a miscellany of switches.

POWER • 70 watts (IHFM); 35 watts per channel.

INPUTS • 12, stereo or mono: magnetic or ceramic phono, tape head, stereo microphones, tape, radio, auxiliary.

OUTPUTS • 7, stereo or mono: left, right and center speaker outputs, left and right channel recorder outputs, center channel voltage output for auxiliary amplifier, headphone output jack.

KEYBOARD CONTROLS • Rumble filter, stereo-mono switch, tape monitor, channel reverse, hi-low gain, volume contour, scratch filter, phase reverse, headphone-speaker output switch.

OTHER FRONT PANEL CONTROLS • Input selector, channel reverse, independent bass and treble controls (friction coupled), blend control, balance control, volume control.

REAR PANEL CONTROLS • Magnetic-ceramic phono input selector, speaker impedance selector.

PRICE • \$366.00 including cabinet. Only 5½" H, 15" W, 11¼" D.



©1963 ALTEC LANSGING CORPORATION

SPECIAL FEATURES • Automatic reset circuit breakers for over-current protection of each channel and AC line. Diffused keyboard illumination plus daylight power indicator. Both headset and speaker monitoring for tape recording on front panel. Variable crossover type bass tone control for bass boost independent of mid-range.

PERFECT PARTNERS



FAVORITE OF BROADCASTERS
The 314A Emperor Royale FM Multiplex Tuner.

For FM stereo that will do justice to the Royale II, the 314A Emperor Royale FM Multiplex tuner is the answer. The 314A is a fully professional component which is offered in the Altec **PLAYBACK** catalog for network relay and rebroadcast applications. Among its distinctive features is a monophonic output for feeding a 351B all-transistor power amplifier for single-channel music distribution throughout the home. Price: \$359.00, including cabinet.

Hear Altec's complete line of genuine studio **PLAYBACK** components soon at your nearest Altec Distributor (see your Yellow Pages).

Also, be sure to ask for your courtesy copy of the Altec Catalog, "PLAYBACK and Speech Input Equipment for Recording and Broadcast Studios," which illustrates how the big name record companies and broadcast networks use Altec equipment to achieve **PLAYBACK** perfection. Or, write for your free copy to Dept. SR11B.

ALTEC LANSGING CORPORATION
LTV A Subsidiary of
Ling-Temco-Vought, Inc.
ANAHEIM, CALIFORNIA

“...major
step
forward”



ACOUSTECH SOLID STATE AMPLIFYING SYSTEM

“... better than the best** ...”
“... seems to ‘grab hold of’ and
control a speaker to a degree that
has led many listeners to remark
that the speaker itself ‘never sounded
better.’” “... the finest square wave
response I have ever observed** ...”

These are examples of the acclaim
accorded the Acoustech I Solid State
Stereo Power Amplifier since its in-
troduction at the 1962 New York High
Fidelity Show. Now the first “all-out”
solid state amplifying system is made
possible with the new Acoustech II
Stereo Decade Control Center. These
two units afford the listener a new
standard in music reproduction and
reliability possible only with solid
state circuitry throughout.

For full information on these remarkable
instruments, send coupon below.

Acoustech I \$395, Acoustech II \$348
(slightly higher west of Rockies)

*High Fidelity Magazine, August, 1962
**HiFi/Stereo Review, February, 1963



ACOUSTECH, Inc., 139 Main St.
Cambridge, Mass. 02142 Dept. R-11

Name _____

Address _____

City _____ State _____

CIRCLE NO. 1 ON READER SERVICE CARD
80

11, and 12) will need little urging to
run out for Haydn's brand of background
music. I certainly defy anyone to resist
such a thing as the *presto* finale of the
F Major Divertimento. The playing is
completely à la mode, exceptional both
from technical and stylistic standpoints.
Save for the *March*, all the pieces seem
to be first recordings, and the sound, ex-
cept for slight blasting effects in the
loudest passages, is clean and intimately
warm.

I. K.

**HONEGGER: *Sonatina for Two Vio-
lins* (see SPOHR).**

© © MENDELSSOHN: *Symphony
No. 4, in A Major, Op. 90 ("Italian");
Fingal's Cave ("The Hebrides") Con-
cert Overture, Op. 26.* WEBER: *Ober-
on: Overture.* Cleveland Orchestra,
George Szell cond. Epic BC 1259 \$5.98,
LC 3859 \$4.98.

Interest: Romantic favorites

Performance: Precise

Recording: Close-miked

Stereo Quality: Okay

The Mendelssohn "Italian" Symphony
has never lacked for first-rate recorded
performances, and this one by Szell, with
its rhythmic verve and careful attention
to the balance of inner voices, can take
its place among the best. A similar ap-
praisal is due the very stylish treatment
of the *Oberon* overture.

Surprisingly, the famous seascape of
the Hebrides is rather sluggish, and while
Szell's views in matters of tempo are not
to be dismissed lightly, there are other
conductors—Peter Maag, in particular—
who bring a good deal more salt spray
and whistling nor'easter into the tonal
picture than one finds in the Cleveland
disc. The recorded sound is on the tight
and dead side, as well—which leaves me
with a mixed reaction to this disc. D. H.

**MONTEVERDI: *Messa a 4 Voci da
Cappella* (see GIBBONS).**

© © MOZART: *Serenade No. 10, in
B-flat Major, for Thirteen Wind In-
struments, K. 361.* Members of the Ba-
varian Radio Symphony Orchestra,
Eugen Jochum cond. DEUTSCHE GRAM-
MOPHON SLPM 138830 \$6.98, LPM
18830* \$5.98.

Interest: Unique and delightful work

Performance: Solid

Recording: Rich-sounding

Stereo Quality: Needs more spread

For several reasons—length, elaborate-
ness of instrumentation, and extraordi-
nary wealth of inspiration—the Serenade
K. 361 is unique among Mozart's many
explorations of the genre. The delightful
scoring, with the inventive flow cease-

lessly cascading from one instrument to
another, makes this a particularly re-
warding work to hear in stereo—an as-
pect fully exploited by the recent
Columbia disc, MS 6344, under Robert
Craft's direction. For technical profi-
ciency, the Bavarians can match anyone.
But the bronze glow of their ensemble
sound and the settled cosiness of Joch-
um's tempos seem less appropriate to the
work than the crispness and the more
varied dynamics of Craft's forces. Also,
though DGG's sound has all the full-
bodied richness one can ask for, Colum-
bia's broader stereo spread and sharper
definition goes further in bringing to the
fore Mozart's delightfully balanced part-
writing.

G. J.

© © MOZART: *Symphony No. 29 (K.
201); A Musical Joke (K. 522).* Orches-
tra San Pietro, Renato Ruotolo cond.
DECCA DL 710068 \$5.98, 10068 \$4.98.

Interest: Routine Mozart

Performance: Not so good

Recording: Fair enough

Stereo Quality: Minimal

These Mozart readings are—granting a
certain amiability—not at all to the
point. The tempos tend to get soggy in



DECCA RECORDS

EUGEN JOCHUM

For a Mozart serenade, a dulcet glow

the A Major Symphony, and the conduc-
tor's wont is to stress the lyricism of the
moment with small regard for the larger
formal considerations.

The *Musical Joke* is even less success-
ful. The performance trick here should
be complete deadpan. No cognizance in
the form of emphasized articulation must
be allowed to take place. The music
must be played with all the elegance and
precision ordinarily brought to the "Jupi-
ter" Symphony, and the musical mala-
props must just be allowed to happen.
Here they are underscored and, as it
were, pointed to.

W. F.

(Continued on page 82)

**This tape
is not for
amateur sopranos,
party capers,
dictation
or
music-to-play-bridge-by**

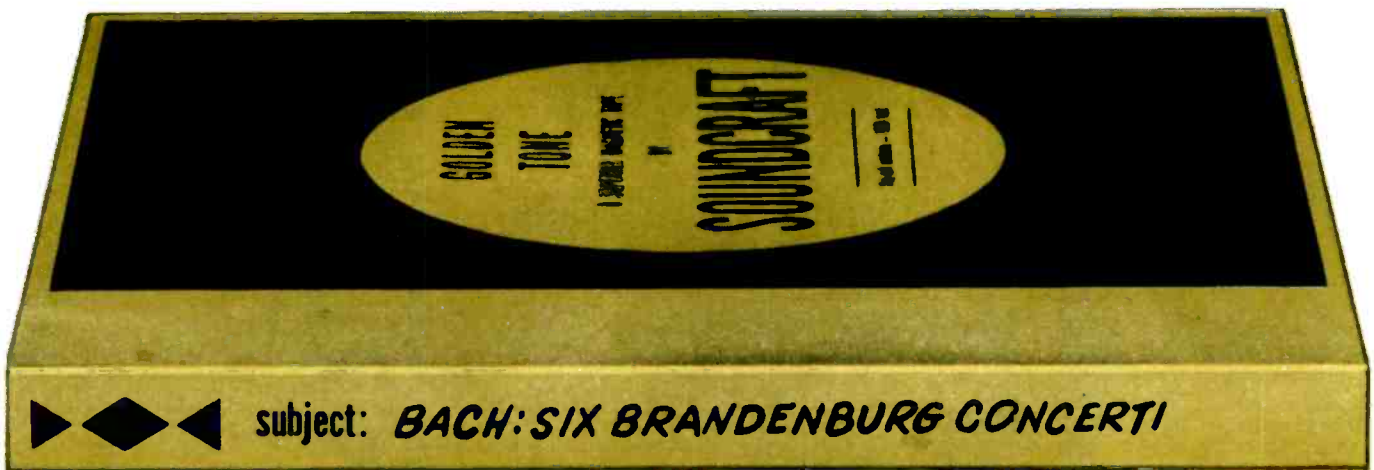

**It's Soundcraft Golden Tone
for your serious recordings**

Created for discerning ears and critical equipment, Golden Tone reflects the highest degree of technical perfection in tape manufacture today. It has exceptionally low modulation noise—a superior signal-to-noise ratio of 77 db—at least 7 db better than other tapes. Its high frequency output is 25% greater than its nearest competitor. And, its dynamic range is the widest found in any tape for home recording. Astonishing specifications indeed... possible because Golden



Tone is also a physically perfect tape. There are no edge burrs. No skew, cupping or curling. Always perfect tape-to-head contact. No drop-outs either, and no low speed or editing squeal. The cost? Only slightly more than ordinary tapes, but worth it if you take your recording seriously. Available on 1½ mil Acetate, 1200 ft.—1 mil Tensilized DuPont Mylar, 1800 ft.—½ mil Tensilized DuPont Mylar, 2400 ft. Write for Golden Tone brochure; ask for Golden Tone at your dealer.

REEVES SOUND CRAFT
DIVISION OF REEVES INDUSTRIES INC

New...and on Mercury

LISZT Piano Concertos 1 & 2. Janis. Moscow Philharmonic, Kondrashin; Moscow Radio Symphony, Rozhdestvensky. SR90329/MG50329

SCHUMANN-LALO Cello Concertos. Starker. London Symphony, Skrowaczewski. SR90347/MG50347

GINA BACHAUER, Queen of the Keyboard. Stravinsky, Chopin, Liszt, Brahms. SR90349/MG50349

MUSIC FOR TWO HARPSICHORDS BY THE BACH FAMILY. Rafael Puyana, Genoveva Galvez. Clarion Concerts Orchestra, Jenkins. SR90322/MG50322

Current best sellers:

THE CIVIL WAR: Vol. II. Eastman Wind Ensemble, Fennell; Martin Gabel, narrator. LPS 2-902/LPS 2-502

GUITAR MUSIC FROM THE COURTS OF SPAIN. Celedonio Romero. SR90296/MG50296

RESPIGHI Pines of Rome; Fountains of Rome. Minneapolis Symphony, Dorati. SR90298/MG50298



For complete catalog, write Dept. "B"
Mercury Records, 745 Fifth Avenue, New York 22, N.Y.

Mercury's GREAT MUSIC Series.
A unique "basic library" series—each disc containing an hour-plus of music—distinguished performances—exciting Living Presence Recording.

RIMSKY-KORSAKOV Scheherazade; Russian Easter Overture. Minneapolis, London Symphonies, Dorati. SR90332/MG50332

MOUSSORGSKY Pictures at an Exhibition; Night on Bald Mountain; PROKOFIEV Love for Three Oranges Suite. Minneapolis, London Symphonies, Dorati. SR90342/MG50342

SELECTIONS by Arensky, Liadov, Khachaturian, Borodin, Glière, Shostakovich. Conducted by Dorati, Hanson, Fennell. SR90346/MG50346

TCHAIKOVSKY Serenade for String Orchestra; RIMSKY-KORSAKOV Coq d'Or Suite. Philharmonia Hungarica, London Symphony, Dorati. SR90344/MG50344

RACHMANINOFF Symphony No. 2; TCHAIKOVSKY Francesca da Rimini. Detroit Symphony, Paray; Minneapolis Symphony, Dorati. SR90345/MG50345

PROKOFIEV Symphony No. 5; Scythian Suite. Minneapolis, London Symphonies, Dorati. SR90343/MG50343

CIRCLE NO. 56 ON READER SERVICE CARD

Newest from Telex

INTEGRAL CHANNEL CONTROL with HEADPHONE STEREO



The famous Stereo-Twin® performance is now linked with the most advanced engineering development in the headset field—INTEGRAL CHANNEL CONTROL.

This newest wonder of miniaturization from Telex Stereo Laboratories has moved the stereo controls into the headset itself. No longer is a separate control center required.

With Telex INTEGRAL CHANNEL CONTROL, each channel is controlled individually by convenient, smoothly styled volume control knobs on each earpiece. Nothing to build, solder or hook up. Just plug into your stereo set and adjust each channel separately to the ideal listening

level. It's better, more convenient and costs less because no separate stereo control center is required.

Audiophiles look to Telex for the best in high fidelity performance. Now Stereo-Twin with INTEGRAL CHANNEL CONTROL adds to the list of Telex "firsts" in listening pleasure. \$29.15

A Product of Sound Research

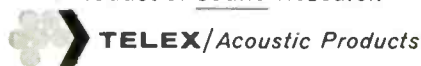

COMMUNICATIONS ACCESSORIES

3054 Excelsior Blvd. • Minneapolis 16, Minn.

CIRCLE NO. 74 ON READER SERVICE CARD

RECORDING OF SPECIAL MERIT

⑤ ⑥ PALESTRINA: *The Song of Songs (Twenty-one Motets for Five Voices)*. Prague Madrigal Choir, Miroslav Venhoda director. VANGUARD BACH GUILD BGS 5059 \$5.95, BG 647 \$1.98.

Interest: Rare Renaissance motets
Performance: Polished
Recording: Good
Stereo Quality: Well spread

This noteworthy addition to the recorded Palestrina literature consists of twenty-one of the twenty-nine motets that comprise the Renaissance master's Book Four, a setting of texts from the *Song of Songs*. The book was published in 1585, at the peak of Palestrina's creative maturity and fame.

Tonal richness and expressive polyphony are the salient features of these settings. Palestrina, the master church musician, treated the poetry of his text in a rather austere fashion. The Prague Madrigal Choir makes an auspicious disc debut here. It is obviously a group of vast experience and keen sympathy with Renaissance music. Rich tone, polished ensemble work, and good intonation distinguish the performance, and the sound of both the mono and stereo versions is excellent. G. J.

PROKOFIEV: *Sonata for Two Violins* (see SPOHR).

RECORDING OF SPECIAL MERIT

⑤ ⑥ RAMEAU: *Pigmalion (Acte de Ballet); Troisième concert from Les Indes Galantes*. Eric Marion (tenor); Andrée Esposito (soprano); Claudine Collart and Edith Selig (sopranos); Choeur Raymond Saint-Paul; Janine Reiss (harpsichord); Orchestre de Chambre des Concerts Lamoureux, Marcel Couraud cond. DEUTSCHE GRAMMOPHON ARCHIVE 73202 \$6.98, 3202* \$5.98.

Interest: First recordings
Performance: Extraordinary
Recording: Excellent
Stereo Quality: Very good

Composed in 1748, the one-act *Pigmalion* is one of that strange breed of ballet-operas that were the rage of the French stage from the time of Lully to the end of the eighteenth century. The familiar plot is outlined in recitatives and arias by the sculptor, the statue-come-to-life, Love, and other personages, including a chorus. Yet more than half the work is given over to the favorite dances of the day. The entire work, lasting forty minutes, is charming, in the typical French Rococo manner. It is ideally supplemented here by a short group of pieces (Continued on page 88)

Here's how a really advanced stereo control amplifier...



becomes this simple to use!



The new Fisher X-101-C: sophisticated stereo design with the new 'basic' look. Even without the dramatically new arrangement of controls, this would still be by far the most advanced single-chassis integrated stereo control-amplifier in its power class. That much is assured by its performance. Its Hinged Control Desk, however, makes it the first genuine all-family amplifier in high fidelity history.

For the audiophiles in the family, the X-101-C incorporates comprehensive controls of the utmost versatility. But for immediate enjoyment of stereo by even the least technically-inclined members of the family, only the 'basic' controls (Program Selector, Stereo/Mono Switch and Volume Control) are in view. The other controls — those that are not absolutely essential for instant use of the amplifier — are concealed behind an attractive, hinged cover. The result is the most uncluttered appearance and the most functional operation ever achieved in a stereo component — as well

as the end of all uncertainty on the part of the non-technical music lover.

The X-101-C is rated at 60 watts IHFM Music Power (30 watts per channel) and features several important innovations in addition to its Hinged Control Desk. The exclusive Fisher Tape-Play System, for example, permits full use of all controls during tape playback and yet retains the convenience of monitoring while recording. A front-panel jack is available for the connection of headphones, and a special switch can silence the main speakers while the headphones are in use. A revolutionary new circuit development permits direct connection of a center-channel speaker without using an additional amplifier!

See and hear the new Fisher X-101-C at your nearest dealer. Even the briefest demonstration will convince you of its superb engineering logic and brilliant performance. Price: \$199.50*. The new X-100-B stereo control-amplifier, an improved 50-watt version of the famous X-100, \$169.50*.

The X-202-B, a highly advanced 80-watt stereo control-amplifier, \$249.50*.

The X-1000, world's most powerful single-chassis stereo control-amplifier (110 watts), \$339.50*.

\$1.00 VALUE ONLY 25¢!

Please send me the new 1963 edition of The Fisher Handbook, a 44-page reference guide, component catalogue, and idea book for custom stereo. I enclose 25¢ double-wrapped, to cover cost of handling and mailing.



FISHER RADIO CORPORATION
21-37 44th Drive, Long Island City 1, N. Y.

Name _____
Address _____
City _____ Zone _____ State _____

021105

THE FISHER

* WALNUT OR MAHOGANY CABINET, \$24.95; METAL CABINET, \$18.95. PRICES SLIGHTLY HIGHER IN THE FAR WEST. EXPORT: FISHER RADIO INTERNATIONAL, INC., LONG ISLAND CITY 3, N. Y.; CANADA: TRI-TEL ASSOCIATES, LTD., WILLOWDALE, ONT.

CRI COMES OF AGE

Four of five new releases find the company providing a platform for new composers, contributing to the American repertoire, and rediscovering some neglected talents

By William Flanagan

WITH five records from Composers Recordings, Inc. crossing my desk in a single month, trends may be discerned and profitable conclusions may be drawn about the over-all accomplishments, limitations, and prospects of this remarkable and indeed unique record company. For within this clutch of releases I observe anew the startling diversity of contemporary musical practice among our American composers. And I also observe again, and admiringly, the remarkable catholicity of taste demonstrated by CRI in its choice of repertoire. But I am also drawn up short with astonishment when I am brought into contact with this organization in malfunction.

Take, for example, CRI 169. With this recording of Ray Green's *Sunday Sing Symphony* and David Van Vactor's *Symphony No. 2* (both works performed by the Hessian Radio Symphony Orchestra, conducted by Van Vactor) we encounter a release that does CRI's reputation as a professional record-maker serious disservice. Both of these works are, to put it mildly, conservative. But this in itself is no limitation, no criticism: so is Theodore Chanler's chamber opera, *The Pot of Fat* (CRI 162). But the last is also the product of a gifted, dedicated composer—a man who is perhaps the finest vocal composer that America has produced—and the very fact of its existence in the CRI catalog is an enormous credit to the organization.

But Van Vactor's conservatism is of quite another color, for this music represents the reactionary posturing of a man with nothing whatever to say. His symphony is stillborn and its mechanics are crude, although Van Vactor has at least taken care to see that his work gets a passable performance. Meanwhile, his conducting of a fellow composer's effort—Ray Green's rather obsessive foray into the territory of American folklore à la Roy Harris, *Sunday Sing Symphony*—results in a performance as catastrophically inept as any I have ever heard on a commercial recording. The disc, from any point of view, is a disaster, and it should never have been released.

Turning immediately (and, by comparison, rather dramatically) to two other CRI releases—164 and 171—an uninitiated observer might wonder that the same label could be involved. On

164, Salvatore Martirano, an impressively gifted young American of moderately avant-garde, twelve-tone orientation, has been introduced to the long-playing catalog with a reverberating bang. The piece is called *O, O, O, O, That Shakesperian Rag*—title: T. S. Eliot; texts: W. Shakespeare—and it created a small sensation at its premiere in New York not too long ago. It is an

© **GREEN:** *Sunday Sing Symphony*. **VAN VACTOR:** *Symphony No. 2*. Hessian Radio Orchestra, David Van Vactor cond. COMPOSERS RECORDINGS, INC. CRI 169 \$5.95.

© **CHANLER:** *The Pot of Fat*. Dixie Stewart (soprano), Arthur Burrows (baritone), Bruce Abel (baritone). CRI Chamber Orchestra, Jorge Mester cond. COMPOSERS RECORDINGS, INC. CRI 162 \$5.95.

© **MARTIRANO:** *O, O, O, O, That Shakesperian Rag*. Princeton Chamber Singers, Thomas Hilbish cond. **ROCHBERG:** *String Quartet No. 2 with Soprano*. Philadelphia String Quartet; Janice Harsanyi (soprano). COMPOSERS RECORDINGS, INC. CRI 164 \$5.95.

© **COPLAND:** *Piano Sonata (1941)*. *Violin Sonata (1943)*. *Trio ("Vitebsk")*. Hilde Somer (piano), Carroll Glenn (violin), Charles McCracken (cello). COMPOSERS RECORDINGS, INC. CRI 171 \$5.95.

© **GIDEON:** *Lyric Piece for Strings*. Tokyo Imperial Philharmonic, William Strickland cond. **NEWLIN:** *Piano Trio, Op. 2*. London Czech Trio. **BRUNSWICK:** *Septet in Seven Movements*. CRI Chamber Ensemble, Fritz Jahoda cond. COMPOSERS RECORDINGS, INC. CRI 170 \$5.95.

elaborately complicated choral-instrumental work simply bursting its asymmetrical seams with raw talent, and its technical and aesthetic complexities, along with the relative obscurity of its composer's reputation, would have pre-

cluded its being recorded on a major label. Along with the distinguished, deeply serious, and finally very moving Second String Quartet by another American composer, George Rochberg, the release does credit to all concerned. It represents CRI's function at its idealized best.

Still another direction of the CRI project can be observed admiringly in CRI 171. This is a highly professional and meaningfully selected program of chamber works by the American master Aaron Copland. It could be argued, of course, that Copland's generous column of recorded works in the Schwann catalog makes him a curious choice, that the disc space CRI has given him would be better devoted to a lesser-known composer. But this is exactly the sort of stability that CRI's catalog so urgently requires—stability in the form of high-class performances representing what must one day emerge as a standard American repertoire. Violinist Carroll Glenn and pianist Hilda Somer thus join forces not only to bring Copland's violin sonata, his piano sonata, and his "Vitebsk" Trio to a record-buying public in meaningful juxtaposition; they contribute as well to the performance tradition (Copland supervised and passed on these readings) of a triad of works that one day must inevitably form a part of the chamber-music repertoire.

With CRI 170, we discover another of the company's functions in the presentation of creditable performances of creditable works by composers who, in spite of their years on the musical scene, remain comparatively little known. A string work by Miriam Gideon, called *Lyric Piece* (1942), is straightforward, serious in intent, and honorable. Dika Newlin's Piano Trio, Op. 2, is a little academic in its vaguely Schönbergian Central European way, but it, too, is a respectable, honorable piece of craft, as is the rather more imaginative Septet in Seven Movements by Mark Brunswick.

Thus we observe CRI in three typical and worthwhile stances, as well as in one that should, at all cost, be avoided in the future. Since its inception in the middle Fifties, CRI has grown with strides both impressive and gawky. It is not unfounded optimism to suggest that its coming-of-age is imminent.

FREE

MAIL
CARD
TODAY

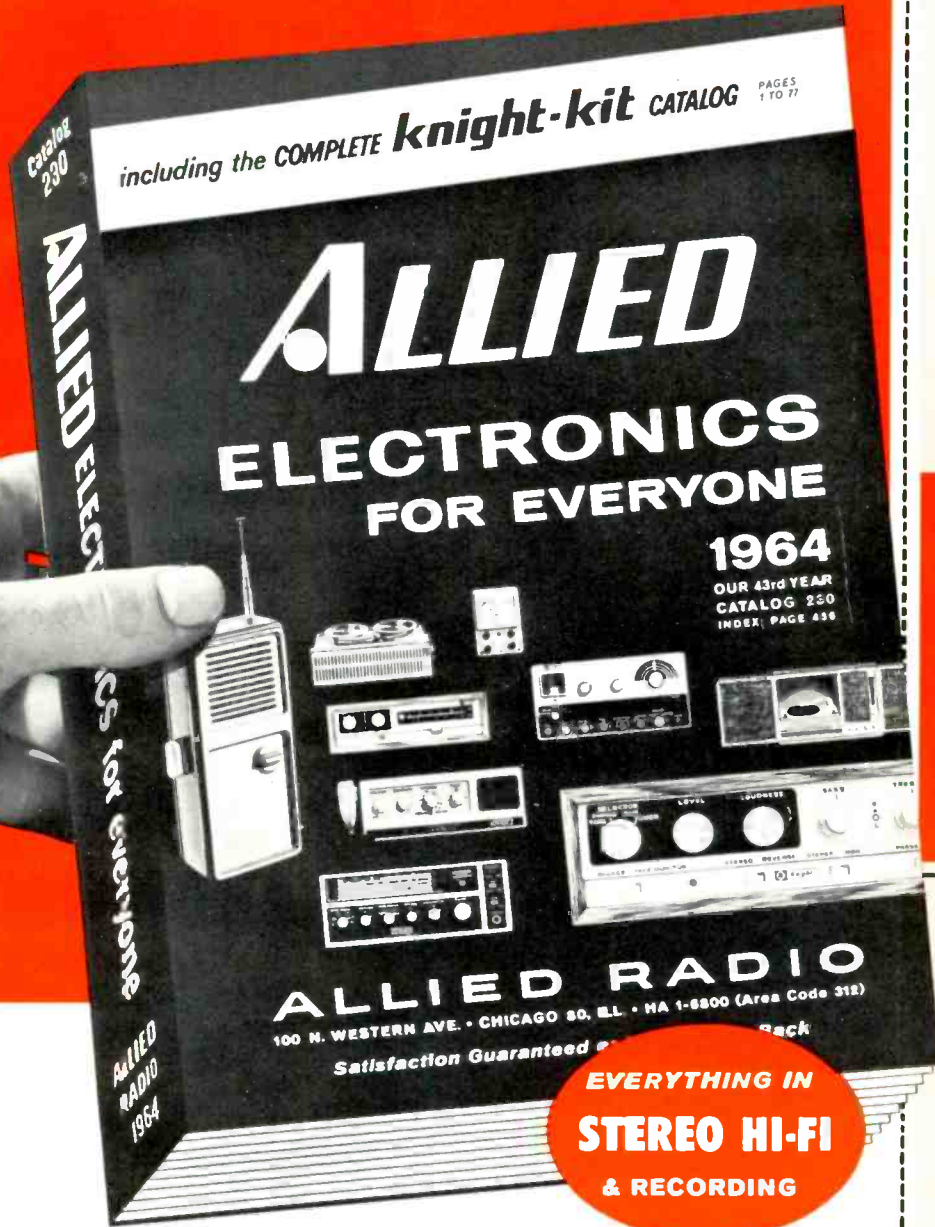

Name
PLEASE PRINT

Address

City _____ Zone _____

State _____

10-L

YOUR **FREE**
ALLIED
1964 CATALOG



EVERYTHING IN STEREO HI-FI

Name
PLEASE PRINT

Address

City _____ Zone _____

State _____

10-L

YOUR **FREE**
ALLIED
1964 CATALOG



EVERYTHING IN STEREO HI-FI

send card today for your money-saving

ALLIED 444-PAGE 1964
CATALOG

WORLD'S LARGEST HI-FI—ELECTRONICS CATALOG
BIGGEST SELECTION • BIGGEST SAVINGS!

satisfaction guaranteed or your money back

NO MONEY DOWN: NOW! MORE BUYING POWER WITH YOUR ALLIED CREDIT FUND PLAN!

SEE
OTHER
SIDE

For your FREE 1964 ALLIED Catalog, fill in card, detach and mail now. (Please give other card to an interested friend.)

SEND
CARD
TODAY

MAIL
NOW

P. O. Box 4398

TO:
ALLIED RADIO
CHICAGO 80, ILLINOIS

TO:

PLACE
STAMP
HERE

P. O. Box 4398

TO:
ALLIED RADIO
CHICAGO 80, ILLINOIS

TO:

PLACE
STAMP
HERE

MAIL
NOW

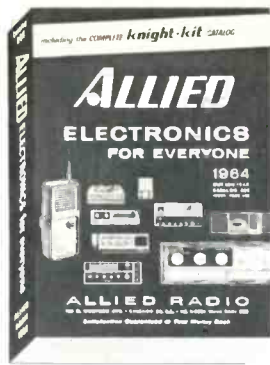

FREE send card today
for your 444-page
money-saving

ALLIED

HI-FI—ELECTRONICS
1964 CATALOG

WORLD'S LARGEST • BIGGEST SELECTION • BIGGEST SAVINGS!

Best Buys in Stereo Systems and Components

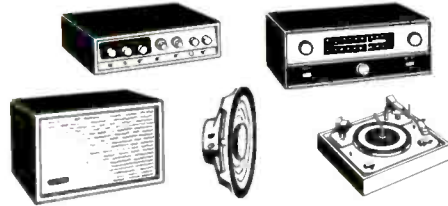

Choose from the world's largest selection of famous-make components and complete systems. See the latest all-transistor Stereo Hi-Fi. Save most on amplifiers, tuners, speakers and enclosures, record changers and players. Get our unbeatable price on a hi-fi system of your own choice.

Newest *knight-kit*® Build-Your-Own Hi-Fi



Build your own—build the best at big savings. It's easy, it's enjoyable to assemble your own KNIGHT-KIT Stereo hi-fi—and you get absolutely professional performance and appearance. Over 100 great hi-fi, hobby, CB radio, ham and instrument kits available.

Money-saving *knight*® Stereo High-Fidelity

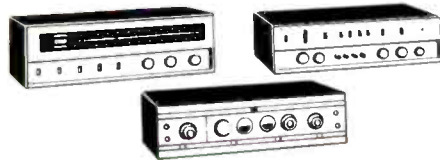

Allied's own top-value hi-fi line. Famous KNIGHT components and systems are equal in quality and performance to the very best, yet they're far lower in cost, give you most for your money. Full selection for every hi-fi need.

Everything in Tape Recorders, Tape and Recording Accessories



Enjoy the largest selection of complete recorders, including latest Stereo and professional types; tape decks, tape record/play preamplifiers, and recording accessories. Top values in quality recording tapes in all leading makes.

More for Your Money in Beautiful Hi-Fi Cabinetry

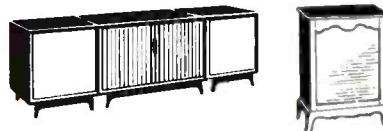

Wide selection of contemporary and authentic period styles—finest woods, construction and finish—at incomparable low cost. Includes complete equipment cabinetry and speaker enclosures.

Everything in Electronics for Everyone

- FM-AM & AM Radios • Phonographs & Accessories
- Citizens Band 2-Way Radios • Amateur Equipment
- TV Tubes & Antennas • Tools & Hardware
- Test & Lab Instruments • PA Systems & Intercoms
- Electronic Parts, Tubes, Transistors • Books

NO MONEY DOWN
Now! More Buying Power
with Your Allied
Credit Fund Plan!

satisfaction guaranteed or your money back

MAIL
NOW

FREE SEND CARD TODAY FOR YOUR
1964 ALLIED CATALOG

and give one card to an interested friend

for magnificent sound

TARZIAN TAPE

engineered for highest fidelity

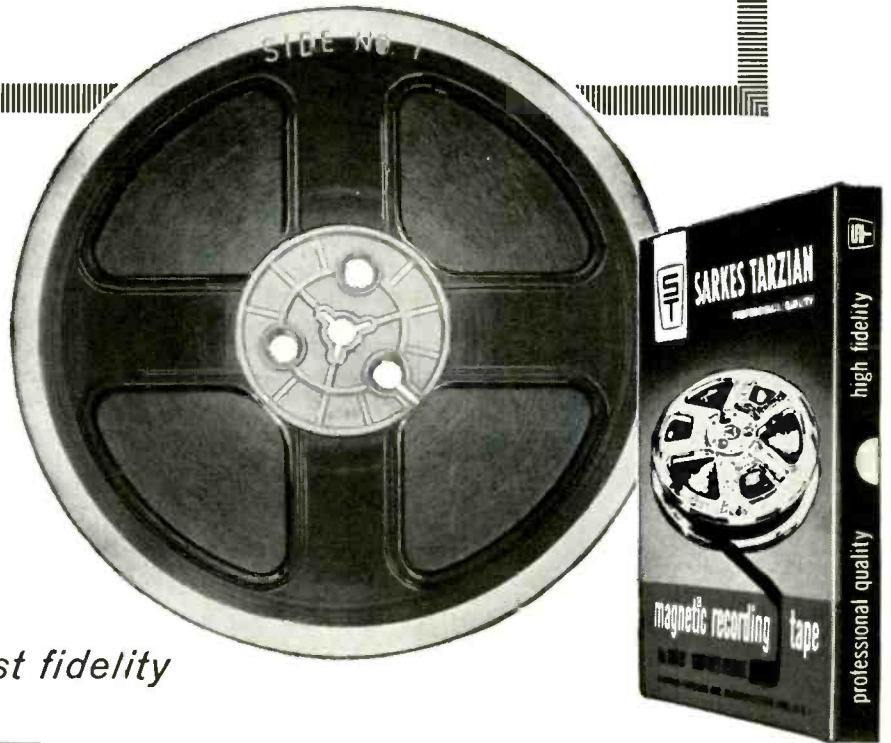

Check these outstanding characteristics

- **High Output**—can accept signals with dynamic range to realize the full potential of even the finest professional equipment.
- **Wide-Range Response**—virtually flat response for all recording frequencies.
- **Low Distortion**—distortion is less than 2½% at maximum record level as measured by Navy Specification W-T-0061.
- **High Uniformity**—uniformity within a 1200-foot reel is within plus or minus ¼ db. A new oxide formula and special selectivity of oxides protect recording heads from wear and prevent abrasion.
- **Humidity and Temperature Protection**—special coating, priming, and binding techniques help keep Tarzian tape in new condition longer in ordinary good tape storage conditions.

■ Given great sound in the first place, Tarzian Tape will keep it for you, and give it back undiminished and undistorted. It is a tape of truly professional fidelity, worthy of your most valued recordings, at a price that lets you use it for all your work (or play).

The proof is in the listening...of course. But you can see the smooth, tightly bonded oxide surface that doesn't flake, that does run smoothly without abrasion and without contributing to wow or flutter. Hold a reel to the light. You can see that Tarzian Tape is wound on the reel at perfect tension. You'll find a written replacement guarantee in every box. The box is well made, with ample identification space. You'll see that the tape is factory sealed in a plastic bag, with labels and a tape-end clip included.

Try Tarzian Tape...let it speak for itself. Choose from 1½ and 1 mil acetate, and 1 and ½-mil Mylar*. Available on 3-, 3¼-, 5-, and 7-inch reels plus professional lengths on reels or hubs. If your dealer cannot supply you from stock, send us his name and we will promptly satisfy your requirements.

Write today for Tarzian's free 32-page illustrated booklet, "Lower the Cost of Fun With Tape Recording."

*DuPont trademark



SARKES TARZIAN Inc.

World's Leading Manufacturers of TV and FM Tuners • Closed Circuit TV Systems • Broadcast Equipment • Air Trimmers • FM Radios • Magnetic Recording Tape • Semiconductor Devices
MAGNETIC TAPE DIVISION • BLOOMINGTON, INDIANA
Export: Ad Auriema, Inc., N.Y. • Canada: E. J. Piggott Enterprises Ltd., Toronto, Ont.

THIS COMPLETE INDOOR ELECTRONIC ANTENNA SYSTEM IS ALL THE RECEPTOR YOU NEED FOR FM STEREO

- no outside wires
- no masts • no rotors
- no installation costs
- no repairs



The MULTITRON by ANTRONICS

Specifically engineered to solve the problems of FM/FM Stereo reception, the Antronics Antenna can be unconditionally guaranteed to do the job — with you as the sole judge — or your money will be refunded. Here are some of the reasons for this unusual offer:

CONVENIENCE: Compact, low-silhouette design fits anywhere, works anywhere, in view or out of sight. Combat reception problems without a rotator or other accessories. No retuning or readjustment. Measures only 9" x 5" x 1½".

SENSITIVITY: Unique, multi-coupled antenna (Pat. Pend.) integrated with multi-stage, stabilized, transistorized amplifier provides full FM bandwidth with high gain. Response from 88 to 108 mc ± 1½ db; gain at least 20 db (100x signal power) over reference dipole at any FM frequency.

RELIABILITY: Glass-epoxy circuit board has special physical & high-frequency electrical properties. Printed, distributed constants, including coupling transformers, replace conventional components for greater precision. Nothing to wear out. No effects from wind, rain or snow.

VERSATILITY: Can be positioned for multi-directional reception or rejection of unwanted signals. Accommodates all tuner antenna inputs. Install it in two minutes.

ECONOMY: No installation labor, no costly repairs, no rotators, etc. Your first investment is your last.

10-DAY MONEY-BACK GUARANTEE

In white or black @ \$29.95

See your Hi-Fi dealer or write for details

ANTRONICS

309 Queen Anne Road, Teaneck, New Jersey

CIRCLE NO. 89 ON READER SERVICE CARD

88

Rameau put together as part of four concerts from his large-scale ballet *Les Indes Galantes* of 1735. In the past, almost all examples of Rameau's operatic writing have been performed and recorded in a slipshod fashion with little awareness of the performing conventions, especially the intricate ornaments, of the time. The present production is notable for singing and conducting as stylish as one might hope for. All the vocalists are excellent, particularly Eric Marion (as Pignation), whose sexless, white tenor voice has just the required agility. The principal congratulations, however, go to Marcel Couraud, who leads his fine chamber orchestra with sophisticated spirit and vigor. The recorded sound is splendid, and complete texts and translations for *Pignation* are included. Not everyone will find this stylized writing to his taste, but as an illustration of mid-eighteenth-century French vocal composition it cannot be bettered. *I. K.*

© RAVEL: *Boléro*; *Pavane for a Dead Princess*. BORODIN: *Polovtsian Dances*. TCHAIKOVSKY: *Marche Slave*. Pittsburgh Symphony Orchestra, William Steinberg cond. CAPITOL SP 8590 \$5.98, P 8590* \$4.98.

Interest: Classical pops
Performance: So-so
Recording: Occasionally brash
Stereo Quality: Okay

Even recognizing the plainly commercial intent that lies behind a release of this sort, when a major conductor is put in



ANNETTE DENHOF

MAURICE RAVEL

(Sculpted from life by Annette Denhof)

charge of the proceedings one has a right to hope that even the most battered war-horses will be revealed in new, fresh perspective. But in this case, no soap. Stein-

berg hustles through the *Polovtsian Dances* as if he were embarrassed by the score, *Marche Slave* is given a high-school band-concert performance, and Ravel's *Boléro* is coarse.

Capitol hasn't helped matters much. The recorded sound is, at best, no great shakes in refinement; at its worst (in the Borodin) it is harsh, monochromatic, and unyieldingly metallic. *W. F.*

© RAVEL: *L'Heure Espagnole*. Janine Linda (soprano), André Dran (tenor), Jean Mollien (tenor), Jean Hoffman (baritone), Lucien Mas (bass). Orchestre Radio-Symphonique de Paris de la Radiodiffusion Française, Rene Leibowitz cond. Vox OPX 150 \$4.98.

Interest: Neglected Ravel
Performance: Only fair
Recording: Average

The availability of this recorded performance serves mostly to remind us that a first-class stereo recording of Ravel's unhappily neglected little masterpiece *L'Heure Espagnole* is not yet in the catalog. This performance is by no means a distortion of the opera, but it abounds in the vaguely sloppy singing that characterizes vocal activity in so many French opera houses, and Leibowitz's reading of the score is ponderous and literal. Still, the disc isn't a bad buy, all things considered, and the recording quite suffices. *W. F.*

RECORDING OF SPECIAL MERIT

© ROSSINI: *The Barber of Seville*. Victoria de los Angeles (soprano), Rosina; Luigi Alva (tenor), Almaviva; Sesto Bruscantini (baritone), Figaro; Carlo Cava (bass), Basilio; Ian Wallace (baritone), Bartolo; Laura Sarti (mezzo-soprano), Berta; Duncan Robertson (tenor), Fiorello. Glyndebourne Festival Chorus; Royal Philharmonic Orchestra, Vittorio Gui cond. ANGEL S 3638 three 12-inch discs \$17.94, 3638 \$14.94.

Interest: Comic masterpiece
Performance: Outstanding Rosina and Figaro
Recording: Not Angel's best
Stereo Quality: Imaginative

In a short accompanying essay entitled "Tradition and Rossini's *Barber*," Vittorio Gui, the highly respected conductor of Angel's new *Barber of Seville*, properly castigates producers who honor decades of interpretive incrustations but pay little heed to the composer's original conception. Though this has been a much-discussed topic, the point is well taken here, since *The Barber* particularly has suffered in this regard. But the tide has turned in recent years. Today no respect-

(Continued on page 90)

MORE

CLEAN,
UNDISTORTED POWER, BANDWIDTH AND FEATURES THAN
FAR COSTLIER INTEGRATED VACUUM TUBE STEREO
AMPLIFIERS **THE NEW AWARD A700**



Let's consider the qualities that really make the difference in performance. Not "gingerbread."

The new Award A700 puts out a big, clean 70 watts of audio power. That's more than enough to drive any speaker—regardless of efficiency. No matter what speaker you use, chances are the A700 will be coasting most of the time.

Now consider the frequency response of the A700—12 – 70,000 cps \pm 1 db! No other integrated vacuum tube amplifier—regardless of price—can approach it! What makes the difference? The A700's solid state power supply, plus its specially designed grain-oriented steel output transformers!

The A700's bandwidth superiority can be demonstrated visually with test instruments. More important, it can be heard in your living room! It is this extended bandwidth—octaves above and below the normal range of hearing—that assures flawless reproduction within the audible range...

and at all power levels!

Run through the gamut of conventional controls on any fine integrated stereo amplifier—individual bass and treble tone controls, tape monitor switch, separate high and low cut filters, balance control, contour control, blend control—you name it, the A700 has them all and more!

But where the A700 really moves "out front" is where it counts—performance! For final proof, ask your dealer to demonstrate the A700 against other costlier amplifiers. Even against some of the so-called "world's-best." For anyone with highly critical standards—and a modest budget—the A700 is the only logical choice. Write Harman-Kardon, Dept. R-11 Plainview, N. Y., for more information on this superb integrated stereo amplifier. The A700—\$199.95. Prices slightly higher in the West.

harman kardon

A subsidiary of THE JERROLO CORPORATION

Ampex introduces a new 4-track stereo recorder for \$299



with an introductory offer of \$50 worth of free stereo tape

Meet the newest stereo tape recorder in town—the UST-4. It's recommended by Ampex engineers as an outstanding value in its price range. And Ampex has this introductory offer: when you buy the UST-4, you get \$50 worth of recorded stereo tapes; choose from hundreds of albums. The total price? Just \$299. Here's what you get: 4-track stereo or 4-track monophonic recording. Two speeds. Sound on sound capability. An excellent self-contained amplifier/speaker system which includes a stereo amplifier and two 5" x 7" speakers. And you get high quality reproduction of your own recordings or recorded tapes. Ask your tape recorder dealer about it today. Or for a brochure and a list of the free recorded albums available, please send in the coupon. Ampex Corporation, Consumer Products Division.

Go stereo tape—start right with Ampex



To: Ampex Corporation, Mail Stop 6-1
Redwood City, California

Please send me the brochure and list of free albums.

name _____
address _____
city _____ zone _____ state _____

Act One, in which Almaviva appears as an *ubriaco*, is perhaps the most notable example. Gui's reading is thoughtful and careful, but it lacks effervescence. And isn't the Maestro guilty of a small interpretive liberty himself when he asks for *détaché* bowing in the orchestral accompaniment to the duet "*A mezzanotte in punto*," where the score calls for, and all other conductors I have heard observe, *legato*?

RCA rates higher in the sonic department also. Angel's sound is acceptable but in no way outstanding. The performance has been thoughtfully produced for stereo, with effective separation—and enough movement and sounds, some of them unintentional, to cause mild distraction at times. Still, it is a fine performance, and the contributions of Victoria de los Angeles and Sesto Bruscantini are exceptional. *G. J.*

⑤ ⑥ **SAINT-SAËNS: *Symphony No. 3, in C Minor, Op. 78*** ("*Organ Symphony*"). Philadelphia Orchestra; E. Power Biggs (organ); Eugene Ormandy cond. COLUMBIA MS 6469 \$5.98, ML 5869* \$4.98.

Interest: Saint-Saëns for hi-fi
Performance: A bit dry
Recording: Likewise
Stereo Quality: Okay

The installation of a new organ in the Philadelphia Academy of Music quite understandably inspired Columbia to try for an Ormandy-Biggs-Philadelphia Orchestra collaboration to compete with RCA Victor's stereo blockbuster by Munch, Zamkochian, and the Boston Symphony (LSC/LM 2341). Unfortunately, the Academy acoustics are a lot drier than those of Boston's Symphony Hall, with the result that the sound is a good deal less imposing than that on the RCA issue, or even on the Columbia mono version done by Ormandy, Biggs, and the Philadelphians in Boston in 1958. Ormandy's reading sounds rather stodgy, lacking even the element of throbbing lyrical sentiment to compensate for less tension of line and rhythm than his competition delivers. All in all, a brave try on Columbia's part, but not an entirely successful one. *D. H.*

⑤ ⑥ **SPOHR: *Duetto II in D Major for Two Violins***. HONEGGER: *Sonatina for Two Violins*. HAYDN: *Duo in B-flat Major for Two Violins*. PROKOFIEV: *Sonata for Two Violins*. David and Igor Oistrakh (violins). MONITOR MCS 2058 \$4.98, MC 2058* \$4.98.

Interest: String curiosities
Performance: Good
Recording: Too bright
Stereo Quality: Suitable

(Continued on page 94)

plays your precious records with a light, gentle touch

Whether you use your Miracord as a manual turntable, an automatic turntable or an automatic changer; whether you play stereo or mono; you enjoy the same gentle quality, the same flawless performance that has made Miracord first choice in the finest consoles and component systems.

It is the only unit of its type obtainable with self-regulated, constant-speed hysteresis motor, the only one with a one-piece, 12-inch turntable and mass-balanced tone arm employing no springs, and the only one with feather-touch pushbutton controls.

Incredibly quiet, smooth and gentle, the Miracord brings out the best in your records with every play, and preserves that quality for long-lasting enjoyment.

Before you choose a record player for your system, be sure to see and hear the Miracord at your high fidelity dealer. Model 10H with hysteresis motor, \$99.50; model 10 with 4-pole induction motor, \$89.50 (less cartridge and base). For complete details, write to:

**BENJAMIN
MIRACORD**



how to be number one in fine cartridges and stay there

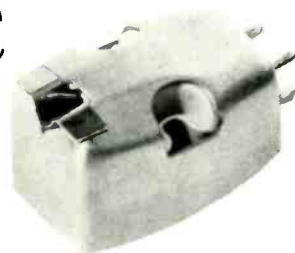

Today's cartridge talk is all about high compliance, low tracking force, low stylus mass and optimum vertical tracking angle.

ADC delivered this in 1960... 3 years ahead of anybody!

ADC cartridge owners recognize the value of these engineering firsts. They know that the popular ADC-1 cartridge performs with brilliance, clarity and presence at a tracking force of less than 1 gram.

They know that ADC's up-to-date knowledge of recording techniques and ability to select the proper materials were behind the startling revolution in quality cartridge design.

They know that high compliance, low tracking force, low stylus mass and optimum vertical tracking angle have advanced the art of cartridge design.

Naturally, ADC continues to refine and improve the products that bear its name. The new R-30 stylus, for example, is recommended for the most modern stereo recordings and has a stylus tip radius of .00035".

ADC owners expect to be years ahead. If you contemplate buying a fine cartridge, you owe it to yourself to investigate how beautifully an ADC cartridge can improve your present high fidelity system. **ADC-1 Mark II \$49.50 (incl. R-10 stylus); ADC-130 \$69.50 (incl. R-10 and new R-30 stylus); R-30 Stylus \$22.50.** Also available, the ADC-2A at \$46.50 and the ADC-3 at \$37.50.

SPECIFICATIONS—ADC-1 with R-10 and R-30 Stylus: Type—Miniature moving magnet. **Sensitivity—**7 millivolts per channel plus or minus 2 db at 1,000 cps. (5.5 cm/sec. recorded velocity). **Frequency Response—**10 to 20,000 cps. ± 3 db. Useful response extends to 30,000 cps. **Channel Separation—**30 db. 50 to 7,000 cycles. **Stylus Tip Radius—**R 30 .00035"; R 10 .0006" (accurately maintained). **Stylus Tip Mass—**.5 milligrams. **Lateral & Vertical compliance—**R 30 40×10^{-6} cms/dyne minimum. R 10 30×10^{-6} cms/dyne minimum. **Vertical Tracking Angle—**14° to 17° (proposed international standard is 15°). **Recommended Load Impedance—**47 - 100K ohms. Note—This value is not critical and may be varied to adjust high frequency response, higher values giving slight treble increase and vice versa. **Inductance—**240 millihenries. **Recommended Tracking Force—**R 30 .4 to 1.5 grams. R 10 .5 to 2 grams. **Mounting Centers—**Standard 1/2" and 3/4" centers. Units adapt to virtually all tone arms. **Connections—**4 pin connector with removable ground strap and spring. For monophonic or stereophonic records. **Actual Weight—**6.8 grams.

ADC **AUDIO DYNAMICS CORPORATION**
Manufacturers of the Famous SERIES 1 ADC Speaker Systems
PICKETT DISTRICT ROAD, NEW MILFORD, CONN.

While this disc is not without its shortcomings, it is a good buy for those who fancy unfamiliar string music. The Spohr is a rather tiresome piece, but the Honegger sonatina has a delicious middle movement, the Haydn duo is a charmer, and the Prokofiev is of some significance.

The performances are not flawless, but they are always alive and interesting. But the recording engineers, in their preoccupation with live string sound, have recorded *forte* playing at a level of ear-splitting shrillness.

But the release deserves investigation by the enterprising collector. *W. F.*

Ⓢ Ⓜ **STAINER: *The Crucifixion.*** Alexander Young (tenor); Donald Bell (bass); Eric Chadwick (organ); Leeds Philharmonic Choir, Herbert Bardgett cond. ANGEL S35984 \$5.98, 35984* \$4.98.

Interest: Popular oratorio

Performance: Reverent

Recording: Good

Stereo Quality: Appropriate

This reverent, exquisitely detailed performance is admirably expressive of *The Crucifixion's* elegiac, reflective tone. Both soloists are excellent: Alexander Young phrases tastefully and sings with consistent purity of tone, and Donald Bell's singing in the soft passages has a particularly ingratiating quality. It is in the quiet moments, incidentally, that the performance rises to its peak, thanks to sensitive over-all direction and flawless engineering. Here the work is given complete except for some of the congregational anthems—a sensible omission that benefits the total effort. For the rest, the choir's contribution is creditable. There are now two first-rate stereo versions of this enduring oratorio. My preference is this Angel disc rather than London OS 25333. *G. J.*

TCHAIKOVSKY: *Marche Slave* (see RAVEL).

RECORDING OF SPECIAL MERIT

Ⓢ Ⓜ **TELEMANN: *Overture, in C Major, for Three Oboes, Strings, and Continuo; Concerto, in B-flat Major, for Three Oboes, Strings, and Continuo.*** Deutsche Bachsolisten, Helmut Winschermann cond. ***Triple Concerto, in E Major, for Flute, Oboe d'amore, Viola d'amore, Strings, and Continuo.*** Hans-Jürgen Möhring (flute); Helmut Winschermann (oboe d'amore); Günther Lemmen (viola d'amore); Deutsche Bachsolisten, Carl Gorvin cond. CAN-TATE 057703 \$6.98, 047703* \$5.98.

Interest: First-class Telemann

Performance: Exceptionally good

(Continued on page 96)

unprecedented

record by Command

Command Records has produced a greater percentage of "Top Chart" albums than any other record company in the world! On the best seller charts for over 3½ years . . . 182 weeks! That's the unprecedented record created by Command. Now these 7 new Command Albums continue Command's spectacular leadership in recorded sound.

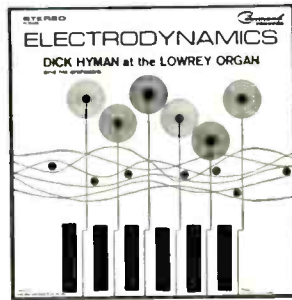

1 ALFRED DRAKE AND ROBERTA PETERS

Sing The Popular Music Of **LEONARD BERNSTEIN** with THE RAY CHARLES SINGERS and **ENOCH LIGHT** and his orchestra. The most exciting album ever made! Here are some of the most compelling songs heard on Broadway in the past 20 years. All composed by the most overwhelming talent in modern American music, Leonard Bernstein. His superb compositions sung by two of the most dynamic vocalists on theatre or opera stages, Alfred Drake and Roberta Peters. Supported by the amazingly versatile Ray Charles Singers. This stunning album conducted and produced in fresh, revealing interpretations by the unrivaled master of modern musical recordings, Enoch Light, with a 50-piece orchestra. Recorded on 35 mm magnetic film. #855

2 1963 THE YEAR'S MOST POPULAR THEMES

ENOCH LIGHT and his orchestra. Until you listen to this fantastic record, you haven't really heard movie music. This album will give you an entirely new conception of motion picture music . . . never displayed more brilliantly or in more powerfully exciting musical terms. Incredibly exciting, with daring emotional power. Recorded on 35 mm magnetic film. #854

3 THE ROBERT DE CORMIER FOLK SINGERS

A significant milestone in folk music history! Here are 25 exciting voices re-

corded by the incomparable Command technique. Full blooded vitality returns to folk singing in these fascinating performances. Every colorful nuance, the finest and most delicate shading as well as the tremendous ensemble power of this 25-voice group is recorded and reproduced by Command with astonishing realism. #853

4 ROMAN ACCORDION CHARLES MAGNANTE and his orchestra

The amazing panoply of sound that Charles Magnante creates on his accordion is one of the wonders of contemporary music. And now, in his first recording for Command Records, the great Magnante has found engineering craftsmanship that can match his own exciting and brilliant musical conceptions. Here is Magnante's miracle of sound recorded with every brilliant nuance and captured so completely by Command, the sheer magnificence dazzles the ear. #852

5 ELECTRODYNAMICS Dick Hyman at the organ and his orchestra

Here is the most exciting NEW MUSICAL SOUND since the invention of stereophonic records. With the brilliant Dick Hyman playing the amazing new Lowrey organ, here is your introduction to an experience in listening you will never forget. Once again Command Records broadens and extends the vast possibilities of musical excitement and beauty by integrating the talents of Dick Hyman, the remarkable new Lowrey Organ and the superb engineering techniques possessed only by Command. #856

6 THE URBIE GREEN 6-TET

America's greatest Trombonist and his sextet

Share in the excitement of on-the-spot creation by one of the great master musicians of our time, Urbie Green, as this superb trombone virtuoso is joined by five other magnificent jazz musicians. Here is one of the most brilliant small jazz groups ever assembled and it produces unique excitement, amazing finesse, dynamic solos, breathtaking ensembles in a jazz sound totally different from anything you have ever heard before. #857

7 BEETHOVEN, SYMPHONY No. 3 in E FLAT

WILLIAM STEINBERG AND THE PITTSBURGH SYMPHONY ORCHESTRA

This is one of the world's most magnificent masterpieces conducted by the maestro who is acknowledged by all critics as one of the greatest conductors of all times. A most exciting addition to the world of recorded masterpieces. Under Steinberg's hand, the noble Eroica rises to new heights . . . brilliantly captured by Command's glorious 35 mm magnetic film recording technique. #11019

All Command Recordings Are Available In Stereo, Monaural, And 4-Track Tape Wherever Records Are Sold

Write for FREE full color brochure of all Command releases

World leader in recorded sound
Command RECORDS

1501 Broadway, New York 36, N. Y.

Announcing the new line of world-famous Schober Organ Kits...

ASSEMBLE YOUR OWN ALL-TRANSISTOR SCHOBER ELECTRONIC ORGAN



Designed by organists for organists, the new Schober Recital Organ actually sounds like a fine pipe organ. The newly-invented Schober Library of Stops provides you with an infinite number of extra voices so that you can instantly plug in the exact voices you prefer for a particular kind of music. Thirteen-piston, instantly resettable Combination Action makes the

All-New, All-Transistor Schober Recital Organ

- 32 voices, 6 couplers delight professional musicians...make learning easy for beginners.
- Standard console, pedals, keyboard correspond exactly to pipe-organ specifications.
- Printed circuit construction and detailed, illustrated instructions make for easy assembly...no previous experience necessary.
- Highly accurate church and theatre pipe tone in 5 pitch registers make every kind of organ music sound "right".
- Optional: Combination Action, Schober Reverbatape Unit, Repetitive Theatre Percussions.
- All-transistor circuitry makes possible full 5-year guarantee.

Recital Organ suitable for the most rigorous church and recital work. The Schober Reverbatape Unit gives you big-auditorium sound even in the smallest living room. An instrument of this caliber would cost you \$5000 to \$6000 in a store. Direct from Schober, in kit form (without optional percussions, pistons, Reverbatape Unit) costs you only \$1500.



New, All-Transistor Schober Console II

Here's the most luxurious "home-size" organ available today...with the same circuitry and musical design as the impressive Recital Organ. Full 61-note manuals, 17 pedals, 22 stops and coupler, 3 pitch registers, and authentic theatre voicing leave little to be desired. Musically much larger than ready-made organs selling for \$1800 and more...the Console II, in kit form, costs only \$850.



New Schober Spinet

The Schober Spinet is among the very smallest genuine electronic organs; only 39 1/4 inches wide, it will fit into the smallest living room or playroom—even in a mobile home. Yet it has the same big-organ tone and almost the same variety of voices as the larger Console II. The Schober Spinet far exceeds the musical specifications of ready-made organs selling for \$1100 and more. In easy-to-assemble kits...only \$550.

HERE'S WHY YOU SHOULD BUILD A SCHOBER ORGAN!

You cannot buy a finer musical instrument for over twice the price. You get the finest in musical and mechanical quality.

It's easy to assemble a Schober Organ. If you can read and use your hands, you can easily make your own superb organ. Everything you need is furnished...including the know-how; you supply only simple tools and time—no knowledge or experience is required.

You can buy the organ section by section...so you needn't spend the whole amount at once.

You can begin playing in an hour, even if you've never played before—with the ingenious Pointer System available from Schober.

Thousands of men and women—teenagers, too—have already assembled Schober Organs. We are proud to say that many who could afford to buy any organ have chosen Schober because they preferred it musically.

Schober Organ Kits are sold in the U.S. only by...

THE Schober Organ CORPORATION

43 West 61st Street, New York, N.Y., 10023

Dealers in Canada, Australia, Hong Kong, Mexico, Puerto Rico and the United Kingdom.

SEND FOR FREE SCHOBER BOOKLET

...Describes the exciting Schober Organ and optional accessories in detail; it includes a FREE 7-inch "sampler" record so you can hear before you buy.

Also available:

10-inch high-quality, long playing record...fully illustrates all three models with different kinds of music. Price is refunded with first kit purchase...\$2.00



The Schober Organ Corp., Dept. HR-14
43 West 61st St., New York, N.Y., 10023

- Please send me, without cost or obligation, the Schober Organ Booklet and free 7-inch "sampler" record.
- Enclosed find \$2.00 for 10-inch quality, LP record of Schober Organ music. (\$2.00 refunded with purchase of first kit.)

Name _____
Address _____
City _____ State _____ Zip No. _____

Recording: Superior
Stereo Quality: Excellent

The members of the German Bach Soloists perform these three Telemann works with great stylishness, enthusiasm, and superb instrumental discipline. There is nothing particularly profound about this music. The French-style suite or overture is very charming and entertaining; the Italianate Concerto in B-flat is relatively brief, with two lively movements surrounding a more thoughtful slow one. The triple concerto is unusual in the choice of instruments, and is a first-class work that makes one wonder why Telemann is still looked on by so many as a minor composer. Both concertos have also been recorded by a slightly smaller ensemble on Deutsche Grammophon Archive 3109 in performances that are equally stylish—with more embellishment of the solos—but that superb disc was made in 1952, and the mono recording is not nearly as rich and full as this stereo pressing. I recommend the Cantate performances very highly, but the English translation of the program notes—which, incidentally, fails to give the movement markings—leaves much to be desired in both accuracy and in idiomatic rendering.

I. K.

WEBER: *Oberon: Overture* (see MENDELSSOHN).

COLLECTIONS

© VIRGIL FOX: *Plays the Philharmonic Hall Organ at Lincoln Center.*
Bach: *Passacaglia and Fugue, in C Minor.* Messiaen: *La Nativité du Seigneur; Dieu parmi nous.* Franck: *Grande Piece Symphonique.* Virgil Fox (organ).
COMMAND CC11018SD \$5.98, CC3311018 \$4.98.

Interest: Philharmonic Hall's new organ
Performance: Superficial
Recording: Impressive
Stereo Quality: Apt

Whatever one might think of this disc as a purely artistic achievement, Command's engineers deserve the highest praise for the organ sound that has here been captured. Neither the new organ nor Philharmonic Hall's tricky acoustics can have been easy to cope with, but the recorded results are breathtaking.

Fox's playing, however, is another matter. It is all sonority and a mile wide. Perhaps this can be got by with in a piece like the Messiaen, and the Franck can be impressive in its rather chilly sonic brilliance. But surely Bach's great C Minor Prelude and Fugue deserves something more than a sonorous, superficial, and rather muddy virtuoso performance.

W. F.

(Continued on page 98)



If not for University's Classic Mark II...

this would be the finest speaker system of them all—

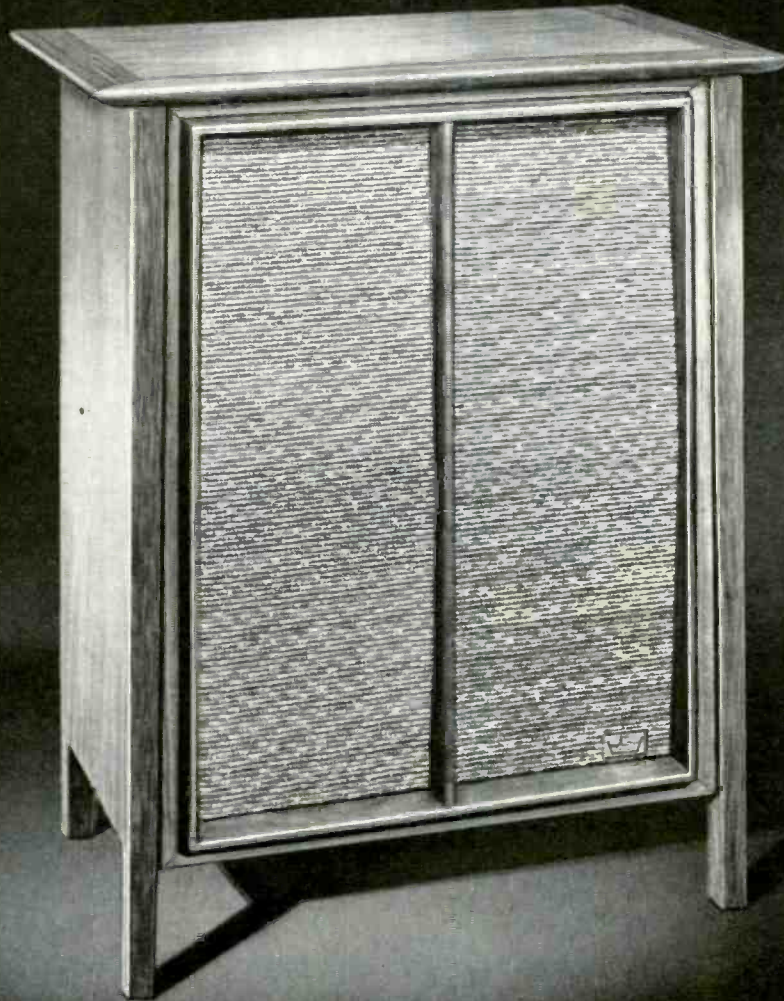

the new Classic Dual-12

the three-way system with two 12" speakers—plus!

From the first moment of its appearance, the Classic Mark II won instant and unanimous acclaim as the most exciting new instrument in the world of music reproduction. Its range, its presence, its spaciousness and dimension are truly outstanding, even when compared with the so-called "world's bests." Its reputation, however, posed this immediate challenge: Could University now create a speaker system with the essential qualities of the Mark II, but in a more compact size... and at a more moderate price? Could University now bring the pleasure of uncompromising big system high fidelity to a broader range of music lovers?

The challenge has been answered with the new Classic Dual-12, created by a totally new approach to the design

of speaker systems. Instead of the conventional 3-speaker arrangement, University's Dual-12 incorporates two 12" speakers...plus the Sphericon Super Tweeter! One 12" speaker is a woofer specifically designed for optimum reproduction of the ultra-low frequencies (down to 25 cps); the other, a woofer/mid-range, reinforces the woofer, removes the peaks and valleys that cause harsh, strident sounds in ordinary systems and provides flawless mid-range performance. The renowned Sphericon is included to assure silky, transparent highs soaring effortlessly up to 40,000 cps! Power Requirements: 10 watts. Size: 23³/₄" x 31¹/₄" x 15¹/₂". Oiled walnut finish. \$229.95 Hear it at your hi-fi dealer, or write: Desk D-11.

CIRCLE NO. 76 ON READER SERVICE CARD

UNIVERSITY
LOUDSPEAKERS
OKLAHOMA CITY, OKLAHOMA
A Division of Ling-Temco-Vought, Inc.

2 of the season's great Landmarks



a star studded performance

Verdi

La Traviata

Joan Sutherland, Carlo Bergonzi,
Robert Merrill and other soloists
—Chorus and Orchestra of the
Maggio Musicale Fiorentino—
John Pritchard.

Stereo: OSA 1366 (3 records) Mono: A 4366



Benjamin Britten

WAR REQUIEM

Galina Vishnevskaya, Peter Pears,
Dietrich Fischer-Dieskau, The Bach
Choir, The Highgate School Boys'
Choir, The London Symphony
Orchestra and the Melos Ensemble—
Benjamin Britten.

Stereo: OSA 1255 (2 records) Mono: A 4255

© © ERICK FRIEDMAN: *Virtuoso Favorites*. Tartini (arr. Francescatti): *Variations on a Theme by Corelli*. Castelnuovo-Tedesco (arr. Heifetz): *Sea-Murmurs*. Wieniawski: *Scherzo-Tarantelle*. Tchaikovsky: *Sérénade mélancolique, Op. 26*. Kreisler: *Menuet in the Style of Porpora*. Rimsky-Korsakoff (arr. Heifetz): *Flight of the Bumblebee*. Szymanowski: *Romance, Op. 23*. Mozart: *Rondo, in C Major (K. 373)*. Paganini: *Caprices, Op. 1, Nos. 17 and 21*. Dinicu (arr. Heifetz): *Hora Staccato*. Falla (arr. Kreisler): *Spanish Dance from La Vida breve*. Erick Friedman (violin); Brooks Smith (piano). RCA VICTOR LSC 2671 \$5.98, LM 2671* \$4.98.

Interest: Fiddle-fanciers' potpourri
Performance: Elegant
Recording: Good enough
Stereo Quality: Likewise

This mixed bag of old and near-contemporary encore pieces makes a fine showcase for Erick Friedman, young protégé of Jascha Heifetz. The chaste elegance of his performing style is heard to best advantage in the Mozart rondo, and in the Tchaikovsky piece he brings to bear an abundance of sweetly lyrical sentiment that yet manages to avoid being cloying. In the introduction to the Paganini *Caprice* No. 17—both Paganini pieces are played as written, without accompaniment—Friedman shows that he is capable of fiery temperament. But for the most part, this aspect of his playing is kept under wraps throughout the disc, even in such pieces as the Wieniawski and the popular Falla *Spanish Dance*. The recorded sound is intimately scaled, and good as such. Brooks Smith accompanies capably at the piano and is given reasonable parity of balance with the soloist—something of a departure in recital discs of this type. *D. H.*

© © NICOLAI GEDDA: *Great Tenor Arias from French Opera*. Adam: *Le Postillon de Longjumeau: Mes amis, écoutez*. Massenet: *Werther: J'aurais sur ma poitrine; Pourquoi me réveiller*. Manon: *Ah! suyez, douce image; En fermant les yeux*. Thomas: *Mignon: Elle ne croyait pas; Adieu, Mignon, courage*. Berlioz: *Benvenuto Cellini: Seul pour lutter; Une heure encore et ma belle maîtresse*. Gounod: *Mireille: Anges du paradis*. Lalo: *Le Roi d'Ys: Vainement, ma bien-aimée*. ANGEL S 36106 \$5.98, 36106 \$4.98.

Interest: Leading stylist
Performance: Impassioned
Recording: A shade dry
Stereo Quality: Natural

For several good exponents of the French operatic style today—a rather special
(Continued on page 101)

Send HiFi/Stereo Review Every Month



Check one: 3 years for \$12
 2 years for \$9 1 year for \$5
IN THE U. S. and POSSESSIONS
 Payment Enclosed Bill Me

Foreign rates: Canada and Pan American Union countries, add \$3.50 per year; all other foreign countries, add \$1.00 per year.

name _____
address _____
city _____ zone _____
state _____

Mail to:
HIFI/STEREO REVIEW
Dept. 1-1029
434 S. Wabash Ave. Chicago 5, Ill.

GUARANTEED!



- Outperforms speakers costing five times more
- Three year warranty against manufacturing defects
- Complete satisfaction or your money back

the KENT **\$19⁹⁵**
all new...all wood
1964 model only

FEATURES AND SPECIFICATIONS
24" wide, 10" high, 9" deep; 8" high compliance woofer; 3" hardened tweeter cone; coaxial wound 1" voice coil; silicone treated edge allows for 1/4" cone displacement; Alcomax III 1-lb. 5-oz. magnet; 10,000 gauss flux density; 8 ohm impedance; zero external magnetic field; 40-18,000 cps; up to 30 watts power capacity; 1450 cubic inch volume; Fibreglass acoustic dampening; matched for stereo. Solid wood—not a composite.
ORDER NOW to insure prompt delivery! This remarkable speaker is probably the best investment you'll ever make in hi-fi equipment! Price—\$19.95 F.O.B. factory. Shipping weight 18 pounds.

Anglo American Acoustics Ltd. HI 11-63
129 Maryland Ave., Freeport, New York
Gentlemen: Enclosed is my check for \$ _____
Please ship me _____ "Kent" natural wood cabinet speaker(s) at \$19.95 each.
I UNDERSTAND THAT THESE SPEAKER SYSTEMS ARE GUARANTEED AND IF I AM NOT COMPLETELY SATISFIED I MAY RETURN FOR A FULL REFUND WITHIN TEN DAYS AFTER RECEIPT.
NAME _____
ADDRESS _____
CITY _____ ZONE _____ STATE _____

CIRCLE NO. 85 ON READER SERVICE CARD

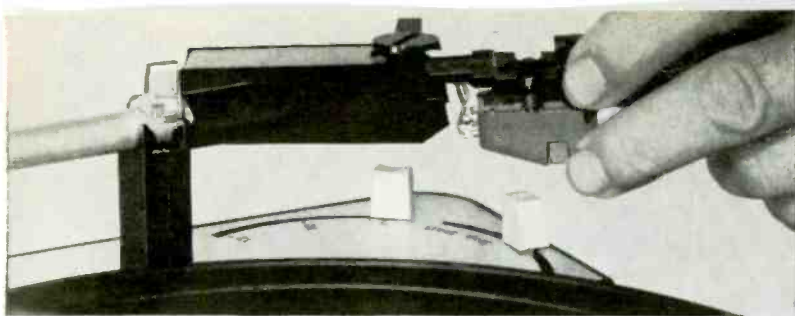

welcomes highest compliance cartridges for flawless tracking even at 1/2 gram or under

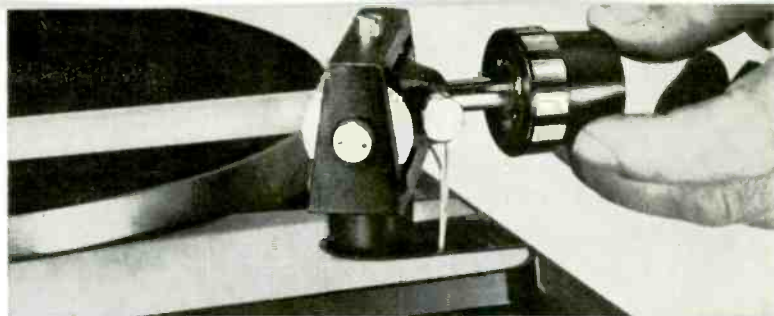

precise tonearm balance with rubber cushioned fine-thread rotating counterweight

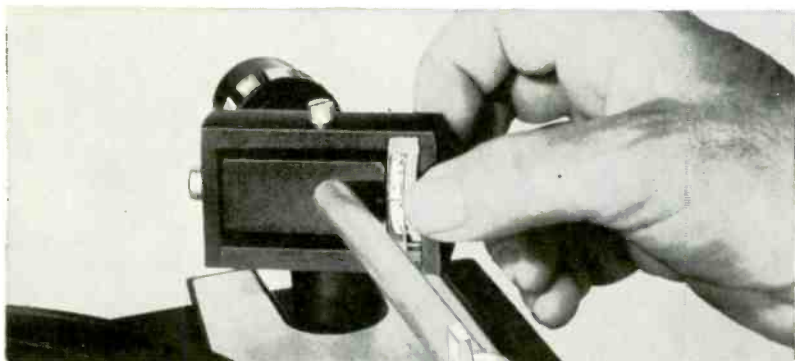

stylus force applied directly at pivot preserves perfect mass balance of tonearm

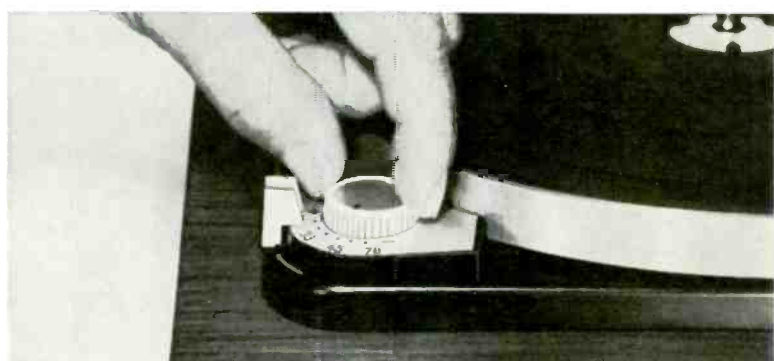

perfect pitch for the most critical ears with 6% variable range for all four speeds



superb over-all engineering permits tilt to almost 90° without spilling a note

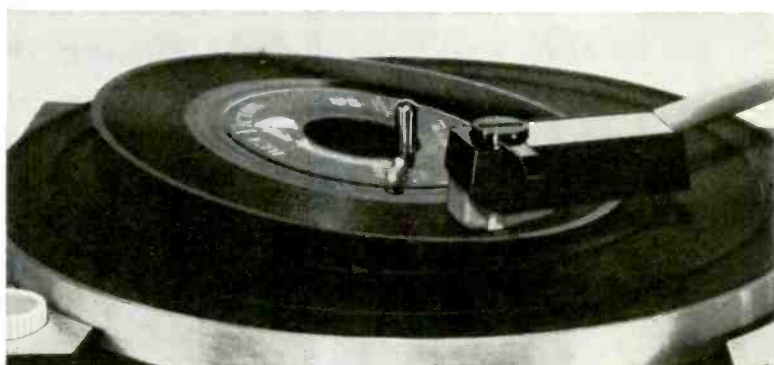

"warped" and eccentric tracking dramatizes frictionless bearings, low tonearm mass

No wonder the new **Dual** 1009 Auto/Professional obsoletes every turntable and changer ever made...at any price!

Standards of performance once associated with professional turntables and separate tonearms have now been matched or surpassed by a remarkable new record playing instrument . . . the Dual 1009 Auto/Professional by United Audio. Consider this achievement: A dynamically balanced automatic tonearm that tracks and trips below 1/2 gram . . . resonance below 8 cps, tracking error below .5°/inch. A solid non-ferrous platter machined to electronically controlled tolerances, then dynamically balanced . . . final weight 7 1/2 lbs. A powerful high-torque motor that maintains speed accuracy with one record or ten . . . and acts like a hysteresis in resisting voltage variations (even beyond ± 10%.) For a convincing demonstration of flawless automatic tonearm tracking with the finest high compliance cartridges, visit your United Audio dealer today. At \$94.75, you'll find the strikingly handsome Auto/Professional a value that welcomes comparison with equipment at \$100 more!



UNITED AUDIO  DUAL
12 West 18th St. N.Y. 11

famous
elevator-action
changer spindle

Quick-See Album File



FRONT-VIEW, FLIP-THROUGH SELECTION

Stop stooping, squinting, straining, to find albums stacked on edge. Quick-See units glide in and out of cabinet or wall for fast, simple selection... you see the full face of your album without removing it. Ends jacket-bottom wear, too. Installs anywhere in five minutes. Sturdy welded steel and ball-bearing construction, brass finish. Nine models for LP's and tape, hold up to 125 albums... available separately or in special cabinet furniture.

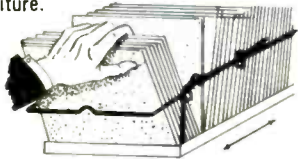

Dealer inquiries invited
KERSTING MFG. CO.

504-R H. Date, Alhambra, California

breed of vocalists—slender vocal resources hinder refined artistry. Not so for Nicolai Gedda, whose voice has a bright ring and whose range is a wonder. Departing from the usual Massenet-Bizet-Gounod sequence, Gedda includes the clarion air from *Le Postillon de Longjumeau*, which has not been recorded in the last thirty years, and two excerpts from *Benvenuto Cellini* that call for a dramatic tenor of Wagnerian endurance.

On the whole, this is a good recital. Gedda has acquired strength and poise in the decade that has elapsed since his recording career began. He has a sound technique, as witness such critical passages as the full-throated pianissimo A in Lalo's *aubade*. There is fine, impassioned sincerity in his "*J'aurais sur ma poitrine*," and his *Mignon* and *Mireille* arias leave little to be desired. Unless you insist on comparing these offerings with those of Clement, Anseau, or Schipa, you will be pleased by this program.

There are some debits. Gedda's *Longjumeau* air is not the equal of Roswaenge's classic version, and more disappointing is "*En fermant les yeux*," Des Grieux's aria from *Manon*, though the fault may lie with conductor Prêtre, whose tense and obtrusive reading of the *ostinato* accompaniment robs the music of its reverie-like quality. G. J.

© ® HERITAGE OF THE BAROQUE, Volume 2. Hotteterre: *Sonata, in C Major, for Oboe and Continuo*. Bernier: *Cantata, "Agréable Caffé."* Loeillet: *Trio Sonata, in F Major, Op. 2, No. 2, for Recorder, Oboe, and Continuo*. Caix d'Hervelois: *Suite, in G Major, for Recorder and Continuo*. Leclair: *Trio Sonata, in F Major, Op. 4, for Two Violins and Continuo*. Telemann Society (Janet Wheeler, soprano; Theodora Schulze, oboe and harpsichord; Richard Schulze, recorder; Harold Kohon and Rachmael Weinstock, violins; Dorothy Walters, harpsichord). Vox STPL 514000 \$4.98, PL 14000* \$1.98.

Interest: French Baroque
Performance: Amateurish and mannered
Recording: A bit harsh
Stereo Quality: Very wide separation

The latest disc of the New York-based Telemann Society includes music of the French Baroque from the end of the seventeenth to the middle of the eighteenth century. Although the performers have obviously delved into the performing conventions of this highly stylized music, the playing and singing can only be described, for the most part, as amateurish. Aside from the many interpretive mannerisms, the technical inadequacy of the winds, and the lack of dynamic variety, the worst feature of the collection is the excruciating unidiomatic execution of the harpsichord parts by



Utah Sorcerer

SPEAKER SYSTEM

means the beat of sound wizardry

Sound all around. Crystal clear. Compelling. Mood setting... such is the magic of Utah's compact Sorcerer. This 2-speaker system brings BIG, full, distortion-free sound into reality. It performs this electronic magic better than many larger and more costly systems. Here is wizardry developed from Utah electronic ingenuity, and found exclusively in the Sorcerer.

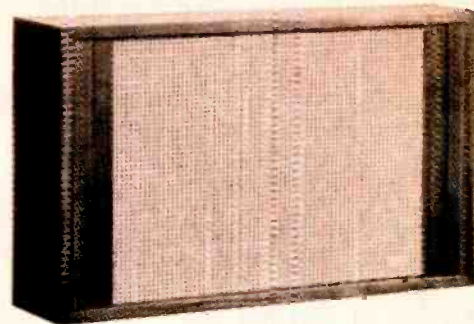

- Styling — fits Early American through Modern decor.
- Components — Two Utah Speakers, an 3" Woofer, 5" Tweeter, Crossover.
- Cabinet — Hand-rubbed, oiled walnut veneer, applied to 1/2" plywood, a standard for fine furniture.
- Location — Wall, bookshelf, floor, table-top.
- Dimensions — 20" in length, 12" high, 5" deep.
- Power rating — 12 watts.
- Uses — Hi-Fi or Stereo, as extension speakers for record player, radio or TV.

\$29.97 Net



utah
ELECTRONICS CORP.

HUNTINGTON, INDIANA

CIRCLE NO. 51 ON READER SERVICE CARD

PURCHASING A HI-FI SYSTEM?

TRADE-INS O.K. TIME PAYMENTS

Up to 2 years to pay!

Send Us Your List Of Components For A Package Quotation

AIREX WON'T BE UNDERSOLD

All merchandise is brand new, factory fresh & guaranteed.

Visit our showroom Free cabinet brochure

AIREX RADIO

CORPORATION

85-MR Cortlandt St., N.Y. 7, WO 4-1820

CIRCLE NO. 3 ON READER SERVICE CARD

CIRCLE NO. 77 ON READER SERVICE CARD

Dorothy Walters: they are dryly pounded and excessively detached, without a hint of legato. The recorded sound, which has very wide stereo separation, is satisfactory if slightly harsh. I. K.

RECORDING OF SPECIAL MERIT

© ① **TOM KRAUSE: Lieder Recital.** Sibelius: *Narciss; Illalle; Säf, Säf, Susa; Kom Nu Hit, Död!*; Lastu Lainehilla; Demanten På Marssnön; Vilse; Svarta Rosor; Var Det en Dröm? Richard Strauss: *Zueignung; Traum durch die Dämmerung; Ständchen; Breit' über Mein Haupt; Ach Weh Mir Unglückhaftem Mann; Heimliche Aufforderung;*



LONDON RECORDS

TOM KRAUSE

New luster for a growing reputation

Ruhe, Meine Seele!; Cäcilie. Tom Krause (baritone); Pentti Koskimies (piano); John Williams (guitar). LONDON OS 25783 \$5.98, 5783 \$4.98.

Interest: New lieder singer
Performance: Impressive
Recording: Excellent
Stereo Quality: Effective

This is Tom Krause's first recorded solo song recital, but his rich baritone may also be heard in Haydn's Mass No. 9 (London OS 25731, 5731) and in *Tristan und Isolde* (London OSA 1502, A 4506).

Born in Helsinki in 1934, Tom Krause made his debut there as a lieder singer in 1957 after taking a medical degree at Helsinki University and studying another year at the Vienna Academy and Opera School. Concert, radio, and TV appearances have already built an enviable European reputation, and his program here should do much to lend additional luster to the American one (he was well-received at his debut appearance in Brit-

ten's *War Requiem* at Tanglewood this summer).

Although the Strauss songs in this program — particularly *Zueignung* and *Ruhe, Meine Seele!*—are musically well-conceived and beautifully sung, attention focuses more naturally on the Sibelius group, Strauss songs being comparatively easy to come by in the catalog. Sibelius songs, fine and numerous though they are, are available only in a vocal collection by Birgit Nilsson (with songs of other composers) and in a full album by Kirsten Flagstad. Five of the nine Krause sings here are also included in the Flagstad album, and although it is good to be able to compare their interpretations of such splendid songs as, say, *Svarta Rosor, Säf, Säf, Susa*, and *Illalle*, new material would have been preferable.

With but a few exceptions, the songs here are all love songs, and Krause sings them with the shadings of joy and passion that communicate love's splendors and disappointments. His voice is dark in color, but without heaviness; powerful, but well-controlled; and gives evidence of ample reserves. A mature solidity and richness of timbre is its most remarkable quality—it is difficult to remember that Krause is only twenty-nine. However, although secure in vocal production and tonal quality, Krause lacks that final polish and refinement we have come to take for granted in Fischer-Dieskau. This will come with experience, however, and on the evidence of this disc, we will be hearing much more from this artist. Perhaps some day he will even find time to record some of the songs of his countryman Yrjö Kilpinen, whom Ernest Newman once called the greatest song writer since Wolf.

Aside from a slight tape hiss, the sound on this disc is clean, and stereo satisfactorily creates the recital-hall illusion—soloist in the embrace of the piano.

William Anderson

RECORDING OF SPECIAL MERIT

© ① **GUIOMAR NOVAËS: Piano Recital.** Chopin: *Barcarolle, in F-sharp Minor, Op. 60.* Debussy: *Les collines d'Anacapri; Soirée dans Grénade; Poissons d'or; Minstrels.* Liszt: *Waldesrauschen; Gnomenreigen; Liebestraum No. 3; Valse oubliée No. 1; Hungarian Rhapsody No. 10 ("Preludio").* Guiomar Novaës (piano). DECCA DL 710074 \$5.98, DL 10074* \$4.98.

Interest: Keyboard artistry
Performance: Exquisite
Recording: Excellent
Stereo Quality: Realistic

Now past her middle sixties, Brazilian pianist Guiomar Novaës can look back on an active concert career that dates from her Paris debut in 1911, when she
(Continued on page 104)

All Wharfedale Achromatic Speaker Systems are designed to reproduce music as music really is. No spurious resonances, no artificial colorations mar the fidelity of reproduction.

* *achromatic*



W40—Ultra-compact (24" x 12" x 10") full-range system at a most attractive price. Two superior speakers: A newly developed 8 1/2" low frequency driver with an extremely high flux density magnet—and Wharfedale's outstanding 5" tweeter—the same used in the larger W60 system. True Wood, \$79.50. Utility model, \$69.50.

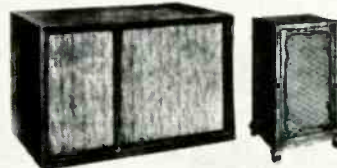

W60 PR

W60—In the streamlined look of fine modern furniture or handsomely crafted provincial, this full-range two-speaker system provides superlative performance—making it the automatic choice when the finest reproduction is desired. True Wood, \$116.50. Utility model, \$101.50. Provincial in genuine Fruitwood, \$134.50.



W70 PR

W70—A three-speaker system—handsome by itself, yet still sufficiently compact for shelf or wall integration. The beauty and excellence of performance of this remarkable system makes it unusually attractive to experts and laymen alike. True Wood, \$164.50. Utility model, \$146.50. Provincial in genuine Fruitwood, \$189.50.



887—Universal Mounting Base for W60, W70 and W90 systems in matching woods. True Woods, \$9.95. Utility model, \$8.95.

THE NEW WHARFEDALE W90—Musical integrity... effortless realism achieved through a new 6-speaker concept ■ Low end realized magnificently through two bass speakers ■ Presence conveyed dramatically through two mid-range speakers ■ Dispersion achieved panoramically through two high-frequency speakers ■ All speakers superbly matched and integrated with a unique sand-filled enclosure.



speaker systems by Wharfedale

W90 A detailed description follows. All 6 speakers incorporate certain recent refinements which have made possible the task of creating the W90 system.

The chassis (baskets) are exceptionally heavy and manufactured by casting. The purpose is to preserve absolute rigidity, maintaining the critical relationship between the moving voice coil and the fixed magnet. The stamped baskets found in ordinary loudspeakers are also designed to be rigid. However, this rigidity is often lost as soon as the speaker is mounted firmly against an inexact wooden front baffle. Some speaker designers have even eliminated the basket, weakening the entire speaker structure. Wharfedale baskets are of cast metal. They hold their shape perfectly in mounting, and are strong enough to permit sufficient openings to maintain absolutely correct airdoling, essential for the full response of the speaker.



The Cone Surround is an exclusive rolled-rim design, the latest and most effective form of the traditional Wharfedale soft suspension. Earlier surrounds (porous foam or cloth) provided such superior bass damping that they became renowned as an outstanding physical characteristic of Wharfedale speakers. Now, more than ever before, the Wharfedale cone is capable of the long excursions required for true bass energy in a sophisticated tuned duct enclosure. The cone material is special... compounded of long fibred wool (traditional to the North of England home of these speakers) and soft pulp! It achieves superior results from the start and its natural resilience assures continuing perfection over the years.



The Magnets are truly impressive, individually and totally. Because of its material, and the special design of the magnetic gap, each provides higher total flux in the gap field than has been true of the magnets in any prior speaker system. The six magnets together make the W90 a "high efficiency" speaker, achieving maximum performance at low amplifier power. All-too-many popular speaker systems are starved for power, depending upon exaggerated amounts of amplifier wattage. In the W90, therefore, the all-important transient bass response is excellent, even at low volume. This clean low end, at reasonable listening levels, is a major reason why all Wharfedales are so pleasant to "live with."



With its six speakers, the W90 is actually a dual 3-way system with all units designed for each other and crossover settings calibrated for undistorted response throughout the audio spectrum. The support effect of the tandem speaker systems results in a sound of exceptional authority, yet in balance over the entire range.

LOW RANGE. Two 12½" low frequency drivers handle the sound from 20 to 1,500 cycles. The listener can expect to enjoy the true, fundamental bass notes, so often masked. The two drivers total a cone area of 94 square inches... thus the W90 tandem idea yields the same result as a single low frequency driver of such massive size and weight as to be impractical in the home.



MID-RANGE. Two 5¼" mid-range speakers cover the relatively narrow but vital band of 1,500 to 6,000 cycles. The listener will be startled, for example, by the clarity of the baritone voice and the exceptional resolution of most solo instruments, permitted to stand in correct perspective. The handling of this "fill" range in the W90 is the recognizable key to its satisfying full-throated sound.



TREBLE. Two 3" treble speakers are the well-established Super 3's, much admired for their ability to present the clear treble without stridency... making them eminently listenable, unusual for tweeters. This is no accident. It is the result of cone-type rather than horn-type construction, and refinements such as low-mass aluminum voice coils ultrasonically tinned, powered by magnets so large that they are seldom found even in speakers four times the diameter!



* **THE W90** is the latest of the Achromatic speaker systems. The literal meaning of "achromatic" is: "Pure sound, uncolored by extraneous modulations." Such modulations, common even in luxury speaker systems, tend to alter the natural sound of music. The W90 enclosure has been designed to preserve the integrity of the speakers' performance, through certain constructional features. Chief characteristic of the Achromatic construction is the sand-filled technique, which consists of packing white sand densely between layers of hardwood. This creates an inert mass, incapable of resonating no matter how deep or strong the bass backwave projected against it. This exclusive technique is the result of years of de-



velopment by G. A. Briggs. While it costs considerably more than standard construction, it has proven so effective in preventing bass distortion that all Wharfedale Achromatic systems incorporate it. Each woofer is mounted in an individual tuned chamber for its own maximum effect, and isolated from the mid-range and tweeter arrays. Therefore, mechanical coupling, so disastrous in ordinary systems, is eliminated. The high and mid-range speakers are mounted from the rear, isolated from the face of the cabinet with front free-floating. This feature helps to eliminate phase distortion. As a final measure, to insure compatibility with the acoustics of the room, the W90 system incorporates a full control panel. Each range of speakers may be balanced and adjusted to the ear of the listener, the requirements of the particular listening area and the other components in the music system.

DECOR. The new W90 is neither a compact, nor a large speaker system. It is a new and highly versatile size, designed from the sound out. Ideally suited to be used in pairs for stereo, the W90 measures 32¼" x 27¼" x 13½". Housed in a meticulously crafted cabinet built to meet every requirement of perfection in sound, the W90 will fit with ease into the living room, and is elegant enough to join the most distinctive furnishings. Its acoustic design adds versatility... permitting horizontal or vertical use, as desired. The Wharfedale Universal Mounting Base makes it a superb free-standing unit. In oiled or polished Walnut hardwood, \$259.50. Utility model in sanded Birch hardwood, without curved molding or dividers, \$244.50. Universal Mounting Base to match, \$9.95.

For illustrated literature, write Dept. WS-123

Wharfedale • Division of British Industries Corp., Port Washington, N.Y.



graduated as a first-prize winner from the Conservatoire. Over the years, Mme. Novaës has enjoyed the unswerving loyalty of a select and discriminating body of listeners, as well as of her fellow pianists. Until the LP era, her recordings were few and far between; but beginning in the early 1950's, she taped for the Vox label almost the whole of her active repertoire, most notably a wealth of Chopin, much Schumann, some Beethoven, and a bit of Mendelssohn. She has since switched her disc allegiance to Decca, and her first recording offers works of Chopin, Debussy, and Liszt.

Mme. Novaës' supreme gift is that of

eliciting tonal beauty from the keyboard. She may lack the sheer power needed for an ideal projection of Liszt or of the more tempestuous moments in the Chopin B Minor Sonata; but to hear the exquisitely spun phrasing of the Chopin slow movement, the magical coloration she imparts to the Debussy pieces, the nocturnal beauty she evokes from the Chopin, and the majesty she brings to the Bach G Minor Prelude—such experiences epitomize the most treasurable and special aspects of Novaës' artistry.

Decca has done a first-rate job of capturing the piano tone in stereo. I

recommend, however, that the playback level be kept relatively low for best results. Let us hope that Decca will issue many more Novaës recordings, not merely of small pieces, but also of major works in the repertoire—with particular emphasis on Schumann, Mozart, and Chopin. *D. H.*

© ① IRMGARD SEEFRIED: *Lieder Recital. Schubert: From Goethe's Faust: Der König in Thule; Gretchen am Spinnrade; Gretchen's Bitte; Scene: Wie anders, Gretchen. Schumann: Five Poems by Mary Stuart; Abschied von Frankreich; Nach der Geburt ihres Sohnes; An die Königin Elisabeth; Abschied von der Welt; Gebet. Brahms: Eleven German Folk Songs. Irmgard Seefried (soprano); Erik Werba (piano). DEUTSCHE GRAMMOPHON SLP.EM 136372 \$6.98, LPM 19372 \$5.98.*

Interest: Rarely heard lieder
Performance: Warm
Recording: Full-toned
Stereo Quality: Suitable

This recital demonstrates once again Deutsche Grammophon's flair for enterprising and imaginative record-making. Except for *Gretchen am Spinnrade*, the entire program is off the beaten track, and the three groupings are of considerable interest. The puzzling thing is that, having committed such interesting material to disc, DGG tells the buyer nothing whatever about it: the liner contains only the texts and the translations.

All four Goethe excerpts date from Schubert's early years. *Gretchen am Spinnrade* is, of course, one of his most stunning inspirations; the others are less significant. The Schumann group (Op. 135) was composed in 1852. The words are by Schiller, based on five melancholy poems by the ill-fated Mary Stuart, and the music depicts their affecting simplicity with gentle eloquence. Simplicity is, of course, also the keynote of the Brahms group. This is a richly harmonized sequence from the composer's extensive collections of German folk songs, and an unhackneyed part of his output.

Miss Seefried presents this unostentatious program with disciplined and expressive musicianship. She keeps a strict check on those peculiarities of her tone production that have unfavorably affected some earlier recitals, and as a result, the listener is not distracted from enjoying her superlative enunciation, her winning temperament, and—in the Brahms sequence—her infectious humor. Some high-lying passages in *Gretchen am Spinnrade* make the going momentarily strenuous, but otherwise she is in good shape vocally, and Erik Werba is his usual dependable self at the piano. *G. J.*

(Continued on page 106)

New RCA Studiomatic Changer



protects your records 2 ways

Now the record changer developed expressly for RCA Victor Total Sound Stereo Phonographs is available as a separate component for custom installation and replacement. Besides delivering brilliant sound in stereo or monaural, the Studiomatic Changer is a long-time investment in record protection:

1 Protects Against Spindle Wear. King-size stabilizer holds records steady and wobble-free—drops them gently with virtually no wear on center hole, thus eliminating a major cause of "wow."

2 Protects Against Groove Wear. Tone-arm and stylus pressure are so light that no audible scratches are produced if tone arm accidentally slides across record. Precision-angled head assures true in-groove tracking over entire record.

RESULT: RECORDS TEST-PLAYED OVER 3,000 TIMES SHOW NEGLIGIBLE LOSS OF FIDELITY

PLUS: • Scientifically balanced, rock-steady cushioned turntable • Automatic shut-off at end of last record • Ultra-sensitive Living Stereo Ceramic Cartridge • Ability to intermix 7", 10" and 12" records of the same speed • Excellent stereo separation.

Ask for it at your nearest RCA Victor dealer's.

RCA PARTS AND ACCESSORIES, CAMDEN, N. J.



The Most Trusted Name
in Sound

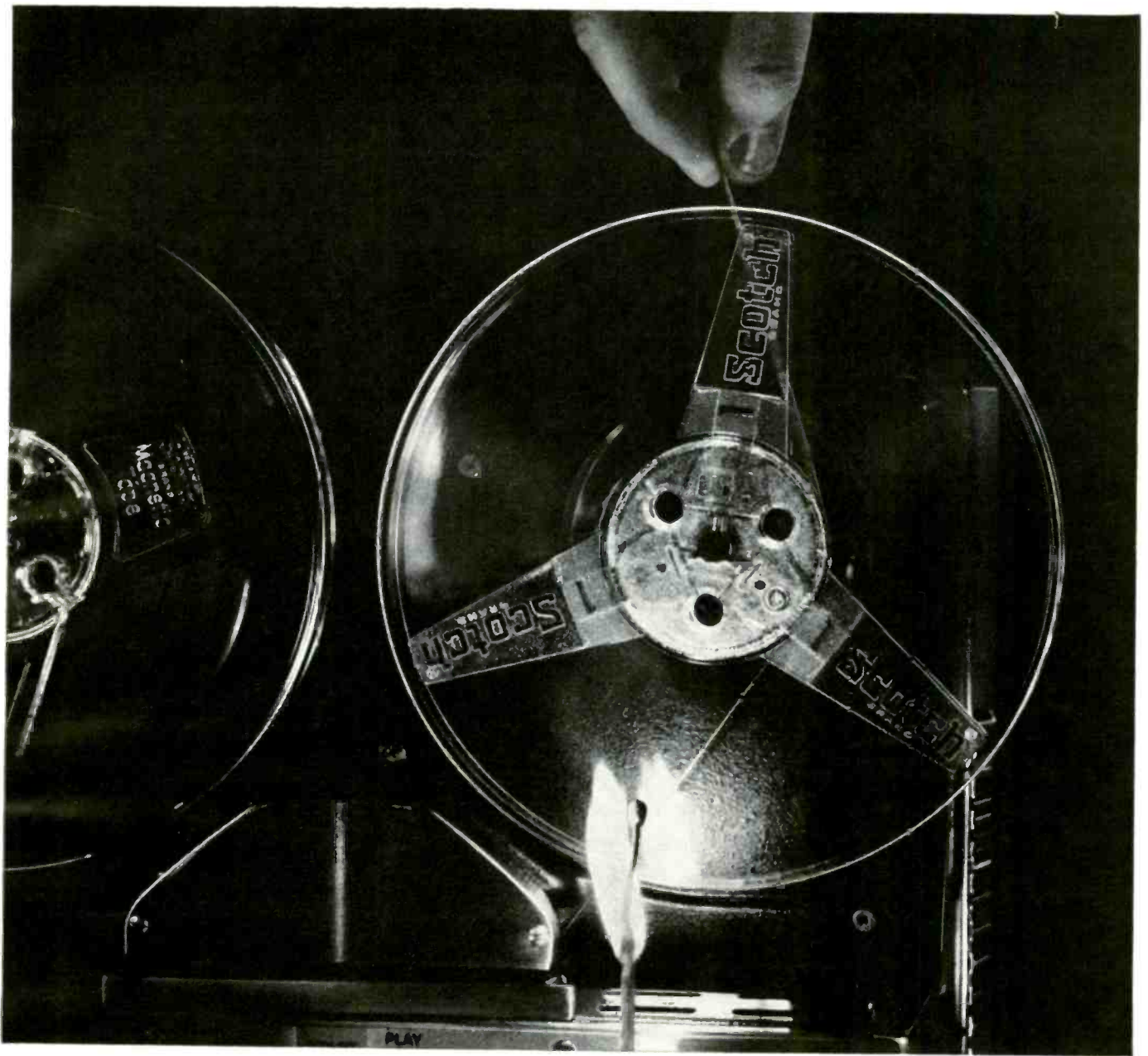

NEW! A tape reel that threads itself!

(even in the dark!)

Just lay recording tape inside this new reel and start your recorder. This exclusive new SCOTCH® BRAND Self-Threading Reel holds tape firmly, but gently, as recorder starts—actually threads up automatically. No hooks, no slots, no attachments—no tape fumbles. This reel does away with thread-up problems. (You wouldn't really need the light of a match to use it!) Now, this reel is offered as a take-up reel for only 39¢ in a special offer from the granddaddy of all tape-makers, 3M.

New reel threads up with all tape thicknesses or with leader tape. Tape rewinds off reel freely and easily. Solid sides protect tape against dust and damage. Reel comes complete with

write-on labels and snap-tight plastic collar that seals reel edges against dust, makes reel self-storing without a box.

SPECIAL OFFER SAVES \$1.11! Now, you can have one of these new "SCOTCH" Self-Threading reels (\$1.50 value) as a take-up reel for only 39¢ with the purchase of three regular 7" reels of a wide variety of "SCOTCH" BRAND Recording Tape. Ask your dealer for the special package, shown below. And for an expandable, gold-plated tape rack (\$4.95 value) that holds up to 40 reels, send the tabs from three "SCOTCH" Recording Tapes, together with \$2.50, to 3M Magnetic Products Division, Dept. MCW-113, St. Paul 19, Minn.

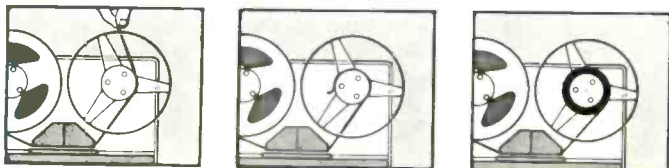

Lay in tape . . . start recorder . . . watch reel thread itself!

Magnetic
Products
Division **3M**
COMPANY

"SCOTCH" AND THE PLAID DESIGN ARE REGISTERED
TRADEMARKS OF MINNESOTA MINING & MANUFACTURING
CO., ST. PAUL 19, MINN. EXPORT: 99 PARK AVE., NEW
YORK, CANADA: LONDON, ONTARIO ©1963, 3M CO.



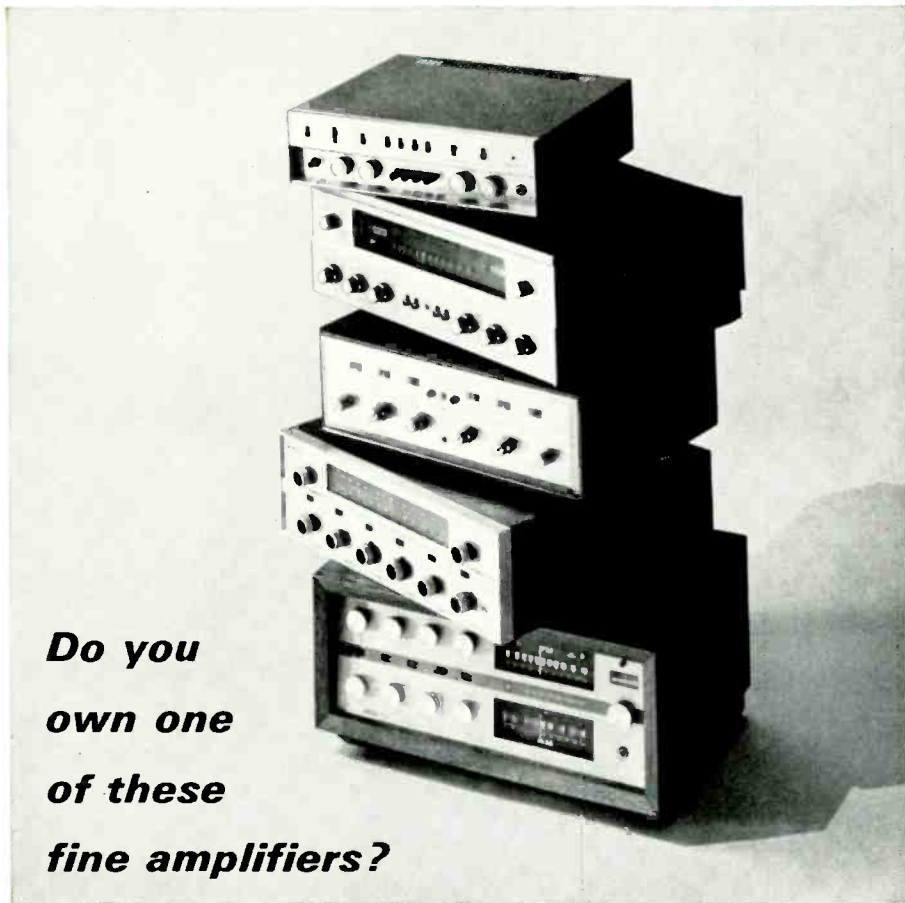

**Do you
own one
of these
fine amplifiers?**

From top: Knight, Fisher, Scott, Bogan, Harmon-Kardon

If you do . . . and you don't own a set of Koss stereo headphones . . . you've got a lot of fun still coming! You've got the whole great experience of Koss "solo flight" listening ahead, because your amplifier is equipped with a jack just right for Koss Stereophones.

Just plug them in, slip them on and . . . well, prepare for take-off. Your Koss phones will send you soaring into private sonic bliss. You'll hear it all with startling clarity and a new "up-closeness" you've never experienced before. What's more, you'll listen in complete seclusion, with no disturbance to or from the others in the room.



PRO-4 STEREOPHONES

Fluid-filled earpads for tight, comfortable seal. A durable phone designed for professionals. 30-20,000 c.p.s. response 4-16 ohms impedance. \$45.00.

SP-3X STEREOPHONES

Wide range 10-15,000 c.p.s. response obtainable only through earphone listening. Sensitive 3½" sound reproducers mounted in each earpiece. Soft sponge foam ear and head cushions. Impedance 4-16 ohms. \$24.95.



KOSS

ELECTRONICS, INC.

2227 NORTH 31ST STREET
MILWAUKEE 8, WISCONSIN

Ⓜ **SINGERS OF IMPERIAL RUSSIA:** Bellini: *I Puritani: Qui la voce*. Aliabiev: *The Nightingale*. Flotow: *Marta: The last rose of summer*. (Olimpia Boronat, soprano). Rimsky-Korsakov: *The Tsar's Bride: Marfa's Aria from Act Two* (Lydia Lipkovska, soprano); *Marfa's Scene and Aria from Act Four* (Antonina Nezhdanova, soprano). Bizet: *I Pescatori di Perle: Mi par d'udir ancora* (Dmitri Smirnov, tenor). Auber: *Fra Diavolo: Zerlina's Aria* (Antonina Nezhdanova, soprano). Borodin: *Prince Igor: Galitsky's Aria* (Feodor Chaliapin, bass). Tchaikovsky: *Eugene Onegin: three excerpts* (Leonid Sobinov and Dmitri Smirnov, tenors). Rimsky-Korsakov: *The Snow Maiden: five excerpts* (Nezhdanova, Lipkovska, Sobinov, and Smirnov). ANGEL COLH 129 \$5.98.

Interest: Historical
Performance: Great vocalists
Recording: Pre-electric

Before the First World War, Europe's greatest singers went to Russia year after year, attracted by its flourishing operatic activity, the enthusiasm of its audiences, and the generosity of its patrons. And when the likes of Caruso, Battistini, Ruffo, Tamagno, and Sembrich appeared in Moscow or St. Petersburg, they were generally flanked by Russian artists of similar standing. The six singers in this collection are representative of the remarkable Russian artists. Their international careers ranged from soprano Antonina Nezhdanova's single fling—she went to Paris in 1912 to sing one *Rigoletto* with Caruso and Ruffo—to the peripatetic Chaliapin. Smirnov and Lydia Lipkovska were members of the Metropolitan Opera Company for a brief period. For Italian-born soprano Olimpia Boronat, Russia became an adopted home, but she confined her roles to the Italian and French repertoire, retired early, and left the country after the Revolution. Leonid Sobinov, on the other hand, ended his long career as a much-decorated artist of the Soviet Union.

Fortunately, the Gramophone Company operated a highly productive and expertly run branch in Russia during those years, and even more fortunately, a large number of matrices have been preserved in good condition. With one exception, the selections on this disc were all recorded from 1904 to 1912. Chaliapin's sole contribution, dating from 1911, displays the robustness of his dramatic and vocal powers. Both Smirnov and Sobinov justify in these excerpts their eminence among the lyric tenors of the period. All three sopranos were major artists. Despite a certain addiction to languid tempos, Boronat phrased most exquisitely. Nezhdanova displayed the

(Continued on page 108)

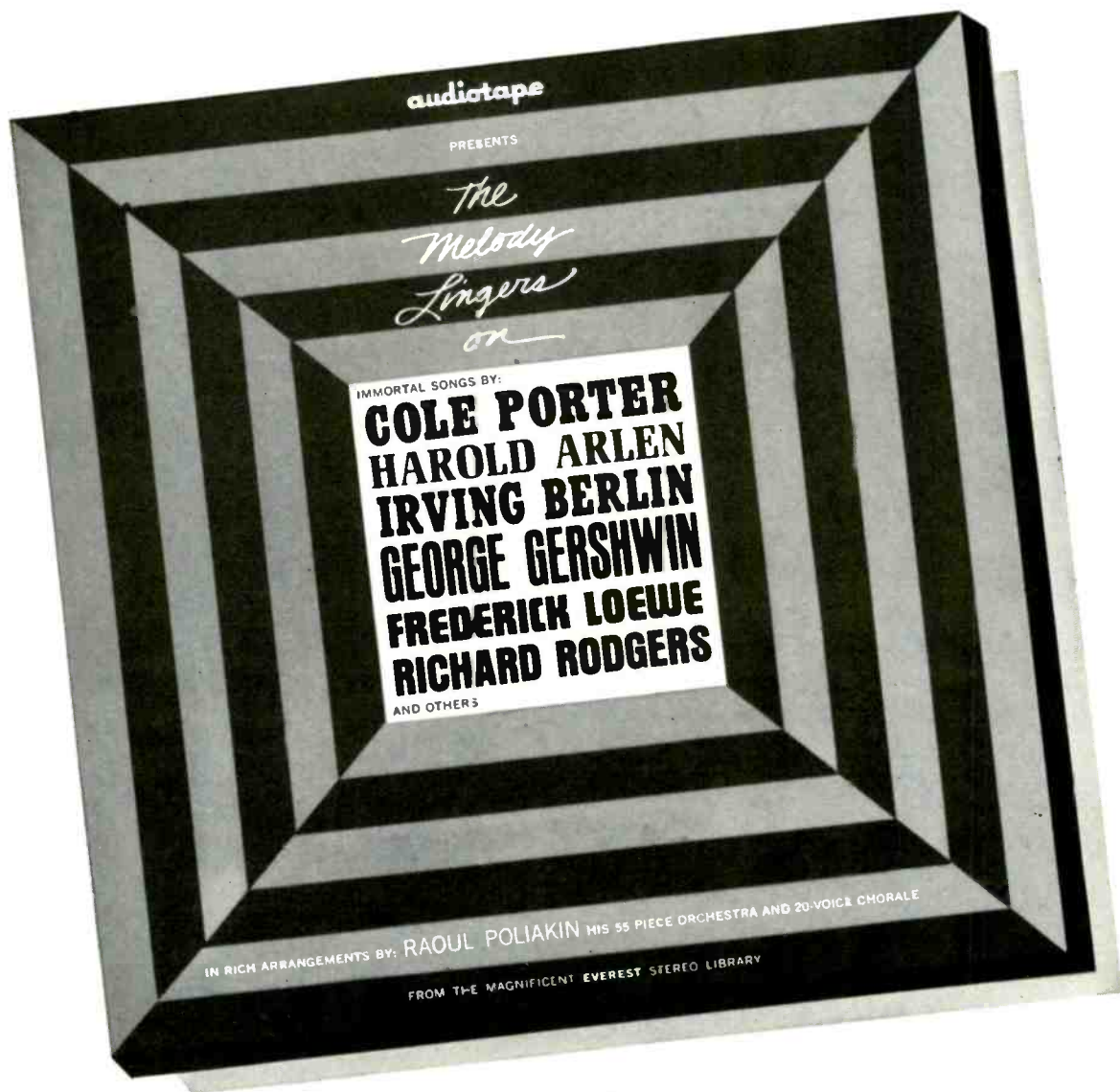

\$1.00

Christmas is early this year! We're offering a superb recorded tape for a fraction of its actual cost for trying a 7" reel of Double Recording Audiotape on Tempered "Mylar." (A great tape in itself: double length plus double strength.) ■ Just buy a reel of Double Recording Audiotape (Type 2431T) at the regular price, and for only \$1.00 additional come away with *The Melody Lingers On*—a magnificent 55-minute program of great popular standards. These unforgettable melodies are performed in luxurious arrangements from the Everest stereo library, long noted for the superb quality of its recordings. ■ The \$1.00 price tag is even more remarkable when you consider that the entire program is recorded on a reel of standard Audiotape which actually sells for more than

twice that price! So even if you erased the tape (heaven forbid!) you'd still be ahead of the game. ■ Go to any store that carries Audiotape products and buy a reel of Double Recording Audiotape, Type 2431T. Then add one dollar for *The Melody Lingers On*, a great tape that you and the women in your life will treasure. Available only in 4-track stereo. And Merry Christmas!

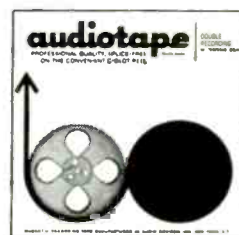

AUDIO DEVICES, INC.
444 MADISON AVENUE,
NEW YORK 22, NEW YORK

CIRCLE NO. 10 ON READER SERVICE CARD

Z-400

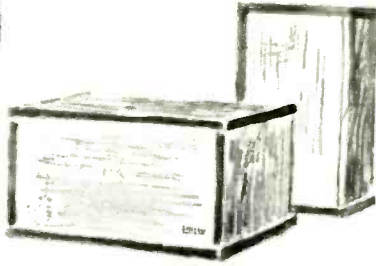

Most authorities look to the Janszen* Electrostatic as the standard of comparison for mid + high frequency sound reproduction.

Other manufacturers, either by recommendation of independent research organizations or by their own choice, advocate or include the Janszen* as an integral part of their best speaker systems.

The Z-400, however, integrates the Janszen* Electrostatic with our own complementary woofer. Result...the best possible speaker system, already assembled and, naturally, at a far better price -- from **\$ 144.50**

send for literature and name of nearest dealer

* incorporating designs by Arthur A. Janszen and made only by

NESHAMINY ELECTRONIC CORP.
Neshaminy, Pennsylvania.

most impressive gifts of tone and technique, Lipkovska the most compelling dramatic personality.

Angel's expert technical restoration retains the voices' natural ring, and the surface noise should not unduly disturb the seasoned collector, for whom the disc was intended. Detailed and informative historical background notes accompany the record. G. J.

RECORDING OF SPECIAL MERIT

© ® VIRTUOSO TRUMPET: *Volume Two.* Haydn: *Trumpet Concerto in E-flat Major.* Biber: *Sonata in B-flat Major for Six Trumpets, Timpani, and Organ.* Manfredini: *Concerto in D Major for Two Trumpets, Strings, Timpani, Harpsichord, and Organ.* Alberti: *Sonata in D Major a 4 for Two Trumpets, Strings, Timpani, and Continuo.* L. Mozart: *Concerto in D for Clarino, Strings, and Continuo.* Torelli: *Concerto in D Major for Two Trumpets, Strings, Timpani, and Continuo.* Helmut Wobisch and Adolph Holler (trumpets); Anton Heiller (organ, harpsichord continuo); Erna Heiller (harpsichord continuo); I Solisti di Zagreb, Antonio Janigro cond. VANGUARD BACH GUILD BGS 5053 \$5.95, BG 641 \$4.98.

Interest: Trumpet fireworks
Performance: Stimulating
Recording: Spectacular
Stereo Quality: Excellent

Vanguard has another winner with this second volume entitled "The Virtuoso Trumpet." The selection of pieces, all originals for brass and orchestra, makes for very exciting listening, and though the key is D pretty steadily, there is plenty of variety in style. Longest of the selections is the popular Haydn concerto, brilliantly played here by Wobisch, though I wish he had emulated his spectacular first-movement cadenza in the indicated places in the finale. The piece least often heard is undoubtedly Leopold Mozart's two-movement work, very *galant* and not as interesting as one might expect, but with a cruelly high solo part. The remaining pieces, all Baroque, benefit as much from the prominently recorded and stylishly played harpsichord and organ continuos of the Heillers as from the more obvious trumpet virtuosity that is the *raison d'être* for the disc. The orchestral support is spirited and precise, the brass solos are dashing, and the whole has been recorded extremely cleanly and vividly. Like its predecessor in the series, this disc is highly recommended. I. K.





Now there are two Troubadors

The New Empire 498 — No Larger Than A Record Changer . . . Every Inch A Troubador. The model 498 is tailor-made for console or equipment cabinets. Record playback in console cabinets has special problems. Acoustic feedback, for one. Because of the close proximity of turntable to speaker, stereo equipment often "talks back." Not too long ago, Audio Magazine tested the Empire Troubador . . . they reported: "We tried to induce acoustic feedback by placing the turntable on top of our large speaker system and turning up the gain—WE WERE UNSUCCESSFUL." Other factors important to cabinet owners are stability and level requirements. Many turntables call for a perfectly level surface, and the jars and jolts of heavy footsteps or accidental bumps can jump some arms even in the most stable of cabinets. Stability under virtually any conceivable situation is assured by Empire's sensational "Dyna-Mount" (vibration-absorbing multiple-floating suspension system). As for levelness . . . the New 498 Troubador with more perfect balance, tracks and plays even while turning upside

down. (Dimensions: 15 $\frac{7}{8}$ " wide x 13 $\frac{1}{4}$ " deep . . . height required above mounting board 2 $\frac{3}{4}$ "; depth required below turntable base plate 3 $\frac{1}{2}$ ".)

The Famous Empire 398. Outstanding! Too perfectly engineered for even a whisper of distortion . . . too handsomely finished to hide behind cabinet doors. The response of the country's hi fi magazines to the Empire Troubador says it as well as we could. High Fidelity, for example, reports: "The 'Troubador' represents a precision-engineered product of the highest quality . . . wow, flutter and rumble completely inaudible . . . first-rate audio components: hum field completely negligible . . . speed accuracy very good . . . maximum tracking error of the arm was judged to be negligibly small . . . very low needle talk, minimum hum pickup . . . clean response . . . one of the finest, handsomest record players available."

TROUBADOR TABLE OF CONTENTS

Empire 3-speed "silent" turntable . . . Empire 550 dynamically balanced playback arm with the sensational Dyna-Lift* . . . and the new Empire 880p mono-stereo cartridge featuring the virtually indestructible Dyna-Life* stylus . . . Complete with handsome walnut base. 498 — \$170
398 — \$190.

For a demonstration: see local Hi Fi dealer / For complete literature write Empire Scientific Corp., Dept. H., Garden City, N.Y.



EMPIRE

"World's Most Perfect Record Playback System."

EXPORT: EMEC, PLAINVIEW, L. I., N. Y. • CANADA, EMPIRE SCIENTIFIC CORP., LTD., 1051 EGLINGTON WEST, TORONTO

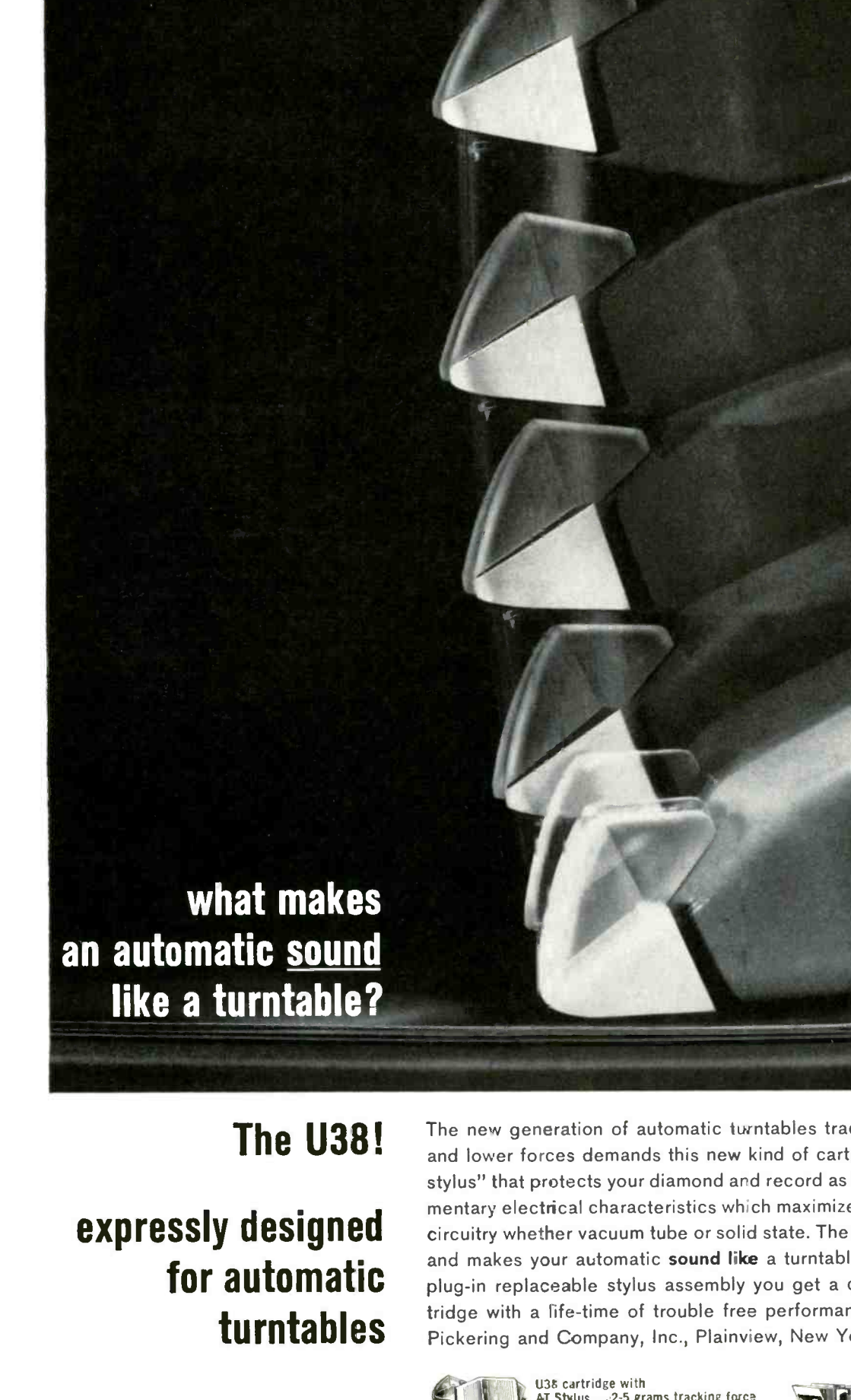

**what makes
an automatic sound
like a turntable?**

The U38!
**expressly designed
for automatic
turntables**

The new generation of automatic turntables tracking and tripping at lower and lower forces demands this new kind of cartridge. Demands a "floating stylus" that protects your diamond and record as it plays...demands complementary electrical characteristics which maximize the use of forward-looking circuitry whether vacuum tube or solid state. The U-38 meets these demands and makes your automatic **sound like** a turntable. With Pickering's famous plug-in replaceable stylus assembly you get a cartridge with a life-time of trouble free performance. **Pickering**
Pickering and Company, Inc., Plainview, New York.



U38 cartridge with
AT Stylus...2-5 grams tracking force
ATG...1-3 grams



Plug-in head assembly for
Garrard Type A and Model AT6

HIFI/STEREO REVIEW'S
CHOICE
OF THE LATEST
RECORDINGS

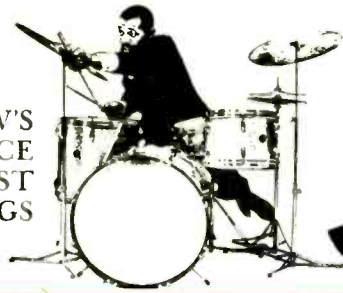

JAZZ

Reviewed by JOE GOLDBERG • NAT HENTOFF

RECORDING OF SPECIAL MERIT

⑤ ④ **CANNONBALL ADDERLEY:** *Jazz Workshop Revisited*. Julian Cannonball Adderley (alto saxophone), Nat Adderley (cornet), Yusef Lateef (flute, tenor saxophone, oboe), Joe Zawinul (piano), Sam Jones (bass), Louis Hayes (drums). *Primitivo; Jessica's Birthday; Marney; The Jive Samba; Lillie; Mellow Buno*. RIVERSIDE RS 9444 \$5.98, RM 444* \$4.98.

Interest: Quintet plus Lateef
Performance: Spirited
Recording: Excellent
Stereo Quality: Good

With this recording, Cannonball Adderley returns to the scene of his group's first great triumph, the Jazz Workshop in San Francisco. It was there, in 1959, that Adderley recorded *This Here*, and he has been unstoppable since. Holdovers from that time are Adderley himself, who is a fluent virtuoso on his instrument; his more thoughtful brother Nat, who is a cornetist; and the excellent rhythm team of Sam Jones and Louis Hayes. The present pianist is Joe Zawinul, who is less forceful than either of his predecessors and the weakest link in the chain. The group here has a sixth member, Yusef Lateef, who plays tenor, flute, and (on the Mingus-like *Primitivo*) oboe—on the last he does not receive liner credit. Lateef's presence is immensely helpful. So, too, is the added rhythmic verve that is usually the result of playing before an audience.

Adderley has an admirably wide jazz book, drawing on only a few standards. The participants' originals are supplemented here by pieces by Quincy Jones and Donald Byrd. This is one of the group's best discs, and seems to indicate that the better Adderley's use of the versatile Lateef, the better his band is going to be. *J. G.*

Explanation of symbols:

- ④ = monophonic recording
- ⑤ = stereophonic recording
- * = mono or stereo version not received for review

④ **CURTIS AMY:** *Tippin' on Through*. Curtis Amy (tenor saxophone), Roy Brewster (valve trombone), Ron Ayres (vibraphone), John Houston (piano), Bob Whitlock (bass), Lawrence Marable (drums). *Tippin' On Through; Summertime; For Ayres Only*; and three others. PACIFIC JAZZ PJ 62 \$4.98.

Interest: West Coast funk
Performance: Lively
Recording: Good

Among Curtis Amy's associates on this set, recorded in a club, are the excellent rhythm team of Bob Whitlock and Law-



CANNONBALL ADDERLEY
Returns to the scene of his first triumph

rence Marable. The former, who is splendid throughout, was bassist in the original Gerry Mulligan Quartet, and has been seldom heard from since. The other musicians are less notable, but vibraphonist Ron Ayres shows promise.

The tunes are mostly blues-based, and the most interesting of them is Amy's Mingus-like title track. The practice of letting the rhythm section play one tune per set is followed here—pianist John Houston plays Brubeck's *In Your Own Sweet Way*. Six minutes, however, is far too long for what he has to say. The remainder of the set is only intermittently interesting. *J. G.*

④ **HAROLD BETTERS:** *Harold Betters at the Encore*. Harold Betters (trombone), John Hughes (piano), Al O'Brien (bass), Joe Ashliman (drums). *Moanin'; Hold It; Stand by Me; Ebb Tide; Georgia; Funny*; and six others. GATEWAY GLP 7001 \$4.98.

Interest: Lounge trombonist
Performance: Flashy
Recording: Okay

Harold Betters, a Pittsburgh trombonist who was briefly with Ray Charles, almost typifies the lounge musician. He has a fine, flashy technique, never uses an original idea if he can substitute a quote, and occasionally sings in a hoarse, energetic voice. His bassist and drummer are good men, but he is hampered by pianist John Hughes, who is completely thrown off by the chords of *Stella by Starlight*.

Betters plays blues, stomps, and standards with skill and energy but scanty musical content. The most engaging number is *When You and I Were Young, Maggie*, which he has turned, Ray Charles fashion, into a quasi-gospel. This album is only for those who care to hear how the techniques of organ-tenor combos can be adapted by trombone players. *J. G.*

⑤ ④ **THE BOSSA TRES.** Luis Parga (piano), Sebastiao Neto (bass), Edison Machado (drums). *Blues Walk; Ceu e Mar; Bossa 3 Theme; Zelao; Nao Faz Assim*; and seven others. AUDIO FIDELITY AFSD 5988 \$5.95, AFLP 1988* \$4.98.

Interest: Brazilian lounge music
Performance: Monochromatic
Recording: Good
Stereo Quality: Good

The Bossa Tres is the Brazilian equivalent of the slick jazz-influenced trios that work our better cocktail lounges and supper clubs. If the group were American, it would have recorded old show tunes. As it is, we get bossa nova, with a few standards tossed in. Bassist Sebastiao Neto and drummer Edison Machado are very good. The pianist, Luis Parga, plays a sort of funky bossa that sometimes contains interesting cross-

rhythms but is more often predictable. None of the Brazilian tunes is especially memorable. The set is skillful but unimaginative, a suitable background for a Brazilian cocktail party. J. G.

⑤ ● **LEE EVANS: *The Lee Evans Trio***. Lee Evans (piano), Joe Dumas (bass), Bill Smith (drums), unidentified guitar. *Taunting Scene; It's All Right with Me; Without You I'm Nothing; Teacher's Blues; West Side Story Medley*; and four others. CAPITOL ST 1847 \$4.98, T 1847* \$3.98.

Interest: Tricky pastiches
Performance: Studied
Recording: Excellent
Stereo Quality: Okay

Lee Evans is the latest in a line of piano players that includes, in its various manifestations, Don Shirley, Alec Templeton, and George Feyer. All play songs "in the style of" various classical composers. The hippest among them toss in a few blue notes and jazz licks, get booked into New York's Hickory House, and are fawned upon by disc jockeys who dream of broadcasting "fine music."

Evans is a good pianist, but here only the strain and effort that go into his arrangements are felt. *It's All Right with Me* has a *Bumble Boogie* bass; *The Sweetest Sounds* employs Chopin's *Fantaisie Impromptu*; *Without You I'm Nothing* utilizes Bach. Evans, who works with bass, drums, and an occasional guitar, climaxes his album with an eleven-minute *West Side Story* medley that is little more than a piano transcription of the score. It is clever, but like the rest of this album, more stunt than music.

J. G.

⑤ ● **ERROLL GARNER: *Best of Garner***. Erroll Garner (piano), bass, drums, percussion. *Scatterbrain; Imagination; Don't Be That Way; Oh Lady Be Good*; and six others. MERCURY SR 60803 \$4.98, MG 20803* \$3.98.

Interest: Slight
Performance: Mostly perfunctory
Recording: Tinny
Stereo Quality: Reprocessed

It is an affront to performer and listener alike to call this compilation "Best of Garner." "Worst" would better suit some of the tracks. The album has been assembled from what sounds like different sessions, all made several years ago, presumably, because Garner's Mercury contract antedated the Columbia, which itself goes back nearly a decade. Often here, Garner relies too much on an indifferent rhythm section, although he is more capable than most pianists of supplying his own swing. Elsewhere, he falls back on the filigree and delayed rhythm

that are his trademarks, revealing that these mannerisms can be irritating and without emotional content. *Scatterbrain* could almost stand as the monotonous low of Garner's swinging approach, and *Cottage For Sale* stands as a warning of the dangers of florid romanticism. Only on *Lazy River* and *All of a Sudden* does he rise above superficiality.

As if the music were not enough to depress those who like Garner, the electronically produced stereo has a dead, tinny sound that would make listening difficult even if the album were what its title claims it is. J. G.

● **DON GOLDIE: *Trumpet Caliente***. Don Goldie (trumpet), Leo Wright (alto saxophone, flute), Parti Bown (piano), Ben Tucker (bass), Eddie Shaughnessy (drums), Ray Barretto (conga drum), Barry Galbraith (guitar), Willie Rodriguez (percussion). *Nightingale; Fast Thought; Shiny Stockings; Goldie's Thing*; and two others. ARGO LP 708 \$4.98.

Interest: Light, pleasant jazz
Performance: Ingratiating
Recording: Good

Trumpeter Don Goldie, who came to notice as a member of Jack Teagarden's group, has a prodigious technique and a



bright Harry James tone. On this recording, however, he keeps both in reserve, merely hinting at what he could play if so inclined, in the annoying way that vocalist Peggy Lee has adopted of late. He throttles his powers down in order to provide pleasant, ingratiating, rather platitudinous performances. With alto- and flute-player Leo Wright, and assisted by various rhythm instruments, he runs through standards, originals, and a few bossa novas. The set is diverting, but there is nothing to remember. J. G.

● **JOHNNY HAMLIN: *Some Other Street***. Johnny Hamlin (accordion), Bobby Sutherland (trumpet), Charlie McFadden (reeds, flute), Red Brown (bass), Jerry Granelli (drums);

Hal Dickinson Singers (vocals). *Italian Street Song; Easy Street; Street of Dreams; On Green Dolphin Street; On the Street Where You Live*; and six others. PHILIPS PHS 600 060 \$4.98, PHM 200 060* \$3.98.

Interest: Negligible
Performance: Gimmicky
Recording: Good
Stereo Quality: Good

According to the notes, "Some Other Street" is an album that delves into new areas to achieve hybrid sounds composed of happy, commercial pop material played and sung with a meaningful jazz feeling." This uninviting rhetoric aside, the set features the Hal Dickinson Singers ("4/5 of a renowned singing combination that started back in the swing era") and the Johnny Hamlin Quintet in eleven songs about streets, a programming idea of surpassing banality. Aside from a few funky overtones, intimations of the Hi-Lo's, and a *Trolley Song* (trolleys travel on streets) that owes much to Brubeck, it all could have been done by the Modernaires twenty years ago. With the exception of the recent pop-country hit *Lonely Street*, cleverly arranged by Alan Copeland as a funky waltz, there is little here of interest. J. G.

● **HAROLD HARRIS: *Harold Harris at the Playboy Club***. Harold Harris (piano and celeste), Lennell Glass (bass), George Harps (drums). *Playboy Theme; Lot of Livin' to Do; Another Time; In Other Words*; and three others. VEE JAY SR 3036* \$4.98, VJLP 3036 \$4.98.

Interest: Splashy cocktails
Performance: Hip
Recording: Adequate

Harold Harris, who leads a trio at the Chicago Playboy Club, displays all the proper credentials of a hip cocktail pianist—borrowings from Garner, Garland, Jamal—and adds a few fillips of his own, such as playing some pieces on the celeste. He is more self-consciously cute than Jamal, but without Jamal's impeccable sense of time. He plays *What Kind of Fool Am I?* at a lugubrious tempo that Garner would not attempt, and he does not have enough melodic invention to fill in the resulting spaces. His block chords lack Garland's distinguished voicing, and his rhythm section is adequate, but little more. Harris' music would make good background for bunny-watching, but it is inadequate when removed from the warren. J. G.

● **JON HENDRICKS: *Salud! João Gilberto***. Jon Hendricks (vocals), Gildo Mahones (piano), George Tucker (bass), (Continued on page 114)

SORRY-

no improvements yet



There will be no improvements this year in the KLH Model Four.

It's not that we aren't improvers. Improvement is our stock in trade. Take electrostatic loudspeakers, for example. Our Model Nine has lower distortion and a wider frequency range than any other electrostatic. Or phonographs — our Model Eleven has, beyond question, the finest performance of any stereophonic portable ever made. The same for the Model Eight among compact FM receivers. We've improved our own speakers, too. We continually explore the possibilities for improving every KLH speaker. Special attention is paid to enclosures, magnetic circuits, cone materials and shapes, as well as the more exotic ways of converting an electrical signal into sound.

But we haven't yet been able to improve on the character of the Model Four. In its own category of size and cost, the Model Four still represents as nearly perfect a blending of desirable qualities in a speaker system as it is presently possible to achieve.

The greatness of this speaker lies in its balance. Balance between size, price and overall sound quality. Balance between bass, midrange and treble. Balance between frequency range and freedom from distortion. Most of all, the natural, musical, octave-to-octave balance which has made this great speaker the *final* choice of so many demanding music-lovers. As with all KLH speakers, every Model Four is guaranteed to match every other Model Four within $\pm 1\frac{1}{2}$ db, note by note and octave by octave, throughout its frequency range.

If you own a Model Four, you can buy another at any time — even years later — with the assurance that they will sound the same. If you don't own one yet, or haven't heard it, we hope you will. You can't buy a high quality speaker system knowledgeably if you are not familiar with the Model Four.

The prices haven't changed either. \$209 to \$231, depending on the finish. Slightly higher west of the Rockies. We'll be happy to send you further information and the name of your nearest KLH dealer on request.



KLH RESEARCH AND DEVELOPMENT CORPORATION
30 CROSS STREET, CAMBRIDGE 39, MASSACHUSETTS

Jimmie Smith (drums), others. *The Duck; Quiet Nights; You and I; Longing for Bahia; Rosa Morena; Once Again*; and six others. REPRISÉ R 96089 \$4.98, R 6089* \$3.98.

Interest: Idiomatic adaptations
Performance: Casually expert
Recording: Good
Stereo Quality: Good

Jon Hendricks, usually one-third of Lambert-Hendricks-Bavan, has made a solo album of bossa nova songs associated with the remarkable Brazilian singer João Gilberto. He has imitated Gilberto's near-whisper—"What a pleasure," Hendricks says in the notes, "to sing softly, gently, after years of so much volume." The arrangements are adapted from the Brazilian originals by Antonio Carlos Jobim and Walter Wanderley, and Hendricks has written English adaptations of the Portuguese lyrics.

Only on Nat Adderley's *Jive Samba* is Hendricks aggressively hip, belligerently and ungrammatically down-home. On the rest of the album, in a context that does not permit him his customary mannerisms, he gives a relaxed, affecting performance, his best yet on records. His lyrics, when they are not too sentimental about love, home, and mother, are his finest to date. He is not the singer Gilberto is, and it may be true that these songs have more charm when one only hears the sounds and cannot understand the words. But this is a fine effort by a singer who knows how to make charming use of limited equipment. J. G.

⑤ ④ PEE WEE HUNT: *The Best of Pee Wee Hunt*. Pee Wee Hunt (trombone); unidentified personnel. *Cow Bell Strut; Vanessa; Swingin' Around; Charleston*; and eight others. CAPITOL DT 1853 \$4.98, T 1853* \$3.98.

Interest: Pseudo-Dixie
Performance: Corny
Recording: Good
Stereo Quality: Reprocessed

There may be those who will be interested to hear that the most popular recordings of Pee Wee Hunt have now been collected on one disc. And further, that they are available in "Duophonic" form, which is an electronic process Capitol tells us is "designed to enrich irreplaceable monophonic recordings that have proven their lasting popularity." Lasting popularity these may have, but as for their being irreplaceable, they are not. These pieces, of which *Twelfth Street Rag* and *Oh!* are probably the best known, are prime examples of the kind of deliberately corny pseudo-Dixie that goes with party hats, buyers' conventions, and clubs trying for a speak-easy atmosphere. Only *Miss Otis Regrets*, in which

Hunt proves that he is a passable trombonist, has any musical value at all. Whether you will like the rest depends on your sense of humor. J. G.

RECORDING OF SPECIAL MERIT

⑤ ④ THE JAZZ CRUSADERS: *Tough Talk*. Wilton Felder (tenor saxophone), Wayne Henderson (trombone), Joe Sample (piano, harpsichord), Six Hooper (drums), Bobby Haynes (bass). *Turkish Black; Boopie; Lazy Canary; Brother Bernard*; and five others. PACIFIC JAZZ S 68* \$5.98, 68 \$4.98.

Interest: Growing group identity
Performance: Hot and disciplined
Recording: Very good

There are no superior soloists among the Jazz Crusaders, but these young musicians are developing considerable impact as a group. The players are obviously compatible in style, which is nonexperimental, blues-laced modern jazz. Moreover, although the unit is youthfully impassioned, it is also well organized. The arrangements, for instance, are scoured of superfluousities and based on supple lines logically and leanly developed.

The Jazz Crusaders are deficient on ballads, but they are learning to adapt their prickly toughness to more subtle ways of expression, as in *No Name Samba*. In the front line, Wilton Felder is a vigorous, bursting saxophonist, and Wayne Henderson plays a blustery, often witty trombone. The rhythm section is crisp and insistently propulsive. N. H.

RECORDING OF SPECIAL MERIT

⑤ ④ QUINCY JONES: *Plays Hip Hits*. Orchestra, Quincy Jones arranger and cond. *Jive Samba; Exodus; Take Five; Watermelon Man; Gravy Waltz; Comin' Home Baby*; and six others. MERCURY SR 60799 \$4.98, MG 20799* \$3.98.

Interest: Expert big band
Performance: Superbly professional
Recording: Excellent
Stereo Quality: Excellent

The growing acceptance of the milder forms of jazz is indicated by the contents of this album. A few years ago, there would not have been enough jazz-influenced pieces on the pop charts to make such a set possible. Quincy Jones, using such top studio-and-jazz men as Joe Newman, Bobby Scott, Phil Woods, Zoot Sims, Roland Kirk, and Jim Hall, has here scored clean, direct, and inventive big-band versions of twelve such hip hits.

Even with his own talent and fine musicians going for him, Jones had a basic problem with the material: for most jazz, the performance is the piece, and the

popularity these compositions have attained is due perhaps more to the sounds of the groups that originated them than to the tunes themselves. Still, Jones has not taken the easy way out. Only *Walk on the Wild Side* is directly indebted to its "chart" performance. On *Desafinado*, Jones models himself after the Gillespie version, rather than the Getz-Byrd hit. For the rest, Jones comes up with fresh, interesting approaches, models of contemporary mainstream big-band writing. His arrangements, plus the soloing of the men mentioned above, combine to make a fascinating record. J. G.



QUINCY JONES

Superb scoring for mild material

⑤ ④ HERBIE MANN: *Sound of Mann*. Herbie Mann (flute), Laurindo Almeida (guitar), Johnny Rae (marimba), Mel Lewis (drums), others. *Baia; Dearly Beloved; Frenesi; Stardust; Autumn Leaves*; and three others. VERVE V6 8527 \$5.98, V 8527 \$4.98.

Interest: Globe-trotting flute
Performance: Pallid
Recording: Good
Stereo Quality: Good depth

Flutist Herbie Mann, whose quest for musical *Lebensraum* has previously taken him to Africa and Cuba, recently annexed Brazil as well ("Do the Bossa Nova"), and he is now more popular than ever. Verve has responded to his popularity with this disc, made up of tracks from several earlier sets. The personnel and approach vary from the lush pop strings of *Stardust* to a trip up *The Amazon River* conducted by Kenya drum and finger cymbals. Mann makes his ingratiating flute solos over superficial rhythmic excitement a common denom-

(Continued on page 116)

WILL



REPLACE



?

No, Music-Lover—take heart. Live music is here to stay. But when recorded music can be so perfectly played back that *even experts* can't tell the difference from a live performance, this is big news for those who love music, live or otherwise. This September, over 4000 audiophiles witnessed a "live vs. recorded" demonstration at the New York High Fidelity Music Show, featuring Gustavo Lopez, guitarist, and for four years now, thousands of discriminating listeners have attended concerts of the Fine Arts Quartet, sponsored jointly by the manufacturers of Dyna amplifiers and AR speakers. Performances were so arranged that the audiences were alternately listening to live and recorded portions, without prior announcement as to which was which. These are typical comments of recognized experts:

C. G. McProud, editor of Audio reported: "We must admit that we couldn't tell when it was live and when it wasn't." The Herald Tribune referred to "awesome fidelity." Record reviewer E. T. Canby wrote: "My eyes told me one thing, my ears another." Ralph Freas, audio editor of High Fidelity, wrote: "Few could separate the live from the recorded portions."

When reproduction and reality cannot be separated, the reproducing equipment has achieved the top-most *practical* level of quality. And when that equipment is so moderately priced as Dyna Mark III amplifiers and PAS-2 pre-amplifiers, the obvious conclusion is that you *can* spend more money but you *can't* get higher quality. Anybody can build a Dynakit, including you, Music-Lover. And you can be confident that it will work well with performance indistinguishable from the original source of sound.

All Dynakits are designed with top performance as the primary objective. In any power range, mono or stereo, the established excellence of Dynakits is assured. If Dyna's superior engineering, high quality parts and functional layout give you such fine performance that you can't *tell* the difference, why *pay* the difference?



TRADITIONAL DYNA EXCELLENCE WITH SMART NEW STYLING. The FM-3 *stereomatic* FM multiplex tuner and PAS-3 stereo preamplifier stack beautifully for a compact control center of matchless performance. Your present Dynatuner and PAS-2 can now look as fine as they sound, too, for identical champagne-gold accessory panels and knobs are available from your dealer. Your Dynakits are never obsolete.

DYNACO, INC. 3912 POWELTON AVE., PHILADELPHIA 4, PA.

CABLE ADDRESS: DYNACO PHILADELPHIA

• Write for complete descriptive literature

inator in every country whose music he professes to explore. More notable are Johnny Rae on vibes and marimba, and bassist Knobby Totah, who has a bowed solo on *Autumn Leaves* that is interesting for perhaps half its distended length. There is a pleasing depth to the stereo version. J. G.

© © **CHAD MITCHELL TRIO: *In Action***. Chad Mitchell, Mike Kobluk, and Joe Frazier (vocals); Paul Prestopino, Jacob Ander, and Bruce Langhorne (guitars); Norman Keenan (bass). *Run Run Run; My Guitar; Green Grow the Lilacs; Ballad of the Greenland Whalers*; and nine others. KAPP KS 3313 \$4.98, KL 1313 \$3.98.

Interest: Attractive group
Performance: Varies
Recording: Good

The Chad Mitchell Trio are new folk-singers. They are assisted by instrumentalists and a musical director—Milt Okun, who does the same job for Peter, Paul and Mary. They put new titles on the old songs—*Leave Me if You Want To* is *Columbus Stockade*, *Adios Mi Corazon* is the haunting *Spanish is the Loving Tongue*. The group as a whole sounds much like the Limeliters, and the leader reminds me of Belafonte. The program includes Bob Dylan's *Blowin' in the Wind*, three separate tracks are devoted to a pseudo-madrigal, and there is also a takeoff on Billie Sol Estes.

"Down with Folksinging" the notes shout. "Up with Folksmanship!" If you agree, you will be highly entertained by much of this rather spotty album. J. G.

© © **WES MONTGOMERY: *Boss Guitar***. Wes Montgomery (guitar), Mel Rhyne (organ), Jimmy Cobb (drums). *Besame Mucha; The Trick Bag; Canadian Sunset; The Breeze and I*; and four others. RIVERSIDE RS 9459* \$5.98, RM 459 \$4.98.

Interest: Expert modern guitar
Performance: Flowing
Recording: Good

I remain unconvinced that Wes Montgomery is, as the title of this album proclaims, the "boss guitar" of modern jazz. He is indeed technically impressive, and he gets an appealing, incisively articulated sound from his instrument. In addition, his time sense is flawless. This album indicates that Montgomery has developed further as a ballad player.

Yet Montgomery is still lacking in melodic invention, and his consistently fluent playing is seldom deeply affecting. He is a thoroughly skillful improviser, but I have yet to hear evidence on recordings that his conceptions are sufficiently original to place him in the front

rank of contemporary jazzmen. Mel Rhyne's playing is discreet, refreshingly economical, and his sound acceptable, but he too is not imaginative. Jimmy Cobb, the former Miles Davis drummer, is steady but rather pedestrian. N. H.

© © **DUDLEY MOORE: *The Theme from Beyond the Fringe and All That Jazz***. Dudley Moore (piano), Peter McGurk (bass), Chris Karan (drums). *I Love Paris; What's New; Just in Time; Chicago*; and four others. ATLANTIC S1403 \$5.98, 1403* \$4.98.

Interest: English parlor jazz
Performance: Offhand
Recording: Good
Stereo Quality: Okay

Dudley Moore is best known in this country as one of the four marauders who, under the corporate title *Beyond the Fringe*, have been hilariously laying many accepted ideas waste. Moore's *perpetuum mobile* variations on *Colonel Bogey* are one of the high points of the show.

In London in 1962, Mr. Moore recorded this jazz piano-trio album. With bassist Peter McGurk and drummer Chris Karan, he runs through seven standards and his own *Theme* from the review. Moore, a pleasant and adept pianist, relies heavily on Erroll Garner for inspiration. He is about equal parts parlor pianist and inventive jazzman. Ingratiating as the album is, it probably would not have been imported had Moore's show not preceded it. J. G.

© © **DAVE NEWMAN: *Fathead Comes On***. Dave Newman (tenor saxophone, alto saxophone, flute), Marcus Belgrave (trumpet), Norris Austin and Hank Crawford (piano), Jimmy Jefferson and Edgar Willis (bass), Charlie Persip and Bruno Carr (drums). *Cellar Groove; Hello There; Lady Day; Scufflin'*; and three others. ATLANTIC S 1399 \$5.98, 1399* \$4.98.

Interest: Newman's alto
Performance: General funk
Recording: Good
Stereo Quality: Good

What was once a way of thinking musically has now become so pervasive a style that a good, competent musician such as Dave "Fathead" Newman, whose work with Ray Charles has kept him in line with the development of funk, seems to have become bland and faceless. Newman plays tenor, alto, and flute here, with two different groups, one of which features trumpeter Marcus Belgrave, another Charles associate, who seldom realizes the potential he has shown for some time. The work of drummer Charlie Persip, in the same unit, is noteworthy.

There are seven titles here, four of which are by Newman, but only *Unchain My Heart* is well known. The alto seems to evoke Newman's best playing and writing: his most individual work is on the two alto tracks, which are also his most affecting compositions, *Alto Sauce* and *Esther's Melody*. Perhaps if Newman limited himself to the alto, he could make a whole album that would be up to the quality of these two tracks. J. G.

RECORDING OF SPECIAL MERIT

© © **SAL NISTICO: *Comin' On Up***. Sal Nistico (tenor saxophone), Sal Amico (trumpet), Barry Harris (piano), Bob Cranshaw (bass), Vinnie Ruggiero (drums). *Cheryl; Ariescene; By Myself; Samicotico*; and three others. RIVERSIDE RS 9457* \$4.98, RM 457 \$4.98.

Interest: New orthodoxy
Performance: Excellent
Recording: Good

If this album by Sal Nistico, the young tenor saxophone star of the new Woody Herman band, had been issued in 1954, it might now be considered a classic. That was the year of the consolidation of the post-bop style, primarily on the Prestige label. Nistico's disc sounds surprisingly like what Miles Davis and Sonny Rollins were creating at that time. And the greater polish of Nistico and trumpeter Sal Amico is the result of their having had a course charted for them.

This is not necessarily to denigrate their efforts here. Both make personal use of the Rollins-Davis ideas, and both are extremely fluent on their instruments. They have an excellent rhythm section in the appropriate style. *Comin' On Up*, their version of *Cherokee*, might even have been beyond their models in 1954—but not in 1956. So what we have, seven years later, is a group of talented young musicians giving us an extremely interesting consolidation of the work of their predecessors. It is a praiseworthy undertaking, and although Sal Nistico sounds on the verge of finding his own unique voice, complete individuality is at present missing. J. G.

© © **LEROY VINNEGAR: *Leroy Walks Again!*** Leroy Vinnegar (bass), Teddy Edwards (tenor saxophone), Freddy Hill (trumpet), Victor Feldman and Mike Melvoin (piano), Feldman and Roy Ayers (vibraphones), Ron Jefferson and Milt Turner (drums). *Hard to Find; Down Under; Subway Grate; Restin' in Jail; Motherland*; and three others. CONTEMPORARY S7608 \$5.98, M3608* \$4.98.

Interest: West Coast funk
Performance: Easy

(Continued on page 118)

Model DLS-529



New Model 711A



New Model 319



New Model 630



A dangerous idea... is hard to stop.

You have been repeatedly warned about the dangers of certain radical engineering ideas developed in the great EMI laboratories in England and embodied in the EMI Model DLS-529 loudspeaker system. These new concepts result in a speaker that speaks the ever-dangerous truth—about the slightest distortion in the rest of the audio chain or the subtlest shortcoming of another speaker in an A-B comparison.

Rival loudspeaker manufacturers have meanwhile been fondly hopeful that the exclusive design and construction features of The Dangerous Loudspeaker would remain available in only one model and one price range. But wishful thinking has never stopped a dangerous idea whose time has come—and so, inevitably, here are *three* more EMI speaker systems to cover every possible application for all classes of audiophiles!

All four models in the EMI line shown here are built in strict accordance with the same EMI standards and the

same EMI design philosophy. All woofers, as well as midrange drivers, are *elliptical*, with patented *aluminum* center cones and molded *polyvinyl chloride (PVC)* suspensions. All tweeter diaphragms have the same specific curve, weight and damping material. All enclosures have a woven *metal* grille.

The original Model DLS-529 still reigns supreme at its remarkably moderate price of \$159.00.* (Also available without cabinet as EMI Baffle #1 for custom installation, \$115.00.*)

The new Model 711A, a three-way system with four drivers, is an all-out design conceived as a professional studio monitor and an unprecedented buy at \$249.00.*

The new Model 319 is a brilliant solution to the "impossible" problem of a no-compromise speaker for less than a hundred dollars—specifically, \$99.75.*

And the new Model 630 at last makes available EMI sound quality in a system small enough to fit *any* bookshelf

—for only \$69.75.*

To understand the full significance of the technological progress represented by the new EMI line, it is essential to read EMI's technical literature and data sheets. To obtain your free copy, fill out and mail the coupon below.

(Scope Electronics Corporation, a subsidiary of Lynch Corporation, has exclusive rights to U. S. and Canada distribution of EMI components.)

Scope Electronics Corporation
10 Columbus Circle
New York 19, N. Y.

Please send me without charge all available technical brochures and data sheets on EMI loudspeaker systems.

Name _____
Address _____
City _____ Zone _____ State _____

*higher in the South and West

EMI

(Electric and Musical Industries, Ltd.), England

Recording: Very good
Stereo Quality: Good

Bassist Leroy Vinnegar's reputation is grounded in a superior ability to "walk"—that is, to provide a firm rhythmic foundation and take interesting solos in which the notes continue a straight four-to-the-bar pattern. He does it very well, but it is an anachronistic ability, something like driving a team of four in the turnpike era. The list of brilliant bassists who have shown that the instrument is capable of much more is still increasing. Evidently drummer Ron Jefferson senses this. When he plays behind a Vinnegar solo, he fashions asymmetrical figures with mallets, as if to make up for the bassist's unchanging beat.

Aside from that, the set is another example of Western funk, but superior to most. Ron Ayers is becoming an increasingly assured vibraphonist. Saxophonist Teddy Edwards is regaining the power he seemed not long ago to have lost, and yet, oddly enough, is retaining the new light tone that probably caused him to lose the power. The two sessions making up the disc were recorded six months apart, and it is heartening to report that Edwards is far better on the second, especially the blues *Wheelin' and Dealin'*. The outstanding track is Vinnegar's lovely *For Carl*, one of the finest of jazz waltzes. But Vinnegar provides, by indirection, a fascinating documentation of why the younger bassists have gone in a new direction. J. G.

⑤ ● GEORGE WEIN: *And the Newport All-Stars*. George Wein (piano, celeste), Ruby Braff (cornet), Marshall Brown (valve trombone, bass trumpet), Pee Wee Russell (clarinet), Bill Takas (bass), Marquis Foster (drums). *Crazy Rhythm; Slowly; Ja-Da; Lulu's Back in Town; At the Jazz Band Ball*; and three others. IMPULSE AS 31* \$5.98, A 31 \$4.98.

Interest: Neo-swing
Performance: Variable
Recording: Good

This is one of George Wein's kaffeklatches of musicians who play various styles, but all of them in the neo-swing camp. The best of them is the great clarinetist Pee Wee Russell, an idiosyncratic poet whose slow *Bends Blues* is a lovely statement and the best thing on this record. After him in quality comes Ruby Braff, a cornetist who is nearly faultless within his chosen Bix-Buck Clayton limits. His phrasing on *Ja-Da*, played much slower than usual and backed by Russell's counterpoint, is a poignant moment worth preserving. With the exception of the fine bassist Bill Takas, the others are only adequate. Marshall Brown plays the expected phrases on both of his instru-

ments, and Bud Freeman gives us his dance-band approach to tenor. George Wein is gradually becoming a passable pianist. His record is easy fun, worth having for Russell and Braff. J. G.

RECORDING OF SPECIAL MERIT

● ● BIG JOE WILLIAMS: *Blues on Highway 49*. Big Joe Williams (vocals and guitar), Ransom Knowling (bass). *Highway 49; Down in the Bottoms; Walk On, Little Girl; Four Corners of the World*; and eight others. DELMARK DL 604 \$4.98.

Interest: Autobiography in blues
Performance: Raw and honest
Recording: Good

Big Joe Williams (not to be confused with the much slicker Joe Williams, the former Count Basie vocalist) is a wandering blues singer and guitarist. This



GEORGE WEIN
Fun in the neo-swing camp

new album is one of his most consistent, and should long endure as a stark documentary of a difficult personal odyssey.

Born in Mississippi sixty years ago, Williams settled in St. Louis for a long time, but later moved on to Chicago. He is still a roamer, and his trips have often taken him back to the South. The result, as the notes on this album indicate, is that he has retained more of the rawness of country blues than many other performers who left their rural beginnings and took root in the big Northern cities. For instance, he often moans and chants to make exclamatory points, and the gritty texture of his voice and his slurred diction are in the direct tradition of deep country blues. Big Joe's urban influences are more manifest in his lyrics than in his musical style. He is not always easy to understand, incidentally, and Delmar might well have included full texts of his songs.

Big Joe's originals are the stories common to all blues travelers—the pleasures

(and betrayals) of transitory relationships with women, and other perils of the wandering life. A particularly affecting number, full of his acute sense of loss, is *Poor Beggar*, in which Williams tells of the death of his wife, who died shortly before this recording session took place. On another track, *Blues Left Texas*, Big Joe sums up one of the blues' oblique messages: "You can read my letter but you sure can't read my mind,/ When you think I'm crazy about the woman, that's when I'm leaving all the time."

Williams accompanies himself on a driving nine-string guitar. A firm rhythmic foundation is provided by bassist Ransom Knowling, a very active sideman on blues dates in the 1920's and 1930's. Big Joe is more uneven and less original than John Lee Hooker or Lightnin' Hopkins, but he is a persistently honest and powerful story teller, one of the last custodians of the heritage of the itinerant bluesman. N. H.

⑤ ● HERB ELLIS/LAURINDO ALMEIDA/JOHNNY GRAY: *Three Guitars in Bossa Nova Time*. Herb Ellis, Laurindo Almeida, and Johnny Gray (guitars), Milt Holland, Bob Neel, and Chicago Guerrero (drums), Bobby Enevoldsen (tenor saxophone), Donn Trenner (piano), Bob Bertaux (bass). *Detour Ahead; Low Society Blues; Bossa Nova #2; Leave It to Me; You Stepped Out of a Dream*; and five others. EPIC BA 17036 \$4.98, LA 16036* \$3.98.

Interest: Easy bossa nova
Performance: Casual
Recording: Good
Stereo Quality: Okay

Admirers of quantity will be distressed to learn that the title of this disc is slightly misleading: you get only two guitars at a time. Herb Ellis solos while either Laurindo Almeida or Johnny Gray plays rhythm accompaniment. With the exception of the auxiliary guitarist and the latin percussion, the personnel comes from pianist Donn Trenner's studio band for the Steve Allen TV show.

Much of this bossa nova session is pleasant, relaxed, light entertainment. There are two unusually good tunes in Almeida's *Bossa Nova Samba* and Trenner's *Sweet Dreams*. But the hotel-band origins of bossa nova make themselves apparent when a ballad like *But Beautiful* is forced into the mold. And bossa nova grapples with *Alt Wien* in a treatment of Ray Brown's *Gravy Waltz!* Much of the set's attractiveness is the charm of the tenor-guitar scoring. The former is played by Bob Enevoldsen, who is heavier-toned and more original than most Lester Young-derived players. Everyone is more than adequate, but no one is especially memorable. J. G.

OVER 2000 COMPONENTS...

Amplifiers
Phono Equipment
Tuners
Tape Machines
Speakers & Cabinets
Accessories

...are covered
in the 1964
edition of the

STEREO/HI-FI DIRECTORY

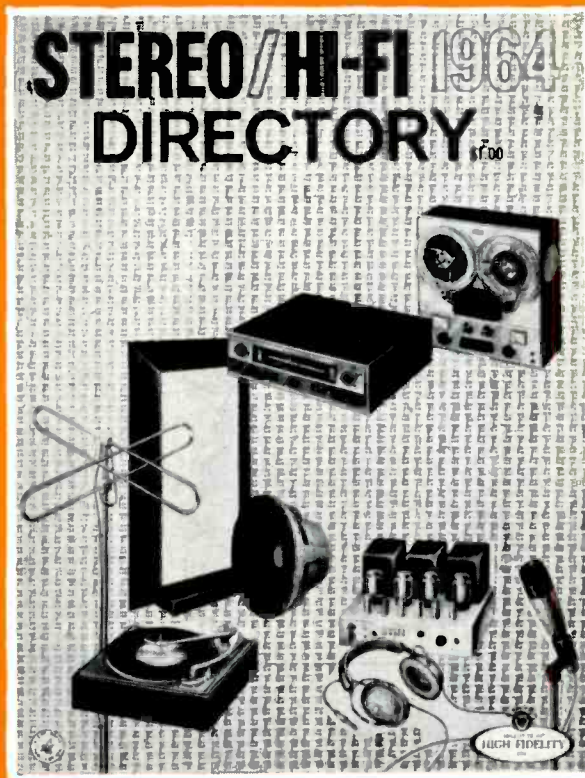

It's the world's most comprehensive **BUYERS' GUIDE** to the hi-fi market. Everything you need in sound is featured in the 180 product-packed pages of the 1964 **STEREO/HI-FI DIRECTORY**. It gives you the vital statistics—photos, prices, and performance data—on over 2000 components from 177 different manufacturers. It's the best way to see and compare speakers, enclosures, cartridges, changers, amplifiers, tone arms, FM tuners, tape recorders and FM antennas *before* you buy.

Plus you get these special features:

- How to select an FM tuner
- Tips on buying Tape Recorders
- Complete listing of all FM Stereo Multiplex Stations broadcasting in the U.S. and Canada (as of September 1963).

- Complete listing of all Hi-Fi dealers throughout the United States.

The 1964 **STEREO/HI-FI DIRECTORY** is your indispensable guide to the total-sound market. It goes on sale October 1st at your favorite newsstand or hi-fi dealer's. Or fill in this coupon and we'll send you a copy.

Price only \$1.00

Ziff-Davis Service Division Dept. SD
589 Broadway, New York 12, New York

Please send me a copy of the 1964 **STEREO/HI-FI DIRECTORY**. I enclose \$1.00, the cost of the **DIRECTORY**, plus 10¢ to cover mailing and handling charges. (Canada & Overseas: \$1.25 plus 20¢ postage.)

NAME _____

ADDRESS _____

CITY _____ ZONE _____ STATE _____

(Add 4% sales tax if N.Y.C. resident)

HF-113



The commanding presence of Sony sound

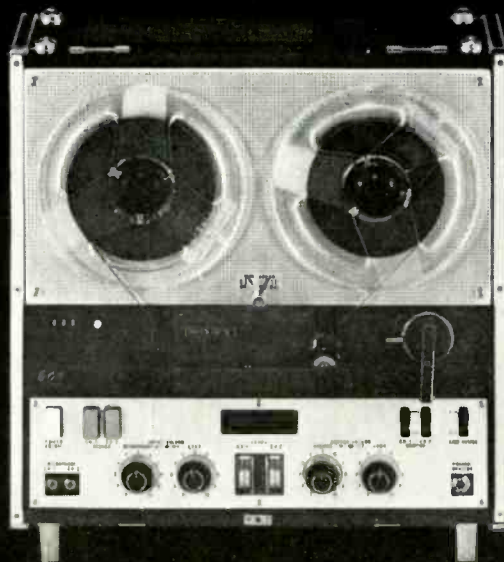

Now enter the world of the professional. With the **Sony Sterecorder 600**, a superbly engineered instrument with 3-head design, you are master of the most exacting stereophonic tape recording techniques.

Professional in every detail, from its modular circuitry to its 3-head design, this superb 4-track stereophonic and monophonic recording and playback unit provides such versatile features as: ■ vertical and horizontal operating positions ■ sound on sound ■ tape and source monitor switch ■ full 7" reel capacity ■ microphone and line mixing ■ magnetic phono and FM stereo inputs ■ 2 V.U. meters ■ hysteresis-synchronous drive motors ■ dynamically balanced capstan flywheel ■ automatic shut off ■ pause control and digital tape counter—all indispensable to the discriminating recording enthusiast. Less than \$450,* complete with carrying case and two Sony F-87 cardioid dynamic microphones.

SONY

SUPERSCOPE

The Tapeway to Stereo

Multiplex Ready!

* Yes, less than \$450!

Sony tape recorders, the most complete line of quality recording equipment in the world, start at less than \$79.50. For literature or name of nearest dealer, write Superscope, Inc., Dept. 8, Sun Valley, Calif. In New York, visit the Sony Salon, 585 Fifth Avenue.



HIFI/STEREO REVIEW'S CHOICE OF THE LATEST RECORDINGS

STEREO TAPE

Reviewed by CHRISTIE BARTER • DAVID HALL

Ⓢ **BEETHOVEN: *Symphony No. 7, in A Major, Op. 92.*** Pittsburgh Symphony Orchestra, William Steinberg cond. COMMAND CC 4T 11014 \$7.95.

Interest: Staple
Performance: Lacks weight
Recording: Good
Stereo Quality: Excellent

This is the fourth currently available Beethoven Seventh on four-track tape, and the only one not paired with another Beethoven symphony. Everest's Josef Krips tape has the "Eroica" as the extra: Ansermet's on London and Boult's on Vanguard offer the "Pastoral."

The Steinberg treatment of the Seventh seems to look to Toscanini's rhythmically crisp interpretation, but it lacks the weight that made the late Italian's reading an overwhelming experience. The Command sound is topnotch, but this is not enough to compensate for the greater communicativeness of the moderately paced readings on the Krips and Ansermet tapes. *D. H.*

Ⓢ **BEETHOVEN: *Symphony No. 9, in D Minor, Op. 125 ("Choral"); Symphony No. 8, in F Major, Op. 93.*** Emilia Cundari (soprano); Nell Rankin (mezzo-soprano); Albert da Costa (tenor); William Wilderman (bass); Westminster Symphonic Choir; Columbia Symphony Orchestra, Bruno Walter cond. COLUMBIA M2Q 511 \$11.95.

Interest: Hefty Beethoven package
Performance: Walter's way
Recording: Orchestrally warm and full
Stereo Quality: Generally good

This fourth tape version of the Beethoven Ninth is the first to offer the delectable Symphony No. 8 in addition—Reiner on RCA and Krips on Everest give us No. 1. My feelings about Bruno Walter's way with the Ninth are mixed. He treats the music in a weighty lyric manner that might work magnificently with Mahler,

Explanation of symbols:

- Ⓜ = monophonic recording
- Ⓢ = stereophonic recording

but not as well with Beethoven. Both Reiner and Krips bring more momentum to their readings, and benefit also from superior choral impact in the finale—the Westminster group sounds surprisingly anemic here.

I found the warm-hearted treatment of the F Major Symphony much the more enjoyable reading, although even in this instance one might take exception



CLIFFORD CURZON

The perfect man for the Brahms D Minor

to Walter's very leisurely treatment of the minuet and finale. The tape sound is full and warm, though not as transparent in the upper reaches as RCA's.

Tape fanciers who want a really outstanding Beethoven Ninth might do well to await the issue of Epic's tape of the Szell-Cleveland Orchestra version or, better yet, Angel's tape of the monumental Klemperer reading. *D. H.*

RECORDING OF SPECIAL MERIT

Ⓢ **BRAHMS: *Piano Concerto No. 1, in D Minor, Op. 15.*** Clifford Curzon (piano); London Symphony, George Szell cond. LONDON LCL 80126 \$7.95.

Interest: Fortunate collaboration
Performance: Penetrating

Recording: Topnotch
Stereo Quality: Outstanding

This reel brings this pianist and this conductor together for the first time, though each has recorded the Brahms D Minor before. George Szell is clearly aware of the score's beginnings as a symphony, a musical fact more talked of than observed by most conductors and the pianists they work with. And in this circumstance, Clifford Curzon was the perfect man for the job—he is entirely in accord with Szell's view and is temperamentally capable of integrating his own interpretation with that of the conductor, to the advantage of both. Curzon's playing, as a result, has more thrust and covers a broader dynamic range than usual, while Szell's leadership is more flexible. Together they shape the music distinctly and firmly. The outer movements are taut and purposeful, and the Adagio moves quietly with a marvelously sustained intensity. The only real competition on tape is the recording Szell made with the then-maturing Leon Fleisher some five years ago (Epic EC 802). This newer tape, which fully captures the pianist's ravishing tone, is as much a technical triumph as a musical one. Rarely has the balance between soloist and orchestra been so artfully achieved, and in no other concerto is that ideal blend so nearly imperative. *C. B.*

RECORDING OF SPECIAL MERIT

Ⓢ **CANTELOUBE (Arr.): *Songs of the Auvergne (Volume Two).*** Netania Davrath (soprano); orchestra, Pierre de la Roche cond. VANGUARD VTC 1666 \$7.95.

Interest: Neo-folk classics
Performance: Disarming
Recording: Bright
Stereo Quality: Adequate

With this reel, all of Joseph Canteloube's delightful settings of folk songs from the Auvergne district of France are available on tape. All but one of the fifteen are here recorded for the first time. Netania Davrath, an Israeli soprano who proved in the first collection (Vanguard



Crown

— first choice
of those who
demand the best!

NEW

**Solid
State**

CONTROL CENTER
FOR SERIES 800, 1000
AND 1400 MODELS

DOUBLES
former performance

Quarter-Track Record/Play Data

ips	db	cps	s/n
7-1/2	±2	50 — 30,000	56db
3-3/4	±2	30 — 20,000	52db
1-7/8	±3	30 — 16,000	50db
15/16	±3	30 — 10,000	48db

The most complete recording instruments ever designed for stereo use. Audio circuitry, ±1/4 db from 10-100,000 cps; extended range, 5-500,000 cps. Plug-in circuit modules are printed on epoxy and gold plated. Engineered to space craft reliability.

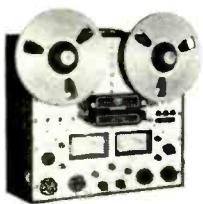

THE HALLMARK
OF CROWN —
SUPERLATIVE
CRAFTSMANSHIP
THROUGHOUT!

**INDIVIDUAL PERFORMANCE
RECORD SUPPLIED
WITH EACH CROWN**

WRITE DEPT. HI-11



**Crown
INTERNATIONAL**
1718 Mishawaka Rd. • Elkhart, Ind.

CIRCLE NO. 24 ON READER SERVICE CARD
122

VTC 1636) that she has a flair for the idiom of these songs, does it again in her second. She vividly conveys the color and elemental drama of the texts in their quaintly archaic tongue. Two songs, *Jou l'pount d'o Mirabel* and *Là Haut, sur le rocher*, with their suggestions of violence, are curiously interesting, because most of the Auvergne songs that Canteloube transcribed have to do with the simple joys and fleeting sorrows of shepherds and shepherdesses. In these latter, it is hard to imagine any singer surpassing Miss Davrath for vocal charm. The sound is very good indeed. *C. B.*

© **CILÈA: *Adriana Lecouvreur* (excerpts)**. Renata Tebaldi (soprano), Adriana; Mario del Monaco (tenor), Maurizio; Giulietta Simionato (mezzo-soprano), Principessa di Bouillon; Giulio Fioravanti (baritone), Michonnet. Chorus and Orchestra of the Accademia di Santa Cecilia Rome, Franco Capuana cond. LONDON LOL 90065 \$7.95.

Interest: Well-chosen highlights
Performance: Robust but variable
Recording: Okay
Stereo Quality: Effective

My feelings about the Tebaldi-Del Monaco performance of this operatic melodrammer, set out in these pages last October, remain unchanged: that the soprano is vocally and temperamentally as suitable an Adriana as any around today, and that the tenor, with whom she has been so closely associated in previous recordings, might better have been replaced for this one. It is worth noting that although their voices seem to clash terribly in their first love duet, they achieve a remarkably fine blend in the finale. Otherwise, the brighter spots among these generally well-edited highlights include Giulio Fioravanti's affecting "*Ecco il monologo*," Giulietta Simionato's lucid "*Acerba voluttà*" opening the second act, and Miss Tebaldi's lovely "*Poveri fiori*" near the end of the opera. The stereo engineering is realistic, the sound clean and full-bodied. *C. B.*

RECORDING OF SPECIAL MERIT

© **PERGOLESI: *Concertinos No. 2, in G Major; No. 3, in A Major; No. 4, in F Minor; Concerto in G Major, for Flute, Strings, and Continuo***. André Jaunet (flute); Zurich Chamber Orchestra, Edmond de Stoutz cond. VANGUARD VTC 1665 \$7.95.

Interest: Baroque gems
Performance: Spirited
Recording: Clean
Stereo Quality: Acceptable

This is the first reel devoted to the music of Pergolesi, and includes one of his

two concertos for flute with violin and figured-bass accompaniment, and three of the six concertinos generally credited to this composer. Among the latter, probably the most ingratiating is the C Major, though the A Major has a lovely Andante played by muted strings, and the F Minor an equally engaging canonic movement nominally based on a theme by Palestrina. The more familiar flute concerto is distinguished by a charming, dance-like finale and, in this instance, by the splendid solo work of André Jaunet. Comparison of this performance of the G Major concertino with that by I Solisti di Zagreb emphasizes the extent to which this Zurich-based ensemble and its conductor favor distinct contrasts in tempo from one movement to the next, for the most part merely observing the composer's markings. Their playing has warmth and dynamic vigor, and the flawless recorded sound serves them most beautifully. *C. B.*

© **TCHAIKOVSKY: *Symphony No. 4, in F Minor, Op. 36***. New York Philharmonic, Leonard Bernstein cond. COLUMBIA MQ 545 \$7.95.

Interest: A long-awaited Fourth
Performance: Compelling
Recording: Tops
Stereo Quality: Impressive

Since its release on discs some five years ago, Leonard Bernstein's recording of Tchaikovsky's Fourth Symphony has been considered one of the most satisfying of all stereo versions. It is therefore particularly welcome on tape, even though it stands pretty much on a par with Pierre Monteux's for RCA Victor (FTC 2031). Neither can be recommended with any decisiveness over the other. Monteux tends to push the second movement, Bernstein rushes the finale. Otherwise the younger conductor adopts surprisingly relaxed tempos, notably in the first movement, yet without sacrificing inner tension or emotional vitality. His slow movement is warmly expressive, his Scherzo appropriately fanciful, his concluding Allegro dynamically robust. The clear and handsomely proportioned recorded sound further distinguish this reel. *C. B.*

© **VERDI: *Un Ballo in maschera* (excerpts)**. Birgit Nilsson (soprano), Amelia; Carlo Bergonzi (tenor), Riccardo; Cornell MacNeil (baritone), Renato; Giulietta Simionato (mezzo-soprano), Ulrica; Sylvia Stahlman (soprano), Oscar. Chorus and Orchestra of the Accademia di Santa Cecilia Rome, Georg Solti cond. LONDON LOL 90060 \$7.95.

Interest: Minimal
Performance: Unconvincing
(Continued on page 124)

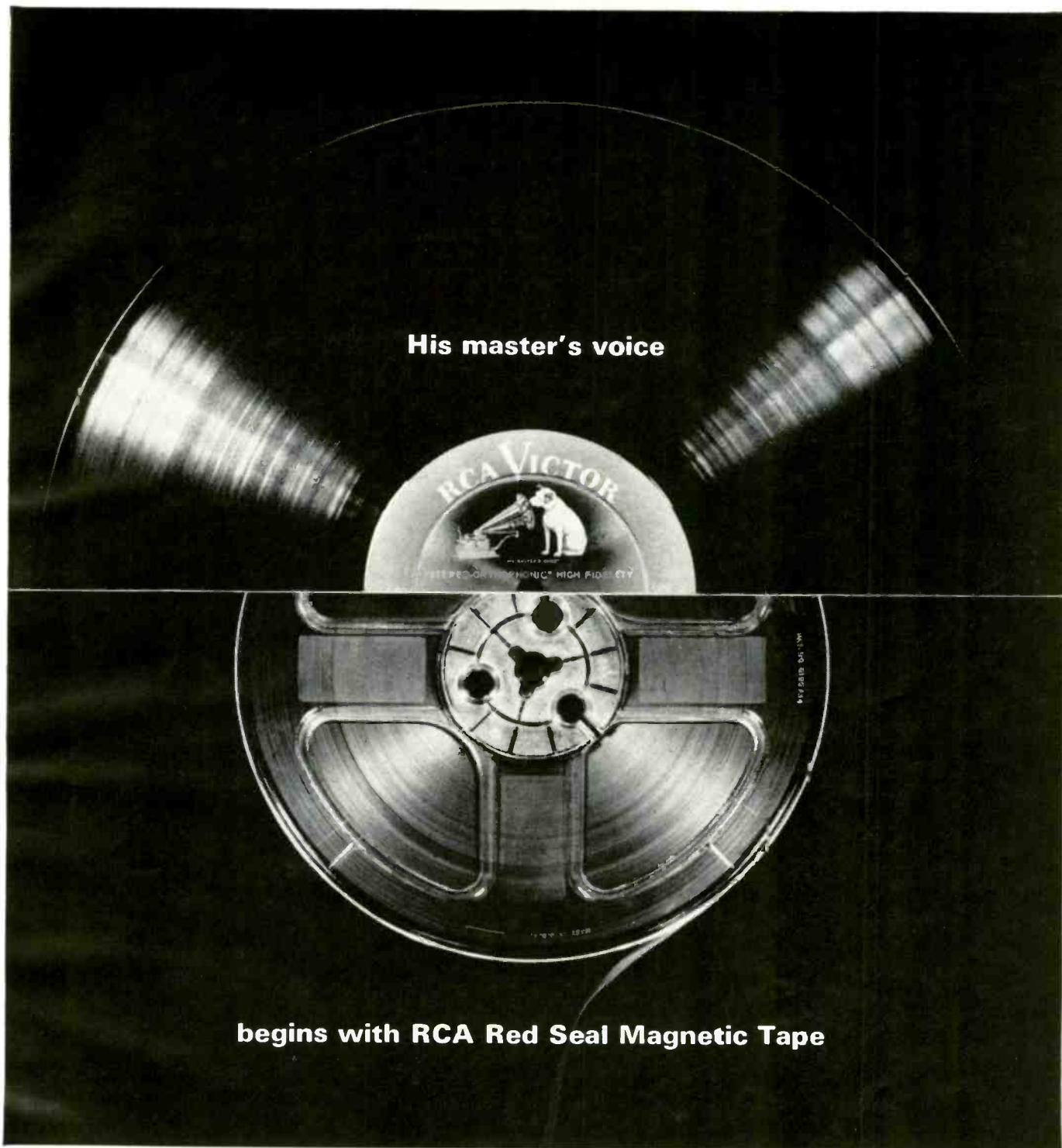

His master's voice

begins with RCA Red Seal Magnetic Tape

(the very same super-quality sound tape available to you!)

The world's greatest artists are recorded on RCA Victor Red Seal Records. And the first-generation source of this great sound is RCA Red Seal Magnetic Recording Tape—the same super-quality tape you can obtain (and should demand!) wherever you buy recording sup-



plies. No matter what the job, for the unqualified best in home recording always specify RCA RED SEAL MAGNETIC TAPE. Also ask your dealer about the economical "Vibrant Series" Sound Tape—the high quality, low-cost magnetic tape, in all standard reel sizes.



The Most Trusted Name in Sound

RADIO CORPORATION OF AMERICA

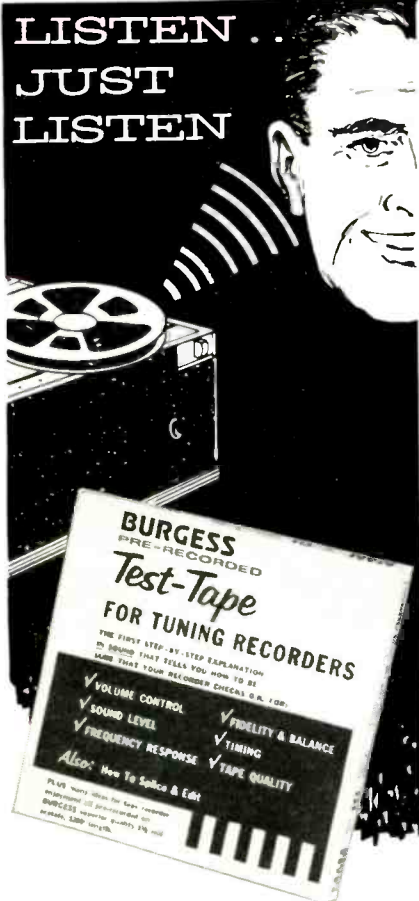

NEW BURGESS Test-Tape

checks your tape recorder
Accurately & Completely
without expensive test gear!

For the first time, the home tape recorder can test his own tape recorder and check it for maximum record and playback efficiency simply by listening to a tape. Burgess Test-Tape is the first step by step explanation in sound that will check home tape recorders... accurately and completely. It's available now from your Burgess tape dealer.

NEW BURGESS Test-Tape CHECKS YOUR RECORDER FOR:

- ✓ Volume Control
- ✓ Sound Level
- ✓ Frequency Response
- ✓ Fidelity & Balance
- ✓ Timing
- ✓ Tape Quality

Also: HOW TO SPlice & EDIT

Get new BURGESS TEST-TAPE at your favorite store or write:

BURGESS BATTERY COMPANY

DIVISION OF SERVEL, INC.

MAGNETIC TAPE DIVISION

Freeport, Illinois • Niagara Falls, Canada

CIRCLE NO. 17 ON READER SERVICE CARD
124

Recording: Very good
Stereo Quality: Impressive

⑤ **VERDI: Arias.** Birgit Nilsson (soprano); Orchestra of the Royal Opera House Covent Garden, Argeo Quadri cond. LONDON LOL 90058 \$7.95.

Interest: Rousers
Performance: Opulent but unidiomatic
Recording: Good presence
Stereo Quality: Fine

The complete London recording of *Un Ballo in maschera* (LOG 90039) proved to be one of the company's least successful operatic productions in recent years, and the reel highlighting the same performance simply confirms that unpleasant fact. There is no other version on tape at the moment. Yet these excerpts make it more apparent than before that the casting was uneven to begin with and that the conductor was unable to rectify the situation. His attempts at feeling what Verdi intended in the music lead to a self-conscious emotionalism that similarly afflicts Birgit Nilsson's portrayal of Amelia and contributes to the sense of strain in Carlo Bergonzi's Riccardo. Together in the second-act duet, these two principals seem to lend one another a helping hand stylistically, but just as they are about to make a go of it, with Riccardo's "M'ami, m'ami... o sia dis-trutto," the sequence break intervenes. As Renato, Cornell MacNeil conveys a nice sense of pathos in his "Eri tu," and Giulietta Simionato is an imposing Ulrica. Sylvia Stahlman's vocally secure "Volta la terra" is harmed by the recording, which elsewhere maintains a pretty favorable balance for the singers. The biggest orchestral tuttis occasionally overwhelm the ensembles, but the tape does faithfully reproduce their full range, as the discs do not, except on the very best playback equipment.

Miss Nilsson's reel of Verdi arias is likewise only a partial success. Again, the ease and opulence of her vocal outpouring is something to marvel at, but it is also obvious that the soprano is temperamentally at odds with the roles—Abigail in *Nabucco*, Leonora in *La Forza*, Eboli in *Don Carlos*, Lady Macbeth—and that she is singing in a language not her own. Argeo Quadri gives her solid support, and the performances reach a high pitch of excitement at times, but Miss Nilsson's enthusiasm for the project is not quite enough to obviate its shortcomings. C. B.

ENTERTAINMENT

⑤ **HARRY BELAFONTE: Streets I Have Walked.** Harry Belafonte (vocals); orchestra and chorus, Howard Roberts cond. *Sit Down; Erev Shel Shoshanim; Waltzing Matilda; My Old*

Paint; and eight others. RCA VICTOR FTP 1196 \$7.95.

Interest: Ballads from all over
Performance: Assured
Recording: Very good
Stereo Quality: Just right

Harry Belafonte's interest in folk music of varied origin is nowhere better exemplified than on this tape, which embraces songs from South Africa (*Mangwene Mpulele*), Israel (*Erev Shel Shoshanim*), Portugal (*Tunga*), and even Japan (*Sakura*), as well as a selection of Negro spirituals. They are all forcefully done, the instrumental backing provided for each number having a distinct color compatible with the source. This is not to say that the program has too high a polish. But, as usual, Belafonte takes advantage of the hard sell to put himself across.

A chorus of young voices from the Springfield Gardens, N.Y., Junior High School, used to create a "setting" for the early spiritual *Sit Down* and some of the other ballads, is a felicitous touch. The recorded sound is lifelike, but Belafonte himself is miked so closely that his words are often too sibilant. C. B.



BIRGIT NILSSON

Vocal ease and opulence for Verdi

⑤ **ELLA FITZGERALD: Sings Broadway.** Ella Fitzgerald (vocals); orchestra. *Hernando's Hideaway; If I Were a Bell; Warm All Over; Almost Like Being in Love;* and eight others. VERVE VSTC 291 \$7.95.

Interest: Mixed Broadway bag
Performance: Variable
Recording: Very good
Stereo Quality: Ditto

Ella Fitzgerald has made quite a thing of Broadway's past in songbooks devoted to George Gershwin, Rodgers and Hart, Irving Berlin, and Harold Arlen. The news here is that she has moved to Frank Loesser and the more recent teams of Rodgers and Hammerstein, Lerner and Loewe, Adler and Ross. Unfortunately, not all of her choices are suited to her

style and temperament. Specialty numbers like *Hernando's Hideaway* and *Steam Heat* demand a feeling for hokum she does not possess, and the essential simplicity of a ballad like *Dites-Moi* or the infectious shoes-off charm of *I Could Have Danced All Night* elude her completely. Ella is best in the ballads that all but sing themselves—*If I Were a Bell*, *Almost Like Being in Love*, *Somebody Somewhere*, and *No Other Love*. Here she sings with warmth and understanding in her customary free-and-easy manner. Her backing is satisfactory, if at times a little overpowering, and the recorded sound is remarkably good. C. B.

© ALAN LOMAX: *Raise a Ruckus and Have a Hootenanny*. Alan Lomax (vocals and guitar); the Dupree Family (vocals and instrumentals). *A Pretty Girl Is Like a Little Bird: Old Blue; Railroad Bill; Brady*; and eight others. KAPP KTL 41054 \$7.95.

Interest: American musical lore
Performance: Lusty
Recording: Good
Stereo Quality: Adequate

The goings-on here are not really as wild as the title makes out, though Alan Lomax's rough-and-ready voice can stir up a fair amount of noise and excitement. The songs he sings on this reel, with the hearty backing of the Duprees, are with one exception American in origin, mostly collected in the field by Lomax himself. As you might expect, they have to do with legendary badmen, vagrant wanderers, an occasional pretty lass, and sundry folks who jus' plain got trouble. A nice collection, well recorded. C. B.

© FRANK SINATRA: *Come Swing with Me!* Frank Sinatra (vocals); orchestra, Billy May cond. *Day by Day; Sentimental Journey; Almost Like Being in Love; Five Minutes More*; and eight others. CAPITOL ZW 1594 \$7.98.

Interest: Songs of Thirties and Forties
Performance: Pro
Recording: Good
Stereo Quality: Morked

Frank Sinatra here revisits some of the vehicles that helped him get his start. The voice of years gone by may be a little huskier now, but it is also freer and more flexible. This collection ranges from some less than memorable ditties such as *Five Minutes More* to the more enduring classics—*Sentimental Journey* and *That Old Black Magic*. They are worthies all, and are rendered with ease, assured style, and I suspect more fondness than shows through the rather slick veneer. Billy May's big-band arrangements are appropriate, and the engineering is altogether acceptable. C. B.

NOW...FAMOUS FREEMAN PROFESSIONAL RECORDERS

*Offer Studio Performance
In Your Family Circle
easiest to operate...most fun to use*

**World's
first...
Stereophonic
Robot**

Shown with C-246 Console Cabinet Price \$149.50 Audiophile Net



FREEMAN "200" STEREOPHONIC ROBOT
Audiophile Net \$995.00

- Automatic Reverse
- 4 Broadcast Heads
- 100% Transistorized
- 4-Channel Mixer
- Touchbutton Operation
- Automatic Continuous Play
- 40 Watt Stereo Output
- Tape or Source Monitoring
- 3 Hysteresis Synchronous Motors
- Echo Chamber

Audiophile Net \$399.50

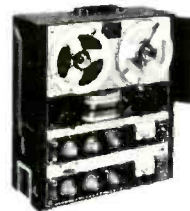

**ONLY THE FREEMAN
"600" OFFERS**

- Automatic Shut-off
- Hysteresis Synchronous Motor
- 3 Head Professional Stereo Design
- 15 Watt Stereo Output
- Qualifies For School Use
- A Complete Home Music System
- No Competition Under \$600

Audiophile Net
\$139.50



THE UNEQUALED "550"

Tapes up to two hours. The finest lecture, report and conference recorder in the world. Battery or AC power.



Audiophile Net
\$159.50

THE FABULOUS "660"

Now, everyone can tape high fidelity anytime, anywhere in a 6-lb package. Battery or AC power.



FREEMAN ELECTRONICS CORP., Dept. HFS-11

729 N. Highland Avenue, Los Angeles 38, California

In Canada: 1156 Beechwood Crescent, North Vancouver, B.C.

19 Le Royer St., W., Montreal 1, Que.

International Office: Ovimpex, Inc., 176 Broadway, New York 38, N.Y.

Please send me:

- Booklet containing ingenious suggestions on how to get the most from a tape recorder at work or play. I enclose 25¢ (coin, stamps) for postage and handling.

- Name of nearest dealer.

Information on:

- Model 200
 Model 600
 Model 550
 Model 660

- Model DM-166
Microphone
 Model SEP-100
Stereophones

Name _____

Address _____

City _____ Zone _____ State _____

WHEN IN LOS ANGELES, BE SURE TO VISIT THE FREEMAN RECORDER SALON, 731 N. HIGHLAND

KODAK

Kodak

SOUND RECORDING TAPE

**Durol Base
NEW HIGH STRENGTH
TRIACETATE**

31A

Kodak

SOUND RECORDING TAPE

1/4 IN. x 1200 FT. 15 SP. 1/2 MI. TRIACETATE No. 31A12

**New DUROL Base for
extra strength.**

**New Polyester Base
for extended play**

SOUND

KO

Kodak

SOUND RECORDING TA

TWO NEW TAPES FROM KODAK...

both with high-performance
oxide layer that provides
brilliant sound quality

With its new bases and oxide layer Kodak Sound Recording Tape now becomes an all-new standard of tape quality:

Two new bases. New DUROL Base for Kodak tape is a new triacetate that is 40% stronger, yet breaks clean in case of accident. It permits splicing a break without loss of recorded sound. Kodak tape on 1½-mil DUROL Base can be your standard of tape excellence. For 50% longer play choose the 1-mil thickness. To double the recording time, get Kodak Sound Recording Tape on ½-mil Polyester Base.

New oxide layer. Kodak emulsion scientists have found a better way to disperse the recording oxide in a new, tougher resin binder. Result: a smoother oxide surface which reduces residual noise and recording head wear, increases high-frequency response.

KODAK Thread-Easy Reel. Simply pull tape through the slot—it's loaded! Timesaving splicing jigs and index scales are on both sides of reel. Try all new Kodak Sound Recording Tape soon. At your Kodak dealer's now!

Exclusive Backprinting. All Kodak tapes are printed on the base side with our company name and manufacturing control number as your assurance of quality and uniformity.



Remember: You get each 7-inch roll of Kodak tape on the popular Kodak Thread-Easy Reel.

EASTMAN KODAK COMPANY
ROCHESTER 4, N. Y.

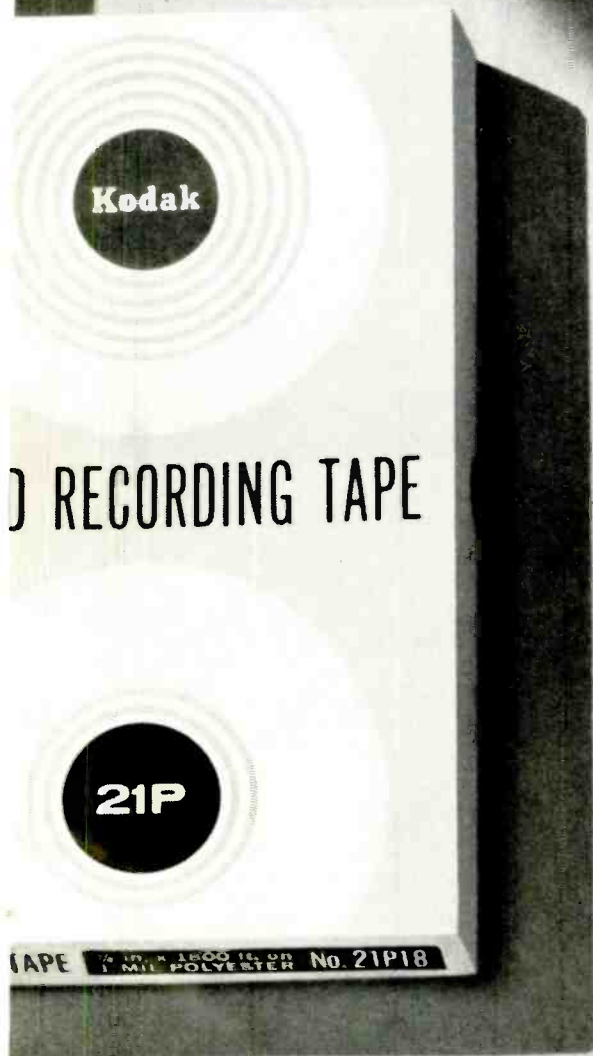

©Eastman Kodak Company MCX114

Kodak
TRADEMARK



SONY®

RESEARCH MAKES THE DIFFERENCE

stars on every gift list

This year let SONY star on every gift list. There is a quality SONY transistorized set for everyone—fine FM for Dad, truly portable TV for Mother, sensitive pocketable for Sis, and powerful multiband for Brother. (1) TR-817, 8-transistor pocketable with tone control. With battery, earphone, case.

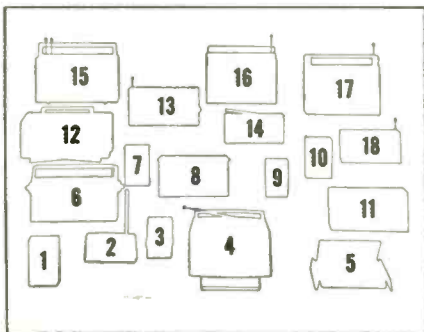

\$39.95. (2) TR-725, 7-transistor pocketable for broadcast, shortwave. With battery, earphone, case. \$39.95. (3) TR-650, 6-transistor pocketable with big sound quality. With battery, earphone, case. \$19.95. (4) Micro-TV, 8-lbs., 25 transistors, 3-way operation. \$189.95. UHF converter, \$49.95. (5) TR-624, 6-transistor desk set pops open and plays. With batteries. \$34.95. (6) EFM-117, 11-transistor FM/AM portable with all top features. With batteries, earphone. \$89.95. (7) TR-826, sensitive 8-transistor pocketable with quality tone. With battery, earphone, case. \$24.95. (8) TR-751, 7-transistor portable with tone control. With batteries, earphone, case. \$29.95. (9) TR-621, 6-transistor pocketable with built-in watch to turn set on, off. With battery, earphone, case. \$49.95. (10) TFM-825, pocketable 8-transistor FM/AM set weighs 10 ozs. With battery, earphone, case. \$39.95. (11) TR-818,

8-transistor portable with extra selectivity. With batteries, earphone, case. \$49.95. (12) TR-6120, 6-transistor cordless table set weighs 4 lbs. With batteries. \$29.95. (13) TR-910T, 9-transistor 3-band portable for standard, shortwave. With batteries, earphone, case. \$59.95. (14) TFM-96, FM/AM portable with 9-transistors and superb sound quality. With batteries, earphone, case. \$49.95. (15) TFM-116A, super sensitive 11-transistor FM/AM portable has marine band, too. With batteries, earphone. \$99.95. Case extra. (16) TFM-951, 9-transistor FM/AM portable doubles as car set, with optional bracket. With batteries, earphone. \$79.95. (17) TR-911, 9-transistor portable for broadcast, shortwave. With batteries. \$99.95. Case optional. (18) TR-820A, 8-transistor broadcast and marine portable. Complete with batteries, earphone, case. \$39.95.

SONY CORPORATION OF AMERICA • 580 FIFTH AVE., N.Y. 36, N.Y. • REGIONAL OFFICES: LOS ANGELES • CHICAGO



HIFI/STEREO REVIEW'S CHOICE OF THE LATEST RECORDINGS

ENTERTAINMENT

POPS • HUMOR • FILMS • THEATER • FOLK • SPOKEN WORD

Reviewed by JOE GOLDBERG • STANLEY GREEN • NAT HENTOFF • PAUL KRESH

Ⓢ Ⓜ ANDREWS GOSPEL SINGERS: *Open Your Heart*. Andrews Gospel Singers (vocals); accompaniment. *Does Jesus Care; I Won't Turn Back; Faith; He's a Mighty God*; and eight others. CAPITOL ST 1959 \$4.98, T 1959* \$3.98.

Interest: Pop gospel
Performance: Fervent
Recording: Excellent
Stereo Quality: Good

It was perhaps inevitable that gospel music should become popular. For the past several years, much of jazz and rock-and-roll has used gospel as a jumping-off place. But the recent spate of "pop gospel" has caused concern to such purists as Mahalia Jackson, and it is the presentation, more than the music itself, that has been the problem. If the sex-and-religion night-club formula continues, we may soon have gospel strip joints, perhaps with an ecdysiast named Amazing Grace.

Capitol here presents an example of what the company paradoxically calls "authentic pop-gospel": the Andrews Gospel Singers, six girls formerly known as the Andrews Sisters. It is difficult not to smile at a hymn to Jesus called *He Satisfies*, and it is impossible to overlook the kinship to sentimental pops in *The Miracle*, in which one almost expects to hear the line, "It took a miracle to bring me you." The Andrews Singers look to Clara Ward for inspiration. They do not come close to the excitement she generates, but, like Miss Ward, they scrupulously avoid the lower end of the emotional scale. The result sounds like poor recording, but it is the frenetic treatment that is responsible.

Soon Ah Will Be Done is the song Mahalia Jackson does as *Trouble of the World*. Miss Jackson's title and approach contain a poetry the Andrews Singers nowhere approximate. J. G.

Explanation of symbols:

- Ⓜ = monophonic recording
- Ⓢ = stereophonic recording
- * = mono or stereo version not received for review

Ⓢ Ⓜ RAY ANTHONY: *Smash Hits of '63*. Ray Anthony Orchestra. *On Broadway; End of the World; Preacher-man*; and nine others. CAPITOL ST 1917 \$4.98, T 1917* \$3.98.

Interest: Mediocre
Performance: Intimate and appealing
Recording: All right
Stereo Quality: Good

Showing the symptoms of myopic press-agentry, the author of the liner notes for this disc states: "Rarely or never in recent years have so many [hits] emerged



COLUMBIA RECORDS

ANITA BRYANT
Ideal interpreter of pop hits

so swiftly as all-time smashes." Of the dozen current chart-leaders included here, I can't imagine any becoming "all-time smashes," save possibly a thirty-four-year-old ringer called *Love for Sale*. Ray Anthony, however, treats them all with imagination and respect, making *Meditation* (a bossa nova) and *Our Day Will Come* not only bearable but genuinely appealing. His approach is generally light and intimate throughout, and many pieces are backed only by a rhythm group. Upon occasion, a muddy-sounding vocal chorus chimes in, though mercifully (except in the case of *Walk Right In*) it seems to have been collectively unable to memorize anything but titles. S. G.

Ⓢ Ⓜ TONY BENNETT: *This Is All I Ask*. Tony Bennett (vocals); The Ralph Sharon Trio; orchestra, Ralph Burns cond. *Sandy's Smile; Autumn in Rome; Tricks*; and nine others. COLUMBIA CS 8856 \$4.98, CL 2056* \$3.98.

Interest: Mixed ballads
Performance: Convincing
Recording: Fine
Stereo Quality: All right

It is a paradox that Tony Bennett's rusty, steel-file voice should be so effective at interpreting ballads. Lacking any inherent warmth, it conveys the appropriate sentiments with honest conviction if not always with vocal ease or purity of tone. Bennett's current crop is a mixed selection, ranging from corny old-timers (*Keep Smiling at Trouble*) through show tunes (the delightful *Other Side of the Tracks*) right up to some of the current Tin Pan Alley output. I find the title piece fairly pretentious ("Wandering raindrops, leave a bit of color for my heart to own"), but there is a tender, folksy piece called *Long about Now* that is worth getting to know. S. G.

Ⓢ Ⓜ ANITA BRYANT: *Greatest Hits*. Anita Bryant (vocals); orchestra. *Paper Roses; Till There Was You; Pretty Lies*; and nine others. COLUMBIA CS 8756 \$4.98, CL 1956* \$3.98.

Interest: Teen-age tunes
Performance: Persuasive
Recording: Fine
Stereo Quality: Satisfactory

Taking some of Miss Bryant's most successful single releases, Columbia has repackaged them into a rather diverting disc. All of the numbers are aimed at the teen-age market, which, of course, means that the emotions will be simple and direct and that there will be a strong country flavor throughout. The songs have been fashioned with skill, and Miss Bryant's lyrical, well-controlled voice is ideal for interpreting them. S. G.

Ⓢ Ⓜ JOHNNY CASH: *Ring of Fire*. Johnny Cash (vocals); orchestra. *I'd Still Be There; The Big Battle; Remem-*

NEW DECOR AND SIZE NEW PERFORMANCE

This is the Exciting New "CG" Cavity Generator Spherical Sound System.

"CG" Construction and Performance are uniquely different than anything you have ever known and create a new awakening in Market Standards, in Quality, and in Price!

Check with your local dealer or send for complete information.



Introducing the
CAMILLE SERIES
Size: 11"x8"x1 1/4"—Full Frequency Range (without boom). Power: 5 Watts (measured). Propagation: 350 Spherical Degrees. Optional Finishes: Oilc Walnut, Harw Maple or Lined Oak. Modestly Priced at **\$39.95**

Murray-Carson Corporation

2424 E. 55th STREET, DEPT. 3A, INDIANAPOLIS 20, INDIANA

NEW LISTENING PLEASURE NEW PRINCIPLE
CIRCLE NO. 59 ON READER SERVICE CARD

3 GREAT NEW ARTISTS



RÉGINE CRESPIN
OPERATIC RECITAL
Arias from Il Trovatore, Un Ballo in Maschera, Otello, La Gioconda, Cavalleria Rusticana, Madama Butterfly, Metastasio. Orchestra of the Royal Opera House, Covent Garden—Edward Downes.
Stereo OS-25799 Mono 5799



Schubert SCHWANENGSANG
Hermann Prey (baritone) with Peter Klief (piano).
Stereo OS-25797 Mono 5797



NICOLAI GHIAUROV: BASS ARIAS FROM RUSSIAN & ITALIAN OPERAS
Arias from Sadko, Boris Godunov, Eugene Onegin, Aleko, Don Carlos, Nabucco, Don Giovanni. London Symphony Orchestra—Edward Downes.
Stereo OS-25769 Mono 5769



ber the Alamo; Peace in the Valley; and eight others. COLUMBIA CS 8853 \$4.98, CL 2053* \$3.98.

Interest: Pop Americana
Performance: Robust
Recording: Vivid
Stereo Quality: Good

The notes on this album, subtitled "The Best of Johnny Cash," proclaim that the performer is "an immensely exciting singer and actor, a gifted composer and something of a philosopher." None of these qualities are in evidence here. Cash, born in Arkansas, has some roots in country music, but like an ever-increasing number of singers shaped in Nashville recording studios, he has become smoothly eclectic.

His material, to be sure, often has a country feeling, and his own compositions sometimes tell of bold exploits of the sort that are associated with folk songs. Yet, there is practically no folk quality in his singing itself—in phrasing or in texture. Cash uses his big, virile voice within far too narrow a spectrum of color. His beat is rather plodding, and despite his clear enunciation he fails to make himself very compelling in narrative songs.

The program includes love ballads, sacred songs, and tales of battle. A challenging musical setting could conceivably spur Cash into more arresting interpretations, but all the backgrounds in this set are quite safely on the commercial side. N. H.

© (M) **NAT KING COLE: Dear Lonely Hearts.** Nat King Cole (vocals); orchestra, Belford Hendricks cond. *Near You; Miss You; Why Should I Cry Over You?*; and nine others. CAPITOL ST 1838 \$4.98, T 1838* \$3.98.

Interest: Mostly tearjerkers
Performance: Typical
Recording: Satisfactory
Stereo Quality: Good

Ever since the success of his *Ramblin' Rose* recording, Nat King Cole has been busily digging for more musical gold in the back-country hills. The current collection embraces some of the better-known staples in the unrequited love area, most of them done with a quasi-country-and-western backing. Cole is all honey and cream throughout, faltering only on an ill-advised rock-and-roll going over he gives to something called *My First and Only Lover*. S. G.

© (M) **NAT KING COLE: Those Lazy-Hazy-Crazy Days of Summer.** Nat King Cole (vocals); orchestra and chorus, Ralph Carmichael cond. *After the Ball Is Over; You Tell Me Your*
(Continued on page 132)

a **marantz** owner

Forever

There is no such thing as a typical Marantz owner—unless one can say they are firmly devoted. Some may have determined at the outset that they would have only Marantz. For still others it may have been a matter of budgeting, with planned growth to a full Marantz system.

We have, however, been receiving an ever increasing number of letters from recent Marantz "converts", indicating surprise at the extent of the improvement obtained. They are now convinced of the difference, and are Marantz owners forever.

Whether one is buying soap or automobiles, it is difficult to evaluate conflicting claims and counterclaims of superiority. Yet, when it comes to stereo amplifiers and preamplifiers, almost anyone will acknowledge that Marantz is outstanding from any point—whether performance, precision, quality of construction, reliability, or sound quality.

Hear for yourself what the finest music reproduction sounds like—and you too will be a confirmed Marantz owner—forever!

an important message



Most of you who visited the recent New York High Fidelity Music Show saw and heard the first production examples of our Model 10 Stereo FM Tuner. I was pleased to personally demonstrate the highly advanced features of this superb tuner to thousands of interested people. In addition we sprung a little surprise—the display of prototypes of our forthcoming indoor antennas, Models 11A and 11B. They are compact, directional, easily rotated, and have at least the gain of a good dipole. There are no electronic boosters to add noise or distortion. This is not intended to be a substitute for a good outdoor antenna, but is designed for use where such installations are prohibited. Drop us a card and we will be happy to send you a data sheet on this interesting product.

S. Marantz President



Superb American Craftsmanship **marantz**
25-14 BROADWAY, LONG ISLAND CITY 6, NEW YORK

Model 7 Stereo Console • 1M distortion @ 10V eq. pk. RMS, within 0.15%, 0.1% typical • Hum and noise, 80 db below 10 mv phono input • Sensitivity, 400 microvolts (0.4 millivolts) for 1 volt output • Equalizer and tone curves matched to better than 0.5 db • Beautiful precision construction • Price \$264 (Cabinet extra)

Model 8B Stereo Amplifier • 35 watts per channel (70 watts peak) • Harmonic distortion, less than 0.1% in most of range, less than 0.5% at 20 cps and 20 kc • Hum and noise, better than 90 db below 35 watts • Exceptional stability assures superb clarity with all types of loudspeakers • Price \$264.

Model 9 Amplifier—70 watt basic amplifier • Response at 70W, ± 0.1 db, 20 cps to 20 kc • Harmonic distortion, less than 0.1% in most of range, 0.3% at 20 cps and 20 kc. • Hum & noise, better than -90 db • Completely stable for smooth response • Built-in metered tests and adjustments • Price \$384 each. (higher in West)



Built in Beauty & Finger-tip Control with — Audio Accessories by Mosley

Six Position Switch Plate

This high quality switch plate is available in two styles and are designed for installation at a central point and control any speaker or combination of speakers installed in remote locations. Mosley No. FAS-6 has six heavy duty push button switches and will control one speaker from each switch. This is a six position switch for switching any combination of six speakers used in Hi-Fi or intercom. Mosley FST-6 has the same outward appearance as the FAS-6 but contains six dual channel switches for stereo installation. Both are easily installed with F-9 mounting brackets.

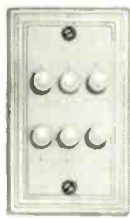

Attenuator Plate

Model No. FAV-1, available in brown or ivory polystyrene plate with satin finished anodized aluminum dial face and modern indicator knob. Use to assemble L-pad, T-pad, Fader etc. for Audio & Hi-Fi systems. Less control. Model No. FAV-2 has the added feature of plug and jack supplied for additional external speakers.



Speaker Wall Plate Outlet

Model No. FAS-1PK, comes in brown or ivory polystyrene flush mounting outlet. Speaker socket and plug are polarized and solderless. Ideal for custom Hi-Fi installation where remote speakers are not permanently installed. Complete with mounting brackets and instructions. Model No. FAS-11PK has the double advantage of two outlets.



Mosley Electronics, Inc.

4610 N. Lindbergh Blvd. — Bridgeton, Mo. 63044
CIRCLE NO. 58 ON READER SERVICE CARD

NEVER FAIL— ZONE YOUR MAIL

The Post Office has divided 106 cities into postal delivery zones to speed mail delivery. Be sure to include zone number when writing to these cities; be sure to include **your** zone number in **your** return address —after the city, before the state.

Dream; Don't Forget; and nine others.
CAPITOL ST 1932 \$4.98, T 1932* \$3.98.

Interest: Mostly old-timers
Performance: Light-hearted
Recording: Satisfactory
Stereo Quality: Good enough

He may be somewhat buried under an energetic vocal chorus, but Nat King Cole seems to be having himself a ball as he goes through this collection of old-timers and imitations of old-timers. It is a carefree collection, fine for that sing-along urge, with the nostalgic period flavor retained throughout. You may be slightly shocked to note on the record label that Cole—who wasn't even born when they were written—is given co-author credit for such public-domain items as *After the Ball Is Over, The Sidewalks of New York, and In the Good Old Summertime.* S. G.

© © PERRY COMO: *The Songs I Love.* Perry Como (vocals); Mitchell Ayres and his Orchestra. *Fly Me to the Moon; Carnival; I Wanna Be Around;* and nine others. RCA VICTOR LSP 2708 \$4.98, LPM 2708* \$3.98.

Interest: Pleasant standards
Performance: Some of Perry's best
Recording: Bright and clean
Stereo Quality: Very good

Mixing some of the more attractive recent pieces with worthwhile standards, Perry Como has turned up with one of his best albums in quite a spell. Though still a genial, relaxed interpreter, he brings to these numbers an unexpected and welcome dramatic projection, particularly noticeable on such heart-on-the-sleeve stand-bys as *San Francisco, My Coloring Book, and What Kind of Fool Am I?* I was also taken with Mr. Como's two bossa nova items, *Slightly Out of Tune (Desafinado)* and *Carnival (the Black Orpheus theme)*, which he invests with just the right note of casualness. Mitchell Ayres' backing is sympathetic, and guitarist Tony Mottola shines brightly on a few of the tracks. S. G.

© © VIC DAMONE: *The Liveliest.* Vic Damone (vocals); orchestra, Joseph Parnello, Jr. cond. *Fascinating Rhythm; A Lot of Livin' to Do; At Long Last Love;* and nine others. CAPITOL ST 1944 \$4.98, T 1944* \$3.98.

Interest: Standard brands
Performance: A bit exaggerated
Recording: Nice presence
Stereo Quality: High

As might be expected, Vic Damone is far less restrained in front of an audience than he is in a recording studio. In this performance taped at New York's Basin

Street East, his up-tempo numbers are just a bit too finger-snapping, his ballads too obviously stylized by the technique of beginning in an intimate, conversational manner and then building to an all-out splashy climax. There is no denying, however, that he is an engaging performer, and that vocally he is currently at the top of his form.

The repertoire is a fairly safe one, consisting of dependable items by Dietz and Schwartz, Cole Porter, and the Gershwin brothers, plus such present-day favorites as *I Left My Heart in San Francisco* and *What Kind of Fool Am I?* (am I the only one to balk at the latter's melodic kinship to *How High the Moon* and at its rhyming of "man" with "am" and "cast away" with "mask of play"?). S. G.

© © VINCENT EDWARDS: *Sometimes I'm Happy . . . Sometimes I'm Blue.* Vincent Edwards (vocals); orchestra, Dick Jacobs and Charles "Bud" Dant cond. *You've Changed; The Thrill Is Gone; Blue Prelude;* and nine others. DECCA DL 74336 \$4.98, DL 4336* \$3.98.

Interest: Tired repertoire
Performance: Leaden
Recording: Excellent
Stereo Quality: Fine

Despite the promise of the album title, television's Ben Casey is seldom happy here. His voice is a dull cross between Vaughn Monroe and Billy Eckstine, and while it does have a professional quality, it too often sounds strained and unnatural. Upon occasion, a vocal chorus props him up, and, in *Glad to Be Unhappy*, even interjects such valid commentary as "Just a bore . . . Just a bore," and "Pretty bad . . . pretty bad." Inexcusably, there are no composer credits on either the album jacket or the label. S. G.

© © FERRANTE AND TEICHER: *The Keys to Her Apartment.* Ferrante and Teicher (pianos); orchestra, Nick Perito cond. *Alone Together; Tenderly; Embraceable You;* and nine others. UNITED ARTISTS UAS 6247 \$4.98, UAL 3247* \$3.98.

Interest: Romantic accompaniment
Performance: Intimate and lush
Recording: Fine
Stereo Quality: Effective

Briefly calling off their usual fireworks display, pianists Ferrante and Teicher here go into the romantic mood-setting field. With the gentlemen seated at opposite speakers, the notes are seemingly strung bead-like from one side of your stereo spread to the other, thus giving the occasional impression that they are emanating from one enormous piano.

The effect is attractive at first, but the approach is too unvarying throughout to make this a wholly satisfactory program.

S. G.

© © **MARTHA FLOWERS AND DON SHIRLEY:** *Don Shirley Presents Martha Flowers*. Martha Flowers (vocals), Don Shirley Trio. *Fools Rush In; Porgy and Bess Suite*; and four others. CADENCE 25055 \$4.98, CLP 3055 \$3.98.

Interest: Trio and vocals
Performance: Mannered
Recording: Close and clear
Stereo Quality: Satisfactory

Don Shirley is an exceptionally skilled though highly mannered pianist, and he is teamed here with a singer who is also exceptionally skilled though highly mannered. Together, they offer a program that, in spite of some effective moments,



COLUMBIA RECORDS

FRANKIE LAINE

His exuberance is undiminished

is just too pretentious. Miss Flowers' dramatic soprano has the right range and color for the likes of *I Had Myself a True Love*, but *Any Time, Any Day, Anywhere* finds her floundering, and the instrumental interludes (piano, cello, bass) strive too sweatfully for unusual effects. The *Porgy and Bess Suite*, which covers the entire second side, is at its best when Miss Flowers sings the affecting lament, *Oh, Doctor Jesus*.

S. G.

© © **FRANKIE LAINE:** *Wanderlust*. Frankie Laine (vocals); orchestra and chorus, Johnny Williams cond. *Serenade; Misirlou; If I Love Again*; and nine others. COLUMBIA CS 8762 \$4.98, CL 1962* \$3.98.

Interest: He-man songs
Performance: Frankie Laine
Recording: Satisfactory
Stereo Quality: All right

Frankie Laine's leathery voice has been belting out songs for almost twenty years, and nothing seems to blunt his exuberance or stamina. Though I haven't the foggiest idea what the album title means, this is a fairly typical recital of numbers—*Wagon Wheels, De Glory Road, What Kind of Fool Am I?*—that are well served by the he-man, outdoorsy approach that Mr. Laine has made his own. However, not all the selections bend to his will so readily: *Serenade* and *Misirlou* are all but smothered under the singer's ham-handed attack.

S. G.

© © **STEVE LAWRENCE:** *Swinging West*. Steve Lawrence (vocals); orchestra, Marion Evans cond. *Your Cheatin' Heart; Ramblin' Rose; Wagon Wheels*; and nine others. COLUMBIA CS 8852 \$4.98, CL 2052* \$3.98.

Interest: Western-style paps
Performance: Nice rhythmic approach
Recording: Splendid
Stereo Quality: Okay

The selections in this country-and-western collection may bear the brands of such sophisticated and civilized writers as Cole Porter (*Don't Fence Me In*), Arthur Schwartz and Leo Robin (*A Gal in Calico*), and Johnny Mercer (*I'm an Old Cowhand*), but I confess I prefer them over some of the more authentic products that have been included. All, however, are made more than palatable by the brash, swinging ease of Steve Lawrence, who is one of the few singers with enough nerve to try an up-tempo treatment of *Home on the Range*. Marion Evans' arrangements have a somewhat dated quality.

S. G.

© © **JOHNNY MATHIS:** *Johnny*. Johnny Mathis (vocals); orchestra, Don Costa cond. *Miracles; Poor Butterfly; I Love You*; and nine others. COLUMBIA CS 8844 \$4.98, CL 2044* \$3.98.

Interest: Nice program
Performance: Overdone
Recording: Splendid
Stereo Quality: All right

The wispy, reedy voice of Johnny Mathis can be a remarkably effective instrument when held in control. But in this current collection, Mathis exhibits so many vocal excesses that he begins to sound like a self-parody. He growls out *The Most Beautiful Girl in the World* in a manner that suggests Lena Horne on a binge, tortures *Never Never Land* in a strange and affected accent, and pours such intensity into *Poor Butterfly* that I thought he might rupture himself.

S. G.

© © **BILLY MAY:** *Bill's Bag*. Orchestra, Billy May cond. *The Late Late Show; Whisper Not; Moanin'*; and nine

Popular Science SEPT. 1963

hi-fi experts panel picks

CABINART MARK 3

"best buy"

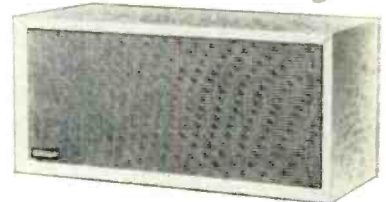

... To pick a low priced system that would still give you musically acceptable sound by true, high-fidelity standards ...

You'll agree Cabinart Mark 3 is most incredible!

First to offer bookshelf Reflex-Horn enclosure around precision engineered loud-speaker. Value and quality beyond compare!

CABINART MARK 3
\$19.50 Unfinished
Oiled Walnut, \$27.00

SPECIFICATIONS: 23" long, 11" high, 9 1/2" deep. Loudspeaker: 8", with rolled annulus • 8 ohm Impedance, 10,000 Gauss • 6.8 Dual Diameter Alnico 5 magnet • 3" whizzer cone for HF dispersion • Free air resonance: 65 cycles. **FREQUENCY RESPONSE:** SPL, 50 to 19,000 cycles. **SENSITIVITY:** 1/2 watt input for 85 DB 10 feet on axis. **POWER HANDLING CAPACITY:** 10 Watts.

CABINART GUARANTEES

You must be satisfied for 10 full days or your money back.

ONE FULL YEAR WARRANTY

Written registration card and warranty included.

Pioneers in hi fi quality since 1948

CABINART

ACOUSTICAL DEV. CORP.

GEYER STREET, HALEDON, N. J.

Cabinart Acoustical Dev. Corp.
31 Geyer St., Haledon, N. J.

Please ship the following to be used in my home for 10 full days. I understand unit(s) may be returned and my money refunded within that time unless fully satisfied.

... Mark 3 Unfinished \$19.50 each

... Mark 3 Oiled Walnut \$27.00 each

(Please make check or money order payable to Cabinart Acoustical.)

Name _____

Address _____

City _____ State _____

CIRCLE NO. 18 ON READER SERVICE CARD

others. CAPITOL ST 1888 \$4.98, T 1888* \$3.98.

Interest: Modern jazz standards
Performance: Energetic brass blowers
Recording: Fine
Stereo Quality: Highly effective

"Bag," according to jazz lingo, means "style" or "approach" or "way of life." Billy May's bag has unquestionably been marked by his affinity for big-brass-band interpretations of jazz standards, and this current collection is no exception. There is no denying the power and thrust of this approach, though I long occasionally for arrangements not so insistently serious. Stereo has been used quite well here, with most of the soloists on the left. An intriguing jazz waltz, *Filet of Soul*, is especially well served by instrumental placement, as is Cy Coleman's *Playboy Theme*, with its muted brass on the right balanced by an imaginative reed counter-figure on the left. S. G.

© © ANDRÉ PREVIN: *But Beautiful*. André Previn (piano). *Flying Down to Rio*; *London in July*; *Moonlight in Vermont*; and nine others. DECCA DL 74350 \$4.98, DL 4350* \$3.98.

Interest: Tasteful program
Performance: Skilled
Recording: Splendid
Stereo Quality: Not noticeable

Judging from such titles as *Island in the West Indies*, *How Are Things in Glocca Morra*, *Honolulu*, *Sidewalks of Cuba*, and the above-listed three, it would seem that the original plan of this collection was a musical tour of the world. However, the idea was apparently grounded midway through the flight since the album contains almost an equal number of nongeographic sentiments. Previn does a particularly commendable job of avoiding a cocktail-lounge flavor, and his interpretations of such familiar items as *You Are Too Beautiful*, *Moonlight in Vermont*, and *It Could Happen to You* possess a sensitivity that is never marred by ostentation. S. G.

© © KEELY SMITH: *Little Girl Blue/Little Girl New*. Keely Smith (vocals); orchestra, Nelson Riddle cond. *Little Girl Blue*; *I'm Gonna Live 'til I Die*; *A Lot of Livin' to Do*; and nine others. REPRIS R 96086 \$4.98, R 6086* \$3.98.

Interest: Sad songs/glad songs
Performance: Persuasive stylist
Recording: All right
Stereo Quality: Lacks depth

Doing an album consisting of torch songs on one side and happy songs on the other is a pretty well-worn gimmick, but it

serves to show off Keely Smith's versatility. Her enunciation may be a bit too Southern for Comfort, but she does a splendid job of interpreting, and her vocal quality is always attractive. Unfortunately, conductor Nelson Riddle's orchestral backing all too often becomes intrusive. S. G.

© © JOANIE SOMMERS: *Sommers' Seasons*. Joanie Sommers (vocals); orchestra, Stan Applebaum cond. *Summertime*; *Early Autumn*; *April in Paris*; and nine others. WARNER BROS. WS 1504 \$4.98, WB 1504* \$3.98.

Interest: Vocal fluke
Performance: Impossible
Recording: Fine
Stereo Quality: Acceptable

Certain fluke successes in the entertainment business are understandable. But why Joanie Sommers' small, husky, expressionless, adolescent voice sells records is one of life's little mysteries that I have no intention of trying to unravel. In this collection, Miss Sommers does the old four-seasons bit—including a couple of "month songs"—with a pretentious orchestral backing that sounds as if it were accompanying Eileen Farrell. I wish it were. S. G.

© © JO STAFFORD: *Getting Sentimental over Tommy Dorsey*. Jo Stafford (vocals); orchestra, Nelson Riddle, Billy May, and Benny Carter cond. *Oh! Look at Me Now*; *I'll Take Tallulah*; *Yes, Indeed*; and nine others. REPRIS R 96090 \$4.98, R 6090* \$3.98.

Interest: Nostalgic fare
Performance: Still appealing
Recording: Satisfactory
Stereo Quality: Good

Jo Stafford's first disc for Reprise plunks her down in familiar territory. As a member of the singing Pied Pipers and later as a featured vocalist with the Tommy Dorsey orchestra, she had the opportunity to introduce many great numbers associated with the late bandleader. Twelve of them have been rounded up here, and Miss Stafford's caressing tones do them almost as much justice as did her delivery more than twenty years ago. Backed by a male singing group, plus Sammy Davis, Jr., on *Yes, Indeed*, she reminds the listener again of the riches in the popular music played by the big dance bands of the Thirties and Forties. Of the three conductors on this set, only Nelson Riddle remembered to include a velvety trombone solo to get us into an even more sentimental mood. S. G.

© © KAI WINDING: *Soul Surfin'*. Kai Winding (trombone), Kenny Bur-

rell (guitar); orchestra. *More*; *Surf Bird*; *Sukiyaki*; *Hearse Ride*; and eight others. VERVE V 68551 \$5.98, V 8551 \$4.98.

Interest: The surfin' fad
Performance: Mechanical
Recording: Blaring
Stereo Quality: Okay

Trombonist Kai Winding is trying in this album to capitalize on a recent fad among the restless young—a coupling of rock-and-roll music with a surfboard motif. In Winding's utilization of this self-conscious fusion, the rock-and-roll is occasionally blended with Hawaiian-type melodies and other brittle exoticisms.

On the basis of this set, surf music is no less repetitious and severely limited in scope than landlocked rock-and-roll. The arrangements—by Winding and Claus Ogerman—sound as if they had been turned out on one of the simpler IBM machines. Winding's own solos are wholly unremarkable, and the usually proficient Kenny Burrell is wasted here—even more powerfully individualistic jazzmen than Burrell could not transcend the tawdriness of this manufactured music. N. H.

COLLECTIONS

© © CURTAIN UP! *Musical Almanac*. Eastman-Rochester Orchestra and Eastman Philharmonia, Howard Hanson cond. London Symphony Orchestra and Philharmonia Hungarica, Antal Dorati cond. Eastman-Rochester Pops, Frederick Fennell cond. MERCURY SR 90337 \$5.98, MG 50337* \$4.98.

© © CURTAIN UP! *Music and Phunk, Tinkle, Ting-a-ling*. Eastman-Rochester Pops and Eastman Wind Ensemble, Frederick Fennell cond. Minneapolis Symphony Orchestra and London Symphony Orchestra, Antal Dorati cond. Eastman-Rochester Orchestra, Howard Hanson cond. MERCURY SR 90338 \$5.98, MG 50338* \$4.98.

© © CURTAIN UP! *Gala Favorites*. Eastman-Rochester Pops and Eastman Wind Ensemble, Frederick Fennell cond. Eastman-Rochester Orchestra, Howard Hanson cond. Detroit Symphony, Paul Paray cond. Minneapolis Symphony Orchestra, Antal Dorati cond. MERCURY SR 90339 \$5.98, MG 50339* \$4.98.

© © CURTAIN UP! *Fennell and the Pops*. Eastman-Rochester Pops and Eastman Wind Ensemble, Frederick Fennell cond. MERCURY SR 90340 \$5.98, MG 50340 \$4.98.

Interest: Light-classics potpourris
Performance: Hard but hearty
Recording: Clear and bright
Stereo Quality: Marked

(Continued on page 136)

pick a subject
for a great
photograph:



and you'll find it
in the... **1964**
PHOTOGRAPHY
ANNUAL

The editors of Popular Photography have gathered the year's outstanding examples of the art of the camera for this edition of PHOTOGRAPHY ANNUAL. There are pictures from the four corners of the earth, all pointing up the universality and versatility of the camera.

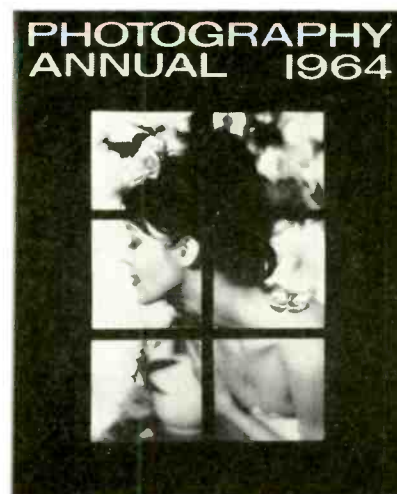

The **1964 PHOTOGRAPHY ANNUAL** is now on sale. Get your copy at your favorite newsstand or camera store. Or use this handy coupon for ordering. **only \$1.25**

Ziff-Davis Service Division Dept. PA
589 Broadway, New York 12, New York

HF-113

Please send me a copy of PHOTOGRAPHY ANNUAL 1964. I enclose \$1.25, the cost of the ANNUAL, plus 15¢ to cover mailing and handling charges. (Canada & Overseas: \$1.25 plus 25¢ postage.)

NAME _____

ADDRESS _____

CITY _____ ZONE _____ STATE _____

(Add 4% sales tax if N.Y.C. resident)

The 1964 Edition Features:

- Portfolios of five of our most creative contemporary photographers.
- Popular Photography's choice of next year's Pulitzer Prize-winning picture.
- Dorothea Lange's "Remembrance of Asia"
- Pictures from Ken Heyman's new book, "Willie"
- Selections from the powerful "Our Daily Bread" show
- Famous International Portfolio—more exciting than ever

Sensational FUJICA Offer

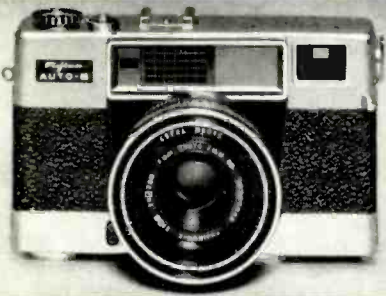

You get a full refund on both camera and color film if you are not fully satisfied with the pictures you take!

Why do we dare make this offer?

The new Fujica is the first camera with a built-in computer electric eye. Patented. It makes all settings for you . . . both speeds and lens openings. You can't make an exposure mistake even if you try. If the light is too bright or too dim, the computer speeds up or slows down the shutter speed . . . instantly! Automatically! You just press the button. Perfect exposure every time.

Professional effects also automatic.

A simple dial turn does it. Soft backgrounds. Sharp backgrounds. Catch incredibly fast action . . . and to top it all, you can switch from fully automatic operation to manual control and make any combination of settings you wish. Speeds are up to 1/500th second.

Takes perfect pictures indoors.

The superb f/2.8 lens gets pictures in light so low, other cameras require flash . . . and if the light is too dim to give you a perfect picture, the Fujica locks . . . won't fire. No more blurs, blanks or wasted shots.

Preview your finished picture.

The viewfinder-rangefinder shows you big, bright and beautifully clear, what your finished picture will look like. You get exactly what you see.

How much does this FUJICA cost?

Less than \$100, and with the money back guarantee . . . you risk nothing.

Like to see how easy it is to operate? . . . just ask your favorite camera dealer or write for **FREE** booklet today.

COMPUTER ELECTRIC EYE

FUJICA

Fully Automatic Auto-M 35

FUJI PHOTO OPTICAL PRODUCTS INC.

111 Fifth Ave., Dept. A-79, New York 3, N. Y.

A subsidiary of Ehrenreich Photo-Optical Industries Inc.

CIRCLE NO. 32 ON READER SERVICE CARD
136

"This record should be played at full room volume," say the album covers for this festive series, and therein lies not just sound technical advice but also a clue to the contents. Mercury is by no means offering more of the usual background music that hounds us through restaurants, airports, factories, and even into the elevators of our office buildings and apartment houses. Instead, light classics ranging from Leroy Anderson's rather cute contributions (*The Typewriter*) to Darius Milhaud's *Provence* from his elegant *Suite Française* make up the bill of fare. There are also waltzes by Strauss, Tchaikovsky, and Liszt, marches by Goldman and Sousa, impressionist sketches by Respighi, Kodály, and Chabrier, and even a couple of serious modern short subjects, such as Chadwick's *Noel* and Gunther Schuller's *Twittering Machine*, to give these musical hors d'oeuvres substance. All are played in the crystal-clear, crisp, and sometimes rather hard style that is a characteristic not only of Mercury's engineering but of the orchestras and conductors the company employs. When Paray is at the helm, there is some subtlety, but, at the other extreme, there are Fennell's rigid tempos and general lack of flexibility and flow. You start wishing, somewhere in the course of the forty-eight numbers on these four energy-packed but tense-sounding discs, that he and Antal Dorati, and even occasionally the adroit Hanson, would throw away their metronomes and then just let the melodies sing. *P. K.*

THEATER - FILMS

Ⓢ Ⓜ **COME BLOW YOUR HORN** (Nelson Riddle). Orchestra, Nelson Riddle cond. REPRISÉ R 96071 \$4.98, R 6071* \$3.98.

Interest: Slick score
Performance: Colorful
Recording: Satisfactory
Stereo Quality: Nice

Nelson Riddle has provided a bright, shiny score for the film *Come Blow Your Horn* that sounds as if it had been turned out on the same assembly line that produces the bright, shiny Henry Mancini scores. The dearth of story information on the jacket may make you wonder what in the world is going on when, for example, the orchestra breaks into variations on *I Dream I Dwelt in Marble Halls*, but there is no denying the surface appeal of the work. The infectious title song, by Sammy Cahn and Jimmy Van Heusen, is done without vocal, but a hard-breathing male chorus can be heard singing the words to something called *Connie's Theme*. *S. G.*

Ⓢ Ⓜ **THE GREAT ESCAPE** (Elmer Bernstein). Orchestra, Elmer Bernstein

cond. UNITED ARTISTS UAS 5107 \$5.98, UAL 4107* \$4.98.

Interest: Movie music
Performance: Appropriate
Recording: Satisfactory
Stereo Quality: Nice

The dependable and prolific Elmer Bernstein has provided what is an apparently fitting collection of background themes for this war-time saga. Unfortunately, save for a *Bogey*-like march, there is little here that can be appreciated without the film situations for which the music was created. *S. G.*

Ⓢ Ⓜ **IRMA LA DOUCE** (André Previn). Sound-track recording. Orchestra, André Previn cond. UNITED ARTISTS UAS 5109 \$5.98, UAL 4109* \$4.98.

Interest: Sound-track
Performance: Well orchestrated
Recording: Satisfactory
Stereo Quality: Good

Ⓢ Ⓜ **IRMA LA DOUCE** (André Previn). Jack Lemmon (piano); orchestra, Jack Marshall cond. CAPITOL ST 1943 \$4.98, T 1943* \$3.98.

Interest: Lemmon
Performance: So-so
Recording: Very good
Stereo Quality: High

Although André Previn is given sole credit for the score of the film version of *Irma la Douce*, it is immediately apparent that at least three themes (*Dis-Donc, Valse Milieu, and Our Language of Love*) have been retained from Marguerite Monnot's score for the original stage production. Surprisingly, the combination works. Previn's inspirations have caught the right flavor, particularly a plaintive leitmotif for Irma (*Look Again*) and a moody piece (*Let's Pretend Love*) that is slightly reminiscent of Kurt Weill. Violin and accordion solos are used with great effectiveness throughout.

Spotlighting Jack Lemmon as a piano soloist on themes from the film took more nerve than intelligence. Lemmon, the star of the film, has perfected a one-finger technique that should make him pretty big at parties, but it is presumptuous for Capitol to pan him off as a pianist worthy of our hard-earned cash. Conductor Marshall presides over a rescue squad that heroically comes to Lemmon's aid whenever he begins to flounder. *S. G.*

RECORDING OF SPECIAL MERIT

Ⓢ Ⓜ **BURGESS MEREDITH: Songs from How the West Was Won**. COLPIX SCP 452 \$5.98, CP 452* \$4.98.

HIFI/STEREO REVIEW

Interest: Songs of the West
 Performance: Outstanding
 Recording: Excellent
 Stereo Quality: Good

The program notes falsely assert that Meredith is making his "recording debut" with this release. Actually, he made an even more auspicious coming-out with Columbia's "Songs and Stories of The Gold Rush," and has distinguished himself on several other discs, notably on the Lively Arts readings of stories by Ray Bradbury. Here he sings, with choral backing, some lively arrangements of familiar Western tunes and a couple of new ones invented for the Cinerama release—among them a worthy train-rhythm number named *Nine Hundred Miles from Home*. And whether he is reading the text of a sentimental verse to the background of *Greensleeves*, pleading for love by "deeds, not words" while a barn-dance waltz plays in the background, singing (on key!) or whooping it up in the rousing finale, Meredith gives his all—and in his case, that's quite a bit—to this snappy and diverting program of out-West vitality. P. K.

FOLK

ARMENIAN SONGS AND DANCES. Hovhanness Badelian, Hamsik Gabrielian, Ophelia Ambartsumian (vocals); instrumental ensembles. *The Blond Lad; Do Not Be Lonely; Yerevan Dance; My Beloved Is Taken Away*; and nine others. MONITOR MF 400 \$4.98.

Interest: Love and loss
 Performance: Intense
 Recording: Good

Unusually skillful and disciplined voices combine with folk instruments in this anthology of Armenian songs and dances. The instrumental dance tracks are buoyant, but most of the songs are slow, undulating evocations of love and absence. The most haunting performance is by Ophelia Ambartsumian in *Soft Breeze*, a wistful tale about a departed lover. Monitor's notes are much too skimpy—there is no information about such native instruments as the tarr and knanon, no indication of the various historical backgrounds of the material, and only paraphrases of the lyrics. Nonetheless, the album is continually absorbing, a cross-section of the passionate Armenian musical temperament. N. H.

BEN ZION SHENKER: *Modzitzer Favorites*. Ben Zion Shenker (vocals); chorus and orchestra, Velvel Pasternak cond. *Simchoh Le'Artzecho; Hiskabtzu; Lo Sevoshi; Ein Kitzvoh*; and nine others. NEGINAH NRS 1203 \$4.98, NR 1203* \$1.98.

(Continued on page 138)

NEW! ENGINEERING BREAKTHROUGH
ROBERTS CROSS FIELD®

"770"

records automatically—



15 high fidelity stereo albums for the price of one

Now, 8 hours of full-range, true, high fidelity stereophonic music, or 16 monaural hours, can be yours on one 7" reel, with the revolutionary new Roberts Cross Field "770" Tape Recorder. The average tape cost per album: only 33¢. The "770" has an exclusive patented third head, the Cross Field Head, which separates recording and biasing functions. The result: the "770" records 40 to 22,000 cps, producing true fidelity at 1 7/8 ips and preserving the high frequency harmonics that breathe life into music playback. The Cross Field playback head has a gap width of only 40 micro-inches, the smallest, most responsive head ever engineered. For this head, Roberts employs NC-88, a new alloy, that is practically wear-proof. Other features: 2-speed, electrically-switched, heavy-duty hysteresis synchronous motor, miniscule wow and flutter at slow speeds; special ventilation system keeps the "770" cool even after 8 hours; two 5" x 7" self-contained elliptical, extended-range, heavy-duty Alnico V-magnet speakers; new automatic total shut-off switch.

Today, see the Roberts Cross Field "770" Tape Recorder at better music and camera centers. \$499.95.

Specifications: 7 1/2, 3 3/4, 1 7/8 ips. Power Amplifier Output: 12 watts • Frequency response: at 7 1/2 ips, 40 to 22,000 cps ± 2 db; at 3 3/4 ips, 40 to 18,000 cps ± 2 db; at 1 7/8 ips, 40 to 13,000 cps ± 3 db • signal to noise ratio: —55 below 0 recorded level • Wow and flutter: at 7 1/2 ips, less than 0.12% rms; at 3 3/4 ips, less than 0.20%; at 1 7/8 ips, less than 0.30% • Blower vent system • 2 large stereo 5" x 7" elliptical, extended range, heavy duty Alnico V magnet speakers • Hysteresis synchronous instantaneous electrically controlled 2 speed motor • Automatic total shutoff • Operates Horizontally or Vertically.

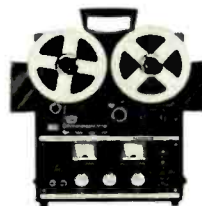

New Model 330: Another achievement of Roberts' electronic engineering. Sound-on-sound multiple recording. 3 heads for separate record, playback, erase; two 7" full-range speakers. Special biasing for FM Multiplex Recording Systems. Speeds: 7 1/2, 3 3/4 ips. 27 lbs. \$349.95.

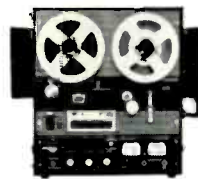

New Professional Model 455: Has three electrically switched, dual-speed motors, separate bass controls, 4 simultaneous mixing inputs, playback loudness controls, track selector, two full range 5" x 7" speakers. 7 1/2, 3 3/4 ips. \$599.95; Remote control, \$49.95.

See the entire line of Roberts professional and home tape recorders from \$269.95 at better music and photo centers.



FREE BOOKLET! "40 AND MORE WAYS TO USE A ROBERTS TAPE RECORDER"

Roberts Electronics, Inc.
 5978 Bowcroft, Dept. HFS-11, Los Angeles 16, Calif.

Please send free booklet
 Please send me complete information about Roberts Tape Recorders.

Name _____
 Address _____
 City _____ State _____

IN CANADA: J. M. Nelson Electronics Ltd., 7725 Adera St., Vancouver 14, B. C. (Prices slightly higher in Canada)

See the **ROCKFORD**
Newest in **Acoustical Cabinetry**

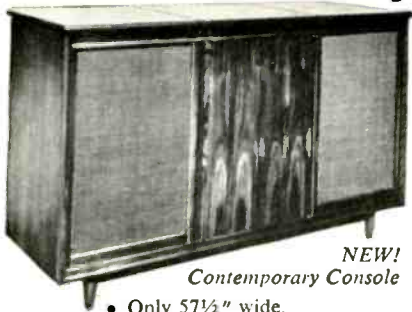

NEW!
Contemporary Console

- Only 57½" wide.
- Houses complete system, including tape deck, changer or turntable, amplifier, tuner and speakers.
- Record storage for over 100 12" LP's.
- Speaker compartments are vented port type with 1" acoustical fibre glass lining. Each compartment houses up to 12" speaker.



FREE illustrated brochure describing equipment cabinets, speaker enclosures in a wide variety of styles and finishes. Write to . . .

FURNITURE-CRAFTED BY
ROCKFORD
SPECIAL FURNITURE CO.

2024 TWENTY-THIRD AVE. • ROCKFORD, ILL.

Dealer Inquiries Invited

CIRCLE NO. 64 ON READER SERVICE CARD

Why?

DO THOUSANDS OF HI-FI
ENTHUSIASTS BUY FROM
AUDIO UNLIMITED

It's Obvious!

- LOWEST PRICES
- FAST SERVICE
- FACTORY SEALED UNITS
- FULLY INSURED SHIPMENTS
- UP TO 2 YEAR
MANUFACTURERS' WARRANTY
- TIME PAYMENT PLAN
 - only 10% down
 - up to 36 months to pay
- FRANCHISED DISTRIBUTORS

Write for FREE Catalog Today

SEND US YOUR LIST
FOR OUR AIR MAIL
QUOTE TODAY

Visit Our Showroom and Warehouse

AUDIO unlimited, inc.

715-S Second Ave., (Nr. 38) New York 16, N.Y.
3 blocks from the U. N.

CIRCLE NO. 12 ON READER SERVICE CARD
138

Interest: Superior Chassidic music
Performance: Appropriately vivid
Recording: Excellent
Stereo Quality: Very good

The Chassidim are Orthodox Jews who base much of their worship on music. They are also known for the joyousness of their faith and their songs. Each Chassidic sect has its own body of music, usually composed by its successive rabbis, and among the most musically accomplished of all rabbinical dynasties, so to speak, have been the Polish Modzitzer "rebbe's." This sensitively arranged and performed collection includes music composed by various leaders of the sect, including the present Rabbi Samuel. The tunes are based on Biblical texts and are used both in the synagogue and as *zemirot*—songs for services at the table in Chassidic homes. There are also dance-like melodies without words, particularly suited to the more ebullient Chassidic celebrations.

Isaac Hager, producer of this album, has succeeded in approximating the light-hearted but devoted aura of Chassidic services. There are solemn moments too, as in the *Nigun of the Homeless*, composed in 1914 when the First World War forced the Modzitzer to leave their native Poland.

Velvel Pasternak's arrangements are faithful to the Chassidic tradition and never stifle the performers. Ben Zion Shenker, the soloist, is able to be both intense and musically subtle and resourceful. His clear tenor voice weaves easily through the musical fabric provided by a relaxed, eight-man chorus, and they are vividly supported by a small, sprightly orchestra.

Unfortunately, although Hebrew texts are included, there are no translations. The notes, however, provide enough information about the essence and background of each song that the music can be quickly assimilated by new listeners. N. H.

Ⓜ THE CARTER FAMILY: *Great Original Recordings*. The Carter Family (vocals). *Meeting in the Air; Kissing Is a Crime; Bear Creek Blues; The Dying Mother*; and six others. HARMONY HL 7300 \$1.98.

Interest: Country archives
Performance: Authoritative
Recording: Adequate

A. P. and Sara Carter, and their three daughters Helen, Anita, and June, made up one of the most influential country music ensembles about thirty years ago. Their style and homegrown repertoire affected many performers now before the public. This important reissue consists of recordings the family made between 1935 and 1940.

The Carters, inheritors of a rich vein of the British-American folk tradition, added to that heritage in several ways. All the songs in this set, for example, are by members of the family, most of them by A. P. Carter. They include religious music, white blues, and diverse love songs. In the last category, the most touching and ingenuous is *I Found You Among the Roses*. A couple of the tunes focus on the hazards of courting, and one of the narrative songs, *Buddies in the Saddle*, tells of death in the field.

The Carters developed an unusually cohesive group-singing style. True to the Southern-mountain tradition of understated emotion, their singing, solo as well as ensemble, was characterized by flowing calmness—but always a suggestion of intense feeling beneath the surface. This is the second Harmony selection of original Carter family recordings, its predecessor being "The Famous Carter Family" (HL 7280). N. H.

RECORDING OF SPECIAL MERIT

Ⓢ Ⓜ NEW CHRISTY MINSTRELS: *Ramblin'*. New Christy Minstrels (vocals). *Hi Jolly; Down the Ohio; Wagoner's Song*; and nine others. COLUMBIA CS 8855 \$4.98, CL 2055* \$3.98.

Interest: Infectious folk collection
Performance: High-spirited
Recording: Excellent
Stereo Quality: Nicely spread out

What an infectious program this is! The eight men and two girls who make up the group sing with great spirit and rapport, and they have selected material that, for the most part, has not been overdone. Moreover, the Minstrels happily do not consider showmanship inimical to good folk-singing. The result is a program that is, by turns, exultant (*Down the Ohio*), tender (*Last Farewell*), lilting (*Wagoner's Song*), and humorous (*Hi Jolly*, which deals with a Syrian camel driver's experience on the American frontier).

The themes of the pieces often turn to such predictable subjects as the lot of the wanderin' man and the loneliness of life on the lone prairie. But the sheer infectiousness of the performances makes each number an exciting experience. If they can keep up the high standards they have set, these minstrels will be worth listening to for a long time to come. S. G.

Ⓢ Ⓜ FLATT AND SCRUGGS: *At Carnegie Hall*. Lester Flatt (guitar and vocals), Earl Scruggs (banjo), Paul Warren (violin), Buck Graves (dobro guitar), Billy Powers (guitar), Jake Tulllock (bass). *Salty Dog Blues; Flint Hill Special; Mama Blues; Let the Church Roll On*; and nine others. COLUMBIA CS 8845 \$4.98, CL 2045* \$3.98.

Interest: Bluegrass in the city
 Performance: Up to par
 Recording: Excellent
 Stereo Quality: Tasteful

This is a recording of the Flatt and Scruggs Carnegie Hall concert on December 8, 1962, and a characteristic program by the most widely popular of all Bluegrass combos. The vocals are by guitarist Flatt, whose drily understated singing makes even the syrupy "heart" songs entertaining. On some tracks, Flatt is joined by his associates in "high lonesome" harmony. A particular delight is the introduction to the North of the Flatt and Scruggs radio commercial for Martha White Flour ("Martha White's surprising flour has got hot rize!")

The leading instrumental virtuoso of the unit is banjoist Earl Scruggs. Although Scruggs was suffering from a high fever that night, his illness did not dilute



WASHINGTON RECORDS

A. L. LLOYD

A relaxed commentary on social history

the biting drive or the cascading melodic variations of his playing. The high-spirited fiddling of Paul Warren adds marked verve to the combo.

Flatt and Scruggs have been able to absorb a variety of folk material into their Bluegrass idiom, but *Take This Hammer* does not fit their style well. In the version performed at Carnegie Hall, this work song becomes oddly serene, as if the laborers were ruminating during their lunch hour. Aside from this single track, the program is another substantial and idiomatic addition to the Flatt and Scruggs discography. N. H.

© MAHALIA JACKSON: *Mahalia Jackson's Greatest Hits*. Mahalia Jackson (vocals); chorus and accompaniment. *Walk in Jerusalem; The Upper Room; He Calmed the Ocean; Move On Up a Little Higher*; and six others. COLUMBIA CS 8804 \$4.98, CL 2004* \$3.98.

Interest: Mahalia looks back
 Performance: Not quite her best
 Recording: Excellent
 Stereo Quality: Good

Depressing as it is to have to go along with publicity's catch phrases, Mahalia Jackson probably is "The World's Greatest Gospel Singer." No one else has her magnificent natural instrument; no one else has the personality—a combination of magisterial dignity, pointed humor, and humility that makes it impossible for her to do anything wrong in her personal performance.

Some critics have deplored Miss Jackson's recent recorded settings, which have employed such inappropriate companions as Percy Faith. Here, with a gospel chorus and what is undoubtedly the piano of Mildred Falls—it is not credited—the singer essays re-creations of her earliest, unsullied triumphs, some of which were originally recorded for the Apollo label. She displays the rhythmic sense of a great jazz singer, an unsurpassable feeling for embellishment and rubato at extremely slow tempos, and the deep conviction and awesome cello sound that are her trademarks. The transcendent flashes of inspiration come less frequently now, and the background is often too busy and popularized. This is not a great Mahalia Jackson album, but only Mahalia herself could match it.

J. G.

RECORDING OF SPECIAL MERIT

© A. L. LLOYD: *Street Songs of England*. A. L. Lloyd (vocals), Alf Edwards (concertina). *The Unfortunate Rake; The Death of Bill Brown; Jackie Munro; Died for Love*; and eight others. WASHINGTON VM 737 \$4.98.

Interest: Insights into history
 Performance: To the manner born
 Recording: Competent

This is another of the valuable folk collections released by Riverside some six or more years ago and then withdrawn. For the album's new life on Riverside's Washington label, A. L. Lloyd's thoroughly informed notes have fortunately been preserved. As Lloyd points out, these vintage broadsides—hawked by ballad-mongers on English streets—"have provided a running commentary on English social history and popular attitudes over the last three or four hundred years." Their perspective is that of "the poor devil who was there, the real genuine 'Man in the Street.'"

The songs tell of murderers, sailors with exotic loves, brave girls who outwit robbers or go to war in men's clothes, and betrayed lovers. Other subjects are cockfights and the romanticization of Napoleon by the "lower classes." Lloyd,

HERE'S ONE WAY TO COOL A HOT AMPLIFIER



but here is a BETTER WAY



Only \$14.85

the ROTRON

Whisper Fan
KIT

Beat the heat that wrecks the set by installing a Rotron Whisper Fan Kit. Breathing 60 cubic feet of cool air over, under and around every heat-generating component, the Whisper Fan improves performance by minimizing drift due to temperature change within the enclosure. Requires only 7 watts, just pennies a week to operate. Measuring only 4 1/8" square and 1 1/2" deep, it can be set in a corner or mounted on the rear panel in minutes. Comes complete with mounting hardware, plug and cord for electrical connections and installation instructions.



Write for details or see your local dealer.

ROTRON mfg. co., inc.
 WOODSTOCK, NEW YORK
 ORiote 9 2401

CIRCLE NO. 65 ON READER SERVICE CARD

Famous LAFAYETTE HI-FI COMPONENTS

LAFAYETTE KT-900 CRITERION® 120-WATT ALL TRANSISTOR AMPLIFIER KIT

KT-900WX

129.50

\$7 monthly

MADE IN U.S.A.



- 60-Watts Output Per Channel
 - Separate Concentric Bass, Treble and Volume Controls
 - Wide Selections of Stereo Inputs
 - Easy-to-Wire Printed Circuit Boards
- Available wired and Tested LA-900 only 189.50

LAFAYETTE PROFESSIONAL 4-TRACK RECORD/PLAYBACK STEREO TAPE DECK

99.50

\$5 Monthly

Mikes and Case
Optional



RK-140 Imported

- Plays 2-Track, 4-Track Stereo; 2-Track, 4-Track, Full-Track Mono
- Records 4-Track Stereo or Mono from FM, AM, FM MPX, Radio or Phono; Live from Mikes
- Complete with 4 Connecting Cables, 7" Take-up Reel

LAFAYETTE 4-TRACK STEREO TAPE RECORDER

129.50

\$7 Monthly

RK-600WX Imported

- Plays 2-Track, 4-Track Stereo; 2-Track, Full-Track Mono
- Records 4-Track Stereo and Mono
- Complete with 2 Mikes, Patch Cords, 7" Take-up Reel, Built-in Record and Playback Preamps

Mail the Coupon for Your
1964 Lafayette Catalog
FREE

LAFAYETTE RADIO ELECTRONICS
Dept. HMK-3 P.O. Box 10
Syosset, L. I., N. Y. 11791

- Rush my FREE 1964 Lafayette Catalog 640
- Send me Stock No. _____, shipping charges collect. \$ _____ enclosed.
- I would like to order Stock No. _____ on the Easy-Pay Credit Plan.

Name _____

Address _____

City _____ Zone _____ State _____

CIRCLE NO. 53 ON READER SERVICE CARD
140

a former sailor, roustabout, and horse-breaker, has become one of Britain's most knowledgeable folklorists. His singing, however, has no trace of the academic. A masterful story-teller, he is craggily informal, and he makes the stories sound contemporary. The accompaniment by Alf Edwards on the alternately mournful and mocking concertina is exactly appropriate to these songs.

N. H.

© BASCOM LUNSFORD: *The Appalachian Minstrel*. Bascom Lunsford (vocals), Freda English (guitar and vocals). *I Shall Not Be Moved; The Miller's Will; Black Jack Davy; John Henry;* and ten others. WASHINGTON VM 736 \$4.98.

Interest: Venerable minstrel
Performance: Well-seasoned
Recording: Competent

This recital of folk tunes collected by Bascom Lunsford in North and South Carolina was first issued about seven years ago in limited quantity on the Riverside label. It is worthy of reissue because of Lunsford's intimate knowledge of this regional music, the result of more than sixty-five years of collecting and performing. He was about seventy-four at the time of this recording. A scholar, collector, and singer, he originated the Mountain Dance and Folk Festival at Asheville, North Carolina, in 1928, and later founded similar festivals.

Despite Lunsford's voice, which is somewhat cracked with age, these rugged vocals provide a distillation of Appalachian folk history and musical practices, the aggregate of party tunes, British-born ballads, mountain love lyrics, and Negro materials that represents three centuries of acculturation. Lunsford animates them through his ability to recapture the feeling of the natural family settings in which he first heard them performed. Kenneth Goldstein provides very useful historical notes on each tune.

N. H.

RECORDING OF SPECIAL MERIT

© FERNANDA MARIA: *Fado*. Fernanda Maria (vocals); Francisco Carvalhinho (Portuguese guitar), Martinho D'Assunção (Spanish guitar). *Quarters of Lisbon; I Want You to Know; Crazy Hearts; Fado of Pain;* and eight others. MONITOR MFS 396 \$4.98, MF 396* \$4.98.

Interest: Portugal's popular song
Performance: Expert
Recording: Very good
Stereo Quality: Satisfactory

For half her twenty-six years, Fernanda Maria has been a professional interpreter of the fado, a Portuguese popular-song form, and in her country today her re-

cordings top the fado hit lists. In this recital, she is accompanied by guitarists Carvalhinho and D'Assunção. Her voice is clear, vibrant, and evocative of bitter-sweet memories. In addition, she effortlessly commands the supple rhythms of the fado. Not all the songs are wistful—some celebrate the vintage attractions of Lisbon, even to imitating its street cries. The essence of the fado, however, is sadness recollected in tranquillity, and Miss Maria's skill in this idiom shows itself in her way of preventing fragile regret from drooping into bathos. Monitor provides full Portuguese texts but only sketchy English paraphrases.

N. H.

RECORDING OF SPECIAL MERIT

© RED ARMY ENSEMBLE: *Red Army Ensemble, Volume Two*. Soloists, chorus, and orchestra, various cond. *Courageous Don Cossacks; Kamarinskaya; Kalinka; Ukrainian Poem;* and seven others. ANGEL S 36143 \$5.98, 36143* \$4.98.

Interest: Great Russian chorus
Performance: Brilliant
Recording: Superb
Stereo Quality: Good

The Red Army Ensemble, formerly called the Soviet Army Chorus and Band, comes across on records with an impact as awesome as one of its dancers' eight-foot leaps. Superbly recorded in England, the eighty-voice chorus possesses a massive power unequalled in my experience, yet it can suddenly drop to a hush behind a soloist.

The repertoire consists of folk songs and Russian popular tunes, all of which remind this listener of Prokofiev's *Alexander Nevsky*. There are whistles, bird-calls, solos, virtuoso instrumental displays, and the exaltation that perhaps only a huge chorus can give. There is great poignancy in *Annie Laurie*, performed in English and almost religiously. *Meadowlands* is a splendid evocation of controlled ensemble movement from soft to roaring to hushed again. The concluding *Zaparozhitsi Dance*, often programmed as a grand finale by the ensemble, made me long to see the dancers.

J. G.

© THE WAYFARERS: *Come Along with the Wayfarers*. Dick Bailey, Sean Bonniwell, Tom Adams, Ray Blouin (vocals and instrumental accompaniment). *Monday Morning; Ticonderoga; Grape Tasters; Havenu;* and eight others. RCA VICTOR LSP 2666 \$4.98, LPM 2666* \$3.98.

Interest: Meager
Performance: Characterless
Recording: Good
Stereo Quality: Very good

The four Wayfarers are yet another group of citybillies who approach all their folk material with an amiable lack of understanding of its style and traditions. Their enthusiasm sounds factitious and their occasional humor is arch and calculated. Neither in ensemble nor in solo passages do the Wayfarers reveal a clearly identifiable musical personality. If anything, theirs tends toward the Fred Waring concept of folk-singing—polished, but hollow at the center. If you believe the credits, incidentally, an astonishing number of familiar folk tunes have been “written” by these young men and their associates.

In recording this unit, RCA is obviously hoping to develop a property like the Brothers Four or Kingston Trio to add to the Limeliters, already in their stable. It is doubtful that the Wayfarers can achieve this status. They are certainly of no interest to anyone looking for durable expositions of the American folk heritage. *N. H.*

© ANTHOLOGY OF CANTE FLAMENCO. José Salazar, La Perla de Triana, Manuel Centeno, Aurelio Selles, Pepita Caballero, Antonio Mairena, Rosalia de Triana, Pepe Torres, La Piriñaca de Jerez, Juan Talega (vocals); guitar accompaniment. *Granadina; Taranta; Caracoles; Buleria Por Solea; Solea De Triana; Saeta Gitana;* and thirty-six others. LONDON OSA 1325 three 12-inch discs \$17.94, A 4353 \$14.94.

Interest: Full-strength flamenco
Performance: Harsh and intense
Recording: Excellent
Stereo Quality: Effective

Antonio Mairena, himself an accomplished flamenco singer, has assembled this three-volume documentary of cante flamenco. Ten singers, male and female, are represented in these intense performances. There are no factitious emotional typhoons for the tourists. The pervading emphasis is on slow, smouldering personal flamenco with appropriately penetrating guitar accompaniment. Most of the major forms of flamenco are represented, and the quality of sound is bristlingly realistic.

Unfortunately, this is an incomplete documentary as far as the notes are concerned. There are no translations or paraphrases of the lyrics and no analyses of the different forms. In the flimsy introductory essay, moreover, there is a confusing, quick reference to the difference between gypsy singing and the smoother, non-gypsy approach to Andalusian music. There is indeed a strong distinction between the two, but it is not enough in an album that has the purpose of this one simply to state that, after hearing this anthology, the listener “will be able to notice what the differences are between

LESA
DIRECT FROM ITALY... OVER 30 YEARS OF QUALITY



The LesaMatic CD3/31 is a superb unit. It plays manually or automatically and has a jam-proof arm, aside from many other features. See and hear it for yourself. Write for free brochures to Lesa of America Corp., 32-17 61 Street, Woodside 77, New York, Dept. C



NOTE: LESA ANNOUNCES A ONE-YEAR GUARANTEE ON ALL PRODUCTS!
CIRCLE NO. 54 ON READER SERVICE CARD

**ROCK
BOTTOM
STEREO • HIGH FIDELITY
PRICES**

GET
OUR
QUOTE

PLUS THESE RABSONS EXTRAS

- Established 1905 58 Years of Reliability
- Franchised Protection Plus
- Rabsons Special Two Year Guarantee
- Easy Payment Plan Up to 24 Months to Pay
- Each Component Double Packed to Insure Safe Arrival... At no extra charge
- Rabsons Sells ONLY Factory Fresh Merchandise in Original Factory Sealed Cartons

SO WRITE RABSONS

Whatever your HI-FI requirements and receive

FREE

A \$1.00 genuine Miracle Record Cleaning Cloth with EVERY Quotation from Rabsons on a component or system of your choice.

RABSONS -57 ST. INC.

119 West 57th St., New York 19, N.Y.

Area Code 212 Circle 7-0070

Diagonally opposite Carnegie Hall

*Limited selection
of Heritage pipes
now available*

Because the amount of fine, imported briar is sorely limited, only a specified number of Heritage pipes can be made each year. If you appreciate selected briar, bench made to exacting standards, write and we'll send a brochure of available shapes. Smooth, Heirloom finish (\$13.50), rugged-looking Antique finish (\$10.50).



Heritage Heirloom finish Octagon Billiard shape

KAUFMANN'S
Fifth Avenue
Pittsburgh, Pa.

CIRCLE NO. 61 ON READER SERVICE CARD CIRCLE NO. 39 ON READER SERVICE CARD

HI-FI BUYERS!

Want to
Save yourself
a sack of
money?



SEND US YOUR LIST OF
COMPONENTS FOR AN
UNBELIEVABLE QUOTATION
THAT CAN NOT & WILL NOT
BE BEAT. WRITE TODAY!

Send for our discount catalog, too.

KEY ELECTRONICS CO., INC.
518 E. 95 St., B'klyn 12, N.Y.
Phone: Dickens 6-4191

CIRCLE NO. 52 ON READER SERVICE CARD

free...
information
on the
world's
happiest
hobby!

ASSEMBLE IT AT HOME



ELECTRONIC ORGAN KITS
for home, school, church, clubs.

The Original "Build-it-Yourself" Organ
sounds like a glorious pipe organ

SAVE 70%
up to



Anyone Can Do It! Here's What You Get



Mail coupon below, and receive... absolutely FREE... complete information on Artisan's new 1963 Organ-Building Kit! Illustrated instructions lead you through every step of this happy hobby, as you assemble-at-home a magnificent custom Artisan electronic organ—the best in tone and styling! No technical skill required, and you save up to 70% of comparable ready-built organ costs by skipping dealer profits and factory labor! You can play as you build and pay as you build. From \$1750 to \$7500. Write today!

ARTISAN ORGANS, 2476 SR N. Lake Ave., Altadena, Calif.

NAME _____

ADDRESS _____

CITY _____

ZONE _____

STATE _____

CIRCLE NO. 9 ON READER SERVICE CARD
142

Cante Gitano and the Cante Flamenco.”

In contrast to this production, there have been several clarifyingly annotated introductions to flamenco, most notably the now out-of-print “History of Cante Flamenco” on Top Rank. There is no faulting the music in this London set, but newcomers to flamenco will have to look elsewhere—particularly to the Folkways catalog—for printed guidance to the complexities of this music. *N. H.*

© ® ALL-STAR HOOTENANNY. Odetta, Oscar Brand, Bob Gibson, Cynthia Gooding, others. *Railroad Bill; A Dying Man's Plea; Raise a Ruckus; Hard, Ain't It Hard;* and eight others. RIVERSIDE RS 97539* \$4.98, RM 7539 \$3.98.

Interest: Mixed folk bag
Performance: Bland to burning
Recording: Good

Riverside has selected a dozen assorted tracks from already-released folk albums in its catalog. Least worth hearing are most of the citybillies—the characterless Bob Gibson, Oscar Brand, Billy Faier, and the Homesteaders. Eric Weissberg, however, plays a sizzling banjo on *Hard, Ain't It Hard*, and the eclectic Cynthia Gooding is effective on *I Know Where I'm Going*. Odetta, not entirely convincing as a blues singer, has first-rate jazz support for her version of *Make Me a Pallet on the Floor*. The Lonesome River Boys, composed of both citybilly and country musicians, are fluent but not pungent enough in their Bluegrass contribution.

The authentic folk performers are responsible for the most substantial music. Heading them are the Staple Singers, the country's most deeply expressive gospel group. There are also the ominous, fiercely personal blues singing of John Lee Hooker, Sonny Terry's re-creation of earthy country blues, and the tough, spare, city blues of Memphis Slim. But the album is too uneven to be recommended. *N. H.*

SPOKEN WORD

RECORDING OF SPECIAL MERIT

© SAMUEL BECKETT: *Molloy; Malone; The Unnamable*. Cyril Cusack (reader). Howard Sackler, director. CAEDMON TC 1169 \$5.95.

Interest: Powerful monologs
Performance: Exceptional
Recording: Excellent

In 1945, Samuel Beckett, a close friend and disciple of the late James Joyce and a fellow exile-by-choice from Ireland, settled in Paris and proceeded to write a number of important works. Among

them were the plays *Waiting for Godot* and *Endgame*, which were to rock the stuffy conventions of the theater with their irreverence and fresh approach, and three novels in the form of dramatic monologs. Beckett wrote them in French because, he said, he wanted to avoid the temptation to cultivate a beautiful style for its own sake in his native tongue. Translated into English, mainly by himself, the three works were presented in condensations over the BBC in 1957 and 1958. These versions Caedmon has put onto this remarkable disc, and it is a major addition to the catalog of the contemporary theater on records. All three of the characters are writers, all have lost their way in the world, and all offer remarkable testimony of the ability of the human spirit, however maimed, distorted, or starved, to triumph over impossible obstacles, draw nourishment

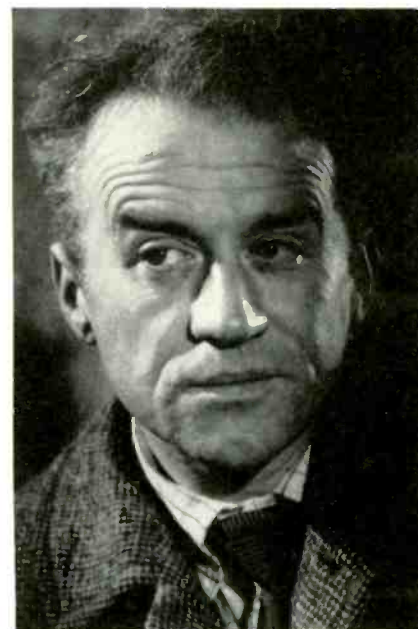

CYRIL CUSACK

A matter-of-fact approach for Beckett

from stones, and find reasons for self-esteem in the most sordid situations. The monologs do not have plots in the usual sense, but rather employ devices of suspense in the gradual self-revelation of each character. Molloy tells of his search for freedom, for the right to live as he pleases, and finally, for a home. Malone, on whose vitality time closes in like a slowly turning vise, mourns his own spiritual paralysis. The condition of *The Unnamable* is even more startling—all that is left of him is his trunk and head, living on in a kind of jar. Yet he manages to adapt to his bizarre situation and make his strange ordeal of daily survival sound credible, even commonplace. At the end Beckett himself seems to step out from behind the scenes to indicate that all three are but aspects of himself, devices for exploring the problem of his own identity. All this is told in strong, lean,

concrete, and sometimes shocking language. Cyril Cusack is the ideal interpreter, keeping his voice low and matter-of-fact, but missing none of the text's irony or humor. He renders each work with perfect clarity and understanding. Like Krapp in Beckett's more familiar *Krapp's Last Tape*, the unholy trio on this record are unforgettable not because of their charm—they are all unsavory—but because they do not lie, to themselves or to us, in discussing the precise nature of their torments, their desires, and their tenacity in the face of the apparent futility of their lives. P. K.

© **SHELLEY BERMAN: *New Sides.***
VERVE V 15036 \$4.98.

Interest: Stand-up comedy
Performance: Uneven
Recording: Night-club flavor

Berman made his well-earned reputation by building routines around situations that won total identification from his audiences. But now the spontaneity seems to be going out of the act. A comedian should never examine himself to find out why he is funny. Shelley remains a likeable fellow, and I enjoyed his efforts here to get the "fourteen hundred pins" out of his new shirt, make a telephone call on his credit card—although the days of jokes about digit-dialing should be numbered by now—and his efforts to get money from the "Easy Loan Finance Company." The rest—a frenetic phone call to an analyst, an attempt to get a doctor in a strange town to make a house call (Elaine May and Mike Nichols have already worked this vein dry), and a bit about a lost dog—are a let-down. Berman seems to be developing certain nervous mannerisms, such as slick asides and conceited references to himself, that lower his lovability quotient. In the liner notes he writes, "A great many of us have worked very hard in order to make this album a piece of quality merchandise." Maybe that is the source of the trouble. P. K.

© **RAY BRADBURY: *There Will Come Soft Rains; Marionettes, Inc.***
Burgess Meredith (reader). LIVELY ARTS 30004 \$4.98.

Interest: Top-drawer fantasy
Performance: Exemplary
Recording: Faithful

Ray Bradbury, whose style is a curious blend of pulp prose and poetry, is, at his best, a terrific storyteller—and it is at his best that you'll find him here. *Marionettes, Inc.*, dealing with the horror of a man's slow discovery that the wife who has been sharing his bed is actually a transistorized duplicate of the girl he married, was once the basis for a

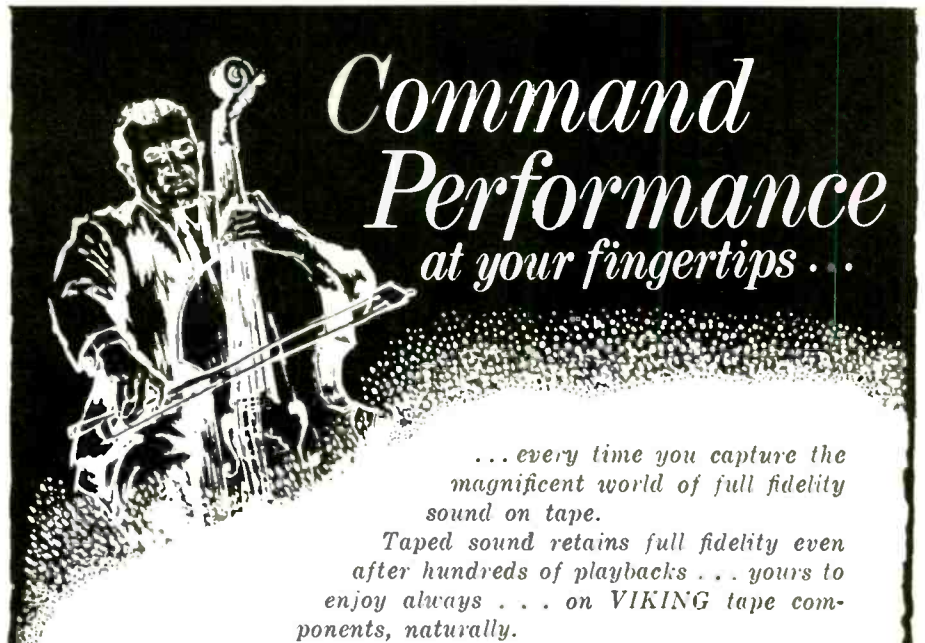

Command Performance at your fingertips . . .

... every time you capture the magnificent world of full fidelity sound on tape.
Taped sound retains full fidelity even after hundreds of playbacks . . . yours to enjoy always . . . on VIKING tape components, naturally.

A VIKING invests you with unlimited versatility to record live programs or off the air including F.M. multiplex, duplicate, put sound on sound and edit with perfect ease.

Retro-matic 220 — ultimate performance with tomorrow's features for discriminating audiophiles and professionals only.

Two-directional playback, quarter track stereo at two speeds. "Feather-touch" push buttons, remote control, 12 watt amplifier, simultaneous record/playback with 20-25,000 cps frequency response. Independent channel controls, "luma-touch" record buttons and illuminated VU meters. Photo electric run-out sensor, four heads, hysteresis capstan motor plus two reel drive motors and digital counter. Superbly styled with stainless steel face plate this compact operates vertically or horizontally.



88 Stereo Compact—for connoisseurs of the fine things in high fidelity stereo sound.

Two speed tape recorder with choice of half or quarter track stereo. Three new type hyperbolic heads—no more old fashioned pressure pads. New design amplifier with excellent 30-18,000 cps frequency response. lets you monitor off the tape with "A-B" comparison switch. Independent channel controls and VU meters, two motors, record indicator light, counter, automatic tape shut-off. With its attractive, brushed aluminum face panel, the 88 Compact fits any installation for vertical or horizontal operation.

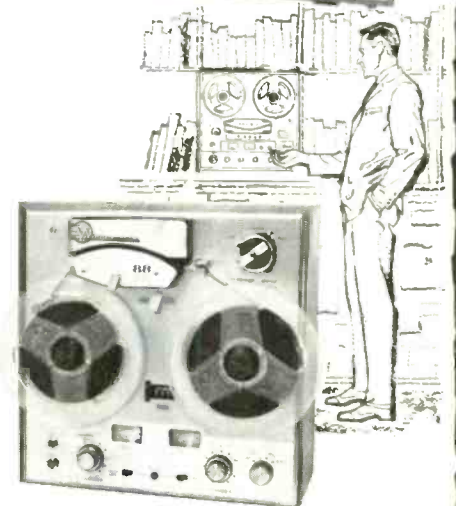

Put Command Performance at your finger tips with VIKING tape components — made by skilled American craftsmen.

Tape recorders, transports, cartridge players—even for your car or boat—at reputable high fidelity dealers most everywhere.



VIKING OF MINNEAPOLIS, INC.
9600 Aldrich Avenue South, Minneapolis, Minnesota, 55420

Your assurance of Quality in Tape Components

SAVE OVER 40% ON HI-FI

USE OUR EASY-PAY PLAN Up to 24 months to pay

DON'T BUY HI-FI COMPONENTS

Take Records or Electronic Equipment until you get return mail quotation from "your friend in the business."

- Trade-Ins—Highest Allowance—Send us your list.
- 15 day money-back guarantee.
- Full 2-year warranty—parts & labor.
- We are factory franchised all lines. We ship from stock.
- 18th year of dependable & reliable service throughout the world.
- We guarantee "We Will Not Be Undersold."
- Call us at (212) EN 9-3700 from any part of U.S.A. You may deduct 3-minute toll charge if your order is in excess of \$100.00.

BEST BUY HI-FI LIST FREE. Send 10¢ for stereo tape catalog—All labels save 33 1/3%.

ELECTRONIC WORLD HI-FI RECORDING TAPE

7" Spools · Splice Free · Freq. Resp. 30-15KC

60M	3 1/4"	600' Mylar	\$1.09	\$1.99
12A	7"	1200' Acetate	1.09	.99
18M	7"	1800' Mylar	1.89	1.79
24M	7"	2400' Mylar	2.59	2.39
24MT	7"	2400' Mylar-Ten.	2.89	2.79

Any assortment permitted for 12+ price. Add 15¢ per reel postage & handling, continental U.S.A. Write for complete listing & 100+ price.

HI-FIDELITY

CENTER

"The House Of Low Low Prices"

1797-H First Ave., New York 28, N.Y.

CIRCLE NO. 40 ON READER SERVICE CARD

SAVE On Stereo HI-FI

SEND NOW FOR FREE

228 PAGE CATALOG

Don't miss the 100's of amazing \$\$\$ savings on Complete Systems, components and kits—found ONLY at B-A!

BURSTEIN-APPLEBEE CO.

Dept. H.F.S. 1012 McGee St., Kansas City 6, Mo.

Rush me FREE 1964 B-A Catalog.

Name.....

Address.....

City..... State.....

CIRCLE NO. 92 ON READER SERVICE CARD
144

terrifying half hour on TV. Read aloud as originally written, it is even more frightening, and the implications for our age, as always with Bradbury, are easy to find. The other side is devoted to what is probably his masterpiece to date, *There Will Come Soft Rains*, the tale of a mechanical house that outlives its occupants. In the telling, the author avoids all the pitfalls of pat situations and pushes the idea to a reeling and delirious climax. Burgess Meredith, the author's own choice for reader of these tales, does not stint on his considerable resources. Joe Goldberg's program notes are highly readable and instructive. P. K.

© SIR WINSTON CHURCHILL—

First Honorary Citizen of the United States. David Perry (narrator). COLPIX PS 2000 two 12-inch discs \$11.96.

Interest: Stirring documentary

Performance: The real thing

Recording: Adequate

If you are growing weary of lampoons on English themes and travesties of wartime documentaries, this saga of the courage and eloquence of a great Englishman may be the perfect antidote. These excerpts from the most memorable speeches of Britain's World War II Prime Minister, linked by a vividly informative—and only occasionally pompous—narration, make this live history lesson more instructive and stirring than most. The voices of other figures of recent history—Hitler, Roosevelt, Chamberlain—are woven in to reinforce the documentary reality and immediacy. Sir Winston rallies the defeated French in their own tongue, promises his own people "blood, tears, toil and sweat," summons beleaguered London to dig in for the worst, relishes moments of victory, and heaps scorn upon the dictators who provoked the bloodshed. He is also heard coining phrases that are now part of our verbal currency, "iron curtain" among them. This album suffers from too much "production," an overabundance of sententious and patriotic music, and the narrator's tendency to drawl, but it is powerful all the same—well written and effectively put together. The technical level of the recording—the dubbing of old transcriptions aside—leaves something to be desired, judged by latest standards, but every word is perfectly understandable. P. K.

RECORDING OF SPECIAL MERIT

© CHARLES DICKENS: *Oliver Twist.* James Mason (reader). DECCA DL 9107 \$4.98.

Interest: Clever condensation

Performance: Ingenious

Recording: First-rate

Good Housekeeping magazine, whose seal of approval now apparently extends to literature as well as appliances, has started out its new library of the classics on a brilliant note with this tight but telling condensation of the Dickens tale. Mason, at the top of his form, is Oliver, Bill Sykes, Fagin, Nancy, and the Artful Dodger, each to perfection, as he re-creates the characters in the familiar story—and narrates too—with verve and virtuosity. Atmosphere is provided by some lovely music suggesting the England of the period. Professor Alice Green Fredman of Columbia University, who did the hour-long adaptation, manages to convey the qualities of the thick novel cleverly and with good taste. The anti-Semitic possibilities in the character of Fagin are bypassed completely, brutality is present but not emphasized, and room has been spared for some charming Dickensian passages of description as well as for dialogue and plot development. Occasionally, as with all condensations, the flavor of hasty synopsis intrudes, but for the most part the story flows easily and absorbingly.

An excellent gift for children, and thoroughly engaging to the adult listener as well. P. K.

© FRED ENGELBERG: *The Smoke Dreams of Fred Engelberg.*

CRESTVIEW CRV 802 \$4.98, 7802* \$3.98.

Interest: Coffeehouse verse

Performance: Soft-spoken

Recording: Good

Stereo Quality: Good

Engelberg, whose approach to life is as woolly as his dense beard, turns your home into a coffee shop as he hums to his guitar, drones out endless pseudo-philosophic verses in a tone somewhere between beat and cute, confronts you with soft, senseless questions such as "Who are you?", and makes coy requests of God: "Please don't make the whole world end." After a while, you start wishing somebody would just bring the check and show you the way out. P. K.

© DEAR ABE LINKHORN—*The Satire of the Civil War.*

David Cort (reader). FOLKWAYS FL 9741 \$5.95.

Interest: Documentary

Performance: Colorful

Recording: Adequate

These selections from the satirical writings of Civil War humorists, selected by Samuel Charters, ruthlessly deglamorize the war and the attitudes of both Yankee and Confederate, even though they have lost much of their power to evoke laughter. The passages from the writings of Artemus Ward and his contemporaries

(Continued on page 147)



Why We Make the Model 211 Available Now

Although there are many stereo test records on the market today, most critical checks on existing test records have to be made with expensive test equipment.

Realizing this, HiFi/STEREO REVIEW decided to produce a record that allows you to check your stereo rig, accurately and completely, just by listening! A record that would be precise enough for technicians to use in the laboratory—and versatile enough for you to use in your home.

The result: the HiFi/STEREO REVIEW Model 211 Stereo Test Record!

Stereo Checks That Can Be Made With the Model 211

- ✓ Frequency response—a direct check of eighteen sections of the frequency spectrum, from 20 to 20,000 cps.
- ✓ Pickup tracking—the most sensitive tests ever available to the amateur for checking cartridge, stylus, and tone arm.
- ✓ Hum and rumble—foolproof tests that help you evaluate the actual audible levels of rumble and hum in your system.
- ✓ Flutter—a test to check whether your turntable's flutter is low, moderate, or high.
- ✓ Channel balance — two white-noise signals that allow you to match your system's stereo channels for level and tonal characteristics.
- ✓ Separation—an ingenious means of checking the stereo separation at seven different parts of the musical spectrum—from mid-bass to high treble.

ALSO:

- ✓ Stereo Spread
- ✓ Speaker Phasing
- ✓ Channel Identification

PLUS SUPER FIDELITY MUSIC!

The non-test side of this record consists of music recorded directly on the master disc, without going through the usual tape process. It's a superb demonstration of flawless recording technique. A demonstration that will amaze and entertain you and your friends.

NOVEMBER 1963

NOW...GET THE FINEST STEREO TEST RECORD ever produced

for just...**\$4.98**

Featuring The Most Spectacular Music Demonstration On Disc Today

UNIQUE FEATURES OF HiFi/STEREO REVIEW'S MODEL 211 STEREO TEST RECORD

- Warble tones to minimize the distorting effects of room acoustics when making frequency-response checks.
- White-noise signals to allow the stereo channels to be matched in level and in tonal characteristics.
- Four specially designed tests to check distortion in stereo cartridges.
- Open-air recording of moving snare drums to minimize reverberation when checking stereo spread.

All Tests Can Be Made By Ear

HiFi/STEREO REVIEW's Model 211 Stereo Test Record will give you immediate answers to all of the questions you have about your stereo system. It's the most complete test record of its kind—contains the widest range of check-points ever included on one test disc! And you need no expensive test equipment. All checks can be made by ear!

Note to professionals: The Model 211 can be used as a highly efficient design and measurement tool. Recorded levels, frequencies, etc. have been controlled to very close tolerances—affording accurate numerical evaluation when used with test instruments.

DON'T MISS OUT—SUPPLY LIMITED

The Model 211 Stereo Test Record is a disc that has set the new standard for stereo test recording. Due to the overwhelming demand for this record, only a limited number are available thru this magazine. They will be sold by HiFi/STEREO REVIEW on a first come, first serve basis. At the low price of \$4.98, this is a value you won't want to miss. Make sure you fill in and mail the coupon together with your check (\$4.98 per record) today.

FILL IN AND MAIL TODAY!

Stereo Test Record N
 HiFi/STEREO REVIEW—Dept. SD
 One Park Ave., New York 16, N.Y.

Please send me _____ test records at \$4.98 each. My check (or money order) for \$_____ is enclosed. I understand that you will pay the postage and that each record is fully guaranteed. (Add 50¢ to partially defray postage costs outside U.S.A.)

Name _____
(Please Print)

Address _____

City _____ Zone _____ State _____

SORRY—No charges or C.O.D. orders! HF113

HiFi / STEREO MARKET PLACE

RENT

STEREO TAPES

- Over 2500 different, 4-track
- No deposit on tapes rented
- Postpaid 2 to 5 day delivery (48 States)

FREE
BROCHURE

stereo-parti

1616-B Terrace Wy, Santa Rosa, Calif.



SAVE

... WHEN YOU BUY
FROM HI-FIDELITY SUPPLY

Write for quotation
on any components.
All factory new and
shipped immediately.

HI-FIDELITY SUPPLY

2817-K THIRD AVE., NEW YORK 55, N. Y.



TAPEMATES

Makes available to you:

- ALL 4-Track Tapes
- ALL labels
- POSTPAID to Your Door

At **40%** Savings

FREE
BROCHURE

5280-B West Pico Blvd., Los Angeles 19, Calif.

BRITISH HI-FI COSTS LESS WHEN YOU BUY DIRECT

FROM

C. C. GOODWIN (Sales) Ltd.
The U.K. Hi-Fi Mail Order Specialists

All equipment carefully packed, insured and shipped promptly at minimum cost.

Send \$1 bill for illustrated catalogue (refundable on first purchase) and details of Hi-Fi equipment required to:

DEPT. HS, 7, BROADWAY, WOOD GREEN,
LONDON, N. 22, ENGLAND

DIXIE

HIGH FIDELITY WHOLESALERS

Largest discount High Fidelity component distributors in the South. Wholesale prices on package or individual components. Latest models in factory sealed cartons. Special attention given to Audio Clubs, Churches and Schools.

Are prices too high?—Write

DIXIE HI-FI

703 Horton Drive, Silver Spring, Md.

SAVE MONEY ON HI-FI COMPONENTS

TAPE RECORDERS TAPES, ACCESSORIES SLEEP LEARN KITS —MERITAPE—

Low cost, high quality recording tape, in boxes or cans.

SEND FOR FREE ILLUSTRATED CATALOG



1523 JERICHO TPKE,
DRESSNER
NEW HYDE PARK 21, N.Y.



DISC- whisk

PATENTED

MIRACLE NEW RECORD CLEANER!

FIRST 100% EFFECTIVE CLEANER! Just 5 seconds to clean both sides simultaneously—leave an invisible magic protective film that will actually prevent new dust or lint from clinging.

DISC WHISK is the only known record cleaner which will remove microscopic-size dirt particles from microgrooves...restore original, static-free sound quality! Expensive needles last longer, too!

JUST
\$2.00
ppd.

Fits all records to 12"—fully guaranteed. Mail \$2.00 cash, check or money order today for immediate delivery. Corey of California, 930 A Linden Avenue, South San Francisco, California.



PROMPT
DELIVERY

LOW
PRICES

AMPLIFIERS — MULTIPLEX —
TAPE RECORDERS, TUNERS
SPEAKER SYSTEMS, ETC.
AIR MAIL QUOTES — COMPARE
WRITE FOR CATALOG

AUDIO DIVISION
L. M. BROWN SALES CORP
Dept. S—242 West 10th Street • New York 14, N. Y.

LEARN WHILE YOU SLEEP

Headquarters

Experiment in this fascinating, educational new field. Use your phonograph, recorder or amazing new *Electronic Educator* endless tape recorder. We carry a full line of endless repeating tape cartridges for all makes of standard recorders plus automatic timers, pillow speakers and complete outfits. Also over 200 unusual educational and self-help courses on tape and record for sleep-learning and hypnosis experimenters. Write for free 300 items catalog and full astonishing details.

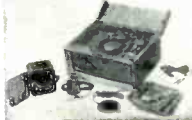

Sleep-Learning Research Association
P. O. Box 24-Y, Olympia, Washington

LOW WAREHOUSE PRICES WAREHOUSE DIRECT SHIPMENTS

SPECIAL WAREHOUSE PACKAGE DEALS
ALL BRAND NEW COMPONENTS
FRESH FROM WAREHOUSE

GET OUR
WAREHOUSE
PRICE LIST

STEREO WAREHOUSE

228-S Greenway Terrace, River Edge, N.J.

WRITE FOR QUOTATION
ON ANY HI-FI COMPONENTS

SOUND REPRODUCTION, INC.

34 New Street, Newark 2, N. J.
Mitchell 2-6816

NATIONWIDE DELIVERY...



on all your Stereo needs.
Recorders, Tuners, Amplifiers
Turntables, etc.
LET US PROVE that we can supply your requirements
PROMPTLY AT LOWEST COST.
FREE CATALOG.

STEREO COMPONENT Supply Co., Dept. S
150 NINTH AVE., NEW YORK 11, N. Y.

HiFi/Stereo
Market Place (Cont.)

FAST SHIPMENTS
COMPONENTS • KITS

RECORDERS • TAPES

- BEST-BY-COMPARISON PRICES
- FACTORY SEALED CARTONS
- SEND FOR "QUOTES" ON PACKAGE DEALS AND SAVE MORE

WRITE FOR MONTHLY SPECIALS
VISIT OUR STORE
CARSTON Studios
125-N East 88 St., New York 28, N. Y.

SAXITONE RECORDING TAPE

*Oxide guaranteed not to rub off or squeak—or money back. Compare ours with other "Bargain" tape. You'll find it's more than just "price" when you deal with us. We are original pioneers in the tape recorder business and our reputation means everything to us.

225' MYLAR, 3" (in mailable box)	.39
600' acetate (plastic), 5 inch	.75
600' MYLAR 5 inch reel	.85
900' MYLAR (Polyester), 5 inch	.89
1200' MYLAR, 1/2 mil., 5 inch reel	1.18
1200' MYLAR, tensilized, 5 inch	1.59
1200' acetate (plastic), 7 inch	1.15
1200' MYLAR, 1 1/2 mil. (strong)	1.29
1800' acetate (plastic), 7 inch	1.39
1800' MYLAR 1 mil. thick, 7 inch	1.89
2400' MYLAR, untensilized, 7 inch	2.59
2400' MYLAR, tensilized, 7 inch	2.69

(Large Users Even Lower)

SAVE 30%
4-track stereo music on tape
(Complete stock)

PLUS POSTAGE

NORELCO SPEAKERS
Famous AD3800M, twin cone 8" (75-19,000 cycles) comparable net 9.90 now 4.95, 2 for 9.00, plus postage. **OTHER Norelco models at BIG DISCOUNTS.** Specifications on entire Norelco line sent on request.

SAXITONE TAPE SALES
dip. Commission Electronics, Inc.
1776 Columbia Rd. N.W., Wash. 9, D.C.

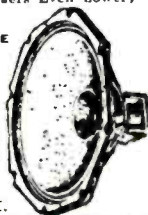

MOVING?

ATTACH LABEL HERE

If you've recently changed your address or plan to in the near future, be sure to notify us at once. Place magazine address label here and print your new address below.

NEW ADDRESS:

NAME _____ PLEASE PRINT

ADDRESS _____

CITY _____ ZONE _____ STATE _____

Please fill in moving date below:

If you have any other questions about your subscription be sure to include your magazine address label when writing us.

Mail to: HiFi/STEREO REVIEW, 434 So Wabash Avenue, Chicago 5, Illinois

throw a merciless light on the pieties of our history books. David Ward Locke's mythical character Petroleum V. Nasby limns the South in broad strokes of folksy humor. Bill Arp's letter to "Abe Linkhorn" implies that the Emancipation Proclamation was just a piece of paper as far as improving the lot of the Negro was concerned: "We received your proclamation, and as you have put us on very short notice, a few of us boys have concluded to write you, and ask for a little more time. . . ." Not all the humor on this disc is as quiet as that, to be sure. Artemus Ward's dialect is exasperating in the extreme, whether you hear it or just read it, and it is hard from this vantage point in time to understand what Lincoln saw in him. Nor does Petroleum V. Nasby grow more lovable on prolonged acquaintance. The shafts of the satirists of the day played an important part in fashioning public opinion on both sides of the Mason-Dixon line. Yet, despite the varied and skillful readings by David Cort, the material is better suited to scholarship than to entertainment.

P. K.

© ® SHAKESPEARE: *Antony and Cleopatra*. Richard Johnson, Irene Worth, Robert Eddison, Patrick Wymark, Miles Malleston, Gary Watson, Jan Lang, Prunella Scales, and Jill Balcon (performers). George Rylands, director. LONDON OSA 1427 four 12-inch discs \$23.92, A 4427* \$19.92.

Interest: Another Cleopatra
Performance: Classic and stately
Recording: Flawless

This is certainly Cleopatra's year—Elizabeth Taylor on the wide screen, Claudette Colbert in TV revivals of the old movie, Colleen Dewhurst in New York's Central Park, Jenny Tourel in Berlioz' musical setting of Viellard's verses: whether one's taste runs to Shakespeare or Joseph Mankiewicz, there appears to be a Cleopatra for almost everybody.

For the Shakespeare Recording Society, Pamela Brown did the Serpent of the Nile to a turn some months ago, with Anthony Quayle as a true colossus of a Mark Antony. Now comes the Marlowe Society—telling us these days who the actors are in their formerly anonymous casts, but not who plays what role—with a version in marked contrast to Caedmon's sweeping, fast-moving panorama in sound. The Queen of Egypt for this recording (I suspect it is Irene Worth) offers us a thoroughly classic portrait—a well-bred Englishwoman, noble and regal, intense but controlled, who can be wry and sarcastic but not comical, feline but never kittenish, decorous even when she loses her temper—even, indeed, when she lusts.

She is surrounded by a dynamic and

resourceful Mark Antony, who can make his voice as harsh or as deep as he pleases, and a number of expert actors with a healthy respect for the beauty of the lines. Under Rylands' measured and unhurried direction, a pageant of symmetry and clarity emerges. Respect for Shakespeare's words makes all else subordinate. There is a consistency of style and an orchestration of words and effects that lend great majesty to Rylands' conception. At this pace, however, it takes the lady an unconscionable time to die from the bite of her snake, and the episodes do not fuse as they should. And though she purrs, shouts, and gives the part her all, this Cleopatra—and the director's total approach—lack that sense of flesh-and-blood that can set one's pulses pounding.

P. K.

© ® SHAKESPEARE: *The Merchant of Venice*. Hugh Griffith, Dorothy Tutin, Harry Andrews, Jeremy Brett, others. Peter Wood, director. CAEDMON Shakespeare Recording Society 209 three 12-inch discs stereo and mono \$17.85.

Interest: Drama of usury and mercy
Performance: Polished
Recording: Excellent
Stereo Quality: Unusually effective

This is the second time Caedmon has recorded this disturbing play about money-lenders, mercy, and music—a slightly abridged version featuring Michael Redgrave as Shylock has been in the catalog for years. This time, the play is done complete, employing stereo more brilliantly than I have heard previously in a Shakespeare production. And the company has added to its fine players expectation-rousing leads in Hugh Griffith and Dorothy Tutin, the latter acclaimed before, in these pages and throughout the English-speaking world, for her performances in *The Hollow Crown*.

Especially praiseworthy is Griffith's conception of Shylock. He plays him without a trace of an accent, which is thoroughly refreshing, and yet he does not dodge either his innate monstrousness, or the opportunities permitted by the lines to reveal the character's humanity. Miss Tutin is a restrained Portia. I was disappointed that, with the resources of her talent, she chose to give so little variety to the part—especially in the scenes in which Portia appears as a man. Under Wood's direction, there is an effective use of modulation from the low, intimate voice in dialogue to the swelling sound of Shakespearean virtuoso declamation. But Miss Tutin's varying dynamics sound studied and unnatural. Her anonymous counterpart on the London Marlowe Society recording creates a more interesting Portia. London's Launcelot Gobbo, too, gives a more orig-

(Continued on page 149)

HiFi/STEREO SHOPPING CENTER

RATE: 40¢ per word. Minimum 10 words. January issue closes November 5th. Send order and remittance to: Martin Lincoln, HiFi/STEREO REVIEW, One Park Ave., N.Y.C. 16

EQUIPMENT AND ACCESSORIES

COMPONENTS at lowest prices anywhere. Write for catalog. The Macalester Corporation 355 Macalester Street, St. Paul 5, Minnesota.

COMPONENTS, Recorders! Free wholesale catalogue. Carston, 125-L East 88, N.Y.C. 28.

KIT Experts—Dynaco Specialists—Kits at reasonable prices are our specialty. Also custom wired kits guaranteed to exceed factory standards at substantial savings. Beautiful handcrafted Walnut cases for complete Dynaco line starting \$15.00 each. Plus everything in audio. Kitcraft, 738 Washington Avenue, Brooklyn, New York 11238, MA 2-6946.

LOW. Low quotes: all components and recorders. HiFi, Roslyn 9, Penna.

WRITE for quotation on any Hi Fi components: Sound Reproduction Inc., 34 New St., Newark, N.J. Mitchell 2-6816.

DISGUSTED with "Hi" Hi-Fi Prices? Unusual Discounts On Your High Fidelity Requirements. Write: Key Electronics, 120 Liberty St., New York 6, N.Y. Dickens 6-4191.

FREE Catalog—name brand tubes 65% discount, phono needles 80% or more discount, phono cartridges, picture tubes 75¢ inch. parts, parts kits, silicon and selenium rectifiers, transmitting tubes, 7" T.V. test tube \$6.99 imported batteries, tube testers, etc. Want to swap or sell tube inventory? Send us your offering. Arcturus Electronics Corp. Dept. Z.D. 502-22nd St., Union City, N.J.

SALE items—tapes—recorders—component quotations. Bayla—Box 131R—Wantagh, N.Y.

MILITARY Discount—Name brands free recording tape and stereo handbook. Include rank and serial number. Electronics International, Box 3066, Charlottesville, Virginia.

BEFORE You Buy Receiving Tubes, Test Equipment, HiFi Components, Kits, Parts, etc. . . . send for your Giant Free Zalytron Current Catalog, featuring Standard Brand Tubes: RCA, GE, Etc.—all Brand New Premium Quality Individually Boxed, One Year Guarantee—all at Biggest Discounts in America! We serve professional servicemen, hobbyists, experimenters, engineers, technicians. Why Pay More? Zalytron Tube Corp., 461 Jericho Turnpike, Mineola, N.Y.

TRANSISTORIZED Products importers catalog, \$1.00 Intercontinental. CPO 1717, Tokyo, Japan.

CANADIANS—Giant Surplus Bargain Packed Catalogs. Electronics, HiFi, Shortwave, Amateur, Citizens Radio. Rush \$1.00 (refunded). ETCO, Dept. Z, Box 741, Montreal, CANADA.

SAVE dollars on radio, TV-tubes, parts at less than manufacturer's cost. 100% guaranteed. No rebrands, pulls. Request Bargain Bulletin. United Radio, 1000-H, Newark, N.J.

HARPSICORDS—Clavichords fine European instruments at reasonable prices. Write 3101 Summit Road, San Bruno, California.

Hi-Fi Components, Tape Recorders at guaranteed "We Will Not Be Undersold" prices. All brands in stock. 15-day money back guarantee. 2 year warranty. Write your requirements for quotation. No Catalog. Hi-Fidelity Center 1797-R, 1st Ave., New York 28, N.Y.

WRITE for lowest quotations, components, recorders. No Catalogs. Hi-Fidelity Supply, 2817-TC Third, New York City 55.

"LISTEN-In-Coil" picks up any telephone conversation in vicinity. No connection to telephone necessary. Easily concealed. \$2.98 complete. Consolidated Acoustics, 1302Y Washington St., Hoboken, N.J.

TAPE recorders. Hi-Fi components, Sleep Learning Equipment, tapes. Unusual values. Free catalog. Dressner, 1523HF Jericho Turnpike, New Hyde Park 9, N.Y.

THE Price is Right! Hi-Fi Components. J. Wright Co., 65-B Jensen St., East Brunswick, N.J.

MAY we give you our quote on your Hi-Fi requirements? You'll be pleasantly surprised that what you had in mind won't cost as much as you thought. We carry all brands in stock. Components are new and fully guaranteed. Ask to be put on our mailing list for special bargains. Crown Electronics Corp., 64 Cortlandt St., New York 7, N. Y. (212) WO 4-0790.

"FM/Q" Metropolitan Broadband Antenna, the finest compact yagi made, completely rustproof, only \$14.95 prepaid. FM Book with station directory 30¢. FM/Q, Wethersfield, Connecticut.

"BUY British—Buy Best! For the finest in all Hi Fidelity Equipment write for our quotation first. The Hi-Fi Export Specialists! Send \$1 for catalogue. When in England call and see us. Telesonic Ltd. 92 Tottenham Court Road, London, W.1. England."

"DUST Bug" Owners—closeout, discontinued Ethylene Glycol anti-static liquid in wick applicator bottles. 3 for \$2.50. Ecobal, Box 62, Kingsbridge Station, Bronx, N.Y. 10463.

MARANTZ IC mono preamp, case \$95; Model 2 mono amplifier \$125; Citation 1 stereo preamp, case \$150; Scott 130 stereo preamp \$50. Excellent condition. Shipping extra. Robert Charles Marsh, 452 Armitage, Chicago 14, Illinois.

IMPORTANT Announcement. The Hermann Scherchen Sterophonon (Patent device for producing stereophonic sound effect from all ordinary mono, radio, gram & tape equipment) now available direct from Sole Manufacturers for only \$16.00 (U.S. or Canadian) including insured post. Send cash, M.O. or cheque or request details, Symphony Amplifiers Ltd., 16 Kings College Rd., London, N.W. 3, England.

OHM'S law never forgotten with copyrighted tool. \$2.00 Postpaid. Beck Radio, 6323 South Dale Mabry, Tampa, Florida 33611.

SAVE Money—Free catalog: Photography, Tape Recorders, Hi Fidelity, Electronics, Tools. Wholesale Radio & Camera Company, Box 3085, Philadelphia 50, Pennsylvania.

RECORDS

RARE 78's. State Category. Write Record-Lists, P.O. Box 2122, Riverside, California.

"HARD To Get" records—all specs. Record Exchange, 812 Seventh Avenue, New York, N.Y.

THE Record Collector Journal—comprehensive, valuable data, varied record mart. Introductory six issues—\$1.50. Record Research, 131 Hart, Brooklyn 6, N.Y.

CASH For Your Unwanted LPs. Reder, Forshay Rd., Monsey, N.Y.

LP's Like new. Send 25¢ for List. Records, Hillburn, P.O., Hillburn, N.Y.

SUPRAPHON L.P. records at only \$2.45 each. Send for complete list of 500 titles, including many new issues just released. All 12" new at \$2.45, 10", \$2.10. Postage extra. The Gramophone Shop, 901 Dumbarton Rd. Glasgow, W.I. Great Britain.

COLLECTORS' items 78's, famous artists autographs. Write for catalogue. Collectors' Corner, 4728 McPherson, St. Louis, Mo. 63108.

TAPE AND TAPE RECORDERS

TAPE sale 1800' Mylar 10+ \$1.70 Postpaid Single \$1.95 Bayla, Box 131-TR, Wantagh, N.Y.

TAPE Recorder Sale. Latest models, \$10.00 above cost. Arkay Sales, 22-11 Riverside Ave., Medford 55, Massachusetts.

BEFORE renting Stereo Tapes try us. Postpaid both ways—no deposit—immediate delivery. Quality—Dependability—Service—Satisfaction—prevail here. If you've been dissatisfied in the past, your initial order will prove that this is no idle boast. Free Catalog. Gold Coast Tape Library, Box 2262, Palm Village Station, Hialeah, Florida.

BARGAIN! Ampex (Shamrock) tape 1800' Mylar 7" reel. 12 for \$24.95 postpaid. Moneyback guarantee. Lowest quotes: all components, recorders. Pofe Electronics, 1716A Northfield, Muncie, Indiana 47304.

RENT Stereo Tapes—over 2,500 different—all major labels—free brochure. Stereo Parti, 1616-G Terrace Way, Santa Rosa, California.

RECORDING Tapes. Free sample. Mail 25¢ (handling). Towers, Lafayette Hill, Penna.

SAVE 30% Stereo music on tape. Free bargain catalog/blank tape/recorders/norelco speakers. Saxitone, 1776 Columbia Road, Washington, D.C.

SELF-Hypnosis. New concept teaches you quickly by tape or LP-record. Free literature. McKinley Publishers, Dept. T4, Box 3038, San Bernardino, Calif.

EMPTY Tape Reels. Save 50%. Package contains: 20-7", 20-5", 5-3/4", 5-3". Shipped postpaid. Send \$10.00. Moneyback guarantee. J. J. Hayes, Box 337, Rockville Centre, New York.

REPAIRS AND SERVICING

ALL Makes of Hi-Fi Speakers Repaired. Amprite, 168 W. 23 St., N.Y.C. 7. CH 3-4812.

TV Tuners rebuilt and aligned per manufacturers specification. Only \$9.50. Any make UHF or VHF. We ship COD. Ninety day written guarantee. Ship complete with tubes or write for free mailing kit and dealer brochure. JW Electronics, Box 51F, Bloomington, Ind.

TAPE Recorder and HiFi repairs. Amplifiers, tuners, turntables. All American and foreign makes serviced. Estimates in 48 hrs. after receiving equipment from any part of U.S. Macken Electronics, 5 West Post Road, White Plains, N.Y., WH9-9777.

TV Tuners Rebuilt and Aligned to Specifications. Guaranteed All Makes. One Price. \$9.50 Complete. Plus Shipping. Valley Tuners, 5641-E Cahuenga, North Hollywood, California.

Hi-Fi Problems solved by "The Hi-Fi Doctor" on the spot. Audio, Acoustic, Radio Engineer, Professional visits, day, evening. New York area. William Bohn, Plaza 7-8569.

METERS—Multimeters repaired and calibrated. Free estimates—Catalog. Bigelow Electronics, Box 71-G, Bluffton, Ohio.

PATENTS

PATENT Searches, \$6.00! Free "Invention Record"/Information. Miss Hayward, 1029 Vermont, Washington 5, D.C.

BOOKS

AUTHORS' Learn how to have your book published, promoted, distributed. Free booklet "ZD," Vantage, 120 West 31 St., New York 1.

VERY Unusual! The Booklover's Answer, bi-monthly magazine for book connoisseurs. One year \$2.00, sample 40¢. The Booklover's Answer, Webster 7, New York.

WANTED: Short stories, books, articles, plays of all descriptions for sale to publishers, producers. Free Literature! Literary Agent Mead, Dept. 39A, 915 Broadway, N. Y. C. 10.

BOOKHUNTING? All subjects searched free! Cambridge Book Service, Box 18K, Cambridge 40, Mass.

SHOPPING GUIDE CLASSIFIED

A HANDY GUIDE TO PRODUCTS AND SERVICES. NOT NECESSARILY IN THE HIGH FIDELITY FIELD. BUT OF WIDE GENERAL INTEREST.

BUSINESS OPPORTUNITIES

I MADE \$40,000.00 Year by Mailorder! Helped others make money! Start with \$10.00—Free Proof. Torrey, Box 3566-N, Oklahoma City 6, Oklahoma.

SONGS into \$\$\$\$\$ — New, unknown Songwriters, Song-poets, Composers share \$33 millions yearly. Any subject, we collaborate, publish, promote. Largest firm, information, appraisals Free. Send Nordyke Publishers, 6000 Sunset, Hollywood, California 3-90028.

EARN Extra money selling advertising book matches. Free samples furnished. Matchcorp., Dept. MD-112, Chicago 32, Illinois.

PHOTOGRAPHY — FILM, EQUIPMENT, SERVICES

SCIENCE Bargains—Request Free Giant Catalog "CJ"—144 pages—Astronomical Telescopes, Microscopes, Lenses, Binoculars, Kits, Parts. War surplus bargains. Edmund Scientific Co., Barrington, New Jersey.

STAMPS AND COINS

20 Different Commemoratives, 1893 up. 10¢. U.S. Approvals, K&B, Box 70, Brooklyn 23, N.Y.

TERRIFIC Stamp Bargains! Israel—Iceland—San Marino—plus Triangle Set—Plus Antigua—Borneo—Virgin—Scouts—Congo—Russia—Plus large stamp book—all four offers free—Send 10¢ for mailing cost. Empire Stamp Corporation, Dept. 22, Toronto, Canada.

SPACEOPHOBIA? 10¢ brings premium, 2¢ approval cure. BKJ Boston 23, Massachusetts.

EDUCATIONAL OPPORTUNITIES

LEARN White Asleep, hypnotize with your recorder, phonograph. Astonishing details, sensational catalog free! Sleep-Learning Association, Box 24-ZD, Olympia, Washington.

HIGHLY-effective home study review for FCC commercial phone exams. Free literature! Wallace Cook, Box 10634, Jackson 9, Miss.

LEARN White Asleep. Remarkable, Scientific, 92% Effective. Details Free. ASR Foundation, Box 7021, Dept. e.g., Lexington, Kentucky.

GOVERNMENT SURPLUS

GOVERNMENT surplus direct from Government. Jeeps \$264.00, radios \$2.53, typical prices. Guns, typewriters, cameras, tools, thousands more. Amazing low prices. How, where to purchase, merchandise available, etc., only \$1.00 to: Surplus, P.O. Box 50512, Dept. R, New Orleans 50, Louisiana.

GOVERNMENT Surplus Receivers, Transmitters, Snooperoscopes, Parabolic Reflectors, Picture Catalog 10¢. Meshna, Nahant, Mass.

JEEPS — \$111.68, Typewriters — \$4.15, Receivers — \$5.65, Televisions, Records, Oscilloscopes, Multimeters. Typical Government Surplus Prices. Exciting Details Free. Enterprises, Box 402-B5, Jamaica 30, New York.

JEEPS \$178, Airplanes \$159, Boats \$7.88, generators \$2.68, typewriters \$8.79, are typical government surplus sale prices. Buy 10,001 items wholesale direct. Full details, 607 locations, procedure only \$1.00. Surplus, Box 177-C1, Abbottstown, Penna.

JEEPS \$111.68, Boats \$6.18, Airplanes, Electronics Equipment, Typewriters, thousands more, typically at up to 98% savings. Complete information \$1.00. Surplus Service, Box 820, Holland 12, Michigan.

EMPLOYMENT INFORMATION

FOREIGN Employment. Construction, other work projects. Good paying overseas jobs with extras, travel expenses. Write only: Foreign Service Bureau, Dept. D, Bradenton Beach, Fla.

EMPLOYMENT Resumes. Earn more by presenting yourself to prospective employers more effectively. Send only \$2.00 (cash or money order) for complete Resume Writing Instructions, including sample and instructions for letter of transmittal. J. Ross, 63-61 Yellowstone Blvd. Forest Hills 75, New York, Dept. 6J-HF.

MISCELLANEOUS

HYPNOTIZE Unnoticed, quickly, effortlessly, or refund! Thousands delighted! \$2.00. Minter Box 244-D, Cedarburg, Wisconsin.

WILD Labels, bumper strips! Strange, startling, unconventional! Krazy Labels, Box 15-H, Olympia, Washington.

DO YOU Know why the Continent of Mu was destroyed? Send 20¢ for Issue 662-The Submerged Continent of Mu. Write: Lemurian Viewpoint, Ramona 6, Calif.

WANTED

QUICKSILVER, Platinum, Silver, Gold. Ores Analyzed. Free Circular. Mercury Terminal, Norwood, Mass.

JENSEN G-510 speaker. Van. 1624 "O" St., Apt. 5, Sacramento 14, California.

NOVEMBER 1963

inal and amusing portrait than Caedmon's Ronnie Barker, who is content with a stock Cockney figure. Zena Walker makes Shylock's daughter Jessica too sweet and ordinary, while Ian Holm's Lorenzo is horribly commonplace—the London recording has the advantage here, too.

On the other hand, I cannot praise too much Jeremy Brett's Bassanio, a beautifully realized characterization that draws attention, as few performances do, to his importance both to the plot and to the intellectual implications of the play. For sheer theatricality, brilliance of production and pacing, for originality, and for the conviction of Griffith's portrayal, the palm goes to Caedmon. P. K.

RECORDING OF SPECIAL MERIT

© Ⓜ SMOTHERS BROTHERS:
(Think Ethnic!) MERCURY SR 60777*
\$4.98, MG 20777 \$3.98.

Interest: Folk-music mockery

Performance: Hilarious

Recording: Stunning

The agile and indomitable Brothers Smothers, whose recent records were beginning to sag and drag, make a spectacular comeback in this unbridled demolition-bomb hurled into the heart of the folk-music encampment. Whether they are applying the screws to some venerable tune such as *John Henry* or ringing a new variation on a tired ballad ("Black is the color of my love's true hair"—"only her hairdresser knows for sure"), these blonde baby-faced monsters allow no dull moment to come between you and them. Tom draws out, with his tongue getting in the way, a series of muddled orations about love, Daniel Boone, and our "Latin American neighbors . . . to the South." A screaming mock battle between him and Dick, which breaks up a leg-pulling presentation of a fast little number called *The Fox*, will leave only the most stony-faced spoil-sport unsmiling. Technically, too, the recording, made at the Crystal Palace in St. Louis before a live audience, is topnotch. I do not want to spoil your good time by telling you what the *Venezuelan Rain Dance* turns out to be, or tip you off which numbers are kidded. Just make your purchase assured that neither folk singers, folk songs, nor that peculiar variety of pseudo-historical patter that usually accompanies their presentation will ever sound the same to you again. P. K.

© EDMUND SPENSER: *The Faerie Queene; Poems*. Michael MacLiammoir (reader). CAEDMON TC 1126 \$5.95.

Interest: Great English verse

Performance: Elaborate

Recording: Good

Poor Edmund Spenser, who died in a low lodging house after skyrocketing to fame as a great poet in England, is probably less read today than anybody in the sacred library of Great Literary Masterpieces. His poems, for one thing, are terribly long, decorous, and ornamented, which prejudices the modern reader who has been taught to extol economy, frankness, and simplicity. Yet there they are, and simply ignoring them does not leave their finely chiselled lines the least bit less beautiful. *The Faerie Queene*, which the poet never completed, is a symbolical and allegorical saga of convoluted adventures. The final cantos of Book III are read by Mr. MacLiammoir. Several passages, dealing, for example, with the discovery by the knight Britomart (he represents Christianity, the annotators obligingly assure us) of a lady bound to a pillar in a glittering chamber while a "vile enchanter" stands over her, sound like ideal material for an Alan Resnais scenario to be set in some medieval Marienbad. There are also scenes of lust and battle quite reminiscent of the technicolor screen. On the second side, MacLiammoir lifts his supple voice for a tour-de-force presentation of the *Epithalamion*, a much more direct piece, written as a hymn for the poet's marriage to Elizabeth Boyle. It remains among the loveliest and most melodious of poems, and receives a sumptuous reading. P. K.

© ALFRED LORD TENNYSON:
Poems. Raymond Massey (reader).
DECCA DL 9018 \$4.98.

Interest: Lyric Victorian verse

Performance: Disappointing

Recording: Good

The mellifluous sighs and measured music of Tennyson's lyrics and legends sound peculiarly stilted to modern ears. It is difficult to be roused by these carefully stitched tapestries of nostalgia and regret when we have become accustomed to the colorful and slashing strokes of the poets who followed him. His *Idylls of the King*, a prim and pallid version of Malory's *Death of Arthur*, seems well suited for the diversion of a Victorian maiden aunt. Indeed, the long section called *Guinevere*, which recounts the indiscretions of King Arthur's wife and her final incarceration in a nunnery, seems to take forever to unfold on this disc. On the other hand, the choric song from *The Lotus Eaters*, the wistful *Ulysses*, and the shorter lyrics—*Tears Idle Tears*, *Crossing the Bar*—with their carefully fashioned sonorities, can still touch a responsive chord in us who inhabit a world so much harsher than Tennyson's. Massey, a performer well qualified for the assignment, offers a performance more commendable for clarity than for lyricism or excitement. P. K.

HIFI/STEREO REVIEW ADVERTISERS' INDEX

READER SERVICE NO.	ADVERTISER	PAGE NO.	READER SERVICE NO.	ADVERTISER	PAGE NO.
1	Acoustech, Inc.	80	40	Hi-Fidelity Center	144
2	Acoustic Research, Inc.	5		Hi-Fidelity Supply	146
3	Airex Radio Corporation	101	41	Honeywell Photographic Products	78
4	Allied Radio	85, 86	48	JansZen Loudspeakers	108
5	Altec Lansing Corporation	8	42	Jensen Manufacturing Co.	3rd COVER
86	Altec Lansing Corporation	77	36	KLH Research and Development Corporation	23
88	Altec Lansing Corporation	79	49	KLH Research and Development Corporation	113
6	American Concertone, Inc.	18	39	Kaufmann's	141
7	Ampex Corporation	74, 75	83	Kaywoodie Pipes, Inc.	12
8	Ampex Tape	92	51	Kersting Mfg. Co.	101
85	Anglo American Acoustics Ltd.	98	52	Key Electronics Co., Inc.	142
89	Antronics	88	87	Koss Electronics, Inc.	106
9	Artisan Organ	142	53	Lafayette Radio Electronics	140
10	Audio Devices, Inc.	107	84	Lansing Sound, Inc., James B.	60
11	Audio Dynamics Corporation	94	14	Lear Siegler, Inc.	27
12	Audio Unlimited, Inc.	138	54	Lesla of America Corp.	141
13	Benjamin Electronic Sound Corp.	93		London Records	98, 130
14	Bogen Communications	27	55	Marantz	131
15	British Industries—Garrard	2	56	Mercury Records	82
16	British Industries—Wharfedale	102, 103	41	Minneapolis-Honeywell (See Honeywell)	78
	Brown Sales Corp., L. M.	146	57	Minnesota Mining & Manufacturing Co.	105
17	Burgess Battery Company	124	58	Mosley Electronics, Inc.	132
92	Burstein-Applebee Co.	144	59	Murray-Carson Corporation	130
18	Cabinart Acoustical Dev. Corp.	133	48	Neshaminy Electronic Corporation	108
19	Cambridge Records	90	81	Pickering & Co., Inc.	110
20	Cantate	76	50	RCA Parts and Accessories	66
	Carston Studios	147	82	RCA Parts and Accessories	104
21	Citadel Record Club	9, 10, 11	60	RCA Red Seal Magnetic Tape	123
93	Clark Co., Inc., David	90	61	Rabsons—57th Street, Inc.	141
22	Columbia Records	62, 63	62	Reeves Soundcraft	81
91	Command Records	95	63	Roberts Electronics, Inc.	137
	Commission Electronics, Inc.	147	64	Rockford Special Furniture Co.	138
23	Concord Electronics Corporation	24	65	Rotron Mfg. Co., Inc.	139
	Corey of California	146	67	Sarkes Tarzian, Inc.	87
24	Crown International	122		Saxitone Tape Sales	147
	Dixie Hi-Fi	146	68	Schober Organ Corporation, The	96
	Dressner	146	69	Scott, Inc., H. H.	13, 15, 17
43	DuPont, Mylar	6, 7	70	Sherwood Electronic Laboratories, Inc.	28
44	Dynaco, Inc.	22	71	Shure Brothers, Inc.	21
80	Dynaco, Inc.	115		Sleep-Learning Research Association	146
45	Eastman Kodak Company	126, 127	72	SONY Corporation of America	128
46	EICO Electronic Instr. Co., Inc.	32		Sound Reproduction, Inc.	146
25	Electro-Voice, Inc.	4th COVER		Stereo Component Supply Co.	146
26	Elpa Marketing Industries, Thorens Division	16		Stereo-Parti	146
27	EMI (Scope Electronics Corporation)	117		Stereo Warehouse	146
28	Empire Scientific Corp.	109		Superox	76
29	Finney Company, The	70	73	Superscope, Inc.	120
30	Fisher Radio Corporation	2nd COVER, 1, 83		Tapemates Club	146
31	Freeman Electronics Corp.	125	74	Telex/Acoustic Products	82
32	Fuji Photo Optical Products, Inc.	136	75	United Audio Products	99
	Goodwin (Sales) Ltd., C. C.	146	76	University Loudspeakers	97
33	Grado Laboratories, Inc.	14	77	Utah Electronics Corp.	101
35	Harman-Kardon, Inc.	89	78	Vanguard Records	68
90	Harman-Kardon, Inc.	91	79	Viking of Minneapolis, Inc.	143
34	Heath Company	64, 65, 67, 69, 71, 73			

HIFI/STEREO REVIEW PRODUCT INDEX

As an additional reader service, we list below, by classifications, the products advertised in this issue. If there is a specific product you are shopping for, look for its listing and turn to the pages indicated for the advertisements of manufacturers supplying that equipment.

CLASSIFICATION	PAGE NUMBERS
Accessories	66, 85, 86, 101, 132
Amplification Systems	2nd Cover, 8, 13, 17, 28, 32, 34, 69, 79, 80, 83, 85, 86, 89, 140
Antennas, FM	70, 85, 86, 88
Cabinets	138
Cameras	78, 136
Cartridges, Phonograph	14, 21, 85, 86, 94, 110
Fans	139
Headphones	76, 82, 85, 86, 90, 106
Multiplex Adaptors	85, 86
Organ Kits	73, 96, 142
Pipes	12, 141
Portable Phonographs	85, 86
Portable Radios	22, 128

CLASSIFICATION	PAGE NUMBERS
Records	9, 10, 11, 62, 63, 68, 76, 82, 90, 95, 98, 130
Speakers and Speaker Systems	1, 5, 8, 23, 60, 71, 77, 85, 86, 97, 98, 101, 102, 103, 108, 113, 117, 130, 133, 3rd Cover, 4th Cover
Tape, Recording	6, 7, 81, 85, 86, 87, 105, 107, 123, 124, 126, 127
Tape Recorders and Decks	18, 24, 74, 75, 85, 86, 92, 120, 122, 125, 137, 140, 143
Tone Arms	16, 85, 86
Tuners and Tuner-Amplifiers	2nd Cover, 13, 15, 17, 27, 28, 32, 34, 64, 65, 67, 69, 85, 86, 91, 115
Turntables and Changers	2, 16, 23, 85, 86, 93, 99, 104, 109, 141
TV	128

the magnificent **NEW**

TF-4

**5-speaker
4-way system**

by
JENSEN



Has Ear Appeal . . .

In Jensen's TF-4, smooth, finely-balanced, full-range reproduction is achieved by expert blending of five speakers: a high-compliance, long-travel FLEXAIR® woofer; a special 8" midrange; two direct radiator tweeters; and Jensen's SONO-DOME® ultra-tweeter for frequency extension beyond audibility. Look, listen and compare. We think you'll agree there's nothing like the TF-4 in sound . . . and in value.

Has Eye Appeal . . .

The new TF-4 comes to you in a new full-size but gracefully slender format that combines big speaker performance with elegant appearance. The wood is *genuine* walnut veneer in oil finish. (Available, too, in the money-saving unfinished gum hardwood for custom finishing or building-in.) Both models are available with a choice of a two-tone harmonizing grille fabric or the popular rattan. Cabinet measures 16" H, 25½" W, 8½" D. Write for Brochure MT.

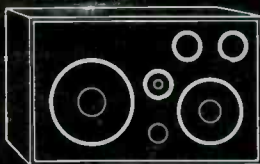

TF-4, 5-Speaker 4-Way System.
Impedance, 8 ohms.
Power Rating, 25 watts.
In Oiled Walnut \$114.50
In Unfinished Hardwood . . . 97.50

Your choice of two decorator fabrics: a two-tone design custom-woven for us in an exciting new pattern, or the popular all-over rattan.



JENSEN MANUFACTURING COMPANY / DIVISION OF THE MUTER COMPANY / 6601 SOUTH LARAMIE AVENUE, CHICAGO 38, ILLINOIS
Canada: Radio Speakers of Canada, Ltd., Toronto • Argentina: Ucoa Radio, S. A., Buenos Aires • Mexico: Fapartel, S. A., Naucalpan, Mex.

A pre-finished compact speaker system kit anyone can assemble in less than 20 minutes without tools. No sanding, no finishing, no special manual skills. And it looks and sounds like a much more expensive factory-built system!

NEW E-V

**CORONET KIT
SPEAKER SYSTEM
ONLY \$39⁰⁰***

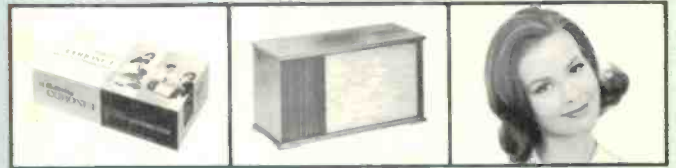

Comes like this . . . looks like this . . . sounds great!

Here's a kit speaker system that goes together virtually by the power of your suggestion alone!

And inside (you'll know it because you'll put it there) is an authentic component-quality speaker—the MC8 full-range, 8-Inch speaker made by Electro-Voice. A heavy die-cast frame. Radax dual-cone construction and a modern ceramic magnet distinguish the E-V MC8 from the ordinary "radio-set" speakers found in most kits. The MC8 is actually made by the same craftsmen as the most expensive E-V speakers!

The E-V Coronet's 3/4-inch AcoustiPLY panels are completely finished in oiled walnut veneers. You'll see at once they aren't made of lightweight, raw wood like so many kits. And the design, an acoustical phase inverter, was developed only after exhaustive tests in the E-V laboratories—by engineers devoted solely to the improvement of loudspeaker and enclosure design.

But the best news of all about the Coronet is the price*: just \$39.00, net, for the basic Coronet I (with MC8 loudspeaker, 50-13,000 cps); \$43.50, net, for the Coronet II (with LS8 loudspeaker, 45-14,000 cps); and \$54.00, net, for the Coronet III (with SP8B loudspeaker, 40-15,000 cps).

See the Electro-Voice Coronet Kit Speaker System on display at your hi-fi dealer's now! Or write direct for complete specifications!

**VALUABLE
CERTIFICATE**
PACKED WITH EVERY CORONET!
\$5⁰⁰
WORTH
toward purchase
of any matching
E-V tweeter kit!



*Slightly Higher West of the Rockies

ELECTRO-VOICE, INC., Dept. 1134F, Buchanan, Michigan

CIRCLE NO. 25 ON READER SERVICE CARD

Electro-Voice
SETTING NEW STANDARDS IN SOUND

