

HiFi/Stereo Review

OCTOBER 1963 • 50 CENTS

**STRAIGHT TALK ON ANTENNAS * THE ESSENTIALS
OF A SPOKEN-WORD LIBRARY * BARTOK IN AMERICA**

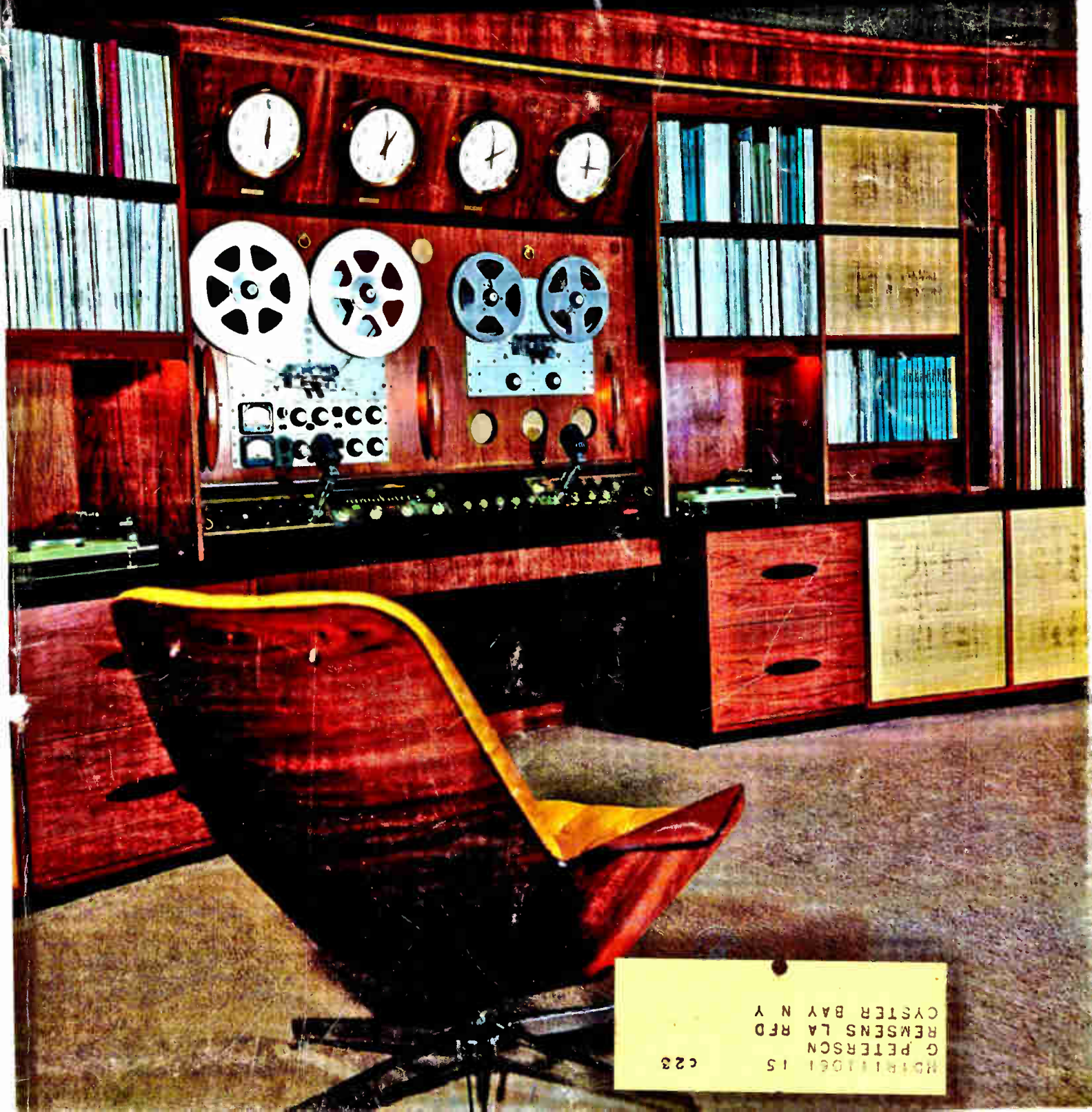

HDRI1101 15
G PETERSON
REMSENS LA RFD
CYSTER BAY N Y
c23

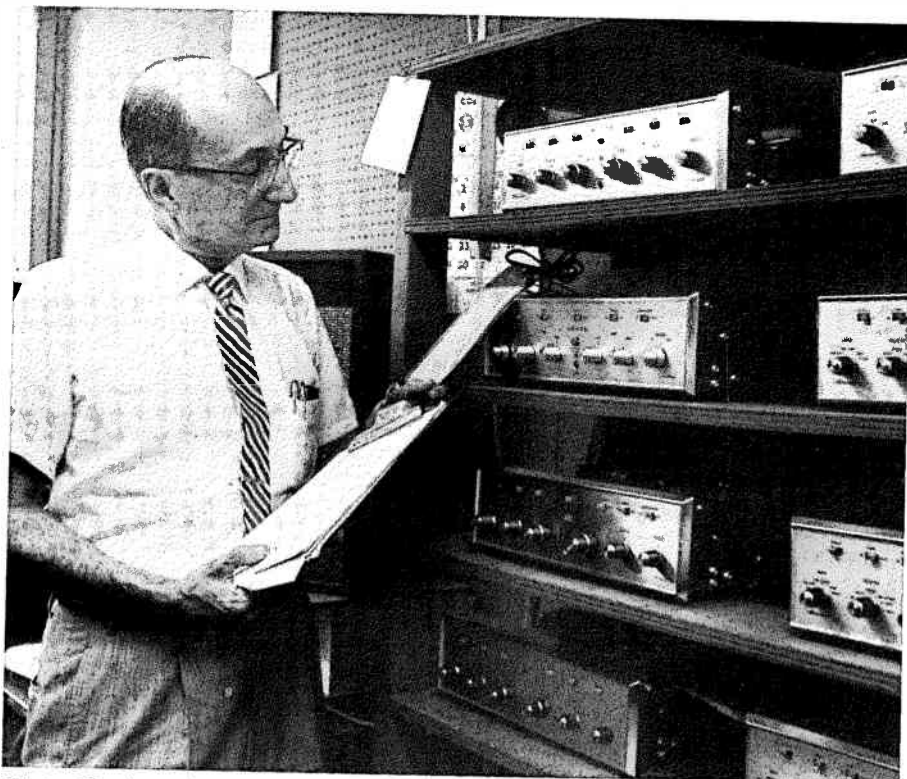

Victor Brociner shown at the "Life Test" Rack. Here production units are subjected to "on-off" cycles and voltages far in excess of those encountered in home use. Three months on this rack is equal to ten years of normal use.

Victor Brociner reports on three new amplifiers of unexcelled power, performance, and reliability.

In my 26 years in audio, I have never before been this impressed by the quality and performance of an amplifier line. The three new Scott units have a combination of power, features, looks, and reliability unparalleled in my experience.

I am most impressed by the pains and expense Scott has taken to insure long, trouble-free life for these amplifiers. The use of an electrolytic aluminum chassis insures cooler operation and minimum hum pick-up. The conservative design of the large power

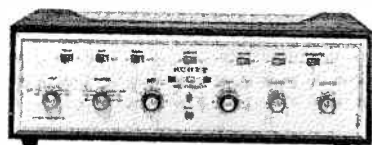

299D 80-WATT STEREO AMPLIFIER

transformer and supply guarantees that years of hard use will not faze these units one bit.

One of the new operating features that you will appreciate is the speaker switch on the 222D and 299D. This switch makes it possible to turn off the speakers if you wish to use stereo headphones for private listening. With

the powered center channel output you can drive extension speakers without an additional amplifier. The power ratings of all three amplifiers are especially

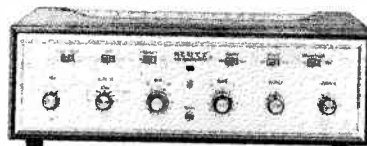

222D 50-WATT STEREO AMPLIFIER

significant because the oversized output transformers provide full power down to the important low frequencies.

A fine music system built around any one of these amplifiers will assure you of years of listening pleasure.

The three great new stereo amplifiers from Scott are: the 299D, 80 watts, for \$229.95; the 222D, 50 watts for \$179.95; and the 200B, 30 watts at \$139.95.

A list of the half dozen people who have been most important in the development of high fidelity would have to include Victor Brociner. In 1937, Brociner designed the first high quality radio-phonograph. It is now at the Smithsonian Institute. His corner horn design revolutionized the speaker industry. His countless amplifier, preamplifier, and loudspeaker designs have continued to make audio history to this day.

Gaylord Russell announces design breakthroughs that make Scott-Kits easiest of all to build.



Gaylord Russell overseeing kit construction. Here, a kit is being built to a "rough draft" instruction book. Before any kit is shipped from the plant, about 50 pre-production kits are built in order to assure accuracy of the instruction book.

We had two goals in mind when we designed the new Scottkits: one was to insure that anyone could assemble them without difficulty, the second was to have the kits, when completed, give

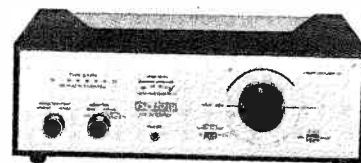

LT-110 FM STEREO (MULTIPLEX) TUNER

the same level of performance as factory built units. I believe we have attained both goals.

The unique full-color instruction

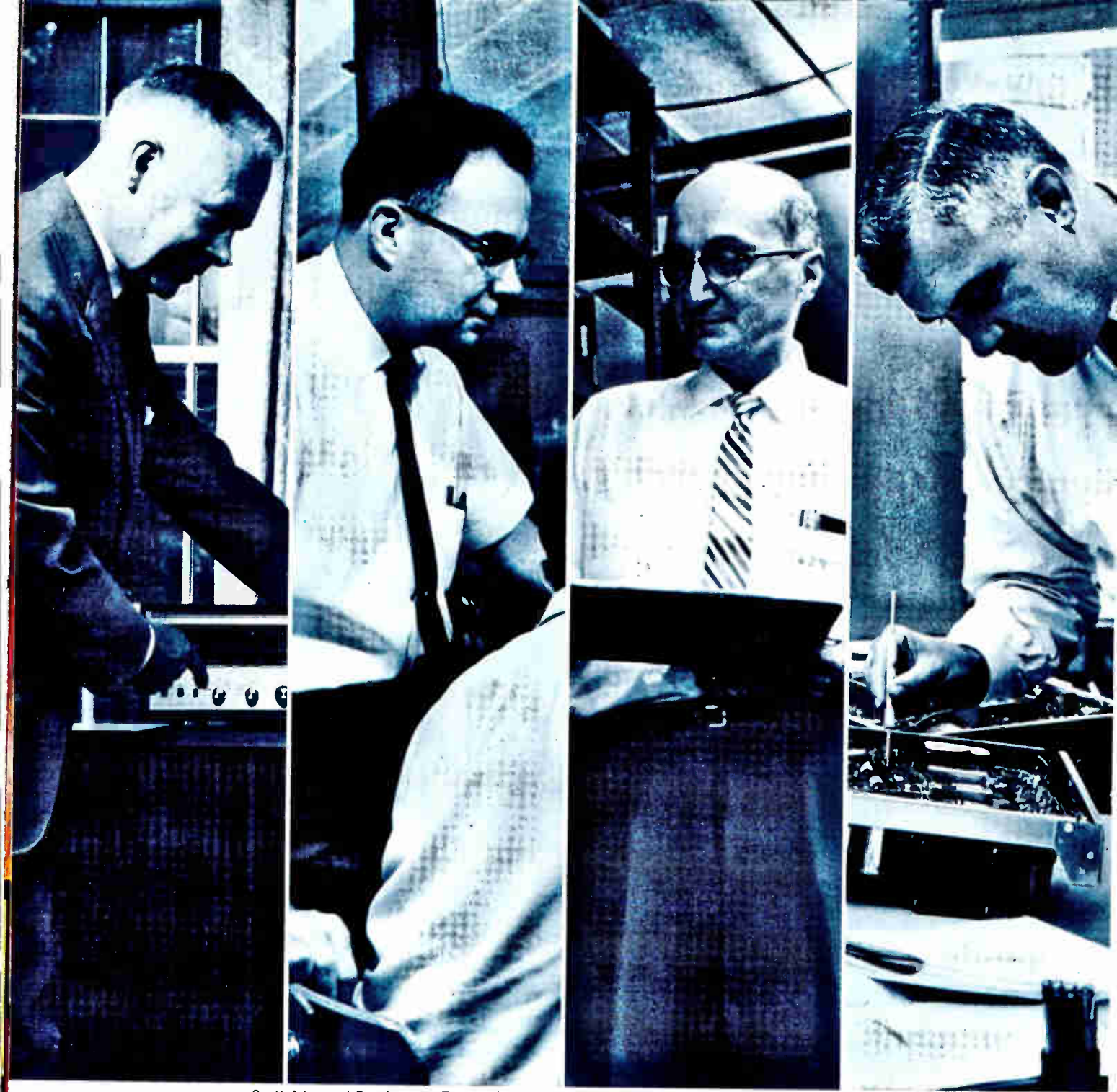

Scott Advanced Development Team, left to right: Hermon H. Scott, Daniel Von Recklinghausen, Victor Brociner, Gaylord Russell.

*Four Famous Audio Engineers
Discuss the Engineering
And Design Advantages of
A Dramatic New Line
Of Stereo Components...*

Daniel Von Recklinghausen
discusses
**significant circuit
advances that make
new Scott tuners the
most sensitive ever
designed.**

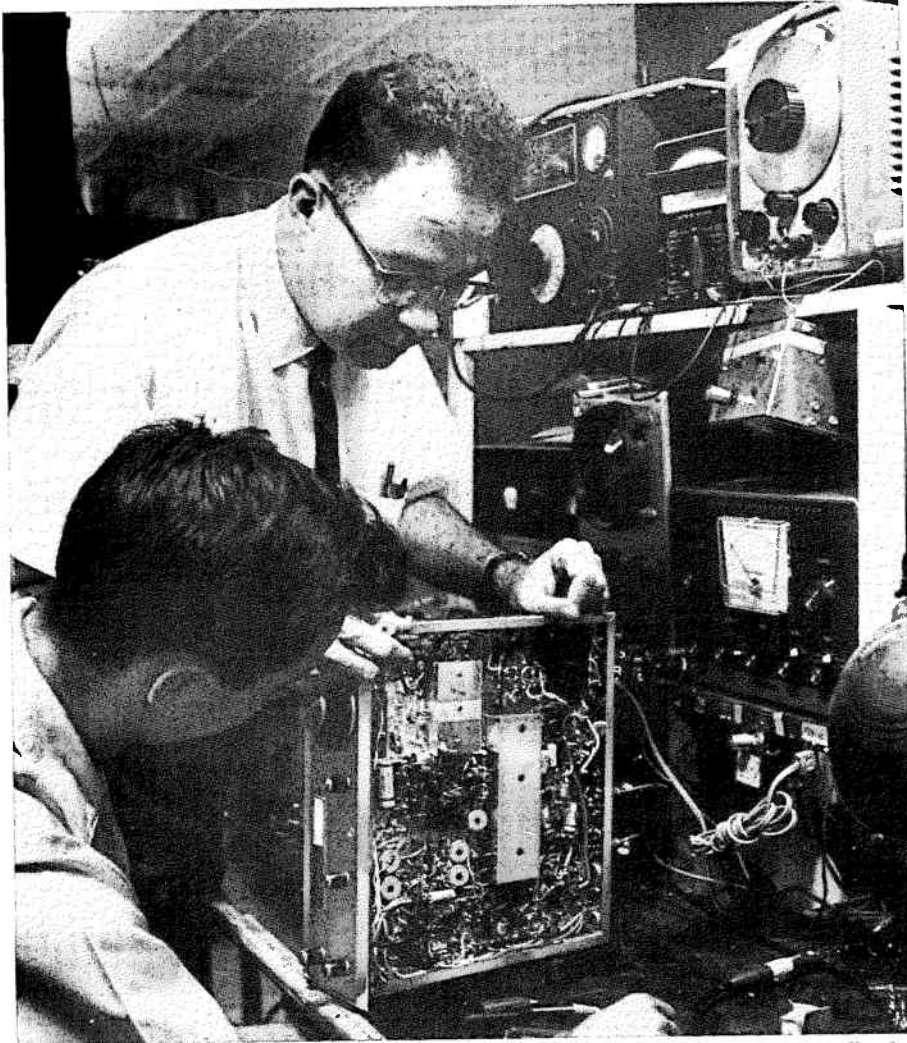

Daniel Von Recklinghausen checks out a new 310E in one of the many specially designed tuner screen rooms. All tuners are tested and aligned in these completely shielded rooms to assure perfect accuracy. No tuner is approved for shipment unless it meets or exceeds published specifications.

There are a great many important aspects in FM stereo tuner design. Most important is a tuner's ability to reject cross-modulation. If you design a tuner for sensitivity and ignore cross-modulation, a strong local station may so overload the tuner that it can be tuned in at several points on the dial. If a station can be tuned in at several points on the dial, it will actually block out other desired stations. With most listeners living in cities and suburbs, good cross-modulation rejection becomes vital. Sensitivity is also important in the design of a stereo tuner. Only a highly sensitive

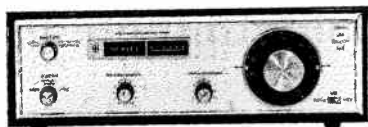

310E BROADCAST FM STEREO TUNER

tuner can pull in weak multiplex broadcasts with clarity and low distortion.

In designing the Scott tuners for 1964, we have paid particular attention to both these features. You obtain sensitivities of $1.9 \mu\text{V}$ on the 4310 and 310E, and even the modestly priced 370B has better than $3.5 \mu\text{V}$. Cross modulation rejection on any new Scott tuner exceeds 80 db and most models are better than 90 db. The prospective tuner buyer should keep

both of these measurements in mind when looking at tuner specifications.

Other new features of the 310E are the Auto-Sensor circuit and stereo threshold. The Auto-Sensor instantly and automatically selects the mode of operation of the tuner, be it stereo or mono, depending on the station tuned in. The Stereo Threshold permits you to adjust for the minimum acceptable stereo broadcast. The tuner switches automatically back to mono if the stereo signal falls below your minimum requirements.

The 350C, 370B, and 333B also incorporate many significant improvements over their popular predecessors.

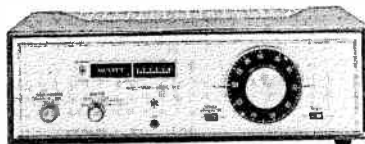

350C WIDE-BAND FM STEREO TUNER

The use of precious metals in the critical RF and IF stages, the specially selected low-noise tubes, and the fast-

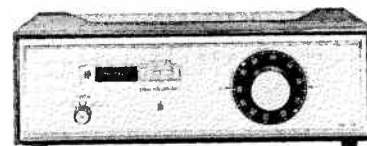

370B FM STEREO TUNER

acting limiters all insure a startlingly low background noise level. The Scott developed Time-Switching multiplex circuit has been refined for better stereo separation over the entire frequency range.

For 1964, Scott is introducing five new Stereo tuners including: the 4310 FM broadcast monitor at \$475; the FM 310E at \$279.95; the FM/AM 333B at \$274.95; the FM 350C at \$224.95; and the FM 370B at \$159.95.

Daniel Von Recklinghausen, Scott's Chief Research Engineer for over 12 years, is a graduate of M.I.T. In this period he has been responsible for the design of innumerable pioneering technological developments like Wide Band design and Time-Switching multiplex. He has written and lectured extensively and is unquestionably one of the most eminent engineers in the industry today.

book with every part shown in actual position, size, and natural color, is the heart of our technique. A separate part-chart is supplied for each page of the book with the parts referred to mounted in order of use. When you open your manual, you do not find pages and pages of errata. In 12 years of experience in the kit field, I have never seen



LK-72 80-WATT COMPLETE AMPLIFIER KIT

kit books so thoroughly checked for accuracy.

The handsome new Kit-Pak makes a perfect work container during the assembly process. Most of the uninteresting mechanical work, and the critical sections like FM front ends, have been assembled and tested at the factory. The wire is already stripped and tinned to proper length. This is just part of Scott's exhaustive program to make these kits absolutely foolproof.

Considering the performance of the completed units, and the ease of assembly, it is no wonder that thousands of

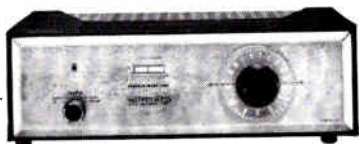

LT-111 FM STEREO TUNER KIT

kit builders have been delighted with their Scottkits. The audio experts have been equally as enthusiastic. Here is a wonderful way to a superb stereo system with all the features and performance you expect from Scott.

Heart of kit assembly technique is full color instruction book.



The new Scottkit line consists of the latest models of the LK-72, 80 watt stereo amplifier kit for \$164.95; the LK-48 50 watt stereo amplifier kit for \$129.95; LK-30 30 watt stereo amplifier for \$99.95; LT-110 FM stereo tuner for \$164.95; LT-111 FM stereo tuner for \$119.95; LC-21 Stereo control center at \$99.95; and the LK-150, 130 watt stereo amplifier for \$179.95.

For twelve years Gaylord Russell has been actively involved in the design and planning of electronic kits. Previous to his appointment as Scott's chief kit engineer, he was responsible for the development of high fidelity, test equipment, shortwave, and marine equipment kits for two of the large companies in the kit field.

OCTOBER 1963

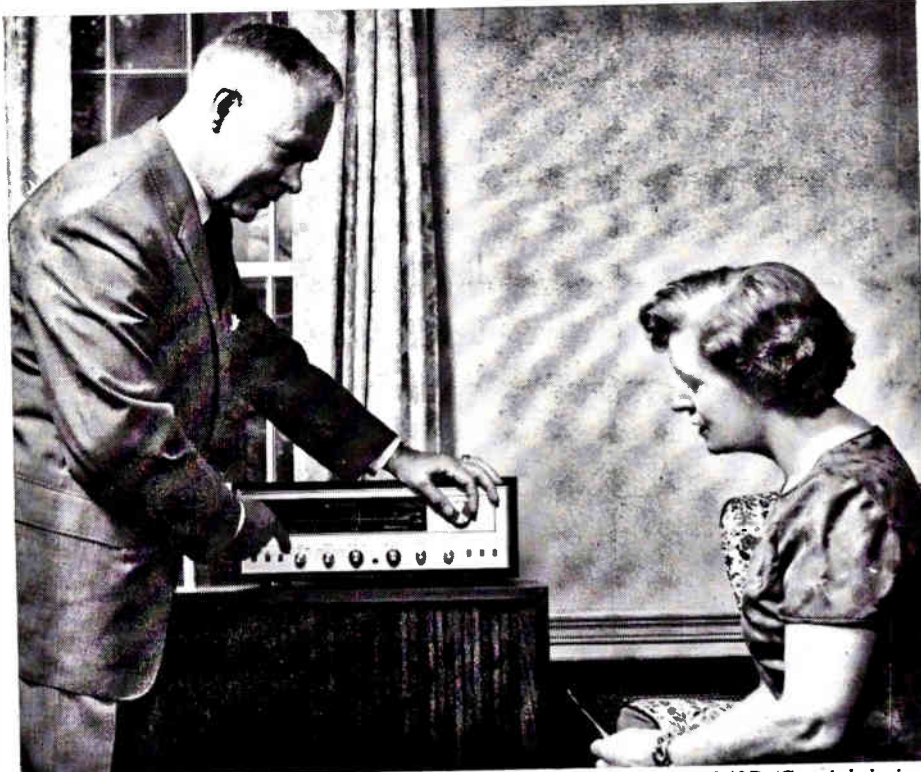

Hermon Scott showing Mrs. Scott operating simplicity of the new 340B. Careful design and control placement make this extremely flexible tuner/amplifier easy for any member of the family to operate.

Hermon Scott describes an incomparable tuner-amplifier with the performance of separate components.

I have always felt that all high fidelity components should not only offer superior performance and flexibility, but that they should also be attractive to the eye and easy to operate as well. The 340B tuner-amplifier more than accomplishes all of these objectives.

Our engineering department has truly outdone itself in obtaining matchless performance without crowding or compromising. All the expected Scott innovations, such as the Silver-Plated front end, the Time-Switching multiplex section, the oversized output transformers and all the controls you could possibly want, are included. Yet the unit looks, and is, simple to operate. The indicator lights and the handy photo-guide make everyone an expert.

With all its features, the 340B is compact enough to be placed anywhere. Add two speakers and a turntable or changer and you have a truly fine stereo music system . . . one that is easy to set up, easy to use, and a delight to listen to.

The new 340B, FM Stereo tuner/70 watt amplifier is \$399.95.

Hermon H. Scott, world famous engineer and inventor (over 25 patents), holds both B.S. and M.S. degrees from M.I.T. Mr. Scott's invention of the Dynamic Noise Suppressor in 1946 paved the way for the beginning of the high fidelity industry. The Scott 210A of 1947 is considered the first true high fidelity amplifier. Mr. Scott has continued to play a vital part in the design and development of all products produced by his company.

It is not possible to give you all the details about our many new products in these few pages. A booklet with all the facts, figures, and pictures plus helpful hints on buying the right components for your requirements, is now being printed. I will be happy to send you a copy at no charge. Send me your name

and address (as well as the names and addresses of any of your friends who might also be interested), and I will see that you receive a copy as soon as it is available. Write to:

H. H. Scott, Inc. Dept. 245-10
111 Powdermill Road
Maynard, Mass.

CIRCLE NO. 61 ON READER SERVICE CARD

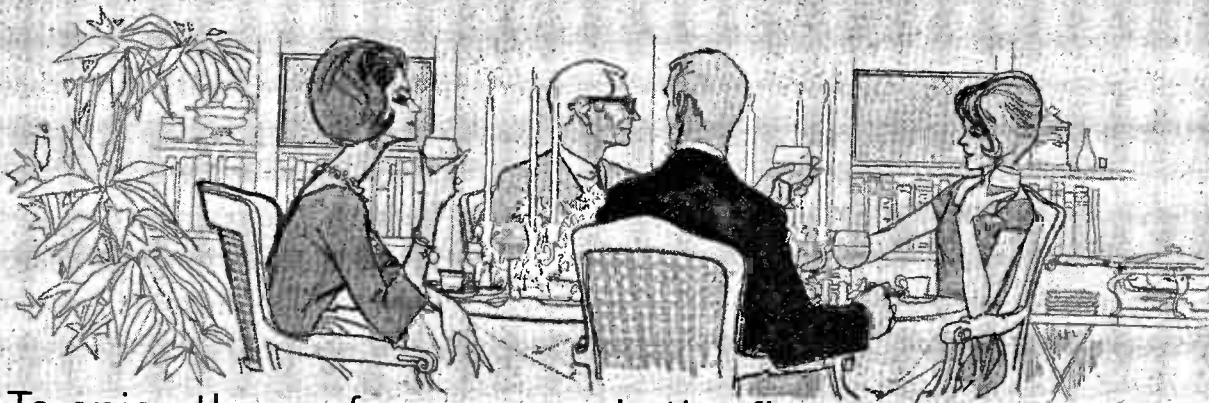

To enjoy the performance only the finest turntable can claim...



and without this...

insist upon a
Garrard Automatic Turntable

(Most people do)



Professional performance with true convenience... one excellent reason why more Garrards are used in the finest systems than all other high fidelity record playing components combined. (Type A Automatic Turntable - \$79.50, AT6 Automatic Turntable - \$54.50, Autoslim Intermix Changer - \$39.50.) For Comparator Guide, write Dept. GM-1223, Garrard Division, British Industries Corp., Port Washington, N. Y.

Garrard
world's finest



Canadian inquiries to Chas. W. Pointon, Ltd., 66 Racine Road, Rexdale, Ont. - Other territories to Garrard Engineering & Mfg. Co., Ltd., Swindon, Wilts, England

HiFi/Stereo Review

OCTOBER 1963 • VOLUME 11 • NUMBER 4

THE MUSIC

- 11** THE BASIC REPERTOIRE
Mozart's "Jupiter" Symphony.....MARTIN BOOKSPAN
- 35** BARTOK'S FULL TRUNK
A fresh light on the composer's American years....EDWARD JABLONSKI
- 42** GUITARRA!
Three thousand years old and still a favoriteGENE LEES
- 47** A BASIC LIBRARY OF THE SPOKEN WORD
Culling the best from an abundant catalogPAUL KRESH
- 52** FIDDLER WITH A FOUNTAIN PEN
Violinist Erick Friedman's odd-hour sketches.....ROBERT OFFERGELD
- 59** BEST OF THE MONTH
Reviews of outstanding new releases

THE EQUIPMENT

- 7** TECHNICAL TALK
*Lab reports on the ADC-18 loudspeaker
and the Tandberg 64 tape recorder*JULIAN D. HIRSCH
- 15** BEGINNERS ONLY
Distortion—Part TwoHANS H. FANTEL
- 40** INSTALLATION OF THE MONTH
A Dream System Come True
- 54** RECOMMENDED FM ANTENNAS
A close look at typical outdoor and indoor types....HERBERT FRIEDMAN
- 58** SOUND AND THE QUERY
Answers to your hi-fi technical questionsLARRY KLEIN

THE REVIEWS

- 66** HIFI/STEREO CLASSICS
- 109** HIFI/STEREO JAZZ
- 117** HIFI/STEREO REEL AND CARTRIDGE
- 131** HIFI/STEREO ENTERTAINMENT

THE REGULARS

- 4** EDITORIALY SPEAKING
- 20** LETTERS
- 28** JUST LOOKING
- 148** ADVERTISERS' INDEX; PRODUCT INDEX

COVER PHOTO: CLARENCE WEST

Copyright © 1963 by Ziff-Davis Publishing Company. All rights reserved. HIFI/STEREO REVIEW, October 1963, Volume 11, Number 4. Published monthly by Ziff-Davis Publishing Company at 434 South Wabash Ave., Chicago, Illinois 60605. Subscription rates: one year United States and possessions \$5.00; Canada and Pan-American Union Countries \$5.50; other foreign countries \$6.00. Second-class postage paid at Chicago, Illinois and at additional mailing offices. Authorized as second class mail by the Post Office Department, Ottawa, Canada, and for payment of postage in cash.

HiFi/Stereo Review

PUBLISHER
PHILLIP T. HEFFERNAN

EDITOR
FURMAN HEBB

MANAGING EDITOR
WILLIAM ANDERSON

MUSIC EDITOR
ROBERT OFFERGELD

TECHNICAL EDITOR
LARRY KLEIN

ART EDITOR
BORYS PATCHOWSKY

ASSOCIATE EDITOR
ROBERT S. CLARK

PRODUCTION EDITOR
MEL SCHINASI

CONTRIBUTING EDITORS

CHRISTIE BARTER
MARTIN BOOKSPAN
HANS H. FANTEL
WILLIAM FLANAGAN
STANLEY GREEN
JOE GOLDBERG
DAVID HALL
NAT HENTOFF
JULIAN D. HIRSCH
GEORGE JELLINEK
IGOR KIPNIS
PAUL KRESH

**ADVERTISING
SALES MANAGER**
LAWRENCE SPORN

**ADVERTISING
SERVICE MANAGER**
ARDYS C. MORAN

ZIFF-DAVIS PUBLISHING COMPANY

Editorial and Executive Offices (212 OREGON 9-7200)
One Park Avenue, New York, New York 10016
William B. Ziff, Chairman of the Board (1946-1953)
William Ziff, President
W. Bradford Briggs, Executive Vice President
Herschel B. Sarbin,
Vice President and General Manager
M. T. Birmingham, Jr.,
Vice President and Treasurer
Robert P. Breeding, Circulation Director
Stanley R. Greenfield, Vice President
Phillip T. Heffernan, Vice President
Midwestern & Circulation Office (312 Wabash 2-4911)
434 South Wabash Avenue, Chicago, Illinois 60605
Advertising: Jerry Sweeney
Western Office (213 Crestview 4-0285)
9023 Wilshire Blvd., Beverly Hills, Calif. 90211
Western Advertising Manager: Bud Dean
Foreign Advertising Representative
D. A. Goodall Ltd., London, England

SUBSCRIPTION SERVICE: All subscription correspondence should be addressed to HiFi/Stereo Review, Circulation Department, 434 South Wabash Avenue, Chicago, Illinois 60605. Please allow at least six weeks for change of address. Include your old address, as well as new—enclosing if possible an address label from a recent issue.

EDITORIAL CONTRIBUTIONS must be accompanied by return postage and will be handled with reasonable care; however, publisher assumes no responsibility for return or safety of art work, photographs, or manuscripts.

Member Audit Bureau of Circulations

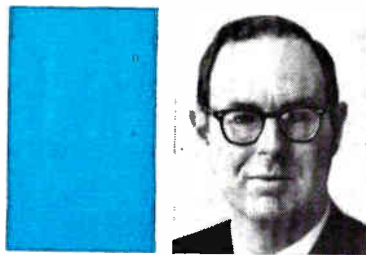

EDITORIALLY SPEAKING

by FURMAN HEBB

As most hi-fi purchasers are aware, discounts on audio equipment have been available in the larger cities for the past few years. To the best of my knowledge, the practice began in New York City, on Cortlandt Street, where a number of radio-parts stores have been competitively clustered together since the early days of radio. When the hi-fi era began, these dealers stocked up on hi-fi components and used them as ammunition in their traditional price wars. Although in most cases the showroom and repair facilities they offered their customers were close to minimal, their prices were below those of the "legitimate" audio stores. Word of the low prices quickly got around, and the standard audio dealers had to reduce either their prices or their services to stay in business. Then the discount houses got into the act, selling hi-fi components on a you-carry-it-out-we-don't-want-to-see-it-again basis. Clerks wrote orders for waffle irons and tape recorders with equal indifference.

The situation as we know it today, while changed in some details, is not really very different. Essentially, the customer has a choice between receiving discounts or receiving service. I personally would lean toward the latter (and this at least partly because I've been around hi-fi equipment long enough to know that it is complex, that it does get out of whack occasionally, and that expert help is required when this happens). I would therefore be inclined to consider, say, an extra hundred dollars paid to a bona fide audio specialist—to someone who knows his hi-fi equipment and stands behind what he sells—as a worthwhile investment. In return for paying a premium price, of course, one has a right to expect to receive premium service: custom installation, some manner of return privilege (especially regarding speakers and cartridges), and free in-the-home repair service for perhaps a year.

Of course, it is not always necessary to make a black-or-white choice between price and service. There are some stores that offer the purchaser moderate discounts together with a number of basic services, such as delivery and hookup, free in-the-shop repairs, and so on. I would imagine that this would be the best type of arrangement for the hi-fi listener who is knowledgeable enough to install his system and to handle minor difficulties himself.

Coming Next Month in HiFi/STEREO REVIEW

AN INTERVIEW WITH JOAN BAEZ

by Nat Hentoff

THE ESSENTIALS OF AN OPERA LIBRARY

by George Jellinek

TIPS ON RECORD WEAR AND CARE

by John Milder

HiFi/STEREO REVIEW

THOUSANDS OF NEW AND SATISFIED MEMBERS EVERY YEAR ATTEST TO THE GROWING POPULARITY OF

Universal Record Club

THE ONLY RECORD CLUB OFFERING ALL RECORDS, ALL LABELS, ALL ARTISTS AT

Discount Prices!

You can choose from an unlimited selection of Pop, Jazz, Classical, Folk, Western, Educational and even Foreign Records. Buy only the records you want and only as many as you want. You can save as much as one half by purchasing on a non-quota, non-obligatory basis . . .

All Records at Cost

Universal Record Club is the only record club that offers all labels in print. It is the only record club that does not require a quota or an obligation to buy a certain number of records per year — and it is the only record club that offers all records, all labels, all artists — at cost!

Simply stated, as a member of Universal Record Club, you will be entitled to select any record on any label, by any artist, and pay only cost price plus a few cents postage. Buy one record or a hundred. If it's in print we have it or can get it for you in a matter of days.

Write for our price list today. Save up to 50% and more on all 33 1/2 mono and stereo L.P. records.

EXTRA — due to our enormous purchasing power, we are able to offer you, as a club member, special super bonuses throughout the year not only on records, but also on phonographs, components and other related items.

Join the thousands of satisfied members of Universal Record Club today and start enjoying tremendous savings on all your record purchases. Membership dues only \$3.00 per year. You can

make this back in savings on your first purchase. PLUS — we send you, absolutely free, by return mail, the newest unabridged world famous Schwann Catalog containing over 25,000 listings and over 400 labels, and information and manufacturers' list prices. This is your bonus for acting immediately.

**ALL RECORDS GUARANTEED
100% FACTORY-FRESH**

ACT NOW!

FILL OUT COUPON AND MAIL TODAY
FOR YOUR FREE BONUS

UNIVERSAL RECORD CLUB Box 1111-W Mountainside, N. J.

Gentlemen:
Enroll me now in the Universal Record Club. Enclosed is my check m. o. for \$3.00 covering one year membership dues. I understand this entitles me to buy all records at cost (savings up to 50% off manufacturers list prices) plus a few cents postage without obligation to purchase any certain amount, that I can choose any records in print and that, further, I will receive absolutely free by return mail, the newest, complete Schwann Catalog as my bonus for acting now.

Name

Address

City State.....



Why did Sherwood zero-in on the problem of tuning accuracy?



It takes wider bands to broadcast the multiple information for stereo FM multiplex, and the most precise "dead-on-center" tuning to receive it . . . with maximum stereo separation and minimum distortion.

This is why in the new S-3000 V Tuner, Sherwood engineers incorporated a professional zero-centered tuning meter. Superior to tuning eyes, better than peak meters, it uses the same D'Arsonval meter needed to design, align and test FM tuner circuits. When the meter reads "zero" . . . you're right on. No guesswork. No maybe's.

Gain three tuning advantages

- Tune accurately, the first time.
- Tune low-power Class "A" stations interspaced between more powerful broadcasts.
- Tune with professional surety.

Added value features of the S-3000 V

- Stereo Indicator Light: identifies stereo broadcasts.
- Superb sensitivity: $1.8\mu\text{v}$ (IHF) for -30db . noise and distortion.
- No background noise: pace-setting 2.4db. capture effect.
- FM Interchannel Hush: suppresses between-station noises.
- Flywheel tuning: smooth as silk.
- 20% longer dial scales: professional accuracy.
- Price: \$165.00. (Leatherette case optional at \$7.50.)

For complete information write Dept.R-10, Sherwood Electronic Laboratories, Inc., 4300 North California Ave., Chicago 18, Ill.

S-3000 V FM Stereo Multiplex Tuner with professional zero-centered tuning meter and Stereo Indicator Light.



New S-8000 III FM Stereo MX Receiver. Combines above tuner features with an 80-watt stereo amplifier. Price: \$319.50. (Leatherette case optional at \$9.50.)

Sherwood

HIGH FIDELITY
Stereo Receivers • Tuners
Amplifiers • Stereo Indicator Lights
Speaker Systems • Contemporary Cabinetry

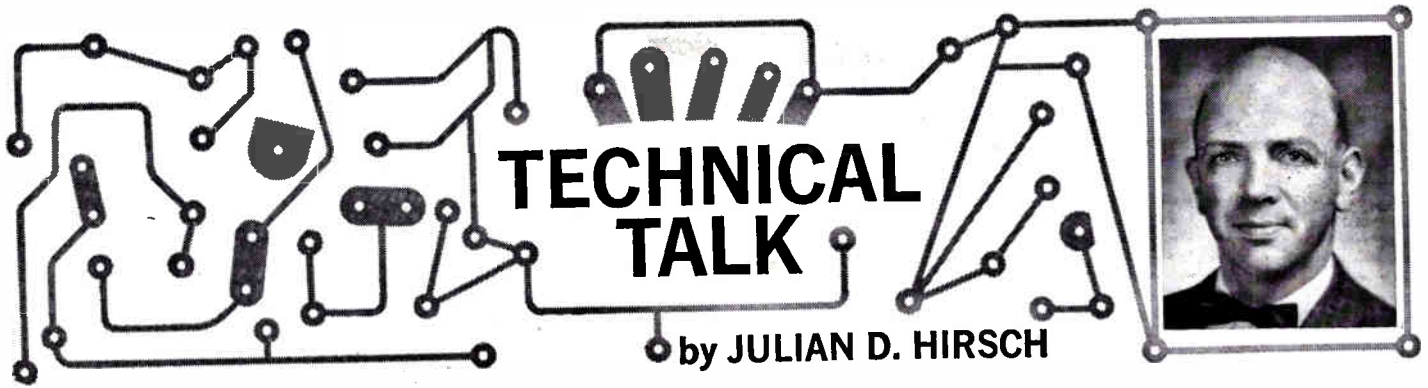

● **EVALUATING LOUDSPEAKERS:** Insofar as listening quality is concerned, I see no urgent need for improvement in the electronic components of high-fidelity systems. I realize that many manufacturers will take issue with this statement, but I feel that it fairly represents the situation.

This is not the case, however, with the electromechanical components, especially loudspeakers. For despite the considerable efforts expended on loudspeaker design and the noteworthy improvements that have resulted, the loudspeaker is still the weak link in the audio chain. One reason for this is that the profound influence of the listening room on a loudspeaker's performance makes it extremely difficult to make measurements that adequately describe the speaker's performance in objective facts and figures. I doubt if anyone really knows what physical characteristics are most important in determining the sound of a speaker. Measurement is an important design tool, but one must first know what to measure.

Frequency-response measurements in an anechoic chamber, free field, or reverberant room tell only part of the story. I have tested many speakers that measure almost alike but sound quite different. Harmonic distortion in speakers is difficult to measure below about 1 per cent, which is near the upper limit of acceptable amplifier distortion. Harmonic-distortion measurements are useful chiefly in evaluating low-frequency performance, since the distortion of any speaker rises abruptly below some critical frequency. And meaningful internodulation-distortion measurements are virtually impossible to make with loudspeakers.

Several techniques using tone-burst signals have been devised for testing a speaker system's transient response. I visually inspect the acoustic tone-burst waveform as picked up by my test microphone, and have found a good general correlation between a speaker's ability to reproduce the tone-burst response accurately and the over-all sound character of the speaker. Even so, this test furnishes only a rough classification, such as "good," "average," or "poor."

In the last analysis, we must lean heavily on critical listening tests by someone trained in evaluating speaker performance. In combination with the results of measurements, this gives a pretty fair evaluation of any speaker system. Of course, there will be some varia-

tions in the conclusions of different observers, but it is surprising how close the general agreement can be. I would estimate that my comments and conclusions on speakers correlate better than 80 per cent with those of other equipment reviewers and the manufacturers themselves.

TANBERG 64 TAPE RECORDER

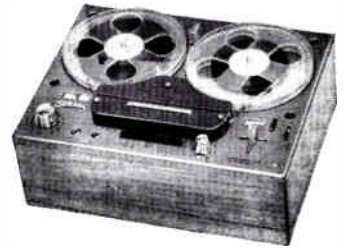

● **THE TANBERG 64** is a three-speed machine, offering a $1\frac{7}{8}$ -ips speed in addition to the usual $7\frac{1}{2}$ and $3\frac{3}{4}$. It has three four-track heads and separate recording and playback amplifiers. Recording levels are monitored on dual magic-eye tubes which, when lit, also indicate that the machine is set to record.

Concentric controls are used for recording-level adjustment, with another pair for playback levels. A switch, mounted concentrically with the latter, selects normal, sound-on-sound, or A-B comparison modes. In the A-B position, the input signal is fed to the output jacks except when the playback buttons are pressed, in which case the signal monitored from the tape is fed to the output.

The basic transport operation is controlled by the familiar Tandberg "T" lever. This single control, moved to the right or left, puts the tape into fast forward or rewind. Pulling it forward puts the machine in normal play or record mode. A fourth position, away from the user, releases the reels from the drive mechanism, permitting easier tape loading.

A row of five push-buttons sets up the recorder for operation. Separate buttons for each channel are pressed to adjust recording level. The tape-motion lever locks these buttons in either the up or down position and releases them when returned to neutral, making accidental erasure of a tape practically impossible. A similar pair of buttons controls the playback amplifiers. Mono or stereo recordings can be

(Continued on page 9)

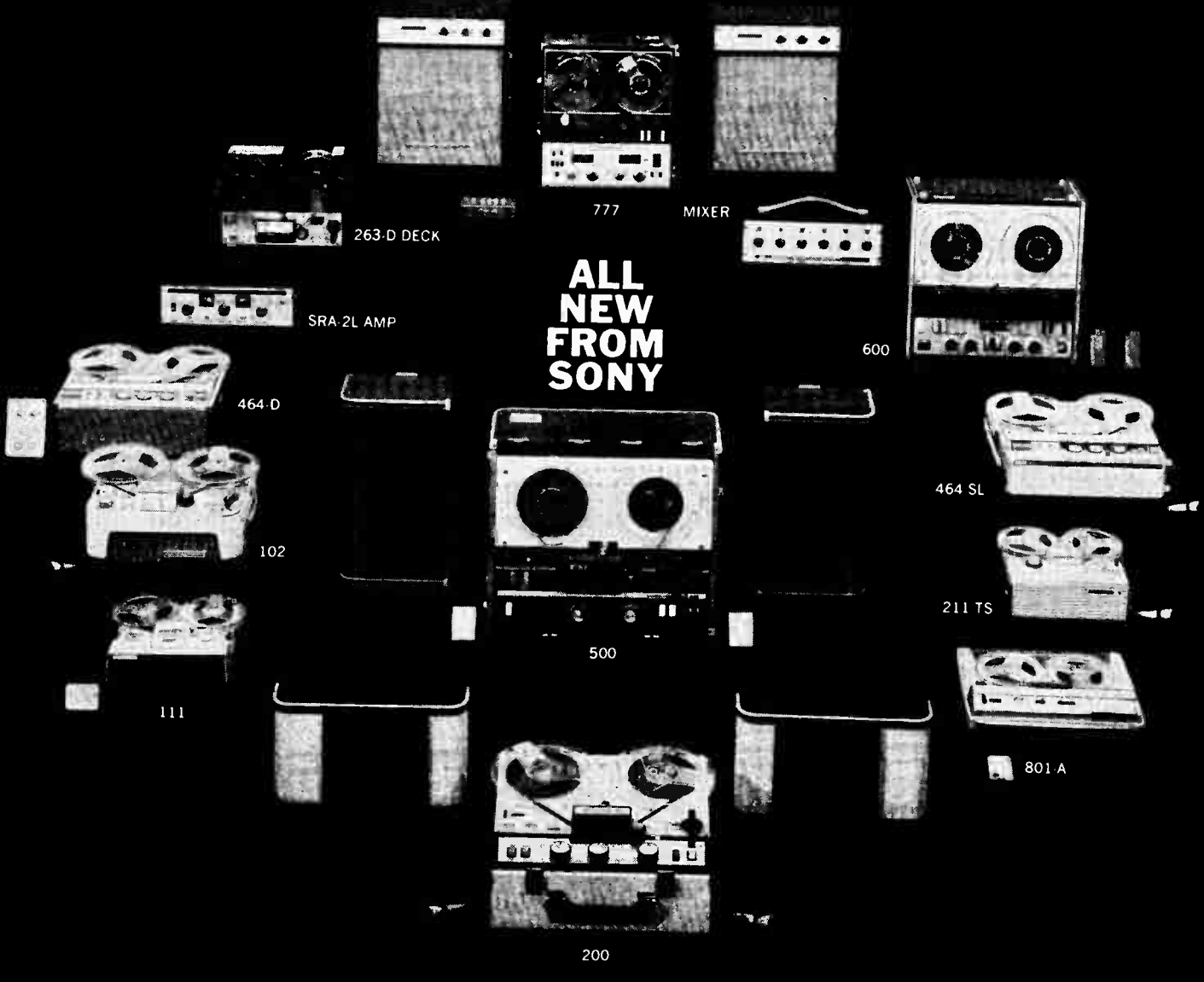

**ALL
NEW
FROM
SONY**

THE MOST COMPLETE LINE OF QUALITY TAPE RECORDING EQUIPMENT IN THE WORLD

■ Sony Stereorecorder 777 S—Professional, all transistorized 2 or 4 track stereo/mono tape recording system featuring remote control and the exclusive Sony Electro BiLateral head control system. World's finest tape recorder. Less than \$695. ■ Sony Amplifier/ Speaker System SSA 777—All transistorized, 10 watt, extended range 8" infinite baffle hi fidelity speakers created to produce perfect, full-sound reproduction with the 777 S. Less than \$175. ■ Sony Stereo Mixer MX 777—For advanced recording techniques, this all-transistorized, battery-powered 6 channel stereo/mono mixer is the perfect accessory to complete the 777 professional system. Less than \$175. ■ Sony Stereo Tape Deck 263-D—Add tape to any sound system with this 4 track stereo playback tape transport, 3 heads, 2 speeds, vertical or horizontal operation. Less than \$119.50. ■ Sony Stereo Recording Amplifier SRA-2L—All the facilities for adding stereo recording to the 263-D unit. Less than \$99.50. ■ Sony Stereorecorder 464-D Deck—2 speed, 4 track, stereo/mono, record/playback compact tape deck with built-in pre-amps. Ideal for custom installation. Less than \$199.50. ■ Sony Portable Tape recorder 102—Rugged 2 speed, dual track, hi fidelity recorder with deluxe features and 7" reel capacity satisfies the most exacting recording requirements. Less than \$129.50. ■ Sony Tape recorder 111—A popularly priced, high quality bantam recorder for everyday family fun. Less than \$79.50. ■ Sony Stereorecorder 200—The most compact and lightweight quality 4 track tape recording system on the market today. Carrying case lid separates into

**NOW ON DISPLAY
AT YOUR FRANCHISED
SONY / SUPERSCOPE
AUDIO/TAPE DEALER**

2 full range speaker systems. Unequalled for performance and price. Less than \$239.50. ■ Sony Stereorecorder 500—A complete 4 track stereo/mono tape system with unsurpassed studio quality. The full range, infinite baffle detachable speaker systems integrate into the recorder lid, and separate 15 feet for optimum stereo effect. Less than \$399.50. ■ Sony Battery-Operated Executive Portable 801-A—A distinctively styled, transistorized, 2 speed all purpose recorder of utmost precision and quality. For the executive desk or portable use. The self-storing mike features a remote stop and go switch. Tape it with you for less than \$250. ■ Sony 'Slide-Sync' Tape recorder 211-TS—Incredibly versatile, serves the photo enthusiast with an exclusive, automatic built-in 'programmer' to activate a slide projector in 'sync' with your own recorded narration. Also the most compact tape teaching recorder available. Less than \$129.50. ■ Sony Tape Teaching Recorder 464-SL—A deluxe language and music teaching aid, 2 speed, 4 track, stereo and mono. Less than \$219.50. ■ Sony Stereorecorder 600—3 heads, tape and source monitoring, sound on sound, vertical or horizontal operating, this 4 track stereo recording and playback unit is perfect for professional quality home installation. Less than \$450. ■ Also available, an extensive line of professional studio quality microphones and accessories. All Sony Stereorecorders are Multiplex Ready! For detailed literature and name of nearest franchised tape dealer write Superscope, Inc., Dept. 8, Sun Valley, Calif. IN NEW YORK, VISIT THE SONY SALON, 585 FIFTH AVENUE.



CIRCLE NO. 65 ON READER SERVICE CARD

made or played back, several program sources can be mixed, one track can be copied onto the other with added commentary, and the program can be monitored off the tape as it is being recorded.

The fifth button is a stop-start, or pause, control. The capstan drive motor is turned off when the tape-motion lever is in neutral, and requires several seconds to come up to speed. This button allows the motor to come to speed for instant tape start.

The Tandberg 64 had an almost perfectly flat response to standard test tapes between 100 and 15,000 cps, showing only ± 1 db variation. The response rose somewhat at frequencies below 100 cps, depending on the test tape used. The over-all record-playback response was also exceptional, within ± 2.5 db from 37 to 15,000 cps, rising to $+4.3$ db at 20,000 cps (at $7\frac{1}{2}$ ips). While this response was extremely good, it no doubt could have been flattened out and extended even more by adjusting the machine's bias for optimum results with the specific type of recording tape being used. Even the $3\frac{3}{4}$ -ips response was fully adequate for most high-fidelity applications, being within ± 2.5 db from 80 to 11,000 cps and falling gradually at lower frequencies. Being accustomed to mediocre

performance at $1\frac{7}{8}$ ips, I was pleasantly surprised to find that at this speed the response was very flat and down only 2 db at 6,000 cps.

In my experience, Tandberg recorders have always been outstanding for their speed uniformity, and the Model 64 was no exception. The wow ranged from an incredibly low 0.005 per cent at $7\frac{1}{2}$ ips to 0.04 per cent at $1\frac{7}{8}$ ips. Flutter was 0.08 per cent at $7\frac{1}{2}$ ips, 0.11 per cent at $3\frac{3}{4}$ ips, and 0.21 per cent at $1\frac{7}{8}$ ips. The signal-to-noise ratio was 50 db on all speeds, and stereo crosstalk was -47 db at 1,000 cps.

By transferring my best records to tape, I proved to my satisfaction that the Tandberg 64 could record any material from discs (or off the air) without my being able to hear any loss or degradation in direct A-B listening comparisons. Even at $3\frac{3}{4}$ ips, it outperformed most $7\frac{1}{2}$ -ips recorders, and also did a very creditable job at $1\frac{7}{8}$ ips.

The Tandberg 64 is, in all respects, an outstandingly fine tape recorder, with virtually no compromises evident in its design and construction. It is also so simple to operate that anyone with any familiarity with tape recorders will hardly need to refer to the instruction manual. The Model 64 is priced at \$498.

ADC-18 LOUDSPEAKER SYSTEM



● ONE OF THE problems of a cone-type loudspeaker is that of making the entire cone move as a single surface. At very low frequencies this is not difficult, but at higher frequencies cone breakup occurs, which results in phase differences between the movements of various sections of the cone.

Some speaker designers have attempted to minimize breakup by designing very rigid cones. One way to do this without adding undesirable mass is to use expanded polystyrene foam as a cone material. The woofer of the ADC-18 speaker system, in addition to being made of polystyrene foam, has its flat front surface covered with aluminum foil, which further adds to rigidity.

This unusual woofer is rectangular in shape, measuring about 12 x 16 inches. This results in a radiating surface that has more effective area than two conventional 12-inch speakers. The very compliant surround is fastened directly to the baffle board rather than to the speaker's basket structure. The ceramic-magnet structure is massive, weighing 9 pounds.

High frequencies are handled by a tiny dome-radiator tweeter. The $1\frac{1}{2}$ -inch Mylar dome is driven by a voice coil of the same diameter, with a heavy

magnet to provide high efficiency and good transient response. A dome radiator inherently has wide dispersion at high frequencies.

The measured frequency response of the ADC-18 was very flat and smooth over-all, within ± 3 db from 200 to beyond 15,000 cps. As is common with most speakers, the low-frequency response fell off smoothly below 150 cps in my test room. There was no sign of resonant peaks, distortion was very low down to below 40 cps, and a strong fundamental output could be obtained at 28 cps. The transient response, in tone-burst tests, was very good in the region covered by the woofer, and even better at higher frequencies.

The ADC-18 had a true, musical sound, with especially fine clarity and dispersion of the high frequencies. Like all good, low-distortion loudspeakers, it gave no hint of bass output until the program material required it. When present, however, the low bass could be felt as well as heard, another characteristic of a good woofer. I found it desirable to use a little bass boost in my listening room, although this might not be required elsewhere. The low distortion of the woofer makes it possible to add quite a bit of bass boost without muddiness or breakup.

The same drivers are available in a smaller enclosure as the ADC-16, and with a slightly smaller woofer as the ADC-14. The ADC-18 is priced, in an oiled walnut enclosure, at \$250.

For additional information, use the reader service card. Circle number 188 for the Tandberg 64 tape recorder, number 189 for the ADC-18 loudspeaker.

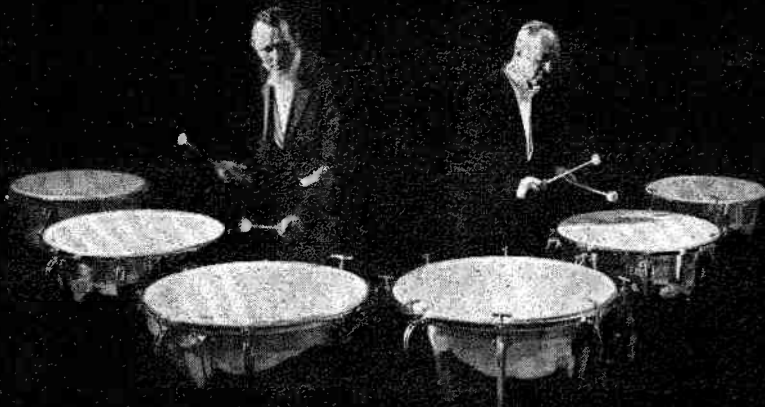

You are
about to hear
the magnificent
sound of
the exciting
new
Sony
Stereorecorder
200...

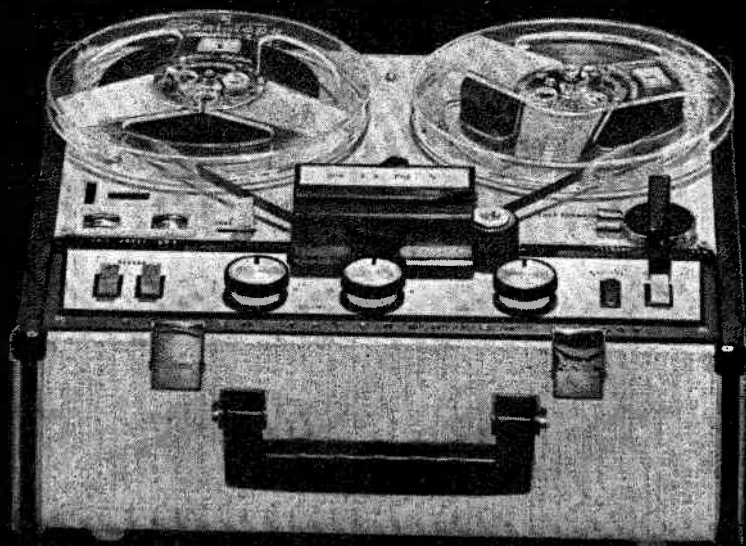
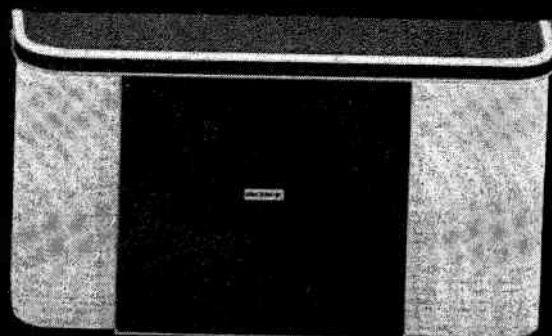
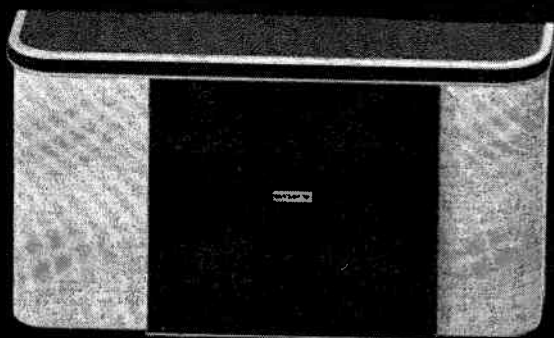

...at your dealer's today. Less than \$239.50, complete with two dynamic microphones and the revolutionary Sony **lid-integrating** high fidelity speakers. For literature, or name of nearest franchised dealer, write Superscope Inc., Sun Valley, California. ■ All Sony Stereorecorders are multiplex ready. In New York visit the Sony Salon, 585 Fifth Avenue.

SONY

SUPERSCOPE

The Tapeway to Stereo

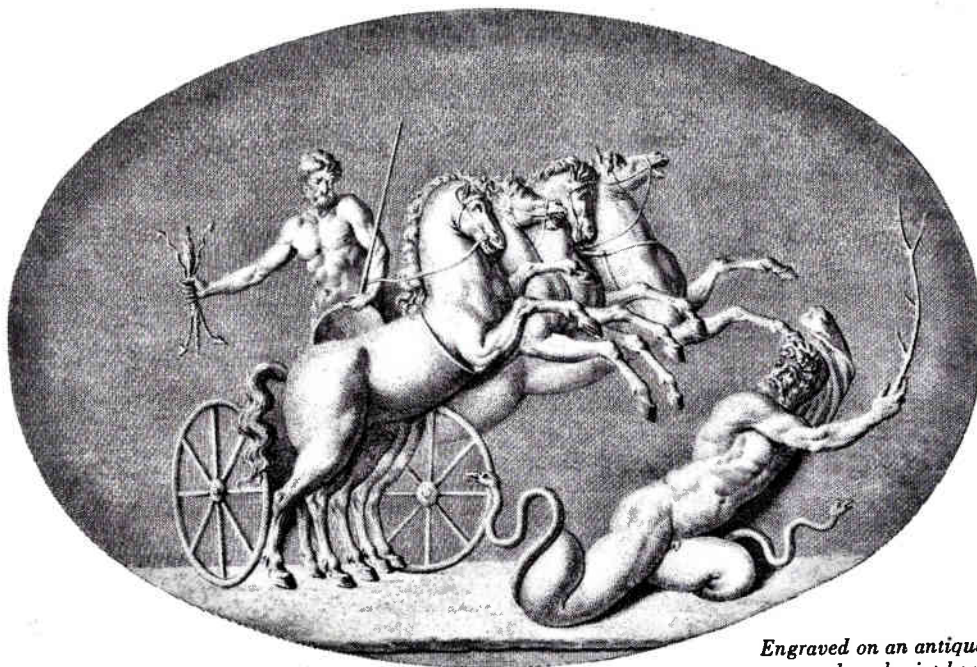

Engraved on an antique gem seal, a chariot-borne Jupiter threatens the prophetic sea god Proteus, who here transforms himself into a tree.

MOZART'S

"Jupiter" Symphony

AT THE beginning of 1788, the year in which the thirty-two-year-old Mozart was to produce his last and greatest symphonies—No. 39, in E-flat; No. 40, in G Minor; and No. 41, in C, the "Jupiter"—he had just been appointed court composer by Joseph II, emperor of Austria. Gluck, his predecessor in that position, had died in November of 1787 and had been receiving an annual salary of two thousand florins. Mozart, however, was offered only eight hundred—the equivalent of about \$224. Because he was in desperate financial straits, he was forced to accept, and turned his attention to composing the inconsequential minuets, waltzes, and court dances expected of him. Later he was reported to have made the complaint that this meager salary was "too much for what I do—not enough for what I can do."

Mozart's fame throughout Europe had brought him

little financial return, and, to maintain himself and his family, he was obliged to perform in public and to teach. This busy life left him no time to concern himself with household bookkeeping, and his wife Constanze was as cavalier as he about money matters—and regularly pregnant besides. *Don Giovanni* had been an instantaneous triumph at its 1787 premiere in Prague, but when it was produced in Vienna for the first time in May of 1788, it was greeted with indifference. Lorenzo da Ponte, librettist of both *Don Giovanni* and *The Marriage of Figaro*, reported the emperor's verdict: "The opera is divine, finer perhaps than *Figaro*, but it is not the meat for my Viennese." When Mozart heard this he is supposed to have replied: "We must give them time to chew it."

Meanwhile, Mozart was concerned about where his
(Continued on page 13)



The lyric majesty of Sony sound



A magnificent new stereophonic high fidelity tape system; precise, versatile, complete in itself, the **Sony Stereorecorder 500**, with the revolutionary lid-integrating speakers, may be purchased for less than \$399.50 complete with two F-87 cardioid dynamic microphones.

Outstanding operational features distinguish the amazing new Sony Stereorecorder 500: ■ Acoustical cone suspension speakers ■ Speakers combine to form carrying case lid ■ 4-track stereo and monophonic recording and playback ■ Vertical or horizontal operation ■ Microphone and line mixing ■ Sound on sound ■ Two V.U. meters ■ Hysteresis-Synchronous drive motor ■ Dynamically balanced capstan flywheel ■ Pause control ■ Contour switch ■ Automatic shut-off ■ Automatic tape lifters ■ FM stereo inputs ■ Multiplex Ready!

SONY **SUPERSCOPE** *The Tapeway to Stereo*

Sony tape recorders, the most complete line of quality recording equipment in the world, start at less than \$79.50. For literature or name of nearest dealer, write Superscope, Inc., Dept. 8, Sun Valley, Calif. In New York, visit the Sony Salon, 585 Fifth Avenue.

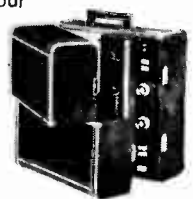

CIRCLE NO. 67 ON READER SERVICE CARD

HIFI/STEREO REVIEW

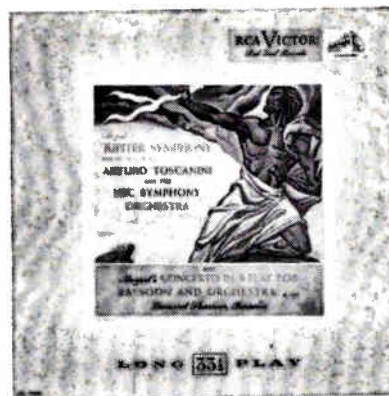
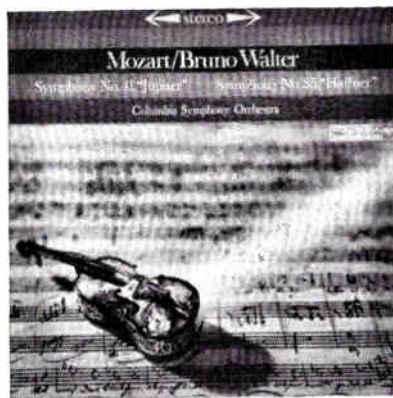
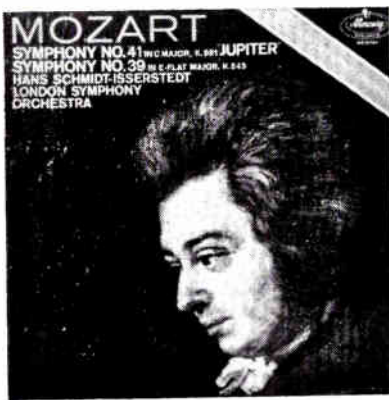

Stereo recordings of Mozart's "Jupiter" Symphony are in abundance. Of the best, Mercury boasts Schmidt-Isserstedt's spirited direction of the London Symphony Orchestra, and Columbia has Walter's affectionate performance with the Columbia Symphony Orchestra. An RCA Victor mono disc preserves Toscanini's classic reading of the late Forties.

next meal would be coming from. On the twenty-seventh of June, 1788, he wrote to his loyal friend (and fellow Mason) Michael Puchberg begging for a loan. "My landlord in the Landstrasse was so pressing," he related, "that I was obliged to pay him on the spot (in order to avoid any unpleasantness), which caused me great embarrassment." He also spoke in this letter of gloomy thoughts that were oppressing him. But none of this seems to have dimmed his creative fire. The day before he wrote this letter he had begun the first of his three final symphonies, and within seven weeks, by August 10, 1788, he finished the last of them, the mighty "Jupiter," one of the cornerstones of the symphonic literature.

A London music publisher named J. B. Cramer is generally held responsible for the sobriquet "Jupiter," bestowing this title on it because of what he called the work's "loftiness of ideas and nobility of treatment." (Parenthetically, about fifteen years ago, when the sleuths of the Haydn Society discovered a manuscript of Haydn's Symphony No. 13, in D Major, H. C. Robbins Landon, the chief musical detective, noticed that the first theme of Haydn's last movement was identical with that of the same movement of the Mozart symphony, and promptly dubbed the Haydn symphony that composer's "Jupiter.")

IN YEARS gone by, the outstanding recorded performance of Mozart's "Jupiter" was one by the London Philharmonic Orchestra under the direction of Sir Thomas Beecham. For vigor and forcefulness, that original Beecham performance, once available in this country in a Columbia 78-rpm album, may well have established the standard for our time. Beecham re-recorded the "Jupiter" twice, both times with the Royal Philharmonic Orchestra, and both performances are still listed in the catalog (Columbia ML 4313 and Angel 35459). Neither, unfortunately, quite matches the power of his first version.

Fourteen other recordings of the "Jupiter" are listed in the current Schwann catalog, nine of them in both mono and stereo. The Toscanini-NBC Symphony Orchestra performance (RCA Victor LM 1030) origi-

nated as a 78-rpm set in the late 1940's and was one of RCA's initial long-playing releases. Though I find almost all of Toscanini's other Mozart performances hectic and frenzied, his "Jupiter" is in a class by itself, a stupendous performance, full of the white heat of passion and drama. The sound is still quite good, too.

The choice among the other available recordings boils down to the versions by Jochum and the Concertgebouw Orchestra (Philips 900004/500004), Schmidt-Isserstedt and the London Symphony Orchestra (Mercury 90184/50184), and Walter and the Columbia Symphony Orchestra (Columbia 6255/5655). Both Jochum and Schmidt-Isserstedt offer well-recorded, probing, and persuasive accounts of the music, and their orchestras respond with vitality. Walter's is altogether a more personal account: he caresses the music, lingering over phrases and bringing out inner voices. The reading will not be to everyone's liking, but I prefer it of all those currently available. The playing of the orchestra is excellent, and Columbia's sound, especially in stereo, is rich and vibrant.

Some readers may have attended Erich Leinsdorf's recent performances of the "Jupiter" either in Boston or at Tanglewood. Leinsdorf's current conception of the "Jupiter" is a revelation, bearing little resemblance to the performance he recorded some years ago in his complete series of Mozart symphonies for Westminster. His current attitude toward the symphony is to elicit its noble grandeur and heroic inevitability. Leinsdorf now observes all the repeats in the score, even those in the slow movement and the finale. The "Jupiter" emerges as a work of herculean splendor, with the architectural dimensions of a Brahms symphony. Fortunately, RCA Victor recorded the "Jupiter" with Leinsdorf and the Boston Symphony Orchestra last season for release in the near future. It promises to be one of the most important recordings of the year, and when I have heard it I will note in this column how completely it fulfills this promise.

In the meantime, my "Jupiter" recommendation is the Bruno Walter performance in either stereo or mono, with the Toscanini recording for those to whom brilliant sonics are not the ultimate consideration.



The commanding presence of Sony sound

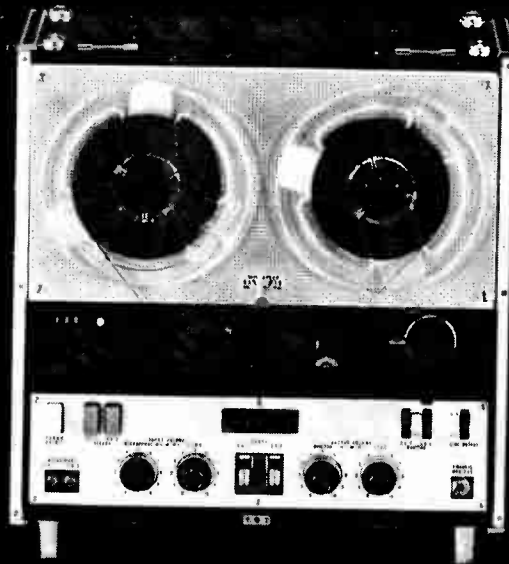

Now enter the world of the professional. With the Sony Sterecorder 600, a superbly engineered instrument with 3-head design, you are master of the most exacting stereophonic tape recording techniques.

Professional in every detail, from its modular circuitry to its 3-head design, this superb 4-track stereophonic and monophonic recording and playback unit provides such versatile features as: ■ vertical and horizontal operating positions ■ sound on sound ■ tape and source monitor switch ■ full 7" reel capacity ■ microphone and line mixing ■ magnetic phono and FM stereo inputs ■ 2 V.U. meters ■ hysteresis-synchronous drive motors ■ dynamically balanced capstan flywheel ■ automatic shut off ■ pause control and digital tape counter—all indispensable to the discriminating recording enthusiast. Less than \$450,* complete with carrying case and two Sony F-87 cardioid dynamic microphones.

SONY

SUPERSCOPE

The Tapeway to Stereo

Multiplex Ready!

* Yes, less than \$450!

Sony tape recorders, the most complete line of quality recording equipment in the world, start at less than \$79.50. For literature or name of nearest dealer, write Superscope, Inc., Dept. 8, Sun Valley, Calif. In New York, visit the Sony Salon, 585 Fifth Avenue.

CIRCLE NO. 68 ON READER SERVICE CARD

HIFI/STEREO REVIEW



DISTORTION—PART II

DISTORTION occurs when the reproducing equipment alters the original sound—that is, when what comes out is no longer a true replica of what went in. The two most common types of distortion are harmonic (HD) and intermodulation (IM).

Harmonic distortion derives its name not from the concept of musical harmony, but from the harmonics, or overtones, that are produced by an instrument in addition to its basic pitch. It is these natural overtones, or harmonics, that give the various instruments their individual tonal character. Harmonic distortion occurs when the amplifier (or any other component) generates harmonics of its own. These unwanted additions mix with the natural harmonics of the music and thus alter its tonal color.

To measure harmonic distortion, a test signal consisting of a single frequency with a very low harmonic content is fed into the amplifier under test. The output signal is then analyzed to see if the equipment has added any overtones. The total amount of spurious harmonics is then measured and expressed as a percentage of the total output. As long as harmonic distortion is below 1 per cent, it has no perceptible effect on the reproduced sound.

Intermodulation (IM) distortion can occur when two or more different frequencies pass through the amplifier simultaneously, which is normally the case in playing music. If the amplifier tends to operate nonlinearly (as discussed in last month's column), the various frequencies and their harmonics interact to generate new, discordant frequencies that were not part of the original sound. Mathematically, these new frequencies are the sums and the differences of the original signal frequencies. As an example, let us suppose that a cello is playing a 100-cps note and a flute is playing a 1,000-cps note. If the amplifier has a bad case of IM, a 900-cps tone and an 1100-cps tone will be reproduced along with the two original tones. Moreover, the two off-tune notes will interact, producing more notes still further off-tune. These intermodulation products add up to make the music sound harsh, shrill, and raucous.

To measure IM distortion, a low note and a high note are fed into an amplifier simultaneously (usually 60 cps and 6,000 cps at a ratio of 4 to 1). At the output, the original test tones are filtered out, leaving only the intermodulation products. These are measured and again expressed as a percentage. If the IM distortion does not exceed 2 per cent, an amplifier will yield respectable performance at its rated power. Top-rated amplifiers, in which IM distortion is 1 per cent or less, generally provide an added measure of clarity, which results in less listening fatigue.

Whenever distortion figures for an amplifier are given, the power output at which the measurement was made should be stated. Customarily, distortion is measured at the maximum rated power of the amplifier. But it is also important to know the amount of distortion at normal listening levels. For this reason, a distortion curve, showing the distortion percentage at various output levels, is an excellent indication of an amplifier's listening quality.



It must be Amphora

AMPHORA, the cool, calm tobacco from Holland that soothes the spirit and relaxes the mind. AMPHORA, fragrant and rich, slow-burning to the bottom of the bowl—mild, full-bodied Cavendish at its best. AMPHORA, the right tobacco for the young man who takes up a pipe, and for the veteran who seldom sets one down. This pipeful and the next, it *must* be AMPHORA, America's biggest-selling Dutch tobacco... still only 40¢.



Douwe Egberts
Royal Factories
Utrecht, Holland

SPECIAL OFFER: Imported Sheffield Steel 3-IN-1 knife-style pipe tool PLUS full 2-oz. pouch of AMPHORA for \$1.00. Mail to Romick's Int'l., Inc., Dept. 85, P.O. Box 3033, North Hollywood, Calif.



CIRCLE NO. 25 ON READER SERVICE CARD



THE ELOQUENCE AND SPLENDOR OF SONY SOUND



STERECORDER 777S-4: ALL-TRANSISTORIZED, WITH THE REVOLUTIONARY SONY ELECTRO BI-LATERAL HEAD*

The perfect integration of superior performance specifications and operational ease. For home or studio use, the new Sony Stereocorder 777S-4 is the finest 4 track professional tape recorder value on the market today. An outstanding array of features includes all-transistorized modular-type circuitry, three motors, the exclusive electro bi-lateral head, tape and source monitoring, sound on sound, illuminated 3" V.U. meters. Sony's solenoid controls (feather touch switching of tape motion in both the instrument and the remote control unit) provide an unsurpassed ease of operation.

Complete with remote control unit: less than \$695.

*A Sony exclusive, the patented Electro Bi-lateral Head enables 2 track stereo and monophonic playback as well as 4 track playback.

For literature or name of nearest dealer write Superscope, Inc., Dept. 8, Sun Valley, California.



All Sony Stereocorders are Multiplex Ready! In New York visit the Sony Fifth Avenue Salon, 585 Fifth Avenue

when the British say
“the best pick-up arm in the world”
 it warrants serious consideration

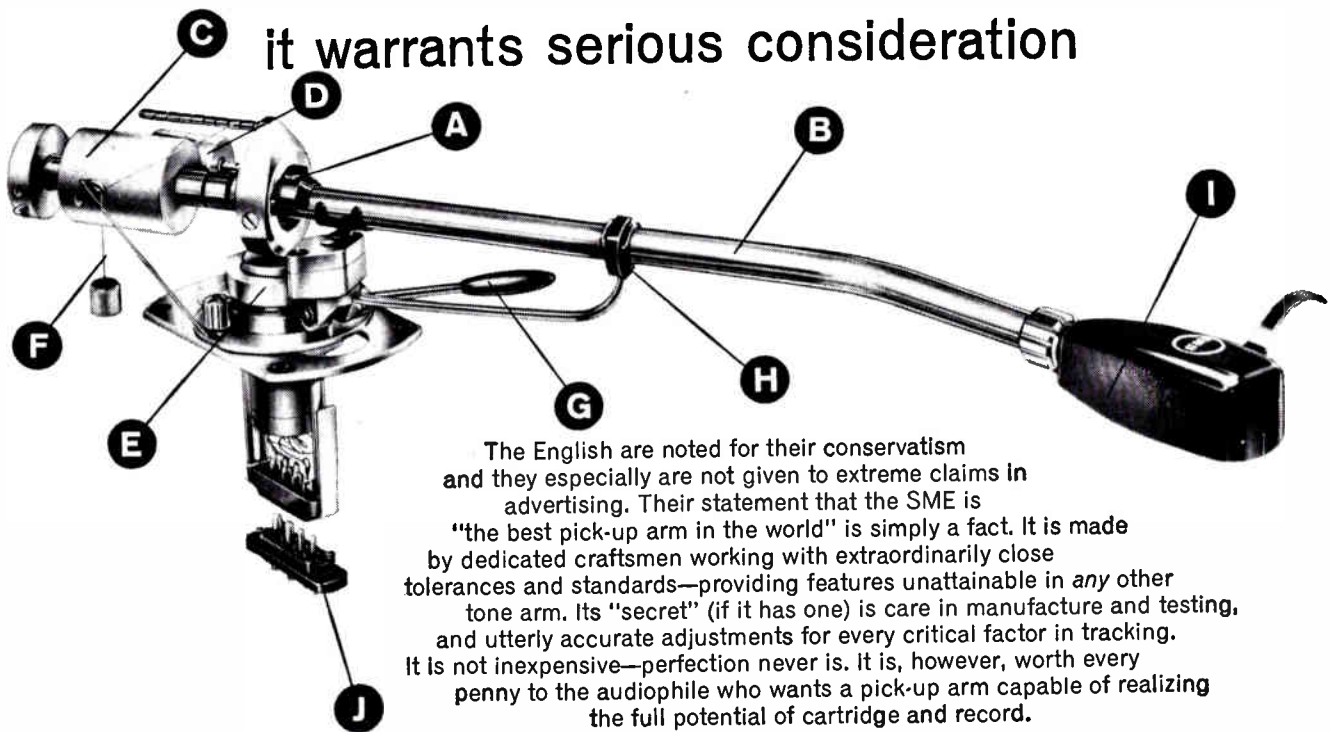

The English are noted for their conservatism and they especially are not given to extreme claims in advertising. Their statement that the SME is “the best pick-up arm in the world” is simply a fact. It is made by dedicated craftsmen working with extraordinarily close tolerances and standards—providing features unattainable in any other tone arm. Its “secret” (if it has one) is care in manufacture and testing, and utterly accurate adjustments for every critical factor in tracking. It is not inexpensive—perfection never is. It is, however, worth every penny to the audiophile who wants a pick-up arm capable of realizing the full potential of cartridge and record.

SHURE SME DESIGN FEATURES

A. Virtually frictionless knife-edge bearings. Pivot friction is less than 20 milligrams, horizontal and vertical!
B. Wood-lined stainless steel tube arm. Resonances are outside recorded range, of small amplitude, and damped.
C. Unique weight system statically balances arm longitudinally AND laterally.
D. Rider weight adjusts tracking force from ¼ to 5 grams, adjustable for ¼ or ½ gm. increments, as accurate as a fine stylus pressure gauge.
E. Sliding base offers alignment adjustment through 1 inch. Height is adjustable through ¾ inch. Fulfills optimum requirements of length, offset, overhang when adjusted with alignment protractor included.

F. “Anti-skating” bias adjuster counteracts tendency of the arm to move toward record center and “favor” inner groove.

G. Hydraulic lever-operated set-down for “slow-motion” feather-light lowering onto any part of the recording.

H. Nylon-jaw arm rest with stainless steel locking link.

I. International standard 4-pin socket. Cartridge shells fitted with detachable pillars and mounting screws at standard ½ inch spacing.

J. Output socket and plug provides a rigid junction for the “stiff wiring” and delicate pick-up lead, eliminating influence on free tone-arm movement.

PRICES:

Includes one shell, arm, template, alignment protractor, hardware

MODEL 3009 for 12” recordings \$89.50 net
 MODEL 3012 for 16” recordings \$99.50 net
 ADDITIONAL SHELL Model A30H \$5.50 each

the
 perfect companion
 cartridge

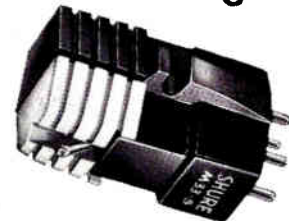

The Shure M33-5, of course. With the SME, provides absolute minimum tracking force . . . *without distortion*. Incredibly transparent sound. Peak-free high end, clean lows, astoundingly natural and clear in the middle range where most other cartridges suffer serious deficiencies. 22 x 10⁻⁶ cm per dyne compliance. \$36.50 net.

SHURE

S

M

E

series
 2
 pick-up
 arm

LITERATURE:

SHURE BROTHERS, INC., 222 HARTREY AVE., EVANSTON, ILLINOIS

Manufactured under U.S. Patents 3,055,988; 3,077,521; 3,077,522; D193,006; D193,934; other patents pending

CIRCLE NO. 63 ON READER SERVICE CARD

LETTERS TO THE EDITOR

Concert-Hall Acoustics

● In the July issue of *HIFI/STEREO REVIEW*, musicologist Fritz Kuttner expressed his views on the acoustics of modern concert halls. There are many things in his article with which I am in complete agreement. However, some of his statements are in direct contradiction to fact.

I question Mr. Kuttner's statement that "Most modern architectural acousticians . . . believe that concert-hall acoustics

is an exact science. . . ." I know of no such acoustician. My recent book (*Music, Acoustics, and Architecture*, John Wiley and Sons, New York) expresses in detail the need for trial, adjustment, and a compatible architecture as necessary parts of success. These are hardly attributes of a precise science. However, there are many things that *are known* and that must be incorporated into a hall design if it is to be successful. An acoustical consultant's life is difficult because each archi-

tect employs a different architectural concept and all variations are not fully predictable.

Mr. Kuttner praises the knowledge of the ancients in the realm of acoustics and catalogs some of their areas of competency, such as acoustic resonators, focus of sound, the twelve-tone system, and the construction of some musical instruments. Unfortunately the ancients did not produce music as we know it today, nor did they leave treatises on suitable environments for their types of music. Certainly, we can learn very little from them pertinent to today's music.

One wonders the basis for Mr. Kuttner's statement that "Dr. Beranek's firm enjoys a reputation based mainly on its work in the construction of recording studios." First, we are not building contractors; we are consultants to architects. Bolt Beranek and Newman's reputation is based on the results of its acoustical consultation on over 100 auditoriums, no two of which are alike archi-

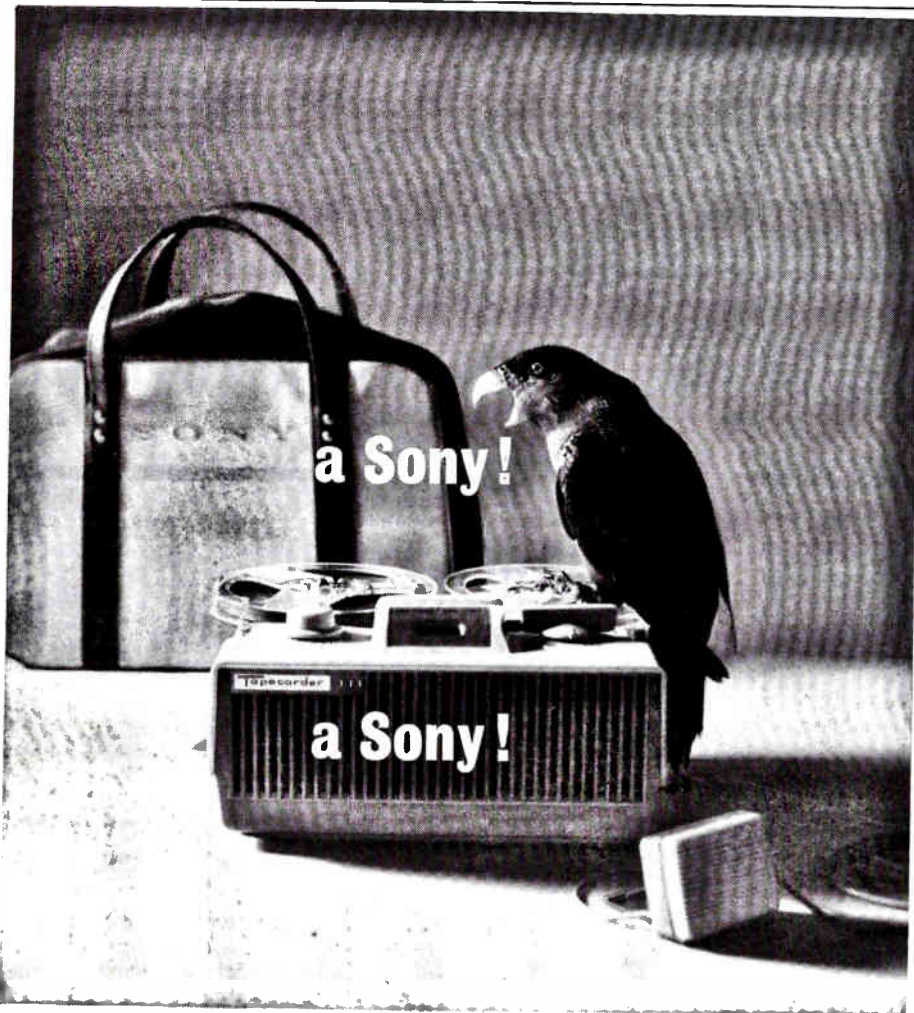

Yes, a Sony!

New TAPECORDER 111 less than \$79⁵⁰!

The first quality tape recorder at a popular price—a smartly-styled instrument so versatile its uses are virtually unlimited! Invaluable for students, world travelers, and businessmen too. The perfect way to start a family album of sound—preserving a child's first word, a confirmation, a wedding day. And nothing could be more fun than to capture party conversation, theatrical readings, a speech or a poetic declamation.

Features are all deluxe; all that you would expect from Sony. Yet the coral and white **Tapecoder 111 is less than \$79.50**, complete with microphone & carrying bag.

All Sony Stereocorders are Multiplex ready!

SONY SUPERSCOPE The Tapeway to Stereo



tecturally or acoustically. Most are multi-purpose, reconciling lecture or theater use with concert-hall use. A number of these halls are well-defined successes for performance of orchestral music. Recent examples include: Tanglewood Music Shed in Lenox, Massachusetts; Municipal Auditorium in Jacksonville, Florida; Binyamei Ha'Ooma in Jerusalem, Israel; Goucher College in Baltimore, Maryland; Santa Fe Opera in New Mexico; Aspen Festival Shell in Colorado; and University of Idaho Auditorium in Boise, Idaho. A few, due to various combinations of circumstances, have been adversely criticized for music acoustics by some listeners. Even in these cases, however, an impartial review would, we are confident, show how much better these halls are for performance of orchestral music than if no scientific knowledge had been applied to the acoustics of these halls.

Mr. Kuttner's listing of five items in
(Continued on page 22)

One-year subscriptions to *HIFI/STEREO REVIEW* may be purchased in Australian pounds (2/15/12); Belgian francs (310); Danish kroner (43); English pounds (2/4/6); French francs (31); Dutch guilders (22); Indian rupees (31); Italian lire (3,900); Japanese yen (2,100); Norwegian kroner (45); Philippine pesos (25); South African rand (4.50); Swedish kronor (33); Swiss francs (27); or West German marks (25). Ziff-Davis Publishing Company also publishes *Popular Photography*, *Popular Electronics*, *Electronics World*, *Popular Boating*, *Car and Driver*, *Flying*, *Modern Bride*, *Amazing*, and *Fantastic*.

**fine music,
flawlessly reproduced
in the least possible
instrument —**

the KLH Model Fifteen



**compact
phonograph
system***

***with complete stereophonic capabilities**

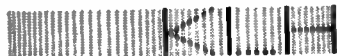

KLH RESEARCH AND DEVELOPMENT CORPORATION
30 CROSS STREET, CAMBRIDGE 99, MASSACHUSETTS

If you've been reluctant to surrender your living room to an elaborate component system or a massive console, your KLH dealer has a thrilling surprise waiting for you. It looks not unlike a small table phonograph, but that's where the resemblance ends. Its sound is the sound of a high quality component system, because the KLH Model Fifteen is a high quality component system with the air squeezed out — the culmination of four years of development aimed at bringing you full, uncompromised stereophonic performance in an incredibly compact instrument.

Three great KLH innovations — each a major advance in its own right — have made the Model Fifteen possible:

- (1) A new KLH-designed, solid state, stereophonic amplifier with an output of 15 watts music power. Beyond the obvious advantages of long, trouble-free service, freedom from heat and noise, etc., a good transistor amplifier, in its ability to handle and recover from peak loads, is equal to tube amplifiers with twice its power (and delivers sound quality to match).
- (2) Revolutionary new full-range KLH speakers (2 in each enclosure) with the highest ratio of magnet power to cone weight ever built into a speaker. These amazing speakers account for the smooth natural sound and freedom from distortion of the Model Fifteen, as well as for its wide frequency range.
- (3) Frequency Contouring. The output curve of the amplifier is shaped to match precisely the low frequency requirements of the long-excursion speakers, to provide a bass performance you have never heard before in a system of this size.

The Model Fifteen is much more than just a compact high quality stereo phonograph. It is a complete stereophonic music center which will accept all other music sources you may wish to add. In addition to its powerful solid state amplifier and the new full-range speakers, the Model Fifteen features a Garrard AT-6 4-speed record changer and a Pickering 380C magnetic pickup, with diamond stylus. Controls are provided for Volume, Balance, Bass (15 db cut or boost), Treble (15 db cut or boost), Mono or Stereo Mode, and Phono or Auxiliary. The speaker enclosures can be separated up to 48 feet with the cables supplied — farther if you wish. Inputs are installed to give you the same flawless performance with a tuner or tape recorder. Outputs are provided for a tape recorder and earphones.

Nothing with such sound quality was ever so compact and convenient before. Or so modestly priced. Just \$259. Hear it at your KLH dealer.

(Continued from page 20)

regard to the design of Philharmonic Hall in Lincoln Center clearly shows that he is not aware of the advanced planning that went into that project. As stated, his five points are not in disagreement with our own philosophy of acoustical design. Finally, where he got the idea that the reverberation time in Philharmonic Hall is low is hard to imagine. It measures 2 seconds at mid-frequencies with full audience!

LEO L. BERANEK
Bolt Beranek and Newman, Inc.
Cambridge, Mass.

Mr. Kuttner replies: "An article subject to the limitations of space and the readers' interest in technicalities cannot give more than general outlines. This accounts for the many (necessary) omissions in my discussion.

"I stand corrected concerning the large number of auditoriums for which Dr. Beranek's firm has acted as consultant. But to an outside observer this looks like mass production or routine processing, and suggests one more weakness of which I was not aware before. Or is not as much care needed or given to multipurpose halls that serve only occasionally for concerts? At any rate, it appears that

this experience did not result in the mastery of the craft one might have expected. Obviously, somewhere along the line something went wrong, which was the point of my article.

"I read Dr. Beranek's book soon after its publication. It does not show that its author is aware of the great history and past achievements of his profession. Nor does his letter, which grudgingly credits the past with 'the construction of some musical instruments.' ALL instruments, if you please, Dr. Beranek, with the exception of—ugh—the electronic organ. That means, among many other things, the acoustics of the priceless Cremona string instruments, the unparalleled Baroque organs, and practically all knowledge of how to build concert halls better than those we get today.

"It is regrettable that Dr. Beranek finds it so easy to dismiss the past, which frequently produced music just as powerful and varied as has our own time, and which left (contrary to his belief) a good many 'treatises on suitable environments for their types of music.' One of the experts entrusted with the acoustic repairs at Philharmonic Hall said that one of their aims must be 'to re-establish the science of acoustics' (see Furman Hebb's

All
this
from
Sony!



For
less
than
\$129.50

Model 102

Professional quality performance in a rugged, compact unit, with 7 inch reel capacity (up to 6¼ hours on one tape), V.U. meter, tape counter, pause control, automatic tape lifters, mike and line mixing. Complete with the new Sony F-96 dynamic microphone, an outstanding value from world famous Sony. For literature or name of nearest dealer write Superscope, Inc., Dept 8, Sun Valley, California. In New York visit the Sony Salon, 585 Fifth Avenue.

The Tapeway to Stereo

SONY SUPERSCOPE

CIRCLE NO. 71 ON READER SERVICE CARD

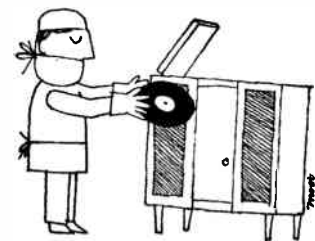

editorial on page 4 of the July issue). This supports my contention that our time has forgotten much of the accumulated knowledge about sound and must recover it from historical sources and procedures.

"I do not share Dr. Beranek's confidence in the accuracy of measurements before a full audience. Whatever the reverberation time of Philharmonic Hall may be, it is too short, as any experienced listener can discover for himself. Dr. Beranek thinks that 'certainly' there is very little to learn from the past. By now it should be clear that he rejects this knowledge at his own risk. He also disagrees with my ideas on how the failures at Lincoln Center and elsewhere can be explained. If he knows better explanations, he should have stated them. The public that pays for these halls has a right to know."

Letter from the Attic

● Dear World: I am happy to know that you all—men, women, and little children—have read my article entitled "Golden Voices in Your Attic" (April). I thank you all for your letters, phone calls, and
(Continued on page 24)

HIFI/STEREO REVIEW

a 264 square-inch woofer
in a 3-way speaker system
only 1¾" thin!

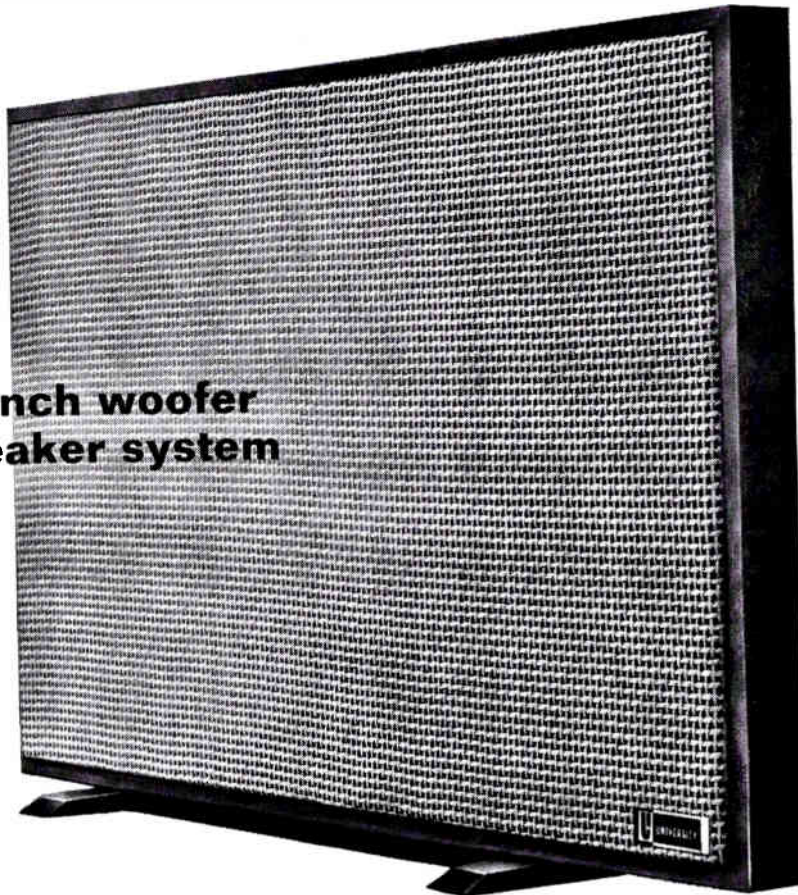

THE UNIVERSITY TRI-PLANAR SPEAKER SYSTEM. Here is the first speaker in which *thinness* is purely a functional matter. The unusually thin shape is actually dictated by its basic engineering design principle. In fact, you have to listen . . . and listen again . . . before you realize that the Tri-Planar's sound comes from a speaker system of such remarkably thin dimensions. The bass range is full and clean. The mid-range and highs are smooth and brilliant. And its balance over the entire range (45 to 18,000 cps) can only be achieved by considerably larger bookshelf systems. The woofer area, consisting of two panel radiators, with custom-matched voice coils, is larger than most speaker systems—264 square inches. And, there are many other features which depart from outworn traditional speaker designs . . . including the exclusive "push-pull" woofer configuration, the open back doublet system, and others. In oiled walnut, with cane grille, 15" x 23" x 1¾" thin. \$79.50. For more about the Tri-Planar and other University Loudspeakers, write Desk D-10.



SYL-O-ETTE — The ultra-thin 3-way system designed to look like a magnificent painting. Choice of Neo-Classic art, Decorator Cane or Petit Point floral grille. 40 to 20,000 cps. Oiled walnut. \$99.95. With Petit Point grille—\$109.90.

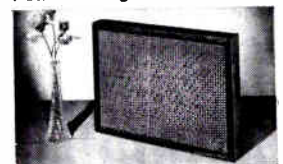

MINI—Big sound in a smaller speaker system measuring 18" x 13¾" x 21"! Utilizes many of the design principles found in the Tri-Planar. 50-17,000 cps. Oiled walnut. \$44.95.

U UNIVERSITY LOUDSPEAKERS
Division of Ling-Temco-Vought, Oklahoma City, Oklahoma

CIRCLE NO. 80 ON READER SERVICE CARD

(Continued from page 22)

personal visits at eleven o'clock at night and eight-thirty in the morning. I humbly acknowledge the fact that I failed to realize that Joe's Bargain Store in Two Forks, Texas had two copies of the Flagstad Camden for sale at 15¢ each, even after my article appeared, and I regret that Joe now wants \$20 each for them—although that only goes to show that Joe, too, reads HiFi/STEREO REVIEW very carefully.

I am pleased and flattered by all this, but please understand: I am not a fabulously wealthy record collector myself,

and cannot purchase your rare records, even if they really are rare. I do not have a direct pipeline to all the other collectors who are avid for your choice items either. Also, I am not in the brokerage business, and do not accept a fee for selling rare records for others. Nor are any of the rare recordings I presently own for sale at any price. I am, God help me, a poor, miserable writer, a mere reporter, who questioned some supposed experts on how was their business, and published the answers. I did this out of greed for the fabulous fees HiFi/STEREO REVIEW pays writers of articles. I admit I should have stood in bed, but I desperately

needed a new ocean-going yacht, and had to earn the money for it by one means or another.

RAY ELLSWORTH
Brooklyn, N.Y.

Swing Street

● Joe Goldberg's review of the Epic set "Swing Street" in the July issue was baffling indeed. On the basis of the music contained in this collection, Mr. Goldberg dismisses, in one fell swoop, that branch of jazz he chooses to call swing. The recorded jazz of this period numbers thousands of discs, and to base a dismissal of all swing on a slender collection like "Swing Street," representative as it may be, is dangerous.

"As contemporary concert music has skipped the nineteenth century in its search for a usable tradition," Mr. Goldberg tells us, "contemporary jazz has done largely the same with swing." Leaving aside the debatable accuracy of both parts of this statement, the description of swing—based on this album's contents—that he uses to support his view is misleading. It so happens that "Swing

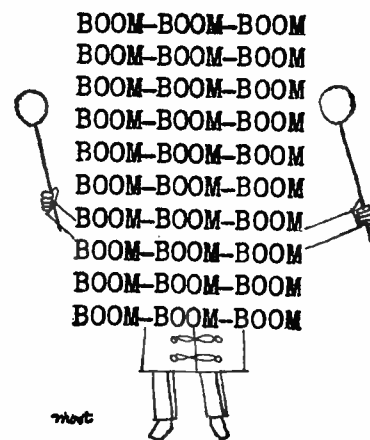

Street" contains very few of the "tricky written riffs" Mr. Goldberg refers to—the great majority of the performances, if arranged at all, are based on unwritten "head" arrangements. No less than sixteen tracks are not swing at all, being in the Chicago, New Orleans, or Dixieland styles, or modifications of them—the Condon, Manone, Prima, Bechet, Freeman, and Marsala pieces. Twelve others are novelty material, mainly vocal—the Three Peppers, Red McKenzie. And two are pure Kansas City blues—Pete Johnson. "Swing Street" is just what it claims to be—and what Mr. Goldberg calls it in his first paragraph: a cross-section of the music heard on Fifty-second Street in the Thirties and Forties, music that had just one official *raison d'être*: to entertain the customers. It is surprising that, in spite of this, so much jazz of lasting value was created in the process.

DAN MORGENSTERN, EDITOR
Jazz Magazine
(Continued on page 26)

new Sony

for portable use*

STERECORDER 464-D

for custom installation

only \$199.50

now both stereo recording & stereo playback!

An unprecedented price for the famed Sony quality! The long-awaited Sony Sterecorder 464-D—dual purpose, dual performance! Dual performance means both 4 track stereo recording and 4 track stereo playback. Dual purpose means custom component installation and portable use. Recording and playback pre-amps are built-in, and such features as sound on sound, language and music training, two speeds, push button track selection and Sony precision engineering make this the most outstanding tape recorder value at less than \$199.50 ■ All Sony Sterecorders are Multiplex-ready!

*Carrying case optional



How to have a compact stereo high fidelity system installed ready-to-play in less than 20 seconds:



Buy the Fisher 500C. Connect two XP-4A speakers. Plug it in.

IN EACH FISHER 500-C you'll find an FM tuner, a Multiplex converter, a stereo power amplifier, and a stereo control-preamplifier. In short, everything you need — on the same, compact chassis.

Never before have so much amplifier power (75 watts), such high tuner sensitivity (1.8 microvolts IHF), so many advanced control features, and such a degree of over-all engineering sophistication been combined on any one chassis, much less one only 17½ inches wide, 5¾ inches high, and 13½ inches deep. And each of these sections is just as ruggedly built and reliable as though it were built as a separate component.

Onward. The Fisher XP-4A is described by one noted authority as "one of the best, most truly musical reproducers available today." Audio says "it

reproduces music as close to the original sound as we have heard in a system anywhere near its category." Its uniquely damped woofer, its two highly specialized mid-range drivers, its hemispherical dome-type tweeter, each of which incorporates significant advances in the field of speaker design, help account for this, as do the separate mid-range and treble balance controls, and the sealed, AcoustiGlas-packed enclosure.

As we were saying, connect two of these 2½-cubic-foot speakers to the 500-C. Then plug it in. You'll have a minimum space component system to do the most discriminating audiophile proud.

The 500-C incorporates Stereo Beacon**, an exclusive Fisher development that signals the presence of Multiplex stereo, and silently, automatically

switches to it — and vice-versa.

Prices: 500-C, \$389.50*. 800-C (AM and FM), \$449.50*. 400 (FM only), \$329.50*. XP-4A, \$199.50†.

All Fisher tubes, diodes and parts are guaranteed for one year from date of purchase. (Usual standard: 90 days.)

\$1.00 VALUE ONLY 25¢!

Please send me the new 1963 edition of The Fisher Handbook, a 44-page reference guide, component catalogue, and idea book for custom stereo. I enclose 25¢ double-wrapped, to cover cost of handling and mailing.



FISHER RADIO CORPORATION
21-37 44th Drive, Long Island City 1, N. Y.

Name _____

Address _____

City _____ Zone _____ State _____

021001/10

The Fisher

†IN WALNUT OR MAHOGANY. *WALNUT OR MAHOGANY CABINET, \$24.95. ALL PRICES SLIGHTLY HIGHER IN THE FAR WEST.
EXPORT: FISHER RADIO INTERNATIONAL, INC., LONG ISLAND CITY 1, N.Y. CANADA: IRI-TEL ASSOCIATES, LTD., WILLOWDALE, ONT. **PAT. PEND.

(Continued from page 24)

Organ Impasse

● Christie Barter's July review of the Franck organ music on London tape LCK 80101 was not written with his customary insight. Franck's *Grand Pièce Symphonique* and B Minor Chorale are not, to my mind, "lumbering," but intricate and thoughtful works by a man who knew the organ well. Miss Demessieux's playing is, of course, subject to debate, but most of the organists I know feel it does justice to the music.

The organ at the Madeleine, described by Mr. Barter as "an unwieldy instru-

ment housed in a cavernous acoustical environment," is a stock Cavillé-Coll instrument built in 1848. The builder was then and is now acknowledged as one of the most successful of the period. His instruments at Saint-Sulpice and Notre Dame have won wide acclaim, and the organ at the Madeleine is closely patterned on them. Since Franck wrote his music at another Cavillé-Coll, namely the one in Sainte-Clotilde, Paris, and it operates in exactly the same way as the one in the Madeleine, it is not possible to criticize the latter as being "unwieldy," because it was just such an instrument Franck intended his music for.

The sound on the recording — which, incidentally, I own — is called "ill-defined, sodden, drab, and thick." Rather it is a close approximation of what one would hear in the church. When Franck wrote his music, he took into account and used with great success the wonderful reverberation of the French churches. Note, if you will, the pauses in the music, deliberately put there so the sound could echo about in a sea of reverberation while the organist changed registration on the console — there were no combination pistons then, remember. It is this sound that has become characteristic of all the great cathedrals of the world. Unfortunately, the world of "high fidelity" today demands something else again. Organists in general prefer a spacious-sounding and reverberating cathedral rather than the dry and sterile interior of, for example, New York's Philharmonic Hall.

JOSEPH DZEDA
Cleveland Hts., Ohio

Mr. Barter replies: "Miss Demessieux, whom I have long admired, undoubtedly does justice to the organ works of Franck on the London twin-pack, and the engineering that went into it undoubtedly reproduces the sound of the Madeleine's Cavillé-Coll as faithfully as possible. Yet Mr. Dzeda and I will be forever divided in our feelings about the music, the intricacies of which, it seems to me, are largely obscured by this recording."

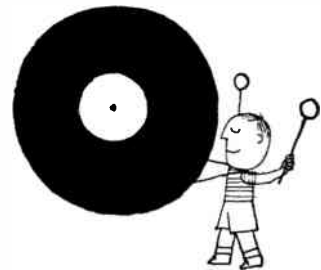

Most Underrated

● I enjoyed Martin Bookspan on the Dvořák G Major Symphony (June) but cannot agree that "Dvořák may well be the most underrated composer of the nineteenth century." That honor goes to Alexander Glazounoff, whose eight symphonies, seven quartets, and other works are practically unknown.

PAUL ERIKSEN
San Francisco, Calif.

Correction

● John Milder, in his article on speaker buying (August), gives the current price of a pair of British-built Quad electrostatic loudspeakers as \$790. Recently the price for a pair has been reduced to \$520.

MORRIS J. SALOB
Harmony House, Inc.
New York, N.Y.

HIFI/STEREO REVIEW



All new from Sony

*Now available, model AD-5 a convenient custom designed flexible microphone holder.

An invaluable aid to the learning process, this 4-track stereophonic tape recorder now makes it possible to have professional assistance at the touch of a knob. Such desirable features as the student/teacher comparison switch permit the language student to match his pronunciation with the instructor's voice; sound-on-sound allows the music student to sit in or sing to pre-recorded professional accompaniment. Other deluxe features such as the pause control and digital tape counter, the self-contained power amplifier and speaker, provides unlimited versatility at school or in the home. Complete with portable carrying case and the new F-96 dynamic microphone. **Less than \$219.50**

■ All Sony Stereorecorders are multiplex Ready! ■ In New York visit the Sony Salon, 585 Fifth Avenue. ■ For literature or name of nearest dealer write Superscope, Inc., Dept. 8, Sun Valley, Calif.

SONY SUPERSCOPE The Tapeway to Stereo

CIRCLE NO. 73 ON READER SERVICE CARD



**Fisher presents the MF-300...
the world's only FM Multiplex tuner
that tunes completely by hand...**

from thirty feet away!

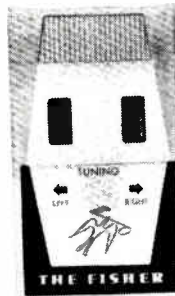

IN A VERY short while, you may wonder why Fisher has put any dials at all on a tuner as automatic as the new MF-300. Simple. They are for those rugged individualists who will insist upon tuning by hand, even though you can now enjoy the luxury of selecting FM stations from your favorite easy chair, plus exact center-of-channel tuning *exceeding even the most careful manual tuning*. You simply press a button on the hand-sized Remote Control unit, or its counterpart on the main control panel. The dial pointer† moves silently to the station desired, stopping *only* at the point of maximum signal. Your program choice emerges in perfect fidelity from the previously silent background.

The MF-300 comes with the Remote Control Station Selector illustrated and thirty feet of cable. With it, you may tune the MF-300 left or right bringing in the station desired perfectly at the point of maximum signal. A *Wireless Remote Control Unit* that turns the MF-300 on or completely off, varies volume continuously and changes stations at the "tilt" of your hand, is available at additional cost.

The MF-300 is a tuner of extraordinary technical sophistication. Sensitivity is 1.6 microvolts (IHF). There are 5 IF stages and 5 wide-band limiters including a germanium diode dynamic limiter. It features the exclusive GOLDEN CASCODE front-end with two Nuvistors, and four tuned circuits utilizing a four-gang tuning

capacitor. Calibration accuracy is of the order of 0.2%. The MF-300 also incorporates Fisher's exclusive Stereo Beacon* which automatically indicates Multiplex broadcasts and switches to them.

Price, including Wired Remote Control, \$359.50**.

All Fisher tubes, diodes and parts are guaranteed for one year from date of purchase.

Foreign residents write to: Fisher Radio, International, Inc., Long Island City 1, N.Y. Canadian residents write to Tri-Tel Assoc., Ltd., Willowdale, Ont.

\$1.00 VALUE! ONLY 25¢! The new 1963 edition of *The Fisher Handbook*, a complete 44-page guide to custom stereo. See the coupon on page 25.

The Fisher

†TUNE-O-LITE *PAT. PEND. **PRICES SLIGHTLY HIGHER IN THE FAR WEST.

JUST LOOKING

...at the best in new hi-fi components



● **Antronics** announces the Multitron, a compact, indoor electronic-antenna system specifically designed for FM and stereo reception. The two-transistor device has a minimum gain of 20 db and can be connected to any tuner input (72-ohm or 300-ohm) in two minutes without special tools.

Inside the Multitron's plastic case is a miniaturized set of printed-circuit antenna elements responsive to all FM broadcast frequencies. The antenna elements are integrated with a transistorized amplifier circuit on a glass-epoxy circuit board. The unit draws little current, and operates from a standard 117-volt a.c.

outlet. Price: \$29.95.

circle 179 on reader service card

● **Concord's** new transistorized stereo tape deck, for use with component high-fidelity equipment, incorporates monitoring power amplifiers and transistorized preamps. The unit is available in two models: 550-D, for horizontal mounting in custom cabinets, and 550-DW, mounted in its own walnut cabinet. The instruments have push-button interlocked controls, three speeds with automatic equalization, tone controls, and dual VU meters. The power amplifiers permit monitoring of recordings directly from the deck through stereo earphones or speakers and will also drive stereo extension speakers. A special extension jack panel permits connection of microphones



or stereo earphones when the jack panel on the side of the deck cannot be conveniently reached in a cabinet mounting. The 550-D is priced under \$230, the 550-DW under \$300.

circle 180 on reader service card

● **Electro-Voice's** Coronet loudspeaker kit combines an 8-inch extended-range loudspeaker with a ducted-port acoustic phase-inverter enclosure and can be assembled in less than twenty minutes without tools. The enclosure is made with interlocking tongue-and-groove joints and is secured by wing nuts recessed into wells in the bottom. Strips of adhesive-backed polyurethane gasket

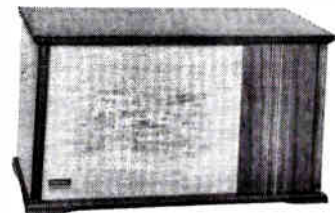

tape are used to line the joints, assuring tight, rattle-free construction. Three versions are available: Coronet I, with an MC8 Michigan loudspeaker; Coronet II, with a Wolverine LS8 loudspeaker; and Coronet III, with an SP8B loudspeaker. All systems have exterior surfaces pre-finished in oiled walnut. Prices: Coronet I, \$39; Coronet II, \$43.50; Coronet III, \$54.

circle 181 on reader service card

(Continued on page 30)

HIFI/STEREO REVIEW



The truly portable new **SONY** tape recorder 801-A

word power!

Wherever you are, wherever you go, whatever the time, your completely portable, battery operated, new Sony 801-A is ready to work for you. Sales meetings, call reports, lectures, conferences, interviews, vacationing, home or office—press the button and it's recorded with the world-famous Sony fidelity. Playback? It's immediate, through the built-in, full-range speaker. Truly portable, the 801-A is

also a strikingly handsome addition to your office or den furnishings. *Additional features include:* adjustable pause and back-up lever (this Sony exclusive enables you to repeat a word, a phrase, a sentence), self-storing microphone (another Sony exclusive), stop and go button on the microphone, two speeds (1½ & 3¼), and a full line of accessories. Complete with microphone and earphone, less than \$250.*



Tape it with you!

*Leather carrying case \$10 additional. For specifications, uses and a list of accessories, write for free illustrated brochure to Superscope Inc., Sun Valley, California. In New York City, visit the Sony Salon, 585 Fifth Avenue.

SONY

SUPERSCOPE

The Tapeway to Stereo



It's difficult to compare the 80-watt Fisher X-202-B with other stereo control-amplifiers in its power class.

Because there are none.

SINGLE-CHASSIS, integrated stereo-control-amplifiers are one of the great Fisher specialties. Their special design problem—that of combining the stereo power-amplifier section with the stereo preamplifier and audio control system in a single, space-saving but no-compromise unit—has been solved by Fisher engineers to an unprecedented degree of technical sophistication.

The 80-watt X-202-B, priced at \$249.50*, is just one of four superb Fisher stereo control-amplifiers. Others are the 50-watt X-100-B, priced at \$169.50*, the 60-watt X-101-C, priced at \$199.50*, and by far the most powerful and advanced control-amplifier in

existence, the 110-watt X-1000, priced at \$339.50. Each of these remarkable stereo amplifiers has virtually non-measurable distortion right up to the limit of its power rating.

All models incorporate the exclusive DIRECT-TAPE-MONITOR**, a unique Fisher development that permits both recording *and* playback with full use of all applicable controls and switches, without any change in cable connections. Third-speaker output facilities (stereo center channel or mono extension) as well as front-panel earphone jacks are also standard on all models.

Listen to a demonstration of the remarkable X-202-B at your Fisher

dealer's. Even a brief listening test will prove that no high fidelity component can surpass a Fisher—except another (and more elaborate) Fisher.

In striking contrast to the industry-wide standard of 90 days, the Fisher Warranty is extended to all tubes, diodes and parts for a period of one year from date of purchase.

Foreign residents write to: Fisher Radio International, Inc., Long Island City 1, N. Y. Canadian residents write to Tri-Tel Assoc., Ltd., Willowdale, Ont.

\$1.00 VALUE! ONLY 25¢! The new 1963 edition of The Fisher Handbook, a complete 44-page guide to custom stereo. See the coupon on page 25.

The Fisher

*LESS CABINET. ALL PRICES SLIGHTLY HIGHER IN THE FAR WEST. EXPORT: FISHER RADIO INTERNATIONAL, INC., LONG ISLAND CITY 1, N. Y. CANADA: TRI-TEL ASSOCIATES, LTD., WILLOWDALE, ONT. ©PAT. PEND.

(Continued from page 28)

● **Harman-Kardon's Award FA30XK** FM stereo-amplifier kit combines a stereo tuner, preamplifier, and power amplifier on a single chassis. The FM section of the kit includes a new multiplex section with a frequency response of 15 to 15,000 cps ± 1 db and 30 db of stereo separation. A stereo-indicator light provides instant identification of stereo broadcasts. A high degree of flexibility is made possible by a full complement of input and control facilities, including a variable blend control, ganged bass and treble

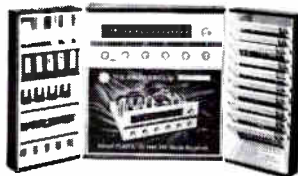

controls, and separate switched high-cut and low-cut noise filters. The 30-watt power-amplifier section has a frequency response of 15 to 70,000 cps at normal listening levels. Price: \$169.95.
circle 182 on reader service card

● **Jensen** has developed a high-efficiency two-way miniature speaker system, Model X-11, with a special woofer precisely matched to the enclosure. High frequencies are reproduced by a 3-inch tweeter with response to 14,000 cps. A volume control is conveniently located

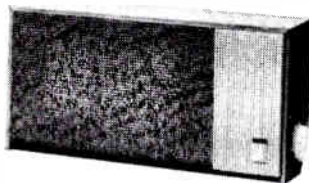

on the side of the oiled-walnut cabinet. Adequate room sound is provided with 1 watt to the speaker. The X-11 speaker system is 6 $\frac{3}{8}$ inches high, 13 $\frac{11}{16}$ inches wide, and 4 inches deep. It may be placed on any flat surface, or hung on a wall. Price: \$29.75.

circle 183 on reader service card

● **Lafayette Radio's** Model LA-214W 10-watt stereo amplifier is designed for either stereophonic or monophonic inputs from record players, tuners, or stereo tape players. Music-power output is 5 watts from each channel, 10 watts mono; frequency response is from 50 to 20,000 cps ± 1 db at 1 watt; intermodulation distortion is 3 per cent at full output; hum and noise are 58 db below full output. Controls include rumble filter, speakers/phones switch, stereo-headphone jack. Size: 12 $\frac{1}{2}$ inches wide, 5 inches high, 7 $\frac{3}{4}$ inches deep. The unit is supplied with a metal cabinet. Price: \$37.50.

circle 184 on reader service card

● **Paralan**, a company new to high fidelity, has as its first product a 60-watt (rms) transistorized integrated stereo amplifier. Frequency response is 10 to 40,000 cps ± 1.5 db at full power and less than 3 db down at 5 and 100,000 cps at

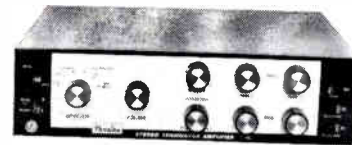

1 watt power output. Harmonic distortion is under 0.5 per cent at full power and is under 0.2 per cent at 1 watt. Intermodulation distortion at full power is under 0.5 per cent. The hum-and-noise level is better than 75 db below 10-millivolt phono and 1-volt tuner input. In addition to the standard tone controls, there are separate balance, separation, and scratch and rumble filters. The transformerless output circuit is rated for a 4-ohm load, but will drive 8- and 16-ohm speakers. Price, including metal case: \$198.50.

circle 185 on reader service card

● **Spico's** new TV-FM transistorized indoor antenna is of the rabbit-ears type with a built-in transistor booster. Gains up to 35 db (over that of a standard dipole) are claimed. Tuning adjustments are included. The Model TR-11 is powered by a transistorized printed-circuit amplifier. The unit plugs into any a.c. line. Price: \$29.95.

circle 186 on reader service card

● **United Audio's** new record changer, the Dual 1009 Auto/Professional, features a dynamically balanced tone arm that can track and trip at a stylus pressure below half a gram. The tone arm has virtually frictionless pivots and ball bearings, and stylus force is applied directly at the pivot by a coiled mainspring. A direct-reading built-in scale indicates the tracking force. The high-torque motor maintains speed accuracy within 1/10 of 1 per cent, with one or ten records on the platter, and line-voltage variations even better,



yond 10 per cent have no effect on speed, which may be varied over a 6-per-cent range for all four speeds. Other features include: 7-pound nonferrous turntable, interchangeable single-play and changer spindles, continuous repeat. Dimensions: 10 $\frac{3}{4}$ x 12 $\frac{3}{4}$ inches, with 6 inches clearance above, 3 inches below. Price: \$94.75.

circle 187 on reader service card

All
new
from
Sony



a stereo
deck
with
3 heads!

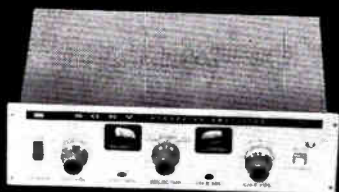

and
stereo
recording
amplifier

Now you can add famous Sony 4 track stereo tape playback to your present hi fi system. Handsomely styled in gold and grey, with 3 heads, 2 speeds, vertical or horizontal mounting, automatic shut-off, tape counter and pause control, the new Sony 263-D is a remarkable value.

Less than \$119.50

For stereo recording, add the new Sony SRA-2L recording amplifier that instantly connects to the 263-D. Its matching gold and grey decor makes a handsome companion for your 263-D. All new from Sony!

Less than \$99.50

■ All Sony Stereorecorders are Multiplex Ready! ■ In New York visit the Sony Salon, 585 Fifth Avenue ■ For literature or name of nearest dealer write Superscope, Inc., Dept 8, Sun Valley, California.

SONY SUPERSCOPE

The Tapeway to Stereo

CIRCLE NO. 75 ON READER SERVICE CARD

No manufacturer can make a top-quality 50-watt stereo control-amplifier for less than \$130.

But you can.

(With the Fisher KX-100 StrataKit, for only \$129.50.)

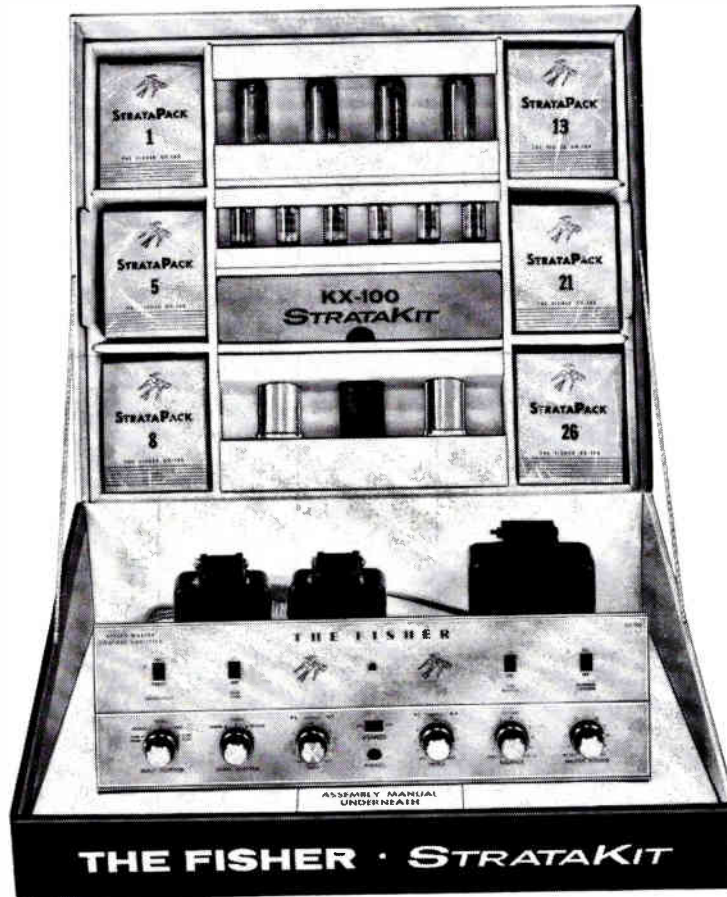

If you want a no-compromise amplifier at a compromise price, you can't buy it—you have to build it yourself. And no one can build a better 50-watt single-chassis stereo control-amplifier than the Fisher KX-100, at *any* price!

Here is today's most spectacular value in amplifier kits. The 50-watt music power output (IHF Standard, both channels) assures superior dynamic range regardless of speaker efficiency. Harmonic distortion at rated output is only 0.5%. A special power output is provided for driving a third speaker (center channel or mono extension) without the use of an additional ampli-

fier. The exclusive Fisher DIRECT-TAPE-MONITOR* permits the use of all controls and switches during tape monitoring without any change in cable connections. The convenient front-panel headphone jack is equipped with a switch for silencing the main loudspeakers, if desired. All other control and switching facilities are equally professional in their flexibility.

And *who* can build the KX-100? Anyone. Previous experience is immaterial. The exclusive Fisher StrataKit method makes kit construction so easy and error-proof that there is no longer a difference between the work of a skilled technician and that of a total novice. You can't *help*

ending up with a faultless Fisher amplifier. All you need is the desire, a few evenings of free time and \$129.50.**

FREE! \$1.00 VALUE! The Kit Builder's Manual: a new, illustrated guide to high-fidelity kit construction.

Fisher Radio Corporation
21-37 44th Drive
Long Island City 1, N. Y.

Please send me without charge The Kit Builder's Manual, complete with detailed information on all Fisher StrataKits.

Name _____
Address _____
City _____ Zone _____ State _____ 02101

The
Kit Builder's
Manual

The Fisher

WALNUT DR. MAHOGANY CABINET, \$24.95. METAL CABINET, \$18.95. PRICES SLIGHTLY HIGHER IN THE FAR WEST. EXPORT: FISHER RADIO INTERNATIONAL, INC., LONG ISLAND CITY 1, N. Y. SAMADA: TRI-TEL ASSOCIATES, LTD., WILLOWDALE, ORT.

EICO 2536 FM STEREO RECEIVER

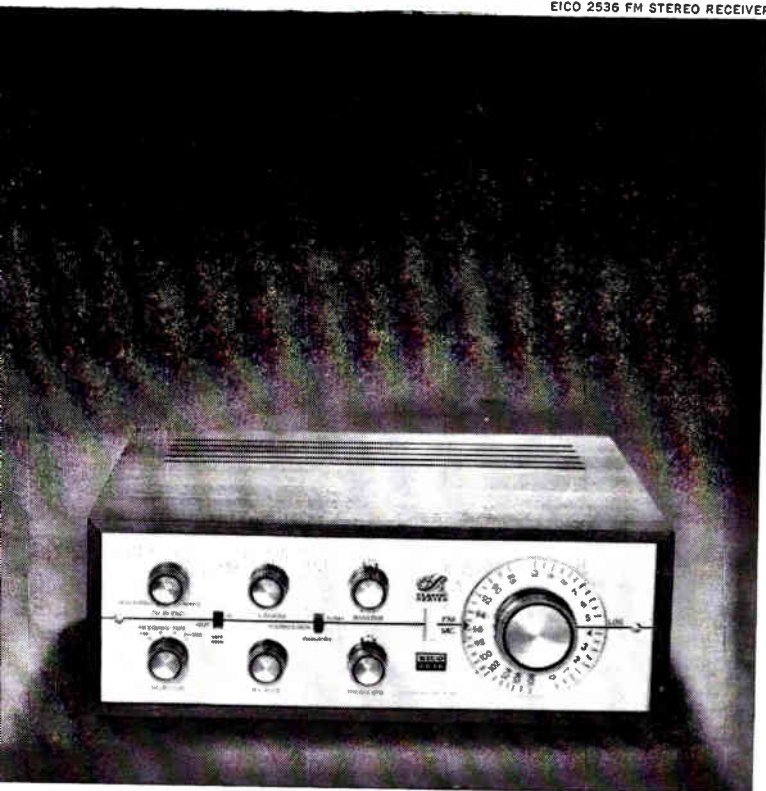

EICO 2200 FM STEREO TUNER

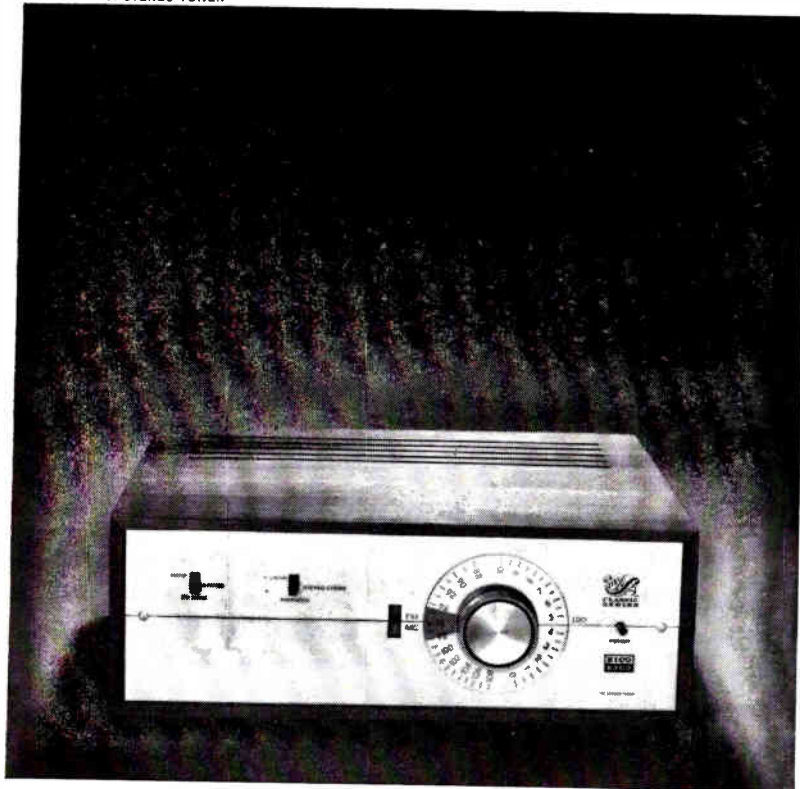

suddenly all other stereo
components
seem overpriced...

EICO 2036 36-WATT STEREO AMPLIFIER

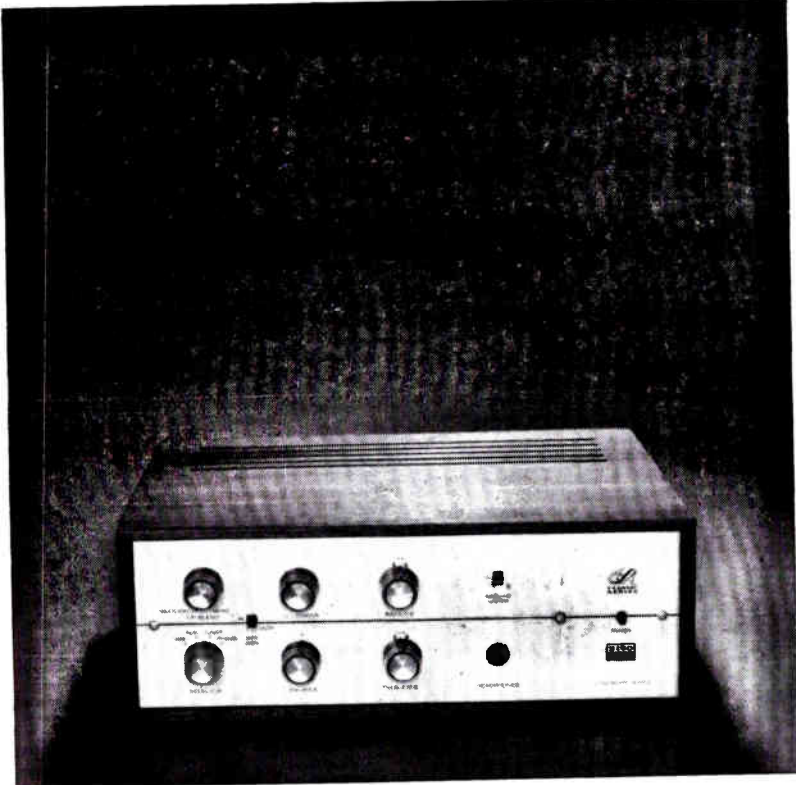

EICO 2050 50-WATT STEREO AMPLIFIER

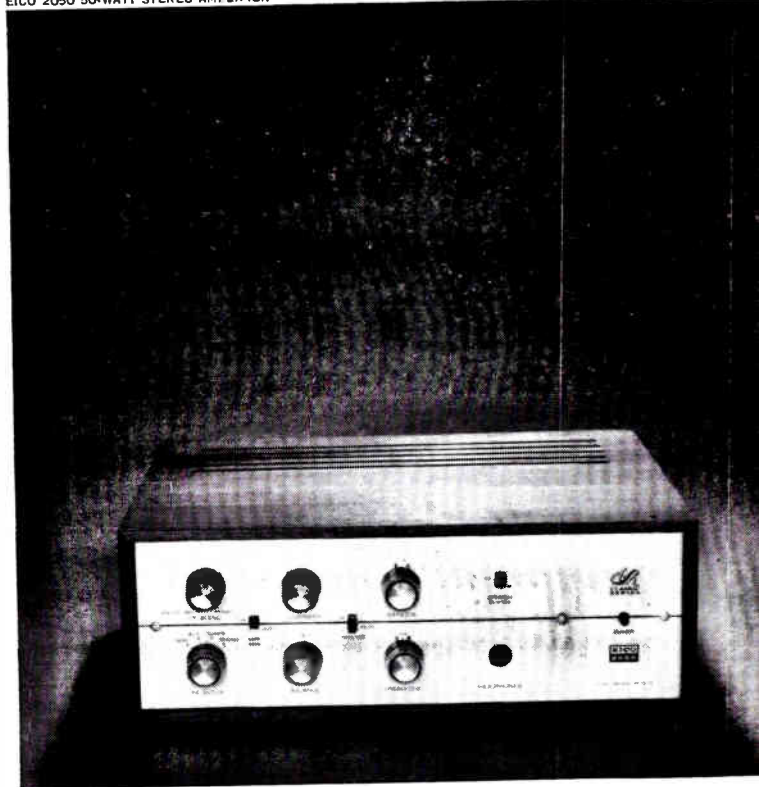

New Classic Series by Eico

In basic performance quality, in overall reliability, and in refinement of appearance and handling, Eico's new Classic Series matches or surpasses components selling for much higher prices. And this is true whether you buy Classic components factory-wired, or build them from the kit.

How did Eico achieve this? Simply by stripping their Classic components of all impractical or unnecessary features . . . by concentrating on circuit and component quality . . . by making top performance their basic engineering goal. For proof—simply examine our specifications. And then listen to any Classic component at your Eico dealer!

Now, if you're interested in building any of these superb stereo components at home, look at the new Classic Series Kit Package, and see the features Eico has built into it for your kit-building ease, convenience, and assurance of success: the logical, orderly arrangement of parts . . . the ease with which the kit sets up for work and closes down between work sessions—with no loose parts to go astray . . . the ready-to-wire chassis with sockets, jacks, terminal boards, and transformers pre-mounted.

Thumb through the 2-color Construction Manual. Ever see such graphic diagrams? Every step is clear and unmistakable—and no diagram covers more than 20 steps. And here's another thing you can see from the diagrams: how simple the wiring is—with no tricky frills, no clutter, no confusion, even around switches and controls. Plenty of space to work in.

Compare these kits with any others on the market, and decide: do any other kits do more to make kit-building an enjoyable, creative experience than the Eico Classic?

EICO CLASSIC 2536 STEREO FM RECEIVER TUNER SECTION: Front end and IF strip are supplied prewired and prealigned; no adjustments or test instruments needed. The IF strip has 4 amplifier-limiter stages and a wide-band (1-mc) ratio detector. A high quality circuit board and pre-

aligned coils are provided for the stereo demodulator circuit. **Sensitive,** bar-type electron ray tube serves as tuning and stereo program indicator. **IHFMS usable sensitivity:** $3\mu\text{v}$ (30 db quieting), $1.5\mu\text{v}$ (20 db quieting). **Stereo sync sensitivity:** $3\mu\text{v}$. **Frequency response:** 20 to 15,000 cycles ± 1 db. **Channel separation:** 30 db. **IHFMS S/N ratio:** 55 db. **IHFMS capture ratio:** 3 db. **IHFMS harmonic distortion:** 0.6%. **AMPLIFIER SECTION:** Baxendall bass and treble controls do not interact or affect loudness, permit boost or cut at extremes of audio range without affecting mid-range. Balance control permits complete fade of either channel. Blend control is variable from switch-out, for maximum separation, to full blend. Tape monitor switch permits off-the-tape monitoring with the Eico RP100 stereo tape recorder. **Power:** 36 w IHFM, 28 w cont. (total). **Power bandwidth at rated power,** 1% harmonic distortion: 30 cps—20 kc. **IM distortion (each channel):** 2% at 14 w, 0.2% at 1 w. **Response:** ± 1 db 15 cps—40 kc. **Noise:** -65 db at 10 mv, mag phono; -80 db, others. **Sensitivity:** 2.3 mv mag phono, 250 mv, others. **Outputs:** 8, 16 ohms. **Kit:** \$154.95. **Wired:** \$209.95. **Optional:** Walnut Cabinet WE-73, \$19.99. **Metal cover, E-12** \$7.50.

EICO CLASSIC 2200 STEREO FM TUNER Identical with the tuner section of the 2536 Receiver. **Audio output** 1.5 volt. **Kit:** \$92.50. **Wired:** \$119.95. **Optional:** Walnut Cabinet WE-72, \$19.95. **Metal cover, E-11,** \$7.50.

EICO CLASSIC 2036 36-WATT STEREO AMPLIFIER Identical with the amplifier section of the 2536 Receiver, plus speaker system switch, headphone jack. **Kit:** \$79.95. **Wired:** \$109.95. **Optional:** Walnut Cabinet WE-72, \$19.95. **Metal cover, E-11,** \$7.50.

EICO CLASSIC 2050 50-WATT STEREO AMPLIFIER Same control facilities as amplifier section of 2536 receiver, plus speaker system switch, headphone jack, and high filter switch. **Power:** 50 w IHFM, 44 w cont. (total). **Power bandwidth at rated power,** 0.8% harmonic distortion: 30 cps—20 kc. **IM distortion (each channel):** 2% at 22 w, 1% at 17 w, 0.1% at 2 w. **Harmonic distortion (each channel):** 0.5% at 17 w, 40 cps—20 kc. 0.3% at 5 w, 30 cps—20 kc. **Response:** ± 1 db 10 cps—40 kc. **Noise:** -65 db at 10 mv, mag phono; -80 db, others. **Sensitivity:** 1.7 mv mag phono, 190 mv others. **Outputs:** 8, 16 ohms. **Kit:** \$92.50. **Wired:** \$129.95. **Optional Walnut Cabinet, WE-72,** \$19.95. **Metal cover, E-11,** \$7.50. See the Eico Classic Series at your high fidelity dealer. Write for new catalog, Eico Electronic Instrument Co., Inc., 3300 Northern Blvd., L.I.C. 1, N. Y. Export: Roburn Agencies Inc., 431 Greenwich St., N.Y. 13.

EICO
add 5% in West

a **marantz** owner

Forever

There is no such thing as a typical Marantz owner—unless one can say they are firmly devoted. Some may have determined at the outset that they would have only Marantz. For still others it may have been a matter of budgeting, with planned growth to a full Marantz system.

We have, however, been receiving an ever increasing number of letters from recent Marantz "converts", indicating surprise at the extent of the improvement obtained. They are now convinced of the difference, and are Marantz owners forever.

Whether one is buying soap or automobiles, it is difficult to evaluate conflicting claims and counterclaims of superiority. Yet, when it comes to stereo amplifiers and preamplifiers, almost anyone will acknowledge that Marantz is outstanding from any point—whether performance, precision, quality of construction, reliability, or sound quality.

Hear for yourself what the finest music reproduction sounds like—and you too will be a confirmed Marantz owner—forever!

**an
important
message**



At the time you read this ad, we will be in production on the new Model 10 stereo FM tuner, and a limited number may already have been shipped to franchised Marantz dealers. During the coming months we hope to fill a substantial number of the many, many advance orders our customers have placed for this unique precision device.

We feel deeply moved by this overwhelming evidence of your dedication to and faith in the Marantz concept of quality.

Marantz President



Superb American Craftsmanship **marantz**

25-14 BROADWAY, LONG ISLAND CITY 6, NEW YORK

Model 7 Stereo Console • IM distortion @ 10V eq. pk. RMS, within 0.15%, 0.1% typical • Hum and noise, 80 db below 10 mv phono input • Sensitivity, 400 microvolts (0.4 millivolts) for 1 volt output • Equalizer and tone curves matched to better than 0.5 db • Beautiful precision construction • Price \$264 (Cabinet extra)

Model 8B Stereo Amplifier • 35 watts per channel (70 watts peak) • Harmonic distortion, less than 0.1% in most of range, less than 0.5% at 20 cps and 20 kc • Hum and noise, better than 90 db below 35 watts • Exceptional stability assures superb clarity with all types of loudspeakers • Price \$264.

Model 9 Amplifier—70 watt basic amplifier • Response of 70W, ± 0.1 db, 20 cps to 20 kc • Harmonic distortion, less than 0.1% in most of range, 0.3% at 20 cps and 20 kc. • Hum & noise, better than -90 db • Completely stable for smooth response • Built-in metered tests and adjustments • Price \$384 each.
(higher in West)





*Heretofore unpublished, this 1940 photograph of Bartók was taken during his first weeks in America. It is presented here on a montage of manuscript sheets from the score of the Viola Concerto, the final legacy in the composer's "full trunk."
(Photo courtesy Peter Bartók)*

BARTOK'S FULL TRUNK

SOME CORRECTIVE FOOTNOTES TO THE COMPOSER'S
FIVE AMERICAN YEARS

By EDWARD JABLONSKI

BELA BARTOK, in voluntary exile from Nazi-dominated Hungary, lived out the final years of his life virtually unrecognized as one of the masters of twentieth-century music. In appalling poverty he was permitted to starve to death in a callous America. Crushed by indifference or hostility to his work, this frail, gentle genius was never to know of the widespread acceptance of his work, an acceptance that came only after his death.

Or so go the legends.

However, as glimpsed in Bartók's own letters, meticulously written in English and quoted here for the first time, his five American years tend to lose the quality of tabloid melodrama, and the composer

BARTOK

emerges as much less forbiddingly austere than he is generally painted. These letters, as well as corroborating details from his son Peter and a few close friends, disclose a warmhearted human being courageously at work, frequently under petty harassment, it is true, and concerned with his failing health, but in the main undismayed and often humorous.

When Bartók died on September 26, 1945, his last words were, "I only regret having to leave with a full trunk," referring to those works he looked forward to completing. One of them, the Piano Concerto No. 3, was intended by the composer as a surprise birthday gift for his wife and one-time piano student, Ditta Pásztory. What was to have been a gift in October became in September a legacy.

A trunk was actually discovered in Bartók's apartment after his death, but it disclosed no new or unknown Bartók compositions. Instead it contained such commonplace items as letters (on the reverse of which Bartók, with characteristic frugality, had drafted his replies), cancelled checks, and concert programs.

IN October of 1940 Bartók left Hungary in protest against its being dominated by the Nazis. When the Bartóks arrived in New York, they had with them only the clothes they wore and, in a briefcase the composer carried, the manuscript of his *Sonata for Two Pianos and Percussion*. In the hectic, disorganized, and uncomfortable trip across Italy, Switzerland, France, and Spain, all the Bartóks' luggage—six massive trunks—went astray. Besides their clothing and other personal belongings, the trunks contained practically all of Bartók's manuscripts—indisputably one of the treasures of modern music—and his monumental research on folk song.

Despite his concern for his manuscripts, his lack of wardrobe, and the effects of the grueling weeks of travel, the fifty-nine-year-old and fragile-looking Bartók immediately threw himself into rehearsals for the American premiere of the *Sonata for Two Pianos and Percussion*. This was followed by a CBS broadcast, after which the Bartóks embarked upon a cross-country tour of duo-piano performances. All of this activity was compressed within the five months between their arrival and March, 1941, when Bartók took up his post at Columbia University as Visiting Associate in Music.

The Bartóks settled in Forest Hills, a not-too-long, though complex, subway ride from Columbia. And there were other complexities, portents of the kind of trivial harassments that were to continue to plague

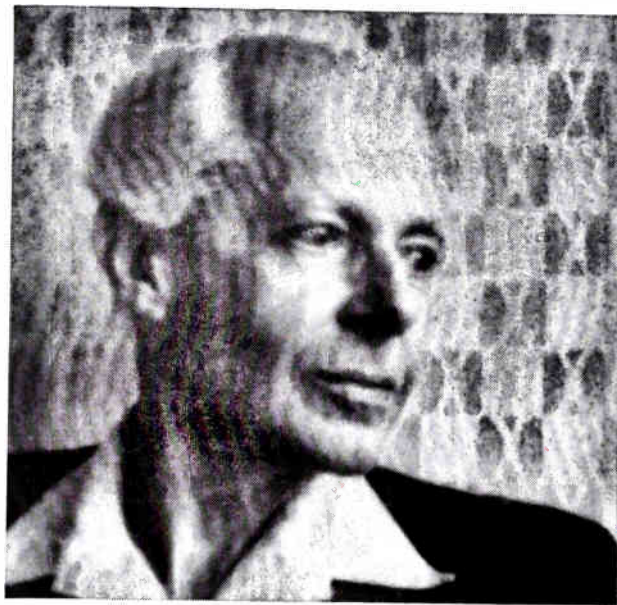

Bartók in 1940, shortly after his arrival in the United States.

Bartók. "The tenant living in the apartment beneath us," Bartók wrote the landlord, "is continuously shouting at us or rings the bell and each time protests that we are making too much noise at night . . ."

Too, there was still the problem of the drifting trunks, last seen in Portugal six months before. Angry letters and cables crossed the Atlantic. Bartók finally lost patience completely and baldly suggested that the shipping people did not know what they were doing. The relationship was not improved when the trunks arrived with a curt reminder: "You will note that there is a credit balance due this office of 38¢, for which we shall be pleased to receive payment."

In his early months at Columbia University, Bartók found considerable satisfaction in his work. He became so absorbed in his study of Serbo-Croatian folk songs that, although he revised and reorchestrated a couple of early works, he did little original composition.

Columbia's academic \$3,000 a year was the major source of Bartók's income. But while the bulk of Bartók's royalties was tied up in a Europe at war, there were also American royalties, plus earnings (small) from concert and lecture appearances, plus royalties from recordings. At no time during Bartók's American years did his income amount to less than \$4,000 a year. Though this was not commensurate with Bartók's stature, it answered for his simple needs. Contrary to the romantically dark legend—one still perpetuated even by respected musical reference works—Bartók did not starve to death in America. Bartók died of leukemia, not malnutrition.

Nor was Bartók the composer ignored by the musical profession—a charge that has often been repeated. His music was performed in America (though not as frequently as it deserved), and, in fact, his celebrity was at times a vexing problem. Besides the usual letters asking for favors and autographs, there seemed to be

a steady stream of musicians parading through Bartók's apartment, often as not with a photographer in tow to preserve the moment and to insure the visitor immortality by proximity. Such intrusions were a drain upon Bartók's time, patience, and energy; though he did not know it, he was already fatally ill. Finally, a system was devised to limit such trespassing.

Whenever an uninvited guest arrived, Bartók informed him that another caller, *with* an appointment, was expected momentarily. In the meantime, his son Peter would have left via the back door, and soon he would buzz from the lobby. "Ah," Bartók would exclaim, "there he is now!" Dashing to the door, he would usher Peter into another room, just as expeditiously lead the uninvited guest to the door, and would then get back to work.

But Bartók was not unapproachable and forbidding. He was exceedingly shy, personally gentle though unyielding in any matter of principle, and completely dedicated to his work. Somewhat diffident in company, he could unbend in the presence of his few close friends. There was one, a lady, whom Bartók delighted to shock by singing, according to Peter, "naughty folk songs, such as are sung at weddings by the peasants, which are wonderful though, like most songs of that kind, unprintable, by American standards."

Even in his most serious works the supposedly austere Bartók enjoyed a joke. Peter came upon him one day, pad and pencil in hand, shaking his head and counting the repetitions of a single theme during a broadcast performance of the Shostakovich Seventh Symphony. Fascinated by this breach of musical economy, Bartók had begun a count that, despite his late start, already reached into the twenties. To Bartók, such infatuation with the sound of one's own theme was ludicrous, and when he came to write the *Concerto for Orchestra*, as a joke he took this overworked theme and transformed it into an impertinent variant of a well-known and rather cheap Viennese café ditty. This

With his wife Ditta, for whom he wrote the Piano Concerto No. 3.



occurs in the movement titled "Intermezzo interrotto," complete with guffaws in the brass and tittering in the woodwinds. Serge Koussevitzky, who had commissioned the work, never objected—as far as anyone knows—to this satirical dig at, in Bartók's words, "his idol Shostakovich."

THE monumental *Concerto for Orchestra* was the first of Bartók's American works. His stay at Columbia was over at the end of 1942. He began seeking positions with other universities, refusing all requests to teach composition (which he felt could not be taught), and finally decided upon a series of lectures at Harvard.

After a single talk the lecture series was cancelled because of illness. Bartók wrote to his publisher Ralph Hawkes on May 30, 1942: "My health is, I am sorry to say, in a rather bad state. Since the first day of April I have a temperature elevation . . . regularly every morning. Even after a costly 6 days' examination in a hospital, doctors are unable to find out the cause. I feel now as if being on a deserted island where no doctors are available!

"Some general remedies are recommended which every lay [man] knows: good food, rest, no worrying, change of climate, most of them which can not be done because of lack of money. All my reserves dwindled away and we are living now on my \$245 salary at Columbia U. This makes me rather low spirited and hampers my work.

"Therefore I really don't know if and when I will be able to do some composing work. Artistic creative work generally is the result of an outflow of strength, high spiritedness, joy of life, etc.—all of these conditions are sadly missing with me at present. Maybe it is a breakdown. Until 60 I could marvelously bear all annoyances and mishaps. But lately I often wondered how long I will be able to endure all these sad experiences I continually was exposed to."

There was, for example, a sequence of annoyances with the Musicians' Union, of which Bartók was a member. He finally decided to resign, whereupon he received the following letter: "Dear Sir and Bro: Your recent letter received and before we can comply with your request for a resignation it will be necessary that your dues for the current quarter, in the amount of \$4.00, be paid."

This was followed by: "I am sorry to inform you that the enclosed remittance in payment for your dues for the current quarter cannot be accepted at this time as you owe 25¢ additional for having failed to pay same during the first month of the quarter . . ." And finally: "I am at a loss to understand why you sent us a money order in the sum of 25¢."

Bartók's reaction was revealed to a friend. "I must tell you," he wrote, "that I left the Union of Musicians

BARTÓK

... and am very glad that I am no longer a member of that conglomeration of stupid blackmailers [he had erased the word "thieves"]... I feel ashamed of having been so long as two years a member of that society."

Much of this asperity can be attributed to his failing health. "On the whole," he reported to Hawkes, not without a touch of irony, "there is no perceptible change!

"Now about the doctors. End of March they made the statement that it is tuberculosis of the lungs, and were extremely glad to have found out this at last. Later, however, it appeared, for various reasons, that [the] disease can not be tuberculosis; so they shifted to other hypotheses. First, they supposed it might be a coccus infection in the lungs; after dropping this hypothesis, they turned to 'monolia,' and finally to 'Beck's sarcoid.' These two are very rare and very interesting (not to me!) ailments."

WEAK and frequently confined to bed with a fluctuating temperature, Bartók noted that he "could not do any regular job as long as this situation lasts." It was at this point that the American Society of Composers, Authors and Publishers, of which he was not a member, came to Bartók's assistance.

Bartók did not, as the legends go, live off ASCAP's charity. Thanks to ASCAP, however, he was able to spend the winter months in Asheville, N. C., and the summer months at Saranac Lake, N. Y. ASCAP also paid hospital bills. The tales about how such aid had to be tendered surreptitiously are apocryphal; Bartók was aware of the Society's help.

"My (dear) doctor," he wrote to a friend, "decided I must be careful after such a long period of illness and have to go South, in order to avoid the inclemencies of the Northern winter (all this, of course, at the expenses of the ASCAP)."

But Bartók would not accept charity. He was extremely proud, terribly proper, and passionately honest in all his conduct. He would not receive money he did not earn (he probably rationalized the ASCAP assistance as a form of advance on royalties, for he was a member of a British performance society that was associated with ASCAP). So some friends, among them Ernő Balogh (who had brought ASCAP into the picture), Joseph Szigeti, Fritz Reiner, and Victor Bator (executor of the Bartók estate and founder of the magnificent Bartók Archives), approached orchestras and instrumentalists to obtain commissions for Bartók.

At first Bartók tended to discourage commissions, feeling that the state of his health might prevent him

from keeping his end of the bargain, and when Serge Koussevitzky proposed his writing a work for the Boston Symphony, the composer turned him down. Only after long discussions was Bartók convinced that he should attempt the commission, and he informed the conductor that he accepted "the conditions [an advance of \$500, with another \$500 on delivery of the manuscript, and the dedication to the memory of Natalie Koussevitzky] mentioned in your letter... of May 4, 1943."

The resulting work, composed from August to October, 1943, was the *Concerto for Orchestra*. With four movements completed and the fifth (and last) half done, Bartók was in good humor and health when he wrote on September 28, 1943: "Some good news. Since 30 days the high fever period disappeared and today I had my first day since Apr. 9, 1942 without the slightest abnormal temperature." He also announced happily that he had "succeeded to write the work for the Kussevitzky [sic] Foundation against all expectations. It is a rather big work of 35' duration..."

ASCAP arranged for Bartók to spend the winter in Asheville, where he worked on yet another commissioned piece, this one for Yehudi Menuhin. The climate and the work agreed with Bartók. "Since I am here I gained 5 pounds. In March 1943 I had 87(!), now I have 105. I am getting as fat as a 'fass' [barrel?]"

He was troubled by the disposition of several bulky cartons of his folk-song materials. Because of the obtuseness of the storage people, Bartók asked Boosey and Hawkes to store the boxes for him. Even they succeeded in rubbing him the wrong way, thus inspiring a typical Bartókian comment: "I should like to have a statement from B & H (in good English) what I wrote you on this subject but without those whereases and officialese junk."

That year, 1944, was brightened by the first performances, in November and December, of the *Sonata for Solo Violin* and the *Concerto for Orchestra*, both

In a 1942 photo. Bartók with an American pupil. Ann Sheaney.



G. D. HACKETT



A 1942 snapshot of the Bartók family: the composer, his wife, and their son Peter, newly a member of the U.S. Navy.

of which Bartók attended to great acclaim. Also, by mid-December Boosey and Hawkes commissioned a string quartet (it would have been the seventh) and agreed to guarantee Bartók a yearly advance of \$1,400 for the next three years. Thus was Bartók's future made a bit more secure, if not luxurious. As Victor Bator recently stated, "He often had, in the last five years of his life in the U.S., worries, feelings of dissatisfaction, animosity against unappreciative people, but his life was far from being 'tormented' . . . I remember a great, in fact an overwhelming number of occasions . . . when he was happy, elated and pleased with his life"

BUT the unusual access of good health did not last. By the summer of 1945 it was obvious that he was very seriously ill. Thoughtfully Bartók kept William Primrose, who had commissioned a viola concerto, informed of its progress. "I am very glad to be able to tell you," he wrote on September 8 [less than twenty days before his death], "that your *Viola Concerto* is ready in draft, so that only the score has to be written, which means a purely mechanical work, so to speak. . . . Most probably some passages will prove to be uncomfortable or unplayable. These we will discuss, according to your observations." He also told Primrose that "a sequence of various illnesses visited us: not only I was ill several times but also Mrs. Bartók." As for the *Viola Concerto*, "If nothing happens I can be through in 5 or 6 weeks. . . ."

At practically the same moment another creative project was under way. Bartók's charming young pupil, the Canadian pianist Agnes Butcher, was knitting him a pair of socks. When she wrote to ask Bartók what

size he wore, his reply was characteristically playful and affectionate. "Oh, my precious socks! I had to locate and use my ruler to find out they were ten (10). But why bother about them? You really are not indebted to me for having listened to your playing when I had nice cute pneumonia (yes, pneumonia, that is what the doctor said weeks afterwards, only I don't believe him)."

High temperature and pain were signs of the terminal stage of Bartók's illness. Even so, he had to be practically forced to enter the hospital. Miss Butcher arrived in New York to learn that Bartók was dead. The "precious socks" were destined to end up in the trunk. William Primrose's *Viola Concerto*, too, might have gone into the trunk, except that Victor Bator placed the fifteen unnumbered manuscript pages in the hands of Bartók's friend and pupil, Tibor Serly. It was Serly who dedicatedly reconstructed this poetic work that might otherwise have been lost.

While waiting for the ambulance to take him to the hospital, Bartók, protesting that he had "something important yet to do," called in his son. His wife's surprise birthday gift was much on his mind. He gave Peter the final pages of the *Piano Concerto No. 3* and instructed him to draw in seventeen bar lines beyond the point at which he was now forced to stop. Bartók then scrawled in the Hungarian word *vége* (the end) after the last bar line. This word is the last he wrote.

*Edward Jablonski, who has written on a variety of musical subjects, is perhaps best known for his book *The Gershwin Years* and a later volume on *Harold Arlen*. Happy with the Blues. He is currently engaged on a history of World War II's B-17 bombers.*



INSTALLATION OF THE MONTH

A DREAM SYSTEM COME TRUE

THE sumptuous stereo system shown on this month's cover and on these two pages began to take shape in the mind of Albert Zajicek three years ago. Mr. Zajicek, a Chicago business executive, wanted to install a stereo system that would permit him complete flexibility in creating evening-long taped musical programs.

In addition to a record changer, Mr. Zajicek wanted two manual record players, so that he could conveniently copy onto tape various tracks of different records. Also, he wanted facilities for dubbing tapes from one recorder to another. All the equipment, of course, was to be stereophonic, and stereo extension speakers were planned for each room in the house.

After deciding that the project he had envisioned would require a professional's attention, Mr. Zajicek called in John Gill, of Gill Custom House, which is a Chicago firm specializing in audio installations. Mr. Gill then set out to find ways of carrying out Mr.

Zajicek's design. About six months and ten thousand dollars later, Mr. Zajicek's dream system finally came into being.

The equipment selected includes separate two-track Crown tape recorders for recording and playback, two Thorens turntables equipped with Grado tone arms and cartridges, a Garrard record changer with Grado cartridge, a McIntosh tuner and pre-amplifier, a Harman-Kardon Citation power amplifier, and Koss headphones. Each of the two main stereo speaker systems is made up of four Stentorian woofers, two mid-ranges, and an Ionovac tweeter. The master control panel, inclined for convenience, features a custom-built six-channel stereo mixer, switching facilities for the extension speakers, and two permanently installed Shure microphones.

In operation for over two years, the system has functioned almost perfectly, the only required adjustment so far being the replacement of two tubes.

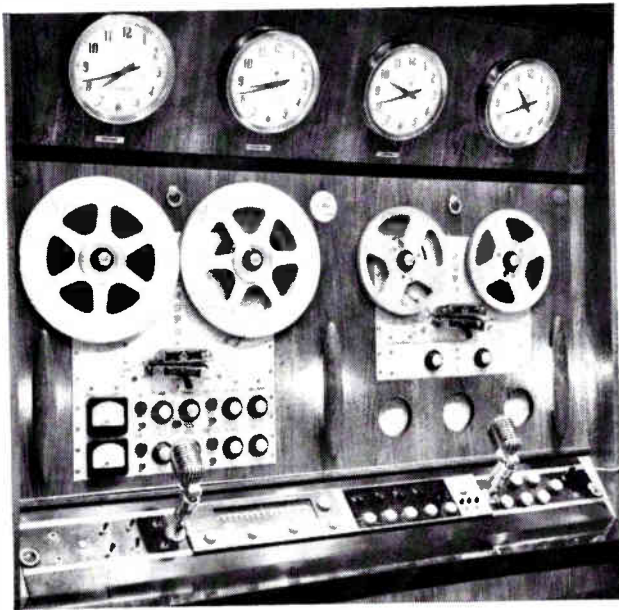

Left, all of the units are quickly accessible for adjustment or repair. The tape-recorder panel is hinged at the bottom and is simply pulled forward at the top for access, and the control-panel equipment slides out as a unit. The four studio-type clocks, above, indicate the time in the U.S.'s four regional time zones.

Below, installation of two manual turntables and two tape recorders permits the utmost flexibility when dubbing stereo programs onto tape. A record changer (in a pull-out drawer) is also included. Note the use of indirect lighting to enhance the system's appearance.

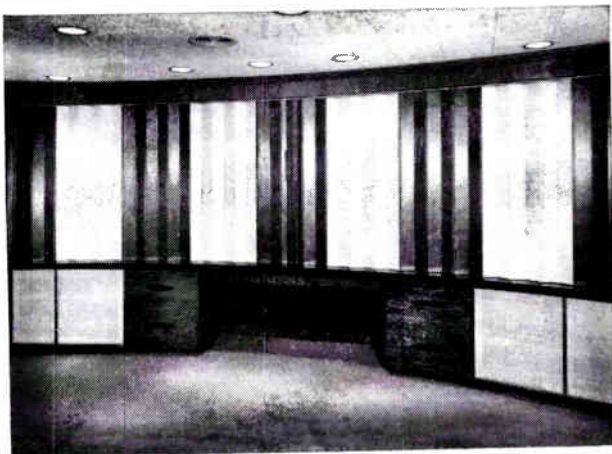
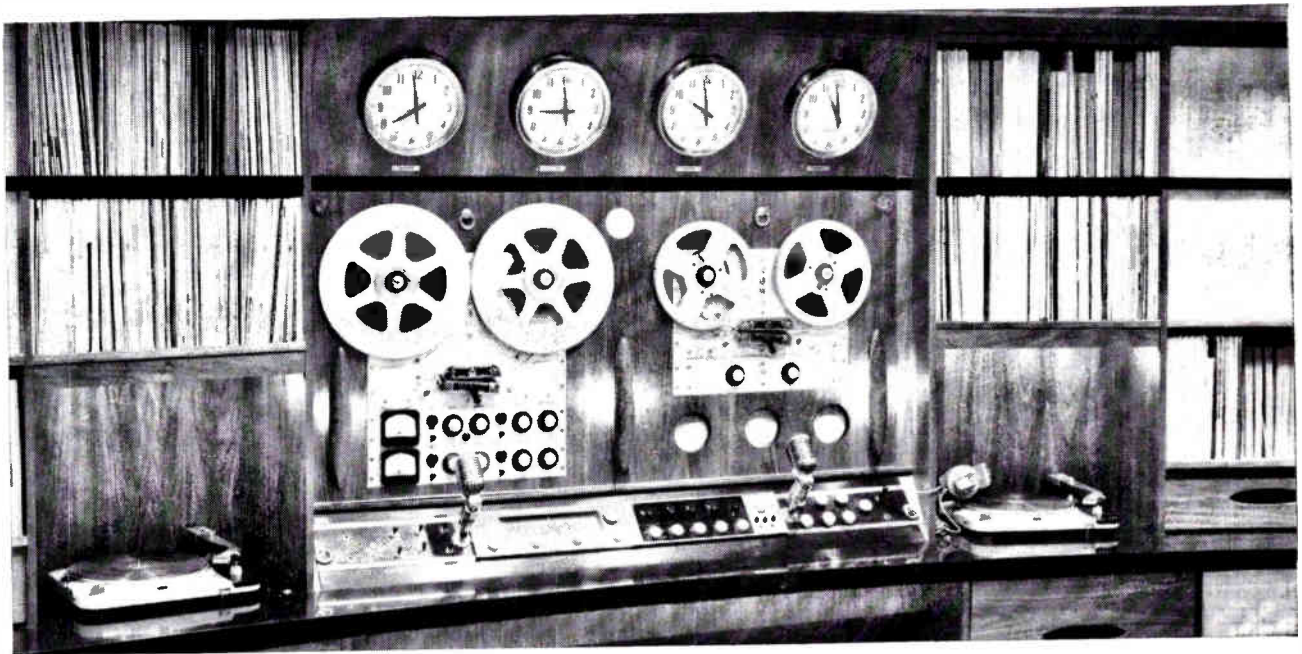

Left, attractive alternating walnut and blonde wood panels close off the system from view when it is not in use. The lower grille-cloth panels, shown here, conceal the woofers for each channel; the tweeter and mid-range units are behind the upper grille-cloth panels, shown in the photo on the opposite page.

ILLUSTRATION BY MURRAY TINKELMAN

By GENE LEES
Guitarra!

*Still going strong
after three thousand years of service,
the guitar remains
a favorite instrument
of folk, classical, and jazz musicians*

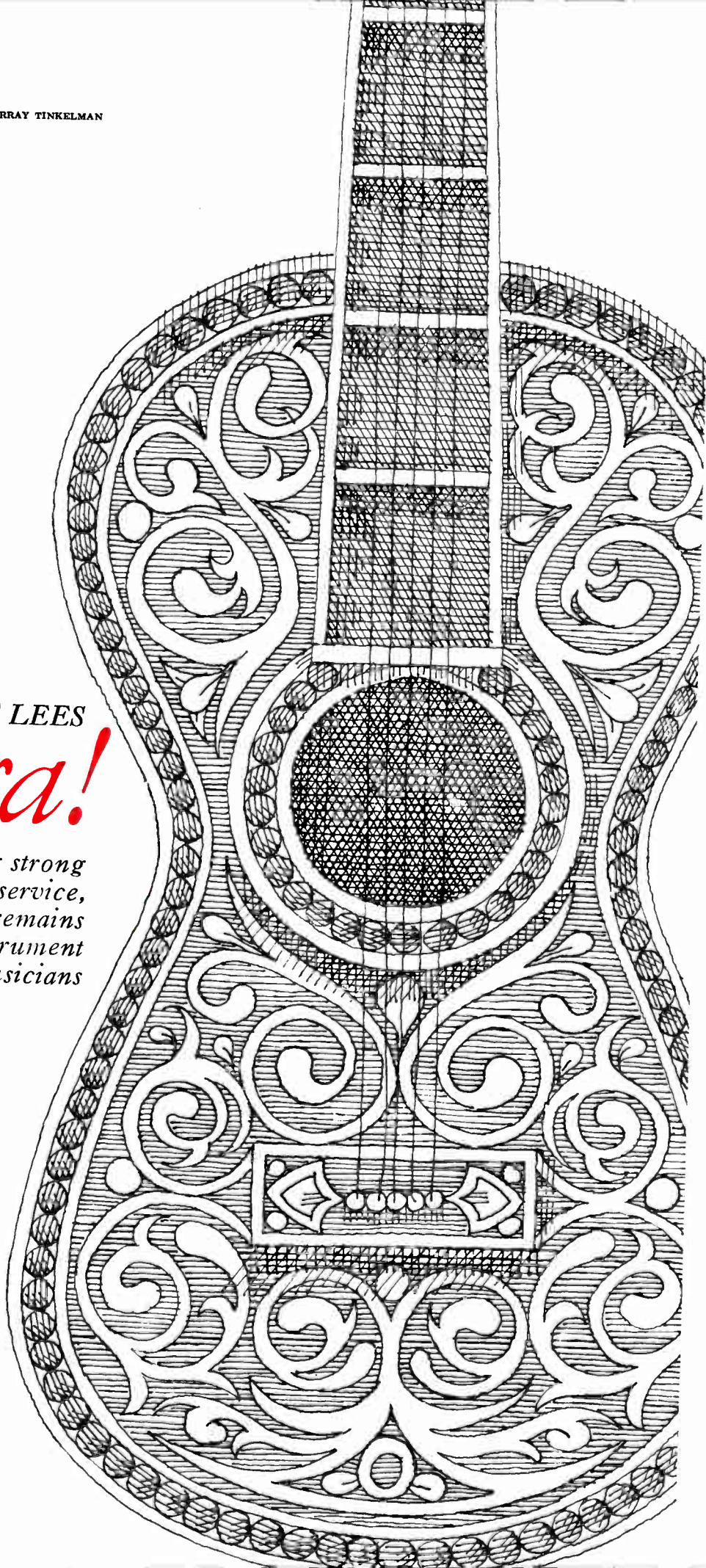

NO ONE knows its origin. Segovia has claimed it dates from the building of the pyramids and that King David and Homer both played it. Other authorities say it was developed in Provence about 1,000 A. D. It seems generally agreed that the sixth string was added to it in Germany.

But the guitar, whatever its source, has always had a split personality, and its ambiguity persists into our day. It is an ingenuous instrument of the people, used to plunk out chords as accompaniment to simple songs on Kentucky doorsteps; it is also, in the hands of a Segovia or a Julian Bream, one of the most exquisitely sensitive instruments ever known, a versatile servant of the broadest range of art music.

There are three totally different ways to play it. Three? There are a dozen. All, however, are the result of variations on, or combinations of, three conceptions of the instrument:

1. It can be plucked with the fingers and thumb of the right hand as a polyphonic instrument.
2. It can be strummed to produce chords and rhythm as accompaniment to the voice or as accompaniment to other instruments.
3. It can be played with a plectrum to produce melodic lines of single notes.

Admirers of the polyphonic approach are contemptuous of the last method, believing it to be a latter-day corruption of true guitar technique. Yet the polyphonic approach has been perfected only in modern times—indeed, within living memory—and the plectrum has been used at least since the fifteenth century. What is more, as played by a master jazz guitarist such as Jim Raney, Jim Hall, or Tal Farlow, the picked guitar—further “corrupted” by electronic amplification—is an instrument of surprising beauty.

For all the length of its history, the guitar is only now getting full recognition as an art instrument. And yet Paganini once gave up the violin for it; Berlioz was an accomplished guitarist (it was the only instrument he played with professional proficiency and he lamented that it was so misunderstood); Schubert did much of his composing on it because he was too poor to buy a piano and because he could play it in bed, where he could keep warm; and Beethoven described it as a “miniature orchestra.”

Today, sales of the instrument are booming. In 1961, 400,000 guitars (compared with 196,000 pianos) were sold in this country, and England is not lagging behind in enthusiasm. There are guitar societies all over the world, with Europe boasting the largest number in proportion to population: some cities there have as many as three societies. In the Latin countries, the guitar has long been a part of everyday life. Literally every Brazilian I encountered during a tour of Brazil last year played the guitar at least a little.

But a wide guitar culture is unprecedented in the United States, as it is in England. The instrument seems on its way to replacing the living-room piano as the leading instrument of popular musical expression. Two reasons for this phenomenon suggest themselves. Rock-and-roll, folk, and country-and-western music all make extensive use of the guitar, and the last decade has seen these three popular music forms in successive ascendencies. They have drawn a tremendous amount of attention to the instrument. Also, the guitar is the easiest of all musical instruments to get started on. There is no instrument on which it is so easy to play a *little*. And since rock-and-roll, folk, and country-and-western music do not require much technique—anyone can learn the basic two or three chord positions in an afternoon—the instrument permits easy participation. Then each chord position can be moved chromatically up the instrument, fret by fret, so that learning four chords means that the player will shortly know about forty.

Although it is an easy instrument to get started on, the guitar is one of the most difficult of all instruments



to play really well. Though elementary chords can be fingered in such a way that all six strings are strummed, the extended or altered chords—ninths, elevenths, thirteenth, chords containing augmented or flatted fifths, and so on—usually do not involve all six strings. Thus, as soon as the neophyte encounters music of any complexity, including even better-quality popular music, he is faced with the necessity of acquiring a modicum of genuine technique. He will either have to learn to play with the fingers of his right hand (like a classical guitarist) instead of strumming with the thumb or a pick, or he will have to learn to touch delicately (but not press) the string he wants deadened with a finger of the left hand (the way jazz guitarists do). Many a youngster who begins by strumming simple music is thus trapped into learning more.

In an article published in 1930, Segovia claimed that Socrates, King David, and Homer were all “guitar” players, and disagreed with authorities who equated the ancient Greek *kithara* with the lyre. Segovia saw the *kithara* as the ancestor of the guitar, as its name would suggest. He also argued that the lute is not fundamentally an instrument differing very greatly from the guitar. *(Continued overleaf)*

Guitarra!



The problem of pinning down the guitar's ancestry, of course, lies in what you consider to be the instrument's distinctive attributes. Most authorities are not inclined to claim as long and illustrious a lineage for the guitar as Segovia does. But it is generally agreed that the instrument is Near Eastern in origin. Persian gypsies, homecoming Crusaders, and the Moorish invasion of Spain all contributed to its rising influence. The Moors had a three-string mandolin-like instrument called the rebec, which was held under the chin and played with a bow. By the thirteenth century, the Spanish church was tut-tutting about the unseemly uses into which the instrument had fallen, and forbade Catholics to play or even to listen to it. So the common folk, ever ingenious in circumventing moral proscriptions, reasoned that since the rebec was a bowed instrument, a plucked rebec was not a rebec. Henceforth, that is how they played it.

An important mutation of the rebec was the vihuela, which was played three ways—with a bow, with the hand, and with a plectrum. Of the three, the *vihuela da mano* was the most popular, and persisted well into the Renaissance. But the vihuela was an instrument of polite society. The common people meanwhile were playing an instrument with four double strings, the pairs being tuned together, as in the twelve-string guitar used by American folk singers. This instrument

Believed by many authorities to be but another form of the guitar, the lute was, in the sixteenth century, the commonest—and most highly regarded—instrument in western Europe.



was called the *guitarra*. Soon a fifth pair of strings was added, and the instrument began to be called the Spanish guitar.

It is generally agreed that the next important development in the guitar's history took place in Germany. The double strings, which are particularly nasty to finger, were disappearing, leaving an instrument of five tuned strings. To them, a craftsman named Jacob Otto added a sixth about 1788. Thus, if you define the guitar as an instrument with six strings, it is German in origin.

In England, in the middle of the eighteenth century, an instrument called the English guitar, which had steel strings and was built like a lute but with a flat back, became popular in polite circles, particularly among the ladies. One Jacob Kirkman was quite dismayed by this development, which was understandable, since he manufactured harpsichords. Confident that his instrument would soon be restored to its rightful position in society, Kirkman ran around buying up harpsichords for resale. But the English guitar only grew more popular with the classes. When Kirkman was almost broke, he had a stroke of genius. He bought a batch of cheap guitars and gave them to street singers, shopgirls, and even more disreputable types, along with easy lessons in how to accompany songs with a few chords. The guitar soon became popular with maids of the masses, and ladies of the classes returned with a sniff to their harpsichords.

The true guitar did not turn up in England until a half-century later. In 1809, José Ferdinand Sor arrived in London, a refugee from the Napoleonic invasion of Spain. His virtuosity startled the English, and he stayed in the city for some years, teaching, composing, and performing. However, despite Sor's success—he appeared as a soloist at a London Philharmonic concert in 1817—it was not until 1951, when the eighteen-year-old Julian Bream startled the critics

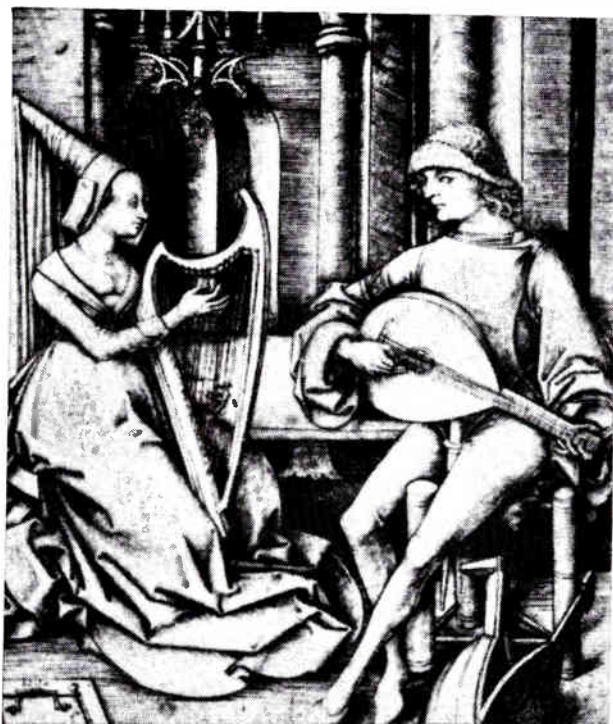



The entrance of the guitar players in a ballet, Grand Bal de la Douairière de Billebahaut, performed in 1629.

(Illustrations courtesy New York Public Library)

as Sor once had done, that London heard a recital by a British guitarist. Sor was responsible for several improvements in the guitar's construction, and is one of the important composers of guitar music.

Shortly after Sor's stay in London, America's thriving guitar industry got a major break. One of the finest European guitar-makers around 1830 was Christian Friedrich Martin of Saxony. Originally a furniture-maker, Martin had studied with a guitar-maker and became a fine craftsman. In the equivalent of a modern labor-union jurisdictional dispute, the instrument-makers' guild took him to court, claiming that if a mere furniture-maker were allowed to make guitars, the industry would soon be driven out of Germany. The guildsmen accomplished what they were trying to prevent: Martin, fed up with the whole silly business, took his talents to New York in 1833. There he made guitars that today are prized and still played. In 1839, Martin moved to Nazareth, Pennsylvania, and his direct descendants now produce what is considered to be the best American-made classical guitar.

IN the late nineteenth century, a Spanish professor of guitar simultaneously created a large part of the classical guitar repertoire and laid the foundations of the method used ever since for classical playing. Francisco Tárrega was born in Villareal in 1854. He graduated from the Madrid Conservatory with a first prize in composition and harmony, and then became a professor of guitar there. Other composers had *thought* of adapting for guitar the works of the great masters. Tárrega *did* it, and at the same time he introduced the technical innovations that made such transcriptions feasible. When you see a guitarist sitting with one foot on a tiny stool, you are seeing an innovation of

Tárrega's. So too with the present positioning of the hands, the placing of the fingers, and the manner of plucking the strings. Tárrega's advances come to full flower in the technique of Andrés Segovia.

Segovia seems to have been largely self-taught, but with a foundation built on observing other guitarists. He gave his first concert in Granada in 1909 (the year Tárrega died) at the age of thirteen and has been concertizing ever since. Like Tárrega, Segovia added to the repertoire while building his method. His transcriptions of masterworks, and his editing of old works for the guitar, constitute (with Tárrega's contributions) a substantial part of the guitar literature. The growing respect for the instrument, in the meantime, has elicited compositions from twentieth-century composers, including Ibert, Villa-Lobos, Ponce, Torroba, Castelnuovo-Tedesco, Falla, and Tansman.

Segovia was virtually alone in his field for many years. Guitar admirers still consider him in a class by himself, a pure and stately eminence. Segovia is not only the greatest living guitarist; he is also, in a very real sense, the creator of the guitar's audience. When Segovia first played in London, a critic, reflecting the widespread prejudice against the guitar, wrote:

In the fullness of our ignorance we went, expecting we did not know what, but hoping, since Señor Segovia's reputation had preceded him and the name of J. S. Bach appeared on his program, that we would satisfy our curiosity about an instrument that has romantic associations without being outraged musically. We did not go to scoff, but we certainly remained to hear the last possible note; for it was the most delightful surprise of the season.

(Continued overleaf)

Guitarra!



So great has grown the audience for concert guitar that guitar aficionados are beginning to be irked. Not that they are opposed to the appreciation of the instrument: their argument for its legitimacy has been too recently won. But wide popularity means bigger audiences, bigger audiences mean bigger concert halls, and bigger concert halls do not provide the best listening environment for the guitar, which is fundamentally an intimate instrument.

Segovia is noted for (among other things) being able to produce an incredible amount of volume. "Yet even in his case," one admirer laments, "I would draw the limit at something smaller than Chicago's Orchestra Hall, which seats 2,500. At the rear of the hall, downstairs, trying to hear a Segovia concert can be frustrating indeed. An auditorium the size of New York's Town Hall is the optimum. In the good old days, before Segovia was so famous, one used to hear him in little halls and sit practically in his lap, watching his technique."

Segovia has been joined by a whole new generation of guitarists. Leading the list are Julian Bream, just turned thirty, and John Williams, who is only nineteen. Both are Britishers, but many nations are contributing to the ranks of fine guitarists, and the never completely accurate identification of the guitar as a Spanish instrument will undoubtedly be diluted in coming years.

Although he is not, strictly speaking, a classical guitarist, Andalusian flamenco player Juan Serrano, twenty-seven, is causing a considerable stir of late. With a technique of electrifying precision and a bold assertiveness of style, he has curled the hair of quite a few New Yorkers in his appearances at a folk-music den called the Bitter End, and has recorded two outstanding discs for Elektra Records.

Among the strictly classical players, Rey de la Torre, Manuel Lopez-Ramos, Narcisco Yepes, Manuel Goyoly, Karl Scheit, Laurindo Almeida, Richard Pick, and

Gene Lees, free-lance writer and fervent amateur guitarist, detailed "The Bossa Nova Bust" for us in last month's issue.

Charles Byrd are well worth the listener's time and attention. Pick and Byrd are Americans. Byrd and Almeida are also jazzmen, and along with a Washington, D. C., guitarist named Bill Harris, they seem to be the only ones able to function successfully on both jazz and classical guitar. Byrd started as a jazz guitarist, then studied with Segovia. Today, oddly enough, musicians consider him a better classical guitarist than a jazzman: in the latter role he is thought to have serious shortcomings.

In recent years, jazzmen have been paying more and more attention not only to classical composition techniques but to playing techniques as well. For example, all the better jazz bassists now use "legitimate" fingerings, and most of them study with symphony players, some of whom, interestingly, turn around and study with jazzmen. Thus, two important guitar traditions—jazz and classical—may be drawing closer together, even as the two musics draw closer in the experiments of Lukas Foss in "classical" improvisation, and in the experiments of jazzmen with larger and more formal musical structures.

It is clear that the classical guitar's struggle for acceptance has been won. Given the popularity of the guitar as a song-accompaniment instrument among America's youth, it is likely that the United States will produce more and better concert guitarists in the future. In the meantime, the instrument's present grass-roots popularity assures an improving climate of critical opinion for performers who master this ambiguous, often misunderstood, but always superbly sensitive instrument.

A GUITAR SAMPLER

Julian Bream: Giuliani, *Concerto for Guitar and Strings*; Arnold, *Concerto for Guitar*. RCA VICTOR LSC/LM 2487.

Bach Program (Chaconne; Preludium; other transcriptions). WESTMINSTER 18428.

Charles Byrd: *Latin Impressions*. RIVERSIDE 9427, 427.

Carlos Montoya: *Flamenco Antiquo*. RCA VICTOR LSP/LPM 2653.

Karl Scheit: *Masterpieces of the Classical Guitar* (including Bach transcriptions by Scheit). VANGUARD BG 625.

Haydn: *Quartet for Guitar, Violin, Viola, Cello*; Boccherini: *Quintet, in D, for Guitar and Strings*. VANGUARD 1044.

Andrés Segovia: *Music for Guitar* (Moussorgsky, Rousset, etc.). DECCA 710046, 10046.

Granada (music of Albéniz, Granados, Sor, etc.). DECCA 710063, 10063.

Juan Serrano: *Olé, La Mano!* (variations on nine flamenco forms). ELEKTRA EKS 7227, EKL 227.

Rey de la Torre: *Recital* (including four preludes by Tárrega). EPIC BC 1151, LC 3815.

Sor: *Sonata for Guitar; Variations on a Theme by Mozart*. EPIC LC 3418.

THE SPOKEN-WORD field embraces many worlds—from poetry, documentaries, drama, science, and religion to talking textbooks and “novelties,” ranging from how to catch a Communist to how to warm up to your wife. One could listen for a thousand hours and still not hear the entire catalog of spoken-word records. And unfortunately, the great majority of them are only of passing interest—if even that. How, then, does the collector go about culling this superabundance for a permanent library?

Obviously, the yardstick in purchasing any phonograph record should be the enduring quality of its contents and the possibility of enjoying it through

many replayings. To measure up, poetry should be read by a fine actor, or by the poet himself. Plays should be enacted by great casts, under directors who understand how to re-create a script for the ear alone. Documentaries should either capture the really great moments of history or the smaller moments that illuminate contemporary life.

The spoken-word records selected here, in my opinion, meet such criteria. These are all records I have heard, liked enormously, and want to keep and hear again. Admittedly, they also inevitably reflect my own tastes, but I sincerely feel that all of these records are well worth including in any record library.

A BASIC LIBRARY OF THE SPOKEN WORD

By PAUL KRESH

PLAYS

EDWARD ALBEE: *Who's Afraid of Virginia Woolf?* Uta Hagen, Arthur Hill, George Grizzard, and Melinda Dillon. Alan Schneider, director. COLUMBIA DOS 687 four 12-inch discs \$17, DOL 287 \$15.

This war of words, wherein two fierce but sterile college faculty couples fire round after deadly round of verbal ammunition, has been committed to records with all the vitality and virtuosity the original cast brought to it on Broadway. Alan Schneider keeps his quartet moving about, re-creating for the ear alone his canny stage direction. The performance is most effective in stereo—ice tinkles in glasses, liquor flows, and the insults fly.

ARTHUR MILLER: *Death of a Salesman.* Thomas Mitchell, Mildred Dunnock, Arthur Kennedy, and Cameron Mitchell. Elia Kazan, director. DECCA DX 102 two 12-inch discs \$9.98.

The Broadway-cast recording of *Death of a Salesman* immortalizes a theater landmark, a monumental study of a little man's heroism and tragedy. The play is great because it transcends mere cleverness and tech-

nical resourcefulness—displayed by so many contemporary playwrights—to reach, as O'Neill did, to the very quick of existence, with shattering and haunting power. The recording captures a performance by a remarkable cast in the hands of a brilliant director.

SHAKESPEARE: *Macbeth.* Anthony Quayle, Gwen Ffrangcon-Davies, and Stanley Holloway. Howard Sackler, director. CAEDMON SHAKESPEARE RECORDING SOCIETY S 231, 231 two 12-inch discs stereo or mono \$11.90.

The pulsating excitement, color, and range of *Macbeth* are meat and drink to Howard Sackler, one of the most sensitive and imaginative directors around today. And the members of the cast, too, outdo themselves. Anthony Quayle makes of Macbeth a demon-possessed man watching with horror the wanton work of his own hands. Miss Ffrangcon-Davies' Lady Macbeth is a woman of many aspects and passions, and Stanley Holloway's bumptious porter is brimming with vitality. The recording moves along in a sweeping procession of words, sound effects, and music, and is in sum the finest recording of a Shakespearean play I have ever heard. (Continued overleaf)

LIBRARY OF SPOKEN WORD

SHAKESPEARE: *Richard II*. John Gielgud, others. Peter Wood, director. CAEDMON SHAKESPEARE RECORDING SOCIETY S 216, 216 three 12-inch discs stereo or mono \$17.85.

Not only is this the most ingratiating of Shakespeare's historical plays to the ear, with its glowing poetic passages and set speeches, but its title role is one of the most fascinating in all theater. Utilizing his consummate vocal skill, Gielgud moves Richard gradually, and with hypnotizing effectiveness, into a dominating position in the action. The supporting cast is superlative in every way.

SHAKESPEARE: *The Tempest*. Hilton Edwards, Michael MacLiammoir, and Daphne Carroll. Dublin Gate Theatre production. SPOKEN WORD A 10 three 12-inch discs \$17.94.

No stage designer could compete with the words of Shakespeare as he paints the enchantment and sorcery of this fantasy set in the "still-vexed Bermoothes." And while the Marlowe Society's London recording of this masterful play seems to deprive it of all its magic, Spoken Word's version distills onto records a remarkable amount of its airy enchantment and profundity.

SHERIDAN: *The School for Scandal*. Ralph Richardson, John Gielgud, Geraldine McEwan, Gwen Ffrangcon-Davies, Meriel Forbes, Laurence Naismith, Malcolm Keen, Peter Barkworth, and Richard Easton. John Gielgud, director. COMMAND SD 13002 three 12-inch discs \$17.94, RS 13002 \$14.94.

This is the best recording of any play to date. It boasts a brilliant cast in dazzling form, re-creating a hilarious

John Gielgud: Brilliant in Shakespeare, Sheridan, and Wilde.



study of man's dissembling that has been amusing audiences since the 1770's. Gielgud keeps his forces moving at a headlong pace, yet neither the speeches nor the scenes sound rushed or skimmed. And each episode is framed beautifully by instrumental music appropriate to the period. Stereo has never been employed more effectively or more imaginatively, and the life-like clarity of the voices, as captured by Command's engineers, makes it possible to dispense with a text and to hear and enjoy every word without straining.

DYLAN THOMAS: *Under Milk Wood*. Richard Burton, Hugh Griffith, and the cast of the original British Broadcasting Corporation production. Douglas Cleverdon, director. SPOKEN ARTS 791/2 two 12-inch discs \$11.60.

This play in verse was originally commissioned for radio. As a consequence, its richly descriptive narration and episodic nature—not to mention the power of its words and imagery—are ideally suited to the phonograph. Though the author's sonorous voice makes the rather crude Caedmon transfer (TC 2005) from an amateur tape of intense interest, the polished BBC production on Spoken Arts is superior in all other respects, and so enjoys a slight edge.

OSCAR WILDE: *The Importance of Being Ernest*. John Gielgud, Dame Edith Evans, Pamela Brown, Celia Johnson, and others. ANGEL 3504 two 12-inch discs \$9.96.

The most delightful of all of Wilde's scintillating plays, probably the wittiest drawing-room comedy ever written, *The Importance of Being Ernest* sends paradoxes spinning into the air like fireworks. Only actors who make every phrase of this play (Wilde subtitled it "A

Michael Redgrave: Unforgettable Chekhovian characterizations.



SPOKEN ARTS

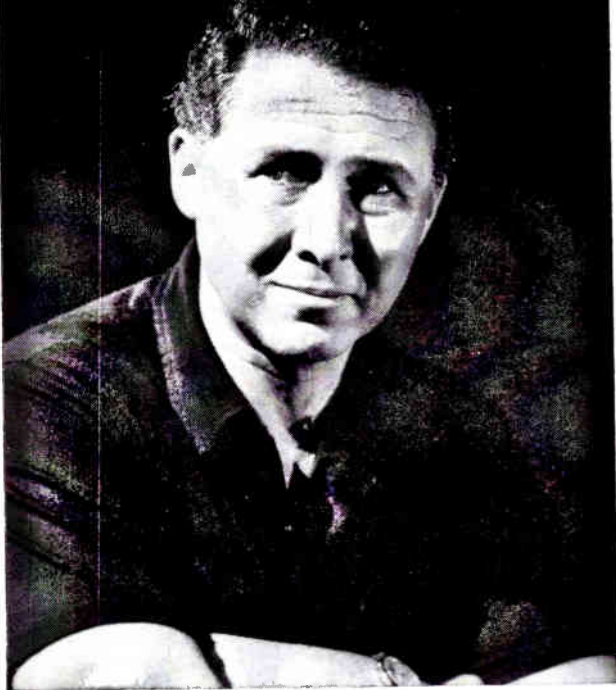

Anthony Quayle: *Demon-possessed in the title role of Macbeth.*

Trivial Comedy for Serious People”) sound as sonorous and grave as the author intended can really bring it to life; the brilliant group here makes the most of every opportunity.

POETRY

CAEDMON TREASURY OF MODERN POETS READING: Readings by Yeats, Eliot, Frost, MacLeish, Aiken, Auden, Moore, and others. CAEDMON TC 2006 two 12-inch discs \$11.90.

Here is a beautifully edited album of modern verse by the giants and geniuses of English poetry in our time. Not only are the selections of particular merit, but the poets themselves are uncommonly good at reading their works aloud.

EMILY DICKINSON: *Poetry and Letters.* Julie Harris (reader). CAEDMON TC 1119 \$5.95.

These seeming bonbons of verse that are in reality tiny charges of depth and meaning have proved too tricky for at least two readers who have attempted them: Nancy Wickwire, on Spoken Arts, and Samuel Charters, on Folkways. Julie Harris, however, performs both the Dickinson verses and letters with singular fervor and ingenuity.

T. S. ELIOT: *Reading Poems and Choruses.* *Ash Wednesday, The Love Song of J. Alfred Prufrock*, others. CAEDMON TC 1045 \$5.95.

T. S. ELIOT: *Reads his Four Quartets.* ANGEL 45012 \$5.95.

T. S. ELIOT: *Reads Old Possum's Book of Practical Cats.* SPOKEN ARTS 758 \$5.95.

The greatest poet of the twentieth century brings music and definition to his own verses, even though he denies that his interpretations should be considered

definitive. If only one record can be purchased, I recommend his acknowledged masterpiece: the *Four Quartets*, a must for any record collector.

PROSE

ANTON CHEKHOV: *The Harmfulness of Tobacco; A Transgression; The First Class Passenger.* Michael Redgrave (reader). SPOKEN ARTS 828 \$5.95.

Michael Redgrave creates three unforgettable characterizations in these stories by the great Russian playwright. *The Harmfulness of Tobacco*, a study in futility, timidity, and thwarted dreams, is a perfect example of the life of “quiet desperation” Thoreau said most men lead. Redgrave’s amusing and compassionate performance is something more than a reading, but it never obscures or upstages the beautiful Chekhovian prose.

DOSTOEVSKY: *Notes from Underground.* Morris Carnovsky (reader). LIVELY ARTS LA 30008 \$5.95.

This story of a retired petty official depicts the homelessness of modern man and the “fatal fantastic element” that leads him to defy reason and be an individual at all costs, and in it Dostoevsky seems to be speaking to us, though we live more than one hundred years after he wrote it. Morris Carnovsky’s performance is almost incredibly varied and profound.

JAMES JOYCE: *Finnegans Wake: “Anna Livia Plurabelle”; “Shawn the Penman.”* Siobhan McKenna and Cyril Cusack. CAEDMON TC 1086 \$5.95.

The word plays, puns, and combinations of meanings and allusions in *Finnegans Wake* blend to make a musical sense only dimly perceived when the book is read.

T. S. Eliot: Musical interpretations of his own masterpieces.



CAEDMON RECORDS

LIBRARY OF SPOKEN WORD

The actors on these discs obviously prepared for their formidable assignments with commendable care. Miss McKenna and Cusack are interpreters of insight and expertness. On Folkways 959314 (two records) Joyce himself can be heard in a Joyce Society recording of "Anna Livia Plurabelle."

HUMOR

RUTH DRAPER: *The Art of Ruth Draper*. SPOKEN ARTS 779, 798, 799, 800, 805. \$5.95 each.

The supreme monologist of our day left these superb renditions of the character studies she wrote and performed herself. If only one record must be selected, I suggest the first volume (SA 779), which includes Miss Draper's best-known effort, *The Italian Lesson*.

MAY AND NICHOLS: *Improvisations to Music*. MERCURY 60040 \$4.98, 20376 \$3.98.

MAY AND NICHOLS: *An Evening with Elaine May and Mike Nichols*. MERCURY 6200 \$4.98, 2200 \$3.98.

MAY AND NICHOLS: *Examine Doctors*. MERCURY 60690 \$4.98, 2080 \$3.98.

Because of their high standards of taste and the care with which they fashion and perform their material, Elaine May and Mike Nichols stand the test of time well. They need no dubbed-in laughter, low clowning, or topical references to prod amusement, but rather look the follies of fashion, high or low, squarely in the eye, and put the finger directly on our fallacies and absurdities.

S. J. PERELMAN: *An Informal Hour*. SPOKEN ARTS 705 \$5.95.

Here are readings by the author, who sounds slightly like Groucho Marx, of three of his maddest sketches, dealing with Hollywood, candy-craving, and weird window displays. He is not only witty and satirical but riotously funny and magnificently literate. Perelman proves to be the ideal man to read his own works.

PETER SELLERS: *Best of Peter Sellers*. ANGEL S 35884 \$4.98, 35884 \$3.98.

The protean Peter Sellers and an adroit cast spoof radio round-table discussions, travelogs, and other worthy targets in one of the most consistently funny albums on the market. None of the episodes on the

Paul Kresh, who regularly reviews spoken-word recordings for HIFI/STEREO REVIEW, is also the editor of American Judaism.

disc marks time or makes use of second-rate lines of ideas. Sellers sets himself a high standard and, for the most part, attains it.

DOCUMENTARY

FDR: *Speaks—Thirty-three Speeches*. WASHINGTON W FDR six 12-inch discs \$29.95.

This collection constitutes a thrilling historical voyage through a period that revolutionized our national character. Two of FDR's most important speeches—his inaugural addresses of 1933 and 1937—can be obtained on Spoken Word 112 for \$5.98.

BERTRAND RUSSELL: *Speaking*. CAEDMON TC 1149 \$5.95.

You do not have to agree with Lord Russell's notions about science, fanaticism, and "taboo morality" to be stimulated and entertained by this hour in the company of a fearless intellect. The record is particularly successful because Russell was skillfully kept to the point. On the two-record Riverside set, "Speaking Personally" (701415), he rambles and reminisces, so the Riverside set is recommended only to those interested in his autobiography as well as his views.

FRANK LLOYD WRIGHT: *On Record*. CAEDMON TC 1064 \$5.95.

The great architect is occasionally infuriating but always provocative in this memento of a brilliant creative mind. Wright does not confine his remarks to architecture, but, with unmatched incisiveness and high good humor, challenges some of the tired notions that still fetter our cultural and intellectual progress.

May and Nichols: set high standards of taste and performance.



MERCURY RECORDS

FURTHER RECOMMENDATIONS FOR ROUNDING OUT YOUR BASIC LIBRARY OF THE SPOKEN WORD

SHAKESPEARE: *Antony and Cleopatra*. Anthony Quayle, Pamela Brown, Jack Gwillim, Paul Daneman, Howard Sackler, director. CAEDMON SHAKESPEARE RECORDING SOCIETY S 235, 235 three 12-inch discs stereo or mono \$17.85. Miss Brown is not the most fiery of Cleopatras, but the general level of acting, particularly Mr. Quayle's Antony, is high, and the production is vivid.

THE HOLLOW CROWN. Produced by John Barton. Dorothy Tutin, Richard Johnson, and John Barton (performers); Tony Church (narrator); James Walker (harpsichord). LONDON OSA 1253 two 12-inch discs \$11.96, A 4253 \$9.96. This evening of readings and songs by and about England's monarchs drew plaudits from Broadway audiences last season. Culled from many of England's greatest writers and superbly acted, this anthology reinforces the judgment of King Henry VI, who, it is said, lamented that "kingdoms are but cares."

EUGENE O'NEILL: *Dramatic Readings from Eugene O'Neill*. Jason Robards, Jr. (reader). COLUMBIA OL 5900 \$4.98. Mr. Robards' long stage experience with O'Neill roles makes him pre-eminently the actor to read these speeches from *Long Day's Journey into Night*, *A Moon for the Misbegotten*, *The Hairy Ape*, and that tour de force, Hickey's confession of murder from *The Iceman Cometh*.

ELSA LANCHESTER: *Herself*. VERVE V 15024 \$4.98. A diverting hour of songs and zany recitations by the wild-eyed, woolly-haired mistress of the unexpectedly wicked line.

AN INVITATION TO ART. Brian O'Doherty (speaker). SPOKEN ARTS 763 \$5.95. A bright, informative, anything-but-patronizing introduction to modern painting.

PIETRO DI DONATO: *Christ in Concrete*.
ANTON CHEKHOV: *Swan Song*. Eli Wallach (reader). Harold Seletsky (music). DA VINCI DS 205 \$5.98, D 205 \$4.98. Di Donato's tough novel of an Italian construction worker's "crucifixion" through the carelessness of a builder has been welded to a twelve-tone musical score in three parts, and in Mr. Wallach's convincing reading the result is shattering. The Chekhov playlet is a tender and beautifully understated close-up of a lonely and aging actor.

KATHERINE MANSFIELD: *The Garden Party; Bliss*. Celia Johnson (reader). CAEDMON TC 1133 \$5.95. Miss Johnson offers impeccable readings of two short-story masterpieces, bringing out all the beauty of Katherine Mansfield's graceful prose.

HERMAN MELVILLE: *Bartleby the Scrivener*. James Mason (reader). LIVELY ARTS 30007 \$4.98. An excellent rendering of a slightly condensed version of one of Melville's lesser-known but especially significant short novels.

BEYOND THE FRINGE. Alan Bennett, Peter Cook, Jonathan Miller, Dudley Moore (writers and performers). CAPITOL SW 1792 \$5.98, W 1792 \$4.98. One of Broadway's brightest hits of the past season, this sophisticated satirical show is a merciless lampoon of British pretensions and pomposities, from pious movies about World War II to the Old Vic's mincing approach to Shakespeare.

EDNA ST. VINCENT MILLAY: *Reading Her Poetry*. CAEDMON TC 1123 \$5.95. In a recital that should move the flintiest of hearts, the voice of the poetess herself is heard in many of the lyrics that brought her fame.

ROBERT FROST: *Reads His Poetry*. CAEDMON TC 1060 \$5.95. The late "poet laureate" of America reads several dozen of his finest verses in his inimitable twang.

CHARLES LAUGHTON: *The Story-teller*. CAPITOL STBO 1650 two 12-inch discs \$11.96, TBO 1650 \$9.96. In this set the spell-binding Mr. Laughton reads selections ranging from the Old Testament to Jack Kerouac, all with the greatest relish.

I CAN HEAR IT NOW. Volume One, 1919-1932; Volume Two, 1933-1945; Volume Three, 1945-1949. COLUMBIA ML 4340, 4095, 4261 \$4.98 each. These records constitute a tour through the recent past narrated by the ever-astute if sometimes pompous Edward R. Murrow, assisted by Fred W. Friendly. Many of the voices and events are the real thing, others are re-creations by actors. The first record covers the years from the Wilson Administration to Roosevelt's first inaugural; the second covers World War II and the years of crisis preceding it; and the final volume brings the chronicle up to 1949.

FIDDLER WITH A FOUNTAIN PEN



THE YOUNG MAN at work above is no ordinary doodler. His name is Erick Friedman, and he is an artistic rarity in more ways than one. In a period that swarms with rambunctious young pianists, Friedman (at twenty-three) is a somewhat lonely virtuoso on the violin. When he made his 1961 recording debut in tandem with his teacher, Jascha Heifetz (in Bach's Concerto for Two Violins), his silky tone and lapidary technique reminded many listeners of a vastly different state of affairs in the Thirties, when platoons of dazzling young Leopold Auer pupils—Elman, Zimbalist, Heifetz—dominated the concert scene.

Friedman is also one of the few musicians who, like Caruso, are talented eye-men as well as ear-men. On the international concert trail he is unavoidably faced

with hours of enforced idleness on busses and trains. At such times, he reaches for his fountain pen and any scrap of paper handy—the Friedman art exhibit on these pages is sketched on everything from a concert program to a registration slip from the London police department. An exception, which was a three-minute studio job done for this feature, is the gentleman opposite with the cigarette holder, who is Friedman's conception of A Critic. Remarked the artist: "This guy is thinking, 'So that bum up there thinks he can play the fiddle, does he? We'll see about that!'" As it happens, the music critics are uniformly happy with Friedman's fiddling; he faces a rougher time with the watchdogs of modern art, since everything he draws is perfectly recognizable.

Robert Offergeld

Both a professionally informed eye and a pupil's respectful affection are evident in Erick Friedman's pencil portrait of his teacher and co-performer, Jascha Heifetz.



PIANO TRIO SERIES

EUGENE ISTOMIN, piano
ISAAC STERN, viola
LEONARD ROSE, cello

Thursday Evening, May 3, 1966

Program

Trio in E flat major, Opus 70, No. 2 **RESTROVER**
 Poco sostenuto—allegro ma non troppo
 Allegretto
 Allegro ma non troppo
 Finito—Allegro

Trio in A minor **SAVSE**
 Moderato
 Fandango—mod. viv.
 Fandango, alla breve
 Finito—mod.

INTERMISSION

Trio in D minor, Opus 49 **REHNSOLSON**
 Molto allegro ed agitato
 Andante con moto tranquillo
 Scherzo—llegro e vivace
 Finito—allegro ma non troppo

Sunday Evening, May 6, 1966

Program

Trio in C major, Opus 67 **GRAND**
 Allegro
 Andante con moto
 Scherzo grave
 Finito—allegro vivace

Trio in D major, Opus 70, No. 1 ("Ghost") **REHNSOLSON**
 Allegro vivace e con moto
 Largo e mesto e sostenuto
 Finito

INTERMISSION

Trio in E flat major, Opus 99 **REHNSOLSON**
 Allegro moderato
 Andante con moto
 Scherzo allegro
 Finito—allegro moderato

*To Erica
 This is exceedingly
 Brock Alvin
 Leonard Rose
 Erick Friedman
 a colleague to
 See the*

ON THE COVER
 L'Assemblee au Concert. Supported by Minnie Loveland
 Dal Pied, 1955

On a concert program (left), Erick Friedman inks his impression of the three participating artists—pianist Eugene Istomin, violinist Isaac Stern, and cellist Leonard Rose. During a bus trip through Texas, Friedman notes (below) the interminable flatness of its plains and the local pronunciation of its name.



With tongue slightly in cheek, Friedman characterizes (above) the somewhat dessicated genus Music Critic. At right, utilizing a foreigner's registration notice from the London Metropolitan Police, the artist visualizes some of the most celebrated faces in music: Pablo Casals (with raised hand) and, on the far right, reading from top to bottom, a nonromantic conception of Beethoven, Schubert, and Chopin.

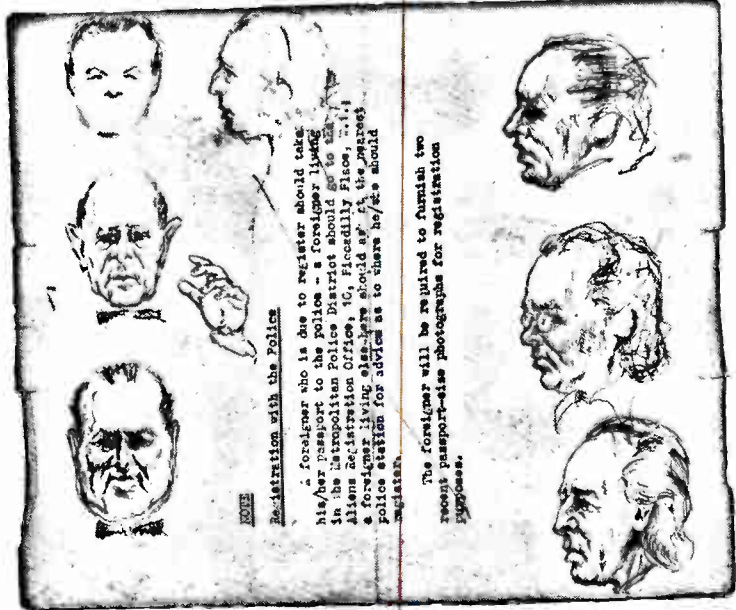
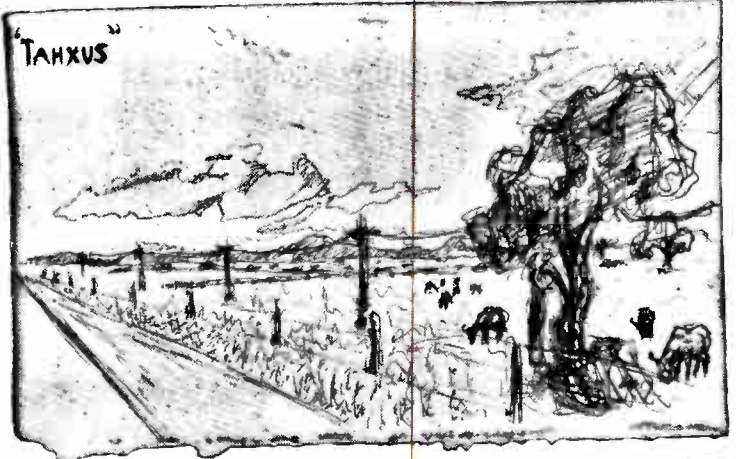



RECOMMENDED

AN ENGINEER TESTS AND EVALUATES

FOR MANY listeners, one of the most disconcerting aspects of the time and the money invested in stereo FM has been the failure to obtain the "glorious new dimension in sound" the advertisements promised them. Whereas the switch from AM to FM reception revealed an obvious sonic improvement, stereo FM has in many instances been a disappointment. Some listeners have blamed their own receiving equipment, others have blamed the stations. But the truth is that with the quality tuners and transmitters presently in use, the fault is usually with the receiving antenna.

Part of the trouble is that, as almost everyone knows by now, FM signals travel in a direct line-of-sight path. But what is not so well known is that FM signals can also bounce off or be reflected by obstacles. These reflected signals are responsible for most stereo-reception problems.

Almost every area has some reflecting surfaces—tall buildings, water towers, hills, and so on. Because reflected signals travel a longer distance than do direct signals, they arrive at the receiver's antenna a fraction of a second later than the direct signal and hence are partially out of phase with it. The distortion resulting from this "multipath" reception is comparable to ghost-reception on television. The reflecting surfaces may bounce back all signals at the high end of the band (say, from 100 to 108 megacycles), all at the low end (from 88 to about 92 megacycles), or only a part of a single station's signal may be reflected. If the last is the case, the type of distortion produced is determined by which frequencies of the transmitted signal are reflected.

Depending on the distance the reflected signal has

traveled, and on what signal frequencies have been reflected, the signal may be completely unintelligible, it may have poor separation, or it may have an unpleasant buzzy quality. Incidentally, all of these effects are frequently blamed on the tuner. Another common multipath effect often diagnosed as a tuner fault is that caused by reflections occurring only on the high end of the band. Because the low-end stations are picked up well and the higher ones poorly, the erroneous assumption is that the tuner is defective.

Another stereo FM problem is noise. Often, satisfactory reception is obtained with a mono signal, but when the station puts on a stereo program, the signal is buried in noise. This is because a stereo FM signal has only about half the range of a mono signal, all else being equal. When a station twenty miles away switches from mono to stereo, the effect is as though the station had suddenly moved an additional twenty miles away. If the antenna intercepts only enough signal to provide marginally good noise-limiting on mono, the signal strength on stereo will not be sufficient for a good signal-to-noise ratio.

Both of these problems—multipath distortion and poor signal-to-noise ratio—are caused and can be controlled by the antenna. The proper antenna can eliminate or reduce multipath reception and can also increase the input signal to the tuner sufficiently to make the reception noise-free. Only one type of antenna can do this: the Yagi. While the Yagi is but one type of highly directional antenna, it has become the generic term used to describe any antenna with similar characteristics. To understand why the Yagi is the best stereo antenna, we should compare it with some of the other antennas.



By HERBERT FRIEDMAN

FM ANTENNAS

THE BASIC TYPES OF OUTDOOR AND INDOOR ANTENNAS

The antenna often claimed to be "the best all-round performer" is the omnidirectional antenna, a term that includes the Turnstile, Halo, S-dipole, Stereo Cone, and other types. What is the omni's claim to fame? Simply that it receives signals from any direction, and can therefore receive any station regardless of its direction. Unfortunately, many stereo enthusiasts have erected an omni and then blamed the ensuing hash and squawks on the tuner. The very factor extolled as a virtue—the fact that the omni picks up signals equally well from all directions—actually invalidates the omni for stereo use, for the omni will pick up reflected, multipath signals as well as the desired signals. Furthermore, the omnidirectional models capture the *least* signal of any outdoor antenna. In as few words as possible, the omni is probably the worst outdoor antenna for stereo reception.

IF budget restrictions dictate a low-cost antenna, acceptable reception is often obtainable from a two-element beam, a type of antenna that usually sells for less than fifteen dollars. The two-element beam has sharply reduced sensitivity to signals originating at its rear and sides (to reduce the reception of reflected signals). Its angle of frontal sensitivity is sufficiently broad to receive stations located in a 110-degree arc. If local stations are so located that they cannot all be included in the frontal arc, the antenna installation should include a rotator (cost: about twenty-five to thirty dollars).

While some TV antennas cannot be used for FM reception because they lack sensitivity at the FM frequencies, many will give performance equal to that of a two-element beam. The way to find out is to

connect the TV lead-in wire to your tuner and check the results. If the sensitivity appears to be good, as evidenced by the tuner's signal-strength indicator or by a good signal-to-noise ratio on known weak stations, the next test is to tune in a station that is located in the same general direction as the TV station. If the sound remains clean, there is no reason why you cannot utilize the TV antenna. If it is already equipped with a rotator, a two-set coupler can be used to enable the antenna to feed both the TV receiver and the tuner. Since most couplers do have a slight signal loss, a combination amplifier-coupler may be required for best results.

In terms of cost, the two-element beam and the TV antenna are advantageous only if their broad pickup pattern eliminates the need for a rotator, because, if you must buy a rotator, then you might just as well (for only about ten dollars more) equip yourself with the *ne plus ultra* in FM reception: the Yagi antenna.

The Yagi, with its absolute minimum of rear- and side-signal pickup, and very narrow angle of frontal sensitivity, is ideal for stereo FM use. The Yagi not only rejects and attenuates all reflected signals, but its frontal sensitivity is up to 10 db greater than that of an omni. If an omni in a given location will deliver ten microvolts to the tuner input, the Yagi will deliver about 32 microvolts.

Several types of Yagis are available, priced from about fifteen dollars up. The more elements the antenna has, the greater its sensitivity and the sharper its rear and side attenuation. The better antennas are broad-band—that is, they are equally sensitive to FM signals on the high and low end of the band. The low-cost models (which are low cost only by about

FM ANTENNAS

five dollars) may have a diminished efficiency at the ends of the FM band.

Though the Yagi offers the best gain and directivity, it can create a serious reception problem: receiver overload. Overload is caused by too strong a signal, usually from a station in the immediate vicinity. It is evidenced when the offending station is picked up at several points on the dial, or as an overriding signal on other stations. The overload can be eliminated by connecting an attenuator (such as the Taco Model

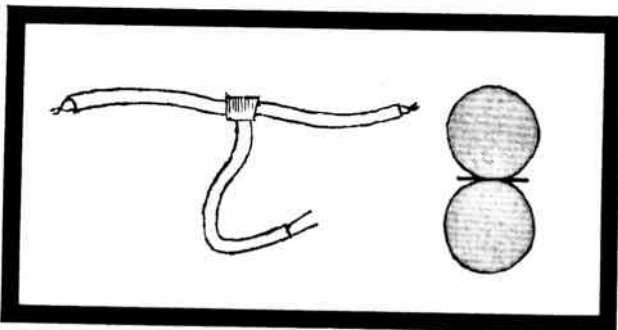

All dipoles, including the "folded" 300-ohm flat-wire models and the TV "rabbit-ears" types, have figure-8 pickup patterns.

835) between the lead-in wire and the tuner. The attenuator, which is switch-operated, mounts on the back of the tuner or equipment cabinet and is normally turned off. When overload occurs, the switch is moved to the position that results in clean sound.

A word about signal boosters. All a booster can do is improve the tuner's quieting by amplifying the signal picked up by the antenna. Boosters are not a stereo cure-all, because they amplify the unwanted multipath signals along with the wanted signals. A signal booster will not reduce multipath distortion one iota.

ALTHOUGH a directional outdoor antenna is a basic requirement for good stereo reception, many listeners, particularly in metropolitan areas, find it impossible to install an antenna on the roof. We therefore ran a series of tests of representative indoor antennas, using a Jerrold Model 704B field-strength meter. This instrument indicates directly in microvolts the amount of signal intercepted by an antenna connected to it. Regardless of antenna type, we were looking for one that would capture enough signal to insure a good signal-to-noise ratio and that could be adjusted to reduce multipath interference. The latter is particularly important since indoor antennas are highly susceptible to multipath originating from the steel

frames of some buildings, metallic carpet runners, and even from the listeners in the room.

Several antennas of each type were selected. Among them were the folded dipole, made of 300-ohm TV lead-in wire; the familiar rabbit-ears dipole; the "switching" rabbit-ears, which has a selector switch in its base; the "under-carpet" antenna, consisting of metal foil printed on a flexible sheet; and the Gallo FMS-101 electronic antenna.

At one time, almost every FM tuner was supplied with a 300-ohm folded dipole as part of the original equipment. Since the dipole is constructed of 300-ohm TV lead-in wire, it is inexpensive, and, before the day of stereo FM, it served adequately for perhaps 80 per cent of all tuner installations. Most mail-order parts suppliers still have dipoles for a little over a dollar.

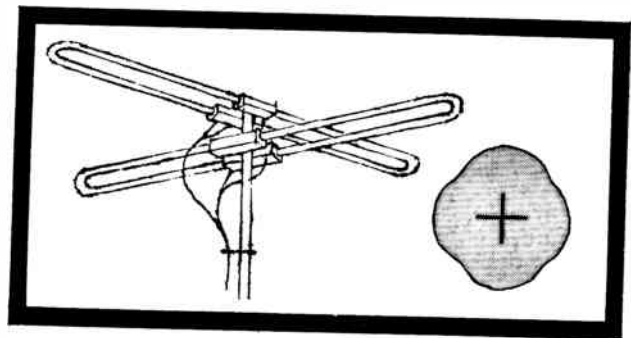

Omnidirectional antennas are generally unsuitable for stereo reception because of their tendency to pick up multipath signals.

The pickup characteristics of the folded dipole are similar to those of the standard dipole: there is maximum sensitivity to signals originating broadside to the antenna, and minimum pickup at the ends. However, the drawbacks of the 300-ohm folded dipole antenna include the fact that they are usually cut for the center of the FM band (95 megacycles) and have a diminished sensitivity at the ends of the band. Also, in practice, they are difficult to orient for optimum signal pickup.

Rabbit-ears dipoles are another story altogether. Of all the antennas tested, simple rabbit-ears (such as Allied Radio's 92CX025 and Lafayette's AN-105, both of which sell for about a dollar) were found to pick up somewhat more signal than other types of indoor antennas. And because a rabbit-ears antenna is supplied on a base, it can easily be oriented to reduce multipath pickup. In addition, the length of its elements can be adjusted for optimum sensitivity at the desired frequency.

The rabbit-ears antenna with a switch built into its base (included in this category are the units with loops, helices, and various other items of futuristic hardware appended to them), such as the Rembrandt AN-138, RCA Starliner, RCA Sentry, and JFD

TA-147, will in certain switch positions reduce multipath pickup without the necessity of changing the antenna position. But in other respects, these antennas

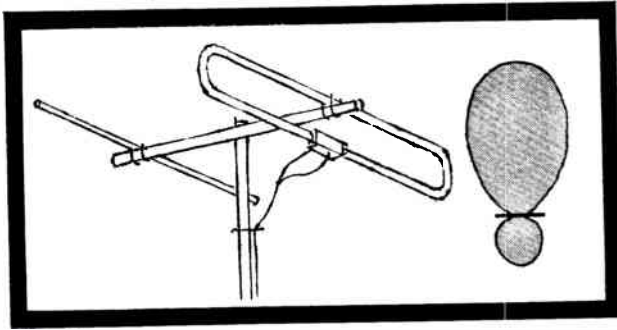

A dipole with a reflector (also called a two-element beam) has decreased sensitivity to signals that originate from the rear.

tested no better than the rabbit-ears antennas, although they cost considerably more. The sole exception was Channel Master's Showman antenna, which was more effective because of its special loading-coil design.

Two under-carpet antennas were tested: the Jerrold Magic Carpet and the RCA Brite Site. These are priced at about five dollars, and are referred to as "all-band" antennas because they are designed to cover both the FM and TV frequencies. They are therefore quite large physically (about two by four feet). They picked up nearly as much signal as the dipole, and had better directivity. Consequently, of the indoor antennas, the under-carpet antennas did the best job of reducing multipath interference. In fact, the under-carpet types delivered the best over-all results of all the indoor antennas tested, although the dipole picked up a little more signal.

The electronic Gallo FMS-101 antenna, priced at fifteen dollars, while holding the most promise, was something of a disappointment. The unit consists of a transistorized radio-frequency amplifier mounted on a printed-circuit board, with a small loop of foil printed around the edge of the board serving as the antenna. Unfortunately, the foil antenna intercepted so little signal that, even when amplified, the total output was 6 to 12 db (depending on frequency) less than the signal captured by the dipole and under-carpet antennas. The unit also is essentially omnidirectional, and is therefore susceptible to multipath interference. In fact, satisfactory reception was impossible to obtain with the FMS-101.

To sum up, for least multipath distortion the choice is: first, the under-carpet; second, the rabbit-ears dipole; third, the folded dipole; and fourth, the "switching" rabbit-ears antenna.

The performance one gets from any indoor antenna is extremely dependent on precise positioning. A change in antenna position of only six inches can

mean the difference between acceptable or unintelligible sound. The dipole offers no installation problems since the length of the telescopic elements and their orientation can easily be adjusted: simply position for least distortion consistent with minimum noise. However—and this applies to all indoor antennas—retire to your usual listening position before you decide whether the antenna orientation is correct. The human body absorbs and reflects FM signals, and the reception obtained when you are standing next to the antenna

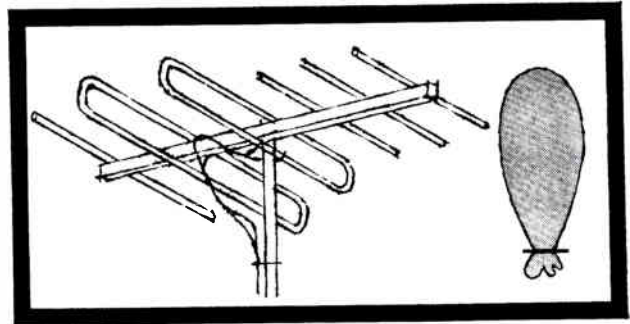

The multi-element Yagi-type antenna has a narrow forward pickup pattern and a reduced sensitivity at the sides and rear.

will be considerably different from that obtained when you are seated away from it.

About the worst position for the folded dipole (made of TV lead-in wire) is on the back of the equipment cabinet, where it may pick up minimum desired signal and maximum multipath. If the antenna must be concealed, try several different locations, such as back of a couch, behind draperies, or under a carpet or rug.

The under-carpet antenna should be stretched out on the floor and its position varied until optimum reception is obtained. Avoid putting it near metallic carpet runners, such as are used to protect the edges of carpets, since they could seriously affect the antenna's performance. If the antenna must be placed near a carpet runner, position the antenna nearly parallel to it while listening for best sound. Whatever the position, make certain the antenna is not near the seating area; if it is, performance will be determined by the number of people in the room and where they are seated.

Regardless of which antenna is used, it is unfortunately true that the position of maximum signal pickup will not always coincide with the position for minimum multipath interference. Your ears are then the best guide to the most satisfactory position.

Herbert Friedman's familiarity with FM reception problems derives from his experience as an engineer with New York City's educational FM station WNYE. Mr. Friedman's article concerning "How to Add Extension Speakers" appeared last month.

S&Q

SOUND AND THE QUERY

PRACTICAL POINTERS ON THE INSTALLATION AND MAINTENANCE OF HOME MUSIC SYSTEMS

BY LARRY KLEIN

High-Pass Filters and Crossovers

Q. What is the difference between a high-pass filter and a crossover network—or are they the same? And which is preferred with a woofer-tweeter setup?

CHARLES ANDERSON
East Orange, N. J.

A. A high-pass filter, as its name implies, permits frequencies above a certain point to pass through it unhindered. Frequencies below that point are attenuated a certain number of decibels per octave. The simplest kind of high-pass filter is a nonpolarized capacitor connected in series with the tweeter. The crossover frequency is determined by the impedance of the tweeter and the rating of the capacitor. You will find a listing of recommended capacitors for common crossover frequencies and tweeter impedances on page 37 of the August issue.

The simplest crossover network has, in addition to the capacitor in series with the tweeter, a coil in series with the woofer. This coil prevents the high frequencies from reaching the woofer, just as the capacitor prevents the low frequencies from reaching the tweeter.

As to whether a high-pass filter or a crossover network is preferred, this is determined by the requirements of the specific woofer and tweeter. For example, RCA's excellent studio monitor speaker, the LC1A, which sells for almost \$200 without cabinet, uses no coil—only a single oil-filled capacitor in series with the tweeter. In general, if the woofer will reproduce distorted highs or if its high-frequency output would interfere (acoustically) with the tweeter output, then it is best to keep all high frequencies away from the woofer. In any case, the lows must be kept out of the tweeter to avoid damaging it.

A + B or A - B?

Q. Following a friend's suggestion, I connected an inexpensive 8-ohm full-range speaker from the 4-ohm tap of my stereo amplifier's right channel to the 4-ohm tap on the left channel. My object was to obtain a center-fill speaker. However, when

playing a stereo record, the volume from the speaker is low and seems to consist mostly of high frequencies. Is the speaker or the connection defective?

PHILIP DAVIS
Inglewood, Calif.

A. Neither. A loudspeaker hooked up as you describe will reproduce the so-called difference signal ($A - B$) rather than a mixed signal ($A + B$) when you play a stereo record. This difference signal contains only the stereo information, most of which is in the range of 300 cps and up. Since the center-fill speaker is usually played at a lower level and because the difference signal will fill whatever hole there may be in the middle, I would leave the setup as it is.

R. F. Interference

Q. In my new apartment, I've been troubled by a buzz (not a hum) in my stereo system that none of the usual shielding and grounding techniques will eliminate.

Do you have any idea as to what could be causing this, and is there anything I can do about it?

HERMAN YEAGER
Brooklyn, N.Y.

A. The buzz probably results from pickup and detection of part of a TV signal by one or both phono

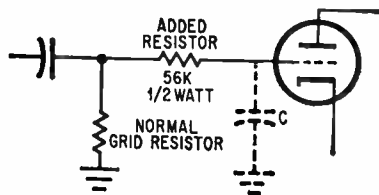

preamplifier tubes in your control unit. Install a resistor between the normal grid resistor and the preamp tube socket as close to the socket as possible. If the resistor alone doesn't do the job, a small disc capacitor (about 10 micromicrofarads) may also be needed.

Audio Impossibilities

Q. I have never read an explanation of how a phono stylus can simultaneously respond to the low and high

frequencies produced by a tuba and a violin playing together. It seems to me that the stylus would be compelled to vibrate at two different frequencies at once. How can this be?

JOHN D. MONROE
Nova Scotia, Canada

A. The stylus does not vibrate at two frequencies simultaneously, of course. What it does do is trace the single composite groove modulation representing the total waveform. To use your original example, if you were to view a representation of the tuba and violin sound on an oscilloscope, you would find that the violin frequencies were, in effect, riding atop the tuba waveform. This is the waveform that comes out of the speaker and which the ear mechanism and the brain together separate and interpret as the sounds of the violin and the tuba. You might as well have asked how the eardrum itself can simultaneously vibrate at two separate frequencies.

Ports and Pipes

Q. What are your feelings on the conflicting claims concerning the advantages of a tunnel or a pipe installed in a bass-reflex cabinet instead of a port?

SHELDON PEARCE
Indianapolis, Ind.

A. The bass-reflex cabinet is essentially a Helmholtz resonator (this is explained in detail in the article "3 Speaker Enclosures" in the August issue) that is tuned by the port or opening. Extending the port inward by a tunnel or duct restricts the movement of the air in the port. In terms of cabinet performance, this means that the restricting or resistive element in the port minimizes the amplitude and sharpness (or Q) of the cabinet's Helmholtz-resonant peak and brings it more into line with the speaker's resonant-response curve. I doubt that a ducted port has any particular advantage over a properly friction-loaded port—which, incidentally, is usually easier to construct and tune. Friction-loading of the port may be accomplished either by using many small holes rather than one large port opening, or by covering the port with porous cloth to impede the air flow. The second technique must not be performed haphazardly, because, besides lowering the Q of the enclosure, it will also tend to close down the port and thus make retuning the enclosure necessary.

BEST OF THE MONTH

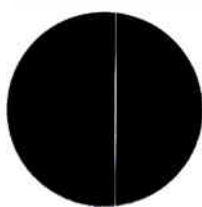

CLASSICAL

MISSA LUBA: THE MASS IMPROVISED IN FOLK IDIOM

A powerful and moving celebration of faith from the Congo

AS A teaching missionary in the Belgian Congo during the decade preceding its independence, Father Guido Haazen became interested in preserving the folk-music heritage of the Congolese from drowning in a flood of Western popular music, and thus founded Les Troubadours du Roi Baudouin, a choir composed of forty-five boys and sixteen native teachers. In addition to having his singers present their own folk songs, complete with African drum accompaniment, Father Haazen hit upon the idea of working out a musical setting of the Catholic Mass based on traditional Congolese songs and rhythms. As did Martin Luther in the early days of the Reformation, he found it was chiefly a matter of adapting the songs and rhythmic formulas already familiar to his congregation—in this case, the children and teachers at the Kamina Central School in the Congo.

The result is the *Missa Luba* (Congolese folk Mass), which is a fascinating and extraordinarily moving work. This is so partly because of the *(Continued overleaf)*



MARGORIE BIRANO, PHILIPS RECORDS

novelty of hearing the liturgical text sung to the type of drum and rasp accompaniment that we usually associate with exotic or primitive dance music, but more particularly because the unique flavor these West Africans bring to recitative lends to the liturgy a special force and urgency totally different from what previous experience has led us to expect. In some portions of this Mass one hears the magnificent Latin of the text as if for the first time, and in fact the violent dislocation of the Latin prosody from its traditional points of musical and grammatical support has the effect of throwing a fresh and strongly dramatic light (*not* a theatrical one) on the many meanings to be found in it—dogmatic, poetic, and historical. This is particularly apparent in the Credo, which in European settings of the Mass is all too often rendered as a perfunctory recitation of sectarian theology. Here it is a fervent affirmation of communal faith shouted from the housetops, syllable by fiery syllable.

Since the melodic and rhythmic patterns used in the Missa Luba are basic in nature (many of them are outright dances) and are treated in call-and-response fashion, the final performance amounts to a form of improvisation familiar to any jazz listener. It is in the simpler, more incantatory sections of the Mass that this treatment becomes most moving in its effect—in the Gloria, and even more so in the Sanctus (which adapts a poignant Kiluban “Song of Farewell”) and the Hosanna. The brief passage of lamentation for solo voice in the Crucifixus is also deeply touching, and it is impossible in such passages to forget the passionately emotional faith with which the African Church, in the early centuries, reinvigorated a Christendom on the point of collapse.

The folk songs on the other side of the record are a delight to the ear and rhythmic sense, sounding wholly fresh and unaffected. Here we have a chance to sample some of the folk roots that are echoed in the Missa Luba. It is also interesting to hear the modern Western influence evident in the *Soldiers’ Song*, the next-to-last item on the side. It might seem that the harmonic elements in the Mass and in many of the folk songs are Western-influenced, but this is not strictly true; for it would appear that harmonizing in thirds came quite spontaneously to many West African tribes.

This disc is not the first issue of these performances in the U.S. It was available on a mono Epic release some three years ago, and

although relatively unheralded, has enjoyed a brisk sale by word of mouth. The combination of highly effective stereo reprocessing with a luxurious art-packaging should do much to give the music in this Philips reissue the far broader circulation that it deserves. *David Hall*

© © **MISSA LUBA; CONGO FOLK SONGS:** *Marriage Song; Emergence from Grief; Marriage Ballad; Dance; Marital Celebration; Soldiers’ Song; Work Song.* Les Troubadours du Roi Baudouin, Père Guido Haazen cond. PHILIPS PCC 606 \$5.98, PCC 206* \$4.98.

VITALITY, ENTHUSIASM, AND STYLE IN TWO HAYDN SYMPHONIES

*Library of Recorded Masterpieces’ series
continues to meet its own high standards*

FIVE of the previous nine discs in the Library of Recorded Masterpieces label’s series of Haydn symphonies have to date been given “Recording of Special Merit” ratings in these pages and two have been tapped for “Best of the Month” recognition. This is, needless to say, an unusually high standard for a series, no matter what its scope, and now, here again, is another album to be hailed with the greatest enthusiasm.

The major work in the latest volume, No. 10, is the so-called “Maria Theresia” Symphony, which received its nickname from the fact that it was performed when the Austrian empress visited Esterházy in 1773. On that gala occasion was also heard Haydn’s burlesque opera, *L’inferdeltá delusa*, whose delightful nine-minute, three-movement overture is included here. Every one of the works in this volume is a gem, including the early Fourth Symphony, written in 1759 or 1760 when Haydn was director of music to Count Morzin in Bohemia. The works of Haydn’s younger years are sometimes more interesting historically than musically—but not so with this one. The symphony features a haunting, syncopated slow movement as well as a lengthy minuet for a finale that puts it completely out of the ordinary class.

The performances are enormously enthusiastic, vital in their energy, and stylistically admirable. Every attention has been paid to the internals of performance to conform with what

Haydn intended: appoggiaturas are executed correctly, a harpsichord continuo is used throughout the album, second violins are placed opposite the firsts rather than next to them, and, perhaps most spectacular (at least in No. 48), the recording presents for the first time the original high trumpet and horn parts, which give the music tremendous impact and excitement. It is tragic that Max Goberman did not live to continue this splendid and worthwhile series, and we must hope that it will nonetheless be completed. The recorded sound in both versions is excellent, and the album, as usual, contains extensive and valuable commentary and complete miniature scores. *Igor Kipnis*

© HAYDN: *Symphony No. 48, in C Major ("Maria Theresia"); Symphony No. 4, in D Major; Overture to "L'infedeltà delusa."* Vienna State Opera Orchestra, Max Goberman cond. LIBRARY OF RECORDED MASTERPIECES IIS 10 \$8.50 (subscription), \$10.00 (nonsubscription), stereo or mono. (Available from Library of Recorded Masterpieces, 150 West 82nd Street, New York 10024, N. Y.)

THE ABBEY SINGERS: A BRILLIANT DISC DEBUT

*Vocal perfection in a varied
a capella program*

EVER HEAR OF William Billings? Daniel Read? Jacob French? Ever see them listed in the record catalog? Well, they are nonetheless part of our great American heritage of song, and it is high time we all learned about them. Each of these earnest and honest New England colonials of the latter part of the eighteenth century is represented once in Decca's new "Five

Centuries of Song," a brilliant first recording by the Abbey Singers, a vocal group of five skilled young artists equally at home in Renaissance, Elizabethan, or contemporary music.

Billings' *I am the rose of Sharon*, a setting of part of the Bible's *Song of Songs*, has a crisp, home-grown harmonic economy refreshingly welcome in these fragile love lyrics, which have on occasion been lushly overworked by other composers. French's *The Death of General Washington* might, in hands more clever, have gone all mawkishly sentimental, bathetic, or banal: it is none of these, but a straightforward, clear-eyed, and strangely moving anthem. French may well have been the last American to be able to call Washington "Father of His Country" unself-consciously. Read's joyous fuguing tune *Sherburne* ("While shepherds watched their flocks by night . . .") has a spare and sprightly pioneer vigor some of our flagging modern writers might try recapturing.

However, the most delightful surprise—and success unqualified—on this disc is a phenomenon, a Swiss-watch marvel, called *Geographical Fugue* by its composer, adoptive American Ernst Toch. Quite perfect and quite impossible to describe, it will teach you more about the nature of the fugue, the human voice, and the languages of man in just one hearing than would a short course in any of these subjects. Ingenious, ingenious, incredible!

The songs of the English group (Weelkes, Byrd, and Farmer) are expectedly expert and winning, but special nods must go to Passcreau's amusing *Il est bel et bon* and young David Kraehenbuehl's marching, muscular *Gloria*.

The Abbey Singers, their voices as evenly matched as pearls, were selected and trained by New York Pro Musica director Noah Greenberg. Perfect in ensemble, impeccable in taste, all five

DECCA RECORDS



Matched pearls, from left to right: Arthur Burroughs, baritone; David Dodds, tenor; Murrin Hayes, bass-baritone; Earnest Murphy, tenor; and Jan De Gaetani, mezzo-soprano.

are also soloists of standing. Marvin Hayes is one of those gratifying basses who sound incapable of bottoming out, and baritone Arthur Burrows has a rich and elegant surety (especially in *Salve Regina*) that inspires a confidence usually reserved for the Bank of England. The opulent-voiced Miss De Gaetani is formidably accomplished, and the tenors are pure silver.

The performance is beautifully recorded throughout, the stereo version being most successful. Have I missed anybody? Oh, yes—thank you, Decca. *William Anderson*

© ① **FIVE CENTURIES OF SONG:** *Thomas Weelkes: Hark all ye lovely Saints. Byrd: Lullaby, my sweet little baby. Farmer: Fair Phyllis I saw. De Rivaflecha: Salve Regina. Kraehenbuehl: Ideo Gloria in excelsis Deo. Costeley: Mignonne. De Lassus: O vin en vigne. Passereau: Il est bel et bon. Billings: I am the rose of Sharon. French: The Death of General Washington. Read: Sherburne. Mozart: Madame has lost her cat. Brahms: Der Jaeger. Toch: Geographical Fugue. Copland-Fine: I bought me a cat. The Abbey Singers: Marvin Hayes (bass-baritone), Arthur Burrows (baritone), Jan De Gaetani (mezzo-soprano), David Dodds and Earnest Murphy (tenors). DECCA DL 710073 \$5.98, DL 10073 \$4.98.*

*****JAZZ*****

WAY OUT FRONT WITH GEORGE RUSSELL

*Another contribution to the
development of serious jazz*

GEORGE RUSSELL'S career is a leading example of how a prestigious jazz reputation can be built almost entirely on the basis of recorded performances. Because of the increasingly bleak economic landscape of the current jazz scene, Russell's avant-garde unit has had hardly any club or concert engagements during the past year. Yet his albums continue to come, and Russell himself continues to grow as a writer and a leader—as his newest Riverside collection "The Outer View" makes clear.

The most remarkable track is a twelve-minute version of *You Are My Sunshine*, which brilliantly illustrates Bill Evans' view (quoted in the July, 1963 issue of *HIFI/STEREO REVIEW*) that "jazz is not a what, it's a how." The tune, long identified with country and western per-



GEORGE RUSSELL
Prestige on the platter

formers, is transmuted by Russell's taut, multi-colored scoring into one of the most mesmeric jazz experiences in recent years. Climaxing the performance is a vocal by Sheila Jordan, the most daring and yet the most subtle jazz singer to have emerged in a long time.

The other tracks are instrumentals. There is a Charlie Parker line, two originals by Russell, and a blithe piece by Carla Bley. Of the hornmen, Don Ellis is particularly effective in distilling varieties of irony. His quick intelligence is matched by an exceptional technical command of his horn and a tone that can switch instantly from crackling warmth to something like a whiff of bitter lemon. Garnett Brown and Paul Plummer, while not yet as resourceful as Ellis, are also musicians of wit and skill. The rhythm section includes Steve Swallow, one of the most inventive of the younger bassists; Pete La Roca, a drummer who obviously *listens* carefully; and Russell himself on piano. As a pianist, Russell is lyrical but at the same time wholly unsentimental and rhythmically incisive.

That jazz of such significance is confined to the recording medium underlines the need for a radical reconstruction of the present inadequate bridge between avant-garde jazz and its potential audience.

Nat Hentoff

© ① **GEORGE RUSSELL: *The Outer View.*** George Russell (piano), Don Ellis (trumpet), Garnett Brown (trombone), Paul Plummer (tenor saxophone), Pete La Roca (drums), Steve Swallow (bass), Sheila Jordan (vocal) on *You Are My Sunshine. Au Privave; Zig-Zag; The Outer View; You Are My Sunshine; D. C. Divertimento.* RIVERSIDE RS 9440 \$5.98, RM 440* \$4.98.

LAWRENCE SHUSTAK

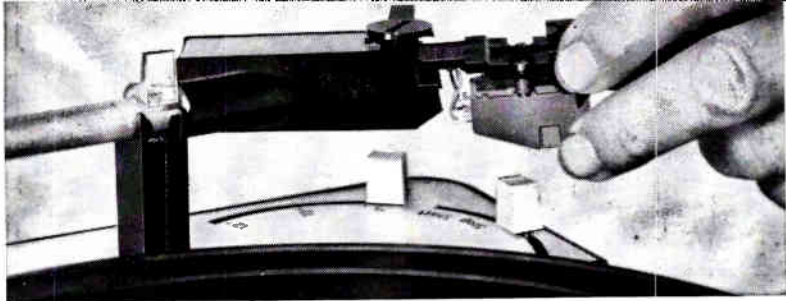

welcomes highest compliance cartridges for flawless tracking even at $\frac{1}{2}$ gram or under

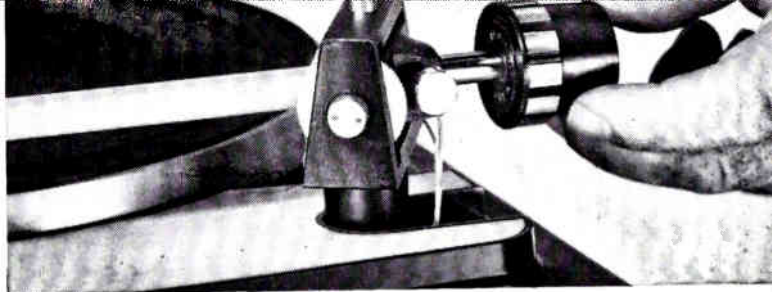

precise tonearm balance with rubber cushioned fine-thread rotating counterweight

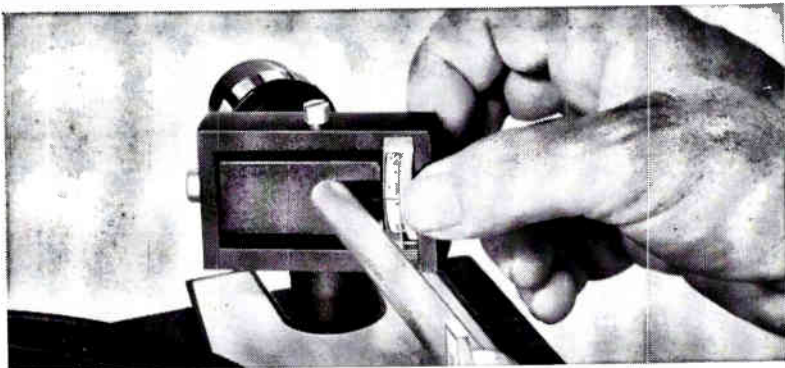

stylus force applied directly at pivot preserves perfect mass balance of tonearm



perfect pitch for the most critical ears with 6% variable range for all four speeds



superb over-all engineering permits tilt to almost 90° without spilling a note

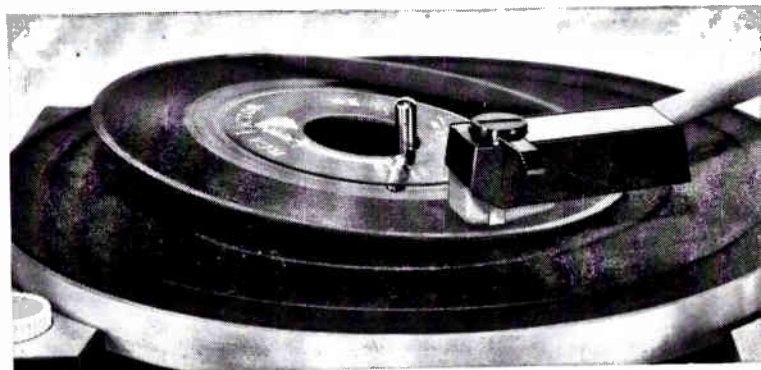

"warped" and eccentric tracking dramatizes frictionless bearings, low tonearm mass

No wonder the new Dual 1009 Auto/Professional obsoletes every turntable and changer ever made...at any price!

Standards of performance once associated with professional turntables and separate tonearms have now been matched or surpassed by a remarkable new record playing instrument . . . the Dual 1009 Auto/Professional by United Audio. Consider this achievement: A dynamically balanced automatic tonearm that tracks and trips below $\frac{1}{2}$ gram . . . resonance below 8 cps, tracking error below $.5^\circ$ /inch. A solid non-ferrous platter machined to electronically controlled tolerances, then dynamically balanced . . . final weight $7\frac{1}{2}$ lbs. A powerful high-torque motor that maintains speed accuracy with one record or ten . . . and acts like a hysteresis in resisting voltage variations (even beyond $\pm 10\%$.) For a convincing demonstration of flawless automatic tonearm tracking with the finest high compliance cartridges, visit your United Audio dealer today. At \$94.75, you'll find the strikingly handsome Auto/Professional a value that welcomes comparison with equipment at \$100 more!



UNITED AUDIO  DUAL
12 West 18th St. N.Y. 11

CIRCLE NO. 78 ON READER SERVICE CARD

BERLIOZ
SYMPHONIE FANTASTIQUE
THE PHILADELPHIA ORCHESTRA/EUGENE ORMANDY

VIVA VIVANT
The Seasons
The Philadelphia Orchestra/Eugene Ormandy
Ansel Brustlow Violin

THE PHILADELPHIA ORCHESTRA | EUGENE ORMANDY

THE MORMON TABERNACLE CHOIR
MESSIAH
Richard P. Condie, Director

THE PHILADELPHIA ORCHESTRA
EUGENE ORMANDY
AFTERNOON OF A FAUN DAPHNIS AND CHLOE NO. 2 LA MER

THE LORD'S PRAYER
THE MORMON TABERNACLE CHOIR
THE PHILADELPHIA ORCHESTRA, EUGENE ORMANDY

BACH
by Ormandy
Tocata and Fugue in D Minor
Sonatas for Double Orch. Op. 10, No. 1
Tocata, Adagio and Fugue in C Major
Paganella and Fugue in C Minor
The Philadelphia Orchestra
Eugene Ormandy, Conductor

WORLD PREMIERE RECORDED
TCHAIKOVSKY SYMPHONY NO. 7
EUGENE ORMANDY

AMERICAN RECORDING PREMIERE
SHOSTAKOVICH SYMPHONY NO. 4
THE PHILADELPHIA ORCHESTRA
EUGENE ORMANDY, Conductor

GRIEG
CONCERTO IN A MINOR FOR PIANO AND ORCHESTRA, OP. 16
RACHMANINOFF
Rhapsody on a Theme of Paganini, Op. 43
PHILIPPE ENTREMONT
THE PHILADELPHIA ORCHESTRA, EUGENE ORMANDY, CONDUCTOR

TCHAIKOVSKY SYMPHONY NO. 5
THE PHILADELPHIA ORCHESTRA
EUGENE ORMANDY

RESPIGI: THE FOUNTAINS OF ROME THE PINES OF ROME
THE PHILADELPHIA ORCHESTRA
EUGENE ORMANDY, CONDUCTOR

RACHMANINOFF SYMPHONIC DANCES
THE PHILADELPHIA ORCHESTRA AND THE PHILADELPHIA TABERNACLE CHOIR
CASELLA: PAGANINIANA
The Philadelphia Orchestra
Eugene Ormandy, Conductor

Carl Orff: CARMINA BURANA Carmina Proteana
The Philadelphia Orchestra, Eugene Ormandy, Conductor
Alice Hensley, soprano; Richard Patrick, tenor; Herve Prémont, baritone
The Rutgers University Choir; Austin Walker, director

ORMANDY THE PHILADELPHIA ORCHESTRA
FRANCK: SYMPHONY IN D MINOR

THE BELOVED CHORUSES
The Mormon Tabernacle Choir,
DR. RICHARD P. CONDIE, DIRECTOR
The Philadelphia Orchestra,
EUGENE ORMANDY, CONDUCTOR

ISAAC STERN
The Philadelphia Orchestra, Eugene Ormandy, Conductor
TCHAIKOVSKY: VIOLIN CONCERTO IN D MAJOR
MENDELSSOHN: VIOLIN CONCERTO IN E MINOR

1812 OVERTURE
THE PHILADELPHIA ORCHESTRA, EUGENE ORMANDY

A triumph of orchestral art
Richard Strauss
A Hero's Life (Ein Heldenleben)
The Philadelphia Orchestra
Eugene Ormandy

CARNIVAL IN VIENNA
EUGENE ORMANDY
THE PHILADELPHIA ORCHESTRA

SYMPHONY NO. 5
THE PHILADELPHIA ORCHESTRA
EUGENE ORMANDY, CONDUCTOR

TCHAIKOVSKY
THE SLEEPING BEAUTY, BALLET SUITE
THE PHILADELPHIA ORCHESTRA
EUGENE ORMANDY

Reis Bartók
Bluebeard's Castle
The Philadelphia Orchestra
Eugene Ormandy
Rosalind Elias as Judith
Jerome Hines as Bluebeard

Serkin/Ormandy
The Philadelphia Orchestra
Brahms: Piano Concerto No. 1 in D Minor

Tchaikovsky Swan Lake
(Ballet Suite)
THE PHILADELPHIA ORCHESTRA
EUGENE ORMANDY

THE LORD'S PRAYER VOLUME II
THE MORMON TABERNACLE CHOIR
RICHARD P. CONDIE, DIRECTOR
THE PHILADELPHIA ORCHESTRA
EUGENE ORMANDY, CONDUCTING

THIS IS MY COUNTRY
THE MORMON TABERNACLE CHOIR
RICHARD P. CONDIE, DIRECTOR
THE PHILADELPHIA ORCHESTRA
EUGENE ORMANDY, CONDUCTOR
THE STAR SPANGLED BANNER - TUNE OF MY COUNTRY
I'M LIVING IN MY HOME AND COUNTRY - LOVE ME, LOVE MY LITTLE TOWN
MATHY - THE WAVE LEAP FOR EVER - AMERICA, THE BEAUTIFUL
THE MARSHMALLOW - A BIRD SINGS THE SONG OF THE OCEAN

PORTS OF CALL
the philadelphia orchestra
EUGENE ORMANDY
navel: bolero la valsa paranaise bertet escalas
debussy: clair de lune chabrier: espagne

Dances for Orchestra
The Philadelphia Orchestra
Eugene Ormandy

TCHAIKOVSKY: PATHETIQUE SYMPHONY (NO. 6)
Eugene Ormandy

ISAAC STERN
BRANNS: VIOLIN CONCERTO IN D MAJOR
The Philadelphia Orchestra
Eugene Ormandy

STRAUSS
PON JIAN / DEATH AND TRANSGURATION
THE PHILADELPHIA ORCHESTRA / EUGENE ORMANDY

THE GLORIOUS SOUND OF WAGNER
The Philadelphia Orchestra
Eugene Ormandy

RESPIGI: FESTE ROMANE
SIBELIUS: Symphony No. 7
THE PHILADELPHIA ORCHESTRA
EUGENE ORMANDY

FINLANDIA
THE PHILADELPHIA ORCHESTRA, EUGENE ORMANDY, CONDUCTOR
SIBELIUS: FINLANDIA / WITH THE MORMON TABERNACLE CHOIR
SIBELIUS: PINE TREE SUITE NO. 1 ALFONSO BARRERA MARRASCO
SIBELIUS: WALK THERE

Serenade THE STRINGS OF
FOR THE PHILADELPHIA ORCHESTRA
SERENADES: SERENADE FOR STRINGS
Tchaikovsky: Serenade for Strings
Vaughan Williams: Fantasia on Greensleeves
Borodin: Nocturne for Strings
Barber: Adagio for Strings

THE SOUND OF GENIUS
EUGENE ORMANDY AND
THE PHILADELPHIA ORCHESTRA
ON COLUMBIA MASTERWORKS

All Stereo albums are also available in Guaranteed High Fidelity (Mono).

Rhapsodies
LISZT
Hungarian Rhapsodies Nos. 1 and 2
ENESCO
Roumanian Rhapsodies Nos. 1 and 2
THE PHILADELPHIA ORCHESTRA
EUGENE ORMANDY
Conductor

RACHMANINOFF/SYMPHONY NO. 2
EUGENE ORMANDY THE PHILADELPHIA ORCHESTRA

THE BLUE DANUBE
A Johann Strauss Festival
The Philadelphia Orchestra
conducted by Eugene Ormandy

SAINT-BARN ORGAN SYMPHONY
Op. 54, No. 1
THE PHILADELPHIA ORCHESTRA
EUGENE ORMANDY
L. POWER BIGGS, Organist

RIMSKY-KORSAKOV
scheherazade
THE PHILADELPHIA ORCHESTRA
EUGENE ORMANDY

SIBELIUS:
SYMPHONY NO. 2 IN D MAJOR OP. 43
THE PHILADELPHIA ORCHESTRA
SERKIN
Brahms Piano Concerto No. 2
Philadelphia Orchestra
Eugene Ormandy

HE PUT THE BLOOM ON THE TIGER...

In the hands of Eugene Ormandy, says Virgil Thomson, The Philadelphia Orchestra's sound has taken on a "wondrous bloom." Thomson compares The Philadelphia's precision, grace and agility to a tiger's. The analogy is apt. For, as conductor of this brilliant assemblage, Eugene Ormandy has shown himself to be not only a formidable musician, but something of a tiger-tamer.

Since 1936, he has wheedled, whipped, petted and pushed his 105 virtuosos, and today they perform with absolute singleness of mind, spirit and style. They respond with lightning coordination. They give shape to the subtlest nuance of meaning. Moreover, they produce a sound that is unique...opulent, lustrous, dazzling.

These gifts illuminate new and varied recordings by The Philadelphia. The rousing tempi of *A Festival of Marches*, by composers ranging from Beethoven to Sousa, Verdi to Prokofiev. Or an inspired performance of Brahms' masterpiece, *A German Requiem*, sung in English by Phyllis Curtin, Jerome Hines and The Mormon Tabernacle Choir. Whoever the composer, whatever the work, Ormandy and The Philadelphia are never less than perfect.

EUGENE ORMANDY AND THE PHILADELPHIA ORCHESTRA ON COLUMBIA MASTERWORKS

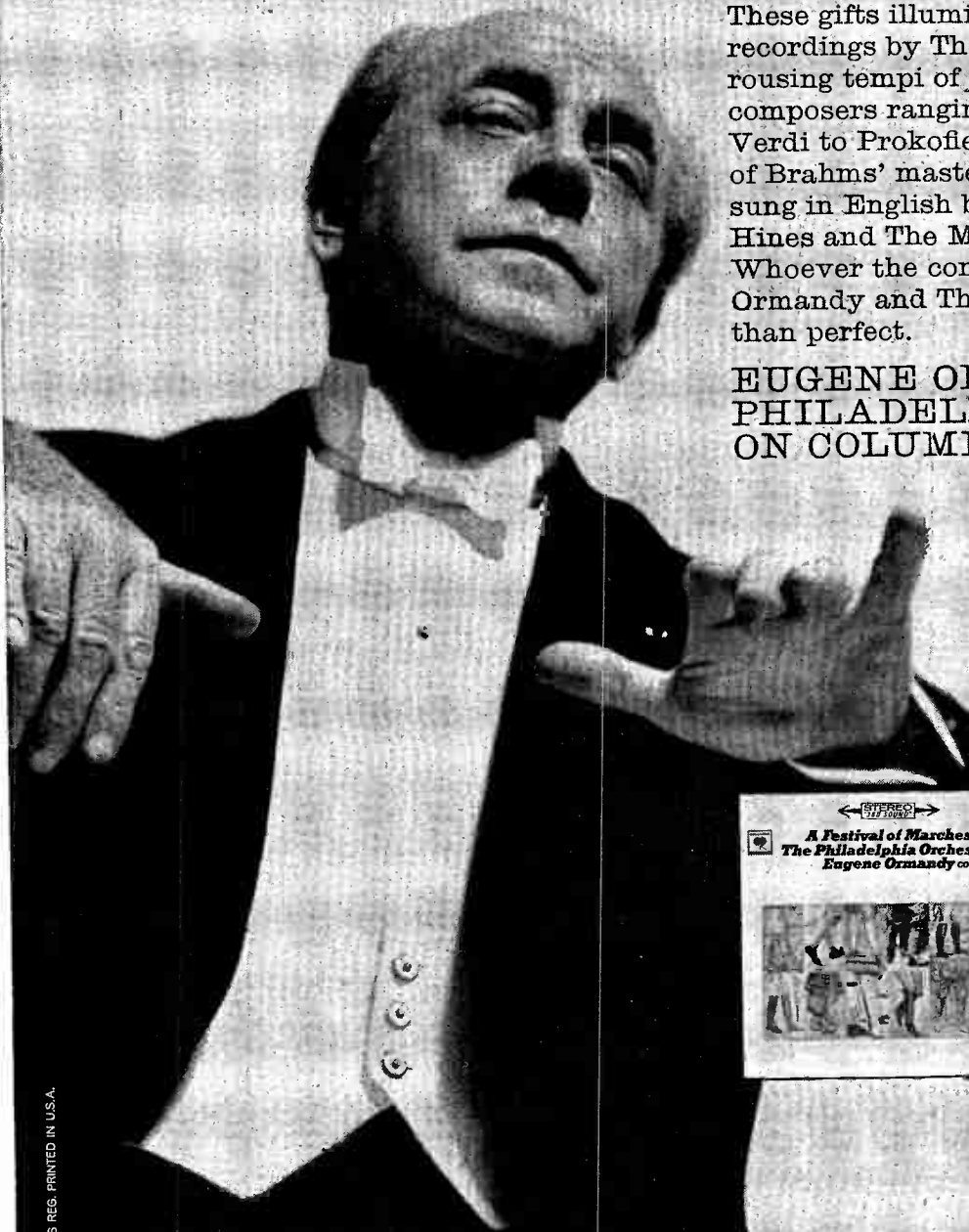

STEREO
BRAHMS
A GERMAN REQUIEM
SUNG IN ENGLISH
PHYLLIS CURTIN, SOPRANO
JEROME HINES, BASS
THE MORMON
TABERNACLE CHOIR
RICHARD P. CONDIE, DIRECTOR
ALEXANDER SCHREINER, ORGANIST
AND
THE PHILADELPHIA
ORCHESTRA
CONDUCTED BY
EUGENE ORMANDY
BRAHMS VARIATIONS & FUGUE
ON A THEME BY HANDEL
ARRANGED FOR ORCHESTRA
BY EDMUND RUBBRA



2-Record Set



classics

Reviewed by WILLIAM FLANAGAN • DAVID HALL

GEORGE JELLINEK • IGOR KIPNIS

Explanation of symbols:

- Ⓜ = monophonic recording
- Ⓢ = stereophonic recording
- * = mono or stereo version not received for review

Ⓢ Ⓜ ARNOLD: *Piano Trio, in D Minor, Op. 51*. LOEILLET: *Trio Sonata, in B Minor, Op. 2, No. 6*. SHOSTAKOVICH: *Piano Trio No. 2, in E Minor, Op. 67*. Lyric Trio (Arthur Tabachnick, violin; Shirley Evans, cello; Hilde Freund, piano). CONCERT-DISC CS 234 \$4.98, C 1234* \$4.98.

Interest: Chicago trio
 Performance: Vital
 Recording: Fine
 Stereo Quality: Excellent

Of the three trios (one properly a trio sonata) in this recital, the most impressive work is the Shostakovich on the entire second side, an alternately moody, sarcastic, and intensely lyrical piece composed in 1944. The charming eighteenth-century trio sonata by Jean Baptiste Loeillet is quite familiar in the present arrangement by Béon, who transferred the key from the original C Minor and readapted the viola d'amore and bass gamba parts for violin and cello. Malcolm Arnold's trio, written in 1956, is a first recording, but one wonders whether this might not be its only distinction: this eclectic work, ranging from overwrought post-expressionism to percussive discords à la Bartók, does not really add up to anything concrete.

The performers, who make their home in Chicago, expertly combine sound musicianship and vitality in the modern works (the unstylistic Loeillet in this edition is hopelessly and anachronistically romanticized) with superior technical finish and immaculate ensemble. The piano reproduction is a bit distant and wooden, but the disc is otherwise well recorded. Excellent stereo placement.

I. K.

RECORDING OF SPECIAL MERIT

Ⓢ Ⓜ BACH: *Cantata No. 6, "Bleib' bei uns, denn es will Abend werden"; Cantata No. 65, "Sie werden aus Saba alle kommen."* Ingeborg Reichelt (so-

prano), Hertha Töpfer (contralto), Helmut Krebs (tenor), Franz Kelch (bass), Pierre Pierlot and Jacques Chambon (oboes), August Wenzinger (violoncello piccolo), Marie-Claire Alain (organ), Monika Scheck-Wache (harpsichord); Heinrich Schütz Chorale of Heilbronn; Pforzheim Chamber Orchestra, Fritz Werner cond. EPIC BC 1261 \$5.98, LC 3861* \$4.98.

Interest: First recording of No. 6
 Performance: Very enjoyable
 Recording: Very good
 Stereo Quality: Fine

This recording of the Cantata No. 6, composed in Leipzig in 1736 for Easter

Wenzinger, makes this movement a real tour de force. Cantata No. 65, written in 1724 or perhaps the following year for Epiphany, is on a larger instrumental scale. Horns, recorders, and oboes da caccia portray the coming of the Magi. Again, the beginning chorus is splendid Bach. As with the previous two discs of Bach cantatas by these forces—No. 76 on Epic BC 1251/LC 3851; Nos. 80 and 87 on BC 1257/LC 3857—the chorus, instrumental soloists, and direction are all first-rate. The weak point of the earlier performances, the soloists, is far less apparent in the present release: each singer here turns in a thoroughly competent job. The recording has an aura of natural church acoustics, and is bright and clear,



THE LYRIC TRIO (SHIRLEY EVANS, ARTHUR TABACHNICK, HILDE FREUND)
Vitality, polish, and immaculate ensemble for works old and new

Monday, is, as far as I can trace, the first. The cantata is a fine work, with an impressive opening chorus, but its high point here is the chorale, for solo soprano, "Ach, bleib' bei uns," which Bach also adapted for organ in the Schübler Chorales. An obbligato solo for violoncello piccolo, brilliantly played here by August

except for some slight blasting in the tenor aria of No. 65 and the final chorale.

I. K.

Ⓢ Ⓜ BEETHOVEN: *Sonatas for Piano and Violin: A Minor, Opus 47 ("Kreutzer"); G Major, Opus 96*. David
 (Continued on page 69)

FREE

MAIL
CARD
TODAY

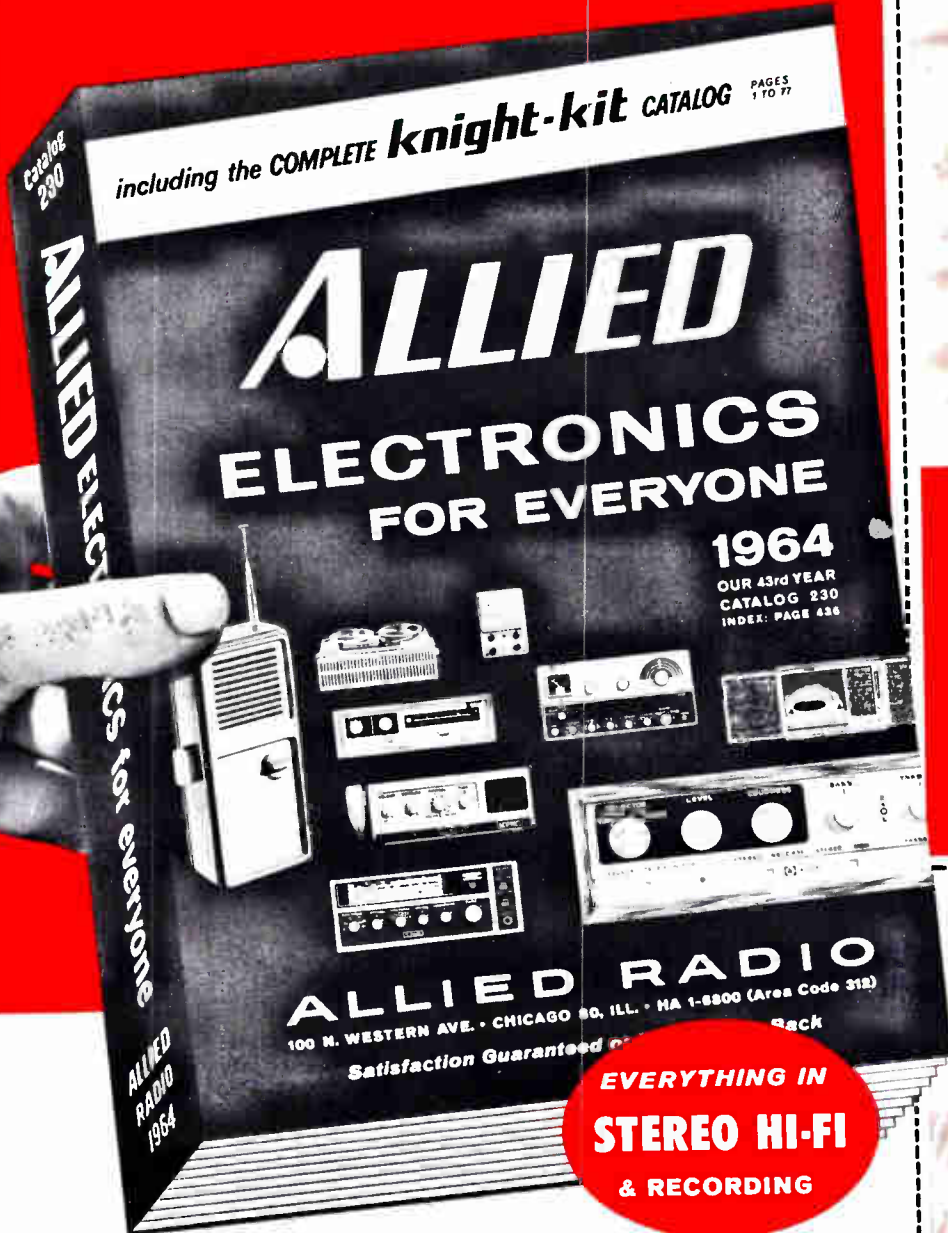

Name
PLEASE PRINT

Address

City Zone

State

10-K

YOUR **FREE**
ALLIED
1964 CATALOG



EVERYTHING IN STEREO HI-FI

Name
PLEASE PRINT

Address

City Zone

State

10-K

send card today for your money-saving

ALLIED 444-PAGE 1964
CATALOG

WORLD'S LARGEST HI-FI—ELECTRONICS CATALOG
BIGGEST SELECTION • BIGGEST SAVINGS!

satisfaction guaranteed or your money back

NO MONEY DOWN: NOW! MORE BUYING POWER WITH YOUR ALLIED CREDIT FUND PLAN!

SEE
OTHER
SIDE

For your FREE 1964 ALLIED Catalog, fill in card, detach and mail now. (Please give other card to an interested friend.)

SEND
CARD
TODAY

MAIL
NOW

YOUR **FREE**
ALLIED
1964 CATALOG



EVERYTHING IN STEREO HI-FI

P. O. Box 4398

TO:
ALLIED RADIO
CHICAGO 80, ILLINOIS

TO:

PLACE
STAMP
HERE

P. O. Box 4398

TO:
ALLIED RADIO
CHICAGO 80, ILLINOIS

TO:

PLACE
STAMP
HERE

MAIL
NOW

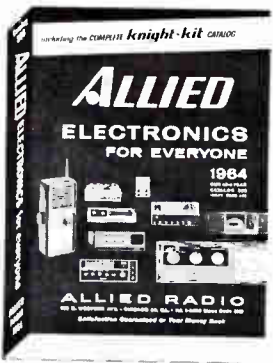

FREE send card today
for your 444-page
money-saving

ALLIED

HI-FI-ELECTRONICS
1964 CATALOG

WORLD'S LARGEST • BIGGEST SELECTION • BIGGEST SAVINGS!

Best Buys in Stereo Systems and Components



Choose from the world's largest selection of famous-make components and complete systems. See the latest all-transistor Stereo Hi-Fi. Save most on amplifiers, tuners, speakers and enclosures, record changers and players. Get our unbeatable price on a hi-fi system of your own choice.

Newest knight-kit® Build-Your-Own Hi-Fi



Build your own—build the best at big savings. It's easy, it's enjoyable to assemble your own KNIGHT-KIT Stereo hi-fi—and you get absolutely professional performance and appearance. Over 100 great hi-fi, hobby, CB radio, ham and instrument kits available.

Money-saving knight® Stereo High-Fidelity

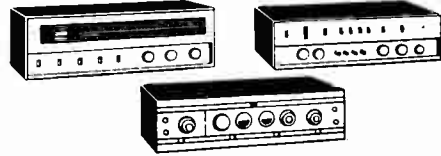

Allied's own top-value hi-fi line. Famous KNIGHT components and systems are equal in quality and performance to the very best, yet they're far lower in cost, give you most for your money. Full selection for every hi-fi need.

Everything in Tape Recorders, Tape and Recording Accessories



Enjoy the largest selection of complete recorders, including latest Stereo and professional types; tape decks, tape record/play preamplifiers, and recording accessories. Top values in quality recording tapes in all leading makes.

More for Your Money in Beautiful Hi-Fi Cabinetry



Wide selection of contemporary and authentic period styles—finest woods, construction and finish—at incomparable low cost. Includes complete equipment cabinetry and speaker enclosures.

Everything in Electronics for Everyone

- FM-AM & AM Radios • Phonographs & Accessories
- Citizens Band 2-Way Radios • Amateur Equipment
- TV Tubes & Antennas • Tools & Hardware
- Test & Lab Instruments • PA Systems & Intercoms
- Electronic Parts, Tubes, Transistors • Books

NO MONEY DOWN
Now! More Buying Power
with Your Allied
Credit Fund Plan!

satisfaction guaranteed or your money back

MAIL
NOW

FREE SEND CARD TODAY FOR YOUR
1964 ALLIED CATALOG

and give one card to an interested friend

Oistrakh (violin); Lev Oborin (piano).
PHILIPS PHS 900031 \$5.98, PHM
500031* \$4.98.

Interest: Great
Performance: Lyrical
Recording: Transparent
Stereo Quality: Pronounced

Though Beethoven sonata recordings have been released at a torrential rate recently, a new arrival with the credentials of this one is very welcome: it is the only coupling of Op. 47 and Op. 96 in the catalog today, and it is exceptionally well recorded. Furthermore, Oistrakh and Oborin, who have given us fine recordings of both sonatas before, offer renewed evidence of their superlative individual gifts and congenial team spirit.

Eloquent lyricism, unhurried tempos, and clean articulation are the salient virtues of this performance. With his golden tone and flawless technique, Oistrakh dominates, but Oborin, a less compelling artistic personality, is nevertheless an outstanding collaborator. Their "Kreutzer" ranks with the best: it is a pervasively lyrical, reposeful statement over thirty-four minutes in length, but it is neatly proportioned and under perfect virtuosic control. Though played no less beautifully, Op. 96 is somewhat less satisfying because the first-movement tempo is rather slow, and Oborin's account of the piano part is a shade unassertive. The Szeryng-Rubinstein and Schneiderhan-Seemann versions of Op. 96 offer better ensemble balance. *G. J.*

⑤ ⑥ BEETHOVEN: *Symphony No. 9, in D Minor, Op. 125 ("Choral")*. Jennifer Vyvyan (soprano), Shirley Verrett-Carter (contralto), Rudolf Petrak (tenor), Donald Bell (bass-baritone); London Symphony Orchestra and BBC Choir, Josef Krips cond. EVEREST SDBR 3110 \$5.98, LPBR 6110* \$4.98.

Interest: The monument
Performance: Worthy
Recording: Still good
Stereo Quality: Good

When this recorded performance was first issued in 1960 as part of a set of the Nine under Josef Krips' direction, it won well-deserved plaudits, for it combines a dramatic and finely molded interpretation in the best Viennese tradition, beautiful orchestral playing, and a first-rate job of stereo recording.

In this single-disc reissue, the solid musical merits of the performance are still vivid. The first two movements are especially noteworthy, and praise is in order for the fine work of the BBC Choir. Minor exception must be taken to the absence of true bass quality in Donald Bell's singing of the celebrated last-movement "O Freunde" recitative.

OCTOBER 1963

←CIRCLE NO. 5 ON READER SERVICE CARD

Considering that each side of this disc is more than thirty-two minutes in length, the technical quality of the recording is better than average, especially in the first two movements. The inevitable tape splice midway in the slow movement has been managed rather clumsily.

Judged with the eight other available Beethoven Ninths on stereo, I rate this on a par with the Klemperer and Szell two-disc versions for its interpretation. But it is by no means the equal of those of Szell or Reiner in quality of reproduction. Ansermet's is the only single-disc version in stereo, and the Krips outstrips it on all counts. *D. H.*

RECORDING OF SPECIAL MERIT

⑤ ⑥ BORODIN: *String Quartet No. 2, in D*. SHOSTAKOVICH: *String Quartet No. 8, Op. 110*. Borodin Quartet. LONDON CS 6338 \$5.98, CM 9338* \$4.98.

Interest: Lovely chamber music
Performance: Sympathetic and sensitive
Recording: Good
Stereo Quality: Good

If you can forget, or have never heard, the ghastly popular song that was culled from Borodin's quartet by the parasitic composers of an abomination called *Kismet*, you should find this simple, radiant work all pleasure and charm. And you will surely wait a long time to hear it in a more winning performance.

The Shostakovich Quartet—which was composed in Dresden in 1960 and which I, at least, have never heard before—is a striking and deeply moving personal statement. Although the musical materials are in themselves unremarkable, one is held in thrall from the first note to the last by the intensity of the musical utterance. One is finally left to wonder at the personal considerations that account for its moments of grave understatement, its dark ruminations.

The Borodin Quartet's performance of the Shostakovich is remarkably sustained, and the recording is subtle and revealing. *W. F.*

BRAHMS: *Liebesslieder Waltzes, Opus 52* (see SCHUMANN).

RECORDING OF SPECIAL MERIT

⑤ ⑥ BRAHMS: *Piano Sonata No. 3, in F Minor, Op. 5; Intermezzos: E-flat, Op. 117, No. 1; C Major, Op. 119, No. 3*. Clifford Curzon (piano). LONDON CS 6341 \$5.98, CM 9341* \$4.98.

Interest: Brahms early and late
Performance: Ripely romantic
Recording: Rich and solid
Stereo Quality: Good

(Continued on page 72)



BIRGIT NILSSON
sings

AIDA

METROPOLITAN
OPERA OPENING
OCTOBER 1963



Birgit Nilsson Soprano, with Grace Hoffman Mezzo Soprano, Luigi Ottolini Tenor, Louis Quilico Baritone, Orchestra of the Royal Opera House, Covent Garden John Pritchard Conductor.
Stereo: OS 25798 Mono: 5798

BIRGIT NILSSON
sings

AIDA

ON A STRIKING
NEW LP

Trademarks Reg. U. S. Pat. Off.
LONDON *ffrr?*
FULL FREQUENCY RANGE RECORDING

**ALFRED and ROBERTA
DRAKE and PETERS
SING THE POPULAR MUSIC OF
LEONARD BERNSTEIN**

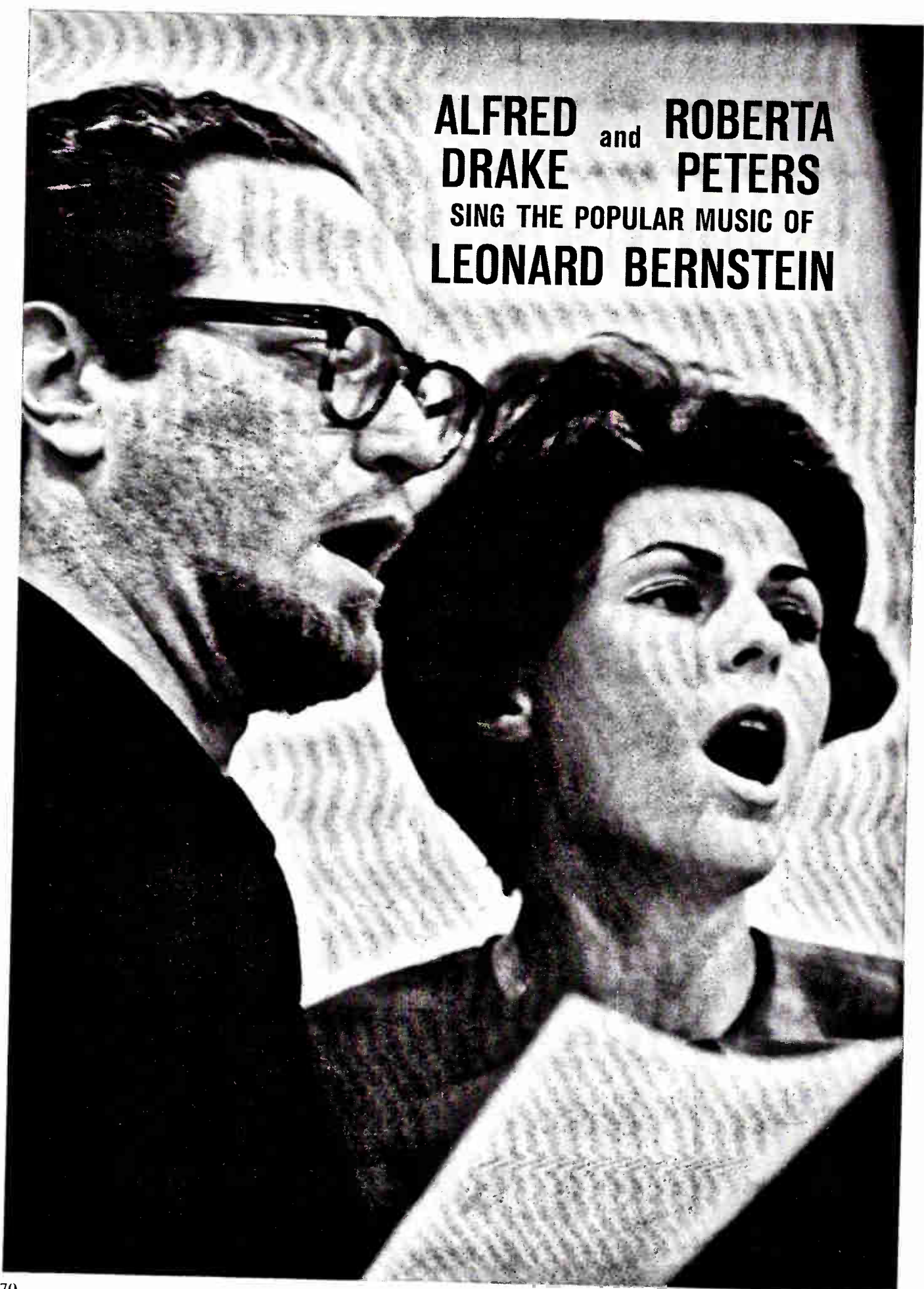

How Command and Enoch Light created the most exciting album ever made



ENOCH LIGHT conducts the COMMAND 50-piece orchestra with RAY CHARLES conducting the singers.

Here is the amazing story of one of the most unprecedented combinations of brilliant artistry that has ever been brought together to create a magnificent record album...

ALFRED DRAKE and ROBERTA PETERS
 Sing the Popular Music of
LEONARD BERNSTEIN
 with THE RAY CHARLES SINGERS
 and
 ENOCH LIGHT and his orchestra

This album is one more giant step in the fantastic succession of advances in recording artistry that have been made by Command and Enoch Light.

An unprecedented combination of brilliant artistry

Think of it! Here are some of the most compelling songs heard on Broadway in the past 20 years, all composed by the most overwhelming talent in modern American music, Leonard Bernstein.

Here is music sung by two of the most dynamic vocalists on theatre or opera stages, Alfred Drake and Roberta Peters, supported by the amazingly versatile Ray Charles Singers.

Here is the music, the talent, the artistry all conducted and produced in fresh, revealing interpretations by the unrivaled master of modern musical recordings, Enoch Light, with a 50 piece orchestra. And recorded in magnificent total reality by Command's astonishing 35 mm magnetic film technique.

No wonder this album must be considered musical excitement without limit!

Incredible aggregation of talent

Leonard Bernstein, of course, is the most fully developed all around musical talent that the United States has yet produced. In this sense he may well be the first complete American musician. He has composed symphonies and ballets as well as Broadway shows. He is, of course, primarily a conductor, the first American-born musical director of the New York Philharmonic and a pianist of great note.

To project the exciting musical concept he was developing on Bernstein's music, Enoch Light chose Alfred Drake and Roberta Peters. Both had received dazzling critical acclaim for their singing in Command's brilliant recorded production of Rodgers and Hammerstein's *Carousel*.

Drake, as versatile a man of the theatre as Bernstein is in the world of music, is an outstanding actor and director on Broadway. He has been the top ranking leading man for musicals ever since he created the role of Curly in the original production of *Oklahoma!*

Miss Peters is that rarity who is equally at home singing popular music as well as in her own *metier*, opera. Her coloratura soprano vocal pyrotechnics has astounded audiences in capitals throughout the world.

The distinctive clarity of their treatment of lyrics and the musical imagination that has always distinguished the Ray Charles Singers on television and radio made them the obvious choice to project the unusual choral effects in these Leonard Bernstein songs.

Painstaking, extremely costly

In preparing this album, Enoch Light and his Command staff researched all of Bernstein's Broadway music with painstaking care. They were not only looking for the most interesting and provocative material, but for the right way to present each song so that its own individual quality could be brought out fully.

Every detail of the recording was carefully studied in advance to establish the best possible conditions for creating performances that would stand as definitive interpretations of the wonderful music that Leonard Bernstein has written.

A multiplicity of microphones, each selected for its response to a particular instrument or voice, were placed around the studio.

The singers worked on a raised stage. Enoch Light stood just below them to conduct the orchestra. He purposely worked as close to the singers as he possibly could, so close that he could actually feel them react emotionally so that he in turn could get the quickest possible response from the orchestra.

Although the volume of the orchestra was always kept at a very low level in relation to the singers, Light was able to make the rhythmic tension and the precision of the accompaniment felt even in the most delicate pianissimo passages.

The overwhelming sense of realism in the final recording is the result of the miraculous properties of Command's unique use of 35 mm magnetic film recording techniques and a painstaking and extremely costly mastering process which involved the unheard of total of thirteen complete mastering sessions before the final result.

We believe this album will become a musical milestone in the history of recorded music.

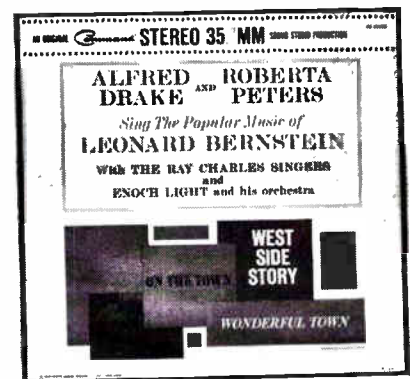

Selections Include: NEW YORK, NEW YORK (On the Town); LUCKY TO BE ME (On the Town); TONIGHT (West Side Story); THE BEST OF ALL POSSIBLE WORLDS (Candide); I FEEL PRETTY (West Side Story); MARIA (West Side Story); GEE, OFFICER KRUPKE (West Side Story); GLITTER AND BE GAY (Candide); LONELY TOWN (On the Town); IT'S LOVE (Wonderful Town); FINALE (West Side Story). ALBUM NO. 855

AVAILABLE IN STEREO,
 MONAURAL AND 4-TRACK TAPE

Write for FREE full color
 brochure of all COMMAND releases

World Leader
 in Recorded Sound
Command
 records

1501 BROADWAY, NEW YORK 36, N. Y.



Now available for the first time in the United States!
THE NINE FOR OUR TIME



BEETHOVEN: THE NINE SYMPHONIES

Winner of the coveted Grand Prix du Disque

HERBERT VON KARAJAN • BERLIN PHILHARMONIC

Beethoven's Nine Symphonies bear invincible testimony to man's fate and man's hope, for all time. The standards set for this project were the highest ever attempted in the annals of recorded music. They were surpassed. This deluxe, handsomely boxed and superbly annotated set of 8 records is now available at finer record stores everywhere.

THE PRICE? Less than you think... Ask your record dealer.
 Mono-KL 1-8 • Stereo SKL 101-108

"This is easily the most consistently satisfying cycle of the Nine to have appeared in Stereo."—THE GRAMOPHONE

Soloists in the Ninth Symphony: Janowitz, Roessel-Majdan, Kmennt, Berry, with the famous Vienna Singverein chorus.

DIRECT IMPORT  **FACTORY SEALED**

MGM RECORDS, CLASSICAL DIVISION, 1540 Broadway, N.Y. 36, N.Y.

The F Minor sonata is an opulent and often stormy piece in five movements. Its performance requires a pianist who is master of the grand Romantic manner and one who has absolute command of structural proportion, phrasing, and tempo. Curzon and Rubinstein (who plays the sonata for RCA) are equally well qualified to tackle it. Rubinstein seeks to lighten the predominantly dark music with something of his own special brand of extraverted rhythmic dynamism. Curzon has no hesitation in emphasizing the somber Romanticism of the work, preferring, in effect, to place it in the traditions of its historical period rather than to modernize it. Both approaches are valid, but I find myself more in tune with Curzon's. And I also like the bite and solidity of London's piano recording. In the intermezzos, Curzon fares best in the lovely Op. 117, No. 1—his touch is just a bit heavy with the lissome C Major, the last of Brahms' works in this form.

D. H.

Ⓢ Ⓜ **CILÈA: *Adriana Lecouvreur*** (excerpts). Renata Tebaldi (soprano), Mario del Monaco (tenor), Giulietta Simionato (mezzo-soprano), Giulio Fioravanti (baritone). Chorus and Orchestra of the Accademia di Santa Cecilia Rome, Franco Capuana cond. LONDON OS 25715 \$5.98, 5715* \$4.98.

Interest: Excellent abridgement
 Performance: Passionate
 Recording: Very good
 Stereo Quality: Appropriate

According to most New York critics, Renata Tebaldi and Rudolf Bing committed an outrage during the Met's 1962-1963 season by forcing on the public an unwanted revival of *Adriana Lecouvreur*. Their fury could have been more wisely spent, I think, on more vital issues of our musical life. Even if Cilèa was a minor light in an age that produced a wealth of major operatic composers, should he be dismissed with such unbridled contempt? Actually, *Adriana Lecouvreur*, an opera in which sensuous melodies are skillfully combined with some obvious but effective musico-dramatic devices, is decidedly worth an occasional revival.

London's disc of highlights, proficiently assembled from the complete three-disc set, argues this most persuasively. It offers the opera's most important scenes, those in which Cilèa's melodic inspiration looms strongest, without exhibiting his striking weakness: repeating his melodies until they wear out their welcome. The cast sings lustily in expert *verismo* vein. Simionato is perfect as the villainous Princess, and Tebaldi and Del Monaco are in characteristic form. Finding some fault with their singing is rela-

(Continued on page 74)

HIFI/STEREO REVIEW

new
low
price:
\$600



FURNITURE DESIGNED BY GEORGE NELSON FOR HERMAN MILLER, INC.

"Handles tape like a \$1000 deck," said one audio editor after an hour with the Vernon 47/26. Most impressive, he found, was the all-electronic keyboard with its computer-type logic circuits that silently masterminded the tape movement in every mode. No relays or electro-mechanical devices. Instead, "one shot multiplex," "flip flop" and diode gate circuits that act with the swiftness of electrons. More than just a superb tape transport, the Vernon is complete with two preamplifiers, two record/playback amplifiers (twenty watts output) and remarkably smooth built-in monitoring speakers. With its impressive complement of 47 transistors and 26 diodes in its highly advanced solid state circuitry, the Vernon offers acoustic performance comparable only to the best of com-

ponent amplifiers. Further, its styling is as functional as it is handsome. All switches and controls are sensibly organized for utmost ease, flexibility and efficiency. The tone/contour, recording and playback level controls function either independently or ganged. Operate the Vernon vertically, horizontally, or at studio-angle. Other notable features: three motors, three tapeheads, multiple intermix inputs (for *authentic sound-on-sound*), automatic shut-off, automatic rewind/replay, one second electronic delay, monitoring from tape or preamp, provision for remote control. Put the Vernon through its many paces at your audio dealer's . . . you'll find it an entirely new experience. Or write for literature. Vernon Audio Division, 144 E. Kingsbridge Road, Mt. Vernon, N. Y.

CIRCLE NO. 90 ON READER SERVICE CARD

vernon
47/26
stereo tape recorder
and audio center

tively easy, but finding other singers who could do these roles as convincingly or as passionately would be difficult. *G. J.*

⑤ ⑥ **DEBUSSY: *La Mer; Three Nocturnes.*** Philharmonia Orchestra, Carlo Maria Giulini cond. ANGEL S 35977 \$5.98, 35977 \$4.98.

Interest: An Italian in France
Performance: Never!
Recording: A mite dim
Stereo Quality: All right

To mince no words, this performance of Debussy's *La Mer* simply will not do. Debussy's score is as tautly constructed as any Mozart symphony, and it is no good to treat it otherwise, presumably to evoke impressionistic "mood." Giulini sectionalizes the movements and then stretches the sections into amorphous blobs of sound. The rhythmic pulse that generates the structure of the second *Nocturne, Fêtes*, keeps the conductor from doing it similar violence—the work almost plays itself. But again, in *Nuages*, games are played that quite do the piece in. The recording is clear, but a little distant and muted. *W. F.*

⑤ ⑥ **DORATI: *Symphony; Nocturne and Capriccio for Oboe and String Quartet.*** Roger Lord (oboe), Allegri

String Quartet; Minneapolis Symphony, Antal Dorati cond. MERCURY SR 90248 \$5.98, MG 50248* \$4.98.

Interest: A conductor composes
Performance: Excellent
Recording: Good
Stereo Quality: Helpful

Dorati's symphony possesses all those qualities one would look for in the composition of an expert, experienced conductor. Every bar, every chord "sounds"; the orchestration, in no apparent way personal or innovating, comes off with a bang—as, indeed, does the piece itself as musical continuity, as formal construction, as musico-theatrical gesture.

Still, I miss something—the authentic something extra of the born creator. The key word is, I expect, "inevitability." I am convinced that the man can compose, and I am even impressed with what he has written. But each new theme, each new section, each new movement seems rather like another costume that its creator has tried on. Each fits splendidly, and he wears them dashingly—but somehow none is really, truly "him."

It should be added that the work, although well spiked with diatonic dissonance, is accessible and, more often than not, quite lyrical. The curious collector—who might be quite properly less than

fully convinced of the infallibility of my findings—will not be faced with a difficult, perverse, or avant-garde work.

An inch or so of left-over disc space is occupied by Dorati's *Nocturne and Capriccio*—a sprightly, idiomatic, but rather mechanical little number that itself seems something of a left-over. *W. F.*

FAURÉ: *Trio, Opus 120* (see MENDELSSOHN).

RECORDING OF SPECIAL MERIT

⑤ ⑥ **HANDEL: *Concerto, in B-flat Major, for Harp and Orchestra, Op. 4, No. 6.*** MOZART: *Concerto, in C Major, for Flute, Harp, and Orchestra (K. 299).* Marcel Grandjany (harp); Samuel Baron (flute); Musica Aeterna Orchestra, Frederic Waldman cond. DECCA DL 710075 \$5.98, DL 10075* \$4.98.

Interest: Harp virtuosity
Performance: Superb
Recording: Splendid
Stereo Quality: Excellent

Neither of these works is new to records, nor is there a dearth of good performances. Yet, at least in the Mozart, the superb playing of Grandjany and Baron (Continued on page 78)

JAZZ AT PRESERVATION HALL

~ ~ ~

THE DEFINITIVE RECORDINGS OF NEW ORLEANS JAZZ

AVAILABLE IN STEREO

ATLANTIC

Volume 1 — 1408

JAZZ AT PRESERVATION HALL

**THE EUREKA BRASS BAND
OF NEW ORLEANS**

AS

Volume 2 — 1409

JAZZ AT PRESERVATION HALL

**BILLIE & DE DE
PIERCE** | **JIM ROBINSON'S
NEW ORLEANS
BAND**

AS

Volume 3 — 1410

JAZZ AT PRESERVATION HALL

**PAUL BARBARIN | PUNCH MILLER'S
& HIS JAZZ BAND | BUNCH & GEORGE LEWIS**

AS

Volume 4 — 1411

JAZZ AT PRESERVATION HALL

**THE GEORGE LEWIS BAND
OF NEW ORLEANS**

AS

YOU COULD SPEND \$100 MORE AND NOT GET BETTER PERFORMANCE

(or better features, or better quality.)

INTRODUCING the new Rek-O-Kut R-34 playback system—a complete 2-speed turntable, tonearm, and base unit, WITH A 5 YEAR GUARANTEE ... unheard of in the audio industry! When we say our turntables are built to take it—we mean it.

INSTANT SPEED SELECTOR.
A mere flick of your finger changes its speed from 33 $\frac{1}{3}$ to 45 rpm. An exclusive Rek-O-Kut feature.

HYSTERESIS SYNCHRONOUS MOTOR. Pabst is its name. Pioneered by Rek-O-Kut. For constant speed no matter what the variation in line voltage. It's the first time *this* motor (used in our higher-priced units) has been used in a system at *this* price.

ISOLATION SUSPENSION: Totally eliminates acoustic feedback. Makes vertical rumble a negative factor. No need for complicated spring devices to shock-mount your playback system. **Ever.**

S-340 TONEARM.
A modified version of the S-320 professional tonearm. Tracks at less than one gram! Resonance factor is *below* 12 cycles. Ruggedly constructed, its removable cartridge shell handles *any* standard cartridge. Available separately at \$24.95.



SOLID OILED-WALNUT BASE. Fine furniture crafted.

SPECIFICATIONS.
Noise and rumble: —60 db below average recorded level (@ 7 cm/sec. @ 1000 cps). Flutter & wow: .08% RMS. Dimensions: 15" x 14 $\frac{1}{2}$ " x 5 $\frac{1}{2}$ " (overall height, including tonearm).

ONE-PIECE CAST ALUMINUM TABLE. Full-size, 12 inch, professional quality. Dynamically balanced. Its weighted rim provides all the necessary flywheel motion for perfect rotation at constant speed.

EXCLUSIVE REKOTHANE BELT. Polyurethane. Individually ground to precision tolerances, this belt reduces noise and rumble *minus 6 db lower than any other belt.* And unless you actually cut or tear a Rekothane belt it should work for the life of the unit.

SIGNIFICANT PRICE. ONLY \$89.95!

A most modest price for such quality. See your dealer for a comparison demonstration. Only then will you know why you could spend \$100 more and not get better performance (or better features, or better quality).

REK-O-KUT, the world's largest manufacturer of turntables. 38-19 108 Street, Corona 68, New York

Export: Morhan Exporting Corp., 458 B'way, N.Y.C. Canada: Atlas Radio, 50 Wingold Ave., Toronto 19

CIRCLE NO. 94 ON READER SERVICE CARD

TODAY...A GREAT NEW A GREAT NEW BREED OF THE INCOMPARABLE 1000



THE A-1000T PROFESSIONAL SOLID STATE INTEGRATED 70-WATT STEREO AMPLIFIER

In much of today's advertising the word great is stretched and strained beyond belief. In the new 1000 Series Harman-Kardon recaptures its full meaning.

The A-1000T and F-1000T provide the cleanest, most transparent sound ever achieved in an integrated stereo amplifier and FM stereo tuner.

Both reflect Harman-Kardon's years of research in the application of semi-conductors to high fidelity design. This new technology breaks through the performance limitations imposed by vacuum tubes and audio transformers in conventional components. It permits the engineer to design to the theoretical limits of perfection.

Consider the A-1000T, 70-Watt Stereophonic

Amplifier. It is the **first** integrated amplifier to extend the range of reproduced sound well beyond the normal range of hearing — an **unprecedented** 10 to 100,000 cps, $\pm 1/2$ db! But equally important — the A-1000T delivers solid usable power across the entire bandwidth.

Through the use of specially designed high power, industrial-grade silicon semi-conductors, its 70 watts is **pure** power. Distortion is actually **unmeasurable!**

The results (a visit to your dealer will verify them): tone quality that is totally transparent and true to the original; unsurpassed instrument separation and perfect speaker control (damping) over the entire audio spectrum! Use any speaker system

TECHNOLOGY PRODUCES STEREO INSTRUMENTS— SERIES BY **harman kardon**

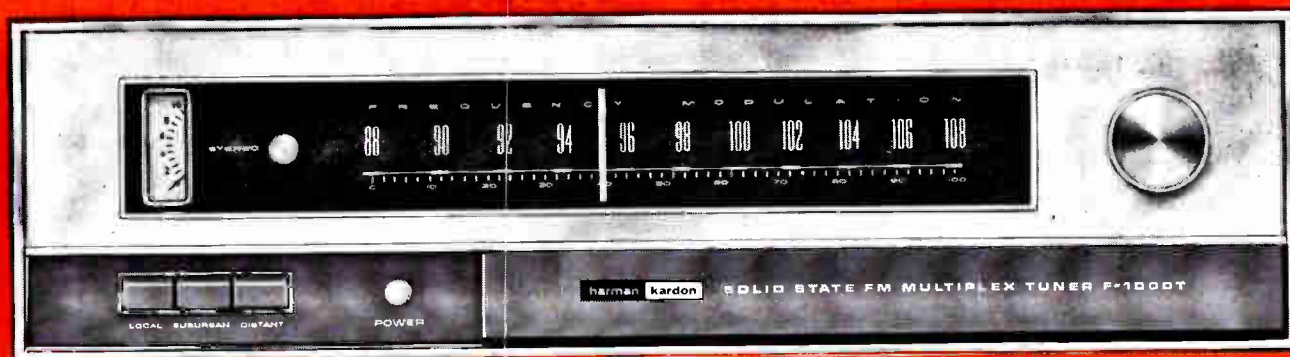

THE F-1000T PROFESSIONAL SOLID STATE AUTOMATIC FM STEREO TUNER

you wish — high or low efficiency — the A-1000T will make it sound better. **Demonstrably** better.

The F-1000T is the perfect mate for the A-1000T. It is the first FM stereo (multiplex) tuner free of drift, distortion, hum, heat and microphonics. With its exclusive STEREO-LOGIC circuit, it even thinks for you. This new device **automatically** switches the tuner to stereo the instant a station broadcasts stereo!

With its high gain, low noise-RF stage, and ultra-wideband IF and limiter stages, the F-1000T's reception is free of noise and interference even in fringe areas. To assure "radar" selectivity and error-proof tuning, the F-1000T offers a new Quadra-tuned front-end with special mesa-alloy

diffused junction transistors, plus a professional D'Arsonval signal strength tuning meter. In short, the F-1000T meets the highest professional broadcast standards.

In their striking good looks, both instruments embody the true elegance of totally functional design. (The lower right-hand panel on each unit is a hideaway door for all infrequently used controls!)

For a completely documented brochure on these remarkable new instruments, write Dept. R-10, Harman-Kardon, Inc., Plainview, N. Y. The price of the A-1000T is \$369.95; the F-1000T, \$299.95. All prices are slightly higher in the West.

harman kardon

A subsidiary of THE JERROLD CORPORATION

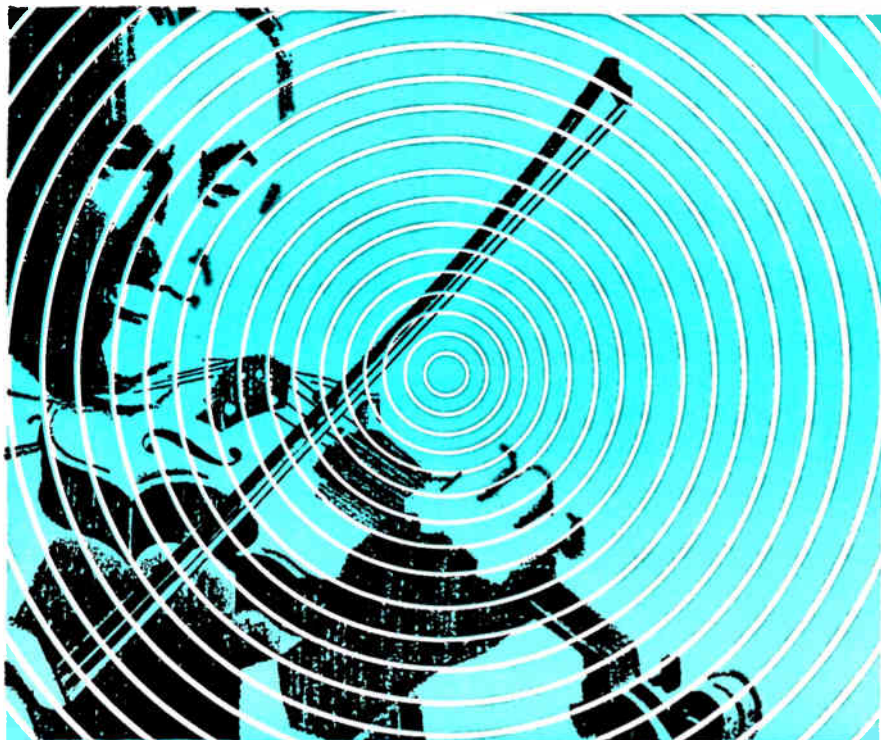

achieve THRILLING LIVING PRESENCE

WITH THE **FINCO**[®]
AWARD-WINNING FM ANTENNA

Broadcasting authorities agree that an outdoor antenna is absolutely essential for the reception of full quality monaural and multiplex FM sound.

A *FINCO* FM antenna will deliver a clean, undistorted signal and bring in more stations, regardless of location.

Guarantee yourself the best seat in the house for tonight's FM concert... install a fidelity-phased *FINCO* FM antenna.

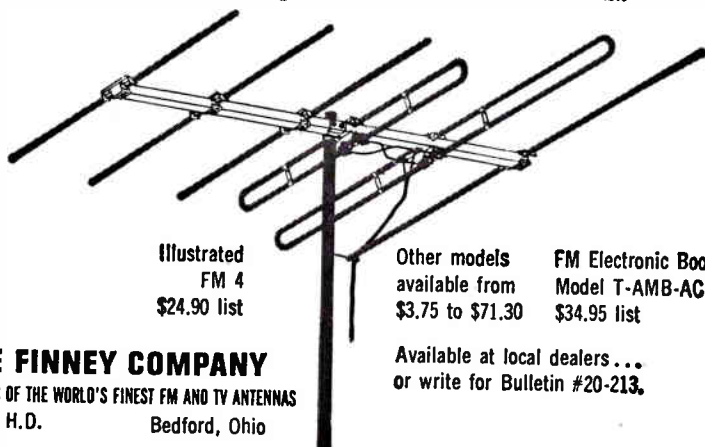

Illustrated
FM 4
\$24.90 list

Other models
available from
\$3.75 to \$71.30

FM Electronic Booster
Model T-AMB-AC
\$34.95 list

Available at local dealers...
or write for Bulletin #20-213.

THE FINNEY COMPANY
PRODUCERS OF THE WORLD'S FINEST FM AND TV ANTENNAS
Dept. H.D. Bedford, Ohio

is so enjoyable that one can easily forget that the flute and harp concerto is not one of the composer's most inspired works. Both artists' uncanny technical abilities, interpretive powers, and splendid rapport with one another make this decidedly the preferred version. Grandjany's elegant virtuosity is also heard to good effect in the Handel, though the interpretation, complete with an elaborate and spectacular second-movement cadenza, is quite Romantic in concept and full of misplaced crescendos and diminuendos. It is very well played, but for a more authentic realization, in a reconstruction for harp and lute, I recommend the performance on L'Oiseau-Lyre 60013/50181. The orchestral support for the present soloists is well handled, and the recorded sound has breathtaking clarity and superb balance between the solo instruments. *I. K.*

© [®] **HANDEL: Six Concerti Grossi, Op. 3.** Mainz Chamber Orchestra, Günther Kehr cond. Vox STDL 500940 \$4.98, DL 940 \$4.98.

Interest: Prime Handel
Performance: Excellent
Recording: Full but a bit harsh
Stereo Quality: Very good

The Op. 3 Concerti Grossi are musically on a par with the more famous and longer Op. 12 set. The performances here are spirited, vital, and graceful, with all the stylistic know-how in double-dotting and embellishment of solo passages that goes to make up a correct Baroque interpretation. The solo keyboard part in the last movement of No. 6 is played here on the harpsichord rather than on the customary organ, but unfortunately no credit is given the adept performer.

Certainly there are not many recorded performances of Handel that are realized as well as this, but with the Op. 3 the record buyer is faced with an embarrassment of riches, for two other equally good recordings of this music are also available. The earlier version, by Boyd Neel on London CM 9117, is contained, like this one, on a single disc in mono only; August Wenzinger's, on Archive ARC 73139/40 (stereo) and 3139/40 (mono), takes up two records but includes an alternate version of the fourth Op. 3 concerto plus the "Alexanderfest" Concerto. The only important difference between the present performance and these others is the quality of the Mainz ensemble: perfectly respectable—with excellent oboe soloists—yet not quite as refined instrumentally as either Neel's or Wenzinger's. Vox's recording is full-bodied, though slightly harsh. *I. K.*

MICHAEL HAYDN: Divertimento in G Major (see MOZART: *Divertimento in B-flat Major*).

RECORDING OF SPECIAL MERIT

© © HUMMEL: *Quartet, for Clarinet and Strings, in E-flat Major*. WEBER: *Quintet, for Clarinet and Strings, in B-flat Major, Op. 34*. David Glazer (clarinet); Kohon Quartet of New York University. Vox STDL 500960 \$4.98, DL 960 \$4.98.

Interest: Chamber rarities
Performance: First-rate
Recording: Very satisfying
Stereo Quality: Excellent

Johann Nepomuk Hummel (1778-1837), today not much more than a textbook name, was a composer and pianist who studied with Mozart, Clementi, and Johann Georg Albrechtsberger, Beethoven's teacher. He had an enormously high reputation as a pianist, and as an improviser at the keyboard he was considered a rival of Beethoven. Very little of his music is heard now, and still less is recorded, but to judge from the quality of the present quartet, written in 1808, we are the poorer for the situation. The quartet's style is Beethovenesque, but it is a lovely composition, well constructed and with engaging ideas.

The Weber piece dates from 1815 and is equally melodious, with a particularly brilliant finale. The only previous recording, also by Vox, has long been out of print. The performances by David Glazer and the excellent Kohon Quartet are all one could ask for in interpretive understanding, technical finish, and perfect blending of ensemble. The soloist's tone and technique are admirable, and he is expertly balanced with his partners. The quality of the recording is perfect. I. K.

© © LORTZING: *Zar und Zimmermann (excerpts)*; *Der Waffenschmied (excerpts)*. Hilde Gueden (soprano), Waldemar Kmentt (tenor), Eberhard Wächter (baritone), Oskar Czerwenka (bass), Fritz Muliari (speaker). Vienna State Opera Chorus and Vienna Volksoper Orchestra, Peter Ronnefeld cond. LONDON OS 25768 \$5.98, 5768* \$4.98.

Interest: German comic operas
Performance: Zestful
Recording: Rich
Stereo Quality: Good

According to a recent survey based on frequency of performances, the popularity of Albert Lortzing (1801-1851) in German-speaking countries nearly equals that of Wagner. This almost incredible fact should stimulate some interest in this collection of highlights from two of Lortzing's best-known operas.

The regional appeal of Lortzing is not surprising, for his operas are the best German counterparts to *opera buffa* and *opéra comique*. They exude national

spirit and abound in folkish melodies and dances. But it is also evident why Lortzing does not hold his own against Rossini, Donizetti, Auber, or Boieldieu in non-Germanic lands. As a composer and as his own librettist, he was singularly unsophisticated, with an unfortunate flair for platitudes. He did have a genuine talent for comedy, and his handling of such scenes as "Den hohen Herrscher" in *Zar und Zimmermann* reveals competent if not quite Rossinian comic craftsmanship.

The lengthy excerpts offered on this disc will probably satisfy the average operaphile's curiosity to hear Lortzing. The

thoroughly idiomatic performances of Gueden and Kmentt rate high for polish and lyricism, and Czerwenka's does the same for gusto and broad buffo flavor. Wächter sings the famous aria "Sonst spielt' ich mit Zepter" acceptably, but without the tonal richness that made the recordings of Schorr and Schlusnus treasurable. The recorded sound is fine and the orchestral performance expert, but for some reason the selections do not follow their normal operatic sequence. G. J.

© © MENDELSSOHN: *Trio in D Minor*. FAURÉ: *Trio, Op. 120*. André Previn (piano), Feri Roth (violin), Jo-

RECORDS AT COST through our Special Membership Plan...

BUILD YOUR RECORD LIBRARY INEXPENSIVELY, QUICKLY, CONVENIENTLY — NO "AGREE TO PURCHASE" OBLIGATION — CHOOSE THE RECORDS YOU WANT

The Citadel Record Club is a membership club that entitles its members to purchase singles, hi-fi and stereo albums at cost: classical, popular, jazz, show hits, folk.

All are available and at prices that never vary from our published price list. There are never any "list price" purchases through Citadel.

CITADEL MEMBERSHIP — THE PROVEN METHOD OF RECORD BUYING USED BY THOUSANDS OF SATISFIED CLUB MEMBERS BECAUSE . . .

- * **YOU DECIDE ON YOUR PURCHASES** — You are not obligated to purchase any particular quantity of records. Buy as few or as many records as you want . . . the choice is yours. Citadel has no "agree to purchase" requirement.
- * **YOU HAVE COMPLETE FREEDOM OF SELECTION** — Virtually any record or album, by any artist on any label is available including all major labels plus hundreds of smaller labels as well as most imports. Again, the choice is completely up to you. Citadel has no "pre-selected" list of recordings for you to choose from.
- * **PROMPT SERVICE** — Many orders are shipped the same day received, rarely later than the next several days. In the event of a delay, partial shipments are made and your order completed as soon as the record is available and, of course without any additional cost to you.
- * **PERIODIC SPECIALS** — Periodically you receive a list of hit albums from all categories of music at prices up to 55% off list. The selections depend on those special purchases we have been able to make. Again, you are under no obligation to purchase any of these selections.
- * **FREE! SCHWANN RECORD CATALOG** — With your membership you receive this quick reference to over 25,000 albums. This easy-to-use catalog contains separate sections for classical, popular, ballet, opera, musical shows, folk music, jazz, etc., and lists a separate section for all new releases. You are not restricted to this catalog, it is simply a handy guide.
- * **100% GUARANTEE** — Citadel completely guarantees their records against defects or damages of any sort. If a damaged or defective record does get through our inspection, we shall immediately replace with a perfect copy.

Membership dues is \$3.00 a year . . . a nominal amount if you reflect for a moment on the record purchases you have made within the past year and the prices you have paid. AS A CITADEL MEMBER BUYING RECORDS AT COST, YOUR DUES WILL BE PAID FOR WITH VIRTUALLY THE FIRST PURCHASE YOU MAKE THROUGH THE CLUB. Additional savings quickly mount up, permitting you to buy many more albums on your record budget.

If you have been faced with the problem of a

complete record source . . . may we suggest that you give Citadel Record Club an opportunity of proving its value to you. You enter no obligations, take no risks . . . simply complete the coupon below, include your \$3.00 yearly membership dues and upon receipt we shall immediately forward all club membership material to you. We cordially invite you to join thousands of other satisfied Citadel members who are purchasing their records at cost price through their Citadel Club membership.

SATISFACTION GUARANTEED Try membership in the Citadel Record Club for 30 days. If at the end of that time you are not completely satisfied, simply request your membership dues back, and it will be immediately refunded.

FREE!

Act now. Fill out the coupon, enclose your dues and we will include a free quality record cleaning cloth as a gift. This is our way of thanking you for your confidence in us.



CITADEL RECORD CLUB

545 Fifth Avenue, New York 17, N. Y. S-103

Enroll me in Citadel for one year. I am under no obligation to purchase any particular quantity of records, but those that I do purchase will be at member prices . . . NEVER more. I am to receive a current Schwann catalog immediately and subsequent periodic lists of specially priced hit albums. I understand that if, after trying membership in Citadel for 30 days, I am not completely satisfied I can get my full membership dues back immediately. Also, include the free quality record cleaning cloth as a gift. \$3.00 dues enclosed.

FULL NAME _____
STREET _____
CITY _____ ZONE _____ STATE _____

**NOT
FOR SALE**

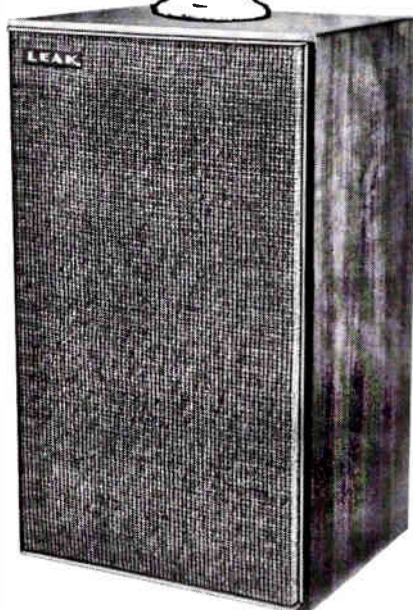

No matter what superlatives, testimonials and/or curves a manufacturer of loudspeaker systems employs in his ads — no one knows better than yourself what sound is best for YOU! That's why this ad doesn't try to SELL you on the dynamic new LEAK Piston-Action Sandwich Speaker System.

Certainly! we have dramatic evidence of its superiority... its absolute smoothness of transient response... its total absence of cone breakup... and other pertinent characteristics... BUT we only want to impart the idea that this New LEAK Speaker System is THE system you must listen to before you select any.

Whether you expect to invest in a system now or sometime soon, you owe it to yourself to visit your nearest Authorized Leak Franchised Specialist and HEAR why Leak has received such superb commendations for its revolutionary principles, smooth performance and "grand sound."... in the meantime, if you want to satisfy your "technical eye"... TEST REPORTS are available at all Leak Franchised Specialists, or write:



Exclusive U.S. Representatives:
ERCONA CORPORATION
432 Park Ave. So.
New York 16, New York

CIRCLE NO. 93 ON READER SERVICE CARD
80

soph Schuster (cello). COLUMBIA MS 6463 \$5.98, ML 5863* \$4.98.

Interest: Beautiful Fauré
Performance: Good
Recording: Excellent
Stereo Quality: Refined

We should be grateful to Columbia for bringing this exquisitely lyrical, subtle, and discreetly innovative late work of Gabriel Fauré to the long-playing catalog. This extraordinary piece—written when Fauré was seventy-eight, just two years before his death—is music for the listener of refined and elegant tastes. It does not yield its secrets easily and it requires a certain patience if it is to be understood. For although it seems tame, even ordinary, on the surface, careful and repeated listening will reveal a subtle and original musical mind at work—in the unexpected turn of a phrase, in a harmonic progression that startles by virtue of its quiet originality.

The Fauré and the gorgeous Mendelssohn Trio are performed with obvious love and dedication by all concerned, although I continue to find Previn's playing unextraordinary at best and superficial at worst. The sonic quality of the recording is first-rate. *W. F.*

⑤ ⑥ MOZART: *Concerto for Bassoon and Orchestra, in B-flat Major (K. 191)*; *Concerto for Flute and Orchestra, in G Major (K. 313)*. Bernard Garfield (bassoon); William Kincaid (flute); Philadelphia Orchestra, Eugene Ormandy cond. COLUMBIA MS 6451 \$5.98, ML 5851* \$4.98.

⑤ ⑥ MOZART: *Concerto for Oboe and Orchestra, in C Major (K. 314)*; *Concerto for Clarinet and Orchestra, in A Major (K. 622)*. John de Lancie (oboe); Anthony Gigliotti (clarinet); Philadelphia Orchestra, Eugene Ormandy cond. COLUMBIA MS 6452 \$5.98, ML 5852* \$4.98.

Interest: Mozart's wind concertos
Performance: Emphasis on virtuosity
Recording: Excellent
Stereo Quality: Excellent

These two discs contain all of Mozart's extant full-length concertos for wind instruments, all well known and frequently heard. Although K. 314 is played variously on either flute or oboe, Mozart originally wrote it for the latter, then on a commission adapted it for flute. One seldom has the opportunity to hear these concertos played with such virtuosity and technical finish. Interpretively, the orchestral accompaniments are a bit heavy and oversize, the slow movements tend toward lushness and even sentimentality, and the flashy solo cadenzas are not always musically suitable to Mozart. But

the standard of orchestral playing—the opening tutti of the clarinet concerto, for example—is breathtaking in its sheen and precision, as are the individual performances of the first-desk men of the Philadelphia Orchestra. The sound is exceptional, and the stereo ideal. *I. K.*

MOZART: *Concerto, in C Major, for Flute, Harp, and Orchestra* (see HANDEL: *Concerto, in B-flat Major, for Harp and Orchestra*).

RECORDING OF SPECIAL MERIT

⑤ ⑥ MOZART: *Divertimento in B-flat Major, K. 287*. MICHAEL HAYDN: *Divertimento in G Major*. Members of the Vienna Octet: Anton Fietz and Philipp Matheis (violins), Günther Breitenbach (viola), Nikolaus Hübner (cello), Johann Krump (bass), Josef Veleba and Wolfgang Tömbock (horns). LONDON CS 6352 \$5.98, CM 9352* \$4.98.

Interest: Delightful Mozart
Performance: Expert
Recording: Clean but bass-shy
Stereo Quality: Centered

The B-flat divertimento, a witty and captivating masterpiece, is sometimes performed by a body of strings larger than the quintet prescribed by Mozart. Several recordings attest to the work's effectiveness in such an enlarged state, most particularly Angel 35562 with members of



EUGENE ORMANDY
Polished backing for Mozart concertos

the Philharmonia Orchestra. Such a widespread practice is not without some justification: the divertimento contains perhaps the most virtuosic violin writing ever done by Mozart, plus many elements of the concertante style, particularly in the elaborate final movement with its operatic mannerisms. The present performance (Continued on page 82)

a jewel
for
Garrard

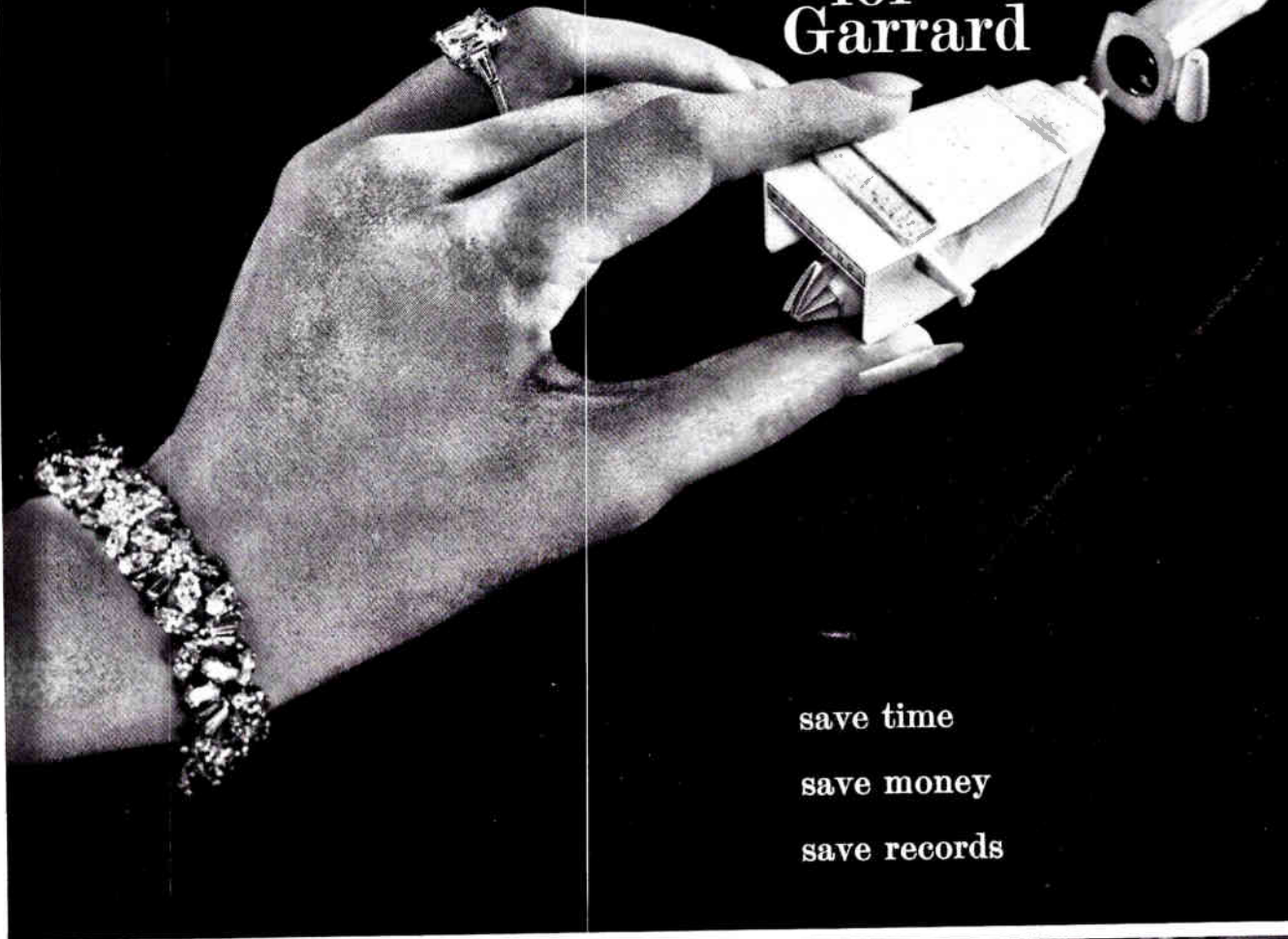

save time

save money

save records

Plug-in head assemblies with pre-mounted cartridges for Type A and Model AT6 Garrard Automatic Turntables.

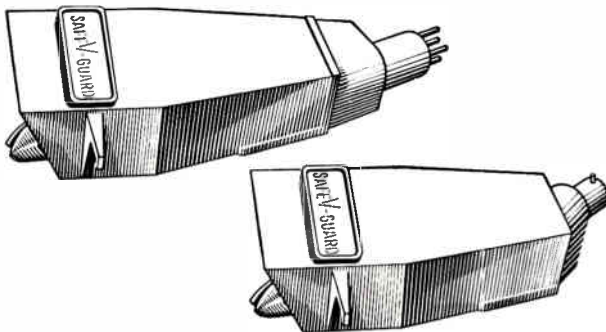

Choose the right pickup for your Garrard installations — choose a Pickering — the new U38/ATG and the famous U38/AT are both available pre-mounted in Plug-in Heads for Garrard Type A and Model AT6 Automatic Turntables.

FEATHERWEIGHT OPERATION — for maximum record protection, 1 to 3 grams tracking (recommended 2 grams) — where environmental conditions permit light tracking forces.

GA/38ATG — for Garrard Type A **G6/38ATG** — for Garrard Model AT6
Includes U/38 Stereo Fluxvalve Cartridge (premounted) with D3807ATG Golden **SAFE V-GUARD** "Floating Stylus"

STANDARD OPERATION — for use where environmental conditions require a nominal tracking force of 4 grams or more.

GA/38AT — for Garrard Type A **G6/38AT** — for Garrard Model AT6
Includes U/38 Stereo Fluxvalve Cartridge (premounted) with D3807AT **SAFE V-GUARD** "Floating Stylus"

© 1963 Pickering & Co., Inc., Plainview, N. Y., U.S.A.



Featuring Pickering's exclusive "floating stylus" ...so little mass that it actually floats on water... so light it "floats" over the surface of your records. The Pickering "floating stylus" action protects the diamond and the life of the record while it plays.

FOR THOSE WHO CAN HEAR THE DIFFERENCE
Pickering PICKERING & CO., INC.,
Plainview, N. Y.

GRADO

"Truly the world's finest..."



LABORATORY SERIES TURNTABLE

FOR THE FIRST TIME THE MAIN FLYWHEEL IS MOUNTED BETWEEN TWO BEARING CENTERS IN AN EXCLUSIVE PATENTED DESIGN.

The first COMPLETELY new turntable in half a century!!

Two vibrationless twelve pole hysteresis motors with ultra light mass armatures (they weigh 4 grams each) drive two massive flywheels in a super low friction system (friction reduced almost 500 times).

Flutter and wow are virtually nonexistent (if at all measurable). Noise and rumble for the full frequency range are completely inaudible.

This is the only turntable designed for the stereo record.

PATENT #3,082,635

SINGLE SPEED TURNTABLE WITH BASE \$99.50

COMPLETE ENSEMBLE (as shown less cartridge) \$153.00

For further information please write:

GRADO LABORATORIES, INC. 4614 Seventh Ave., B'klyn 20, N.Y.

formance, however, conforms to Mozart's original conception and in a most delightful manner. One immediate advantage is that the horns emerge in clear perspective, whether in support or in counterpoint. Altogether, there is a transparency to this combination of instruments that a larger group would find difficult to match. The playing itself is expert and elegant, rather brisk in the allegros, expansive and somewhat romanticized in the slow movements, but always well controlled and radiant with the players' enjoyment. Tasteful and stylistically proper cadenzas and ornamentations are appropriately used.

Michael Haydn's divertimento—apparently a first recording—is cheerful and unpretentious.

G. J.

© MOZART: *Idomeneo, Rè di Creta, K. 366; Ballet Music for Idomeneo, K. 367.* Horst Taubmann (tenor), Idomeneo; Greta Menzel (soprano), Idamante; Herbert Handt (tenor), Arbace; Gertrud Hopf (soprano), Ilia; Gertrud Grob-Prandl (soprano), Electra; Erich Majkut (tenor), High Priest; Anton Heiller (bass), Voice of Neptune. Vienna Symphony Orchestra and Chorus of the Vienna State Opera, Meinhard von Zallinger cond. Vox OPBX 161/2/3 three 12-inch discs \$9.95.

Interest: Vital Mozart

Performance: Earnest

Recording: Fair

Idomeneo was one of Mozart's favorite scores, but it has fared less than well with Mozartians. This old-fashioned *opera seria* is a static, dramatically unyielding work, not easily adaptable to modern staging. But the score contains many magnificent arias, ensembles, and choruses that, given a first-class performance, assure a rewarding listening experience.

The version at hand—a reissue of a decade-old Haydn Society set—is, unfortunately, not exactly that kind of performance. It has virtues, to be sure: the lengthy score is given nearly complete on three discs—more than three hours of music. Then, conductor Zallinger manages the rather uneven forces under his direction with evident authority, forcefulness, and a strong sense of drama. But what we need here are singers capable of coping with *Idomeneo's* demands. Admittedly, these demands are extraordinary: the title part calls for that extreme rarity, a heroic Mozart tenor, the role of Electra requires a Birgit Nilsson—who, incidentally, sang it in 1951. The only satisfying performers in this set are Gertrud Hopf as Ilia and the American tenor Herbert Handt, who, in addition to the minor role of Arbace, also helps out with some of *Idomeneo's* high-lying passages. There is no mention

(Continued on page 86)

Great Sopranos Of Our Time



Maria Callas



Elisabeth Schwarzkopf



Birgit Nilsson



Victoria de los Angeles



Joan Sutherland



Regine Crespin

These, and all of Angel's Great Sopranos of Our Time albums, are specially priced this month. Reductions of 25% at participating dealers.

No less than six of the most glorious singers of our day are to be heard on a fabulous new Angel disk: Victoria de los Angeles, Maria Callas, Elisabeth Schwarzkopf, Regine Crespin, Birgit Nilsson and Joan Sutherland. Some of the most beloved, spine-tingling operatic arias of all time are here for your constant pleasure. But this is just an introduction to the Angel sorority of the great sopranos of our time. There are scores of other wondrous Angel albums in which great sopranos are heard at their most thrilling best. Your favorite dealer has them on prominent display this month.

In addition to this new release, Angel album (S) 36135, you may want to hear Schwarzkopf sing in *Der Rosenkavalier* (S) 3563 D/L, or with Sutherland in *Don Giovanni* (S) 3605 D/L. And, in Angel album 3508 B/L, Callas sings in Puccini's *Tosca*. Victoria de los Angeles is *Madame Butterfly* in Angel's (S) 3604 C/L, and she sings *Carmen* in (S) 3613 C/L. Birgit Nilsson sings Beethoven, Weber and Mozart in Angel album (S) 35719. And Regine Crespin is *The Voice of Wagner* on (S) 35832.

TRANSATLANTIC TREASURE

CAPITOL RECORDS ANNOUNCES AN UNPRECEDENTED SELECTION OF EMI'S CLASSIC EUROPEAN RECORDINGS

By David Hall and George Jellinek

WITHOUT question, the British record firm of EMI (Electric and Musical Industries, Ltd.) possesses the greatest collection of major recordings made during the first half of this century. In addition to its English recordings, EMI has access to records released through such affiliates as La Voce del Padrone in Italy, Pathé-Marconi in France, Electrola in Germany, and Skandinavisk Grammophon in Denmark and Sweden.

Some small measure of the size of EMI's pre-stereo treasurehouse can be gained from a perusal of the catalog of the fifty-odd Great Recordings of the Century issued on the Angel label over here, in remarkably fine transfers from 78-rpm originals. Other outstanding EMI recordings have been obtainable over the past few years through specialty record shops, but only intermittently, despite listings in the Schwann catalog for such labels as Electrola, Pathé-Marconi, and Danish Odeon.

With the aim of bringing both reason and order into the servicing of EMI recordings, the American affiliate of EMI, Capitol Records, has established Capitol Records International Corp., which has issued its first list of available imports, covering more than eight hundred LP's from its British, Italian, French, and German catalogs—all imported under the Odeon and Pathé trademarks at \$5.98 per 12-inch disc (\$6.98 for stereo where available), and a dollar less for 10-inch records.

Listed in the first catalog of imports is virtually everything that has been listed in Schwann, plus much—very much—more. And while there are quite a few recently recorded items on the list, it is the enormous number of heretofore unavailable great recordings from the past that are of main interest. For instance, we discover the prized recordings of Arturo Toscanini with the BBC Symphony Orchestra: the Beethoven "Pastoral" and Fourth Symphonies, Brahms' *Tragic* and Mozart's *Magic Flute* overtures, as well as Beethoven's *Leonore No. 1*. Then we come across a remarkable Bruno Walter gem, his inspired rendering, with the Vienna Philharmonic, of the Beethoven "Pastoral," recorded just before the German occupation of Austria.

The Great Recordings of the Century series yields thirty-seven new items, among them the complete Beethoven violin sonatas with Fritz Kreisler, the legendary Weingartner reading of the

Beethoven Ninth with the Vienna Philharmonic and with Richard Mayr singing the bass solo in the final movement, and Wanda Landowska's second volume of Scarlatti, recorded in Paris while the city was under bombardment.

The EMI catalog of English discs is slim compared to its companions from Italy, France, and Germany, but it contains some pearls: the Brahms Horn Trio with Rudolf Serkin, Adolf Busch, and



WILHELM FURTWÄNGLER

His powerful readings are still preferred

Aubrey Brain (father of the late Dennis); the Sibelius Second Symphony recorded in concert with Sir Thomas Beecham; a beautiful pair of Beecham-conducted Delius discs from the 1940's, including two of the English composer's inexcusably neglected masterpieces, the *Song of the High Hills* and the Violin Concerto.

Of the vocal recordings, the largest and richest selection is found under the German Electrola label. Here are the famous Glyndebourne sets of *Don Giovanni* and *Così fan tutte* and the Berlin *Die Zauberflöte*, milestones of the recording art. Here also are Furtwängler's powerful interpretations of the complete *Fidelio* and *Die Walküre*, which are still the preferred choices of many collectors. For ardent Wagnerians, Electrola lists an abridged *Siegfried* with Lauritz Melchior at the height of his artistry. There has never been another *Siegfried* like Melchior, nor, for that matter, another Wanderer like Friedrich Schorr (who is heard in the same two-record set). Another memorable Wagner disc offers Kirsten Flagstad and Wilhelm Furtwängler in Brünnhilde's *Immolation Scene*.

Lieder fanciers will welcome two long-

absent Gerhard Hüsch volumes: *Die Winterreise* and *Die Schöne Müllerin*. The Hüsch interpretations still have magnetism for the listener, and in purely vocal terms Hüsch was an artist in a class by himself. The same compliment can be paid to Erna Berger, who is heard in Schumann's *Frauenliebe und Leben* and on a disc of highlights from Mozart's *Entführung aus dem Serail*.

Among recital discs devoted to the immortals of the vocal art, the connoisseur will be pleased to find several recitals each by Beniamino Gigli, Richard Tauber, Joseph Schmidt, and Marcel Wittrich, as well as single entries by Margarete Teschemacher, Karl Erb, and Sigrid Onegin.

Opéra comique is richly represented on the Pathé label. The long list of attractive titles includes not only the best of Lecocq, Offenbach, Planquette, Messager, and their confrères, but also a great deal of Johann Strauss, Lehár, and Vincent Youmans—all in French and infused with the appropriate Gallic spirit. An absolute delight, and nowhere to be duplicated, is the complete *La Périchole*, in which a good cast responds to Igor Markevitch's baton with results that completely overshadow the Metropolitan's recent efforts on this operetta's behalf. Important historical items include the complete *Werther* with Ninon Vallin and Georges Thill, Madeleine Grey's original *Songs of the Auvergne*, Charles Panzéra's collections of Duparc, Fauré, and Schumann, and Honegger's *Le Roi David*, under the composer's direction.

Finally, the vocal collector's special delight: the opera-laden Italian list, combining the catalogs of La Voce del Padrone and Italian Columbia. For those who feel that Beniamino Gigli was uniquely satisfying in the complete recordings of *La Bohème*, *Un Ballo in maschera*, and *Andrea Chénier*, there is now a renewed opportunity to acquire these sets. The same goes for two more albums of venerable age: *Don Pasquale* (the only complete recording in which Tito Schipa participated, and unquestionably the most polished and artistic recorded treatment ever given to this mercurial gem) and *Il Trovatore* (a singularly unpolished but high-spirited performance distinguished mainly for the Count di Luna of Apollo Granforte).

These are but a few items in the new Capitol-EMI import catalog. The company deserves our sincere thanks for making its treasures available once again.

**NEW LOOK...
NEW SOUND...
NEW VALUE...
NEW HEATHKIT
SPEAKER
LINE**

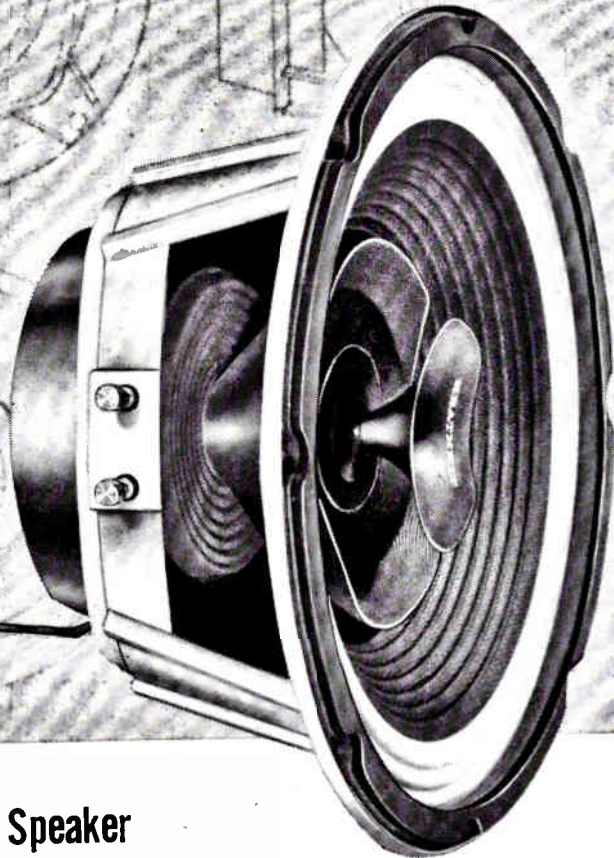

**Need A High-Efficiency, High Fidelity Speaker
For A Particular Music System Job?
... You'll Find It In Heath's Exclusive New Line!**

Whether you want an advanced-engineered, professional-performing speaker for your custom music system, or need to replace a radio or TV speaker, you'll find it in this exciting new Heathkit line. Specially designed to meet Heath's exacting specifications, each speaker has been carefully crafted to perform a particular job. And regardless of which speaker you choose, each has a ceramic annular ring magnet for high efficiency and superior performance, plus polarized speaker terminals for proper phasing. All speakers except the least expensive in each size, have rugged, die-cast metal frames for life-long, trouble-free performance. In addition, each speaker is handsomely styled in a richly warm two-tone cinnamon and light tan motif, and carries a full one-year guarantee. Prices range from \$4.95 to \$49.95 . . . truly superb performance at unmatched savings! Send for your free Heathkit Catalog now, and select the proper Heathkit speaker to fulfill your needs!



HEATH COMPANY
Benton Harbor 40, Michigan 49023

Please send Free copy of new 1964 catalog.

Name _____
Address _____
City _____ State _____ Zip Code _____

HEATHKIT-1964

**NEW! FREE
1964 HEATHKIT CATALOG**

See the latest new products in Heathkit's wide, wonderful line. Over 250 do-it-yourself kits for stereo/hi-fi, marine, TV, electronic organ, amateur radio, test instruments, educational, home and hobby that will save you up to 50%. Send for your free copy today!



Sensational FUJICA Offer

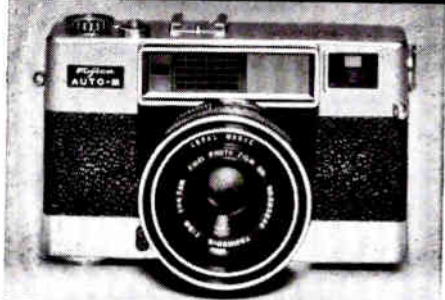

You get a full refund on both camera and color film if you are not fully satisfied with the pictures you take!

Why do we dare make this offer?

The new Fujica is the first camera with a built-in computer electric eye. Patented. It makes all settings for you... both speeds and lens openings. You can't make an exposure mistake even if you try. If the light is too bright or too dim, the computer speeds up or slows down the shutter speed... instantly! Automatically! You just press the button. Perfect exposure every time.

Professional effects also automatic.

A simple dial turn does it. Soft backgrounds. Sharp backgrounds. Catch incredibly fast action... and to top it all, you can switch from fully automatic operation to manual control and make any combination of settings you wish. Speeds are up to 1/500th second.

Takes perfect pictures indoors.

The superb f/2.8 lens gets pictures in light so low, other cameras require flash... and if the light is too dim to give you a perfect picture, the Fujica locks... won't fire. No more blurs, blanks or wasted shots.

Preview your finished picture.

The viewfinder-rangefinder shows you big, bright and beautifully clear, what your finished picture will look like. You get exactly what you see.

How much does this FUJICA cost?

Less than \$100, and with the money back guarantee... you risk nothing.

Like to see how easy it is to operate?... just ask your favorite camera dealer or write for **FREE** booklet today.

COMPUTER ELECTRIC EYE

FUJICA

Fully Automatic Auto-M 35

FUJI PHOTO OPTICAL PRODUCTS INC.

111 Fifth Ave., Dept. A-79, New York 3, N.Y.

A subsidiary of Ehrenreich Photo-Optical Industries Inc.

CIRCLE NO. 34 ON READER SERVICE CARD

86

anywhere of this expedient, but it is apparent because, in a cast heavily burdened with Teutonic inflections, Handt's idiomatic handling of the Italian text is a standout.

The set is attractively priced, has a bonus in the form of the opera's ballet music, and sounds good for its age. But the competing version, a Glyndebourne performance on Angel 3574, seems to me preferable. It is less complete, to be sure, but more satisfactorily recorded, and its more idiomatic vocal contributions include exceptionally fine performances by Sena Jurinac as Ilia and Lucile Udovick as Electra. A performance that fully comes to grips with the demands of *Idomeneo* is yet to be recorded, however.

G. J.

© © MOZART: *Sinfonia concertante, in E-flat, for Violin and Viola, K. 364*. Stephan Romascano (violin); Marie-Rose Guet (viola). *Sinfonia concertante, in E-flat, for Oboe, Clarinet, Bassoon, Horn, and Strings, K. Anh. 9*. Eduard Meylan (oboe), Robert Kemblinsky (clarinet), Bozidar Tumpelj (bassoon), Jozsef Molnar (horn). Chamber Orchestra of Lausanne, Victor Desarzens cond. WESTMINSTER WST 17036 \$5.98, XWN 19036 \$4.98.

Interest: Major Mozart

Performance: Earthbound

Recording: Very good

Stereo Quality: Natural

Coupling Mozart's two *Sinfonia concertanti*—each for different featured instruments, but both similar in style—was a commendable move. Appealing too is the generosity of the offering: the two works add up to more than one hour of music. But, having acknowledged these virtues, the fact must be set down that both works can be obtained separately in superior interpretations. The Swiss players are certainly a competent group, and the soloists are all skilled and experienced musicians, but there is more diligence than inspiration in their efforts. The K. 364, in particular, is too small-scale: emotionally understated in its central Andante, and lacking propulsive brio in the final Presto. The stereo recording is clean and clear.

G. J.

© © MOZART: *Sonatas and Variations for Violin and Piano: Sonatas K. 296, 301-306, 376-380, 402, 454, 481, 526, 547; Variations K. 359, 360*. György Pauk (violin), Peter Frankl (piano). Vox SVBX 546 and 547 (two sets, each with three 12-inch discs), each set \$9.95. VBX 546* and 547*, each set \$9.95.

Interest: Bargain Mozart

Performance: Neat and cool

Recording: Good

Stereo Quality: Well balanced

There are no fewer than forty-one sonatas and variation sets for violin and keyboard by Mozart, the first written in his eighth year, the last in 1788, the year of the last three symphonies. Through these compositions can be traced the genre's development: the violin is gradually elevated from an accompanying role to full partnership, and dramatic give-and-take and contrapuntal richness replace the placid and often predictable early pattern.

This anthology omits the sixteen childhood sonatas, the group of six "Milanese" sonatas of doubtful authenticity, and four incomplete works. But the seventeen sonatas and variation sets included in these two Vox Boxes (each containing three discs) give us the most comprehensive survey yet offered of this significant phase of Mozart's work. Every one of them here deserves to be heard. Even the two relatively unimportant variation sets (K. 359 and 360) are imbued with that particular captivating charm on which Mozart seems to have enjoyed a monopoly.

There can be little argument that at least six of these sonatas deserve the rank of masterworks: the early K. 304, in a minor key and permeated with hints of tragedy; K. 377 and 379, both restless, probing, and full of ingenious turns; and the magnificent threesome, K. 454, 481, and 526, in which Mozart brought the form to a new level and set the stage for Beethoven's mighty ten.

Vox supplies detailed and informative notes with the albums, but not a word about the artists—a curious procedure for a production of such magnitude. But they are extremely good. To the earlier sonatas, in particular, they bring a self-effacingly musical and wholly spontaneous approach. In these sonatas their somewhat restricted dynamic range is consistent with the music, and their ample technical resources make for a refined and consistently satisfying tone quality. Where passion, boldness of expression, or sweeping lyricism is required, on the other hand, Pauk and Frankl cannot deliver the ardor and abandon that enrich the work of Morini and Firkusny in K. 481 or Grumiaux and Haskil in K. 454 or K. 526. There is excessive caution in their tempo choices: the *allegro molto* opening of K. 481 is hardly that, their rondo movements lack fire, and they seem reluctant to impart a truly lyrical expression to some of the slow movements' broad phrases. But even if these are not virtuoso performances on the highest level, they serve the music with seriousness and undeviating taste. And ten of these selections are not otherwise available at the present time. The technical processing is clean; the stereo is well spread and has a pleasing natural sound.

G. J.

(Continued on page 88)

SOLID-STATE* STEREO

BY HEATHKIT



**Solid-State*—a term used to refer to germanium or silicon transistors which are of a solid crystalline structure as opposed to vacuum tubes which are evacuated glass bottles containing various fabricated wire structures.

Cooler, faster operation . . . lower power consumption . . . longer life . . . and the clean, quick realism of "transistor sound." You'll enjoy all this and more with Heathkit's newest All-Transistor Stereo "Twins." Compact, low-silhouette styling magnificently fashioned in rich walnut cabinets neatly fits this handsome pair into a "proud place" in any hi-fi stereo system. Add to this extruded brushed gold-anodized aluminum front panels that serve practically to conceal secondary controls and decoratively to enhance over-all beauty. The AA-22 Amplifier provides 40 watts of continuous power at ± 1 db from 15 to 30,000 cps with no fading, no faltering . . . just pure solid sound! The AJ-33 Tuner offers selection of AM, FM, or FM Stereo to please any listening preference. Check both unit's features and discover why Heathkit leads in Transistor Stereo. The price? A great value, you'll agree . . . \$99.95 each!

AA-22 40-watt Transistor Stereo Amplifier, 14 lbs. \$10 mo. \$99.95

AJ-33 Transistor AM-FM Stereo Tuner, 14 lbs. \$10 mo. \$99.95

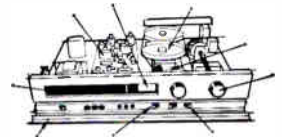
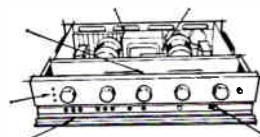

- 40 watts of power (20 per channel)
- 5 stereo inputs
- Speaker phase switch
- Miniature indicator light for each position on mode switch
- Transformerless output circuits
- Brushed gold-anodized aluminum front panel conceals secondary controls
- Walnut cabinetry

- Stereo phase control
- Automatic stereo indicator
- AFC and AGC
- Filtered stereo tape recorder outputs
- Built-in stereo demodulator
- Tuning meter
- Flywheel tuning
- Slide-rule dial
- Prealigned FM tuner and circuit board construction
- Brushed gold-anodized aluminum front panel conceals secondary controls
- Walnut cabinet



NEW! FREE 1964 HEATHKIT CATALOG
See the latest new products in Heathkit's wide, wonderful line. Over 250 do-it-yourself kits for stereo/hi-fi, marine, TV, electronic organs, amateur radio, test instruments, educational, and home and hobby items that will save you up to 50%. Send for your free copy today!

HEATH COMPANY Benton Harbor 40, Michigan 49023

- Enclosed is \$ _____, plus postage. Please send model No. _____
- Please send Free Copy of New 1964 Catalog.

Name _____
Address _____
City _____ State _____

RECORDING OF SPECIAL MERIT

© © RACHMANINOFF: *Piano Concerto No. 3, in D Minor, Op. 30*. Vladimir Ashkenazy (piano); London Symphony Orchestra, Anatole Fistoulari cond. LONDON CS 6359 \$5.98, CM 9359* \$4.98.

Interest: Topnotch Rachmaninoff
Performance: Refined and lyrical
Recording: Good
Stereo Quality: Good

With Richter and Gilels, young Vladimir Ashkenazy completes the triumvirate of top contemporary Soviet pianists. His decision this past spring to take up resi-

dence in England found London-Decca very much on the alert—hence the speedy production and release of the Rachmaninoff Third and Tchaikovsky First piano concertos as recorded by Ashkenazy in England.

Anyone who has heard Ashkenazy's remarkable two-disc Soviet MK set of the complete Chopin Études is aware of this artist's flawless technique, in rapid passagework especially, his exquisite refinement of tone and phrase, and his wonderfully keen Romantic sensibility. He may not have Gilels' flair for Lisztian thunder, but he is the peer of Richter as a Romantic stylist. All this adds up to his being the perfect interpreter for the Rachmaninoff Third Piano Concerto,

which is Romantic to the core, yet a formal tour de force with cunningly woven melodic lines and thematic interrelationships. Unlike the more popular C Minor concerto, this music offers few opportunities for vulgarization.

Despite a pair of brilliant recordings by Pennario and Janis issued within the past two years, it has been Van Cliburn's 1958 RCA Victor disc from his homecoming concert as a Tchaikovsky Competition victor that has remained the interpretive touchstone for recordings of this music. In Ashkenazy, however, Cliburn has met his match, for the Russian offers much the same lyrical flair and tonal refinement, together with an added
(Continued on page 91)

The Victrola Series

A NEW LOW-PRICE LINE FROM RCA VICTOR

AFTER some tentative probing of the market with its Camden series, RCA Victor has finally begun an all-out push into the low-price (\$3.00 stereo, \$2.50 mono) record field with an initial release of fifteen tastefully packaged items under the new Victrola label, all featuring top-name conductors and soloists.

Of the first fifteen discs, two are new issues; the remainder are reissues dating from the early tape-stereo days of 1955 to as recently as 1961. With few exceptions, all are musically and technically worthy, and some are genuine contributions to the recorded literature.

Whether taken quantitatively or qualitatively, the new Victrola list is topped by conductor Pierre Monteux. His reading of the Beethoven "Eroica" Symphony (VICS/VIC 1036, one of the two new releases here) is absolutely top-rank, and belongs in the same illustrious company as the higher-price Toscanini, Klemperer, and Szell versions—though the recorded sound lacks ultimate refinement. Monteux's collaboration with Henryk Szeryng in the Brahms Violin Concerto (VICS/VIC 1028) is comparable in musical merit and also has excellent sound. The Victrola series puts another great Monteux symphonic reading back in the lists again: the Berlioz *Symphonie fantastique* with the Vienna Philharmonic (VICS/VIC 1031). The review disc exhibited a touch of overloading on the climaxes of the *March to the Scaffold*, but the sound was otherwise true and full. The Monteux reissue of Rimsky-Korsakov's *Scheherazade* (VICS/VIC 1013) is beautifully poetic and refined, and is inferior only to Beecham's supremely imaginative interpretation on Angel. The above-mentioned Monteux recordings date from 1959 and

1960; however, the recordings on the disc containing the Stravinsky *Firebird Suite* and the three *Nocturnes* of Debussy (VICS/VIC 1027) are from 1957 and 1956. The *Firebird* reading is opulent, but the recorded sound is tubby; and the reading of the *Nocturnes* is not as good as Monteux' recent recording for London.

Charles Munch conducts on four discs, and, surprisingly enough, some of the best sound is on one of the earliest recordings, the 1956 Schubert "Unfinished" Symphony coupled with the Beethoven Fifth (VICS/VIC 1035). The acoustics are about perfect here, and Munch brings a fine aura of warmth to an often-abused score. Save for a somewhat hasty first movement, the Beethoven emerges as a thoroughly respectable accomplishment.

Munch's collaboration with Henryk Szeryng in the Tchaikovsky Violin Concerto (VICS/VIC 1037) is on a high level, if a bit coldly brilliant. Szeryng's intonation is flawless both here and in the Kreisler arrangement of the Tartini "Devil's Trill" Sonata (accompanied by piano) that completes the disc, and the 1960 sound is very good. Debussy's *La Mer*, Ravel's *Rapsodie espagnole*, and the Franck D Minor Symphony (VICS/VIC 1034) fill out the Munch contribution. The Debussy-Ravel readings are stylish enough, but their 1956-1957 sonics stress presence at the expense of tonal warmth. The same trouble afflicts the Franck recording from the same period, and the Munch pacing strikes me as unnecessarily hectic.

Debussy can be heard in a fine acoustic setting in the 1960 Fritz Reiner disc of *Ibéria* (VICS/VIC 1025), which also offers Reiner's 1957 recordings of Tchaikovsky's *1812 Overture* (the most musi-

cal on discs) and the Liszt's *Mephisto Waltz* (a virtuosic thriller here). The sound of the Reiner-Gilels Tchaikovsky B-flat Minor Piano Concerto (VICS/VIC 1039) dates from 1955 and is, by contemporary standards, a little faded. The performance, however, is not, for it combines in splendid measure romantic fervor and virtuosic fireworks, and is still among the three or four best disc versions in the catalog.

The four final items constitute a miscellany of varying merit. Young Bolivian-born violinist Jaime Laredo was the 1959 Queen Elisabeth of Belgium Competition laureate at the time he recorded the Mendelssohn E Minor and the Bruch G Minor concertos (VICS/VIC 1033). The recorded sound is magnificent, and while Señor Laredo is brilliant in such matters as velocity and intonation, his tone and phrasing are distinctly too cool for these pieces. The same fault invalidates Alexander Brailowsky's approach to the Rachmaninoff C Minor Piano Concerto (VICS/VIC 1024). The performance is brittle and analytic, and the close-miked, dual-perspective recorded sound emphasizes this all too distressingly. Solo pieces by Weber and Mendelssohn complete the disc.

The Dvořák *Slavonic Dances* disc (VICS/VIC 1054), a new release, finds Jean Martinon and the London Symphony robbing these lovely pieces of their Czech flavor by playing them too fast. On VICS/VIC 1057, Jean Morel and the Covent Garden Royal Opera House Orchestra turn in tasteful versions of the Bizet *L'Arlésienne* suites, plus Chabrier's *España* and *Marche joyeuse*, all in good sound.

Despite my reservations regarding details, I would say that RCA's Victrola label has been launched in a most promising fashion, and I hope that as its catalog grows it will serve the purpose of keeping available outstanding recordings that in recent years have been deleted all too soon.

David Hall

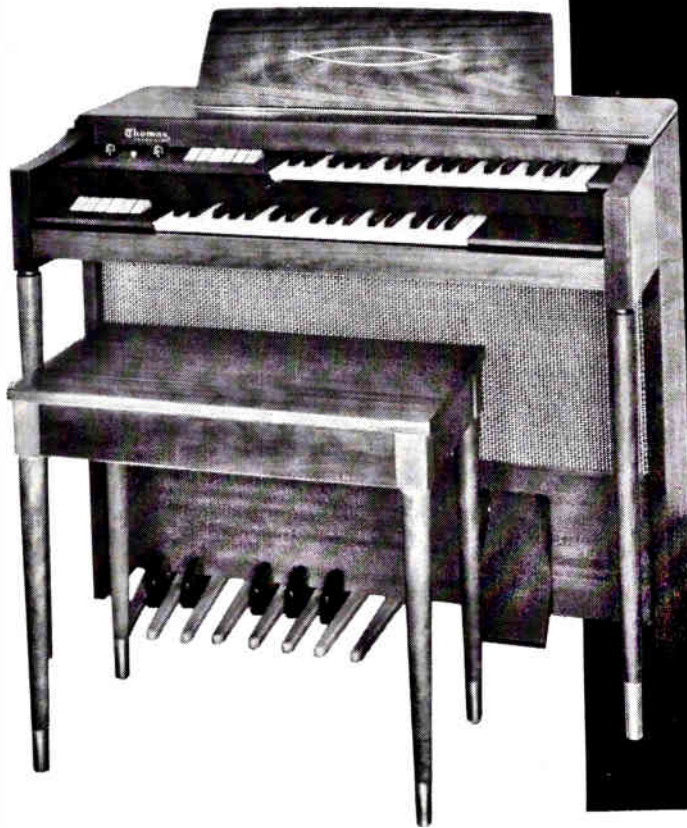

Who says you can't afford an organ this Christmas?

**This New Feature-Packed 1964 Model Of The HEATHKIT
2 Keyboard "Transistor" Organ Costs Just \$349.95 ...
AND YOU CAN BUILD IT!**



What a delightful surprise on Christmas morning! And there's endless hours of fun, relaxation, education and achievement ahead for the whole family with Heathkit's 1964 version of the famous Thomas Organ. You'll be saving big money too, by easily building it yourself! No experience necessary! And you're assured long, faithful performance with the full 5-year warranty on tone generators. Can't play a note? Learn quickly and easily with a complete 48-lesson self-teacher course on 4 LP records (GDA-232-2) that's valued at \$50 . . . it's yours for only \$19.95! Like to hear it perform? Send 50c to the address below, and ask for demonstration record GDA-232-5. Plan now to give your family the exciting dimension of live music with the 1964 Heathkit Electronic Organ this Christmas!

Kit GD-232R, Organ, 160 lbs., no money dn., \$23 mo. **\$349.95**
GDA-232-1, Matching walnut bench, 16 lbs., no money dn., \$5 mo. **\$24.95**

Attention Heathkit Organ Owners! Add Variable Repeat Percussion to your Heathkit Organ with the easy-to-install kit.

GDA-232-4, 1 lb. only **\$9.95**

**COMPARE THESE FEATURES
WITH UNITS COSTING
TWICE AS MUCH!**

* 10 True Organ Voices; Trombone, Reed, Flute, Oboe, Cornet, Violin, Saxophone, Horn, Viola, Diapason * **New! Variable Repeat Percussion**; produces effects of banjo, marimba, mandolin, balalaika, etc. * **Variable Bass Pedal Volume Control** * **Manual Balance Control**; adjusts volume of keyboards in any degree for solo work * **Variable Vibrato** * **Standard Expression Pedal**; adjusts volume from soft to full * **13-Note Heel & Toe Bass Pedals** * **Two Over-Hanging Keyboards**; each with 37 notes, range C thru C * **Beautiful Walnut Cabinet**; modern styling, hand-rubbed, hand-crafted * **20-Watt Peak-Power Amplifier & Speaker** * **Compact Size**; 34½" H x 39¾" W x 21½" D * **Transistorized**; for longer life, better tone, trouble-free operation.



HEATHKIT-1964

NEW! FREE 1964 HEATHKIT CATALOG
See all the latest products in Heathkit's exciting line. Over 250 do-it-yourself electronic kits in all . . . by far the world's largest line! There's something for every interest . . . stereo/hi-fi . . . marine . . . amateur radio . . . test and lab . . . television . . . home . . . and hobby. Send for your free copy today, and learn how you can save up to 50%.

- Enclosed is \$349.95, plus postage, please send my Heathkit Electronic Organ, model no. GD-232R.
- Enclosed is \$24.95, plus postage, please send matching walnut bench, model no. GDA-232-1.
- Please send my free copy of the new 1964 catalog.

HEATH COMPANY, Benton Harbor 40, Michigan 49023

Name _____ (please print)

Address _____

City _____ Zone _____ State _____

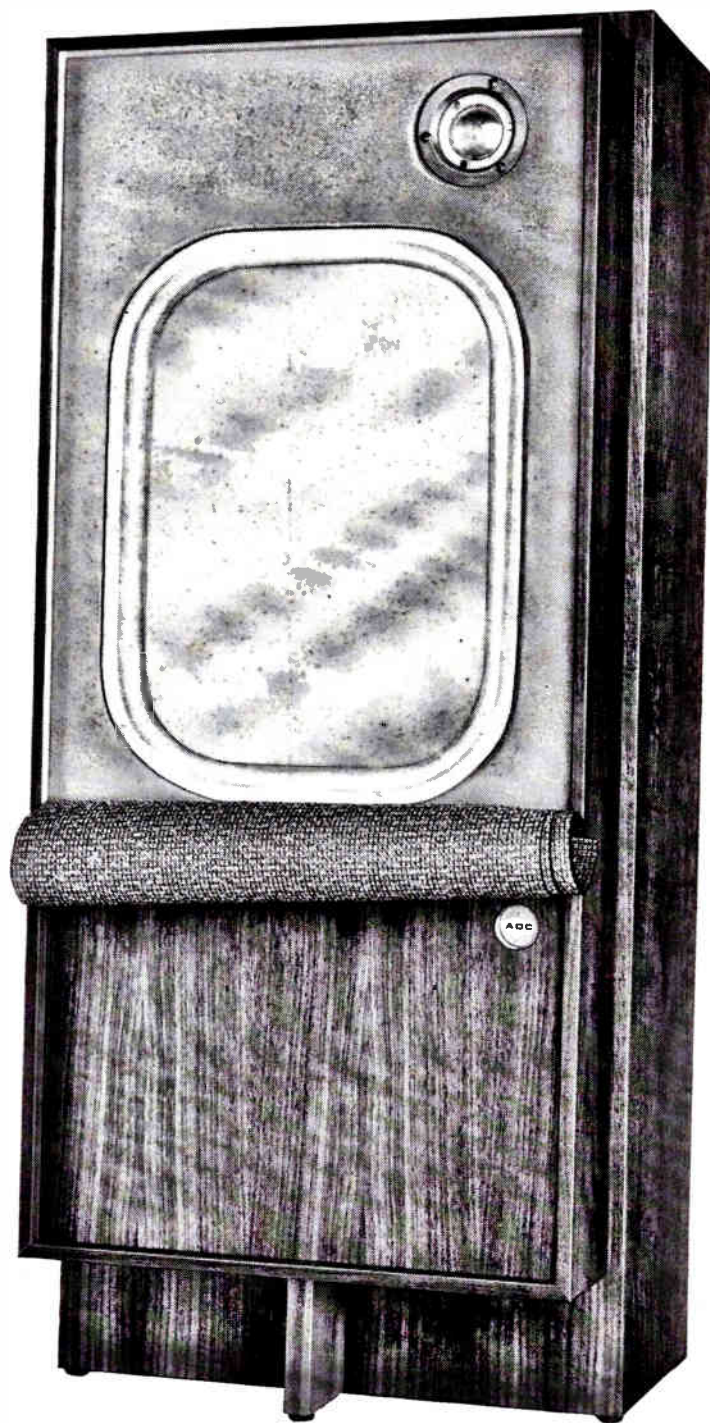

No, you're not seeing things.

You're looking at the first rectangular woofer in history.

Listen!

The sound you hear comes provocatively close to the real thing.



AUDIO DYNAMICS CORPORATION
PICKETT DISTRICT ROAD, NEW MILFORD, CONNECTICUT

CIRCLE NO. 13 ON READER SERVICE CARD

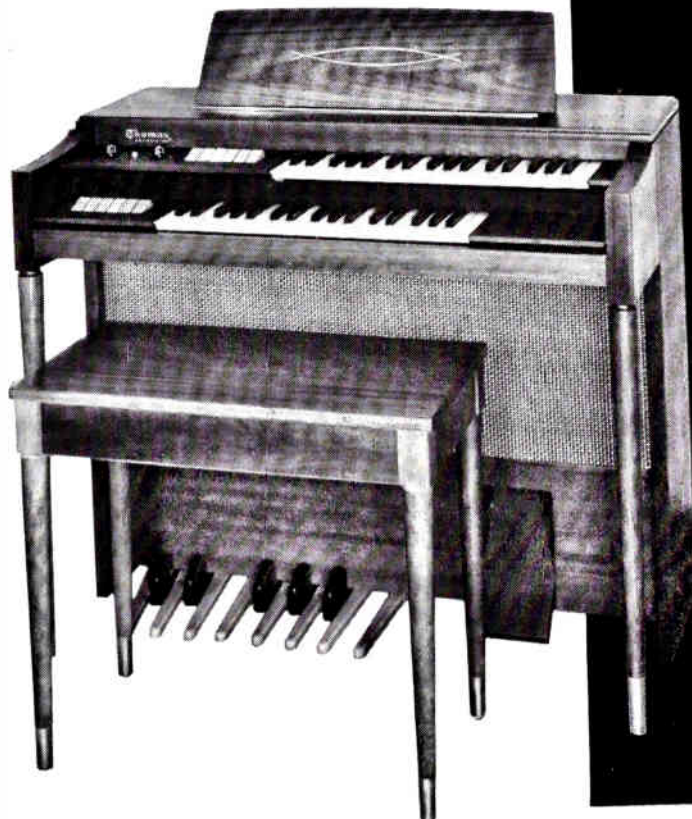

**Who says
you can't
afford
an organ
this
Christmas?**

**This New Feature-Packed 1964 Model Of The HEATHKIT
2 Keyboard "Transistor" Organ Costs Just \$349.95 ...
AND YOU CAN BUILD IT!**



What a delightful surprise on Christmas morning! And there's endless hours of fun, relaxation, education and achievement ahead for the whole family with Heathkit's 1964 version of the famous Thomas Organ. You'll be saving big money too, by easily building it yourself! No experience necessary! And you're assured long, faithful performance with the full 5-year warranty on tone generators. Can't play a note? Learn quickly and easily with a complete 48-lesson self-teacher course on 4 LP records (GDA-232-2) that's valued at \$50 . . . it's yours for only \$19.95! Like to hear it perform? Send 50c to the address below, and ask for demonstration record GDA-232-5. Plan now to give your family the exciting dimension of live music with the 1964 Heathkit Electronic Organ this Christmas!

Kit GD-232R, Organ, 160 lbs., no money dn., \$23 mo. \$349.95

GDA-232-1, Matching walnut bench, 16 lbs., no money dn., \$5 mo. \$24.95

Attention Heathkit Organ Owners! Add Variable Repeat Percussion to your Heathkit Organ with the easy-to-install kit.

GDA-232-4, 1 lb. only \$9.95

**COMPARE THESE FEATURES
WITH UNITS COSTING
TWICE AS MUCH!**

* 10 True Organ Voices; Trombone, Reed, Flute, Oboe, Cornet, Violin, Saxophone, Horn, Viola, Diapason * **New! Variable Repeat Percussion**; produces effects of banjo, marimba, mandolin, balalaika, etc. * **Variable Bass Pedal Volume Control** * **Manual Balance Control**; adjusts volume of keyboards in any degree for solo work * **Variable Vibrato** * **Standard Expression Pedal**; adjusts volume from soft to full * **13-Note Heel & Toe Bass Pedals** * **Two Over-Hanging Keyboards**; each with 37 notes, range C thru C * **Beautiful Walnut Cabinet**; modern styling, hand-rubbed, hand-crafted * **20-Watt Peak-Power Amplifier & Speaker** * **Compact Size**; 34½" H x 39¾" W x 21½" D * **Transistorized**; for longer life, better tone, trouble-free operation.



NEW! FREE 1964 HEATHKIT CATALOG
See all the latest products in Heathkit's exciting line. Over 250 do-it-yourself electronic kits in all . . . by far the world's largest line! There's something for every interest . . . stereo/hi-fi . . . marine . . . amateur radio . . . test and lab . . . television . . . home . . . and hobby. Send for your free copy today, and learn how you can save up to 50%.

- Enclosed is \$349.95, plus postage, please send my Heathkit Electronic Organ, model no. GO-232R.
- Enclosed is \$24.95, plus postage, please send matching walnut bench, model no. GOA-232-1.
- Please send my free copy of the new 1964 catalog.

HEATH COMPANY, Benton Harbor 40, Michigan 49023

Name _____ (please print)
Address _____
City _____ Zone _____ State _____

Quality - Economy - Dependability

QUALITY WITH POWER



FM-3 Dynatuner with automatic multiplex facility and Stereocator. Low distortion and high sensitivity. Can be completely aligned without special test equipment.

PAS-3 Famous PAS-2 preamplifier with new styling. Outperforms preamplifiers of many times higher price.

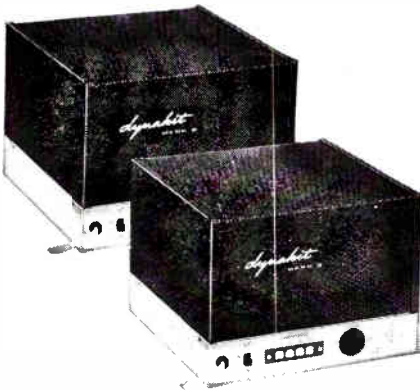

MARK III 60 watt power amplifiers for a perfectionist's system. The Mark III has been chosen for public demonstrations of live versus recorded sound with outstanding success.

Complete \$339.80 in kit form
Complete \$479.80 assembled

DYNA designs rigidly adhere to one principle — the creation of a level of performance in audio reproduction which cannot be bettered regardless of price. This performance is not fully detailed by current measurement standards which are unable to define how the equipment SOUNDS. Check the printed specs rigorously, but in the final analysis — LISTEN!

LISTEN to any DYNA amplifier on the finest speaker system you can find. You will realize the DYNA amplifiers will not limit you, no matter what your associated components. Choose according to your budget and power requirements, for within their power ratings, all DYNA amplifiers yield the same superlative sound, free from noise and distortion. You may find a DYNA sounding better than its power rating would indicate. This is as it should be.

LISTEN to a DYNATUNER under the most difficult reception conditions. Try it on the weakest signals, in bad multipath locations, on overmodulated signals and in the shadow of the transmitter. It will stand comparison with any so-called professional monitor tuner. Further, alignment is no problem when you own a DYNATUNER. When in doubt — after tube replacement, shipping, etc. — just a few minutes spent with the DYNA home alignment procedure — no instruments — will assure you of laboratory results.

A product is only as good as its components. The kit builder recognizes and appreciates this. (Maybe that explains why most of our kit sales are owner recommendations.) DYNA pioneered quality etched circuit construction in the high fidelity field, and its advantages pay you over the years in dependability and ease of maintenance. DYNACO output transformers have a worldwide reputation for excellence and are used in much more expensive equipment than our own. They are the major factor in DYNA's quality sound.

It's easy to operate! We have tried to engineer complexity out of high fidelity. Those 3 large knobs do all the work! But, there is full flexibility for the enthusiast's subtle adjustments.

We devote a major part of our engineering effort to distillation and refinement of every design. This extra effort, primarily appreciated by the kit builder, means a more thoroughly proofed assembled DYNA tuner or amplifier too. DYNAKITS are easier to build, lower distortion in operation, and more trouble-free over the years.

You can pay more, but you can't buy better performance.

QUALITY WITH ECONOMY



FM-3 Combination of famous FM-1 tuner and FMX-3 multiplex integrator with new decorator styling. Its deceptively simple appearance masks the fact that this unit approaches the theoretical limits for high sensitivity and low distortion. Logical simplicity of control through full automation of stereo-mono switching and uniquely simplified tuning. Exclusive Stereomatic circuit locks in and signals stereo automatically and silently. FM listening was never so enjoyable; never before so simple.



SCA-35 New all-in-one stereo amplifier and preamplifier. Matchless listening quality from a moderate power, low cost unit which combines functional simplicity with full flexibility. Its compact size and modest 35 watt continuous power rating belie its impressive performance with even the most inefficient loudspeakers.

Complete \$209.90 in kit form
Complete \$309.90 assembled

ASK YOUR DEALER FOR A DYNA DEMONSTRATION

Complete descriptive literature available on request

DYNACO INC. 3912 POWELTON AVENUE, PHILADELPHIA 4, PA.

tautness in phrasing. Most important, the recording job by London is—understandably—a vast improvement over what emerged from RCA's concert miking. Fistoulari and the London Symphony provide orchestral support thoroughly worthy of Ashkenazy's remarkably fine musicianship. *D. H.*

© © **RESPIGHI: *The Pines of Rome; The Fountains of Rome.*** Minneapolis Symphony, Antal Dorati cond. MERCURY SR 90298 \$5.98, MG 50298* \$4.98.

Interest: Pair of crowd-pleasers
Performance: Sober
Recording: Lacks clarity
Stereo Quality: Good

Dorati approaches *The Pines of Rome* like a man who would like to go swimming without getting wet. The piece is a crowd-rouser—one of the best in the repertoire—and a conductor is not guilty of patronizing the piece by treating it like one. Dorati's performance is cool, shapely, even musicianly; what it lacks is a sense of humor and a sense of fun. For only the most jaded listener would deny that *Pines* is just that: a lot of big-sounding, pretty-sounding fun.

The Fountains of Rome, on the second side, wants a conductor who will revel in Respighi's orchestral color and succulent

instrumentation—and of course these are not the first descriptions of Dorati's style that would come to mind. The recording lacks clarity of detail—especially in the bang-up finale of *Pines*, which can be more intense and interesting if its part-writing is clearly heard. *W. F.*

RECORDING OF SPECIAL MERIT

© © **SCHUMANN: *Spanische Liebeslieder, Opus 138.*** **BRAHMS: *Liebeslieder Waltzes, Opus 52.*** Lois Marshall (soprano), Regina Sarfaty (mezzo-soprano), Léopold Simoneau (tenor), William Warfield (baritone) [in Schumann]. Veronica Tyler (soprano), Regina Sarfaty (mezzo-soprano), Charles Bressler (tenor), John Boyden (baritone) [in Brahms]. Gold and Fizdale (duo-pianists). COLUMBIA MS 6461 \$5.98, ML 5861 \$4.98.

Interest: Vocal chamber music
Performance: Excellent
Recording: Very good
Stereo Quality: Very effective

This release deserves nothing but praise. It offers the record premiere of the Schumann cycle, composed in 1849 and first published after the composer's death in 1857. It was largely unheard for decades until Gold and Fizdale and the artists on

this record presented it in concert about two years ago. These *Spanish Love Songs*—Spanish only in the origin of their lyrics, for the music is plainly and unmistakably Schumann—had a certain influence on the *Liebeslieder* of Brahms, but basically the two cycles are quite different. The Schumann settings are reminiscent of his lieder: the emphasis is on personal communication. There are several songs for solo voice and for duet in which this aim is further underscored. The piano accompaniments are more meaningful in Schumann, and there are two numbers in the cycle for piano alone. With Brahms, of course, the idea of vocal chamber music was uppermost: the voices and the piano accompaniment form a delicate and haunting blend that is rather instrumental in feeling, less concerned with textual communication than with ensemble effect. The waltz rhythms give the Brahms cycle a unity the freely conceived Schumann inspirations do not have.

The performances capture the expansive lyricism of Schumann and the refreshing lilt of Brahms with equal felicity. The playing of Gold and Fizdale is a model of rich tone and elegance, and the vocal ensembles blend with a beautiful precision. Warfield is in particularly good form in the Schumann cycle. The light, well-matched, and youthful-sounding

Are You Getting Only 1/2 of What Good Music Offers You?

ARS gives you PLEASURE plus ACHIEVEMENT...through guided listening

Greater listening enjoyment comes with greater understanding of good music. The America Record Society now offers 18 planned programs of instructive listening. Each is complete on a 12", 33 1/3 rpm L.P. high fidelity record (\$2.98 each, three for \$7.95).

Each record includes stimulating, printed program notes on background of composers and the music, PLUS A SECOND-BY-SECOND COMMENTARY—YOUR KEY TO FOLLOWING AND UNDERSTANDING THE MUSICAL SCORE.

Join the thousands of music lovers who get more pleasure from serious music.

Join the America Record Society today (simply mail coupon), and take advantage of Special Introductory Record "ALL ABOUT MUSIC" under direction of musicologist C. J. McNaspy.

THERE'S NO OBLIGATION TO BUY ANYTHING, NOW OR LATER



AMERICA RECORD SOCIETY
920 BROADWAY • NEW YORK 10, NEW YORK

Special Introductory Record
"ALL ABOUT MUSIC"
with your membership in the ARS

Explains and demonstrates the elements of music: rhythm, melody, harmony...and much more! Guaranteed to increase your knowledge and enjoyment of good music or your money back.

ONLY \$1.00
retail value \$4.98

12", 33 1/3 RPM L.P. HIGH FIDELITY RECORD.



MAIL COUPON TODAY

America Record Society, 920 Broadway, New York 10, N.Y.

Gentlemen: Please send special introductory record "All About Music". Enclosed is \$1.00. I understand I will be enrolled in the America Record Society and will review new offerings in a monthly Newsletter. I will accept or reject a record at that time. I will not have to buy any specific number of records and I may cancel my membership whenever I choose.

Name

Address

CityZone.....State.....

NOW

50% MORE TAPE

with New



“TRIPLE PLAY”

by

AMERICAN



3600 FEET ON A 7 INCH REEL

Introducing: American's New Professional Length "TRIPLE PLAY" Recording Tape . . . 3600 feet of Tensilized Mylar on the standard seven inch reel. Only "TRIPLE PLAY" offers 50% more tape, 50% more recording time . . . up to 12 full hours of recording pleasure on a single reel of tape.

See your dealer or write to:

GREENTREE



ELECTRONICS

291 S. LA CIENEGA BOULEVARD
BEVERLY HILLS, CALIFORNIA

voices in the Brahms work are perfectly appropriate to the music, and Charles Bressler sings his *Nicht wandle, mein Licht* with graceful phrasing and purity of line. The stereo version is distinctly preferable, though both stereo and mono offer good sound.

G. J.

SHOSTAKOVICH: *String Quartet No. 8, Op. 110* (see BORODIN).

© **STOCKHAUSEN:** *Gesang der Jünglinge; Kontakte*. Realization of the Electronic Studios of WDR Köln. DEUTSCHE GRAMMOPHON SLPM 138811, ST 33 \$6.98.

Interest: The avant-avant-garde
Performance: Unimprovable
Recording: Good
Stereo Quality: Appropriately tricky

Karlheinz Stockhausen's *Gesang der Jünglinge* (1955-56), according to the sleeve annotation supplied by Deutsche Grammophon, "combines sung sounds and electronically produced ones (vowel-type sounds, consonant noises; a scale of intermediary forms of tone-mixtures). Sung sounds are individual organic members of the more comprehensive 'synthetic' sound family. At certain points in the composition, the sung sounds become comprehensible words; at others they remain pure sound values; between these extremes there are various degrees of comprehensibility of the word."

In other words, a far-out, advanced work in an electronic medium. The reader might wonder what such a piece sounds like. For the most part—at least where human voices are used—it sounds like a particularly imaginative score for an avant-garde horror film. I do not so describe the work to denigrate it: as a matter of fact, Hitchcock's latest film, *The Birds*, makes use of the electronic medium to particularly felicitous dramatic effect.

One imagines that Stockhausen has something rather more significant in mind, and it is only fair to point out that a good many more startling sounds can be found in this work than in the run-of-the-mill electronic piece. For an example of the latter, *Kontakte* serves perfectly. This is conceived in a four-track version for electronic sounds, piano, and percussion, with the electronic sounds being played over a loudspeaker system and two instrumentalists playing (at the same time) metal, skin, and wooden percussion instruments and piano.

Taken altogether, the release represents the work of a young composer whose accomplishments in the electronic medium are as serious and as intelligent as any to be found. It is the aural fancy that pervades the "vocal" work on this disc, however, that gives this music the sort

(Continued on page 94)

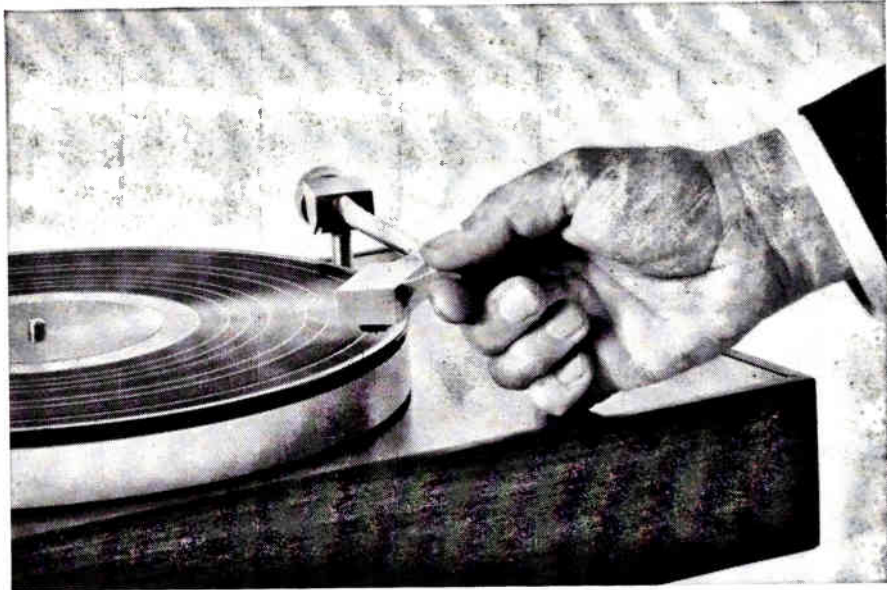

**IF YOU HEAR RUMBLE FROM AN AR TURNTABLE,
CHANGE THE RECORD.**

Hi-Fi/Stereo Review's Julian Hirsch writes: "... the only rumble that can be heard with the AR turntable, even with the tone controls set for heavy bass boost, is the rumble from the record itself." John Milder reports on the AR turntable in *Modern Hi-Fi*: "... the only time rumble is audible is when it has previously been engraved on a record by a noisy cutting lathe." Reviews of the AR turntable in *Audio*, *High Fidelity*, and in various non-hi-fi publications have reported its exceptionally silent operation.

AR turntables are guaranteed, as a condition of sale, to meet NAB Standards for professional broadcast equipment on rumble, wow, flutter, and speed accuracy. Literature, including reprints of the two reviews quoted from above, will be sent on request.

\$68⁰⁰ 33 $\frac{1}{3}$ and 45 rpm, complete with arm, oiled walnut base,
and dust cover, but less cartridge

(33 $\frac{1}{3}$ only, \$66)

5% higher in the West and Deep South

ACOUSTIC RESEARCH, INC., 24 Thorndike Street, Cambridge, Massachusetts 02141

VANGUARD
RECORDS

Recorded on location at Carnegie Hall
May 2nd and 3rd at two historic concerts
celebrating the 15th ANNIVERSARY
of the Weavers

THE WEAVERS

Reunion at Carnegie Hall · 1963

Mono and Stereo



BERNIE KRAUSE • RONNIE GILBERT • FRANK HAMILTON • PETE SEEGER
• ERIK DARLING • LEE HAYS • FRED HILBERMAN

CIRCLE NO. 81 ON READER SERVICE CARD

Now—

A hand made, hand
turned pipe for only
\$10⁵⁰

Hold it. Lift it. Try the
bit. It's unique. It's a
Heritage pipe. Examine
the aged, imported briar.
Notice the careful atten-
tion to detail. Only the
craftsmanship of gifted
artisans could have
imparted this rich
rugged looking finish.
Now smoke it and dis-
cover Heritage—one of
the world's great pipes.

Available in smooth
Heirloom (\$13.50), and
rugged Antique (\$10.50)
finishes. Send for Free
Brochure!

ROOS/ATKINS
San Francisco, California

Heritage,
Antique
finish,
Billiard
shape



CIRCLE NO. 38 ON READER SERVICE CARD
94

of immediate listenability that serious-
ness and intelligence alone cannot always
provide.

W. F.

RECORDING OF SPECIAL MERIT

© ® STRAUSS: *Also Sprach Zara-
thustra, Op. 30*. Philharmonia Orchestra,
Lorin Maazel cond. DEUTSCHE GRAMMO-
PHON SLPM 136001 \$5.98, LPM 19144
\$4.98.

Interest: Teutonic bombast
Performance: Jet-propelled
Recording: Vivid
Stereo Quality: Expansive

In spite of the stiff recorded competition
from the likes of Böhm, Karajan, and
Reiner, young Lorin Maazel has given
us a *Zarathustra* that more than holds its
own. *Zarathustra*, the fifth of Richard
Strauss' nine tone poems, is one of his
big, bloated jobs, a work that, from the
rather more sober point of view that
characterizes the musical approach of our
own century, is both amusing and im-
pressive. If its considerable rhetoric is
taken too seriously, it spills all over the
place. If, on the other hand, its rhythmic
schemes are set forth with rigid disci-
pline, it can be heard as an impressive
piece of musical composition.

The latter, in the main, is Maazel's
view of the work—a view that is un-
questionably the best one for those who
are a little cynical and wary about
Strauss' more grandiose tone poems. The
recording is splendid—absolutely first-
rate.

W. F.

© ® TCHAIKOVSKY: *Piano Con-
certo No. 1, in B-flat Minor, Op. 23*.
Vladimir Ashkenazy (piano); London
Symphony Orchestra, Lorin Maazel
cond. LONDON CS 6360, CM 9360* \$4.98.

Interest: Ashkenazy-Maazel
Performance: Rather hectic
Recording: Brilliant
Stereo Quality: Vivid

In view of the number of times the Tchai-
kovsky concerto has been recorded—
there are more than a dozen stereo ver-
sions currently available—one may legiti-
mately ask whether or not Ashkenazy and
Maazel have anything to add to what
has been said by such as Cliburn-Kon-
drashin (RCA Victor), Entremont-Ber-
stein (Columbia), Gilels-Reiner (RCA's
new Victrola series), Curzon-Solti (Lon-
don), and Horowitz-Toscanini (RCA
Victor). The combination of Soviet
Russia's finest pianist of the younger gen-
eration, and the man Europeans regard
as the hottest young American conductor
around would seem to be promising. But
such is not the case, for Ashkenazy's re-
fined pianism is at odds with the super-
charged reading attempted here. Save

for the slow movement, in which Ash-
kenazy shines in the lyrical portions and
in the passage-work of the scherzando
middle episode, the performance sounds
forced and hectic, especially the finale,
which is taken at a terrific clip. D. H.

WEBER: *Quintet, for Clarinet and
Strings, in B-flat Major, Op. 34* (see
HUMMEL).



LORIN MAAZEL

Holds his own amid stiff competition

© ® YARDUMIAN: *Symphony No. 1;
Violin Concerto*. Anshel Brusilow (vio-
lin); Philadelphia Orchestra, Eugene
Ormandy cond. COLUMBIA MS 6465
\$5.98, ML 5862* \$4.98.

Interest: The grand gesture
Performance: Above criticism
Recording: Excellent
Stereo Quality: Good

Richard Yardumian (b. 1917) is an
American composer whose career, as far
as I can discern, has been developed al-
most totally outside The Establishment.
He has lived and worked in the vicinity
of Philadelphia, and in Eugene Or-
mandy he has a powerful friend.

Certainly this present release, which
involves two very large and ambitious
works in superlative recorded perform-
ances, is an accommodation that even a
venerable American composer might
envy. And if seriousness and mastery are
the requisites for such a reward, Yardu-
mian has been given no more than his
due.

Having said this, I must confess that
the music is not at all my dish of tea.
For all its skill, I find it ponderous, re-
mote, lacking in charm, lacking in humor.
Its stylistic posture is conservative, and
although it is far from obviously deriva-
tive, its eclecticism brings vaguely to
mind such composers as Vaughan Wil-
liams, Sibelius, and even Hindemith. The

(Continued on page 97)

HIFI/STEREO REVIEW

CIRCLE NO. 16 ON READER SERVICE CARD →

plays your precious records with a light, gentle touch

Whether you use your Miracord as a manual turntable, an automatic turntable or an automatic changer; whether you play stereo or mono; you enjoy the same gentle quality, the same flawless performance that has made Miracord first choice in the finest consoles and component systems.

It is the only unit of its type obtainable with self-regulated, constant-speed hysteresis motor, the only one with a one-piece, 12-inch turntable and mass-balanced tone arm employing no springs, and the only one with feather-touch pushbutton controls.

Incredibly quiet, smooth and gentle, the Miracord brings out the best in your records with every play, and preserves that quality for long-lasting enjoyment.

Before you choose a record player for your system, be sure to see and hear the Miracord at your high fidelity dealer. Model 10H with hysteresis motor, \$99.50; model 10 with 4-pole induction motor, \$89.50 (less cartridge and base). For complete details, write to:

**BENJAMIN
MIRACORD**



pick a subject
for a great
photograph:

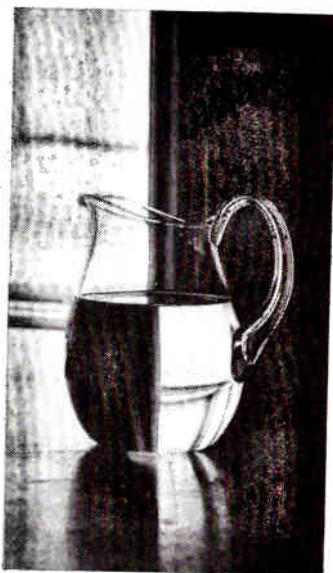

and you'll find it
in the... **1964**
PHOTOGRAPHY
ANNUAL

The editors of Popular Photography have gathered the year's outstanding examples of the art of the camera for this edition of PHOTOGRAPHY ANNUAL. There are pictures from the four corners of the earth, all pointing up the universality and versatility of the camera.

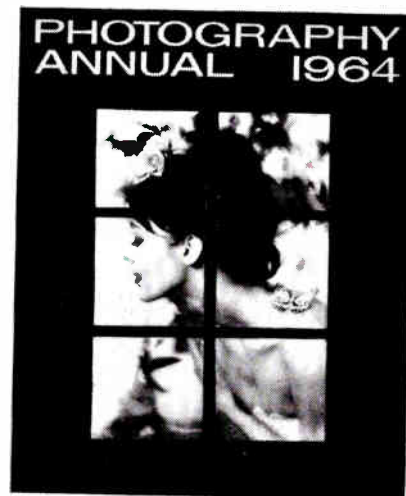

The **1964 PHOTOGRAPHY ANNUAL** is now on sale. Get your copy at your favorite newsstand or camera store. Or use this handy coupon for ordering. **only \$1.25**

Ziff-Davis Service Division Dept. PA
589 Broadway, New York 12, New York

HF-103

Please send me a copy of PHOTOGRAPHY ANNUAL 1964. I enclose \$1.25, the cost of the ANNUAL, plus 15¢ to cover mailing and handling charges. (Canada & Overseas: \$1.25 plus 25¢ postage.)

NAME _____

ADDRESS _____

CITY _____

ZONE _____ STATE _____

(Add 4% sales tax if N.Y.C. resident)

The 1964 Edition Features:

- Portfolios of five of our most creative contemporary photographers.
- Popular Photography's choice of next year's Pulitzer Prize-winning picture.
- Dorothea Lange's "Remembrance of Asia"
- Pictures from Ken Heyman's new book, "Willie"
- Selections from the powerful "Our Daily Bread" show
- Famous International Portfolio—more exciting than ever

Contemporary OR Baroque Records

WITH SOLOISTS, CHORUS
AND INSTRUMENTS

1962

Serious, practical works for small groups by Flanagan, Kay, Rorem, Wuorinen — commissioned by Daniel Pinkham under a Ford grant. Choir of King's Chapel (Boston)* Mr. Pinkham conducting. CRM 416, CRS 1416.

1714, 1645

Bach Cantata No. 61 "Nun komm, der Heiden Heiland", featuring tenor Hugues Cuenod; Schütz, The Seven Words on the Cross. Old North Singers of Christ Church (Boston)† conducted by John Fesperman. CRM 417, CRS 1417.

* Composers present at recording sessions.
† Composers not present.

CAMBRIDGE
RECORDS, INC.

471 Washington Street, Wellesley 81, Mass.

CIRCLE NO. 20 ON READER SERVICE CARD

SAVE OVER 40% ON HI-FI

USE OUR EASY-PAY-PLAN Up to 24 months to pay

DON'T BUY HI-FI-COMPONENTS

Tape Recorders or Electronic Equipment until you get return mail quotation from "your friend in the business."

- Trade-Ins—Highest Allowance—Send us your list.
- 15 day money-back guarantee.
- Full 2-year warranty—parts & labor.
- We are factory franchised all lines. We ship from stock.
- 18th year of dependable & reliable service throughout the world.
- We guarantee "We Will Not Be Undersold."
- Call us at (212) EN 9-3700 from any part of U.S.A. You may deduct 3-minute toll charge if your order is in excess of \$100.00.

BEST BUY HI-FI LIST FREE. Send 10¢ for stereo tape catalog—All labels save 33 1/3%.

ELECTRONIC WORLD HI-FI RECORDING TAPE

7" Spools - Splice Free - Freq. Resp. 30-15KC

60M	3 1/4"	600' Mylar	3-11	12+
12A	7"	1200' Acetate	\$1.09	\$.99
18M	7"	1800' Mylar	1.89	1.79
24M	7"	2400' Mylar	2.59	2.39
24MT	7"	2400' Mylar-Ten.	2.89	2.79

Any assortment permitted for 12+ price. Add 15¢ per reel postage & handling, continental U.S.A. Write for complete listing & 100+ price.

HI-FIDELITY

CENTER

"The House Of Low Low Prices"

1797-H First Ave., New York 28, N.Y.

CIRCLE NO. 39 ON READER SERVICE CARD
OCTOBER 1963

symphony is far and away the livelier piece of the two—if I may apply so unlikely an adjective to this music.

The recording is topnotch Philadelphia-Columbia: a superb production all 'round. But although chauvinism is not ordinarily my number, I was puzzled by the annotator's—and presumably Mr. Yardumian's—pleasure in a remark that seems frequently to have been directed toward the composer during a recent European musical tour: "But you are not typically American, you are like us!" Perhaps my puzzlement at Mr. Yardumian's acceptance of the comment as the *dernier cri* in flattery is the key to my coolness toward his music. W. F.

COLLECTIONS

⑤ ⑥ THE ART OF THE PRIMA BALLERINA. Minkus: *La Bayadere: Grand pas de deux; Don Quixote: Grand pas de deux.* Adam: *Giselle: Grand Adagio and Variations; Danse des Vignerons; Peasant Pas de deux.* Lovenskjold: *La Sylphide: Scène de la Sylphide.* Drigo: *Les Millions d'Arlequin: Pas de trois.* Donizetti: *La Favorita: Ballet Music.* O'Turner (arr.): *Bolero (1830).* Pugno: *Pas de quatre.* Rossini: *William Tell: La Tyrolienne.* Tchaikovsky: *Swan Lake: Black Swan Pas de deux; Sleeping Beauty: Bluebird Pas de deux; The Nutcracker: Grand Pas de deux.* London Symphony Orchestra, Richard Bonyngue cond. LONDON CSA 2213 two 12-inch discs \$11.98, CMA 7213 \$9.98.

Interest: For balletomanes
Performance: Conscientious
Recording: Good
Stereo Quality: Good

As a follow-up to the historical survey of bel canto he directed for his celebrated wife, Joan Sutherland, Richard Bonyngue now essays a parallel study in ballet with England's great prima ballerina, Alicia Markova, as consultant in tempo and style. The result is altogether fascinating for ballet fans, but may seem a bit dull for others. Minkus, Drigo, and Pugno sound pretty deadly to these ears. But the Donizetti and Rossini excerpts are sheer delight, and are conducted by Bonyngue with a real sense of style.

London's recording offers a natural sound, free of gimmicks or exaggerated brilliance. D. H.

RECORDING OF SPECIAL MERIT

⑤ ⑥ LEONARD BERNSTEIN CONDUCTS FOR YOUNG PEOPLE. Richard Strauss: *Till Eulenspiegel's Merry Pranks.* Debussy: *Afternoon of a Faun.* Copland: *El Salón México.* Tchaikovsky: *Six Dances from the Nutcracker Suite.* New York Philharmonic, Leonard

GUARANTEED FM and FM STEREO Up to 200 Miles!

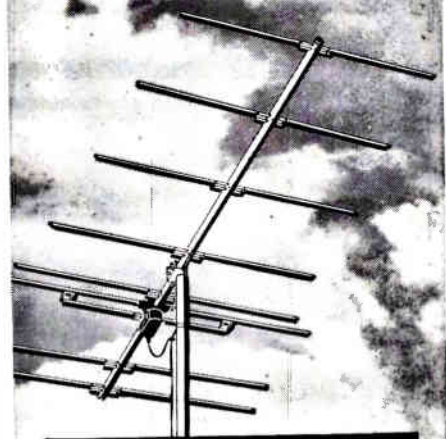

NEW Winegard STEREOTRON FM ANTENNA with Twin Nuvistor Amplifier

The reception ability of even the most expensive FM or FM stereo outfit is restricted by the performance of the antenna to which it is connected. If you want to see what your equipment can really do, you need a new Winegard Stereotron.

The Stereotron antenna and twin nuvistor amplifier is the only antenna amplifier combination that can be used anywhere—responds to 1 microvolt of signal, yet takes up to 200,000 microvolts of signal without overloading. Antenna is GOLD ANODIZED, amplifier completely weather-sealed. Exceptionally high front-to-back ratio to prevent multi-path distortion. Antenna and amplifier are available separately.

We firmly believe that the Stereotron FM antenna is in a league by itself and therefore we make the following written guarantee:

1. We guarantee the Winegard Stereotron to be the most effective, sensitive, finest constructed antenna available.
2. We guarantee the Stereotron with Stereotron amplifier will pull in 85% of all FM stations in a 200 mile radius over average terrain.
3. We guarantee you will be 100% satisfied with a Stereotron or your money back.

STEREOTRON ANTENNA Model SF-8—\$23.65

STEREOTRON NUVISTOR AMPLIFIER Model AP-300 input 300 ohms, output 300 ohms—can be used with any FM antenna—\$39.95

Amplifier Model AP-375 for use with coax cable. Input 300 ohms, output 75 ohms—\$44.95

Write for technical spec's, gain charts, polar patterns, VSWR, etc., plus Free FM Station Log and Map.

World's Most Complete Line of FM and TV antennas, FM-TV Couplers and Amplifiers

Winegard

ANTENNA SYSTEMS

3018-10 Kirkwood Blvd. • Burlington, Iowa
CIRCLE NO. 84 ON READER SERVICE CARD

NEW! ENGINEERING BREAKTHROUGH ROBERTS CROSS FIELD "770"

records automatically—

**15 high fidelity
stereo albums
for the price of one**

Now, 8 hours of full-range, true, high fidelity stereophonic music, or 16 monaural hours, can be yours on one 7" reel, with the revolutionary new Roberts Cross Field "770" Tape Recorder. The average tape cost per album: only 33¢. The "770" has an exclusive patented third head, the Cross Field Head, which separates recording and biasing functions. The result: the "770" records 40 to 22,000 cps, producing true fidelity at 1 7/8 ips and preserving the high frequency harmonics that breathe life into music playback. The Cross Field playback head has a gap width of only 40 micro-inches, the smallest, most responsive head ever engineered. For this head, Roberts employs NC-88, a new alloy, that is practically wear-proof. Other features: 2-speed, electrically-switched, heavy-duty hysteresis synchronous motor, miniscule wow and flutter at slow speeds; special ventilation system keeps the "770" cool even after 8 hours; two 5" x 7" self-contained elliptical, extended-range, heavy-duty Alnico V-magnet speakers; new automatic total shut-off switch.

Today, see the Roberts Cross Field "770" Tape Recorder at better music and camera centers. **\$499.95.**

Specifications: 7 1/2, 3 3/4, 1 7/8 ips. Power Amplifier Output: 12 watts • Frequency response: at 7 1/2 ips, 40 to 22,000 cps ± 2 db; at 3 3/4 ips, 40 to 18,000 cps ± 2 db; at 1 7/8 ips, 40 to 13,000 cps ± 3 db • signal to noise ratio: —55 below 0 recorded level • Wow and flutter: at 7 1/2 ips, less than 0.12% rms; at 3 3/4 ips, less than 0.20%; at 1 7/8 ips, less than 0.30% • Blower vent system • 2 large stereo 5" x 7" elliptical, extended range, heavy duty Alnico V magnet speakers • Hysteresis synchronous instantaneous electrically controlled 2 speed motor • Automatic total shutoff • Operates Horizontally or Vertically.



New Model 330: Another achievement of Roberts' electronic engineering. Sound-on-sound multiple recording, 3 heads for separate record, playback, erase; two 7" full-range speakers. Special biasing for FM Multiplex Recording Systems. Speeds: 7 1/2, 3 3/4 ips. 27 lbs. \$349.95.

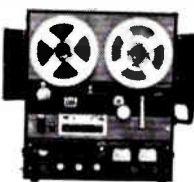

New Professional Model 455: Has three electrically switched, dual-speed motors, separate bass controls, 4 simultaneous mixing inputs, playback loudness controls, track selector, two full range 5" x 7" speakers. 7 1/2, 3 3/4 ips. \$599.95; Remote control, \$49.95.

See the entire line of Roberts professional and home tape recorders from \$269.95 at better music and photo centers.



FREE BOOKLET! "40 AND MORE WAYS TO USE A ROBERTS TAPE RECORDER"

Roberts Electronics, Inc.
5978 Bowcroft, Dept. HFS10, Los Angeles 16, Calif.

Please send free booklet

Please send me complete information about Roberts Tape Recorders

Name _____

Address _____

City _____ State _____

Bernstein cond. COLUMBIA MS 6441
\$5.98, ML 5841 \$4.98.

Interest: Young People's Concerts
Performance: Colorful
Recording: Tops
Stereo Quality: Spectacular

If memory serves, this entire program stems from the New York Philharmonic's popular Young People's Concerts series, so there is something to justify the label affixed to this package of assorted contents. Even the annotations, with their characteristic blend of the folksy and the factual, suggest the influence and perhaps even the authorship of that most persuasive pitchman for good music, Leonard Bernstein. And more power to him, the New York Philharmonic, and Columbia, for this endeavor. Young and not-so-young listeners will find much enjoyment here, for Bernstein's *Till Eulenspiegel* is rich in descriptive detail, his *Afternoon of a Faun* is colorfully evocative, and his *El Salón México* is full of spice and vitality. There is nothing routine about his *Nutcracker* dances, either: the much-played score is given a shimmering tone and the conductor's obvious affection. The sound is Columbia's best, the stereo at times spectacular. G. J.

© ® **DULCET PIPES.** Warlock: *Capriol Suite*. Farnaby: *Rosasolis*; *Woody Cock*. Holborne: *Suite for Five Recorders*. Byrd: *The Bells*; *Callino Casturame*; *The Earle of Oxford's Marche*. Palestrina: *Ricercare à quattro del primo tuono*. Handel: *Sonata No. 2, in G Minor, for Recorder and Continuo, Op. 1*. Schmelzer: *Sonata for Seven Recorders*. Stanley Taylor Recorder Consort (Richard, Christopher, Christine, Honora, and Stanley Taylor, Janet Whale, and Rainer Schuelein, recorders; James Blade, tenor drum and bells; Ruth Dyson, harpsichord); Stanley Taylor director. VANGUARD BGS 5057 \$5.95, BG 645 \$4.98.

Interest: Music for recorders
Performance: On the sluggish side
Recording: Good
Stereo Quality: Excellent

This is an attractively varied collection of ensemble and solo recorder music that ranges from the late Renaissance through the Baroque and throws in for good measure a surprisingly idiomatic arrangement for five recorders of a delightful twentieth-century piece, Peter Warlock's *Capriol Suite* for string orchestra. Almost the entire program is made up, in fact, of arrangements—contrary to the notes, the Palestrina piece was for organ—and only the Handel was written for recorder. But the arrangements are well done, especially the imaginatively scored *Earle*
(Continued on page 101)



Brubeck plays Bogen at home

The message is clear. BOGEN satisfies the critical requirements of Dave Brubeck, a giant in contemporary music, with the RP60 FM/AM and FM-Stereo Receiver and B61 Turntable. Why? In a word, performance—as near to live as possible. The sound amplified by the RP60 will impress you with clear, clean highs and honest, mellow bass tones. Here are six more excellent reasons for the RP60's marked superiority: 1) 60 watts, more than enough to drive all low efficiency speakers. 2) "Stereo-Minder" lights up indicating FM stereo transmission; 3) Front panel, switched stereo headphone jack for private listening . . . flick of a switch cuts off speakers; 4) Electronic tuning eye also serves as tuning meter to indicate strength of received signal; 5) Rumble and scratch filters . . . and tape recording filter in multiplex circuit which eliminates whistles and beeps while taping off-the-air; 6) \$314.95, a price no

other receiver with the RP60's features can match. Available with FM band only, \$279.95. And the "silent partner" performance of the Swiss-made, precision B61 Turntable, which tracks as low as ½ gram, takes special care of your records. Play Brubeck on BOGEN in your home. BOGEN components (tuners, amplifiers, receivers) begin at \$99.95; turntables at \$49.90.

LEAR SIEGLER, INC.  BOGEN COMMUNICATIONS DIVISION
PARAMUS, NEW JERSEY

I'd like the whole story on Bogen components. Send me your free 1964 Stereo/High Fidelity Catalog.

Name

Address

City..... State.....

BOGEN

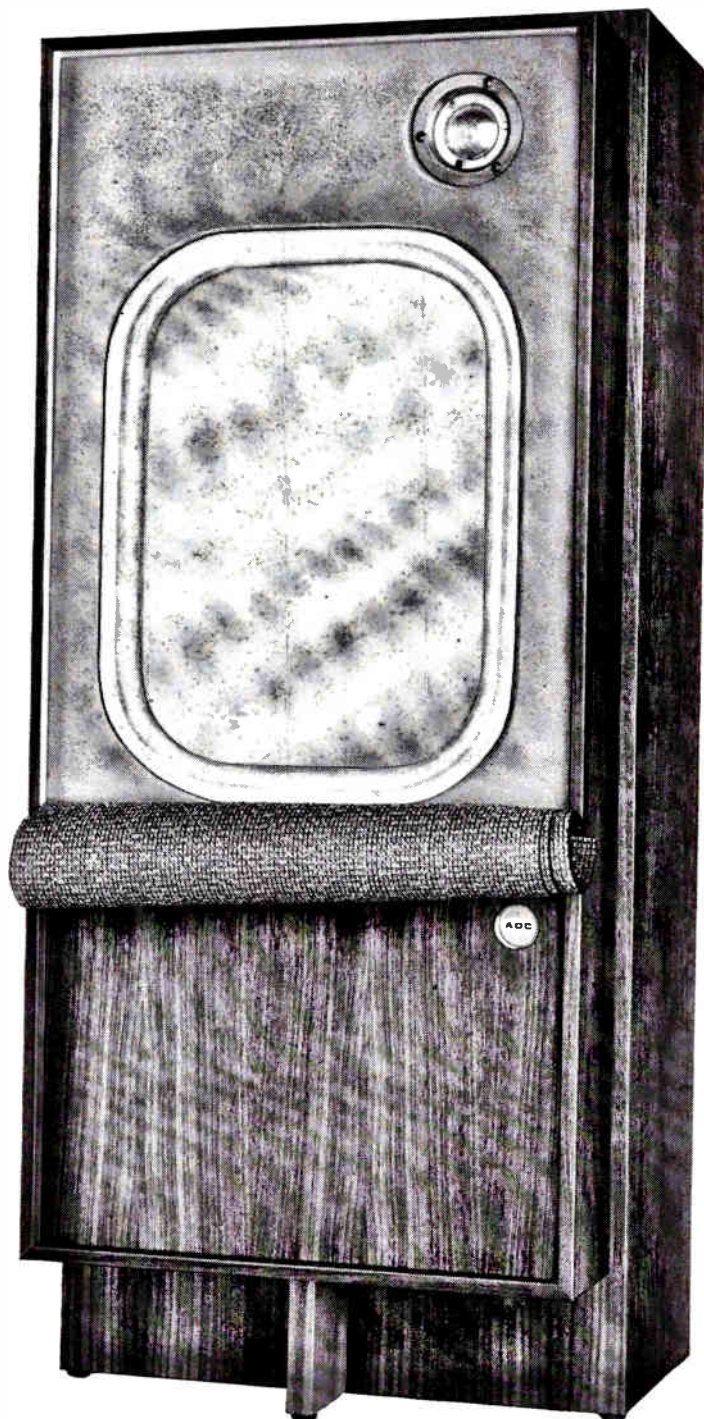

No, you're not seeing things.

You're looking at the first rectangular woofer in history.

Listen!

The sound you hear comes provocatively close to the real thing.



AUDIO DYNAMICS CORPORATION

PICKETT DISTRICT ROAD, NEW MILFORD, CONNECTICUT

CIRCLE NO. 13 ON READER SERVICE CARD

of Oxford's Marche and The Bells of William Byrd. Taylor's consort, primarily made up of members of his family, has previously been heard on some of the Alfred Deller recordings. In this, its first solo album, the consort sounds like a thoroughly competent if not always truly inspired or virtuosic ensemble. Both in the consort numbers and in his own solos on a variety of recorders, Taylor tends to somewhat rigid and sluggish tempos. His sense of style is admirable—the Handel embellishments, for example, are first-rate—but neither in technical fluency nor in ability to shade and vary the dynamics of his instrument can he compare with the more dashing manner of Carl Dolmetsch. The recorded sound is very good in both stereo and mono, and the stereo is particularly effective in the ensemble pieces. I. K.



MOURA LYMPANY

A fresh approach for some old chestnuts

RECORDING OF SPECIAL MERIT

© ① FAMOUS CLASSICS FOR THE PIANO. Debussy: *Clair de Lune*. Liszt: *Valse-Improptu*. Chopin: *Préludes in A Major, Op. 28, No. 7, and C Minor, Op. 28, No. 20*. Granados: *La Maja y el ruisenor*. Dohnányi: *Capriccio in F Minor, Op. 28*. Chopin: *Valse No. 2, in A-flat Major, Op. 34, No. 1*. Albeniz (arr. Godowsky): *Tango in D Major, Op. 165, No. 2*. Poulenc: *Pastorale*. Schumann: *The Prophet Bird, Op. 82, No. 7*. Brahms: *Intermezzo in B-flat Minor, Op. 117, No. 2*. Chopin: *Étude in C-sharp Minor, Op. 10, No. 4*. Moura Lympany (piano). ANGEL S 359995 \$5.98, 359995* \$4.98.

Interest: Elegant pianism
Performance: Thoroughbred
Recording: Good
Stereo Quality: Okay

The serious concert artist who would undertake a recital of this sort becomes

prey to certain dangers. Obviously, if these all-too-staple staples are to justify presentation in agglomeration, a certain freshness of musical observation is desirable. On the other hand, the pieces—overpopular though they may be—are more often than not likely to be small masterpieces. And freshness of observation, if it takes the form of mannerism and perversity, can degenerate into insult. Too often have we heard a major recitalist perform a repertoire chestnut by “discovering” all kinds of inner voices that the composer never intended for emphasis.

Miss Lympany, one observes with pleasure, falls victim to none of these self-aggrandizing abuses. In almost every case, she lets the music go its way without excessive comment. Her concern with playing each piece as naturally and beautifully as she can, she seems to say to us, in itself constitutes a freshness of approach. Angel, as if to parallel her musical approach, has provided a recorded sound that is subtle and muted. W. F.

© ① KIRSTEN FLAGSTAD: *In Memoriam*. Wagner: *Die Walküre: War es so schmäählich; Der Männer Sippe; Du bist der Lenz. Das Rheingold: Wotan, Gemahl! Erwache! Wesendonck Songs: Im Treibhaus; Träume*. Kirsten Flagstad (soprano); George London and Otto Edelmann (baritones); Claire Watson (soprano); Vienna Philharmonic Orchestra, Georg Solti and Hans Knappertsbusch cond. LONDON OS 25778 \$5.98, 5778* \$4.98.

Interest: Flagstad
Performance: Phenomenal
Recording: Opulent
Stereo Quality: Rich in depth

Having reached the end of its unreleased Flagstad material, London Records has combined excerpts from various albums into a disc titled “Kirsten Flagstad In Memoriam.” Here is the great soprano as both Sieglinde and Brünnhilde in performances from the two *Walküre* sets issued in 1958. She is also heard in a long scene from the 1959 *Das Rheingold*, for which she learned the role of Fricka. To complete the miscellany, two Wesendonck songs have been added from yet another early source.

Unfortunately, this highly promising program suffers from serious miscalculations: all four operatic excerpts are subjected to fade-out endings that let the listener down badly. The fact that, in two cases at least, scenes of some length have been included does not really alleviate the situation. Who, for instance, will be satisfied with the last scene of *Die Walküre* in a rendering that ends at the point where Wotan should begin his “*Leb' wohl, du kühnes, herrliches Kind!*”?

Flagstad's voice glows with its remem-

ENTICING



ADC-12 at \$139.50

ALLURING



ADC-14 at \$175.00

TEMPTING



ADC-16 at \$220.00

EXCITING



ADC-18 at \$250.00

Let only your pocketbook be your guide.

You're right with any one of these ADC speaker systems. They all have the exclusive rectangular woofer and the Mylar domed tweeter . . . from the value-packed new ADC-12 at \$139.50 to the top-rated ADC-18.



AUDIO DYNAMICS CORPORATION
PICKETT DISTRICT ROAD,
NEW MILFORD, CONNECTICUT

CIRCLE NO. 13 ON READER SERVICE CARD

Holiday for Pianos



FERRANTE & TEICHER

A lush sounding musical tour of the world.

UNITED
ARTISTS
RECORDS

CIRCLE NO. 77 ON READER SERVICE CARD

MOST VERSATILE!

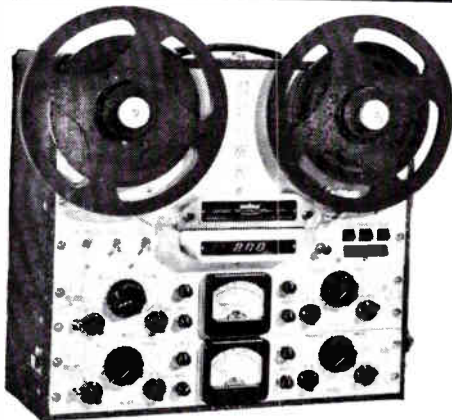

THE CROWN 824 HOME-STUDIO-LAB

- 3 motors — 3 heads — 3 speeds
- 1/4 track stereo (sound-on-sound)
- electronic "Micro Touch" controls
- 4 mixing inputs (high or low level)
- separate bass/treble controls
- magnetic brakes (no adjusting)
- echo recording facility
- guaranteed performance
- and many others (write today)

Crown
INTERNATIONAL
1718 Mishawaka Rd. • Elkhart, Ind.

CIRCLE NO. 88 ON READER SERVICE CARD

bered richness and warmth, and only a few strained top notes betray that this was an artist past sixty—a vocal phenomenon to the end. Edelmann and London give solid support as the two Wotans, and the sonorities Solti and Knappertsbusch draw from the Vienna Philharmonic are absolutely gorgeous. *G. J.*

© ① LISZT-BARTÓK INTERNATIONAL PIANO FESTIVAL. Liszt: *Sonata in B Minor*. Gabor Gabos (piano). Liszt: *Mazepa*. Clark David Wilde (piano). Bartók: *Sounds of Night; The Chase*. Dino Cianni (piano). Liszt: *Les Funerailles*. Valentyn Belcsenko (piano). DEUTSCHE GRAMMOPHON SLPM 136292 \$5.98, LPM 19292 \$4.98.

Interest: Young keyboard wizards
Performance: Impressive
Recording: Good enough
Stereo Quality: Adequate

Fifty-seven entrants from twenty-one countries took part in Budapest's International Piano Competition in 1961. The hundred-and-fiftieth birthday of Franz Liszt and the eightieth birthday of Béla Bartók were the occasions for the celebration, and, with the four young winners whose performances are documented here, the competition proves to have unearthed four stunning young pianists.

One is, however, hard put to decide on what basis the judges decided the rank of excellence. Third-prize-winner Valentyn Belcsenko, a Russian born in 1939, is heard in a performance of Liszt's *Les Funerailles* that, for flair, temperament, and brilliance, is at least as impressive as first-prize-winner Gabor Gabos' performance of the *Sonata in B Minor*. And the fastidiousness and formal clarity that England's first-prize entrant Clark David Wilde brings to Liszt's *Mazepa* is simply a different approach, not a more valid one.

Only the Italian, Dino Cianni—the second-prize winner—is a shade disappointing, not because he lacks technical and musical resources, but because his Bartók playing is a bit wanting in clear stylistic approach: the playing is loose rhythmically and lacks tension. *W. F.*

① TREASURY OF MUSIC OF THE RENAISSANCE. Vocal and instrumental works by Binchois, Dufay, Dunstable, Isaac, Chastelain, Ghiselin, Holborne, Dowland, and others. Singers and instrumentalists of La Société de Musique d'Autrefois, Pierre Chaillé and Yvonne Gouverné directors. ELEKTRA EKL 229 two 12-inch discs \$4.98.

Interest: Well-chosen anthology
Performance: Poor vocal direction
Recording: Quite good

The selection, divided almost uniformly between instrumental and vocal music of

fifteenth-century France and Italy and sixteenth-century France and England, was well done for this anthology, originally released in France by Chant du Monde in 1957. Unfortunately, there is little else to commend the set. Many tempos are taken entirely too fast, and I often had the feeling that the vocal ensemble was completely disregarding the meaning of the words: songs of passion, grief, or piety are rendered in a blasé fashion, and though the individual singers, particularly the men, are vocally satisfactory, they seem to have no awareness of differences in style between periods and countries. The ensemble singing is distressingly unrefined and unexalted. The album jacket gives the impression that Renaissance instruments were used for several instrumental pieces, but what are designated as sackbuts and a chalumeau sound suspiciously like modern trombones and an oboe—if this is indeed the case, a clarinet would have been a more suitable substitution for the defunct chalumeau. The lutes are out of tune and the violas da gamba plug along soggily, so the instrumental selections, although played with great gusto, cannot be taken very seriously. Texts and translations are included for all but the English pieces. Sound is close-miked and bright. *I. K.*

RECORDING OF SPECIAL MERIT

© ① VIRTUOSO OBOE, Volume Three. Vivaldi: *Concerto, in A Minor, for Oboe and Strings (P. 42)*. J. C. Fischer: *Oboe Concerto No. 2, in E-flat Major*. Leclair: *Concerto, in C Major, for Oboe and Strings, Op. 7, No. 3*. Albinoni: *Concerto à cinque, in D Minor, for Strings and Oboe Solo, Op. 9, No. 2*. André Lardrot (oboe); Wiener Solisten, Wilfried Böttcher cond. VANGUARD VSD 2138 \$5.98, VRS 1100 \$4.98.

Interest: High-quality grouping
Performance: Superb
Recording: Expert
Stereo Quality: Perfect

Of the four concertos contained in this third volume in Vanguard's series, three are typical examples of the Baroque concerto, and the other belongs to the era immediately after. This one, alone new to discs, is by Johann Christian Fischer (1733-1800), a contemporary and friend of Johann Christian Bach, and the work, typically galant, is a complete charmer. All four concertos are lovely pieces and are gracefully written for the solo instrument. Lardrot's playing here is even more impressive than it was in the previous two volumes, not just for the virtuosity manifested in the album title, but for the stylishness of the interpretations. Lardrot's expertness is brilliantly matched by the accompanying forces. The recorded sound could not be better. *I. K.*

***what hi-fi news
makes the
non-hi-fi
press?***

Events that loom large in the hi-fi world — a new design or a hi-fi show — rarely seem important to the world outside. But the live vs. recorded concerts staged by Acoustic Research (most of them in collaboration with Dynakit) have made news headlines in New York, Chicago, Toledo, Ontario, and Washington.

These concerts present a direct comparison between the live performance and its reproduction in stereo. At periodic intervals AR-3 loudspeakers, playing a previously recorded tape, take over from the musicians.

If the function of high fidelity equipment is to reproduce musical sound rather than to create its own kind of sound, such a comparison is the final test of loudspeaker quality. We know of nine reviewers* who reported that during these concerts they were unable to detect most of the switchovers from live to reproduced sound, from string quartet or pipe organ to AR speakers.



AR-3 speakers are \$203 to \$225, depending on finish. Other models are from \$89, all with a five-year guarantee whose coverage is complete, even to shipping charges. Literature, including a list of dealers in your area, is available on request.

*In addition to newspaper reviewers, critics in Audio, The American Record Guide, High Fidelity, and the Saturday Review.

ACOUSTIC RESEARCH, INC., 24 Thorndike Street, Cambridge, Massachusetts 02141



BRAHMS ANYONE?

If you're thinking about buying a recording of a Brahms symphony, just look in the Schwann catalog. You'll find 68 records listed—23 of the First, 14 of the Second, 13 of the Third, 18 of the Fourth.

Confusing, isn't it?

To spare you from having to choose between 68 pigs-in-a-poke (or is it pig-in-a-pokes?), we have reprinted Martin Bookspan's recapitulation of the first fifty recorded items in his "Basic Repertoire" series—including the Brahms symphonies. Mr. Bookspan gives in addition to his choices of Brahms (he likes Klemperer all the way, incidentally) 46 other "best recorded performances" of the standard repertoire.

The handy 4-page folder is reprinted from Mr. Bookspan's wrap-up articles in the April and May issues of HiFi/STEREO REVIEW, and should enable you to round out your record collection intelligently and economically. The cost is only 25 cents. Use this convenient coupon to order.

Ziff-Davis Reprint Service
Department BR

589 Broadway, New York 12, N.Y.

I enclose 25¢ to cover costs of mailing and handling. Please send me the recapitulation of the "Basic Repertoire" series. 10-63

Name

Address

City, Zone, State

MORE CLASSICAL REVIEWS



IN BRIEF



DATA

COMMENTARY

⑤ ⑥ BACH: *Cantata No. 17, "Wer Dank opfert, der preiset mich"; Cantata No. 110, "Unser Mund sei voll Lachens."* Herrad Wehring (soprano), Emmy Lisken (contralto), Georg Jelden (tenor), Jakob Stämpfli (bass); Adolf Scherbaum (trumpet), Reinhold Barchet (violin); Windsbacher Boys' Choir; Southwest German Chamber Orchestra of Pforzheim, Hans Thamm cond. CAN-TATE 651210 \$6.95, 641210* \$5.95.

These cantatas, both recorded for the first time, are worth hearing, though their over-all musical quality does not match that of Bach's most inspired compositions. The performances are stylistically sound and tasteful, with excellent singing by the male choir, and the soloists and the conductor are thoroughly competent. The recording and stereo placement are excellent, but a slight treble boost is needed. I. K.

⑤ ⑥ BARTÓK: *Bluebeard's Castle, Op. 11.* Olga Szonyi (soprano), Mihaly Szekely (bass); London Symphony Orchestra, Antal Dorati cond. MERCURY SR 90311 \$5.98, MG 50311* \$4.98.

This recording is almost completely out-classed by the Ormandy-Elias-Hines version on Columbia, although it has the advantage of being sung in the original Hungarian. W. F.

⑤ ⑥ BEETHOVEN: *Sonata No. 8, in G Major, for Violin and Piano.* BRAHMS: *Sonata No. 3, in D Minor, for Violin and Piano.* Erica Morini (violin); Rudolf Firkusny (piano). DECCA DL 710065 \$5.98, DL 10065 \$4.98.

Unity of purpose, elegance of expression, and singing tone characterize both soloists here. The Beethoven sonata is virtually flawlessly performed, its bright-spirited lyricism delightfully captured. In the Brahms, Firkusny's playing seems too restrained, and my own preference is the Szeryng-Rubinstein interpretation. Clear, warm sound, but poor surfaces on the review copy. G. J.

⑤ ⑥ MOZART: *Quintet, in E-flat, for Piano and Woodwinds; Divertimentos K. 213 and 270.* Camillo Wanausek (flute), Friedrich Wächter (oboe), Ernst Mühlbacher (horn), Richard Schönhofer (clarinet), Leo Cermak (bassoon), Hans Graf (piano). WESTMINSTER WST 17023 \$5.98, XWN 19023 \$4.98.

The Quintet K. 452 is one of the most frequently recorded chamber works of Mozart, and with good reason: it has instrumental writing of continual felicity and imagination. Both it and the divertimentos, here arranged for woodwind quintet, receive zestful and virtuosic performances, true to the Mozartian spirit. The sound is live and transparent, the stereo well-defined. G. J.

⑤ ⑥ CLASSIC CYMBALOM: *Couperin: Le rossignol et double; Le papillon; Le moissonneur; Les folies françaises.* D. Scarlatti: *Sonatas: in C Minor; in F Major; in D Minor.* Aládár Rác (cymbalom); Ivonne Rác (piano). WESTMINSTER WST 17011 \$5.98, XWN 19011 \$4.98.

The cymbalom, a popular Hungarian gypsy form of the ancient dulcimer, would appear to be one of those instruments that, even when superbly played (as it is here), will never make the classical big time. The performer's virtuosic gifts are wasted on an unworthy instrument. Good sound. W. A.

⑤ ⑥ HALLELUJAH! HALLELUJAH! GREAT SACRED ARIAS AND CHORUSES. Works by Handel, Mozart, Giordani, J. I. Schnabel, Bizet, Schubert, Bruckner, Beethoven, and Bach-Gounod. Lisa Otto (soprano), Donald Grobe (tenor); Berlin Handel Choir and Radio Symphony Orchestra of Berlin, Günther Arndt cond. DEUTSCHE GRAMMOPHON SLPEM 136366 \$6.98, LPEM 19366* \$5.98.

In this varied program of unfamiliar works the excellent choir and orchestra do their jobs well. Lisa Otto sings Mozart's beautiful "Laudate dominum" from *Vesperae solennes de confessore*, K. 339, with ethereal tone, and Grobe's voice is attractive but pushed too hard in the Bizet *Agnus Dei*. Little information about the selections or the lesser composers is given. Good sound, rather unspectacular stereo, and quiet surfaces. G. J.

The JBL Energizer/Transducer raises audio reproduction to a degree of perfection and precision never before available to the home listener. You hear music re-created in all its detail, rich and splendid, life size, without hum or distortion. The Energizer/Transducer sets new standards for fully controlled bass, completely realistic mid-range, immaculate highs, and transient reproduction without equal.

An Energizer/Transducer has its own source of power: the Energizer. The Energizer is exactly matched to the specific loudspeaker-and-enclosure system in which it is used. Energizer and transducer are engineered as a unit. Given a flat, pure signal from a preamplifier, the Energizer/Transducer delivers sound that is perfectly flat and pure — an exact replica

NOW! ALL ARE AVAILABLE SELF- ENERGIZED

— with exactly the right amount of damping at all frequencies. No other home high fidelity equipment can give you these results.

The JBL Energizer is a stereophonic all-solid-state device of scientific-instrument quality. Devoid of microphonics, generating negligible heat, it can be mounted within an acoustical enclosure. All JBL loudspeaker systems are available as Energizer/Transducers. The JBL loudspeaker system you now own can be made into an Energizer/Transducer. When ordering your matched Energizer, you need only provide your Audio Specialist with the complete model number of your system. Write for your free copy of the new Energizer/Transducer six-page brochure.

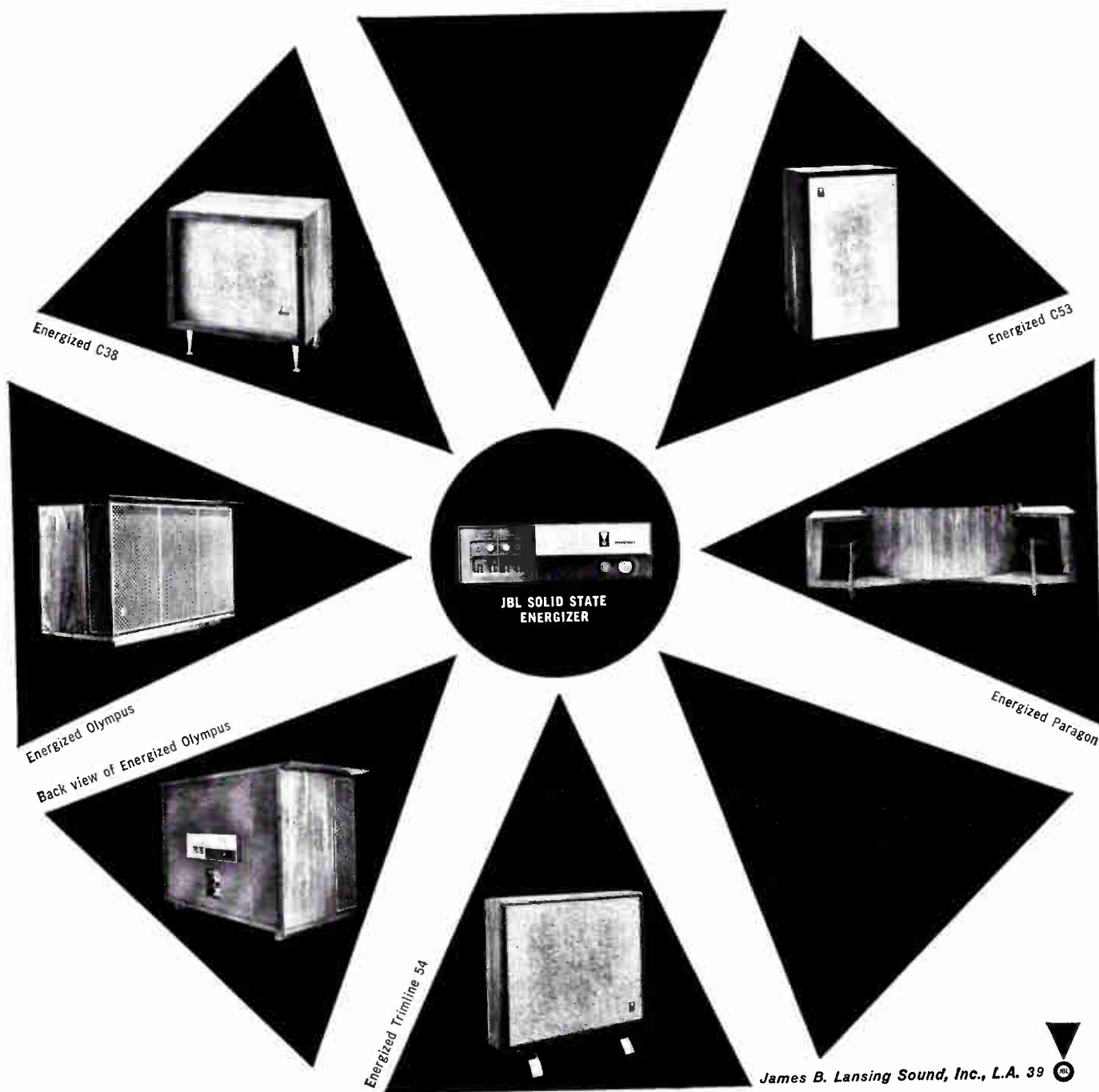

James B. Lansing Sound, Inc., L.A. 39

CIRCLE NO. 47 ON READER SERVICE CARD

NINE BEETHOVEN SYMPHONIES WITH KARAJAN

I HAVE never been a great admirer of Herbert von Karajan as a symphonic conductor, although I have found many wonderful moments in his recordings of opera and oratorio. But what emerges from this fourth complete set of the Beethoven symphonies to appear in stereo, recorded by Deutsche Grammophon from December of 1961 to November of 1962, is the expression of a major artist of our time who aspires to establish himself as a truly great Beethoven interpreter. The listener immediately senses, from the razor-sharp precision, flexibility, and cantabile quality of the Berlin Philharmonic's playing, that this is not just another go-round with Beethoven, with the rough edges to be taken care of by tape editors. There can be no doubt that the performances are the result of a new and thorough study of the music by Karajan. Authoritative sources say that he has given particular attention to the classic Toscanini interpretations. This is not hard to believe, because what results is an infusion of the Austrian lyrical spirit into the overpowering rhythmic vitality that was Toscanini's hallmark.

Taking the readings in order, Symphonies Nos. 1 and 2 sound a bit like warmups. Everything is elegance and proportion, but Karajan equals neither the dynamism of Toscanini in No. 1 nor the virile songfulness of Beecham in No. 2. Karajan's "Eroica," however, is on a par with Toscanini's. The first movement is tightly integrated and has shattering power. The funeral march follows Toscanini rather closely, save for a more expansive treatment of the fanfare episodes. The two final movements are hair-raising in their brilliance.

Symphony No. 4, the precursor of the lyrical Romantic symphonism of the mature Schubert and of Schumann at his best, has much brilliance but little of the poetry of the older recorded performances of Beecham or Monteux, or the more recent ones of Klemperer and Walter. It is the perennial problem of balancing phrase tension, weight of sonority, and tempo. Karajan's prevailing rapid tempos lack sufficient counterbalancing weight, so that, for instance, the dominating figure that acts as a whip-lash in the first movement tends to get lost in the shuffle.

The first movement of No. 5 receives a hell-for-leather reading, but like Toscanini's, it lacks effective articulation and the impact that goes with it. Everything else comes off beautifully, and the finale is probably the most persuasively majestic on records.

The "Pastoral" will doubtless be the

subject of controversy: it is a question of whether one conceives Beethoven's country excursion as occupying a relaxed afternoon in mid-June or a bracing late morning in early May. Karajan, in common with Toscanini, subscribes to the latter view, and carries it out even better. His *Scene by the Brook* is magically murmurous but not soporific, his peasants are lively rather than clodhopperish, and his storm makes even Toscanini's cloudburst seem like a sprinkle. The final *Thanksgiving* portion is likewise so paced that the repetitions do not pall. Undoubtedly, there will be those who will complain of the lack of *Gemütlichkeit* in this reading. But because Karajan's kinetic energy is so well tempered by the



DOUGLAS GLANS

HERBERT VON KARAJAN
After restudy, the Toscanini approach

lyrical sweetness of the orchestral playing, I find this version very much to my taste.

Symphony No. 7 is for me the least successful in the Karajan cycle—an attempt to outdo Toscanini in velocity. The slow introduction lacks weight, the famous allegretto movement is almost devoid of those accents that carry the meaning, and the finale is frenetic.

The little giant of the Beethoven symphonies, No. 8, is played with beautiful precision, especially the famous "metronome" movement. But, as in the Fourth Symphony, there is little poetic charm, let alone wit, in the reading. For this we must turn to Monteux, Beecham, or Walter.

With the first two movements of No. 9, Karajan again scales the heights he reached in the "Eroica." Shattering is again a fitting word for the first movement here, and the Scherzo has breathtaking satanic fury. In the two final

movements, however, Karajan fails to convey a sense of spiritual commitment such as shines through every bar of the readings by Toscanini, Furtwängler, and Klemperer. Nor does the somewhat distantly placed chorus in the finale achieve the impact common to these earlier recorded performances. For me, the ideal recorded Beethoven Ninth would consist of the first two movements by Karajan followed by the final two movements by Klemperer.

While I cannot say that Karajan has yet placed himself among the all-time great interpreters of Beethoven, where he is good he is so very good that I look forward to his second essay of these symphonies—on whatever will be the recording medium a decade from now. For if what he has done here in the "Eroica," the "Pastoral," and the first two movements of the Ninth can be tempered with spiritual intensity, if the Nietzschean *hubris* can be softened by humility, then there can be little question that Karajan will be an interpreter of universally valid artistic truth.

A few words about the DGG recording: I found it solid and wholly true to life, skillful in its projection of stereo illusion, and wonderfully satisfying in presence, particularly in relation to the double-bass and timpani sound. My only serious reservation is the placing of the chorus in the Ninth Symphony. The brochure in the review set was in German only; English translations will presumably be furnished with store sets.

I have never been in favor of the idea of buying a packaged Beethoven nine by a single conductor and orchestra—unless one wants to make a whopping impression on some hardy friend at Christmas time. If you (or your friend) want the finest orchestral playing and stereo sound that you can get, then this DGG set is clearly the best one available. But no single conductor has a monopoly on superior Beethoven interpretation. One can learn much more about Beethoven and the art of musical interpretation by listening to two or more good disc versions of each of the nine. The Toscanini, Walter, Klemperer, and Karajan recordings are all fine for this purpose.

David Hall

© © BEETHOVEN: *Symphonies Nos. 1-9*. Berlin Philharmonic Orchestra; Vienna Singverein Chorus; Gundala Janowitz (soprano); Hilde Rössl-Majdan (contralto); Waldemar Kmentt (tenor); Walter Berry (bass); Herbert von Karajan cond. DEUTSCHE GRAMMOPHON SKL 101-8 eight 12-inch discs \$47.95, KL 1-8 \$47.95.

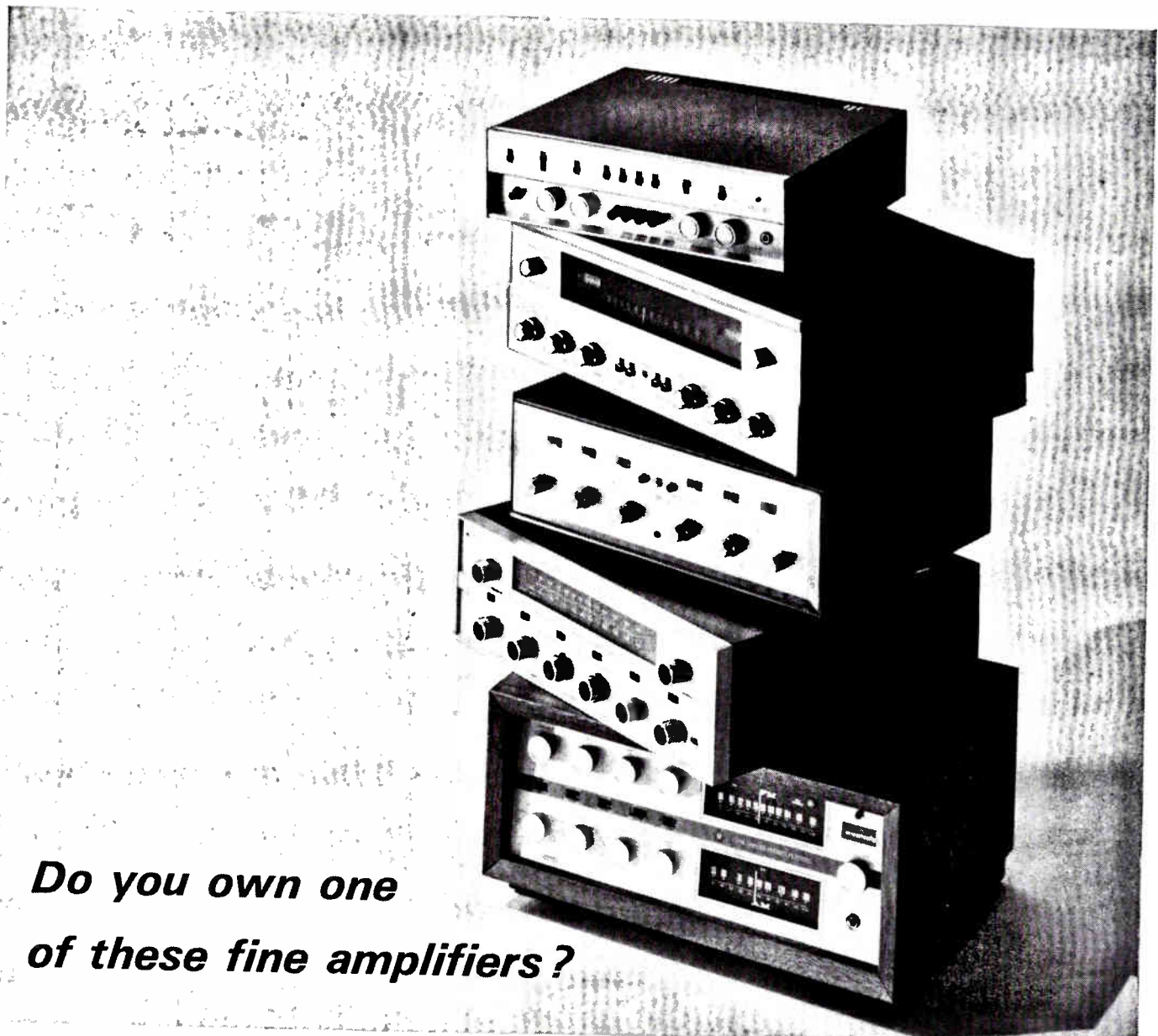

***Do you own one
of these fine amplifiers?***

From top: Knight, Fisher, Scott, Bogan, Harman-Kardon

If you do — and you don't own a set of Koss stereo headphones — you've got a lot of fun still coming! You've got the whole great experience of Koss "solo flight" listening ahead, because your amplifier is equipped with a jack just right for Koss Stereophones.

Just plug them in, slip them on and . . . well, prepare for take-off. Your Koss phones will send you soaring into private sonic bliss. You'll hear it all with startling clarity and a new "up-closeness" you've never experienced before. What's more, you'll listen in complete seclusion, with no disturbance to or from the others in the room.



PRO-4 STEREOPHONES

Fluid-filled earpads for tight, comfortable seal. A durable phone designed for professionals. 30-20,000 c.p.s. response 16 ohms impedance. \$45.00.

SP-3X STEREOPHONES

Wide range 10-15,000 c.p.s. response obtainable only through earphone listening. Sensitive 3½" sound reproducers mounted in each earpiece. Soft sponge foam ear and head cushions. Impedance 4-16 ohms. \$24.95.

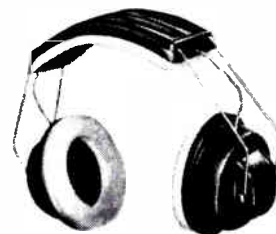

KOSS electronics inc.

2227 N. 31ST STREET • MILWAUKEE, WISCONSIN 53208

CIRCLE NO. 45 ON READER SERVICE CARD

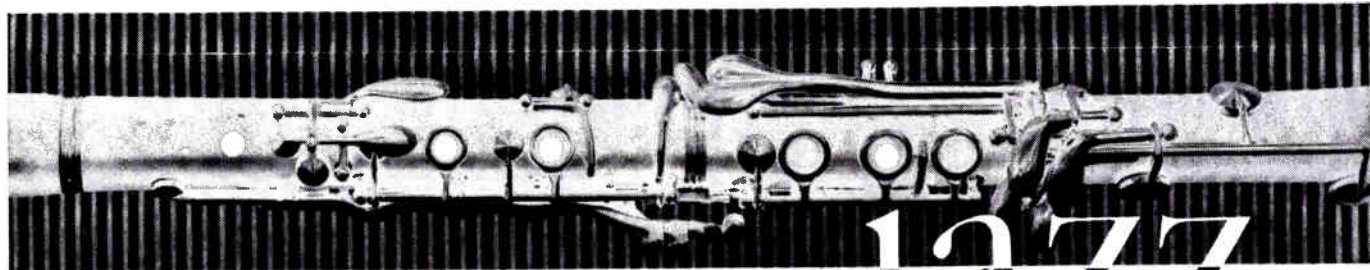

Jazz

Reviewed by JOE GOLDBERG • NAT HENTOFF • STANLEY GREEN

Explanation of symbols:

- Ⓜ = monophonic recording
- Ⓢ = stereophonic recording
- * = mono or stereo version not received for review

Ⓢ Ⓜ **ART BLAKEY: *A Night in Tunisia*.** Art Blakey (drums), Bill Hardman (trumpet), John Griffin (tenor saxophone), Jackie McLean (alto saxophone), Sam Dockery (piano), Jimmy De Brest (bass). *Night in Tunisia; Could It Be You?; Off the Wall; Theory of Art; Evans*. RCA VICTOR LSP 2654 \$4.98.

Interest: Earlier Blakey
Performance: Spotty
Recording: Good
Stereo Quality: Reprocessed

This reissue of an album recorded by the Jazz Messengers in 1957 is a microcosm of all that is best and worst in Art Blakey's approach to jazz. The drummer himself is incomparable in the kind of heated African percussion he prefers, and he shows it here in solo after solo. In *Night in Tunisia* there is an example of his interest in polyrhythms, when his hornmen exchange their usual instruments for timbales, bongos, and claves for a highly stimulating session. Blakey is capable of finding young musicians of unusual promise, as is made evident here by the work of Jackie McLean and Johnny Griffin. But he is ruthlessly committed to hard bop, and will, if necessary, employ a minor musician of that persuasion rather than a better man with a different style. Bill Hardman and Sam Dockery are merely weak carbons of Clifford Brown and Horace Silver, both Blakey alumni, and Blakey's relentless accompaniment can swamp all but the most assured musicians.

Although these five hard-bop exercises contain long arid stretches, they are more than made up for by some superb Blakey solos. The "reprocessing" is effectively realistic. J. G.

Ⓢ Ⓜ **CHARLIE BYRD/ART MOONEY/MARK MURPHY/RAY BARRETTO/BILLY MURE: *Everybody's Doin' the Bossa Nova*.** Charlie

Byrd and Billy Mure (guitars), Mark Murphy (vocals); orchestras of Art Mooney and Ray Barretto. *Sugar Loaf; O Pato; St. Louis Blues; Midnight Sun*; and eight others. RIVERSIDE RS 93521 \$4.98, RM 3521* \$3.98.

Interest: Mixed bossa nova bag
Performance: Seldom absorbing
Recording: Good
Stereo Quality: Okay

A third of these dozen exercises in bossa nova by American groups have been previously released on long-playing records by the various groups involved. The rest were either issued as singles only or have never before been available. The



HANK CRAWFORD
Piercing, preaching directness

collection, involving five different leaders, is uneven. The most appealing tracks are three by Charlie Byrd, whose graceful lyricism is particularly well attuned to the bossa nova idiom. At the other end of the scale are four predictably commercialized performances by Art Mooney. In between are an innocuous track featuring Billy Mure, two crisp vocals by Mark Murphy, and two numbers by Ray Barretto that are more for dancing than for repeated listening. As a whole, the album is likely to be as transitory as the bossa nova fad itself. The sound varies somewhat from track to track, but it is generally good. N. H.

Ⓢ Ⓜ **HANK CRAWFORD: *The Soul of the Ballad*.** Hank Crawford (alto saxophone); orchestra, Marty Paich cond. *Blueberry Hill; Stardust; Any Time; Stormy Weather; Whispering Grass*; and seven others. ATLANTIC S1405 \$5.98, 1405* \$4.98.

Interest: Crawford with strings
Performance: Passionate
Recording: Excellent
Stereo Quality: Good depth

Alto saxophonist Hank Crawford, a Ray Charles stalwart since 1958, usually records soulful albums with combos extracted from the Charles big band. This time he is assisted by a large string orchestra in arrangements by Marty Paich, whose string numbers on Charles' two phenomenally successful country-and-western albums follow the same formula. There is even an uncredited pianist who sounds like, and may even be, the Genius.

A few tunes on the set have country overtones, and others come from such unlikely sources as the Ink Spots. On all, Crawford, virtually the only soloist, plays with a piercing, preaching directness derived from certain facets of Charlie Parker's blues style. His performance of *Getting Sentimental Over You* is practically a textbook example of how to turn a chorus of straight melody into jazz through tone, phrasing, and inflection. The album as a whole is a superior rhythm-and-blues-flavor pop date, somewhat monochromatic in feeling, but with far more power than the majority of such efforts. J. G.

Ⓢ Ⓜ **BILL ENGLISH: *Bill English*.** Bill English (drums), Martin Revere (bass), Lloyd G. Mayers (piano), Seldon Powell (tenor saxophone, flute), Dave Burns (trumpet). 222; *Rollin'; Heavy Soul; Sel's Tune*; and four others. VANGUARD VRS 9127 \$4.98.

Interest: Superior mainstream jazz
Performance: Casual but adept
Recording: Sharp and full

A few years ago, drummer Bill English left the Apollo Theater house band to free-lance in New York, and made some telling contributions to the small group

YES, THERE NOW IS AN INDOOR ELECTRONIC FM ANTENNA THAT DELIVERS WHAT OTHERS PROMISE!

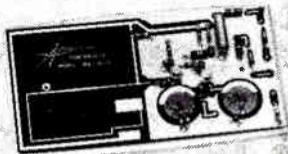

THE MULTITRON BY ANTRONICS

Specifically engineered to solve the problems of FM/FM Stereo reception, the Antronics Antenna can be unconditionally guaranteed to do the job — with you as the sole judge — or your money will be refunded. Here are some of the reasons for this unusual offer:

CONVENIENCE: Compact, low-silhouette design fits anywhere, works anywhere, in view or out of sight. Combat reception problems without a rotator or other accessories. No retuning or readjustment. Measures only 9" x 5" x 1 1/2".

SENSITIVITY: Unique, multi-coupled antenna (Pat. Pend.) integrated with multi-stage, stabilized, transistorized amplifier provides full FM bandwidth with high gain. Response from 88 to 108 mc \pm 1 1/2 db; gain at least 20 db (100x signal power) over reference dipole at any FM frequency.

RELIABILITY: Glass-epoxy circuit board has special physical & high-frequency electrical properties. Printed, distributed constants, including coupling transformers, replace conventional components for greater precision. Nothing to wear out. No effects from wind, rain or snow.

VERSATILITY: Can be positioned for multi-directional reception or rejection of unwanted signals. Accommodates all tuner antenna inputs. Install it in two minutes.

ECONOMY: No installation labor, no costly repairs, no rotators, etc. Your first investment is your last.

10-DAY MONEY-BACK GUARANTEE

In white or black @ \$29.95

See your HI-Fi dealer or write for details

ANTRONICS

309 Queen Anne Road, Teaneck, New Jersey

CIRCLE NO. 91 ON READER SERVICE CARD
110

led by trumpeter Joe Newman. Now he has made this straightforward album. It is devoid of exhibitionism, and contains some of the most lasting musical moments to be put on discs in a long while. These are the work of tenor saxophonist Seldon Powell. On *Fly Me to the Moon* and *A Blues Serenade*, his solos have a timelessness like that of the best swing-era musicians. Unfortunately, he is less successful on the flute. Trumpeter Dave Burns adds quietly assured solos throughout, and pianist Lloyd Mayers and bassist Martin Revere are almost as good. English himself propels the set gently, never calling attention to himself. Most of this is good mainstream jazz, and the two bands *Fly* and *Serenade* are more than that. J. G.

⑤ ⑥ **ERROLL GARNER: *One World Concert*.** Erroll Garner (piano), Edward Calhoun (bass), Kelly Martin (drums). *Misty; Lover Come Back to Me; Movin' Blues; Happiness Is a Thing Called Joe;* and five others. REPRISÉ R9 6080 \$4.98, 6080* \$3.98.

Interest: Garner in concert
Performance: As expected
Recording: Good
Stereo Quality: Okay

This is Erroll Garner's first album for Reprise, and his first recorded in performance since "Concert by the Sea" for Columbia seven years ago. Garner's style might be said to be similar to the Volkswagen's: it took its over-all shape some years ago, and now only minor reworkings are necessary to keep it a going concern. There are still those long, complicated introductions that give no hint of the song to come and are probably stage-waits while Garner decides what to play. Then there are the lagging beat, the infectious swing, the florid romanticism, the crowd-pleasing and -teasing.

On this record, selected from twelve hours of tape made at concerts at the Seattle World's Fair, there is some evidence that the style has hardened too much for Garner's own good. The introduction to *Mack the Knife* is so inappropriate as to be shocking. There is much facile charm, but no added depth or maturity. But on a piece such as *The Way You Look Tonight*, Garner shows why he is probably the most imitated jazz pianist since Tatum and Bud Powell. There is still no one who can swing like Garner, or who can make a throw-away like *Dancing Tambourine* a cotton-candy delight. Other pianists offer depth, but for easy fun, you can do no better than this—and the vociferous audience seems to agree. J. G.

⑤ ⑥ **TERRY GIBBS: *Straight Ahead*.** Terry Gibbs (vibraphone), Pat Moran (piano, organ), Max Bennett and John

Doling (bass), Mike Romero (drums). *Hey Jim; For Keeps; C. C. Blues; Hippie Twist;* and three others. VERVE V6 8496 \$5.98, V 8496* \$4.98.

Interest: Superior Gibbs
Performance: Happy
Recording: Good
Stereo Quality: Okay

Vibraphonist Terry Gibbs, playing an instrument dominated in style by the figures of Milt Jackson and Lionel Hampton, still manages to be something of an original. His work is marred by a hard, flat sound, and all too often he seems to skitter on the surface of the music. But he has a joyful buoyancy that at its best is quite infectious. This new quartet album is his finest in some time, so the music has far more staying power than usual.

Gibbs is aided considerably by Pat Moran, a very good if eclectic pianist. For a while in her career, her work seemed to be passing from fresh originality into a collection of hip clichés, but now she is again herself. On two numbers here, she plays the organ, but less effectively than she does the piano. The rhythm section gives fine support.

The most affecting moment on the album is the out-of-tempo opening of *You Go to My Head*, played by the two soloists without accompaniment. Gibbs is particularly fine and straightforward on the often cloying *Memories of You*, and even has some excellent moments on the unfortunately ubiquitous *Green Dolphin Street*. This is not a great nor an especially memorable collection, but it boasts good, unpretentious craftsmanship, even if there is only an occasional flash of genuine inspiration. J. G.

RECORDING OF SPECIAL MERIT

⑤ ⑥ **DIZZY GILLESPIE: *Something Old, Something New*.** Dizzy Gillespie (trumpet), James Moody (alto saxophone, flute), Kenny Barron (piano), Chris White (bass), Rudy Collins (drums). *Cup Bearers; November Afternoon; Good Bait; This Lovely Feeling;* and five others. PHILIPS PHS 600091 \$4.98, PHM 200091* \$3.98.

Interest: Gillespie's new team
Performance: Assured and economical
Recording: Good
Stereo Quality: Good

This appropriately titled Gillespie album, in which familiars Leo Wright and Lalo Schifrin are replaced by James Moody and Kenny Barron, finds Dizzy Gillespie leading the best combo he has had since he finally gave up his big band a few years ago. Moody is the more important addition: it is gratifying to hear a man adapt so well to the ideas

of his juniors—he functions with Dizzy much as John Coltrane did with Miles Davis.

Gillespie, of course, is the virtuoso jazz trumpeter, now at his relaxed, economical best, and Moody is more than capable of keeping up with him. For his first recording with this personnel, Gillespie has chosen to split the album into two sections. One side is made up of new pieces, all but one written by the young trombonist Tom McIntosh, all in a lyrical, melodic vein, typical of the post-bop Establishment. While drummer Rudy Collins is skillful and adept throughout, bassist Chris White seems to fit in better on this portion of the set, his close-to-the-bridge work being more suited to this music.

The other, more fascinating side of the disc consists of reconsiderations of music associated with Gillespie's revolutionary playing of the Forties: *Be-Bop*, Dizzy

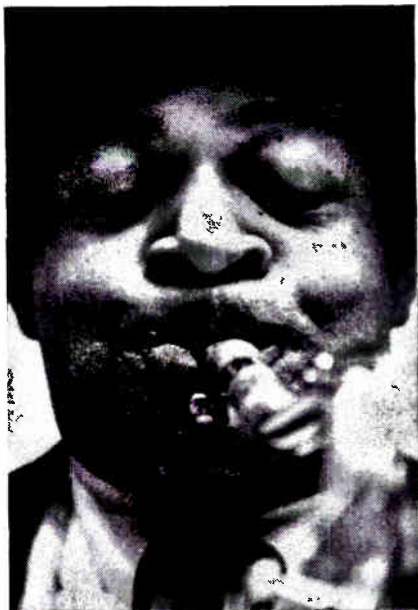

COLUMBIA RECORDS

COLEMAN HAWKINS
Imagination at the Village Gate

Atmosphere, *Good Bait*, and so forth. Perhaps no other group could execute the killing *Be-Bop* as easily and cleanly as this one. But there is more than virtuosity to the quintet. It must have taken courage to approach *I Can't Get Started* again, for Gillespie's earlier recording is the definitive jazz version. The new one, while owing much to the former, shows the ease and authority Gillespie has gained in twenty years. And only he would have dared to end *'Round Midnight* with a bugle call.

Gillespie and Moody, while giving evidence that their partnership can be expected to produce superlative music, have at the same time fashioned a retrospective exhibit of the bop quintet that surpasses all but the greatest of their models. The recording is very brilliant but well-balanced. J. G.

OCTOBER 1963

⑤ ⑥ COLEMAN HAWKINS: *Hawkins! Alive! At the Village Gate*. Coleman Hawkins (tenor saxophone), Tommy Flanagan (piano), Major Holley (bass), Ed Locke (drums). *All the Things You Are; Joshua Fit the Battle of Jericho; Mack the Knife; Talk of the Town*. VERVE V6 8509 \$5.98, V 8509 \$4.98.

Interest: Superior Hawkins
Performance: Compelling
Recording: Very good
Stereo Quality: Lacking brilliance

The latest in a seemingly endless stream of musicians to be recorded in performance at New York's Village Gate is Coleman Hawkins. Working with his regular rhythm section—pianist Tommy Flanagan, bassist Major Holley, drummer Ed Locke—Hawkins has recorded extended versions of four standbys: *All the Things You Are*, *Joshua*, *Mack the Knife*, and *Talk of the Town*. At times, the incessant, granitic roll of his succession of eighth-notes becomes oppressive, but there is a fecundity of imagination that Hawkins has not always shown recently. The opening of *Talk of the Town*, in particular, is a gem, a capsulized document of everything Hawkins does best. Flanagan is his usual understating, excellent self. Locke is a quiet and generous drummer, and Holley a fine bassist whose solos can be tiring. The monophonic version has a clarity and brilliance that the stereo lacks. But the main consideration is Hawkins, for he is still a master. J. G.

⑤ ⑥ WOODY HERMAN: *Encore*. Woody Herman (clarinet, alto saxophone); orchestra. *That's where It Is; Watermelon Man; Jazz Me Blues; Caldonia*; and four others. PHILIPS PHS 600092 \$4.98, PHM 200092* \$3.98.

Interest: Woody's roaring again
Performance: Zestful
Recording: Clear and live
Stereo Quality: Excellent

Recorded at Basin Street West in Hollywood, this second Philips album by the Woody Herman band is even more exciting than the first, "Woody Herman-1963" (Philips 600065/200065). Within the past couple of years, Herman has recruited an enthusiastic unit of youngsters, and their collective gusto has proved that extensive big-band bookings are still available for a sufficiently explosive and vital orchestra.

In this newest of his herds, moreover, Herman has his best rhythm section in many years, particular credit going to the resilient drumming of Jack Hanna. Also outstanding is a brass team of exhilarating power and precision.

The weak points in the Herman band

"...major step forward*"

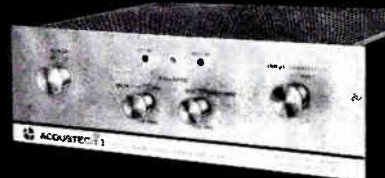
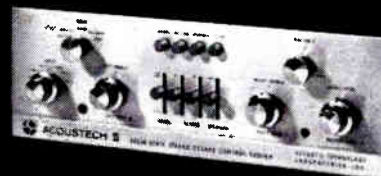

ACOUSTECH SOLID STATE AMPLIFYING SYSTEM

"... better than the best** ..."
"... seems to 'grab hold of' and control a speaker to a degree that has led many listeners to remark that the speaker itself 'never sounded better.'** ... the finest square wave response I have ever observed** ..."

These are examples of the acclaim accorded the Acoustech I Solid State Stereo Power Amplifier since its introduction at the 1962 New York High Fidelity Show. Now the first "all-out" solid state amplifying system is made possible with the new Acoustech II Stereo Decade Control Center. These two units afford the listener a new standard in music reproduction and reliability possible only with solid state circuitry throughout.

For full information on these remarkable instruments, send coupon below.

Acoustech I \$395, Acoustech II \$348 (slightly higher west of Rockies)

*High Fidelity Magazine, August, 1962
**HiFi/Stereo Review, February, 1963



ACOUSTECH, Inc., 139 Main St.
Cambridge, Mass. 02142 Dept. R-10

Name _____

Address _____

City _____ State _____

CIRCLE NO. 1 ON READER SERVICE CARD
111

New Science-Age Filter-Pipe

PATENT PENDING



KAYWOODIE

perfects new ceramic filter
for milder, drier smoking



Here is a filter so new... so different that Kaywoodie designed an entirely new pipe for it. The filter is a special ceramic that literally devours tars, nicotine and moisture. When it darkens, replace it.

The bowl is crafted of rare, imported Kaywoodie briar. And it's interchangeable. Thus, you always get a fresh, mild, dry smoke. Try a Kaywoodie Filter-Pipe and enjoy a new smoking experience!

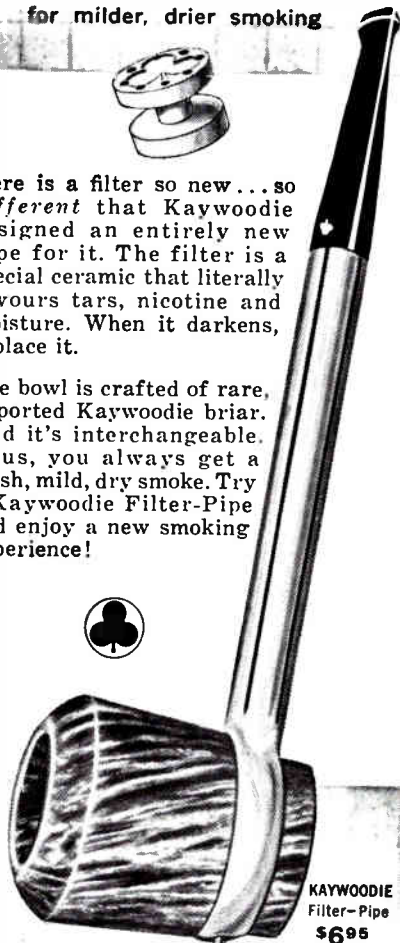

KAYWOODIE
Filter-Pipe
\$6.95
with 3 extra filters

Extra interchangeable Kaywoodie Briar Bowls. \$3.50 ea.

Aluminum shank encasing stainless steel smoke tube assures a cool smoke.

Disposable ceramic filter.

Extra filters 25¢ per pack of three.

Pipe base unscrews with coin for easy filter change.



For further information about this great new pipe, send for FREE Booklet. Kaywoodie Pipes, Inc., Dept. Z30, New York 22, New York.

KAYWOODIE

CIRCLE NO. 41 ON READER SERVICE CARD

are the soloists and the writing. Only trombonist Phil Wilson is an unmistakably important improviser. Trombonist Henry Southall and several of the trumpeters show potential, but aside from Wilson, this is an orchestra stronger as an ensemble than as a collection of soloists. Tenor saxophonist Sal Nistico, the most publicized of the Herman sidemen, is long on stamina but short on ideas.

The scores Herman uses here are narrow in emotional range and limited in inventiveness. Yet there is no denying the youthful thrust of this band. The sidemen reflect the unflagging pleasure their leader takes in big-band shouting, and, like him, they apparently identify jazz with high spirits, lack of pretense, and the perennial attraction of the blues.

N. H.

⑤ ⑥ JAZZ AT THE PHILHARMONIC: *Konserthuset—JATP in Europe, Volume I.* Dizzy Gillespie (trumpet), Cannonball Adderley and Benny Carter (alto saxophones), J. J. Johnson (trombone), Chuck Lampkin (drums), Lalo Schiffrin (piano), Art Davis (bass), Stan Getz, Coleman Hawkins, and Don Byas (tenor saxophones), Roy Eldridge (trumpet), Jo Jones (drums). *Bernie's Tune; Swedish Jam; All the Things You Are.* VERVE V 68539 \$5.98, V 8539 \$4.98.

Interest: Postgraduate jamming
Performance: Good
Recording: Live and clear
Stereo Quality: Okay

⑤ ⑥ JAZZ AT THE PHILHARMONIC: *Konserthuset—JATP in Europe, Volume II.* Stan Getz (tenor saxophone), J. J. Johnson (trombone), Vic Feldman (vibraphone, piano), Sam Jones (bass), Louis Hayes (drums). *Sweet Georgia Brown; Bop 'n Boogie; I Waited for You; Yesterdays; Trotting.* VERVE V 68540 \$5.98, V 8540 \$4.98.

Interest: Polished modern
Performance: Too often bland
Recording: Very good
Stereo Quality: Well-balanced

RECORDING OF SPECIAL MERIT

⑤ ⑥ JAZZ AT THE PHILHARMONIC: *Konserthuset—JATP in Europe, Volume III.* Coleman Hawkins and Don Byas (tenor saxophones), Benny Carter (alto saxophone), Roy Eldridge (trumpet), Lalo Schiffrin (piano), Art Davis (bass), Jo Jones (drums). *Indiana; Yesterdays; You Go to My Head;* and four others. VERVE V 68541 \$5.98, V 8541 \$4.98.

Interest: Jazz's elder statesmen
Performance: Robust
Recording: Crisp and warm
Stereo Quality: Good

RECORDING OF SPECIAL MERIT

⑤ ⑥ JAZZ AT THE PHILHARMONIC: *Konserthuset—JATP in Europe, Volume IV.* Dizzy Gillespie (trumpet), J. J. Johnson (trombone), Stan Getz (tenor saxophone), Leo Wright (alto saxophone, flute), Art Davis (bass), Chuck Lampkin (drums), Lalo Schiffrin (piano), Candido (conga drums). *Kush; The Mooch; Wheatleigh Hall.* VERVE V 68542 \$5.98, V 8542 \$4.98.

Interest: Dizzy in charge
Performance: Most cohesive of the lot
Recording: Very good
Stereo Quality: Tasteful

Although apparently convinced that the American circuit for his Jazz at the Philharmonic ensembles has become profitless, Norman Granz continues to book these big-name jam sessions in Europe. In the first of these four recordings made at Danish concerts in 1961, the front line



BURT GOLDBLATT

ROY ELDRIDGE
Dazzling, ferocious power

for the two initial tunes is dominated by Dizzy Gillespie and Benny Carter. Gillespie, the most consistently brilliant soloist on the set as a whole, is now the most resourceful trumpet player in jazz. Carter, who has concentrated largely on arranging in recent years, demonstrates that he is still an exceptionally graceful and lucid improviser. Cannonball Adderley is fluent but rhetorical, and J. J. Johnson is skillful but seldom gripping.

On the tune to which the entire second side is devoted, Roy Eldridge is buoyantly relaxed. The tenor saxophones—Hawkins, Byas, and Getz—who follow Eldridge do not play up to their full capacity. It is particularly interesting to hear expatriate Don Byas in this and in the third volume. These are among the very few of his recordings released in this country in the past decade, and they

bear out visiting American jazzmen who have said that Byas is still a powerful soloist with an unusually full, firm tone. The album as a whole, like most jam-session recordings, is uneven. When a performance is based largely on a string of solos, it is only by the happiest of accidents that everyone involved improvises at a continually absorbing level.

The most disappointing of these four recordings is the second. The two principal soloists, Getz and Johnson, often need passionate work from their colleagues to shake them out of their smooth, self-contained fluency. On this occasion, they do not stimulate each other, and the result is a collaboration of enormous facility but little emotional substance. On the ballads (Johnson on *I Waited for You* and Getz on *Yesterdays*), there is more feeling than on the medium- and up-tempo tunes, but again, the attractively lyrical soloists seldom plunge very deep. Gillespie plays on one track, *Bop 'n Boogie*, and his solo combines virtuosity and ardor.

The last two albums are the most worthy of repeated listening. For the third, Granz has assembled four players who continue to disprove the maxim that jazzmen over forty no longer have the capacity to surprise. Coleman Hawkins' solos have rugged rhythmic virility and his characteristically subtle harmonic imagination. Benny Carter, one of the most soaring of all soloists, combines taste with passion. Don Byas plays with enveloping warmth and authority. Roy Eldridge sometimes loses control of his spiraling emotions in an attempt to dazzle the audience with his ferocious power, but he improvises with intense imaginativeness during the majority of his solos. An additional bonus is a witty, intriguing solo by drummer Jo Jones on *Indiana*, reminding us that he began his career as a dancer. Also impressive is bassist Art Davis' fusion of technical command and daring inventiveness in his solo in the same cut.

The final disc is the most cohesive of the four because Dizzy Gillespie clearly takes command as musical director. The entire first side is his impressionistic *Kush*. Dizzy not only maintains the exotic mood of this Afro-Cuban piece throughout the long performance, but also masterfully controls the pacing so that there is an accumulating intensity. Getz and Johnson are spurred by Gillespie into much freer solos than usual. Ellington's *The Mooch* is far from the composer's dense textural conception in this airy and much less distinctive version, but Gillespie does pull it together effectively. The final, exceedingly swift *Wheatleigh Hall* is somewhat marred by the insistent conga drums of Candido, but again Gillespie is so confidently in command that the performance is much

(Continued on page 114)

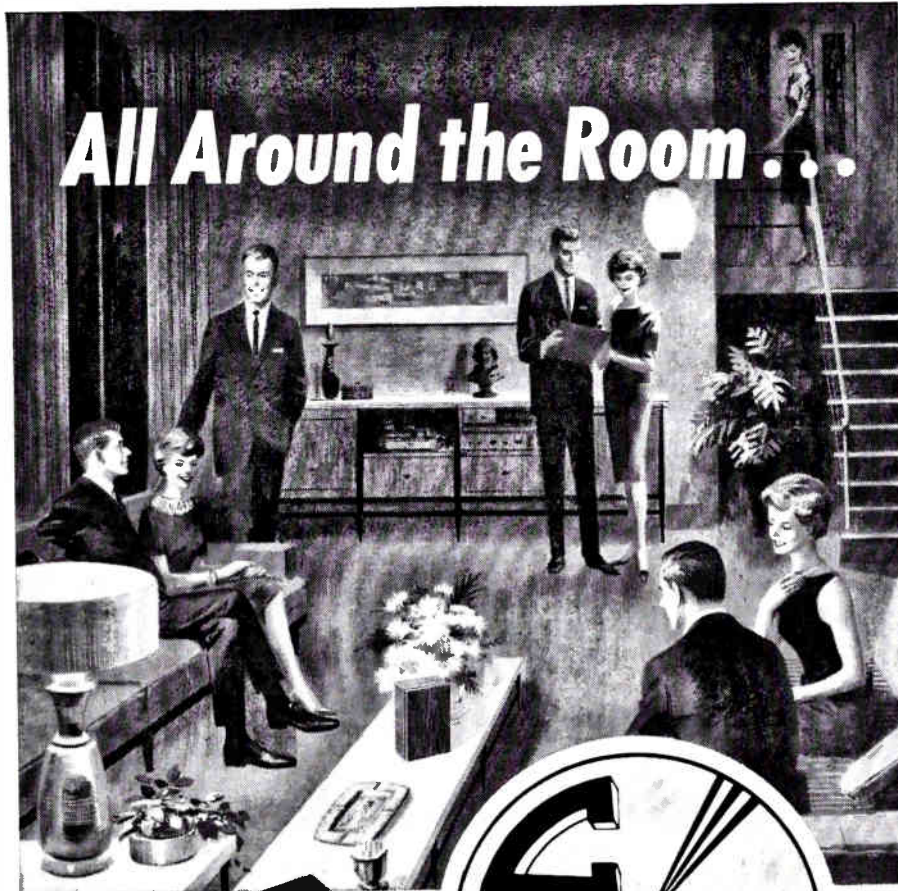

NEW DECOR AND SIZE NEW PERFORMANCE

CAVITY
GENERATED
SPHERICAL
SOUND is **Everywhere!**



NEW LISTENING PLEASURE NEW PRINCIPLE

These people are enjoying an exciting new principle in sound reproduction. Everyone is receiving a uniform intensity of program material from this single Murray-Tone Cavity Generator Spherical Sound System regardless of his relative position or distance from the instrument!

True 360° spherical propagation is but one of the unique principles built into this quality instrument and offered to the listener for the first time from a single sound source.

"CG's" spherical principle and compact design encourage complete flexibility of placement — even under or behind furnishings — without distortion of performance in either monaural or stereo application.

The use of a single driver in Murray-Tone "CG" systems produces balanced, full-range sound with a new dimension of timbre, presence and response.



Introducing the
CAMILLE SERIES

Size: 11"x8"x4 1/4"—Full Frequency Range (without boom).

Power: 8 Watts (measured).

Propagation: 360 Spherical Degrees.

OPTIONAL FINISHES:

OILED WALNUT, HARVEST MAPLE OR LINED OAK
Moderately Priced at **\$39.95**

Murray-Carson Corporation

2424 E. 55th STREET DEPT. A, INDIANAPOLIS 20, INDIANA

SEND FOR LITERATURE AND
DEALER INFORMATION



sharp

You're looking into a Super-Takumar 55mm f/1.8 lens, standard equipment on the Honeywell Pentax H3v. There are many things that can be said about a lens, but the word 'sharp' sums this one up precisely.

This lens is *very* sharp. So sharp that the results from your first roll of film will probably startle you. Not long ago, a fellow in South Africa shook up the photographic world by making a print well over ten feet high from a negative taken with this lens. Not everyone does things on such a grand scale, but it's nice to know your Pentax has a lens equal to the task.

Besides being sharp, fast, and fully corrected, this lens has an automatic, instant-open diaphragm, de-
tent f/stops and half stops, a depth-of-field preview lever, and 12 interchangeable brothers of equally high quality. Coupled to a Honeywell Pentax, the Super-Takumar gives you an unbeatable combination, yet camera and lens are yours for just \$229.50!



See the H3v at your Honeywell Photo Products Dealer's soon or write for full-color folder to: John Thornton (209), Honeywell, Denver 10, Colorado.

Honeywell
PHOTOGRAPHIC PRODUCTS

CIRCLE NO. 40 ON READER SERVICE CARD

more than the fragmented virtuosity it might otherwise have been.

In sum, this newest collection of Granz one-night stands proves how indispensable Gillespie is to the intermittent Jazz at the Philharmonic tours. *N. H.*

Ⓢ **LES MC CANN: *Les McCann Ltd. Plays the Shampoo***. Les McCann (piano), Herbie Lewis (bass), Ron Jefferson (drums). *The Shampoo; Too Close for Comfort; Woody 'n You; Smile Stacey*, and four others. PACIFIC JAZZ PJ 62 \$4.98.

Interest: Soul city
Performance: Mannered
Recording: Fair

Les McCann is a pianist who wears his soul on his sleeve. His trio is billed as Les McCann Ltd., and it is indeed limited—to funk. McCann plays as if he would rather be at a revival meeting than in a club. The bridge of a song such as *Out of This World* disturbs him because it cannot readily be made funky, and he has trouble getting through it.

This album was recorded on stage at New York's Village Gate. McCann works with the capable assistance of bassist Herbie Lewis and drummer Ron Jefferson. Most of the tunes are McCann's own, and it is only on his own *Smile Stacey* that he gives a hint of how good a pianist he could be. *J. G.*

Ⓢ **DINAH WASHINGTON: *This Is My Story***. Dinah Washington (vocals); orchestra, Quincy Jones cond. *Salty Papa Blues; Trust in Me; This Bitter Earth; Harbor Lights*; and eight others. MERCURY SR 60788 \$4.98, MG 20788* \$3.98.

Interest: Dinah looks back
Performance: Highly stylized
Recording: Sometimes strident
Stereo Quality: Competent

This, the first of a two-record set with the same title, is a collection of fairly recent singles by Miss Washington along with remakes of old performances. The arrangements are, for the most part, doggedly commercialized, often with sighing strings and a modified but constricting rock-and-roll beat. Miss Washington no longer sings with the tart spontaneity of her earlier years, but her voice is still compellingly sensual and her silences in a song often imply almost as much as the lyrics. Her phrasing remains wholly personal—swift, cutting, and full of fervor. As a jazz singer, Miss Washington has become less and less an improviser, but she is certainly one of the few sizable presences on the pop-music scene. Her personality is singular, and it cannot be entirely stifled even by these commercial arrangements. *N. H.*

CIRCLE NO. 12 ON READER SERVICE CARD →

audiotape
"it speaks for itself" TRADE MARK



Play Fiddle, Play (Audiotape is listening)

Audiotape can be your best friend. Talk to it by the hour and it will never protest. Speak gently and Audiotape returns the compliment. Play your violin and Audiotape will respond graciously, and never comment on your talent. Let a thousand violins fill the air and Audiotape remembers every note . . . and reminds you whenever you ask. It never volunteers an opinion, speaks only when spoken to. And when heard, its voice is unmistakable . . . clear, far ranging, free from distortion. They say friendship can't be bought. This one can. Buy a reel, and a friend, soon.

AUDIO DEVICES, INC., 444 Madison Avenue, New York 22, N. Y. • Offices in Los Angeles • Chicago • Washington, D. C.

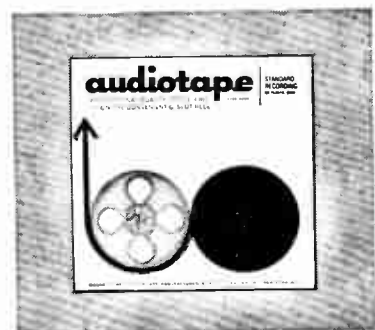

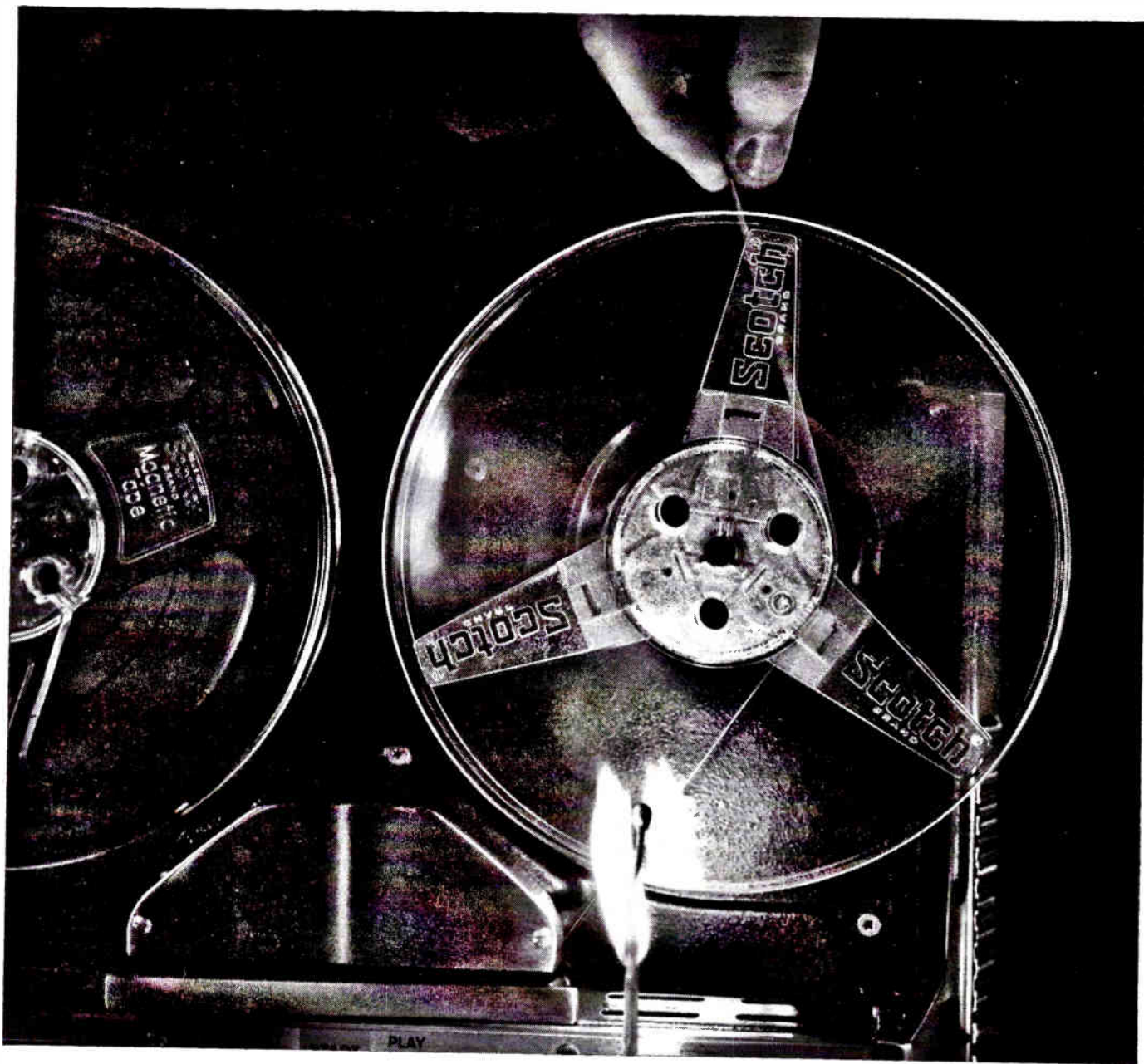

NEW! A tape reel that threads itself! (even in the dark!)

Just lay recording tape inside this new reel and start your recorder. This exclusive new SCOTCH® BRAND Self-Threading Reel holds tape firmly, but gently, as recorder starts—actually threads up automatically. No hooks, no slots, no attachments—no tape fumbles. This reel does away with thread-up problems. (You wouldn't really need the light of a match to use it!) Now, this reel is offered as a take-up reel for only 39¢ in a special offer from the granddaddy of all tape-makers, 3M.

New reel threads up with all tape thicknesses or with leader tape. Tape rewinds off reel freely and easily. Solid sides protect tape against dust and damage. Reel comes complete with

write-on labels and snap-tight plastic collar that seals reel edges against dust, makes reel self-storing without a box.

SPECIAL OFFER SAVES \$1.11! Now, you can have one of these new "SCOTCH" Self-Threading reels (\$1.50 value) as a take-up reel for only 39¢ with the purchase of three regular 7" reels of a wide variety of "SCOTCH" BRAND Recording Tape. Ask your dealer for the special package, shown below. And for an expandable, gold-plated tape rack (\$4.95 value) that holds up to 40 reels, send the tabs from three "SCOTCH" Recording Tapes, together with \$2.50, to 3M Magnetic Products Division, Dept. MCW-103, St. Paul 19, Minn.

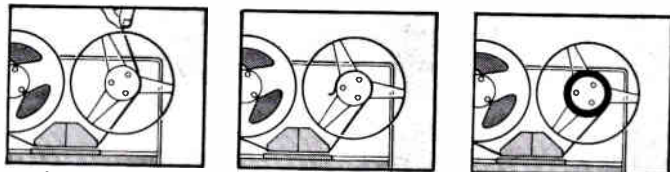

Lay in tape . . . start recorder . . . watch reel thread itself!

Magnetic
Products
Division **3M**
COMPANY

"SCOTCH" AND THE PLAID DESIGN ARE REGISTERED TRADEMARKS OF MINNESOTA MINING & MANUFACTURING CO., ST. PAUL 19, MINN. EXPORT: 99 PARK AVE., NEW YORK, CANADA: LONDON, ONTARIO ©1963, 3M CO.



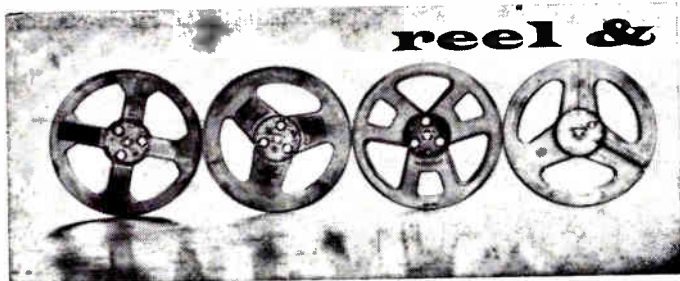

Reviewed by CHRISTIE BARTER • DAVID HALL

Explanation of symbols:
 Ⓜ = monophonic recording
 Ⓢ = stereophonic recording

RECORDING OF SPECIAL MERIT

Ⓢ BRAHMS: *Symphony No. 3, in F Major, Op. 90; Tragic Overture, Op. 81.* Pittsburgh Symphony Orchestra, William Steinberg cond. COMMAND CC 4T 11015 \$7.95.

Ⓢ BRAHMS: *Symphony No. 3, in F Major, Op. 90; Tragic Overture, Op. 81.* Vienna Philharmonic Orchestra, Herbert von Karajan cond. LONDON LCL 80122 \$7.95.

Interest: Brahms cornerstones
 Performance: Steinberg is preferable
 Recording: Command scores
 Stereo Quality: Command is A-1

If reputation alone were relied upon to determine a choice between these recordings of identical Brahms programs, one would have to declare in favor of Karajan. But an actual hearing reverses such expectation. For Karajan is off-hand in the symphony and rather mannered in his choice of tempos for the overture, but Steinberg turns in readings of both works that are models of justly proportioned tempos and dynamics, and above all of communicative power. Everything breathes naturally, the climaxes peak just as they should, and there is a sense of the phrases taking their own shape. Only the venerable Bruno Walter's reading of the symphony on Columbia offers any semblance of competition for Steinberg's in musical values.

London's recorded sound is not up to that company's best standard, but Command's job is front-rank in every way.
 D. H.

BRUCH: *Scottish Fantasia, Op. 46* (see HINDEMITH).

RECORDING OF SPECIAL MERIT

Ⓢ DELLO JOIO: *Fantasy and Variations (1962).* RAVEL: *Piano Concerto, in G Major.* Lorin Hollander (piano); Boston Symphony Orchestra, Erich Leinsdorf cond. RCA VICTOR FTC 2138 \$8.95.

Interest: Ravel and successor
 Performance: Virtuoso
 Recording: First-rate
 Stereo Quality: Good

Both of these performances are four-track tape firsts, and although the coupling of Ravel's blues-flavor concerto with a new score by American Norman Dello Joio may seem strange at first thought, they go very well together in the listening. For the Dello Joio *Fantasy and Variations* represents a robust updating of Ravel's glittering stylization, to which Dello Joio has added both specifically American rhythmic elements

RECORDING OF SPECIAL MERIT

Ⓢ DVOŘÁK: *Symphony No. 5, in E Minor, Op. 95* ("From the New World"). Vienna Philharmonic, István Kertész cond. LONDON LCL 80120 \$7.95.

Interest: Perennial
 Performance: Grotifying
 Recording: Bright
 Stereo Quality: Well-defined

István Kertész, a Hungarian by birth, has a natural feeling for this music and conducts it with considerable flair. In fact, once past the rather labored first



LONDON RECORDS

ISTVÁN KÉRTESZ
 Displaying a natural flair for Dvořák

and his Italianate lyrical flair. Though the piece is tautly constructed around a four-note series, there is nothing cerebral about the result. It provides a virtuoso holiday for both Lorin Hollander and the Boston Symphony under Leinsdorf. Performance and recording are the last word in high-octane vigor and brilliance.

The performance of the Ravel concerto lays less stress on Gallic *chic* than some, but both pianist and conductor strive for just balances over-all and among the inner voices of the music. Thus we are treated to a reading that is unusually interesting, free of interpretive cliché, and genuinely revealing. RCA's recording is masterly in every respect.

D. H.

movement, he makes this thrice-familiar score sound very fresh indeed. The slow movement is suitably expressive, the Scherzo amiable and brisk, the finale enormously vivid—in all, an enthusiastic and colorful, yet superbly controlled, performance. As such it has a place next to the best versions of the "New World" on tape; the unique statement by Toscanini (RCA Victor FTC 2082), the mellow reading by Walter (Columbia MQ 339), and the radiant performance by Kubelik (London LOK 80008). Here London's stereo engineering is full-bodied and realistic, with a tendency to be a little too bright on top. Tape hiss is evident but unobtrusive.

C. B.

(Continued on page 118)

© **GRIEG: Piano Concerto, in A Minor, Op. 16.** **RACHMANINOFF: Rhapsody on a Theme of Paganini, Op. 43.** Philippe Entremont (piano); Philadelphia Orchestra, Eugene Ormandy cond. COLUMBIA MQ 526 \$7.95.

Interest: Romantic done-to-deaths
Performance: Glittering
Recording: Clean and full
Stereo Quality: Good

Entremont's tape competition in the Grieg is extremely fast company, even for a virtuoso of his remarkable gifts—Rubinstein (RCA Victor), Curzon (London), and Fleisher (Epic). Young Entremont brings to it more velocity and dynamic range than the others, but he is hardly their equal in probing the heart of the lyrical substance. The finale, taken at a brisker pace than usual, becomes a virtuosic tour de force in this Entremont-Ormandy combination.

Julius Katchen represents the only serious taped rival for Entremont in Rachmaninoff's cleverly kaleidoscopic blend of sentiment and diabolism woven around the Paganini twenty-fourth caprice for solo violin. And the stunning orchestral playing by the Philadelphians under Ormandy's fiery direction swings the scale decisively in Entremont's favor.

Both performances emerge in full sonic splendor on Columbia's four-track tape, with the Rachmaninoff having slightly the better quality in terms of recording-hall acoustics and transparency of texture. **D. H.**

RECORDING OF SPECIAL MERIT

© **HINDEMITH: Violin Concerto (1939).** **BRUCH: Scottish Fantasia, Op. 46.** David Oistrakh (violin); London Symphony Orchestra, Paul Hindemith and Jascha Horenstein cond. LONDON LCL 80119 \$7.95.

Interest: Hindemith masterpiece
Performance: Intensely lyrical
Recording: Good
Stereo Quality: Okay

Fanciers of the overripe and sentimental Bruch piece are not likely to go for the virile modern classicism of Hindemith, but it is the powerful and altogether beautiful modern score that is the main interest of this tape. Written at the composer's creative peak, during which he produced *Mathis der Maler* and *Nobilissima Visione*, the concerto is a glorious synthesis of the expressive and formalist Hindemiths. I remember well its first American performances, and have never been able to understand why it has not taken its place in the regular repertoire with such other modern masterpieces of the genre as the concertos of Berg (1935) and Bartók (1937). Com-

pared to the 1958 Everest recording with Joseph Fuchs and the late Sir Eugene Goossens, Oistrakh and the composer in this reel underline the lyrical rather than the aggressive aspects of the music, and provide fascinating insights into a score that can legitimately profit from several first-rate interpretations. The recorded sound is satisfactory, if not as brilliant as Everest's. But the composer's presence on the podium, plus Oistrakh's magisterial performance, make this particular recording a must for those who care either about the best in twentieth-century music or about major contributions to violin-concerto literature.

The Bruch and its performance need no comment beyond the observation that Oistrakh, Horenstein, and the London



PAUL HINDEMITH

As composer, classic—as conductor, lyrical

Symphony do full justice to its lush content. If your preference is for romantic fireworks rather than the somewhat stern expression here, you may find the Heifetz-Sargent coupling with the Vieuxtemps Concerto on RCA Victor more to your liking. **D. H.**

RECORDING OF SPECIAL MERIT

© **HOLST: The Hymn of Jesus, Op. 37; The Perfect Fool: Ballet Music, Op. 39; Egdon Heath, Op. 47.** BBC Chorus and Orchestra; London Philharmonic Orchestra, Sir Adrian Boult cond. LONDON LCL 80117 \$7.95.

Interest: Holst in panorama
Performance: Authentic
Recording: Good
Stereo Quality: Impressive

A close friend of the late Ralph Vaughan Williams, Gustav Holst (1874-1934) had a mystical strain in his nature, and it combined in an interesting way with his other preoccupations—British

folk music and practical music-making. The three scores on this tape show Holst's epic and mystical moods, his love of good tunes and occasional humor, and an austerity that seems akin to that of the later Sibelius. Holst's extraordinary gift for harmonic coloration in his choral sonarities is intriguing in *The Hymn of Jesus* even after its quasi-Byzantine grandeurs have begun to pall somewhat. In the final section of the *Perfect Fool* ballet music, the surge of the dargason, an old English dance measure that Holst also used in the last movement of his *St. Paul* suite, is jolly good fun, wholly uninhibited in its kinetics and orchestral power. *Egdon Heath*, inspired by Thomas Hardy's celebrated descriptive passage at the opening of *The Return of the Native*, is Holst at his most poetic, and is one of his most compelling symphonic scores—a far cry from the cinematic *Planets* and the forthrightly folkish suites for band.

Adrian Boult, who introduced a goodly share of Holst's work to the public, directs heartfelt and wholly authentic readings here, though his treatment of *The Hymn of Jesus* emphasizes harmonic detail at the expense of cumulative power. The BBC Chorus acquits itself superbly in its exacting role, and the quite excellent recorded sound is even more so in the *Hymn*. Since the music calls for double chorus, children's chorus, and a very large orchestra with an organ, bigger and better equipment will pay handsome sonic dividends. **D. H.**

© **MAHLER: Symphony No. 1, in D ("Titan").** Boston Symphony, Erich Leinsdorf cond. RCA VICTOR FTC 2129 \$8.95.

Interest: BSO and Dynagroove
Performance: Disappointing
Recording: Excellent
Stereo Quality: Impressive

Following his splendid recording of the Bartók *Concerto for Orchestra*, Erich Leinsdorf's account of Mahler's First Symphony comes as a bit of a letdown. The sound is glorious, to be sure. The technical apparatus of RCA's new Dynagroove process, which was used to produce the master tape, clearly paid a handsome dividend in the form of this four-track release. The Boston Symphony, too, plays like a dream. Yet the performance glides over many fine points, especially in the first two movements, which have neither the warmth nor the pliancy they should have. Leinsdorf's sense of proportion and appreciation of dramatic emphasis carry the listener through the longer closing movements, but still the reading tends toward the literal. At the moment this is surely the tape performance I prefer, though I hope that Columbia will soon release the *(Continued on page 120)*

This is a great
high fidelity tape recorder.
It takes two of them to make one
stereophonic WEBCOR SQUIRE.

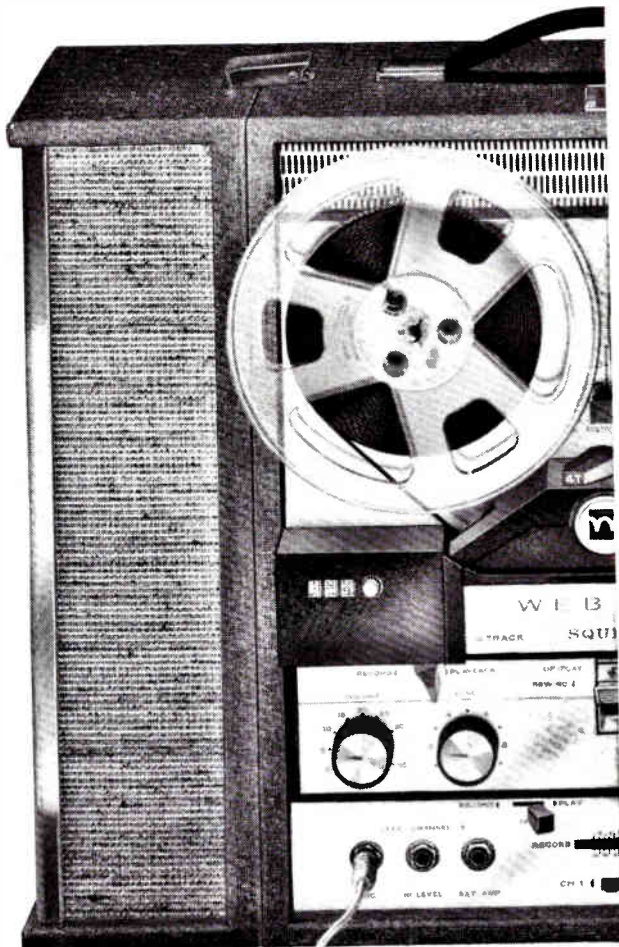

If you wish, you may play the SQUIRE one half at a time. However, we suggest playing it at its six-speaker, stereophonic best. Separate its speaker enclosures up to sixteen feet, slip on a 2- or 4-track stereo tape. Listen. Chances are you've *never* heard stereo fidelity like that before! If you can stop listening to the SQUIRE long enough, you can: record stereo (or monaural) from records, FM or live (you get two mikes); record on one track while playing back on the other (we call that SYNCHRO-TRACK); prepare synchronized sound tracks for your slide shows (it has a slide synchronization jack). As a matter of fact, the only non-professional aspect of the SQUIRE is its price. Ask your Webcor dealer about that!

WEBCOR
Fifty years of sound leadership

Webcor Inc., Chicago tape recorders, portable and console phonographs, radios, and components, Dormeyer appliances and power tools

See the **ROCKFORD**
Newest in **Acoustical Cabinetry**

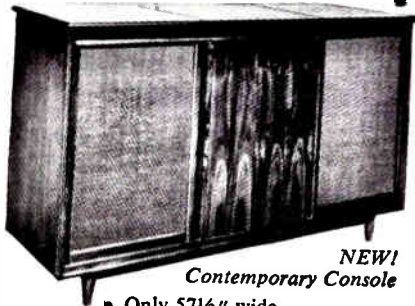

NEW!
Contemporary Console

• Only 57½" wide.

- Houses complete system, including tape deck, changer or turntable, amplifier, tuner and speakers.
- Record storage for over 100 12" LP's.
- Speaker compartments are vented port type with 1" acoustical fibre glass lining. Each compartment houses up to 12" speaker.



FREE Illustrated brochure describing equipment cabinets, speaker enclosures in a wide variety of styles and finishes. Write to . . .

FURNITURE-CRAFTED BY
ROCKFORD
SPECIAL FURNITURE CO.
2024 TWENTY-THIRD AVE • ROCKFORD, ILL.

Dealer Inquiries Invited

CIRCLE NO. 59 ON READER SERVICE CARD

SAVE On Stereo HI-FI SEND NOW FOR **FREE**

228 PAGE CATALOG

Don't miss the 100's of amazing \$\$\$ savings on Complete Systems, components and kits—found ONLY at B-A!

BURSTEIN-APPLEBEE CO.

Dept. H.F.S. 1012 McGee St., Kansas City 6, Mo.
 Rush me FREE 1964 B-A Catalog.

Name.....
Address.....
City..... State.....

CIRCLE NO. 19 ON READER SERVICE CARD

genuinely sympathetic Walter performance in this medium. C. B.

RECORDING OF SPECIAL MERIT

© MAHLER: *Symphony No. 2, in C Minor ("Resurrection")*. Elisabeth Schwarzkopf (soprano), Hilde Rössl-Majdan (mezzo-soprano); Philharmonia Orchestra and Chorus, Otto Klemperer cond. ANGEL ZB 3634 \$14.98.

Interest: Monumental
Performance: Authoritative
Recording: Very good
Stereo Quality: Realistic

Otto Klemperer has almost ignored the music of Mahler in recent years—at least in the recording studio—although he has long been recognized as one of its master conductors. By making a stereo version of the Second, the "Resurrection" Symphony, he returns to one of his early LP triumphs, still available on the Vox label (VBX 115). As might be expected, he surpasses the earlier recording both in performance and sound here.

Klemperer's understanding of this gigantic score has perceptibly matured over the past decade or so, just as his ability to project the power and beauty of its vision has grown. He is fortunate in having the Philharmonia and two soloists of the caliber of Elisabeth Schwarzkopf and Hilde Rössl-Majdan, both of whom sing angelically. The tape transfer is excellent; the dynamic range is all that it should be, especially in the symphony's taxing closing pages; and the clarity of instrumental detail, so important in a work of this complexity, is remarkable. The Klemperer recording may win many adherents on the basis of its sound, and fortunately the sound is matched in scope and tonal grandeur by the interpretation. Some may wish to wait for the more lyrical Bruno Walter performance, dating from the late 1950's, to appear on tape. Either way, the advantages of the longer playing time of this medium, particularly in twin-pack format, as here, are obvious, since, for example, it obviates the need for a break in the fifth movement. C. B.

© MOUSSORGSKY: *Pictures at an Exhibition*. RIMSKY-KORSAKOV: *Capriccio espagnol*. New York Philharmonic, Leonard Bernstein cond. COLUMBIA MQ 538 \$7.95.

Interest: Familiar Russians
Performance: Colorful
Recording: Fair
Stereo Quality: Okay

This Leonard Bernstein performance of the Moussorgsky tone poem, in tandem with Rimsky-Korsakov's *Capriccio espagnol*, was released on discs over three years ago, and at the time was received

with enthusiasm. On tape, however, it must take second place to the Ansermet recording (London LCK 80054). The latter will cost the buyer about four dollars more, since Bartók's *Music for Strings, Percussion, and Celesta* occupies the second sequence. The additional cost, however, is justified by sufficient playing time for both works to run their course without interruption. Here the first sequence only goes through *The Market Place at Limoges*. Columbia's stereo engineering, too, sounds rather dated. The dynamic range, although more impressive here than on discs, is somewhat restricted. Directionality is adequate, but the illusion of depth is slight. C. B.

RECORDING OF SPECIAL MERIT

© MOZART: *Così fan tutte*. Elisabeth Schwarzkopf (soprano), Fiordiligi; Christa Ludwig (mezzo-soprano), Dora-bella; Alfredo Kraus (tenor), Ferrando; Giuseppe Taddei (baritone), Guglielmo;



DECCA RECORDS

KARL BÖHM

Precision polish for a Mozart gem

Hanny Steffek (soprano), Despina; Walter Berry (baritone), Don Alfonso. Philharmonia Orchestra and Chorus, Karl Böhm cond. ANGEL ZD 3631 two reels \$28.98.

Interest: Merry Mozart standard
Performance: Radiant
Recording: Excellent
Stereo Quality: Satisfying

Here is an opera tailor-made for stereo. In both dramatic and musical construction, *Così fan tutte* is a work that moves in pairs—pairs of lovers and companions, duets and two-by-two quartets, with a couple of "center-channel" characters added now and then to fill out the larger ensembles. In this, the first complete recording of the opera on stereo tape, the two ladies are sung by artists identified with their roles not only on stages in Vienna, Salzburg, and Chicago but on discs as well. Elisabeth Schwarzkopf, in supremely fine voice, perhaps surpasses

her much-admired performance in the eight-year-old monophonic recording for Angel, and Christa Ludwig brings a good deal more security and vocal charm to the part of Dorabella than she did for London a few years back. Together they sing divinely. Hanny Steffek, unknown in this country except as the Valencienne of Angel's recent *Merry Widow*, makes a pleasing Despina, though her characterization might have a little more vocal bite.

Alfredo Kraus, making his debut on tape as Ferrando, is a Spanish tenor with a splendid instrument that he forces at times, but his sense of style, at least his consonance with the Viennese style ingrained in the others, is always just right. None of the male cast members had sung their roles before the sessions that went into the making of this recording. Giuseppe Taddei has sung Figaro and Leporello for discs, but he sings Guglielmo here for the first time. And Walter Berry, who has sung Guglielmo, undertakes his first Don Alfonso, a role for which he now feels better suited. The results are enormously gratifying, no doubt due in part to Karl Böhm's experienced Mozartian hand. The whole performance is a marvel of jewel-like precision, and is wholly irresistible in spirit despite the rather relaxed pace one might expect from Böhm.

The engineering, too, is almost flawless. The rear-stage choruses are a little too remote, and the balance between Miss Schwarzkopf and Kraus in their second-act duet favors the soprano. But these are only minor faults in an otherwise beautifully executed, marvelously transparent recording. The format on tape is such that each of the two acts is contained on a single reel. A libretto is free on request. *C. B.*

RECORDING OF SPECIAL MERIT

© **PUCCINI: *Manon Lescaut* (excerpts).** Renata Tebaldi (soprano), Manon Lescaut; Mario del Monaco (tenor), Des Grieux; Mario Boriello (baritone), Lescaut; Fernando Corena (bass), Geronte. Chorus and Orchestra of the Accademia di Santa Cecilia Rome, Francesco Molinari-Pradelli cond. LONDON LOL 90061 \$7.95.

Interest: Best Manon
Performance: Ardent
Recording: Excellent
Stereo Quality: Effective

Believe it or not, this performance is nearly a decade old. Yet by every standard it remains the best *Manon Lescaut* in the LP catalog. More's the pity that London chose only to highlight it on tape, for the opera does not lend itself easily to such treatment. Renata Tebaldi and Mario del Monaco, however, were



Command Performance

...at your fingertips

Every time you capture the magnificent world of full fidelity sound on tape. Taped sound retains full fidelity even after hundreds of playbacks — yours to enjoy always — on VIKING tape components, naturally.

A VIKING invests you with unlimited versatility to record live programs or off the air including F.M. multiplex, duplicate, put sound on sound and edit with perfect ease.

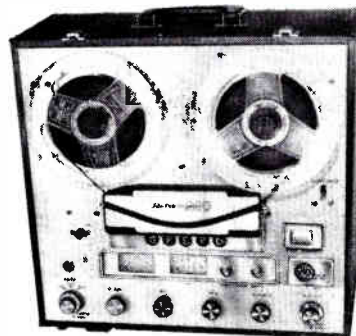

Retro-matic 220—ultimate performance with tomorrow's features for discriminating audiophiles and professionals only.

Two-directional playback, quarter track stereo at two speeds. "Feather-touch" push buttons, remote control, 12 watt amplifier, simultaneous record — playback with 20 - 25,000 cps frequency response. Independent channel controls, "luma-touch" record buttons and illuminated VU meters. Photo electric run-out sensor, four heads, hysteresis capstan motor plus two reel drive motors and digital counter. Superbly styled with stainless steel face plate this compact operates vertically or horizontally.

88 Stereo Compact — for connoisseurs of the fine things in high fidelity stereo sound.

Two speed tape recorder with choice of half or quarter track stereo. Three new type hyperbolic heads—no more old fashioned pressure pads. New design amplifier with excellent 30-18,000 cps frequency response, lets you monitor off the tape with "A-B" comparison switch. Independent channel controls and VU meters, two motors, record indicator light, counter, automatic tape shut-off. With its attractive, brushed aluminum face panel, the 88 Compact fits any installation for vertical or horizontal operation.



Put Command Performance at your finger tips with VIKING tape components — made by skilled American craftsmen.

Tape recorders, transports, cartridge players—even for your car or boat—at reputable high fidelity dealers most everywhere.



VIKING OF MINNEAPOLIS, INC.

9600 Aldrich Avenue South, Minneapolis, Minnesota, 55420

Your assurance
of Quality in
Tape Components



THE PERFECT TAPE RECORDER

... is instantly revealed in Telefunken's M-97. With push-button ease, this fully self-contained 4-track stereo record/stereo playback system with 2 loudspeakers shows its Telefunken lineage. No compromises here: are you sure you're not in the concert-hall?

Now, hear the secrets of its marvellous sound... Telefunken's patented extra-sensitive brake mechanism assures correct tape tension always, protecting heads and tapes. Pre-amplifier equalization automatically optimizes frequency response (30-18,000 cps at 7½ ips, 30-16,000 at 3¾, 30-9,000 at 1¾). At 7½ ips wow and flutter are less than 0.15%, and signal-to-noise ratio better than 50 db.

Versatility? The M-97 takes reels to 7", offers sound-on-sound recording, mixing, and transcription from one track to another. You can edit, monitor and use it as a public address system. There's a built-in tape splicing groove and a digital counter—and a full line of accessories. Hear the "touch of perfection" to believe it: or mail the coupon today.



American Elite, Inc., Dept. 20
48-50 34th Street
Long Island City 1, N. Y.

Please send me literature
and technical information
on the M-97 Tape Recorder.

Since 1903

Name _____
Address _____
City _____ Zone _____ State _____

CIRCLE NO. 8 ON READER SERVICE CARD

both in their prime in the mid-Fifties, when this recording was made, and together they generate a good deal of vocal excitement, especially in the second-act duet and the close of the last act.

Miss Tebaldi is far from the capricious young thing Puccini strove to create in the title role, but her voice is always fresh and supple and her handling of the high tessitura effortless and pure. Del Monaco has some awkward moments, but generally his singing has a golden ring and only a trace of the affectations that were to take hold later. Francesco Molinari-Pradelli's direction is robust, and the sound is absolutely first-rate.

How, one may ask, could it be that London's engineers were so skillful, so early in the stereo age, at solving the problems of the two-channel medium applied to opera? Whatever their sorcery, their success is a matter of record, this reel serving as a vivid testament. Accompanying it is a helpful outline of the plot, but no texts. *C. B.*

RACHMANINOFF: *Rhapsody on a Theme of Paganini* (see GRIEG).

© **RACHMANINOFF: *Symphony No. 2, in E Minor, Op. 27.*** Pittsburgh Symphony Orchestra, William Steinberg cond. COMMAND CC 4T 11006 \$7.95.

Interest: Russian Romantic
Performance: Dispassionate
Recording: Clean
Stereo Quality: Good

Steinberg's approach to Rachmaninoff displays little of the impassioned verve that he has brought to his remarkable Brahms symphony recordings for the Command label. This somewhat sprawling symphony particularly needs rhetorical abandon to make its full effect, as it did in the uncut version once available on disc (Decca 9874) with Sanderling and the Leningrad Philharmonic.

The orchestral playing of the Pittsburghers is neat and clean, though the recorded balance slights the timpani somewhat. I also noted a passing pitch fluctuation at the first-movement recaptulation on the review tape. The stereo is up to Command's standard. *D. H.*

© **RACHMANINOFF: *Symphony No. 3, in A Minor, Op. 44; Chanson Géorgienne ("O Cease Thy Singing, Maiden Fair"), Op. 4, No. 4.*** Netania Davrath (soprano); Utah Symphony Orchestra, Maurice Abravanel cond. VANGUARD VTC 1662 \$7.95.

Interest: Mature Rachmaninoff
Performance: Heartfelt
Recording: Good
Stereo Quality: Good

The symphony, the next to last of Sergei Rachmaninoff's works, was recorded on RCA Victor 78-rpm discs by the Philadelphia Orchestra under the composer's direction in 1940, but this performance has never been made available on LP's. And neither Ormandy's brilliant monophonic long-playing disc with the same orchestra, nor this stereo version by Abravanel with his Utah instrumentalists, are any match for the composer's fiery thrust and wholly compelling power as conductor on those old 78's.

In this music, as in the *Paganini Rhapsody* and the *Symphonic Dances*, Rachmaninoff did not achieve melodic flights comparable to the most famous pages of earlier works such as the Second Piano Concerto and *The Isle of the Dead*. On the other hand, in these late works, his musical utterance is harmonically more pungent, the construction more taut, and the handling of orchestral texture absolutely unerring.

For this first tape version of the Rachmaninoff Third, Abravanel's Utah players cope with the music convincingly, and are handsomely abetted by the Vanguard engineering team. Soprano Netania Davrath does well, too, with the Borodinesque oriental line of the early *Chanson Géorgienne*. *D. H.*

RAVEL: *Piano Concerto, in G Major* (see DELLO JOIO).

© **RESPIGHI: *Fountains of Rome; Pines of Rome.*** Philadelphia Orchestra, Eugene Ormandy cond. COLUMBIA MQ 525 \$7.95.

Interest: Roman holiday in stereo
Performance: Rousing
Recording: Good
Stereo Quality: Okay

Though these performances were issued as part of Columbia's initial stereo disc release, the recorded sound stands up remarkably well in tape processing, thanks in good measure to Ormandy's lavishly colorful treatment of Respighi's now gaudy, now sensitively poetic scores. As against other tape versions of the same couplings—Toscanini's uniquely dynamic performances (reprocessed from mono originals) and Reiner's (marred in its initial tape release by overload distortion)—this Ormandy tape has its own very solid merits, particularly tonal warmth. *D. H.*

RIMSKY-KORSAKOV: *Capriccio espagnol* (see MOUSSORGSKY).

© **SCHUMANN: *Carnaval, Op. 9; Fantasiestücke, Op. 12.*** Artur Schnabel (piano). RCA VICTOR FTC 2150 \$8.95.

(Continued on page 124)

Ultra Motional
Stereo Hi-Fidelity

Spectacular Breakthrough!

Vastly extends low-range of speaker response to achieve world's first distortion-free sound!

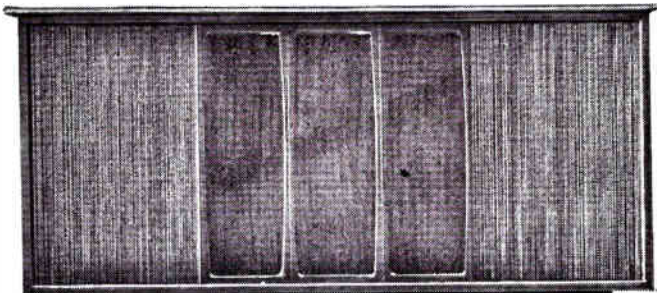

No. 6011 60" Danish Modern Genuine Walnut Cabinet with exclusive Ultra-Motional Sound System.

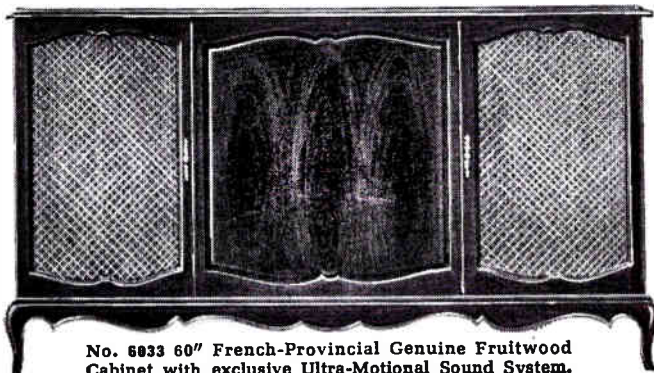

No. 6033 60" French-Provincial Genuine Fruitwood Cabinet with exclusive Ultra-Motional Sound System.

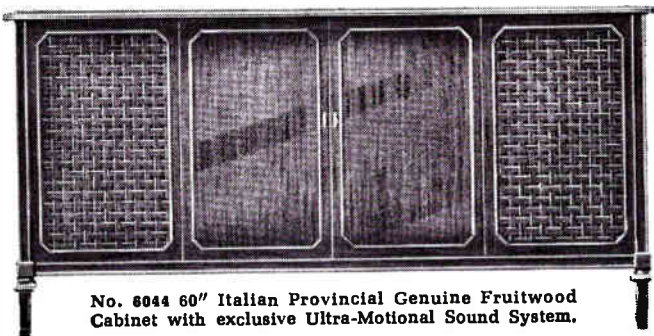

No. 6044 60" Italian Provincial Genuine Fruitwood Cabinet with exclusive Ultra-Motional Sound System.



Ultra-Motional available in very compact speaker-amplifier system: Model MF-800W (Metal Case, MF-800M)

Matsushita Electric, established world leader in the manufacture of precision electronics, has developed a hi-fidelity sound system of truly remarkable dimension.

Unique achievement, Ultra-Motional utilizes a distortion-feedback technique. The only previous use of feedback was of voltage pickup in the proportion to velocity of speaker cone. But Ultra-Motional feeds back the voltage in proportion to the acceleration determined by the velocity of the speaker movement to the drive stage of the audio amplifier.

The net result of this spectacular new breakthrough is the world's first distortion-free sound system. Vastly extending the low range of speaker response, regardless of size of speaker or enclosure, Ultra-Motional achieves the nearest approximation to live music yet devised.

Recreating most precisely the complete tonal range of the concert hall, Ultra-Motional is setting new standards within the hi-fidelity industry as well as among the most sensitive audiophiles.

Ultra-Motional is featured exclusively in

PANASONIC
Stereo
HI-FIDELITY

60" consoles. Never before such hi-level component quality in console models!

- FM/AM FM-Stereo Tuner, with AFC control for FM and FM-Stereo.
- Automatic stereo-eye indicator for fast, sure stereo tuning.
- Special FM-Stereo switch automatically blocks out monaural FM stations.
- Solid state pre-amplifier.
- Ultra-Motional Stereo Amplifier, 34 watts music power.
- 6 Speaker, Ultra-Motional System.
- MIRACORD 4-speed custom changer.
- 15 tubes plus 12 transistors plus 7 diodes plus 5 power rectifiers.



By MATSUSHITA

MATSUSHITA ELECTRIC CORPORATION OF AMERICA
Pan Am Building, 200 Park Ave., N.Y. 17, N.Y., Tel: 973-5700

Interest: Piano masterpieces
 Performance: Highly personal
 Recording: A trifle hard
 Stereo Quality: Good enough

These suites of short mood pieces—by turns capricious and brooding, heroic and quietly songful—represent the literature of the German Romantic piano at its very peak, yet this release marks their debut on tape. One may have reservations about Rubinstein's somewhat mannered rubato treatment of some of the lyrical movements, but his brio is thrilling to hear in the more brilliant and virile episodes, notably the beginning and end of *Carnaval*. Above all, Rubinstein can never be accused of cold-bloodedly sacrificing the soul of Schumann's musical utterance for the sake of virtuosity. For those who like their Schumann with emphasis on rhythmic verve, these performances will fill the bill to perfection. The recorded piano sound is very clean, but is a little lacking in reverberant warmth. *D. H.*

RECORDING OF SPECIAL MERIT

© VIVALDI-BACH: *Organ Concertos: in G Major, BWV 592; in A Minor, BWV 593; in C Major, BWV 594; in D Minor, BWV 596.* Anton Heiller (organ). VANGUARD VTC 1664 \$7.95.

Interest: Bach's transcriptions
 Performance: Admirable
 Recording: Very good
 Stereo Quality: Okay

It is not surprising that this is the first set of Bach's transcriptions to appear on tape. The Concerto in G Major, once ascribed to Vivaldi, is now known to have



VANGUARD RECORDS

ANTON HEILLER

The Baroque manner for Bach's adaptations

been composed by Prince Johann Ernst, a friend and probably a student of Bach. Even as transcribed, it remains a fairly insubstantial piece of music, but the rest

are masterpieces—the A Minor and D Minor concertos being familiar to all lovers of Baroque as Nos. 8 and 11 of Vivaldi's *L'Estro armonico*, Op. 3, and the C Major as No. 5 of Op. 7. The last is distinguished in its second movement for a florid recitative reminiscent of the Italian aria style Bach himself employed in his *Chromatic Fantasy*. The long cadenza in the same work's concluding Allegro, however, was clearly meant for the violin and is not too successfully realized on the organ. Playing a fine Baroque instrument built in 1959 for St. Mary's Church at Hälsingborg, Sweden, Anton Heiller chooses his stops wisely and adopts convincing tempos. Even when his registrations are thickest, linear detail is generally well defined, and the clean recording, too, is a great asset. The recorded sound is bright and true-to-life throughout. *C. B.*

RECORDING OF SPECIAL MERIT

© WAGNER: *Das Rheingold: Entry of the Gods into Valhalla; Die Walküre: Ride of the Valkyries; Magic Fire Music; Die Götterdämmerung: Siegfried's Rhine Journey; Funeral Music.* Pittsburgh Symphony Orchestra, William Steinberg cond. COMMAND CC 4T 11012 \$7.95.

Interest: Handsome package
 Performance: Splendid and vital
 Recording: Fine
 Stereo Quality: Good

Steinberg is a topnotch Wagner conductor, with a knack for achieving a most effective blend of romantic splendor and rhythmic vitality. If the performances on this tape are accepted as a criterion, it would not be unreasonable to claim that Steinberg is up to the best that Toscanini and Stokowski were giving us in the 1930's.

The *Magic Fire Music* is more extended here than in usual orchestral versions, for it begins at the point of Wotan's final kiss of farewell to the errant Brünnhilde, and the *Götterdämmerung* Rhine Journey episode is performed in the Toscanini edition that includes not only the dawn episode but part of the Siegfried-Brünnhilde duet. Regrettably, the vulgar Humperdinck concert ending is also used, but this is a minor point, because both the Rhine Journey and the great Funeral Music get a performance and recording here that brought back to me the thrills of first hearing this music.

Command's recording has wonderful richness and impact, but my review tape suffered from a defective left track during the opening half of the first side, probably because of the tape's faulty contact with the tape head during the dubbing process. *D. H.*

(Continued on page 126)

What's new from Ampex?

Collector's Library

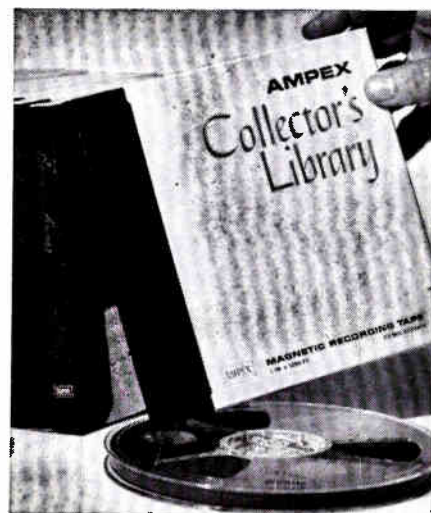

Here's good news for people who care how their sounds sound—and how their tape collection looks. It's Collector's Library—a new tape from Ampex. It's ideal for all general recording needs and for building an attractive tape library. Here's why: 1) An exclusive Ferro-Sheen* oxide surface gives maximum frequency response, clean operation and low head wear. 2) The new book-like design on the box gives your tapes a matched set appearance. Just five or six boxes look like a collector's library. In addition to this each box comes with famous "Signature Binding"—the simulated leather binding and gold foil strip for custom labeling of your tapes. 3) Collector's Library is economically priced. You'll save money on every box of tape you buy. Available on Mylar** and acetate bases in all popular sizes. Collector's Library is the latest addition to the fine line of Ampex precision tape. Ampex Corp., Redwood City, California.

*TM Ampex Corp.

**TM for Dupont Polyester Film



CIRCLE NO. 86 ON READER SERVICE CARD
 HI-FI/STEREO REVIEW

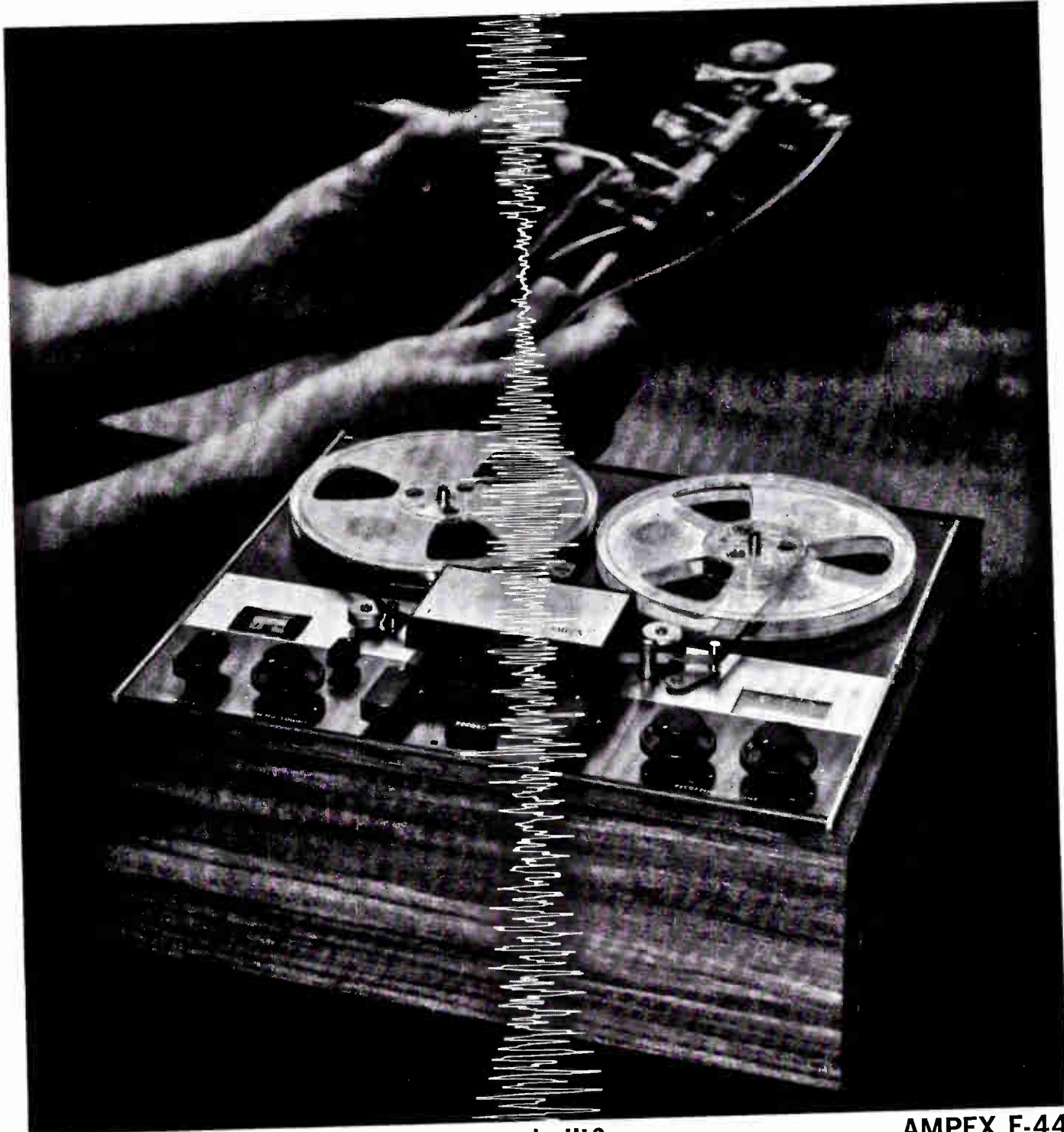

What new recorder is virtually custom-built?

AMPEX F-44

The F-44 is a brand new 4-track stereo recorder from Ampex. It's Ampex through and through. And there's this, too: at every stage of manufacture Ampex tunes, adjusts and aligns each F-44 to obtain its maximum performance — far beyond minimum specifications. Thus, no two F-44s are quite alike. Each is virtually a custom-built recorder. Each performs to the utmost of its capabilities. And each gives you the best possible sounds today — and for many years to come. As an F-44 owner, you'll receive from Ampex a record of the individual performance specifications of your own F-44. This record shows the frequency



response curve, the signal-to-noise ratio, the flutter and wow, and the crosstalk rejection measurement. And it is signed by the Ampex engineers who tuned and adjusted your recorder. The new Ampex Fine Line F-44 also features a new special design hysteresis motor for smooth, quiet, accurate operation; an easy-to-read point-to-point record level meter for each channel; multiple sound-on-sound capability; new simplified controls; and the Ampex one year warranty. See and hear the new F-44 at your local Ampex dealer. Brochure? Write: Ampex Corporation, Redwood City, California. Sales and service throughout the world.

CIRCLE NO. 10 ON READER SERVICE CARD

OCTOBER 1963

125

LESA

DIRECT FROM ITALY... OVER 30 YEARS OF QUALITY



Lesamatic
record player

\$79.50

(with Jam-proof arm)

For more information about this and other exciting new products, please write for brochure to Lesa of America Corp., 32-17 61 Street, Woodside 77, New York, Dept. H-F

NOTE: LESA ANNOUNCES A ONE-YEAR GUARANTEE ON ALL PRODUCTS!

CIRCLE NO. 48 ON READER SERVICE CARD



Free valuable Handbook

"11 ways to really improve your Hi-Fi listening"

An authoritative study on the uses of earphones.

For the first time a comprehensive compilation of data on one of the newest and most efficient methods of Hi-Fi listening issued by

SUPEREX

The only stereo/phones containing woofers and tweeters in each phone plus crossover networks... full 20-20,000 cps range; 8-16 ohms impedance. For true stereo or monaural listening without muddling, interference from room noises or conventional background sounds. ST-M \$29.95



SUPEREX stereo/phones
3-S Radford Place • Yonkers, N. Y.

Please send me "Your Free Handbook"

Name _____

Address _____ City _____ State _____

ROCK BOTTOM PRICES

GET
OUR
QUOTE

STEREO • HIGH FIDELITY

PLUS THESE RABSONS EXTRAS

- Established 1905 58 Years of Reliability
- Franchised Protection Plus
- Rabsons Special Two Year Guarantee
- Easy Payment Plan Up to 24 Months to Pay
- Each Component Double Packed to Insure Safe Arrival... At no extra charge
- Rabsons Sells ONLY Factory Fresh Merchandise in Original Factory Sealed Cartons

SO WRITE RABSONS

Whatever your HI-FI requirements and receive

FREE

A \$1.00 genuine Miracle Record Cleaning Cloth with EVERY Quotation from Rabsons on a component or system of your choice.

RABSONS -57 ST. INC.

119 West 57th St., New York 19, N.Y.

Area Code 212 Circle 7-0070

Diagonally opposite Carnegie Hall

CIRCLE NO. 55 ON READER SERVICE CARD

COLLECTIONS

RECORDING OF SPECIAL MERIT

© **MUSIC FOR OBOE AND ORCHESTRA:** Handel: *Oboe Concerto No. 1, in B-flat*. A. Marcello: *Oboe Concerto, in C Minor*. Fiocco: *Adagio*. J. S. Bach: *Sinfonias to Cantatas Nos. 12, 21, 156*. Telemann: *Oboe Concerto, in F Minor*. Harry Shulman (oboe); orchestra, Daniel Saidenberg cond. **MUSIC FOR FRENCH HORN AND ORCHESTRA:** Telemann: *Concerto, in D Major, for Three Horns and Orchestra; Suite, in F Major, for Two Horns and Orchestra*. Handel: *Concerto, in F Major, for Two Horns and Orchestra*. Steinmetz: *Horn Concerto, in D Major*. Bartsanti: *Concerto, in D Major, for Two Horns and Orchestra*. James Stagliano, Arthur Berv, and James Buffington (horns); Kapp Sinfonietta, Richard Dunn cond. KAPP KTK 49009 \$11.95.

Interest: Varied virtuosic program

Performance: Tasteful

Recording: Good

Stereo Quality: Good

This hour-and-a-half reel offers no soul-shattering masterpieces, but rather a beautifully contrasted sequence of familiar and obscure music from the first half of the eighteenth century. There is the easy lyricism and outright extroversion of Handel, the moody poignancy of Bach, and the fluent virtuoso writing of Telemann. The Telemann concertos are the genuine finds here—or else the brilliance of the solo performers makes the works sound better than they are. For sheer technical acrobatics, however, the horn concerto attributed to Steinmetz takes the prize—hats off to James Stagliano.

Conductors Saidenberg and Dunn do a tasteful job of accompaniment in abetting the technical and musical proficiency of Harry Shulman and the elite trio of horn players. Good sound. D. H.

RECORDING OF SPECIAL MERIT

© **I SOLISTI DI ZAGREB:** *Notturmo*. Pergolesi: *Concertino No. 2, in G Major*. Mozart: *Eine Kleine Nachtmusik, K. 525*. Sibelius: *Valse Triste, Op. 44*. Respighi: *Ancient Airs and Dances—Suite No. 3*. Vaughan Williams: *Fantasia on Greensleeves*. Barber: *Adagio for Strings, Op. 11*. I Solisti di Zagreb, Antonio Janigro cond. VANGUARD VTC 1663 \$7.95.

Interest: Music for strings

Performance: Fine ensemble

Recording: Full-bodied

Stereo Quality: Satisfactory

A reel that brings together six ingratiating works such as these, in rich and loving

HIFI/STEREO REVIEW

performances by I Solisti di Zagreb, must be wholeheartedly recommended. The closest thing to it in the catalog is the Ormandy-Philadelphia Orchestra "Serenade for Strings" (Columbia MQ 431), which also includes the Barber *Adagio for Strings* and the Vaughan Williams *Fantasia*. In the present tape, though, the string ensemble is considerably reduced, imparting a desirable leanness to these two lovely scores and to Sibelius' *Valse Triste*. The crisp formality of the music by Mozart and Pergolesi and the stately neoclassicism of Respighi's *Ancient Airs and Dances* (the third suite is the first of the series on tape) provide an agreeable contrast. Clarity, balance, and ample separation are features of the recorded sound. C. B.

ENTERTAINMENT

© **JOHN COLTRANE: *Ballads***. John Coltrane (tenor saxophone), McCoy Tyner (piano), Elvin Jones (drums), Jimmy Garrison (bass). *Say It Over and Over Again; You Don't Know What Love Is; Too Young to Go Steady; All or Nothing at All*; and four others. IMPULSE ITC 306 \$7.95.

Interest: Tame 'Trane
Performance: Ingratiating
Recording: Good
Stereo Quality: Distinct

This is a free-and-easy session by one of the iconoclasts of contemporary jazz. In one number after another Coltrane demonstrates what his followers have always claimed, that he can stick reasonably close to a melody, bending it, coddling it, and coloring it as he sees fit, doing so with the utmost delicacy and, yes, even charm. The sweet sounds he produces in *It's Easy to Remember*, the mood of quiet contemplation he creates in *You Don't Know What Love Is*, and the sunny disposition he radiates in *Nancy* are cases in point. Aside from *All or Nothing at All*, which is quasi-Arabic in feeling, this is Coltrane playing it straight, with the sympathetic partnership of pianist McCoy Tyner. The recording's major flaw is that Tyner's discreet backing is often obscured by the more assertive rattle of Elvin Jones' drums. Otherwise the sound is clean and suitably robust. C. B.

© **BILL EVANS/SHELLY MANNE: *Empathy***. Bill Evans (piano), Shelly Manne (drums), Monty Budwig (bass). *With a Song in My Heart; Goodbye; I Believe in You*; and three others. VERVE VSTC 288 \$7.95.

Interest: Slack materials made spirited
Performance: Deft
Recording: Good
Stereo Quality: Pronounced

NOW...FAMOUS FREEMAN PROFESSIONAL RECORDERS

*Studio Performance
In Your Family Circle
easiest to operate... most fun to use*

Shown with C-246 Console
Cabinet Price \$149.50
Audiophile Net

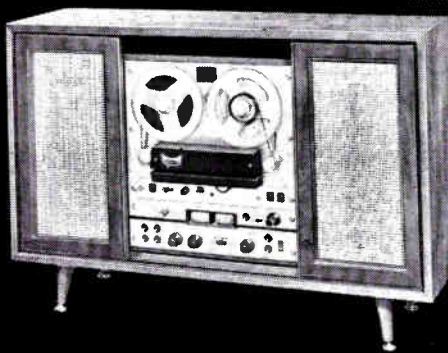

FREEMAN "200" STEREOPHONIC ROBOT
Audiophile Net \$995.00

- Automatic Reverse
- 4 Broadcast Heads
- 100% Transistorized
- 4-Channel Mixer
- Touchbutton Operation-Echo Chamber
- Automatic Continuous Play
- 40 Watt Stereo Output
- Tape or Source Monitoring
- 3 Hysteresis Synchronous Motors
- Sound on & with Sound

World's first...

Stereophonic Robot

Audiophile
Net \$399.50



ONLY THE FREEMAN "600" OFFERS

- Automatic Shut-off
- Hysteresis Synchronous Motor
- 3 Head Professional Stereo Design
- 15 Watt Stereo Output
- Qualifies For School Use
- A Complete Home Music System
- No Competition Under \$600



Audiophile Net
\$139.50

THE UNEQUALED "550"

Tapes up to two hours. The finest lecture, report and conference recorder in the world. Battery or AC power.



Audiophile Net
\$159.50

THE FABULOUS "660"

Now, everyone can tape high fidelity anytime, anywhere in a 6-lb package. Battery or AC power.



Net
\$29.95

PROFESSIONAL DYNAMIC MICROPHONE DM-166
in walnut presentation case.

REVOLUTIONARY UNDER-CHIN HIGH FIDELITY STEREOPHONES SEP-100
Net \$24.95



FREEMAN ELECTRONICS CORP., Dept. HFS-10
729 N. Highland Avenue
Los Angeles 38, California

Please send me:

- Booklet containing ingenious suggestions on how to get the most from a tape recorder at work or play. I enclose 25¢ (coin, stamps) for postage and handling.
- Name of nearest dealer.

Name _____

Address _____

City _____

Zone _____ State _____

AMERICANA

on L. P. Records

ANGOLA PRISONERS' BLUES—Recordings of three old-time country blues singers, Hogman Mazey, Guitar Welch and Robert Pete Williams; recorded in Louisiana State Penitentiary. "... one of the most disturbingly autobiographical statements in recorded folk music." *NY Times* . . . \$3.99

THOSE PRISON BLUES: Robert Pete Williams—"... Williams has . . . the 'tremendous drive and anguish' that characterized the fabled Leadbelly." *Time* . . . \$3.99

Plus a wide selection of other Folk-Lyric records (LP)

CONTEMPORARY AFFAIRS SOCIETY

----- Send coupon today -----

CONTEMPORARY AFFAIRS SOCIETY
National Press Bldg.
Washington 4, D.C. 20013

Please send me:

ANGOLA PRISONERS' BLUES @ \$3.99
 THOSE PRISON BLUES @ \$3.99

Enclosed find: \$ _____ (Add 25¢ per record for handling charges; include sales tax where applicable. (Outside U.S. add 75¢ handling charges.)

Please send catalogue of Folk-Lyric Records and tell how I join C.A.S.

Name _____
Address _____
City _____ Zone _____ State _____

CIRCLE NO. 27 ON READER SERVICE CARD

Why?

DO THOUSANDS OF HI-FI ENTHUSIASTS BUY FROM AUDIO UNLIMITED

It's Obvious!

- LOWEST PRICES
- FAST SERVICE
- FACTORY SEALED UNITS
- FULLY INSURED SHIPMENTS
- UP TO 2 YEAR MANUFACTURERS' WARRANTY
- TIME PAYMENT PLAN
 - only 10% down
 - up to 36 months to pay
- FRANCHISED DISTRIBUTORS

Write for FREE Catalog Today

SEND US YOUR LIST FOR OUR AIR MAIL QUOTE TODAY

Visit Our Showroom and Warehouse



AUDIO unlimited, inc.

715-S Second Ave., (Nr. 38) New York 16, N.Y.
3 blocks from the U. N.

CIRCLE NO. 15 ON READER SERVICE CARD
128

It takes nerve to pick numbers like *The Washington Twist* and *Let's Go Back to the Waltz* for serious jazz treatment, excerpted as they are from a Broadway score—Irrving Berlin's *Mr. President*—marked by the critics as mediocre. But that is what Bill Evans has done, with spirit and style—which should surprise no one familiar with his work and his unerring if eclectic tastes. Evans' quiet, introspective rendering of *Danny Boy* on this reel, his first, I believe, is yet another instance of his rare ability to illuminate the unlikely corners. Shelly Manne, in these three pieces and in the three less startling choices that fill out the set, lends discreet but sturdy support—he and Evans really share the empathy of the title. The recording itself is a good one, though a little weak on picking up the bass. *C. B.*

© STAN GETZ & LUIZ BONFÁ: *Jazz Samba Encore!* Stan Getz (tenor saxophone), Luiz Bonfá (guitar), Antonio Carlos Jobim (guitar and piano), Maria Toledo (vocals). *Sambalero; So Dance Samba; Insensatez; Samba de Duas Notas*; and six others. VERVE VSTC 293 \$7.95.

Interest: Bossa nova sequel
Performance: Lucid
Recording: Outstanding
Stereo Quality: Pronounced

Stan Getz's first jazz-samba recording with Charlie Byrd (Verve VSTC 276) was a runaway best-seller that in effect launched the bossa nova fad a year or so ago. This reel, its sequel, enlists the participation of two of bossa nova's originators, Brazilian guitarist Luiz Bonfá and song-writer Antonio Carlos Jobim, and could easily do as well commercially except that what was once a fad has now become one more offshoot of mainstream jazz—up North here, at least. Getz is once again in fine form, though, and being steeped in this music from the beginning, plays it fluently and idiomatically. Most of the numbers were written by Bonfá, some with the help of singer Maria Toledo, who contributes haunting vocal effects in a few of the choruses. The sound is first-rate, even if the stereo separation is a mite overdone. More perspective on the ensemble as a whole would have been preferable. *C. B.*

RECORDING OF SPECIAL MERIT

© THE GARY MCFARLAND ORCHESTRA. Gary McFarland (leader, vibraphone), Bill Evans (piano), Jim Hall (guitar), others. *Reflections in the Park; Night Images; Tree Patterns; Peachtree*; and two others. VERVE VSTC 292 \$7.95.

Interest: McFarland as composer
Performance: Sympathetic

Recording: Fine
Stereo Quality: Distinct

Although he is copiously recorded as an arranger and vibist, Gary McFarland makes his bow here as a composer in what amounts to a one-man show. He is fortunate to have pianist Bill Evans as "special guest soloist." The brace of little tone poems McFarland has written for the eleven-piece combo bearing his name have just the airy and pensive qualities Evans specializes in. McFarland's scoring is resourceful, especially for the string quartet in *Night Images* and the closing number, *A Moment Alone*—possibly a carry-over from his work as an arranger of bossa nova, in which hovering strings play an important role. But as delicate as it is in texture, the music never fails to swing—its lighthearted moments, in *Peachtree* and the more extended *Misplaced Cowpoke*, are highly effective. The acoustic ambience is marked by intimacy and warmth. *C. B.*

RECORDING OF SPECIAL MERIT

© GERRY MULLIGAN: *The Concert Jazz Band, Volume Two.* Gerry Mulligan (baritone saxophone, clarinet), Clark Terry (trumpet), Bob Brookmeyer (trombone, piano), Jim Hall (guitar), others; Gerry Mulligan leader. *Little Rock Getaway; Ballad; Big City Life; Big City Blues*; and four others. VERVE VSTC 289 \$7.95.

Interest: Mulligan band sound
Performance: Contained
Recording: Excellent
Stereo Quality: Ditto

Although the first reel by Gerry Mulligan's Concert Jazz Band (Verve VSTC 250) was not a complete success, its successor surely is. The sound of this crackjack outfit has come to have a personality of its own, a sound similar, as Dom Cerulli points out in his liner notes, to the Ellington sound, but easily identified by Mulligan's low-key style. This personality is mostly in the weight and texture of the band's horns and reeds, whether in a solid swinger like *Little Rock Getaway* or in the suave, easy-going treatment given *My Kind of Love*. The really outstanding numbers are the two by Bob Brookmeyer—*Big City Life* and *Big City Blues*. The latter opens and closes with a haunting trio by pianist Brookmeyer, guitarist Jim Hall (a newcomer to the group), and Mulligan, playing—as he rarely does on recording dates—the clarinet. The magically subdued color achieved in these few bars is almost worth the price of the reel. Over-all, the feeling of controlled energy is evident, as is a unity of purpose that must be attributed to Mulligan's leadership. The recording itself is first-class. *C. B.*

COMMONSENSE STEREO

You start at least
\$50 ahead with a
KENWOOD!

We believe it should be possible to enjoy the magnificence of quality stereo without having to spend a small fortune. That is why we designed our receivers, tuners and amplifiers to give you the fine performance expected only from the best systems — but at a price that's a comfortable fit for most budgets. For example:

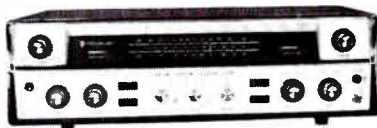

**THE KW-70 AM/FM STEREO
MULTIPLEX RECEIVER**

The KW-70 combines tuning, preamplification and amplification on a single chassis. It receives AM, FM and FM/Stereo broadcasts, stereo and monaural records, tape in stereo and monaural.

Turn the KW-70's tuning dial. The Stereo Indicator tells you when you've got a stereo broadcast in your sights. Listen. The KW-70's sensitivity makes weak stations strong.

If you hear buzzing, there's a bee in the room. If you hear rumble, there's an earthquake in the neighborhood. The KW-70's noise filtering circuits allow no such intrusions. Turn up the volume. 65 watts of musical power comes booming through—32.5 watts in each channel with harmonic distortion of only 1%.

Acoustics not right? The separate tone controls for each channel make the KW-70's tone fit the room like wallpaper. Want to capture all the beauty of the broadcast on tape? A Tape Monitor lets you listen to the recording and judge its quality as you tape it.

Now listen to the KW-70's price. Only \$269.95. At least \$50 less than anything else as good.



**THE KW-40 AM/FM STEREO
MULTIPLEX RECEIVER**

Here is a fully-integrated AM-FM/Stereo receiver combined with dual-channel 20-watt amplifiers. Its credentials include exceptional sensitivity and stereo separation. An on-off Automatic Frequency Control heads like a homing pigeon for the clearest sound in the channel. It has an exclusive sub-channel circuit that bypasses monophonic FM transmission to provide positive identification of stereo stations. An AM circuit and built-in antenna will satisfy any sudden desire you might have for standard broadcasts.

The KW-40 takes tape. It takes records. Feeling selfish? A headset jack enables you to enjoy your stereo all by yourself. And as much as you will appreciate the sounds you get, the sounds you don't hear are important too. The KW-40 DC filament circuit hushes hum. Its high-frequency filter scrubs out scratch. Its low-frequency filter rubs out rumble. But the biggest surprise is the price. \$199.95. At least \$50 less than anything else as good.

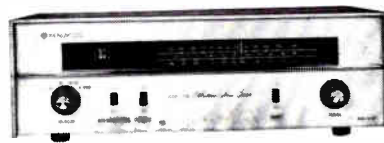

**THE KW-100-T AM/FM
MULTIPLEX TUNER**

The advanced technology that puts the KW-70 and KW-40 out in front makes Kenwood's new KW-100-T Tuner a superb musical instrument.

Sensible controls and an extra-wide tuning band make the KW-100-T easier to tune. An FM Stereo Monitor guides you straight to stereophonic broadcasts. An AFC switch grabs hold of the strongest point of the signal. A flick of a switch disposes of high-frequency noise. A 3-gang variable condenser gives an extra margin of purity to your reception. Price? Only \$139.95. At least \$50 less than anything else as good.

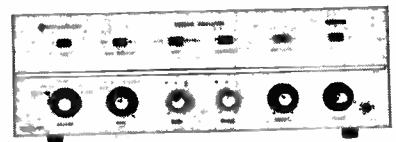

**THE KW-200-A STEREO
AMPLIFIER**

The KW-200-A offers you the kind of powerful undistorted amplification you need to bring out the full potential of your stereo system.

Its 65 watts give you sound that's big enough for a ballroom. Its harmonic distortion of only 1% makes even the most towering musical passages come through with clean, crisp definition.

Like the KW-70, the KW-200-A amplifier has a Tape Monitor to let you judge the quality of a recording as you record it, and a headset jack.

And along with the bigger sound of the KW-200-A, you get a smaller price. Only \$139.95. At least \$50 less than anything else as good.

For more detailed information, write: Kenwood Electronics, Inc. at 212 Fifth Ave., New York 10, N. Y. or 3700 S. Broadway Pl., Los Angeles 7, Calif.

KENWOOD

The Sound is Priceless

GENUINE PLAYBACK EQUIPMENT

A DISTINCT STEP-UP FROM HIGH FIDELITY

Genuine studio **PLAYBACK** equipment is as superior to conventional "hi fi" components as these components are superior to typical package "hi fi." The reason: **PLAYBACK** equipment is what the conductors, artists and recording engineers rely on in the studio to accurately compare the realism of a recording with the live rendition.

In professional audio, where no compromise with performance and reliability is tolerated, only genuine **PLAYBACK** equipment is deemed acceptable. Altec Lansing is synonymous with **PLAYBACK**, because major professional users—studios, concert halls, theatres—have used Altec equipment predominantly since the beginning of modern sound technology.

The Altec 605A "Duplex"® is an outstanding example of such studio equipment and has been judged the finest single-frame speaker in existence. It is the ultimate refinement of Altec's original 604 which had served as the **PLAYBACK** standard since the birth of long play records.

One hearing will quickly demonstrate why the 605A "Duplex" is supreme. These specifications will explain some of the reasons: The 605A is a 15", two-way speaker system employing a true multicell horn for perfect dispersion of high frequencies throughout the entire audio range. Its guaranteed frequency response is 20-22,000 cycles. The Altec 605A "Duplex" is so free of distortion and false coloration that other speakers sound shrill and constricted by comparison. That's why leading Capitol recording stars such as Judy Garland, Peggy Lee, Nat King Cole and Vic Damone can rely on the "Duplex" in studio **PLAYBACK** for evaluation of their work before the recording is "wrapped-up."

WIDE VARIETY OF WIDE-RANGE SPEAKERS

The 605A is priced at \$168.00 including dividing network. At 35 pounds, it is the "heavyweight" of the line. Two other "Duplex" **PLAYBACK** speakers of exceptional quality are also available. The 602C is a 15" two-way speaker which provides outstanding performance at the modest cost of \$132.00. For those who want genuine **PLAYBACK** sound in comparatively small space, Altec's two-way 601C is the ideal answer at \$108.00.

For "starter" systems on a budget, consider Altec full-range, single voice-coil "Biflex"® speakers: the 15" 415C and the 12" 412C. And, for speakers throughout the home, there's the remarkably smooth 8" 755C "pancake," a popular utility monitor in the broadcast and recording field for many years.

AUDIO'S MOST IMPORTANT FORMULA

Whatever you invest in your system, put major emphasis on the speakers. The speakers are the voice of your system and here, a compromise is most audibly apparent. If, for various reasons, you must compromise with overall quality, it is best not to do so in speaker selection but elsewhere in the audio system. Naturally, you will be assured best results by a stereo system made-up entirely of components of homogeneous quality such as offered by genuine Altec **PLAYBACK** speakers, amplifiers, and tuners.

Hear Altec speakers, speaker systems and other **PLAYBACK** components at your nearest Altec Distributor's (see your Yellow Pages). And while you're there, be sure to ask for your courtesy copy of "PLAYBACK and Speech Input Equipment for Recording and Broadcast Studios." Although prepared specifically for the recording and broadcast industry, it provides the obvious answers to better home listening as well. Or, for your free copy, write Dept. SR-10.

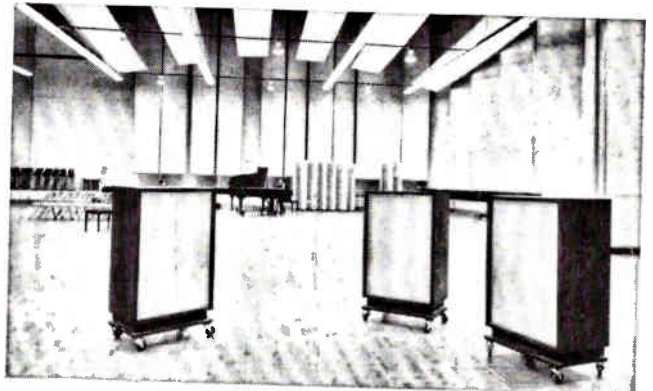
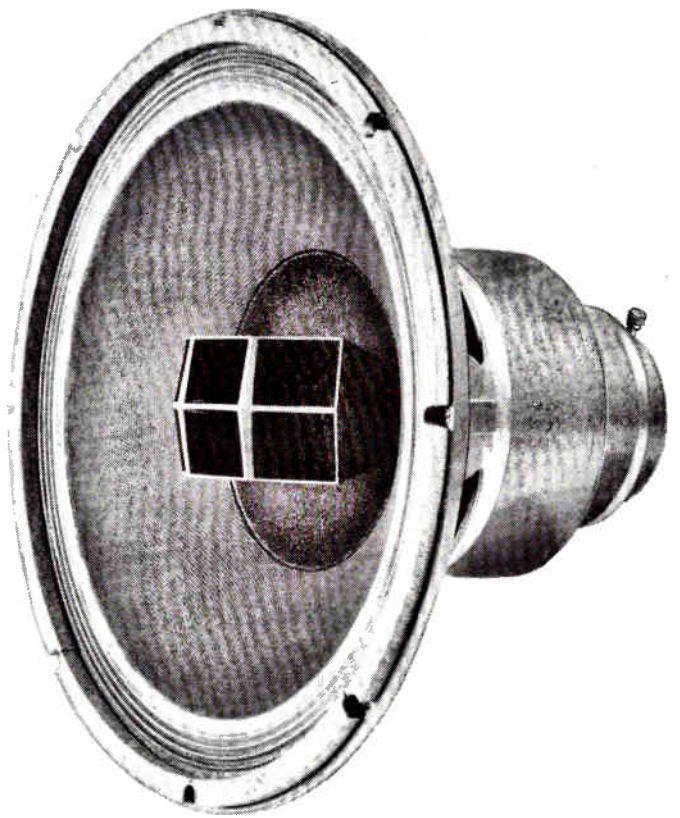

Interior of Columbia Records' Studio A in Hollywood showing CBS-built cabinets housing Altec 605A "Duplex" Loudspeakers for professional **PLAYBACK**.

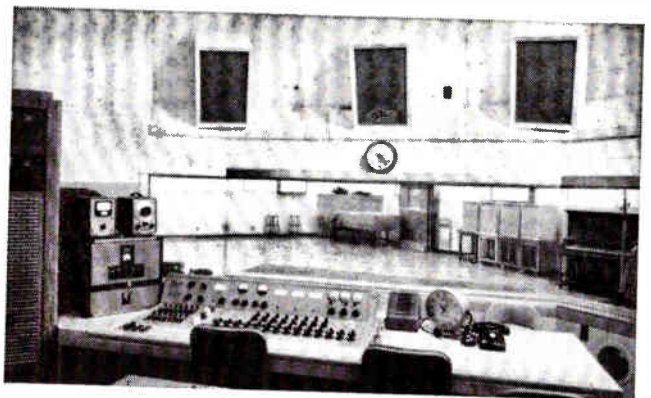

Monitoring with Altec "Duplex" speakers in Capitol's Control Room. More than 70 Altec "Duplex" speakers are used for various **PLAYBACK** purposes throughout Capitol Records' recording facilities.



©1963 ALTEC LANSING CORPORATION

**ALTEC LANSING
CORPORATION**

LTV A Subsidiary of
Ling-Temco-Vought, Inc.
ANAHEIM, CALIFORNIA

HiFi/Stereo

ENTERTAINMENT

POP II FILMS
UMOR
Theater FOLK

Reviewed by STANLEY GREEN • NAT HENTOFF • PAUL KRESH

Explanation of symbols:

- Ⓜ = monophonic recording
- Ⓢ = stereophonic recording
- * = mono or stereo version not received for review

Ⓢ Ⓜ **BILL ANDERSON:** *Still*. Bill Anderson (vocals), chorus and orchestra. *Still; Get a Little Dirt on Your Hands; Restless; Happiness; I Wish It Was Mine* (all by Anderson); and seven others. DECCA DL 74427 \$4.98, 4427* \$3.98.

Interest: Doggerel and music
Performance: Idiomatic
Recording: Good
Stereo Quality: Okay

If young composer-performer Bill Anderson would stop doing those awful imitations of Edgar Guest and devote a little more time to writing songs like *Get a Little Dirt on Your Hands*, he might well end up as one of our few identifiable folk-song writers. *Get a Little Dirt* is wry, real, and ironic. The rest of these songs have a smarmy snake-oil melloquence you will not like. Jacket notes say that the Bill Anderson story has no ending. None of these songs do either—they all jes' trail off, like. . . .

William Anderson

Ⓢ Ⓜ **JO BASILE:** *Paris with Love*. Jo Basile (accordion); orchestra. *Les Innocents; Petite Fleur; La Mer*; and nine others. AUDIO FIDELITY AFSD 5938 \$5.95, AFLP 1938* \$4.98.

Interest: Bal-musette stuff
Performance: In the proper spirit
Recording: Perfect
Stereo Quality: High

In this, his umpteenth album of Parisian melodies, Jo Basile takes off in his accustomed bright, bubbly fashion to offer another gay musical tour of the city. The spirit is appropriately intimate: the soloist is backed by no more than drums, guitar, an occasional clarinet, and a vibraphone alternating with a xylophone. Audio Fidelity's crisp, clear recording helps maintain the proper lively flavor; and the excellent use of stereo enhances the listener's pleasure. S. G.

RECORDING OF SPECIAL MERIT

Ⓢ Ⓜ **PATSY CLINE:** *The Patsy Cline Story*. Patsy Cline (vocals); orchestra. *Heartaches; Strange; Foolin' Around; True Love; Imagine That*; and nineteen others. DECCA DXSB 7176 two 12-inch discs \$9.96, DXB 176* \$7.96.

Interest: Country-and-western
Performance: Tops in the field
Recording: Beautiful
Stereo Quality: Fine

Patsy Cline was not only one of the better singers of country-and-western music, but also a remarkably persuasive



PATSY CLINE

A marked loss for the c-&-w circuit

interpreter of other popular music. Her untimely death last March ended a career that was unquestionably expanding in scope and ascending in quality.

As this two-record compendium attests, Miss Cline was among the most legitimate of country singers, avoiding the nasal excesses and vocal quirks of far too many of her contemporaries in the field. Sincerity infused everything she sang, making even the most mawkish sentiments palatable. From time to time, as in *Imagine That*, she shows a refreshing sense of comedy, reminiscent of Pearl Bailey, even though this collection is made up, for the most part, of laments

about lovers who got away or the trials of deciding which man to marry.

Some of the musical highlights of Miss Cline's brief career are included: *Walking after Midnight*, which she first sang on the Arthur Godfrey program, and her first record hit, *I Fall to Pieces*, among others. Occasionally, the repertoire strays to such citified offerings as *Heartaches*, *True Love*, and that masochistic dirge, *I Love You So Much It Hurts*. So much suffering over four record sides might easily be wearying well before the end. But Miss Cline almost makes you believe in these sentiments.

The accompanying album, four pages of text and photographs, fails to credit any songwriter, and neither do the jacket nor the record label. S. G.

RECORDING OF SPECIAL MERIT

Ⓢ Ⓜ **MICHAEL FLANDERS AND DONALD SWANN:** *The Bestiary*. *The Warthog; The Sea-Horse; The Chameleon; The Whale (Mopy Dick); The Sloth; The Rhinoceros; Twosome—Kang and Jag; Dead Ducks; The Elephant; The Armadillo*; and four others. ANGEL S 36112 \$5.98, 36112 \$4.98.

Interest: Mad menagerie
Performance: Authoritative
Recording: Good
Stereo Quality: Incidental

Michael Flanders and Donald Swann are this elegantly loony pair of *diseurs*—British ones—who write and sing funny songs. They played a very successful two-man show on Broadway not too long ago, and *The Bestiary*, their latest Angel recording, will demonstrate (to any who would still question it) their thoroughly justified claim to international fame.

The Bestiary—"songs and verses about animals by Michael Flanders and Donald Swann"—is a song cycle not easy to describe. Would I be getting anywhere near to it, I wonder, if I were to call it a nutty cross between James Thurber's *Animal Carnival*, Lewis Carroll, and Pogo? We encounter, en route, *The Spider*, "that great big hairy spider in the bath"; the truly heartrending courtship of an armadillo; the hummingbird who hums (quite obviously, because no lyrics quite describe his extraordinary percep-

SANBORN'S

DALLAS, TEXAS

"HI!"

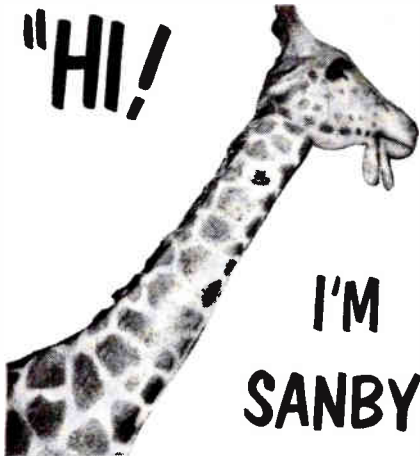

I'M
SANBY"

WITH SOME FABULOUS NEWS
NO MONEY DOWN
3 YEARS TO PAY
LOW INTEREST RATES

Let Us Send You
A Quote For Lowest Prices



OVER 50 BRANDS

FREE! Send for

Sanborn's 120-page
catalog featuring ...

- KITS
- CHANGERS
- AMPLIFIERS
- SANBORN'S SPECIALTY EQUIPMENT CABINETS
- MICROPHONES
- TUNERS
- SPEAKERS

Write Us for Your Special System Prices

SANBORN'S STEREO CITY
5551 W. LOVERS LANE
DALLAS 9, TEXAS

Name _____

Address _____

City _____ Zone _____

State _____

CIRCLE NO. 60 ON READER SERVICE CARD
132

tions); and the curious, sad, inverted universe of the sloth, ruminating on the dazzling accomplishments he just hasn't got round to: "The door's not shut/ On my genius but/ I just don't have the time."

The last selection on the program is, significantly, devoted to the ostrich and his celebrated view of the world: "Peek-a-boo, I can't see you/ Everything must be grand/ Peek-a-boo, they can't see me/ As long as I've got me head in the sand." This plaintive refrain is suddenly interrupted by the realistically recorded sound of an explosion. The hydrogen bomb, of course.

Frank Page's album jacket portraying all these odd beasts is a thorough joy and worth framing. *William Flanagan*

⑤ ⑥ **TRINI LOPEZ:** *Trini Lopez at PJs*. Trini Lopez (vocals); trio. *Cielito Lindo; La Bamba; Granada*; and eleven others. REPRISÉ R 96093 \$4.98, R 6093* \$3.98.

Interest: Lively program
Performance: Frequently exciting
Recording: Fine
Stereo Quality: Impressive

Trini Lopez may not have a great voice, and his enunciation is pretty dreadful, but he can put on a whale of a show. Accompanied only by drums, bass, and his own guitar, he leads the liveliest, noisiest, and most spontaneous sing-along choristers now on records. This group is composed of the customers at PJs, a night spot in Hollywood, where chatting, laughing, beating time, and sing-alonging is the order of the day, thus encouraging Señor Lopez to give one of the most contagious performances ever recorded in concert. The tempos are insistently up-beat, and achieve genuinely spine-tingling propulsiveness when applied to the likes of *This Land is Your Land, When the Saints Go Marching In*, and *Granada*. A remarkable feeling of presence in the album helps give the listener the impression that PJs may be one of the few bistros where people really have a good time. *S. G.*

⑤ ⑥ **MARIAN MONTGOMERY:** *Swings for Winners and Losers*. Marian Montgomery (vocals); orchestra, Dick Hyman cond. *My Buddy; 'Deed I Do; All by Myself*; and nine others. CAPITOL ST 1884 \$4.98, T 1884* \$3.98.

Interest: Promising newcomer
Performance: Engaging
Recording: Great
Stereo Quality: Very good

Although Miss Montgomery's disc debut is not an unalloyed success, she shows adequate promise of a bright future. She has an engaging sandpaper voice that

moves easily between up-tempo numbers and torch songs. But she occasionally sings without seeming to know or care what the songs' words mean, and thus mars such a piece as *When Your Lover Has Gone*, which gets an ill-advised up-tempo approach. Miss Montgomery



MARIAN MONTGOMERY
A sandpaper voice and a personal style

scores most impressively on the sprightly *Can't Help It*, and even makes something personal out of Billie Holiday's old trademark, *Good Morning Heartache*. Dick Hyman's jazz-flavor backing is appropriate and sympathetic. *S. G.*

⑤ ⑥ **JOHNNY PROPHET:** *This Is Johnny Prophet*. Johnny Prophet (vocals); orchestra, Axel Stordahl cond. *I Should Care; Angel Eyes; That's All*; and nine others. REPRISÉ 9 6081* \$4.98, 6081 \$3.98.

Interest: Attractive standards
Performance: Persuasive balladeer
Recording: Splendid

There is a suggestion here of Vic Damone, and once in a while you may detect the influence of Frank Sinatra, but in general Johnny Prophet has enough individuality to score as a highly persuasive interpreter of romantic sentiments. His voice is suitably mellow, his range is commendable, and his interpretations have the ring of sincerity. Unfortunately, his enunciation is occasionally sloppy—he pronounces "sometimes" as "suntimes," and "sort of" as "sut of." The orchestral backing of Axel Stordahl is not especially inspired. *S. G.*

⑤ ⑥ **MARTY ROBBINS:** *Hawaii's Calling Me*. Marty Robbins (vocals); orchestra. *Ka-lu-a; Echo Island; Blue Sand*; and nine others. COLUMBIA CS 8840 \$4.98, CL 2040* \$3.98.

Interest: Languorous program
Performance: Persuasive interpreter

Recording: Very good
Stereo Quality: All right

With singers from elsewhere now converging on the country-and-western pastures, it is refreshing to find a c-&-w regular extending his horizon. Marty Robbins has long had an affinity for Hawaiian music, and his way with these island songs is not a result of hasty preparation. He can put on a nicely controlled falsetto (traditional among Hawaii's male singers) with the best of them, as in *Drowsy Waters*, and has even contributed compositions of his own that blend well with the more standard luau fare. S. G.

⑤ ⑥ **FRANK SINATRA: *The Concert Sinatra***. Frank Sinatra (vocals); orchestra, Nelson Riddle cond. *Lost in the Stars*; *Bewitched*; *Ol' Man River*; and five others. REPRISÉ R 91009 \$5.98, R 1009* \$4.98.

Interest: Broadway's best
Performance: Tries hard
Recording: A bit cloudy
Stereo Quality: All right

The trouble with hearing Frank Sinatra in concert is that he does not have a concert voice. As a pop singer, he is unquestionably one of the best, but when called upon to project the full meaning of these songs, most of them by Rodgers and/or Hammerstein, he does not have the vocal resources to do them full justice. This fact is painfully accentuated by the seventy-three-piece orchestra that seems to inhibit the singer's natural exuberance and forces him to strain. Most successful are *My Heart Stood Still* and *Bewitched*; least excusable is *Ol' Man River*, in which Mr. Sinatra holds the note on "jail" for so long that it sounds as if he did it on a bet. S. G.

THEATER—FILMS

⑤ ⑥ **THE BOYS FROM SYRACUSE** (Richard Rodgers-Lorenz Hart). Off-Broadway revival cast. Ellen Hanley, Clifford David, Stuart Damon, Karen Morrow, Rudy Tronto, Danny Carroll, Julienne Marie, others; orchestra, René Weigert cond. CAPITOL STAO 1933 \$5.98, TAO 1933* \$4.98.

Interest: Top-drawer R & H
Performance: High average
Recording: A bit sharp
Stereo Quality: Poor placement

Rodgers and Hart's twenty-five-year-old score was the brightest and most buoyant collection of songs heard on or off Broadway this season. Written during the team's most significant productive period, the score reveals Rodgers in an especially lyrical and inventive vein, and

Hart as a lyricist whose work was equally distinguished for poetic insight, technique, and wit. Such pieces as *Falling in Love with Love* and *You Have Cast Your Shadow on the Sea* have a poignancy and depth that raise them to the level of American art songs, and the rowdier numbers, *He and She* and *What Can You Do with a Man?*, demonstrate that unerring blend of words and music that makes a comic song more than a series of clever rhymes. And has anyone ever written a more skillfully negative song than *This Can't Be Love*, with affection implied by absence of sighs, sorrows, and sobs?

In general, the current cast does well by the songs. Ellen Hanley's throbbing vibrato makes her rendition of *Falling in Love with Love* almost definitive, and fine contributions are provided by Stuart Damon, Clifford David, and Karen Morrow. Comparison of this issue and the now withdrawn Columbia recording discovers a point or two in the earlier recording's favor, particularly in the matter of tempos. I also find Capitol's sound a bit sharp, and I am sorry that full advantage was not taken of stereophonic placement. For example, Karen Morrow and Rudy Tronto sing *What Can You Do with a Man?* from "between" the speakers, though the song clearly sanctions their standing apart. And certainly the girls' voices should have been spread out for the show-stopping *Sing for Your Supper*. S. G.

⑤ ⑥ **I COULD GO ON SINGING**. Sound-track recording. Judy Garland (vocals); orchestra, Mort Lindsey cond. CAPITOL SW 1861 \$4.98, W 1861* \$3.98.

Interest: Suitable for a single
Performance: Intense
Recording: Cloudy
Stereo Quality: Adequate

The four songs that Judy Garland sings in the film by the same name as this album would fit neatly on two sides of a 45-rpm disc. Capitol has padded things so much that we are forced to pay the price of a 12-inch disc with two very loose sides. In addition to Miss Garland's intensely wrought songs, there are bits of background music, a title-song reprise, and an irritatingly cute Gilbert-and-Sullivan excerpt. Miss Garland's unsteady voice is not helped by the generally inferior recording quality. S. G.

⑤ **SALAD DAYS** (Julian Slade-Dorothy Reynolds). Original London cast recording. Eleanor Drew, John Warner, James Cairncross, others. LONDON 5765 \$4.98.

⑥ **PIECES OF EIGHT**. Original London cast recording. Kenneth Williams, Fenella Fielding, Myra de Groot, Peter

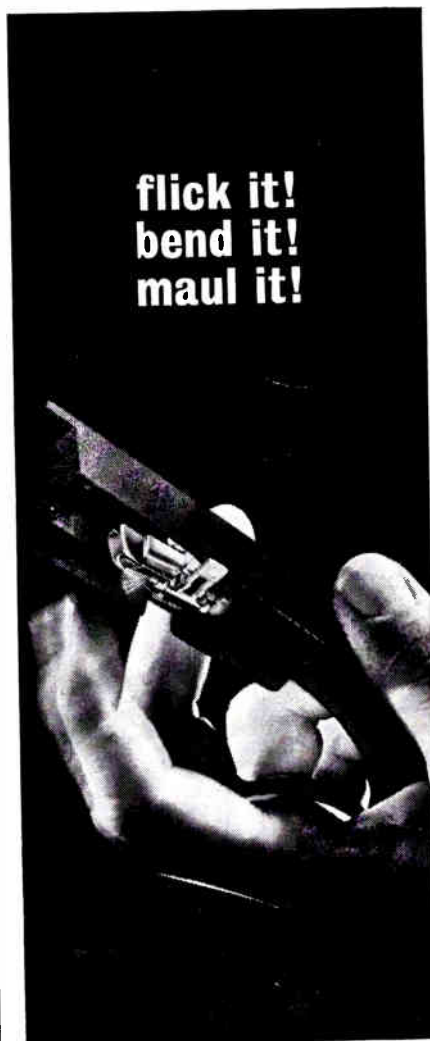

flick it!
bend it!
maul it!

it still provides superb performance

The new Sono-Flex® needle incorporated in the Velocitone Mark III and other Sonotone cartridges brings new pleasure to music lovers. Not only does it overcome the problem of broken needle shanks, but it increases music listening pleasure by providing higher compliance, wider and flatter frequency response, lower distortion, less needle and record wear.

Make sure the next cartridge you buy is the Sonotone Velocitone Mark III with Sono-Flex needle. And, if you're one of 14 million phonograph owners with a phonograph equipped with a Sonotone cartridge, replace your current needle with a Sono-Flex. You'll notice a marked improvement in performance. Available at all leading hi-fi dealers.

**NEW SONOTONE
SONO-FLEX® NEEDLE**

SONOTONE CORPORATION, ELMSFORD, N. Y.
CIRCLE NO. 64 ON READER SERVICE CARD

NEW
from
MOSLEY
the
**Scotch Master
Switch Plates**
for
Stereo, Hi-Fi & Intercom

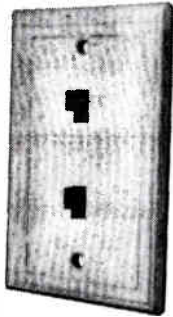
MOSLEY FSSW-2 and FSSW-4

Mosley's New FSSW-2 and FSSW-4 represents an outstanding achievement in central control units for Hi-Fi, Stereo and intercom speaker systems. Low in cost, these new switch plates permit positive selection of up to four combinations of speakers.

"Positive Action" slide switches, "Decor Matching" ivory and brown polystyrene and "Ease of Installation", are just a few of the many outstanding features included in the New "Scotch Master Central Control Switch Plates" at a nominal investment. Comes complete with F-9 mounting brackets.

MOSLEY HAS A COMPLETE LINE OF TV/FM ACCESSORIES DESIGNED AND ENGINEERED TO PROVIDE BETTER TV/FM RECEPTION THROUGH A BETTER INSTALLATION!

FREE  **FREE**

Please send me your catalog containing the complete line of Stereo and TV accessories.

Name

Address

City/State

Mosley
Electronics Inc.

4610 N. Lindbergh Bridgeton Mo.
CIRCLE NO. 52 ON READER SERVICE CARD

Reeves, others; the Frank Horrox Quintet. LONDON 5761 \$4.98.

© **ONE OVER THE EIGHT.** Original London cast recording. Kenneth Williams, Sheila Hancock, Toni Eden, Lance Percival, others; the Frank Horrox Sextet. LONDON 5760 \$4.98.

Interest: Imported musicals
Performance: *Pieces of Eight* best
Recording: Rather sharp

In a commendable hands-across-the-sea gesture, London Records has recently released a group of English original-cast recordings of recent musicals. The three listed above are particularly interesting examples of the changes that have taken place in the post-war English musical stage.

Salad Days, which opened in 1954 and racked up over two thousand performances, is the kind of whimsical fantasy always thought of as being typically British. The recording, which includes generous portions of dialogue connecting the songs, reveals a show that was almost oppressively arch and self-consciously cute, in my opinion. In spite of such attractive pieces as *We Said We Wouldn't Look Back* and *I Sit in the Sun*, there is an amateurish quality about the somewhat infantile situations that is hard to take.

It is doubtful that *Salad Days* would be such a smash again today. The revolt of Britain's angry young librettists and composers has brought about a complete transformation in English musicals. Realistic situations and dialogue and sharply satirical songs are now very much the thing. *Pieces of Eight*, which opened in 1959, and its 1961 successor *One Over the Eight*, are revues that hew closely to the new line. The former is unquestionably better. In song and sketch it takes frequently hilarious potshots at English life, and it is performed by an expert company. The *Buy British* sketch has deservedly become a classic, and there is also a winning and tender piece, *Outdoor Girl*, that tells the sad plight of the streetwalker who must stay indoors. Of special interest is a strangely affecting scene by Harold Pinter that shows his earlier work to be not too different from his more recent efforts (for example, *The Caretaker*).

One Over the Eight tries hard to rework the formula of its predecessor. The sketches have far less bite and point, however, and there is too much of Kenneth Williams, who is also in the earlier show. Of the songs, Lionel Bart's *Send Me* is attractive, in a style just made for Eartha Kitt. S. G.

© **SHE LOVES ME** (Jerry Bock-Sheldon Harnick). Original-cast recording. Barbara Cook, Daniel Massey, Bar-

**DO YOU SAVE YOUR COPIES OF
HiFi/Stereo Review**

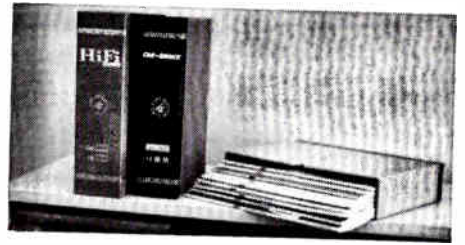

Make sure they're kept neat and always handy for instant reference — with this handsome file that's designed to hold a full year's copies!

- washable Kivar cover creates a leather-like appearance
- available in maroon backing with black sides or black with maroon
- 24-carat solid gold leaf embossed lettering for magazine's name
- attractively priced at only \$2.95 each, 3 for \$8.00, 6 for \$15.00
- files are shipped to you prepaid and are fully guaranteed

NOTE: these special-quantity prices apply for any combination of titles, so you can have them for all your favorite magazines.

Order several today—for all the Ziff-Davis magazines: Popular Photography, Modern Bride, HiFi/Stereo Review, Electronics World, Popular Electronics, Flying, Car and Driver, Popular Boating, Amazing, and Fantastic, and for your other favorite publications, as well.

Jesse Jones Box Corp., Dept. HF Box 5120
Philadelphia 41, Pa.

Please send me: (Fill in title, quantity and check appropriate column for color desired)

MAGAZINE TITLE	QUANTITY	BLACK BACKING/MAROON SIDES	MAROON BACKING/BLACK SIDES
HF/SR	_____	_____	_____
_____	_____	_____	_____
_____	_____	_____	_____
_____	_____	_____	_____

\$2.95 each, 3 for \$8.00 or 6 for \$15.00 — shipped prepaid — fully guaranteed

Total amount enclosed _____

Name _____

Address _____

City _____ Zone _____ State _____

bara Baxley, Jack Cassidy, Ludwig Donath, Nathaniel Frey, others; orchestra, Harold Hastings cond. MGM SE 4118 OC2 two 12-inch discs \$7.95, E 4118 OC2* \$6.95.

Interest: **Appealing Broadway score**
 Performance: **Fine company**
 Recording: **Satisfactory**
 Stereo Quality: **All right**

Old-world charm is served up here in a generous two-record set that apparently includes every note of music written for the score. Composer Jerry Bock and lyricist Sheldon Harnick, two of the brightest talents in the theater today, have turned their attention away from New York politics and corruption, the themes of *Fiorello!* and *Tenderloin*, to operetta-world Budapest, in which songs are woven around the privations to be endured when one tries to stop eating candy, and the joy of being offered ice cream by a beau. This team has wisely kept its music melodic and its lyrics simple, and, thanks to Don Walker's atmospheric arrangements, much of the flavor comes through well.

On the debit side, the songs all seem to have a story function, and are thus less interesting when removed from their theatrical context. And there is a disturbingly imitative, even anachronistic air about a few of the pieces. *Ilona* sounds like second-rate Cole Porter, and *Grand Knowing You* is straight from the Thirties' Harry Richman. But *Dear Friend* is a lovely ballad, *Days Gone By* a gentle nostalgic waltz, and *Ice Cream* a dainty, charming bit that builds in intensity as the singer realizes she is falling in love with someone she had not liked before.

Barbara Cook, who apparently can do no wrong, is wonderfully persuasive, and the rest of the cast, including Daniel Massey, Barbara Baxley, and Jack Cassidy, could scarcely be improved upon. MGM's sound leaves something to be desired, and stereo could have been put to better use. But the manufacturer does deserve all credit for making sure that a complete original-cast album is really complete. S. G.

③ ④ **TOVARICH** (Lee Pockriss-Anne Crosswell). Original-cast recording. Vivien Leigh, Jean Pierre Aumont, Louise Troy, Louise Kirtland, George S. Irving, Margery Gray, Byron Mitchell; orchestra and chorus, Stanley Lebowsky cond. CAPITOL STAO 1940 \$5.98, TAO 1940* \$4.98.

Interest: **Eclectic score**
 Performance: **Acceptable**
 Recording: **Fine**
 Stereo Quality: **High**

The score that Lee Pockriss and Anne Crosswell created for *Tovarich* seems to



If you're willing to pay anything for professional quality.....but would rather not

The Concertone 605 is for the one man in several who can't stand less than perfection...but can't see why professional quality should cost so much. Never before have so many features and so much professional quality been available at this price. Read ahead carefully and see: Precision plug-in head assembly...includes four precision heads; Separate microphone and line controls (input can be mixed); Delay memory control circuit (never spill or break tape); Automatic glass tape lifters, including electric cue feature; Sound on sound and add sound; Solenoid operated brakes; Three motors, including 2-speed hysteresis synchronous drive; Automatic rewind; Exclusive Reverse-O-Matic®. Learn all about the 605 in complete detail. Ask your dealer for a demonstration or send for free literature today.



CONCERTONE 607

Broadcast version

The Concertone 607 with higher impedance is for the true professional or broadcaster. Remote control optional. This superb tape recorder is constructed to 19" x 14" dimensions, permitting it to be used as an exact replacement for old or outdated tape recorders.

CONCERTONE 400 COSMOPOLITAN

For people on the go...it's the Cosmopolitan - Combination Tape Recorder with AM Radio. A versatile companion and co-worker for business or pleasure travels. 5" reel capacity. Push-button operation. Amazing fidelity. Remote mike. Foot-pedal control. This all-transistorized recorder has big recorder features in miniature form.

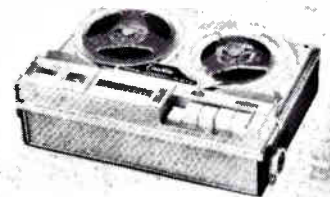

for further information write:



AMERICAN CONCERTONE, INC.
 A DIVISION OF ASTRO-SCIENCE CORP.
 9449 W. JEFFERSON BLVD. • CULVER CITY • CALIF.

Export: J. D. Marshall International, 170 W. Washington, Chicago, Illinois

FREE!

LAFAYETTE RADIO ELECTRONICS



1964 Catalog No. 640

422 Giant-Size Pages

LAFAYETTE
"World's Hi-Fi Shopping Center"
GIVES YOU MORE IN '64

MORE STEREO HI-FI • MORE TAPE RECORDERS
• MORE C.B. • MORE TOOLS • MORE TEST
EQUIPMENT • MORE HAM GEAR • MORE
BOOKS • MORE RADIO & T.V. ACCESSORIES

MORE BUYING POWER—choose from Lafayette's
three Easy-Pay Credit Plans. NO MONEY DOWN,
up to 24 months to pay, as little as \$5 a
month.

Mail the coupon below for your FREE 1964
Lafayette catalog.

LAFAYETTE PROFESSIONAL 4-TRACK RECORD/PLAYBACK STEREO TAPE DECK

99.50

No Money Down
\$5 Monthly
Mikes and Case
Optional



RK-140K Imported

- Plays 2-Track, 4-Track Stereo; 2-Track, 4-Track, Full-Track Mono
- Records 4-Track Stereo or Mono from FM, AM, FM MPX, Radio or Phono; Live from Mikes
- Complete with 4 Connecting Cables, 7" Take-up Reel

LAFAYETTE 4-TRACK STEREO TAPE RECORDER

129.50

No Money
Down

\$7 Monthly



RK-600WX Imported

- Plays 2-Track, 4-Track Stereo; 2-Track, Full-Track Mono
- Records 4-Track Stereo and Mono
- Complete with 2 Mikes, Patch Cords, 7" Take-up Reel, Built-in Record and Playback Preamps

LAFAYETTE RADIO ELECTRONICS

Dept. HMJ-3 P.O. Box 10
Syosset, L. I., N. Y. 11791

- Rush my FREE 1964 Lafayette Catalog 640
- Send me Stock No. shipping charges collect. \$..... enclosed.
- I would like to order Stock No. on the Easy-Pay Credit Plan.

Name.....

Address.....

City.....Zone.....State.....

CIRCLE NO. 46 ON READER SERVICE CARD

have been written on three levels. The story is of Russian nobility living in Paris during the late Twenties, and the team ably caught the sad-gay quality of the self-pitying emigrés in such pieces as the rousing *Nitchevo* and the ironic *It Used to Be*, in which Communist life is amusingly contrasted with life in Czarist Russia. I assume that the haunting *I Know the Feeling* was also intended to have a brooding Slavic flavor, though in orchestration and mood it seems closer to Kurt Weill.

On a second level, the writers have had some fun in satirizing the songs of the Twenties. *Wilkes-Barre, Pa.*, which gives Miss Leigh the opportunity to do her celebrated Charleston, is full of the old ragtime razz-ma-tazz as it enumerates the virtues of a rather unlikely metropolis. *Stuck with Each Other* and *Uh-Oh* aim with less success at a different vogue of the period: the insipid vocal duets by musical-comedy juveniles.

The third level, of course, is the commercial Broadway product that producers hope will go on to a life of its own when the show is a memory. The effervescent *All for You* and the tender *The Only One* are appealing pieces that may do well on the East Side supper-club circuit.

Miss Leigh tries a Marlene Dietrich baritone with fair success, and Mr. Aumont oozes Maurice Chevalier charm with slightly better results. Two of the smaller parts are well sung by Michael Kermoyan and Gene Varrone.

Capitol's sound is quite good, and imaginative stereo placement contributes to the dramatic illusion. S. G.

FOLK

◎ THE BALLAD OF ROBIN HOOD.

Anthony Quayle (reader and singer);
Desmond Dupré (lute). CAEDMON TC
1177 \$5.95.

Interest: Ballads of Merrie England
Performance: Impeccable
Recording: Good

If tales of the exploits of Robin Hood and his merry men still make your spine tingle, here is a record made for you. Quayle proves conclusively that he can sing with as much precision and persuasion as he acts, and he performs these ballads about the drinking habits, lusty adventures, and tender sentiments of England's hero as though his career depended on it. Yet as ballad followed ballad in chronological sequence, as Friar Tuck was quoted now and again in quaint rhyme, as Quayle intoned flawlessly, and as Desmond Dupré's lute twanged, I found myself fighting a yawn. But then, I have secretly suspected for some time, as has Mel Brooks' two-thousand-year-old man, that "the bold, feck-

less hero of the merry greenwood" didn't rob from the rich to give to the poor at all, but "robbed from them both and kept everything." Whether Robin was actually born in Nottinghamshire in 1160 or was really Robert Fitzooth, the outlawed Earl of Huntingdon, as some scholars claim, he will always be a high-handed nuisance to this listener, begging the Earl's pardon. P. K.

◎ DIÁN AND THE GREENBRIAR BOYS. Dián James (vocals), Bob Yellin (banjo), John Herald (guitar), Ralph Rinzler (mandolin). *Alabama Bound; Tragic Romance; Sweet Willie; If I Were Free*; and nine others. ELEKTRA EKL 7233* \$5.95, EKL 233 \$4.98.

Interest: Citified Bluegrass
Performance: Dián needs seasoning
Recording: Excellent

The Greenbriar Boys have already proved on their Vanguard album (9104) that city-billies can sound reasonably convincing in Bluegrass if they have appropriately pungent musical temperaments. On this recording, they again succeed in adapting Bluegrass to their expressive needs, while yet remaining close to the essence of their originals.

The Bluegrass flavor is somewhat diluted, however, by the presence of Dián James, an actress and television singer. Miss James has a vibrant, interestingly textured voice, and she performs with spirit. But she is not yet at ease in the Bluegrass idiom. In ensemble passages with the Greenbriar Boys she does approximate the lonesome sound and dying-fall phrasing characteristic of Bluegrass. But in her solos, she is self-conscious, particularly when she tries to "swagger," as in *Giving Everything Away* and *Brown's Ferry Blues*. On the softer, more introspective tunes, Miss James sounds studied, but she is considerably closer to the Bluegrass spirit. N. H.

◎ CURTIS JONES: *Trouble Blues*.

Curtis Jones (vocals and piano), Johnny "Moose John" Walker (guitar), Robert Banks (organ), Leonard Gaskin (bass), Belton Evans (drums). *Lonesome Bedroom Blues; Trouble Blues; Low Down Worried Blues; Fool Blues; Whole Lot o' Talk for You; Suicide Blues; Weekend Blues; Love Season*; and three others. PRESTIGE/BLUESVILLE 1022 \$4.98.

Interest: A life of blues
Performance: Haunting
Recording: Good

Curtis Jones, never a bluesman of wide renown in this country, was fifty-six before he recorded this, his first album under his own name. In Europe, however, (Continued on page 138)

OVER 2000 COMPONENTS...

Amplifiers
Phono Equipment
Tuners
Tape Machines
Speakers & Cabinets
Accessories

... are covered
in the 1964
edition of the

STEREO/HI-FI DIRECTORY

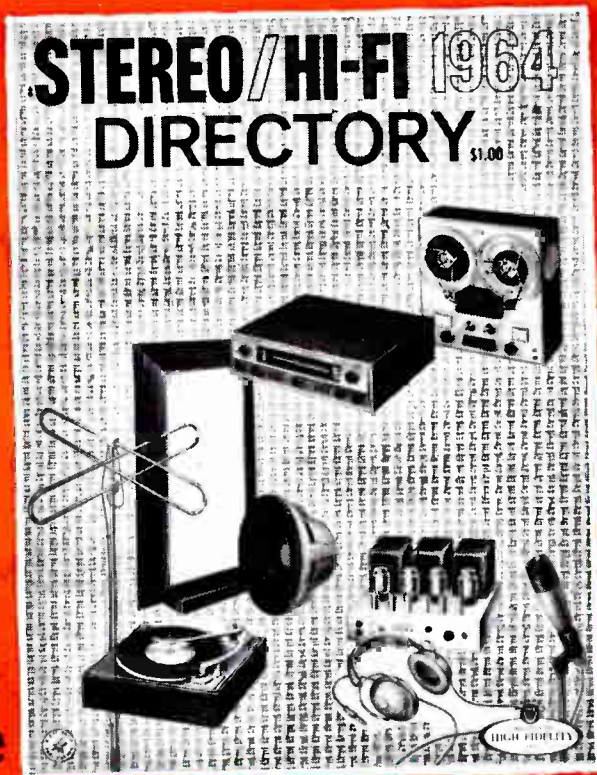

It's the world's most comprehensive **BUYERS' GUIDE** to the hi-fi market. Everything you need in sound is featured in the 180 product-packed pages of the 1964 **STEREO/HI-FI DIRECTORY**. It gives you the vital statistics—photos, prices, and performance data—on over 2000 components from 177 different manufacturers. It's the best way to see and compare speakers, enclosures, cartridges, changers, amplifiers, tone arms, FM tuners, tape recorders and FM antennas *before* you buy.

Plus you get these special features:

- How to select an FM tuner
- Tips on buying Tape Recorders
- Complete listing of all FM Stereo Multiplex Stations broadcasting in the U.S. and Canada (as of September 1963).

- Complete listing of all Hi-Fi dealers throughout the United States.

The 1964 **STEREO/HI-FI DIRECTORY** is your indispensable guide to the total-sound market. It goes on sale October 1st at your favorite newsstand or hi-fi dealer's. Or fill in this coupon and we'll send you a copy.

Price only \$1.00

Ziff-Davis Service Division Dept. SD
589 Broadway, New York 12, New York

Please send me a copy of the 1964 **STEREO/HI-FI DIRECTORY**. I enclose \$1.00, the cost of the **DIRECTORY** plus 10¢ to cover mailing and handling charges. (Canada & Overseas: \$1.25 plus 20¢ postage.)

NAME _____

ADDRESS _____

CITY _____ ZONE _____ STATE _____

(Add 4% sales tax if N.Y.C. resident)

HF-103

50th Anniversary Announcement

**NOW - Pay the
SAME PRICE for an **AF**
AUDIO FIDELITY[®]
STEREO LP as for MONO!**

■ It is a known fact that production costs for stereo have recently begun to approximate those of mono recording. Therefore, Audio Fidelity Records (producers of the first commercial stereophonic record) once again take the lead in announcing this price benefit to the consumer.

At the same time, DAUNTLESS mono LPs now selling at \$3.98 (list) will be equalized with stereo LPs at \$4.98 (list) beginning October 1, 1963!

BUY DAUNTLESS MONO NOW AND SAVE BEFORE THE INCREASE!

NEW AUDIO FIDELITY & DAUNTLESS RELEASES!



MUSIC OF CLEOPATRA AND THE NILE...
Melodious magic as Cleopatra used it to enrapture Caesar and Mark Antony! Provocative! Historic! Love songs and dances of the fabulous queen recreated.
AFLP 2115-AFSD 6115

A GIFTED FOLK TRIO...
Tip & Tinker and Charlie Scott sing:
MOANIN' N' GROANIN',
Mean Muddy River,
Ghost Riders In The Sky, others.
AFLP 2110-AFSD 6110



A JAZZ ORIGINAL... SUNDAY AFTERNOON WITH BABS GONZALES at Small's Paradise. "He (Babs) is one of the truly original spirits in jazz..." RALPH GLEASON, San Francisco
Chronical
DM 4311-DS 6311



A GREAT GOSPEL GROUP
...New excitement in gospel! **THE GOSPEL TRUTH**
The **GALILEANS** sing:
Build Me Up; Glory, Glory; Stay There, others.
DM 4310-DS 6310



New manufacturer's suggested list price:
Audio Fidelity & Dountless Records (MONO & STEREO)—\$4.98

Available at your record shop, OR WRITE TO:
AUDIO FIDELITY, INC.
770 Eleventh Ave., New York 19, N.Y.
SEND FOR NEW FREE CATALOG

CIRCLE NO. 14 ON READER SERVICE CARD
138

he has many admirers among blues aficionados, and he is gradually being recognized here for his ability to underscore the loneliness of the city. Although his voice is not immediately arresting in power and texture, his slightly acrid, alternately plaintive and wry sound stays long in the mind.

Jones' repertoire on this album has little variety in subject matter—the tales are mostly of absent love and present emptiness. Yet Jones, who was born in Texas and was a wanderer for many years before settling in Chicago, does create an enveloping mood. His accompaniment is generally competent, and organist Robert Banks is more than that—he is skillful at getting the organ to "speak" as a singer would, and draws a singularly pungent sound from his instrument, most intriguingly in his solo on *Trouble Blues*. The album, in sum, is an authentic autobiographical document of urban rootlessness.
N. H.

© **SÁNDOR LAKATOS ENSEMBLE OF BUDAPEST: *The Gypsies Are Singing.*** István Csongor, Jolán Boros, Károly Solti, Mária Pataki, László Szalay, Sári Vörös, Károly Kis, Erzi Zala-Tóth (vocals); Sándor Lakatos Ensemble (instrumentals). *Bujdosik a kedves rózsám; Eresz alatt fecskéfszék; Valamikor néked vittem;* and twenty others. WESTMINSTER WST 17022 \$5.98, XWN 19022 \$4.98.

Interest: Hungarian gypsy music
Performance: Sweeping
Recording: Clear and warm
Stereo Quality: Good

Recorded in Budapest in 1961, these eight gypsy singers, accompanied by the Sándor Lakatos Ensemble of Budapest, sound as if they have more classical training than is usually characteristic of the more spontaneous gypsy singers one usually finds on records. But they all share the unabashedly romantic temperament required for the alternating wild abandon and brooding introspection of gypsy music. They are also skilled at maintaining the undulating rhythms of this swirling idiom. The instrumental group is authentic in texture and phrasing, but seems rather subdued by contrast with less discreet gypsy ensembles, who can improvise with much bolder passion. The enjoyment of the album is considerably lessened by Westminster's failure to provide translations or paraphrases of the lyrics.
N. H.

© **EWAN MAC COLL: *Street Songs of Scotland.*** Ewan MacColl (vocals), Alf Edwards (concertina). *The Brewer's Daughter; The Butcher Boy; The Banks of Sweet Dundee; Come All Ye Tramps and Hawkers;* and eleven others. WASHINGTON VM 738 \$4.98.

Interest: Scottish social history
Performance: Knowledgeable
Recording: Good

Like A. L. Lloyd's instructive "Street Songs of England" on Washington 737, Ewan MacColl's collections of Scottish broadsides, ballads, and children's tunes was first released in small quantity on the Riverside label some six or seven years ago. And like Lloyd, MacColl is able to reanimate this material and to do it without pedantry or self-conscious folksiness. In addition, MacColl's playing of the diverse roles required by the songs is often more convincing than Lloyd's. MacColl is also impressive in technique. He sings without accompaniment on eight of the fifteen tracks, shaping and freshening the rhythmic lines of these



EWAN MAC COLL

Broadsides and ballads with a fresh rasp

stories with expert ease. As befits this material, his voice, although disciplined, has the bite and rasp that must have marked the work of the wandering street-singers themselves.

The pieces provide a patchwork of Scottish social history: among them are beggars' songs, murder tales, laments of those about to be exiled, and descriptions of the various obstacles to love's consummation. Among MacColl's most impressive accomplishments is his version of the contemptuous *MacPherson's Lament*, a gallows farewell which is just as defiant as that of the American Sam Hall under similar circumstances.
N. H.

© **JUAN SERRANO: *Flamenco Fenomeno.*** Juan Serrano (guitar). *Amina; Alma; Rhumba; Flamenco Impressions of New York;* and six others. ELEKTRA EKL 7235* \$5.95, EKL 235 \$4.98.

Interest: Not up to his debut
Performance: Technically brilliant
Recording: Superior

Juan Serrano's first Elektra album (EKL 227) was an uncommonly mesmeric dis-

play of flamenco skills. His second set is not in every instance on the same level. The opening *Flamenco Variations on Autumn Leaves* is an unnecessary commercial concession, and is particularly out of place for an artist of Serrano's capacity. The remainder of the program combines latin tunes from various sources with traditional flamenco forms. The flamenco tracks are substantial performances, but do not have the sustained intensity and inventiveness that pervaded Serrano's first album. The final *Flamenco Impressions of New York* is surprisingly inchoate in view of his preoccupation with carefully balanced structure.

Of the Latin American numbers, *Memories of Peru* is an especially tender theme, and is played with luminous delicacy. The others are agreeable but not strikingly memorable. Throughout, Serrano reinforces the impression his first album gave, that of controlled and flexible craftsmanship. This time, unfortunately, his emotions do not appear to have been as fully engaged as they were in his recorded debut. N. H.

SPOKEN WORD

RECORDING OF SPECIAL MERIT

Ⓢ JAMES BALDWIN: *Giovanni's Room* (excerpt). James Baldwin (reader). CALLIOPE CAL 11 \$1.95.

Ⓢ WILLIAM STYRON: *Lie Down in Darkness* (excerpt). William Styron (reader). CALLIOPE CAL 12 \$1.95.

Ⓢ BERNARD MALAMUD: *The Magic Barrel* (excerpt). Bernard Malamud (reader). CALLIOPE CAL 13 \$1.95.

Ⓢ PHILIP ROTH: *Letting Go* (excerpt). Philip Roth (reader). CALLIOPE CAL 14 \$1.95.

Interest: Major American authors
Performance: Admirable
Recording: Good

Calliope is an enterprising new company in Boston that may end up supplying the record industry's answer to the paperback book. These four seven-inch, 33 $\frac{1}{3}$ -rpm discs are the first of a series, each of which will offer approximately a quarter-hour of a major American author reading from one of his successful works. The length seems to me ideal, making each listening experience a delight rather than an ordeal.

Baldwin is the best performer of the lot. He has chosen one of the most moving passages from his novel *Giovanni's Room*, and has clearly prepared the reading with a great deal of thought and practice. The episode in which the narrator recalls his friendship with a boy named Joey is a complete story in itself

OCTOBER 1963

Newest from Telex INTEGRAL CHANNEL CONTROL with HEADPHONE STEREO



"HEADPHONE" today spells stereo sales . . . and the "standard" for quality with knowledgeable audiophiles is the fast-selling Telex Stereo-Twin[®].

Now famous Stereo-Twin performance is linked with the most advanced engineering development in the headset field—*Integral Channel Control*. This newest wonder of miniaturization from Telex Stereo Laboratories has moved the stereo controls into the headset itself. No longer is a separate control center required.

With Telex *Integral Channel Control*, each channel is controlled individually by convenient and stylish volume control knobs on each earpiece. Nothing to build, solder or hook up. Just plug into

the stereo set and adjust each channel. It costs less because no separate stereo control center is required.

Another example of profit-building sales appeal from Telex leadership engineering. Stock Telex Hi Fi accessories and capitalize on new INTEGRAL CHANNEL CONTROL.

A Product of Sound Research



TELEX/Acoustic Products

COMMUNICATIONS ACCESSORIES

3054 Excelsior Blvd. • Minneapolis 16, Minn.

CIRCLE NO. 76 ON READER SERVICE CARD

Quick-See Album File



FRONT-VIEW, FLIP-THROUGH SELECTION

Stop stooping, squinting, straining, to find albums stacked on edge. Quick-See units glide in and out of cabinet or wall for fast, simple selection . . . you see the full face of your album without removing it. Ends jacket-bottom wear, too. Installs anywhere in five minutes. Sturdy welded steel and ball-bearing construction, brass finish. Nine models for LP's and tape, hold up to 125 albums . . . available separately or in special cabinet furniture.

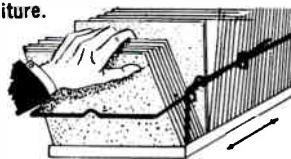

Dealer inquiries invited
KERSTING MFG. CO.
504-R S. Date, Alhambra, California

CIRCLE NO. 43 ON READER SERVICE CARD

HI-FI BUYERS!

Want to
Save yourself
a sack of
money?



SEND US YOUR LIST OF
COMPONENTS FOR AN
UNBELIEVABLE QUOTATION
THAT CAN NOT & WILL NOT
BE BEAT. WRITE TODAY!

Send for our discount catalog, too.

KEY ELECTRONICS CO., INC.
518 E. 95 St., B'klyn 12, N.Y.

Phone: Dickens 6-4191

CIRCLE NO. 44 ON READER SERVICE CARD

INDOORability



Mirandette's AC power conserves its batteries when you record party fun, tape language studies, dictate letters and reports, or synchronize sound for home movies. Can be used as a public address system.

OUTDOORability



Whither thou goest, Mirandette goes too . . . up mountains, down caves, on sail boat or sale call. All on four standard batteries. Interference free . . . use in car, train, etc.

PORTability

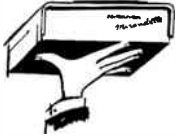

Mirandette plays all the angles. On shoulder or desk, speed remains constant. Measures a mere 9 1/4" x 8 1/4" x 3". All-transistorized circuitry keeps weight under 7 lbs.

ENJOYability



Push button ease, fast forward and rewind, recording level indicator, 3/4" and 1/4" ips, capstan drive for playing prerecorded tapes, 2 1/4" x 4" speaker, external speaker jack.



At CAMERA, Dept. stores & Audio Dealers. Under \$165.00,* including dynamic microphone with remote controls, 3" extra-play tape, takeup reel, AC cord, carrying strap. 1 YEAR GUARANTEE! Other accessories available.

Oh that
Miranda®

MIRANDETTE

ALLIED IMPEX CORPORATION
300 PARK AVENUE SOUTH, NEW YORK 10, N. Y.
CHICAGO 45, ILL. • DALLAS 7, TEX. • LOS ANGELES 16, CALIF.
*See Your Dealer For Exact Price © Reg. By Allied ImpeX Corp., Excl. U. S. Importer
CIRCLE NO. 4 ON READER SERVICE CARD

140

—the listener does not have to puzzle over the identities of the characters, or "what has happened so far." Baldwin's reading is impressive and eloquent, particularly in his use of beats of silence and the quiet elegance of his voice.

Styron, who has a strong, resonant voice not marred by the expected regional mannerisms, is not as fortunate as Baldwin in his choice of a passage. The encounter, from *Lie Down in Darkness*, of the retarded child Maudie with a workman named Bennie, as recalled by her mother, will mean little to those who have not read the book. What does come through superbly is Styron's power of description, his ability to evoke a location and atmosphere. A few minutes of listening will confirm the fact that Styron is a first-rate talent.

Bernard Malamud's short story *The Mourners*, from his book *The Magic Barrel*, starts out sounding like just one more sordid slice of life about an old man in a grubby tenement, but it soon soars far above that level. The vicissitudes of the destitute Kessler and his duel with the landlord, who eventually kneels next to him to pray, are unforgettable. Malamud reads modestly but well.

Old men and a rooming house of another kind are described by Philip Roth in a passage from the "Paul Loves Libby" section of his uneven but shattering novel *Letting Go*. Roth has edited the episode so that it stands well alone, and he is a talented performer. The passage he has chosen details the intrusion of two old men into the lives of the young couple. Paul Herz comes home to his furnished room in Detroit after a factory accident to struggle with, among other things, the decision whether or not to let his pregnant wife go through with an abortion. The seedy team of Levy and Korngold stumble in, seeking help in blackmailing Mr. Korngold's successful son so that he will stop neglecting his father. At this point, Roth suddenly breaks out of his quiet polite tone into the rich and distinctly different accents and intonations of the two old men. He throws a whole new light on the presence of these two figures in the story, and reveals at the same time an unexpected comic gift.

Should authors read their own works aloud? These authors should. P. K.

RECORDING OF SPECIAL MERIT

© STEPHEN VINCENT BENET: *John Brown's Body*. Douglas Campbell, Burt Brinckerhoff, John Colicos, Peter Donat, Sean Garrison, Maxwell Glanville, Jeremiah Morris, Lester Rawlins, Nancy Wickwire (readers); Richard Boone (narrator). George Kleinsinger (music). Joseph K. Chomyn (director). Anti-Defamation League of B'nai B'rith recording \$4.00.

Interest: Epic plea for humanity
Performance: Rousing
Recording: Satisfactory

Back in 1926, Stephen Benet concocted this huge mural-in-words of the Civil War. Seeking to evoke the spirit of America, he chose a documentary style and folksy rhythms—a narrative technique that was later debased by radio and television into a merely portentous tone—and a group of characters who reflected the various morals of his tale: Wingate, the aristocratic Southern soldier; Ace, the runaway slave; Jake Diefer, the farmer from Pennsylvania; Jack Ellyat, the Yankee intellectual; Sally Dupré, who mourns the young and fair slaughtered in battle. The epic has its stirring and moving moments, and many flawlessly beautiful passages. But even in an extremely competent complete performance, such as the still-available



NANCY WICKWIRE

Topflight in Benet's mural-in-words

Columbia release of some years ago starring Tyrone Power, Judith Anderson, and Raymond Massey, the work shows its defects glaringly: unwieldy length, leaden Robert-Service-able jokes, and a tendency to sink into either pretentious overwriting or doggerel.

All this is by way of leading up to warm congratulations to Harold Flender for his hour-long adaptation, telecast originally by CBS, whose Department of Public Affairs produced the show in cooperation with the Anti-Defamation League of B'nai B'rith. By eliminating the wearying choruses, pruning the narrative passages, directing at a brisk pace, and getting the best out of a topflight cast, Flender and director Joseph Chomyn transformed Benet's sprawling epic into an hour's drama worthy of the Pulitzer Prize the poem won in 1928. Although the unfortunate pieties and solemnities could not be completely purged, the impassioned and elo-

HIFI/STEREO REVIEW

quent denunciation of human slavery and bloodshed that is at the heart of the work dominate this version. The original music by George Kleinsinger adds much to the atmosphere and impact of the performance. The recording quality is not exceptional—it is taken from the TV sound track—but is satisfactory, and perfectly clear. P. K.

● **THE ESTABLISHMENT.** John Bird, Eleanor Bron, John Fortune, and Jeremy Geidt (players). RIVERSIDE RM 850 \$5.98.

Interest: Outspoken satire
Performance: Nimble
Recording: Fair

Perhaps we are getting too accustomed to improvisation and instant theater, perhaps these four nimble clowns have to be seen to be truly loved, or perhaps it is too late to make jokes about Cuba. Whatever the reason, *The Establishment*, written by *Beyond the Fringe's* Peter Cook and this show's foursome, and almost too much of a good thing when seen on stage, is rather too little in this recorded version. Eleanor Bron gets things started in an exhilarating fashion with her perfect parody of Queen Elizabeth offering independence to the City of New York. One of the funniest skits in the show, the (pre-Profumo) take-off on *Advise and Consent* in which the Prime Minister of England learns that his new Foreign Secretary is being blackmailed, comes through funny if a little confusing when not seen. The bits about the wife trying to inform her husband in painfully British fashion that she is pregnant, and the touching colloquy of a self-conscious young London couple trying to get past the talking stage of their blooming affair remain ingratiating. The total effect, however, is slightly wearying, probably because of the form's familiarity. Missing are the bounce and variety of the show, which had visual as well as verbal humor—screens and maps descending, "Prime Ministers" cavorting across the boards—and the air of invincible, irreverent youth that this group exudes in person. P. K.

RECORDING OF SPECIAL MERIT

● **SHERLOCK HOLMES:** *The Adventure of the Speckled Band; The Final Problem.* Basil Rathbone (reader). CAEDMON TC 1172 \$5.95.

Interest: Victorian sleuth tales
Performance: Resourceful
Recording: Good

These period pieces are still delightful, especially when read by Rathbone, who, as everyone knows, is Sherlock Holmes to the nines. *The Adventure of the Speck-*

OCTOBER 1963

ENGINEERING BREAKTHROUGH



ELLIPTICAL STYLUS

EXCLUSIVE with

Ortofon

"SEPPRA-SPECTRUM SOUND"

Now the long acknowledged superior elliptical stylus is a reality, made possible by Ortofon Engineering in conjunction with its diamond supplier. This most drama-

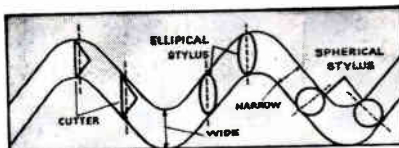

tic design improvement in years minimizes pinch effect, inner groove distortion, bottoming and reduces phase distortion—long major problems of Pick-Up Manufacturers.

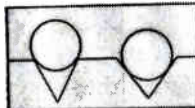

PINCH EFFECT

... occurs when as illustrated in the drawings at left, the cutter, while moving from side to side in plotting a wave form, left a groove of varying width, which literally forces the playback stylus upward at the narrower portion of the groove. Since stereo cartridges have vertical as well as horizontal compliance, this undesirable motion creates an output by the cartridge which manifests itself as "second harmonic distortion."

Since the elliptical stylus essentially has the same shape as the cutter, it traces the actual path made by the cutter with the sides of the record. The playback stylus maintains the same tangential contact with the groove walls as the side of the cutter did while cutting the groove.

This is not true with a spherical stylus, since its tangential angle of contact with the record grooves will vary as illustrated in opening paragraph.

INNER GROOVE DISTORTION

... occurs when the modulations of the record groove are so severe and the angle so acute that a conventional sized spherical stylus cannot maintain continuous contact with both sides of the groove at the correct velocity.

It should be noted that there is just as much recorded information on the innermost groove of a record as there is on the first. In less than 50% of the space!

The elliptical stylus is far better suited to trace these severe modulations than the conventional sized spherical stylus.

BOTTOMING

... This can occur when a record groove is either not perfectly "V" shaped or is too wide for the size stylus used. Distortion is introduced if the stylus tip contacts the bottom of the groove while not maintaining proper contact with the groove walls.



A stylus in proper position in a well cut groove. A stylus out of control because of a rounded and poorly formed groove.

Write for full details and catalog—Dept. HFR-10



ELPA MARKETING INDUSTRIES, INC.
Ortofon Division, New Hyde Park, N.Y.

CIRCLE NO. 30 ON READER SERVICE CARD

SENSATIONAL NEW

Carmen

AVAILABLE OCTOBER 15

Resnik
Del Monaco
Sutherland
Krause
Schipper

Stereo: OSA 1368
Mono: A 4368

Trademarks Reg. U.S. Pat. Off.

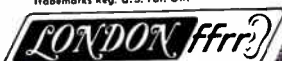

FULL FREQUENCY RANGE RECORDING



Drawing by Bernard Buffet

PURCHASING A HI-FI SYSTEM?

TRADE-INS O.K. TIME PAYMENTS

Up to 2 years to pay!

Send Us
Your List Of
Components
For A
Package
Quotation

**AIREX
WON'T BE
UNDERSOLD**

All merchandise is
brand new, factory
fresh & guaranteed.

Visit our showroom
Free cabinet brochure

AIREX RADIO

CORPORATION

85-MR Cortlandt St., N.Y. 7, WO 4-1820

CIRCLE NO. 3 ON READER SERVICE CARD

Jim Lansing*
Altec Lansing
Electrovoice
Jensen • Leak*
Hartley*
University
Acoustic Research
Janszen
Wharfedale
USL Citizen Band
International Crystals
Gonsel • Hallcraft
Texas Crystals
Concertone • Viking
Bell • G.E.
Weathers
Harman—Kardon
Eico • Pilot
Sherwood*
ESL • Frazier
Superscope
Dual Changer
Bogen • RCA
Dynakit • Fisher
H. H. Scott
KSC Speaker Systems
Finco • ECI
DeWald
Sony • Roberts
Challenger
Browning • National
Garrard • Norelco
Miracord
General Radio
Rek-O-Kut
Polytronics
Tandberg*
Fairchild
Pickering • Sonar
Audio Tape
Magnecord*
Rockford Cabinets
*Fair Traded

led Band is top-drawer Holmes: it concerns a distraught lady, an evil doctor, mysterious deaths, and a fake bell-rope, all these set in the mystery-shrouded atmosphere of a stately country home. This is the very stuff of life for A. Conan Doyle and his hero, who, as Rex Stout points out in his appropriate introduction to the album, images "our aspiration to put our reason in control of our instincts." As read here by the skillful Rathbone, who uses the full gamut of impersonations, whispers, screams, and suspense-creating tricks, the story is blood-curdling and quaintly arresting. On the second side, Mr. Rathbone tells of what was to have been the final struggle between Conan Doyle's hero and Professor Moriarty ("He is the Napoleon of crime, Watson"), a tale that aroused such protests from Holmes readers that the author had to bring his hero back to life. Both stories have undergone considerable but discreet cuts, yet they have survived this fat-trimming in excellent Victorian health. Rathbone should record more of the Holmes stories as soon as he can.

P. K.

© H. P. LOVECRAFT: *Horror Stories*. Roddy McDowall (reader). LIVELY ARTS LA 30003 \$4.98.

Interest: Eldritch horrors
Performance: All stops pulled
Recording: First-rate

H. P. Lovecraft spent his days partly in the offices of *Weird Tales*, eking out a dismal living, and the rest in some dim room carrying on in the tradition of Edgar Allan Poe, composing murky horror stories distinguished by plot ingenuity and, at their best, evocative writing. His devotees deny the kinship to Poe, but it is there, right down to vocabulary—ululation, nepenthe, chamber door—and a fondness for macabre and imprecise description. Two of his best efforts are recorded here: *The Outsider*, about a monster who practically frightened himself to death, and *The Hound*, a pleasant little sojourn among ghouls and graves, which, despite the vagueness of its imagery, is chilling enough that I recommend the suggestible listen to it strictly in broad daylight. Roddy McDowall gets everything there is out of both stories, working himself up each time to a pitch of tremendous excitement. The album notes, by Joe Goldberg on McDowall, and by August Derleth, a writer of hair-raising stories particularly qualified to deal with Lovecraft, are as absorbing as the record itself.

P. K.

RECORDING OF SPECIAL MERIT

© PHILIP ROTH: *Epstein*. Larry Storch (reader). LIVELY ARTS 30005 \$4.98.

Interest: Hard-hitting character study
Performance: Subtle and vivid
Recording: Excellent

Philip Roth, writing fiercely and well, here smashes the sacred stereotype of the kindly Jewish father to reveal a lonely man, sick and agonized. This portrait of *Epstein* hangs in the collection *Goodbye, Columbus*, the deserving winner of the National Book Award for fiction a few years ago. Because his grossness is not concealed, nor his selfishness, nor his lust, old Epstein at first disturbs us, then breaks our hearts, then lives on, long after his fictional death, like a restless ghost. The man, and the hypocrisy and the forces of restraint that surround him like malevolent angels, are powerfully haunting.

The performance will come as a real surprise to those who know Larry Storch only as a comedian. He shows tremendous range in this most exacting assignment, sustaining a full-fledged and complex character not only with humor and tremendous animation, as one might expect, but with real pathos and the subtlest shading as well.

P. K.

© SHAKESPEARE: *Henry V*. Marlowe Dramatic Society: Gary Watson, Dudley Jones, Tony White, Susanne Fuller, Denis McCarthy, Tony Church, Vivienne Chatterton, William Squire. George Rylands, director. LONDON OSA 1415 four 12-inch \$23.92, A 4424 \$19.92.

Interest: Martial pageantry
Performance: Creditable
Recording: Clear and bright
Stereo Quality: Panoramic

"What a wretched and peevish fellow is this King of England," says the Duke of Orleans in the third act of *Henry V*, but it is abundantly evident throughout this sweeping drama that Shakespeare did not think him so. He is drawn as a proper hero, brimful of all the English virtues—a sportsman on the battlefield, a tower of almost supernatural strength in the hour of crisis, a bulwark of honesty who practices *noblesse oblige* with his troops, a man adroit with horses but clumsy (though gawkishly charming) in the presence of women. He plunges into war with France at the drop of an insult. At Harfleur he takes the town by words alone—a poet's dream. After soliloquizing on the unpleasantness of bloodshed, he goes disguised among his soldiers to argue with them the morality of warfare. On the battlefield he is his own general, and after conquering the French, he is openhanded in his terms, sealing the treaty by marrying the French monarch's daughter. In short, he is a model ruler, warrior, and mediator. The play has many speeches deploring the sufferings of

(Continued on page 145)

MOVING?

ATTACH
LABEL
HERE

If you've recently changed your address or plan to in the near future, be sure to notify us at once. Place magazine address label here and print your new address below.

NEW ADDRESS:

NAME _____ PLEASE PRINT

ADDRESS _____

CITY _____ ZONE _____ STATE _____

Please fill in moving date below:

If you have any other questions about your subscription be sure to include your magazine address label when writing us.

Mail to: HiFi/STEREO REVIEW, 434 So. Wabash Avenue, Chicago 5, Illinois



Why We Make the Model 211 Available Now

Although there are many stereo test records on the market today, most critical checks on existing test records have to be made with expensive test equipment.

Realizing this, HiFi/STEREO REVIEW decided to produce a record that allows you to check your stereo rig, accurately and completely, just by listening! A record that would be precise enough for technicians to use in the laboratory—and versatile enough for you to use in your home.

The result: the HiFi/STEREO REVIEW Model 211 Stereo Test Record!

Stereo Checks That Can Be Made With the Model 211

- ✓ Frequency response—a direct check of eighteen sections of the frequency spectrum, from 20 to 20,000 cps.
- ✓ Pickup tracking—the most sensitive tests ever available to the amateur for checking cartridge, stylus, and tone arm.
- ✓ Hum and rumble—foolproof tests that help you evaluate the actual audible levels of rumble and hum in your system.
- ✓ Flutter—a test to check whether your turntable's flutter is low, moderate, or high.
- ✓ Channel balance—two white-noise signals that allow you to match your system's stereo channels for level and tonal characteristics.
- ✓ Separation—an ingenious means of checking the stereo separation at seven different parts of the musical spectrum—from mid-bass to high treble.

ALSO:

- ✓ Stereo Spread
- ✓ Speaker Phasing
- ✓ Channel Identification

PLUS SUPER FIDELITY MUSIC!

The non-test side of this record consists of music recorded directly on the master disc, without going through the usual tape process. It's a superb demonstration of flawless recording technique. A demonstration that will amaze and entertain you and your friends.

OCTOBER 1963

NOW...GET THE FINEST STEREO TEST RECORD ever produced

for just...**\$4.98**

Featuring The Most Spectacular Music
Demonstration On Disc Today

UNIQUE FEATURES OF HiFi/STEREO REVIEW'S MODEL 211 STEREO TEST RECORD

- Warble tones to minimize the distorting effects of room acoustics when making frequency-response checks.
- White-noise signals to allow the stereo channels to be matched in level and in tonal characteristics.
- Four specially designed tests to check distortion in stereo cartridges.
- Open-air recording of moving snare drums to minimize reverberation when checking stereo spread.

All Tests Can Be Made By Ear

HiFi/STEREO REVIEW's Model 211 Stereo Test Record will give you immediate answers to all of the questions you have about your stereo system. It's the most complete test record of its kind—contains the widest range of check-points ever included on one test disc! And you need no expensive test equipment. All checks can be made by ear!

Note to professionals: The Model 211 can be used as a highly efficient design and measurement tool. Recorded levels, frequencies, etc. have been controlled to very close tolerances—affording accurate numerical evaluation when used with test instruments.

DON'T MISS OUT—SUPPLY LIMITED

The Model 211 Stereo Test Record is a disc that has set the new standard for stereo test recording. Due to the overwhelming demand for this record, only a limited number are available thru this magazine. They will be sold by HiFi/STEREO REVIEW on a first come, first serve basis. At the low price of \$4.98, this is a value you won't want to miss. Make sure you fill in and mail the coupon together with your check (\$4.98 per record) today.

FILL IN AND MAIL TODAY!

Stereo Test Record
HiFi/STEREO REVIEW—Dept. SD
One Park Ave., New York 16, N.Y.

Please send me _____ test records at \$4.98 each. My check (or money order) for \$_____ is enclosed. I understand that you will pay the postage and that each record is fully guaranteed. (Add 50¢ to partially defray postage costs outside U.S.A.)

Name _____ (Please Print)

Address _____

City _____ Zone _____ State _____

SORRY—No charges or C.O.D. orders!

HF103

HiFi / STEREO MARKET PLACE

NATIONWIDE DELIVERY...



on all your Stereo needs.
Recorders, Tuners, Amplifiers
Turntables, etc.
LET US PROVE that we can supply your requirements PROMPTLY AT LOWEST COST. FREE CATALOG.

STEREO COMPONENT Supply Co., Dept. S
150 NINTH AVE., NEW YORK 11, N. Y.

WRITE FOR QUOTATION
ON ANY HI-FI COMPONENTS

SOUND REPRODUCTION, INC.

34 New Street, Newark 2, N. J.
Mitchell 2-6816

BRITISH HI-FI COSTS LESS WHEN YOU BUY DIRECT

FROM
C. C. GOODWIN (Sales) Ltd.
The U.K. Hi-Fi Mail Order Specialists

All equipment carefully packed, insured and shipped promptly at minimum cost.
Illustrated catalogue \$1
Send details of Hi-Fi Equipment required to:
DEPT. HS, 7, BROADWAY, WOOD GREEN, LONDON, N. 22, ENGLAND

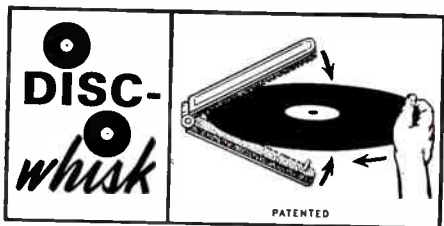

MIRACLE NEW RECORD CLEANER!

FIRST 100% EFFECTIVE CLEANER! Just 5 seconds to clean both sides simultaneously—leave an invisible magic protective film that will actually prevent new dust or lint from clinging.

DISC WHISK is the only known record cleaner which will remove microscopic-size dirt particles from microgrooves... restore original, static-free sound quality! Expensive needles last longer, too!

JUST \$2.00 ppd.

Fits all records to 12"—fully guaranteed. Mail \$2.00 cash, check or money order today for immediate delivery. Corey of California, 930 A Linden Avenue, South San Francisco, California.

LEARN WHILE YOU SLEEP

Headquarters

Experiment in this fascinating, educational new field. Use your phonograph, recorder or amazing new *Electronic Educator* endless tape recorder. We carry a full line of endless repeating tape cartridges for all makes of standard recorders plus automatic timers, pillow speakers and complete outfits. Also over 200 unusual educational and self-help courses on tape and record for sleep-learning and hypnosis experimenters. Write for free 300 items catalog and full astonishing details.

Sleep-Learning Research Association
P. O. Box 24-Y, Olympia, Washington

PROMPT DELIVERY
LOW PRICES

AMPLIFIERS — MULTIPLEX — TAPE RECORDERS, TUNERS — SPEAKER SYSTEMS, ETC.
AIR MAIL QUOTES — COMPARE
WRITE FOR CATALOG

AUDIO DIVISION
L. M. BROWN SALES CORP
Dept. S—242 West 10th Street • New York 14, N. Y.

SAXITONE RECORDING TAPE

*oxide guaranteed not to rub off or squeak—or money back. Compare ours with other "Bargain" tape. You'll find it's more than just "price" when you deal with us. We are original pioneers in the tape recorder business and our reputation means everything to us.

225' MYLAR, 3" (in mallable box)	.39
600' acetate (plastic), 5 inch	.75
800' MYLAR 5 inch reel	.85
900' MYLAR (polyester), 5 inch	.89
1200' MYLAR, 1/2 mil, 5 inch reel	1.18
1200' MYLAR, tensilized, 5 inch	1.59
1200' acetate (plastic), 7 inch	1.15
1200' MYLAR, 1 1/2 mil, (strong)	1.29
1800' acetate (plastic), 7 inch	1.39
1800' MYLAR 1 mil, thick, 7 inch	1.89
2400' MYLAR, untensilized, 7 inch	2.59
2400' MYLAR, tensilized, 7 inch	2.89

(Large Users Even Lower)

SAVE 30%
4-track stereo music on tape (Complete stock) PLUS POSTAGE

NORELCO SPEAKERS
Famous AD3800M, twin cone 8" (75-19,000 cycles) comparable net 0.30 now 4.25 plus postage. OTHER Norelco models at BIG DISCOUNTS. Specifications on entire Norelco line sent on request.

SAXITONE TAPE SALES
div. Commission Electronics, Inc.
1776 Columbia Rd. N.W., Wash. 9, D.C.

SAVE MONEY ON HI-FI COMPONENTS

TAPE RECORDERS
TAPES, ACCESSORIES
SLEEP LEARN KITS

MERITAPE
Low cost, high quality recording tape, in boxes or cans.

FREE 1963 CATALOG

DRESSNER 1523 JERICHO TPKE.
NEW HYDE PARK 21, N.Y.

FISHER COMPONENTS

Our Specialty

Write for lowest quotations on Fisher and other brands.
WHOLESALE—DIRECT FROM WAREHOUSE

BROADWAY HI FIDELITY
3600 Broadway
Kansas City 11, Missouri

WHOLESALE RADIO AND CAMERA CO.

P.O. BOX 3085 PHILA. 50, PENNA.

SAVE \$\$—BUY Direct From Distributor
HUNDREDS OF NAME BRAND PRODUCTS

- HI-FI COMPONENTS
- CAMERAS
- TAPE DECKS
- STEREO COMPONENTS
- TAPE RECORDERS
- PHOTO EQUIPMENT

FREE CATALOG NOW AVAILABLE

Distributor price lists sent upon request.
Special bargain offers included.

FAST SHIPMENTS

COMPONENTS • KITS
RECORDERS • TAPES

- BEST-BY-COMPARISON PRICES
- FACTORY SEALED CARTONS
- SEND FOR "QUOTES" ON PACKAGE DEALS AND SAVE MORE

WRITE FOR MONTHLY SPECIALS
VISIT OUR STORE
CARSTON Studios
125-H East 88 St., New York 28, N. Y.

RENT

STEREO TAPES

- Over 2500 different, 4-track
- No deposit on tapes rented
- Postpaid 2 to 5 day delivery (48 States)

FREE BROCHURE **stereo-parti**
1616-B Terrace Wy, Santa Rosa, Calif.

HiFi/Stereo
Market Place (Cont.)

LOW WAREHOUSE PRICES
WAREHOUSE DIRECT SHIPMENTS

SPECIAL WAREHOUSE PACKAGE DEALS
ALL BRAND NEW COMPONENTS
FRESH FROM WAREHOUSE

GET OUR
STEREO WAREHOUSE
PRICE LIST

WAREHOUSE

228-S Greenway Terrace, River Edge, N.J.

DIXIE

HIGH FIDELITY WHOLESALERS

Largest discount High Fidelity component distributors in the South. Wholesale prices on package or individual components. Latest models in factory sealed cartons. Special attention given to Audio Clubs, Churches and Schools.

Are prices too high?—Write
DIXIE HI-FI

703 Horton Drive, Silver Spring, Md.

Pre-recorded 4 Track Stereo
Tape at Cost through our Special
Membership Plan . . .

Citadel Membership — Proven by thousands of satisfied club members because . . .

- YOU DECIDE ON YOUR PURCHASES — Buy as few or as many tapes as you want.
- FREEDOM OF SELECTION — Virtually any tape, on any label, by any artist is available.
- FREE! COMPLETE TAPE CATALOG — You receive this current catalog of all 4-track stereo tapes.
- PROMPT SERVICE — Many orders are shipped the day received . . . rarely later than the next several days.
- 100% GUARANTEE — All tapes are guaranteed factory fresh and free of defects.

(Special! All LP records also available under your Citadel Tape membership.)

For complete details write . . .

CITADEL TAPE CLUB
division Citadel Record Club
545 Fifth Ave. Dept. ST New York 17, N. Y.



TAPEMATES

Makes available to you:

- ALL 4-Track Tapes
- ALL labels
- POSTPAID to Your Door

At **40%** Savings

FREE BROCHURE | 5280-B West Pico Blvd., Los Angeles 19, Calif.

OCTOBER 1963

war, and subtle near-subversive comments abound in the dialogue, touching upon everything from the destructiveness of combat to the divine right of kings. Yet it remains an argument for wars, for kings, for class distinctions, for the innate superiority of the English—the French are treated with the contempt meted out to Indians in cowboy pictures. Max Beerbohm thought the play “just a dull, incoherent series of speeches, interspersed with alarums and excursions.” Sometimes it is, but is also a marvelously suspenseful pageant, full of unexpected twists and charms, wisdom and humor, not to mention spectacle.

The Marlowe Society has taken special pains with this production, supplying more than the usual effects, music, and breadth of stage illusion through sound. All the parts have been most carefully cast, and the usually anonymous players have been identified—though not, unfortunately, with the role each plays. The minor characters and brief vignettes that lend dramatic contrast to the big scenes are directed and performed with uncommon care. The player of the title role, it must be said, lacks the genius that the part demands, although he is quite capable and, in the major speeches, acceptably eloquent. In the exquisite love scene with the French king's daughter Kate he is a mite too coy. He seems to have taken too much to heart Henry's own Act IV self-judgment, “I think the king is but a man.” Shakespeare thought Henry something of a superman, and even when he is gentle, a gruffness should show through. All the same, the play comes off well here. I was especially happy that Rylands decided against the customary forcing of regional accents on the Welsh and Scottish soldiery. For once, they are understandable even to American ears.

© © SHAKESPEARE: *The Merchant of Venice*. Marlowe Society players; George Rylands (director). LONDON four 12-inch discs OSA 1412 \$23.92, A 4416* \$19.92.

Interest: Controversial Shakespeare
Performance: Excellent
Recording: Clear and sharp
Stereo Quality: Unobtrusive

The controversy over the character of Shylock, certainly an unsavory portrait of the Jew, and even more offensive in an age when so many millions of the Jewish people have been driven from their homes, tortured, and put to death, can easily distort perspective on the play as a whole. Undoubtedly Shylock dominates the play, but it deals with other characters and other themes as well. The play is a startling mixture of intolerance and compassion, of ugliness and gossa-

mer beauty, of coarse laughter and fragile lyricism. It may be disliked, and with some justice, but it cannot be dismissed.

The Marlowe Society, using an anonymous cast as usual, has done a remarkably fine job of committing the complete text to records. The performance never tries to accomplish the impossible—to make the villain of the piece more sympathetic than he is, but the character of Shylock does come through as a powerful and arresting portrait. Portia is extremely lyrical and subtle, if a bit sugary in the early scenes, but this makes all the more effective her transformation into a forceful masculine orator when she shows up at the trial. Jessica is just charming enough, never cloying, and Bassanio is more than equal to the demands of his part. Most effective performer of all is the player of Launcelot Gobbo, Shylock's servant. Alone among the principals, the lisping interpreter of Antonio is ridiculous. And some of the minor characters have the stock-company approach, an unfortunate hallmark of the Marlowe Society tradition. Yet, in all, they do unusually well, and George Rylands' direction, especially his handling of stereo to add dimension to the big scenes, is quite expert.

P. K.

RECORDING OF SPECIAL MERIT

© TREASURY OF NURSERY RHYMES: *Volume One*. Christopher Casson (singer and reader). SPOKEN ARTS 857 \$5.95.

Interest: Grown-up nursery rhymes
Performance: Winning
Recording: Outstanding

I have listened to more nursery rhymes on records than is perhaps good for the stability of a normal adult, and I must confess I approached this latest package with trepidation, if not outright revulsion. Surprise! No child shall wrest this consistently beguiling album from me! Casson, who reads verse in the manner of Edith Sitwell, and sings like an angel, performs dozens of nursery rhymes, and accompanies himself on a Gaelic harp in delightful arrangements that are also his own. The production of the record is particularly noteworthy, giving evidence of much taste, thoughtfulness, and care. Sound effects as well as music are used with intelligence and discretion. There is one moment when they even carry the story, drowning the words in the most realistic gurgling as the three wise men of Gotham sink below the brine in their unseaworthy bowl. You don't have to concern yourself with the psychiatric implications, symbolism, or historical allusions of Mother Goose or the sources of Humpty Dumpty to enjoy this one. Even children should be pleased.

P. K.

HiFi/STEREO SHOPPING CENTER

RATE: 40¢ per word. Minimum 10 words. December Issue closes October 5th. Send order and remittance to: Martin Lincoln, HiFi/STEREO REVIEW, One Park Ave., N.Y.C. 16

EQUIPMENT AND ACCESSORIES

COMPONENTS at lowest prices anywhere. Write for catalog. The Macalester Corporation 355 Macalester Street, St. Paul 5, Minnesota.

COMPONENTS, Recorders! Free wholesale catalogue. Carston, 125-L East 88, N.Y.C. 28.

GREATEST Buys! Electronic Surplus List 10¢. Western Electric Mercury Wetted Relay SPST 5AMP Contacts, only \$2.95 postage paid 2 for \$5. (\$15. value) Fertik's, 9th Tioga, Phila. 40, Pennsylvania.

KIT Experts—Dynaco Specialists—Kits at reasonable prices are our specialty. Also custom wired kits guaranteed to exceed factory standards at substantial savings. Beautiful handcrafted Walnut cases for complete Dynaco line starting \$15.00 each. Plus everything in audio. Kitcraft, 738 Washington Avenue, Brooklyn, New York 11238, MA 2-6946.

LOW, Low quotes: all components and recorders. HiFi, Roslyn 9, Penna.

WRITE for quotation on any Hi Fi components: Sound Reproduction Inc., 34 New St., Newark, N.J. Mitchell 2-6816.

DISGUSTED with "Hi" Hi-Fi Prices? Unusual Discounts On Your High Fidelity Requirements. Write: Key Electronics, 120 Liberty St., New York 6, N.Y. Dickens 6-4191.

FREE Catalog—name brand tubes 65% discount, phono needles 80% or more discount, phono cartridges, picture tubes 75¢ inch, parts, parts kits, silicon and selenium rectifiers, transmitting tubes, 7" T.V. test tube \$6.99, imported batteries, tube testers, etc. Want to swap or sell tube inventory? Send us your offering. Arcturus Electronics Corp. Dept. Z.D. 502-22nd St., Union City, N.J.

SALE Items—tapes—recorders—component quotations. Bayla—Box 131R—Wantagh, N.Y.

MILITARY Discount—Name brands free recording tape and stereo handbook. Include rank and serial number. Electronics International, Box 3066, Charlottesville, Virginia.

BEFORE You Buy Receiving Tubes, Test Equipment, HiFi Components, Kits, Parts, etc. . . . send for your Giant Free Zalytron Current Catalog, featuring Standard Brand Tubes: RCA, GE, Etc.—all Brand New Premium Quality Individually Boxed, One Year Guarantee—all at Biggest Discounts in America! We serve professional servicemen, hobbyists, experimenters, engineers, technicians. Why Pay More? Zalytron Tube Corp., 461 Jericho Turnpike, Mineola, N.Y.

TRANSISTORIZED Products importers catalog, \$1.00 International, CPO 1717, Tokyo, Japan.

CANADIANS—Giant Surplus Bargain Packed Catalogs. Electronics, HiFi, Shortwave, Amateur, Citizens Radio. Rush \$1.00 (refunded). ETCO, Dept. Z, Box 741, Montreal, CANADA.

SAVE dollars on radio, TV-tubes, parts at less than manufacturer's cost. 100% guaranteed. No rebands, pulls. Request Bargain Bulletin. United Radio, 1000-H, Newark, N.J.

HARPSICHOIDS — Clavichords fine European instruments at reasonable prices. Write 3101 Summit Road, San Bruno, California.

Hi-Fi Components, Tape Recorders at guaranteed "We Will Not Be Undersold" prices. All brands in stock. 15-day money back guarantee. 2 year warranty. Write your requirements for quotation. No Catalog. Hi-Fidelity Center 1797-R, 1st Ave., New York 28, N.Y.

WRITE for lowest quotations, components, recorders. No Catalogs. Hi-Fidelity Supply, 2817-TC Third, New York City 55.

DON'T buy any components until you have seen our quotation. Shipments made from stock. C. M. Sales Co., Box 140, Simpsonville, Maryland.

"LISTEN-In-Coil" picks up any telephone conversation in vicinity. No connection to telephone necessary. Easily concealed. \$2.98 complete. Consolidated Acoustics, 1302R Washington St., Hoboken, N.J.

TAPE recorders, Hi-Fi components, Sleep Learning Equipment, tapes. Unusual values. Free catalog. Dressner, 1523HF Jericho Turnpike, New Hyde Park 9, N.Y.

THE Price is Right! Hi-Fi Components. J. Wright Co., 65-B Jensen St., East Brunswick, N.J.

"FM/Q" Metropolitan Broadband Antenna, the finest compact yagi made, completely rustproof, only \$14.95 prepaid. FM Book with station directory 30¢. FM/Q, Wethersfield, Connecticut.

DYNAKITS, 25% off West Coast prices. Shure M3D, \$12.50. Arkey Sales, 22-12 Riverside Ave., Medford 55, Mass.

MAY we give you our quote on your Hi-Fi requirements? You'll be pleasantly surprised that what you had in mind won't cost as much as you thought. We carry all brands in stock. Components are new and fully guaranteed. Ask to be put on our mailing list for special bargains. Crown Electronics Corp., 64 Cortlandt St., New York 7, N. Y. (212) WO 4-0790.

WHY Pay More for components, recorders, tape? Soundcraft tape, new first quality, 1800' Mylar \$1.89, 10/\$18.00, 2400' Mylar \$2.79, 10/\$25.95, 4 track tapes 30% off. Big discounts Concord, Concertone, Wollensak etc., Monarch Stereo Headphones \$11.95, Weathers Synchronic 66 w/walnut base, arm & ADC-1/11 \$105, many other specials. Write for list. S & F Electronics, 7959 Melrose, Los Angeles 46, California.

WANTED

QUICKSILVER, Platinum, Silver, Gold. Ores Analyzed. Free Circular. Mercury Terminal, Norwood, Mass.

TAPE AND TAPE RECORDERS

RENT Stereo Tapes—over 2,500 different—all major labels—free brochure. Stereo Parti, 1616-G Terrace Way, Santa Rosa, California.

SAVE 30% Stereo music on tape. Free bargain catalog/blank tape/recorders/morelco speakers. Saxitone, 1776 Columbia Road, Washington, D.C.

SELF-Hypnosis. New concept teaches you quickly by tape or LP-record. Free literature. McKinley Publishers, Dept. T4, Box 3038, San Bernardino, Calif.

RECORDING tape, top quality by major U. S. manufacturer. 1800 feet, 1 mil, 7 inch reel, \$1.95 each, 10 for \$17.70 postpaid. Moneyback guarantee. Western Magnetics, Box 3722, Portland 8, Oregon.

RECORDING Tapes. Free sample. Mail 25¢ (handling). Towers, Lafayette Hill, Penna.

MYLAR Ampex tape 1½ mil (strong) 7" reel 1200' \$1.49 postpaid. Alamo Discount Barn, 200 Rose Street, Alamogordo, New Mexico.

TAPE Recorder Sale. Latest models, \$10.00 above cost. Arkey Sales, 22-11 Riverside Ave., Medford 55, Mass.

RECORDING tape highest quality 1800' Mylar 7" reel 10 for \$18.50 postpaid. Moneyback guarantee. Lowest quotes: all components, recorders. Pofe Electronics, Box 217, Muncie, Indiana, 47305.

BEFORE renting Stereo Tapes try us. Postpaid both ways—no deposit—immediate delivery. Quality—Dependability—Service—Satisfaction prevail here. If you've been dissatisfied in the past, your initial order will prove that this is no idle boast. Free Catalog. Gold Coast Tape Library, Box 2262, Palm Village Station, Hialeah, Florida.

REPAIRS AND SERVICING

ALL Makes of Hi-Fi Speakers Repaired. Amprite, 168 W. 23 St., N.Y.C. 7. CH 3-4812.

TV Tuners rebuilt and aligned per manufacturers specification. Only \$9.50. Any make UHF or VHF. We ship COD. Ninety day written guarantee. Ship complete with tubes or write for free mailing kit and dealer brochure. JW Electronics, Box 51F, Bloomington, Ind.

TAPE Recorder and HiFi repairs. Amplifiers, tuners, turntables. All American and foreign makes serviced. Estimates in 48 hrs. after receiving equipment from any part of U.S. Macken Electronics, 5 West Post Road, White Plains, N.Y., WH9-9777.

TV Tuners Rebuilt and Aligned to Specifications. Guaranteed All Makes, One Price. \$9.50 Complete. Plus Shipping. Valley Tuners, 5641-E Cahuenga, North Hollywood, California.

Hi-Fi Problems solved by "The Hi-Fi Doctor" on the spot. Audio, Acoustic, Radio Engineer, Professional visits, day, evening. New York area. William Bohn, Plaza 7-8569.

METERS—Multimeters repaired and calibrated. Free estimates—Catalog. Bigelow Electronics, Box 71-G, Bluffton, Ohio.

RECORDS

RARE 78's. State Category. Write Record-Lists, P.O. Box 2122, Riverside, California.

"HARD To Get" records—all speeds. Record Exchange, 812 Seventh Avenue, New York, N.Y.

THE Record Collector Journal—comprehensive, valuable data, varied record mart. Introductory six issues—\$1.50. Record Research, 131 Hart, Brooklyn 6, N.Y.

CASH For Your Unwanted LPs. Reeder, Forshay Rd., Monsey, N.Y.

LP's Like new. Send 25¢ for List. Records, Hillburn, P.O., Hillburn, N.Y.

LP's at discount prices—Free information. Mail Order Record Club, 3506 West 73rd Place, Chicago 29, Illinois.

ADULT Party Record & catalog \$1.00. Pioneer, Box 38-S, Station F, Toledo 10, Ohio.

STEREO LP's \$2.00. Send for free list. Brown, 929-14 Street, Slivis, Illinois.

PATENTS

PATENT Searches, \$6.00! Free "Invention Record"/Information. Miss Hayward, 1029 Vermont, Washington 5, D.C.

BOOKS

AUTHORS' Learn how to have your book published, promoted, distributed. Free booklet "ZD," Vantage, 120 West 31 St., New York 1.

VERY Unusual! The Booklover's Answer, bi-monthly magazine for book connoisseurs. One year \$2.00, sample 40¢. The Booklover's Answer, Webster 7, New York.

WANTED: Short stories, books, articles, plays of all descriptions for sale to publishers, producers. Free Literature! Literary Agent Mead, Dept. 39A, 915 Broadway, N. Y. C. 10.

BOOKS New Out-of-print. Order from Wallace Hill, Books, HiFi Dept. Malvern, Arkansas.

BOOKHUNTING? All subjects searched free! Cambridge Book Service, Box 18K, Cambridge 40, Mass.

HORROR Books—Buy direct! Save 50%! Bargains, discounts! Free literature. The world famous Trans-International Publishing Co., Box 2942, Paterson, New Jersey.

SHOPPING GUIDE CLASSIFIED

A HANDY GUIDE TO PRODUCTS AND SERVICES, NOT NECESSARILY IN THE HIGH FIDELITY FIELD, BUT OF WIDE GENERAL INTEREST.

STAMPS AND COINS

20 Different Commemoratives, 1893 up. 10¢. U.S. Approvals, K&B, Box 70, Brooklyn 23, N.Y.

SMASHING Collection Free—Includes Triangles, Early United States, Rockets, Sports, British Colonies, High Value Pictorials, etc. Complete collection plus big illustrated Magazine all free. Send 10¢ for postage. Gray Stamp Co., Dept. 22, Toronto, Canada.

PHOTOGRAPHY — FILM, EQUIPMENT, SERVICES

SCIENCE Bargains—Request Free Giant Catalog "CJ"—144 pages—Astronomical Telescopes, Microscopes, Lenses, Binoculars, Kits, Parts. War surplus bargains. Edmund Scientific Co., Barrington, New Jersey.

SATISFACTION Guaranteed aircraft transparencies, literature 10¢ deductible. Aeroslides, Richelieu, Quebec, Canada.

GOVERNMENT SURPLUS

GOVERNMENT Surplus Sales Bulletin — "Directory-Procedure"—50¢—INDUSTRIAL, Box 770(A), Hoboken, N.J.

GOVERNMENT surplus direct from Government. Jeeps \$264.00, radios \$2.53, typical prices. Guns, typewriters, cameras, tools, thousands more. Amazing low prices. How, where to purchase, merchandise available, etc., only \$1.00 to: Surplus, P.O. Box 50512, Dept. R, New Orleans 50, Louisiana.

JEeps \$111.68, Boats \$6.18, Airplanes, Electronics Equipment, Typewriters, thousands more, typically at up to 98% savings. Complete information \$1.00. Surplus Service, Box 820, Holland 12, Michigan.

GOVERNMENT Surplus Receivers, Transmitters, Snooperscopes, Parabolic Reflectors, Picture Catalog 10¢. Meshna, Malden 48, Mass.

JEeps — \$111.68, Typewriters — \$4.15, Receivers — \$5.65, Televisions, Recorders, Oscilloscopes, Multimeters. Typical Government Surplus Prices. Exciting Details Free. Enterprises, Box 402-B5, Jamaica 30, New York.

JEeps \$178, Airplanes \$159, Boats \$7.88, generators \$2.68, typewriters \$8.79, are typical government surplus sale prices. Buy 10,001 items wholesale direct. Full details, 607 locations, procedure only \$1.00. Surplus, Box 177-C1, Abbottstown, Penna.

EMPLOYMENT INFORMATION

FOREIGN Employment. Construction, other work projects. Good paying overseas jobs with extras, travel expenses. Write only: Foreign Service Bureau, Dept. D, Bradenton Beach, Fla.

EDUCATIONAL OPPORTUNITIES

LEARN While Asleep, hypnotize with your recorder, phonograph. Astonishing details, sensational catalog free! Sleep-Learning Association, Box 24-ZD, Olympia, Washington.

HIGHLY-effective home study review for FCC commercial phone exams. Free literature! Wallace Cook, Box 10634, Jackson 9, Miss.

LEARN While Asleep. Remarkable, Scientific, 92% Effective. Details Free. ASR Foundation, Box 7021, Dept. e.g., Lexington, Kentucky.

DRAFTING Home Course \$15.00 (Blueprint Reading, Electronic, Mechanical, Architectural, Art). Prior Inc., 23-09 169 Street, Whitestone 57, New York.

BUSINESS OPPORTUNITIES

INVESTIGATE Accidents—Earn \$750 to \$1,000 monthly. Men urgently needed. Car furnished. Business expenses paid. No selling. No college education necessary. Pick own job location. Investigate full time. Or earn \$6.44 hour spare time. Write for Free Literature. No obligation. Universal, CZ-10, 6801 Hillcrest, Dallas 5, Texas.

I MADE \$40,000.00 Year by Mailorder! Helped others make money! Start with \$10.00—Free Proof. Torrey, Box 3566-N, Oklahoma City 6, Oklahoma.

\$100 weekly possible. Compile Mailing lists and address envelopes for advertisers. Home—spare time. Particulars free. National Service, 81 Knickerbocker Station, New York City.

MAKE \$25-\$50 week clipping newspaper items for publishers. Some clippings worth \$5.00 each. Particulars free. National, 81, Knickerbocker Station, New York City.

EARN Money at home sewing or assembling our products. No charge for material to fill store orders. Write: Jiffy Company, Hot Springs 22, Arkansas.

JAPAN, Mail Orders available catalog or information 30¢. Japan Merchandisers, CPO Box 480, Tokyo.

MISCELLANEOUS

HYPNOTIZE Unnoticed, quickly, effortlessly, or refund! Thousands delighted! \$2.00. Minter. Box 244-D, Cedarburg, Wisconsin.

DO YOU Know how prayer works? Send 20¢ for Issue 162 The Prayers of Men... Who Hears... Who Answers? Write: Lemurian Viewpoint, Ramona 6, California.

MORE ENTERTAINMENT REVIEWS IN BRIEF

DATA

⑤ ⑥ **SHLOMO CARLEBACH:** *At the Village Gate.* Shlomo Carlebach (vocals and guitar). *Open the Gates; Have Mercy; Break Through; Song of Life;* and six others. VANGUARD VSD 2133 \$5.95, VRS 9116 \$4.98.

⑤ ⑥ **ARTHUR FIEDLER:** *Our Man in Boston.* Boston Pops Orchestra, Arthur Fiedler cond. *Theme from Exodus; Hey, Look Me Over; Bugler's Holiday;* others. RCA VICTOR LSC 2599 \$5.98, LM 2599* \$4.98.

⑤ ⑥ **SERGIO FRANCHI:** *Our Man from Italy.* Sergio Franchi (tenor); orchestra, Henri René cond. *Arrivederci, Roma; Santa Lucia; Luna Rossa; Dicitencello vuie; Summertime in Venice; Mamma;* and six others. RCA VICTOR LSC 2657 \$5.98, LM 2657* \$4.98.

⑤ ⑥ **KINGSTON TRIO:** *The New Frontier.* Nick Reynolds, Bob Shane, and John Stewart (vocals, banjo, guitar). *Greenback Dollar; Adios Farewell; Long Black Veil; Dogie's Lament;* and eight others. CAPITOL ST 1809 \$4.98, T 1809* \$3.98.

⑤ ⑥ **LAWRENCE OF ARABIA** (Maurice Jarre). Sound-track recording. London Philharmonic Orchestra, Maurice Jarre cond. COLPIX SCP 514 \$5.98, CP 514* \$4.98.

⑤ ⑥ **LIONEL LONG:** *Waltzing Matilda.* Lionel Long (vocals); Noel Gilmour Sextet; the Delltones. *Wallaby Stew; Moreton Bay; Wild Rover No More; Rush Away;* and eight others. CAPITOL ST 1823 \$4.98, T 1823* \$3.98.

⑥ **ART PEPPER:** *The Artistry of Pepper.* Art Pepper (alto saxophone), Bill Perkins (tenor saxophone), Russ Freeman (piano), Shelly Manne and Mel Lewis (drums). *A Foggy Day; Diana Flow; Zenobia;* and six others. PACIFIC JAZZ PJ 60 \$4.98.

⑥ **THE SECOND SHEPHERD'S PLAY.** Joss Ackland, Peter Bayliss, Diarmid Cammell, Robert Stephens, Avril Elgar, Owen Wynne, Patricia Somerset (players). Howard Sackler (director). CAEDMON TC 1032 \$5.95.

COMMENTARY

Shlomo Carlebach, a rabbi and travelling singer, illustrates here the Chassidic traditional worship, which is characterized by emotional spontaneity and bursting exultation. Carlebach sings with zest, but his voice is lacking in color. N. H.

Four movie themes, three show tunes, a program piece by Leroy Anderson, a medley from *Guys and Dolls*, and a medley of television-commercial themes make up the oddly assorted fare here. The selections are colorfully treated, but some seem overblown. The stereo recording is adequate. S. G.

RCA wants to make the flamboyant Franchi into a slimmer and sexier Mario Lanza. He has a big, resonant, but slightly inflexible voice that milks everything from an emotional song. About half of these numbers came from movie sound tracks. The recording lacks bass. S. G.

The Kingston Trio has lost its best member, Dave Guard, has already recorded its best material, and now depends more upon energy than skill for impact. Two unusual songs, Ewan MacColl's tender *The First Time* and Stewart's *New Frontier*, a sincere propaganda piece, spur the heretical thought that "folk" songs can be written and still be good. J. G.

Maurice Jarre is a young French composer whose work here places him in the front rank of film-music creators. His melodic score captures the spell of the desert, and colorfully and hauntingly underlines the film's exciting action. The recording is fine. S. G.

This collection of folk and folk-like songs from Australia is of unusual interest, for it reveals a history that remains largely unfamiliar to Americans. But Long seldom provides intensity and vigor, and the bland vocal and instrumental backing muffles the music's ardor. The sound is good. N. H.

This is a reissue of recordings by alto saxophonist Art Pepper with four different groups. As Pepper showed with Miles Davis' rhythm section, he can be an excellent musician. Here, though, he is generally held back by the almost cata-tonic coolness of his associates. J. G.

The Second Shepherd's Play is an example of the kind of religious pastoral comedy performed in the 1400's in English villages. After a fund of smart talk by comic doltish shepherds, the lot hears that Christ has been born and bursts into poetry, interspersed with bleating sheep, howling winds, and hymn-singing. P. K.

HIFI/STEREO REVIEW ADVERTISERS' INDEX

READER SERVICE NO.	ADVERTISER	PAGE NO.	READER SERVICE NO.	ADVERTISER	PAGE NO.
1	Acoustech, Inc.	111	42	Kenwood Electronics	129
2	Acoustic Research, Inc.	93	43	Kersting Mfg. Co.	139
85	Acoustic Research, Inc.	103	44	Key Electronics Co., Inc.	139
3	Airex Radio Corporation	142	45	Koss Electronics, Inc.	108
4	Allied Impex Corporation	140	46	Lafayette Radio Electronics	136
5	Allied Radio	67, 68	47	Lansing Sound, Inc., James B.	105
6	Altec Lansing Corporation	130	17	Lear Siegler, Inc.	99
7	American Concertone, Inc.	135	93	Leak & Company, Ltd., H.J.	80
8	American Elite, Inc.	122	48	Lesa of America Corp.	126
9	America Record Society	91		London Records	69, 141
10	Ampex Corporation	125	49	Marantz	34
86	Ampex Tape	124	50	Matsushita Electric Corporation of America	123
11	Angel Records	83	40	Minneapolis-Honeywell (See Honeywell)	114
91	Antronics	110	51	Minnesota Mining & Manufacturing Co.	116
87	Atlantic Records	74	52	Mosley Electronics, Inc.	134
12	Audio Devices, Inc.	115	53	Murray-Carson Corporation	113
13	Audio Dynamics Corporation	100, 101	54	Pickering & Co., Inc.	81
14	Audio Fidelity, Inc.	138	56	RCA Red Seal Magnetic Tape	3rd COVER
15	Audio Unlimited, Inc.	128	55	Rabsons—57th Street, Inc.	126
16	Benjamin Electronic Sound Corp.	95	94	Rek-O-Kut	75
17	Bogen Communications	99	58	Roberts Electronics, Inc.	98
18	British Industries—Garrard	2	59	Rockford Special Furniture Co.	120
	Broadway Hi Fidelity	144	38	Roos/Atkins	94
	Brown Sales Corp., L.M.	144	60	Sanborn's Stereo City	132
19	Burstein-Applebee Co.	120		Saxitone Tape Sales	144
20	Cambridge Records, Inc.	97	61	Scott, Inc., H.H.	2nd COVER, 1
	Carston Studios	144	62	Sherwood Electronic Laboratories, Inc.	6
21	Citadel Record Club	79	63	Shure Brothers, Inc.	19
	Citadel Tape Club	145		Sleep-Learning Research Association	144
22	Columbia Records	64, 65	64	Sonotone Corporation	133
23	Command Records	70, 71		Sound Reproduction, Inc.	144
	Commission Electronics, Inc.	144		Stereo Component Supply Co.	144
27	Contemporary Affairs Society	128		Stereo-Parti	144
	Corey of California	144		Stereo Warehouse	145
88	Crown International	102		Superex	126
24	Deutsche Grammophon	72	65	Superscope, Inc.	8
	Dixie Hi-Fi	145	66	Superscope, Inc.	10
25	Douwe Egberts Royal Factories	15	67	Superscope, Inc.	12
	Dressner	144	68	Superscope, Inc.	14
26	Dynaco, Inc.	90	69	Superscope, Inc.	16
28	EICO Electronic Instr. Co., Inc.	32, 33	70	Superscope, Inc.	20
29	Electro-Voice, Inc.	4th COVER	71	Superscope, Inc.	22
30	Elpa Marketing Industries, Ortofon Division	141	72	Superscope, Inc.	24
93	Ercona Corporation	80	73	Superscope, Inc.	26
31	Finney Company, The	78	74	Superscope, Inc.	28
32	Fisher Radio Corporation	25, 27, 29, 31	75	Superscope, Inc.	30
33	Freeman Electronics Corp.	127		Tapemates Club	145
34	Fuji Photo Optical Products, Inc.	86	76	Telex/Acoustic Products	139
	Goodwin (Sales) Ltd., C.G.	144	77	United Artists Records	102
35	Grado Laboratories, Inc.	82	78	United Audio Products	63
92	Greentree Electronics	92	79	Universal Record Club	5
36	Harman-Kardon, Inc.	76, 77	80	University Loudspeakers	23
37	Heath Company	85	81	Vanguard Records	94
57	Heath Company	87	90	Vernon Audio	73
95	Heath Company	89	82	Viking of Minneapolis, Inc.	121
39	Hi-Fidelity Center	97	83	Webcor, Inc.	119
40	Honeywell Photographic Products	114		Wholesale Radio and Camera Co.	144
89	KLH Research and Development Corporation	21	84	Winegard Antenna Systems	97
41	Kaywoodie Pipes, Inc.	112			

HIFI/STEREO REVIEW PRODUCT INDEX

As an additional reader service, we list below, by classifications, the products advertised in this issue. If there is a specific product you are shopping for, look for its listing and turn to the pages indicated for the advertisements of manufacturers supplying that equipment.

CLASSIFICATION	PAGE NUMBERS
Accessories	67, 68, 120, 134, 139
Amplification Systems	2nd Cover, 1, 29, 31, 32, 33, 34, 67, 68, 87, 90, 111, 120
Antennas, FM	67, 68, 78, 97, 110
Cabinets	120
Cameras	86, 114
Cartridges, Phonograph	19, 67, 68, 81, 120, 133, 141
Headphones	67, 68, 108, 120, 126, 139
Multiplex Adaptors	67, 68, 120
Organ Kits	89
Pipes	94, 112
Portable Phonographs	67, 68, 120
Records	5, 64, 65, 69, 70, 71, 72, 74, 79, 83, 91, 94, 97, 102, 128, 138, 141

CLASSIFICATION	PAGE NUMBERS
Speakers and Speaker Systems	.21, 23, 25, 67, 68, 80, 85, 100, 101, 103, 105, 113, 120, 123, 130, 4th Cover
Tapes, Pre-recorded	124
Tape, Recording	67, 68, 92, 115, 116, 3rd Cover
Tape Recorders and Decks	8, 10, 12, 14, 16, 20, 22, 24, 26, 28, 30, 67, 68, 73, 98, 102, 119, 120, 121, 122, 125, 127, 135, 136, 140
Tobacco	15
Tone Arms	67, 68, 120
Tuners and Tuner-Amplifiers	2nd Cover, 1, 6, 25, 27, 32, 33, 34, 67, 68, 76, 77, 87, 90, 99, 120, 129
Turntables and Changers	2, 21, 63, 67, 68, 75, 82, 93, 95, 120, 126

Be A Pro: Record with the tape used to capture the World's Greatest Artists

A fabulous performance by Perry Como, Van Cliburn, Peter Nero, Harry Belafonte, Artur Schnabel or Arthur Fiedler! In the studio, RCA Victor recording engineers must be sure they can depend on every inch of master recording tape to capture the ultimate in quality of every great performance. That's why they developed RCA Red Seal Mag-

netic Tape for their own use. Now it's available for your use on home equipment.

Quality-control tested for frequency response, distortion, drop-out noise, print through, Red Seal Tape is also mechanically tested for coating thickness, anchorage, layer-to-layer adhesion, aging, cupping, slitting. Every inch has the same

magnetic properties, the same recording-bias characteristic, so you can use these tapes interchangeably anytime!

Try RCA Red Seal Magnetic Tape. If your dealer doesn't have it, he'll be glad to order it for you. But be a pro: stubbornly refuse any substitutes!

 The Most Trusted Name in Sound





The Most Sweeping Change in Speaker System Design... Starts with the New E-V FOUR!

Until now, there have been just two ways to determine the absolute quality of a speaker system: the scientific method, and the artistic approach. But each, by itself, has not proved good enough.

The scientist, with the help of impersonal equipment, charts and graphs, has strived to obtain the finest possible measured results. If the figures were right, then it *had* to sound right, and anyone disagreeing was dismissed as "not objective". But often, two speakers measured substantially the same, yet sounded quite different.

On the other hand, the artistic school of loudspeaker design has depended on the judgement of a handful of experts whose "golden ears" were the final yardstick of perfection. If you didn't agree with the experts, your ear was "uneducated" and not discriminating. But too often the measured response of the expert's system fell woefully short of reasonable performance—proof that even trained listeners can delude themselves when listening to loudspeakers.

Now, with the introduction of the E-V FOUR, Electro-Voice has pioneered a blend of the best features of both measurement methods to lift compact speaker performance to a new level of quality. It wasn't easy. The use of both techniques required extensive facilities, something E-V enjoys in abundance.

For instance, E-V has one of the industry's largest, most completely-equipped laboratories for the study of acoustical performance. Actually, the E-V engineering staff alone is larger than the entire personnel complement of many other speaker firms. In the E-V lab, measurement of speaker performance can be made with uncommon precision. And the interpretation of this data is in the hands of skilled engineers whose full time is devoted to electro-acoustics.

But beyond the development of advanced scientific concepts, E-V embraces the idea that a thorough study of the

subjective response to reproduced sound is essential. E-V speakers must fully meet both engineering and artistic criteria for sound quality. Where we differ from earlier efforts is in greatly increasing the sample of expert listeners who judge the engineering efforts.

To this end, experts in music and sound from coast to coast were invited to judge and criticize the E-V FOUR exhaustively before its design was frozen. Adjustments in response were made on the spot—in the field—to determine the exact characteristics that define superb performance. It was not enough to say that a unit needed "more bass". What kind of bass? How much? At what frequencies? These are some of the more obvious questions that were completely settled by immediate adjustment and direct comparison.

The new E-V FOUR is the final result of this intensive inquiry into the character of reproduced sound. According to widespread critical comment, the E-V FOUR sound is of unusually high calibre. And careful laboratory testing reveals that there are no illusions—the measurements confirm the critics' high opinion of this new system.

Of course, it is one thing to design an outstanding prototype—and something else to produce an acoustic suspension system in quantity at a fair price. It is here that extensive production facilities, combined with creative engineering approaches, guarantee the performance of each E-V FOUR. And these same facilities ensure reasonable value. For instance, the E-V FOUR sells for but \$136.00 with oiled walnut or mahogany finish and just \$122.00 in unfinished birch. Yet, in judging its sound qualities, it was successfully compared with speaker systems costing as much as \$200.00.

We urge you to join in the analysis of E-V FOUR compact speaker performance. Visit your E-V high fidelity showroom and compare, carefully, this new system. We feel certain that you will agree with the engineers and the critics that the new E-V FOUR offers a truly full measure of high fidelity satisfaction.

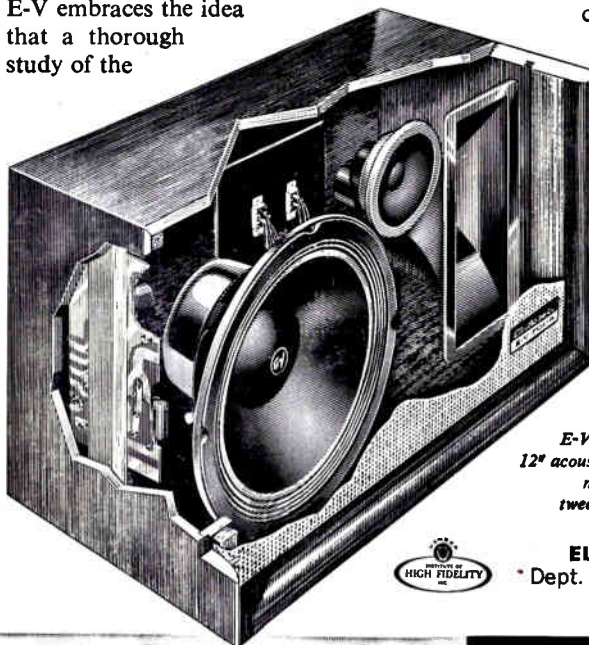

*E-V FOUR components include:
12" acoustic suspension woofer / Ring-diaphragm
mid-range driver / 5" dynamic cone
tweeter / Etched circuit crossover*



ELECTRO-VOICE, INC.
Dept. 1034F, Buchanan, Michigan

CIRCLE NO. 29 ON READER SERVICE CARD



E-V TWO



E-V FOUR



REGINA



E-V SIX

Electro-Voice
SETTING NEW STANDARDS IN SOUND