

serving: recording, broadcast and sound contracting fields

# db MAGAZINE

- Insights on Mastering
- Five Boston Recording Studios
- Lab Report } ART's MultiVerb-EXT
- Hands On
- Audio in the Church
- Learned: In North Africa
- Hot Tips from Barilla;  
and Hoffner, Battles,  
and Bartlett



# Letters

# db

The Editor:

In Len Feldman's review of the Rocktron Hush IICX Noise-Reduction unit, there is a difference between dBv (the way we measure output on this unit) and dBV (which Mr. Feldman apparently used). Further, since all the measurements in the article were quoted in dBV, which measurements were used in the Vital Statistics where the measurements were in dBv, when they should have been in dBV?

Jim Waller  
Rocktron

Len Feldman responds:

Upon further investigation, I have determined that Rocktron is correct. In other words, my AP equipment was set

up to measure dBV (ref: 1V=0 dB). Thus +18 dBV does indeed equal approximately +20 dBv.

The only points of error are in the Vital Statistics chart, where the three references to dBv (lower case v) should have been dBV as Mr. Waller has correctly pointed out.

While the error is ours (mine) I frankly feel that even maximum input level and line output levels as *incorrectly* appearing in the Vital Statistics chart (18 dBv) represent excellent amounts of headroom. After all, 20 dB above 1 volt equals 10 volts, while 20 dB above 0.775 volts RMS equals 7.75 volts. Both numbers are well above what one is likely to feed into this equipment.

Editor/Publisher  
**Larry Zide**

Associate Publisher  
**Elaine Zide**

Senior Editor  
**John Barilla**

Editorial Assistant  
**Edward Lieber**

Contributing Editors  
**Bruce Bartlett**  
**Brian Battles**  
**Drew Daniels**  
**Len Feldman**  
**Robyn Gately**  
**Randy Hoffner**

Graphics & Layout  
**Karen Cohn**

BPA Audit applied for May 1989

Now  
Solve All Your  
Tape Recorder Problems  
Under One Roof

**JRI**  
MAGNETIC SCIENCES

- Head Refurbishing
- Replacement Heads
- Custom Head Assemblies
- MRL Alignment Tape
- Center Track Time Code
- Optical Alignments

**201-579-5773**

Reel  
Tek

- Specializing in Personal Studio Tape Recorders
- Machine Overhaul
- Complete Calibration
- Authorized Fostex/Otari/Teac Service Center
- Technical Assistance

**201-579-7215**

249 Kennedy Rd. • Greendell, NJ 07839 • Fax. (201) 579-6021

2 db September/October 1989

Circle 13 on Reader Service Card

db, The Sound Engineering Magazine (ISSN 0011-7145) is published Bi-monthly by Sagamore Publishing Company Inc. Entire contents copyright 1989 by Sagamore Publishing Company Inc., 203 Commack Road, Suite 1010, Commack, NY 11725. Telephone: (516) 586-6530. db Magazine is published for individuals and firms in professional audio recording, broadcast audio-visual, sound reinforcement-contracting, consultants, video recording, film sound, etc. Application for subscription should be made on the subscription form in the rear of each issue. Subscriptions are \$15.00 per year (\$28.00 per year outside U.S. Possessions, \$16.00 per year in Canada) and payable in U.S. funds. Single copies are \$2.95 each. Editorial, Publishing, and Sales offices are at 203 Commack Road, Suite 1010, Commack, NY 11725. Second Class postage paid at Commack, NY 11725 and an additional mailing office. **Postmaster: Form 3579 should be sent to db Magazine, 203 Commack Road, Suite 1010, Commack, NY 11725.** Trademarked names are editorially used throughout this issue. Rather than place a trademark symbol next to each occurrence, we state that these names are used only in an editorial fashion and to the benefit of the trademark owner, and that there is no intention of trademark infringement.



# DIGITAL PERFECTION



## THE MULTIVERB II

A.R.T. proudly introduces a stunning new version of one of the finest sounding effects processors ever made. The Multiverb II offers four studio quality effects at once, pitch transposing, Performance Mici® and new reverb algorithms that border perfection—with noise and distortion figures dramatically lower than comparable units! The Multiverb II offers more power and performance than anything in its class.

## FEATURES

- Reverb • Delays • Stereo Panning • Chorus
- Flange • Gates • Reverses • Tap Delays • Eq
- Real-Time Performance Midi®
- Up to four top quality effects at once
- Pitch transposing - 2 full octaves
- The finest sounding algorithms available
- 16 bit state-of-the-art digital to analog converters
- 200 memory locations • Full parameter variability
- Rugged internal power supply
- Midi mapping/Midi in/out/thru
- Ultra wide dynamic range • Full stereo in/out
- Software updateable-product never becomes obsolete
- System exclusive codes-edit/store via computer

## THE MULTIVERB EXT

Sampled Perfection! This new super-effector does everything that the Multiverb II does with delay time of two full seconds and studio quality sampling! You can create shimmering layered sounds and sample on the fly using manual or automatic triggering. Besides using four effects at once, you can control everything in real time with Performance Mici®. The EXT provides the amazing reverbs and musical accuracy that A.R.T. is famous for, with the power to create all you can imagine.



APPLIED RESEARCH & TECHNOLOGY INC.  
Circle 14 on Reader Service Card

### Export Distributors:

THE NETHERLANDS/Audio script B.V. Soest:02155-2044/FINLAND/MS-Audiotron/Helsinki/90-5664644. SWEDEN/Musikantor & Co./Molndal:031-878080/France/High Fidelity Services SA/Paris/(1) 42.85.00.40/CANADA/Yorkville Sound LTD/Scarborough:416-751-8481/ITALY/ERATELLI CRASIO/PAVIA/0385 48 029/WEST GERMANY/PNE Audio/RAD FRIEDRICHSHALL/07136-6029/SWITZERLAND/Musikengros P. Gutter/Sissach/061-983757/HONG KONG/Audio Consultants LTD./Kowloon/3-712525/JAPAN/Nihon Electro Harmonic/Tokyo/031232-7601/THAILAND/Beh Ngiep Seng Musical Instruments/Bangkok/222-5281/INDONESIA/PT Kirana Yudha Teknik/Jakarta/3806222/SINGAPORE/Lingier PTE. LTD./7471951/SPAIN/Aplicaciones Electronicas Quasar SA/Madrid/6861 800/TURKEY/Kadri Cadmak/Istanbul/ T. 1661672/DENMARK/M.I. Musik/Kobenhavn/1-854800 U.K./Harmon U.K./Slough/075376911/NEW ZEALAND/Maser Digitek/Auckland/444-3583/4/ISRAEL JAZZ ROCK/Tel Aviv/03-24-9941/ARGENTINA/Lagos Sarmiento/Buenos Aires/40-6455/NORWAY/AUDIOTRON/OSLO/2 35 20 96/TAIWAN/Sea Power Co./TAIPEI/023143113/GREECE/ZEF/PIRAEUS/014170151

Due to an oversight on our parts, Electro-Voice was left out of last issue's Buyers Guide on Microphones. This is the information that should have been there.

**ELECTRO-VOICE, INC. (A MARK IV COMPANY)**

N/D408	dyn	super card	60-18k 3	150 50	4.55 2.85	6.7	blk	XLR	\$249.10	Pivoting instrument mic with special element for wide frequency response and high output.
N/D457	dyn	hyper card	55-18k 3	150 50	7.12 2.05	7	blk	XLR	\$242.20	Hand-held vocal mic with hypercardioid pattern for very high gain before feedback.
N/D757	dyn	super card	50-18k 3	150 50	7.12 2.05	7.7	blk	XLR	\$319.90	Hand-held vocal mic with extended frequency response, switchable low-frequency roll-off filter and special element.
BK-1	cond	card	50-18k 3	150 50	7.5 1.97	12	blk	XLR	\$192.80	Hand-held electret condenser mic offering condenser sound and high performance.
RE45	dyn	card	150-12 3	600 50	11.5 1.87	7.5	blk	XLR	\$405.00	Short shotgun mic designed for hand-held field applications requiring ruggedness and reliability.
N/D						1				
RE20	dyn	card	45-18k 3	150 57	8.5 2.3	26	fawn beige	XLR	\$555.95	Wide response studio mic for demanding recording, reinforcement and broadcast applications.
PL10	dyn	super card	75-15k 3	150 55.8	5.3 1.7	11	gray	XLR	\$298.80	Variable instrument mic for recording and reinforcement applications.
PL80	dyn	super card	60-17k 3	150 56	7.5 2	12	gray	XLR	\$186.00	Hand held vocal mic designed for high gain before feedback, low handling noise, and smooth frequency response.

The following is an E-V Wireless Mic

MS1000	dyn	super card	5-18k	150 50	4.45	10.5	black	\$1368.00	Dual receiver, true diversity using two separate receivers on the front end. The mic head is the N/D757 capsule.
--------	-----	------------	-------	--------	------	------	-------	-----------	--

# Calendar

• **Synergetic Audio Concepts** of Norman, Indiana, announces a series of special three day classes to be held at

the Syn-Aud-Con farm in Southern Indiana. These classes feature the opportunity for gaining direct learning experiences for specific objectives in fundamental audio systems measurement and analysis.

**The Farm in Southern Indiana: September 22-24, and October 5-7.**

New York area (Secaucus, NJ): October 17-18

DC area (Rockville, MD): October 26-27

Orlando, FL: November 15-16

For additional information, call or write:

Synergetic Audio Concepts, RR #1, Box 267, Norman, IN 47264

(812) 995-8212

• **The Sony Professional Audio Training Group** in Fort Lauderdale, Florida has announced its 1989 schedule of technical service training courses and engineering seminars. The program is designed to educate the professional audio industry about changing technology and new products, and is aimed at systems designers and studio engineers, technical service personnel, dealers, end users and engineering instructors and students.

The courses and seminars are held in a fully operational, state-of-the-art facility located in the Sony Professional Products Company in Fort Lauderdale, Florida. Upon request courses can be conducted on-site at recording

studios, video post-production facilities, dealerships, corporations or colleges and universities.

Here are the dates: September 28 to 29—Broadcast Console Applications  
 • October 2 to 6 - Sony MXP-2000 Technical Service  
 • November 7 to 10 - Sony APR-5000 Technical Service  
 • November 13 to 17 - Sony APR-24 Technical Service  
 • December 6 to 8 - Large Console Applications  
 • December 11 to 15 - Sony MXP-3000 Technical Service

For further information contact Raymond Callahan or James Gayoso at (305) 491-0825, Ext. 186.

• **SPARS (The Society of Professional Audio Recording Services)** will host a technical conference and audio work station interface with leading international manufacturers. The event will take place in Chicago, this September 23 and 24. Murray Allen, president of Universal Recording, will chair the events, with SPARS president Bruce Merley, executive director Shirley Kaye, and other SPARS board members in attendance. Manufacturers participating and providing hands-on demonstrations will include, AMS, DAR, Lexicon, New England Digital, SSL, and Waveframe.

All events will take place in the Midland Hotel, 172 West Adams at La Salle, Chicago, Illinois. For further information, please contact: Shirley Kaye, Executive Director, SPARS, 4300 Tenth Avenue North, Suite 2, Lake Worth, Florida 33461. Telephone (407) 641-6648

## ACOUSTIC CONTROL

QUICK SOUND FIELD™  
BY TUBETRAP™



"... for sampling and vocal work, we couldn't ask for anything more."  
—Pete Townsend

QSF™ links talent to the mic with today's most advanced acoustic technology. The Quick Sound Field™ puts more control where you need it.

- Signals so crisp, yet dry, they stay clean through time delay, reverb and digital sampling.
- Instrument and lead solos spring to life in mixdown and sound huge when double-tracked.
- Retrofit kits for any room. Easy to install even between sessions and without costly renovation.

Call our studio design group at  
1-800-ASC-TUBE.

**ASC** ACOUSTIC SCIENCES CORPORATION  
 P.O. Box 1189 Eugene, OR 97440  
 (503) 343-9727

APPLIED ACOUSTICS-RESEARCH, DESIGN & DEVELOPMENT



# THERE'S A BIG IDEA BEHIND OUR NEW PCM-3324A

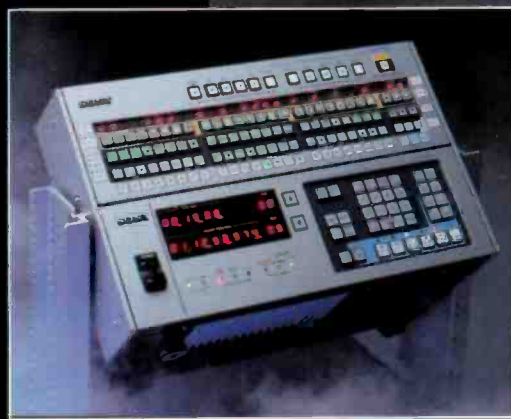

It's the PCM-3348, Sony's 48-channel digital breakthrough. The technology behind our new PCM-3324A.

The PCM-3324A is Sony's second generation DASH 24-channel multitrack recorder, incorporating key technologies developed for the PCM-3348. Like 2X oversampling with digital filters for enhanced sonic performance. Reduced power consumption. And upward compatibility with the PCM-3348.

But as remarkable as the technology of the PCM-3324A and PCM-3348 is, the true beauty of the family of DASH products is that they compliment the way music is made. Tracks laid down on the PCM-3324A play back flawlessly on the PCM-3348. And are undisturbed as the

PCM-3348 adds up to 24 more channels of digital audio to the original recording.

Clearly, the creative possibilities are limitless. To explore them, call your regional Sony Professional Audio office: East: (201) 368-5185. West: (818) 841-8711. South: (615) 883-8140. Central: (312) 773-6001.

# SONY®

PROFESSIONAL AUDIO

Sony Communications Products Company, 1600 Queen Anne Road, Teaneck, NJ 07666. © 1989 Sony Corporation of America. Sony is a registered trademark of Sony.

# Editorial

Many of you may well be seeing this issue for the first time, having picked it up at the New York AES Convention. It's a good introduction to our way of doing things. For example:

The theme of this issue is a visit to the city of Boston. Toward that end, we commissioned Steve Langstaff, who is affiliated with the **Berklee School of Music** in that city. Steve obliged with five studios in or around Boston—**Soundtrack, Editel, Silver Linings, Vizwiz, and Target**. Each offers its own individual personality, business approach, and recording sophistication.

As a sixth Bostonian offering, **Jay Rose's Attic Studio** takes the concept of the *Electronic Cottage* to its full professional flowering.

The cover story, however, takes us to the foremost mastering studio of the east, **Masterdisk**. Senior Editor John Barilla interviewed Masterdisk's Bob Ludwig. I'm sure you will find Bob's history and his comments about the latest mastering technology useful. But be sure to note the final two pages in which Bob tells all of us how to prepare tapes, particularly digital tapes, for mastering.

This issue also introduces a new column, **Audio for the Church**, written by Brent Harshbarger. Brent has installed many sound systems in numerous large and small churches. He will be sharing his special knowledge with us.

Along these lines, read Ed Learned's latest installment, entitled **Sound Reinforcement in North Africa, Part I**. Ed continues to tour the world for the United States Information Agency, and his articles continue to explore the real world of providing superior sound reinforcement under extremes of environmental constraints.

\*

\*

\*

Many of you are aware that **db Magazine** actively participates in a number of conventions and shows. This issue, as already mentioned, is receiving extra distribution at the NY AES Convention. We also exhibit at the two NAMM (National Association of Music Merchants) dealer-only shows (although large numbers of end users do seem to get in). One show, held in January in Anaheim, California, displays and therefore attracts many attendants and exhibits from manufacturers of technology products for recording and sound reinforcement, along with the more traditional musical instruments.

These same exhibitors also go to the Summer Expo that NAMM hosts in June in Chicago, and periodically in other cities as well. For manufacturers of technology-rich products, that summer show has been increasingly frustrating, mostly because of steadily reducing attendance.

At the Expo held this year, petitions were passed around, and actively signed, to do away with the summer shows. These may be misguided in part, since the summer show may well still be needed by the musical instrument people.

It's our theory that NAMM's two basic exhibit factions, *technology* and *traditional instruments* seem to be going in different directions. It seems that the music people need a summer show to sell to dealers for the school year and Christmas selling seasons. The technology people need a winter show to sell into the summer touring season.

These are simplifications, of course. Perhaps the real reason for the problems of the summer show's declining attendance is that dealers simply don't need two shows. The music dealer of today is a far cry from the small musical instrument stores of yesterday. Today's dealer may well still have a guitar department, and even do a brisk business in school-year instrument rentals. But more and more he must also be selling the products of the technology companies—amplifiers, speaker systems, recording systems, synthesizers, and all sorts of MIDI-equipped products. Does this dealer need two shows? The evidence so far seems to lead to the belief that he does not. Further, he prefers to go to the winter show in Anaheim.

In sum, we are not necessarily advocating one show. But it seems clear that for many manufacturers and their dealers, one NAMM show a year is what is needed.

Since NAMM's voting membership is the music retailer, it's going to be interesting to see what will happen in the coming few years. L.Z.



# Incredible stereo. Great imaging. No trade-offs.



Until now, there have been only two choices for stereo microphones.

Mid side and X-Y mics gave good mono compatibility but produced wishy-washy imaging and sacrificed ambience. The second choice, near-coincident pairs, produced sharper imaging at the expense of poor mono compatibility and required awkward stands and field assembled parts.

Either way, low end has been weak and off-axis coloration lurked in the background.

All that has changed with the introduction of Crown's

Stereo Ambient Sampling System™: SASS™. Now, two new choices are available, each with no sacrifice in performance.

SASS-P with switchable battery or phantom power and Crown's best studio grade PZM capsules; or SASS-B to utilize the world standard Bruel & Kjaer 4003 and 4006 studio mics.

Full ambience without coloration, excellent sum to mono and an extraordinarily broad frequency response, SASS offers fantastic imaging with pinpoint

localization for both music and non-music sources.

It's all done within a single, lightweight, Crown-patented frame that is easily adaptable to all common stands and mounts. A cushioned grip is provided for hand-held applications.

On one hand, portability and impressive high end; on the other, ultraquiet response to the lowest audible frequency. Both SASS models have it all.

See your Crown representative. You'll find the new SASS family stands alone as THE choice for stereo. No trade-offs.



**CROWN** INTERNATIONAL, INC.

1718 W. MISHAWAKA ROAD, ELKHART, IN 46517

Circle 17 on Reader Service Card



## **Graham Nash**

**Member, Rock & Roll Hall of Fame**

**Fostex Equipment: E-16 MTR, 4050 MIDI Remote, T-20 Headphones.**

Recent Projects: Graham's recent solo album, "Innocent Eyes" (Atlantic) was recorded in Los Angeles, Hawaii and Massachusetts. Most of the compositions and arrangements were worked out at home on his E-16. The hit "Shadowland" from CSN&Y's latest album, "American Dream" (Atlantic), was recorded on the E-16.

## **TIMBUK3**

**Pat & Barbara K. MacDonald**

**Fostex Equipment: D-20 Digital Master Recorder, E-8 MTR, 4030/4035 Synchronizer / Controller, 4010 SMPTE Time Code Generator, RM-865 and RM-900 Near-Field Reference Monitors, T-20 Headphones.**

Recent Projects: TIMBUK3's first album, "Greetings from TIMBUK3" (I.R.S.), was recorded on a B-16 (forerunner of the E-16). Their third and newest album, "Edge of Allegiance" (I.R.S.), is the first digital project for the group. They use a D-20.

## **Tom Scott**

**Musician/Composer**

**Fostex Equipment: E-16 MTR (2), E-2 Master Recorder, 4030/4035 Synchronizer / Controller, 4010 SMPTE Time Code Generator, T-20 Headphones.**

Recent Projects: Nationally recognized band leader of "The Pat Sajak Show", Tom's latest albums are "Streamlines" and "Flashpoint" (GRP Records). He also scored the NBC TV Movie "American River", and the film "Sea of Love" starring Al Pacino features his distinctive sax.

**FOSTEX PRO**



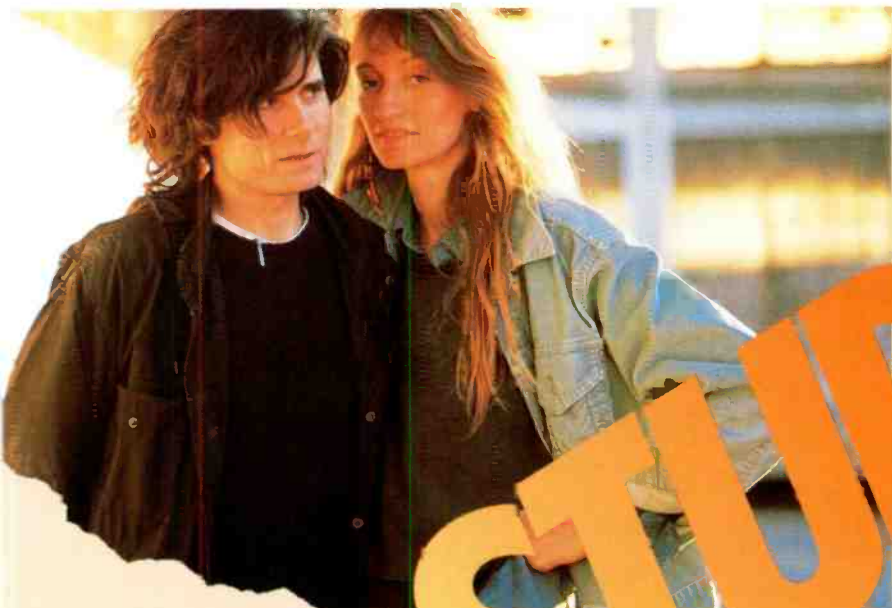

# PROJECT STUDIOS.

Throughout the audio production cycle—from composition/demo to multitrack master to digital stereo master—you'll find Fostex products in use by professional composers, arrangers, engineers and producers. You hear the results of Fostex Project Studios every day on TV, film soundtracks and, of course, radio & records. Trust Fostex for great products at great prices. Trust in yourself for the sound of success.

## Fostex®

© 1989 Fostex Corporation of America  
15431 Blackburn Ave. • Norwalk, CA 90650  
(213) 921-1112 • FAX (213) 802-1964



**Stewart Levin**  
Musician/Composer

**Fostex Equipment:** B-16 MTR, 4030/4035 Synchronizer/Controller, 4010 SMPTE Time Code Generator, T-20 Headphones.

**Recent Projects:** Stewart writes the music for several popular TV shows — "thirtysomething", "The Wonder Years", "The Dick Van Dyke Show '88" — and he scored the feature film "Heathers."

# Insights on Mastering

*The author, db Magazine's Senior Editor, interviews Bob Ludwig and takes us on a visit to Masterdisk Corporation.*

**T**he role of the mastering engineer has undergone a subtle but steady change over the past ten years. The image used to be one of a technical virtuoso whose job was to optimize a master recording for commercial release, and perhaps—more heroically—to resuscitate marginal mixes, thereby saving not just an occasional producer from the wrath of record company executives. As such, the mastering engineer has been accorded a place of great honor in the audio industry. None of this, of course, has diminished in the least.

But a new and exciting dimension has been added to the mastering engineer's role. They have become, as Bob Ludwig puts it, "little producers," participating in the shape of a recording long before it ever arrives at the mastering laboratory. Ludwig, who is currently Chief Engineer and Vice-President of Masterdisk, New York's premier mastering facility, and is sought out daily for his input on a rather conspicuous number of major record releases. Why? Because a sonic consultation with Ludwig seems to be worth its (proverbial) weight in gold—or perhaps even platinum.

Perhaps "sonic consultant" is a better and more descriptive term than "little producer." Ludwig's opinion—and those of his well-trained staff—are much more than remedial afterthoughts. Instead, for major artists at least, these opinions are budgeted in and constantly utilized from the very inception of the project. They have come to be seen as an indispensable tool in crafting a commercially and aesthetically successful musical product. Ludwig offers an example:

"A couple of summers ago, when Bruce Springsteen was doing the 'Live' album; we worked on it from June to September, a little bit every day for the whole summer."

Ludwig and his staff received bits and pieces of the project daily and performed what could be termed "experimental mastering"—cutting "references" for this five-record set. The artist and the production team would listen to the references as well as comments from Ludwig, most often finding something which could be improved prior to the actual mastering. This "feedback" generated from the mastering engineer often resulted in re-mixes or even re-tracking. "More often than not," says Ludwig, "Bruce would decide to change some of his phrasing."

This sort of interactive record production—where immediate adjustments can be made on the basis of

expert opinion—seems to be the distinguishing mark of a hit record today. Because there is such competitiveness in certain genres of music (e.g., rock n' roll), it has become extremely important to give the product a frame of reference to its competition. And this, of course, can best be done under the laboratory conditions of the mastering suite.

## THE DEFINITION OF MASTERING.

According to Bob Ludwig, "mastering is the final creative step in the record making chain and the first step in the manufacturing chain. It's that transition point."

While mastering engineers are capable of making both technical and aesthetic decisions, certain kinds of music, by their very nature, require very little tweaking. For Bob Ludwig, classical music is certainly repre-

*Figure 1. Part of one wall, plus additional aisles filled with gold and platinum earnings by Masterdisk.*





Last chance!  
\$1,000 MC

# "~~\$2500~~ Says You Can't Find a Better Gate!"

*Marvin Caesar, President*

**A**t Aphex we have a problem with the President. Marvin Caesar wants everything the company makes to be the "best." Marvin is *not* an engineer, he is an audio zealot who doesn't understand the word "impossible."

When engineering approached him with a design for a gate, he wasn't satisfied. He wanted the ultimate gate, an *expander/gate* that was extremely fast, perfectly click-free, loaded with features, with traditional Aphex audio quality.

Impossible with available technology they said. Marvin wasn't satisfied.

So, the engineers developed a new VCA, the Aphex VCA 1001. Then they created the Aphex 612 Expander/Gate. Marvin was finally satisfied.

In fact, he is so confident that the Aphex 612 is the world's best expander/gate he is offering \$2500 to the person who finds a better one. If you think you

know of a commercially available expander/gate that can begin to compete with the Aphex 612, write for full details of this offer.

If you would rather spend your time more usefully, contact your professional audio dealer for a demo of the best!

Here are a few highlights of the world's best expander/gate:

- Attack time—variable from less than 4 $\mu$ Sec (with no clicks!) to 100mSec
- Ratio—variable from 1.2:1 to 30:1
- Range—0 to 100dB
- Bandwidth—5Hz to 100kHz, + 0, - 0.2dB
- THD @ + 20dBm—0.006%
- IMD (SMPTE) @ + 10dBm—0.006%
- Noise and hum—fully attenuated - 94dBm
- Servo-Balanced Transformerless Inputs and Outputs

Can you beat that?



**APHEX**  
SYSTEMS

Aphex Systems Ltd. • 11068 Randall Street  
Sun Valley, CA 91352 • (818) 767-2929

Circle 19 on Reader Service Card

representative of this category. Live recordings done with two or three quality microphones are usually perfectly coherent mixes—since air is the great summing amplifier. But pop music is where the mastering engineer really needs to exercise creative judgement. Bob Ludwig compares pop music to 'musique concrete' (the twentieth century experimental musical form typified by Pierre Boulez, using assorted sounds and noises in place of musical tones).

"Pop music," says Ludwig, "is really 'musique concrete' because it's a group of mixed-together sources that never existed in real-time, that are recorded usually in different acoustical environments. When you start to put 24 or 48 channels together, it starts to be more like mixing paint than anything else. The more things you blend together the more it turns into mud. Quite the opposite of a two or three mic recording. (Pop music) is really a function of the monitor system you are mixing on and the quality of the console that it's being mixed through." According to Ludwig, the chances of getting a well-rounded mix are inversely proportional to the number of individual sound sources the mixer has to deal

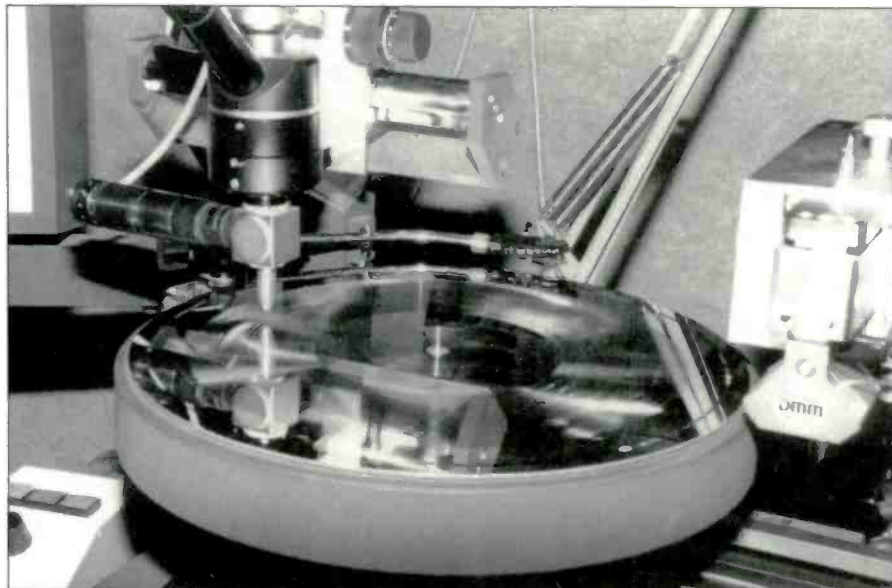

Figure 2. The Neumann lathe has a copper disc on it with the DMM cutter poised along side.

with. He goes on to say: "Engineers sometimes don't get to spend as much time as you might think on a mix. Some engineers only take three or four hours to get the mix 90 percent there. Then, to get it that additional 10 percent right, might take another four or five hours. A lot of times, because of budget, they don't

have time to do that. So a good engineer will know what he can get away with in mastering, and will say, 'Well, this mix is good enough.' Sometimes due to loud levels or all night mixes, ears get fatigued. A lot of what we do is get the tape back to what the producer thought he had in the first place.

# Why our first stage monitor





"Nowadays, in a facility like ours, where you have (engineers like) Howie Weinburg and myself, people send us tapes just wanting our input. They don't even give us any suggestions. They just say, 'Do it like you hear it.' That's the kind of situation that I don't really like, to tell you the truth. I really prefer the artist's input, because it's their record. And I don't ever want to feel like I put my imprint on their musical concept."

Despite the considerable weight of Bob Ludwig's opinion, his policy is to always remain open to the artists' ideas, even if they seem unorthodox. Speaking of a situation where he was working interactively with Michael Been, bass player and vocalist with "The Call," Ludwig tells of how he would send reference tapes to Been, who was in San Francisco. Been, who had some strong opinions of his own on how the ultimate product should sound, would do some tweaking on his own equalizers, and then call asking Ludwig to try the new changes.

Ludwig recounts the episode: "Once he called with a suggestion about adding what seemed to me to be a ridiculous amount of bass. And I said, 'Well, it's his record', and I went and did it.

And after I did it and was listening to the record, the record kind of spoke to me in a new way. He did have a concept—kind of a unique concept—as to the way the record should sound that didn't strike me initially as the right thing, but it turned out after all, that it was the right thing."

Undoubtedly, Ludwig's respect for artistic expression, and willingness to 'go the extra mile' to ensure artistic goals, has contributed to his great popularity and unanimous respect in the industry.

A glance at Billboard's *Top 200 lps and Tapes* testifies to this phenomenon, for a disproportionately large number of releases have been mastered at Masterdisk under the auspices of Bob Ludwig. (At the time this article was written, the number was 48 out of 200—nearly 25 percent.)

## THE BOB LUDWIG STORY

Part of Bob Ludwig's empathy for artists is traceable to his early training, for his natural proclivities always set up a dynamic tension between his fascination with technology and his drive to express himself as an artist. During high school he was drawn both to engineering and to music. In a quandary as to which career to pursue, his music teacher tipped the balance by encouraging him to a career in music. He decided on a conservatory education and was accepted into the rather competitive program at the Eastman School of Music in Rochester, NY, where he completed his bachelor's degree in music education.

While at Eastman, Ludwig played principal trumpet in the Utica Symphony Orchestra and in the Eastman Wind Ensemble. Simultaneously, he was active in the recording department, recording (as he put it) "probably thousands" of student recitals and professional concerts. To make bucks on the side, he found himself in his first audio industry job as an engineer for Century Records—a small "custom" label that recorded and coordinated the lp manufacturing of high-school band recitals. At this

# console may well be your last.



In a world where today's hits often become tomorrow's Muzak™, it's refreshing to find the Yamaha PM2800M Monitor Console.

Because it has what it takes for a long stage life. Like 14 mixes. Four matrix outputs. Meters for each primary output. Four band variable EQ. 20 to 400 HZ pass filter. And it's available in either 32 or 40 input versions.

To improve your stage presence, it has Programmable Mute Groups. They let you switch large groups of channels on or off, silently.

The PM2800M also lets you change your act without changing consoles. Because it's a stage mixer that also can double as a house mixer.

And, it's a Yamaha. Built with a commitment to reliability that'll make it one of the few things on stage that isn't temperamental.

For an audition, just stop by any Yamaha Professional Audio dealer.

But do it soon. Because even though the PM2800M is built to last, it tends to go quickly in the showroom.

Yamaha Corporation of America, Professional Audio Division, P.O. Box 6600, Buena Park, CA 90622—6600. In Canada, Yamaha Canada Music Ltd., 135 Milner Avenue, Scarborough, Ontario M1S3R1. Muzak™ is a registered trademark of Muzak.

**YAMAHA**  
Engineering Imagination™



point he was comfortable standing on either side of the control room window garnering his formative experiences in playing and recording.

Speaking of that era in his life, (during the 1960s in Rochester) Ludwig muses that “those were magic years. I went to school with Tony Levin (bass player with King Crimson), Lou Soloff (Blood, Sweat and Tears), and Steve Gadd (ubiquitous session drummer).” Ludwig went on to achieve an M.A. in music literature. It was during that period when he was surely, to quote a well-worn phrase, “in the right place, at the right time.”

Success was once defined as “the conjunction of preparation and opportunity.” Certainly that was the case from this point on in Bob Ludwig’s career. When Phil Ramone was asked to teach the first recording workshop at Eastman, Ludwig was assigned to be his assistant. Ramone was favorably impressed with young Ludwig and subsequently hired him at A&R (one of the now-legendary New York recording studios). He ended up working as Phil Ramone’s assistant for 1-½ years, during which he learned the art of mastering. Again, preparation and opportunity coincided as he mastered several hit records working with the likes of Burt Bachrach, Dionne Warwick and BJ Thomas. (Not bad for a journeyman mastering engineer!)

From that point on, Ludwig made some very prudent career moves. Towards the end of his stint with A&R, Mr. Neumann (of the microphone company) had invented the SX68 which was a ground-breaking cutter head. Ludwig was one of the first to try it out. He knew immediately that the success of any mastering house depended on access to this new technology, and asked A&R to buy the head. They refused. But Bob Ludwig had seen the future and was not about to miss out on it.

“At that time,” remembers Ludwig, “Sterling Sound had just started up with all-European equipment (including the new Neumann cutter head). I knew there was no way I could compete against that equipment with the stuff at A&R.” Sterling was then a fledgling company, but Ludwig joined them, becoming their first employee. He, and the principals of the company, did “lots and lots of records. For almost a



*Figure 3. Bob Ludwig stands along side one of his pair of Duntec Sovereign 2001 monitors. At the right, the much smaller Fourier Model 8 “bookshelf” reference.*

whole year we were the only studio to have this equipment.”

In 1969, Sterling Sound was, as it were, ‘the only game in town.’ But after seven years, and with his ascending to vice-president of the company, Ludwig was forced to make another major career move. Ludwig’s reputation had now grown to proportions that alarmed his employers at Sterling. Apparently, they feared that if he ever left the company, many of their prized clients would follow him. A dispute arose over a clause they wanted written in to his employment contract stating that in the event he quit or was fired, he could not work within 200 miles of New York for a period of 5 years. “They said, ‘Sign it or leave,’ so I left!”, says Ludwig.

He then joined Masterdisk (a competitor which was oddly enough owned by the same parent company and occupied a different floor in the same building). Masterdisk is now considered to be one of the finest facilities in the world.

#### DOING IT RIGHT

There are several keys to Masterdisk’s capturing of such a large market share. Ludwig’s charisma is certainly one of them, but as he perceptively points out, Masterdisk is a

company that has decided to really do things right—to become an undisputed state-of-the-art facility. Such facilities are forged not only from acquisitions of the most current technology, though that is of great importance. But equally important is an upward looking management policy that allows employees to grow and innovate, and to receive kudos in a team-like atmosphere of mutual support. Masterdisk has the aura of a happy shop. That undoubtedly enhances its reputation, and says much about Ludwig’s skills as a manager of human resources.

Technically speaking, Masterdisk has given Ludwig the latitude to acquire all the equipment he needs to stay a step ahead of the competition. There are six rooms at Masterdisk which seem to be constantly active: three mastering rooms, two editing rooms and a direct-to-metal (DMM) mastering room (which communicates with all the other rooms through tie-lines). Most of the rooms have modified Neumann cutting consoles and Neve DTC-1 digital consoles as well.

Ludwig seems to be extremely proud of the DMM room. Why? It’s not only because the DMM lathe cost a quarter-of-a-million dollars and enables vinyl records to have



audiophile specs. It's because the unit is useful. Ludwig speaks of how the DMM method of lp mastering has breathed new life into the sagging lp market by making things possible which were previously unthinkable, such as record sides of 30 minutes or more. While DMM was once used strictly for classical and elite jazz albums, Ludwig notes, "it is now used for almost every major act that we do. A couple of years ago, when we did the Def Leopard "Hysteria" record; the A side of that is almost 32 minutes long! It would have been physically impossible to do without this lathe. And because that record sold like 12 million, it kind of 'broke the dam.'

The most important tool of the trade is to be found, however, right in Bob Ludwig's personal mastering suite. He stands next to one of his \$15,000-a-pair Duntech Sovereign 2001 speakers. These time-aligned, four-way speakers, known for their extreme low-end accuracy, are probably more than 6-1/2 feet tall! The fact that Ludwig loves these speakers, relies on them constantly, and trusts them implicitly is evident from this anecdote:

"On Sting's solo album there was a recorded sample. Whenever the sample finished, we kind of felt our pants shake! On the console we used a 25 Hz hi-pass filter and it completely got rid of it. So you can do meaningful EQ down in the 20 Hz range and hear it on these speakers. They are completely smooth. There are no horns in them. I hate horns!"

The other half of the monitoring equation is, of course, the amplifiers. Ludwig uses Cello Performance Amplifiers which are rated at 3000 watts per side. He credits the pristine sound quality necessary to make sonic decisions with utmost accuracy



Figure 4. The modified Neumann Analog Mastering Console. The row of knobs at left are part of a Sontec Mastering EQ.

to these amplifiers. And, in case you are curious, his alternate monitors are Fourier Model 8s (unfortunately not manufactured any longer) which serve as a 'bookshelf' reference, and, of course, the normally-expected NS-10Ms and Auratones.

### SOME FINAL THOUGHTS

Bob Ludwig says that "record making is one huge compromise." The engineer is always splitting the difference, between how it sounds on various monitors and dealing with the limitations of the final product (CD, cassette, vinyl, broadcast, etc.). But ever since the CD emerged as a dominant technology, Ludwig always does what he calls "a no-holds-barred" master. This master reflects what a listener would be able to hear under ideal circumstances. The technology now makes this possible. That being done, he then turns to the task of realizing the medium and the con-

text that the recording will most likely be playing in (will it be a disco or a car radio). Then he starts to practice the art of compromise, turning down one frequency and replacing it with another, adding a subtle amount of compression—whatever it takes to insure that the product has universal impact.

Ludwig concludes: "To further that definition of mastering (mentioned earlier in the article), it's like we try to get as much musicality as possible, and then when the producer and myself are here in the room and we hear it over the loudspeakers, and we say, 'Yeah, we wish everybody could hear it like that...'" (His voice trails off, eyes adrift, as if he had just remembered a sonic experience of unearthly proportions.) "Once you determine that maximum musicality, then our job becomes the first manufacturing step."

## FIVE TIPS FROM BOB LUDWIG ON MIXING FOR RELEASE

I asked Bob Ludwig to give me a list of the five things he wished every producer and mixing engineer knew about the mastering process—tips to help people come up with a more successful product.

Here's his advice. (The parenthetical statements are editorial clarifications).

### 1. BE DISCIPLINED WHEN IT COMES TO DIGITAL

"If the project is digital—and especially if it's the producer's first project in digital: it really is a different discipline. His mastering budget can go sky-high if he's not disciplined. For example, they can run up a lot of money to re-sequence (change the order of songs) on a digital master.

(Since all digital editing for CD mastering is done on the 1630 compatible format) with Sony or JVC video-based systems, everything has to be done from the top."

(Only *assembly style* editing is possible. Insertions are out of the question here. Any changes? You have to record it all over from the top!) "Vari-speed is not easy in digi-

tal. It requires a sampling-rate converter that can handle vari-speed. Vari-speed should be done from the multi-track, at the mix stage for optimum results."

### 2. PREPARE TAPE PROPERLY

"Analog tape should have 1 k, 10 k, 15 k, 100 Hz and 50 Hz—minimum. A 1 k tone is sufficient for digital systems. But if you are using non-professional digital (such as consumer DAT machines and F-1 type units) then include a 10 k tone along with the 1 k. Since consumer (EIAJ) systems very often have only one A/D converter instead of two, they sample left and right putting an 11  $\mu$ s delay between channels—which will tend to narrow the stereo image and reduce high frequencies in mono. You'll need a Harmonium Mundi (essentially an expensive digital time-base manipulator) to compensate for it. With a 10 k tone the Lissajous pattern on an 'scope will reveal out-of-phase information and the need to re-time in the digital domain."

### 3. DIGITAL IS NOT FOR EVERY PROJECT

"If you are working on classical or anything where you are trying to recreate an event that already took place, digital is the choice medium. For pop products, maybe not. At this time no one has come up with a digital algorithm that simulates tape saturation (a phenomenon only possible on gently overloaded analog tape). The name of the game when making a record is to make it as musical as possible. Sometimes a producer will say that a mix to analog tape sounds better than just going straight through the console. (That) producer should print to both analog and digital mediums. Let the analog tape "cook" for 24 hours to allow whatever print-through is going to happen. Then he should make a judgement. Print-through is never musical, because it's non-harmonic distortion. (Print-through occurs frequently when printing "hot" to 1/2-inch tape at 30 in./sec).

### 4. GET IT AS RIGHT AS YOU CAN IN THE MIX

(Don't accept a horrible mix and expect the mastering engineering to fix it for you. Be satisfied with your

end of the bargain first.) "If, however, you know that the mastering facility's compressors will work better than those available in the studio, wait to compress the total product.

However, since 1974 with the introduction of the Neumann SAL 600 w/channel cutter, there has been no need to compress to get a master on disc. Compression is for aesthetic reasons only."

### 5. AVOID SPLICING A DIGITAL MASTER TAPE

"When bringing in a Pro-Digi or DASH digital tape, it's best to have a tape with no splices and continuous SMPTE time-code on it if you want to use it with a digital console. Splices disrupt SMPTE because time-code tracks are small (in these formats) and console automation becomes inaccurate. I recommend doing electronic editing on anything digital." 

## **Gauss.**

### **The World's Greatest Woofers**

At Gauss, we make low frequency transducers, not just bass guitar speakers. And we make them to be the best. Every Gauss loudspeaker is designed to perform at rated output levels where others *only survive*.

Gauss woofers are the greatest because they're *engineered* to be the best. They have the largest voice coil in the industry, 4.125 inches. It is directly wound on a unique metal former for maximum heat dissipation and efficiency. Our innovative double spider insures that the voice coil stays centered under high power operating conditions. Even our cast aluminum frames are thicker and heavier to make them more robust.

The result of these innovations is a line of woofers that are superior to all others. Bar none. Best of all, they're built to survive in the real world.

## **gauss**

a MARK IV company

9130 Glenoaks Blvd.

Sun Valley, CA 91352

(213) 875-1900

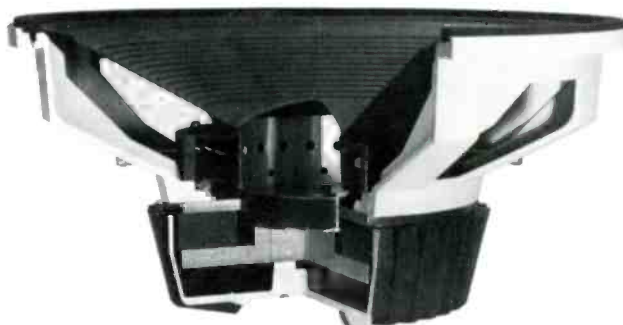



The 87th Convention of the  
AUDIO ENGINEERING SOCIETY

OCTOBER 18-21, 1989  
NEW YORK



AES  
AES  
AES  
AES

# AUDIO

*for the next decade and beyond*

New York Hilton &  
New York Sheraton Centre



**AUDIO ENGINEERING SOCIETY**

60 East 42nd Street, Room 2520, New York, New York 10165

Fax: 212-682-0477 Telephone: (212) 661-8528 or (800) 541-7299 (N. America, except NY)

# Broadcast Audio

## STEREO SYNTHESIZERS AND SURROUND SOUND DECOR: NOT THE BEST OF FRIENDS

• The television station engineer may soon begin to receive a new kind of call (if such a call hasn't already been received) from a viewer who is listening to stereo television audio with a surround-sound decor and does not like some of what is heard.

### STEREO TELEVISION BROADCASTING

In the early days of stereo television broadcasting, just a few short years ago, stereo programs were the exception rather than the rule. Television broadcasters wanted to take full advantage of this new capability, and the void left by lack of stereo programming was filled with stereo synthesizers.

Opinions are divided on the aesthetic value of these devices, but it is fair to say that the public and the broadcasters liked the effect enough that very few of them have taken off-line, even though there is considerably more true stereo programming available today.

The virtually ubiquitous stereo synthesizer is now creating problems for the increasing number of viewers who use surround-sound decors to listen to broadcast television programs. Surround sound has been a part of motion picture audio for the past decade or so, and the initial impetus for its inclusion in television sound systems was the availability of surround-encoded movies on video-cassette.

Surround sound decoding, reduced to its simplest form, directs left-minus-right or difference signals to the rear or surround speakers. The surround signals are usually delayed slightly with respect to the front signals, to take advantage of the precedence effect to accurately locate the

front sound field. The surround encoding process is principally one of insuring that the various components of the audio mix are directed to their desired destinations. The dialogue components, for example, are required to come from the center speaker, in the middle of the front sound field. It is an undesirable, indeed unpleasant, experience for the listener to hear dialogue emanating from both the front and the rear speakers. Not only is the directional sense incorrect, but the delay imparted to the rear signals also creates an "outer space" effect in which dialogue comes from all around the room.

Because the surround encoding and decoding process relies on phase shifting in the left and right stereo signals, which is effective manipulation of the stereo difference signal, it follows that decoders based on such an algorithm will often serendipitously produce pleasing results in the absence of any specific encoding actions. In fact, those production and broadcast practices that are observed to ensure mono compatibility, such as centering dialogue and paying strict attention to the preservation of interchannel phase integrity, contribute to successful surround decoding of normal television stereo sound tracks.

The technique by which stereo programs are produced results in centered dialogue for the most part, and no L-R component is generated from dialogue or other intentionally centered sounds. Such sounds as audience reactions, on the other hand, are naturally rich in L-R content. When a stereo audio program containing the foregoing elements is passed through a surround sound decor, dialogue comes out of the cen-

ter front speaker, left and right sounds come out of their intended speakers, and ambience and other environmental types of sounds are heard from the rear or surround speakers. This is exactly the result sought from surround sound decoding, and it happens serendipitously quite often.

### THE SURROUND SOUND DECODER

Because so much of television stereo programming lends itself so well to the surround sound decoding algorithm, it is not surprising that those who have surround sound decoders use them extensively, even in the absence of much programming specifically surround encoded. The number of consumers with surround sound decoders is on the upswing. According to the available statistics, there are around a half-million surround decoders in the hands of United States consumers.

While this is not a very large percentage of television households, it is on the rise. Most, if not all, the major manufacturers of television receivers are either building surround decoders into some of their models now or will be doing so in the near future. These range from the simplest approach of simply sending L-R to the rear speaker, to the most sophisticated proprietary decoding approaches which enhance the inherently poor separation between certain of the decoded channels with steering logic. It is safe to say that the trend toward including surround sound decoding on an increasingly sophisticated scale in television receivers and their associated sound systems will continue to rise. The increase in decoder availability will be accompanied by an expansion in the



offering of surround encoded television programming.

So what's the problem? The problem is that our old friend the stereo synthesizer can cause some unpleasant auditory experiences for the viewer using surround sound decoding. This happens because the synthesizer generates an L-R component from all audio that it operates on, including dialogue. This, of course, results in the sending of dialogue all over the room in direct opposition to the desired effect. Some synthesizers recognize dialogue and limit the amount of "spread" imparted to it to effectively keep the dialogue narrower than the non-dialogue elements for stereo listeners. This feature results in less L-R being generated from dialogue than is the case with synthesizers that have no facility, but it does not totally solve the problem.

If a stereo synthesizer with an automatic stereo/mono recognition facility, even one that works perfectly in an ideal world, is operating on programming that is subsequently

heard with surround decoding, any mono programming elements, for example commercials, will produce synthesis, and thereby, undesirable side effects. In real-world, stereo programming centered dialogue, in the absence of a sufficient amount of uncorrelated background sound or just plain noise, will also cause the synthesizer to synthesize, as is now well known.

Given all this, it is not surprising that most people who listen to broadcast television sound through sound decoders are not fond of stereo synthesizers. It is also not surprising that many who use surround decoders are true audiophiles, individuals tending to spend a lot of time and money on their audio systems, and who are quite vocal about anything they perceive as a degradation of the audio signal.

#### NO GUARANTEES

Of course no guarantee was ever issued that a surround decoder would be compatible with broadcast stereo television, but it is also true

that as the number of surround decoders in the living rooms of consumers increases, the number of irate calls to television stations about synthesizers and surround decoders will also increase.

It is not really difficult in many cases to solve this problem to the satisfaction of the surround decoder owner. The solution is to avoid reliance on a stereo/mono recognition switch, by manually disabling the synthesizer for blocks of true stereo programming, and manually enabling it for blocks of mono programming. The penalty exacted for doing so is that any mono commercials or other mono program elements within the stereo block will not be synthesized, but this is exactly the intended objective for the viewer using a surround decoder. The reward is that the growing audience with such decoders will be very pleased with the result. Those in the audience who listen in stereo and object to the false triggering of a synthesizer's automatic switch will also be pleased with the manual switching approach. 

## 1200 WATTS, FOUR INDEPENDENT CHANNELS, FLEXIBLE, 2/3/4 CHANNEL SELECTABLE...



The new model 300X4 MOSFET power amplifier from Soundcraftsmen features a multi-channel design allowing the user to select either two-channel, three-channel or four-channel operation. It is ideal for anyone needing very high power—600 watts per channel (two-channel)

at 8 ohms, or wishing to bi-amp—210 watts per channel (four-channel) at 8 ohms. Or tri-amping using two of the 300X4's (each in the three-channel mode) to provide 600 watts per channel for woofers, 210 watts per channel for mid-range and 210 watts per channel for high

frequency drivers.

The 300X4 has two completely independent power supplies and two separate power transformers, sharing only a common power cord. It is completely protected against short circuits, open circuits and input overloads.

**CIRCLE READER CARD # FOR COMPLETE SPECS, FEATURES AND PRICES ON OUR 100-WATT, UP TO 600-WATT POWER AMPS, PLUS POWER AMP COMPARISON CHART.**

*Soundcraftsmen*

MADE IN U.S.A.

2200 SO. RITCHEY, SANTA ANA, CA 92705 • TELEPHONE: 714-556-6191 • FAX: 714-682-0750 • TELEX: 910-595-2524

Circle 22 on Reader Service Card

# Ad Ventures

## HOMEBREW SFX

• In the early days of radio broadcasting, programming was dominated by elaborate dramatic presentations, music programs featuring live orchestras and performers, news and sporting events, and all manner of entertainment, largely adapted from vaudeville-type performances.

Since radio is an audio medium, it was seized by creative producers as an opportunity to create a "theater of the mind." Unlike film, or even live presentations, radio did not require lavish visual displays or expensive scenery and props. To develop a scene or set a mood, production specialists used sound effects and music.

In the early days, sound effects were not available on pre-recorded CDs, records, or tapes; they had to be generated live at each broadcast. With experience, radio broadcasters devised techniques to create sounds that were inexpensive, better-suited to use inside a studio, and often came across to listeners better than the actual sounds themselves.

It is impractical, for instance, to run a locomotive past a mic on cue, or to route a babbling brook through a studio. Broadcasters had to come up with alternate methods. A gunshot merely sounds like a sharp "whap" when picked up by a mic, so even effects that could be produced by natural means were often unacceptable.

Here are a few ideas to get you started on creating realistic-sounding studio noises that can be used to

simulate natural sound effects in commercials and radio drama. Some are old standbys, and others are ones I've stumbled across (sometimes literally) in my quest for imaginative scenarios.

### FIRE:

Crumple cellophane from a cigarette pack in front of the mic. Try differing degrees of cellophane-manipulating and distances from the mic to suggest the proper magnitude of the blaze.

### SMASHING WOOD:

Step on, tear apart, or squash wooden berry boxes, bushel baskets, or fruit crates.

### GAME SHOW "CORRECT ANSWER" CHIME:

Many modern elevators emit pleasant "dings" when they stop at your floor. Also, try the Emergency Stop buzzer as a "wrong answer" razz. (Warn building managers before you try this one.)

### FISTFIGHT:

This one requires a bit of painful self-sacrifice (go ahead, you can take it!). Bop yourself on the insides of your forearms with your fists. Or, for those of a more delicate constitution, clobber a whole watermelon.

### WALKING IN FALLEN LEAVES:

Let your fingers do the walking through a tabletop covered with a deep layer of corn flakes. Scuffle as desired.

### DIGGING HOLE:

Scoop your corn flakes into a large bowl, and "shovel" with a cupped hand or spatula.

### ARROW:

Use the palm of your hand or a very heavy stack of books to hold a ruler down on a table with several inches sticking out beyond the edge. Sharply "strum" the ruler vertically downward with your thumb. To create a more comical "boing", adjust the length of the overhanging length of ruler. Also, try sliding the ruler farther onto or off of the tabletop in mid-boing.

c2

Free Catalog of

# Professional SOUND recording & duplicating SUPPLIES



POLYLINE™ EMPTY REELS & BOXES

BLANKLOADED CASSETTES

BOXES ALBUMS LABELS

AGFA AMPEX 3M Scotch TDK maxell tapes

now from STOCK in CHICAGO and L.A.

Call Polyline  
**312 / 298-5300**  
8:30 am-5 pm Central Time

**Polyline Corp.**  
1233 Rand Road  
Des Plaines, IL 60016



### SHAVING:

Scrape a fingernail across your palm in continuous light scratching motions of varying rhythms, with a quick flick at the end of each stroke.

### CAR CRASH:

Somewhat firmly pack a heavy-duty corrugated cardboard box with large shards of broken glass, books, pots and pans, and other assorted junk. Drop it on the floor or slide it into a wall to simulate a simple collision; tumble it down a flight of stairs to suggest a plunge down a cliff.

### APPLAUSE:

There are two standard ways to simulate a large group of people applauding:

1) Rather than beating hands together, you can double the size of a "crowd" by enlisting a host of accomplices to clap their hands against opposite biceps simultaneously.

2) Use the common TV studio-audience gimmick of having the folks applaud faster than normal. The resulting effect is that of a horde 3-4 times the size of the number of people actually present.

### SPACESHIP:

Hold a length of plastic vacuum cleaner hose in one hand and whirl it over your head helicopter-style. This produces a bizarre howling sound that you can adjust by varying the speed you twirl it.

The following techniques may be applicable now that the Halloween season is upon us. Warning: these are definitely not for the faint of heart!

### GUILLOTINE:

Run a metal ruler swiftly along the edge of a wooden desk, and at the moment of truth, grab your trusty Boy Scout hatchet and deftly chop a nearby cabbage in two. Follow by immediately dropping another cabbage into a shredded paper-lined plastic wastebasket.

### THE RACK:

Crack your knuckles close to the mic, while leaning slowly back in that creaky old office chair.

### BONES BREAKING:

Grab a nutcracker, a handful of walnuts, and get up next to the mic.

### BODY FALLING ON FLOOR:

I've often used a laundry bag or large mail sack full of sneakers, phonebooks, and other heavy, non-rigid items, dropped from various heights above the floor. Experiment. Don't deign to take a dive yourself; the only way to sound convincing is to drop from a considerable height and land on your back. Not recommended.

This brief list should get you started. Experiment with various tape recording/playback speeds, backward tape effects, and other electromechanical techniques. You'll probably discover a few new sounds of your own! I'd like to continue this list by adding ideas from readers. Send me your own personal discoveries or suggestions in care of **db**, and if your idea is used, you'll be given credit in this column. **db**

## Meet the New Community



### RS880 and VBS415

While you were out doing tours and installations, Community's engineers were developing the next generation of trapezoidal Wavefront Coherent™ flying array speaker systems. These systems incorporate the latest in dynamically controlled, feedback-loop sensing circuitry in a single rack space.

*Give us a call and find out how easy flying can be!*

**Community**

PROFESSIONAL SOUND SYSTEMS

333 East Fifth Street • Chester, PA 19013 • (215) 876-3400 • FAX (215) 874-0190

# db Visits Boston

## SOUNDTRACK

**O**n the fifth floor of the Scotch 'n Sirloin building on North Washington Street sits the largest audio recording facility in Boston—Soundtrack.

The city styles itself as the hub of many things, but it is rightly known as a fertile hotbed for music, as the headquarters of several major advertising agencies, and as a center of high technology. Over the past twenty years, sound production facilities in this town that reach for record label work have proliferated boldly, if not ingenuously, engaging the extremes of competition prevalent in any media metropolis.

In the past decade or so, Boston has also risen to the challenge and opportunities in post production for visual media. There, too, competition has become fierce, but the investment required has tended to exclude from the stakes small operators such as those who have worried and decimated the profit margins of studios specializing in popular music, in the rock and roll dream.

Soundtrack began humbly, some twelve years ago. Despite ambitions bred of the music business giddiness of those times, it chose not to enter that seductive fray. The Boston end of Soundtrack now features a staff of thirty, two twenty-four track rooms, one of which is equipped with a 40-channel SSL 6000 and a Synclavier with four hours of Direct-to-Disc recording capability. There are four eight-track rooms, including as one their Lexicon Opus system. A little over three years ago they expanded into the New York market, setting up six rooms, four of which are 56-channel, 48-track SSL. Soundtrack is unique, at the very least in this area,

in that it offers three generations of audio processing technology for mix to picture: One room is equipped with Alpha Audio's Boss controller, Lynx, one-inch- and three-quarter-inch video, an Otari 24-track, a Harrison MR-4 console, plus Performer, Korg M1R, Yamaha DMP-7, etcetera—technology that was state-of-the-art through the mid-to-late 1980's. Another room features the SSL 6000 and a Synclavier with Direct-to-Disc, which approach has just recently come into its own. And the third is a Lexicon Opus room, at the cutting edge of workstation capability.

### SOUNDTRACK'S CREATIVE DIRECTOR

I visited with John Kiehl, the amiable Creative Director of Soundtrack, at the end of June. Rob Cavicchio, the studio's owner, was busy in New York:

**JK:** I met Rob in 1971. I was still in school. Upon graduating in 1973, I joined one of the bands he was booking. Rob was an astute businessman and also something of an undirected soul. He comes from a musical family. He knew he wanted to be in the recording business, because it seemed the most sane part of the music world. So he said John, stick with me. We are going to get into recording. I'm not sure how we are going to do it, but we'll figure that out.

It didn't take him long to realize that the only people in town with both consistent budgets and needs were the ad agencies. Being musicians, that meant jingles to us. So jingles we did, for two or three years, then added voice work.

When we moved to Washington Street, our intention, believe it or not, was to build a four-track room for jingles, and to work with the bigger music studios in town. What we sold was service. Our clients had little choice back then. They used one or two places in town, joints they often found ornery. We had few preconceptions, except that the customer is always right and his needs are what you deliver. So that's what we built our business on.

Eventually, it was one hand washing the other. We would meet a client through voice work and he'd learn that we did jingles, or we would do jingles for somebody who would discover that we could do all his post production work. The Boston Globe's jingle led to doing all their daily stuff. Of course we made ten times as much money on the daily stuff as on the jingles.

(Music was always and still is important to Rob and me. That's who we were, creative people. The rock thing never made sense to us, so we never got into it. We didn't need the aggravation.)

Each of the three generations of post technology rooms has its own specialist. John and I visited the Synclavier room first, then moved to the 24-track analog, Boss lock-to-one inch video suite, where we were able to talk in the adjacent machine room.

**SL:** When you folks started out, mixing sound to image was different from your current procedures.

**JK:** When I started, twelve years ago, the BTX people brought in this box and said, "This is your future. This is mix-to-picture. This is lockup."



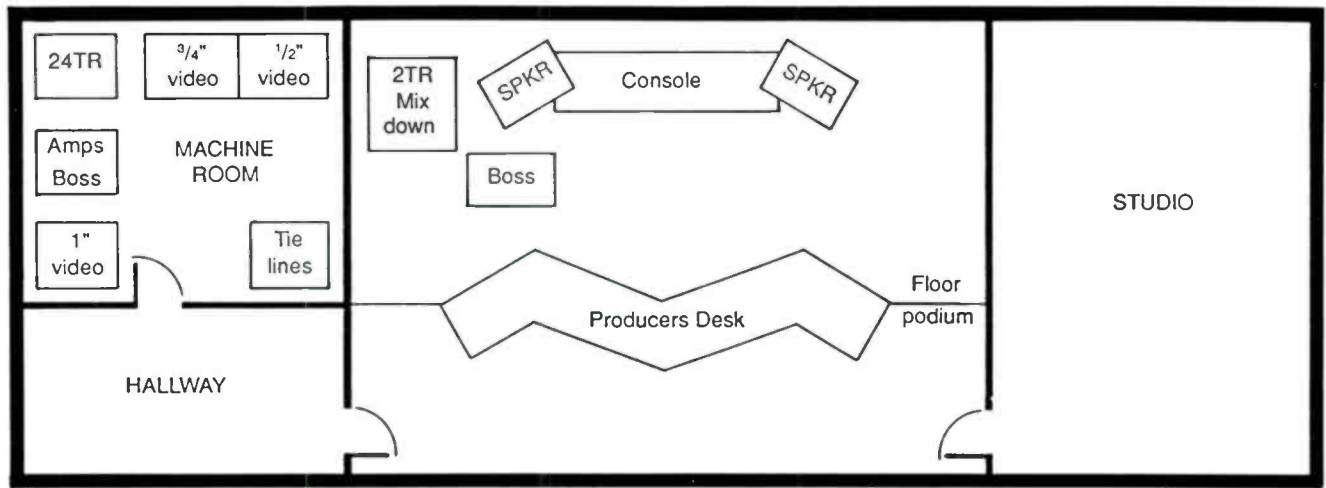

Figure 1. Floor plan of the Lockup Room.

**SL:** I recall some early reliability problems.

**JK:** There wasn't much choice back then. BTX seemed to be coming at it from the rock and roll studio mentality. They knew the way we thought about audio. They were trying to bring the video people over to us. So we got a BTX as a beta test site, and we learned. But it was painful. You knew instead of a five minute setup it was a two hour setup, as you trouble-shot ground loops, unmatched SMPTE codes.

**SL:** Do you find that the Lynx works fairly well?

**JK:** Plug it in and it runs. The headaches and the horror show are gone. The client base is now pretty well educated to the process. They know what they are going to run into,

they know that there is a little bit of start time as the machines settle down.

### THE CHANGING ENGINEER

**JK:** What is interesting now is the evolution of the engineer's contribution. Tom Love, here in the Boss/Lynx one inch/twenty four-track lockup room, doesn't come from a musical background, but Bill Bookheim in the Synclavier room is a musician. As you go around to the other post studios in town, I think you're going to find that their audio people are musicians. What these facilities are marketing now, besides the ability to drop in a sound effect, is knowledge about samplers, transposing, synthesizers, and so on.

The modern post engineer is a creative audio specialist. You don't want just an engineer anymore, you want a guy who sees the whole picture at a conceptual level and can tell you "OK, I'll throw in what your asking me to throw in, but have you thought about *this* issue?"

**SL:** Your engineers each work a single room?

**JK:** Yes. Tom can work in here fast. To think through all these levels one step at a time would take me an hour to set up. It takes him only minutes.

**SL:** How long did it take Tom to get proficient at it?

**JK:** I would say it took us, as a facility, with Tom being the dedicated guy in this room, around six months. It didn't hurt that the Alpha Audio Boss people came along just in time.

Figure 2. The Opus Room. It measures 18 by 12 feet

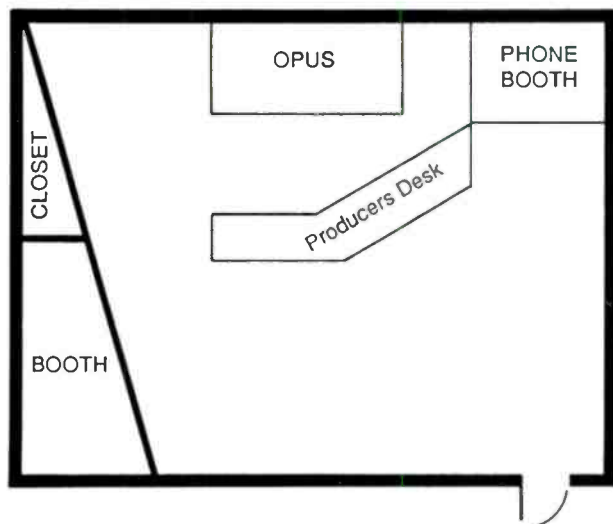

Figure 3. The Blue Room.

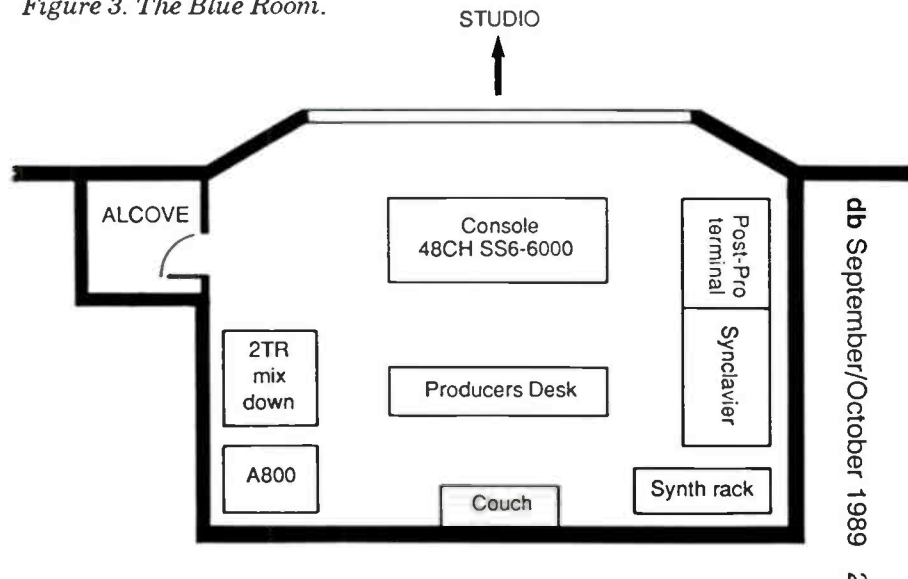



Figure 4. Freelance engineer Jonathan Wiener at the console in the Blue Room.

**SL:** I see you're not working from the one-inch video at the moment.

**JK:** One inch is real overkill. But in the old days you would work on an audio track, the music bed, or the finished track, and ship it across town to somebody else who might not care about audio. Then you'd hear your spot on the air and it would be distorted, or too low or too hot. And you'd say, wait a minute! My reputation's at stake here.

We went to one-inch machines to get control of that step. We're able to tell the client, "Bring your one-inch over. We'll strike our own 3/4-inch dub." If the client brings in the one-inch and a 3/4 that they've struck somewhere else, they might not get the SMPTE right. Slight capstan-speed variations can also be problematic. We learned the hard way that, even though this is all supposed to be standard, it isn't necessarily, in practice. Better to deal with the equipment on its terms than to say it shouldn't be that way.

In New York, we started out with two or three sets of Lynx controller gear, figuring we could just move them from room to room, as needed. It never worked. Ground problems, and so on. So every room has its own Lynx units, all settled down. We can guarantee that what is supposed to happen actually happens.

The newest addition to the facility is the room dedicated to the Lexicon Opus, which was our next stop.

**JK:** One of the interesting things about tapeless audio is that you have eliminated all those headaches about capstan and speed control, it's now just clock sync, and those are issues for which computers are the killer.

This Opus has two hours of stereo, but it can go up to six, eight, whatever you want. They seem to have put to bed the issue of sufficient time for a project.

#### LOADING SOURCE MATERIAL

**JK:** What has not been put to bed, and it's a real problem that I hear few people talk about, is loading source material in. At best, these systems seem to work in twice real time. For a twenty-minute audio/visual, or a forty-minute film, it takes a significant time to load your audio back in—unlike pulling a two-inch reel off the shelf, throwing it on a deck, re-winding it, and we're ready to go. We're used to booking sessions ten to twelve, twelve to two, two to six. If we tell the client that we're going to bill them extra half hours at either end of their session to allow for this, the client is going to say "Wait a minute! Give me that eight-track room; I'm just doing voice and a music bed."

There can also be problems in confirming backups. We have found that many times, after backing something up and loading it back in to just check it, that the tapes fail with no indication of failure while we were doing the back up. What am I supposed to do, discover that problem three months later when the client comes back?

Both New England Digital and Lexicon are working on improving that bug. Reliability is improving. Nevertheless, we archive everything analog as well as digital to cover ourselves. Next year we might be quite content with the digital machines in that respect.

In contrast to the Synclavier, the Opus integrates the recording medium with a console. I understand that the Synclavier people are building a console to work with their stand-alone tapeless environment. Meanwhile, however, the Opus doesn't have automation, so it almost makes moot the question of having a console. If you had a studio these days, would you buy any console that didn't have automation on it? No. Lexicon is promising automation by the fall.

**SL:** Upgradable?

**JK:** It will have to be upgradable. I'm pretty sure automation took them by surprise. They had no idea what an absolute must it is in the audio world these days.

The Opus has ninety-nine conceptual tracks, of which any eight you can call up and work on. You use submixes. For instance, we can call up seven tracks of birds, create a submix of bird ambience, then call up dialog tracks and do the same. And so on. Then, finally, we work with the submixes. What we really want is an automated mix without the need for subbing, so that we can work off-line, so to speak.

The Synclavier's strength is in the databasing of audio elements. It's very sexy. You just go out and record all these little noises that the client has brought in, or that you're lifting off sound effects libraries, or whatever. You scoop them up, you can trim them up quickly, it's all point and shoot, scrub. Meanwhile the machine automatically gives the segment a name that you can override.

**SL:** How useful do you find the visual display of segments?

**JK:** We tend to do it the old way: by ear. We scrub and listen for modulation, end of modulation, and mark it. Nothing is destructive. Opus has what are called Safe Segments. When you put things in, you create safe segments that are locked. Everything else is just a duplicate of that, so to speak. But the duplicates don't take up more memory. The duplicate is just a new set of pointers to where you begin and end play back from that Safe Segment.

I think the fact that audio people have spent years learning to use their ears took these computer people by surprise. Good audio engineers don't need visual confirmation. Just give



them a tool like a scrub wheel, that's all they need. Another nice feature in the Opus is its cross-fade editing.

**SL:** You clearly have a range of approaches to post production covered.

## MIX-TO-PICTURE

**JK:** As we grew, it became imperative that all our rooms have mix-to-picture capabilities. It's no longer a speciality of one room. But it's easy to get very chauvinistic about doing it the new way, when some old down and dirty ways are all that's called for. The client is not buying into this because of the experience, he wants to get out of here.

**SL:** He wants product, he doesn't necessarily want to learn the systems.

**JK:** Right. You know, we thought our Synclavier clients were going to be the high-end people, the people from the big agencies, who have been working on a spot with a \$150,000 budget for the last three months. Now is their final audio day. They have got all day booked, and are going to spend a ridiculous sum of money to do what could be done in forty-five minutes. Because there are going to be twelve chiefs and no Indians, we'll have to accommodate everybody's little whim over the course of the day. Tempers are going to flair. We thought that the client was going to want the Synclavier, because anything less wasn't good enough for his project.

In fact, even though we were right to some extent, the people who are really buying into this technology are the people from the retail stores, like the Star Market and Stop and Shop, who do a job every day. The Boston Globe comes here daily for a radio spot. If we can get them done in ten minutes instead of twenty minutes or forty-five, great.

I'm really intrigued that it's the low-end guy, just doing business as usual, who wants to use this equipment. It makes his life more pleasant. I have been doing this for twelve years, and have grown not to enjoy non-music audio production. There've been many reasons, but this new technology has eliminated them all. You can work as fast as your mind can possibly handle.

**SL:** At considerable cost.

**JK:** OK. A problem in every aspect of music media is that, though it's always been a big commitment to get into this business, it used to be more generally rewarding.

**SL:** The rate structure has gotten so crazy, in music studios especially.

**JK:** No one is doing well, but those of us who know we are not doing well are the old guys who are looking forward to retiring from the business. The young guys are just ecstatic that they can be doing what they want to do, and they can make an extra five hundred bucks per month or a thousand bucks. They don't quite realize that they're not really running a business.

**SL:** The concept of return on investment separates the people that are playing from the people who are actually doing business. In 1970, one studio in Boston offered four-track audio at sixty five dollars an hour. Now you can get twenty-four track for thirty, or less.

**JK:** We are constantly figuring out how to keep ahead. Not everybody is going to be able to buy an Opus System. So the little guy on the block is going to have his Macintosh and Sound Designer tools. Currently that's a two-track format. But next year it will be eight tracks. What is the difference between that and this? None, except that my machine will work a little better, it will be a little more rugged, it will be faster. I've got to keep buying into the difference the high-end makes.

Both Synclavier and these people now can talk digitally to another.

Not the labeling information, but you can port track elements. We'll go to the Synclavier, grab stuff on DAT, then bring it in here and throw it into the Opus digitally. I'm real excited about this.

One of my busiest clients is a Boston-based global information company. They are a twenty-nine nation company, and everything they do has to be in four languages. They are just going crazy with work. And this kind of thing is perfect for it. To be able to do a video, and then, on another track, do the French, Italian, and the German, and slip and slide around because all those languages take different amounts of time to say what usually is quickest in English. That's what I see this kind of equipment just being a killer at.

## INFOMERCIALS

**JK:** In the corporate world, video is replacing paper right and left, with infomercials. Everyone would prefer to have information spoon feed to them. Some companies have closed-circuit TV running infomercials all day. They need this kind of production and ability. And they are going to need the young guy who knows how to run it.

**SL:** How do you think that will affect Soundtrack?

**JK:** Definitely adversely, but I think there will always be room for us because we will always be better.

**SL:** They will probably be more specialized.

**JK:** We are always doing everything under the sun, so we are always able to have a slightly higher vision about what this job needs.

**SL:** What you're talking about is a particular niche of corporate needs, as opposed to, say, the creative aspects of advertising. They probably still would not deal with ads.

**JK:** But that corporate thing is where all the growth is going to be in the next ten years. Anybody who is in this business should be lassoing their corporate neighbors. The video houses already know about this, because corporate video is what has kept them alive. But I think they may start suffering, because video has become so big that the corporations need to put it in-house.

**SL:** Do you still do straight music projects after hours?

**JK:** Yes. Anybody who comes to us and says John, I've got a client. I would love to work here. What can we work out? If I know you're going to be here every hour, and you're telling me that these people are gentlemen, and you just need my equipment, of course we will work out something.

I come in here and tread water from nine to five, and as soon as this place cools down, I've got three artists I'm working with, a Jazz artist, an R&B artist and a rock artist.

**SL:** So you're still pursuing music?

**JK:** Yes. Though Soundtrack has yet to break the record deal nut. We haven't signed a single artist. However, on another level, Critique Records are starting to use us a lot. The reason they stayed away from us before is because they thought we

# NEW AND BETTER THAN EVER!

## The Best Book In The Recording Industry Is Now Even Better!

Completely revised and up to the minute; this  
is the book you must have.

*Revised by Alan P. Kefauver, director of  
recording at the world famous Peabody  
Conservatory of Music, this book is for  
everyone who is involved in recording.*



This book has information on:

- DIGITAL
- MIDI
- AUTOMATED CONSOLES
- SMPTE TIME CODE
- AND SO MUCH MORE!

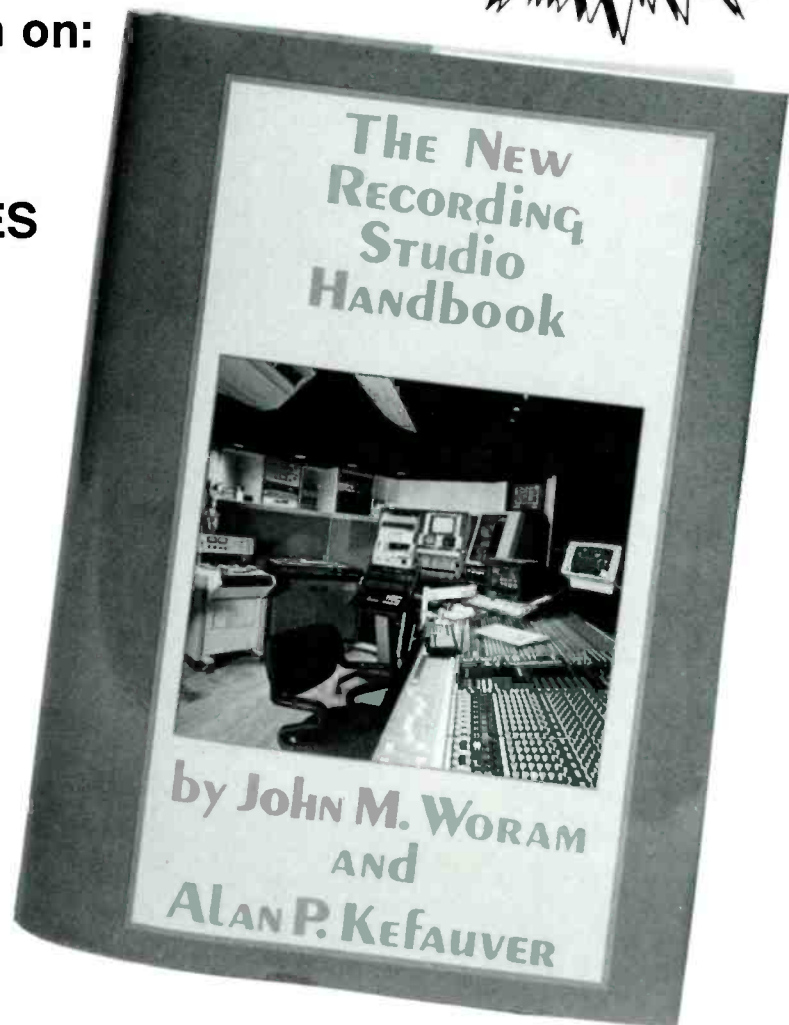

ELAR PUBLISHING CO. INC.  
203 Commack Road, Suite 1010, Commack, NY 11725

Yes! Please send me \_\_\_\_\_ copies of the New Recording Studio  
Handbook @\$44.50 per copy. Add \$2.00 for shipping. (New York  
State residents please add appropriate sales tax.)

- Payment Enclosed or charge my  
 Charge Card (Visa/Master Charge only)

Acct # \_\_\_\_\_ Expiry Date \_\_\_\_\_

Name \_\_\_\_\_

Address \_\_\_\_\_

City \_\_\_\_\_

State \_\_\_\_\_ Zip \_\_\_\_\_

Signature (required for charge cards) \_\_\_\_\_

Outside the U.S.A. add \$3.00 for postage. Checks must be in US  
funds drawn on a US bank.

If you are not satisfied you can return your copy in good condi-  
tion in fifteen days for a full credit or refund.



# MICROPHONES!

At long last, all the questions you ever asked...all the problems you ever grappled with...are answered clearly and definitively!

## The Microphone Handbook

In 256 fact-filled pages, liberally sprinkled with over 500 illuminating photographs, drawings and diagrams, John Eargle covers virtually every practical aspect of microphone design and usage.

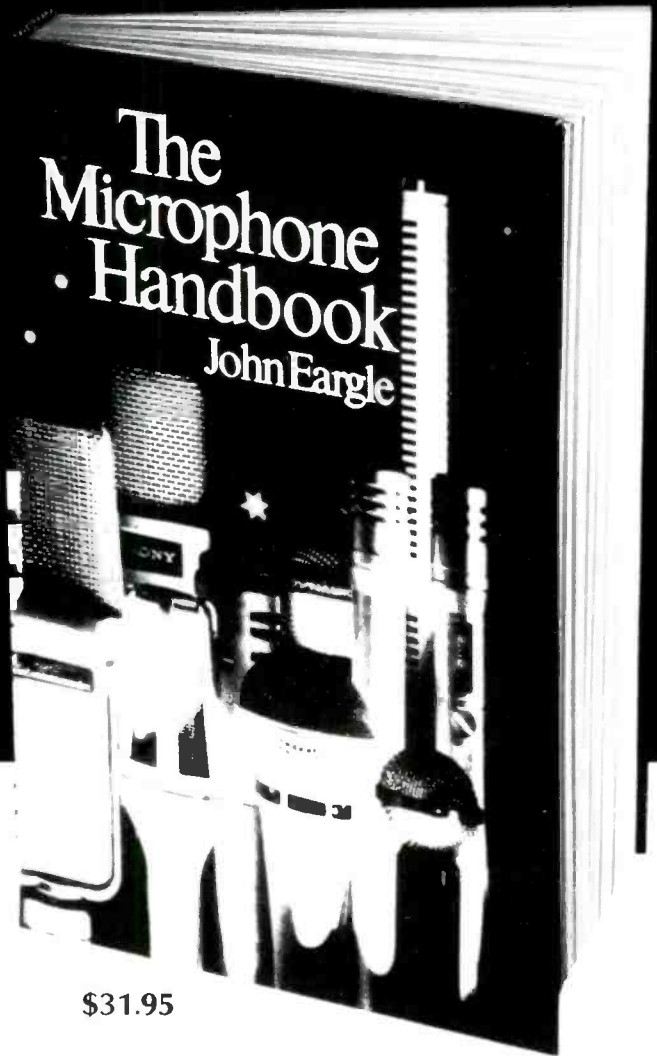

\$31.95

Completely up to date, this vital new handbook is a must for any professional whose work involves microphones. Here are just a few of the topics that are thoroughly covered:

- Directional characteristics—the basic patterns.
- Using patterns effectively.
- Microphone sensitivity ratings.
- Remote powering of capacitors.
- Proximity and distance effects.
- Multi-microphone interference problems.
- Stereo microphone techniques.
- Speech and music reinforcement.
- Studio microphone techniques.
- Microphone accessories.
- And much, much more!

**THE MICROPHONE HANDBOOK. You'll find yourself reaching for it every time a new or unusual problem crops up. Order your copy now!**



**JOHN EARGLE**, noted author, lecturer and audio expert, is vice-president, market planning for James B. Lansing Sound. He has also served as chief engineer with Mercury Records, and is a member of SMPTE, IEEE and AES, for which he served as president in 1974-75. Listed in *Engineers of Distinction*, he has over 30 published articles and record reviews to his credit, and is the author of another important book, *Sound Recording*.

ELAR PUBLISHING CO. INC.  
203 Commack Road, Suite 1010, Commack, NY 11725

Yes! Please send me \_\_\_\_\_ copies of the Microphone Handbook @ \$31.95 per copy. Add \$2.00 for shipping. (New York State residents please add appropriate sales tax.)

- Payment Enclosed or charge my  
 Charge Card (Visa/Master Charge only)

Acct # \_\_\_\_\_ Expiry Date \_\_\_\_\_

Name \_\_\_\_\_

Address \_\_\_\_\_

City \_\_\_\_\_

State \_\_\_\_\_ Zip \_\_\_\_\_

Signature (required for charge cards) \_\_\_\_\_

Outside the U.S.A. add \$3.00 for postage. Checks must be in US funds drawn on a US bank.



Figure 5. Soundtrack's John Kiehl standing and mix engineer John Nagy at the Lockup Room console.

weren't interested. Now they're coming in.

We have weaknesses and we have strengths. I'm not interested in fixing all my weaknesses, because it would cost too much. And whatever my weakness remains, you can solve that across town, then come back and take advantage of our strengths. So go ahead and do that.

**SL:** Do you do most of the non-commercial music at night?

**JK:** Yes.

**SL:** How do commercial music and post rates compare?

**JK:** Music to sound track means our jingle business. When we are doing music we charge New York rates, two hundred and sixty bucks an hour. Our feeling is that you have chosen Soundtrack. And at the same time, if one of my clients says John, I've only got two thousand dollars to do this, no problem. I'm able to some how work that out.

Unlike New York, we have never really priced ourselves on how much the room is worth for an hour. In working out a budget, we say this is going to be six hours of studio time, that's two hundred and fifty bucks an hour roughly. That is what jingle rates are in New York, and we figure if you're not going choose Soundtrack, you will probably go to New York or LA, or one of the big jingle houses. If that wasn't your intention and you're going to go to one of the smaller jingles houses in town, then

clearly you're on another financial level.

**SL:** So for post, what are the rates?

**JK:** Our post rate is one hundred sixty an hour. In all three rooms. There's only so little you can charge for this service, because you have so much invested in it. What you really want to sell is the surgeon, not the operating room.

**SL:** That sounds pretty low, actually.

**JK:** Video houses charge a lot more, sometimes. Our client is not going to go for a huge premium to work with this technology. But I know what's going to happen. I know that kids across town are going to go out and buy a WaveFrame for forty grand, and sell it at thirty-five an hour. And if they do just a halfway decent job I got Bill Bookheim from a group of four young Berklee kids who each pooled about ten grand and bought an incredible MIDI pit.

### SOME BACKGROUND

**SL:** How long has Bill been with you.

**JK:** A year. He and his partners would come over every few months, telling me about this client and that client, and then they'd say but John, we're not getting anywhere. We want the big accounts. My response was, if I had had what you have in my first year of business, I would have been ecstatic. I couldn't make them see that no one is going to give you the big account. Forget that. What you

need is to get in bed with little agencies, little guys who will become the big accounts over ten years. That's what I did.

I got involved in this business when the recession was in full swing. There was a reason not to go to New York all of a sudden. People were forced to look to home for suppliers. So I just proved myself. They weren't little agencies at the time, even then, but still they weren't super-sophisticated production-wise, the Humphrey-Brownings and the Hill-Holidays and the Cabots and the Arnolds. I proved myself while they developed the confidence that they really could do this themselves, that they didn't need some big name director in New York putting the stamp of approval on their creative ideas. After all, there are only a few ways to put up a microphone. And how deep can a deep male voice go? You don't need that guy in New York. There are three or four men in this town who have that sound.

Fortunately, we came along at a time when the economy forced people to look closer to home. We proved ourselves and grew that way. But to this day we still don't get invited on the big stuff. They still go to New York.

**SL:** How is the New York facility doing?

**JK:** Very well. But when you say music in New York, you're talking record product, Debbie Gibson and so forth. That is weird for us. We have four rooms there with giant SSL consoles. Three of the rooms are forty-eight track Otaris. One has a pair of Sony twenty-four track digital machines. What's weird is that we are not involved with what goes on in the room at all. Personally, it seems we might as well be in the restaurant business.

**SL:** So you're just renting out space?

**JK:** Right. That's so different for us. For us, our facility was our workstation. Rates are so competitive down there. I think our rate for music in New York is \$1,400 for a twelve hour block. A long way from \$260 an hour. And, quite honestly, that's a negotiable rate.

**SL:** Why did you folks decide to set up there?



**JK:** Personal ego gratification. It was always our goal to be record producers when we started out.

**SL:** So you were aiming at the record thing specifically, or was it expansion?

**JK:** We got real comfortable with what had happened to us in Boston, which we just fell into. And we were smart enough to recognize that in fact a big part of audio is not music. We thought, let's go down to New York and do the same thing. Let's be one of the few in New York that does music and non-music. To some extent we are very happy with what Soundtrack-New York is. It's one of the select studios that the big jingle houses use when they need a jingle. Many of them create the product out of their living rooms, nowadays.

Our bread and butter in the Big Apple is the re-mix guy, the young twenty-four-year-old who was a DJ last month. All of a sudden, he's been entrusted with a Grace Jones re-mix because she has a hit. And they don't trust the album producer to do the re-mix, because what does he know about being in dance clubs? So they give it to this young kid. He gets a couple of grand and we make a couple of grand and everybody's happy.

After three years, he's twenty-eight or thirty, and he's now in charge of Grace's whole album. So he comes to us. He loves working with us, because we worked with him. It's the same thing I tried to teach these young kids up here in Boston. You start humbly, and it takes time.

**SL:** You grow with your clients.

**JK:** New York definitely has three things going. The esoteric record thing, which we have little to do with creatively. Our own little jingle business, which has really never taken off because we just haven't had the manpower to pursue it or the energy to put up with the bull that surrounds it. And we have our non-music mix to picture stuff. We have a Synclavier room, we have a room with Lynx units and an automated Sony console, and we have a young guy from Universal in Chicago, who has done everything under the sun. He knew he didn't want to be a music engineer and knew he loved to do this kind of work.

Again, a main reason you would come to Soundtrack here is because you like working with one of our

people. It's been harder to get that concept working in New York. They want to know that your specialty is recording live drums, or your specialty is recording drum machine, or your specialty is playing the acoustic guitar.

## THE COUNTRY CLUB

**JK:** We call this the country club. Any of our staff who have worked down in New York can't believe how relaxed it is here. No one is in a rush. Nobody is putting pressure on us. On the other hand, the New York staff still doesn't understand the ad man, still doesn't understand his needs or how you mess up. You don't mess up by distorting the tape. That's never a mess up in the ad world. You mess up by typing his name wrong on the label. You mess up by not getting the dub to the radio station at the set time.

We've already made all those mistakes, and have been slapped around up here for ten years. When we make the mistakes now, we know them, and we scurry and pick up. In New York they don't see themselves making a mistake. But then again, in New York, their machines are always aligned. The two-inch in every room has virgin tape on it, with tones already printed. You're never going to find that here.

**SL:** A matter of form.

**JK:** Totally. So Rob and I take pleasure in seeing the two versions. We try to make one affect the other. But at some point, there are too many people to push in a new direction.

**JK:** Many of the other places here that you might be talking to are video houses with a captive audience. They already got the guy for thirty grand, so why not finish the job off? When someone brings a job over here I know they're choosing us because they feel we are a little more dedicated to the audio issues.

Maybe that means we have a better library, or maybe they know that if they suddenly feel the need for a synthesizer *zip* or *zap*, that I am here, or Bill's here, and we can whip it off. So when it comes to mix-to-picture, one of the things that makes us different is the concept of having in-house musicians. And people come here because we work with them.

The young guy reading this article who dreams about getting into the business, or the guy who has been in the business five years or three, but still hasn't flourished, has to tune into the fact that no matter where he thought he was going, that's probably not where the business is headed. If he starts tuning into what is really going on, he'll start flourishing like crazy. You're going to have to help the corporate client understand his needs, and that you're the answer to his needs, a bit like the Music Man.

There's a real need, and it's growing by leaps and bounds. Those of us who have been fortunate enough to work with these people are going after it. The digital workstation is incredibly elegant. It's something you can get into inexpensively at the small end. There's a client base that only needs that lower level of sophistication. Over time, you can grow along with your client to larger things.

The awards festooning, Soundtrack's corridors are a quiet but hardly mute testimony to the success of their philosophy.

## EQUIPMENT

### Lock Room

Console: Harrison MR4

24-track: Otari MTR90

Mixdown: Studer A810 with center track time code

Lock: Boss Controller, LYNX synchronizers for 1-in. or 3/4-in. video

Outbound: SPX 90, BBE 822, (2) dbx 165A, Ashley parametric EQ, Orban de-esser

Video: Sony BVH 1100A, JVC 3/4-in 8250, Sony 3/4 U-matic 1/2 VHS

Monitors and Amps: Bryston 4B, Urei 309

### Blue Room

Console: SSL series 6000 with total recall

24 track: Studer A800

Digital Workstation: Synclavier Post-Pro and synthesizer, 16 track D-T-D, 12-in. laser disc, 24 sampled voices, 8 FM voices

Mix: Mag dubber, DAT Sony 4500, Otari MTR 10 2 TR

Outboard: Lexicon 480, PCM 70, SPX 90, Harmonizer H3000, Rev 7, (2) LXP-1, PCM 41, Prime time, BBE 822

Lock: LYNX synchronizers for 3/4-in. video

Video: JVC 3/4-in. model 8200

• The newest arrival on the media scene in Boston is Editel. Well-known around the country, Editel has major operations in New York, San Francisco, Chicago, and Los Angeles. Editel's owner, Scanline, bought the Century III production facilities in Kenmore Square last year, moving in in October. Construction is still in progress in their Beacon Street building, as they revise and improve the setup. Buying out a long successful studio complex meant that they would be up and running almost immediately, with an excellent staff already in place. Don Berman, president of Editel-Boston, explained some of the attractions during our first meeting:

"When Scanline tries to grow, they look for a complementary facility. They don't want to simply recreate what they have. One of the things we saw in Century III is Digital Images, a national graphics company that does television IDs in addition to the post business. Another was the audio. Ross Cibella (Century III's owner and founder) had a big interest in audio. In some of our other facilities, we found that audio was a growing area while graphics work system capabilities were starting to level off. Mix-to-pix and custom-designed music up-front was becoming critical."

### FULL TIME COMPOSER

"A third thing we liked about this operation was the presence of a full-time composer, a staff position the market is driving us to include. Many composers I've talked to like sitting in front of real instruments, and never dreamed that they'd be sitting in a digital room, able to call up all these sounds. Once they get in there, the things that come out are just incredible. And the insistence on real instruments goes away. They have the freedom to compose in a completely different environment, from a different perspective, and have complete access to everything.

Monitor and Amps: Bryston 4Bs, UREI 813B, Yamaha NS10, Tannoy PBM 6.5

### OPUS

Digital workstation: Opus

## EDITEL BOSTON

It's probably the fastest-growing area in our organization.

"I think some people look at audio as a low ticket. But clients don't focus on that in a post facility, because the film-to-tape chain is \$600 an hour and an edit suite could run as much as \$900 an hour, depending on all the bells and whistles you add on. Yet an audio suite is an audio suite. We have some pretty high-end equipment, but for us the audio department is really people-driven, and that's why clients come to us.

"I would say that one-third of our business is post-related, one third is graphics-related, and one-third of it is audio only. In the audio department, total projected annual revenues are about \$800,000.

Our San Francisco operation took a close look at what's going on here, and put in similar rooms. New York is now looking at it. I don't think if you're a post facility, you can open up tomorrow as a music facility. But here, audio was already an established business."

The audio portion of Editel-Boston's facility currently includes a 24-track mix-to-picture room; a library space for clients who need to screen voice talents, stock music, or sound effects; an 8-track studio for radio production and voice work; plus the space in which, two days later, I had the opportunity to talk at length with Mike Szakmeister, the head of audio, and engineer Bob Reardon.

The music production room where we met is small, but packed with gear. Used primarily for music composition-to-picture, and as a pre-composing workstation for jingles, it locks up to all the rest of the studios. We spoke about the exploitation of this equipment, their operational philosophy, and their feelings about the newer technologies.

**BR:** The DMP-7s offer more programming than an SSL, because you can automate the EQ and sends in real time. They have some nifty

Mixdown: DAT Sony 4500, Otari MTR 10

Video: 3/4-in. (playback only) PB5000 Sony

Monitor and amp: Yamaha P2075, Urei 809

Reverb: Lexicon 480L

things, such as simultaneous positive and negative variations of a parameter. For instance, they can be used to do doppler shifts. Or you can couple the pan movement as a positive variation, and have the negative variation be a mix of reverb. You'll achieve something that moves across and gets closer.

**MS:** Or a crossfade in one motion, one going down, one up; two different reverb parameters, for instance. Instead of Total Recall, we have a *reset* of everything. It's even a little beyond the Harrison Series 10 or Trident Di-An. All the reverb and EQ parameters are continuously variable, automated, and glitch-free.

**SL:** Does this program only run on Atari?

**BR:** There is a version coming out for the Macintosh.

**MS:** Not available yet.

**SL:** Are there any problems?

**BR:** With the Mac, the Atari, the IBM, and different brands of boxes like the Akai S-1000 and MIDI, getting samples from your editing environment to the sampler storage gets a little funny at times, given that some stuff is SCSI, some stuff is RS-422.

**MS:** You need to have a separate computer for the automation. There's a lot of continuous controller information. With all the controllers and the MIDI datastream, you just have to separate some of the tasks onto different computers. Otherwise, you could go nuts.

**BR:** We were previously doing the console automation in Performer 3.0, along with the music sequences, but it binds up. The new Performer has some great features, though. You can edit velocities on final screen, draw a controller, and assign switches that are not defined control numbers of the MIDI spec. The name of the game is getting all these boxes to talk to each other.



**MS:** You need to arrive at a standard configuration, and then become accustomed to it and make sure that it works. That's why we have 32 voices of Alesis drums, so that the mapping stays the same all the time. No matter what file you call up, you've got the right percussion there, you've got everything. If you mess around with pad and voice assignments, from file to file, then you won't have a reset, which is a main feature of this room; instant total reset of mix, EQ, reverb, voice assignments, everything. (Call up a file, press a button. It configures everything, and you're ready to run.)

The Trident Di-An is a definitive multi-track console, but what about all your outboard stuff? If a client is doing film-to-tape transfer and they want to stop over to check the progress on the audio and make a few suggestions, you can try some things. Then the next client comes in a few minutes later, and you can go right back to where you left off on their project. In an environment where you have a number of projects going on at the same time, you don't want to waste that time. That's why total reset is key, beautiful.

**SL:** What about workstations?

**MS:** Well, the WaveFrame is a workstation, but it's not a disc recorder at this point. I'm not sure that we want it. It seems that the biggest problem is the load time. Something's got to be done about storing and retrieving the data faster. Another consideration is that of the weakest link. In the case of something that's all cut on film, sync sounds are cut with the pictures and perhaps overlapped or checkboarded, then down-loaded into your AMS AudioFile. Now we've got a perfect digital recording of a junky mag track. We add other elements, and then lay the result back to a not-so-great one-inch video audio track, and that gets dubbed onto a one-inch dub master, which is then dubbed further onto a bunch of VHS tapes.

**SL:** Generation losses.

**MS:** Right. You need a good perspective on your overall audio quality, in the long run. Workstations are fine, but expensive. And that cost is transferred to the client. I was just trying to point out a potential flaw in the whole idea of staying digital. You're only digital in that one step. If



Figure 6. Editel's 24-track mix-to-pix room. (Photo by John Garrett.)

instead of an AudioFile, we used 30 in./sec. 24-track, the difference is definitely going to be negligible.

**SL:** The processing, scrubbing, and timing features in workstations are mighty attractive, though, for some kinds of work.

**MS:** Right. In a video project, the issues are accessibility, speed and creative flexibility. There are things that you couldn't do any other way. That is really what should be looked at. Longer format stuff won't exploit the workstation optimally unless you have the original elements there anyway. There's little that can't be done with a high-powered, tape-based editing system such as our CMX or Boss. I see a workstation being more sensibly used in shorter duration projects: spot work and advertising, where everything is MOS, and you're building from scratch. Everything is clean.

You can get all your elements in there and move them around faster. But you still have to load everything in from, most often, tape. The elements come in on tape. In the amount of time it takes to feed everything into the workstation, you've already got it sync'd on a tape-based editor. Anyone that says that such a unit does everything better than anything else is definitely stretching it. I think it's important to have all these technologies—a digital workstation and high-powered tape-based editor, MIDI music composition, etcetera.

**BR:** When the time-code DAT players get here, I think it's going to change some of the things we're talking about.

## A VARIETY OF TECHNOLOGIES

**MS:** Anyway, the important thing is to have a variety of technologies and to integrate those technologies on a case-by-case basis in the most effective way. If you do all your gunshots on the WaveFrame and then drop a half hour's worth of gunshots down onto your multi-track format, you're done and out of there. Having different stations, different technologies, and well-rounded operators is paramount. The WaveFrame is excellent as a sound effects workstation. You can call up a huge library of effects online.

**BR:** It's kind of like Foley on a keyboard.

**MS:** Or you can do EDL style on the WaveFrame also. You can cut an entire spot on the WaveFrame—it's fine.

Editel-Chicago loves their AudioFiles. Editel-New York has decided it is not time for a workstation, yet. And I tend to agree with them, in terms of disc recording, because anything long-format in video would be edited on one-inch video tape and laid back to one-inch video tape—and whatever you've got in between there, as long as it's good and clean, digital or 30 in./sec., Dolby SR or whatever, is more than enough.

It's more of an operational matter: how quickly and effectively can you do things. Long-format stuff on a workstation makes a lot of sense if you're doing the same thing all the time like every episode of *Miami Vice* for instance, because you've got similar elements all the time. They stay loaded, you don't have to wait for





**MS:** Sure, but in terms of a video project, you feed everything into your Synclavier from whatever formats you have, and the workstation provides zero generation loss while you manipulate the sounds. Then you put that on your one-inch. It gets dubbed onto a protection master, which becomes the source for further dubs. Putting the first generation of your mix on both the master and the PM is a significant improvement. You lose more in dubbing one video tape to another than you do by using an analog 30 in./sec. 24 track.

So that's what we do. Being a video house helps. We make the PM first and roll CMX simultaneously, so the first generation mix goes onto the actual dub master, which really is the final product. The generation losses produced by editing sound in a video edit may eventually be avoided by relaying the original sound bytes from the camera rolls or the Nagra directly to your Opus, or whatever. It's time consuming, but a good idea, given the unavoidable losses further on down; the one-inch going to a three-quarter or one-inch broadcast dubs or something. We have to keep the chain in perspective. Right now, with C type one-inch video tape, I think the real issues in workstation or MIDI applications are speed of execution and creative flexibility.

**SL:** That echoes the attitude of houses I've talked to that do have these machines.

**BR:** Some other parts of the chain have to change before workstations become ideal.

### **A RAM SYSTEM IS STILL BEST**

**MS:** Hopefully, by that time, we'll have better ways of recording long-duration digital audio: removable optical discs and so on. Meanwhile, I think a RAM system is better than a hard disc recorder for given portions of a long-duration project. It offers more capability in terms of pitch, complex envelopes, and layering, though currently you can only do three, five, or ten minutes worth of stuff. AKG has a RAM system that acts like a disc recorder. We haven't gotten a disc recorder because I can't see that it would contribute much over the wise application of other technologies, in long format stuff.

**SL:** How is your music work proportioned?



*Figure 9. A portion of Editel's music composition room. (Photo by John Garrett.)*

**MS:** Two thirds is video related—the rest is radio and music for radio. No record stuff. We can get much better rates in our fast turnaround business than studios that are strictly music, some of which are peddling beautiful rooms for \$50 an hour.

**SL:** Their engineers often don't make much either.

**MS:** Back to the workstation thing. A disc-based editor is great for CD pre-mastering, editing, dances mixes, etcetera—it's super. There you're working on one project for a good deal of time and you've got long durations of audio, tremendous editing capability, and no fast turnover, with somebody new walking in the door a half hour later. Now if you want to talk about music-for-video, I think having a dedicated music room is important, and it's worked out tremendously for us. Our clients like having everything under one roof, though we hear that some potential clients are not yet aware that we have an audio facility here. Their experience in the past has been with video houses that have meager audio resources, which has accustomed them to using pure audio houses for their sound. What we have is an audio business within a video business: Editel Sound, with its own account executive, operations coordinator, four engineers (three with degrees in music), a music and sound effects specialist, and a staff composer, and a full service sound shop, with all the extra capabilities of

the video setup. In fact, quite a bit of the stuff that comes in the door isn't even related to video.

There are definite advantages to doing your project all in one place. You can stop in and pre-pro with the composer and music producer, and check the progress while you're going from your offline edit to your online edit, or while you're up in graphics working on a 3-D thing. You have more input and you don't have tapes chasing back and forth across town. Another advantage of being under one roof is that there's no question about who's responsible for the quality of the final product. If we handle the whole thing, then we'll do it right.

**SL:** And it's more synergistic.

**MS:** Right. It's also important for the picture editor to have something to go by, in terms of timing the scenes, and to see the direction and growth of the music itself. On the other hand, in composing music-for-picture, it's important for us to have pictures to make the music just right. The answer to that is a combination of pre-score and post-score.

**BR:** On the Reebok project, we gave the client a feel, a groove that they liked. It wasn't just cut to a click track. For a video editor, a feel is a lot nicer, more suggestive. So they cut to that, and when we got it on the other end, we dressed up the hits, and so forth.

**MS:** Nothing wrong with putting a big cymbal crash on beat two.

**BR:** Sure, they do it in reggae, right? (laughs)

**MS:** At the beginning of the project, we didn't know where the hits were going to be. Now we do, so we add the right stuff, and it sounds great and looks great. I'd like to mention something else about that, too. Scoring sound effects in a MIDI room, where you can record and manipulate digital samples, as well as access musical sounds, gives you more creative flexibility. There's less distinction between what is a sound effect and what is a musical cue. For a certain scene, a door slam may be exaggerated, tuned down, doubled or layered, and accompanied by a little bassoon note or riff. It ends up quite different from what you might strive for with an AudioFile or an editor system.

Certain projects lend themselves to that. One that comes to mind is a children's show for Channel 5, *A Likely Story*. It's a weekly half-hour series with a combination of sound effects, dialogue, and a lot of little magical things. In many cases those effects were done in this room, half musical and half literal. In some cases they had to match the music the client brought in the key, the tempo, and such. You'd be hard pressed to do that with anything other than a RAM system. Our MIDI keyboard-driven RAM system enabled us to get a lot done, much,

• There was once a heyday for multi-image shows based on 35mm slides. Who can forget *The New York Experience*, in the basement of the McGraw-Hill building in Manhattan, or *Where's Boston*, originally shown in its own pavilion. Slide A/V presentations were very much the standard tool in training programs and information dissemination for corporations and institutions. But times change.

Ten years ago, a young audio engineer working at Envision, a Boston A/V production house, struck out on his own to service the sound end of this media integration. Arklay King started small, setting up an audio pre facility in Copley Square that evolved, of necessity, into an audio

much better. Long duration ambiences, bird twitters and crickets, or just simple rock slamming. That can easily be done in an editing room. But it's in the more creative things, in musical and sound effects, that this room shines. Having the two rooms tied together is really the way to do it. We had an operator in each room, downloading back and forth, working on different segments simultaneously. In a single multi-track mix room with MIDI gear, you can't have operators and creators working at the same time so quickly. Having all these technologies, and being able to optimally integrate them into the various aspects of a project, will get you good product.

Editel Boston will complete their revisions and upgrades of Century III's old space by this fall.

### MIX-TO-PICTURE STUDIO

Sync'd SFX, ambient SFX, Foley SFX, music production and editing to picture, 1/100 frame accuracy, automated mixing.

CMX CASS-1 Editing System, MCI 636 32 channel console, Otari MTR 90 24-track, Sony BVU 800 3/4-in. VTR, Studer A-810 2-track ATR with time-code center track, Otari 5050 Mark III 2 and 4-track sync'd ATRs, NEC 650 CD player, UREI 811, Yamaha NS-10M and Auratone monitors, digital FX processors, reverbs, compressors, compellers, single and double ended noise reduction, and exciters.

## SILVER LININGS

post house as the market graduated from slide-based shows to video. Though still not very big, Silver Linings has grown to three rooms and is thriving.

Sitting comfortably with Arklay and musician/engineer John Kusiak in their largest room on a hot day last June, I started our discussion with historical background.

### SOME EARLY HISTORY

**AK:** The name Silver Linings came from an artists collaborative in my seminary days. Nobody there minded that I took the name, so I incorporated, and started primarily with sound tracks for slide shows. Slide shows hit their peak around 1985. Since then, that niche has been

## AUDIO PRODUCTION STUDIO

All tape machines controlled by a custom-designed remote. An Adams Smith Zeta-3 Synchronizer locks up picture or slaving decks from other suites.

MCI 618 console, MCI JH 110-B 1 in. 8-Track, Otari MTR-10 and MX 5050 ATRs, Studer B67 and Fostex 3-Track ATRs, Sony PCM 2500-A DAT and BVU 800 3/4-in. VTR, ReVox B-223 CD player, GoldLine ASA-10C spectrum analyzer, UREI 811 and Auratone monitors, plus delays, compressors, compellers, digital reverbs, single ended noise reduction, and exciters.

### DIGITAL MUSIC ROOM

Accelerated Mac SE, Performer 3.0, (3) Yamaha DMP-7s, an Atari ST with 45 M removable disc running Steinberg's Desktop Mixing program.

(3) AKAI extended memory S-1000s with digital I/O, 400 M hard disc and 45 M removable discs, Korg M-1R, Roland D-550, Kurzweil K-250, AX+ and PX+, (2) Oberheim 1000s, (2) Alesis HR-16 drum machines, Yamaha TX-802 and, Emulator Proteus, Roland A-80, Octipad II, D-50, D-550, Steinberg SMP-24 Interface, OpCode Studio III, Lexicon LXP-1 & MRC, Drawmer gates, AudioArts parametric EQs, dbx compressors, Fostex E-2 center-track ATR.

taken over by video, I would say. In 1984, I bought a synchronizer and started doing video sweetening.

**JK:** But Silver Linings still did slide shows, primarily.

**AK:** Right. Museums, sales presentations, big sales meetings. Video was then still too expensive. Nobody wanted to buy all the equipment. At the bottom, in terms of cost, were slide shows. Above that, video, and higher still, film. The slide show, back then, was the most cost efficient and easily changed format.

**SL:** But everyone had to rise to the next level.

**AK:** Definitely. We had two studios doing just those sound tracks. We have a real good reputation for doing that kind of evocative work. We have



a very large music library, with a lot of sound effects. Even though I'm not a musician, I have a good memory, and I'm good at using existing music.

**JK:** When the scene changed, some A/V producers moved into video. Those people still come to us for the quality of our work, though they may have done their video at Editel or Target. Otherwise it would be difficult for us, since the video houses, of course, want the clients to use their audio setups.

**SL:** John, you came on later?

**JK:** I came in (in 1984), and we built another room. I came at it from the other end, as a working musician and composer doing music and sound tracks. After a couple of years the A/V business began to slide, and I moved into more original music and audio post. The two go hand in hand. With A/V multi-image sound tracks, the music comes first. You program your slides to it. So stock music works real well. But in scoring a video, stock music can be a problem.

**AK:** In 1985, 1986, the client base was changing. Producers who had been pumping out a lot of slide shows began to turn to video. The core of our business was changing, and we wanted to get back into a niche. Original music and video post seemed the best ways to go. We tried talking books, but that was a bomb. We were already too big for that to pay off. It's best left to small solo operators.

**SL:** You don't get involved with record work.

**JK:** No. But we have a relationship with a stock music library in Toronto. We provide them with original music for their CDs. We record it here, using synthesizers and players, whatever we need. But that's probably only 15 to 20 percent of our business, in terms of time.

**AK:** It's actually an investment.

**JK:** It's a typical fifty-fifty publishing deal. It'll get shifted, if time doesn't allow. We also do personal in-house projects as well as occasional after-hours music projects for others. But few musicians can afford the rates for this studio during the day. You can get twenty-four track in town for pretty low rates. The top rate for this room is \$100/hour, and \$125 for video sweetening.

**AK:** I've been thinking of the other groups you've talked to. Soundtrack is a big place! I think we're sort of unique, more of an audio boutique. The bigger video houses you've been talking to will sell whatever product they have for audio, rather than let that producer out the door. Perhaps saying, "if you do your audio here, we'll give you a break on the video." We came very close to moving in with a big Boston video editing house last year as their audio end, but at the last minute we got concerned about losing our identity in such a large operation and pulled out. They set up their own sound studio. In our search for a niche, we've had a lot of luck with cable TV in New York. The Chronicle show was recently sold to the Arts and Entertainment network. We're replacing a lot of the

music in that show with library music. We're ideally suited for that because of the size of our library.

**JK:** There's no one in New England with a library this size.

**AK:** I started this library fifteen years ago. I've got all the old stuff, including records one can't get anymore, and I keep them up to date.

**JK:** And all the sound effects libraries that we know of in the world—

**AK:** We have them. Anyway, this worked out really well. It was a lot cheaper for them to send their tape to Boston than it was to use New York. Now we're working on post production for Esquire's cable show. They ship us the finished tape, fax us the notes for what they want, we do it, and send it back.

**JK:** We did a hundred shows for Chronicle, and we're doing another seventy-five starting soon. So these are major projects that go from six months to a year.

**AK:** Which poses a problem: how do we budget the time?

**SL:** Yes. A lot of houses deal mostly with projects that are in and out far more quickly.

**JK:** Sometimes these clients are late on their production schedule, so we may have to shift the date scheduled for them, only to find that another client who wanted that date isn't there anymore.

**AK:** Mark Humphrey, our youngest staff member, is in the third room right now, handling a mammoth dubbing project for Disney's World of English, a program that teaches

Figure 10. Floor plan of Silver Linings.

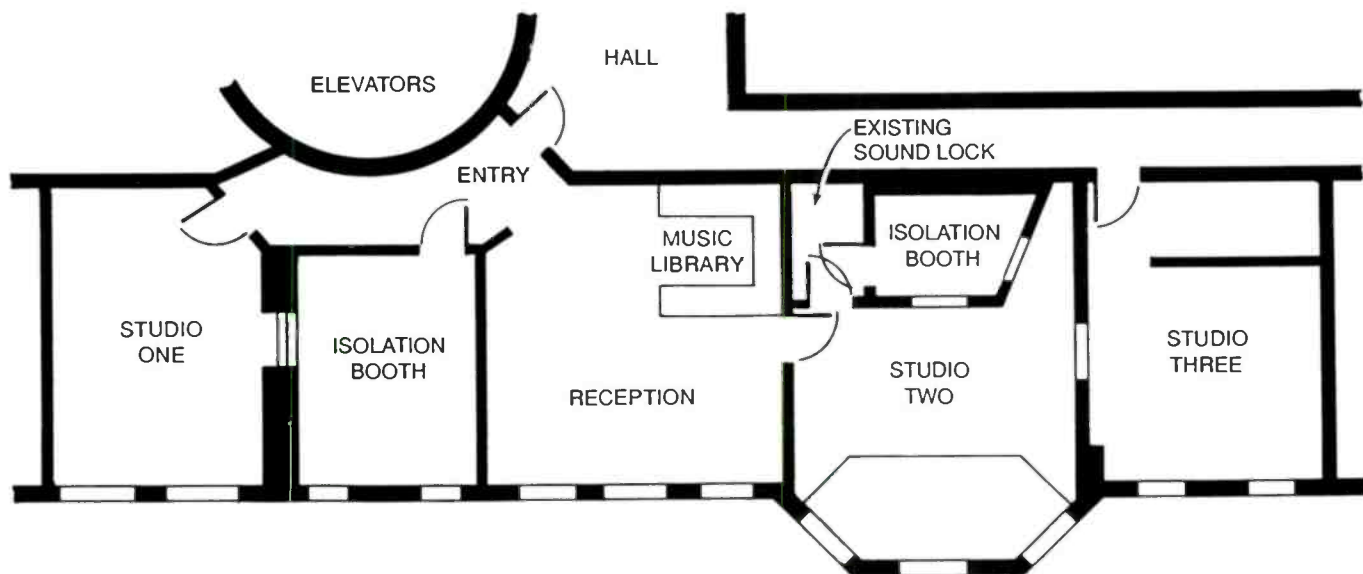



Figure 11. "John's Studio." Left to right—Mark Humphrey, John Kusiak, and Arklay King.

English to Japanese kids. The tapes were made over a ten-year period and they didn't store them properly. Now all of them have print-through. They can't go back and re-record them, because it's all Disney characters, and would cost a fortune. So we're cleaning up all the print-through, all 57 hours of tape! Mark's starting to talk a little funny.

**AK:** I think we're one of the few places that charge by the person, rather than by the equipment. I cost more than John, who in turn costs more than Mark. So far, that approach seems to have worked.

**SL:** Most of the people I've talked to recently who are involved in post work have indicated that a transition to digital, for their multi-track sessions, is unlikely. In fact, that step may end up being skipped, as disc-and/or RAM-based workstations become more accessible.

**JK:** I think we work more quickly than if we had a workstation. By the time we could finish loading in a lot of stuff for a five minute item, we'd be done with the project. Arklay is one of the fastest engineers I've ever seen. And the other thing is, though I love this Macintosh, I don't want to sit in front of a CRT all day long.

**AK:** It seems to be turning out to be more and more dangerous

**JK:** I like moving around and working with tape and razor blades.

**SL:** DigiDesign's and WaveFrame's system have some nice features.

**AK:** We saw the WaveFrame system. What overkill! We had a Synclavier here for a while. It just took so

long. It makes repeating the same thing thirty times much easier. But to do each effect once. You can usually fly that in by eye and ear.

**JK:** When I'm placing effects that have to be perfectly timed, I load them into the Kurzweil and sync them up with Performer and SMPTE, and it works fine. If I'm laying in traffic ambience in the background, why load it into a sampler? I can fly it in from a CD, cue it up, and lay it in. Most of the time the sampler approach would take me two or three times as long.

**SL:** The workstation learning curve can be pretty steep, initially. Do you think your opinion would change once you get through that?

**AK:** Given that we are at the bottom of that learning curve, I can't be sure. But it seems to me that one still needs more time for loading than we get.

**JK:** It depends on the job. If you are going to be doing some forty-seven spots that are all going to have the same effects, and one different tag, it would be much faster. There have been only a few times when a workstation would have been appropriate here, as I see it. For most of our things, I doubt it would make things better. With dbx and careful attention to signal level, we maintain very high quality, especially going to videotape. How can you get any quieter than dbx?

**AK:** We use dbx noise reduction on all analog tracks, except the ones that go out the door. And we have four DATs, with their invaluable indexing features, for all narration recording: one portable and three

console. So this is a very quiet studio. It's already quieter than digital tape. I don't feel we've compromised on quality. And I don't want to be under that kind of overhead, dead weight, for something I don't really need.

**JK:** Not having a digital workstation or an SSL board helps keep our overhead low, and also wards off the work we don't want to do. We could put ourselves into serious debt with that kind of equipment, but then we'd have to take every single job that comes in, and would have to hustle the work.

**AK:** We don't have an account executive. I always hated being in the position of having someone else sell the job. And having the client, sitting where you are, say, "but they told me I was going to be able to." Then I get to disabuse them. The image I have of this company is of select, high-tech craftspeople.

**JK:** It's just the three of us (AK, JK, and MH). King Features, for whom we're doing the Chronicle and Esquire stuff, really enjoy working in a situation where they know who they're going to talk to each time that they call. They always get either Arklay or me. We know exactly what's going on, and we really care about what we do. They love it!

**SL:** People are the difference.

**JK:** We don't have an SSL or exotica of that level, but we have the know-how and the equipment to handle most any problem that comes in here. What comes out of here sounds good. You don't always need all that equipment, and you may not have the people who really know how to use it. I'd love to get some of the newer machines, but we can't afford to keep buying more synthesizers. I've actually found that not having them allows me to fully plumb the depths of what I do have.

**SL:** As opposed to exploiting these synths in a shallow fashion, then thinking that now you need a newer item.

**AK:** This may be the only ARP 2600 still in existence! (laughs) You can't buy a synthesizer now with a white-noise generator in it. So if you want to make a *Pooffshsh!*, you can't do it with a modern synthesizer. With the old ARPs, you can.)

**AK:** This has been an interesting experiment for all of us. We've wanted to stay the same size; we've



all worked together for five years now. And if we can make a go of it as a little company that takes care of the clients and the people in it, I think that's real exciting.

### SILVER LININGS EQUIPMENT LIST (PARTIAL)

#### Audio:

(2) Sound Workshop Logex-8 mixing consoles  
Ramsa WR-8210A mixing console  
(2) Otari MTR-90 2 in. 16-tracks  
(2) Otari 5050 BQII ¼-in. 4-tracks  
(3) Otari 5050 B ¼-in. 2-tracks  
(1) Tascam 40-4 ¼-in. 4-track  
Panasonic SV3500 DAT  
Sony DTC-1000ES DAT  
Sony 500 DAT  
Technics SV-MD1 DAT  
Nakamichi DMP-100 Digital Processor  
(3) Technics SL 1200 turntables  
(3) Technics CD players  
52 channels of dbx Type 1 noise reduction

• By the early 1970s, Ace was no longer "the Place" when I first dropped in. Boston's oldest recording studio was selling their vintage microphones, their huge three-track Ampexes, their Presto disc-cutters, and anything else they could cash in. Over the years, it had produced, among other things, the minor hit "Psychotic Reaction," noted recording engineers Shelly Yakus, and Peter Fasciano.

Though he came from audio, Peter took off into the video business, and became, according to some, one of the local *enfants terribles*—the guy with the wild ideas, the guy who would wear a clown nose to a session. He set up a two-inch Quad video edit suite on Sleeper Street in East Boston, one of only two or three in town at the time. In 1979 he moved Vizwiz to the current location on Dummer Street in Brookline, near Boston University, eventually expanding to four video edit suites, a large production studio, two Quantel Paintbox rooms, and an Alias 3-D animation space. In September of last year, Vizwiz opened their newest addition, an audio post suite equipped with a Neotek Elan console, JL Cooper

(3) Burwen transient noise filters  
EAW MS-50 and Auratone monitors

#### Processing:

Orban de-esser, parametric EQ, stereo synthesizer, stereo limiter  
Ashley stereo parametric EQ and noise gates  
UREI limiters  
Aphex Compellor  
Aphex 612 expander  
EXR Aural Exciter  
Alesis MIDIverb  
Ursa Major Space Station  
Klark Teknik DN-780 reverb  
Eventide Harmonizer  
Yamaha SBX-90

#### Microphones:

Neumann U-89s, AKG C-451s, EV, Shure, Sony, and others

#### Video:

Studer A-80 1 in. layback recorder  
JVC CR-850U ¾-in. VTR  
JVC CR-8250U ¾-in. VTR

Panasonic VHS VTR  
Sigma color sync generator  
TimeLine Lynx time-code modules  
BTX Shadow II Synchronizer  
BTX Cypher SMPTE reader/generator

#### Instruments:

2.5 M, 60 M HD Macintosh Plus running Performer, Opcode patch librarian, and Intelligent Music's "M" and Jam Factory software  
Kurzweil K-250 with sampling and QLS  
Alesis HR-16 drum machine  
Yamaha DX7  
Yamaha TX802 expander  
Yamaha TX81Z expander  
Oberheim Matrix-6  
Casio CZ-3000  
ARP 2600  
ARP Odyssey  
Roland MKS-70 expander  
Roland M-160 mixer  
Southworth Jambox 4+  
JL Cooper MSB + MIDI patchbay

## VIZWIZ

MAGI automation, Otari, and other analog decks, dbx noise reduction, and a variety of MIDI equipment, processing gear, and software, all controlled by a Macintosh II.

Ken French came on board in May of 1988 as audio design director. Now 32, Ken started as a musician recording in his four-track basement studio in 1976. Doing live sound for local clubs and bands led him into larger studio facilities and ultimately into jumping on the MIDI bandwagon in 1985, sequencing on an IBM clone. He started a production outfit, Keynote Music, and began selling music to TV stations and other production companies. After a few months with Soundtrack, he landed his current position.

During my summer '89 survey of Boston post facilities, I had lunch with Ken and Jim Ball, Vizwiz's other audio engineer, who comes from a similar background. Previously a competitor of Ken's, Jim joined the company in December of '88 to help handle the ever-increasing workload. After observing that most people in audio post work are on staff somewhere, as opposed to the prevalence of freelancers in album

recording and other aspects of video and film crafts, we talked a bit about the differences between working in straight music, as opposed to post and mix-to-pix.

**KF:** The biggest difference I've found, coming from music production into this environment is the production time scale. When you're producing an artist, you may be in pre-production for a month. Then you spend lots of time in the studio. Here, a project might take three or four weeks to go through the entire building. So, at the beginning, I might make some audio recommendations. After a month or so, the project arrives in this audio suite, and I'll usually have no more than one or two days to finish it. You don't have the luxury of taking home rough mixes. You just bang it out.

**SL:** How do you find that?

**KF:** I think you have to be real organized. You have to anticipate problems early on, not discover what's unusual about the project at 9 o'clock on the day of the session. And composing music with a client is a challenge. People generally don't have the vocabulary to talk about what they want in their music track. They

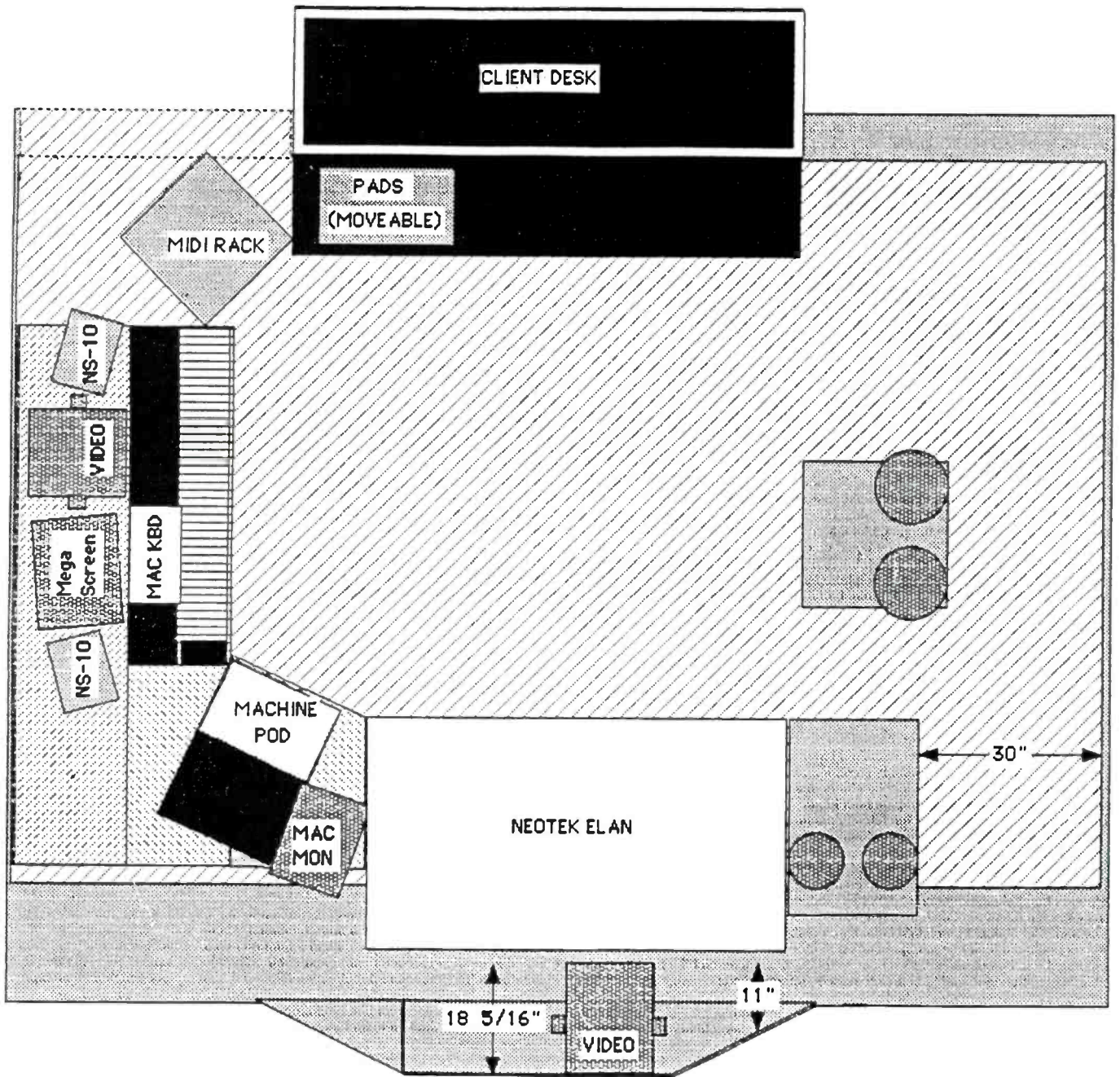

Figure 12. Floor plan of the Audio Suite at Vizwiz.

might say they want something upbeat with a good tempo, something that moves along.

**SL:** And something different.

**KF:** I try to draw them out. Do they want it to sound like Bob James, or is it going to sound like Prince, or whatever. I'll ask them about the focus of the project—are they selling a piece of hardware or a process, are there people involved? Those are the main keys to the music—different feels for different products. And it's rewarding—because clients are usually blown away. We also have about

300 CDs of music to draw from, to further emotional impact.

We produce mostly hybrids of acoustic and synthesized music for our clients. We did a television news opener recently, for instance. First we prepared a tape with timecode, a click track, and a reference track. Then we recorded a seven piece horn section from the Boston Symphony at a larger 16-track studio that uses the same multi-track format. We recorded harp, flute, piccolo, and a percussionist here, and then finished with synthesized voices, oboe, clarinet, timpani, triangle, synthetic

strings. It came out marvelously. While it might have been nice to have a complete orchestra do it, it would have cost far more than \$2-3,000 to produce a finished piece this way.

**SL:** Live musicians bring that extra nuance and timbral richness to the work.

**KF:** We use them mostly for the performance, actually. Jim and I both play guitar, too, so we're able to add that critical little bit of unpredictability.



After lunch, we repaired to the audio control room, very new and very sleek.

**KF:** Until last year they had only a voice over booth. This involved big start-up costs, but we're still not real high end. We didn't want to sell the whole store, just to put in all the fanciest bells and whistles. We use a one-inch sixteen-track with dbx noise reduction for our video sweetening. It's going to go back to video tape, after all. The 3/4 inch is the master for the sync chain, with two Zeta-3 units for synchronizing the 16 track and the 2 track. We're thrilled with the Neotek (24x24 Elan) board. Each instrument is pretty much dedicated to a channel. That way there's less guesswork when revisions are called for a month later.

## NEW SOFTWARE

**KF:** The new Mac system software will be a breakthrough. They will have the MIDI manager as part of their system, with serial port ins and outs patchable to different applications. Then you can also patch applications to other applications. And there's lots more. It looks like Apple has finally recognized that they're huge in the music business.

**SL:** Let's talk about workstations.

**KF:** We've just made an agreement with DigiDesign to beta test the next generation of Sound Tools. Their system is currently optimized for music editing. You can define regions of a song and play them back in a list seamlessly. It's quite inexpensive, provided you have a Mac 2 with at least 2 Meg and hard drives. We're trying to help them develop software more oriented towards audio post, with MIDI implementation similar to Q-Sheet. Q-Sheet can trigger events through MIDI, but looks like an event list. As in a sequencer, you can change the notes, velocities, and ending times.

## THE JL COOPER MAGI

Another attractive feature of this program is cost-effective automated mixing. The JL Cooper MAGI, with its dbx VCAs, inputs and outputs a continuous stream of controller code to Q-Sheet in the Mac, giving us add-on automation at a fraction of the cost of larger systems. The way we have this set up, patching can become a juggle, so we just automate

tracks that really need that tight control.

A lot of what we do here is fix bad audio tracks. That's the nature of the business. Though when we do a project from start to finish, we don't encounter that problem. For example, I had a voice over track that was really a mess: recorded on three different microphones, at three different locations. I multi-tracked it into three tracks and used the automation to switch back and forth. If I were switching and matching by hand, I might go nuts. So we automate the difficult tracks and do the others by hand—it's a combination.

**SL:** You chose MIDI automation over other types?

**KF:** We're investing in the future of MIDI as the controlling code. And DigiDesign is very interested in our ideas. We get the feeling that a lot of Q-sheet units out there are not being fully exploited. But we've built our system around it—for both assembling and mixing the sound tracks. We're also beta-testing for S & S Research's Video Timepiece, which converts VITC to MIDI. VITC has been around for a long time, but only in few video facilities. S & S wants this box to be in everybody's home studio ultimately, an under-\$800-box that will read and write MIDI onto video tape, convert to MIDI, and control your sequencer or Q-Sheet. On our work dub with VITC time code, we'll be able to scroll the video right to where a door closes and capture the exact time code location

with a click. Currently, everyone uses a window dub, the only way to get a frame-accurate representation of exactly where you are, then types the number in by hand. Or captures it. But it can still be off by half a second. It's also going to be very useful in mixing, mutes at scene changes, and so on. So we're enjoying the developing of new Mac-based software and systems.

**SL:** Other than your own stuff, you don't do any non-post audio?

**KF:** Obviously video-related jobs come with a bigger ticket. We used to bring voice tracks, some music off a CD, and a couple of sound effects to the edit suite, which is what is still done in some places. But generation-quality losses from bounces between video tapes are hard to swallow nowadays, particularly at several hundred dollars an hour. Now the producer can come upstairs at half the price and have a lot more flexibility, quality, and fun.

Some buyers like to go to specialists: an audio boutique, a film-to-video tape transfer boutique, a graphics boutique. Now we do everything here, so we sell the whole process—and the people with it. We form a SWAT team, as it were for a project, with an in-house producer, a director, script writers, lights and cameras, and so on, to work with a client all the way through the production. Then in post-production we have the editors, the graphic designers, and the audio. And we make the dubs.

Figure 13. A front-of-room view of the Audio Suite.



The climate in the video production is more competitive than ever because there are more facilities than ever. People who have a good idea and are able to communicate it and produce it are the people who are going to survive. Our corporate mission is to find the business professional with a communication problem and solve his problem for a profit.

## CORPORATE VIDEO

**SL:** Corporate video work appears to be the principal nut for most of the post houses in this town.

**KF:** It's 50 percent of our business. The rest is about half and half TV ads and broadcast theme music. The corporate business, however, is tied to general economic cycles, probably more so than advertising and broadcast work. So we're looking for more national business. We've just expanded from four to six full-time sales people this year.

*Vizwiz also has a healthy interactive video disc production business. We stopped by one of their Paintbox rooms.*

**KF:** The discs have two channels of audio. The computer in the kiosk brings up a text graphic screen for a quiz or exam. Typically, channel one goes with the video. Channel two is wild audio for the user to access. Sometimes I'll pre-mix an audio track and they'll cut to it. And other times, the other way around. It depends on how organized the project is, if their story boards are tight enough, and so forth. So it's a pretty wild world of video.

**SL:** To compare Vizwiz further to the competition

**KF:** I guess what makes us different from any other facility is that we try to get involved with the client early on, effectively replacing the agency. We did a campaign recently for a national auto body repair chain. They had a problem. People thought of them just as a car-painting company. So we did a series of spots and image designs to address the fact that they do collision work, all the copywriting, and everything from

scratch. An agency might have hopped from boutique to boutique.

**JB:** We cut out the middle man and go directly to the client.

**KF:** And we don't find ourselves fixing bad audio, which is rarely fun.

**JB:** But the variety is nice. I didn't have as much radio background as Ken. He's always describing this work as flying by the seat of your pants. That's where we try to come from. We want to get the stuff done quickly, but creatively.

**KF:** Vizwiz has developed a reputation as a high-end company that can solve challenging problems. It grew from the ground up to four one-inch editing suites. I believe we were the first in town to get the Paintbox and 3-D graphics systems. But the last in town to get in-house audio.

## AUDIO EQUIPMENT LIST

### Computer Hardware

Apple Macintosh II w/2MB RAM  
Jasmine 70MB Inner Drive  
Jasmine 100MB DirectDrive  
MegaGraphics 19-in. Monochrome monitor  
Apple 13-in. Monochrome monitor  
Apple Imagewriter II printer  
Sonus MacFace MIDI interface  
JL Cooper MSB+ MIDI switcher  
Roland MPU-105 MIDI to CV interface

### SOFTWARE

Mark of the Unicorn Performer and Professional Composer  
DigiDesign Q-Sheet A/V, Sound Designer II, Turbosynth, and FX Designer  
Opcode Systems Editor Librarians for Yamaha DX/TX, Roland D-50 and Super Jupiter, and Ensoniq ESQ

### AUDIO COMPONENTS

Neotek Elan 24x24 Mixing console  
JL Cooper MAGI mixer automation  
Yamaha DMP-7 MIDI automated mixer  
2 Neumann U-89 microphones  
UREI 803 and Yamaha NS-10 studio monitors

## TARGET PRODUCTIONS

• Over the past ten years, the production of TV commercials and corporate videos has grown into an

industry estimated by New England Business at \$50 million a year. In 1986, after a long and illustrious

Crown D-150 power amplifier  
Technics SL-1200 turntable and SLP-1200X CD player

## RECORDERS AND SYNCHRONIZATION

JVC CR-850U ¾-in. VCR  
Panasonic VHS hi-fi VCR  
Otari MX-70 16-track ATR  
Sony 5003 2-track ATR w/ center track  
Otari MX5050 2-track ATR  
18 channels of dbx type I noise reduction  
DigiDesign Sound Tools digital audio editing system  
Panasonic SV-250 DAT ATR  
2 Nakamichi MR-2 cassette recorders  
2 Adams Smith Zeta III synchronizers w/remote  
S & S Research Video Time Piece VITC to MIDI converter  
Opcode Time Code Machine

## MUSICAL INSTRUMENTS

Kurzweil MIDI Board and PX-100 Sound module  
2 AKAI S-900 Digital samplers  
Yamaha TX-802 sound module and RX-5 drum module  
Roland D-550 and MKS-80 sound modules  
Ensoniq ESQ-M sound module  
Various guitars, amplifiers, and percussion instruments

## SIGNAL PROCESSING

Lexicon PCN 60 digital reverb and PCM-70 digital effects processor  
Korg DRV-3000 digital effects processor  
2 UREI LA-4 compressor/limiters  
dbx 166 dual channel compressor/limiter  
Orban 422A gate/compressor/limiter/de-esser  
Troisi 518 parametric EQ rack  
Symmetrix 511A noise reduction  
Ashley SC-33 dual channel noise gate  
BBE Electronics 802

career in television that garnered him multiple Emmy awards, Chet Collier decided to leave the network



arena to start Target Productions. Networks had long been losing ground to independent stations and cable, and the involvement of corporations in video communication potential was experiencing explosive growth: an ideal fray for the qualified, connected, and knowledgeable entrepreneur.

Taking advantage of the-then relatively low cost of space in Charlestown, Target leased 12,000 feet in the old Schrafft's candy building, setting up a video studio, two edit suites and a Quantel Paintbox room. They soon added a second Paintbox, and then decided to incorporate an in-house audio facility. It includes a Macintosh and MIDI based music composition room and another with a 16 Meg, 32-voice Synclavier, four tracks of Direct-to-Disc tapeless recording, a Studer A-80 24-track, and a Neotek console.

This past summer, I had a chance to tour Target and chat with operations manager Pete Fiedler (Arthur's son), VP and engineering manager Bob Peirce, and my friend and colleague Steve Blake, now Target's senior audio engineer.

### SOME EARLY SCENES

**SL:** At first, you farmed out the audio?

**BP:** The object at our inception was to build the best possible video production house. Money is always limited, so rather than cut corners to squeeze everything in, we chose to specialize. The best couldn't include audio at that point, because that's where the budget ran out. We had a deal cooking for an audio house to join us, but it didn't work out. So we added our own audio on the second round, which was just about a year after we opened the doors.

**PF:** Before this place was even finished, I remember Bob standing in the middle of all the sawdust and two-by-fours, asking with considerable excitement if I had heard of "this thing called a Synclavier?" You can make the sound of an ocean by pushing one key. It's unbelievable. Bob kept that bee in his bonnet.

**BP:** I got to know Steve Blake through his assistance in the acoustical aspects of our facility. When it became apparent that we wanted to upgrade the talent in the audio control room, I asked him if he knew anyone who would like to learn to run a Synclavier.

**SB:** I started hunting around town for possible people, then suddenly flashed "wait a minute!" and jumped at the opportunity myself.

**BP:** This was two o'clock in the afternoon. I said, can you be here at four, for a pre-pro meeting. And that's where it took off. Steve came in the next day and spent the whole weekend here learning the system.

**SL:** I notice that your console faces the client desk, with the Synclavier at the front of the room.

**BP:** Steve actually spends a great deal of his time at either the Synclavier keyboard or the CRT, working with the picture monitor at the front of the room. For the final mix, the Synclavier goes on auto-pilot, and he sits at the console, with direct two-way communication with the client. It turns out to be an enormously beneficial way to work. I've been thinking of building a video edit suite that way.

**SL:** Did you consider other workstations?

**BP:** At that time, it was really either the Fairlight or Synclavier. Opus was still only a mockup. We were courted by New England Digital, who has proven to be a great partner. They've been very supportive, in both maintenance and operation. I'm also convinced that they really have their act together. They're out in front of everybody, with a lot of others still trying to catch up.

Figure 14. Floor plan of Target Productions.

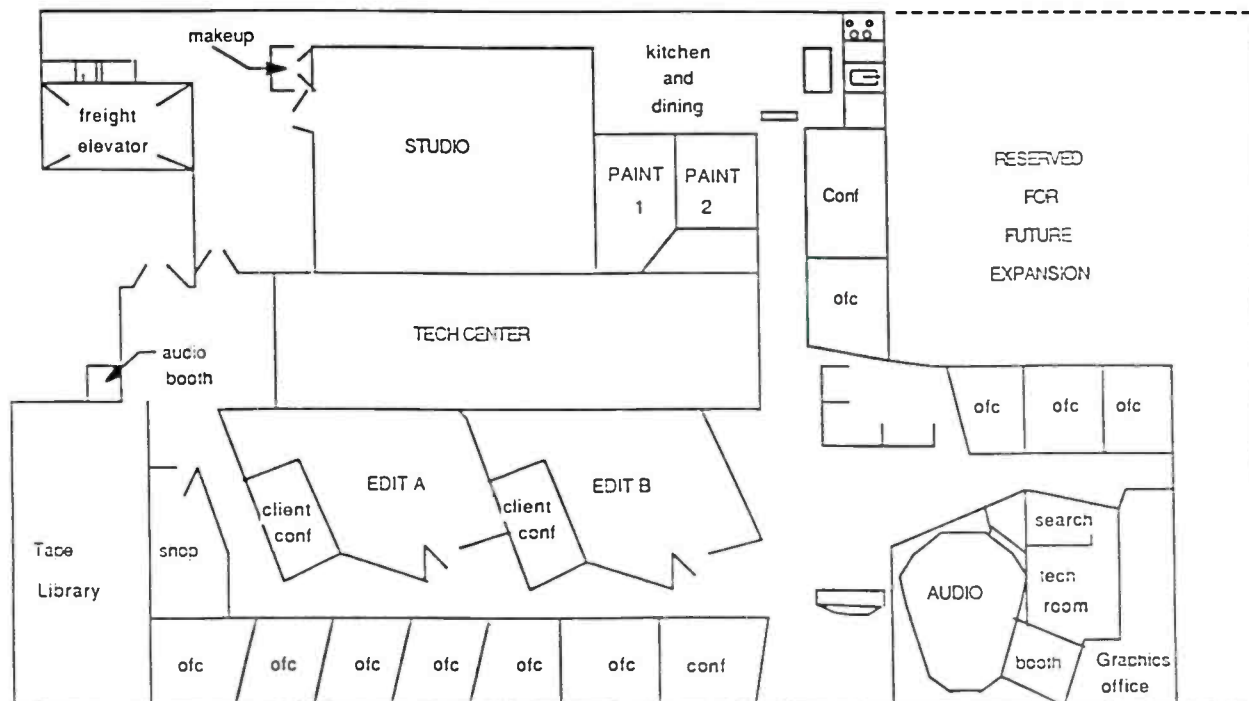



Figure 15. Target caught by a wide-angle lens.

**SL:** How do you feel about the loading-time frustrations of current workstation technology?

**SB:** Projects tend to come into Target's audio suite for a full day or more, rather than for two or three hours each, four different ones a day. The twenty minutes or so of loading or backup time required for our typical audio tracks can be handled early in the morning, during lunch, and in the evening. To the client, that aspect is quite transparent.

**BP:** This week's client is working on an hour-long training audio tape for salespeople. He wants to keep them awake while they're listening to it, so it's absolutely wall-to-wall sound effects. And there's an hour of voice overwork, with a lot of actors. We master the voices on the Sony F-1, and then only load into the Synclavier what's really required. We'll edit and assemble the stuff in the Synclavier, and do the loading and unloading when they're not present.

#### USING THE SYNCLAVIER

**SL:** Do you keep everything inside the Synclavier?

**SB:** That was the approach I inherited here when I arrived. But now I try to balance the technologies of the Synclavier, the Direct-to-Disk tapeless system, the F-1, and the 24-track, using each where appropriate. We usually start with a 3/4-inch video tape with address track time code, feed voice-over to it through the F-1, and transfer that to the tapeless system for editing. Ambient sound effects are loaded into the Direct-to-Disk from CDs, and others are triggered from the Synclavier sampler by its keyboard. Music sequencing is constructed offline on the Macintosh, and instrument sounds are transferred track by track from the Synclavier to the 24-track, played by the Mac sequencer. But we generally only use the 24-track for large orchestral pieces.

**BP:** Whenever possible, we'll stay in the Synclavier. It's faster, has better quality, and is easier to manipulate; all the obvious reasons. The 24-track is a better storage format when you're trying to do a lot of real instruments. Some of the instruments we store in the Synclavier are enormously memory-intensive

**PF:** Flute takes up 7.9 Meg.

**BP:** One, it samples at 100 K. Two, we need new samples every three notes of the scale. And three, we use separate sets of samples for different velocities, and different envelopes.

**PF:** But we're finding that we actually get a lot more sounds off the MIDI gear than off the Synclavier for a lot of the music we're writing.

**BP:** For the television and commercial stuff.

**PF:** But you can't beat the Synclavier for strings, and for some of the drums.

**SB:** And for full orchestral sounds. We recently worked up the second movement of Beethoven's Fifth, initially as a demo of the machine's capabilities. It was later used by a European client who needed some cleared classical music as a bed. It came off beautifully.

**SL:** Some I've talked to feel that workstations in general are more appropriate to shorter projects.

#### MEMORY MANAGEMENT

**PF:** One of the things required for operating the Synclavier is good management of available memory space. That was one of our toughest lessons. Initially, we were configured with a rather small amount of memory, but we've since upgraded.

**BP:** Memory management turns out to be the whole thing. Skill at marshalling resources. In a tape environment you just keep throwing new tape into the hopper if you need to. In this kind of environment, you must be aware of your limitations, of the most efficient way to do things, of what to save and what not, and so forth. The absolute skill of the operator as a manager becomes vital. When we were first running the system, we didn't have that kind of capability, and would run up against a wall early on in some long projects. The project we were just visiting is an hour-long audio tape, voice-over all the way, and loaded with sound effects they never stop: they're butted up against each other all the way through.

**PF:** And the reason the clients come here is that they can stay in the digital format and do fantastic high-speed manipulation of sound effects and revisions. The editing capabilities are so powerful.



**BP:** I think we've shown that you can do long-format things with this gear. We've done documentaries for PBS—

**PF:** Three Frontlines—

**BP:** And two Novas, right. You have to have a wizard sitting in the seat who knows what he's got to work with and where he has to go. Using the Sony F-1 system is one of the classic ways of saving memory space until you need to commit.

**SL:** Have you used DAT recorders or are you waiting for SMPTE stripe-able DATs?

**BP:** Right. Everything in this house runs on SMPTE time code, and we need that kind of control.

**SL:** Do you see yourselves moving from your Studer A-80 24-track to digital multi-track, or will you wait for the workstations to become more capable, with more and cheaper RAM and optical disc recording?

**BP:** We're not seeing any pressure to move toward digital multi-track. Digital is probably wonderful for a production studio that's doing albums, given all the tracks 32, 48, or more.

**SL:** One of those, Newbury Sound, just installed the area's first digital multi, a Mitsubishi X-850.

**PF:** When we first opened, we had built this place to be a one-inch (video) production house, more than anything. And what emerged immediately was the onslaught of Beta and Beta-SP. We are not seeing that in the audio, nor are we seeing it in the video, in terms of D-2 and that influx. So I don't think the digital audio multi-track format is going to become a major thing in the video sector. I don't think the savvy is there on the part of the clients, in some respects. Nor the need for the clarity.

**BP:** Heavy editing and relaying are tough to do in digital. And digital is unforgiving of sudden overloads.

**SL:** Ironically, compressors are a real necessity at times.

**BP:** In the video world, people come in with on-site recordings, and you get what you get. Analog handles overloads rather gracefully.

## FROM START TO FINISH

**SL:** Obviously, none of your work involves records.

**BP:** Right. Most of the music we've done has been in conjunction with video. For instance, we just did the

theme for channel 56's News here in Boston. We did one piece of music for A&E Network. We did all of their graphics. The ideal client for us is somebody who shoots in the studio, posts in the edit suite, and then completes their audio post in the Synclavier room. We optimized the facility for video and mix-to-pix. We don't have a large recording studio and can't accommodate large numbers of studio musicians. What we have done instead is build a rather complete facility for music composition, particularly in conjunction with pictures. We use a few simple synthesizers and drum machines with Performer software on Macintosh to actually write the music, to get all the basics done. Then we take the Performer software into the main room, and cause Performer to drive the Synclavier to produce the real sound. We'll add a few live musicians to it where that's appropriate, and put the music together that way. We do that not only for our own stuff with our own on-staff composers, but we have some outside composers who will bring in their own Macintosh disc, written under Performer, and we'll produce their music.

**SL:** How would you describe Target's position in the local audio post market?

**BP:** Off the cuff, the first difference is that we've got Steve Blake. No matter what one has for hardware, the guy who says good morning when you walk in the door is the whole project. Steve has been wonderful for us in making the place perform. My responsibility encompasses new equipment and repairs. Steve just drives me unmercifully, saying, "I can do better with this. You've got to do something about it." He's that kind of a guy. That's been important in making this work for our clients.

**PF:** Steve understands what it is to be a client. He's been one, and has also been a salesman. He's a *potpourri* of experience and he just will not stop until he gets it done right. The clients that work with him come back because they have such a great experience. He has also taken the time and the effort to master the tool that he's working with. He knows the Synclavier, and converses beautifully with it. That's a real plus. When you combine such a powerful

tool with a powerful operator, the result is success.

**BP:** Beyond that, with Peter's and Dave Grimes' talent for writing music, we have unique composition abilities here. And the Synclavier will do what most other houses in town can't do. It is not all things to all people. There are still some things that can be done better with a razor blade, and we are not equipped for serious razor editing. Further, I think we have the finest audio control room East of the Mississippi, acoustically.

**SL:** How about Target versus New York?

**PF:** I think the mentality of this city is different from New York. For example, Joe Pasquale, who does our 3-D graphics, loves it here because, as he says, "Gee, I can actually get involved in creating, along with your designers, the projects that we're doing. In New York, I'm handed boards from an agency, and you just draw lines, make the circles, put in the colors, and ship it out. Boom boom!"

That contrast flows over into the audio, here. Plus the market is so much different. Boston has a large corporate-work base, versus an agency-based market in New York. Corporate and agency demands and approaches are quite different. I doubt we're competitive with New York. I don't think that's really a question.

## CORPORATE CLIENTS

**BP:** A corporate client may tie this place up for an entire week, but it's not like it locks somebody else out, because they're over at their place writing their project, which will go to tape the following week. It's a whole different scheduling idea, a whole different thinking process, creative process. We do spots here too, and we have agencies come in, but the driving force is corporate. A very different world. Corporate clients are not interested in the jingle that captures an extra 100,000 customers. They're interested in music which conveys the message, and gives them a bed for long-form pieces. For instance, a piece for a trade show, in which the audio has to catch people by the booth and has to tell them something in a long form. It's got to capture their attention for five minutes, say. Not 30

seconds. There's a different design philosophy involved.

**SL:** How about the future for Target.

**BP:** Well, we're expanding our off-line composition facility.

**SL:** A nice big room for off-line, the new one.

**PF:** But we have to keep a noose around Steve's neck. (Laughs.) Obviously he wants to max out the Synclavier. We'd like to continue to upgrade it, for more power: more Ram, more Direct-to-Disc space, optical disc recording, a new Macintosh-based control system. All that stuff. Very costly.

**BP:** There is still a need to educate producers about the workstation capabilities. That's a hard sell. Producers do not like to admit that they don't know it all, when they walk in the door. They need to know that

working in this environment is totally different from that of tape. Once they've learned, they just have a grand time discovering all the things they can do. So that's a continuing process. To expand our market, we have to educate people more than sell them.

**PF:** One client that came here that completely flipped out over the Synclavier was Bose Corporation. They came here to work on a video about the Acoustic Wave cannon, for theaters that were installing that system, and wanted this huge gong sound. We worked with Steve Ruggere, their senior creative director. This is the only place he could get what he wanted. They were blown away by the Synclavier's sound.

**SL:** And their appreciation was helped out by having a good listening environment.

**PF:** Right.

**BP:** Absolutely.

**SL:** Both being designers, Steve and I know that having the room-as-instrument work properly can be critical.

**Both:** Right!

## AUDIO EQUIPMENT

Synclavier Digital Audio System with Direct-to-Disc

Neotek console with automation

Studer A-80 24-track

Sony 1/4-in. 2-track with center track

Sony F-1 with time code

Sony 3/4-in. with time code

Bryston and UREI monitoring

Peripherals by dbx, Valley People, Lexicon, Klark-Technic, Roland, Yamaha

## JAY ROSE'S ATTIC STUDIO

### db STAFF

• If you order a hamburger in Boston, listen to the Boston Symphony, or even make a phone call, chances are pretty good your decision was influenced by tapes made in a hundred-year-old attic in suburban Brookline.

A century ago, *Jay Rose's Attic Studio* was a maid's room. Now it's the 8-track home of commercials for such major advertisers as McDonald's and New England telephone, and video tracks for clients including The Boston Symphony Orchestra and Parker Brothers. Director/editor Rose is a twenty-year veteran of the audio business, and winner of over a hundred awards, including thirteen Clios. He opened his attic studio in the Fall of 1977, after resigning as Principal Sound Designer at Century III (now Editel/Boston), one of the largest audio/video facilities in New England.

The Boston market is saturated with major 24-track music and audio-for-video facilities. Rose's attic success can be an encouraging lesson for any *Electronic Cottage*.

### THE OPERATION

The attic studio is not, in the classic sense, a studio at all; there is no isolated recording space.

"Most radio or television production time is spent in post editing and mixing," Rose explains, "so I modeled the room after a video post suite. I can record basics anywhere I want, then come home to a comfortable editing room and put the job together." A recent telephone company commercial sent him to the L.A. Studios in Hollywood to direct character players, to Atlantic Studios in New York for the music, and then to Boston's Le Studio and Editel to engineer and direct voice-overs and Foley.

"The aural difference between any two good studios isn't in the control room, it's in the recording space. Since I'm not committed to a recording space of my own, I can go to wherever I'll get the best possible tracks. And since I usually engineer myself, wherever I go, I get a technically consistent sound out of any space." Rose keeps engineering relationships with a number of 24-track studios in New England. Because he's considered an expert audio-for-video editor and mixer, and is an Associate Professor on the subject at Berklee College of Music, he's frequently hired by those same facilities to work for their clients.

Jay Rose's Attic Studio staff consists of Rose and a hard-working Macintosh SE computer (see sidebar, *The Computerized Cottage*). "I

wanted the kind of operation where I could shut down for a week or two and not worry about rent or salaries. The studio itself doesn't cost me much to keep running—attics are known for their low overhead—and the Mac handles most everything else.

### THE FACILITY

The attic is small; all of its audio functions take place in a 9 x 15 space. (He has a separate home office which he shares with his wife, a free-lance writer). Isolation was a matter of luck; there are no adjacent living spaces, and immediately below the studio is a quiet bedroom. Absorption is provided by glass fiber batts in the ceiling and along one slanted wall. An 8500 BTU room air conditioner, mounted in a distant attic window and ducted through flexible glass fiber for noise reduction, provides unobtrusive cooling and ventilation.

Broadcast production more often demands accurate editing and fly-ins than multiple overdubs. For this reason, advertising rooms usually feature multiple quarter-inch decks and an eight track, rather than a twenty-four track with a single mix-down machine.

The facility uses four ReVox/Studer decks: a pair of well-maintained A700s for lay-ups, a high-speed full-track A77 for blade



editing, and a brand new C278 for multi-track. All of the machines are being constantly babied and modified by Rose:

"The ReVox A77HS is a dynamite editing deck—much faster than anything by Ontari—if you make a few changes in the muting and front panel arrangement. Similarly, A700s are great lockup decks, if you know where to grab the tach signal. Any good pro deck of that vintage can come pretty close to new analog specs if you keep it clean and adjusted, and give it new heads and rubber." Rose also believes mechanical adjustment, often neglected in service shops, is as important as electronic tweaking. He keeps a full range of test equipment on hand

While he likes to exploit classic tape recorders, much of his other equipment is state-of-the-art. He uses samplers extensively (Casio FZ-1 and Kurzweil K-1000); maintains a large and varied CD sound effects library; and has Eventide H3000B, BBE and Aphex processors. He is also involved in cutting-edge equipment design as a consultant to AKG Acoustics' Boston-based Digital Division on their newly-introduced DSE-7000 audio work station.

## DESIGN PHILOSOPHY

Despite his busy booking schedule, technical and teaching activities, and free-lance writing for major clients, Rose swears he's basically lazy: "The goal is to have everything right under your fingertips, when you need it." He frequently works ten-hour days during productions, so ergonomics was an important consideration in studio layout.

The studio is designed to accommodate four distinct functions: editing, tracking, synthesis, and mixing (see Figure 16). Each has its own overlapping operating position, with specialized tools handy.

For blade editing, he sits at a countertop-mounted A77HS, with direct down-lighting, CD and tape sources close by; an Aurotone dedicated to the edit deck; and even a bulletin board for tacking up copy. Space is provided for taping trims along the counter.

Once elements are cut, he builds by flying-in from a pair of A700s flush-mounted on a separate counter alongside the multi-track. Rose settled on the A700s, which he recently bought used and then rebuilt, after a long search of compact decks that included the current ReVox line and the Otari MX-50 and MX-55. "The Otaris start well enough for fly-ins, but don't lend themselves to

mounting in a two-foot-deep countertop. The ReVox 272 is compact, but starts slowly and the manufacturer refused to discuss modifications." The two decks are mounted alongside each other, so tape can be wound from one to the other.

Output from the A700s goes through a routine switcher, and then to a distribution network feeding the first six inputs of the adjacent 278 (the last two channels are usually used for stereo mixdowns, or for mixdown-plus-timecode). Outputs of the multi-track are normalled into the mixer, then through a compressor and to the power amp. For most tracking and layup, no patch cords are ever needed.

The routine switcher also sees an outboard Kawai mixer located in the synth rack. With this input connected, he can lay synth tracks without having to move from an operating position directly in front of the keyboards. A pigtail hangs from the synth rack to support the Mac SE for sequencing.

Mixing takes place at a modified Kawai 8 x 5 x 1 sound-reinforcement board, directly in front of a color video monitor and a real-time analyzer, and between two Advents (chosen for their smooth mid-range) and two Radio Shack "Minimus"

Figure 16. Layout of Jay Rose's Attic Studio.

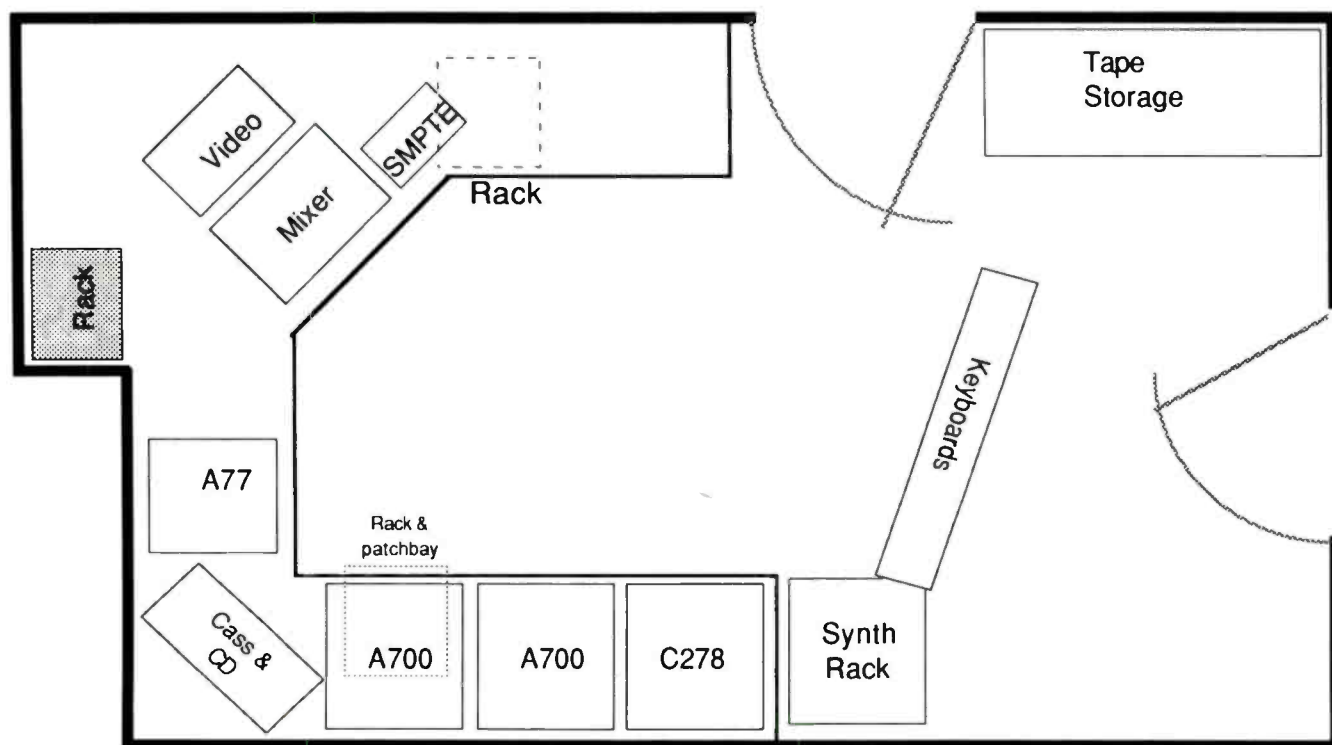



Figure 17. Jay Rose in a corner of the home office.

speakers. Rose uses extensive out-board equalization, including Orban parametrics and Crown cutoff filters, so he wasn't concerned with more than three-knob EQ on the board. Effects are organized into racks within arms' length of the mix position, with a custom switcher to insert frequently used effects combinations (e.g., limiter/gate/de-esser) without patch cords.

He frequently prepares multiple music and effects tracks for video projects, which he then mixes either in his own facility or at local 24-track mix-to-picture suites. For sync, he uses a four-machine BTX rig based on the "classic" 4600 edit controller:

the first practical editor that allowed previewing and frame-accurate trimming of punch-ins.

New England is a competitive studio market and growing production center, dominated by advertising and video/audio studios. Extensive client services, ranging from fully-staffed kitchens to plush game rooms, are common. Some studios employ commissioned "account executives," who drop in on mixes and make sure the clients are happy.

"This is my home. I'm glad to have friends in, to work on a job with me. And since these are friends, they're welcome to use the phone or pour a

cup of coffee. The fact that they're also agency personnel or video producers, and paying for my time, is secondary. But if they need to be entertained, then they're probably not contributing anything to the project. Occupancy by more than three people is counter-productive."

Some advertising sessions do require, for valid creative or political reasons, more clients or client-handholders than Rose is willing to accommodate in his attic. When this happens, he'll prepare special effects at home and then edit and mix at the same outside studio he uses for tracking.

He believes positioning is very important in studio marketing: "You can't be all things to all clients.

"It's even arguable that an advertising or video post studio can't be both a creative boutique and a multi-room factory...at least, as far as I can remember in both Boston and New York, nobody's managed to carry it off."

Rose definitely specializes as an advertising-oriented, audio- and video-post creative "boutique" engineer. It's an image he's carefully nurtured over his career, with agency contacts and through the marketing of his previous studios.

Throughout most of the 1970s and early 1980s, he ran an advertising-oriented multi-room facility under his own name. While he offered such specialized services as a full-time needle-down music and effects librarian, and the first mix-to-picture facility in Boston, it made a point of not being equipped with a drum booth. Jay Rose even ran Yellow-pages advertising that read simply, "We do not Rock 'n Roll!"

Since he already had a strong name in the advertising and video markets, moving to an in-home free-lance business didn't present the usual studio recognition problems. "Some of my clients even said they were glad they could hire me directly now, without having to be tied down to one facility or another."

He currently promotes primarily by word-of-mouth, with occasional directory advertising. His rates, in the hundred-dollar-an-hour range, are similar to the larger Boston operations. "Sure, I don't have a parking lot or a switchboard operator. But I do a better job in less time; so why should I charge less?"

Figure 18. The mixing position. Note the SMPTE controls surrounding the console, and a spectrum analyser sitting atop the video monitor.





There are so many new digital devices being introduced now, Rose says he sometimes feels "like a kid in a candy shop." His next major upgrade will probably be the replacement of his stereo Nagra with time-coded DAT, as standardized SMPTE machines become available. He's also looking very closely at digital audio workstations, both because of his affiliation with AKG's new product and because of his long-term interest in editing technology (He also worked with CMX on the beta-testing of their CASS-1 audio editing controller). "A year and a half ago, I edited a Tammy Grimes voice-over entirely on my Casio FZ-1 keyboard sampler. It was the best machine for the subtle intonation changes the client wanted. One nice thing about advertising work is that you have access to the whole world of MI technology, and the broadcast clients have no problem paying for specialized equipment and techniques to help them get the job done."

One thing he refuses to do is let the attic studio grow large. It will always stay an *Electronic Cottage* industry. As owner of a successful downtown multi-studio complex during most of

the 1970s and early 1980s, he learned what he calls the disadvantage of a big operation:

"When I had a big studio, I was constantly torn between making the spots better—and winning a few more Clios—and making the company more efficient.

"The attic is big enough to do the job I want. Getting bigger wouldn't make me any happier."

## EQUIPMENT LIST

### Tape recorders

8 track: Studer/ReVox C-278

1/4 inch: ReVox A-700 (two), ReVox A-77HS full track, Tascam 32 (two; one modified f/t record)

Portable: Nagra IV-S, Nagra SN miniature

Cassette: Teac 270 (three)

### Keyboards

Casio: FZ-1, CZ-101

Kurweil: K-1000 (enhanced)

Roland: MKS50, PG300

EML: 101 Analog

### Outboard Gain Processing

Allison: Gain Brain (two), Keyplex (two)

Quad-8: Noise Gate (two)

Orban: 516 De-esser, 418 Stereo Limiter

### EQ Filter

Orban: 621 Parametric

Crown: VFX-2A Cutoff

### Time Function

Eventide: H3000B

Ursa: Space Station

Alesis: MIDI0-verb two

ART: 1.5 second Delay

Ibenez: Harmonics Delay

### Psychoacoustic

Aphex: Model E

BBE: Model 422

### Noise Reduction

DBX: 150 Type one

Burwen: DNF 1200, TNE 7000

### Microphones

AKG: C 451 w/ CK1, CK8, CK9 capsules (two sets)

EV: RE-16

Sony: ECM 50

## THE COMPUTERIZED COTTAGE

Nine years ago, when personal computers were new to the recording industry, Jay Rose bought one of the first: a 4-K Radio Shack TRS-80 Model 1. He eventually expanded it with additional RAM and disk drives, and used it for basic studio management functions.

When the Macintosh came out, Rose invested in one as a computer both he and his wife—an advertising writer, and then computer-phobe—could share: "Carla hated the TRS-80. It had too many ribbon cables coming out of it. She didn't want anything to do with the TRSDOS commands. The Mac seemed like an ideal solution."

He still has his original 128 K Mac, now upgraded to 512 K status and in constant use as a homework machine by his high-school-aged son. But at the home office, he and his wife feature a Mac Plus, which she writes on, and an SE which he uses for just about every aspect of studio management. Both machines have General Computer 20 megabyte external hard drives.

Two local networks circulate through this *Electronic Cottage*. One, an Appletalk-compatible Farallon PhoneNet, connects the two larger Macs and the 512 to a GC Postscript laser printer.

Another, designed by Rose, uses a serial patch bay with DIN connectors to route the computers to a modem and dot-matrix printer.

When the Roses renovated their house a few years ago—long before any thought of an attic studio—they buried then unassigned cables in most of the walls: "I went down to a surplus store and bought a hunk of random wire. We've got telephone quad, RG-59, and a 12-conductor twisted-pair ribbon running between most of the rooms. It's been handy for computers and cable TV, and who knows what we'll use it for next year. My ten-year-old plays keys and clarinet; maybe he'll want to run MIDI into his bedroom!"

He runs most of the Attic Studio's business on modular stacks he wrote in Apple's Hypercard program, which also serves as a shell for the

other software he uses. The modules include: a billing program, which also computes sales tax reports and aging schedules; a mailing list and client history database; a mini word-processor and document filing system; and a daily schedule. The modules are linked so that, for example, booking data can be passed from the schedule to the invoice, or phone numbers can be captured and dialed while looking at a client's invoice. Rose also uses Hypercard to generate a 7,000-listing sound effects catalog, cross-indexed by keywords.

Other software in the Attic Studio includes Monogram's Dollars & Sense, for general accounting, T-Maker's Writenow word processor, and Silicon Beach's Superpaint and Click-on Worksheet. Rose also has a Farallon MacRecorder and SoundEdit System to generate sound effects on the Mac, and Southword's MIDI-Paint for SMPTE-linked sequencing.



# Sound Reinforcement in North Africa, Part I

ED LEARNED

In the past few months, I've talked to many fellow engineers who have enjoyed my articles published in **db**. In response to their suggestions, I'm taking a little different slant in this next offering about sound in Africa. Rather than concentrate on one tour, I'll discuss three different tours of the region with zydeco, rock-a-billy, and electric jazz groups.

Between 1985 and 1989, I spent my winter months as sound engineer on USIA (United States Information Agency) sponsored tours with three groups of varied musical style. The common ground between them was in sonic presentation (all three groups were "electric") and the itinerary: North Africa. We visited major cities in Sudan, Egypt, and Algeria and travelled extensively throughout Morocco and Tunisia. Most of the time we carried our own sound equipment, but certain tours at certain times required the use of locally procured equipment. It is interesting to note that when we did carry PA, we used the same system for each group. A careful look at this sound system, and our philosophy of operation for each group, will reveal some of the planning that made for successful concerts.

## THE HOUSE SYSTEM

System rental expense for USIA tours had become prohibitively expensive in the mid 1980s, so the agency had purchased a complete system from the local Washington music store. The house system was based around four Bose 802 cabinets on Ultimate support tripods (see *Figure 1*), the monitor system on four Peavey 1245 floor monitors and two Crest 4001 power amps provided the power for both mains and monitors. A Soundcraft 200 16-channel console handled mixing chores. A rack containing two MXR  $\frac{1}{3}$ -octave graphic equalizers, a DBX 160X limiter, and a Bose 802 controller rounded out the house electronics

package (see *Figure 2*). A 19-channel 125-ft. snake was provided for mic lines and feeds from the house mix point, and there were plenty of speaker, AC, and mic cables in various trunks. The mic compliment consisted of eight Shure SM-57s and 6 SM-58s, with three Whirlwind passive D.I. boxes; fourteen mic stands of varying types were included. There was a cheap VOM and a handheld Goldline octave-bandwidth spectrum analyzer for test equipment. Three Peavey instrument amplifiers were available if needed. Two Bandit 65 guitar-type amps and a TKO 65 bass amp provided stage amplification for our electric instruments. The entire system shipped in nine road cases and weighed about 1700 pounds.

Power in North Africa is predominantly 220 volt, 50 Hz, so voltage modification throughout the system was called for. The instrument amplifiers had small 110/220 conversion transformers built in; these could be by-passed if 110 volt use was desired. The Crest power amps had been internally modified for 220 volt use; the Soundcraft console and DBX limiter had switchable voltage power supplies. A small (2.5 amp) transformer was provided for the rest of the 110 volt house electronics, and two extra transformers were included for extraneous stage or sound equipment. No voltage regulation equipment was provided, so the selection of equipment that could tolerate voltage swings was most important.

A sound system cannot be all things to all groups, so one of the first things I did was establish parameters for use. USIA believed the system would be adequate for rooms of up to 1500 people. Considering the electric nature of these three groups, I felt a more realistic appraisal would be 1000 people. We agreed that for larger venues, or outdoor gigs, local PA equipment would be procured to augment the USIA system. If group needs dictated, I would carry along a

few select mics of high caliber. On certain tours, I also carried my own effects devices and limiting. My personal add-ons were limited to one small case of no more than 100 pounds. I'm sure many sound men would cringe at the thought of using four Bose 802s for an amplified group in a 1000-seat hall. We would all like to work on a large Meyer or Turbosound PA, but considering the reality of production and transportation costs on a USIA tour, you work with what you've got. Co-operation from the bands can make all the difference in the world under these circumstances. Part of my advance work for these tours was to contact the band leader, give a rundown of the basic system, and discuss how to make it work best for that particular group. Compromise was always necessary.

## 1985: JAY HOGGARD QUINTET

Jay is one of today's outstanding young vibraphonists, equally at home with the traditional and electric forms of jazz (see *Figure 3*). His powerful quintet included Pheeroan Aklaiff, drums; Jerome Harris, electric bass; Vernon Reid, electric guitar; and Onaje Allen Gumbs, piano and synthesizer (see *Figure 4*). Jay used a Deagan Commander vibraphone with a pickup system designed by Gilberto Serna of Century Mallet Instrument, Chicago Illinois. A contact pickup was attached to each bar of the vibraphone with an adhesive putty. Each pickup was then paralleled onto one of two lines: the first contained all the naturals, and the second contained only the flats. Jay combined these with a Y-cord into one composite signal. This was then fed into a Korg PME-40X effects board, which contained chorus, distortion, and compressor modules. The Korg output was then relayed to Jay's stage amplifier, one of USIA's Bandit 65 guitar amps. This amp used a single 12-in. speaker in an open-back enclosure. I mic'd the amp



with an SM-58, pointed directly at the junction of dome and cone. I also inserted a direct box into the line pre-effects, which gave me both a "dry" and "wet" signal on the vibes. Our most immediate problem was amplifier distortion. Even with effects bypassed, the sound was distorted badly when Jay struck the bars with medium force or greater. After some experimentation, I found that by inserting the compressor module first in line at the effects box, the transients could be effectively reduced with limiting, eliminating our breakup problem. This also gave Jay better sustain when the amp was run hotter, something he put to good use in his more electrified compositions! I also gave Jay an SM-58 as a dedicated announce mic.

Vernon Reid is now well known to the American public, thanks to his rock group Living Colour. As guitarist for Jay's group, he used Steinberg and Gibson Les Paul guitars predominantly, carrying an ESP Strat-type guitar for occasional use. He ran the guitar into a wah-wah pedal and a plethora of other effects boxes, then into the other Peavey Bandit 65 amp. The guitar amp was mic'ed with an SM-58, placed well off-center of the speaker, about half-way up the cone, and positioned around 4-6-in. away. With both vibes and acoustic piano to consider, I needed a smoother guitar tone for a good blend. With the natural high-end boost inherent in SM-58s, I didn't lose a significant amount of highs using this technique, and got the warmer sound I was looking for.

Onaje Allan Gumbs played acoustic piano and DX-7 synthesizer. USIA usually arranged for grand pianos in each location, but the reality of some places dictated otherwise! We decided that if a grand was not available, Onaje would play only the DX-7, so we had something we could depend on. I carried my own mics for the acoustic piano: a Crown PZM-31S and a Sennheiser 421. The PZM was taped to the side of the piano by the sound holes and cushioned with foam to prevent mechanical vibration. The 421 was positioned where the low and mid strings cross, angled towards the hammer and slightly away from the open side of the piano. The lid was always on the short stick; gain-before-feedback was improved, yet the piano still had "air." Onaje's DX-7 was taken direct: he used no



Figure 1. Our Bose 802 speakers are on tripods. Terrence Simien and the Mallet Playboys at the U.S. Ambassador's Residence, Khartoum, Sudan.

amplifier, depending on the monitor system to hear himself.

Jerome Harris used a Steinberger electric bass, run into a Sho-Bud volume pedal. The pedal output fed the TKO 65, which contained a single 15-in. woofer. I used a D.I. on Jerome's instrument, inserted post-pedal so I could get the fade outs and other effects Jerome created with this volume pedal.

Pheeroan Aklauff used sonar drums and Sabian cymbals. His kit consisted of kick, snare, three mounted toms, and a floor tom. Pheeroan's bass drum had the front head cut out, with foam inside the shell for damp-

ing. Our mic, an AKG 310 that Pheeroan carried with him, was placed in a foam cylinder for protection, then laid inside the drum on the shell foam, about 4-in. from the back head. The snare was mic'd with an SM-57, positioned just off the rim to pick up some hi-hat as well. The three mounted toms were arrayed in a triangle, the smallest one above the bigger two.

The small tom had its head removed, so by carefully positioning a single SM-58 under the small and over the large, I could pick up all three toms. I used another SM-58 on the floor tom, and placed my own

Figure 2. Front-of-house gear. My Terrence Simien aux rack is the one on top.



**1988: TERRENCE SIMIAN & THE MALLETT PLAYBOYS**

Terrance fronts a very hot zydeco group from Opelousas, Louisiana (see Figure 6). Their tour repertoire included several reggae, blues, and rock numbers along with cajun and zydeco classics. The group consisted of Terrance on accordions and vocals; Sherman Robertson, electric guitar and vocals; Popp Esprite, electric bass; Earl Salley, rub board; and Roy "Chubby" Carrier, Jr. on drums (see Figure 7). Terrance played two different accordions: an Acadian diatonic single-row in C, and an Acadian diatonic triple-row in G, C, or F. The single-row had a Shure SM-58 element mounted to it via a metal bracket; this was taken direct. We used another SM-58, on a straight mic stand, to pick up the triple-row. For his vocals, I used an E-V DS-35 that I carried with me. This mic gave me superior isolation from the drums, located directly behind Terrance, and allowed me to really crank his monitor. Terrance used no amp for his accordions, depending on monitors for himself. I needed all the gain-before-feedback I could get!

Sherm Robertson played a 1978 Gibson 355 electric guitar, with a 1962 Fender Jazz Master as back-up. He used one of the two Peavey Bandit



Figure 3. On stage at Assuit, Egypt with the Jay Hoggard Quintet.

AKG 451 as an overhead (see Figure 5).

All the monitors were run off a single mix, designed primarily to kick keyboards and vibes back to the band. We found that by placing Jerome's bass amp on a case upstage right of Pheeroan's drums, we could get enough bass back to him acoustically; no need for bass in our monitor

mix. I could cover both Jay and Jerome with one monitor by angling Jay's wedge slightly. I found I needed to cover the open back of Jay's amp to prevent the vibes from bleeding into the piano.

We ended up with a bit of dry and wet vibes in the monitors, and, depending on the venue, we might add a bit of bass drum.

Figure 4. Stage layout for the Jay Hoggard Quintet.

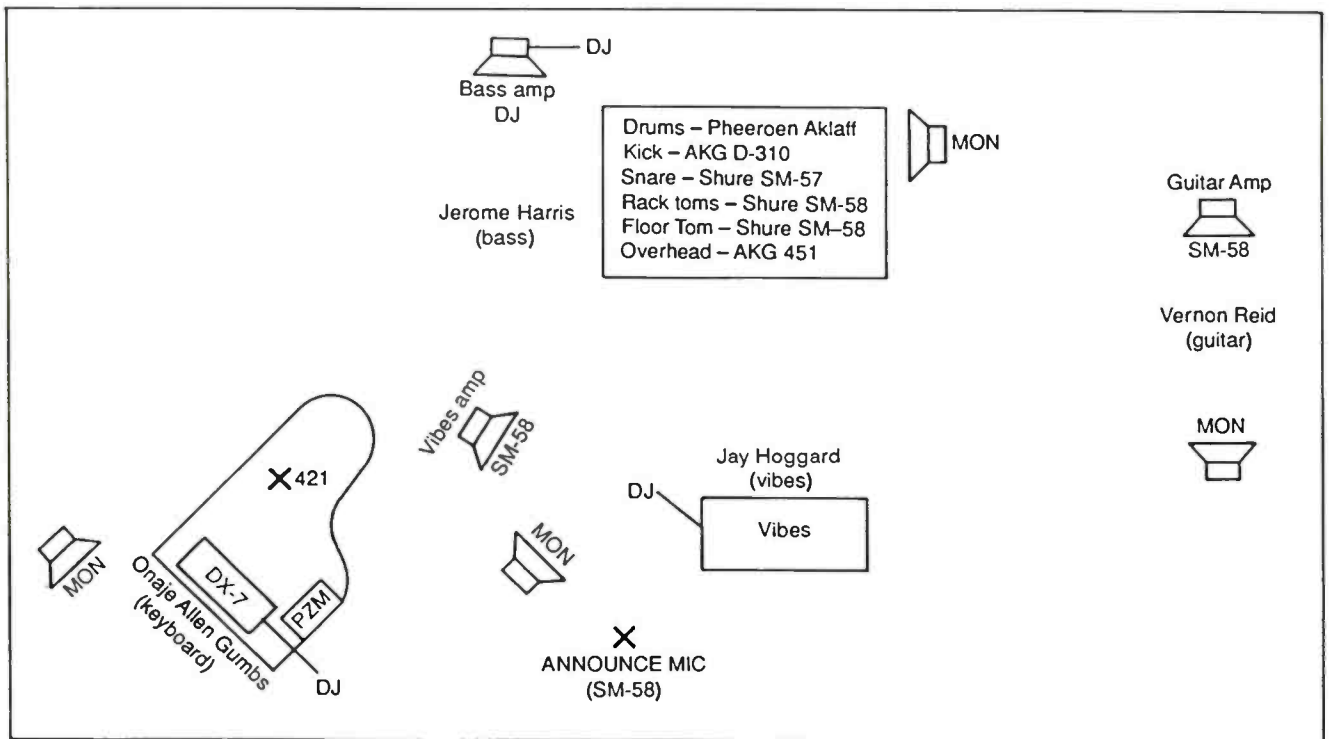



65 guitar amps for stage amplification, although at some of the outdoor gigs he used both. The years had not smiled on this gear: in mid-tour we began to have amplifier problems, which led Sherm and I to spend many hours dealing with on-sight repairs. It's part of the price paid doing this type of tour. I used one of my E-VND-757 mics, with a windscreen, hung over his amp and positioned just off-center of the cone. For his vocals, I used another DS-35 (see Figure 8).

Popp Esprite used a Peavey T-40 bass guitar, modified with Fender tuning pegs. He favored Peavey Glider bass strings, a rock-and-roll set. He used the Peavey TKO bass amp for stage amplification, and I took a direct signal off the line output of the amplifier rather than off the instrument itself. Popp would infrequently sing. We worked it out for him to share Terrance's mic when he did.

Earl Salley played the rub board, one of the more interesting instruments I'd ever had to deal with. There are two of them. Each was shaped like a vest and worn over Earl's chest. Earl played these by scraping over the ridges with a set of spoons, creating rhythmic patterns to add propulsion to the music. One of the boards had more ridges per inch than the other, giving it a denser sound. One thing I can tell you: it was incredibly loud! I almost never had to mic it, save for outdoor shows or when I taped a concert. When I did mic it (using a Shure 3M-58), I kept it down in the mix because it bled into everything. When Earl was featured, we had him move to the triple-row accordion mic and play into that, as Terrance usually didn't play that instrument when Earl soloed.

Roy Carrier Jr., known to all as Chubby, used a Ludwig rock drum set. His compliment included a 22x16 kick, a 14x6 1/2 snare, 12x13 and 13x14 mounted toms, and a 16x16 floor tom. Zildjian 13-in. New Beat hi-hats, a 16-in. rock crash, and a 22-in. rock ride were used for cymbals. Terrance wanted a big drum sound, and I had the channels to spare, so I fully mic'd the drums. I brought most of the drum mics with me, with a USIASM-57 on the snare. I used an E-VRE-20 on the kick, laid on a towel and placed inside the drum about halfway back. E-VND-757 mics were used for hi-hat, mounted



Figure 5. Mic'ing Pheeroan Aklaiff's drum set.

toms, and floor tom. If I used an overhead, it was another 757.

By this time, a Yamaha REV-7 digital reverb had been added to the USIA system in deference to the needs of the 80s. Since we would tour Algeria and Morocco without the USIA system, I brought along an auxiliary rack containing a Yamaha SPX-90 II, an SPX-90, and two dbx-903 limiters in a dbx two-space rack. I use the REV-7 for vocals, the SPX-90s for instruments and drums. On several tunes, I used SPX pitch change programs to create vocal or guitar harmonies, an effect Terrance fell in love with. The two limiters

were channel patched on the two vocal channels, so I could control levels much more easily. The group used a single monitor mix for all four wedges. This mix contained Terrance's vocal and accordions on top, with Sherman's vocal a hair under. We might add just a touch of snare in reverberant halls to facilitate time-keeping, and that was it! When Sherman felt he needed more guitar level on stage, we would angle his amp more towards him. For several outdoor shows, we even added our extra amplifier so Sherm had two amps to play through. When we did go with two, I made sure they were angled

Figure 6. Terrence Simien and the Mallet Playboys at Ewart Hall, American University, Cairo, Egypt.



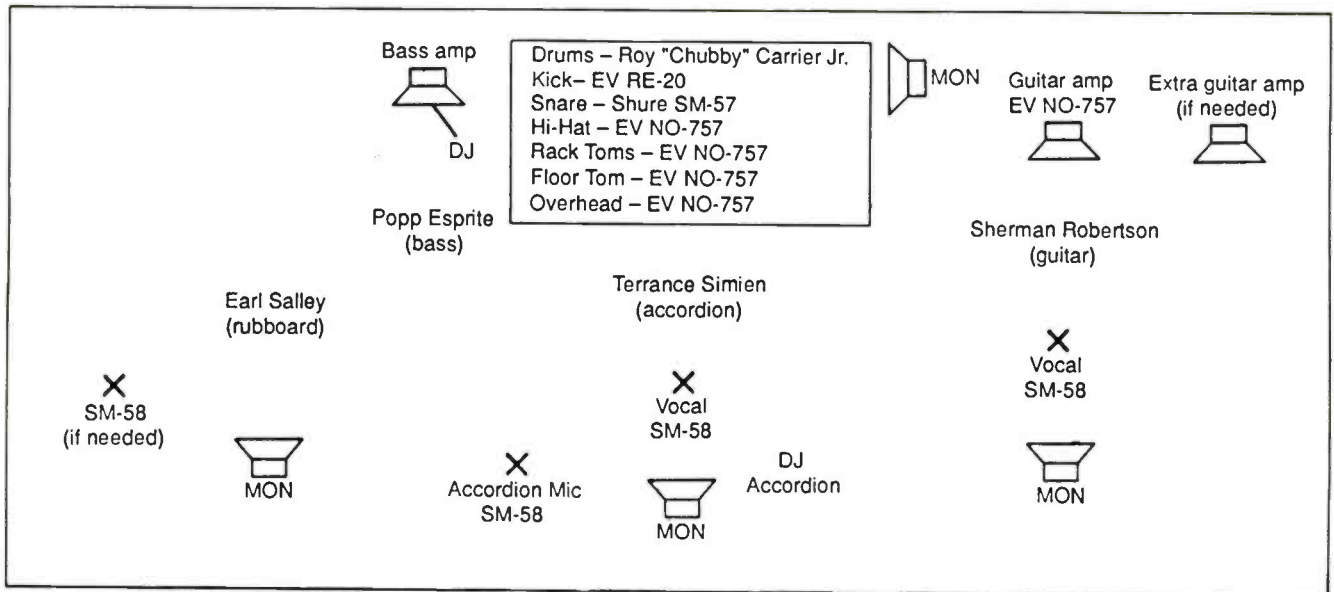

Figure 7. Stage Layout for Terrence Simien and the Mallet Playboys.

slightly away from the accordion mics to minimize stage level bleed problems.

### 1989: THE SUN RHYTHM SECTION

This group is composed of former studio musicians and recording artists with Sun Records of Memphis, the label known for launching Elvis Presley (see Figure 9). Their repertoire included rock-a-billy and early rock-and-roll classics, played by the

Figure 8. Sherman Robertson works out! Notice the guitar microphone hanging on the amplifier.

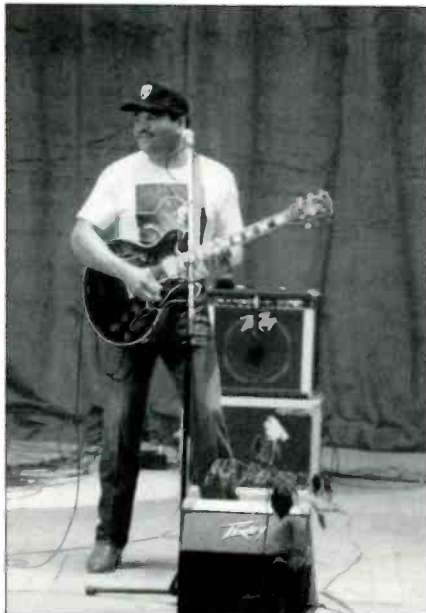

men who originated the sounds in the first place. The group was composed of Sonny Burgess, electric guitar and vocals; Paul Burlison, electric guitar; Marcus Van Story, harmonica, acoustic guitar, slap bass, and vocals; Jerry Lee "Smoochy" Smith, electric piano; Stan Kesler, electric bass; and D.J. Fontana, drums (see Figure 10). Paul played a Fender Telecaster, Sonny a Gibson. Sonny also used an overdrive box, which enabled him to get a very nasty tone, an effect he used for soloing on certain songs. I mic'd their amps with Shure SM-57s, hung from the amplifier's handles and positioned dead center on the speaker. I'd brought a small assortment of E-V mics along with me on this tour. I used an ND-757, with a windscreen, on Sonny's vocal,

Marcus Van Story played several different instruments during the course of our shows, and each posed a different challenge. For vocals and harmonica, I used an ND-757 with windscreen. For Marcus' acoustic guitar and slap bass, another ND-757 was employed, this time without the windscreen. I was very concerned about getting his acoustic instruments audible over the electric instruments, but I needn't have worried. Marcus' guitar was mostly as prop: the band didn't want it heard! The slap bass was used as an effect: Stan told me the important part of the sound was the slap of the strings against the fingerboard. I'd brought along a Yamaha 2031 stereo

1/3-octave graphic EQ, and used one side of it, via a channel patch, on the slap bass. I could roll off the lows and certain mid frequencies, leaving everything else that enhanced the slap sound.

Bassist Stan Kesler played a vintage Fender Precision through the Peavey TKO bass amp. I took him direct, using the line output of the amplifier; this provided the bottom end the slap bass could not. With his recording engineer's experience, Stan was able to offer many tips on how the group should sound. I noticed that Stan's playing dynamics were all over the place. As I again carried my two DBX 903 limiters, I inserted one on the bass channel. This smoothed out his levels enough to give us a rich, very consistent bass level.

Pianist Smoochy Smith was accustomed to acoustic pianos in the U.S., but, in deference to our travel situation and the state of pianos in North Africa, he agreed to use the Yamaha PF-85 electronic piano that was part of the USIA sound system. This piano had a small amp and two speakers built-in, very important because we didn't have another amp to spare for the piano. I'd used this instrument on a previous tour, and knew that the on-board amplification was not going to cut it for an electric band. I planned on giving Smoochy his own monitor mix, something I was able to do only by bringing along another graphic. The



PF-85 was run direct, with a DBX 903 inserted in the channel for control and gain. I could give Smoochy as much piano as he wanted without killing the other guys. I used an ND-757, with windscreens, for Smoochy's vocals.

D.J. Fontana is perhaps best known as the drummer with the original Elvis Presley group. Most drummers I'd worked for on USIA tours carried their own sets. Not D.J.—he elected to pick up a set in each country. Advance cables confirmed this would be possible everywhere except Sudan. A drum set had been located, but the heads were in unplayable shape. We had to buy heads to fit this set in the U.S. and bring them with us, as music stores in Sudan aren't known for their wide selection of equipment! My generic mic'ing for D.J. included



Figure 9. The Sun Rhythm Section, Tunis, Tunisia.

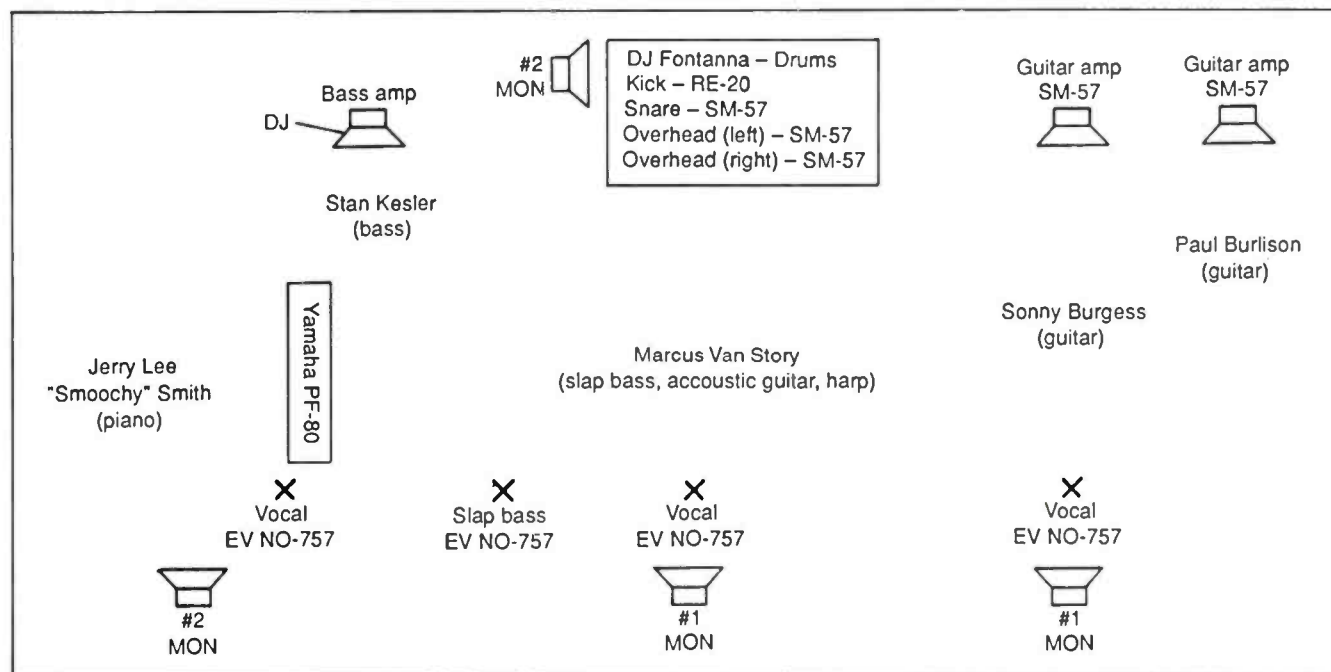

Figure 10. Stage Layout for the Sun Rhythm Section.

an E-V RE-20 on the kick, an SM-57 on the snare, and two SM-57s for overheads, positioned in such a way as to pick up more toms than cymbals.

Monitor requirements for the Sun Rhythm Section were dictated by our piano listen situation. Smoochy needed his piano loud to hear it, yet this level was unacceptable to the other musicians. I used the open

channel of my Yamaha graphic as house EQ. This freed up the two MXR graphics for two monitor mixes. Mix number 1, assigned to Sonny, Paul, and Marcus, contained Sonny's and Marcus' vocals on top, with Smoochy's vocal just under them. They also wanted piano: enough to hear, but well under the vocals. Mix number 2 was assigned to Smoochy and D.J. This mix con-

tained loud piano and Smoochy's vocal, with the other two vocals mixed under the piano and piano vocal.

I usually placed D.J.'s wedge further away from him to avoid excess piano bleed into the drum mics. The other three were on top of the respective singers they covered.

(More next issue.)





## THE ELECTRONIC COTTAGE

### Hot Tips For Akai 12-track Users

•In the early 1970s a noted jazz musician, who had done much to popularize the Fender Rhodes electric piano, was asked in a magazine interview what he thought of the instrument. The interviewer, who I'm sure expected a word of unqualified praise for the instrument, received instead a rather cryptic answer. The musician's reply went something like this: "The Fender Rhodes? Oh yeah, nice idea. Too bad they never finished it."

Somehow I never forgot that quote. Back then I too had been an itinerant musician, lugging my Fender Rhodes from gig to gig, up and down the east coast. I identified with that musician's ambivalence towards what was then considered to be a wonderfully expressive but quirky new instrument.

I'll also never forget how many hours I spent adjusting the tines—the steel rods that vibrated over a magnetic pickup to create the unique sound—only to have one break in the middle of my best solo. That, of course, was not an unusual event, but a periodic occurrence that

Rhodes players just learned to put up with for the sheer joy of playing such a responsive instrument. It seemed a valid trade-off.

What has all this got to do with the Akai 12-12 and 12-14? Well, some fifteen years after my love affair with the Fender Rhodes piano, my current passion is for this marvelous 12-channel, 12-track mixer/tape recorder. But my feelings for the two units are quite equivalent: Overwhelming amounts of love, pride, and loyalty, alloyed with sufficient annoyance to make me want to re-quote that famous jazz musician: "The Akai 12-track? Oh yeah, nice idea. Too bad they never finished it."

But lest you think that I'm about to launch out on some criticism, let me state this out front: While the Akai has its quirks, all of them are surmountable and definitely worth the effort. It's difficult to imagine how you could purchase a more professional sounding multi-track for anything in this price range. For under \$6,000 (actual market price) you can have 12 tracks of very high quality analog audio (94 dB S/N ratio

with built-in dbx Type I noise reduction). Since they have a *hidden* time code track, *all* twelve tracks can be utilized for your program. And two Akai 12-14s can be linked together with something like a Fostex 4030/4035 Synchronizer to give you, at about \$14,000, probably the world's least-expensive, self-contained 24-track recording studio. All in all—judged by any standard—the Akai 12-track is still an incredibly sweet-smelling deal. But the rose does have a few thorns.

Another Akai user I know had a conversation with one of the Japanese engineers who designed the unit, and confronted him about these *thorns*. The engineer was rather cavalier about the issue, saying that one had to be "brave" to operate the Akai 12. In other words, it was not a tool for the timid. You had to be a real aficionado to get the most from it. I have found that to be absolutely true. After operating my Akai 12-12 for four years, I have learned through perseverance, trial-and-error, and consultation just how to get the Akai

### EDITORIAL CORRECTION!

We apologize for a puzzling bit of text in our July/ August issue in John Barilla's *Hot Tips For The Home Studio*. Regarding item #4, "DIY Headphone Distribution Box," the resistor designations in the text do not agree with the designations in the circuit diagram. Originally, they did agree, but the diagram was a re-labeled in order to make it more readable. Unfortunately, the text was not changed to comply. The circuit diagram *is* correct, but the text should read as follows (third column, second paragraph):

"The variable resistor (potentiometer) R3-4 controls the level of the sound to each set of headphones. For convenience, the left and right sides are ganged together on a concentric shaft so that both sides go up or down in volume by turning a single knob. R1 and R2 are thrown in just to make sure there is always sufficient resistance to prevent the amp from shorting to ground—even when the variable wiper R3-4 is all the way up, hence functioning as a straight wire."



Figure 1. The Akai cassette.

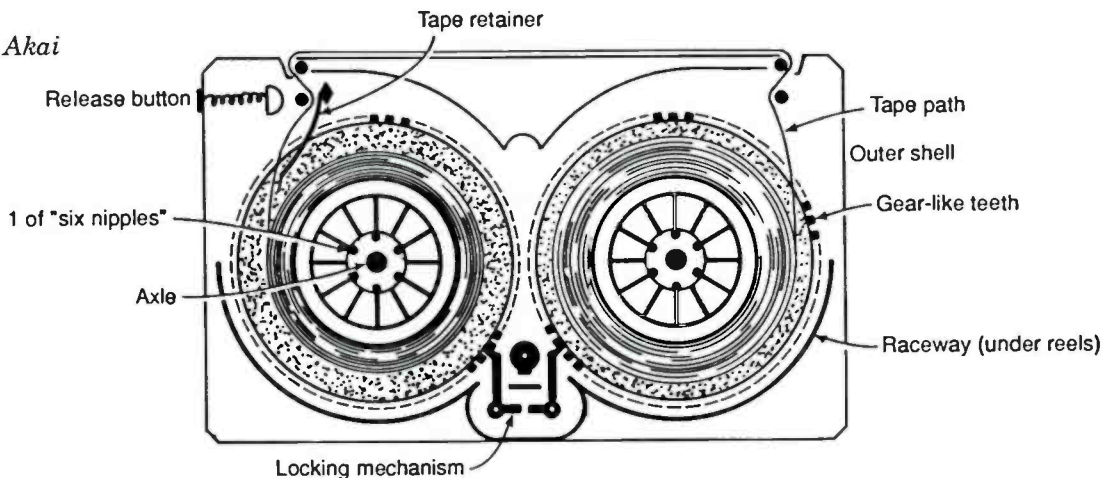

12 to function as a reasonably predictable and stable recording device.

### CASSETTE PROBLEMS?

Show me an Akai user who hasn't encountered a bum cassette, and I'll show you a person who doesn't record very often. I have hit a number of these problem cassettes and I'll wager that you have too. You know how it is. They seem to operate smoothly at first, but as your session goes on they start making weird noises on rewind or fast-forward, even worse they bind up. What do you do then? You can despair, throw the tape out and start from scratch. Or you can be "brave," open up the shell, and try to figure out what's hanging the thing up.

The initial reaction of the neophyte Akai user to this annoyance is, "Why the @#%\* should I have to do that for?" I can't answer that question. Let's just say it's a fact of life. According to IMC, the exclusive American Distributor for Akai products, the problem is with the quality control in the manufacturing process. Apparently Akai tried manufacturing themselves, then tried using some Taiwanese subcontractors who proved to be unsatisfactory. Now the cassettes are being manufactured in Japan once again. The official stance is that, design-wise and manufacturing-wise, the problem has been (more likely, is currently being) ironed out. Nonetheless, complaints of defective cassettes keep rolling in.

In my first encounter with this problem, I was more than 100 hours into the project—ready for a mix—when the cassette began to malfunction. At first I panicked and cursed the day I bought the Akai. Then I opened up the shell and started poking around. I got it to work and

finished the mix with no further problems. Still, at that point, I wasn't sure of the exact chain of cause and effect. Which of the dozen things I did really turned the trick? It took a few more close encounters and some hypothesizing and testing to come up with the following theory and treatment. But it works every time. No more panic.

My theory is this: The Akai is a machine that normally runs hot. Pull a cassette out of the transport after an hour's use and you can feel how much warmth the plastic shell has absorbed. Thankfully it's not enough to do any harm to the tape, but after some hours of operation it seems that it may be enough to ever-so-slightly deform the shell. Since the tolerances are pretty tight and the shell is being pulled together by the screws that hold it, this slight inward deformation may be enough to cause a binding of the tape. All this would probably never cause a problem if the tolerances between the reels and the shell were subject to sufficient quality control, but obviously they have not quite *finished* that aspect of the design. Nevertheless, if you do encounter a defective cassette, in most cases it can be permanently remedied with a simple procedure. Here's how I approach the problem.

1. The first echelon of treatment is simply to take a break and let the tape chill out. Loosening the screws a bit and letting it sit in a cool place—such as right in the path of an air conditioner may be all you need to save the day.

2. More persistent cases may require minor surgery. If you are in a hurry, it may be sufficient simply to exchange the shell of the troubled cassette with another one. The permanent cure,

however, involves a couple of more steps:

- A. Remove all the screws from the cassette and press the release button on the left side of the shell to open it up.

- B. Remove the reels from shell. Get a small piece of fine abrasive paper (emery cloth is fine). Turn the reels over and buff the burrs off the *back* of the serrated flange (the gear-like surface). (See Figure 1.) Apparently the extrusions are not perfect here, and gently planing them helps the reel to spin more smoothly in the *raceway* provided by the shell. It's a good idea to smooth out this raceway as well, since the burrs may have worn some pits in the surface. Finally, lightly smooth the six little *nipples* on the front of the reel. Don't take down the large center one at all (this is just the *axle* that the reel spins on), just slightly round off and even out the six nipples that surround it.

- C. At this point you may have some plastic dust trapped between the tape and the inside of the flange. Have a little can of compressed air on hand (you know, the stuff that photographers always use), and simply blow out all the particles. No problem at all. It's really a whizz—or should I say, a gas.

- D. Put the thing back together and you should have a hassle-free cassette from now on.

### THERMAL PROBLEMS?

If you run a 12-12 or a 12-14 in a small room for long periods of time you may encounter some weird errors in the logic of the machine. Perhaps it refuses to load or unload the tape, or has trouble counting, or it might not want to record or play-back. Almost any enigmatic phenomenon can happen to a control



Figure 2. "Doctor" Harry Barber performing surgery on an Akai 12-12.

function. Often simply pushing the reset button will restore everything. That failing, it might be time to take a lunchbreak to give Mr. Akai a chance to relax and cool off his hot head.

I found out the cause of this eccentric behavior from my Akai technician. Apparently, the power supply for the unit—a potent heat producer—is located right under the CPU (the central processing unit) which controls all logic functions. It's not really an ideal location, but it beats putting it near a channel line (where it might induce hum), or near the tape transport (where it could bulk-erase your tape). There's only

so much room in a self-contained mixer/recorder unit, so they probably made a prudent engineering compromise. Unfortunately, nobody bothered installing a fan there either. So if you operate your Akai in hot weather, in a room that is not air conditioned, you may encounter some weird behavior.

There are several things that can be done to alleviate this nuisance. Raise the unit off the table so air can circulate underneath. This is an absolute necessity. It's even better if you remove those pretty wooden rails on either side of the console. Wood is an insulator, retaining heat. When the metal chassis is left exposed, it

acts more as a heat sink, draining the heat off into the air. Those two items will probably allow you to do more extended sessions without problems. Installation of a small whisper-type fan would probably be an all around perfect solution. I am sure it would increase the longevity of the unit as well.

### SOME SIMPLE MODIFICATIONS

Speaking of longevity, the capstan motor will last a lot longer if you can shut it off when you are not recording. Probably a good 50–60 percent of time spent in the studio today involves auditioning sounds or building a sequencer pattern—essentially tapeless functions. Having the capstan in motion during all that time can contribute to an early burnout. If you are fairly electronically competent, you can probably insert a bypass switch yourself on the power lead to the motor. If you have any reservations about pulling your machine apart (or if it's still under warranty), it's best to have an authorized technician do the work for you. Here in New York, I'm blessed to have an excellent Akai doctor who makes house calls. (See technician Harry Barber performing surgery on my 12-12 in Figure 2.)

Another useful modification is a footswitchable punch-in button. (The unit has a remote, but it makes no provision for a footswitch. Keyboard players may get by, but guitarists will be out of luck without one.) Fortunately, this is another relatively inexpensive mod that can be done by a service technician or the user. If you are going to work on the Akai yourself, it would pay to purchase a service manual. It's available through:

IMC, International Music Company, 1316 E. Lancaster, Fort Worth, Texas 76102. Telephone: (817) 336-5114.

### TIPS AND TRICKS WITH THE AKAI 12

Enough has been said about how the Akai 12 could be improved. Most of the things it claims to do, it does extremely well. Such as recording sound, for example. Isn't that the *raison d'être* for a tape recorder? Despite the storms in the relationship, I am still very much in love with my 12-12. The romance seems to in-

Model	Adams-Smith Zeta 3	Fostex 4030
MG12-12	Reads SMPTE in fast mode. Does not require tach-pulse  Requires simple modification. 1 hr. + parts: Approx. \$50-70 total	Requires tach-pulse. Does not read SMPTE in fast mode  Requires installation of additional parts and alignment by tech experienced on the MG. 3-4 hrs. + parts (including 15 pin D sub): Approx. \$350 total
MG12-14	No mod required	Same as above, except for 15 pin D sub: Approx. \$350 total
MG-14D	No mod required	No mod required



tensify every time I hear one of my tapes next to stuff from other electronic cottages. Even when compared to recordings from very expensive studios, the Akai holds its own quite well. In a word, it sounds pro. The highs are there, the lows are there, and the signal-to-noise ratio is almost as good as it can be for an analog recorder.

Where the *tips and tricks* come in is in Akai's mixer section. It's really a pretty versatile board—especially considering what you usually get on most mixer/recorder combo units. There are an awful lot of things it can do that is not clearly defined in the manual.

For example, the *Solo Enable* button also has a nice side effect. Once pushed, it inhibits anything other than the previously-chosen track(s) from going into record—a nice feature if you tend to be a klutz.

Another nice thing is that while it does have one stereo and one mono send (both having stereo returns), the monitor send (called *Track Send* in Akai parlance because it monitors directly off the tracks) can be used as an additional *Stereo Send* or two *Mono Sends* during mixdown. This—*Track Out (Left and Right)*—can be patched into whatever effect device or devices you choose and manually patched back into the mix at a patch point called *Auxiliary In (Left and Right)*. I have two mono delay lines I patch into the left and right track sends. Having discrete units for left and right can be real helpful in recreating *stereo* images from monaural tracks during mixdown.

Another *really* nice trick I recently learned from Andy Burgess—the reigning Akai specialist from IMC's engineering department. The Akai, although limited to twelve recorded tracks, is capable of functioning as a 24-channel mixer.

Here's how. Your recorded tracks will be mixed from the *track monitor* (as if you were doing an overdub) patched from *Track Out (Left and Right)* directly into the *Auxiliary In (Left and Right)*. If you have previously striped the time code, you now can run twelve channels of



Figure 3. The author in his Akai-based studio.

sequenced sounds into the channel line inputs of the board. The twelve *live* sequenced channels will now run synchronously and be mixed with the twelve pre-recorded tracks. *Send B* will provide an effects loop for the tracks (just push the track button on each channel's individual *Send B* control), and, of course, *Send A* will provide an effects loop for the incoming *live* sounds. For folks who do a lot of virtual tracking and don't want to run out and buy a sub-mixer, this is really the way to go.

#### A LETTER FROM ANDY

Finally, I asked Andy Burgess, if there was any advice he would like to give Akai users. I will duplicate a portion of his reply as follows:

"Please advise users to thoroughly clean all of the heads, guides, and pins that the tape contacts when running. Be careful not to bend the back-tension arm. Cleaning of the pinch-roller and capstan-pin is especially

important. Don't be afraid to *scrub* the heads and guides, etc. Place your thumb behind Q-tip, but don't overdo it! If machine is used daily, clean and demagnetize daily. Never energize or de-energize a demagnetizer closer than 24 inches (60 cm) to the heads. Ensure that the tape machine is *switched off*.

"There is some confusion concerning the synchronization of two or more MGs or a VTR and an MG. The considerations vary from model to model, the most important aspect being, will the synchronizer read SMPTE in fast mode or does it rely on a tach-pulse when the transport is shuttling? The MGs will not sync together without the control of an intelligent interface! Below is a chart indicating the requirements for each MG and two popular synchronizers.

"I hope there is some useful material here. 

# Recording Techniques

## AES WORKSHOP: THE STATE OF THE ART OF REMOTE RECORDING

• How do the pros handle remote recordings and broadcasts? A workshop was held on this subject at the 1988 Convention of the Audio Engineering Society in Los Angeles.

Why should we do remote recordings? This question was answered by Xanobia Villet, the organizer of the workshop: The right sound and a good musical feeling can't always be achieved in a studio. You may need a large venue. It may be more convenient to have the participants meet at a particular venue than at a studio. As Guy Charbonneau says, if a band likes playing in a warehouse, they'll play better music there, and better music makes better sound.

In the remainder of this article, comments from each participant have been paraphrased and edited for clarity. I've tried carefully to preserve the original intent, but if anyone's meaning has been misrepresented here, please send your corrections to **db**.

### ERRATA

In the July/August issue in my article on sound at the Special Olympics, I neglected to list White Instruments as a donor of equipment. We appreciate their generosity for this worthy cause.

### JOHN FASARANO, STUDIO ON WHEELS, GLENDALE, CALIFORNIA

I take my remote truck to musicians' homes and plug into the facilities there. This is convenient for musicians who don't want to disassemble their home MIDI setups. I pull up and tie into their homes' AC panel. Two trucks are used: a half-semi, or a van with a cube on the back.

### Broadcast remotes are less common these days because they cost so much.

Equipment in the small truck includes a Spectra-Sonics 28-input console and an M79 recorder. Equipment in the large truck includes an Amek 40-input console, Ampex 1200 recorders, and distribution amps for satellite feeds. Both trucks also have effects, Yamaha NS-10M monitors, JBL monitors, 36 microphones, and six limiters (1176 and dbx).

To prevent ground loops and hum, I usually don't connect ground on the AC power. This solves 80 percent of the hum problems. I also flip the ground lifts or run AC into the house, and have them plug into that.

The recorder runs at 30 in./sec., with a +5 or +6 recording level.

The control room in the truck is an LEDE design by the Record Plant. Although the truck has no acoustic studio built in, I have recorded vocals

in the control room. This is sometimes done without headphones by using close mic'ing. Vocals can also be recorded in a quiet room in the house, with blankets on the walls. My talkback mic goes to their headphones or to their stereo system.

I run a 27-pair snake and 3-way splitters with ground lifts. (I made one splitter with Jensen transformers and bought one from Wally Heider.) Setup takes as little as five minutes.

My rate for the large truck, live concerts, dual machines, is \$1800 a day; and for a single machine is \$1500 a day. Recording sessions are \$500 a day for the large truck, \$300 a day for the small one. Mixdown is usually done in the truck.

### MICHAEL CALLAHAN, KIS-FM

Mr. Callahan is chief engineer of KIS-FM, an SBE-certified AM/FM broadcast engineer, and a teacher in the California Community College district. He developed and taught the SBE certification course, and is a writer for *Radio World* Newspaper and *Broadcast Engineering* magazine.

His comments follow.

Broadcast remotes are less common these days because they cost so much. Early remotes were of musical shows, such as a live band playing in a hotel. Today, we take the DJs on the road, and they do their programs from a remote location.



One type of remote is the DROP-IN. During the regular program, someone calls in on a telephone and says, "Here I am at..." and we put them on the air. Since this is not high-quality audio, it is avoided.

Another type is the VOICE-ONLY remote. The DJ in the field does intros, outros, and comments; while all the music is played at the radio station.

Still another type of remote is called VOICE PLUS BITS. The DJ takes a cart and a cassette recorder to play stereo material along with his or her voice. Back-haul channels send the radio program to the remote if it is out of the broadcast range.

In a MIX-MINUS remote, we send all of the program to the DJ except his voice; the DJ can hear the program but not himself. This is necessary because of transmission delays. At the remote site is a console with drop-ins and mics. The crowd at the remote listens to a P.A. system playing the DJ's console audio and the station's music. A communication line from the station (containing comments from station engineers) goes to the DJ's headphones. In the studio, the audition channel (containing music) feeds to the program channel. The DJ listens only to the audition channel (as shown in *Figure 1*).

Four methods are used to get remote audio to the studio:

1. A dial-up telephone.
2. Leased loops (for example, you ask for an 8 kHz loop from 8 a.m. to 12 p.m., ready for testing Friday morning).
3. Microwave (which is relatively inexpensive).
4. Satellite (which is good for distant broadcasts. It has a 60 dB S/N ratio with companding).

To broadcast from cars or boats, we use cellular phones. Unfortunately, they are less reliable than hard wires.

A 5 kHz bandwidth for sports announcing on am radio is adequate and inexpensive. For fm we use an 8 or 15 kHz line. A non-equalized line is a last resort. It helps if you add companding noise reduction to the phone line.

A stereo remote is expensive. Phase matching of the two channels requires similar routing of the two remote lines; otherwise you get inter-channel delay. It costs \$300 to phase

each end. Telephone stereo pairs may take two days to set up. In a stereo pair, you may be given both terrestrial and satellite channels. If this happens, hang up and try again.

To check the line, put tones, a frequency sweep, or pink noise at the sending end. Check polarity with a 100 Hz tone or a pulse generator.

The phone company might use lines on which they hear no signal. To prevent the phone company from using your line, keep audio on it. You can use Morse Code, or a cart machine continuously playing a message stating your location. You could also use DAK's solid-state devices that play several seconds of a digital recording.

---

**A satellite remote link is expensive. It may cost \$17,000 for a feed from Disney World, or \$26,000 for a feed from London.**

---

For microwave links we use parabolic antennas with remote antenna rotors. The *Street* program for IBM computers has proven useful in aiming the antennas: It gives the distance and direction from your geographic location to another.

At the microwave receiving end is a variable-frequency oscillator (VFO) controlled by the signal strength. We run its tone through the phone lines and listen on the sending end. Then we rotate the antennas until we hear the highest pitch; and then both the sending and receiving antennas are aimed at each other. On some occasions we have used mountains for passive reflectors.

A satellite remote link is expensive. It may cost \$17,000 for a feed from Disney World, or \$26,000 for a feed from London. The satellite transmission causes a delay.

Preparation is extremely important for remotes. Have a check-off list with such items as a flashlight, digital clock, station banner, dial telephone, and fax machine (say, to get sports from the L.A. Times).

### GUY CHARBONNEAU, PRODUCER AND OWNER OF LE MOBILE, HOLLYWOOD

Having done live recording since 1973, Guy has done location recording in North America from 1975 to the present with the Le Mobile truck. He also did record projects and TV and radio programs. His clients include NBC, HBO, Van Halen, and numerous other artists. Guy has this to say about his operation:

Le Mobile is a truck with a 25-ft. long box. It's a control room I bring to musicians. The truck is lined with lead sheet to make it more solid acoustically.

Equipment includes a modified 30-input Neve 8058 console with Necam II automation. The transformer-input Neve sounds great and saves ground troubles. I use a TAC sub-mixer for the crowd and keyboards. Other equipment includes 2-track and 4-track Studers, EMT 250 reverb, Yamaha REV 7 and SPX 90, gates, delays, TC sampler, Eventide Harmonizer, and JBL, Yamaha NS-10M, and Tannoy loudspeakers.

I record at a level of 250 nw (+3) at 15 in./sec. with Dolby SR noise reduction. I listen 6 feet from the main speakers and also use close-field monitoring.

The truck uses 3-phase, filtered, 240 V power with a 25 kVA transformer having six different taps. I don't use the neutral; it carries a lot of current from lighting systems. The truck chassis is grounded. I use no ground lifts 99 percent of the time; I carry through the shield with the sound company. In some clubs, I bring 50 amps to the stage on a 220 V line with a distribution box. All the

*Figure 1. The setup for a mix-minus remote.*

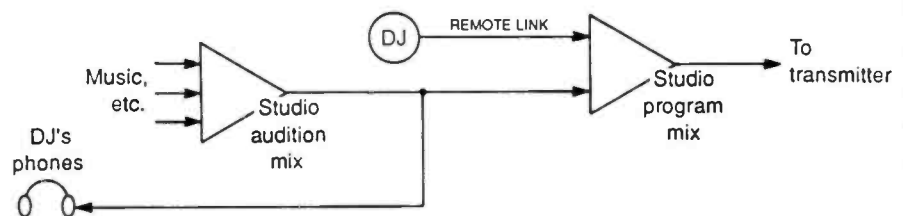

musicians' instruments and the club console plug in there. This prevents ground loops and AC line noises from coffee machines and dishwashers. When working with a big P.A. company, I just ask for their split. Often a Y-adaptor works.

It's risky on the road, so get a contract and a 50 percent deposit before doing a recording session. It helps to get a fax of the input list.

For Van Halen I have used 30 drum mics and eight guitar mics on one man. I plan in advance with the sound technician or the musician, working out the inputs and planning subgroups. I often use all 60 inputs.

Lately, I pull the truck alongside a building with two or three rehearsal rooms. I record the band's full set on the last day of rehearsal. When they go to full production on stage, the tape can be replayed as often as desired for TV-cue practices without wearing out the musicians.

I also use Le Mobile myself to produce others. I bring the client to a place (say, a living room or garage) where they feel right doing their music. It's an interesting challenge.

I know what I'm going to hear in this truck; I know the equipment. The main variable is the recording room.

Preventive maintenance on the truck itself is important. I clean the equipment cards and look for loose wires. Also, I ask people not to smoke around the equipment to prevent getting smoke particles in the switches.

For a live broadcast, a telephone technician gives me a wire pair and says "Here's your feed." I tie it to the truck and feed to the radio station with a cellular phone or phone line. I test for polarity and play a tone. In the first 30 seconds of a feed, I listen to a mono TV or radio playing my remote. If I hear a weak signal or just reverb, one channel is out-of-phase. I have a patch cord ready to fix it.

I compress the bus for a phone line, and often cut EQ instead of boosting. I may boost 5 to 10 kHz a little to

compensate for phone-line losses. I match the truck's direct-monitored signal with the TV audio. My audio is sent at -2 level, not 0, for a little more headroom.

It's best to use two trucks for multiple stages (one truck per client).

Here's a tip: To make certain instruments effectively louder in the mix, try cutting the level of too-loud instruments, rather than boosting quiet ones. Another tip: use a small live room, not a big one, to get a big drum sound.

### **RON STREICHER, REMOTE RECORDING ENGINEER**

Ron does remote recordings by setting up equipment at the site, rather than using a truck. He's done broadcast remotes, classical albums, recordings in Pakistan, and digital projects in Russia. Here are his comments.

---

**In my primary mic kit I have nine Schoeps preamps with 26 capsules, four AKGs, two Neumanns, two stereo mics, and a Calrec Soundfield microphone.**

---

The four words any remote engineer hates to hear when arriving at the gig are, "Oh, by the way..." It's all downhill from there! The most important part of any remote is preplanning, but invariably your plans will change when you get there.

The first thing to do when you unpack is to measure the AC power: test the polarity, ground, and voltage. Hold a de-tuned radio next to the outlet to check for buzzes. Use a 2:1 or 1:1 transformer, a variac, EMI and RFI filters, surge protection, and an ammeter to know if you're getting near the circuit limits.

To improvise a mic stand, take some Atlas AD-6 tubes (with a mic-stand adapter on both ends) and attach it with gaffer tape to anything high.

Take your own cables so you'll know they'll work. Have a patch cord for flipping polarity. Also take an adapter kit, twice as many cables as you think you'll need, and filtered AC power strips. You have to take extras in case something goes wrong.

To feed Telco lines, I use a box that drives +18 dBm into a short. It has transformers, termination switches, polarity switches, binding posts, and XLRs.

Especially for international travel, make sure your documentation is up to date and matches the equipment you're carrying. Make a list of everything you take: all the details, such as each pencil, razor blade, connector, etc.

Also make sure your insurance is up to date. You need insurance for enroute as well as at the destination.

In past remotes, I used one tape machine and cued the conductor to stall while I changed reels! Now with digital recording, I can get two to three hours per roll of tape.

I organize my cases so I know where every item is. They're ready to go anytime and make setup much faster. The cables are packed with their associated equipment, not in a cables case. I check everything coming and going, and try to have 100 percent redundancy, such as a small mixer to substitute for the large console.

In my primary mic kit I have nine Schoeps preamps with 26 capsules, four AKGs, two Neumanns, two stereo mics, and a Calrec Soundfield microphone.

I use a Sony PCM-F1 with two transports, rolling two tapes at a time because of dropouts. I also run a DAT backup and a double cassette machine for the client's copy.

For more information on remotes (such as logistics and paperwork), refer to Streicher's AES preprint 2155. 

**Free Federal  
Consumer Information Catalog.**  
Dept. RW, Pueblo, Colorado 81009

**We need you.**

WERE FIGHTING FOR  
YOUR LIFE

**American Heart  
Association**





# Audio for the Church

• One of the most misunderstood subjects in church audio is the mic'ing of a choir or ensemble. First we'll review some of the basics of microphone technique. Then we'll look at practical choir mic'ing based on these principles.

## BACK TO THE BASICS

First, let's review the differences between omni-directional and uni-directional (usually referred to as directional) patterns. The microphone's polar patterns are best understood with a visual illustration so you can see the pick-up patterns (see *Figure 1*). You can determine the best microphone for the application if you understand how to read the polar response of a microphone. You'll notice in *Figure 1* that the pick-up pattern of the Omni-directional mic is a 360 degree uniform pattern. It picks up no matter which side of it you stand, and as long as you are facing it, you will have the same level.

Looking at the cardioid mic in *Figure 1*, you will notice that it has only half the pick-up pattern of the omni-directional. If you stand at the 0 axis you will have optimum gain, but if you stand at the rear (180 degrees), you will have minimal gain.

Some polar patterns show you several different frequencies, enabling you to get a better idea of the true over-all pick-up pattern. The reason for this, is a microphone may have a cardioid pattern of 500 Hz to 18 kHz, but may go to an omni pattern below 500 Hz. Plus, you need to know where the dB down points are in the polar pattern to help with aiming for clarity.

## THE 3:1 RULE

Now that your memory has been jogged on the basics of microphone patterns, let's move on to the rules of mic'ing. The first is the 3:1 rule,

which I consider to be one of the golden rules of mic'ing. 3:1 is the ratio of how close you can safely place microphones together before they start working against each other. If you have a microphone 1 foot from someone speaking, the next microphone needs to be at least 3 feet away. If not, your sound may be colored (hollow), or one microphone may be considerably weaker and lacking gain-before-feedback. The effects of breaking the 3:1 rule are due to phase cancellations.

---

**A common belief in church audio is the more mics, the more sound. This is incorrect!**

---

## THE INVERSE SQUARE LAW

The next thing that we have to look at is the inverse square law. The basic concept is that every time you double the distance, you lose 6 dB of gain. Keeping this in mind and pertaining to the subject at hand, you need to remember that there are gain losses from the source to the microphone, as well as in distance itself. The inverse square law is more involved than what I just described, but that's as far as I'm getting into it.

To summarize the rules and regulations of mic'ing technique, I'll paint a little picture. The first thing you need to look at is how close you are going to place the mics to the source (keeping in mind the inverse square law). Then, make sure that you are not violating the 3:1 rule. Next, use the pick-up pattern to aim the mic to get the most uniform gain possible.

## HOW MANY MICS?

A common belief in church audio is the more mics, the more sound. This is incorrect! Every time you open more than one microphone you lose gain-before-feedback. In fact, every time you double the amount of open microphones you will lose 3 dB of gain to your system. (See *Figure 2*.)

Looking again at *Figure 2*, you will notice that if you use the typical four microphones to mic a choir, you are losing 6 dB of gain-before-feedback in your system, and it forces you to use close mic'ing techniques. Now I know that those using this technique do it so that each section can be mic'ed for balance, but from the size of the average church choir (which ranges from ten to seventy-five members), you are defeating your purpose. Because of the extremely close mic'ing, you are going to get isolated voices. You can't amplify something that is not there, and chances are you are violating the 3:1 rule.

I use two approaches when it comes to mic'ing the typical church choir. I start with two mics, because most choir lofts are split, and then locate the mics slightly above and approximately 1-1/2 to 2-1/2 feet in front of the first row. Next, by picturing what the polar pattern looks like, I will aim the microphones so that the first row of the choir is just within the 3 dB-down point of the polar pattern. You have to make sure that the mic you select to do the job has tight uniform frequency response throughout the polar pattern. By having this uniform frequency response, you will keep the tone quality fairly constant even at the 3 dB down point in the pattern. You will notice in *Figure 3(A)* that there are minimal microphones open, which keeps the system gain high. The 3:1 rule is not in violation, which keeps the clarity in the sound. Using fairly close mic'ing also

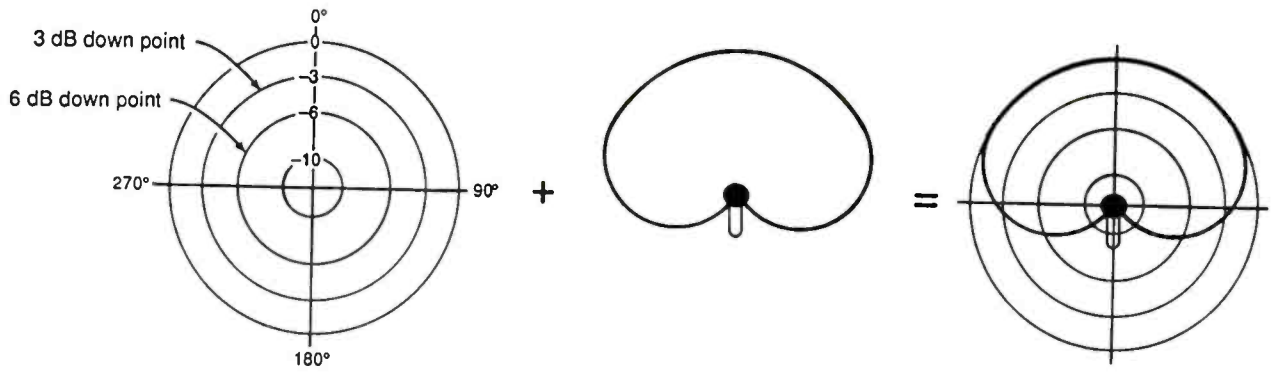

(A)

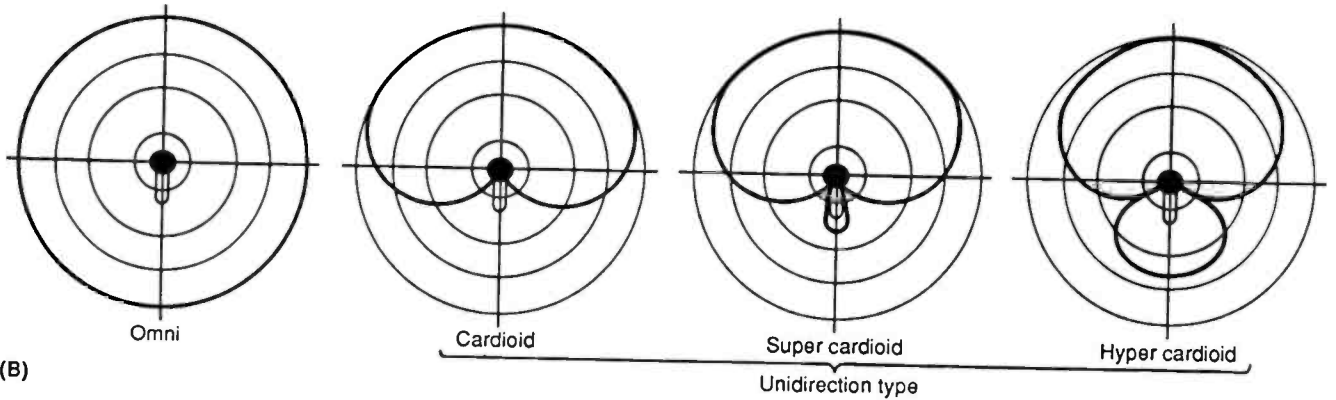

(B)

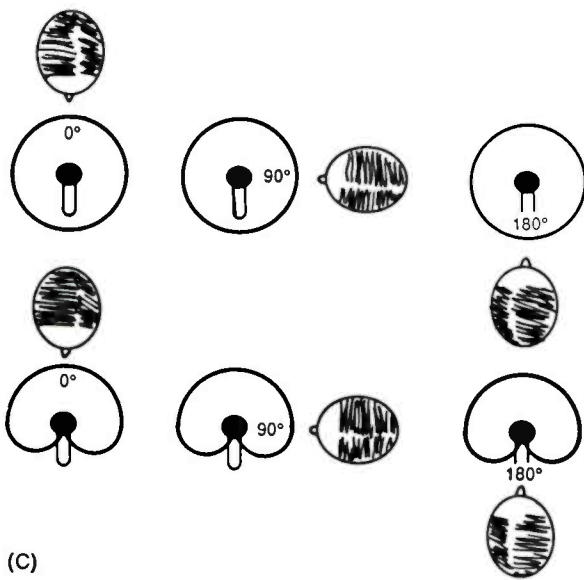

(C)

Figure 1. Various microphone types. At (A) 3 dB and 6 dB down points, at (B) the four patterns, while at (C) you can see what happens if you use an omni or directional mic at different angles of acceptance.

keeps the system gain high, but notice that it is far enough back it lets the natural blend of the choir come through. The placement just described would primarily be used for a choir positioned in a rectangle formation with an aisle down the middle.

For some reason the bass, baritone, and tenor sections are usually smaller than the alto and soprano. If this is the case at your church and the choir is in a slight U position, you could add a microphone back toward the men's section of the choir, again as in *Figure 3(B)*. By using only three

microphones you are only going to lose approximately 1.5 dB of gain-before-feedback from the previous two mics.

**Using cardioid-type microphones is usually preferred because of monitor speakers being so close, which helps keep them from fighting against each other.**

Therefore, you will only be down 4.5 dB, whereas if you add just one more to make four microphones you will be down a total of 6 dB of gain-before-feedback.

It looks as if this is not a large loss of gain-before-feedback, but you need to remember that we are looking at a logarithmic measurement in which it takes the doubling of the power to get 3 dB increase, and you're decreasing the power by half with a 3 dB loss. I feel a loss of 3 dB is acceptable, but you are compromising gain-before-feedback when you are losing 6 dB of gain.



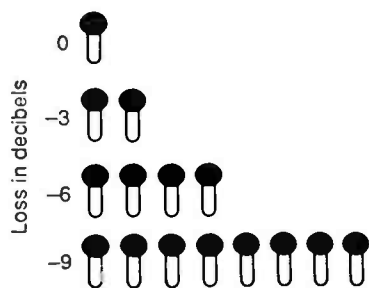

Figure 2. Using more mics results in fixed dB losses.

### MIC'ING SMALL GROUPS

When mic'ing a small group or ensemble you need to remember the same general rules. The only thing that I am going to vary from is the type of microphone that is going to be used. They are all designed with specific purposes in mind, so each application warrants finding the type of microphone that will best suit the purpose.

**There is no concrete right or wrong for microphone placement as long as you follow the inverse square law and the 3:1 rule.**

The most common situation in church audio is the gospel quartet. It is also one of the easiest. In most cases you don't have to worry about the 3:1 rule because the mic is usually only an inch or two from the singers' mouth. Even if it is more than two inches away, the next closest mic can be six inches. The inverse square law applies, but you are using such close mic'ing, that it has an excellent trade off. Using cardioid-type microphones is usually preferred because of monitor speakers being so close, which helps keep them from fighting against each other. Most quartet singers like the advantage of the microphone's proximity effect, which is a bass boost the closer your sound source gets to the mic.

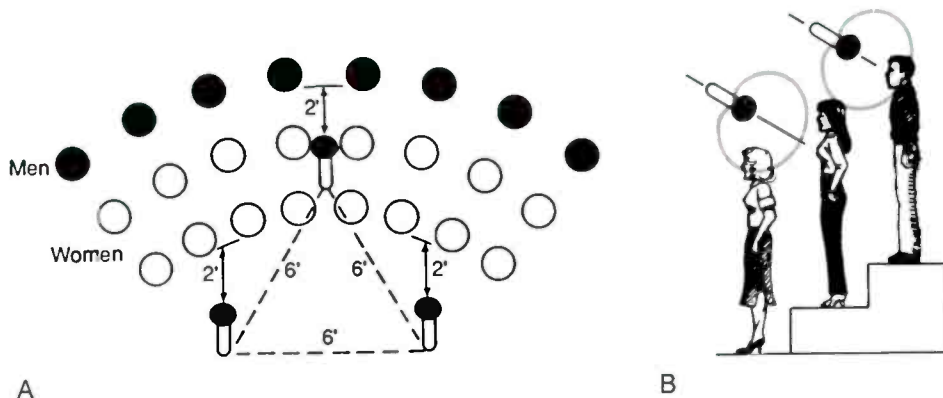

Figure 3. At (A) Make sure you don't violate the 3:1 rule. (B) Keep the rows at the 0 dB mic contours.

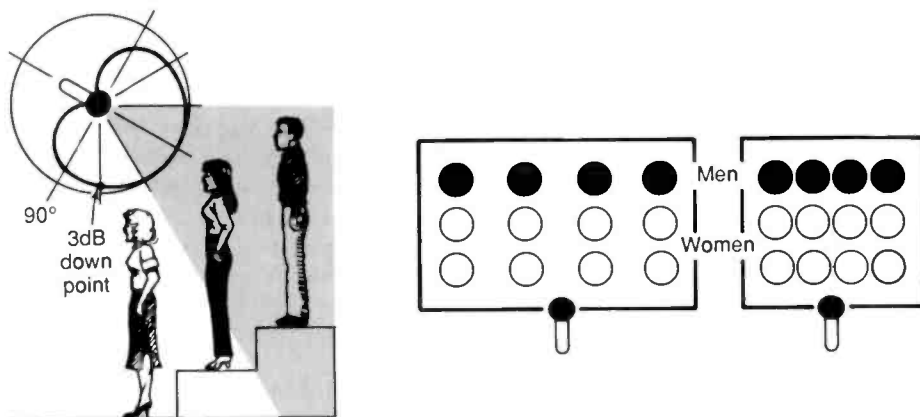

Figure 4. shows the strongest pickup area (shaded area) for the back rows.

The next case of interest is the vocal ensemble, a group of eight to ten people that stand in formation. There are two ways of mic'ing. The first is similar to the mic'ing technique of the quartet. Close-mic'ing or hand-held microphones for each singer is probably the best way of mic'ing this type of singing group even though you are losing 6 dB or more of gain-before-feedback, depending on whether you have eight or ten singers. Again, the extremely close mic'ing is going to be your saving grace in this situation. Most churches don't have an extra eight to ten channels available for this type of mic'ing. Therefore, you can have several people sharing the same microphone. If the singers are using steps or choir risers, using omni-microphones will be your optimum choice, see Figure 4. If you have to use this type of mic'ing you do need to keep the inverse square law in mind—"less is best." Split the sing-

ers into groups of three or more and keep the mic as close as possible to a central point, keeping maximum gain-before-feedback. Remember to check the 3:1 rule when using this mic'ing technique.

### EXPERIMENT

There is no concrete right or wrong for microphone placement as long as you follow the inverse square law and the 3:1 rule. Look at what you want to accomplish, and, based on the guidelines that we discussed in the beginning of this article, try a couple of different placements. Make notes of the outcome and use the one that best accomplishes your goals.

I would be interested in hearing about some of your experiments, or any subject in church audio that you would like covered. You can write me at: P O Box 1702, Springfield, OH 45501, or in care of db Magazine

## AES PREVIEW

*These manufacturers are among those exhibiting at the New York AES Convention. The information on this page was supplied by them.*

**AMS/CALREC**—has the AudioFile Digital Work Station, and the Logic 1 Digital Mixer with all the latest software. See us at AES booth number 511.

**APHEX**— will show the new Aural Exciter III, and the Model 150 dual channel VCA remote-control system. See us at AES booth 504.

**AUDIO-TECHNICA**—introduces a new line of wireless microphone systems, the TriPoint microphone, the AT4051 cardioid microphone, the ATM25 microphone, the AT853PM miniature cardioid condenser microphone, the 900 Series studio phones. See us at AES booth number 151.

**COMMUNITY LIGHT & SOUND**—debuts the field-tested R880 Speaker System for fixed and flying installations needing the latest in three-way design. See us at AES booth number 116A.

**CONNECTRONICS**—brings new wire and cable, patch bays, and his unique bodge plugs. See us at AES booth number 405.

**CREST**—has their full range of Crest amplifiers, and the Gamble EX56 (a 56 channel, live mixing console), and the FA Series of amplifiers. See us at AES booth number 134.

**CROWN**—is bringing their new SASS-P Microphone System. Using a PZM technology, the Stereo Ambient Sampling System stereo condenser microphone has a wide range of applications. Much of the full Crown line will also be shown. See us at AES booth number 510.

**db MAGAZINE**— will have the issue you are now holding at its stand. In addition, our sister company, ELAR Publishing will have copies of "The New Recording Studio Handbook", "The Microphone Handbook" and "The Handbook of Sound System Design." See us at booth number 518.

**ELECTRO-VOICE**—introduces their new Vega wireless mic system, a new E.Vhard-wired mic, and the N-DYM 1-2 MT High Frequency Driver Manifold System. See us at AES booth number 206B.

**FOSTEX**— Introduces their new moving-fader automation, a bank of sixteen motorized faders that can read SMPTE or MIDI commands, they will also show the 2016 line mixer which can be configured as a 16 x 2 or two 8 x 2s, the RM1000 Near Field Monitor with its 12-in. woofer and Fostex RP Technology ribbon tweeter, also they will show MidiRemote Software for the Fostex MTC-1 and IBM, Atari, and Mac computers. See us at AES Room number 524/26.

**GAUSS**—will show their full line of coaxial speakers and their 12-18-in. woofers with 4.125-in. voice coils. See us at AES booth number 206B.

**HM ELECTRONICS**—has a new portable wireless intercom system, the 800 Series, the RP755 Four Channel Power Station of the 700 Series Cabled Intercom Line, the RW760 Interface Unit. See us at AES booth number 209.

**JRF MAGNETIC SCIENCES**—shows their new center-track time-code conversion systems. The TC-50 Time Code/FM Processor is for use with Otari MX5050 series machines, other retrofitted kits are available for the Studer A-80, Sony/MCI JH110A/B, Ampex ATR102, and Otari MX505 Mk III machines. This year, a new BC-BII kit permits an Otari MX5050 II to be externally controllable and adaptable for center-track time-code operation. See us at AES booth number 164/5.

**MEYER SOUND**—celebrates their 10-year anniversary. They will show the CP-10 Complimentary Phase Parametric Equalizer, the MS-2, MS-3 Power Amps, the MSL-3 Reinforcement Speaker, the UPA-1A UltraSeries Loudspeaker, the USW-1 UltraSeries Subwoofer, the 650-R2 Subwoofer, the UM-1A Ultramonitor, the UPM-1 UltraSeries Reinforcement Loudspeaker, the 500A Loudspeaker System, the MS 1000A Stereo Power Amplifier, and their SIM Equalization Process. See us at AES booth number 701.

**NEVE**—shows the Neve VR 60 Flying Fader Automation, their Digital Transfer Console, and now the Mitsubishi—X880, X86HS, X86, and XE2. See us at AES booth number 725.

**SHURE BROS**—will have their Automation Mic Series, the SP Series of audio circuitry products, the Shure wireless mic systems, the new Beta series mics, as well as their regular line of SM series mics. See us at AES booth number 422.

**SONY**—brings the now famous PCM3348 48-channel DASH multi-track digital recorder and also their MXP-3056VF 56-input mixing console. They will also show their line of professional mics for studio recording, production and sound reinforcement application. See us at AES booth number 138B.

**STEWART**—introduces the MM-4, a 4-channel mixer and a battery operated +48 V Phantom Power Supply, as well as their Half-Rack Power Amps. See us at AES booth number 111.

**STUDER**—introduces a pre-production version of the D820-48 (multi-channel digital recorder which is DASH format 48-track). See us at AES booth number 733.

**TASCAM**—brings the new 688 "Midistudio" a new portable eight-track mix recorder, the new MTS-1000 Midiizer, and the new TSR eight-track recorder/reproducer, as well as the equally new MSR-24 recorder/reproducer. See us at AES booth number 94B.

**YAHAMA**—in addition to two booths at the show, they will have exhibits and demonstrations at their nearby Yamaha Communications Center. They will be introducing a new digital sound processor, a new commercial digital delay, and a new PM1200 console for sound reinforcement. Also promised, the MIDI Grand Piano—an old friend in a revolutionary new context. See us at AES booth number 180-1.



# New Products

## 4-CHANNEL MIXERS

The MM-4 from Stewart Electronics is a 4-channel mixer designed to provide high performance and flexibility in a space saving half-rack chassis. It is available with stereo output (MM-4S) or monaural output (MM4-M). The MM-4 is ideal for any application requiring a compact mixer with four independent channels. Its four channels accept either microphone or line level inputs. Each of the unit's balanced input channels features a Mic/Line switch, Level adjust and (MM4-S) L/R Pan control. The MM-4 also features a switchable +48v/10ma regulated Phantom Power Supply to provide power for condenser mics and active direct



boxes. Because of the MM-4's switchable output operating level, the unit may be used in broadcast applications (in -10 setting) as well as all stage and studio environments (in +4 setting). It operates from a 24 V

AC power supply included with the product.

*Mfr.-Stewart Electronics*

*Price-MM-4M-\$349.00*

*MM-4S-\$399.00*

*Circle 60 on Reader Service Card*

## NEAR FIELD MONITOR

Tannoy's NFM-8 (DMT) near field monitor has all the accuracy and benefits of the larger dual concentric monitors. It incorporates a revolutionary, new 8-inch Dual Concentric driver in a ported, mediate enclosure offering solid bass reproduction. The speaker's compact dimensions make them ideally suited for use in small studios, broadcast facilities, remote recording vehicles, or as an easily-transportable reference source for independent engineers and larger recording studios. The drive unit uses a deep-drawn, aluminum high frequency diaphragm, seated in a polyamide based suspension. This combination provides the piston-like rigidity associated with titanium, yet avoids the inevitable high frequency break-up modes, resulting in flat-frequency response up to 25 kHz ( $\pm 3\text{dB}$ ) with superb clarity and unmatched transient response. Improvements in the low frequency section include a new roll-surround design that ensures linearity by maximizing acoustic radiation from the cone's accurate piston action, while minimizing acoustic interference from the surround itself; and inter-

nal cross bracing that locks the driver and enclosure into a single unit. The latter provides the two-fold advantage of both increasing the structural strength of the monitor as well as virtually eliminating unwanted cabinet resonances. The Dual Concentric design results in an exceptional reference monitor offering true point-source performance,

being aligned not only in space but also in time. The monitors are finished in high-tech, anthracite gray, and pro-calibre, bi-wired crossover networks complete the package.

*Mfr.-Tannoy*

*Price-\$998.00 per pair*

*Circle 61 on Reader Service Card*



## IQ SYSTEM

Crown's IQ System 2000 has ten major monitoring functions, along with six control features. The monitoring functions allow review of the on/off status for each amplifier channel, input attenuation level, audio signals at each amplifier's input and output, the inversion of the audio signal, the IOC (Input/Output Comparator) and ODEP (Output Device Emulator Protection) signals, VCC (rail voltage) signal, on/off status of the auxiliary control line, and the DSPI (Data Signal Presence Indicator) on/off status.

The control functions let you turn any channel's high-voltage supplies on or off, decrease or increase the input level attenuation in increments of 1 dB, invert the audio signal's polarity, mute the audio signal, turn any device you have connected



to the auxiliary control line on or off, and turn the DSPI trouble-shooting feature on or off.  
Mfr.-Crown

Price-IQ P.I.P. Card-\$349.00  
IQ System Interface-\$895.00

Circle 62 on Reader Service Card

## SPEAKER CABINETS

The RED LINE 15 is a PA speaker system offering exceptional performance in a compact, affordable package. A compression horn, 15-in. driver, and 2000 Hz cross-over are housed in an attractive multi-ply Fir cabinet with black pebble finish, recessed handles, and stack-lock corners. The connector, which is hidden in the handle, allows added protection to your cabling and connections.

Mfr.-Joe's Sound and Salami  
Price-\$449.00

Circle 63 on Reader Service Card



## OCTAVE EQUILIZER

The model 4700 is an analog equalizer based on White's implementation of R-C active filters. It maintains a high degree of audio performance while taking advantage of convenience, flexibility and security of digital control. Its one-third octave filters are programmed in 0.5 dB steps. The program is stored in one of the ten memory registers. High and low-pass filter adjustments as well as output gain settings are also stored. Each equalizer is housed in a single rack space and can be ordered as a two channel version. Multiple channels can be networked to respond to one command source: the first equalizer's front panel or optional RS-232/EIA-422 interface. The network can also be programmed with up to



ten presets when controlled by the first equalizer, or an unlimited number when controlled with an external computer. Other features include: Active servo-balanced inputs and outputs; Less than 0.05% THD and better than 98 dB signal to noise ratio; Variable gain from -6 to +12

dBu, adjustable in 0.5 dB steps; EQ in/out switch; Clip indication; 90-130/180-260,50/60 Hz V AC operation.

Mfr.-White Instruments  
Price-mono-\$875  
stereo-\$1375

Circle 64 on Reader Service Card



## MIX-MINUS SYSTEM

The 1900 Mix-Minus permits up to 8 discrete, simultaneous mix-minus/IFB set-ups for field correspondents. It will be used for newscasts, talk shows, sporting events, elections and other applications where it is necessary to feed program information to a remote location minus the audio from that location. It is a stand alone system that may be used with most existing audio consoles.

*Mfr.-Auditronics Inc.*

*Price-\$8,000.00 (16 x 8 typical)*

*Circle 65 on Reader Service Card*

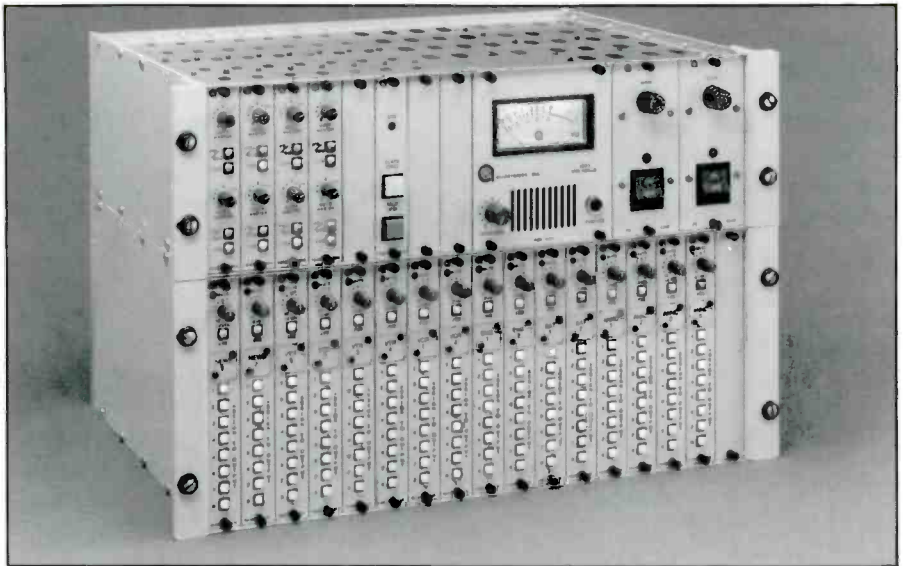

## MICROPHONE POWER SUPPLY

The MP-12 T microphone power supply is designed to provide optimum operating voltage to condenser microphones configured for 12 volt T or A-B powering, such as the Sennheiser MKH 416/816 and Schoeps CMC4. It's compact and battery operated. It features selectable 0, -10, or -20 dB attenua-

tion; as well as two steps of bass roll-off. The unit will operate up to 60 hours from two 9-volt alkaline batteries. Input and output connectors are standard XLR 3-pin; the output side also features a 15-in built-in cable that conveniently eliminates the need for a separate jumper cable.

*Mfr.-Audio Services Corporation*

*Price-175.00*

*Circle 66 on Reader Service Card*

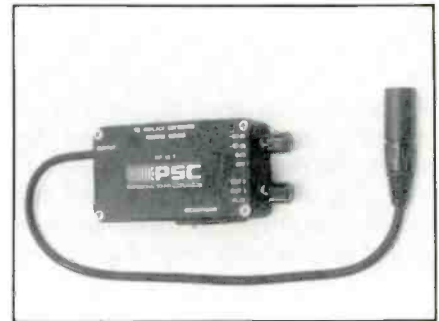

## EXTENDED RANGE SPEAKER LINE

The Extended Range speaker line has been expanded with the SH-1810-ER speaker systems. The models include the SH-1810-ER, a three-way, full-range main speaker system; SH-1810-ER, an 18-inch subwoofer system; and SH-1810H-ER, a high-output, mid/high enclosure. The systems utilize the DH3 titanium-diaphragm, "convex-drive" compression driver with the unique Time Path phase plug providing smooth, powerful highs. The DL10X midrange driver is used in conjunction with the patented Aperiodic Enhancer phase plug. The phase plug design automatically adjusts for high frequency "beaming", allowing a single driver to cover the critical vocal range without crossover interference. The mid and high components are identical to those used in EV's professional concert/touring MTH-4 Manifold Technology system. The 60 degree x 40 degree, all horn-loaded design provides uniform, large-room audience coverage with constant directivity. The low-



frequency section, utilizing the Sub-Scoop design with the EVM-18B Pro-Line woofer, combines all of the advantages of a vented box—extended low-frequency response and reduced excursion—with horn-loaded efficiency. The SH-1810-ER is also available as a modular system. The SH-1810L-ER is an 18-inch subwoofer providing efficient low-frequency output, with power handling of 400 watts long-term and 1,600 watts peak. It may be used either as the low end of this modular system, or as a subwoofer for other full-range speaker systems. The SH-1810H-ER is a high-output mid/high enclosure, using DL10X and DH3 components for high performance with power handling of 300 watts long-term and 1,200 watts peak. The optional 1810P mounting system is used to assemble the modular system.

*Mfr.-Electro-Voice*

*Price-1810-ER-\$2249.90*

*1810H-ER-\$1199.90*

*1810L-ER-\$959.90*

*Circle 67 on Reader Service Card*

# Lab Report

## Applied Research and Technology, Inc. (ART) MultiVerb EXT Digital Signal Processor.



### GENERAL INFORMATION

The MultiVerb EXT is a digital signal processor that can create multiple effects. The unit has been programmed with many digital algorithms to provide a wide range of natural and simulated stereo reverberation effects. Also included are digital delay, stereo chorusing and flanging, multi-tape delays, and pitch transposition. It is possible to combine effects or even to create your own sound effects with this versatile processor.

The MultiVerb EXT can be used in a variety of setups (including mixing consoles), with effect and return facilities, directly in line between a musical instrument and amplifier, in the effects loop of an amplifier, and even in the tape loop of a home receiver.

A wide variety of input/output combinations may be used with the MultiVerb EXT. *One in one out* (mono), *one in two out* (stereo image), *two in one out* (summed mono output), and *two in two out* (stereo). When using the MultiVerb EXT in the stereo mode, only the dry signal will remain totally left and right oriented at the outputs. The processed signal will be a mix of the outputs with its own individual stereo image dictated by the particular algorithm used.

### CONTROL LAYOUT

The unit has no power on/off switch and, according to ART, can be powered continuously. The presumption is that if it is to be rack mounted there will undoubtedly be a master power switch somewhere that controls the entire rack system. An input level slide control is located just below the bank of input level indicators and is used to adjust the input signal level. The input level indicators are colored differently (green LEDs for -24 and -12 dB, yellow for -6 dB and red for 0 dB). "Mix" and "Output" level slide controls are mounted one above the other. The mix control varies the amount of effect signal in the output from "dry" only to "effect" only. A fifty/fifty mix is achieved when this control is at its detented center position. The output level control adjusts the final output level of the unit. While the unit can be used to achieve some overall signal gain, that is, of course, not its purpose, and so the center-detented position of the output level control corresponds to unity gain.

A seven segment display towards the left side of the front panel informs the user of the current operation mode, preset number or memory location. A decimal point indicates whether you are in keypad mode, edit mode, or MIDI/title mode. All information relative to a preset effect is displayed by a backlit LCD, whose viewing angle can be changed for best visibility.

All of the remaining control buttons with the exception of "preset select up" and "preset select down" buttons and the "Bypass" button, serve a dual purpose. The split functions are identified by colors. Preset selection is depicted by the color purple. Preset control functions are labeled in gray. Preset selection can be done either by using the "up" and "down" buttons or by keypad number entry. A keypad mode/edit mode button is an extremely important button that can easily be misused if you are not careful. When you are in the keypad mode, you are able to access all of the 200 possible effects presets either by scanning or by keypad direct entry. When in the edit mode you can create your own effects, using the *Add Effect* button and calling up the nineteen various type of effects available (e.g. *equalizer*, *flanger*, *reverb*, etc., etc.) A button that, in this mode, is labeled *delete effect* allows you to erase preset effects, while another one labeled *title edit* allows you to edit or create titles for the various presets you have memorized and created. *store*, *select*, and *value* (*up* and *down*) buttons are all used as their names suggest to access the various variables available in the system and to store them as part of newly created preset effects.

Since this unit is equipped with MIDI interface, there are additional controls that allow you to access all MIDI parameters. The *MIDI/title* button is used to initiate most of the control functions associated with the MIDI interface. John Barilla, in his "Hands On" evaluation of the MultiVerb EXT will discuss the MIDI applications in more detail.

Inputs and outputs to and from the unit are connected by means of cables terminating in 1/4-inch unbalanced phone plugs that plug in to jacks on the rear panel. A remote jack is also found here. It is intended to be used with a foot-switch or some other form of momentary switch. This jack can be programmed to be used for three different modes: unit bypass, increment preset mode, or



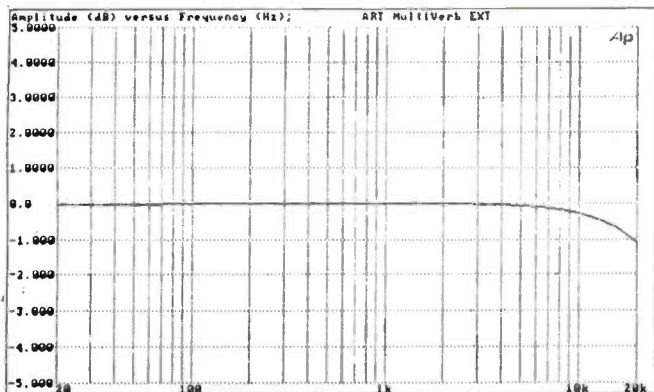

Figure 1. The MultiVerb-EXT's frequency response. Note that deviation is by 1 dB.

sample trigger mode (for instant replay or "grabbing" of a sample of previously created program material). MIDI input and output DIN connectors complete the rear-panel layout.

### LABORATORY MEASUREMENTS

As you can see from the VITAL STATISTICS chart that appears at the end of this report, there are not too many operating parameters for a unit of this type that lend themselves to laboratory or bench measurement. The very nature of a signal processor is its dynamic character. Its behavior depends in great measure upon the type of musical or dynamic signal applied to it as well as upon the type of effect that has been called forth from one of its many presets. Accordingly, our measurements were confined primarily to a plot of basic frequency response (or bandwidth), as shown in *Figure 1*, and to a plot of total harmonic distortion at input levels corresponding to 0 dB indications on the input level LED metering system (*Figure 2*).

Frequency response was perfectly flat down to 20 Hz and was off by only -1.0 dB at 20 kHz. (The manufacturer only claims a bandwidth extending to 15 kHz.) Distortion plus noise hovered at or below the 0.04 percent point over the entire range of frequencies measured. We also measured the signal-to-noise ratio of the unit, again re-

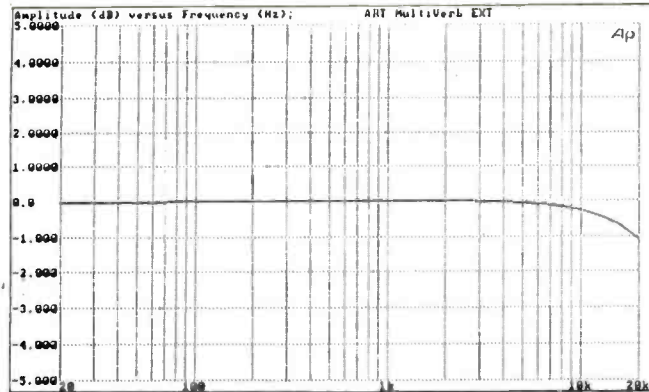

Figure 2. Total harmonic distortion (including noise) from 20 Hz to 10 kHz.

ferred to an input corresponding to 0 dB and with output adjusted for unity gain. Under these conditions, A-weighted signal-to-noise ratio measured 94.6 dB for one channel and 93.8 dB for the opposite channel.

### CONCLUSIONS

Without having access to a complete recording studio in which to put a unit such as this through its paces in the real world of signal processing, it would be somewhat presumptuous of me to draw many conclusions concerning the effectiveness of the ART MultiVerb EXT Signal Processor. For this reason, **db** Senior Editor John Barilla joins me in this test report and he will describe his experiences with the unit. This much I can say, from simply having read the owner's manual and experimented with the unit briefly on the test bench: it is truly amazing what manufacturers and designers such as ART have been able to do since the introduction of digital signal processing. I can't imagine how much hardware would have been required to achieve all of the possible effects that this unit can deliver before the advent of digital signal processing. It would probably have taken up the entire cubic space of the typical small studio. Contrast that with this compact unit that occupies less than two vertical inches of rack space and you begin to realize just what the digital age has done for audio technology. **db**

## VITAL STATISTICS

SPECIFICATION	MFR'S CLAIM	db MEASURED
Presets	110	Confirmed
Memory Locations	200	Confirmed
Bandwidth	15 kHz	See <i>Figure 1</i>
Max. Operating Level	+16 dBV	+18 dBV
Dynamic Range	90 dB	94.4 dB
Input Impedance	1M ohm	Confirmed
Output Impedance	1K ohm	Confirmed
Dimensions	1.75" H x 19" W x 10" D	Confirmed
Power Requirements	117V AC, 60 Hz	
Suggested Price	\$675.00	

# Hands On Review: The ART MultiVerb-EXT

JOHN BARILLA

This new opus from Applied Research and Technology (ART) opens the door on a whole new generation of reasonably priced digital multi-effects units. Utilizing a 20-bit processor, this unit is fast, clean, and user friendly. Listing at \$675.00, the MultiVerb-EXT offers the most comprehensive combination of sonics and programmability I have seen in this price range. And while understandably some compromises had to be made in order to pack so much versatility into a single rack-space unit, the trade-offs seem to be wise ones. In fact, it is the very elegant simplicity of design which makes the MultiVerb-EXT so useful.

## FEATURES AT A GLANCE

There are 200 memory locations in the MultiVerb-EXT, and 110 of them are pre-programmed combinations of effects. A maximum of four simultaneous effects is possible in many cases, but with certain effects which have more sophisticated algorithms (hence, using up more RAM), only two or three simultaneous effects may be possible. The user may customize factory presets or start from scratch putting together his/her own combination of effects from twenty-two categories of algorithms. Included are EQ, chorus, flanger, pitch-Ext transposer, stereo and mono DDLs, various reverbs and gated-EXT reverbs, some very breath-Ext taking multi-tap delays, and a rudimentary sampler.

Access to the parameters of each independent effect, the levels of each effect relative to the others, and in some cases, the actual routing of the effects (series/parallel, pre/post) is possible through the front panel or via MIDI controllers. MIDI implementation is extensive, allowing any MIDI controller to be assigned to virtually any accessible function on the unit.

## INS, OUTS, AND SIGNAL FLOW

There are two single-ended 1.0 M ohm inputs on the MultiVerb-EXT which allows the unit to be driven adequately by either a high-level signal from a mixer or directly from a low-level musical instrument such as a guitar. The two inputs are mixed together prior to being digitized and is hence routed to the DSP (digital signal processor) as a summed mono signal. The stereo algorithms, however, will result in a stereo output for the processed signal. (While I am always hoping that a unit of this type will offer *discrete* stereo inputs and outputs, I realize that would probably require two separate DSPs, thereby increasing the cost beyond the reasonable category).

So the upshot is this: When patched into an effects send/receive circuit on a recording console, a mono send will be sufficient to drive the unit, even though the output will require a stereo return. The two inputs on the MultiVerb-EXT do have value when the unit is driven by a stereo instrument. Since the onboard mix circuit allows the stereo aspect of the dry signal to remain intact and later summed with the processed signal, it is then possible to retain some of the original imaging of the instrument by adjusting the ratio of dry/wet from the front panel of the unit.

Input metering is by way of an LED headroom meter monitoring a range from -24 to 0 dB. Like all digital devices, the unit is optimized when the input signal only occasionally kisses 0 db. The input and output sliders are center detented at unity gain. With a reported 90 dB signal ratio, the MultiVerb-EXT is a quiet unit, but most especially so when the sliders are kept as close to unity gain as possible.

Other I/O considerations include MIDI in and out. The output may be configured to *echo* input information to the output (merging with the unit's own output). This is valuable if it is desired to drive another unit with similar MIDI information. A *programmable* remote jack is also available on the rear panel.

The MultiVerb-EXT has one of the most user friendly front panel controls that I have ever used. Every detail of it seems to be engineered to help you get what you are looking for with as little distraction as possible. Creative people really appreciate this kind of design.

For example, the view-angle of the LCDs is adjustable from the front panel. (How often have you installed a unit at the height and angle convenient for you, only to find that the display seemed washed out and difficult to read from your normal position?) Happily, with the MultiVerb-EXT, I was able to adjust the LCD for maximum readability from the front panel.

All functions are easy to access. There are really three modes of operation for the MultiVerb-EXT. In the keypad mode, memory location numbers can be directly typed in. No need to scroll through 200 numbers. Nonetheless, if you do need to scroll, you can do it at two speeds, what I'll call normal and hyper. At the hyperspeed, numbers increment/decrement by units of ten, which makes 200 presets go by very quickly.

If you want to "get inside" the sounds you'll need to enter the edit mode. In this case the 0-9 keys that were otherwise used to punch in memory locations, now become sophisticated multi-function keys. With them you can add or delete any of the twenty-two categories of algorithms or adjust the parameters of the each individual algorithm in the effects chain that you have configured.

The third mode of operation is MIDI/Utility which allows the user to access MIDI channels, modes, and the MIDI program table, to perform MIDI dumps and so on. The title function is also accessed here. On some other units, titling can be a laborious process, but not so on the MultiVerb-EXT. Because it is such a fast processor, titling is a breeze.

## HOW DOES IT SOUND?

That's the bottom line, isn't it? A DSP can do cartwheels and make coffee but the sound has to be on par, else the pyrotechnics are vacuous. The MultiVerb-EXT scores very high in this regard. It is a clean, natural sounding unit worthy of use in the most demanding applications.

What's even more impressive though is the architecture of the algorithms. As mentioned earlier, a multi-effects processor (where several effects may be used simultaneously) must, of necessity, extract only the most salient features from each algorithm, and make those accessible to the user. ART's engineers seem to have made



all the right choices here. They have picked the parameters that are essential to making a reverb *reverberate* or *flange/flangelate*—if you get the point—and left out some of the less important parameters. Of course, much of this is a design necessity.

With four effects going, it means that each can only utilize a proportion of the DSP's power, so they each have to be less sophisticated. Nonetheless, for the user, there is a certain liberation here. You don't have to scroll through a long list of parameters, many of which seem to be of more academic interest than practical sonic significance. Each of the parameters here does something important, which makes the job of ganging three or four customized effects together a lot quicker.

There is one algorithm about which I am particularly impressed. ART actually considers it two algorithms: Tapped DDL Short and Tapped DDL Long. But for now, let's consider from a generic perspective. What we have here is an extremely high quality multi-tap delay capable of one to seven taps, distributed in stereo or mono. As the diagram shows, there are three ways of organizing the relationship of the taps. If, for example, we chose an overall delay time of 100 ms and decided on four taps, if the relationship of the taps was chosen to be *even*, then each tap would be about 25 ms apart. Likewise, choosing a *shortened* relationship would mean that the taps are not evenly spaced, but start out sparsely spaced and run closer together as the overall delay time is approached. Of course the *lengthened* relationship is just the opposite: taps are initially more closely spaced, becoming further apart as the overall time is approached.

Superimpose upon this an envelope that shapes the level of these taps so that it is either *flat* (all taps at same level), *sloped* (diminishing over time), or *reverse* (increasing over time), and you have a fairly sophisticated multi-tap delay.

What ART does (that eliminates a lot of unproductive user decision making), is serve this up to you on sort of a matrix grid where the eighteen possible combinations (*even, shortened, lengthened*) x (*flat, reverse, slope*) x (*stereo, mono*) are available to you as a single selection. What this does is enable the user to A/B/C (etc.) a tremendous number of possibilities in an incredibly short period of time.

While certain other algorithms are *verboten* with this multi-tap algorithm, digital EQ and reverb are allowable. The EQ is automatically placed in the beginning of the chain, so it's pre-EQ. And the reverb is automatically placed after the multi-tap, which is its most useful place anyway. With some other combinations such as EQ + DDL + Chorus + Gated Reverb, the chorus can be assigned to the beginning or the end of the signal chain.

I guess the point of it is this: ART allows you many of the most useful combinations and prevents you coming up with anything that might sound like digital mud! It does not do everything, but what it does, it does extremely well.

One area where no stone has been left unturned is the area of MIDI control. The implementation here is rather extensive. To examine all of it in the context of a short review is not possible. But once again, there is one feature I tested which is particularly useful. ART calls it PM or performance MIDI. That means simply that the MultiVerb-EXT allows the user to map any MIDI controller onto any

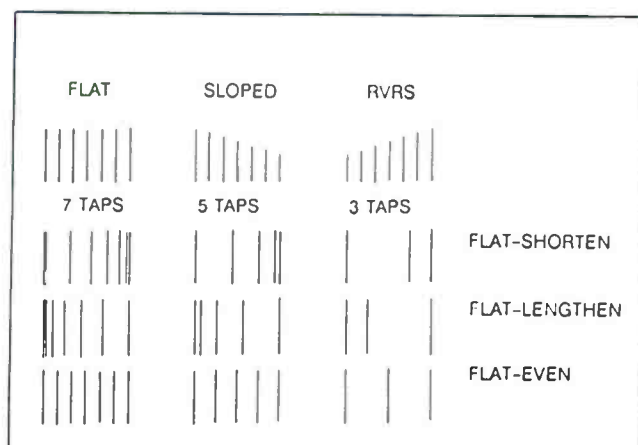

Figure 1. An algorithm used by the ART MultiVerb-EXT.

parameter control of any algorithm, and to scale the response of the controller. For example, I could program the *Note On Key #* to control the *Position* parameter in a Reverb algorithm. The effect would be that as I ascended the keyboard (the higher the note #), the greater the apparent distance from the source the listener would appear. (These parameter changes would be enacted smoothly, in real-time and reflected as a percentage in the LCD readout.) Simultaneously, I could program *Reverb Time* to respond to *Pitch-Bend Wheel* so that as I manipulated the wheel (or stick) from my keyboard, the reverb time would go from 0 to the maximum time available. I could also scale this to adjust the response so that the range was pleasing. Of course this could be again allowing multiple controllers to modify the parameters of multiple algorithms. Perhaps this all might sound a little hairy to a marginal MIDI user, but it's really quite simple to program—particularly the way ART has it laid out.

Alas, there is something about this unit which does not live up to the high standards it sets for itself in terms of signal processing. It's the sampler. No, there is absolutely nothing wrong with it sonically. It delivers a nice clean sample, virtually identical with the original sound. The problem is, it's such a rudimentary *one-shot* kind of a unit.

First of all, any editing of the two second sample can only come from one side. So a 2-second loop can be made to be 1.7 seconds, but the start time is always the same. There is no provision for chopping any time off the beginning of the sample.

Fortunately, the user's manual indicates that the software for the MultiVerb-EXT can be easily upgraded. Perhaps in future versions we can expect a truly sophisticated algorithm that will permit better editing capabilities.

## CONCLUSION

Despite my criticism of the present sampling algorithm, there is no doubt about it, ART has come up with a winner. The signal processing, the multi-effects programmability, the sophisticated MIDI control, and sonic fidelity of this unit make it almost a "must have" kind of unit. Dollar for dollar, it's hard to imagine how you could get such a useful DSP for such a reasonable price. db

# Handbook of Sound System Design

## by John Eargle

**AVAILABLE NOW!**

• If you are in sound reinforcement, John Eargle's **Handbook of Sound System Design** has the answers to those needs you have for accurate technical information. It is the technical bible on everything from a small church to Madison Square Garden, from live sound for 60,000 to canned sound for 600.

There are chapters on:

- High-Frequency Speaker Systems
- Mid-Frequency Speaker Systems
- Low-Frequency Speaker Systems
- Dividing Networks
- Central Loudspeaker Arrays
- Distributed Systems
- Paging Systems
- Microphones
- Ambiance Systems
- All this and so much more.

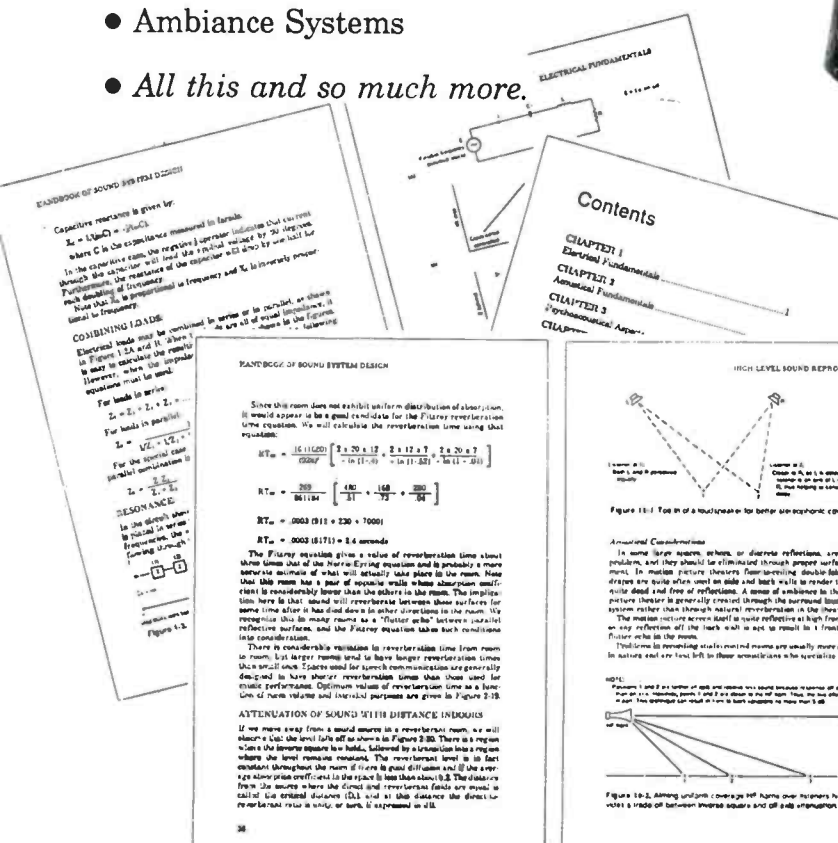
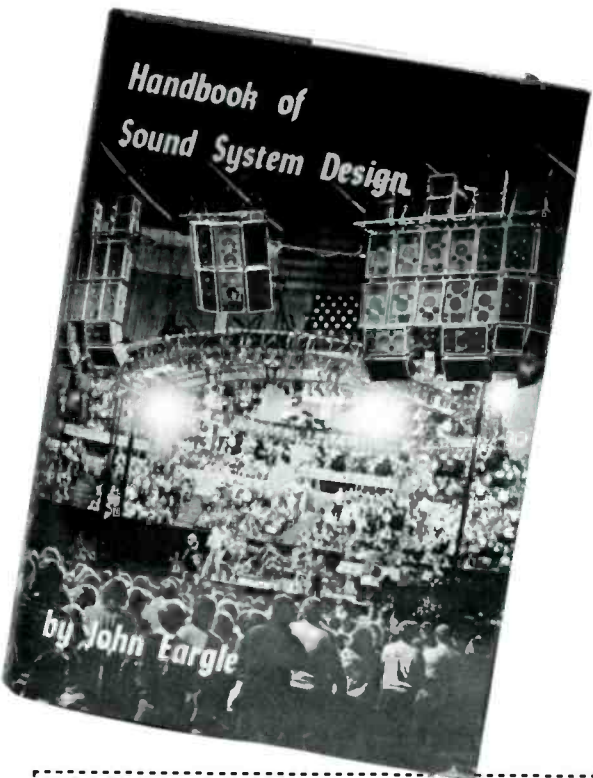

**ELAR PUBLISHING CO. INC.**  
 203 Commack Road, Suite 1010, Commack, NY 11725

Yes! Please send me \_\_\_\_\_ copies of the Handbook of Sound System Design @\$37.50 per copy. Add \$2.00 for shipping. (New York State residents please add appropriate sales tax.)

Payment Enclosed or charge my  
 Charge Card (Visa/Master Charge only)

Acct # \_\_\_\_\_ Expiry Date \_\_\_\_\_

Name \_\_\_\_\_

Address \_\_\_\_\_

City \_\_\_\_\_

State \_\_\_\_\_ Zip \_\_\_\_\_

Signature (required for charge cards) \_\_\_\_\_

Outside the U.S.A. add \$3.00 for postage. Checks must be in US funds drawn on a US bank.





## Archiving Audio

On April 12, 1989, in Universal City, California, AGFA Corporation, Magnetic Tape Division, hosted a seminar announcing their new AGFA-NXT Process for restoring previously unplayable tapes. The majority of the seminar preceding the announcement addressed the problems recording engineers are encountering when attempting to play tapes that have been in storage for many years.

Over 150 of the top recording engineers from the Southern California area were in attendance.

### RESTORING THE OLD MASTERS

Entitled *Restoring the Old Masters*, the all day session started with John G. (Jay) McKnight, President of Magnetic Reference Laboratories and chairman of many standards committees, explaining the various track, equalization, and level standards that have been in existence since AMPEX released the model 200 in 1948, a 30 in./sec. full track machine. He explained some of the reasons for and differences between the NAB, AES, AME, and CCIR curves, pointing out that CCIR, IEC, and DIN are all the same, with different names. He also noted that with all the careful adherence to tape standards, there has never been a standard or even a method of comparison for listening rooms.

*Shelley Herman is Shelex Records of Hollywood, CA as well as SAVET. (For SAVET information see People, Places, Happenings, this issue.)*

Jay also listed the saturation points on some popular recording tapes, and how tape has improved over the years. A part of that improvement being that less high frequency emphasis is needed on newer tapes. He also addressed print through, suggesting several methods of reduction that have been used over the years.

During the question period, Jay recommended that when azimuth difficulties were encountered, one should turn the alignment tape upside down and check it again. If the azimuth is not the same, the culprit is probably head zenith or a polished or damaged capstan. When asked about pink noise as an equalization method, he said it was very good, but white noise was better because it did not roll off at high frequencies and phase differences were very obvious.

McKnight's final point was: "Even after alignment, use your ears."

---

**One stereo hour is  
equivalent to a half a million  
pages of text.**

---

Werner Singhoff, AGFA's Technical Director, explained how extended storage affects magnetic media.

The first subject was mechanical damage. Uneven winding is probably the worst culprit, and the most easily avoided. It causes creases, pancake deformation, edge damage, and tape stretch. The cure is to wind the tape, tails out, in one pass, at a reasonable speed before storage. Storage conditions are important. Although both SMPTE and EBU have storage recommendation documents, they all boil down to a clean environment at

65 degrees F, 35 to 40 percent humidity

### TAPE DAMAGE

Other conditions that affect tape are: smoke (the particles of smoke from cigarettes are large enough to reduce high frequencies on tape,) dust, finger prints, and head cleaner residue. He pointed out that if alcohol must be used as a head cleaner (which is generally **not** recommended), care must be taken to keep the container sealed to avoid the absorption of water from air.

Major contributors to tape damage are: scratching, residue and unrelied stress, all due to multi-track shuttling. This was another reason that he recommended one pass winding even before short term storage.

Singhoff indicated that the tape companies were doing their best to improve tape with flatter and smoother oxide surfaces, better lubricants, more stable magnetic materials, more stable film compounds, and better binders. Some of the popular materials have been tested, and they found that ferric oxide has had no problems in losing magnetism over 50 years. CRO<sup>2</sup> has held up for fifteen years, so far, but metallic powder tape does not tend to oxidize. He pointed out that AGFA has been experimenting with various lubricants, binders and oxides for many years as they feel that they have a responsibility to make a good, long-lasting product.

### AUDIENCE QUESTIONS

Mr. Singhoff received many questions from the audience. Most of them wanted to know if there was a lubricant available to stop older tapes from squealing. He was unable

to recommend one. However, in answering a question about old, brittle, acetate tapes, he said that storage in a warm, high-humidity room for several days might make the tape playable once or twice. When asked if older tapes such as 3M 111 have less print through, he said yes, because the newer, lower noise tapes have finer particles that are more subject to print through. Answering a question about AGFA tape damaging pinch rollers, he said that the company has heard these rumors, conducted tests, and concluded that the rumors were completely unfounded.

## NONOISE

Mary Sauer, VP of Marketing and Operations, Sonic Solutions, explained how the NoNoise system has been used for restoration and CD reissue. NoNoise is a computer system for removing noise without affecting the signal. It needs 10.5 megabytes per stereo minute. One stereo hour is equivalent to a half a million pages of text. It does 53 million calculations to clean up one second of signal. When the system was first introduced in 1986, it took 500 times real-time to work. It now works in 6-times real-time.

Much has been written about this system, but briefly, it receives information from program material already transferred to 1630 format digital, is then transferred to hard disc where it is analyzed and de-clicked, then the background noise is removed. The program is then returned to tape. Physically, the system is installed in a Macintosh II, and has editing, EQ, CD preparation, project management, and NoNoise.

Gene Wolley, VP Recording and Quality Assurance of MCA Records, and owner of a NoNoise System, explained how they were utilizing the entire system as a complete work station, and how it was saving both time and money. In the question period, Ms. Sauer explained that the device was being used in forensic applications also, and the price was in excess of 40 thousand. They then played before and after tapes of Jim Morrison and the results were excellent.

## PREPARATION FOR REMIX

After a gourmet "box lunch" courtesy of AGFA, attention turned to Lee Herschberg, Director of En-

gineering, Warner Brothers Records. He told about the preparation of original analog masters for Compact Disc remix.

---

**Once the tape has been processed, there is only a one-hour window when it must be played before it starts to deteriorate again.**

---

Herschberg said that the Warner Brothers library was complete, beginning with album number one, in three-track stereo, although not all masters are on the same format. For instance, the *Concert Sinatra* album was recorded by Todd AO on six-track magnetic film, then mixed to three-track, then to stereo. Presently, Warner Brothers Records is restoring a Peter, Paul, and Mary recording from three-track to 3M 111.

## THE LOST LENNON TAPES

Dave Kephart of Westwood One played parts of the *Lost Lennon Tapes*, then explained the process of restoration. First the tapes were checked for phasing, then equalized. As they were quite noisy, he tried several methods, settling on a Berwen system. He also played some Jimi Hendrix tapes that were essentially home recordings on good equipment. He had been able to clean these up to make some high-quality releases.

Dave indicated that on projects of this type "sonic consistency from cut to cut is important. The customer will perceive that something is wrong and not be entertained."

Andy McKaie, Director of A&R Special Markets, MCA Records said that being in charge of reissues was "A&R for the Dropped and the Dead." His main point was that it was necessary to be very selective in the use of noise reduction, cleanup and equalization. The importance of the new systems is preservation of music and rebuilding libraries, some of which are in very bad shape as MCA has purchased many small labels over the years.

Larry Walsh, a recording engineer with Capitol Records, said that the recording engineer as an archivist, becomes a producer. In order to prop-

erly do the job, he must listen to the tapes, especially the slates and chatter, for valuable information. He must check any paperwork he can get his hands on, including union records, Billboard, Hot 100, record company paperwork, the tape boxes, and original release publicity. He must talk to the original artist if he is available, or anyone else that may have been involved. The most important thing is to remain true to the original, especially if it has a multi-track master, to resist the temptation to make it sound "better" than the original. That's not what the consumer is buying.

During the Q&A period of this panel it was suggested that for older tapes that shed, a play only machine with less contact surfaces might be a solution.

## THE AGFA-NXT PROCESS

Finally, the day ended with John Matarazzo, National Technical Manager of AGFA, announcing the new AGFA-NXT Process, a five-step process involving a variety of processes to clean up old tapes. Using a slide presentation, he showed an old tape before and after treatment. The tape was shredding so much before treatment that it was unusable. After AGFA-NXT, it was playable once, so it could be transferred.

Once the tape has been processed, there is only a one-hour window when it must be played before it starts to deteriorate again. At the time of the announcement, JRF Magnetics will be the U.S. agent in charge of the process, and a crew will come to the customers facility to process tapes on the spot so that they can be transferred immediately. At this time, the process is available for audio tapes only, up to two inch wide, but they say that they know no reason why it would not also work with videotapes.

Unfortunately for those in attendance, AGFA, for legal reasons, was unable to disclose the actual process of AGFA-NXT. Just the fact that a tape company has committed the resources for such a project is encouraging to the industry. With the ascent of the CD, restoration is important, and a seminar of this type was most welcome and definitely an asset to the industry. 





## Buyer's Guide

*On the pages that follow, we present this issue's Buyer's Guide on signal processing equipment. The information contained is supplied by the respective manufacturers. Further, if a manufacturer that you seek is not listed, the chances are strong that, as many times as we tried, we could not get information from them.*

\*Editorial Note: Only units whose sole function is creating reverb have been classified as "Reverbs." Units which utilize algorithmic (software) representations of several signal processing functions (which usually include reverb), have more accurately been labeled as "Multi-Effects Processors."

### MULTI-EFFECTS PROCESSORS

#### **APPLIED RESEARCH AND TECHNOLOGY** — See our ad on page 3

MULTIVERB EXT (Model 370) is a multi-effects processor with sampling capabilities. Effects include flange, chorus, delay, multi-tap, and pitch transposition. Up to 4 effects may be used simultaneously. Programmable and MIDI controllable, it occupies a single rack-space.

Price: \$675.00

MULTIVERB II (Model 360), a multiple effect/pitch transposer capable of combining 4 effects simultaneously. It has 19 effects categories with multiple algorithms, 200 memory locations, is fully programmable, and real-time controllable via MIDI. Occupies single rack-space.

Price: \$599.00

MULTIVERB (Model 330), a multiple effect/pitch transposer with 200 memory locations, including 100 factory presets. Total programmability allows you to create your own presets combining 4 effects at once. Occupies a single rack-space.

Price: \$575.00

PROVERB 200 (Model 320) is a digital effects processor with 200 presets offering a full range of studio effects. Over 120 reverb variations as well as delay, multiple effects, chorusing, and flanging.

Price: \$399.00

SGE (Model 380) is an effects processor/digital reverb/pitch transposer that includes various guitar amplifier simulations (such as overdrive and distortion). Up to 9 effects may be utilized simultaneously and controlled in real time via MIDI or front panel. Fills a single rack-space.

Price: \$699.00

#### **DIGITECH**

DSP-128 allows user to access 4 effects simultaneously at a full 20-20 kHz bandwidth. Includes reverb, chorusing, flanging, delays to 1.2 s, and multi-tap delay. Features real-time MIDI control of operating parameters.

Price: \$479.00

MSP-4 provides digital reverberation, chorusing, flanging, delays to 500 ms and multi-tap delay. Up to 4 effects may be used at one time and controlled through MIDI, 128 presets may be stored. Responds to MIDI program changes.

Price: \$369.00

GSP-5 is a digital processor for guitars allowing 5 simultaneous effects including various types of digital distortion ranging from warm tube sounds to hard-edged metal. Includes reverb, chorus, flange, delay, doubling, and equalization with MIDI control.

Price: \$549.00

#### **LT SOUND**

ECC is a digital delay system with microplate reverb. Delay and reverb may be used simultaneously or independently. Delay range is from 1 ms to 1 s. Effects include doubling, chorus, flange, plate reverb with delay, acoustic chamber, and tremolo. Dimensions are 1.75 x 19 x 7.5.

Price: \$995.00

#### **PEAVEY ELECTRONICS**

QFX-4X4 contains 4 multi-effects processors, each equipped with individual stereo/mono inputs, housed in one single rack-space chassis. Has full MIDI implementation including Sysex Load and Dump. Up to 2.75  $\mu$ s of delay per processor.

Price: \$1,199.00

DSR-1000 has true multi-effects capabilities, up to 2.75 seconds of delay echo, and 16-bit processing. There is full MIDI access with re-write and re-map facilities. Effects include delay, chorus, reverb and more, in a single rack-space.

Price: \$499.00

MULTIFEX contains 4 multi-effects processors, each equipped with individual stereo/mono inputs, housed in one single rack-space chassis. Has full MIDI implementation, including Sysex Load and Dump. Up to 2.75 s of delay per processor.

Price: \$1,199.00

ULTRAVERB has true multi-effects capabilities, up to 2.75 seconds of delay/echo, 16-bit processing, full MIDI access, and full re-write and re-map facilities. Effects include delay, chorus, reverb and more, in a single rack-space.

Price: \$449.00

ADDVERB II is capable of delivering digital delay, reverb and other effects. It has up to 680 ms of delay/echo, 128 re-mappable presets, 16-bit processing, full MIDI capability, and effects mix and output level in a single rack-space.

Price: \$399.00

UNIVERB II is a digital delay/reverb/effects processor featuring 128 16-bit effects using VLSI technology. It has a bandwidth of 20 Hz to 12 kHz, stereo and mono-to-stereo configurations, and remote bypass capability in a single rack-space.

Price: \$299.00

### **ROLAND CORP. U.S.**

DEP-3 is a digital multiple effects unit featuring delay, reverb, and EQ. Up to 500 ms delay, 99 memory locations, and 3-band digital EQ. Dimensions are 1.9 x 19 x 11.4 and weight is 7.7 lbs.

Price: \$695.00

DEP-5 is a digital multiple effects unit featuring delay, reverb, chorus, EQ, and stereo panning. Up to 2000 ms delay, 99 memory locations, and 3-band digital EQ. Dimensions are 1.9 x 19 x 11 $\frac{3}{8}$  and weight is 11 lbs.

Price: \$1,095.00

R-880 is a digital reverb/effects processors with 4 independent DSPs. Has programs for reverb, non-linear reverb, early reflections, chorus, delay, equalization and compression. Has 90 dB dynamic range, and both analog and AES/EBU digital I/O connections. Accommodates 48 kHz and 44.1 kHz signals, weight: 22 lbs.

Price: \$3,995.00

GC-8 is a "graphic" remote control unit for the R-880. Has large LCD readout (256 x 40 dot), 5 rotary knobs with numeric keypad and memory card slot for storing and loading programs. Dimensions: 2 x 13.1 x 6.9, weight: 2 lbs., 10 oz.

Price: \$850.00

### **YAMAHA** —See our ad on page 12

SPX1000 is a digital multi-effects processor utilizing "second generation" DSP technology. Features 40 factory presets and 59 RAM user memory locations. Includes dual and multiple effects programs. Full MIDI compatibility.

Price: \$1,795.00

FX500 provides up to 5 different effects simultaneously and has extensive programming capability. Has full 20 kHz bandwidth, 60 preset programs and 30 additional RAM locations for user defined programs. Full MIDI compatibility.

Price: \$495.00

REV5 is a digital reverb/multi-effects processor featuring 30 main effects programs, 9 combined programs, and 60 user memory locations, and 3-band parametric equalization is included with switchable I/O level monitoring. MIDI Dump capability.

Price: \$1,995.00

SPX900 is a digital multi-effects processor utilizing "second generation" DSP technology. There are 50 factory presets and 49 RAM user memory locations. Dual and multiple effects programs are featured. Full MIDI compatibility.

Price: \$995.00

## **REVERBS**

### **LT SOUND**

RCC reverb control center is a complete microplate reverb system for use with or without a mixing board. It has 2 microphone inputs, inputs for 2 additional stereo sources, an output for a tape recorder, plus 3-band equalization. Dimensions are 1.75 x 19 x 7.5, weight is 7 lbs.

Price: \$595.00

RV-2 stereo reverb unit features the microplate reverb system and has over 18 kHz of frequency response. Other features include 4 simultaneous inputs per channel for 3 different sounds, 7-segment LED level indicator on each channel, and decay time control of 0.6 to 2.4 seconds, weight is 8 lbs.

Price: \$895.00

## **DIGITAL DELAYS**

### **APPLIED RESEARCH AND TECHNOLOGY (ART)** —See our ad on page 3

DELAY SYSTEM VII (Model 400) is a fully programmable digital delay/sampler with a 20-20 kHz frequency response, infinite delay, chorus, flange, doubling, and echo. Can store presets and has a MIDI interface. Occupies a single rack space.

Price: \$499.00

DELAY SYSTEM V (Model 390) is a full bandwidth digital delay/sampler featuring 4 delay ranges (which are switchable), infinite repeat and bypass. Capable of echo, delay and modulated delay effects. Occupies a single rack-space.

Price: \$349.00

DD3 ALIGNMENT DELAY (Model 250) is a 1in/3out digital time delay offering 256 ms per tap. It has balance ins/outs plus terminal strip, and offers 64 kHz sample rate, all in a single rack-space.

Price: \$749.00

### **AUDIO LOGIC**

RDS 7.6 Time Machine is a rack mounted digital delay and sampling unit offering up to 7.6 seconds of delay or sample re-



cording at full bandwidth (15 kHz, 87 dB), 4 delay/sample ranges, multiple footswitch controllable functions and a 10 to 1 ratio for flanging or chorusing.

Price: \$399.95

RDS 2001 rack mounted digital delay and sampling unit offers up to approximately 2 seconds of full bandwidth (15 kHz, 87 dB) delay or sampling, multiple footswitch controllable functions, and a 10 to 1 ratio for flanging or chorusing.

Price: \$339.95

RDS 1900 rack mounted digital delay unit offers approximately 2 seconds of full bandwidth delay (15 kHz, 87 dB) for echo, slap back and infinite repeat effects, and a 10 to 1 ratio for flanging or chorusing.

Price: \$319.95

RDS 3.6 rack mounted digital delay unit offers up to 3.6 seconds of delay at half bandwidth (8 kHz, 87 dB), full bandwidth at all other delay ranges (15 kHz, 87 dB) and a 10 to 1 flange or chorus ratio.

Price: \$299.95

R2D3 has 3 independent delay outputs, each capable of up to 327 ms of delay. (Optional up to 1,307 seconds of delay). The unit has linear PCM 16 bit A-to-D-to-A conversion and a battery back-up memory. Minimum delay increment is 20  $\mu$ s.

Price: \$799.00

R1D1 is a single channel digital delay with a maximum delay time of 320 ms. The unit has linear PCM A-to-D-to-A conversion and is DIP switch programmed. Minimum delay switching increments are 5 ms.

Price: \$450.00

### **ROLAND CORP. U.S.**

SDE-3000A is a programmable digital delay with 8 memory locations and a 10 Hz to 17 kHz frequency response. Features up to 4500 ms delay time, 100 dB dynamic range, 0.03% harmonic distortion. LFO with modulation rate and depth controls.

Price: \$1,095.00

### **SOUND CONCEPTS INC.**

SSD550 is a 2-channel delay featuring a delay time of 5 to 50 ms switchable to 100 ms. Has a 90 dB (A-weighted) S/N ratio and a frequency response of 20 Hz to 8 kHz. Contains a built-in mix and surround decoders. Occupies 2 rack-spaces.

Price: \$869.00

## **CROSSOVERS**

### **ALTEC LANSING CORP**

15594A is a low pass crossover/equalizer "plug-in" module for the 9400 series power amplifier. It has an 18 dB/octave roll-off pre-programmed at 125 Hz, 500 Hz, 800 Hz, and 1250 Hz. Customer programmable for other frequencies.

Price: \$80.00

15595A is a plug-in module for 9400 series power amplifier which has an 18 dB/octave roll-off pre-programmed at 125 Hz, 315 Hz, 500 Hz, 800 Hz, and 1250 Hz. Customer programmable for other frequencies.

Price: \$80.00

1631A is a single channel 18 dB/octave crossover with selectable crossover point from 100 Hz to 8 kHz, 4 dB of cut/boost at 10 kHz, 25  $\mu$ s to 2 ms variable delay for low-pass output. Dimensions: 1.75 x 19 x 4.8, weight: 4.74 lbs.

Price: \$598.00

1632A is a dual channel 2-way or single channel 3-way active crossover with user selectable crossover points from 50 Hz to 10 kHz, 30/60 Hz HP inputs, hard limiters on all 4 outputs, and sub-modules to customize response, weight: 8 lbs.

Price: \$1,050.00

### **ASHLEY**

XR-1000 is a 24 dB/octave electronic crossover providing stereo 2-way or mono 3-way. Has variable filter response which allows tuning-in Linkwitz, Butterworth or other filter performances. Has XLR inputs/outputs and 20 Hz hi-pass filter.

Price: Available upon request.

XR-2000 is a 24 dB/octave electronic crossover that can be variously configured as stereo 3-way, mono 4 or 5-way, 4 channel 2-way, etc. Has variable filter response which allows tuning-in Linkwitz, Butterworth or other filter performances. Has XLR inputs/outputs and 20 Hz high-pass filter.

Price: Available upon request.

XR-3000 is a 24 dB/octave electronic crossover in a mono 4-way configuration. It features an extra-wide tuning range of 40 Hz to 24 Hz for special applications. Has variable filter response which allows tuning-in Linkwitz, Butterworth or other filter performances.

Price: Available upon request.

XR-4000 is a 24 dB/octave electronic crossover in a stereo 4-way version. Features an extra wide tuning range of 40 Hz to 24 kHz for special applications. Has variable filter response which allows tuning-in Linkwitz, Butterworth or other filter performances. Has XLR inputs/outputs and 20 Hz hi-pass filter.

Price: Available upon request.

XR-22 is a 12 dB/octave electronic crossover with continuously adjustable crossover points in a stereo 2-way configuration. Output stages have wide range gain adjustment to match power amps and drive long cable runs. Has state-variable filters.

Price: Available upon request.

XR-70 is a 12 dB/octave electronic crossover with continuously adjustable crossover points in a 3-way configuration. Output stages have wide range gain adjustment to match power amps and drive long cable runs. Has state-variable filters.

Price: Available upon request.

XR-77 is a 12 dB/octave electronic crossover with continuously adjustable crossover points in a stereo 3-way configuration. Output stages have wide range gain adjustment to match power amps and drive long cable runs. Has state-variable filters. Price: Available upon request.

XR-88 is a 12 dB/octave electronic crossover with continuously adjustable crossover points in a stereo 4-way configuration. Output stages have wide range gain adjustment to match power amps and drive long cable runs. Has state-variable filters. Price: Available upon request.

### **AUDIO LOGIC**

X324 is a stereo 3-way, stereo 2-way with a mono sub woofer, or a mono 4-way crossover. The unit has 18 dB/octave Butterworth filters in a state-variable configuration with a switchable 40 Hz high-pass filter.

Price: \$380.00

X223 is a microprocessor controlled stereo 3-way, stereo 2-way, or stereo 2-way with a mono sub-woofer crossover. The unit has 24 dB/octave Linkwitz-Riley filters in a state-variable configuration.

Price: \$500.00

### **CARVIN**

XC1000 is a dual electronic crossover utilizing high-grade ICs for a transparent, uncolored sound. Distortion under 0.01% THD and a dynamic range of 112 dB. Dimensions: 19 x 3.5 x 7, weight: 10 lbs.

Price: \$299.00 (direct)

### **CROWN INTERNATIONAL** —See our ad on page 7

FFX-2 is a 2-way stereo, 3-way mono fixed frequency crossover with 18 dB/octave provided. It can function as a mono sub-woofer combining crossover. Dimensions: 0.19 x 6.5 x 1.8, weight: 4 lbs. 5 oz.

PIP-XOV allows user to select fixed frequencies, format of the filter and 24 "modes of operation." It allows for bi-amping and tri-amping from inside the amplifier. Dimensions: 6.4 x 1.9 x 3.9, weight: 8.5 oz.

Price: \$95.00

PIP-SPC provides both a variable 4th order Linkwitz-Riley crossover and an IOC driven dual-band variable-threshold compressor. Variable equalization provides "constant directivity" horn equalization and filter assisted box equalization, weight: approx. 8.5 oz.

Price: \$165.00

PIP-AMC enables the sound contractor to more intricately tune acoustical enclosures; allows the acoustician to precisely model the constant directivity horn rolloff. Dimensions: 6.4 x 1.9 x 3.9, weight: approx. 8.5 oz.

Price: \$165.00

### **ELECTRO-VOICE, INC. (A Mark IV Company)**

XEQ-2 is a 2-way, monophonic, active crossover network that incorporates various 18 dB/octave cross-over frequencies via different plug-in modules. It has switch selectable "Thiele" low-frequency equalization for tuned-port woofer assemblies.

Price: Available upon request.

XEQ-3 is a 3-way, monophonic, active crossover network. It incorporates 2 switch-selectable fourth order Linkwitz-Riley 24 dB/octave cross-over hinge points. Accepts "Thiele" low frequency equalization plug-in modules.

Price: Available upon request.

EX-18 is a dual channel 2-way, single channel 3-way electronic crossover with 18 dB/octave filters. Crossover frequency range is continuously variable from 100-8 kHz. Has normal/reverse phase switches. Dimensions 1.75 x 19 x 5.

Price: Available upon request.

### **DOD ELECTRONIC CORP.**

R 835 is a stereo 2-way or mono 3-way crossover with 18 dB/octave Butterworth state variable filters. Switching from stereo to mono mode is internal and requires no patching or rewiring.

Price: \$269.95

### **LT SOUND**

ECU-2 is a stereo electronic crossover unit capable of stereo bi-amping as well as stereo tri-amping. Crossover points are continuously variable from 70 Hz to 11 kHz. It has 12 dB/octave Butterworth filters, summed mono output for subwoofer operation, individual phase switches on mid and high bands.

Price: \$295.00

### **PEAVEY ELECTRONICS**

V4X is a variable 4-way frequency dividing network with calibrated controls for low, mid, high, and very high frequencies. Features specially tapered high EQ (switch selectable) and high- and low-pass filters. Balanced XLR and TRS ins/outs in a single rack-space.

Price: \$379.99

### **YAMAHA** —See our ad on page 12

F1030 is a 2-way or 3-way frequency dividing network with 3 outputs, 3 high-pass and 2 low-pass filters. Each filter has a selectable crossover point. Filter slopes are also selectable 12 dB/octave or 18 dB octave, weight: 16.5 lbs.

Price: \$745.00

F1040 is a 2-way, 3-way or 4-way active frequency dividing network with 4 outputs, 3 high-pass and 3 low-pass filters. Each filter has a selectable crossover point. Filter slopes are selectable 12 dB/octave or 18 dB/octave, weight: 17.6 lbs.

Price: \$920.00



# EQUALIZERS

## ALTEC LANSING CORPORATION

8558B programmable microaudio equalizer has eight memories, 28  $\frac{1}{3}$ -octave filters with 12 dB of cut/boost, fixed HP/LP filters, electronically balanced in/out (transformer in/out is optional). Has no front panel controls.

Price: \$1,198.00

1753A is a boost/cut  $\frac{1}{3}$ -octave monaural equalizer with 28 constant-Q filters from 31.5 Hz to 16 kHz. Capable of 12 dB cut/boost per filter, it has 20 dB broadband gain, variable HP/LP filters and electronically balanced in/out.

Price: \$1,096.00

1750A is a cut only  $\frac{1}{3}$  octave mono equalizer with 28 constant-Q filters from 31.5 Hz to 16 kHz. It features 15 dB of attenuation per filter, 20 dB of broadband gain, variable HP/LP filters and electronically balanced in/out.

Price: \$1,096.00

## APPLIED RESEARCH AND TECHNOLOGY (ART) —See our ad on page 3

HD-31 (Model 350) is a single-channel 31-band graphic equalizer offering 60 mm travel sliders, XLR, TRS, and terminal strip ins/outs, "fail-safe" hardware bypass, subsonic/ultrasonic filters, 7.5/15 dB scale switch and "new high-definition" circuitry in a 2 rack-space package.

Price: \$425.00

HD-15 (Model 340) is a dual-channel, 15-band graphic equalizer offering 60 mm travel sliders, TRS and terminal strip ins/outs, "fail-safe" hardware bypass, subsonic/ultra sonic filters and "new high-definition" circuitry in a 2 rack-space package.

Price: \$425.00

IEQ-31 (Model 300) is a single-channel, 31-band graphic equalizer with "SmartCurve," which eliminates band interaction. It has balanced ins/outs provided by TRS phone jacks and terminal strip. Unit is MIDI controllable with RS232 option available.

Price: \$829.00

IEQ-31 (Satellite Model 310) is a single channel 31-band programmable EQ which is controlled by the Model 300. Up to 15 satellites may be used with the controller. Satellite has no front panel interface making it ideal for fixed installations. Fits single-rack space.

Price: \$629.00

IEQ-15 (Model 270) is a single channel 15-band programmable EQ with "SmartCurve," which can control up to 15 satellites. It has 128 preset locations, is MIDI controllable, and has an RS232 interface option, packaged in a single-rack space.

Price: \$629.00

IEQ-15 (Model 280) is a single channel 15 band programmable EQ controlled by Model 270. No front panel controls make it ideal for tamper-proof installation. Fills a single-rack space.

Price: \$429.00

## ASHLEY

PQ-66 is a stereo, 4-band parametric equalizer with center frequency tunable over a 5.5 octave range. It has adjustable bandwidth from  $3\frac{1}{3}$  to  $\frac{1}{20}$ -octave (maximum Q of 35), master and individual band in/out bypass switching, 20 dB headroom.

Price: Available upon request.

PQ-63 is a single channel, 3-band parametric equalizer with center frequency tunable over a 5.5-octave range. It has adjustable bandwidth from  $3\frac{1}{3}$  to  $\frac{1}{20}$  octave (maximum Q of 35), master in/out bypass switching, 20 dB headroom.

Price: Available upon request.

GQ-215 offers 2 channels of  $\frac{2}{3}$  octave, 15-band graphic equalization. It features a peak-indicating LED, a fixed, switchable 40 Hz subsonic filter and a boost/cut range of  $\pm 15$  dB. Weinbridge filters for accurate response.

Price: Available upon request.

GQ-131 is a mono  $\frac{1}{3}$  octave, 31-band graphic equalizer, incorporating a switchable subsonic filter tunable between 8 Hz and 200 Hz. Boost/cut range selectable at  $\pm 6$  or  $\pm 15$  dB. Has 9-position, 3-color LED level meter.

Price: Available upon request.

GQ-231 offers 2 separate channels of  $\frac{1}{3}$  octave, 31-band graphic equalization each incorporating the same features as the GQ-131.

Price: Available upon request.

## AUDIO LOGIC

SC131 is a graphic equalizer offering  $31\frac{1}{3}$  octave, ISO-centered frequency bands with either 12 or 6 dB of cut only in a 2-rack space. Contains XLR, TRS, barrier strip connections, and variable frequency high- and low-pass filters.

Price: Available upon request.

SC215 graphic equalizer offers 2 channels of  $15\frac{2}{3}$  octave bands of equalization. Each band has 12 dB of cut or boost and a selectable range of 6 dB cut or boost in a compact 2 rack-space size.

Price: Available upon request.

## CARVIN

EQ2029 1/3-octave graphic equalizer utilizes advanced active band circuitry and Butterworth ultra and subsonic filters. For both professional and home use. Dimensions: 19 x 3.5 x 7, weight: 11 lbs.

Price: \$299.00 (direct)

## DOD ELECTRONICS CORP.

R231 graphic equalizer is a 2-channel, graphic equalizer with 31-1/3-octave bands per channel in a 2 rack-space chassis, with 12 dB of cut or boost per band. THD is 0.01% and frequency response is from 18 Hz to 22 kHz,  $\pm 0.05$  dB.

Price: \$599.95

R430C is a dual channel 15-band graphic equalizer offering up to 12 dB of boost or cut in a single rack-space size. The bands are 1/3-octave ISO centered and are detented at 0 dB. THD is 0.01% and frequency response is from 18 Hz to 22 kHz,  $\pm 0.05$  dB.

Price: \$359.95

R431C is a single channel, 31-band graphic equalizer offering up to 12 dB of boost or cut in a single-rack space. The bands are 1/3-octave ISO centered, detented at 0 dB. THD is 0.01% and frequency response is from 18 Hz to 22 kHz,  $\pm 0.05$  dB.

Price: \$359.95

R831C graphic equalizer is 31-1/3 octave, ISO centered frequency bands with 12 dB of boost or cut in a 2 rack space size. Sliders are long throw and center detented at 0 dB. THD is 0.01% and frequency response is from 18 Hz to 22 kHz,  $\pm 0.05$  dB.

Price: \$344.95

R830C is a dual channel, 15-band graphic equalizer with 12 dB boost/cut in a double rack space with 45 mm long throw sliding pots. Bands are 2/3-octave ISO centered. THD is 0.01% and frequency response is from 18 Hz to 22 kHz,  $\pm 0.05$  dB.

Price: \$349.95

R815C is a single channel 15-band graphic equalizer offering 12 dB of boost/cut with long-throw sliding pots in a double rack space. THD is 0.01% and frequency response is from 18 Hz to 22 kHz,  $\pm 0.05$  dB.

Price: \$214.95

## ELECTRO-VOICE, INC. (A MARK IV COMPANY), INC.

EVT-2230 is a single channel combining filter 1/3-octave equalizer with 27 ISO center frequencies from 40 Hz to 16 kHz. Features a high-pass filter, output control, EQ in/out switch and a security cover. Fits double rack space.

Price: Available upon request.

EVT-2210 is a stereo one-octave equalizer with identical 10 band channels capable of 12 dB boost/cut. Center detented slide faders with separate output control and EQ in/out switch for each channel. Security cover included.

Price: Available upon request.

2710 is a 1/3-octave equalizer with built-in pink-noise generator. It has 27 constant-range filters on ISO standard frequencies from 40 Hz to 16 kHz. Incorporates variable high pass filter and variable low pass filter.

Price: Available upon request.

## LT SOUND

PEQ-2 is a dual-channel, 4-band parametric equalizer with selectable peak/dip or shelving response on upper or lower bands, overall hard-wire bypass and individual bypass on middle 2 bands. Bandwidth variable from 0.15 to 2 octaves.

Price: \$595.00

PEQ-1 is a single-channel version of the PEQ-2. Utilizes a single-rack space.

Price: \$349.00

## ORBAN

764A unites digital control and "fourth generation" analog audio in an expandable parametric equalizer system. Three large knobs control rotary digital encoders for adjusting filter parameters. Capable of addressing and recalling 99 preset configurations.

Price: \$2,495.00 per 2-channel unit.

674A is a full parametric with "intuitive" graphic controls. It offers 8 bands of (stereo) fully parametric control in a 3-rack unit space.

Price: \$1,299.00

672A is a full parametric with "intuitive" graphic controls. It offers 8 bands (mono) fully parametric control in a 3-rack unit space.

Price: \$689.00

642B features 2 channels comprised of 4 bands each of constant Q parametric equalization with "totally non-interactive" filter bands. Each band has separate bypass switch and both coarse and fine tuning potentiometers.

Price: \$995.00

## OXMOOR

DEQ-29 is a 1/3-octave programmable equalizer without a physical control panel. Adjustments up to 16 units can be made using TWEEQ software and a Macintosh computer. Once unit is programmed, 8 memory locations can be recalled by simple contact closure.

Price: Available upon request.



## ROLAND

E-660 is a fully programmable, digital parametric EQ storing 99 settings in memory. Operates as a 2-channel 4-band EQ or single-channel 8-band EQ. Has analog, AES/EBU and digital I/O connections.

Price: \$1,995.00

## PEAVEY ELECTRONICS

PME-4 is a parametric equalizer featuring state-variable filters, variable Q with a range of  $\frac{1}{6}$  to 2 octaves. Outputs include normal EQ out jack and a special 40 Hz high-pass output for instrument preamp applications. Unit fills one standard rack-space.

Price: \$199.99

PME-8 is a stereo parametric equalizer retaining all the features of the PME-4 in a dual configuration. There are 4 parametric bands and a front panel bypass for each channel. Boost/cut range is 18 dB. Packaged in a 2 rack-space unit.

Price: \$349.99

AEQ-2800 is a MIDI automated 28-band  $\frac{1}{3}$ -octave graphic equalizer. It has a 40 x 2 character "easy read" liquid crystal display, slave capability controllable from master and MIDI controllable sliders allowing 12 dB boost/cut in 1 dB steps or 6 dB boost/cut in 0.5 dB steps.

Price: \$449.99

EQ-31 is a 31 band equalizer on standard ISO frequency centers. It is switch-selectable for 6 or 12 dB boost/cut, has variable high and low cut filters, bypass switch and a broadband level control with 24 dB input/output capability.

Price: \$309.99

EQ-215 is a dual 15-band  $\frac{2}{3}$ -octave equalizer with 6 or 12 dB boost/cut capability, independently selectable bypass, range and high- and low-cut filters. It has balanced XLR and  $\frac{1}{4}$ -in. outputs, independent broadband level controls, and takes a single rack-space.

Price: \$359.99

## SOUNDCRAFTSMEN — See our ad on page 19

AE2000 equalizer real-time analyzer incorporates differential/comparator measurement system for  $\pm 0.1$  dB accuracy. It is a dual-channel 10-band equalizer with built-in pink-noise generator, automatic octave scanning and an S/N ratio of 114 dB.

Price: \$849.00

PRO-EQ22 is a C-MOS "0.1 dB differential/comparator" octave equalizer which provides a fast, accurate method of balancing input-to-output voltages visually, regardless of equalization curve selected. S/N ratio of 114 dB, with 80 dB of channel separation.

Price: \$349.00

PRO-EQ44 is a C-MOS "0.1 dB differential/comparator"  $\frac{1}{3}$ -octave equalizer containing 2 independent channels of equalization. Standard ISO center frequencies from 40 Hz to 1 kHz are at  $\frac{1}{3}$  octaves, but from 1 k to 16 k frequencies are at  $\frac{2}{3}$  octaves.

Price: \$549.00

## TASCAM PROFESSIONAL DIVISION (TEAC CORPORATION OF AMERICA) — See our ad on Cover III

PE-40 parametric equalizer is rack-mountable and has 4 EQ channels, each with 4 EQ bands: 800 Hz to 16 kHz, 500 Hz to 10 kHz, 200 Hz to 4 kHz, and 40 Hz to 800 Hz. Each band has frequency, Q (bandwidth) and gain controls.

Price: \$650.00

GA-30 is a 2-channel graphic equalizer providing 10 linear equalization controls with 12 dB boost or cut in a rack-mount chassis. Also included is switchable EQ defeat and tape monitor controls.

Price: \$350.00

GE-20B is a 2-channel graphic equalizer with 10 linear equalization controls per channel, each providing up to 12 dB of boost/cut. Each channel also has separate 12 dB/octave high-pass and low-pass filters.

Price: \$325.00

## SYMETRIX

SX201 is a parametric equalizer/notch filter featuring +15 dB boost and -30 dB cut capability, unbalanced preamp input, balanced line-level inputs and outputs.

Price: \$239.00

## YAMAHA — See our ad on page 12

GQ1031BIII is a single-channel  $\frac{1}{3}$ -octave graphic equalizer occupying a single rack space. It has 31 bands of EQ, each with 12 dB boost/cut. It has a 22 k ohm input impedance for easy interfacing and an output source impedance of 600 ohms.

Price: \$345.00

Q1027 is a single-channel  $\frac{1}{3}$ -octave graphic equalizer, featuring 27 bands of EQ at ISO frequencies, calibrated 1 dB stepped input level control, selectable high-pass filter (40 Hz or 80 Hz) and both XLR and  $\frac{1}{4}$ -in. jacks for both input and output.

Price: \$1,095.00

Q2031A is a dual channel  $\frac{1}{3}$ -octave equalizer with 31 bands of EQ on ISO-frequencies from 20 Hz to 20 kHz, variable high pass filters on each channel and an octal socket for optional BRT-15K transformers. Electronically balanced XLR and  $\frac{1}{4}$ -in. unbalanced inputs.

Price: \$695.00

DEQ7 is a digital equalizer featuring 30 preset programs which can be edited and stored in 60 RAM locations. Includes graphic, parametric, tone, notch filter, variable band pass, dynamic PEQ, and filter programs. Has direct digital inputs and outputs.

Price: \$1,395.00

# TAPE RECORDERS

## **FOSTEX** —See our ad on page 9

X-26 is a 6-channel/4-track cassette mixer/recorder. It is a 2-head machine running at 1-7/8 in./sec. with a frequency response of 40 Hz to 12.5 kHz, a flutter rate of 0.15%, and a S/N ratio of 58 dB (A-weighted).

Price: \$449.00

160 is a 4-channel/4-track cassette mixer/recorder. It is a 2-head machine running at 3-3/4 in./sec. with a frequency response of 40 Hz to 14 kHz, a flutter rate of 0.1%, and a S/N ratio of 70 dB. THD is 1.5% at 1 kHz.

Price: \$ 840.00

260 is a 6-channel/4-track cassette mixer/recorder. It is a 2-head machine running at 3-3/4 in./sec. with a frequency response of 40 Hz to 14 kHz, a flutter rate of 0.1%, and a S/N ratio of 70 dB. THD is 1.5% at 1 kHz.

Price: \$1,295.00

R8 is a 8-channel/8-track reel-to-reel recorder. It is a 2-head machine running 1/4-in. tape at 15 in./sec. with a frequency response of 40 Hz to 18 kHz, a flutter rate of 0.06%, and a S/N ratio of 78 dB. THD is 1.0% at 1 kHz.

Price: \$2,800.00

E2 is a 2-channel/2-track reel-to-reel recorder. It is a 3-head machine running 1/4-in. tape at 15 in./sec. with a frequency response of 30 Hz to 20 kHz, a flutter rate of 0.05%, and a S/N ratio of 74 dB. THD is 1.0% at 1 kHz.

Price: \$3795.00

E8 is an 8-channel/8-track reel-to-reel recorder. It is a 2-head machine running at 15 in./sec. with a frequency response of 40 Hz to 18 kHz, a flutter rate of 0.05%, and a S/N ratio of 80 dB. THD is 1.0% at 1 kHz.

Price: \$4,495.00

E16 is a 16-channel/16-track reel-to-reel recorder. It is a 2-head machine running 1/2-in. tape at 15 in./sec. with a frequency response of 40 Hz to 18 kHz, a flutter rate of 0.05%, and a S/N ratio of 80 dB. THD is 1.0% at 1 kHz.

Price: \$7,995.00

D20 is a 2-channel/2-track DAT recorder. It is a 4-head machine running at 8.15 mm/s with a frequency response of 20 Hz to 20 kHz, and a S/N ratio of 90 dB. THD is 0.05% at 1 kHz.

Price: \$7,995.00

## **MITSUBISHI**

X-880 is a 32-channel digital recorder with a frequency response of 20 Hz to 20 kHz (+0.5/-1.0 dB). Running at 30 in./sec. ( $\pm 10\%$ ), it uses 1-in. tape and weighs approximately 550 lbs. Its power consumption is 2.0 kVA.

Price: Available upon request.

X-86C and X-86HS are both 2-channel digital recorders which utilize sampling at 96 kHz. X-86C has a frequency response of 20 Hz to 20 kHz, +0.5/-1.0 dB. X-86HS has a frequency response of 20 Hz to 40 kHz (+1.0/-3.0 dB). Both use 1/4-in. tape, weigh about 220 lbs., and consume about 450 VA.

Price: Available upon request.

X-400 is a PCM 16 channel digital recorder using 1/2-in. tape and running at 30 in./sec.. Its frequency response is 20 Hz to 20 kHz (+0.5/-1.0 dB), weight is 485 lbs. and power consumption is 1.8 kVA.

Price: Available upon request.

## **OTARI CORPORATION**

DTR-900-32 is a 32-channel digital tape recorder utilizing 1-in. tape with an up to 14-in. reel-size. It has 4 heads, 0 wow and flutter, and a frequency response of 20 Hz to 20 kHz (+0.5 dB/-1.0 dB). It has a 9600 Hz PLL capstan motor and 2 servo 1/2 H.P. DC reel motors.

Price: \$150,000.00

MTR-10CT is a 2-channel recorder with center-track time code utilizing 1/4-in. tape. It has 4 heads, a DC servo-controlled 9600 Hz PLL capstan and DC servo controlled, high-torque reel motors. Frequency response is 42 Hz-29 kHz (30 in./sec.) and S/N ratio is 74 dB at 30 in./sec.

Price: \$12,095.00

MTR-100A is a 24-track recorder utilizing 2-in. tape. It features automatic alignment, a quartz PLL DC brush-type, direct-drive capstan motor. Wow and flutter at 30 in./sec.. is 0.04%, frequency response is 50 Hz-25 kHz,  $\pm 2$  dB, and S/N ratio is 70 dB at 1040 nWb/m.

Price: \$59,950.00

MX-55N is a 2-channel, 4-head compact recorder utilizing 1/4-in. tape. It features a DC servo-controlled capstan, a frequency response of 30-22 kHz ( $\pm 2$  dB) at 15 in./sec. and an unweighted S/N ratio of 69 dB at 1040 nWb/m. Mic input impedance is 10 k ohms.

Price: \$3,895.00

MX-70 can be variously configured as an 8-track, 8 pre-wired for 16, and 16-track recorder using 1 in. tape. All feature DC servo reel motors and brushless a DC capstan motor (crystal referenced). Frequency response is 50-22 kHz (+2/-3 dB). Unweighted S/N is 70 dB.

Price: \$17,200.00 to \$21,650.00



MX-80 comes in both 24 and 32-track versions. Both utilize 9600 Hz PLL capstan motor, microprocessor controlled, 2 servo 1/3 HP DC reel motors, and 3 heads. Signal to noise at 30 in./sec. is 67 dB (1040 nWb/m), frequency response is 60 Hz to 22 kHz ( $\pm 2$  dB).

Price: \$33,850.00 to \$39,150.00

MK-III-8 is an 8-channel recorder utilizing 1/2-in. tape. It has a DC servo-controlled capstan motor, 2 induction reel motors and 3 heads. Wow and flutter measures 0.04% at 15 in./sec. Frequency response is 40 Hz-22 kHz ( $\pm 2$  dB).

Price: \$5,495.00

MTR-90-II is available in various configurations: 1 in. 8-channel, 2 in. 16-channel, 2 in. 16-channel pre-wired for 24-channel and 2 in. 24 channel. Frequency response at 250 nW/m is 45 Hz-29 kHz (30 in./sec.). S/N ratio at 1240 nW/m is 78 dB (30 in./sec.) All configurations are 3-head machines.

Price: Available upon request.

### **SONY PRO AUDIO** —See our ad on page 5

APR-24 is a 24-channel analog recorder utilizing 2-in. tape. It features amorphous steel heads and "DC constant tension design." Frequency response at 30 in./sec. is 48 Hz - 25 kHz (+0.75 /-3.0 dB). S/N is 70 dB at 30 in./sec. and 66 dB at 15 in./sec. Includes remote control with stand.

Price: \$45,500.00

APR-5000 is a 2-channel analog recorder which can be purchased in various configurations (including an IEC center-track time-code version). The 5002W version features a 50 Hz-28 kHz (+0.75/-3.0 dB) frequency response and a S/N ratio of 65 dB. Other versions features 9-pin serial interface.

Prices: From \$8,875.00 to \$11,950.00.

PCM-2500 is a 2-channel, 2-head DAT recorder whose running speed is 8.15 mm/s. It has a S/N ratio of 90 dB and 0.05% THD. Frequency response is 2 Hz to 22 kHz. It is driven by a servo type motor, has LED record indicators and measures 17 x 4 x 16.6 in, weight: 24 lbs., 11 oz.

Price: \$3,550.00

PCM-2000 is a 2-channel, 2-head DAT recorder whose running speed is 8.15 mm/s. It has a S/N ratio of 90 dB and 0.07% THD. Frequency response is 2 Hz to 22 kHz. It is driven by a servo type motor, has LCD record indicators and measures 8.4 x 3 x 7.6 in, weight: 8 lbs., 13 oz.

Price: \$5,000.00

TCD-D10 PRO is a 2-channel, 2-head DAT recorder whose running speed is 8.15 mm/s. It has a S/N ratio of 85 dB and 0.08% THD. Frequency response is 20 Hz to 20 kHz. It is driven by a servo type motor, has LCD record indicators and measures 10 x 2.3 x 7.6 in, weight: 4 lbs. 7 oz.

Price: \$3,550.00

### **STUDER**

A820 series includes 24-, 16-, and 8-track analog recorders which feature automatic and simultaneous audio alignment for all channels with alignment parameters stored in non-volatile memory. Has a "menu-programmable" transport and optional Dolby SR or Telcom C4 noise reduction.

Price: \$71,275.00 (24-track w/o noise reduction.)

A827-24 is a 24-track microprocessor controlled recorder featuring phase compensated MDA controlled amplifiers with switchable Dolby HX Pro and menu-programmable transport functions. Parallel and serial RS232/422 ports for easy integration into editing systems.

Price: \$47,500.00

A820 2/2 VUK is a 2-track master recorder featuring the same processor control for audio and tape transports and the same transport and drive assembly as the A820-24. Frequency response is 40 Hz to 22 kHz ( $\pm 2$  dB).

Price: \$13,750.00

D820X DASH format 2-channel digital audio recorder offers "twin recording" at 15 in./sec. Transport design features DC-driven spooling and capstan motors. Frequency response is 10 Hz to 23 kHz ( $\pm 0.4$  dB.)

Price: \$19,000.00

A812 2/2 Time-Code (option) VUK is a compact recorder especially suited for broadcast application. Featuring the same processor control for audio and tape transport as the A 820, it is available with or without overbridge. Unweighted S/N ratio is 70 dB.

Price: \$14,750.00

A807 series of 2- and 4-channel recorders are especially suited for broadcast and post-production environments. Features include: tape shuttle wheel, reverse play, right hand edit, tape dump, multi-function tape time and autolocator with programmable "soft-keys."

Price: \$8,795.00 (2 channel), \$11,495.00 (4-channel)

Revox Pr99 MKIII is a 2-track production recorder featuring a real-time counter that reads both plus and minus time, auto search-to-cue for any preselected address, and auto repeat for continuous replay. Also available in "playback only" configuration.

Price: \$2,995.00

Revox C270 series 2-, 4-, and 8-channel recorders all feature microprocessor-based control logic (including precise search-to-cue), and "one-hand" editing under full servo control. Dolby HX PRO and RS 232 interface is standard in this series.

Price: From \$3,995.00 (2-channel) to \$7,995.00 (8-channel).

A721 professional cassette recorder features a 4 motor, dual capstan, die-cast transport and head block with Dolby B and C noise reduction as well as Dolby HX PRO. Automatic microprocessor control self-alignment for level, bias and EQ.

Price: \$2,995.00

## **TASCAM PROFESSIONAL DIVISION (TEAC CORPORATION OF AMERICA)** —See our ad on Cover III

688 Midistudio is a 10-channel, 8-track recorder/mixer with 20 inputs, each with independent gain, pan, and effects controls. Has built-in MIDI-to-tape synchronizer and bi-directional shuttle dial. S/N measures 90 dB with built-in dbx Type II NR.

Price: \$3,299.00

644 Midistudio is an 8-channel, 4-track recorder/mixer with 16 inputs, each with independent gain, pan, and effects controls. Built-in MIDI-to-tape synchronizer and bi-directional shuttle dial. S/N measures 90 dB with built-in dbx Type II NR.

Price: \$1,495.00

TSR-8 is an 8-channel, 8-track recorder/reproducer using 1/2-in. tape. It is a 2-head, 2 slotless DC motor machine. Tape speed is 15 in./sec., line input is 10 k ohms unbalanced and S/N measures 108 dB A-weighted with built-in dbx Type I NR.

Price: Available upon request.

MSR-16 is a 16-channel, 16-track recorder/reproducer using 1/2-in. tape. It is a 2-head machine featuring a phase-lock looped DC drive capstan motor with a ceramic shaft. Tape speed is 7.5 and 15 in./sec. S/N measures 108 dB A-weighted with built-in dbx Type I NR.

Price: Available upon request.

ATR-60/16 is a 16-channel, 16-track recorder/reproducer using 1 in. tape format. It is a 3-head machine featuring a phase-lock looped DC drive capstan motor with a ceramic shaft. Tape speed is 7.5 and 15 in./sec. S/N measures 108 dB A-weighted with built-in dbx Type I NR.

Price: Available upon request.

MSR-24 is a 24-channel, 24-track recorder/reproducer using 1-in. tape. It is a 2-head featuring a phase-lock looped DC drive capstan motor with a ceramic shaft. Tape speed is 7.5 and 15 in./sec. S/N measures 108 dB A-weighted with built-in dbx Type I NR.

Price: Under \$15,000.00

112 is a 2-channel, 2-track recorder/reproducer. It is a 2-head, 3-motor machine with a tape speed of 1.875 in./sec. Frequency response is 25-19 kHz  $\pm 3$  dB (metal tape) and S/N is 78 dB with Dolby C in. Unit is rack-mountable.

Price: \$679.00

238 Syncaset is an 8-channel, 8-track standard cassette recorder/reproducer. It is a 2-head, 3 motor machine with a tape speed of 3.75 in./sec. Frequency response is 30-16 kHz and S/N measures 54 dB with dbx out. Unit is rack-mountable.

Price: \$2,295.00

## **UHER OF AMERICA**

CR1600 is a portable stereo cassette 4-track recorder. Features include: auto-reverse operation, 2 speeds, 3 heads, Dolby B, switchable ALC, full remote control, built-in voice activation system. Dimensions: 9 x 2 x 7 in, weight: 7 lbs.

Price: \$1,799.00

CR1601 is a 4-track monaural portable cassette recorder. Features include: 3 speeds (1 $\frac{1}{32}$ , 1 $\frac{1}{16}$ , 1- $\frac{7}{8}$  in./sec.), switchable ALC, solenoid control, full remote control, voice activation system. Dimensions: 9 x 2 x 7 in, weight: 7 lbs.

Price: \$1,799.00

1200 Report Synchro is a portable open-reel full-track monaural recorder with pilot track. Speed is 7.5 in./sec. Features include: 3 heads, belt drive, 2 mixable microphone inputs, and selectable equalization. Dimensions: 11 x 3.5 x 9, weight: 8 lbs.

Price: \$5,049.00

6000 Report Universal is a portable open-reel, 2-track monaural recorder. Features include 4 speeds, 3 heads, solenoid control, belt drive, voice activation and "memory pulse facility". Dimensions: 11 x 3.5 x 9 Weight: 8 lbs.

Price: \$2,150.00

4000 Report Monitor AV is a portable open-reel 2-track mono recorder. Features include: 4 speeds, 3 heads, belt drive, mic inputs (200 ohms), switchable ALC and LED function indicators. Dimensions: 11 x 3.5 x 9, weight: 3 lbs.

Price: \$1,665.00

4200 Report Monitor is a portable open-reel 2-track stereo recorder. Features include: 4 speeds, 3 heads, belt drive, 2 VU meters, 200 ohm mic inputs and switchable ALC. Dimensions: 11 x 3.5 x 9, weight: 8 lbs.

4400 Report Monitor is a portable open-reel, 4-track stereo recorder. Features include: 4 speeds, 3 heads, belt drive, 2 VU meters, 200 ohm mic inputs, switchable ALC and LED function indicators. Dimensions and weight same as 4200.

Price: \$1,779.00

## **YAMAHA** —See our ad on page 12

C300 is a "professional quality" 2-channel, 3-head cassette recorder featuring 12-layer laminated amorphous heads, a double-gap ferrite erase head and a closed-loop dual capstan transport. With dbx noise reduction "on," S/N is 95 dB.

Price: \$995.00

MT100 is a 4-channel/4-track cassette mixer/recorder with self-contained mixdown capability. Motors are DC servo type and top speed frequency response is 40 Hz-18 kHz. With dbx noise reduction "on," S/N is 85 dB.

Price: \$495.00

MT2X is a 6-channel/4-track cassette mixer/recorder with self-contained mixdown capability. Motors are DC servo type and "top speed" frequency response is 20 Hz-18 kHz. With dbx noise reduction "on," S/N is 85 dB.

Price: \$845.00

MT3X is a 6-channel/4-track cassette mixer/recorder with self-contained mixdown capability, "comprehensive" monitor system and programmable auto punch-in. Motors are DC servo type and top speed frequency response is 40 Hz -18 kHz. With dbx noise reduction "on," S/N is 85 dB.

Price: \$995.00



# ADDRESSES

Altec Lansing Corp.  
10500 West Reno Ave.  
Oklahoma City, OK 73128

Applied Research and Technology  
215 Tremont Street  
Rochester, NY 14608

Ashley Audio Inc.  
100 Fernwood Ave.  
Rochester, NY 14621

Audio Logic  
(see DOD)

Carvin Corp.  
1155 Industrial Ave.  
Escondido, CA 92025

Crown International, Inc.  
1718 W. Mishawaka Rd.  
Elkhart, IN 46517

DOD-Digitech-Audio Logic  
5639 S. Riley St.  
Salt Lake City, UT 84102

Electro-Voice, Inc.  
600 Cecil St.  
Buchanan, MI 49107

Fostex Corp. of America  
15431 Blackburn Ave.  
Norwalk, CA 90650

Mitsubishi Pro Audio-Neve  
Berkshire Industrial Park  
Bethel, CT 06801

LT Sound  
7980 LT Parkway  
Lithonia, GA 30058

Orban  
645 Bryant St.  
San Francisco, CA 91340

Otari Corp.  
378 Vintage Park Dr.  
Foster City, CA 94404

Oxmoor Corp.  
237 Oxmoor Circle  
Birmingham, AL 35209

Peavy Electronics Corp.  
711 A St.  
Meridian, MS 39301

Roland Corp.  
7200 Dominion Circle  
Los Angeles, CA 90040

Sony—Pro Audio  
1600 Queen Anne Rd.  
Teaneck, NJ 07666

Sound Concepts  
27 Newell Rd.  
Brookline, MA 02146

Soundcraftsmen  
2200 So. Ritchey  
Santa Ana, CA 92705

Studer-ReVox  
1425 Elm Hill Pike  
Nashville, TN 37210

Symetrix Inc.  
4211 24th Ave. W.  
Seattle, WA 98199

Tascam-Teac Corp. of America  
7733 Telegraph Rd.  
Montebello, CA 90640

Uher of America  
7067 Vineland Ave.  
N. Hollywood, CA 91605

Yamaha—Pro Audio  
PO. Box 6600  
Buena Park, CA 90622

# Classified

## FOR SALE

For Sale: Neumann SM2 microphone with power supply. Contact Martins Saulespurens at (805) 687-0327.

How To Produce Great Radio Commercials, by Brian Battles. This unique four-cassette package contains essential tips and advice that teach you how to set up your own lucrative advertising production business, and the presentation showcases sample spots using many of the techniques described in this column, and much more.

To order your copy, please send a check or money order for \$99.95 (includes domestic shipping) to: Porkpie Productions, P.O. Box 176, Colchester, CT 06415-0176.

**We're Fighting For Your Life.**



**American Heart Association**

## 937 Bestsellers

The U.S. Government Printing Office has put together a new catalog of the Government's bestselling books. Find out what Government books are all about. Send for your free catalog.

### New Catalog

Post Office Box 37000  
Washington, D.C. 20013

Custom Cases    Acoustic Foam    Custom Stands    Studio Furniture

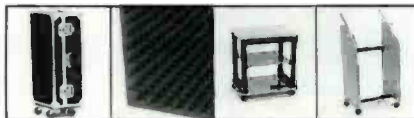

Request Catalogue 800-343-1433, 516-563-0633  
Island Cases • 1120-20 Lincoln Ave. • Holbrook, NY 11741

**MAGNETIC RECORDING HEADS RELAP/REPLACEMENT** for Audio, Video, Time Code, Duplication. 30 years of head design experience. IEM, 350 N. Eric Drive, Palatine, IL 60067. (312) 358-4622.

## WANTED

**RADIO TRANSCRIPTION DISCS:** Any size, speed. Drama, comedy, music, variety, adventure, soaps, childrens, AFRS, big band remotes, library services. Kiner-db, Box 724, Redmond, WA 98073-0724.

## Worth writing for.

If you're looking for some good reading, you've just found it. The free Consumer Information Catalog.

The Catalog lists about 200 federal publications, many of them free. They can help you eat right, manage your money, stay healthy, plan your child's education, learn about federal benefits and more.

So sharpen your pencil. Write for the free Consumer Information Catalog. And get reading worth writing for.

**Consumer Information Center  
Department RW  
Pueblo, Colorado 81009**

U.S. General Services Administration.

Closing date is the first of the second month preceding the date of issue.

Rates are \$1.00 per word with a \$25.00 minimum. Boxed ads are \$40.00 per column inch. db Box Numbers are \$8.50 additional for wording "Department XX" plus \$1.50 additional for postage and handling.

Quantity discounts are:  
3X - 15%; 6X - 30%.

**ALL CLASSIFIEDS  
MUST BE PREPAID**

Send copy to:  
db, The Sound  
Engineering Magazine,  
203 Commack Road,  
Suite 1010, Commack,  
NY 11725.



# People, Places... & Happenings

## SAVET IN SAN FRANCISCO

• SAVET (Save Entertainment Technology), organized to save entertainment technology from extinction, produced a retrospective display at the San Francisco High End HiFi Show sponsored by Stereophile magazine.

Started by Jack Mullin, Peter Hammer, and Shelley Herman, SAVET has been collecting artifacts for several years. With the addition of Jack Mullin's collection, it had its first official outing on April 20-23, 1989.

Entitled "A Museum of High End Audio, 1877-1957," the display traced the history of entertainment in the home, including a disc-operated music box of the 1800s, a replica of Edison's first cylinder recorder, the Berliner "Trademark" disc player (complete with Nipper), some early disc and cylinder record players, the Orthophonic Victrola, an acoustic record player designed by Bell Laboratories that was the first "HiFi," the first electrical recordings

• Ray Dolby and Ioan Allen of Dolby Laboratories have been awarded an Oscar by the Board of Governors of the Academy of Motion Picture Arts and Sciences. It was presented to them for their continuous contributions to motion picture sound through the research and development of Dolby Laboratories Inc.

• Sigma Sound founder Joe Tarsia has announced that the assets of Sigma's New York studios have been

(1925), and the first single groove stereo recordings (1931).

Among the magnetic recorders shown were early wire recorders and the AEG Megnatophon tape machine, which still worked, that Mullin brought back from Germany in 1945. That modified AEG unit inspired the tape recording industry here in the U.S. Other milestones exhibited included: a Brush Soundmirror, the first home tape recorder in the U.S.; an Ampex model 200 from 1947, America's first professional tape recorder; a Magnecord PT-6, an early portable professional tape recorder; and Ampex's Model 612, the first home stereo tape player.

Also on exhibit was a collection of Type 77 RCA broadcast microphones, a two-arm example of an early stereo record player that didn't work very well, and a Macintosh 20-watt amplifier using a pair of 6V6GT tubes in the output stage, an early example of "High End HiFi."

purchased by M & M Syndications, Inc., headed by Michelle Pruyn. According to Tarsia, "The new owners of Sigma Sound Studios of New York are committed to the Sigma Tradition of delivering the very best in recording services." In addition to Michelle Pruyn, key staff members in New York include General Manager Gary Robbins, Chief Technical Engineer Don Cuminale, and Production Manager Kayla Ritt.

Each group of people to enter the room was taken on a personal tour of the display by either Mullin or Herman. According to Hammer: "Despite the conventional wisdom that no one cares about the past, the desire for knowledge at the display was intense. The other reaction was, nostalgia: *I used to have one of those, or more often, my (grand)parents had one of those* were the most often-heard phrases."

The positive reaction to the display led to donations as well. SAVET went home with more equipment than it brought. When people saw that there was someone saving this technology they would go home and bring something back to add to the collection.

Herman said, "The response to this latest SAVET exhibit, and the exhibit at the AES convention in November 1988, shows that people are interested in keeping the knowledge of our past alive. The public's enthusiasm justifies the efforts of those who support SAVET."

Jacques Robinson, President of Carillon Technology, Inc., has announced that a formal letter of intent for the purchase of the dbx Professional Products Division has been received from AKG Acoustics, Inc., Stamford, Ct., and it has been accepted.

Bolt Beranek and Newman Inc.'s (BBN) architectural acoustics and environmental technologies group has recently become Acentech Incorporated, a subsidiary of BBN

**Systems and Technologies Corporation.** Acentech provides services in architectural acoustics, audio-visual systems, noise and vibration control, air quality, and computer-aided environmental systems. The company has offices in Cambridge, MA, and Los Angeles, CA.

- **Gil Nichols** has been appointed as the division leader for **Crown International's** North American amplifier microphone marketing and sales operations. The position is part of a newly-instituted organizational plan designed to facilitate optimum coordination and cooperation at all levels of each division within the company. A 1966 graduate of Wheaton College, Nichols was an executive director of an international non-profit organization's Michiana branch before accepting his current post at Crown.

- **Steve Bramberg**, former studio owner and manager of several major east coast recording facilities has announced the opening of a new business catering to the needs of the audio production industry. The New York based company **STUDIO SUPPORT SERVICES** is a referral, representation, consultation, studio time brokerage and production coordination service aimed at filling the various needs of studios, producers, engineers, musicians, recording labels and managers etc. He can be reached at (516) 767-3295.

- **A Conrad Reeder update**—As a result of her appearance in the July/August 1988 **Electronic Cottage**, we are pleased to report that she has a cut on the new John Denver album, out in July; has her own band **SNAFU**, and is playing club dates in the Nashville area, and has the decided interest of several record labels. We'll keep you posted, and a follow-up story is in order soon.

- **Greencorp Magnetics Pty Ltd.**, the leading tape manufacturer in Australia, is entering the tape market for the first time in the United States, announced **Stephen L. Green**, managing director. **Fujii International**, of Northridge, California, has been appointed its exclusive marketing and sales representative in the United States.

- In response to demand from audio professionals, **Tascam** has added a third sampling rate to its popular **DA-50 R-DAT** recorder. In addition to sampling at the standard baud rates of 32 kHz and 48 kHz, the Tascam digital audio tape deck now records at the rate of 44.1 kHz, permitting two-track mastering direct to compact discs with no additional interface required.

- **The 1988 Senate Productivity Award**, an annual awards program that recognizes the one company in the State of Alabama that has achieved the most significant increase in productivity for the year, has been presented to the **Ampex Recording Media Corporation, Opelika**, Alabama manufacturing center.

- **Paul McGuire**, formerly vice president of marketing at **Electro-Voice**, was recently promoted to the position of executive vice president. McGuire assumes operating responsibility for the engineering, manufacturing, sales and marketing functions of Electro-Voice in the United States and Canada. In another move the company announced the appointment of **Claude Kleiman** as market development manager for wireless microphones. The announcement was made by **Jim Long**, E-V director of marketing. Working in conjunction with the E-V market development managers, Kleiman will be responsible for the marketing and sales of high-performance wireless microphone systems—under both Vega and Electro-Voice brand names—to all professional audio markets.

- **Richard Salter** has been appointed to the position of Development Director at **Focusrite Audio Engineering Limited** by the company's new owner Phil Dudderidge. Salter was previously in charge of digital audio product development as Sony Broadcast in the United Kingdom, and was a member of the original design team of Solid State Logic's S1-4000E console.

- In a major move to support the recently added Mitsubishi professional digital audio product line, **Neve** announced the promotion of **Rick Plushner** to the newly created position of National Sales Manager for PCM Products. The announcement

was made by **Barry J. Roche**, President of Neve North America.

- **Aphex Systems** has moved their headquarters to a new facility in Sun Valley, California, more than doubling their physical space. "We had reached the point of having no room for expansion in our North Hollywood facility," explained **Aphex President Marvin Caesar**. "Within the past year or so, we have virtually doubled our business. This has come through increased sales from our signal processing equipment, the addition of our new MIDI products, and new products developed around our VCA. In addition, we are building Aphex developed surround sound decoders for Proton." The new address for Aphex is 11068 Randall Street, Sun Valley, California 91352. They can be reached at (818) 767-2929.

- **Mark IV Industries** has acquired the assets of **Electro Sound, Inc.**, a division of **Electro Sound Group**. The Electro Sound audio tape duplication hardware division will become part of the product offerings of Mark IV Audio, which includes **Gauss**, the world leader in the manufacture of high-speed cassette tape duplication systems and equipment. **Robert D. Pabst**, the head of Mark IV Audio, said the newly-acquired Electro Sound division will continue to manufacture and market tape duplicating systems in its facility in Sunnyvale, California, and will report operationally to Gauss.

- **39th Street Music** has upgrading their studio to a 56 input SSL console with G-Series computers and total recall. A Studer A800 will also be added, giving the studio 48-track capability.

- **Telarc International**, based in Cleveland, Ohio, announced the exclusive world-wide distribution agreement with **Digital Music Products, Inc. (DMP)** of Stamford, Connecticut. The philosophy of approach to recording, which is shared by the two companies, provided the incentive for the agreement and proved to be a natural. The agreement lets DMP improve its distribution in both domestic and international markets, and at the same time provides Telarc with expansion into the jazz market.





## IF YOU WANT THE BEST PRODUCTION 16 TRACK, YOU'LL HAVE TO SPEND A LITTLE LESS.

There's no getting around it. No one beats the 6016 on features. At any price.

Check it out. Two speeds without recalibrating each time you switch. Proprietary head technology so accurate that final EQing decisions can be made right in sync mode without rewind and repro verification. Gapless/seamless punch in/out with superior transparency. And unlike other 16s, the 6016 has built-in dbx professional Type-I.

The compact, rugged 5015 also gives you lightning fast lookup for use with synchronizers, incredibly precise spot erase, D-sub multi-connectors for faster setup with fewer cables and, oh yes, brilliant sound.

There simply is no other 16 track available. Compare it with any other machine out there. Then compare the price. If money is an issue, you may have to settle for the best.



# TASCAM

© 1988 TASC Corporation of America, 7733 Telegraph Road  
Montebell, CA 90643, 714/726-0103

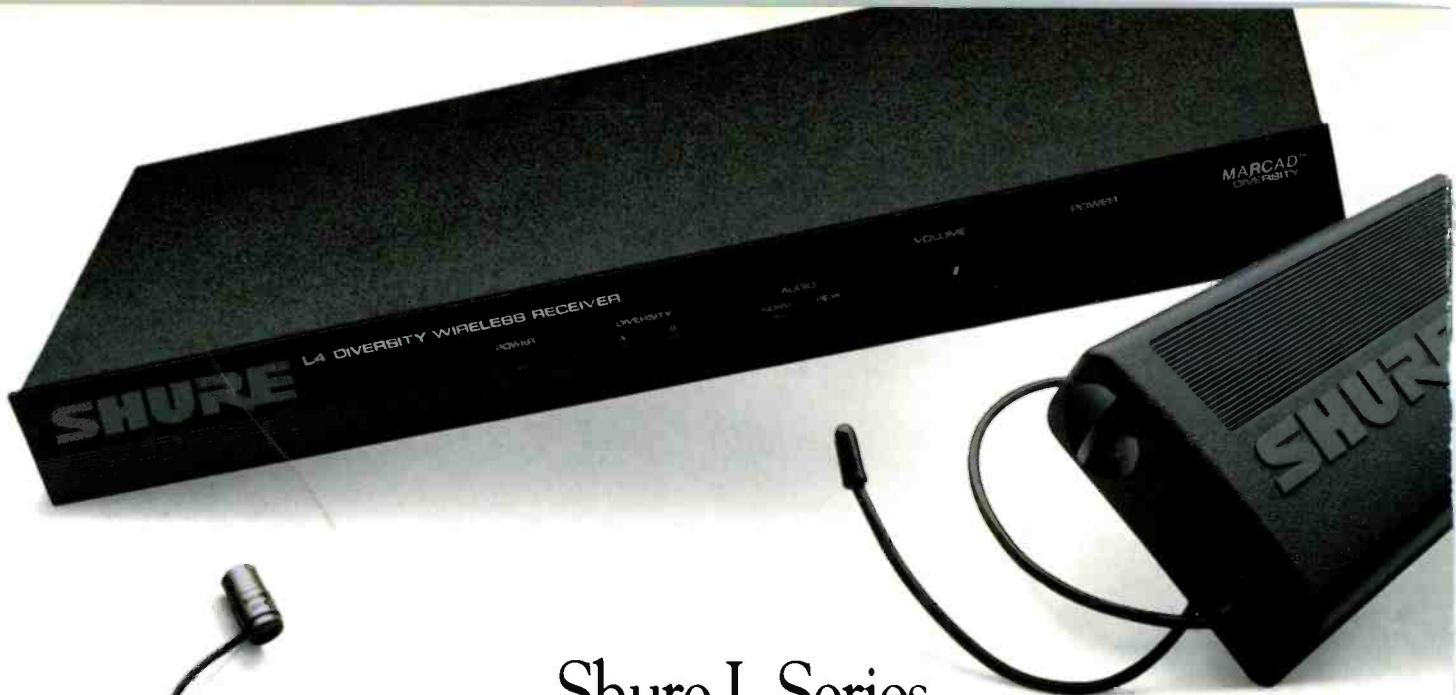

## Shure L Series brings reliability to affordable wireless. Why take chances with anything else?

If you're providing wireless microphone systems to churches, schools, or other value-conscious users, you need reliable equipment you can sell at an affordable price—and make a profit doing it.

That's what the new L Series from Shure is all about. The L Series sets a new standard of value in its price range, offering features, performance and reliability other "economy" systems can't match.

### **We didn't forget the details.**

Designed and built by Shure in the U.S.A., L Series systems include many of the features that set professional-quality wireless systems apart from the "toys." L Series receivers are sturdy, metal-cased, and rack-mountable. Antennas are detachable and may be placed in remote locations, providing excellent performance in situations where many other wireless systems have trouble.

Our L1 Body-Pack Transmitter has features like a separate audio mute switch and a universal 4-pin "Tiny QG" connector that accepts a variety of microphone and musical instrument sources. And L Series

lavalier systems come with the 839W, a reliable Shure condenser microphone designed for clear, natural vocal pickup.

### **Performance meets economy.**

Even though L Series components are economically priced, they incorporate sophisticated RF technology. The L4 Diversity Receiver utilizes "intelligent" MARCAD™ circuitry to monitor signals from its two independent RF sections, blending them in the optimum proportion—not merely switching them. The result is reliable, uninterrupted audio with no clicks, no pops. And all L Series systems feature Shure "Mirror Image" companding, plus high-gain, low-noise MOSFETs, a high-fidelity quadrature detector, and a 3-pole Chebyshev audio low-pass filter. It all adds up to outstanding audio quality with exceptional freedom from noise and distortion.

### **Why risk callbacks with anything else?**

Other systems may not meet expectations. But you can recommend a Shure L Series system with confidence. So why risk callbacks—and your reputation—with anything else?

For more information about the Shure L Series, call Shure Customer Services at (312) 866-2553.

**THE SHURE® WIRELESS**  
**L SERIES**

THE SOUND OF THE PROFESSIONALS®... WORLDWIDE  
222 Hartrey Avenue, Evanston, IL 60202-3696

Circle 12 on Reader Service Card