

MAY 1983
\$1.95

db

THE SOUND ENGINEERING MAGAZINE



ALLI ZOTI POND 193
DOUGLAS M POMERUY
POMEROY AUDIO
193 BALTIC ST
BROOKLYN

NY 11201

**“For two years
we’ve heard it all.”**



“Choosing the Delta Omega™ was a simple matter of knowing its capabilities.

This amplifier exercises unique voice coil control, employing a principal without precedent—delivering more punch, clarity and headroom than we’ve ever heard.

After two years with Delta Omega™ not a single acoustic detail has been missed. Only after you experience it will you know more than we could ever tell you.”

Tres Virgo Studio
San Rafael, CA



1000 watt. All of these features are a typical studio monitor amplifier.



CROWN

1718 W. Mishawaka Road, Elkhart, IN 46517
(219) 294-5571

Call or write for details.

Circle 10 on Reader Service Card

www.americanradiohistory.com



Editor/Publisher
Larry Zide

Associate Publisher
Elaine Zide

Managing Editor
Mark B. Waldstein

Associate Editor
Ricki Zide

Technical Editor
Linda Cortese

European Editor
John Borwick

Technical Advisor
John Eargle

Layout & Design
Kathi Lippe

Advertising Coordinator
Karen Cohn

Book Sales
Lydia Calogrides

Circulation Manager
Eloise Beach

Graphics
K & S Graphics

Typography
Spartan Phototype Co.

FEATURES

AUDIO VISUAL CENTRE WISSELOORD 28	<i>B. Baars</i>
USING THE TECRON TEF SYSTEM 10 ACOUSTIC ANALYZER 32	<i>Bruce Bartlett</i>
C-DUCED 35	<i>Jesse Klapholz</i>
GLASS IN THE STUDIO, PART II 39	<i>F. Alton Everest</i>
THE FATHER OF SOUND SYSTEMS 43	<i>William C. Matthews</i>

COLUMNS

SOUND REINFORCEMENT 10	<i>John Eargle</i>
COMPUTER AUDIO 16	<i>Jesse Klapholz</i>
THEORY AND PRACTICE 20	<i>Ken Pohlmann</i>
DIGITAL AUDIO 22	<i>Barry Blesser</i>
SCENES FROM EUROPE 24	<i>John Borwick</i>

DEPARTMENTS

LETTERS 2	CALENDAR 6	EDITORIAL 27	CLASSIFIED 55
NEW PRODUCTS AND SERVICES 47			
PEOPLE, PLACES, HAPPENINGS 51			

db, the Sound Engineering Magazine (ISSN 0011-7145) is published monthly by Sagamore Publishing Company, Inc. Entire contents copyright © 1984 by Sagamore Publishing Co., 1120 Old Country Road, Plainview, L.I., N.Y. 11803. Telephone (516) 433 6530 db is published for those individuals and firms in professional audio-recording, broadcast, audio-visual, sound reinforcement, consultants, video recording, film sound, etc. Application should be made on the subscription form in the rear of each issue. Subscriptions are \$15.00 per year (\$28.00 per year outside U.S. Possessions, \$16.00 per year Canada) in U.S. funds. Single copies are \$1.95 each. Editorial, Publishing and Sales Offices: 1120 Old Country Road, Plainview, New York 11803. Controlled circulation postage paid at Plainview, NY 11803 and an additional mailing office.



Ask for our
44 PAGE CATALOG
 of
**PROFESSIONAL
 SOUND RECORDING
 & DUPLICATING SUPPLIES**

Recording Supply Div. of Polyline Corp
 1233 Rand Road, Des Plaines IL 60016
 (312) 298 - 5300

Circle 13 on Reader Service Card

Q: The Department of Defense picked what sound effects library as the one to use in all their radio stations around the world?

The Production EFX Library. 5 stereo albums arranged by categories. Shouldn't you give a listen?

A:

Stereo Sound Effects

PRODUCTION EFX LIBRARY
 2325 Girard Ave. S.
 Minneapolis, MN 55405

Circle 15 on Reader Service Card

Letters

PUTTING A FINGER ON ACOUSTIC POLLUTION

TO THE EDITOR:

From the viewpoint of this long-time audio practitioner and reader of various publications serving the field of audio (recording, broadcast, sound reinforcement, etc.) the acuity that some "golden ears" profess in print is fantastic. In fact, some claims are downright incredible—especially in view of their failure to address a common source of pollution.

It's true that one's auditory discernment can be honed to a fine edge; true that one comes to perceive, after prolonged and critical listening to reproduction that initially sounded great, those small imperfections that actually were there all along. Levels of noise and percentages of distortion that once were acceptable "hi-fi" now are intolerable, and the ever-increasing "transparency" of audio components unmasks minute faults that used to be hidden from the most critical among us.

Even so, I have to be skeptical when I read that someone's console is so clean that its owner can hear the difference between a Switchcraft and a Cannon microphone connector. Sorry, but you're going to have to *prove* that one to me! I'm even skeptical that you can really hear the difference between a totally transformerless path and one with a single, good transformer (such as Jensen), properly used—particularly with analog tape, which actually couples a primary winding (record head) to its secondary (playback head) in a "transformer" process whose inherent nonlinearities must be an order of magnitude greater than those of, say, an input transformer.

The current controversy over digital vs. analog recording involves a lot of subjective prejudices; surely the criterion for fidelity of any recording method is comparison with *live* pickup, not another recording! Yet I see many arguments comparing one recorded product with the other, when the question of which is superior could better be settled by listening to each when individually A-B'd with the live reproduction (I realize that this can't be done when the recording is a highly processed mixdown of discrete live segments that never

Index of Advertisers

Amber	19
Audio-Technica	3
Brooke-Siren	17
Cerwin Vega	5
Crown	Cover II
David Hafler Co.	6
Emilar	18
JBL	Cover III
Polyline	2
Production EFX	2
Shure Bros.	Cover IV
Studer Revox	15
Tektronix	12-13
3M	8-9
Yamaha	7

About The Cover

• This month's cover features Wiseloord Studios in Hilversum, The Netherlands. For the inside story of this beautiful state-of-the-art audio-visual studio, see page 28.

JOURNEY

First, you have to hear yourself!

Now Journey depends on new ATM63 dynamic microphones for full control of their monitor and live concert sound. With better rejection of not just off-axis sound, but everything else on stage.

Even with a stack of Marshalls up close, the monitor mix is cleaner, with better separation than ever before.

Find out what Journey's Steve Perry, Jonathar Cain, Neal Schon, Ross Valory,

and Steve Smith heard on stage.. and why monitor mixer Chris Tervit and producer/live mixer Kevin Elson insist on the ATM63. Now at leading music and sound specialists.

The ATM63

chosen by JOURNEY
because...

When you
sound right to yourself,
you sound great to everyone!



audio-technica®

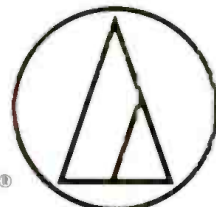

Audio-Technica U.S., Inc., 1221 Commerce Dr. Stow, OH 44224 • (216) 686-2600
Circle 14 on Reader Service Card

existed as a coherent performance, but most studios have some occasion to record a group or orchestra performing in real time, when A-B comparisons could be made.)

What puzzles me is why there seems to be no outcry among all these golden ears about one proliferating source of audio pollution: the cathode ray tube display. Deflection coils in TVs, data terminals, and computer displays tend to "sing" at the deflection frequencies, creating corresponding sound fields that are nothing but a form of acoustic pollution. In the case of NTSC TV, the frequencies are about 59.94 Hz vertical and 15,734 Hz horizontal; higher frequencies are used for high-definition monitors and terminals. I have made a very small-scale survey of this phenomenon which, while it is statistically insignificant, I believe to be pretty typical.

The acoustic radiation resulting from the vertical sweep coils usually is negligible, because there is little coupling to the air at low audio frequencies. However, my SPL meter reveals that a 19-inch TV will typically create a 45-50 dB sound field at the *horizontal* sweep frequency in a typical home viewing room. One small industrial video editing room delivers over 50 dB at 15.7 kHz to the editor's ear position, and this is with only four monitors, three of which are nine inches or less. What must be the acoustic field intensity in a broadcast control room with its dozens of monitors?

In my office is a personal computer with a monochrome CRT display. It produces an 18,430 Hz sound at a level of 50+ dB at the keyboard operating position, increasing to 70 dB directly above the ventilation grillwork on the top of the CRT housing. An identical CRT in another office generates 80 dB SPL at the grillwork; yet another shows only about 60 dB. Evidently the acoustic radiation of CRT sweep coils and/or flyback transformers varies widely among otherwise similar components. An SPL meter check of about two dozen assorted CRT terminals in a design and production facility showed wide variations in acoustic output within the octave centered on 16 kHz, ranging from about 80 dB to unmeasurable. I suspect some of the high-resolution CRTs that produced no appreciable meter indication are radiating at frequencies above the 22.6 kHz upper edge of that octave,

thereby exceeding the meter's range.

Where are all the complaints from the golden ears who want absolute purity to 20 kHz and beyond? How come *no* one complains about the piercing squeals of TVs and CRT terminals? Can it be that these golden ears don't hear them? Or kids, cats and dogs don't? When I was in my twenties and could hear 21 kHz, I found the squeal of early TV sets extremely annoying; fortunately, TV didn't become a household fixture until sweep circuit componentry improved and age tempered my supersonic acuity, so I can now vent my annoyance at the programming instead of the horizontal-frequency squeal. But my meter says it's there, and the VU meters or bargraphs on audio consoles also should indicate some horizontal-frequency pollution whenever a microphone is open in a TV studio (which always has at least one monitor on the floor) or a TV announce booth. This should be particularly true in the announce booth, where the SPL may be only 15-20 dB below speech level; if announce booth squeal isn't evident at the board, either the audio chain (including microphone) suffers a restricted frequency range or the monitor is exceptionally well sound-proofed. And a little bit of 15.7 kHz becomes a lot after the preemphasis of FM transmission or recording equalization, with 20 dB down suddenly becoming more like 3 dB down. Yet no one ever mentions any problems with this source of pollution, or even hints that it's there. It's enough to shake one's faith in the "golden ears" fraternity.

Apart from my puzzlement over the failure of this noise source to receive even passing mention in the trade press, I have a deeper concern: Are we overlooking a growing environmental hazard? We somehow arbitrarily assume that acoustic radiation above the range of audibility is harmless, at least at moderate intensities. But is it? We certainly know that photon radiation above the visible frequencies, such as x-ray and ultraviolet, can be harmful even at low intensity and even though we don't perceive it. And there is some reason to believe that prolonged exposure to *subsonic* sounds of moderate intensity creates undesirable physiological effects; why should high-frequency sounds be different? Certainly supersonic frequencies that are sufficiently concentrated

and intense *are* dangerous and potentially lethal; what is a "safe" level for the continuous exposure that today's TV- and computer-filled environment imposes? Does all-day exposure to 16 or 18 kHz at 50 dB or more, even though inaudible to the individual, accelerate the high-frequency hearing loss that commonly accompanies aging? Is there any other possible physiological effect of prolonged exposure to this sound field? Can it in some way contribute to the inexplicable "eyestrain" or other difficulties many CRT operators complain of? It certainly is an environmental factor that never before existed in nature, so man hasn't evolved inherent defenses against it.

It probably does not devolve upon the audio fraternity to research the physiological effects of continuous exposure to supersonic sound fields, particularly since they are not directly caused by audio equipment. But it *may* be our obligation to call to the attention of the appropriate scientific disciplines and agencies the *existence* of this new environmental pollution, of which they seem blissfully unaware. After all, who is better qualified to identify, measure, and quantify the phenomenon than the golden-ear gang?

R. H. CODDINGTON

db replies:

Writer Coddington certainly asks some pertinent questions in his letter. The real question, however, is are there any answers? Has anyone done real research on this problem? We'd love to know. More than that, we'd like to publish it.

FOOTNOTE FOLLIES

TO THE READERS:

Discerning readers of db (and we assume that means all of you) are by now no doubt aware that the first two footnotes of Jesse Klapholz's article, "On the Boardwalk" (March, '84), are not the real thing. It has occurred to us that some of you may not have found those belated April Fool's jokes amusing, but rather might have felt that we were trying to belittle the intelligence of our readership, make light of the excellent sound systems in use at the hotels in Atlantic City, or poke fun of Carolyn and Don Davis' fine book, Sound System Engineering. Rest assured we were not. We were simply trying to inject a little humor into the magazine.

Our apologies to anyone who might have been offended.

THE SPEAKERS THAT SHOOK THE INDUSTRY



As an audio professional, you've probably already heard a lot of good things about Cerwin-Vega. That's because for the past thirty years we've been able to combine inspired engineering with real-world practicality to provide new standards in acoustic and electronics performance.

Our efforts have resulted in superior live music sound reproduction, (the Rolling Stones used our products for guitars and keyboards on their '81 U.S. tour), the Academy Award winning Sensurround® cinema special effects system, and the single-handed invention of high level dance music playback (or disco, as it came to be known).

With these credentials, it's no accident that we currently manufacture the most capable line of professional products for the wide, diversified world of commercial sound.

Our current product line is based on highly evolved performance principles of enormous power handling, excellent efficiency, clear, intelligible midrange and high frequency projection, and ultimate reliability.

The Cerwin-Vega V-100 system, for instance, is something of an engineering marvel. Its dual 18" horn loaded bass components are direct descendants of the speakers which reproduced an earthquake for Universal Studios, and the midrange and high frequency compression drivers use advanced diaphragm technology which reduces distortion ten fold over competitive designs. The V-100

is rated at 1000 watts power handling E.I.A., and can produce sound pressure levels approaching 130 dB.

That's a lot of system. But even the smallest Cerwin-Vega pro speaker, the 12" two-way V-19, delivers more performance value than anything else on the market. And between these two extremes, we've got enough speakers in enough configurations to cover any possible commercial sound application. They're even available in a variety of finishes, including a rugged carpet covering, and a textured epoxy paint for fixed installations.

And, of course, we offer a full line of compression drivers for jobs requiring custom installation.

If you're looking for a way to turn any pro sound job into something special, into a true audio experience, then you should consider the real movers and shakers in the industry—Cerwin-Vega Professional Audio Products.

Even if you don't have to recreate an earthquake.

 **Cerwin-Vega!**

12250 Montague St., Arleta, Ca. 91331
(213) 896-0777 Telex No. 662250

Circle 17 on Reader Service Card

**THE BEST
VALUE IN
PROFESSIONAL
POWER
AMPLIFIERS ...
HAFLER.**



hafler
The David Hafler Company
Department DJ
5910 Crescent Boulevard
Pennsauken, N.J. 08109

6 db May 1984

Calendar

MAY

11-14 **2nd AES International Conference: The Art and Technology of Recording.** Location: Disneyland Hotel, Anaheim, CA. For more information, contact: Convention Services, Audio Engineering Society, 60 East 42nd St., New York, NY 10165. Tel: 212/661-2355.

19 **Audio Aspects of Post Production.** Organized and sponsored by the Hollywood Section of SMPTE. Locations: Paramount Studios, Glen Glenn Sound and Warner Hollywood Studios. For more information, contact: Jack Spring, c/o Eastman Kodak Co., 6706 Santa Monica Blvd., Hollywood, CA 90038; Tel: 213/464-6131, or Howard La Zare, c/o Consolidated Film Industries, 959 N. Seward St., Hollywood, CA 90038. Tel.: 213/462-3161.

JUNE

4-29 **Summer Program in Underwater Acoustics and Signal Processing.** Given by The Pennsylvania State University's Applied Research Laboratory and Graduate Program in Acoustics. Written inquiries should be directed to Dr. Alan D. Stuart, Summer Program Coordinator, c/o The Penn

State Graduate Program in Acoustics, P.O. Box 30, State College, PA 16801. Telephone inquiries may be made to Mrs. Barbara Crocken, Administrative Assistant, at 814/865-6364.

18-29 **Techniques of Digital Audio Processing.** Given by the Experimental Music Studio at MIT. For application information, contact: Director of the Summer Session, Room E19-356, Massachusetts Institute of Technology, Cambridge, MA 02139.

JULY

17-19 **4th Annual WOSU Broadcast Engineering Conference.** Sponsored by the Ohio State University Public Broadcasting Stations. Location: The Fawcett Center for Tomorrow, Columbus, OH. For more information, contact: WOSU Stations, 2400 Olentangy River Rd., Columbus, OH 43210. Tel.: 614/422-9678.

2-27 **Workshop in Computer Music Composition.** Given by the Experimental Music Studio at MIT. For application information, contact: Director of the Summer Session, Room E19-356, Massachusetts Institute of Technology, Cambridge, MA 02139.

WANTED

PREFERABLY ALIVE !!!

We are looking for you out there, you who may have developed computer programs or devices for the audio industry.

If you are a manufacturer who has developed a new idea or method of testing or producing using a computer—tell us! We want your idea in our new computer column.

If you are an audio engineer who has come up with an innovative way to use a computer in the recording, broadcast

or sound reinforcement field—tell us! We want you to tell us and the world about it.

If you are a programmer or someone who has a special knowledge of computers in audio—tell us! We'll let everyone know about it.

This is your opportunity to tell the world about your brainchild—your innovations—your genius!

Tell us—here at db—The Sound Engineering Magazine.

Sagamore Publishing Co.
1120 Old Country Road
Plainview, NY. 11803
(516) 433-6530

YOUR WORLD

For you, it's the sixth session of the day. For them, it's the biggest session of the year. So you push yourself and your board one more time. To find the perfect mix between four singers and 14 musicians. Between 24 tracks and at least as many opinions. To get all the music you heard—from the deepest drums to the highest horns—on to the one thing they'll keep. The tape.

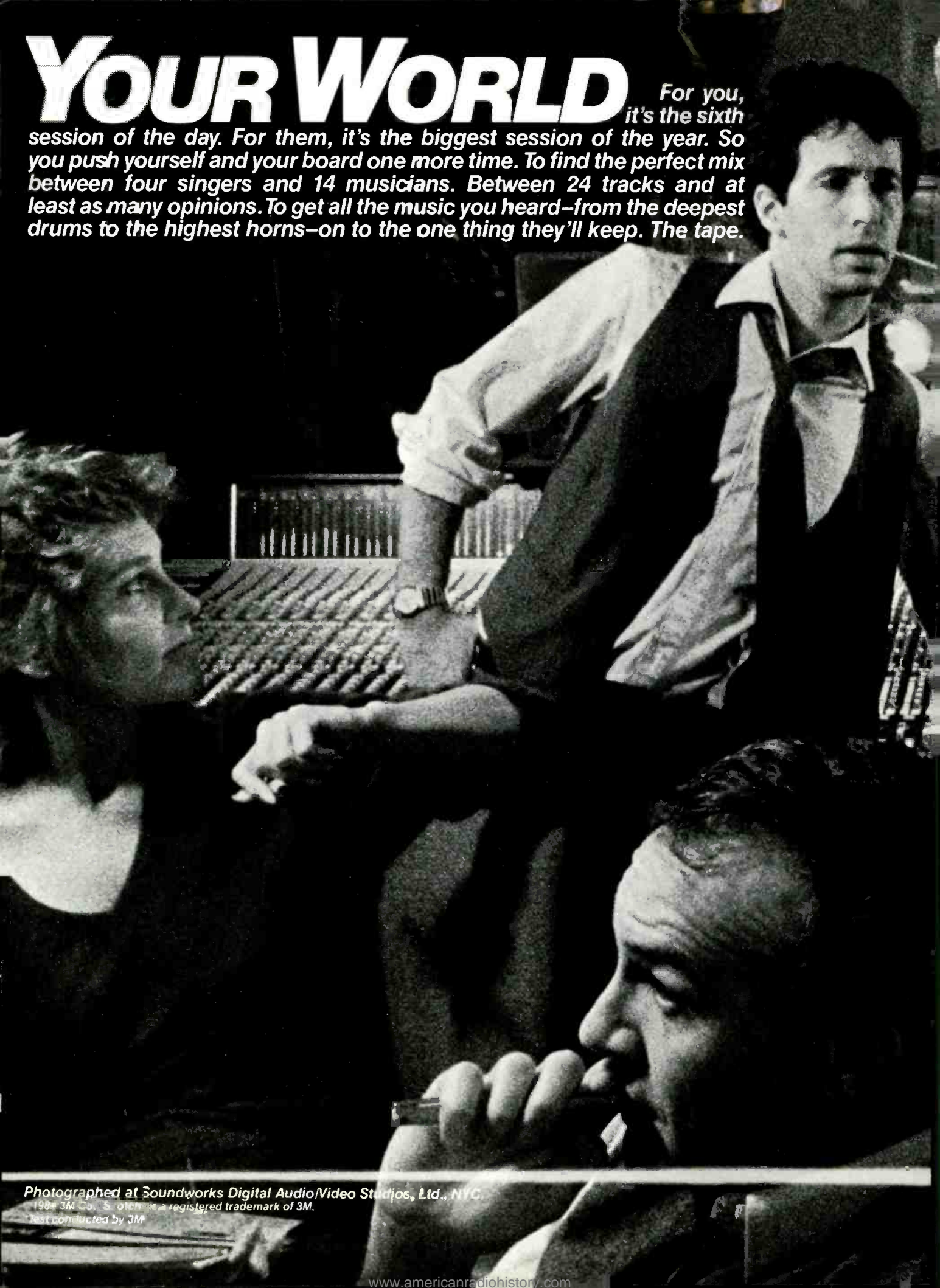

Photographed at Soundworks Digital Audio/Video Studios, Ltd., NYC.

© 1998 3M Co. "3M" is a registered trademark of 3M.

Test conducted by 3M



OUR TAPE

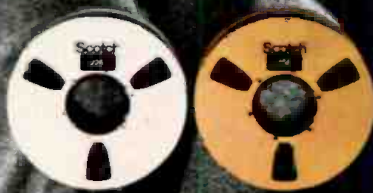

We know that our tape is the

one constant you have to be able to count on. So we make mastering tapes of truly world-class quality. Like Scotch® 226, a mix of Scotch virtuosity and the versatility to meet your many mastering needs—music, voices, effects. And Scotch 250—with the greatest dynamic range and lowest noise of any tape, it is simply the best music mastering tape in the world. Both tapes were preferred by Ampex and Agfa users at a listening test* conducted at the 1983 Audio Engineering Society

convention in New York. They are both backed by our own engineers a call away. They are just two of the tapes that make us...number one in the world of the pro.

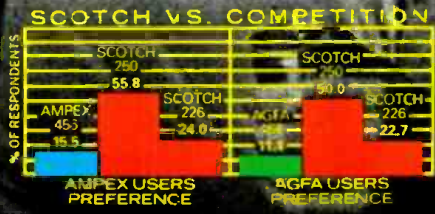

Scotch®
AUDIO & VIDEO TAPES

NUMBER ONE IN THE WORLD OF THE PRO



Circle 18 on Reader Service Card



System Intelligibility Estimates

• Long before a reinforcement system is on the drawing board, while it is still in the negotiating stage, the designer must have a clear idea of how well the system will work. The aim of any reinforcement system is to provide adequate intelligibility for the intended audience under all anticipated listening conditions.

Over the years, a number of methods have been developed for helping the designer estimate the effectiveness of the system while it is still in the conceptual stage. We hasten to underscore the term estimate, since these methods are only rough guides to what might be expected when the system is finally installed.

ARTICULATION TESTING

The final measure of a system's intelligibility is gained through a set of syllabic articulation tests. In this testing method, a talker reads from a random list of one-syllable words, and listeners at various points in the space write down the words as they hear them. An 85% score on these tests indicates that the system will provide overall speech intelligibility on the order of 97%, due to the contextual nature of speech. If the articulation score is 75%, then the listener will be able to understand approximately 94% of the words in normal speech context.

FACTORS DETERMINING SYSTEM INTELLIGIBILITY

The main factors in determining the effectiveness of speech transmission in a room are speech level, reverberation time, direct-to-reverberant ratio, background noise, and the presence of discrete interfering reflections. Unfortunately, there is no simple way to include all these factors into a method that will estimate the behavior of the system.

We have a number of models as useful tools, each which seems to work under certain circumstances. About a year and a half ago, we discussed, in a column dealing with sound fields, the Peutz method of estimating system intelligibility. The Peutz estimate, as we chose to employ it, considers the effects of reverberation time and the direct-to-reverberant ratio in the 1 to 2 kHz range as the determinant of system intelligibility performance. We also assumed that the effective noise level below peak speech levels was at least 25 to 30 dB.

The method is especially effective in auditoriums and houses of worship, where the background noise level can be kept fairly low. The method further assumes that there are no deleterious reflections and that the

room reverberation pattern is fairly normal.

ESTIMATES IN NOISY ENVIRONMENTS: THE ARTICULATION INDEX

The question of what to do in noisy environments leads us to the Articulation Index (AI) of French and Steinberg¹. Their work has been modified in later years by Kryter² and Smith³.

In its simplified form, an AI estimate can be made by observing the peak speech levels relative to RMS noise levels in each of five octave bands: 250, 500, 1000, 2000, and 4000 Hz. These ratios are approximately weighted, and the weighted values are summed to give an Articulation Index.

FIGURE 1 shows the method by

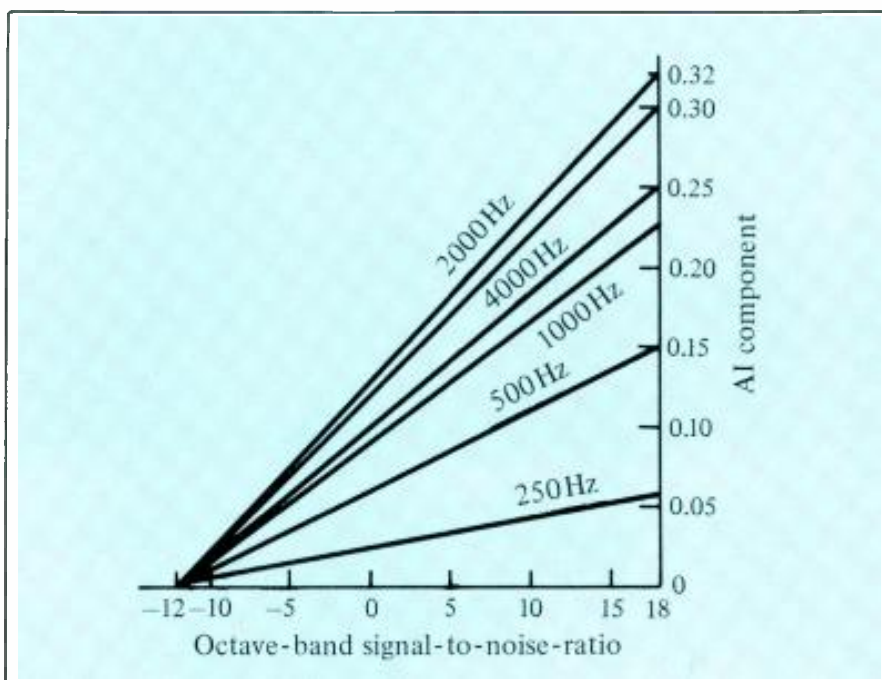

Figure 1. Calculation of Articulation Index (AI).

MICROPHONES!

At long last, all the questions you ever asked...all the problems you ever grappled with...are answered clearly and definitively!

The Microphone Handbook

In 256 fact-filled pages, liberally sprinkled with over 500 illuminating photographs, drawings and diagrams, John Eargle covers virtually every practical aspect of microphone design and usage.

Completely up to date, this vital new handbook is a must for any professional whose work involves microphones. Here are just a few of the topics that are thoroughly covered:

- Directional characteristics—the basic patterns.
- Using patterns effectively.
- Microphone sensitivity ratings.
- Remote powering of capacitors.
- Proximity and distance effects.
- Multi-microphone interference problems.
- Stereo microphone techniques.
- Speech and music reinforcement.
- Studio microphone techniques.
- Microphone accessories.
- And much, much more!

THE MICROPHONE HANDBOOK. You'll find yourself reaching for it every time a new or unusual problem crops up. Order your copy now!



JOHN EARGLE,

noted author, lecturer and audio expert, is vice-president, market planning for James B. Lansing Sound. He has also served as chief engineer with Mercury Records, and is a member of SMPTE, IEEE and AES, for which he served as president in 1974-75. Listed in *Engineers of Distinction*, he has over 30 published articles and record reviews to his credit, and is the author of another important book, *Sound Recording*.

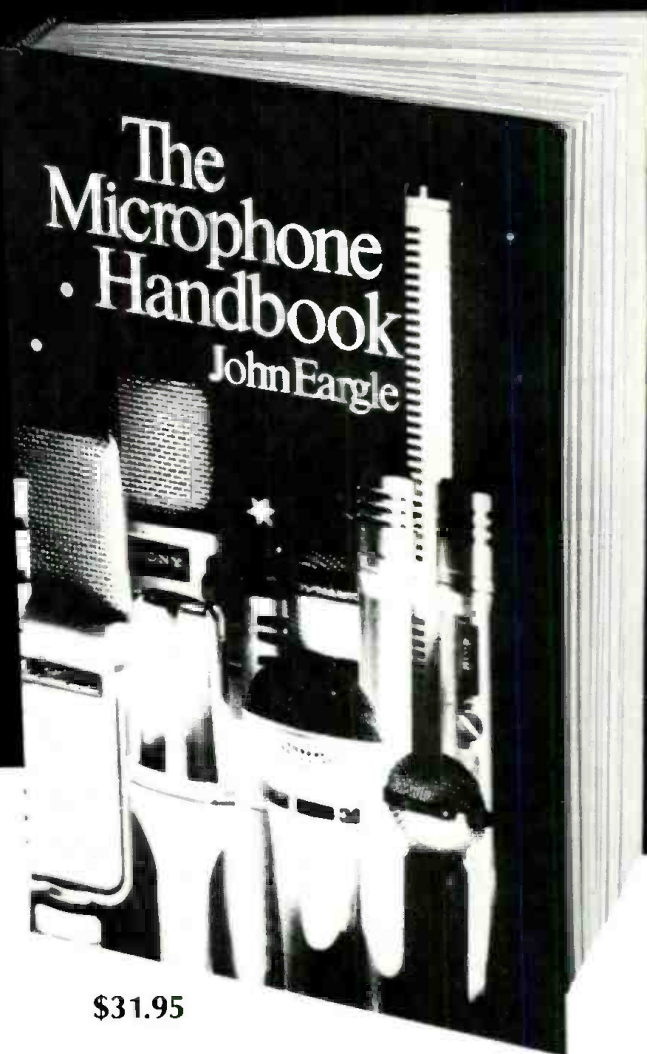

\$31.95

ELAR PUBLISHING CO., INC.

1120 Old Country Road, Plainview, NY 11803

Yes! Please send _____ copies of **The Microphone Handbook @ \$31.95** per copy. (New York State residents add appropriate sales tax.)

Payment enclosed.

Or charge my MasterCard Visa

Acct. # _____ Exp. Date _____

Name _____
(please print)

Address _____

City _____

State/Zip _____

Signature _____

Outside U.S.A. add \$2.00 for postage. Checks must be in U.S. funds drawn on a U.S. bank.

If you aren't completely satisfied, you may return your copy in good condition within 15 days for full refund or credit.

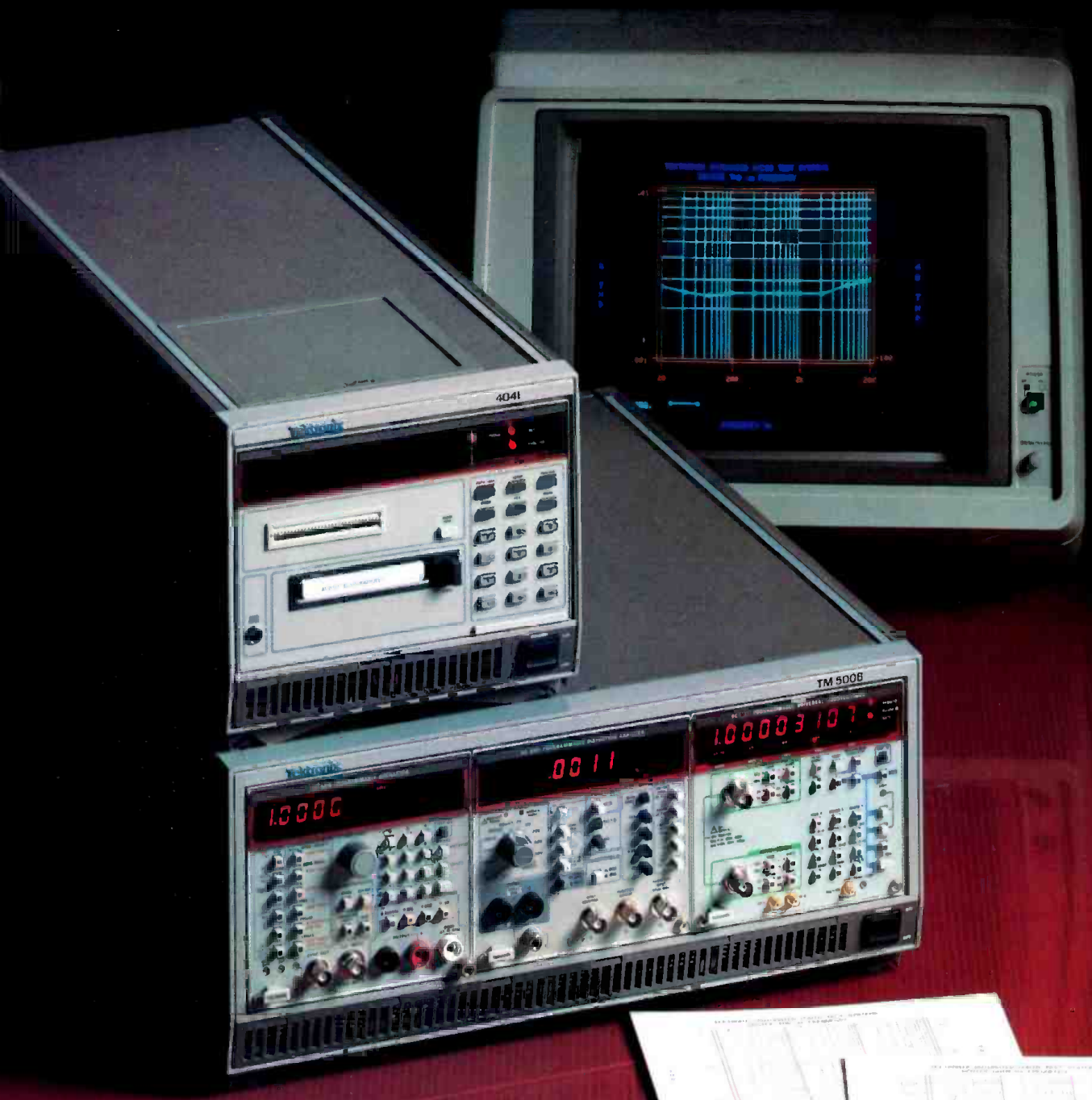

Tektronix automated audio test systems: built to test the best.

Tek's new SG5010/AA5001 Programmable Audio Oscillator and Distortion Analyzer System lets you test the finest professional audio and communications equipment, with uncompromisingly high-quality measurements.

Finally, you can count on computer-controlled audio test equipment that's better than the products you're testing. Coupled with an IEEE-488 controller, the SG5010/AA5001 completes most audio tests quickly, automatically, even unattended.

The new Tek system features extremely low residual noise (less than 3 microvolts) and low distortion (typically 0.0012% at midband when using the audio bandpass filter). It allows you to make all standard audio tests—including THD, IMD (SMPTE, DIN, CCIF difference tone), gain/loss, and signal-to-noise ratio.

Perform most audio production tests up to ten times faster than manually.

Tek's Programmable Audio Test System will help your technicians achieve both faster throughput and more comprehensive testing. And because one Tek automated system can do the work of five to ten fully equipped benches, your investment will pay for itself several times over.

Eliminate most slow, repetitive performance testing involved in audio design. Use the new Tek test system to automate measurements, then display the results via graphics for quickest interpretation. Free up design engineers for more creative tasks.

Detect broadcast signal degradation promptly, before equipment failure. The Tek audio test system can help cut downtime by accurately measuring and documenting increases in noise or distortion, or other trends affecting signal quality. Thorough audio proof reports can be generated automatically, every day if desired.

Test with the best. Highly accurate results, made quickly

and automatically, add up to savings in the audio field. Even if you're not ready for full automation, Tek also makes the fastest, easiest-to-use manual audio test equipment. Our AA501/SG505 package offers performance equivalent to our new programmable system.

Find out more about how Tek instruments can pay off in your audio application.

Call your nearest Tektronix Sales Office, or contact: U.S.A., Asia, Australia, Central & South America, Japan Tektronix, Inc.

P.O. Box 1700

Beaverton, OR 97075

Phone: 800/547-1512

Oregon only: 800/452-1877

Europe, Africa, Middle East

Tektronix Europe B.V.

Postbox 827

1180 AV Amstelveen

The Netherlands

Telex: 18312-18328

Canada

Tektronix Canada Inc.

P.O. Box 6500

Barrie, Ontario L4M 4V3

Phone 705/737-2700

Tektronix
COMMITTED TO EXCELLENCE

SUPPORT THE HOME TEAM.



Buy An Olympic Coin.

For the first time in history, the United States Mint is issuing Olympic commemorative coins. Each beautiful gold and silver coin depicts an Olympic theme in honor of the first Summer Olympics held on American soil in over 50 years, the XXIII Olympiad in Los Angeles.

The gem-like, proof coins will be a treasure to own for years to come. And all profits go directly to the Olympic effort.

Help support our athletes and the 1984 Games. Buy an Olympic coin today.

Coins can be purchased through your local post office and at participating banks and coin dealers across the country. Or, write to: U.S. Mint, Olympic Coin Program, P.O. Box 6766, San Francisco, CA 94101.



© 1984 U.S. Mint and the U.S. Olympic Organizing Committee M-1

which the weighting is obtained. Along the X-axis, we enter the octave band signal-to-noise ratio, and along the Y-axis we read the corresponding AI component for that band. Since it is usually easier to measure average levels of long-term speech, these are the values to be entered in the graph.

Generally, we assume that average speech levels in each band are some 12 dB lower than their peak levels.

Suppose that we measure average speech levels and RMS noise spectra as given in FIGURE 2. Then, we simply enter the level differences between them and read the corre-

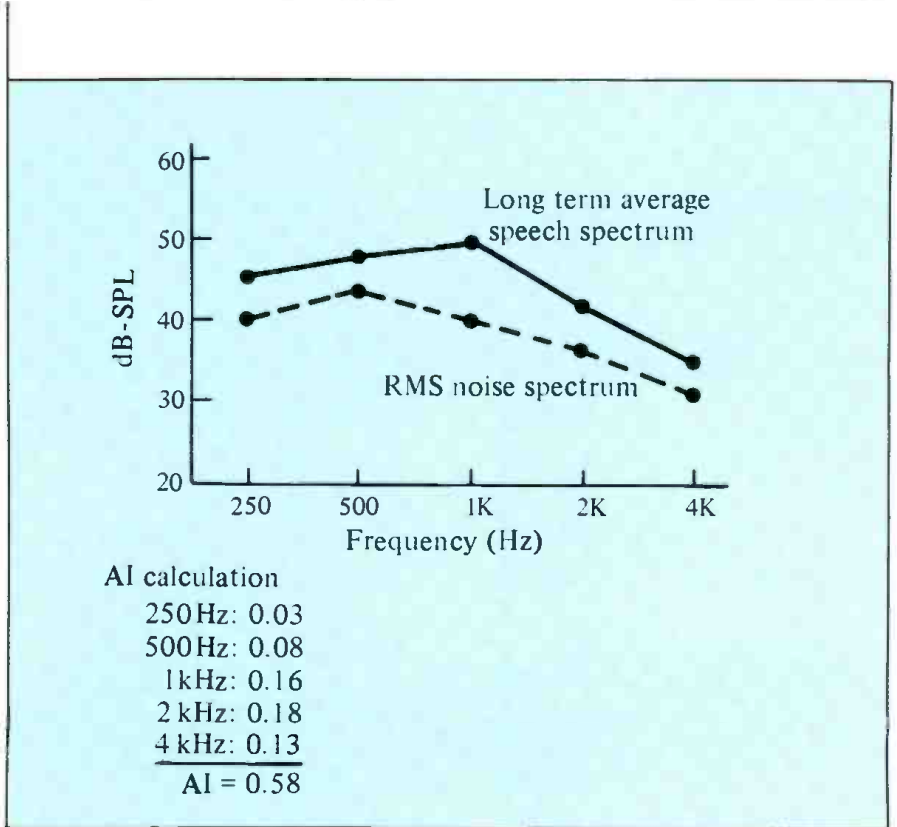

Figure 2. Sample speech and noise spectrum.

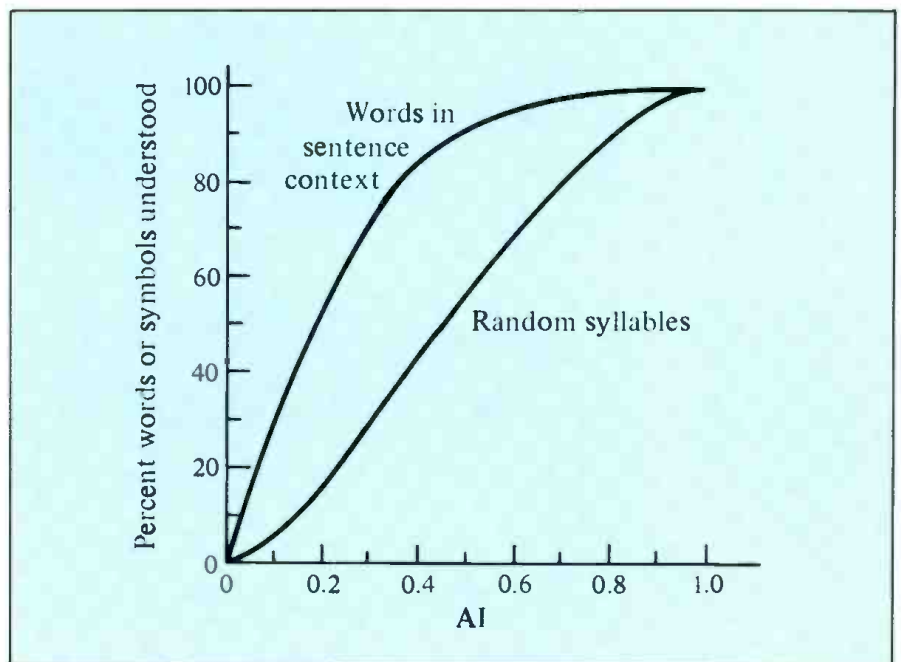

Figure 3. Comparison of AI and syllabic tests.

sponding AI component values from FIGURE 1, as indicated.

Note that the total AI is 0.58. As a measure of performance, we refer to the graph of FIGURE 3. Here, we observe that the AI value of 0.58 corresponds roughly to an accuracy well up in the 90% range for syllables in normal speech context. For random syllables, the accuracy would be around 70%.

There is a vast body of data relating AI estimates to actual measurements, and the agreement is quite good. The AI method is especially useful in public spaces, such as office areas and transportation terminals, where background noise can be significant.

ESTIMATES IN THE PRESENCE OF REVERBERATION

The adaptability of the AI method to spaces having both noise and excessive reverberation is not well established. While reverberation times less than, say, 1.5 seconds, probably have little deleterious effect on system intelligibility, longer reverberation times will certainly affect the intelligibility.

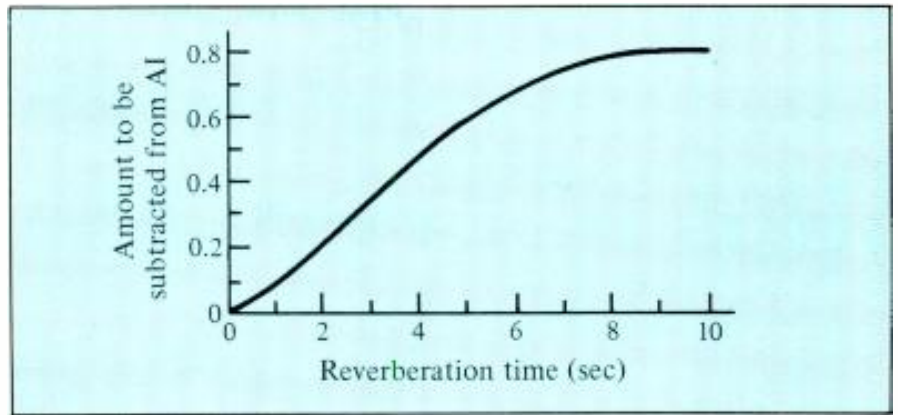

Figure 4. AI derating as a function of reverberation (Kryter).

Kryter suggests simply derating the AI value by the amount given by the graph of FIGURE 4. However, this is not recommended. Smith and others suggest that excessive reverberation be considered as additional noise to be summed, on a power basis, with the fixed noise spectrum in each octave band. In this manner, a reasonable AI estimate can be made for a sound system in a large space which is both noisy and reverberant. ■

References

1. French, N. R. and Steinberg, J. C., "Factors Governing the Intelligibility of Speech Sounds," J. Acoustical Society of America, Volume 19 (1947).
2. Kryter, K. D., "Methods for the Calculation and Use of the Articulation Index," J. Acoustical Society of America, Volume 34 (1962).
3. Smith, H. G., "Acoustic Design Considerations of Speech Intelligibility," J. Audio Engineering Society, Volume 29 (1981).

The Standard-Setting Telephone Interface (Modestly Improved)

It's no secret. Studer has become the acknowledged leader in high quality telephone interfacing equipment. The Studer Telephone Hybrid – already selected by hundreds of U.S. broadcasters, including all three major networks – has been praised for its straightforward design, long-term reliability, and consistently outstanding performance.

At the heart of the Studer Telephone Hybrid is an auto-balancing hybrid circuit which automatically matches phone line impedance while isolating send and receive signals for maximum sidetone attenuation. A built-in limiter prevents sudden overloads, and bandpass filters shape the voice signals for optimum clarity and system protection. The new updated Studer Hybrid includes additional noise suppression circuitry

to eliminate unwanted noise and crosstalk while still preserving true 2-way hybrid operation.

Now the Studer Telephone Hybrid is also available as part of a complete Telephone System. Designed to operate independent of the studio console, the self-contained Telephone System includes a microphone input plus a palm-sized remote module (on a 30' cable) with VU meter for line level, headphone output, and level controls for microphone, headphone, and telephone receive.

The time-tested Studer interfaces. Improved for even better performance. Expanded for more flexible operation. And built to set the quality standard for years to come. Call your Studer representative today for complete details.

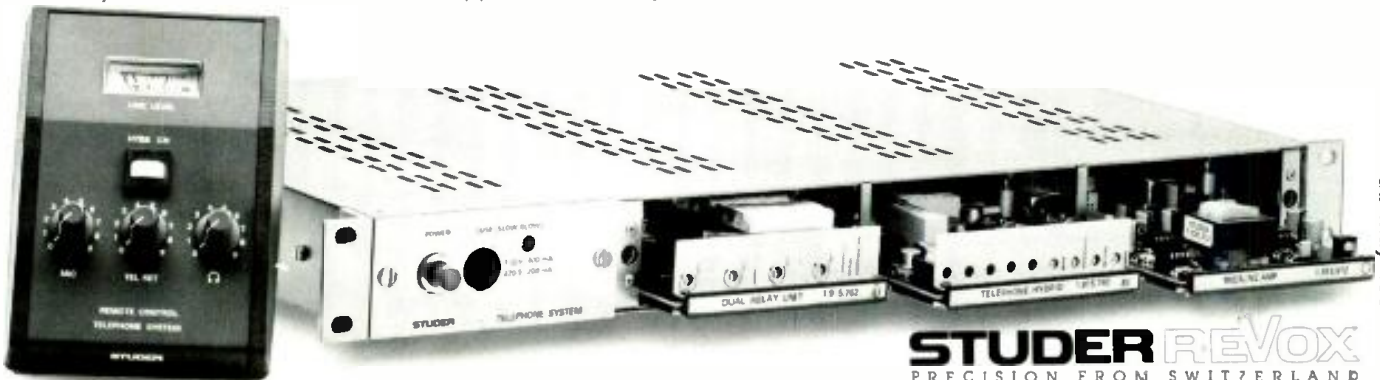

1425 Elm Hill Pike, Nashville, TN 37210 (615) 254-5651 • Los Angeles (213) 780-4234 • New York (212) 255-4462 • Dallas (214) 760-8647

Circle 20 on Reader Service Card



What Do Computers Do?

• Since you're reading this column, someone or something has put the notion into your head that a small computer might be useful around the office or workplace. But you may not be sure just what these little machines can do for you.

What if we told you that a typical small computer could make writing proposals, specifications, and correspondence a breeze, type perfectly, check spelling, fine tune business plans, simplify accounting, keep track of loads of information, instantly sort through it and print out a report, handle inventory, print invoices, run off a mailing list, and let you blast Klingons to the other side of the galaxy (in your spare time, of course)? Do you think *you* could make use of a computer?

The most popular myth regarding computers is that they replace people. That is simply nonsense. What happens is that the person using the computer gets more work done—often more efficiently and better than ever before. In other words, you shouldn't buy a computer in a misguided attempt to replace your bookkeeper. A computer will *aid* your bookkeeper by allowing him/her to handle twice as many accounts in half the time. It will then have time to help you chase down new customer leads, earn more commission than your star salesperson, and become the new studio manager, leaving everyone ecstatic (except for the former star salesperson).

Perhaps now you're wondering, "How did I do without a computer all this time?" You're ready to learn a little more about how the current generation of computers developed, how they work, and the resulting languages and standards.

BITS AND PIECES

As mentioned in last month's column, the current fourth generation of computers began with the advent of the microprocessor. The microprocessor is a complete central processing unit (or CPU) on one integrated circuit chip. Recent technological advances have permitted memory and input/output features

to be incorporated on the same chip so that a total microcomputer is on one chip.

The most basic piece of information that a computer can handle is a bit. A bit is computer lingo for binary digit. A binary digit is either a 0 or a 1 and it can only represent two conditions: on or off. To represent more complex conditions, such as a position between on and off, more bits need to be grouped together; the more bits grouped together, the more possible combinations.

The most common number of bits that are grouped together is eight. With eight bits, you can represent 256 different values or codes. The term "byte" refers to a group of eight bits. One byte is used to represent one character, such as a letter, space, or punctuation mark.

Back to the microprocessors. The first microprocessor was a 4-bit processor. It appeared on the market in 1971, but was quickly succeeded by an 8-bit microprocessor. Now, 16-bit microprocessors are available. The number of bits a processor can handle is an indication of its capabilities or computational power. The more bits, the greater the power—if everything else is equal. The earlier microprocessors were limited in their computational power, but by the late 70s, microprocessors were as powerful and sophisticated as the

CPUs in the second generation, or even some of the third generation computers. Some of the most popular microprocessors are listed in FIGURE 1.

It wasn't the microprocessors by themselves that were responsible for the microcomputer revolution. However, they were the "brains" of computer system kits built by computer hobbyists. And those computers built from kits were actually the beginning of the fourth generation of computers. The first such commercially available kit was the Altair 8800, featured on the January '75 cover of *Popular Electronics* magazine.

THE CULT GROWS

Once those microcomputer kits were built, there wasn't much that could be done with them except perhaps to program their front panel lights to flash in some sort of sequence. Had you asked, "Can they do something useful?," it would have been a whole different story, involving plugging additional interface and memory boards into the microcomputer's "bus." And, if one wanted to communicate with a microcomputer, that involved peripherals such as teletype machines, computer terminals, and line printers. What started out as an evening's project for under \$500 ended up in an invest-

NUMBER OF BITS	MANUFACTURER	TYPE NUMBER
4	Texas Instruments	1000
4	Intel	4004
8	Intel	8080, 8085
8	Fairchild	F-8
8	Motorola	6800, 6809
8	National	IMP-8
8	RCA	Cosmac
8	Mos Technology	6502
8	Signetics	2650
8	Zilog	Z-80
16	Texas Instruments	9900
16	Motorola	68000
16	Intel	8086
16	Zilog	Z-8000

Figure 1. Popularly used microprocessors.

ment approaching \$10,000 for a "system."

Once you had a computer system, for the most part the computer had to be programmed to perform tasks for the user's applications. Most computer hobbyists were engineers or programmers. In fact, many were so fascinated with the technology that they didn't care if their computers were relatively useless.

Some microcomputer hobbyists used their technical expertise and ingenuity to develop products that took the microcomputer from the hobbyist market to the consumer, electronic, and small business markets. Microdome's "two Steves"—Stephen Wozniak and Steven Jobs—were directly responsible for introducing microcomputers to the general public when they designed the first Apple computer in Jobs' parents' garage.

The Apple I was one of the first microcomputers to combine important components such as memory, intelligence, input, and output on a single circuit board. After exhibiting the Apple I with great success, Wozniak (better known as "the Woz") and Jobs upgraded the Apple I to the Apple II and entered the micro-

computer business. Apple Computer, Inc. was thereby born. It has since become one of the most successful microcomputer companies, with yearly revenues averaging more than \$100 million, and now selling more than 20,000 computers per month.

The Apple II and its first competitors, the Commodore PET and the Radio Shack TRS-80, were much easier to use than the Altair 8800. These newer "user-friendly" machines came with typewriter keyboards and video displays instead of the banks of lights and switches on the earlier kit models. They also employed built-in BASIC computer language, which was displayed as soon as you turned on the machine. In contrast, to use BASIC on an Altair, the operator had to go through long, involved processes, which usually took from 20 minutes to an hour.

With the introduction of the Altair 8800, companies began producing plug-compatible boards for the Altair or S-100 bus. (A bus is a series of electrical pathways which take information and power from place to place within a computer system. Memory, serial and parallel I/O [input/output], video and graphics

display, analog I/O, voice systems, music synthesis, and many other boards operate through one of the standard buses in computer systems.) FIGURE 2 shows some of the bus standards of each manufacturer and the microprocessors they used.

Regardless of the microprocessor used in the system or the number of lines on its bus, the address, data, and control signals are the bus' main ingredients. The address lines are used by the processor to tell the memory section and other peripherals the location with which it wishes to communicate. The 8080, Z80, 6800 and 6502 have 16 address lines that are divided into two 8-bit bytes.

The eight data lines carry instructions and data between the processor and all the peripherals, including the memory. All processors have bi-directional data lines which carry information both into and out of the processor. The direction of information flow on these lines is usually under processor control. All buses, except the S-100 and the Digital Group, maintain the bi-directional data lines.

The control lines coordinate the operations of all system components. Most buses include a master clock

Brooke Siren Systems

For years our MCS200 series crossovers have been used by major touring companies worldwide. The same high technology is available in our FDS300 series crossovers. Our products include some very unique features, highlighted below, but perhaps our best feature is the way we'll sound with you. Available now through professional audio distributors and music stores nationwide.

- 24dB/Octave Slope
- Subsonic/Ultrasonic Filters
- Section Mute Control
- Limiters on Each Section
- ± 6 dB Level Control
- Sealed Potentiometers

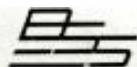

Brooke Siren Systems, 262A Eastern Parkway, Farmingdale, New York 11735 (516) 249-3660
Gerraudio Inc., 363 Adelaide Street East, Toronto, Ontario M5A 1N3 (416) 361-1667



FDS 340

Frequency Dividing Systems

- FDS320 2-Way Stereo
- FDS340 3 or 4-Way Mono
- AR116 Active Direct Box
- AR125 Cable Tester
- MCS200 Modular Series 3, 4, or 5-Way Stereo

Circle 21 on Reader Service Card

BUS	MANUFACTURER	MICROPROCESSOR
S-100	MITS	8080
Benton Harbor	Heath Co.	8080
SBC Multibus	Intel	8080
TRS-80	Radio Shack	Z-80
The Digital Group Bus	The Digital Group	8080, Z-80, 6800
SS-50	South West Technical Products	6800, 6502
Exorcisor	Motorola	6800
KIM	MOS Technology	6800
Apple II	Apple Computer	6502
PET	Commodore Business Machines	6502
Ohio Scientific	Ohio Scientific	6502

Figure 2. Buses by type, manufacturer, and μ -processor(s) used.

line, which indicates to the system when valid data is on the line and can be transferred. Direction of the data flow is determined by one or more of the processor's outputs. The Memory-Read and Memory-Write lines control direction of data flow during memory operations. The I/O Read and Write lines control data direction during I/O operations. Most buses also include Reset lines that reset the system to the original operating system.

At this point let's take a look at what a compute system includes:

- Hardware, which is the machine itself
- Software, which consists of instructions that tell the machine how to perform a particular task, such as accounting or word processing
- Input & Output Devices, which allow the computer to communicate with the operator or other computers

- You, the person who, after training and hours spent with instruction manuals, can make the whole system come to life (and play Pac Man).

SOFTWARE

One of the key ingredients of a computer system is the software. Software is like a road map for the computer; it instructs the computer what to do with the data you enter from the keyboard (or any other data acquisition device), how to send it out to the printer, and how to perform all those wonderful tricks for which you got a computer in the first place.

Without software, a computer is just a pile of chips that won't do anything at all. Computer hardware by itself has no personality; this is determined by the software. The first uses of computers were for sorting and tabulating large volumes of data. Because of the few and highly specialized applications in early computing, almost all early computer programs were written by people with "tunnel vision"; that is, people looking for solutions to their immediate problems. The programs were written for one application without considering that slight modifications to the programs would allow them to solve others' problems as well.

Fortunately, someone woke up to the fact that they were using many of the same steps, or even whole blocks of steps, in many different one-application programs. This led to the development of programs and procedures that were more general and could be used in other applications.

LINGUISTIC COMPUTERESE

A computer program is written in a special computer language. The most simple and universal computer language is called machine language, which consists of binary digits. As stated earlier, there are only two binary digits, 0 and 1 (the short name for binary digit is bit). Machine language is what the computer uses to talk to itself. However, this language is much too tedious and time-consuming for an operator to use to talk to the computer. Because of this, higher level programming languages were developed. These languages allow us to make one short, simple statement using our alphabet and decimal system to instruct the computer to perform an operation that may take many steps of machine

150Hz-8kHz

emilar

1365 N. McCan St. Anaheim, CA 92806 • 714.632.8500 • 800.854.7181 • TWX 910.591.1191

Circle 22 on Reader Service Card

language within the computer. Let's look at some of these higher-level language developments.

FIGURE 3 shows the languages that computers of the first several generations used, and that are still the most popular today. Two of the commonly used high level languages are FORTRAN (for scientific applications) and COBOL (for business applications). These have been further developed and refined since their introduction to make them more versatile and useful. These were, and still are, powerful languages; however, many other languages have also been developed. One of these, PL/I, was developed by IBM by combining features of FORTRAN and COBOL.

The Pascal programming language was developed as a tool for teaching

good programming techniques. Pascal uses structured programming techniques to bundle program steps as groups of procedures or routines to be used in different programs. With these techniques, a program segment written for one application could be used over again in another program for another application. Because of this time/cost-efficient programming method, Pascal has become a language used by programmers in business, scientific, and computer game applications.

Another programming language called BASIC was developed to simplify programming so that many more people could use computers. Instruction statements in BASIC look very similar to an ordinary mathematical statement in the English

language. BASIC received widespread usage when the personal computer came on the market. It is an interactive language; that is, the computer responds directly to input instructions by displaying the results as the program is executed. BASIC is the most popular and universal computer language, and has become available for all personal computers.

With all this traffic of bits and bytes flowing around inside of computers, traffic jams and crashes would seem to be a fairly common event. Fortunately, we have a "traffic cop" to make sure that traffic doesn't get all snarled up and that crashes don't occur too often. Our computers' traffic cop is called the *operating system*, or OS (pronounced "oh ess") for short. The operating system allows us to take care of our necessary tasks, such as loading a program from a storage medium to the computer's memory, printing a file from a disk onto a printer, and, in general, handling all data transfer from one location to another.

Next time we'll take a closer look at operating systems, higher-level programming languages and techniques, and how these digital computers work. ■

LANGUAGE	ACRONYM DEFINED	APPLICATION
FORTRAN	FORmula TRANslating system	Scientific
COBOL	COmmon Business Oriented Language	Business
PL/I	N/A	Scientific and Business
Pascal	Named after the French scientist Blaise Pascal	Universal
BASIC	Beginner's All-purpose Symbolic Instruction Code	personal computers

Figure 3. High-level computer languages.

Looking for a Distortion Measurement System?

The Amber model 3501 is quite simply the highest performance, most featured, yet lowest cost audio distortion and noise measurement system available.

It offers state-of-the-art performance with THD measurements to below 0.0008% (-102dB), maximum output level to +30dBm and noise measurements to below -120dBm.

It has features like automatic operation, optional balanced input/output and powerful IMD measurement capability. It includes comprehensive noise weighting with four user changeable filters. Unique features like manual spectrum analysis and selectable bandwidth signal-to-noise measurements.

The 3501 is fast, easy to use and its light weight and small size make it very portable. It can even be battery powered.

And the best part is that it is 20% to 50% below what you would pay elsewhere for less performance. The Amber 3501 starts at \$2100. Send for full technical details.



amber

Amber Electro Design Inc.
4810 Jean Talon West
Montreal Canada H4P 2N5
Telephone (514) 735 4105

Report From the Far East

• To travel from the U.S. to Japan you don't exactly fly west, and you don't really fly east either. You fly north. Here's why: From Seattle you cruise over Alaska and down along Russia (not too close), and enter Japanese airspace from the north. It's shorter that way; if you don't believe me, check it out with a piece of string and a globe. For example, Russian ICBMs would come in over the north pole—it's faster, and saves on fuel. In any case, it's still a long trip.

From my south Florida home to the hotel in Tokyo involves 26 hours of travelling, I think. You're never really sure, what with the international date line and all. Don't misunderstand me. I'm not complaining. Would I complain about a week in Japan and the opportunity to look over the shoulders of Sony engineers hard at work on research and development of new products? Are you kidding?

People always say that the Japanese steal American research, perfect it, miniaturize it, and then mass produce it. To some degree that is true; like all marketing geniuses, the Japanese are always on the lookout for basic discoveries and creative development potentials. They understand that the utility (and profit) in science comes from its application. More and more, Japanese companies are proving themselves to be formidable engineering enterprises. Even in the highest of high tech, such as supercomputer development, they are applying science like no one else in the world.

During my recent visit to Japan, I was mightily impressed by Sony Corporation's expertise in research and development; they demonstrated prototypes of new products which will certainly reshape our enjoyment of entertainment and utilization of information. Among the areas of development are products from digital television to direct broadcast satellite systems, from digital audio cassette recorders to the CD Walkman, from digital VTRs to CR ROM,

which promise to digitize consumers and professionals alike. Among this product phalanx, two especially caught my eye as being important to the professional scene. They are almost available and will most likely be successful in fueling the analog to digital transition taking place in many recording studios. Moreover, they embody long-term implications which could ultimately change the nature of professional recording.

Like many studios, mine is equipped with MCI JH-110s, which are show-

frequency response of 20 to 20,000 kHz +0.5/-1.0 dB and dynamic range of 90 dB. It uses ¼-inch tape for two hours of recording time on 10½-inch NAB reels; data is readable at fast forward or rewind. Razor blade splicing with transition smoothing, or electronic editing with cross-fade are possible.

This recorder, like the multitrack PCM-3324, is a DASH machine. Cross Interleave Code is performed with even/odd word offset, and the CIC can correct random errors corresponding to a maximum of three words. The interleave guards against burst errors with perfect correction for 8,640 bits (0.57 cm), good correction for 33,932 bits (2.23 cm), and marginal concealment for 83,232 bits (5.51 cm). Error correction is performed independently for each track, thus a bad track would not affect correction on other tracks. The 2-track DASH format calls for 8 digital data tracks, a control track, a time code track for machine synchronization, and 2 analog tracks. The control track accomplishes servo lock, skew reference of data track, detection of splice point, record of absolute address, record of control signal, and automatic waveform equalization; its low data density (1/20 the density of the data tracks) protects against damage. If all



The Sony PCM-3102 2-track reel-to-reel digital recorder.

ing their age both literally and in terms of sophistication of technology; when should we go digital? Last fall I saw a digital tape recorder prototype in Ft. Lauderdale; now in Atsugi all the pieces have come together as the PCM-3102 two-channel digital audio recorder. Sony was inexplicably slow in developing a stationary head machine, but the 3102 appears to consolidate most of the features we have come to expect in a pro recorder. This is a 16-bit machine, sampling at either 44.1 or 48 kHz to obtain a



Sony's 8-channel digital mixing console.

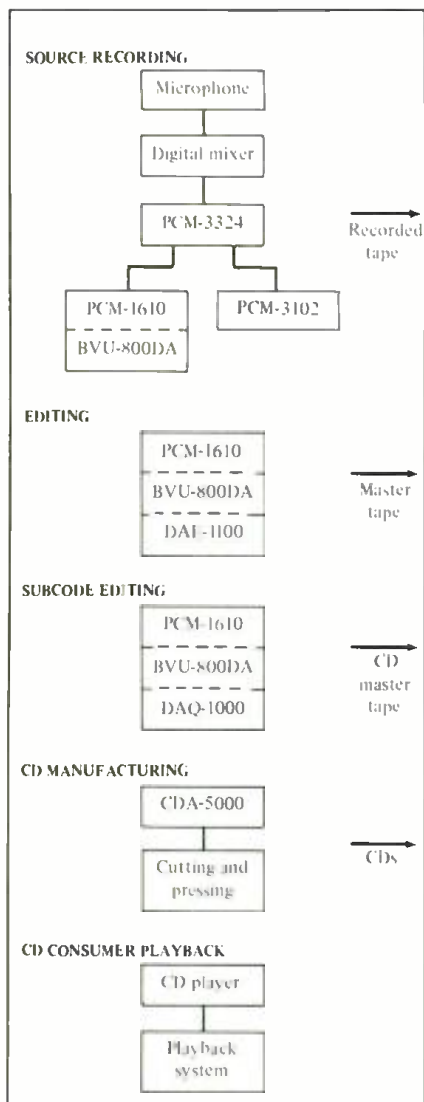

Sony's complete system of digital technology.

digital operation fails, the analog tracks would remain as back-up. Sony is presently developing DASH ICs which would increase reliability and substantially reduce size, power consumption, and cost. Speaking of cost, rumor has it that the PCM-3102 should sell for less than \$20,000.

This recorder has already been placed in service for the NHK Japanese broadcasting network and should appear in the U.S. in late summer (or at least in time for the fall AES show). With the introduction of the PCM-3102 in the U.S. market, Sony will enter the hardcore professional 2-track reel-to-reel recorder market, to compete against Mitsubishi and 3M, as well as future entries such as Studer's DASH machine. Just a short time ago, it was predicted that half-inch analog 2-track machines would yield the highest quality cost-effective fidelity. Now it is clear that digital recorders

have already been technically perfected and marketed at a competitive price. Any philosophical questions concerning the acceptance of digital tape recorders is over; the only question left is the speed of market penetration.

Following the introduction and acceptance of digital tape machines, the next battle will inevitably be fought over the digital mixing console. The price of professional consoles is quite high; the world is waiting to see if anyone will be able to afford a digital console. Sony is demonstrating an 8-channel digital console as a cost-effective introduction to the technology. While it is targeted toward the specialized needs of Compact Disc mastering (and all of those engineers who are using passive consoles and digital 2-track recorders), its modularity will make it useful for a variety of applications. The system consists of a signal processor, A/D converter, and D/A converter (all rack-mountable), and a user unit which controls eight-channel digital mixing and four-point equalization. The system interfaces with 16 bit systems such as the 1610, except that 24 bits are used internally. A complete digital mixing system could consist of just the signal processor and the control unit; a Compact Disc mastering system would require the addition of the PCM-1610 recorder, DAE-1100 editor, and DAQ-1000 cue editor for CD sub-code generation. The system would be digital throughout, since the processor accepts both digital inputs and outputs, 2-channel direct outputs, 2-channel sub outputs, and 8-channel direct outputs. A stand-alone digital mixer would require the A/D and D/A units for interfacing to the analog world.

Before we proceed, perhaps we should identify the DAE-1100 and DAQ-1000 units. The DAE-1100 is a digital audio editor consisting of a rack-mount processor and keyboard controller. The DAE is designed to interface with the PCM-1610 and two or three U-matic recorders such as the BVU-800DA to provide edit accuracy to 363 microseconds, which is equivalent to 16 words of the PCM-1610; this subframe accuracy is a result of the SMPTE time-code reader/generator incorporated in the DAE. In the edit mode, six seconds of program are stored in memory and 10 selectable cross-fade times from 1 to 99 milliseconds are available. A digital offset gain fader is used to

match the output of the player to that of the recorder; it can also be used for fade-in and fade-out.

The DAQ-1000 is essential for Compact Disc mastering; every CD contains subcode for control and display, and the DAQ can generate and memorize subcode data, record them onto the master tape, and produce a hardcopy of the subcode and timings. Subcode data may be stored in internal memory or recorded on audio track 1 of the U-matic. With the addition of a DABK-1000 PQ generator, the DAQ-1000 can output the subcode data in real-time for recording the Compact Disc.

With the introduction of their digital console, Sony will have single-handedly completed the digital recording and reproduction chain. The only remaining analog pieces will be the microphones, amplifiers, and loudspeakers. The digital mixer and its peripherals would accept a microphone input and accomplish the A/D conversion. Digital recording and remixing could be done with the console and a PCM-3324 digital multitrack, and the final mix recorded on a PCM-3102 or a BVU-800DA via a PCM-1610. The digital master tape could be edited with a BVU-800DA, PCM-1610, and DAE-1100 digital editor. The production master could be subcode-edited with a BVU-800DA, PCM-1610, and DAQ-1000 cue editor. The edited and coded master could be cut onto a Compact Production master plate, and replicated at the pressing plant. The consumer could play the digital disc in his (Sony) CD player and thus perform the D/A conversion.

While other companies offer bits and pieces of digital technology, only Sony offers the complete system. This represents the outcome of a monumental development effort and, I think, is cause for serious historical recognition. The complete product line of professional digital recording and consumer digital reproduction is a reality today because of the efforts of Sony. Those who argue that Japanese companies merely copy foreign technology should look to this example for clarification of the facts.

Now that my trip to Japan has ended, the only thing left is fond memories and the long ride home—26 hours—more than enough time to polish off this little opus, as well as a few others. In upcoming issues I'll detail other new developments and surprises from the secret labs of Oriental engineers. ■



FT: Part I

ing I sat down to write this article on the FFT, which stands for Fast Fourier Transform. The subject matter is important and relevant but it requires the use of mathematics in order to explain it elegantly.

The key element in much of the mathematics of signal processing and filter design is the use of the concept of the square root of -1 ($\sqrt{-1}$). If you have not seen the idea before, you will probably (and reasonably) be befuddled. There is no number which when multiplied by itself will give a negative number. A negative multiplied by a negative is a positive number. How can we find a number that has a square which is negative? The answer is that we create such a number. Engineers call it operator "j" and mathematicians call it "i." This is a created concept for which there is no proof. We simply say "there exists this thing, which we create, that has the property of $j \times j = -1$. You cannot find it in the laboratory or the grocery store.

We say that j is one unit of "imaginariness." The number $7j$ is seven units of "imaginariness." Ordinary numbers are now given the property of "realness" (the adjective form is dropped so that we have imaginary numbers and real numbers). By analogy, we could define location in space as real miles and imaginary miles. This concept would be useful if we assign real miles to be along the East-West axis and imaginary miles to be along the North-South axis. This allows us to say that Boston is approximately $+150 + 50j$ miles from New York City. Notice that the composite number is a vector since it contains both distance and direction. It is a two-dimensional representation. It is equivalent to saying that Boston is about 200 miles northeast by east from New York City. The first description is the "rectangular" form; the second is the polar form. Both the polar and rectangular forms are vectors because they contain information about size and direction. Ordinary numbers are one-dimensional in that they only give the amount of something.

As we go forward in the discussion, you can think of real numbers as "red"

stuff and imaginary numbers as "blue" stuff. Terms containing both real and imaginary numbers are considered "complex." For addition, we add the amount of red stuff from one number to the amount of red stuff from the other number to give the total amount of red stuff. The same is true for the blue stuff. This is illustrated below:

$$\begin{array}{r} 3 + 8j \\ -1 + 1j \\ \hline 2 + 9j \end{array}$$

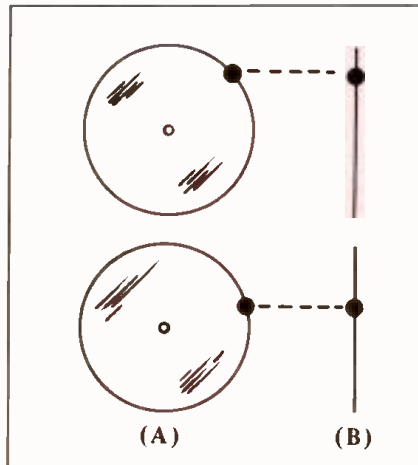

Figure 1. Rotating glass disc: a) front view, b) edge view.

Simple, is it not? Multiplication is a little more complicated since we must do the multiplication with all of the cross terms. Consider the following example:

$$(3 + 8j) \times (-1 + 1j)$$

Each of the terms from the first expression must be multiplied by each of the terms from the second expression. This gives the following:

$$(3 \times -1) + (8j \times -1) + (3 \times 1j) + (8j \times 1j)$$

The first term is 3 real times -1 real which is -3 real. The second term is 8 imaginary times -1 real which is -8 imaginary. The next term is 3 imaginary; and the last term is 8 imaginary squared. But, the imaginary times the imaginary is -1 ; thus the last term is -8 real.

We are now in a position to manipulate complex numbers. You may ask why we have bothered to introduce the two-dimensional aspects of numbers. The answer is: the sine wave.

COMPLEX SINE WAVE

The sine wave is a complicated function which changes its value according to some property that is difficult to understand. One way of simplifying the sine wave is to consider the following idea.

Take a transparent glass disc and paint a black dot on the rim. Now turn the disc edgewise in the vertical position so that you see the dot looking through the glass. The glass looks like a line when viewed from the edge. Let us rotate the glass disc at a constant velocity. What does the dot do? It goes up and down. FIGURE 1 shows the two views of the disc at different instants of time. The left part of the figure is the frontal view, the right part the edge view. As we watch the dot move up and down in the edge view we notice that it is a sine wave in time! In other words, it is a sine wave rotation projected onto a single dimension.

If we were to look at the edge of the disc from the top instead of the side, we would see the same thing. However, the phase would be delayed by 90 degrees, so instead of a sine wave, we would see a cosine wave. By looking from both the top and the side, we can determine the exact location of the dot; in contrast, by looking only from one direction we cannot tell its exact location. There are two locations for each projection value. When the dot is in the center of the up-down range, the actual location of the dot might be at 0 degrees or at 180 degrees. The front view allows us to resolve the difference, since it will be either fully left or fully right. The two views of the disc are like the "red" stuff and "blue" stuff. Or, we can assign one projection to be real numbers and the other projection to be imaginary numbers.

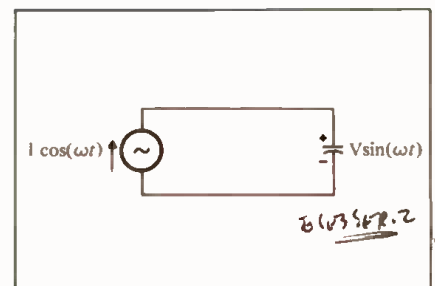

Figure 2. A simple circuit.

Looking at the disc from the frontal view, when the dot is at 45 degrees we could say that it is located at $0.707 + 0.707j$. When it is at 90 degrees we would say that it is at $0 + 1j$; at 135 degrees it is at $-0.707 + 0.707j$; at 180 degrees it is at $-1 + 0j$. From now on, we will consider all sine waves as coming from the rotating disc. To get back to the real world, we say that the signal is either a left-right projection or an up-down projection of a two-dimensional process. The angle of the dot defines the final result. Notice that the size of the disc becomes the magnitude of the number.

Mathematically, we say that the "signal" is defined as the following:

$$M \cos(\theta) + j M \sin(\theta)$$

where:

M = radius of the disc and θ is the angle of the dot.

For any given radius and any given angle, we know the location of the dot. At first glance, this would appear to be a lot of trouble for us engineers. The trouble is a real blessing, however, because it makes many mathematical tasks very simple. I admit that these ideas can be more than a little mysterious if you have not seen them before.

I was motivated to teach this set of ideas because they are applicable to much more than the FFT. They are used in digital filters, ordinary analog filters, signal processing, and many other aspects of audio engineering. Rather than rush to the subject of the FFT, which will be discussed next month, let us stop and have a little practice with these ideas in the context of simple analog circuits.

COMPLEX VOLTAGES AND CURRENTS

Let us assume a set of circuits that are excited only by sine waves of the form $I \sin(\omega t)$, $I \cos(\omega t)$, $V \sin(\omega t)$ and $V \cos(\omega t)$. Instead of thinking of these as sine waves, we could think of them as coming from our rotating disc.

To convert from one projection to another, we need to convert from "red" stuff to "blue" stuff; or we need to convert from real numbers to imaginary numbers (or vice versa). Notice that multiplying by j does this conversion. A real number multiplied by a complex number becomes complex; a complex number multiplied by a complex number becomes real.

The act of phase shifting is the same as multiplication by a complex num-

ber. A full 90 degree shift requires a multiplication by j but a 45 degree shift requires a multiplication by $(0.707 + 0.707j)$. A capacitor having an impedance of 10 ohms at a given frequency is thus represented as having a complex impedance given by:

$$Z = -10j.$$

A 1 amp current source is represented by:

$$I = 1.$$

And the resulting voltage by ohms law becomes:

$$V = Z I = -10 j \text{ volts.}$$

The magnitude 10 gives us the size of the sine wave and the $-j$ gives us the phase.

The normal problem with RLC circuits and sine waves is that we cannot add two voltages or currents in terms of magnitudes because there is the phase shift to consider. We can, however, add the sine part to other sine parts and the cosine part to other cosine parts. Complex numbers are therefore perfect for representing both parts in one number; a single number contains both the magnitude and the phase. This is the real power of these numbers.

We can further illustrate the power by taking the simple lowpass filter of FIGURE 3. This would be a simple voltage divider if both components had been resistors. It is still a voltage divider if we use the complex impedance for the components. The gain or attenuation is represented as:

$$G (\text{complex}) = \frac{Z_2}{Z_1 + Z_2} = \frac{V_o}{V_i}$$

where:

the impedance of the resistor, Z_1 , is defined as $Z_1 = R$ and the impedance of the capacitor, Z_2 , is defined as:

$$Z_2 = \frac{1}{j \omega C}$$

where:

j is our complex number, ω is $2\pi \times$ frequency in radians, and C is the capacitance in farads.

This results in the expression:

$$G = \frac{\left(\frac{1}{j\omega C}\right)}{\left(\frac{1}{j\omega C}\right) + R} = \frac{1}{1 + j\omega RC}$$

We got this result by substitution and then by multiplying the numerator and denominator by $j\omega C$. The final result tells us all there is to know about the circuit. When ω is very low,

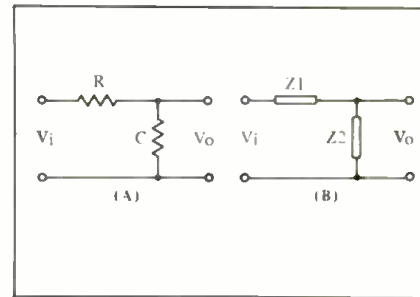

Figure 3. A low pass filter.

the gain is approximately 1; when ω is very large, the gain is approximately $1/(j\omega RC)$. There is a 90 degree phase shift, and each doubling of frequency results in a halving of gain. When $\omega = RC$, the gain G becomes $0.500 - 0.500j$ which has a phase shift of 45 degrees and a gain of 0.707 (magnitude = -3 dB).

Our little example is rather trivial but it does demonstrate the incredible power of having a single number to contain both magnitude and phase. We can multiply two complex gains to get a net gain which is also complex. We can do circuit analysis as if each component were like a resistor but we use the complex impedance. This makes capacitors and inductors very simple because the phase is included in the impedance.

In digital signal processing, the element of delay is like phase shift. A complex digital filter, which is made up of delays, can be analyzed by changing each delay to an equivalent phase shift. A delay of 10 degrees corresponds to a complex number of $0.984 - 0.174j$. Therefore, multiplying this gain by the input signal will result in an output signal which has the same magnitude but a delay of 10 degrees.

If you have not had the mathematical training in this area it would be hard to completely understand the ideas. My main hope is that you would at least believe that a complex number is not just some crazy idea of a mathematician to make an engineer's life harder. If the word complex makes you nervous because you do not believe in the concept of the $\sqrt{-1}$, then just change the names real and imaginary to red and blue stuff or sine stuff and cosine stuff.

Sometimes, simple ideas are hard to understand only because the words are strange. If that is your problem, just change the words. Next month we will continue this discussion but with an application to the Fourier transform and Fast Fourier transform. ■

Scenes From Europe

An AKG Update

• Way back in the October, '79 issue of *db* John Woram described a visit to AKG in Vienna. I have recently returned from a tour around the AKG laboratories and can bring the story up to date.

The most interesting product I saw being built and tested was the new C 460 B preamplifier designed to operate with, and improve the performance of, the existing CMS modular series of microphone capsules (though a new series of C 460 capsules is planned). The background to this preamplifier was given in a paper presented at the 71st AES Convention in Montreux. A principal objective, as the paper's author Alexander Fritz explained it to me, was to respond to the new demands of PCM recording and produce very wide dynamic range with low self-noise. Using the new FET circuit configuration has resulted in a dynamic range of 125 dB,

with equivalent noise level only 15 dB SPL and the maximum sound pressure level for 0.5 percent THD an impressive 140 dB, or 150 dB with the 20 dB pre-attenuation switched in.

WHAT'S NEW?

At the same time, AKG have extended the versatility of their CMS range by introducing new capsules that can be used remotely from the preamplifier (either the new C 460 B [see FIGURE 1] or the standard C 451 E). These are very inconspicuous (weighing only 30g), making suspension and hand-boom operation much easier. They use an electret permanently charged capsule with a miniature connector and 3m (10-ft)

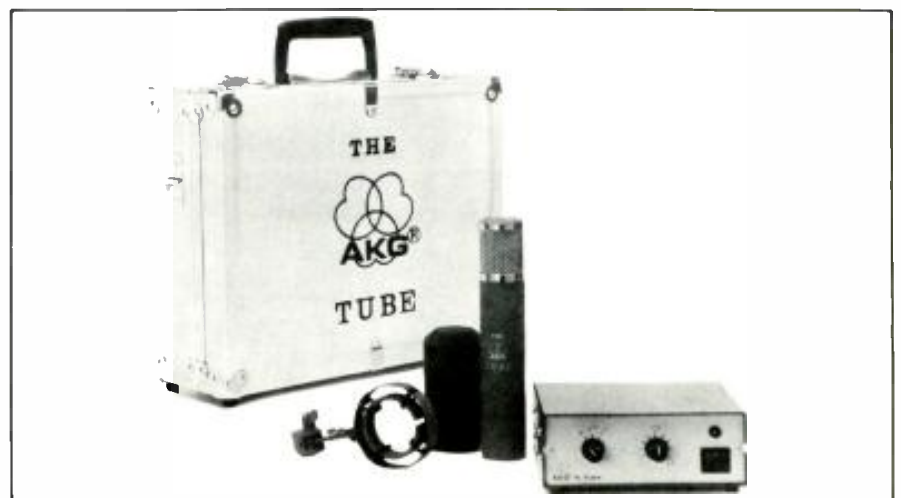
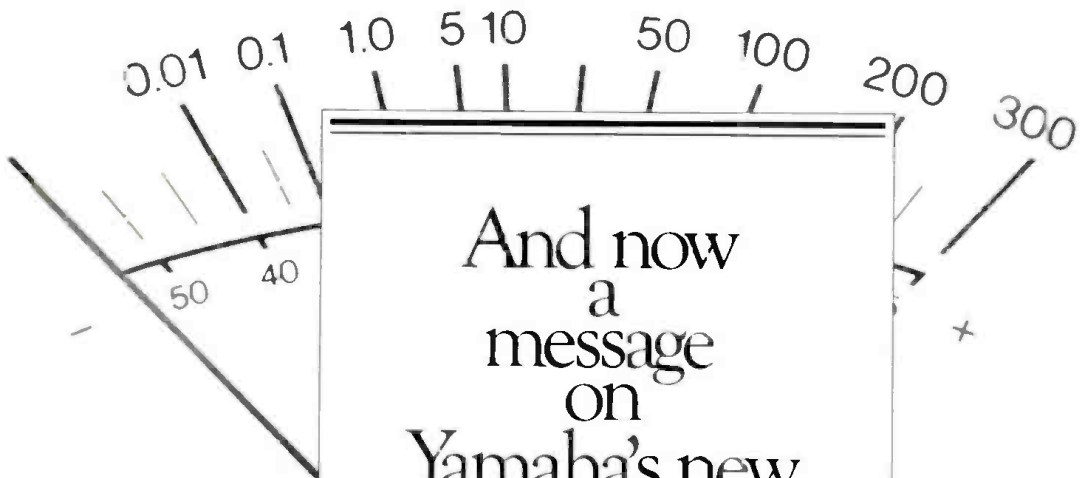

Figure 1. The AKG C 460 B capsule.

Figure 2. "The Tube" package.

PEAK
WATTS/8Ω

● CLIP



And now
a
message
on
Yamaha's new
PC2002M
power amp.

CHANNEL A

CHANNEL B

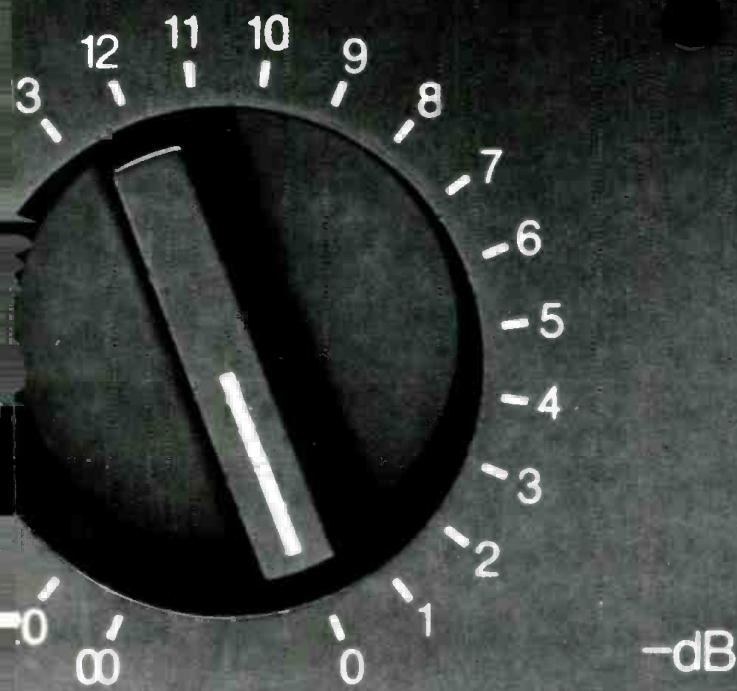



PC2002M

SPECIFICATIONS

		PC2002/PC2002M
POWER OUTPUT LEVEL	Continuous average sine wave power with less than 0.05% THD. 20 Hz to 20 kHz	Stereo, 8 ohms Stereo, 4 ohms Mono, 16 ohms Mono, 8 ohms 240W + 240W 350W + 350W 480W 700W
FREQUENCY RESPONSE	10 Hz to 50 kHz, 8 ohms, 1W	+0dB -0.5dB
TOTAL HARMONIC DISTORTION	Stereo 8 ohms 120W Mono 16 ohms 240W Mono 8 ohms 350W	1 kHz 20 to 20 kHz 20 to 20 kHz Less than 0.003% Less than 0.007% Less than 0.01%
INTERMODULATION DISTORTION	70 Hz and 7 kHz mixed 4:1	Stereo 8 ohms, 120W Mono 16 ohms, 240W Less than 0.01% Less than 0.01%
INPUT SENSITIVITY	Input level which produces 100W output into 8 ohms.	0 dB (0.775 V rms)
INPUT IMPEDANCE	Balanced and unbalanced inputs, maximum attenuator setting.	25 k ohms
8 OHM DAMPING FACTOR		1 kHz 20 to 20 kHz Greater than 350 Greater than 200
S/N RATIO	Input shorted at 12.47 kHz Input shorted at IHFA	110dB 115dB
SLEW RATE		Stereo 8 ohms Mono 16 ohms 60V/μsec 90 V/μsec
CHANNEL SEPARATION	8 ohms 120W 8 ohms 120W	1 kHz 20 to 20 kHz 95dB 80dB
DIMENSIONS (W×D×H)		18-7/8×16-1/4×7-1/4" (480×413×183 mm)
WEIGHT		PC2002 44 pounds (20 kg) PC2002M 45 pounds (20.5 kg)

All specifications subject to change without notice.

The performance of the PC2002M speaks for itself. So does its sound, with exceptional low end response. And you can count on its superior performance over the long haul. We use massive side-mounted heat sinks, extensive convective cooling paths and heavy gauge steel, box-type chassis reinforced by heavy gauge aluminum braces and thick aluminum front panels. Yamaha's reliability is legendary, and with the PC2002M and PC2002 (same amp without meters), the legend lives on. For more complete information write: Yamaha International Corporation, P.O. Box 6600, Buena Park, CA 90622. In Canada, Yamaha Canada Music Ltd., 135 Milner Ave., Scarborough, Ont. M1S 3R1.



Circle 24 on Reader Service Card

standard cable, extendable to 60m (200-ft) where RF interference is not severe. I was also shown a prototype of a new C 568 short shotgun microphone in a neat one-piece case.

The latest AKG miniature condenser microphone is the CK 67-3. This can be fixed to the clothing with a tie-pin or just as easily clipped to a violin tailpiece, cello bridge, guitar or flute body. It can be connected via its 1 metre cable to any of the available wireless pocket transmitters. Its capsule and FET preamplifier are elastically suspended and the clip is designed for minimum clothing noise.

THE 'TUBE' RETURNS

Of course I was given a demonstration of the well-publicized "The Tube," AKG's return to a vacuum tube microphone amplifier instead of solid-state. This is not just nostalgia for nostalgia's sake, but acknowledgment of an often expressed desire by a vocal minority out there in the recording studios for the "tube

sound." The trusty 30-year-old AKG C12 tube microphone is still a favourite with many engineers, producing very musical sounds. This prompted AKG to take a modern look at the design. The C12 capsule now works into an updated circuit using the original 6072 vacuum tube, selected for low noise. Admitting the tube's greater fragility and sensitivity to movement, the designers have suspended the tube between special shock-absorbers. The casing is suitably tube-shaped and coated with "soft-feel" Nextel. The complete package (see FIGURE 2) includes a fitted flight case with an elastic suspension adaptor, 10m (30-ft) cable, windscreen and N-Tube power unit, which powers the microphone and provides remote selection of the nine polar-diagram settings, two-position bass rolloff and 10 or 20 dB pre-attenuation—all for a price of around \$1,000.

With some 1,300 patents to their name, AKG continue to be inventive. New techniques for capsule manufacture which I observed employed a

new, temperature-stable, cheaper diaphragm of 6µm Teflon plastic foil gold-sputtered to a thickness of 0.03µm. This has to be spaced at 35µm from the fixed plate with 1µm accuracy. Like most of the assembly stages, this is naturally a manual operation, though using sophisticated jigs and tools all made in-house. Quality control is 100 percent, with every microphone frequency-tested in an anechoic chamber (producing the customer's individual response graph) and given a vibration test using a B & K accelerometer.

AKG have come a long way, and have sold over 30 million microphone capsules since their formation in 1947—16.5 million in the last 10 years. Their 700 employees produce 20,000 complete microphones each week in meticulously clean workrooms. Add to this their headphones, pickup cartridges, reverberation-spring units and digital delay boxes and it is no wonder that this compact factory in downtown Vienna represents one of the best-known brand names in professional audio. ■

DO YOU KNOW WHERE?



Have you misplaced your db again? Our high quality, royal blue vinyl binders keep 12 copies of db neat and handy for ready reference.

Just \$9.95, available in North America only. (Payable in U.S. currency drawn on U.S. banks.) ORDER YOURS NOW!!

Sagamore Publishing Co., Inc.

1120 Old Country Road
Plainview, NY 11803

YES! Please send _____ db binders @ \$9.95 each, plus applicable sales tax. Total amount enclosed \$ _____

Name _____

Company _____

Address _____

City _____

State/Zip _____

Updated Recording Studio Handbook

A must for every working professional... student... audio enthusiast

Features latest state-of-the art technology of creative sound recording.

21 Fact-Filled Chapters

- | | |
|--|--|
| <p>I. The Basics</p> <ol style="list-style-type: none"> 1. The Decibel 2. Sound <p>II. Transducers: Microphones and Loudspeakers</p> <ol style="list-style-type: none"> 3. Microphone Design 4. Microphone Technique 5. Loudspeakers <p>III. Signal Processing Devices</p> <ol style="list-style-type: none"> 6. Echo and Reverberation 7. Equalizers 8. Compressors, Limiters and Expanders 9. Flanging and Phasing <p>IV. Magnetic Recording</p> <ol style="list-style-type: none"> 10. Tape and Tape Recorder Fundamentals 11. Magnetic Recording Tape 12. The Tape Recorder <p>V. Noise and Noise Reduction</p> <ol style="list-style-type: none"> 13. Tape Recorder Alignment 14. Noise and Noise Reduction Principles | <ol style="list-style-type: none"> 15. Studio Noise Reduction Systems <p>VI. Recording Consoles</p> <ol style="list-style-type: none"> 16. The Modern Recording Studio Console <p>VII. Recording Techniques</p> <ol style="list-style-type: none"> 17. The Recording Session 18. The Mixdown Session <p>Three all-new Chapters</p> <ol style="list-style-type: none"> 19. The In-Line Recording Studio Console
(The I/O Module, The Basic In-line Recording Console, Signal flow details) 20. An Introduction to Digital Audio
(Digital Design Basics, Digital Recording and Playback, Error Detection and Correction, Editing Digital Tapes) 21. Time Code Implementation
(The SMPTE Time Code, Time-Code Structure, Time-Code Hardware.) |
|--|--|



\$39.50

The *Recording Studio Handbook* is an indispensable guide with something in it for everybody. It covers the basics beautifully. It provides in-depth insight into common situations and problems encountered by the professional engineer. It offers clear, practical explanations on a proliferation of new devices. **And now it has been expanded with three all-new chapters... chapters on the in-line recording studio console, digital audio and time code implementation.**

Sixth printing of industry's "first" complete handbook

The *Recording Studio Handbook* has been so widely read that we've had to go into a sixth printing to keep up with demand (over 30,000 copies now in print). Because it contains a wealth of data on every major facet of recording technology, it is invaluable for anyone interested in the current state of the recording art. (It has been selected as a textbook by several universities for their audio training program.)

Highly Acclaimed

Naturally, we love our book. But don't take our word for it. Here's what others have to say:

"John Woram has filled a gaping hole in the audio literature. This is a very fine book... I recommend it highly." *High Fidelity*

"A very useful guide for anyone seriously concerned with the magnetic recording of sound." *Journal of the Audio Engineering Society*

15-Day Money-Back Guarantee

When you order *The Recording Studio Handbook* there's absolutely no risk involved. Check it out for 15 days. If you decide it doesn't measure up to your expectations, simply send it back and we'll gladly refund your money.

Easy to Order

You can enclose a check with your order or charge it to Master Charge or BankAmericard/Visa. Use the coupon below to order your copies of the new updated *Recording Studio Handbook* (\$39.50)

ELAR PUBLISHING COMPANY, INC.

1120 Old Country Road, Plainview, N.Y. 11803

Yes! Please send _____ copies of THE RECORDING STUDIO HANDBOOK. \$39.50. On 15-day approval.

Name _____

Address _____

City/State/Zip _____

Total payment enclosed \$ _____
(In N.Y.S. add appropriate sales tax)

Please charge my Master Charge
 BankAmericard/Visa

Account # _____ Exp. date _____

Signature _____
(changes not valid unless signed)

Outside U.S.A. add \$2.00 for postage.
Checks must be in U.S. funds drawn on a U.S. bank.

Westward Ho

IN THIS MONTH's Theory and Practice, author Ken Pohlmann writes about his anyway-but-west trip to Japan to see the wonders of Sony.

Two weeks earlier, your editor was on a Pan Am non-stop from New York City that *did* go mostly westward to get to Tokyo for transfer there to another Pan Am Clipper to Osaka. Unlike Ken's mighty air safari, the start-to-finish was 14 hours from JFK to Narita and one hour more from Narita to Osaka. My purpose was to meet with other editors coming from other directions for a week as the guests of Matsushita Electric. Matsushita, as many of you know, is Panasonic, Technics, Ramsa, Quasar, and National as world-wide brand names.

There was a lot to see and learn in that week. Much of what we saw were hi-fi products to be introduced at a later date in the U.S. But finally they brought us to some of the things they are doing with digital audio. For one, they have an active plant producing Compact Discs for the world market. Many of the more recent Telarc releases on CD are squeezed out in this plant. This production, as you might expect, is done in clean rooms; we could see what went on through the glass but could not actually enter the production area.

Matsushita is part of the group of manufacturers that have subscribed to the DASH open reel digital format. They did not have a complete machine to show us, but there was a show-

ing of the amazing thin film head technology. In fact, it is this technology being given by Matsushita to the rest of the DASH group that is making possible the entire DASH concept.

Elsewhere we were shown a working model of a broadcast CD player that permits exact cueing and precise timing. As this is being written (before NAB), it is expected that this unit will be at the Panasonic booth. However, what may not be at NAB was a different unit for the Compact Disc. This was a changer device that held up to fifty discs and permitted them to be played in almost any kind of sequencing.

Another visit of special interest to db readers was to Matsushita's Museum of Technology. There, in one large building, the visitor sees the beginnings of the company in the 30s (making an a.c. adapter plug) and then on to the giant industrial complex that company has become. Many of the products along that road are on display there. Among them, a tape recorder from the very early fifties, and other audio disc and high fidelity products of the late forties.

The museum does not stop at the present, but moves right along to the future with working computer-controlled living rooms, kitchens, and even entire homes that the visitor can operate. All in all, a fascinating side trip.

It was a hectic five days I spent in Japan at Matsushita. But it was educational and useful to be there, so I am certainly grateful to my hosts for their invitation. L.Z.

Audio Visual Centre Wisseloord

According to the author, Wisseloord Studios can make even a Dutch concert sound all right.

ATTRACTED BY GENIAL DUTCH hospitality combined with superb technical equipment and recording techniques, many well-known artists and producers have already found their way to Wisseloord recording studios at Hilversum in the Netherlands. Situated in the wooded outskirts of the home town of Dutch television and radio, the studios are centrally located in the heart of the country. However, one is hardly stuck out in the sticks, working in these woods. Fabled, gabled Amsterdam, for example, is only a twenty minute drive away.

Wisseloord Studios recently extended their equipment (see FIGURE 1), adding a Sony 24-track digital recorder (the first of its kind in Europe), a must for anyone contemplating or working with future sound.

Polygram's (of which Wisseloord is a part) reputation for high quality is universally recognized by the audio world. Working closely together with such well-known acoustics experts as Tom Hidley and Jeff Cooper, they have realized various studio projects around the globe, creating their masterpiece here at Wisseloord Studios.

What is the secret behind this mecca of audio recording ingenuity? The answer lies with a unique team of active recording engineers who draw on their wealth of experience in working closely with a team of highly skilled audio engineers at Polygram's Audio Engineering Department. When it came to exploring the resources of electro acoustics, Wisseloord could not have been in a better position, having Philips as their parent company and the former Decca engineers who made the first actual digital recording system operational about five years ago on their team as well.

Wisseloord comprises three studios and a suite for commercials and post-production plus a restaurant/bar and a recreation lounge. For both digital recordings and Compact Disc work, the studios possess state of the art equipment and operating expertise. Wisseloord contains an impressive range of recording equipment and musical instruments in addition to having mobile equipment at hand for on-location recording. No restrictions or compromises bore on the technical side of the project.

A 'HOUSE-WITHIN-A-HOUSE'

Although there is a considerable amount of high technology equipment about and a lot of highly skilled activity

going on, making Wisseloord Studios quite a busy place, there is a remarkably relaxed and stress-free atmosphere that results directly from their design. The architect concerned, Hans Ruysenaars—responsible for the studios' interiors as well as their main structure—formulates his thoughts about recording work as follows.

"Producing high quality sound recordings is very intensive work for musician and engineer alike. Concentration on sound dominates all other sensory activities. Sound and sight isolation from the outside world is unavoidable. The rapid development of acoustics as a science necessitates a method of construction leaving open the possibility of last minute alterations in the studios' definitive shape. Should any change appear to be desirable, it ought then to be possible to carry it out without affecting the building's structure proper. These considerations indicate a 'house-within-the-house'

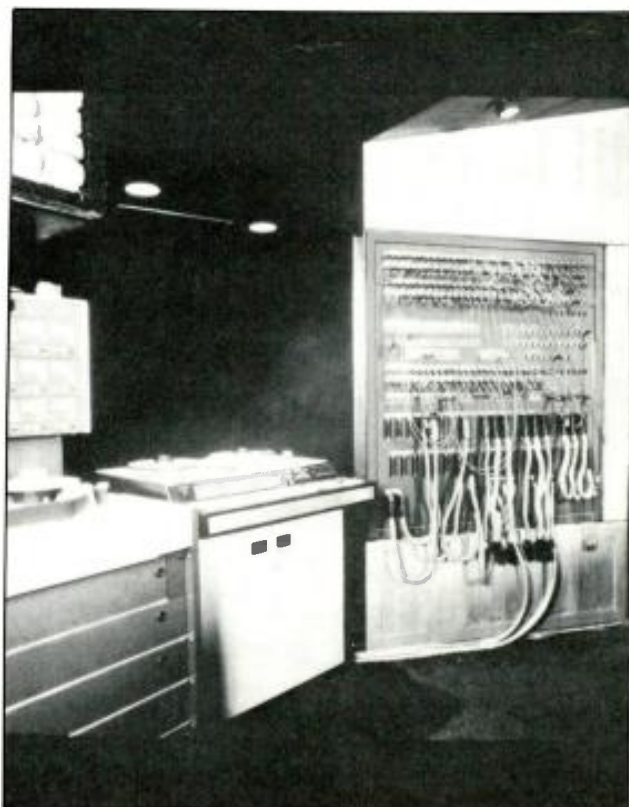

Figure 1. Wisseloord's new Sony 24-track PCM 3324 digital recorder.

Mr. Baars is affiliated with Wisseloord Studios in Hilversum, The Netherlands.

concept whereby the outer structure offers protection from the elements and the bulk of unwanted noise and like influences. The inner layer provides further protection and shielding. The question is how to create an environment for performing artist and engineer in which both can do extremely delicate work, given the form of a room without access to daylight and without a definitive shape (as required for sound control). The studio interior may show consideration for the sound to be produced—in the care applied to wall finishing, choice of materials and the selection of shapes, lighting, and equipment.

“On the outside, however, it appears possible to do even more in this respect. The approach to the building should have the easy and relaxed feeling about it that is conditional for the efforts within the studio. The complex stands in a fine wooded area (see FIGURE 2), where there is a constant natural change in light and mood. One design idea was to make use of this, allowing the relaxing multitude of sensory perceptions to penetrate into the

complex as far as possible. Those rooms not described in the requirements especially lend themselves well to this. They will include the connecting areas between the spaces required. Transitional areas from forest to complex, from office to studios, from canteen to meeting-room, from light to dark area, from active to quiet atmosphere, from hard to soft—any connecting area is important.

“The three studios are next to each other, on separate foundations, giving on to an east-west running street (see FIGURE 3). The same street also leads to subsidiary rooms on two floor levels. The two canteens at the terminals of the main street form a gradual transition to the woods outside. The shape of the street’s roof adapts to the decreasing sizes of the studios.

“For reasons of vibration conduct, the connection between the studio area and the subsidiary rooms area is formed by a street of constant height and flexible construction. As a result, light becomes weaker to the east as the studios become smaller, making possible a gradual transition to the non-daylight studios and control rooms. This applies to the smaller studios in particular. The street constitutes the meeting area for all spaces and rooms.”

ACOUSTICS AND CONSTRUCTION

The three studios have an exterior shell consisting of a steel beam roof-frame covered by 14cm (5.5-inch) thick lightweight concrete panels. The inner shell structure, at an average distance of 40 centimetres (approximately 16 inches) from the outer shell, is fully separated from the latter and is supported by its own concrete slab on an almost perfect foundation of woodland soil. The inner shell is entirely constructed of timber and plaster slabs plus soundboard panel laminations. Wood was chosen for its high sound-damping factor. The total isolation of the inner shell from the outer one is a major asset (see FIGURE 4).

Any potential sound leaks and shorts, including airducts and cables, have been taken care of in a proper and effective way. It might seem to be superfluous to report that control rooms and iso-booths have been



Figure 2. The main entrance to the beautiful Wisseloord Studios.

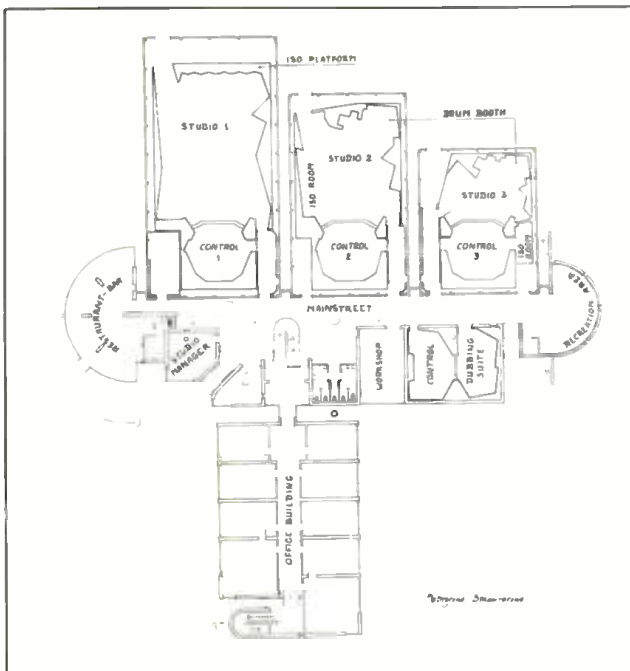

Figure 3. Floor plan of Wisseloord.

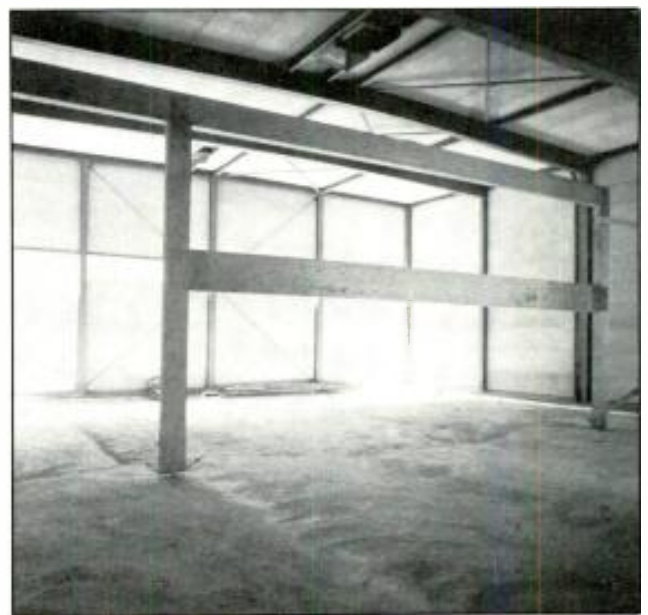

Figure 4. Wisseloord's shell within a shell construction.

constructed in a similar way, having full mechanical isolation on all sides. Isolation values of 65 dB for low frequencies and 95 dB at mid-range frequencies look quite normal, but those of us in the business are aware of how hard they are to achieve. A careful application of plaster slabs and layers of soundboard were called for.

In order to achieve adequate absorption in the lower frequency range, which means a low cut-off frequency, the resonating wall structure was finished with layers of one-inch-thick solid wood, which greatly reduced resonance frequency owing to their appreciable mass. Those using the studios at present are all very satisfied with their excellent low-end properties.

The application of vibrating-wall principles, commonly used in housing construction in the United States, and introduced to Europe via the designs by Tom Hidley, is particularly noteworthy. Whereas the lower frequency band is controlled by the wall structure and added slot-resonators where needed, the higher frequencies are very effectively controlled by sound traps and absorbers, made effective mainly through the use of fiberglass.

Midband frequency absorption was realized through covering large surfaces with foam-backed fabric, which absorbs midband frequencies while reflecting high-end frequencies.

A detailed calculation on acoustics was made for Studio Two, the first to be erected. Any measured deviations from these calculations that showed up in the process of building were made use of in the subsequent calculations and construction of the following studios. Here again, it showed that textbook absorption values of building materials can never be relied upon to be entirely accurate. For completeness' sake, it should here be mentioned that all the other rooms in the complex, such as the streets, the offices, bars and meeting rooms, were given their fitting acoustic characteristics, so as to make working in them pleasant.

THE STUDIOS

Looking at the recording side of things, let us start with the largest studio, Studio One. It has a floor area of 155 sq. metres (approximately 185 square yards), and a volume of 1314 cubic metres, for a total of approximately 1708 cubic yards. Facilities required for groups and bands of up to sixty people are at hand. Average reverberation time is 0.7 seconds. This studio features dead and live areas and a piano trap as part of the acoustics. Variable acoustics are made possible by exchangeable panels and sliding curtains. Studio One has been used for live jazz recording—holding an audience of 120—to mention just one application.

Studio Two, a medium-sized studio with a floorspace of 95 square metres (approximately 114 square yards) and a volume of 638 m³, for a total of approximately 829 cubic yards, has a reverberation time of 0.38 seconds, and all facilities for groups. These include a piano trap, like Studio One, a very efficient drum booth, and guitar-amplifier traps. There is a special iso booth, instantly available, with variable reverberation times of between 0.4 and 2.5 seconds for voice dubbing, guitar or even piano in a special set-up; this iso booth can even hold a twelve piece violin group, if required. (The iso booth can be formed at a moment's notice by closing a folding glass door-wall over half of its rectangular outline, thereby creating an acceptable isolation level. One inner wall has a glass mirror surface finish and sliding curtains to make adjusting reverberation time possible, as shown in

FIGURE 5.) Artists can perform here with a clear sound, apart from the main studio acoustics, and yet be in close contact with the other musicians.

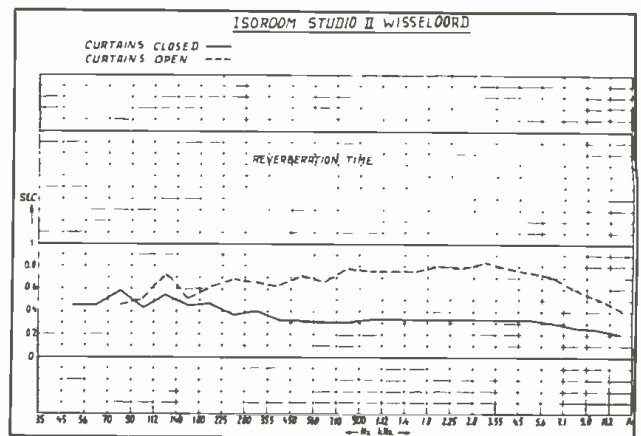

Figure 5. Reverberation times for Studio Two's iso booth with curtains closed and then open.

Studio Three, though smaller in size, is, in other respects, identical to Studio Two except for the special iso booth. Its floorspace is 40 sq. metres (approx. 48 sq. yards) and its volume is 250 m³, for a total of some 325 cubic yards. It is provided with a small iso booth for dubbing purposes that has visual contact with the studio proper and the control room.

The drum-booths belonging to Studios Two and Three, mentioned above, have no windows and feature a transmission cut-off frequency of 150 Hz and below; attenuation from 150 Hz downwards is over 20 dB down to 40 Hz. This construction was chosen to prevent the cylinder-piston effect of closed booths, which artists do not like to perform in owing to the considerable air pressure on their ears.

A separate studio, Studio Four, with a floorspace of just 25 m², or roughly 30 sq. yards, is available for demos, dubbing, commercials, jingles, rehearsals and multitrack sound post-production for video. Of course, it has its own control room with all the necessary equipment.

AIR CONDITIONING

Often neglected, but nevertheless one of the major aspects of any good recording studio, is its air conditioning layout. At Wisseloord it was realized that people, and artists particularly, are likely to perform at their optimum level and be most creative in pleasant surroundings. The Dutch climate, with temperatures ranging from approximately 15 degrees Centigrade (5°F) to maybe over 30 degrees Centigrade (86°F), with air humidity ranging from 45 to as much as 90 percent, clearly necessitates some drastic measures in this respect. Consequently, each studio and control room was provided with their own individual air-conditioning units, whose noise level does not exceed VC 20, at an airspeed of well under 1 metre per second.

CONTROL ROOMS

There are three superb identical control rooms (see FIGURE 6) designed by Tom Hidley separated from the studios by double windowpanes of 12 and 15 millimetres thickness (roughly ½- and ⅝-inch respectively) and a soundlock with two highly effective isolating doors, 38 dB each. (For reverberation times, see FIGURE 7.) All available knowledge about monitoring techniques has

been applied to these control rooms. Extensive testing with a wide variety of loudspeakers resulted in perfect monitoring sets, meeting the most arduous demands. Careful acoustical treatment of primary and secondary reflection areas was an important design consideration.



Figure 6. Studio Three control room, featuring a custom-designed Polygram console.

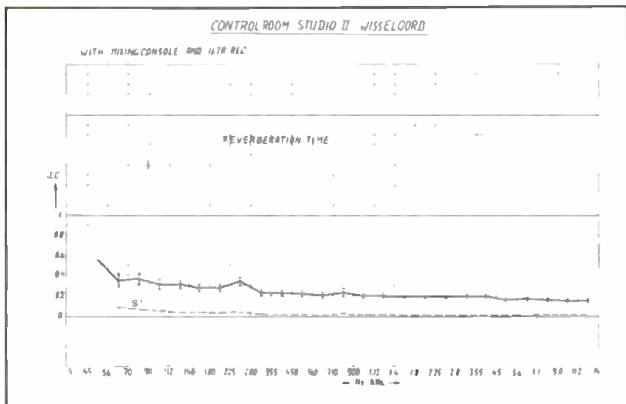

Figure 7. Reverberation time for Studio Two control room.

As with so many cases concerning sound, only practical experience could give the final answers. The monitoring system incorporates an Eastlake two-way monitoring loudspeaker system, powered up by UREI type 6233 stereo amplifiers with electronic crossovers and Klark Teknik DN27 1/3-octave room equalizers. Extensive measuring and listening tests, as shown in FIGURE 8, were carried out to meet the highest demands for monitoring quality. Maximum sound pressures at the listening spot is 115 dB SPL. Producers and artists of international repute are enthusiastic about the realistic character and transparency of the sound.

In studio reproduction it is a must nowadays to tune the sound image of the monitoring system in the studio so that the final result is suitable for hi-fi as well as walkman-type sets.

EQUIPMENT

Besides a large amount of equipment immediately available from the outside, the most significant equipment comprises microphones, tape recorders, and consoles. All three control rooms have identical consoles of superb quality, customer-designed and built by Polygram's Audio Engineering Department, in close cooperation with the studios' engineers. This combination warranted an up-to-date and advanced design incorporating the results of everyday experience. There are 40 input/24 output consoles with extensive EQ and reverb facilities and true peak indicators, linked to the 24-track Studer A80 or A800, with their custom-built auto-locators designed by Polygram. Of course, automatic mixdown facilities are present.

As the studios have very good connections with the Studer company of Switzerland, the entire studio was outfitted with Studer recorders, ranging from stereo to multitrack type. In recent years this outfit was completed with digital recorders by Sony, such as the PCM 1610, and most recently the 24-track PCM 3324. The studios are now fully equipped to meet any demands for fully digital master tapes.

A wide range of microphones with the lowest noise floor and ultra low distortion levels are available. The most convincing proof of the outstanding quality of the recording facilities and really great work atmosphere, however, are the names of the artists who have come to Wisseloord to make recordings here over the past few years including Elvis Costello, The Electric Light Orchestra, Dr. Hook, Lene Lovich, Barry Manilow, The Police, David Soul, Status Quo and The Undertones. ■

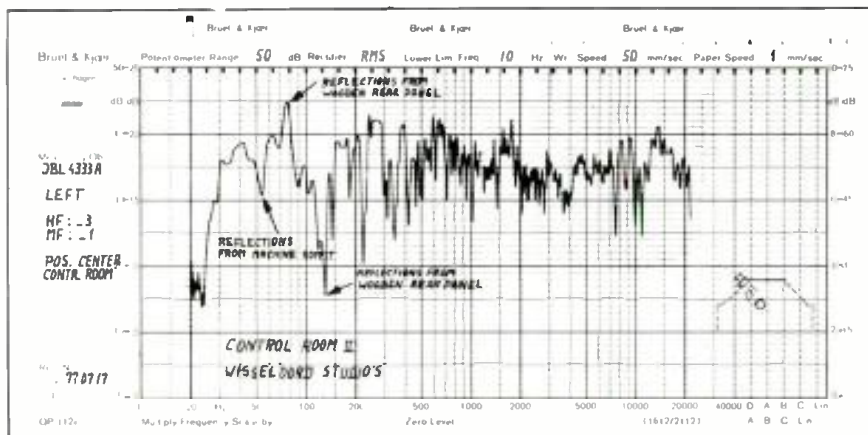

Figure 8. Measuring and listening tests for control room Two.

Using the TECRON® TEF System 10 Acoustic Analyzer

This new and useful acoustical device can be used in the construction of studio, theatres, clubs, etc. The following article explains just what measurements can be made, and how to make them.



STUDIO DESIGNERS AND acoustic consultants now have access to one of the most powerful analytical tools ever made available: The TECRON TEF System 10. This is a portable computer designed to make quick, accurate measurements of room acoustics and sound systems. It includes a keyboard, built-in monitor screen, and two built-in disk drives for data storage and operating software.

This sophisticated instrument is based on the development of Time Delay Spectrometry by Dr. Richard

C. Heyser. The TEF System 10 generates a frequency sweep into a sound system, then picks up the sound of the sweep through a tracking filter. This tracking filter can be time-offset to compensate for sound-propagation delay. By varying the bandwidth and time-offset of the tracking filter, you can look at the spectrum of the direct sound by itself, or certain sound reflections, or both.

The tracking filter also greatly increases the signal-to-noise ratio of the measurement, so that accurate tests can be run even in noisy environments, with conversation going on in the background.

The TEF System 10 permits measurements of energy vs. frequency (frequency response), energy vs. time (energy level of sound reflections vs. time), and frequency response vs. time ("3-D" display as shown in FIGURE 1). It

Bruce Bartlett, Microphone Project Engineer at Crown International, is also a contributing editor to Modern Recording & Music Magazine.

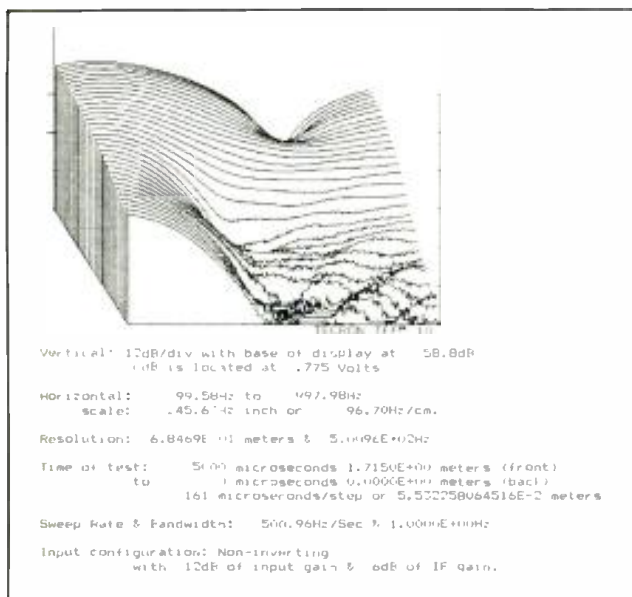

Figure 1. A 3-D display on the TEF screen.

also makes phase measurements and Nyquist plots. Measurements made at different times or places can be compared and differenced.

SUGGESTED APPLICATIONS

The TEF System 10 can remove all the room reflections from the measurement, leaving only the direct sound. This means you can actually measure the anechoic frequency response of a speaker cluster after installation. Or you can see the effect of early sound reflections on the speaker-system response, excluding the room reverberation.

Acoustic consultants use the TEF System 10 to pinpoint acoustic problems such as confusing echoes, early sound, and so on. They can measure the absorption-vs.-frequency of acoustic treatments in situ.

With the TEF System 10, you can see on the screen what you hear with your ears. For example, the analyzer can show the pattern of sound reflections in a room. FIGURE 2 shows a typical display of the energy level of sound reflections vs. time. The tallest line to the left is the direct sound, followed by discrete early reflections, followed by closely-spaced random reflections, or reverberation.

If a strong cluster of reflections occurs more than 20 milliseconds after the direct sound, intelligibility can be impaired. With the TEF System 10, you can determine the arrival time and source of these reflections.

Once the problem reflections are identified, the offending surface can be modified to diffuse or absorb the incident sound. Only those surfaces causing the problem need to be acoustically treated—not the entire room. This can save the expense of unnecessary modifications.

The TEF System 10 is a necessary tool for the design of Live End-Dead End (LEDE™) control rooms. LEDE design requires that several criteria be measured and controlled, including direct/diffuse sound ratio, rear-wall reflection delay and level, sound decay, and speaker

time alignment. The TEF System 10 performs all these measurements.

It can be used as a regular computer, too. The TEF System 10 includes three Z-80 microprocessors that let you run CP/M or BASIC programs such as circuit analysis, sound system design, or even word processing. Of course, you can write your own programs for particular applications.

USING THE TEF SYSTEM 10

Being a computer-age test instrument, the TEF System 10 takes a little getting used to. There are no knobs to set. Instead, all control settings are done through the keyboard (aided by prompts from the built-in monitor screen). This offers a notable advantage in that settings can be recalled and duplicated exactly whenever needed.

To use the TEF System 10, it helps to be familiar with personal computer operation. The instruction manual assumes the user has no experience with computers, and explains step-by-step how to get started. If you need help in the field, the computer has instructions built into the software that can be recalled through the keyboard.

Let's run through a typical test procedure. Assume you've been asked to improve the acoustics and the sound system of a new auditorium. Musicians who play on-stage complain that the sound is so "confusing" that they can't play together. In addition, a theatre critic reported that she couldn't localize the reinforced sound. Others claim that the reproduction is unnatural.



There are more than 2,000 kinds of birth defects. Call your local chapter for the free booklet:

"Be Good to Your Baby Before it is Born"



March of Dimes
BIRTH DEFECTS FOUNDATION

So you carry in the TEF analyzer, a measurement microphone and stand, a mini computer and power amplifier, and some cables. First you tackle the musicians' problem. To simulate the instruments and ears of the musicians, you place the speaker and the microphone on stage. Then you connect the TEF sweep output to the power amp driving the speaker. You connect the microphone to the input of the TEF analyzer.

Next, you insert the floppy disk containing the TEF program. The monitor screen lights up, asking you to type in your name and the date. Then you hit "M" to read the Main Menu (a list of options). The Menu appears.

To document the test, you type "J" to choose a job number. Then you type "e" to set up the ETC measurement (Energy Time Curve). This measurement shows the energy level of the room reflections vs. time.

After entering the needed information, you type "E" to run the ETC measurement. The TEF System 10 plays a sinewave sweep through the speaker on-stage. The measurement microphone receives the direct sound from the speaker, as well as the room reflections. These reflections are displayed as a function of time on the TEF monitor screen.

You see a cluster of reflections centered around 200 milliseconds after the direct-sound pulse. When you move the microphone toward the rear wall of the auditorium, the delay decreases. This shows that you're approaching the source of the reflections (in this case, the rear wall).

So, you've discovered that the rear wall is echoing the stage sound back to the musicians (after a delay of 200 milliseconds). That's why they can't play in sync. You break up the rear wall with some splayed reflecting panels, re-measure, and find that the echo has disappeared.

Now let's take care of the localization problem. This particular auditorium uses a main speaker cluster over the stage, as well as distributed speakers near the audience. The main cluster is far from the audience, while the distributed speakers are close to the audience. A digital delay has been inserted in the audience-speaker lines to compensate for propagation delay.

However, an ETC measurement reveals that the direct sound from the main cluster arrives slightly after the direct sound from the distributed speakers. There's been a miscalculation in setting the delay.

Due to the Haas effect (precedence effect), some audience members localize the sound at the earliest sound source (the distributed speakers). The signal feeding the distributed speakers should arrive at the listener a little later than the direct sound from the main cluster. That way, the audience will localize the sound up-front near the stage. TEF measurements indicate visually when the delay is properly set.

Some theatre critics have complained that the system sounds tonally imbalanced. So you place the measurement microphone in an audience location and run a frequency-response measurement of the main cluster's direct sound. This is done by typing "t" to set up the TDS measurement parameters, and by typing "T" to run a TDS sweep.

The screen shows a deep notch in the response around 2 kHz. The frequency of this notch corresponds to a signal delay of about .25 milliseconds. This might indicate that some of the speaker-cluster components are staggered in space (and time), rather than being time-coherent.

After inspecting the cluster, you align the acoustic centers of the drivers using the TEF display as a guide.

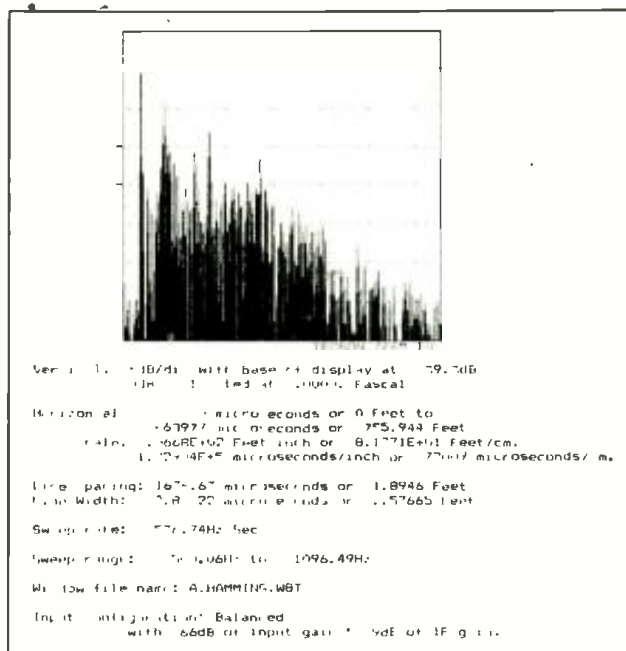

Figure 2. An ETC display showing the energy level of sound reflections vs. time.

The notch disappears. You play some music through the system and are impressed with the improvement.

After about two hours in the building, you will have gathered an enormous amount of data, all on disk. It's time to pack up and leave.

That evening at home, or even a week later, you power up the machine, insert your disks, and begin the process of analysis. The digitally stored data can be assembled in any form you wish: frequency-response curves, phase vs. amplitude (Nyquist), or phase vs. frequency.

You will be able to see differences between any two sets of data, as the computer subtracts one set of data from the other and displays only the remainder. You may even wish to difference data from various halls as part of your research. You can make hard-copy printouts for yourself or your clients.

The amount of data you have obtained with the TEF analyzer will enable you to suggest precise areas of further investigation. That additional research, like the original analysis, can be accomplished more quickly and easily than in the past.

IN CONCLUSION

The TEF System 10 offers surprising insights into the behavior of room acoustics and sound systems. If you're an acoustical or audio design consultant, you now have a new tool to speed up your analysis and verify your predictions.

After using the Tecron TEF System 10 for over a year in my own work, I've consistently been impressed with the elegant handling of data and the amount of sophistication packed into the portable package. Watching the TEF System 10 in action is a fascinating process (which, incidentally, always impresses clients). It makes you feel like the future is here. ■

TEF[®] is a registered trademark of Crown International. Product information and a dealer list are available from Crown International, 1718 W. Mishawaka Rd., Elkhart, Indiana 46517

C—Duced

*A c-ductive new pickup that looks like a piece of tape?
C what it's all about.*

I WAS FIRST introduced to C-Tape Developments' C-ducers in 1980 by Bernie Kirsch at Carnegie Hall in New York City. Since there were no microphones or pickups in sight for the reinforcement of the piano, and this was Chick Corea's gig, the conversation of the day naturally started with "Wheere's the mics?"

Kirsch told me about a most bizarre pickup from England that he was using on (or should I say under) the piano. It obviously couldn't work. How could a 30-inch piece of tape, stuck underneath the piano keyboard with a cable sticking out of it, actually reproduce this nine-foot instrument at all, let alone with any degree of accuracy?

The sound check proved that the pickup did indeed work, and that evening's performance certainly made a believer out of me. In fact, there was no one at the concert who could detect the amplification of that beautiful piano, and that is quite a statement in itself.

Several years went by until this mysterious tape was heard of again around this neck of the woods. All of a sudden an ad appeared with an 800 phone number, asking us to call. So we did, and a C-ducer was on its way for our evaluation.

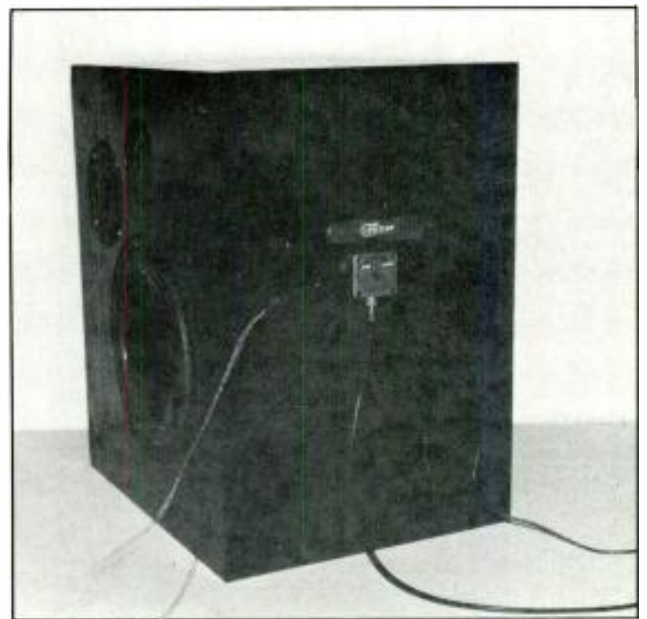

THE TAPE

The C-ducer is a vibration transducer system comprised of a flexible tape 3/32-in. thick by 3/4-in. wide and eight inches long (optional, three inch length), and a preamp. FIGURE 1 shows the cross-sectional view of the tape. The tape is coaxially constructed, with an outer foil electrode functioning as both a shield and as one plate of the sensing capacitor. The inner foil electrode is a conductive element coated with layers of piezo-electric plastic (primarily for insulating purposes). The air gap

Jesse Klapholz is a regular db columnist.

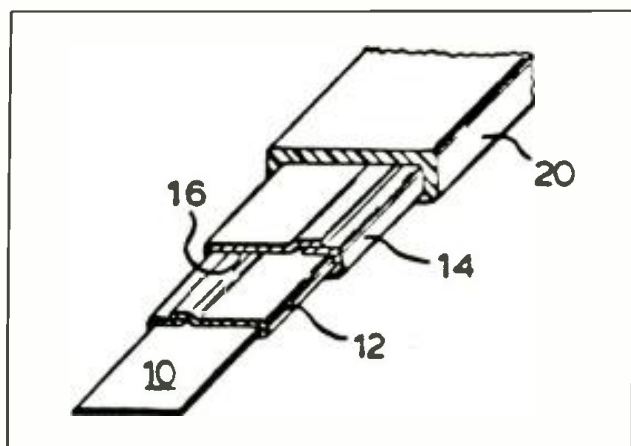

Figure 1. Cross-sectional view of the tape.

between the inner and outer foils, when in contact with a vibrating surface, produces a change in capacitance proportional to the physical spacing of the two foil electrodes. An interesting enhancement to the capacitive elements of the transducer is the emf voltage generated by the foil's piezo plastic layer. Therefore, the tape-transducer operates on a hybrid of piezo-electric properties and the effects of change in capacitance.

What we know so far is that the tape works on two principals: the rate of change in capacity between the inner and outer foil electrodes, and a piezo-electric

enhancement from the polymer coatings. Therefore, the C-ducer (capacitive-transducer), for all intents and purposes, operates as an acceleration and velocity transducer. Since the primary resonance is near the GHz region, its frequency response is practically flat to 5 MHz, and it responds down to 0.1 Hz. The C-ducer effectively integrates all vibrations coherently over its entire length (six square inches for the eight-inch tape and two and a quarter square inches for the three-inch tape). Therefore, it "samples" a much greater area of a vibrational surface than the typical discrete-point contact pickup.

The C-ducer has essentially no inductive component, and is basically a pure voltage generator in series with a pure capacitance. However, due to its piezo-electric contribution, the capacitance as measured on a bridge (the static capacitance) is different than the effective capacitance when the transducer is set in motion. Another way of looking at this is that the pure voltage generator in series with the capacitance has basically a negative impedance. Since the series impedance is so low, the usual problems of cable-generated noise and other high-impedance difficulties are virtually eliminated.

The tape is terminated with a seven-foot-long coaxial cable that has, in addition to its braided shield, a conductive plastic one as well, with 100 percent shielding properties. The tape is very quiet and has no RF pickup or cable-induced noise problems. The dynamic range output capabilities of the tape are extremely wide. Nominal output levels in the 30-millivolt range are typical of acoustic string instruments. However, fastening the tape on a table and then striking the table with a light blow can produce output voltages from the tape in the 20-to 30-volt range. Outputs of up to 100 volts without clipping have been reported in specialized testing applications.

THE PREAMP

With the hybrid characteristics of the tape and its output's dynamic capabilities in mind, the preamp is critical in the implementation of the transducer system. The preamp is a capacitor-balanced-input design; in the "Pro" version, with 600 ohm balanced output(s), it requires 24-48 volt phantom power. The capacitor-balanced-input approach is basically comprised of a differential input amplifier with a capacitor balancing the tape signal to the second half of the input stage. As a side light, the performance of many commercial capacitor (condenser) microphones have been improved by changing the high impedance FET amplifier to a balanced-capacitor-input.

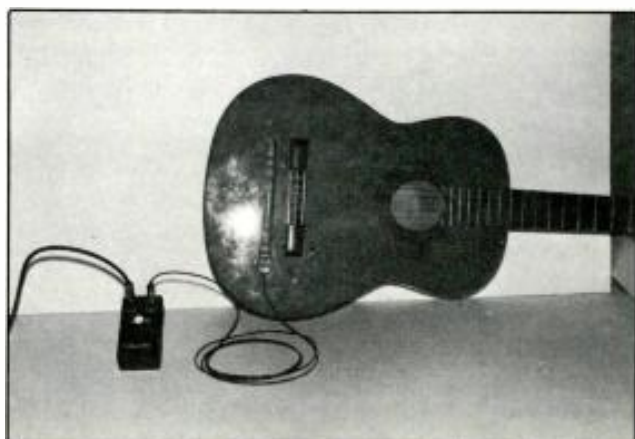
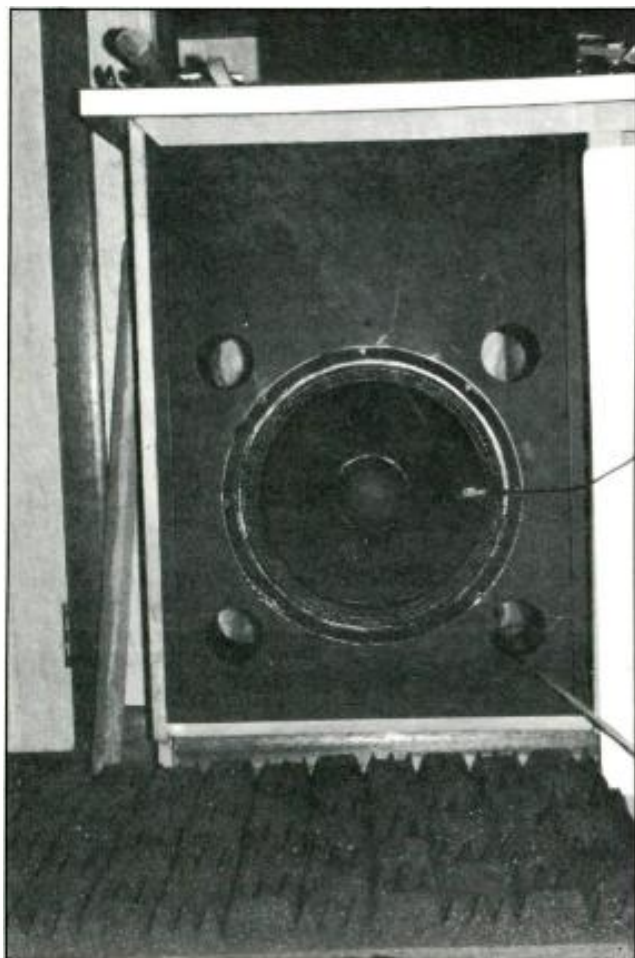

The rest of the preamp buffers the signal, and, in the Pro version, provides transformerless balanced output(s) matched to 600 ohms, buffered Hi-Z output(s), and gain that is variable from mic to line level via a rear panel trim pot for each channel. The input and buffering stages in the high-impedance and low-impedance preamps are identical. However, the high-impedance preamp has a front panel knob for output level adjustment. There are three different Pro preamps available: one input, two input, and six input configurations.

MEASUREMENTS

Measurements of such a radical new concept are a formidable challenge. It is difficult enough to decide on how to present data on "conventional" transducers, especially when the AES Standards Committee have not been able to settle on transducer specification standards themselves! With this in mind, we are not attempting to present any data as "the real picture." However, we feel that some of our in-house test results should be interesting.

For our first experiment, we attached a C-ducer to a cone loudspeaker, and measured the speaker's on-axis response to a test pulse with a mic. The C-ducer was electrically "off" at this point. However, it was hooked up so that any damping taking place would appear in both curves. With the mic's response curve in computer memory, we measured the C-ducer's response to the test pulse, and plotted the two measurements for easy comparison in FIGURE 2. An interesting experiment that anyone can try is to monitor the output of the C-ducer (a test signal into an analyzer, or music into headphones can be used) and change the position of the tape on a loudspeaker. The contributions of all the different parts of the loudspeaker to the total sound output can be simply demonstrated in this way.

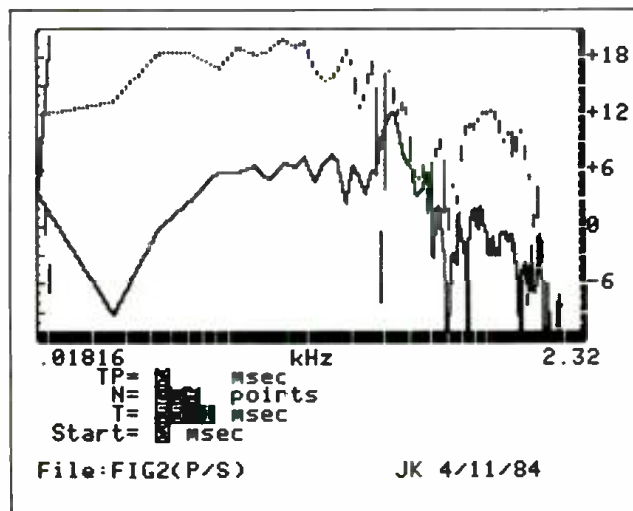

Figure 2. Response of a cone loudspeaker as picked up by the C-ducer (upper dotted trace) and by a microphone (lower solid trace).

For our second experiment, we attached a C-ducer to a classical guitar and analyzed the response of the plucked open A string with a test mic. With the mic's response curve in computer memory, we measured the C-ducer's response to the plucked open A string, and plotted the two measurements for comparison in FIGURE 3. A single note was used for this guitar test since it could produce an uncluttered display for ease of comparison, and could easily be repeated without any practical deviation.

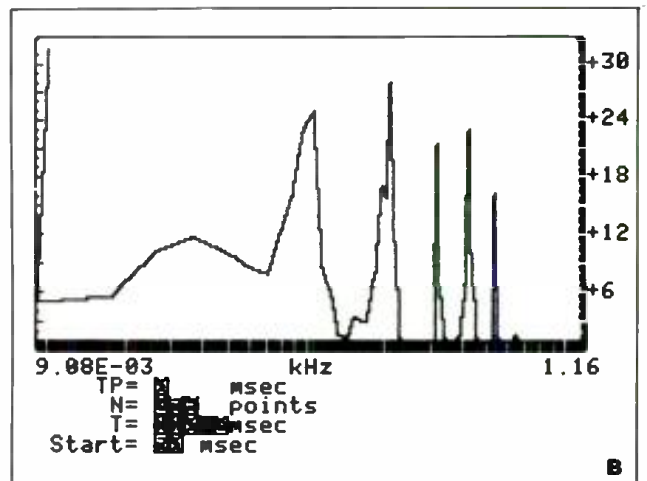
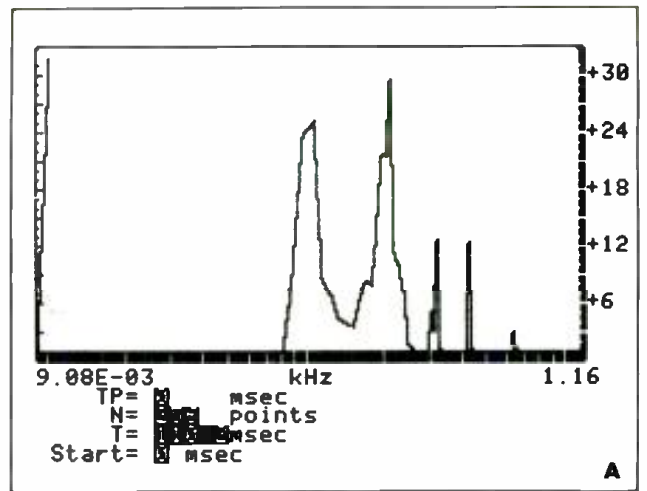

Figure 3. Response of a plucked open "A" guitar string as picked up by a microphone (A) and by the C-ducer (B).

FIGURE 4 shows the comparison between the pickup of loudspeaker cabinet resonances with a standard piezo-type industrial vibration pickup and the tape. Since the tape behaves as both an accelerometer and a velocity transducer, its response bandwidth far exceeds that of the industrial accelerometer.

An interesting observation made through some of our testing was that the structure of the tape enables the

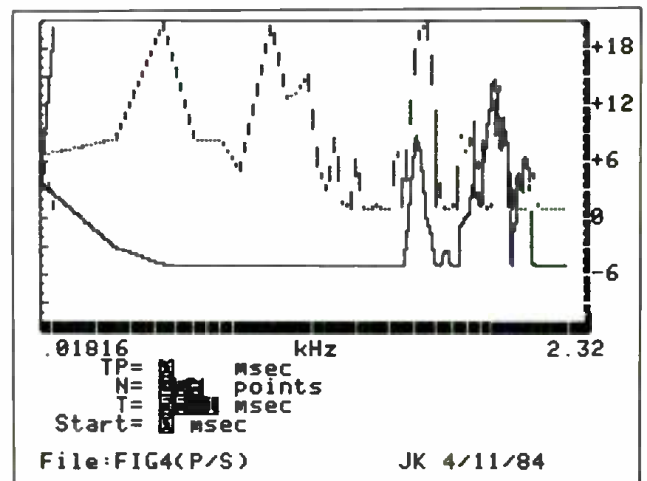

Figure 4. Pickup of loudspeaker cabinet resonances with a standard piezo-type industrial vibration pickup (lower solid trace) and with the tape (upper dotted trace).

pickup of vibration patterns in selective areas; this allows us to locate the nodes and peak displacement areas of vibration. Using basic geometric triangular relationships, the "epicenter" can be found, since maximum sensitivity will occur when the tape is perpendicular to the incident wave front and aligned with it.

APPLICATIONS

The most popular use of the C-ducer has been on the piano; however, applications range from drums to strings and everything in between. The list of people using C-ducers reads something like a "who's who in music." Part of the list includes Chick Corea, Joni Mitchell, Stevie Wonder, Crystal Gayle, Abbey Road Studios, the Royal Opera House, UB40, Swiss Radio, North German Radio, the BBC, Eric Clapton, Pink Floyd, Duran Duran, Dire Straits, Culture Club, Jon Hiseman, Linda Ronstadt, Jose Feliciano, Anne Murray, Willie Nelson, Baryshnikov Ballet, the Grand Ole Opry, and Resorts International Casino in Atlantic City.

Joe Marchione, the lead sound tech at Harrah's Casino in Atlantic City, was first introduced to the C-ducer by Greg Kirkland, Neil Sedaka's sound engineer. Marchione has since replaced the PZM 30-GP mic in the Yamaha grand piano in Harrah's Atrium Lounge with a two channel C-ducer. Says Joe, "The C-ducer not only eliminated the pickup of the waterfall in the lounge, it also sounds a lot more like a real piano!" Similarly, in the theatre, Joe is now using a C-ducer in Harrah's nine-foot Baldwin Grand with great results, both for monitors and mains: "...better sound and more gain before feedback than mics, and much more realistic and even reproduction of the piano than the Helpinstill."

On the other side of the fence are those who have tried the C-ducer and haven't been satisfied with its results. A typical example is a rock group currently using a grand piano on a stage with amplified instruments whose average sound levels are in the 115 dB range. With such high sound levels in the proximity of the piano, this sound field will obviously be induced into the soundboard of the piano. The piano soundboard is acting as an acoustic transducer, converting airborne sound energy into mechanical resonances. When a C-ducer is attached to such a soundboard, it will faithfully reproduce all vibrations within it.

When such a piano is amplified via a C-ducer, so is the loudspeaker's sound; hence the complaint of, "There's no separation." After being involved with and having heard many different groups and pianos through live PA, I believe the bottom line is, "Why even bother to use a grand piano with a pickup system/technique that makes that piano sound inferior to an electronic piano?"

COMMENTS

Back over on the C-ducer side of the fence, if a piano's sostenuto pedal squeaks, or if a kick drum's pedal creaks, a can of WD-40 or Teflon spray can be very helpful in eliminating such mechanical noises. You piano tuners out there better keep on your toes!

The tape is a very low mass device. Therefore, it does very little in terms of damping the surface to which it is attached. The exceptions to this are: drum heads (which may be desirable), eight-inch tapes on small and light cymbals, eight-inch tapes on small diameter/lightweight loudspeaker cones, and in general any situation where the ratio of the mass of the tape to the mass of the surface to which it is attached is high.

The first time I tried the C-ducer in a musical context was in an A/B comparison with the Underwood pickup on a friend's acoustic bass at a small club date. The Underwood is a split pickup design, restricted to a mounting position in the bass' bridge. The flexibility of being able to place the C-ducer almost anywhere on the instrument allowed us to achieve many different "voicings." With this "voicing" capability, the applications are only limited by the imagination and creativity of the user.

Through our evaluations in applying the tapes to various surfaces, we found the tape's flexible construction to be pretty convenient in terms of minimizing the restrictions of its placement. The "low tack" double-sided adhesive tape contained in the kit presented no problems with musical instrument finishes. We also found that as long as the surfaces were kept clean, the tape could be repositioned many times, removed, and even re-applied before having to replace the adhesive strip. As with mic placement technique, *where* you apply the tapes is important, but you'll find them a lot more forgiving than you'd expect. In our experience and conversations with other C-ducer users, the general consensus is to use eight-inch tapes when C-ducing an instrument; the use of the three-inch tape usually only becomes necessary when the size of the surface prohibits the use of the eight-inch tape.

The C-ducer manual and accompanying application notes provide good starting points. In most cases, the tapes won't need much adjusting. The timbre of the instrument, as far as the tape hears it, may be adjusted by moving the tape in relation to the resonating surface and vibrating medium (strings vs. body, drum head vs. shell, etc.). However, remember that sound travels through wood over 10 times faster than through air!

Several notes of caution: Poor tape-to-instrument contact will degrade the signal transfer process. Any material and/or air space introduces a mechanical impedance mismatch, which modifies the transfer function in terms of both level and frequency. When using the C-ducer with percussion instruments, input levels need to be monitored judiciously. Because of the wide dynamic range of these instruments and the C-ducer system's capabilities of swinging high peaks without clipping, an input meter may hardly budge even though console input clipping may be taking place.

A SUBJECTIVE OPINION

One experiment with a single eight-inch tape on an upright Steinway was quite interesting. The piano was on a deep pile rug and couldn't be moved easily, so the pickup was "blindly" placed on the bottom of the soundboard at the low end of the keyboard and was recorded on a Sony SL-5200 Beta Hi-Fi VCR. The results? The playback sounded like a studio recording of a large concert grand, very even and natural. Natural? In this day and age when guitars are designed to sound like synthesizers, and synthesizers are made to sound like guitars, who is to say what sounds right? The word "natural" is taking on new meaning as the instruments we use become more mechanized. With the four-track mini-studio becoming a popular household appliance, what's next? Who will be the first manufacturer to sell a console that does it all? Just as our PZMs from Ken Wahrenbrock's kitchen back in '79 were a great addition to our mic kits, we feel the C-ducer is a revolutionary addition to today's "bag of tricks." ■

Glass in the Studio, Part II

Here, author Everest returns to discuss the effects of absorption, dissimilar planes, different types of glass, and other topics relating to acoustical holes in the studio.

WE HAVE SEEN that the control of standing waves in the cavity between the two panes of a double glazed window requires absorption. The TL advantage in using such absorption is revealed by measurements plotted in FIGURE 1, in which two 5/32-inch (4mm) glass panes are separated two inches (50mm). This arrangement is not particularly desirable for a practical window because of the small spacing and deep coincidence dip; it is, however, excellent as an actual "before" and "after" controlled demonstration of placing absorbing material on the reveals of the window cavity, yielding, in this example, STC 33 without absorbent and STC 37 with absorbent. A gain of 4 points is therefore directly attributable to the absorbent. The TL gain in using an absorbent at the edges is less with heavier glass, but it is still desirable to use peripheral absorbent in all double glazed windows.

Quirt has also verified the value of absorbent lining around the interpane perimeter of double glazed windows.¹ With 1-inch glass fiber lining he found a TL gain at 4 kHz of about 5 dB, coming down to about 1 dB at 1 kHz, and negligible effect at lower frequencies. Low frequency TL can be improved, of course, by use of thicker absorbent to suppress axial and tangential modes in the interpane cavity.

EFFECT OF DISSIMILAR PANES

If both glass panes in a double glazed window are of the same thickness, their coincidence dips appear at the same frequency, deepening the dip. For this reason, it is standard practice to use glass panes of different thicknesses to minimize the effect. Measurements verifying and quantifying the effect are shown in FIGURE 2.¹ Measured TL of two 1/4-inch (6mm) glass panes placed 2 1/2 inches apart are compared to an almost identical situation, except that one glass is 1/8 inch (3mm) in thickness. The window of FIGURE 2A, having two 1/4-inch panes, has a coincidence dip around 2 kHz as predicted by Equation 5. The window of FIGURE 2B, having panes of dissimilar thicknesses, eliminate, or at least moderate, the coincidence dip. In this frequency region, higher TL is obtained in the window having the thinner glass.

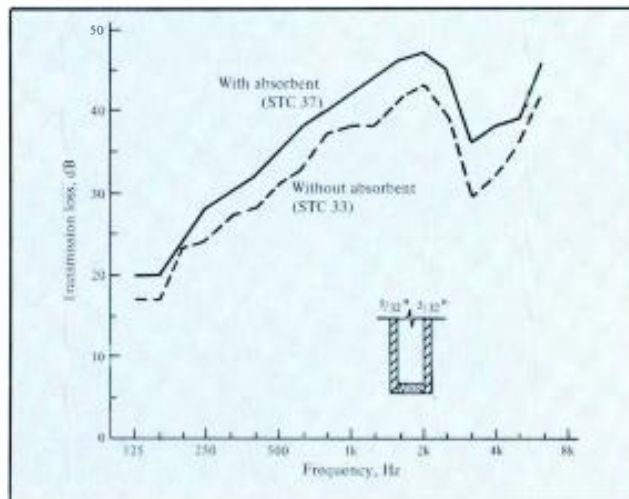

Figure 1. Actual measurements showing improvement of transmission loss of double glazed windows by covering the edges of the interpane cavity with sound absorbing material. A gain of 4 STC points is attributable to the absorbent. In this case, 5/32-inch (4mm) glass is used. Improvement of TL due to absorbent is greater with thin than with heavier glass. (Adapted, with permission, from A. Cops et al.)

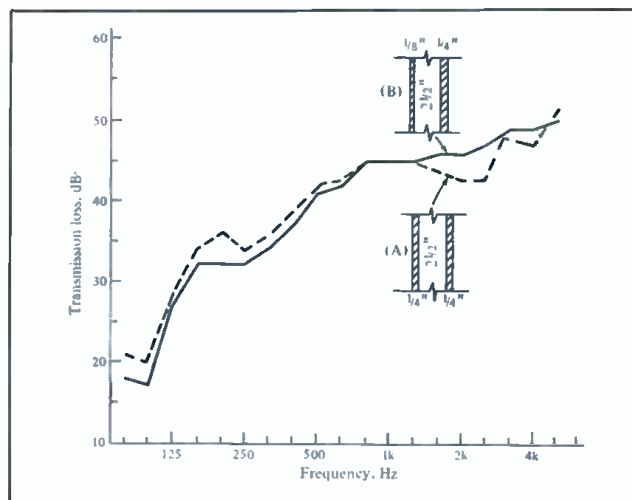

Figure 2. The use of glass of different thickness in double glazed windows serves to minimize the coincidence irregularities by staggering the two coincidence frequencies. Curve A is for a window utilizing two panes of 1/4-inch (6mm) thickness spaced 2 1/2 inches (63mm). Curve B is the same window with one glass reduced to 1/8 inch (3mm). (Adapted, with permission, from Quirt, Ref. 1.)

Registered consulting engineer F. Alton Everest is the author of a number of books on audio-related topics.

EFFECT OF LAMINATED GLASS

The mass law discussed in Part 1 (April, '84) applies only to a limp mass, i.e., one having no stiffness. Glass panels would offer greater TL if stiffness could be reduced. One way to do this is to laminate the glass. In FIGURE 3, the measured TLs of two typical double glazed windows are displayed, each having one 1/4-inch pane and one 1/2-inch pane with a 6-inch spacing between them.⁴ The 1/4-inch pane of FIGURE 3B, however, is made up of two 1/8-inch panes with a 0.045-inch plastic inter-paner. This plastic sheet in the sandwich makes the pane

behave more like a limp mass, and a significant improvement in TL results. The improvement in this particular window is greatest in the 1 to 2 kHz coincidence region. The cost of laminated glass runs something like 50 percent more than plain glass plate or float.

PLASTIC INSTEAD OF GLASS

There may be conditions in which the properties of plastic sheets (such as flexibility and being nearly shatterproof) might be preferred to those of glass for

The Language of STC

The effectiveness of glass or other materials as sound barriers is measured by the sound transmission loss offered. A graph of transmission loss (TL) vs. frequency describes the effectiveness of such a barrier completely and accurately. It is convenient, however, to be able to represent such a graph by a single number. The arbitrary concept of Sound Transmission Class (STC)¹ is designed to do just that. An STC single number rating, while not perfect, is designed to correlate with subjective impressions of common noises penetrating partitions in homes and offices and is commonly applied to audio rooms as well. The standard STC contour, shown in FIGURE 1, reflects the lower sensitivity of the human ear to low frequency sounds. It can be readily plotted to any convenient scale by connecting the three following points by straight lines: 125 Hz/TL of 24 dB, 400 Hz/TL of 39 dB, and 1250 Hz/TL of 44 dB. The measured transmission loss of the barrier is plotted against frequency, and the standard STC contour, plotted as an overlay to the same scale on tracing paper, is adjusted vertically until the following conditions are fulfilled for the 1/3 octave points from 125 Hz to 4 kHz: 1) the sum of the deviations below the contour at 1/3 octave intervals shall not be greater than 32 dB and 2) the maximum deficiency at any single 1/3 octave point shall not exceed 8 dB. When the contour is adjusted to the highest value that meets these requirements, the STC of the barrier is the TL value corresponding to the intersection of the contour and the 500 Hz ordinate.

As an example, the determination of the STC for the measured values of transmission loss for a partition² of 1/2 inch plasterboard on either side of 2x4 studs, 16 inches on centers, is illustrated in FIGURE 2. Setting the STC overlay first at an estimated STC 38, the deficiencies of the plasterboard walls total 40 dB. Lowering the STC overlay to intersect the 500 Hz ordinate at 37 dB (STC 37), the deficiencies total 33 dB. This is close to the 32 dB mentioned the first condition above, establishing the STC single figure rating for the plasterboard wall of FIGURE 2 at STC 37.

References

1. "Determination of Sound Transmission Loss." *ASTM E413-70T*.
2. Northwood, T. D. *Transmission Loss of Plasterboard Walls*. Building Research Note No. 66 (revised July 1970), National Research Council, Ottawa, Canada.

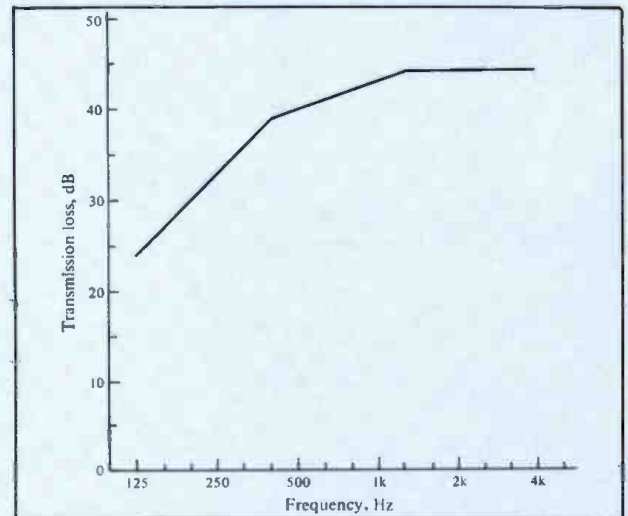

Figure 1. The standard STC contour.

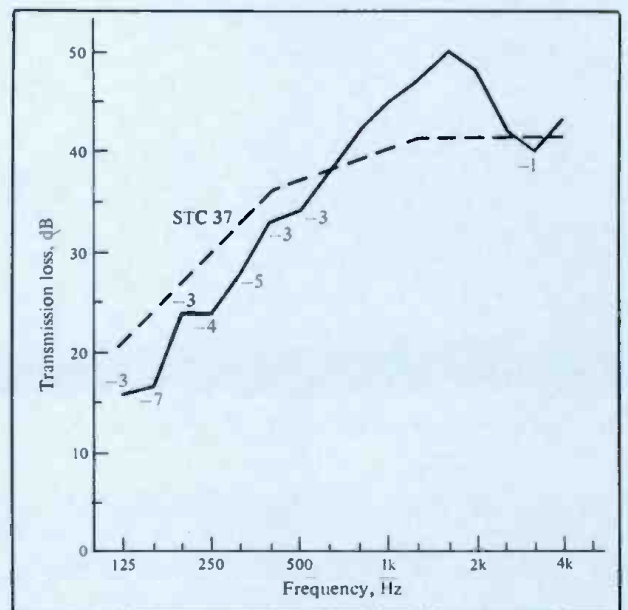

Figure 2. The determination of the STC for the measured values of transmission loss for a partition of 1/2-inch plasterboard.

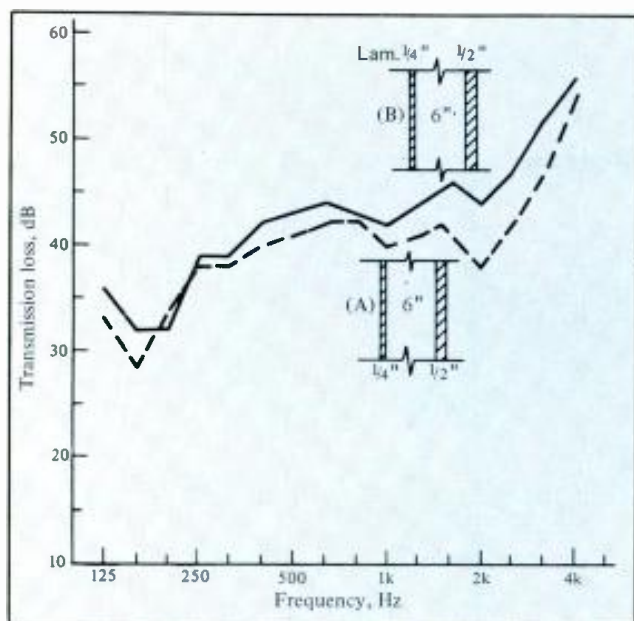

Figure 3. Laminated glass offers less stiffness than comparable solid glass: (A) Normal double glazed window of 1/4-inch and 1/2-inch glass sheets spaced 6 inches; (B) the same window except the 1/4-inch solid sheet has been replaced by two 1/8-inch sheets laminated with 0.045 inch plastic. The window with the laminated sheet shows the greater transmission loss. (Libby Owens Ford, Ref. 3.)

sound insulating windows. What are the trade-offs? For one thing, greater thicknesses of plastic would be required for a given TL because the density of plastic is about half that of glass. Plastic sheets may be cold-bent on the job to form convex windows.⁵ It is feasible to use a convex plastic sheet on the studio side of an observation window to control slap-back reflection problems, backing it up with one or more spaced, heavy glass sheets to make up for its lower TL. Modern plastic materials offer reasonably good light transparency and low optical distortion.

HOW ABOUT THERMAL-TYPE GLASS?

There are many forms of proprietary glass utilizing two glass sheets with an airspace between them that are very effective for thermal insulation. If the spacing between the two glass sheets is small (1/4-in. to 1/2-in. is common), thermal properties might be quite satisfactory. But for sound insulation the performance of such units, as previously noted, is the same as a single glass plate of combined surface mass. Only when the airspace exceeds one inch or so does the TL begin to exceed the mass law value.

HOW ABOUT SLIDING GLASS DOORS?

Sliding glass doors are very popular these days for closing off an isolation booth or drum booth or even as an entrance to the studio. Specifications for such doors show great concern for security, weathertightness, and ease of operation, but, to my knowledge, no test results for sound transmission loss. Because of the growing number of sound sensitive applications of sliding glass doors, the justification for the expense of such tests should be forthcoming.

A few generalizations are in order for sliding glass doors to be used as sound barriers. The two main paths for sound to traverse such a door are a) through the glass (mass law) and b) leakage around the door edges.

There is little point in paying a high price for heavy glass when leakage is great. Look for the glass doors that have excellent sealing wipers around the entire periphery of each moving unit.

Measurements made by the writer on an ordinary 6-ft., 9-in. by 10-ft. home-type sliding door to an isolation booth in one studio gave the following noise reduction values:

Frequency, Hz	Noise Reduction, dB
63	18
125	21
250	25
500	29
1000	25
2000	25
4000	29

(The above "noise reduction" values are those made *in situ* without corrections for room absorption or knowledge of flanking paths; hence they apply only to that particular overall setup rather than being transmission loss values characteristic of the sliding door alone.)

SHALL WE SLANT THE GLASS?

Speaking of double glazed windows, Rettinger says, "The vertical angle of the panes should not be less than six degrees in respect to each other, to avoid a strong standing wave between the sheets of glass when a prolonged note is incident on the window."⁶ He is probably referring to the axial modes set up in the interpane cavity. What do recent measurements have to say about the value of inclining one or both of the glass panes? Again we turn to Quirt's recent report of his exhaustive measurements.¹ His tests embrace four glass thicknesses with interpane separation three times greater at one end than the other, varying from 1/2 inch to 4 inches on the average. His results are as follows:

- If the parallel glass separation is equal to the *maximum* separation of the slanting glass, the parallel glass windows show superior transmission loss of 1 to 2 dB across the frequency band.
- If the parallel glass separation is equal to the *average* separation of the slanting glass, the two perform equally well across the band.
- If the parallel glass separation is equal to the *minimum* separation of the slanting glass, the slanted glass is definitely superior by 1 to 4 dB across the band, an average of 3 dB. These tests, which focus attention on the importance of *average* interpane separation, led Quirt to say, "nonparallel glazing does not appear to offer any significant benefits." *Quid est demonstratum* (QED).

The above discussion pertains only to transmission loss. Other external factors may be affected by how the glass is inclined. For example, light reflections in the window are affected by inclination of the glass, but recessed light sources control such reflections much better. The effect of acoustical reflections on the studio side may sometimes be a minor consideration to program quality.

WEAK WINDOWS IN A STRONG WALL

It is much more difficult and expensive to build an STC 55 window than an STC 55 wall between studio and control room. A nice little trick is to build the wall heavier than required to compensate for a weaker window because the sound penetrating the partition involves the window area, the remaining wall area, and the STC values of each. Let us say that a window of 32 square

feet is set in a 12- by 20-ft. wall (240-32=208 sq. ft.), and that the favored window construction yields STC 45 and the wall construction yields STC 55. The STC rating of the wall-window combination may be found by the following formula:

$$\text{Combined STC} = 10 \log \left(\frac{S_g}{\text{STC}_g} + \frac{S_w}{\text{STC}_w} \right) \quad (1)$$

where:

S_g = fractional surface of glass window,
 S_w = fractional surface of wall,
 STC_g = STC rating of glass window,
 STC_w = STC rating of wall.

The fractional window area is $32/240 = 0.133$. The fractional wall area is $208/240 = 0.867$. Substituting these figures and the STC values in equation (1) yields:

$$\text{Combined STC} = 10 \log \left(\frac{0.133}{10^{15}} + \frac{0.867}{10^{55}} \right) \quad (2)$$

where:

Combined STC = 51.6

The STC 45 window can then be tolerated if STC 50 were the overall goal for the partition.

PROPRIETARY WINDOWS

Many studio windows are built by workmen who have never built one before and who do not appreciate the fine points of resiliently mounting the glass panes, caulking, etc. The same may often be said of the supervisor. Unless constantly watched by someone knowledgeable in acoustically significant details, the transmission loss of the resulting window can easily be degraded in spite of good intentions. For these reasons, the use of proprietary windows may make good sense. Excellent prefabricated windows of known performance are available at reasonable prices from numerous sources.

Typical prefab windows in the recording studio of the U.S. Naval Training Devices Center, Orlando, Florida,



Figure 4. Proprietary windows in the recording studio of the U.S. Naval Training Devices Center, Orlando, Florida. (Courtesy Industrial Acoustics.)

are shown in FIGURE 4. These windows were supplied by Industrial Acoustics Company.⁷ The construction of several high TL windows supplied by IAC is illustrated in FIGURE 5. Sound Transmission Class ratings of STC 47 and higher are available in double glazed and even higher in custom-designed triple glazed windows.

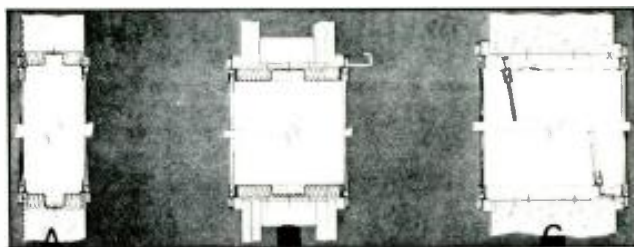

Figure 5. Constructional features of high transmission loss windows supplied by Industrial Acoustics Company: (A) Standard Noise-Lock Window, 4-inch (25mm) Moduline® Panel; (B) standard double glazed Noise-Lock Window utilizing split frame for new or existing openings; (C) custom triple glazed design for split or fixed frame.

SUMMARY: OPTIMIZING THE DOUBLE GLAZED WINDOW

To increase window transmission loss:

- Use large interpane spacing (3 dB TL gain for each doubling of space)
- Use heavy glass (6 dB per doubling of surface mass)
- Use different thicknesses of glass (Stagger coincidence dips by 2:1 in frequency)
- Use thick absorbent on edges of interpane cavity (To control interpane cavity modes)
- Use laminated glass (For very high TL windows)
- Inclining glass panels not justified by transmission loss measurements. ■

References

1. Quirt, J. D. "Sound Transmission Through Windows—I Single and Double Glazing." *Jour. Acous. Soc. Am.*, Vol. 72, No. 3 (September 1982) pp 834-844.
2. *Breaking The Sound Barrier*. Brochure AR-3, Libby Owens Ford Company.
3. Rettinger, Michael. "Angled Control-Room Window Sound Diffraction Phenomena—A Practical Solution Using Laxon Plastic Panels." *Recording Engr./Prod.*, Vol. 12 No. 2 (April 1981) pp 58, 60.
4. Rettinger, Michael. *Studio Acoustics*, Chemical Publ. Co., Inc., New York (1981), page 82.
5. Industrial Acoustics Company, 1160 Commerce Ave., Bronx, New York 10462, phone (212) 931-8000. Their bulletin 3.1002 describes standard and Custom Noise-Lock® Window details.

Other Helpful Papers

- Quirt, J. D. "Sound Transmission Through Windows—II Double and Triple Glazing." *Jour. Acous. Soc. Am.*, Vol. 74, No. 2 (August 1983) pp 534-542.
- Quirt, J. D. *Measurements of the Sound Transmission Loss of Windows*. Division of Building Research Note No. 172 (April 1981), National Research Council of Canada, Ottawa.
- Cops, A. and H. Myneke, "Sound Insulation of Glass By Means of Scale Models." *Acustica*, Vol. 31 (1974) pp 143-149.
- Heebank, T. B. "Sound Reduction of Windows in Exterior Wood-Framed Walls." *Sound and Vibration*, Vol. 9, No. 6 (June 1975) pp 14-18.

The Father of Sound Systems

This affectionate biography of Milton Boom, written by a man who worked with him for 15 years, recounts the tremendous impact Mr. Boom had on the development of today's sound systems.

HIS SWEDISH PARENTS were still in their teens when they passed the Torch of Liberty in New York Harbor. After leaving Ellis Island, Fred and Lena Boom travelled to Geneseo, Illinois.

Shortly after the turn of the century, Milton, their first son, was born.

As soon as he was old enough, Milton had his first taste of hard work on the surrounding farms. When he had finished high school, Milton went to Milwaukee to study electrical theory at the Milwaukee School of Engineering.

After graduating, he obtained a job at the Hatfield Electric Company in Chicago with the help of his cousin, George Carlson, then the City's Gas and Light commissioner.

He soon became interested in the new medium, radio, and worked in Chicago's Wrigley building for radio station WHT. From there, Milton went on to Erickson Electric where he specialized in sound reinforcement systems.

In 1926 Milton met and later married Miss Lorraine Whitney, then employed by the Chicago, Milwaukee and St. Paul Railroad. That same year he was involved in providing sound for a crowd of over one hundred thousand at the Catholic Eucharistic Congress using a Western Electric "Loudspeaking Telephone System." Audio power was expensive in those days, but so efficient were the forty long Western horns that only thirty watts of power were required for intelligible sound over the restricted frequency range.

BOOM ELECTRIC CO.

Later in 1926, Milton, with a volunteered loan of twenty-five hundred dollars from his wife's mother, bought out the Erickson Electric Company and the Boom Electric and Amplifier Company was born.

William C. Matthews is senior systems engineer at Ancha Electronics, Inc., Elk Grove Village, IL.



Milton Boom—the father of Sound Systems.

In 1927, he toured the country by rail with four "Morning Glory" horns and a three watt Western amplifier to cover the Whistle Stop crowds on Vice-Presidential candidate Senator Curtiss's political tour.

In 1928, Milton helped install the first Chicago motion picture sound system for Al Jolson's "talkie" (*The Jazz Singer*) at the McVickers Theatre.

Milton's company was one of the first unionized

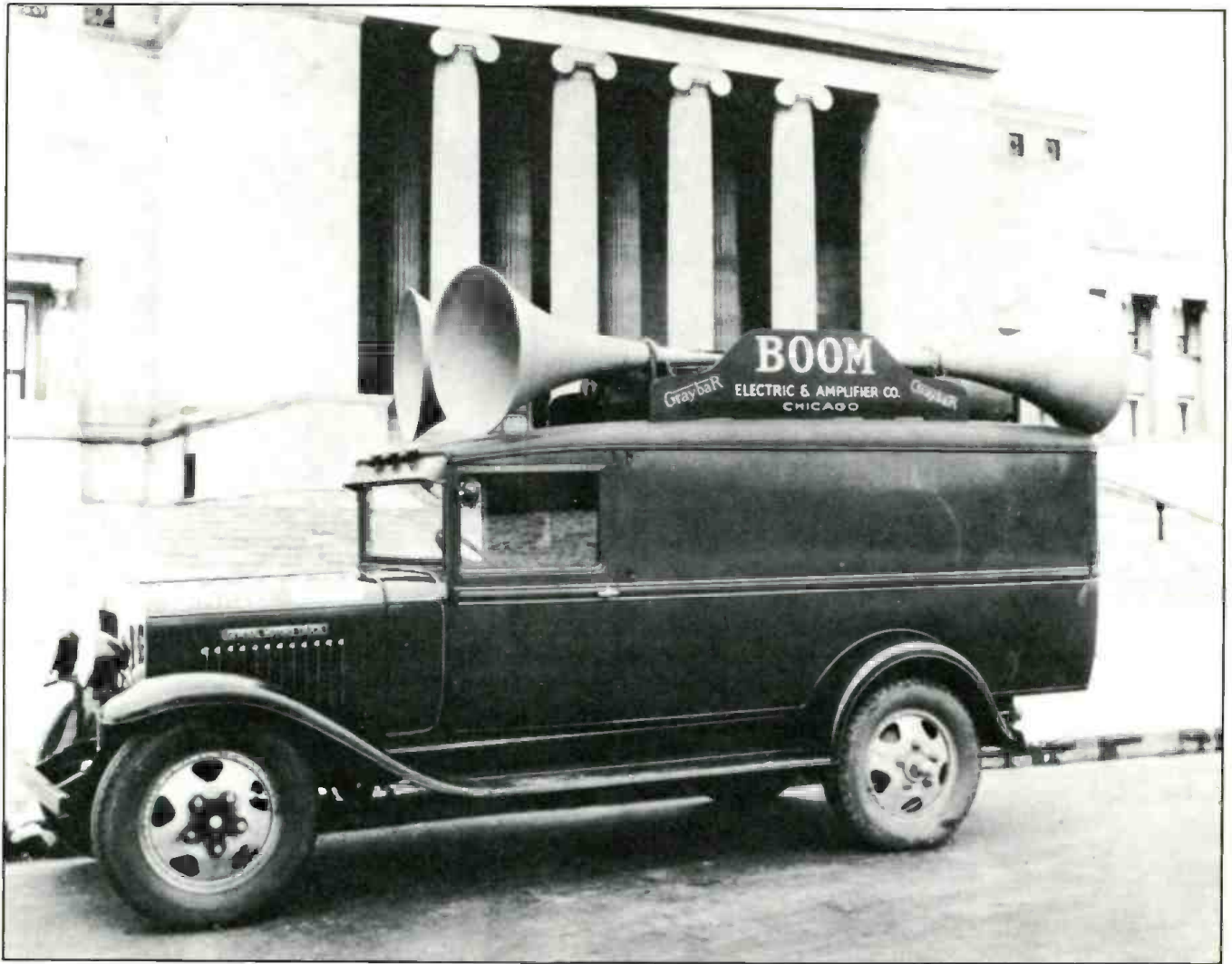

One of Boom's early sound trucks with long, efficient Western Electric trumpets.

communications organizations. Having begun his career as a journeyman electrician, Milton maintained his union card throughout his life. He was well-liked by Chicago's management as well as labor leaders; an association which paid off well as his company was always considered for the biggest sound contracts.

In the early thirties, Milton's younger brother, Norton, fresh out of high school, moved to Chicago and joined the company.

A 'BOOM'-ING BUSINESS

When the Chicago 1933 World's Fair began, the Boom Electric and Amplifier Company, despite the problems of the Depression, was well-established in the Chicago area. For the Fair, Milton installed one of the first stereo outside sound systems at the Swift Bridge Exhibit to reinforce music produced by the Chicago Symphony Orchestra.

During the thirties, communications systems finally began to be recognized as necessities rather than novelties. During this period Milton's company made

numerous large installations including: The National Cornhuskers Convention where a crowd of 120,000 gathered on an Indiana prairie; a customized sound system for Soldier Field; sound systems for the Chicago Stadium, the International Amphitheatre, the Aragon Ballroom, the Colosseum shows, hotel ballrooms and nightclubs, churches of all denominations, International Harvester and a myriad of other prestigious jobs.

Intercommunication grew in demand in business offices and factories across the country and Boom designed and installed Webster Electric intercom systems all over the Chicago area.

As the Country was recovering from the Depression, Pearl Harbor blasted it out of its complacency and Milton's Company speedily expanded to keep pace, supplying the communication requirements of wartime Chicago area plants.

MUZAK AND WW II

Background music for employees working unprecedented long shifts became a new factor and Boom



The 1937 Cornhusker's Convention, where Boom covered a crowd of 120,000 on an Indiana prairie.

installed many systems, eventually becoming the "Muzak" franchiser for the Chicago area. This acquisition ultimately provided a monthly income equivalent to the annual net of most communications companies.

Norton Boom spearheaded the background music development. Unlike many franchisers, Boom's operation was systematically planned from the inception. Sales engineers would determine the loudspeaker coverage based on ceiling height and dispersion. Power per loudspeaker would be calculated depending upon the noise levels as measured with a sound level meter. Then, Western Electric (and later Langevin) amplifiers with special modifications would be installed. (A Boom engineer later designed a special music amplifier that was widely used.) Plug-in equalization modules designed and built to accommodate variations in telephone line response as measured by Boom field engineers were installed for consistent frequency response. Resistive rotary switch volume controls designed and built for 500 ohm and 70 volt loudspeaker loads were matched to the impedance of area loudspeakers. The fact of tube deterioration due to heat and age prompted the now Boom Sound Engineering Corporation to provide regular inspections of company installations. A 24 hour emergency service was inaugurated for continuous system performance insurance.

THE COMPANY CONTINUES TO GROW

As the company grew, the need for better organization became apparent. An organizational outline showing the president (Milton), vice presidents, department heads, supervisors, office and field workers was distributed to all departments in a manual of company policy.

Thinking ahead, Milton was instrumental in organizing national and local sound and communication groups to discuss and plan solutions to their common problems.

In 1955 he began a profit-sharing incentive-oriented program for staff, supervisors and engineers.

In 1956, after years of constant day and night efforts, Milton had his first heart attack, a serious one which put him out of action of months. In the meanwhile, Norton took over running the Company and due to his efforts and the organizational and financial stability of the business, operations went on mostly as usual.

Milton tried to change his lifestyle upon his return. He found that the company still ran well without all of his former extra efforts. He began an instructional program among staff and supervisory personnel by bringing in a retired instructor from Illinois Bell. In evening sessions, procedures and practices of years past and present were discussed, agreed upon and recorded in manuals.

In 1959, Norton, who had long desired his own business,



Early 50s Boom service wagons and delivery truck.

moved to Davenport, Iowa. He began his own communications company, which he called F. N. Boom, Inc.

For the next few years, Milton, taking better care of his health, stayed at the helm of his still thriving company. In 1964, yielding to that organization's policy of major city corporate operation, he sold the "Muzak" portion of Boom Sound Engineering to the Muzak Corporation.

CHANGING TIMES

For two more years the sound and communications division of the company was run under Milton's direction. In 1966, when the strain became too great, Milton sold his company to the Downer's Grove-based Servicemaster Corporation which, at that time, was engaged in a major expansion and diversification program. Before leaving, he asked all personnel to remain and continue to operate the company as usual. The great majority agreed to stay.

For a while it appeared that the Boom Sound Engineering division of Servicemaster would continue to thrive as in the past. The new owners, after some months of study, commissioned a plant manager experienced in manufacturing to head up the company. Mutual efforts were made at cooperation, but for reasons still unknown, the profit picture began to slowly deteriorate. Meetings of personnel at all levels were held, but failed to unearth the contributing problems.

HIS LAST YEARS

Now financially secure, Milton spent his retired years attending occasional industry events, communicating with long-time friends and finally catching up on well-deserved rest. A lifetime fisherman and golfer, he as health permitted, participated in these sports.

On his 79th birthday a selected group of former employees, business friends and ex-competitors gathered to honor the man who had contributed so greatly to the industry. In a short speech, Milton showed some of his old spirit, but it was evident that his health was deteriorating.

In February, 1981, Milton suffered a fatal heart attack.

IN CONCLUSION

There were other dedicated pioneers in the sound and communications business when the century was young, but those who knew and worked for Milton Boom considered him, because of his integrity in business and his demand for perfection, the first of the professionals in the business.

In 1964, when his company was at the peak of success, a session of his peers was held at an industry seminar to pay tribute to Milton's forty years in the business. Don Davis, the Altec's district representative, spoke for all present when he proclaimed, "In the beginning, there was Boom!" ■

CD-SUBCODE PROCESSOR/EDITOR

• Philips' new CD-Subcode Processor/Editor, the LHH 0425, offers extensive operational facilities for Compact Disc program production houses, and enables significant reductions on administration and paperwork. The LHH 0425 provides a convenient and reliable way of generating and editing CD-PQ cue code data. In its editor function, it also has the unique facility of enabling program and mastering-related text information to be added to the tape master. When the cue codes are printed out from the tape master, a visual indication of subcode and text information is provided. This eliminates the need for extensive and time-consuming administrative work. The processor function of the new CD-Subcode Processor/Editor enables the CD-PQ cue code data to be translated into the standardized CD-Subcode format. Further operational facilities of the LHH 0425 give the user the possibility of generating CD-PQ cue code data for recording onto the standardized CD-Master tape. This is achieved by using the

logically laid-out system keyboard, or during CD-Master tape editing. In addition, the LHH 0425 reads CD-PQ cue code information from the standardized CD-Tape Master, providing full editing possibilities for this data. With the new Philips system, automatic generation of CD-PQ Subcode data, according to the standardized CD-Subcode Format, is also possible. Operation of the CD-Subcode Processor/Editor is straightforward, with all commands entered via an alphanumeric keyboard. Selected functions and all relevant data are displayed on an easy-to-read visual display. The keyboard can also be used to control all tape recorder functions. This is a particular advantage when automatic operation of PQ-cue code data storage or readout during CD-tape mastering, or control over the tape recorder on the CD-disc mastering process is required. To ensure optimum performance and maximize the capabilities of the new CD-Subcode Processor/Editor, the ideal system configuration includes a video display



unit with alphanumeric keyboard, hard copy printer, U-matic tape recorder, SMPTE time-code reader, and a PCM-audio program editor.

Mfr: Philips

Circle 25 on Reader Service Card

PATTERN CONTROL BASS HORN

• Community Light & Sound's CB594, said to be the first pattern control bass horn, has a mouth area of 16 square feet and an air column length of 50 inches. The high directivity and long throw capabilities of this horn make it extremely useful in situations requiring controlled LF projection down to 50 Hz. Its pattern control features prevent mid-range beaming and afford a proper directivity match to midrange or high frequency horns. Horizontal coverage is 90 degrees at 500 Hz and 60 degrees at 800 Hz. The CB594 will accept either one 18-inch loudspeaker (for use in three-way sys-

tems, crossing over at around 350 Hz into the M4 midrange loudspeaker) or one 15-inch loudspeaker (for use in two-way systems). The CB594 is hand-laminated of weatherproof fiberglass. There are no materials in it that can rust, corrode, or otherwise deteriorate due to weathering. The rear chamber containing the loudspeaker is provided with double-sealed neoprene gasketing and is water-tight. The horn with compression chamber is 68¼-in. long. The mouth of the horn is 43¼-in. by 53¼-in.

Mfr: Community Light & Sound

Circle 26 on Reader Service Card



NEW 24-BUS CONSOLES

• Amek Consoles' new Matchless series of 24-bus audio consoles offer such standard features as full 24-bus routing, 4-band EQ with swept mids and selectable Q, 8 sends, 8 returns, 8 mono subgroups, two programmable mute groups, and line return facility through the monitor section during mixdown. The Matchless is a scaled down version of the highly successful "Angela" series, utilizing the same circuit design and many of the same operational features but in a smaller, more compact package. The Matchless comes standard in a 26/24 mainframe configuration with larger frames and retrofit extenders also available. An optional version containing a full patch bay and producer's desk is forthcoming.

Mfr: Amek Consoles, Inc.

Price: Standard Matchless 26/24, \$19,950.

With patch bay and producer's desk included, \$24,950.

Circle 27 on Reader Service Card

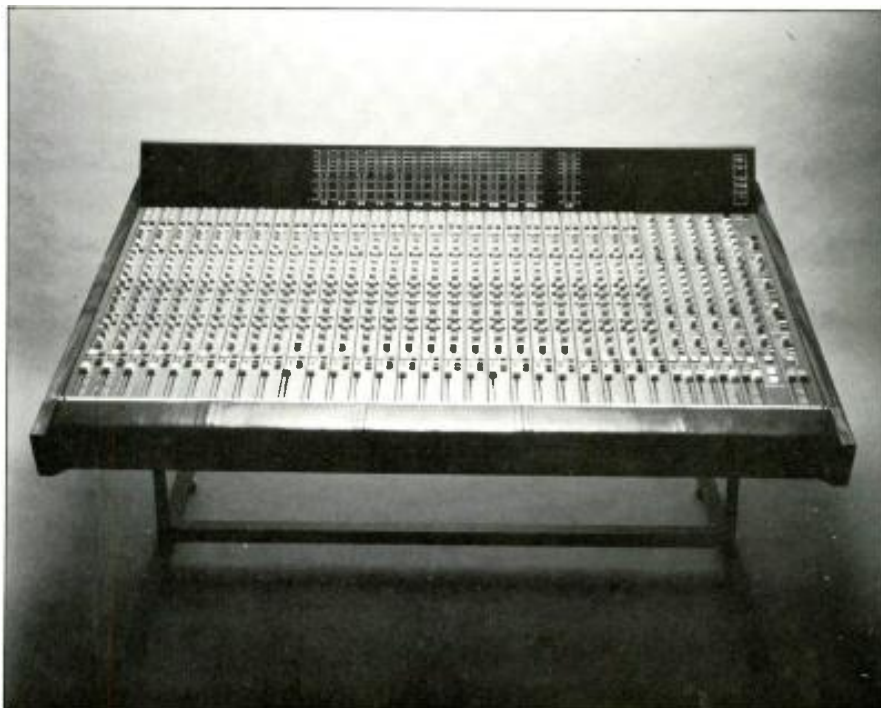

NEW DISTORTION STANDARD

• Frye Electronics' new FONIX Type 100 Distortion Standard is said to be the first instrument of its kind. The Type 100 is used to check the calibration of all types of harmonic distortion analyzers. It produces an electrical sinusoidal signal that is distorted to a precisely known percentage. The amplitude, the frequency, and the amount of distortion of the sine wave are under the control of the operator. The Type 100 Distortion Standard was produced so that distortion measurements could be easily verified. It has been observed that measurements of harmonic distortion vary between one distortion analyzer and another. With the Type 100 it is possible to know which measurement, if any, is correct. The user of the FONIX Type 100 Distortion Standard has control over the frequency of operation, the distortion percentage, and the distortion harmonics. The fundamental output frequencies are as follows: 400, 500, 800, 1000, 1500, 1600, and 2000; the harmonics are: none, 2nd, 3rd, and



2nd plus 3rd; harmonic amplitudes are: 1, 3, 10, and 30. The instrument weighs 9 lbs. and measures 10.25-in. wide by 4.5-in. high by 12.75-in. long.

Mfr: Frye Electronics, Inc.

Price: \$950.00

Circle 29 on Reader Service Card

PORTABLE REAL-TIME SOUND ANALYZER

• Spanta Inc.'s Model ATR 1 Real Time Sound Analyzer is said to be the first portable unit to incorporate a CMOS memory capable of memorizing 15 acoustical frequency responses including octave level, SPL level, weighting, and gain. The acoustical reading is displayed with bright LEDs next to calibrated scales. A flat frequency response of 20 Hz to 16 kHz assures a high degree of accuracy. Weighing only 25 ounces, the portable ATR 1 Analyzer is ideal for checking noise levels in a wide variety of applications including buildings, factories, and other environments; and for frequency response and level checking of hi-fi systems, tape recorders, and sound systems. Other advantages of the ATR 1 Analyzer include water-tight touch keyboard for easy access to various functions; fast, slow, and peak response selection

with peak response having infinite hold time; long time memory storage using CMOS technology of 1 kbit capacity; scale variation in 1, 2, or 3 dB divisions by simple touch; display luminosity automatically regulated to ambient lighting conditions; blinking LED for early warning of low battery condition; input available for analyzing exterior electrical signals (microphone, tape recorder, etc.); output available for direct recording equipment or exterior analysis equipment, and the large dynamic range/low noise microphone permits measurement at very low sound levels. The ATR 1 is supplied with a leather carrying case and power charger for charging the internal Nicad batteries or for direct use if desired.

Mfr: Spanta, Inc.

Circle 31 on Reader Service Card

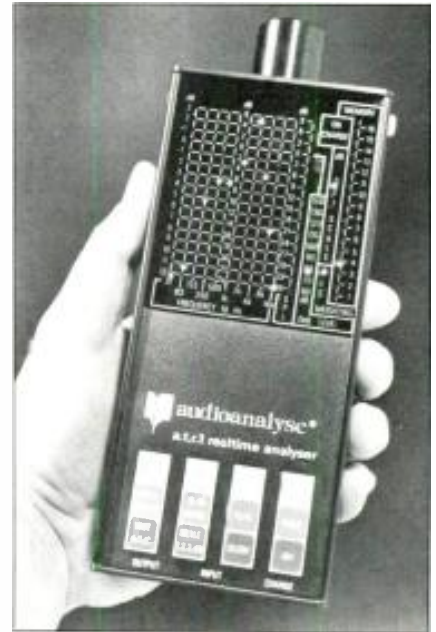

MONITOR MIXING CONSOLES

• Pulsar Labs' new M8 Series of professional monitor mixing consoles come in mainframe sizes ranging from 16 x 8 to 48 x 16. The M8 Series features total modularity (including back panel), a three-band sweep EQ, phase reverse switch, mute switch, priority cue system, 48-volt phantom power, LED metering on all gain stages, two talkbacks (house and stage), extensive headphone monitoring, and at-the-console monitoring of the cue and auxiliary mixes. The outputs also have sweepable high- and low-pass filters, mute, and cue. Pulsar also designed an additional four-send matrix on the inputs. These four-sends-per-channel are sent to the four aux. receives on the outputs. These four sends allow subgrouping of several channels together. The M8 Series consoles are capable of accepting on-board signal processing such as compressors/limiters, additional EQ, etc.

Mfr: Pulsar Labs, Inc.

Circle 30 on Reader Service Card

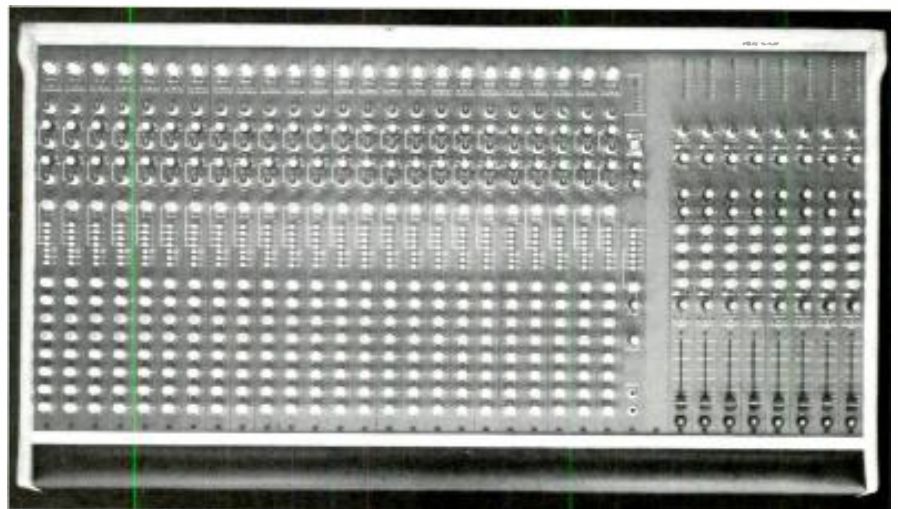

NEW XLR CONNECTORS

• Connectronics Corporation is now distributing a new range of XLR-type connectors. Constructed in England by Key Technology from black glass-filled nylon material, these connectors are light in weight, yet virtually unbreakable under normal conditions. The range consists of a male and female cable connector, male and female panel/chassis-mount connector, and an adapter for wiring the panel mount connectors to a printed circuit board. All the connectors are of a three-pin configuration. The panel mount con-

nectors are for front or rear mounting, and both the male and female require identical cut-outs for mounting. The PCB adapter is a push-on item which connects to the rear of either the male or female panel mount. This allows PCBs to be completed and wired with only a small adapter in place—without the full connector in the way until final assembly.

Mfr: Connectronics Corporation
Circle 32 on Reader Service Card



ACOUSTICAL DIFFUSOR

• The RPG™ is a new reflection phase grating acoustical diffusor that offers a novel approach to providing excellent sound diffusion over a broad frequency bandwidth, with uniform wide angle coverage. The RPG™ can be used to furnish the necessary diffusion in the live end of a LEDE™ control room and to help maintain a uniform stereo perspective across the entire width of the mixing console. It can be used to improve the acoustics of small isolation rooms, mobile studios, and drum booths by greatly increasing the number of reflected wavelets, thereby adding ambience and body to the sound. In the studio, it can be optimally mounted on the walls and ceiling to tailor the overall diffusion and reverberation, or used as a movable gobo, allowing the acoustical

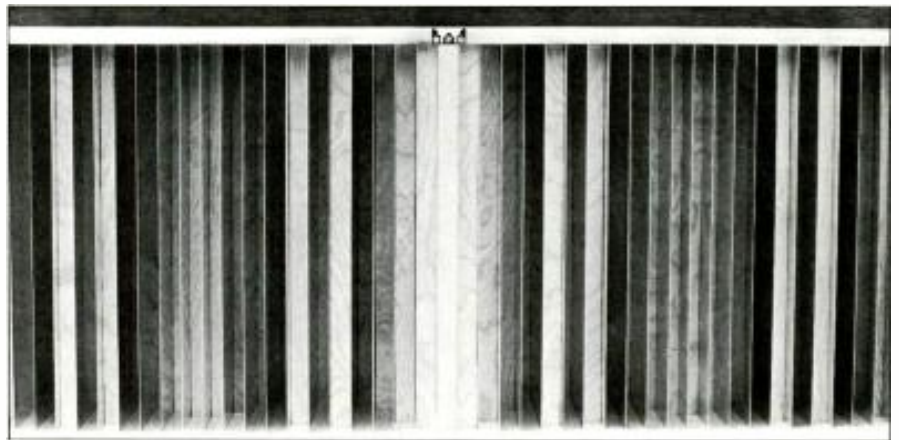

characteristics of selected “live” areas—reserved for recording acoustic instruments—to be easily altered. The units are available in kit form, and are custom-designed with a

computer aided construction and evaluation program.

Mfr: RPG Diffusor Systems, Inc.
Circle 34 on Reader Service Card

PROFESSIONAL BULK AUDIO CASSETTE TAPE

• Agfa-Gevaert's new Magnetite-12 is a magnetite formulation professional bulk audio cassette tape (Fe_3O_4) versus standard iron oxide (Fe_2O_3). Although magnetite formulations are used in some super, high-end consumer cassette tapes, this is the first time such a magnetite formulation has ever been incorporated into a professional bulk audio cassette tape. Agfa-Gevaert's new Magnetite-12 is actually several tapes in one. Its first and primary use is as an extremely high-quality bias I tape designed to meet the high demands of critical music and data recording. Because of its formula-

tion, Magnetite-12 has clear-cut advantages over standard iron oxide tapes. These include a lower noise floor and superior high-frequency output. Magnetite-12 also has a special advantage for duplication. This tape offers the advantages of a chrome-type formulation in addition to the benefits of a super-iron oxide. Without changing the bias, Magnetite-12 can be used to produce a recording for 70-microsecond playback equalization and still maintain brilliant high-frequency output. Magnetite-12 also offers all of the advantages of Agfa bulk audio cassette tape including consistency,



superior slitting, excellent wind, secure packaging, and customer service.

Mfr: Agfa-Gevaert, Inc.
Circle 33 on Reader Service Card



• **James V. Farrell and Ernest L. Heisser** have been appointed regional sales managers of the Magnetic Audio/Video Products Division, 3M. The former position of national sales manager has been split into two responsibilities due to rapid business expansion. Farrell was named western regional sales manager, broadcast/recording, commercial and educational markets. Most recently, he was national sales manager for the division. Farrell joined 3M in 1965 as a sales representative in Washington, D.C. He has held various sales management positions since then, including those of area sales manager, Los Angeles branch and International Magnetic Audio/Video Products manager. Heisser was named eastern regional sales manager, professional markets. Most recently, he was International marketing manager for the division. Heisser joined 3M in 1971 as a sales representative in Chicago. He is a former sales manager of the San Francisco branch.

• **Bruce D. Simpson** has been appointed director of sales for ITT Cannon-North America. The announcement was made by **George Ashmore**, president. As director, Mr. Simpson has responsibility for all marketing, sales, advertising, distribution and program management activities for ITT Cannon-North America. Prior to joining ITT Cannon, Mr. Simpson was vice president of marketing for **Parker Hannifin Aerospace Group** in Irvine, CA, and held that same position with **Bertea Corporation** prior to its merger with Parker in 1978. Mr. Simpson also was director of marketing and sales for **Hydraulic Research and Manufacturing Company** in Valencia, CA.

• **Andre M. Bourget** has recently joined **Solid State Logic** as International Marketing manager. Mr. Bourget, who speaks fluent English, French, German and Spanish, was previously with **Studer International** in Zurich where he was in charge of the Marketing Department. A former head of Technical Training at **Nagra Kudelski**, Mr. Bourget is a well-known figure in the professional audio world, the author of many interesting papers, and an active member of organizations such as the **SMPTE**, **IEEE**, **AES** and **SIA**.

Liftin (Regent Sound), **Leonard Pearlman (Editel/Chicago)**, **Murray Allen (Universal Recording)**, **David Teig (Independent Engineer)**, **Jerry Barnes (United Western Studios)**, and **Gary Helmers (Executive Director, SPARS)**. Following a tour of the research and development facility and administrative offices, the group met with an executive team from Otari to discuss several topics of mutual interest. **John Carey**, Otari's National Sales manager summed up the day as follows: "We were proud to host one of the first in a series of these events which began when SPARS formed as a group to represent the studio owners to manufacturers. Their opinions regarding many current equipment topics, including digital standardization, gave us many good insights."

• **Otari Corporation** recently hosted the executive committee of **SPARS (Society of Professional Audio Recording Studios)** at their facilities. The SPARS personnel included: **Mac Emerman (Criteria Recording)**, **Chris Stone (Record Plant)**, **Charles Benanty (Soundworks)**, **Nick Colleran (Alpha Audio)**.

• **Gibson** recently announced that it will be marketing **Legend Amplifiers**. Legend manufactures a series of amplifiers, cabinets and enclosures, all designed for the professional musician market. The Legend Amplifier Line includes: the Series II rock 'n' roll amplifiers available in both 50 and 100 watt R.M.S. versions and a number of different speaker configurations; the Legend Model A Series II Hybrid Amplifiers, which combine tube preamplification with solid state semiconductor technology; and Super Lead II Guitar Amplifiers with bass boost. Also offered are a variety of Legend speaker enclosures for guitar, cabinets, PA enclosures and the MS-570, a patented, professional built-in mic'ing system option on all Legend speaker cabinets and self-contained amps.

• **Cerwin-Vega Inc.** has acquired the product line of **Acoustic Control, Inc.**, Van Nuys, CA, a manufacturer of high quality musical instrument guitar and bass guitar enclosures, amplifiers, mixers and monitors. **Gene Czerwinski** remains Chairman of the Board of Cerwin-Vega. Czerwinski will be responsible for the philosophy and direction of the firm as well as research and development of all new products.

Joining the operation as president and Chief Executive Officer is **Roy H. Slavin**. Slavin was president and owner of **Standard-Grigsby, Inc.**, Aurora, Illinois, a manufacturer of electronic and audio switches. Slavin was also Chairman of **W. Gunther, GMBH**, Nuremberg, Germany, also a manufacturer of electronic switches. Slavin, who will acquire an equity position in Cerwin-Vega, will be responsible for the day-to-day operation of the company, as well as its financial direction.

Art Deco Resuscitation

• **Coronado Studios, Image Devices International** and a group of dedicated volunteers donated their professional production services to shoot a promotional tape for the Miami Beach Development Corporation drive to restore the historic Art Deco district of Miami Beach. As their contribution to the preservation drive, Coronado Studios and Miami equipment suppliers joined forces to provide the highest quality production services available to produce the best possible presentation for the restoration effort. The promotion is aimed at gathering popular and financial support for the restoration project. The tape also demonstrates the Hollywood-quality production Florida producers can provide with the state-of-the-art equipment now available in the state.

The Coronado production team covered a large portion of the district and designed a spectacular shot at the landmark Carlyle Hotel utilizing a Chapman Titan crane donated by Image Devices International. **Fred Singer**, head of Coronado Studios and mastermind of the shoot, credits the presence of the IDI Chapman Titan crane on the production and in



The IDI Chapman Titan.

the city as a major step toward the establishment of Miami as an international film capital. The availability of the Titan will help draw first-rank producers to Florida as never before.

Coronado Studios, IDI and the rest

of the Miami film community is committed to the restoration of the Art Deco district both as a local architectural treasure as well as a unique location for future film productions.

High Level Meeting

• **Philip Clarke**, managing director of **Klark-Teknik Research Limited**, was one of five highly successful Midlands businessmen invited by the British Prime Minister, **Margaret Thatcher**, to a reception at 10 Downing Street in recognition and celebration of some of the many outstanding examples of enterprise shown in British Industry today. Mr. Clarke was accompanied by his wife. Also invited to the reception was Klark-Teknik's production manager, **Doug Smith**, representing the workforce.



British Prime Minister Thatcher with Mr. and Mrs. Clarke.

Classified

Closing date is the fifteenth of the second month preceding the date of issue.

Send copies to: Classified Ad Dept.

db THE SOUND ENGINEERING MAGAZINE

1120 Old Country Road, Plainview, New York 11803

Minimum order accepted: \$25.00

Rates: \$1.00 a word

Boxed Ads: \$40.00 per column inch

db Box Number: \$8.50 for wording "Dept. XX," etc.

Plus \$1.50 to cover postage

Frequency Discounts: 6 times, 15%; 12 times, 30%

ALL CLASSIFIED ADS MUST BE PREPAID.

FOR SALE

AMPEX REEL TO REEL/CASSETTE TAPE. Grandmaster/High Performance. Pro Stereo/Mono Duplication. Volume Wholesale Pricing. MSC "The Cassette Works," 806 W. 7th, Amarillo, TX 79101. (806) 373-8473.

TECHNICS TURNTABLES IN STOCK! AKG, Neumann, UREI, Orban Eventide, dbx, Lexicon. Best pro-audio equipment. Lowest prices. IMMEDIATE DELIVERY. UAR Professional Systems. (512) 690-8888.

SENSURROUND LOW FREQUENCY ENCLOSURES with 18" CER-VEG 300 watt die-cast 96 oz. magnet driver. \$195.00. Empirical Sound, 1234 East 26th Street, Cleveland, OH 44114. (216) 241-0668.

Quality audio equipment, supplies, low prices, any quantity, custom records, on-location recordings, cassette duplicating, printed labels, blank cassettes any length, recording tape. Our twentieth year. FREE CATALOG. Stith Recording Services, 8 Redwood Lane, Ithaca, NY 14850 (607) 273-2309.

FREE 32pg Catalog & 50 Audio/Video Applic.



PHONO, MIC
TRANS, ACN
TAPE, VIDEO
LINE, OSC

Storage Mono Per Ampl

8-in 2-out, 12-in 4-out, 18-in 4-out
TV Audio & Recd Prod Consoles

Video & Audio Dist Ampl

OPAMP LABS INC (213) 934-3566
1033 N Sycamore Av LOS ANGELES CA, 90038

WANTED: Used recording equipment. All ages and varieties. Dan Alexander, 965 Hillsdale, Berkeley, CA 94708. (415) 527-4789.

BLANK AUDIO AND VIDEO CASSETTES direct from manufacturer, below wholesale, any length cassettes: 4 different qualities to choose from AMPEX and AGFA mastertape—from 1/4-inch to 2-inch. Cassette duplication also available. VHS T-120's \$6.00. Brochure. Andol Audio Products, Inc., Dept. db, 42-12 14th Ave., Brooklyn, NY 11219. Toll free 1-800-221-6578, ext. 1, NY residents (212) 435-7322.

FOR SALE: AKG and NEUMANN tube type mics, all types. Other miscellaneous equipment. Dan Alexander, 965 Hillsdale, Berkeley, CA 94708. (415) 527-4789.

MICROPHONES. Immediate delivery via UPS. All popular models in stock. Best prices you'll see in '83; PLUS we pay freight. UAR Professional Systems, 8535 Fairhaven, San Antonio, TX 78229. (512) 690-8888.

THE MOST COMPLETE
SELECTION OF

AUDIO TEST TAPES

All formats including cassettes
Write or phone for free catalog



STANDARD TAPE LABORATORY, INC.
26120 Eden Landing Road #5, Hayward, CA 94545
(415) 786-3546

SERVICES

SONGWRITERS RESOURCES and SERVICES is a non-profit organization dedicated to the education and protection of songwriters. For free information, write or call SRS, 6772 Hollywood Blvd., Dept. DB, Hollywood, CA 90028; (213) 463-7178.

New York Technical Support, Ltd

IS SERVICE

"We provide the support necessary for today's recording technology. Our work is guaranteed."

**CALL
GREG HANKS
914-776-2112**

1440 MIDLAND AVE., SUITE-1D
BRONXVILLE, NY 10708

MOVING?

Keep **db** coming without interruption!

Send in your new address *promptly*.

Enclose your old **db** mailing label, too.

Write to:

Eloise Beach, *Circ. Mgr.*
db Magazine
1120 Old Country Rd.
Plainview, N.Y. 11803

you write it

Many readers do not realize that they can also be writers for **db**. We are always seeking meaningful articles of any length. The subject matter can cover almost anything of interest and value to audio professionals.

You don't have to be an experienced writer to be published. But you do need the ability to express your idea fully, with adequate detail and information. Our editors will polish the story for you. We suggest you first submit an outline so that we can work with you in the development of the article.

You also don't have to be an artist, we'll re-do all drawings. This means we do need sufficient detail in your rough drawing or schematic so that our artists will understand what you want.

It can be prestigious to be published and it can be profitable too. All articles accepted for publication are purchased. You won't retire on our scale, but it can make a nice extra sum for that special occasion.



Precious Life

St. Jude Hospital stands on the threshold of a dream — that someday no child will lose his life to catastrophic illness. But there is still much work to be done, more diseases to conquer.

Life is a precious gift. Give the gift of life.

Danny Thomas, Founder

**ST. JUDE CHILDREN'S
RESEARCH HOSPITAL**

Box 3704, Memphis, TN 38103



Have you misplaced your **db** again? Our high quality, royal blue vinyl binders keep 12 copies of **db** neat and handy for ready reference.

Just \$9.95, available in North America only. (Payable in U.S. currency drawn on U.S. banks.) **ORDER YOURS NOW!!**

Sagamore Publishing Co., Inc.
1120 Old Country Road
Plainview, NY 11803

YES! Please send **db** binders
(@ \$9.95 each, plus applicable sales tax)
Total amount enclosed \$

Name

Company

Address

City

State Zip



1 year of
db for **\$10.00**
 (\$5.00 off the regular subscription price)

For New Subscribers Only

Charge to my Mastercharge Visa account

My account number is
 Exp. Date /

Name

Address

City State Zip

Signature

This rate limited to the USA and its Possessions, for Canada and Mexico add \$1.00; all others add \$10.00.

Please allow 8 weeks for delivery.

Check must be in U.S. funds drawn on a U.S. bank.

1 year of
db for **\$10.00**
 (\$5.00 off the regular subscription price)

For New Subscribers Only

Charge to my Mastercharge Visa account

My account number is
 Exp. Date /

Name

Address

City State Zip

Signature

This rate limited to the USA and its Possessions, for Canada and Mexico add \$1.00; all others add \$10.00

Please allow 8 weeks for delivery

Check must be in U.S. funds drawn on a U.S. bank

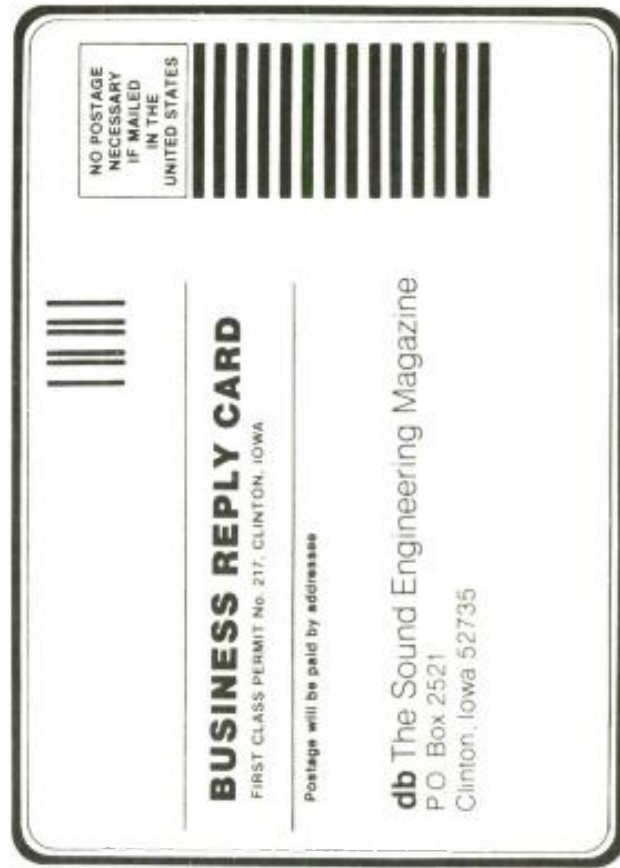

Free Information Service

To receive manufacturer's information about products advertised or editorially mentioned in this issue.....Circle the numbers on the card to correspond with the key numbers at the bottom of the advertisement or editorial mention that interests you.

1	2	3	4	5	6	7	8	9	10
11	12	13	14	15	16	17	18	19	20
21	22	23	24	25	26	27	28	29	30
31	32	33	34	35	36	37	38	39	40
41	42	43	44	45	46	47	48	49	50
51	52	53	54	55	56	57	58	59	60
61	62	63	64	65	66	67	68	69	70
71	72	73	74	75	76	77	78	79	80
81	82	83	84	85	86	87	88	89	90
91	92	93	94	95	96	97	98	99	100

May 1984—Use this card before Sept. 1984

Please type or print

Name _____

Address _____

City _____ State _____ Zip _____

City _____ State _____ Zip _____

Free Information Service

To receive manufacturer's information about products advertised or editorially mentioned in this issue.....Circle the numbers on the card to correspond with the key numbers at the bottom of the advertisement or editorial mention that interests you.

1	2	3	4	5	6	7	8	9	10
11	12	13	14	15	16	17	18	19	20
21	22	23	24	25	26	27	28	29	30
31	32	33	34	35	36	37	38	39	40
41	42	43	44	45	46	47	48	49	50
51	52	53	54	55	56	57	58	59	60
61	62	63	64	65	66	67	68	69	70
71	72	73	74	75	76	77	78	79	80
81	82	83	84	85	86	87	88	89	90
91	92	93	94	95	96	97	98	99	100

May 1984—Use this card before Sept. 1984

Please type or print

Name _____

Address _____

City _____ State _____ Zip _____

Drawn on a U.S. Bank

BUSINESS REPLY CARD

FIRST CLASS PERMIT No. 1043, HICKSVILLE, N.Y.

Mail to:



The Sound Engineering Magazine
Sagamore Publishing Co.
1120 Old Country Road
Plainview, New York 11803



NO POSTAGE
NECESSARY
IF MAILED
IN THE
UNITED STATES



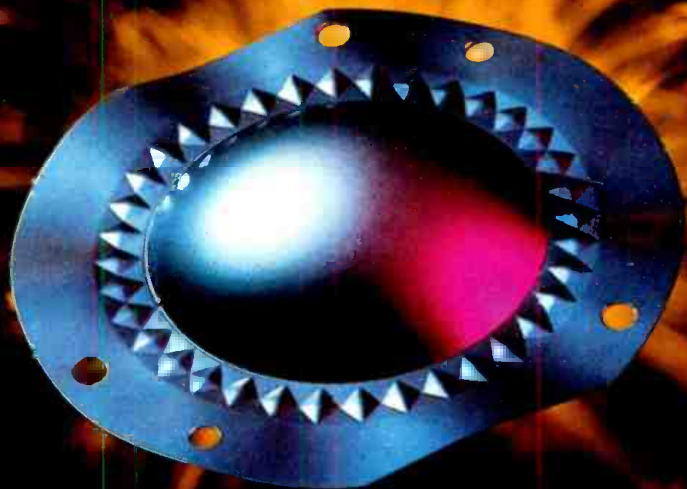

JBL's unique titanium diaphragm and "Diamond Surround" bring new purity and consistency to high frequency response.

IT TOOK JBL SCIENCE, A NITROGEN EXPLOSION, AND PURE TITANIUM TO GIVE YOU PERFECTED HIGH FREQUENCY SOUND.

High frequency sound has always fought with the technology that brings it to the ear. The driver diaphragm has been most vulnerable, pushed to the breaking point, unable to hold uniform frequency response.

JBL scientists decided to fight back. They exploded nitrogen into a remarkable metal, pure titanium, encircling their unique diaphragm with a vibration-absorbing "Diamond Surround," so revolutionary it warranted its own patent.

The result? A diaphragm that delivers and sustains a power and purity to high frequency response never before approached in the industry.

Perfecting titanium technology is just one of innumerable ways in which JBL science is re-shaping the quality of sound. From ultimate accuracy in laying down your initial tracks, to capturing the full power and subtlety of your final mix, JBL audio systems are focused on the most exacting demands of the recording studio professional. To find out which system is designed to meet your specific requirements, contact your authorized JBL professional products dealer today.



JBL Incorporated,
8500 Balboa Boulevard
P.O. Box 2200,
Northridge, CA 91329
U.S.A.



JBL/harman international ©JBL INCORPORATED, 1984



Shure's new FP31 Mixer takes a big weight off your shoulders.

Introducing the most innovative field production mixer of its kind. Shure's FP31. You won't find another mixer this small with these features, dependability and ease of operation.

The FP31 measures only 6⁵/₁₆" x 5⁵/₁₆" x 1⁷/₈", and weighs just 2.2 pounds! Incredibly, it offers the same important features as much larger mixers. Plus, a few of its own.

Every channel has a mic/line level and a low-cut filter switch. And to prevent overload distortion, there's a built-in limiter with adjustable threshold.

The FP31 can be powered by two internal 9-volt batteries, or from an external 12-volt source. A green LED flashes to remind you that the mixer is on. Phantom and A-B power are also provided to operate lavalier and shotgun microphones.

A slate tone can be laid

down on the tape for locating specific takes, and there's also a built-in mic for voice slating.

The mixer also has two separate mic/line outputs for 2-camera shoots and a tape output to feed a cassette. For monitoring, there are two stereo headphone jacks—one 1/4-inch and one for miniplugs. The FP31's rugged nylon carrying case allows you easy access to every mixer function and lets you piggyback the mixer on your VCR or other equipment.

For ENG, EFP and film use, Shure's FP31 has everything you need to make your mix a perfect success. Coming from a mixer this small, that's quite an accomplishment.

For more information on Shure's FP31 Mixer, call or write Shure Brothers Inc., 222 Hartrey Ave., Evanston, IL 60204, (312) 866-2553.



SHURE

THE SOUND OF THE PROFESSIONALS®...WORLDWIDE

Circle 12 on Reader Service Card