

APRIL 1984
\$1.95

db

THE SOUND ENGINEERING MAGAZINE



REPRODUCTION OF THE
ORIGINAL RECORDING OF
THE COMMUNICATIONS
RECORDING
MAY 1984
1984

WHY IT'S OTARI FOR MORE POST-PRODUCTION PROS.

Today's hot topic is audio post-production. At Otari, it was a hot topic years ago—and still is.

In 1979, we introduced the MTR-90 multi-track recorder which featured our new pinchrollerless tape drive system. It was quickly accepted as a superior performer under synchronizer control—with faster search and lock-up for quicker, easier sessions.

In 1980, we introduced the MTR-10/12 1/4-inch and 1/2-inch machines—the industry's first with microprocessor-controlled transports.

In 1981, the Series II MTR-90 provided even faster, more accurate tape handling, and was the first audio machine to offer

a serial port for computer control of the transport functions.

Along the way, we've worked with every major synchronizer and video editor manufacturer to provide our customers with the interfaces they require. Synchronizer interface connectors are now standard equipment on all MTR Series recorders.

Our commitment to audio post-production continues.

In 1983, we adopted the IEC standard for center-track SMPTE/EBU time code recording on 1/4-inch tape. We also developed a 1-inch C format audio layback recorder conversion kit for the MTR-90, and an RS232C Serial control port for the MTR-10/12.

Now, we're introducing the EC-400

Series' an advanced tape speed resolver capable of phase lock over a $\pm 30\%$ frequency range.

These are just a few of the ways we've delivered on our commitment to the audio post-production professional. To get the complete picture, contact your nearest authorized Otari dealer.

Otari Corporation
2 Davis Drive
Belmont, California 94002
(415) 592-8311 Telex 910-376-4890



The EC-401 Resolver: A precision speed controller with Widelok™—everything necessary to lock a tape machine's speed control track to any internal or external time base reference. Available as a compact, rack mount package, or for the MTR-10/12, as a plug-in module.



Post Sound, Los Angeles

Technology you can Trust.



Editor/Publisher
Larry Zide

Associate Publisher
Elaine Zide

Managing Editor
Mark B. Waldstein

Associate Editor
Ricki Zide

Technical Editor
Linda Cortese

European Editor
John Borwick

Technical Advisor
John Eargle

Layout & Design
Kathi Lippe

Advertising Coordinator
Karen Coffin

Book Sales
Lydia Galogrides

Circulation Manager
Elise Beach

Graphics
S&S Graphics

Typography
Spartan Phototypes Co.

FEATURES

GLASS IN THE STUDIO 28	<i>F. Alton Everest</i>
DIGITAL AUDIO BROADCASTING AT WGBH, BOSTON 34	<i>Peter Swanson</i>
TESTING. ONE TWO, THREE 37	<i>Jesse Klapholz</i>
SPARS: DATA TRACK 46	
db TEST REPORT: THE SHURE FP31 ENG MIXER 54	<i>Len Feldman</i>

COLUMNS

SOUND REINFORCEMENT 6	<i>John Eargle</i>
SCENES FROM EUROPE 14	<i>John Borwick</i>
COMPUTER AUDIO 18	<i>Jesse Klapholz</i>
THEORY AND PRACTICE 20	<i>Ken Pohlmann</i>

DEPARTMENTS

LETTERS 2	CALENDAR 4	EDITORIAL 27	CLASSIFIED 60
NEW PRODUCTS AND SERVICES 67			
PEOPLE, PLACES, HAPPENINGS 62			

db, the Sound Engineering Magazine (ISSN 0014-7146) is published monthly by Sagamore Publishing Company, Inc. Entire contents copyright © 1984 by Sagamore Publishing Co., 1920 Old Country Road, Plainville, N.Y. 11803. Telephone (516) 438-6590. db is published for those individuals and firms in professional audio recording, broadcast, audio-visual, sound reinforcement, consultants, video recording, film sound, etc. Application should be made on the subscription form in the rear of each issue. Subscriptions are \$15.00 per year (\$28.00 per year outside U.S.). Postage, \$16.00 per year Canada) in U.S. funds. Single copies are \$1.95 each. Editorial, Publishing and Sales Office: 1920 Old Country Road, Plainville, New York 11803. Controlled circulation postage paid at Plainville, NY 11803 and at additional mailing offices.

ONE PASS

**The Only Four-Second
Tape Erasers**

**That's Garner...
The Quality Eraser**

You're recording on a machine that costs hundreds or thousands of dollars, and you're reording on recycled tape. Can you guarantee that tape is absolutely clean? You can if you're using a Garner Audio Tape Degausser.

Garner is the standard of the industry...designed to the specifications of leading tape manufacturers. Garner is a conveyor-belt tape eraser. It can erase in less than five seconds what most degaussers take up to a minute to erase, and Garner erasers do a better job.

Time savings, ease of operation, quality of erasure, and rugged construction make Garner the most cost-effective eraser available.

Garner has established a reputation as the "Eraser People" because we manufacture a complete line of both audio and video erasers. Call and let us show you what a Garner eraser can do for you.



Dependability...Guaranteed

garner industries

4200 N. 48th Street Lincoln, NE 68504
Phone: (402) 464-5911 Telex: 438068

Letters

HEY GUYS, HOW ABOUT IT?

TO THE EDITOR:

As a freelance writer, I would like to express a problem I run into all the time. I call it the Mod NDP (Model Number Designation Problem). It pertains specifically to the manufacturers of audio equipment (though I'm sure it applies to other fields of technology as well). Come on, you guys...in a time when creating standards is *in*, why not create one amongst yourselves that will make it easier for us writers—and the editors as well—to determine whether a particular model number is two letters followed directly by three numbers, two letters followed by a hyphen followed by three numbers, or two letters followed by a space followed by three numbers...or maybe one letter followed directly by three numbers, or two letters, a hyphen, two numbers, and a letter. I mean, I just go nuts trying to find out how a certain company designates a certain product. OK, OK. You want to be different. You don't want to be confused with anyone else. I can understand that. But what about the poor guy/gal who has to sit with an article or transcribed tape in front of them in which a studio owner, producer, engineer, or artist explains what type of equipment they like, or have, in every category?! It's enough to drive me nuts. If there was a single format say, for microphones, another for recording consoles, another for monitors, etc., at least there would be some logical structure to make things a little easier. But as haphazard as things are now, it's a tough act to follow.

—SUSAN CLARKE
NYC

db replies:

Ms Clarke, we wonder if you realize the can of wiggling worms you are opening up. Imagine the idea of manufacturers actually talking to each other and agreeing entirely on doing something. Seriously, though, we have the same problems all the time and your letter has touched a semi-raw nerve. Manufacturers—are you out there? Are you reading this?

Index of Advertisers

Alpha Audio	25
Amber	19
BASF	5
Bruel & Kjaer.....	Cover III
Carvin	15
Cetec Gauss	17
Crown	3
Garner	2
Klark-Teknik	16
LT Sound.....	60
Orban	4
Otari	Cover II
Polyline.....	59
Production EFX	58
Shure Bros.....	Cover IV
Studer Revox	11
Tektronix	12-13
3M	8-9

About The Cover

• This month's cover features the ABC Radio Network in NYC. Among the equipment currently in use (L-R): an Otari MTR-90II 24 track master recorder, an Otari MTR-10 (½ inch 4 track) recorder, Panasonic turntables (with Dolby noise reduction below), a Yamaha M916 console, and an Otari MTR-10 (¼ inch 2 track) recorder.

We Didn't Believe it Either.

Our introduction to the Pressure Zone Microphone® broke our previous record for skepticism. But the hardware converted us. Like Orville Wright's gas powered kite, it outperformed its appearance. The rest, as they say, is history. In the 3 years since we began production, sales

have mushroomed and the best recording studios use PZM®. So do a whole lot of other people on a whole lot of stages, church podiums, and conference room tables.

Success has changed us. One of these days we'll probably start telling you we knew it would work all along.



CROWN

1718 W. Mishawaka Road, Elkhart, IN 46517
(219) 294-5571

Call or write for details

Circle 15 on Reader Service Card

www.americanradiohistory.com

Calendar

MAY

- 5 **MAC '84.** Sponsored by the Midwest Acoustics Conference in conjunction with the School of the Arts Institute of Chicago. Location: Film Center, School of the Arts Institute of Chicago, Columbus Drive and Jackson Blvd., Chicago, IL. For more information, contact: Thomas Yackish at 219/844-0520, ext. 471, or Brian Homas at 312/677-3340.
- 11-14 **2nd AES International Conference: The Art and Technology of Recording.** Location: Disneyland Hotel, Anaheim, CA. For more information, contact: Convention Services, Audio Engineering Society, 60 East 42nd St., New York, NY 10165. Tel: 212/661-2355.

- 19 **Audio Aspects of Post Production.** Organized and sponsored by the Hollywood Section of SMPTE. Locations: Paramount Studios, Glen Glenn Sound and Warner Hollywood Studios. For more information, contact: Jack Spring, c/o Eastman Kodak Co., 6706 Santa Monica Blvd., Hollywood, CA 90038; Tel: 213/464-6131, or Howard La Zare, c/o Consolidated Film Industries, 959 N. Seward St., Hollywood, CA 90038. Tel.: 213/462-3161.

JUNE

- 4-29 **Summer Program in Underwater Acoustics and Signal Processing.** Given by The Pennsylvania State University's Applied Re-

search Laboratory and Graduate Program in Acoustics. Written inquiries should be directed to Dr. Alan D. Stuart, Summer Program Coordinator, c/o The Penn State Graduate Program in Acoustics, P.O. Box 30, State College, PA 16801. Telephone inquiries may be made to Mrs. Barbara Crocken, Administrative Assistant, at 814/865-6364.

- 18-29 **Techniques of Digital Audio Processing.** Given by the Experimental Music Studio at MIT. For application information, contact: Director of the Summer Session, Room E19-356, Massachusetts Institute of Technology, Cambridge, MA 02139.



It speaks for itself.

We thought about hiring an expensive superstar to extoll the virtues of the famous Orban 622B Parametric EQ. After all, there are 622B's backing up superstars worldwide in recording studios, arena shows, broadcast facilities. . . you name it! But we decided not to. Because ultimately, the Orban 622B speaks for itself—it's the most widely used, popular professional Parametric in the world.

The 622B combines full, four-band Parametric equalization with tunable notch filtering to offer extraordinary versatility and control. Our "constant-Q" design provides -40dB attenuation while allowing gentle, musically-useful broadband EQ too. This makes the 622B ideal for critical sound reinforcement chores as well as studio production work.

Call your local Orbandealer for further information.

orban Orban Associates Inc. 645 Bryant St.
San Francisco, CA 94107 (415) 957-1067
TLX: 17-1480

Circle 14 on Reader Service Card

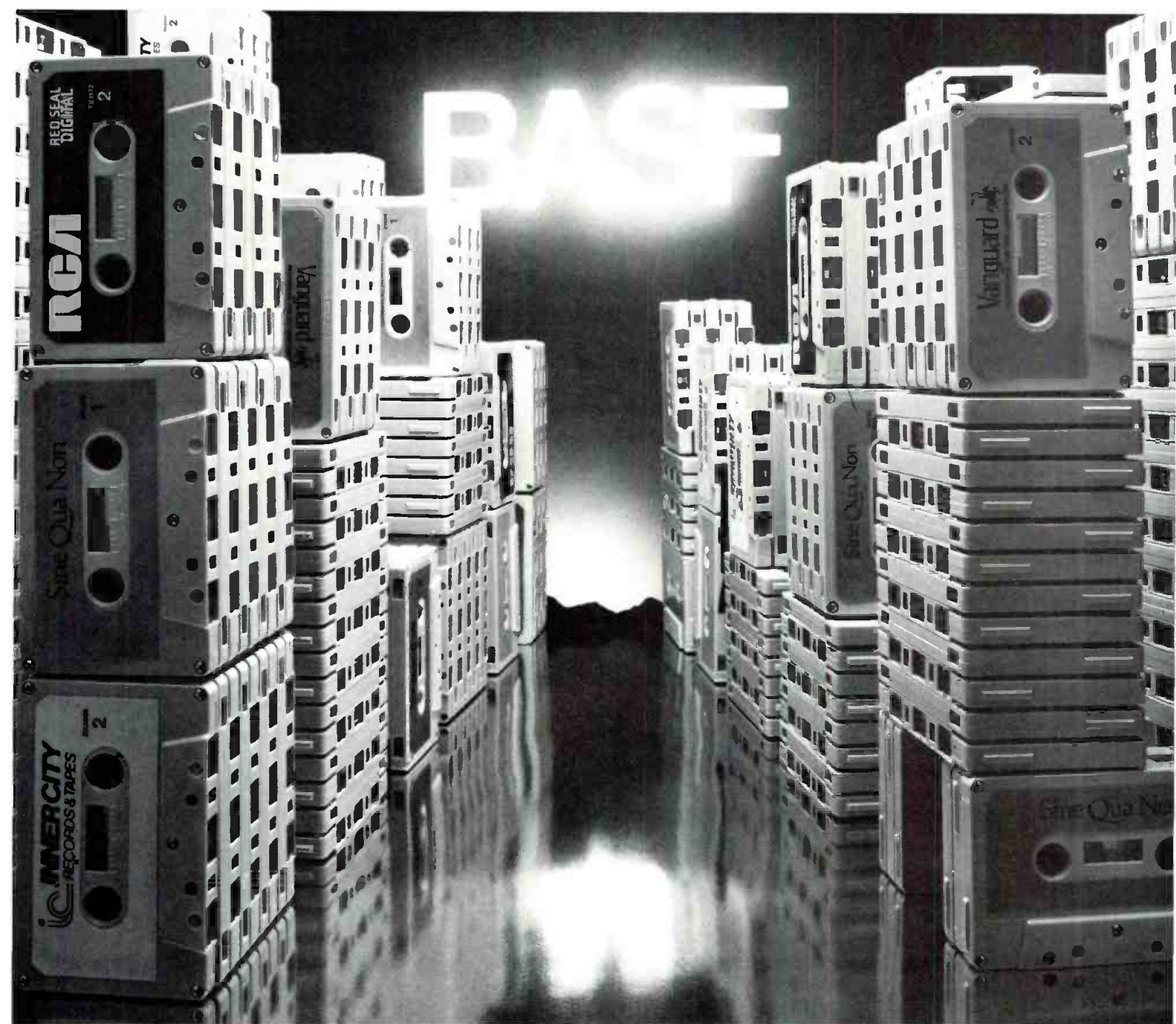

THE ROAD TO PLATINUM IS PAVED WITH BASF PURE CHROME.

The only place to be in the recording business is #1. And with cassettes taking over nearly 50% of the industry's pre-recorded sales this year, the best way to get to the top is on BASF Pure Chrome duplicating tape.

BASF Pure Chrome helps you climb the charts faster because it duplicates your sounds more perfectly than any other brand. Technically speaking, BASF Pure Chrome offers extended high frequency Maximum Output Level (MOL), plus the world's lowest background noise. And our exclusive Pure Chrome formulation is extremely clean and stable at even the highest duplicating speeds. The payoff? Audio performance that's virtually indistinguishable from a studio master recorded at 15 I.P.S.



Best of all, just about anyone can change over from ferric oxide to BASF Pure Chrome with the greatest of ease—and without any need for additional equipment or expenses.

Find out why such major names as RCA Red Seal Digital, Sine Qua Non, Vanguard and Inner City all put their trust in us. Switch to BASF Pure Chrome duplicating tape. Because when you put "CrO₂" on your label, you're not just guaranteeing the public the pure music they're paying for. You're paving your way to platinum with BASF Pure Chrome.

 **BASF**
Chrome Audio & Video Tapes

Circle 16 on Reader Service Card

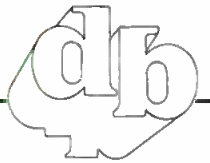

Determining Near and Far Coverage Requirements in a Central Array

• Continuing our discussion of last month, we will now combine two high-frequency horns to provide smooth coverage from front to back of a long room.

TYPES OF HORNS

The horns commonly available have nominal horizontal and vertical coverage angles of 90-by-40 degrees, 60-by-40 degrees, and 40-by-20 degrees. These nominal coverage angles are those at which the response is -6 dB relative to the on-axis response of the horn. Several manufacturers make these horns in larger designs, which maintain their pattern control down to the 500 Hz range. Smaller versions of these horns usually maintain their pattern control down to the 1 or 1.2 kHz range. The choice of which ones to use should be based mainly on the acoustical considerations of the space. A fairly reverberant space, for example, would call for tight pattern control as low in frequency as possible; this would be a good argument for using the larger horns. There are, of course, space limitations as well as cost considerations in most jobs.

The pertinent characteristics of our "building block" horns are:

Coverage (degrees)	Directivity Index (2 kHz band)	Sensitivity (1 watt at 1 meter)
90-by-40	11 dB	113 dB SPL
60-by-40	13 dB	115 dB SPL
40-by-20	16 dB	118 dB SPL

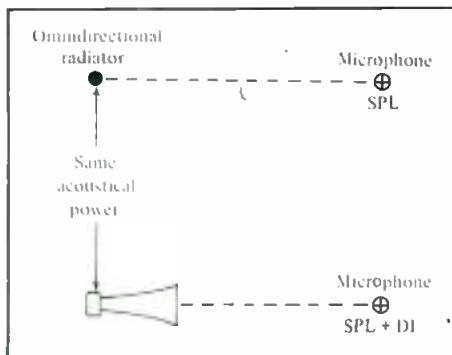

Figure 1. Directivity Index (DI).

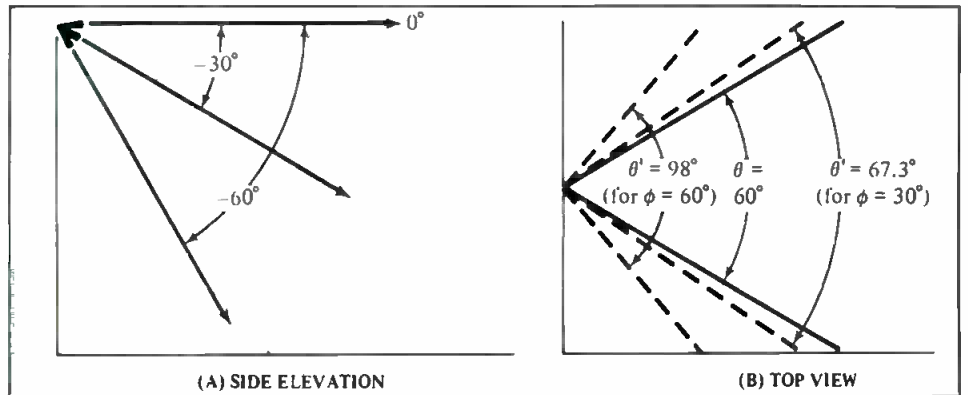

Figure 2. Foreshortened coverage angles.

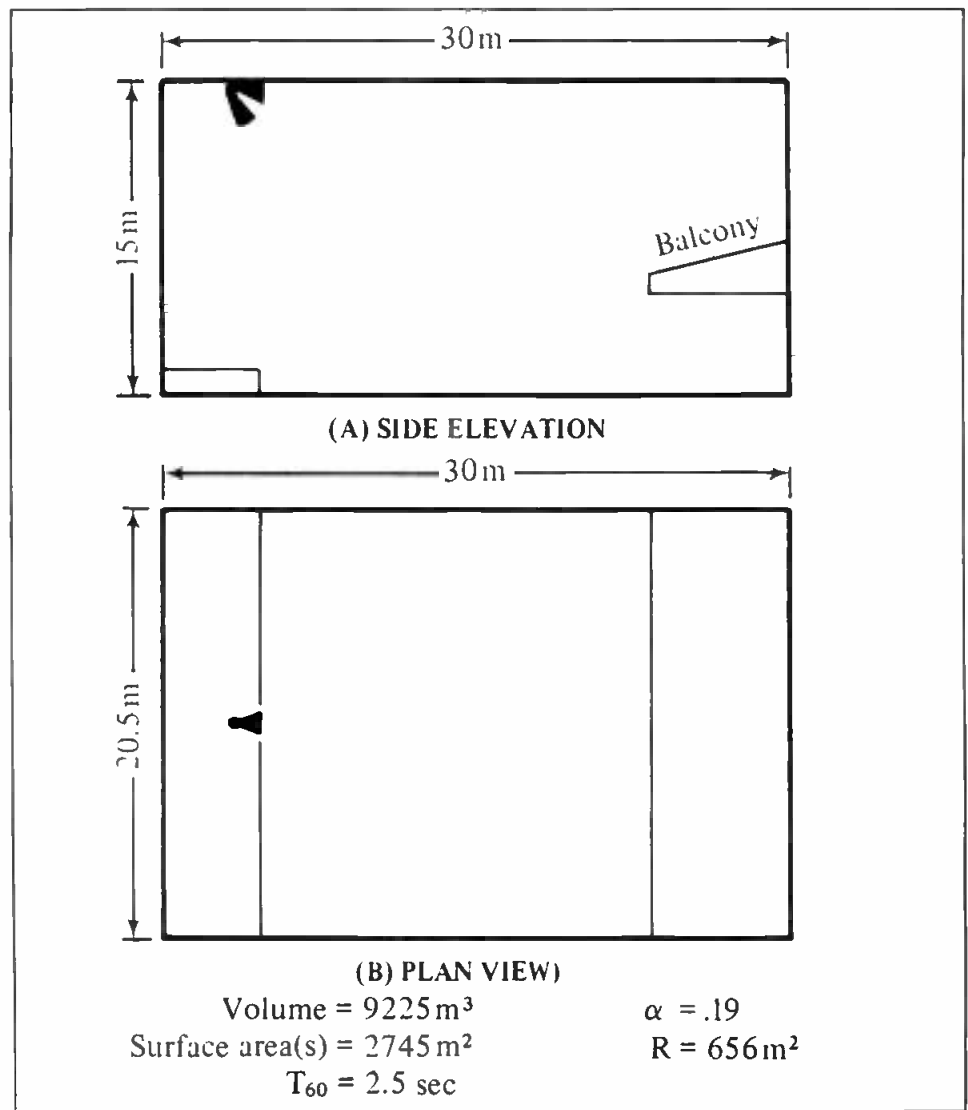

Figure 3. Details of a House of Worship.

The directivity index (DI) is a measure of the horn's on-axis directivity relative to an omnidirectional source radiating the same acoustical power. The notion is shown in FIGURE 1.

The sensitivity is measured along the major axis of the horn, and it, of course, determines how much power must be available for a given direct field coverage. Maximum power will depend upon the compression driver chosen for the job; typical devices used in sound reinforcement can handle inputs in the range of 50 to 100 watts.

FORESHORTENED COVERAGE ANGLES

As an aid to geometrical plotting of coverage, it is useful to determine the apparent coverage angle, as seen in plan view, of a given horn. FIGURE 2A shows the side elevation views of a nominal 60-degree-wide horn aimed at three angles—zero, -30, and -60 degrees. In FIGURE 2B, we show how the plan view of the coverage angle seems to splay outward as the elevation angle is increased.

The equation which relates the apparent coverage angle and the actual coverage angle and the elevation angle is:

$$\theta' = 2 \arctan \left(\frac{\tan \frac{\theta}{2}}{\cos \phi} \right)$$

In this equation, θ is the actual coverage angle, θ' is the coverage angle as seen foreshortened in plan view, and ϕ is the elevation angle.

A DESIGN EXAMPLE

FIGURES 3A and 3B show views of a large space with a balcony at the rear. Pertinent acoustical data on the space is given.

FIGURE 4 expands the view to show how we would aim horns in order to get the coverage we want. First, we observe the rather low throw from the loudspeaker location to the rear of the room. This suggests that one of the 40-by-20-degree devices would be appropriate.

From FIGURE 4A we determine by inspection that a downward elevation angle of 25 degrees will point the horn at the center front of the balcony. Let us aim it accordingly and use our equation to determine the horizontal coverage angle as seen in the plan view in FIGURE 4B. Entering $\theta = 40$ and $\phi = -30$, we determine θ' of 44 degrees. Plotting this at 4B,

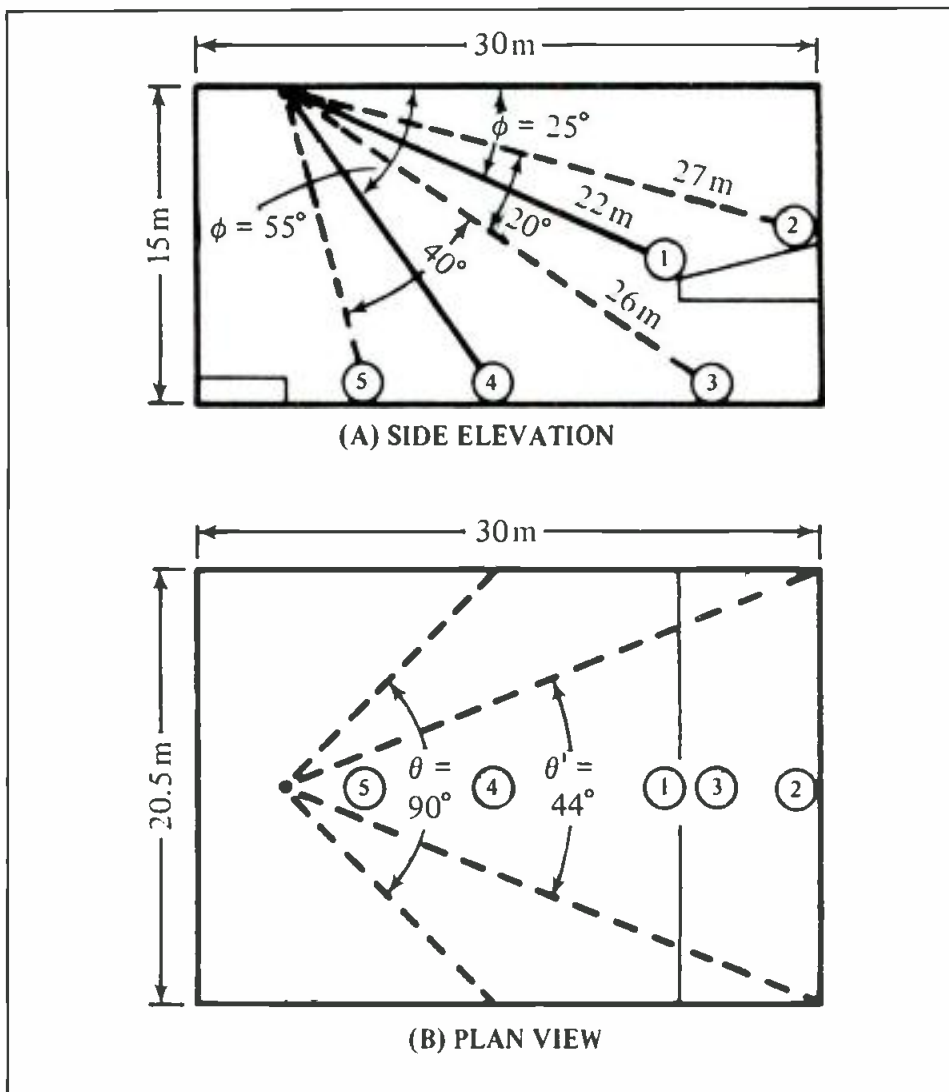

Figure 4. Determining elevation and coverage angles.

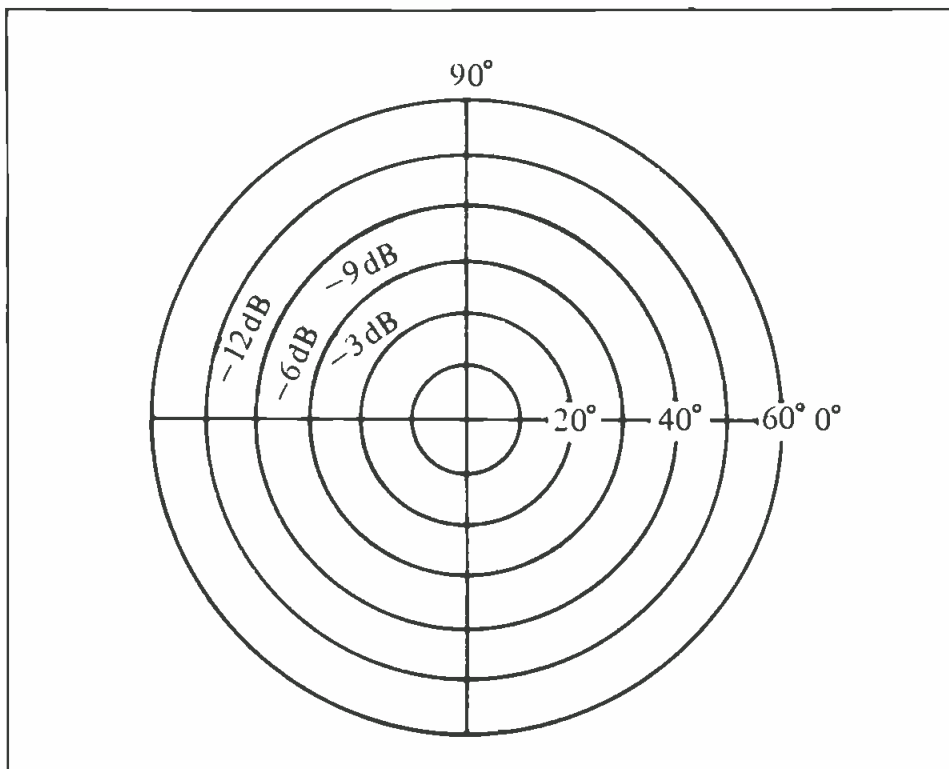
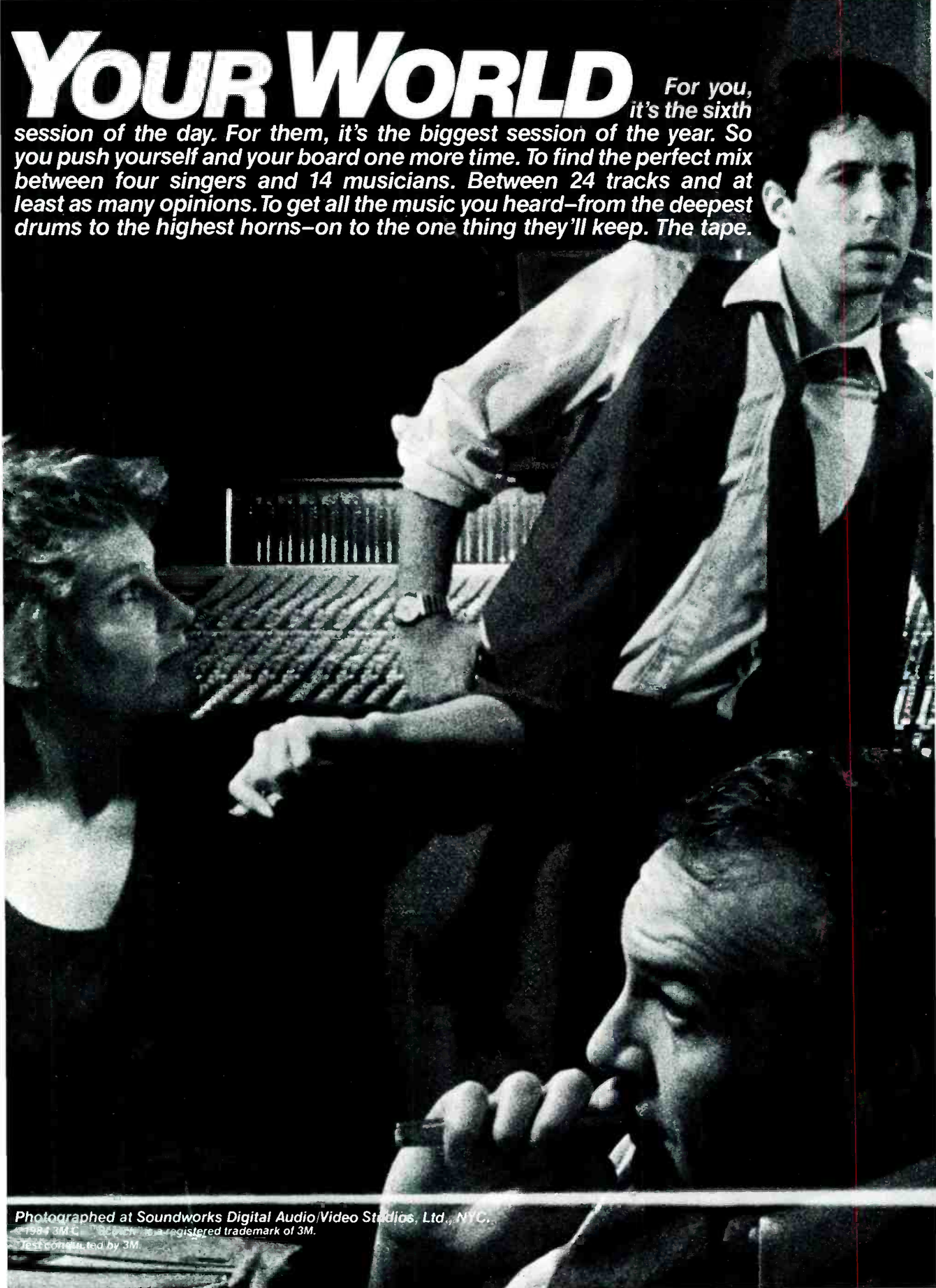

Figure 5. Typical Isobars (at 2 kHz) for a large 60 x 40 degree horn.

YOUR WORLD

For you, it's the sixth session of the day. For them, it's the biggest session of the year. So you push yourself and your board one more time. To find the perfect mix between four singers and 14 musicians. Between 24 tracks and at least as many opinions. To get all the music you heard—from the deepest drums to the highest horns—on to the one thing they'll keep. The tape.



Photographed at Soundworks Digital Audio/Video Studios, Ltd., NYC.

© 1994 3M. "3M" is a registered trademark of 3M.

Test conducted by 3M.

OUR TAPE



We know that our tape is the one constant you have to be able to count on. So we make mastering tapes of truly world-class quality. Like Scotch® 226, a mix of Scotch virtuosity and the versatility to meet your many mastering needs—music, voices, effects. And Scotch 250—with the greatest dynamic range and lowest noise of any tape, it is simply the best music mastering tape in the world. Both tapes were preferred by Ampex and Agfa users at a listening test* conducted at the 1983 Audio Engineering Society

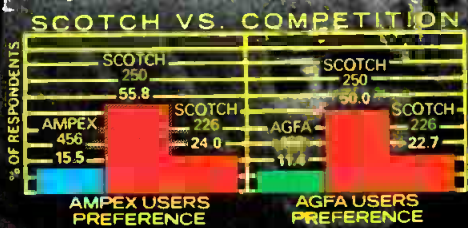

convention in New York. They are both backed by our own engineers a call away. They are just two of the tapes that make us...number one in the world of the pro.

Scotch

AUDIO & VIDEO TAPES

NUMBER ONE IN THE WORLD OF THE PRO



Circle 17 on Reader Service Card

we observe that the horn will provide nearly complete coverage of the entire width of the balcony. In the side elevation view, we note that the rear of the balcony and the floor space under the balcony are just within the vertical -6 dB beamwidth of the horn.

At this point, it is appropriate to determine actual levels in the seating areas. Taking a reference input of one watt to the horn, we determine, by inverse square law, that the direct field level at point 1, the front of the balcony, will be $118 - 20 \log(22)$, or 91 dB SPL. At point 2, the rear of the balcony, the level will be $118 - 20 \log(27) - 6$, or 83.5 dB SPL. Note here that we subtracted 6 dB, inasmuch as the rear of the balcony lies along the -6 dB zone of the horn's vertical beamwidth. Likewise, the level at point 3, the area just under the front of the balcony, will be $118 - 20 \log(26) - 6$, or 84 dB SPL.

Our next step is to provide coverage for the rest of the space. By inspection of the side elevation view, it appears as though a 60-by-40 device might work. We will try one of these, orienting its elevation angle so that the -6 dB zone lies along that of the far-throw horn at point 3 on the floor.

First, we draw the horn's vertical coverage angle at 4A. Again, using our equation, we calculate that a nominal 60 degree angle tilted downward 55 degrees will appear in plan view to be 90 degrees wide. We plot this angle in 4B, noting that the horizontal -6 dB zones intersect the side walls at just about floor level.

Now we will power this horn so that, at point 3, it will produce the same level as the far-throw horn produced, or 84 dB SPL. We do not yet know what input power to the driver will do this, so we must work backwards:

Level (1 meter on axis) = $84 + 6 + 20 \log(26) = 118$ dB SPL.

Since the horn's rated sensitivity is 115 dB, one watt at one meter, we must power the horn 3 dB greater in level if it is to match the long-throw horn at point 3.

When this is done, the new level at point 3 will be 6 dB greater or 90 dB SPL, since the two radiators are effectively combining in phase at that point. Further, we can calculate the level at point 4 to be 93 dB SPL and the level at point 5 to be 88 dB SPL.

Thus, the direct field levels at the five points analyzed are:

Point 1 91 dB SPL

Point 2 83.5 dB SPL

Point 3 90 dB SPL

Point 4 93 dB SPL

Point 5 88 dB SPL

In general, this coverage along the center line of the room is fairly smooth, front to back. We will leave it to the reader to calculate other levels in the space, taking into account the -6 dB zones of the loudspeakers at the side walls.

The next question we must ask is whether there is sufficient coverage at the front of the room toward the sides. It is obvious that a horn does not simply "shut off" outside its nominal coverage angles. As we stated, these are the -6 dB down angles. If we study the horn's directional characteristics in isobar form, we will see that the coverage angles along the -9 dB zones are wider than those along the -6 dB zones. With a set of isobars, we can determine, using the methods we have demonstrated in this column, just what the coverage will be. FIGURE 5 shows the -3, -6, -9, and -12 dB isobars for a large 60-by-40 degree horn in the 2 kHz band. If such a horn were to be used in the example we have worked here, then the system would probably be adequate. Note in the figure that at the -9 dB points, the horn is about 90 degrees wide horizontally and 70 degrees vertically.

If the designer felt that the coverage beyond the -6 dB zones were insufficient, then more horns would be added. Two of these would suffice, each splayed to cover the left and right front of the room.

We have not included in this discussion the requirement of a low-frequency section for the system. One would, of course, be needed for spectral balance, crossed over at the correct frequency, powered as required, and aimed toward the middle of the seating space. The sufficiently broad pattern of a 380mm (15-in.) loudspeaker below 800 Hz makes orientation relatively non-critical.

The final question we will answer has to do with the direct-to-reverberant ratio in the room. In order to calculate this, we must determine the reverberant level in the space at our reference power inputs to the two horns. The equation which relates horn efficiency to on-axis sensitivity and DI is:

$$\text{Sensitivity} = 109 + \text{DI} + 10 \log \text{efficiency.}$$

Since we know the sensitivities and DI values for the two horns, we can calculate the efficiencies. ■

For the 40-by-20 horn:
10 log efficiency = -7 dB.
The efficiency is given by:

$$\text{efficiency} = 10^{\frac{-7}{10}} = 0.2, \text{ or } 20 \text{ percent.}$$

We make the calculation for the 60-by-40 horn, and we get the same value of 20 percent.

Our reference inputs are 1 watt and 2 watts; therefore, the total acoustical power will be:

$$\text{Acoustical power (W)} = 0.2(1) + 0.2(2) = 0.6 \text{ acoustical watts.}$$

From the acoustical data on the room itself we take the room constant, R, of 656 square meters and use the following equation to get the reverberant level in the room:

$$L(\text{rev}) = 126 + 10 \log(W/R).$$

Solving this equation, we get a reverberant sound pressure level in the room of 95.5 dB. Comparing this reverberant level with the direct field levels tabulated earlier, we observe that all of the points we examined are within 7 dB of the predominating reverberant level. The exception is the rear of the balcony, where the direct field level is about 12 dB lower than the reverberant level.

The reader who has been following these columns for the last year and a half will now want to go back to October, 1982's column and look at FIGURE 6. That figure illustrates the Peutz criteria for system intelligibility as a function of reverberation time and direct-to-reverberant ratio. Note that the direct-to-reverberant ratio of -12 dB and a reverberation time of 2.5 seconds corresponds to intelligibility just beyond the "acceptable" line. In all probability, things would work out OK at the rear of the balcony for most listeners, but certainly those with any degree of hearing problem should sit on the main floor.

There is another thing that will work to our advantage. If the house is filled with people, then the reverberant level will be lower due to the high absorption that the first incident sound will see on the floor. The reverberant level we calculated earlier was one that would correspond to an essentially empty house.

CONCLUSION

This column demonstrates many of the principles we have studied over the last two years. System design involves a number of interrelated disciplines, and the trade-offs involved in good system design require broad knowledge in many areas. ■

The Studer for Tomorrow's Teleproduction



Introducing the A810 stereo recorder with center track SMPTE code...from Studer, the world leader in audio recording equipment.

Stereo+ SMPTE Code on 1/4" Tape

This is the one recorder made to meet your demand for better quality stereo audio for video productions. With a Studer A810 you can produce state-of-the-art audio tracks, then use any SMPTE-based synchronizing/editing system to lock the A810 to your VTR's.

You don't need a 4-track recorder. You don't need 1/2" tape. And you don't have to program offsets into your synchronizer.

It's all possible because the A810's optional center-track SMPTE code system uses a separate set of code heads, working in conjunction with a microprocessor controlled digital delay. The separate heads assure code-to-audio crosstalk rejection of better than 90 dB. And the digital delay automatically compensates for the tape travel time between code and audio heads at all four tape speeds.

Total Microprocessor Control

The on-board CPU controls all A810 transport functions, all audio status switching, and all audio parameter settings. Design flexibility lets you program the A810 to do what you want it to do. A zero locate and one autolocate position are fixed, but three additional "soft keys" may be programmed for a variety of functions, including up to three more locate positions and two different edit modes. All audio parameters (bias, level, EQ) are set digitally and stored in memory, with memory storage for two different formulations at all four speeds. After initial set-up, you can switch to your alternate tape simply by pushing a button.

External Computer Control

With the optional serial interface, you can control all transport and audio functions with your personal computer (RS232) or with any device conforming to the forthcoming EBU/SMPTE standard (RS422 modified).

Studer Performance and Reliability

Using all-new electronics with advanced phase compensation circuits, the A810 delivers audio performance that is – compared to most other recorders – just short of phenomenal. And, as with all Studer products, the A810 is made from solid components and assembled with Swiss precision.

Get your production room ready for tomorrow's stereo audio. Call today for the location of your nearest Studer dealer.

STUDER REVOX

Studer Revox America/1425 Elm Hill Pike/Nashville, TN 37210/(615)254-5651

Circle 25 on Reader Service Card

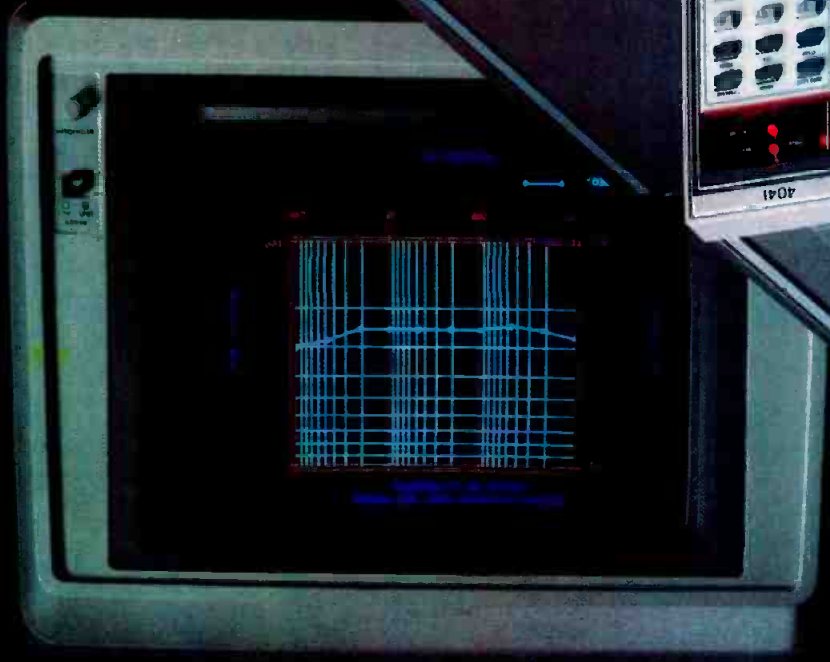
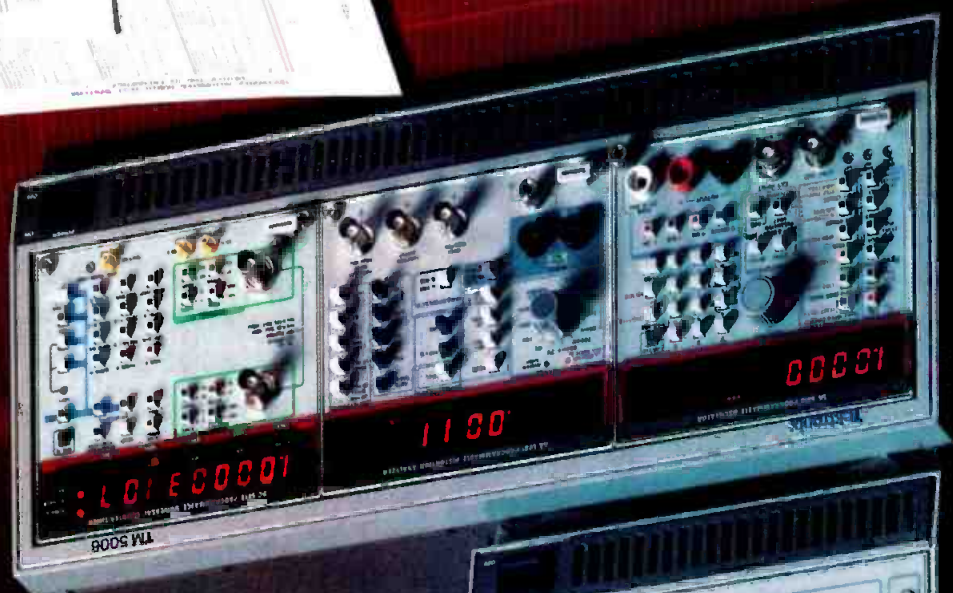

Tektronix automated audio test systems: built to test the best.

Tek's new SG5010/AA5001 Programmable Audio Oscillator and Distortion Analyzer System lets you test the finest professional audio and communications equipment, with uncompromisingly high-quality measurements.

Finally, you can count on computer-controlled audio test equipment that's better than the products you're testing. Coupled with an IEEE-488 controller, the SG5010/AA5001 completes most audio tests quickly, automatically, even unattended.

The new Tek system features extremely low residual noise (less than 3 microvolts) and low distortion (typically 0.0012% at midband when using the audio bandpass filter). It allows you to make all standard audio tests—including THD, IMD (SMPTE, DIN, CCIF difference tone), gain/loss, and signal-to-noise ratio.

Perform most audio production tests up to ten times faster than manually.

Tek's Programmable Audio Test System will help your technicians achieve both faster throughput and more comprehensive testing. And because one Tek automated system can do the work of five to ten fully equipped benches, your investment will pay for itself several times over.

Eliminate most slow, repetitive performance testing involved in audio design. Use the new Tek test system to automate measurements, then display the results via graphics for quickest interpretation. Free up design engineers for more creative tasks.

Detect broadcast signal degradation promptly, before equipment failure. The Tek audio test system can help cut downtime by accurately measuring and documenting increases in noise or distortion, or other trends affecting signal quality. Thorough audio proof reports can be generated automatically, every day if desired.

Test with the best. Highly accurate results, made quickly

and automatically, add up to savings in the audio field. Even if you're not ready for full automation, Tek also makes the fastest, easiest-to-use manual audio test equipment. Our AA501/SG505 package offers performance equivalent to our new programmable system.

Find out more about how Tek instruments can pay off in your audio application.

Call your nearest Tektronix Sales Office, or contact:
U.S.A., Asia, Australia, Central & South America, Japan
Tektronix, Inc.
P.O. Box 1700
Beaverton, OR 97075
Phone: 800/547-1512
Oregon only: 800/452-1877
Europe, Africa, Middle East
Tektronix Europe B.V.
Postbox 827
1180 AV Amstelveen
The Netherlands
Telex: 18312-18328
Canada
Tektronix Canada Inc.
P.O. Box 6500
Barrie, Ontario L4M 4V3
Phone 705/737-2700

Tektronix
COMMITTED TO EXCELLENCE

Scenes From Europe

BBC Radio Takes to the Road

• The British Broadcasting Corporation is a model of the public service broadcasting tradition. While primarily serving its home radio and TV audiences in the UK, it has also built up a worldwide reputation in all programme categories from its accurate and unbiased news reporting on the BBC World Service to high quality music recordings, television drama and comedy shows distributed

on tape to stations in all countries. A vital part of all this BBC activity is its fleet of sophisticated vehicles for location ("outside broadcast") assignments. I recently visited the BBC's new central depot for these vehicles in London and was given a demonstration of all their facilities.

One type of vehicle, which comes in different custom-built versions, is the stereo control vehicle. In one of these,

for example, I found a 40-channel Solid State Logic computer-assisted mixer (see FIGURE 1) capable of doubling up to 80 microphone inputs. This desk uses 400-series software and operates in real time, allowing total recall. The monitor loudspeakers are BBC-designed LS5/8s; CCTV is used for picture-monitoring on opera relays, etc. This can be seen alongside the SSL visual display unit. FIGURE 2



Figure 1. Interior of Type A stereo control vehicle featuring 40-channel solid state logic console.



Figure 3. A smaller version (Type B) of a stereo control vehicle.



Figure 2. Another view of the interior of the stereo control vehicle.



Figure 4. Interior of Type B stereo control vehicle featuring a 40-channel Calrec mixer.

shows another interior shot of this vehicle with three two-track recorders over the SSL computer, and a 24-track Studer A800 on the right.

A smaller stereo control vehicle is shown in FIGURE 3. It houses a 40-channel Calrec mixer (FIGURE 4) and four Studer B62 recorders. All these vehicles can be supported for very complex broadcasts or recordings by a special multi-track recording vehicle carrying two 24-track Studer A800s and associated equipment. Double-doors and a tail lift allow



Figure 5. Radio 1 Roadshow on location.



Figure 6. Interior of a mobile studio.

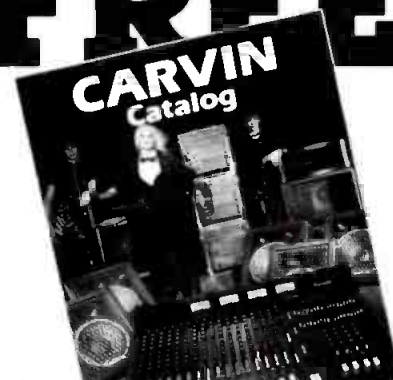

Figure 7. Control room of a mobile studio featuring a 30-channel Glen Sound mixing desk and Studer B62 recorders.

these machines to be used in the truck or removed to a suitable venue location.

The largest vehicle in the BBC fleet is the huge "Radio 1 Roadshow" articulated trailer (FIGURE 5) whose side folds down to form a 3-metre deep stage for instant on-air presentations. Equipment includes two EMT950 turntables, three ITC/SP tape-cartridge machines, radio microphones, etc. Not much smaller are the mobile studios, which contain everything needed to cover interviews and commentaries on outside events (the roof has been reinforced and has a guard-rail to allow roof-top commentating). The Ford R1114 coach chassis measures 11 x 2.5 metres (the maximum size allowed on British roads), and contains three main areas: an acoustically-treated studio (FIGURE 6) with TV monitors for "off-tube" commentaries, a control room (FIGURE 7) with 30-channel Glen Sound mixing desk, four Studer B62 recorders and comprehensive communication facilities, plus a radio-link compartment having a 10-metre pneumatic antenna mast and various fixed and manpack transceivers.

FREE!



1984 Pro-Line Guide

- ★ If you're a pro sound user or contractor, get the FREE 84 page CARVIN catalog. See top groups like *Missing Persons*, *Alabama*, *Roy Clark*, and *Jefferson Starship* play CARVIN.
- ★ Choose from hi-end recording consoles with parametric EQ, 800 watt amps, 1/3 octave equalizers, bi & tri amp crossovers, pro monitor & concert speaker systems with Electro-Voice, Renkus Heinz, & MagnaLab drivers. Over 25 sound systems with further reduced prices. Also, a complete line of guitars and amps.
- ★ Compare Carvin's exceptional values and service. Buy DIRECT at Pro-Net prices — saving you hundreds of dollars.

Write: CARVIN, Dept. DM84, 1155 Industrial Ave. Escondido, CA 92025. PH 619-747-1710

FREE CARVIN CATALOG

Free Catalog \$2 for Rush 1st Class Mail

Name _____
 Address _____
 City _____
 State _____ Zip _____ DM84

WORLD'S FIRST ALL-DIGITAL

Though the BBC has operated a small digital recording vehicle since 1979, at first using two Sony PCM 1600 digital recorders, and more recently a pair of Telefunken/Mitsubishi MX80 machines, their most exciting project to date is the new all-digital control vehicle (FIGURE 8). Though incomplete when I saw it, this 12.2 x 2.5 metre articulated trailer was being kitted out to go into service shortly, thus making it the world's first mobile all-digital facility. It uses hydraulically operated rams to expand the control room to 1.2 metres beyond normal. At its centre is a Neve DSP (Digital Signal Processing) console employing the BBC's own COPAS (Computer for Processing Audio Signals) channel processing system. The 48 inputs are



Figure 8. Overhead view of the BBC's all-digital control vehicle.

converted from analogue to digital in transportable boxes connected via

fibre optic cable to the main processor. A combination of "pipe-lining" and external multipliers means that 16 separate "activities" can be programmed into each 56-bit micro-instruction and executed in 140 nano-seconds.

The digital console can be carried into the recording venue or used in the truck. It has 48 motorized faders, expandable to 62 if required, which are freely assignable to inputs, groups or main outputs. All channel facilities including equalization, limiting, compression, echo, and cue are accessed on two main assignable panels, reducing the number of controls by an amazing factor of 20.

This investment in the very latest sound recording technology is typical of the BBC's dedication to the highest standards of broadcasting and should further enhance their reputation at home and abroad. ■

The unequaliser— from Klark-Teknik Research.

When you're engineering the sound system for a major auditorium, you need something special in fit-and-forget technology ... the Klark-Teknik Research DN301. This Attenuating Graphic Equaliser has an unfair advantage over the competition: the micro-electronic reliability of active-circuit filters and thick-film technology earn it a 5-year parts warranty.

Designed for theatres, conference centres and multi-media installations, 30 precision faders give up to 15dB of cut at 1/3

octave ISO frequencies matching our DN60 Spectrum Analyser. The state-of-the-art DN301 has sweepable high and low pass filters and selectable low pass slope, 20dB overall gain restores signal gain to unity, and a built-in failsafe bypass ensures uninterrupted performances.

Specification includes:

Frequency response $\pm 0.5\text{dB}$
20Hz-20kHz
Distortion $< 0.01\%$ @ 1kHz
Equivalent input noise $< -90\text{dBm}$
Output gain 0 to +20dB

The Klark-Teknik promise — a bigger investment in the future with:

1. Greater R&D investment, with 12% of all company personnel directly involved in new product development.
2. Consistent attention to production economies for professional performance at 'breakthrough' prices.
3. Effective 'Reliability Control' during manufacture.



KLARK TEKNIK



British designed, British made



Manufactured by Klark-Teknik Research Limited
Coppice Trading Estate, Kidderminster DY11 7JJ,
England. Telephone: (0562) 741515 Telex: 339821

Klark-Teknik Electronics Inc.
262a Eastern Parkway, Farmingdale,
NY 11735, USA. Telephone: (516) 249-3660

Omnimedia Corporation Limited
9653 Côte de Liesse/Dorval, Quebec H9P 1A3,
Canada. Telephone: (514) 636 9971

Circle 19 on Reader Service Card

At Last, a 200 Watt Coax!

Everyone knows the benefit of a well designed coaxial loudspeaker... a single-point sound source. Until now, the most popular coaxials presented severe power limitations... had to have "trick" crossovers... and needed time compensation. Gauss technology has changed all that.

The new Gauss 3588 is the first computer designed coaxial. But, we know computers can't hear, so we used a panel of "golden ears" at the fall AES to help determine the final sound of the loudspeaker. This combination of computer design and great ears gives you a coax with the sound and the power you want!

With a conservative power rating of 200 watts RMS, this new Gauss coaxial has been tested to 750 watts delivering clean sound... and can "coast" along at control room levels still delivering great sound. Metric sensitivity is 95dB for the low frequency and 109dB HF.

Because of our proprietary design parameters, both drivers are virtually in the same acoustic plane, eliminating the need for costly time compensation networks. For bi-amp operation, you can use any standard professional quality crossover.

The unique *cosh* horn was designed using

Gauss's exclusive Computer Aided Time Spectrometry (CATS™) program. This design provides an extremely stable image... reduced second harmonic distortion... and virtually no midrange shadowing.

For additional information on the new Gauss coaxial loudspeaker, call or write Cetec Gauss, 9130 Glenoaks Blvd., Sun Valley, CA 91352, (213) 875-1900. Or better yet, hear it at a selected sound specialist soon.

Sound Ideas for
Tomorrow... Today!
gauss
by Cetec

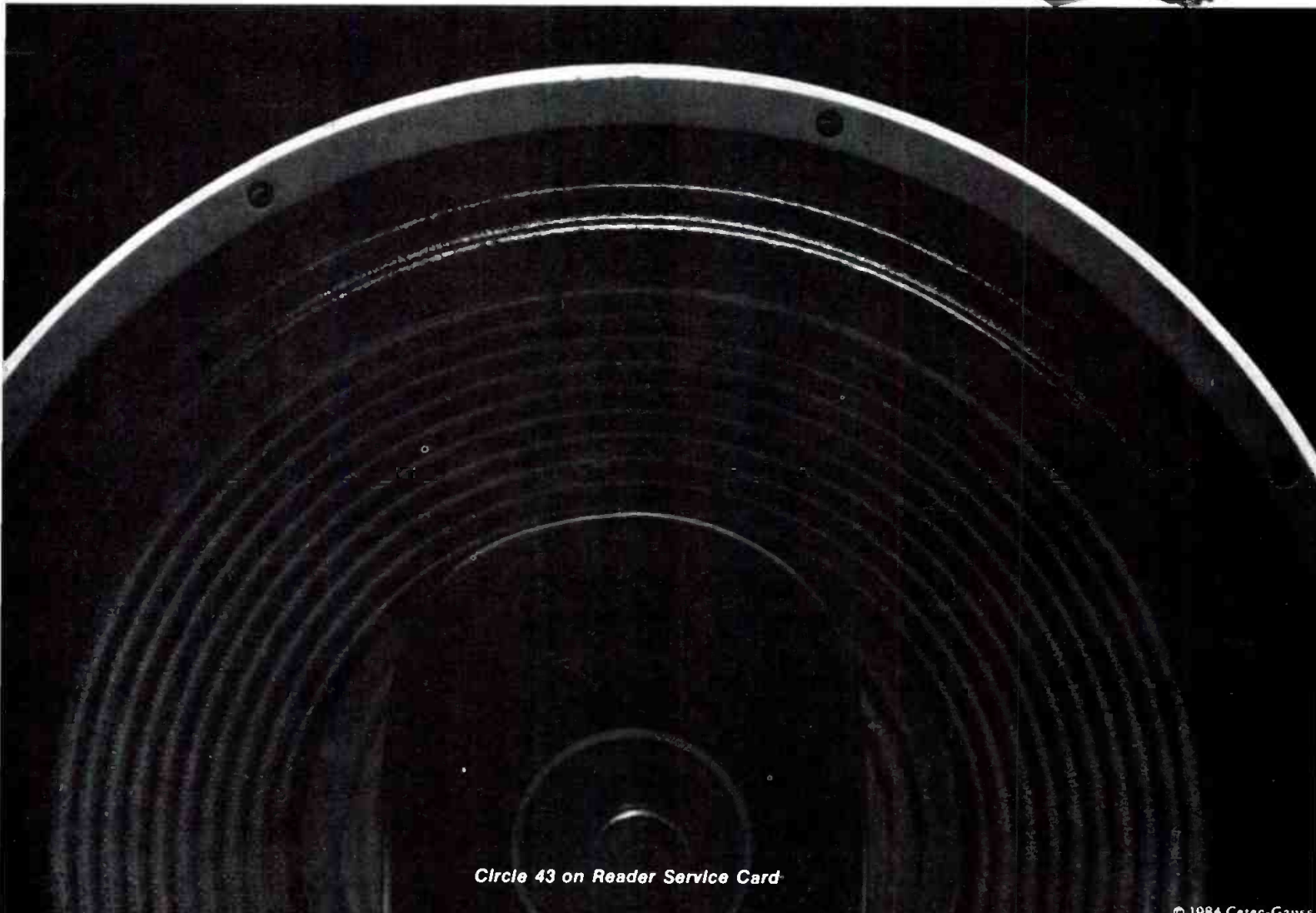

Circle 43 on Reader Service Card

© 1984 Cetec-Gauss



Welcome to the Future

• To start this column off with the common scenario of someone walking into the vast world of microcomputing as we know it today would tell us nothing we don't already know. However, consider what the year 2001 might bring.

It's Friday, March 29, 2001 at 5:00 PM and the crew is preparing for a concert that evening in the Klingon Memorial Hall. This evening's performance is an intergalactic tribute to two great pioneers in audio and acoustics: Smarth Nader and Eey Tee. The crew (all two of them) is discussing the show setup with the Inter-Galactic Arkestra's conductor Moon Mah as they all take turns passing the Orb to each other. The entire hall is run by a single computer, d2-b2. By the standards of the day, d2-b2's functions are quite normal. All of the auditory illusions of the concert are partially created and completely controlled by it. There are no speaker or electronics systems as we used in the 70's and 80's; instead, there are antennas (concealed within the architecture, of course) that induce an RF carrier into the hall. This carrier frequency is then modulated by another radio frequency, thus creating a sound field in the air itself! The parameters defining the total auditory experience, including the imaging, dimensionality, and dispersion characteristics of the sound field, are all monitored through every note of the performance by d2-b2.

It's now 8:00 PM and we find our way to our respective experiencing spaces (conventional seating, as we knew it in the 80's, has long since become obsolete). Each experiencing space has a control panel with the facilities to adjust all of the experience parameters. You say that you don't like the mix? No problem—a couple of hits on this button and that one, and the experience is just right for you! You don't like the lighting designer's choice of colors? No problem—d2-b2's remote panel will fix

that right up for your individual space!

During intermission, we browse by the museum display in the lobby; its theme is the history of sound. The display starts with the telephone and goes right through all of those obsolete loudspeakers, microphones, compact disc players, digital synthesizers, automated and digital mixing consoles, digital recorders, and a whole slew of video recorders and two-dimensional image display devices. How did these people ever live with this archaic equipment! Oh well, it's time to return to the hall for the conclusion of this evening's experience.

A few minutes into part two, I realize that I don't like this vocalist, so I turn her off. Much better now. Soon the concert is over and the crew breaks the show down, which only takes two minutes.

This may all seem a little too sci-fi for some of us, but with technology growing at its current rate, this 2001 scenario may be a little conservative. For example, Jaffe Acoustics is currently using systems in concert halls that control the acoustic environment via an integrated system of transducers and electronics under the control of a computer. Also, Ricoh of Japan (that's right, the copying machine people), is currently developing what they call a "sound laser," which uses a modulated RF carrier wave to produce a directivity controlled sound field in any environment.

Now that we have some idea of where we might be headed in this world of bits and bytes, let's take a look at a little history.

THREE THOUSAND NINE HUNDRED AND EIGHTY-FOUR YEARS OF COMPUTING

Date

Cavemen: Use of pebbles in grooves in a board for counting.

2000 B.C.: The development of the Abacus in China—still in use in China and Japan.

1614 A.D.: The discovery of logarithms by John Napier.

1617 A.D.: Primitive slide rule, "Napier's bones" developed; its parts were carved from ivory.

1642 A.D.: Blaise Pascal introduces toothed wheels into a mechanical calculator.

1812 A.D.: Babbage's analytical engine designed; a mechanical mathematical digital computer.

1940 A.D.: Professor Howard Aiken and others at Harvard University develop Mark I, an automatic sequence controlled calculator using more than 760,000 electro-mechanical parts. The Mark I measured 51 feet long by 8 feet high and could multiply two numbers in about three seconds.

1944 A.D.: ENIAC, the first electronic digital computer was developed at the University of Pennsylvania in Philadelphia. ENIAC (Electronic Numerical Integrator And Computer) used over 18,000 thermionic valves (vacuum tubes) and could complete over 5,000 additions per second. It was maintained by teams of technicians whose job was to keep all the tubes operating, change plug-in connections, and set switches to accomplish programming tasks. ENIAC was used by the US Army to calculate artillery firing tables.

First Generation Computers

1951 A.D.: The first mass-produced electronic digital computer, the UNIVAC I, was built; it could complete two million additions per second (cost several million dollars), and was sold by Remington Rand. The first UNIVAC I was installed for and used by the US Bureau of Census.

1953 A.D.: IBM enters the scene with the 701.

Second Generation Computers

1959 A.D.: This generation was sparked by the changeover from vacuum tubes to transistors in

commercial computers. This generation of computers was smaller, more reliable, less expensive, and used less electrical power for the same computational power as the first generation machines. RCA produced a business machine, the 501. Control Data produced scientific machines, the 1604 and 3600, while the UNIVAC and IBM machines were both business and scientific machines.

Third Generation Computers

1966 A.D.: Manufacturers introduced the concept of a family of computers, where each model had a unique number and, in general, the higher the number, the greater the computational power. Now programs and data from the small machine could be used on the larger machines with little or no modification. This is referred to as upward compatibility.

Fourth Generation Computers

1975 A.D.: Microprocessor-based computer systems able to complete over one million instructions per second at a cost of a few hundred dollars.

Today: Digital computers that can execute over four million instructions per second with a memory storage of over 64,000 characters (of data and program) for under a hundred dollars.

SO WHAT'S A COMPUTER

"So what exactly is a computer?" you ask. The IEEE Standard Dictionary of Electrical and Electronic Terms, Second Edition, defines the computer, "(1) A machine for carrying out calculations. (2) By extension, a machine for carrying out specified transformations on information. (3) A stored-program data-processing system." Further, it defines the Analog Computer, "(general)—An automatic computing device that operates in terms of continuous variation of some physical quantities, such as electrical voltages and currents, mechanical shaft rotations, or displacements, and which is used primarily to solve differential equations.... Results are measured on meters, dials, oscillograph recorders, or oscilloscopes."

The IEEE Dictionary then defines the Digital Computer—"(1) (information processing). A computer that

operates on discrete data by performing arithmetic and logic processes on these data. Contrast with Analog Computer. (2) (test, measurement and diagnosis equipment). A computer in which discrete quantities are represented in digital form and which generally is made to solve mathematical problems by iterative use of the fundamental processes of addition, subtraction, multiplication, and division."

In this column we will be dealing exclusively with the Family of Digital Computers. Uh oh, did I say digital? But don't panic. One can make this analogy: If everyone that took their driver's license test had to explain the inner workings of a combustion engine, there would hardly be anyone on the road! To own and operate a computer does not require that a person know how every chip talks to the other. However, it does require the know-how of filling up the gas, checking the oil, and keeping those tires in good shape.

Next month we'll take a look at how the current generation of computers developed, how they work, and the resultant languages and standards. ■

Looking for a Distortion Measurement System?

The Amber model 3501 is quite simply the highest performance, most featured, yet lowest cost audio distortion and noise measurement system available.

It offers state-of-the-art performance with THD measurements to below 0.0008% (-102dB), maximum output level to +30dBm and noise measurements to below -120dBm.

It has features like automatic operation, optional balanced input/output and powerful IMD measurement capability. It includes comprehensive noise weighting with four user changeable filters. Unique features like manual spectrum analysis and selectable bandwidth signal-to-noise measurements.

The 3501 is fast, easy to use and its light weight and small size make it very portable. It can even be battery powered.

And the best part is that it is 20% to 50% below what you would pay elsewhere for less performance. The Amber 3501 starts at \$2100. Send for full technical details.



amber

Amber Electro Design Inc.
4810 Jean Talon West
Montreal Canada H4P 2N5
Telephone (514) 735 4105

Circle 21 on Reader Service Card



Is Mixing a Heuristic Process?

• I have always believed, perhaps naively, that any task becomes more successful and meaningful if an attempt is made to understand the nature of the endeavor. I have always championed the idea of knowing essentially and intuitively what things are about. Along those lines, I think that nothing is learned until the philosophical root of the idea has taken hold. The simplest way to test for that germination is to take a task that you think you know, and try to teach it to someone else. Only in your attempts at verbalization of your knowledge can you determine whether or not you really understand what it is you have hitherto taken for granted. A teacher is thus privileged because he knows all too well how little he knows. The greatest teachers readily understand that knowledge is something they know, but when asked to explain it, they know that they do not know. Perhaps the greatest teacher of them all, Socrates, often confessed his supposed ignorance to better illustrate the need for a man to question what he thinks he knows. Socrates was fearless in his belief that an unexamined life is not worthy of a man, and so outspoken in his philosophical beliefs that the leaders of Athens sentenced him to death.

CREATIVE PROBLEM-SOLVING

I have often supposed that one of Socrates' favorite ideas, an idea that certainly would cause consternation

to a corrupt government, was embodied in the word "heuriskein," which when translated to modern English becomes "heuristic." Ancient Greek is an amazing language in which far-reaching concepts can be very compactly expressed. The word heuristic has many connotations and requires many English words to express, such as; getting, inventing, devising, anything serving to find out and acquire. Overall, heuristics involves a study of the methods and rules of discovery, and, in terms of problem solving, presents a systematic process to attain a preconceived goal for which no absolutely identifiable method previously existed. In other words, a heuristic problem solving method invents its own means of solution. It doesn't have to rely on previous methods—its algorithm creates its own means of solution anew. I can almost imagine Socrates in the Athenian forums exhorting his pupils to discard old ideas and think for themselves, heuristically.

That advice still holds good for people solving today's problems. Heuristics is still a good method, and its efficiency can be enhanced if computers are brought into the solution. Heuristic programming differs from standard algorithmic techniques because ad hoc methods are used instead of a traditional sequence of instructions. Instead of subdividing the final solution into a large number of contributing solutions, a heuristic program deals in general principles of self definition.

Chess playing is an example of problem solving where no practical algorithm for solution exists; the better heuristic wins, using adaptive reasoning working from basic principles. A classic method of computer programming for heuristic operations is to provide a model, from which interpretations of the model are heuristic. For example, using the principle of "control the center of the chess board," a program could more effectively choose its moves, discarding unpromising ones in favor of strategy-satisfying ones. Thus given a statement of purpose, a heuristic problem-solver may perform operations (or behavior) and measure its progress toward its goal. It is an axiomatic system with rules of inference, capable of generating its own theorems. It is a system which reaches its goal by learning how to solve the problem. Rather than program a computer to solve a specific problem through calculation, it could be heuristically prepared to handle a large number of situations or complex problems for which there is no prearranged method of solution. Of course, there are strong parallels

between this kind of computer programming and the way humans make decisions: both man and machine use a synthetic method instead of a strictly logical one—it is a more enlightened approach to all but analytical problems. In other words, everyday tasks are perhaps best

MICROPHONES!

At long last, all the questions you ever asked...all the problems you ever grappled with...are answered clearly and definitively!

The Microphone Handbook

In 256 fact-filled pages, liberally sprinkled with over 500 illuminating photographs, drawings and diagrams, John Eargle covers virtually every practical aspect of microphone design and usage.

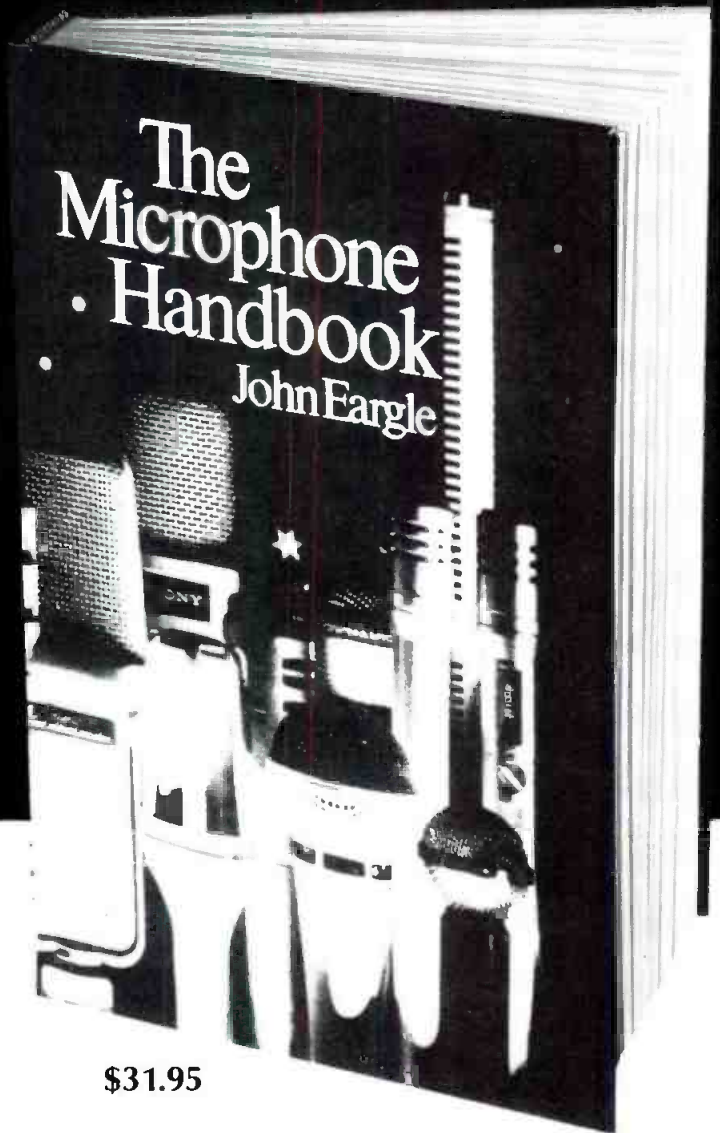

\$31.95

Completely up to date, this vital new handbook is a must for any professional whose work involves microphones. Here are just a few of the topics that are thoroughly covered:

- Directional characteristics—the basic patterns.
- Using patterns effectively.
- Microphone sensitivity ratings.
- Remote powering of capacitors.
- Proximity and distance effects.
- Multi-microphone interference problems.
- Stereo microphone techniques.
- Speech and music reinforcement.
- Studio microphone techniques.
- Microphone accessories.
- And much, much more!

THE MICROPHONE HANDBOOK. You'll find yourself reaching for it every time a new or unusual problem crops up. Order your copy now!



JOHN EARGLE,

noted author, lecturer and audio expert, is vice-president, market planning for James B. Lansing Sound. He has also served as chief engineer with Mercury Records, and is a member of SMPTE, IEEE and AES, for which he served as president in 1974-75. Listed in *Engineers of Distinction*, he has over 30 published articles and record reviews to his credit, and is the author of another important book, *Sound Recording*.

ELAR PUBLISHING CO., INC.

1120 Old Country Road, Plainview, NY 11803

Yes! Please send _____ copies of **The Microphone Handbook @ \$31.95** per copy. (New York State residents add appropriate sales tax.)

Payment enclosed.

Or charge my MasterCard Visa

Acct. # _____ Exp. Date _____

Name _____
(please print)

Address _____

City _____

State/Zip _____

Signature _____

Outside U.S.A. add \$2.00 for postage. Checks must be in U.S. funds drawn on a U.S. bank.

If you aren't completely satisfied, you may return your copy in good condition within 15 days for full refund or credit.

Updated Recording Studio Handbook

A must for every working professional... student... audio enthusiast

Features latest state-of-the art technology of creative sound recording.

21 Fact-Filled Chapters

- | | |
|---|---|
| <p>I. The Basics
1. The Decibel
2. Sound</p> <p>II. Transducers: Microphones and Loudspeakers
3. Microphone Design
4. Microphone Technique
5. Loudspeakers</p> <p>III. Signal Processing Devices
6. Echo and Reverberation
7. Equalizers
8. Compressors, Limiters and Expanders
9. Flanging and Phasing</p> <p>IV. Magnetic Recording
10. Tape and Tape Recorder Fundamentals
11. Magnetic Recording Tape
12. The Tape Recorder</p> <p>V. Noise and Noise Reduction
13. Tape Recorder Alignment
14. Noise and Noise Reduction Principles</p> | <p>15. Studio Noise Reduction Systems</p> <p>VI. Recording Consoles
16. The Modern Recording Studio Console</p> <p>VII. Recording Techniques
17. The Recording Session
18. The Mixdown Session</p> <p>Three all-new Chapters
19. The In-Line Recording Studio Console
(The I/O Module, The Basic In-line Recording Console, Signal flow details.)</p> <p>20. An Introduction to Digital Audio
(Digital Design Basics, Digital Recording and Playback, Error Detection and Correction, Editing Digital Tapes)</p> <p>21. Time Code Implementation
(The SMPTE Time Code, Time-Code Structure, Time-Code Hardware.)</p> |
|---|---|



\$39.50

Easy to Order

You can enclose a check with your order or charge it to Master Charge or BankAmericard Visa. Use the coupon below to order your copies of the new updated *Recording Studio Handbook* (\$39.50).

ELAR PUBLISHING COMPANY, INC.

1120 Old Country Road, Plainview, N.Y. 11803

Yes! Please send _____ copies of THE RECORDING STUDIO HANDBOOK. \$39.50. On 15-day approval.

Name _____

Address _____

City/State/Zip _____

Total payment enclosed \$ _____
(In N.Y.S. add appropriate sales tax)

Please charge my Master Charge
 BankAmericard/Visa

Account # _____ Exp. date _____

Signature _____
(changes not valid unless signed)

Outside U.S.A. add \$2.00 for postage.
Checks must be in U.S. funds drawn on a U.S. bank.

The *Recording Studio Handbook* is an indispensable guide with something in it for everybody. It covers the basics beautifully. It provides in-depth insight into common situations and problems encountered by the professional engineer. It offers clear, practical explanations on a proliferation of new devices. **And now it has been expanded with three all-new chapters . . . chapters on the in-line recording studio console, digital audio and time code implementation.**

Sixth printing of industry's "first" complete handbook

The *Recording Studio Handbook* has been so widely read that we've had to go into a sixth printing to keep up with demand (over 30,000 copies now in print). Because it contains a wealth of data on every major facet of recording technology, it is invaluable for anyone interested in the current state of the recording art. (It has been selected as a textbook by several universities for their audio training program.)

Highly Acclaimed

Naturally we love our book. But don't take our word for it. Here's what others have to say:

"John Woram has filled a gaping hole in the audio literature. This is a very fine book . . . I recommend it highly." *High Fidelity*

"A very useful guide for anyone seriously concerned with the magnetic recording of sound." *Journal of the Audio Engineering Society*

15-Day Money-Back Guarantee

When you order *The Recording Studio Handbook* there's absolutely no risk involved. Check it out for 15 days. If you decide it doesn't measure up to your expectations, simply send it back and we'll gladly refund your money.

approached heuristically, for both people and computers.

WHEN TO USE THE HEURISTIC APPROACH

In general, a heuristic approach is the best choice when the following criteria are at hand: limited data, a model is available, an exact method is not practical, there's a repeated need to solve the same problem, and there are resource (time or budget) limitations. A heuristic method frequently has the following properties: simplicity, speed, accuracy, robustness, multiple starting points, multiple solutions, good stopping criteria, and interactive ability with analyst and decision maker. As several mathematicians have noted, heuristics are advocated by practice-oriented persons who "want to improve their current operation as cheaply and quickly as possible, care little about an optimal solution to a problem with usually inexact data, and will not accept a new solution they do not understand." I can think of no finer definition of the process we undergo in the recording studio known as mixing. Consider: good mixing engineers are intensively practice-oriented and they are always seeking to improve their operation. They do not want an optimal solution (at least in the mathematical sense) because the perfect mix is only an elusive ideal and never a practical concern. They are dealing with subjectively evaluated and thus inexact data, and a new solution (an off-the-wall mix) would not be understood.

MIXING AND HEURISTICS

Mixing is a very unique kind of problem solving process (somewhat akin to chess playing) in which there are no specific means to a goal; furthermore the goal itself can be only generally stated. In the same way that a heuristic strategy must be employed to win at chess, heuristics must be used to "win" at mixing: each mix is necessarily different, so pre-conceived decisions cannot apply. Rather, a real-time strategy must be used to adapt one's experience to fit the context at hand. That is, to accomplish a mix of a song the engineer must learn how to mix that song. And that learning process is heuristically different for each song—and indeed for every mix of every song. The successful engineer thus devises, invents, and discovers a solution to the problem of combining his tracks into the most pleasing

result possible. I think that whether he knows it or not, he is behaving heuristically.

If our hypothesis is true, the question naturally arises: If mixing is heuristic, and computers can be heuristically programmed, could a computer be programmed to successfully accomplish a mix? In a technological era in which computer programs have humiliated world chess masters, written poems and novels, and conducted psychiatric counseling for patients, the idea of a self-mixing console is perhaps not so distant. Mixing is inherently a decision-making process and could be modelled as a tree in which fundamental decisions lead to more specific ones, until finally, with the final decision, the end of the last branch would be reached and the mix would be complete. Thus mixing is not a logical relationship as much as a casual relationship in which one decision leads to another. Surely a computer could be programmed to engage in data collection, examine the possible decisions and choose the most promising ones, and thus conduct a tree search. In the same way that an engineer immediately discards unworkable choices and thus limits his choices, a computer could guide itself to a successful result; even if it required the examination of more dead-ends, it would hold a distinct speed advantage over a human. In addition, the computer could more successfully learn how to mix—unworkable branches would never be repeated. Just as an experienced engineer mixes faster, an experienced program might mix *much* faster.

Mechanically, it would appear to be easy to provide models of mixes and their rules of mixing, then let the computer program generate applicable theorems, conduct a heuristic search, and arrive at a solution. There is, of course, more to mixing than simple mechanics. Mixing decisions involve at least three levels: fundamental concerns of balance, questions of idiom and style, and creative judgments often based on nothing more than musical instinct. It is the latter aspect which might present the greatest challenge to the idea of a self-mixing console. Music abounds in creativity, from its inception through its production. Today, mixing is a highly creative endeavor and a good mix must contain new and unique artifacts; that is, it must be

creative. The question is, can a computer be programmed to be creative? Humans seem to be highly qualified to draw the conceptual world into the empirical world, but how about a machine? The answer, I think, is built into the mixing process itself. First, we must consider that what is expressed in language differs from what reality is. Thus, when we discuss creativity, we must be careful to understand that it is not a thing in itself, but rather a state of affairs.

Even the most inspired work of art is nothing more than the result of a series of decisions of craft. In the course of a mix, no engineer decides that now it is time to become creative. Rather, his creativity is implicitly contained in each of his decisions. In this way, the totality of the mixing process tends to converge toward creativity. We cannot say that any one thing is creative; rather it is the context of the entire mix, a state arrived at through a heuristic process, which lets the state of creativity reflect upon specific elements of the mix. The point is this: There is every reason to believe that a heuristically programmed computer *could* produce a pleasing mix and, moreover, that mix would be both pragmatic and creative, because both utility and imagination are implicitly contained in the process of discovery in a properly executed heuristic search.

Of course, long before we enjoy the benefits of a self-mixing console, we ourselves must fully understand what the mixing process entails. We must examine the technique we employ when we mix and treat it not only as an intuitive process, but as a knowable, more learnable process; in that way we become better mixers. Only when we fully understand our task can we begin to relegate it to devices. Even with such understanding, could a self-mixing console ever be realized? That question presents an ideal for every mixing engineer as he first asks himself, "Is mixing a heuristic process?" In the light of that examination the engineer learns how to mix—that is, he learns how to learn. ■

REFERENCES

- George F.H. *The Brain As a Computer*. (Pergamon Press, 1973.)
Zanakis, S. H. and Evans, J. R. "Heuristic Optimization," *Interfaces*, Oct., 1981.

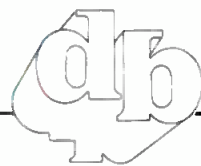

The Async Race

• This is not the story of sports cars on an open track or a gentleman's horse sport. This is a tale of a new computer company that started in a garage and became very successful. At first, they introduced very small mini-computers at a time when IBM was king. Gradually they became more successful and their computers became larger and larger; their customers became dependent on their superior technology and reliability. By the late 1960s they developed a very, very large system for large corporate customers.

After a typical installation of a multi-million dollar computer system, the customer requires that the machine be put through a series of software tests to confirm that the machine can handle the desired task. Usually the test involves the customer's application programs rather than special test programs. By being successful in this kind of test, the customer can be sure that the machine will solve the problem it was purchased to solve. The machine in question was installed and the computer company confirmed that all was well with their special test programs. However, when running the customer's applications, the machine would "crash" randomly every couple of hours.

For those who are unfamiliar with the concept of a "crash," we can describe it in the following way. Certain types of computer execution errors result in incorrect data. For example, the product of 2.1 and 3 yields a result of 6.6. Usually this kind of error can be traced using certain hardware and software tools. A "crash" is a kind of error where the program follows the wrong path, executing instructions incorrectly, e.g., an add is executed as a jump. When the dust settles, the main memory is junk, the trail of data is junk, and it cannot be restarted. One must start completely from the

beginning since there is no useful data about how the condition appears. With a crash every few hours, one cannot simply stare at the data waiting for an error. If the execution rate is three instructions per-microsecond, then an hour represents one billion instructions.

The computer company was somewhat concerned because these kinds of failures can be difficult to find. They had their best field service repair people come to the company since this was an important sale. These maintenance types used the standard method for fixing: they replaced modules one at a time. Since the error rate was so low, they had to spend several days at the task. By the end of a week, they had replaced every board in the system.

It was now time to call in the software experts. After some days of analysis, they were convinced that the problem was hardware. To prove their point, they designed a method by which the computer was initialized to a fixed state. Then they ran the master program. The point where the crash happened was random. We all know that a software error must repeat. So, the hardware experts had to return. At this point, the senior executives were becoming concerned; they forced the chief design engineering team to come to the computer. After much investigation, this group was able to demonstrate that the error was somehow related to the teletype. When nobody used the teletype for data input, there was no crash. But simply replacing the teletype, the teletype interface, and cables did not change the situation.

More time passed and still there were no clear results. The head scientist was brought in to help the design engineers. Eventually, the issue was understood and a demonstration experiment was designed. It confirmed the hypothesis of the group. Once having demonstrated

the issue, the solution took 10 minutes! This illustrates, if nothing else, that the problem is always more interesting than the solution. The rest of this month's article is the story of what they found. We are presenting it here because of its simplicity, subtlety, and because it will appear in some digital audio systems.

A FLIP-FLOP

During the past months we have studied the properties of a flip-flop, such as the 74LS74. It is a D-flop, which means that information on the D input wire is transferred to the flip-flop's output when the clock makes a low-to-high transition. From the data sheets, we know that there is a certain set-up time, which means that the data must be at the D-input so many nanoseconds before the clock transition. We also know that there is a hold-time requirement, which means that the D-input data must remain there for some nanoseconds after the clock. For some devices, one of these numbers may be 0 or negative.

In the application of the teletype, there was a D flip-flop connected such that the D-input came from a switch connected to one of the keys of the teletype. Clearly there was no relationship between the D-input and the clock. The D-input could change at any time since this was a function of hitting a key. The key was asynchronous with the clock. The designer could therefore not insure that the set-up or hold-time requirement would be met. He solved this problem by designing the system such that if the information about the D-input did not get there in time for the clock, it would be acquired on the next clock. The system did not care if the teletype key information arrived on any particular clock, since the data rate for manual key pressing is only 10 per second compared to a 1 MHz clock.

What the designer had not understood is that certain characteristics of the flip-flop changed dramatically if the input data changed during the undefined interval between set-up and hold-time. To understand this, consider the following case. When the D data changes, the flip-flop will think that it is neither a 1 nor a 0. Which way will the output change? A digital engineer cannot make any sense out of the question. He has no insight because his model of a 1 or 0 is not sufficient. Inside the flip-flop there are ordinary transistors connected in such a way that they have analog properties. The basic flip-flop is in fact wired as an amplifier with positive feedback. The positive feedback means that the amplifier is

This was the situation with the teletype; for some change in the teletype key relative to the D flip-flop's clock, the ball was placed on top of the mountain and the output took a much longer time to settle to a 1 or a 0. The increased propagation time was part of the problem. The other part was that the output could actually remain between a 1 and 0 for some time before going to the end state. It could also produce a small burst of oscillation.

When the design engineers analyzed their computer, they found the equivalent of the logic shown in FIGURE 1. The flip-flop's output went to many places in the machine via different paths. They had assumed that the data would reach the end of

the path before the next clock. Instead, one part of the computer thought that the flip-flop had a 1 and the other part thought that it had a 0. This was obviously not a case they had considered; this case sent the computer into a strange state where it crashed.

A MODEL

We can make a model of this situation by taking an ordinary amplifier with a positive feedback connection. The amplifier is assumed to have the equivalent frequency response of a simple RC lowpass filter. This is shown in FIGURE 2. Let us assume that the amplifier's output is internally limited to either 0 or 5 volts and let us also assume that it has a gain of 100.

We begin by letting the output be at 5 volts with a - input of 0 volts. The + input has 2.5 volts and the amplifier stays in saturation. Now let the - input jump to a voltage of 2.51 volts. The difference is now 0.01 volts, which will cause the amplifier to head toward 0 volt output. With a difference of 0.01 volts times a gain of

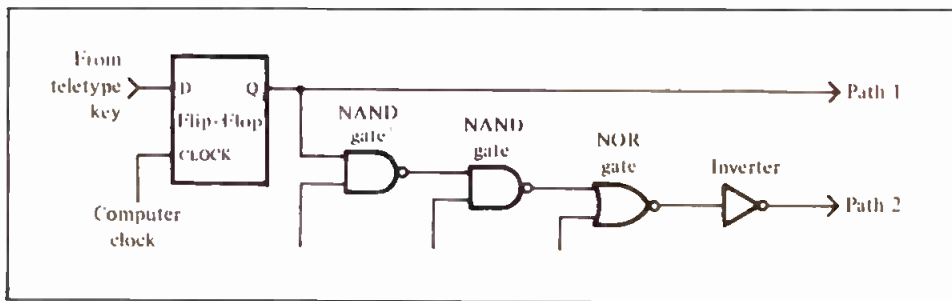

Figure 1. Path 1 and Path 2 would have different values when the D-input changed at a critical time.

unstable and will go into saturation or cut-off. This is a desired property for a digital device.

We need to ask the question: Could there be an input signal that made the "amplifier" go part way between a 0 and a 1? The answer is yes. If the input changed at just the right time relative to the clock, the amplifier would suddenly be forced into linear operation. All of the classical digital parameters such as a propagation delay become meaningless. By analogy, consider placing a ball on top of a mountain. Assume that the mountain is a perfect mountain—such as a cone. The ball will roll down one side or the other. We do not care which side. However, if we place the ball very carefully right at the peak and balance it, it may take much longer to fall off. We know that it cannot stay forever, because the slightest vibration or wind (read noise) will eventually push it off of dead center; gravity will then do the rest. The interesting question is: How long will it take? The answer is that this is a function of how carefully we balance it before we let go. With perfect balance, it will take a very long time.

100, the internal RC circuit is being charged with a 1 volt source. It will clearly take some time before the output actually changes state. As it begins to change and goes from 0 to 0.1 volts, the difference at the input

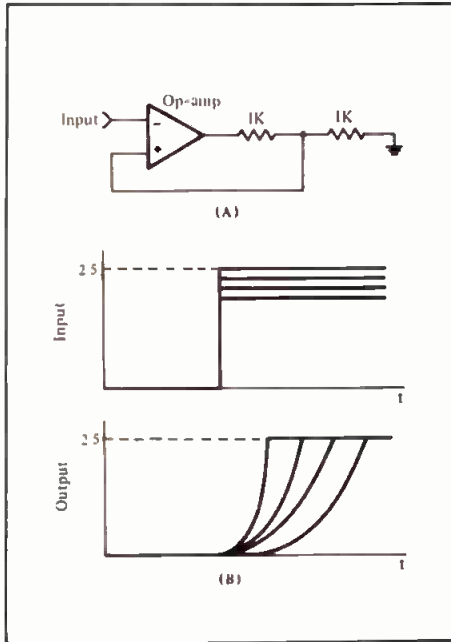

Figure 2. Model of a flip-flop (A) and input/output responses (B).

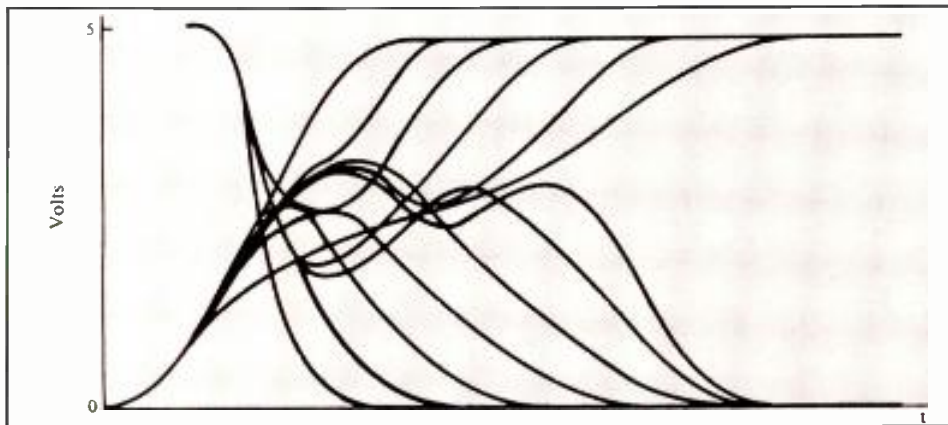

Figure 3. Flip-flop outputs.

goes from 0.01 to 0.06. This charges the RC faster. With a classical positive feedback, we get a rising exponential response. The initial derivative of the response is a function of the initial difference. Had the initial step been 2.501 instead of 2.51, then the initial difference would have been 0.001 instead of 0.01; the rate of charging would be one tenth as great. In the lower part of FIGURE 2, we have the various output for different overdrives.

The computer company ran this experiment with a low frequency servo to set the overdrive as close to the mountain peak as possible. The

response time then becomes very long. Instead of a few nanoseconds, one could get a response time of 100s of nanoseconds. Further study showed that the probability of reaching the final state, regardless of which state, is given by the following simple formula: add 4 nsec for each decade of probability. This means that to be sure of reaching one state or another with 90 percent confidence, we need to add 4 nsec to the settling time. To be sure of reaching the result 99.9 percent, we need 12 nsec (three decades). When the engineers had multiplied out all of the probabilities, they found that the random failures were in fact consistent with their result. They had a probability of failure corresponding to one billion clocks. That was nine decades of probability.

FIGURE 3 shows what the test system produced with the auto servo creating the worst case. This shows all of the possible outputs that were observed. We see the long settling time for a few inputs and we see that most settlings are short, even if longer than the specification.

SOLUTION

The solution is very simple; it is called double clocking. We place a second flip-flop in series with the first, as shown in FIGURE 4. The data input take two clock cycles to get into

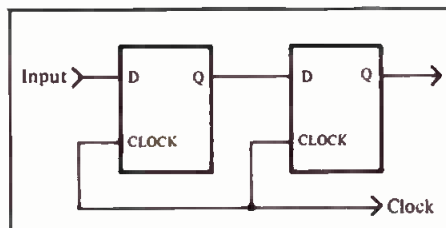

Figure 4. Double buffer.

the computer. On the first clock it enters the first flip-flop, and on the second clock this data is passed to the second flip-flop. Adding a $\frac{1}{2}$ - μ sec delay on a teletype key is not important. The reason that this solution works is that we allow 500 nsec for the first flip-flop to settle before the second one needs to assume a stable digital result. By the above computation, there will be 125 decades of probability for each error. That means a worst case of one error in 10^{125} clock cycles, or one error in 10^{110} years!

From a hardware point of view, the solution uses half of a 30-cent IC! We have brought this subject up because digital audio people are often faced with this issue without really knowing it. It is called the asynchronous-to-synchronous conversion problem. Any user switch or comparator will produce digital outputs that are unrelated (asynchronous) with a synchronous clock. For example, a front panel switch connected to a microprocessor flag might have this problem if the flag wire was changing just at the time the microprocessor needed to test it. Fortunately, most commercial devices have a double clocking, but some do not. Thus, the user should buffer or double buffer any such connections. Failure to do so can result in a random error that will not happen very often. How can you diagnose a failure that happens every other day on average? It will clearly not be reproducible by field service or by the factory technicians. Yet the error rate will remain unchanged in the user's studio. The equipment will have a reputation for being "flaky" and unrepairable. They will eventually give up even though the engineer of the equipment can "prove" that the design is perfect. It never makes an error when he is there. And, if it did make such an error, he will blame the power lines or static.

The purpose of this article is to remind many beginning engineers that even the digital world has some subtlety, and this subtlety cannot be understood in digital terms. The digital world is inherently analog. Those digital engineers who first solved the problem had their training as analog engineers. Had the problem not been found until 1980, there might not have been an engineer who could have found the solution. All present digital engineers believe the world is as well behaved as 1s and 0s.

There is hope yet for us old-timers! ■

Bits 'n Pieces

SHARP-EYED READERS of mastheads will notice that a significant change has taken place with this issue. Noted audio authority John Eargle joins us as Editorial Advisor. He brings to us a much-needed engineering authority and expertise that will be reflected in the future articles we publish. This expertise will certainly be a continuation of his fine series on Sound Reinforcement.

In this issue, beginning on page 46, we are pleased to again present the latest issue of the SPARS DataTrack publication. SPARS is, as many of you must know, the Society of Professional Audio Recording Studios, and as such represents the key studios in the United States.

In England, and with some Continental representation, APRS—The Association of Professional Recording Studios—has served a similar function for many years. As has been recorded in these pages before, SPARS and APRS has been talking joint action and even merger. We are pleased to report that progress in this direction has been made. Hopefully, soon after you read this, something further will be able to be said.

SPARS recently completed its Digital Conference, held at the University of Miami's main campus in Coral Gables, Florida. I attended it and found it extremely educational and otherwise well worth the trip and expense. This issue contains a report on that Conference by Ken Pohlmann (it's in the SPARS DataTrack), who regularly appears in these pages and is also on the U of M's Recording School faculty. Ken, incidentally, was the host for the Conference. We're also pleased to inaugurate a new feature that will appear from the pen of our European Editor, John Borwick. It's called, appropriately enough, Scenes From Europe.

* * *

This April issue marks a return to our on-time delivery, also promised in these pages. We expect to stay that way. This issue is also being distributed at both the NAB, taking place on April 28th in Las Vegas, and the AES Conference on May 11th in Anaheim's Disneyland Hotel. Both of these conventions will be reported on in upcoming issues.

L.Z.

Glass in the Studio

The following article (the first of a two-part series) offers a review of the acoustical holes in multi-pane windows and the methods for plugging them.

SINCE THE BEGINNING of radio broadcasting glass windows between control room and studio have been in common use. These windows continue to serve well in providing visual contact between the board and the band. Acoustically, however, they often allow too much sound to pass through. The engineering involved in such observation windows over the years has been largely of the "seat of the pants" type, based on past experience and rule-of-thumb. The simple reason for this is that few actual measurements of transmission loss through glass were available. Numerous theoretical approaches to calculating transmission loss of windows have also suffered from lack of experimental verification. During the last few years, comprehensive measuring programs (such as those of J.D. Quirt of Canada and A. Cops *et al* of Belgium), stimulated by growing awareness of environmental noise, have yielded data of great practical value for audio rooms. It is well for us to review

the factors that limit window transmission loss in light of the new data available.

Glass fits beautifully into the modern concept of making studios and control rooms esthetically pleasing as well as technically efficient. It is said that the output of artistic types can be improved in both quantity and quality by providing those amenities in the workspace which appeal to the artistic mind. Skylights have appeared in control rooms and studios. Some studios have even built on scenic promontories with large picture windows. In addition to letting in the view, such glass can also let in cow moos, bird tweets, horn toots, and other sounds at odds with studio fare, which abruptly brings us back to the technical need for high sound transmission loss.

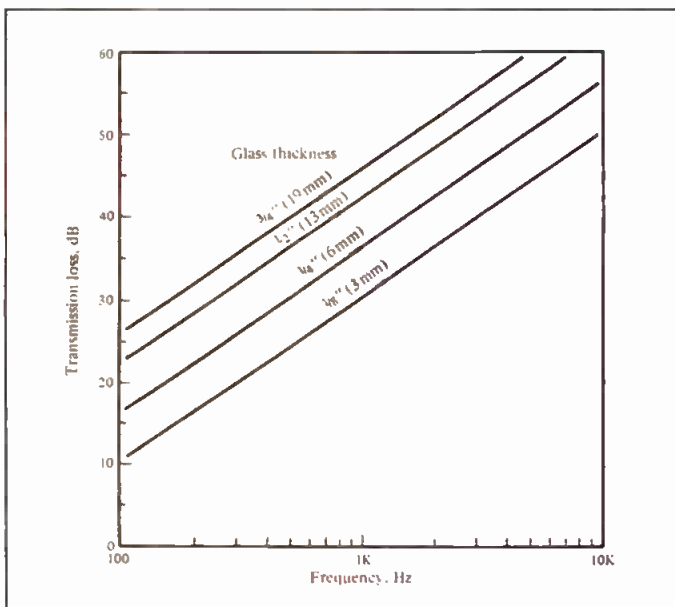

Figure 1. Transmission loss of glass sheets of different thickness due to the mass law expression of Equation 1. Considering only mass, the transmission loss (TL) increases 6 dB with each doubling of frequency or doubling of glass thickness.

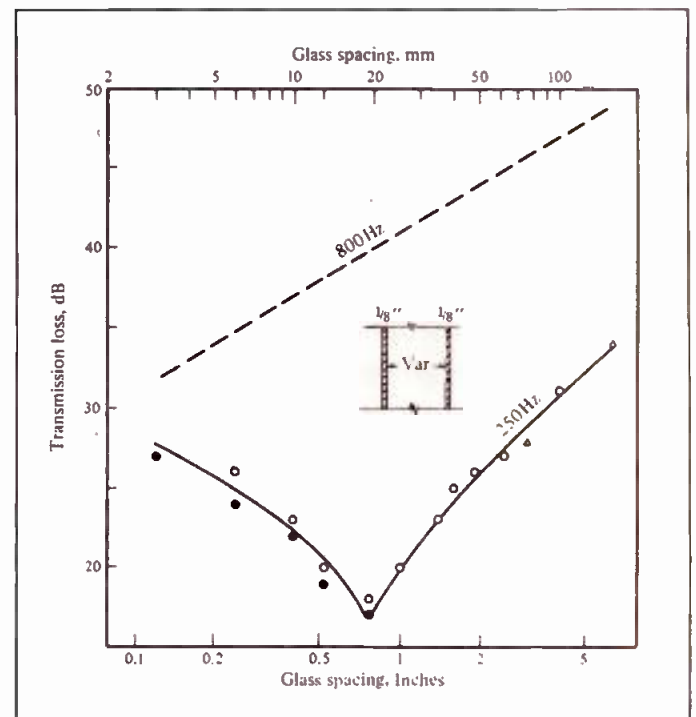

Figure 2. Illustrating the effect of mass-air-mass resonance in double glazed windows in which the masses of the two glass sheets and the springiness of the air entrapped between them come into resonance like weights on either end of a spring. Here the separation between two $1/8$ -inch (3mm) glass panes is varied. At 800 Hz the TL increases uniformly with increase of spacing, but at 250 Hz a pronounced dip in TL appears at a spacing between $1/2$ - and $3/4$ -inch due to the mass-air-mass resonance effect.
(Adapted, with permission, from Quirt, Ref. 1)

A sheet of glass (or two, or three) mounted properly can facilitate production and inspire artists. Glass is readily available to serve our purposes, so let's consider a few tricks to get the most out of it. First, we must examine the numerous factors affecting the sound transmission loss (TL) of glass windows. The most basic is called the "mass law."

MASS LAW

In porous barriers, such as those made of brick or concrete block, a small amount of sound may pass through the air-filled interstices within the material. This air patch tends to reduce the effectiveness of the massive wall as a sound barrier. There is no such air path in glass, but there are plenty of other ways sound can pass through windows. The most basic of these is related to the mass of the material. The entire glass pane is forced into vibration by sound impinging upon it. The vibrating pane then becomes a secondary source, inducing sound on the other side. The more massive the glass pane, the less motion imparted to it by the sound falling upon it. Hence, the less sound radiated on the other side. The transmission loss of a glass panel depends upon its surface mass (mass per unit area). For approximate random incidence of sound, this mass law is expressed as:

$$TL = 20 \log (fm) - 34 \quad (1)$$

where:

- TL = transmission loss, dB
- f = frequency of sound, Hz
- m = surface mass, lb/ft².

Taking the density of glass as 160 lb/ft³ (2563 kg/m³) the surface mass may readily be found for any thickness of glass pane. For example, a glass pane one inch thick has a surface mass of 160/12 = 13.3 lb/ft², a pane ¼ inch thick, a surface mass of 3.33 lb/ft². The transmission loss of glass panes as a function of frequency, calculated from Equation 1, is shown graphically in FIGURE 1. The transmission loss due to the mass effect alone is seen to increase about 6 dB for each doubling of frequency or doubling of surface mass.

The mass law applies to single panes or to closely spaced multiple panes. Two panes spaced ¼ inch or less tend to follow a mass law curve applying to a single pane combining the surface mass of both. For example, using two ¼ inch glass panes spaced ¼ inch apart or so could very well be cheaper than a single ½ inch pane to serve as one pane of a double glazed window. As the two panes are further separated, they begin to show signs of independence from each other. Life would be simple if the mass law alone determined the loss of a single glass pane, but numerous gremlins intrude which alter the straight lines of FIGURE 1.

THE MASS-AIR-MASS ACOUSTICAL HOLE

Resonances of several kinds tend to reduce the TL of a double glazed window. The first to be considered is called the mass-air-mass resonance, in which the mass of the glass on one face and the mass of the glass on the other face interact with the springiness of the air entrapped between them, much as metal balls on either end of a

Do You Know Where?

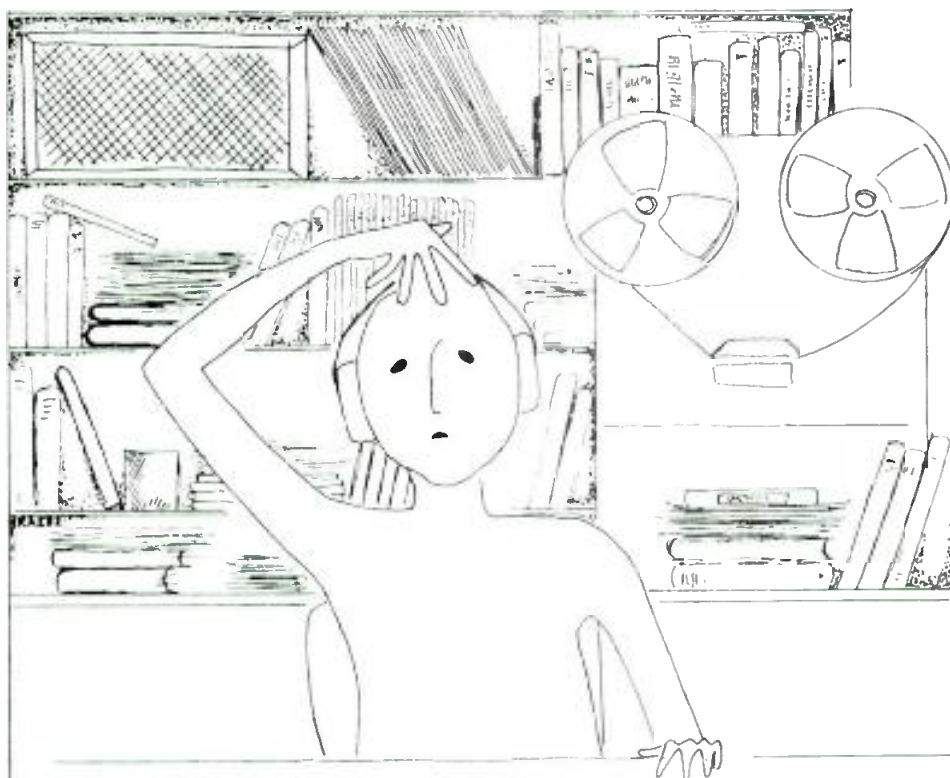

Have you misplaced your db again? Our high quality, royal blue vinyl binders keep 12 copies of db neat and handy for ready reference.

Just \$9.95, available in North America only. (Payable in U.S. currency drawn on U.S. banks.) ORDER YOURS NOW!!

Sagamore Publishing Co., Inc.

1120 Old Country Road
Plainview, NY 11803

YES! Please send _____ db binders @ \$9.95 each, plus applicable sales tax. Total amount enclosed \$ _____

Name _____

Company _____

Address _____

City _____

State/Zip _____

db April 1984

29

spring. The entrapped air behaves like a simple spring as long as the spacing between the two panels is small compared to the wavelength of sound in air. The frequency of resonance is determined by the surface mass of each glass and the spacing. At this resonant frequency there is a dip in the transmission loss—a sort of “acoustical hole” through the window.

The mass-air-mass resonance effect is illustrated in FIGURE 2. These two curves are based on Quirt's recent measurements,¹ each curve being the average of many measured TLs, but simplified for clarity. The TL of two 1/8 inch (3mm) glass panes was measured for many spacings. For the 1/3 octave centered on 800 Hz, TL increases about 3 dB for each doubling of the spacing. For the 1/3 octave centered on 250 Hz, however, the TL goes through a deep minimum. The exact frequency of the minimum cannot be precisely determined because of the coarse 1/3 octave resolution, but it was estimated to be at some spacing between 13 and 19mm (1/2 to 3/4 inch). Studio windows utilize greater spacings than this, but the 10 to 15 dB “acoustical hole” resulting from mass-air-mass resonance is dramatically illustrated.

FIGURE 3 shows measured transmission loss versus frequency for two 1/8 inch (3mm) glass panes separated by

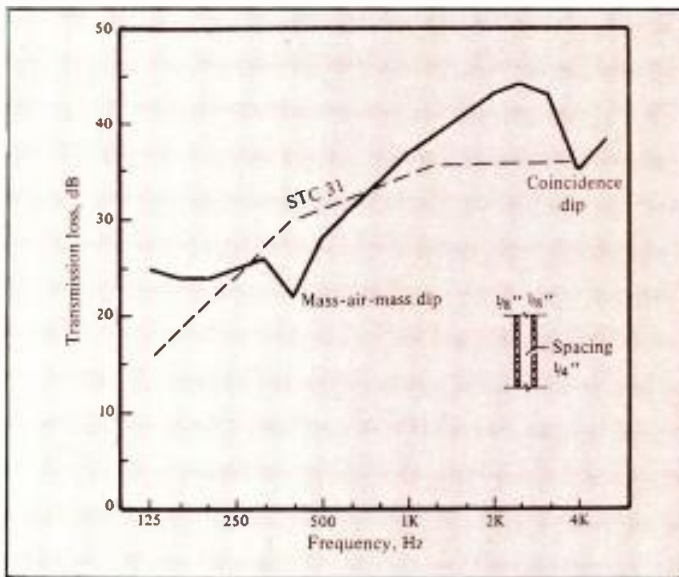

Figure 3. The appearance of mass-air-mass resonance dip at about 400 Hz on a typical transmission loss vs. frequency plot. Two 1/8-inch (3mm) glass panes separated only 1/4-inch (6mm) are chosen to place the resonance at a relatively high frequency. This resonance is often obscured in practical windows having heavier glass and greater spacings. The coincidence dip occurs near 4 kHz. (Adapted, with permission, from Quirt, Ref. 1)

1/4 inch (6mm). Measurements were made at 1/3 octave intervals.¹ The dip at about 400 Hz is due to the mass-air-mass resonance of the window and is the only dip in this figure under consideration at the moment. This case of thin glass closely spaced has been purposely selected to place this resonance at a relatively high frequency. Heavier glass and greater spacings move the mass-air-mass resonance to lower frequencies where it is often obscured by other effects.

The mass-air-mass resonance frequency can be calculated from the approximate equation:

$$f_0 = 170 \sqrt{\frac{m_1 + m_2}{m_1 m_2 d}}$$

where:

- f_0 = frequency of resonance, Hz
- m_1 = surface mass of glass A, lb/ft²
- m_2 = surface mass of glass, B, lb/ft²
- d = distance between glass panes, inches.

As a test for Equation 2 let us see how it agrees with the measurements of FIGURE 3, with two 1/8 inch glass panes separated 1/4 inch. In this case, $m_1 = m_2 = 1.667$ lb/ft² and $d = 0.25$ inch. Substituting these values in Equation 2 gives:

$$f_0 = 170 \sqrt{\frac{1.667 + 1.667}{(1.667)^2 (0.25)}} = 372 \text{ Hz}$$

which is reasonably close to the measured 400 Hz dip in FIGURE 4.

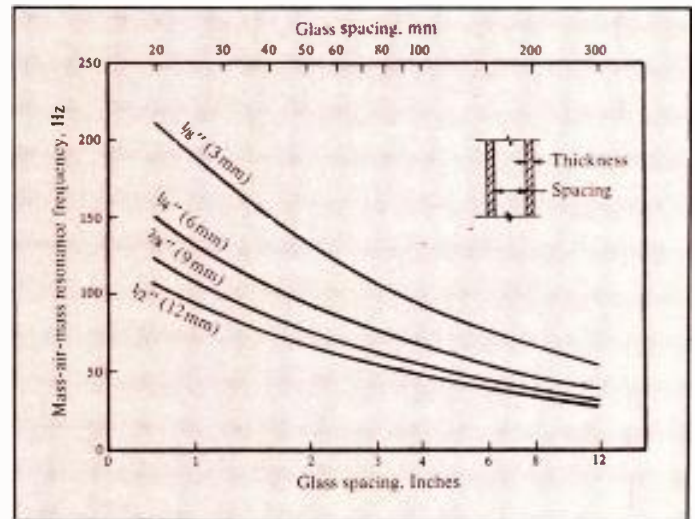

Figure 4. Mass air-mass resonance frequencies for double glazed windows calculated from Equation 2.

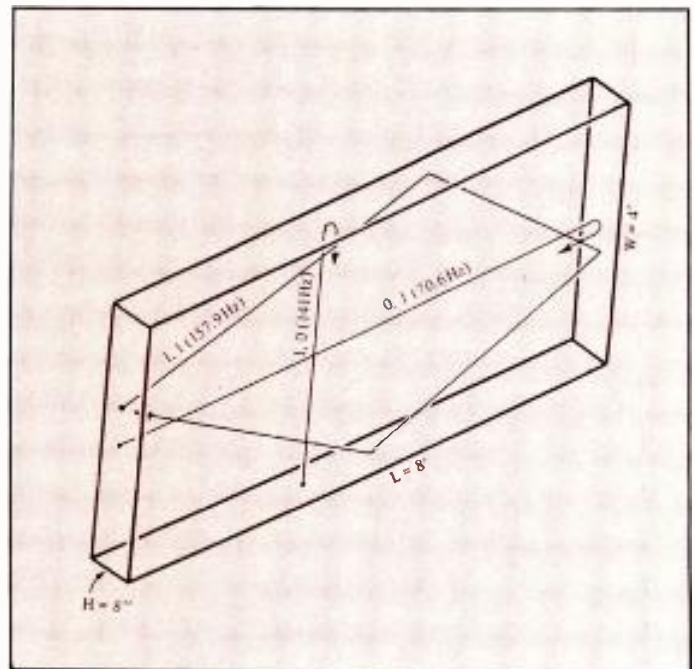

Figure 5. Standing waves are set up in the cavity between the glass panes of a double glazed window by vibration of the glass. Because the modal resonances tend to reduce the transmission loss of the window, they must be controlled by absorbing material on the edges of the cavity.

To observe the effect of heavier glass panes and different spacings, Equation 2 has been used to calculate the curves of FIGURE 4. It is noted that mass-air-mass resonance frequency for the heavier glass panes and greater spacings commonly used in control room windows is around 50 Hz or lower.

ACOUSTICAL HOLES CAUSED BY STANDING WAVES IN THE CAVITY

FIGURE 5 draws attention to the cavity formed by the two glass panes and the "reveals," or edges of the cavity. This brings us right back to small room acoustics. If these reveals are reflective, then axial, tangential, and oblique standing waves are set up in the cavity at frequencies determined by the following expression, which is a solution of the wave equation:

$$f_{p,q,r} = \frac{c}{2} \sqrt{\frac{p^2}{L^2} + \frac{q^2}{W^2} + \frac{r^2}{D^2}} \quad (3)$$

where:

- c = speed of sound in air, 1130 ft/sec
- L, H, D = length, height, and depth of space, ft
- p, q, r = integers 0, 1, 2, 3...n.

If the wavelength of the incident sound is greater than twice the spacing H between the glass panes, the third term of Equation 3 can be neglected, simplifying to:

$$f_{p,q} = 565 \sqrt{\frac{p^2}{L^2} + \frac{q^2}{H^2}} \quad (4)$$

For the 8 × 4 ft. window of FIGURE 5, calculated axial and tangential modal frequencies for integers of p and q up to and including four are listed in Table 1. When q = 0, the axial mode associated with the length of the cavity is active; when p = 0, the axial mode associated

with the width of the cavity is dominant. When neither p nor q are zero, the tangential mode involves all four reveal surfaces. A more complete treatment of standing waves in small rooms may be found in the author's *Master Handbook of Acoustics*, Chapter 6.²

TABLE 1
CAVITY RESONANCES
IN OBSERVATION WINDOW
Cavity dimensions: 8' × 4' × 8"

	Modal Freq.		Modal Freq.
p,q	Hz	p,q	Hz
1,0	70.6	3,2	353.1
0,1	141.3	4,2	399.5
2,0	141.3	0,3	423.8
1,1	157.9	1,3	429.6
2,1	199.8	2,3	446.7
3,0	211.9	3,3	473.8
3,1	254.6	4,3	509.3
0,2	282.5	0,4	565.0
4,0	282.5	1,4	569.4
1,2	291.2	2,4	582.4
2,2	315.8	3,4	603.4
4,1	315.8	4,4	631.7

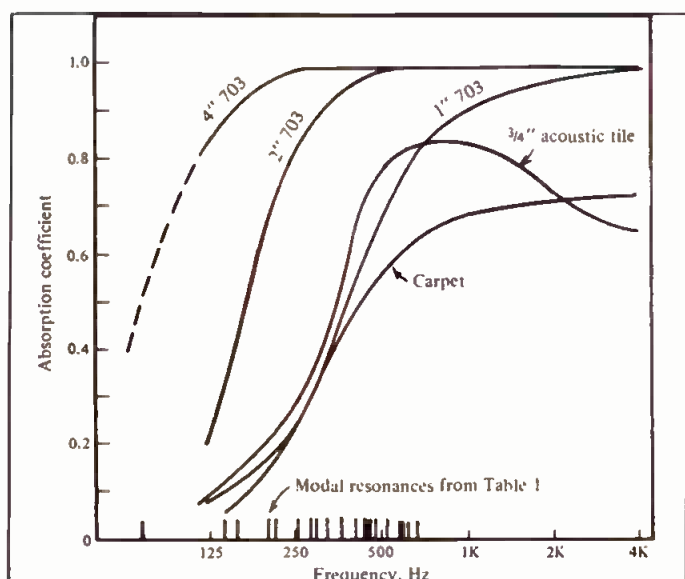

Figure 6. Typical sound absorption/frequency characteristics for materials to control standing waves in the interpane cavity of double glazed windows. The lower modes of the 8 × 4 ft. window of Figure 5 are indicated on the frequency scale. Many absorbing materials commonly used in double glazed windows are poor absorbers at the lowest modal frequencies.

Based on an understanding of what takes place within the cavity, it is obvious that treating the reveals with absorbing material is the way to reduce the effects of standing waves. The calculated modal frequencies of Table 1 give some idea as to what type of absorbing material is required. The lowest frequency involved in our 8'L × 4'H × 8"D window cavity is 70.6 Hz, associated with the 8-ft length. At 141 Hz the doubling up of the first order axial mode associated with the 4-ft height and the second order axial mode associated with the 8-ft window length occurs. Such a "pile-up" (or degeneracy as the experts call it) results in doubling the effect at 141, 282 Hz, etc. These "hot" frequencies could have been avoided (or at least minimized) by not making the window length a multiple of window height.

To show that the 8-inch spacing can be neglected, let's make p, q, and r equal to 1. This yields the first (lowest) oblique mode at the relatively high frequency of 862 Hz, at which absorption is easily obtained. The usual 1-inch thickness of 703 Fiberglas or 3/4-inch acoustical tile are poor absorbers below 500 Hz (as shown in FIGURE 6). A 2-inch thickness of 703 also offers poor absorption below about 250 Hz. Thus we conclude that in the typical observation window these modal resonances from 70 to 250 Hz or 70 to 500 Hz are subject to very little absorption. A 4-inch thickness of 703 covered, perhaps, with a highly perforated metal or with stretched fabric is required, and special window framing is necessary to accommodate its bulk. There is the possibility of mounting a perforated Helmholtz resonator under a 1- or 2-inch layer of 703 to absorb at the lower frequencies, but these are also bulky.

The cavity resonance action is quite independent of the mass-air-mass resonance action even though the

two effects share the same air in the cavity. If, however, the mass-air-mass resonance frequency coincides with one of the cavity resonance frequencies, the coupling between the two glass panels would be materially increased at that frequency and another acoustical hole (or at least a "thin" place) would result in the sound barrier. Let us assume that our 8 × 4-ft observation window utilized ¼-inch glass panels spaced about 4 inches. From FIGURE 4 we find that the mass-air-mass resonance frequency is about 70 Hz. From Table 1 we see that the axial modal frequency associated with the length of the air cavity between the glass panels is also about 70 Hz. We would expect the transmission loss of the observation window to have a dip near 70 Hz greater than that created by the mass-air-mass effect alone.

THE COINCIDENCE ACOUSTICAL HOLE

In the transmission loss graph of FIGURE 3 for closely spaced, thin (¼-inch) glass panels, we note that in addition to the mass-air-mass dip near 400 Hz is another dip near 4 kHz. This latter one is due to what is called the coincidence effect. This is a resonance-like interaction of the impinging sound and the flexural, bending vibrations set up in the glass panel. In FIGURE 7, plane waves of wavelength λ strike the glass panel at some angle θ .

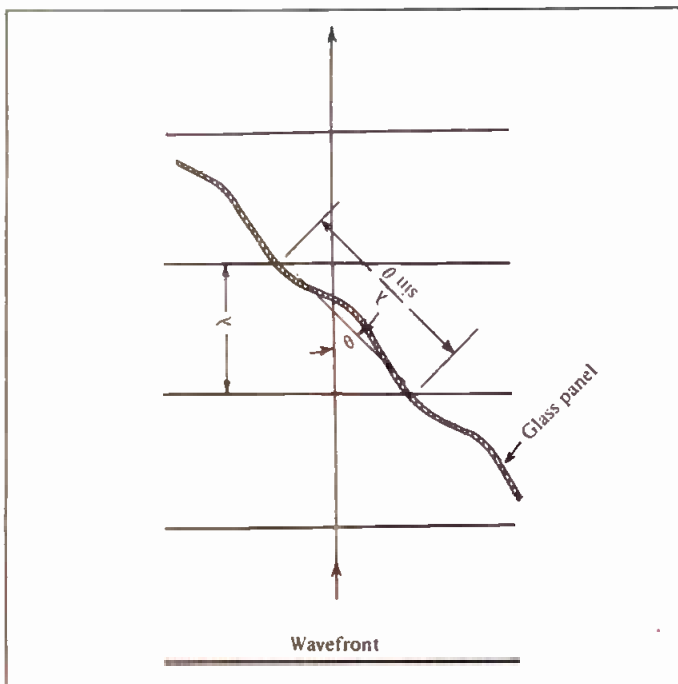

Figure 7. When the angle of incidence of the impinging sound is such that the wavelength of sound in air and the wavelength of sound in the glass are equal, a "coincidence" condition results. At coincidence, a major dip in transmission loss occurs (as in Figures 3 and 8).

At certain frequencies, the phase of the flexural vibration of the clamped glass panel will coincide with the phase of the incident sound in such a way that an abnormal amount of sound is transmitted through the glass. This occurs when the pressure crests of the incident sound and the pressure crests of the flexural vibration of the glass are in phase, i.e., when the wavelength of the flexural vibration of the glass is $\lambda/\sin \theta$, where λ is the wavelength of the impinging sound and θ is the angle

of incidence of the sound impinging on the glass panel at random angles, which, at an angle of θ , excites the coincidence effect. The glass is not a very good sound barrier under this condition.

Unlike the velocity of sound in air, the velocity of a bending wave in the glass panel increases with frequency. There is a critical frequency at which bending wave velocity equals the velocity of sound in air. The coincidence effect can occur only at frequencies above this. For a given material, such as glass, this critical frequency is inversely proportional to the thickness of the panel. This allows us to estimate the frequency at which coincidence occurs in materials such as glass by the approximate empirical relationship:

$$f_c = \frac{500}{t} \quad (5)$$

where:

f_c = coincidence frequency, Hz
 t = thickness of glass, inches.

For ¼-inch glass panels, $f_c = 4,000$ Hz, which agrees with the coincidence dip of FIGURE 3.

THE BENEFITS OF DOUBLE GLAZING

Two glass panels closely spaced, as in thermal insulating windows, offers the same sound transmission loss as a single pane of combined mass. Therefore, this type of double glass window offers little advantage in sound insulation. When two glass panes are separated more than ¼ inch or so the transmission loss is considerably higher than that expected from the mass law alone. At greater spacings there is a tendency for each pane to act as a separate and independent barrier. The meticulous measurements of A. Cops and his colleagues have given us the curves of FIGURE 8, which show transmission loss vs. frequency of a double glazed window composed of two 5/32 inch (4mm) panes separated 4 inches (100mm), as compared to a single pane of 5/32-inch glass.³ Shallow mass-air-mass dips appear at about 200 Hz and deep coincidence dips at about 3 kHz. The double glazing advantage is practically non-existent below about 250 Hz, but at many higher frequency points the double glazing offers 10-12 dB advantage. A maximum difference of 6 dB between the two curves can be attributed to doubling of glass mass, and the remainder must be attributed to the glass spacing effect. In terms of Sound Transmission Class (STC), the single pane window gives a rating of STC 27 and the double pane a rating of STC 36 or a gain of 9 STC points.

Comparing the measured TL curves of FIGURES 3 and 8 with their corresponding STC curves shows dramatically that the STC approach, as applied to windows, is very crude. The rich detail of TL measurements at 1/3 octave intervals is by far preferred, but, alas, such measurements are not always available. The most disturbing thing is that the depth of the coincidence acoustical hole is not fully accounted for by the STC assumptions. However, the simplification of representing an entire TL vs. frequency plot by a single STC number cannot be denied.

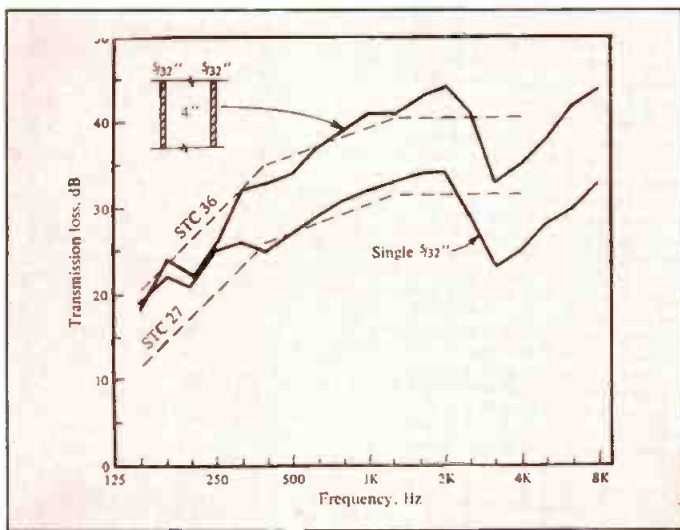

Figure 8. Measured transmission loss characteristics of a single 5/32-inch (4mm) glass compared with double 5/32-inch glasses spaced 4 inches (100mm) apart. Below 250 Hz the difference is minor, but the double glass offers a 10-12 dB advantage at higher frequencies. If the two glasses were close together, doubling the mass would increase the TL 6 dB. Beyond this the increase in TL is attributed to spacing. Shallow mass-air-mass dips are noted at about 200 Hz. (Adapted, with permission, from A. Cops et al, Ref. 2)

The effect of glass spacing on STC rating of the barrier is shown in FIGURE 9 taken from Quirt's measurements.¹ Measured points are shown for 1/4-inch (6mm) and 1/8-inch

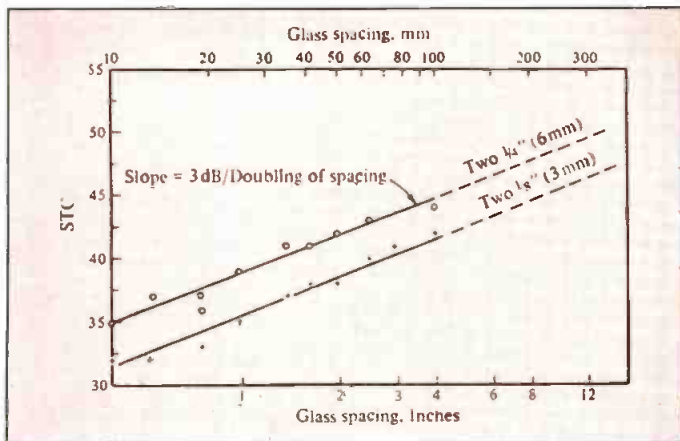

Figure 9. The effect of glass spacing on the STC rating of double glazed windows. The measured points are for two 1/4-inch (6mm) and two 1/8-inch (3mm) glass panels with different spacings. The straight lines represent slopes of 3 dB per doubling of the spacing, not best fit of the data. (Adapted, with permission, from Quirt, Ref. 1)

(3mm) glass panels spaced varying amounts. The straight lines represent slopes of 3 dB per doubling of space. The adherence of the measured points to this slope is reasonably good. On this basis, increasing the glass spacing from 4 inches to 8 inches can be expected to give a 3 dB improvement in TL. By the same token, increasing the spacing from 8 to 16 inches or 16 to 32 inches would give the same 3 dB improvement in TL. This is a good rule to remember.

Some measurements by A. Cops *et al* dramatize the wide range of performance between single and double glazed windows.³ In FIGURE 10A the TL of a single 5/16-inch (8mm) glass pane is shown. A coincidence dip

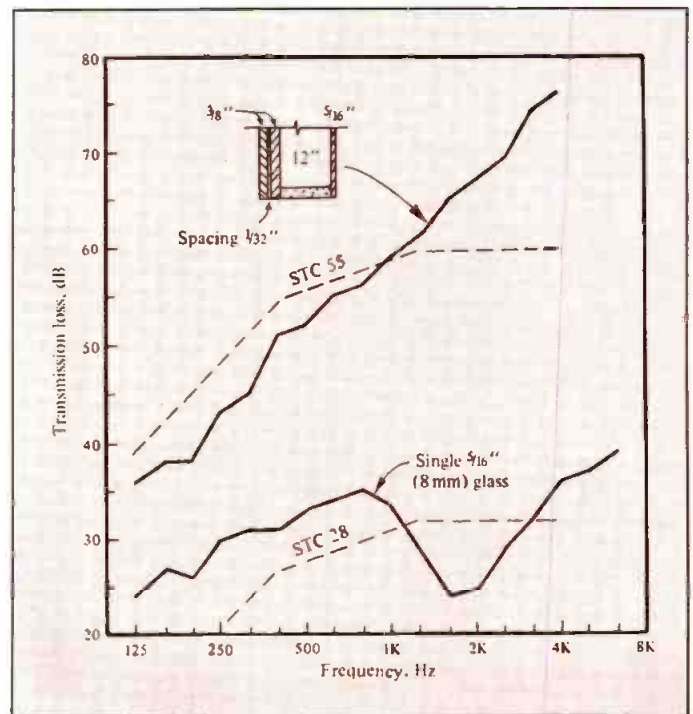

Figure 10. The transmission loss characteristics of a single 5/16-inch (8mm) glass pane (A). The coincidence dip at 1.6 kHz results in a low STC 28. The increase in transmission loss made possible by a double glazed window having more glass and generous interpane spacing (B). Two 3/8-inch (10mm) glass panes are laminated with a 1/32-inch butyl layer and spaced about 12 inches (300mm) from a 5/16-inch (8mm) pane. Absorbing material is on the reveals between the panes. (Adapted, with permission, from A. Cops et al, Ref. 2)

about 12 dB deep occurs at 1600 Hz, in agreement with Equation 5. This dip results in a very low rating of STC 28. FIGURE 10B shows the very great increase in TL obtainable by using more glass, greater spacing, and a bit of absorption. A window involving two 3/8-inch (10mm) glass panels laminated by a 1/32-inch (1mm) butyl layer are spaced 12 inches (350mm) from a 5/16-inch (8mm) glass panel. Note that this is not a true triple glazed window because the two heavy panels are bonded together making them act as a single panel of combined surface mass. Note also that absorption (to be discussed later) is included in the periphery of the cavity.

There are several interesting observations concerning the window of FIGURE 10B. First, it has excellent transmission loss. Second, it is an unusually smooth curve with little trace of coincidence or other dips. Third, the double-glazing effect has added 10 dB or more above 400 Hz to the TL expected from the surface mass of the three panels as calculated from Equation 1. By adding glass of an effective thickness of 3/4-inch and a 12 inch airspace, the rating is increased from STC 28 for the single 5/16-inch glass to STC 55, a gain of 27 points.

In Part II, the effects of absorption, dissimilar planes, and different types of glass (and not-glass) will be discussed.

REFERENCES

1. Quirt, J.D., "Sound Transmission Through Windows—I Single and Double Glazing." *Jour. Acous. Soc. Am.*, Vol. 72, No. 3 (September 1982) pp. 834-844.
2. Everest, F. Alton, "The Master Handbook of Acoustics." TAB Books #1296, Blue Ridge Summit, PA 17214.
3. Cops, A., H. Myncke and G. Vermeir, "Insulation of Reverberant Sound Through Double and Multilayered Constructions." *Acustica*, Vol. 33 (1975) pp. 257-265.

Digital Audio Broadcasting at WGBH Radio, Boston

With the help of the dbx 700 digital audio processor, classical music lovers in the Boston area are now enjoying the broadcast of the BSO even more.

WHEN NEW TECHNOLOGY is introduced to the broadcast engineering community, the reception is consistent only in its variability. One school of thought embraces the new for newness' sake. The other rejects the new in favor of the old and familiar. Somewhere in the middle lie the great majority of us, who seek to stay current with technology but like to reserve judgement until the device or technique has been in the field for a while or at least experienced first-hand. This was the case with digital audio broadcasting at WGBH Radio Boston, where we

considered "Luddites," voiced our misgivings about a harshness or "edge" that the technique seemed to impart to the music, e.g., a Handel and Haydn Society concert.

Assertions were made that we were merely hearing detail that was lost by earlier technologies. The quality of the recovered audio, however, "felt" different than what some of us were used to hearing live through our mixing consoles during in-house performances.

Still intrigued by the possibilities afforded by PCM, we decided to test Compact Discs. Although this music source does not lend itself to A/B testing of live vs.

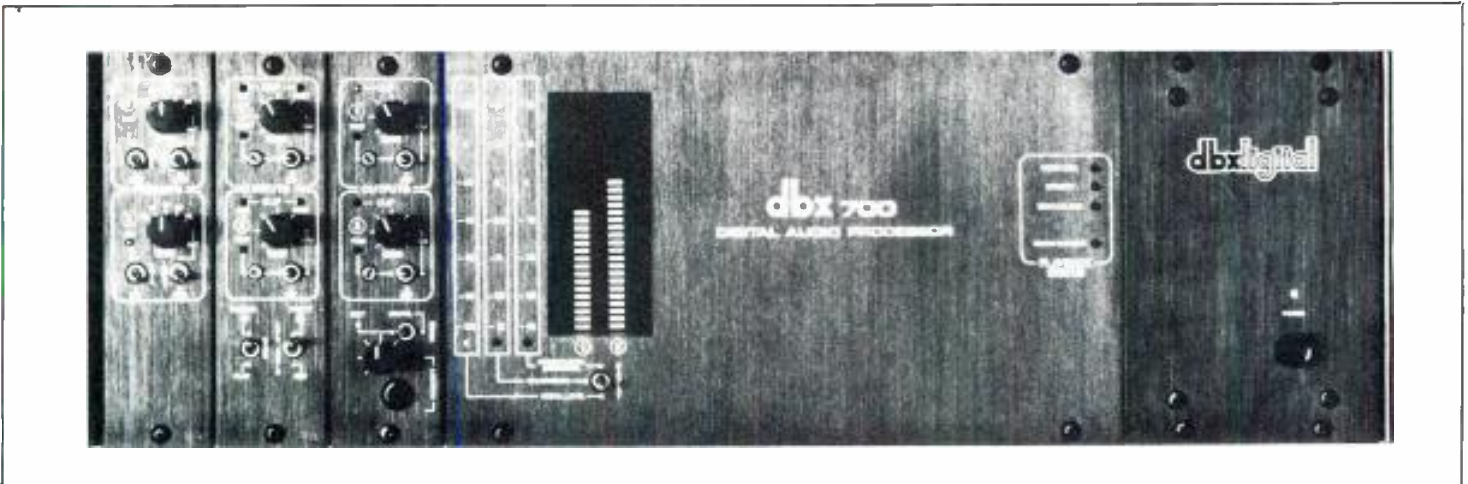

The dbx 700 digital audio processor.

had the opportunity to work with both PCM and the new dbx CPDM systems.

WGBH, in seeking a means of improving transmission quality from remote sites to our studios, had the opportunity to experiment with PCM (Pulse-Code Modulation), the most well-known type of digital audio processing, through the use of a Sony PCM-F1.

The initial reaction to the PCM system was mostly favorable. The dynamic range and absence of noise were impressive. Some of us, in spite of the fear of being

encoded sources, listener reaction was similar to that of the test with the Sony PCM-F1. Many of the staff were awed by the CDs sound. Some heard the "edge."

Enter the folks from dbx Inc. in neighboring Newton, MA. Their "black box," dubbed the 700 (dbx Model 700 Digital Audio Processor), translates analog audio to a digital format suitable for storage via a VCR/VTR or transmission via a video link like PCM audio processors. But here at the video connection, the similarities end.

PCM VS dbx's CPDM DIGITAL AUDIO SYSTEM

In professional PCM systems, the audio signal is sampled 48,000 times a second, providing a string of

Peter Swanson is the chief operator, WGBH Radio, Boston, MA.

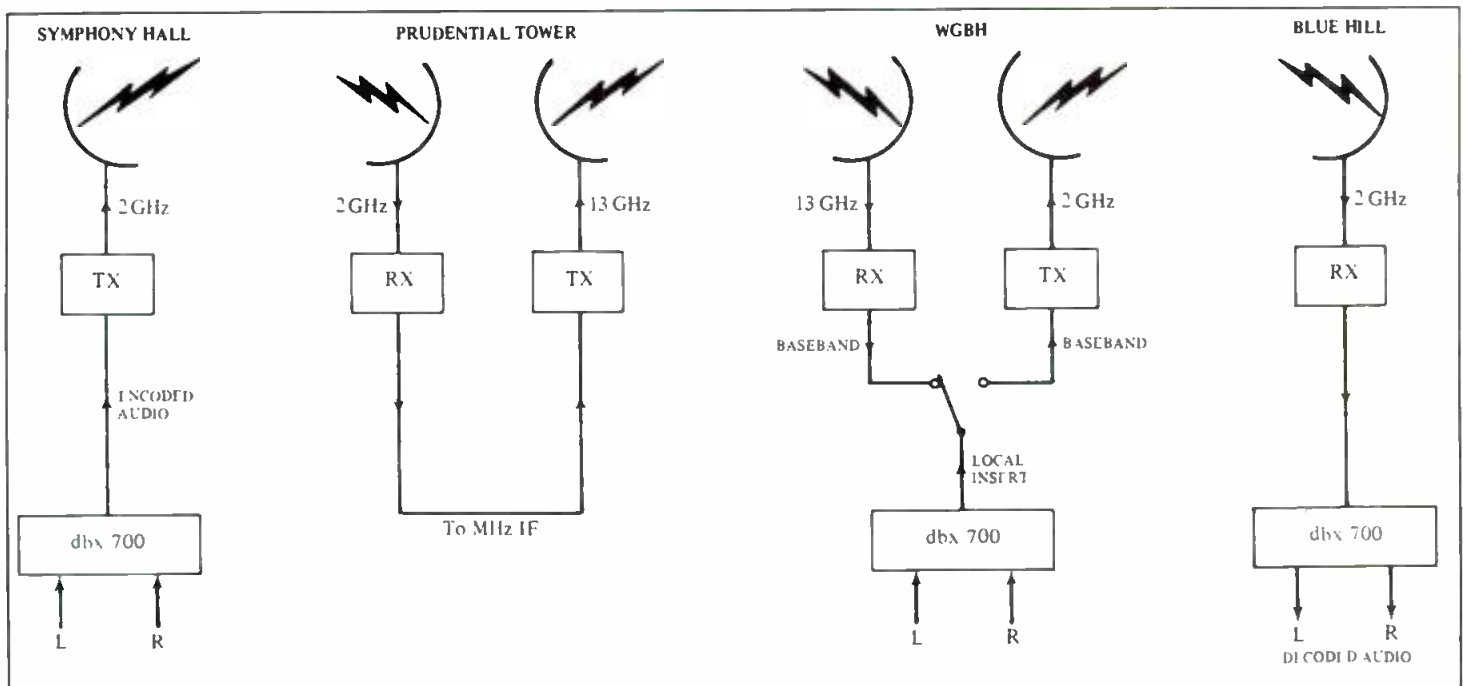

Figure 1. WGBH experimental microwave path used for the unannounced test.

discrete numbers in a binary code that ultimately is used to achieve a connect-the-dots type of reconstruction of the original audio signal. PCM requires extremely sharp filters just beyond the highest audible frequencies in order to work properly. Many professionals believe that these filters significantly degrade the highs because they cause a certain amount of phase shifting.

The dbx digital audio system does not use PCM. For both sonic and cost reasons, dbx has chosen to employ a system incorporating delta modulation, which they call CPDM (Companded Predictive Delta Modulation)—“delta” signifying *changes* in voltage, not exact levels of voltage.

The dbx CPDM system samples the incoming audio 644,000 times per second, more than 13 times greater than PCM. If the dbx unit senses a rising audio waveform, it generates more digital 1s than 0s; if the wave is falling, it generates more 0s than 1s. If there is silence, the system alternates 1s and 0s. After the 1s and 0s (higher vs. lower voltage) are integrated by means of a gentle low-pass filter to remove the 644 kHz sampling component, the encoded audio is recovered, i.e., decoded.

CPDM, with its more frequent sampling of the waveform, achieves greater phase accuracy in the audio band and more extended reproduction of high-frequency material. The potential for phase scrambling due to the steep anti-aliasing and low-pass filters required by PCM is greatly reduced.

The above sounds great on paper. Happily for us, we’ve found that the dbx 700 lives up to these claims in real life!

When the people from dbx brought over a Model 700 and a demonstration tape, a gathering of “golden ears” and civilians was convened. The demo tape, which had been played at some of the various broadcast and recording trade shows, consisted of a variety of material from jazz and blues to a full symphony orchestra. Monitoring through our ADS 610s, even the “Luddites” were astounded! Here were the ingredients for excellent audio: ultra-wide dynamic range (around 110 dB), an inaudible noise floor, incredible detail, and...*no digital edge!*

dbx, MEET THE BSO

Since the early 1950s, WGBH Radio has broadcast concerts of the Boston Symphony Orchestra. Despite attempts to enhance the program lines between Symphony Hall and our studios with Dolby A, Burwen, etc., there has been a constant struggle to keep the BSO broadcasts sounding as clean as we would like. Impressed with the dbx 700 and its potential for digital audio broadcasting, we immediately began to plan a test of the system from Symphony Hall.

First, a team combining talents from both WGBH Radio and WGBH TV (Channel 2) was set up. Dave St. Onge, chief engineer of WGBH TV/FM, enlisted two of Channel 2’s top ENG/microwave people, Gordon Mehlman and Steve Damas, to set up microwave links between Symphony Hall and Boston’s Prudential Center (see FIGURE 1). Channel 2 has a video repeater at the Prudential Center to the WGBH studios since there is no line-of-sight path for a single “hop.”

To eliminate the last weak audio link, another microwave path was established between the studios and the FM transmitter site, atop Great Blue Hill (GBH) in Milton, MA (see FIGURE 1).

Normally, our STL (studio-to-transmitter-link) path affords a signal-to-noise ratio of only 65 dB even with Dolby A noise reduction, and the lines from Symphony Hall only approach that when the wind is right.

In an end-to-end test of the dbx digital path from Symphony Hall to the “Pru” to our studios and on through to the transmitter site, we measured S/N in excess of 80 dB. Add to that another 30 dB headroom above the Symphony Hall Neve console’s nominal operating level, and we ended up with 100 dB remote link! And this was with the dbx decoder (another Model 700) at the transmitter end being bombarded with RF energy. (One of the fluorescent lights in the transmitter building never really goes out because the high RF in the room keeps it lit.) Despite the RF, we found ourselves with one hell of a clean STL.

After satisfying ourselves that the path and equipment



Bill Busiek, engineer-in-charge for WGBH 89.7 FM, initiated the dbx 700 in unannounced test from the Symphony Hall recording booth.

were working properly, we prepared to conduct a blind test. With a dbx Model 700 unit set to encode from Symphony Hall and a second Model 700 at the studios to encode studio-originated programming, we undertook an unannounced 24-hour on-air test. Channel 2's Tom Dilley coordinated the video switching necessary to carry out the transitions between the studio and Symphony Hall.

A small group of colleagues from outside WGBH and dbx were apprised of the test only when it was underway. The results were as good as anyone could have hoped for. Broadcast engineers from other Boston stations, who were invited to listen and critique, were unanimous in their praise.

During parts of the test period we A/B'd our Dolby A'd studio-to-transmitter link with the dbx-digital path while keeping our levels matched. Not only was the absence of noise remarkable, but the absolute flatness of frequency

response of the dbx system prompted one of WGBH's severest critics to call up the station and blurt out, "Best damned Symphony (BSO) broadcast I've heard in 20 years!" (He prefaced this with "Holy s---," but I don't think *Reader's Digest* or *db* would consider this a quotable phrase.)

During the "secret" test of the system, other listeners also called spontaneously to comment on the unusually clean and live-sounding broadcast. Soon we'll be able to tell them what we were up to, because, as this is written, we are planning an announced version of the dbx 700 Boston Symphony experience.

In short, our results in employing the dbx Model 700 Digital Audio Processor have been so encouraging, we are scrambling to find the capital to set up a permanent STL system based on these experiments. Once you've heard audio this good, you don't want to give it up! ■

Testing...One, Two, Three

Ready for a history lesson? Read carefully, there might be a test afterwards.

FOR MORE THAN HALF a century, loudspeaker development has evolved with a mixture of science, art, and intuition. A brief look at the history of the development of audio analysis will enable us to fully appreciate how we got this far. Even though it's easy for us to underestimate the "old-timers," everything we develop today is a direct result of their work.

In *Seeing What You Hear* (Nov./Dec. and Jan./Feb.) we talked about the need for adequate objective methods of evaluating loudspeaker performance and we presented some solutions. This month we'll take a look at how the field developed, and how some of the state-of-the-art testing techniques evolved.

AND IN THE BEGINNING... LET THERE BE AUDIO

A sound field has two quantities that are readily accessible for measurement: sound pressure and particle velocity. The first known method of measuring particle velocity was developed in 1882 by Lord Kelvin Rayleigh, and was called, appropriately enough, the Rayleigh disk. The Rayleigh disk is quite simple in its principle of operation, but it was a landmark invention and state-of-the-art in the 19th century.

FIGURE 1 illustrates its operation. A light plane disk is

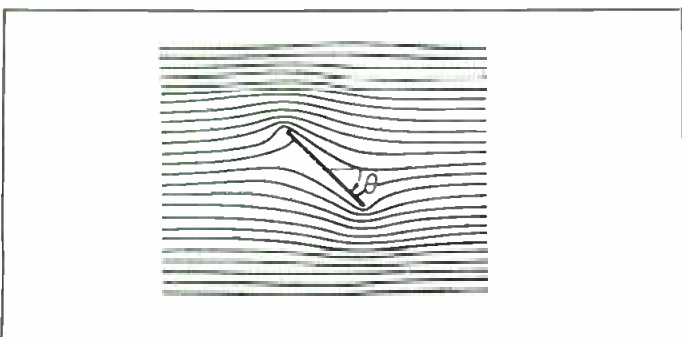

Figure 1. Rayleigh Disk, obliquely placed disk in a constant flow.

placed obliquely in a constant flow, and the flow lines are crowded together at the edges; that is, the speed of flow is increased and the static pressure is reduced. Meanwhile, the static pressure increases at the two stagnation points. Therefore, the disk undergoes, overall, a turning moment

that tends to set it perpendicular to the flow. If the direction of the flow is reversed, the turning moment acts in the same direction. Since a sound wave acts as an alternating flow, the result is rotation of the disk.

Unfortunately, the Rayleigh disk had many practical drawbacks, even though it was great in theory. The Rayleigh disk is now only of historical interest; it is practically never used to determine particle velocity anymore.

The famous German physicist Hermann von Helmholtz (1821-1894) invented perhaps the most classic analyzer; this was used in experiments forming many theories on which modern acoustics and physico-acoustics are based. Even before the era of electronic Fourier spectrum analyzers, Helmholtz used a large set of his acoustic resonators to verify the existence of harmonics in complex tones. By holding successively smaller (i.e., higher frequency) resonators to his ear with a musical note playing into the resonator's large opening, Helmholtz heard an increase in the amplitude of any frequency that was present in the harmonic structure of the instrument. Thus, he could roughly determine the Fourier spectrum of the note.

ATTACK, STEADY-STATE, AND DECAY

Speech and music are transient in nature, even though some sounds exhibit repetitive waveform patterns (which audibly resemble steady-state signals). For all practical purposes, musical tones have three sections: attack, steady-state or sustain, and decay. Helmholtz theorized that timbre is determined by the spectrum of the steady-state. However, this theory has problems when applied or tested. In 1947, Eagleson & Eagleson (1) found that musical instruments could be recognized even from a very poor recording, despite the fact that their spectra were radically changed by such distortion. In 1935, Wentz (2) showed that a normally reverberant room could have a frequency response with deviations of as much as 20 dB, and the response was different at every point in the room. However, when one changed position in a normally reverberant room, the timbre was not totally changed as you would expect it to be if the timbre was completely dependent upon the frequency spectrum.

Continuing along this path, it can be demonstrated that changing the relationship between the attack, steady-state, and decay portions of sound will change the timbre. Eliminating the initial segments of notes played by various instruments makes the recognition of these instruments extremely difficult, as shown by Stumpf as

Jesse Klapholz still runs an audio consulting firm specializing in acoustical analysis and design in the Philadelphia area.

early as 1910 (3). Tape recorder manipulations of recorded musical instruments have been used to show the influence of time factors on tone quality by George in 1954 (4) and Schaeffer in 1966 (5). For example, playing a piano tone backwards gives a non-piano-like quality, even though the recording played forward or reversed has the same frequency spectrum. An interesting project to bring up at this point is Olson's musical instrument synthesis (6). Olson was able to recreate piano sounds and wind instruments by superimposing attack and decay curves on steady-state sounds.

Based on the studies of Wentz, Olson, and others, it would have seemed logical for them to have used transient signals when testing or evaluating transducers used for speech and music reproduction. In fact, it was our forefathers who introduced the concept of transient testing techniques. To put this in perspective, we're talking about the period following the introduction of the moving coil loudspeaker by Rice and Kellogg at Western Electric in 1925.

Early investigations carried out by McLachlan and Sowter (7) using a step unit signal, and also by Helmbold in 1937 (8) using interrupted tone, were able to demonstrate the relationship between build-up time and steady-state frequency response. Not long after these works, Shorter (9) at the British Broadcasting Corporation suggested that, since correlation between subjective quality and frequency response irregularity was still unsatisfactory, the interrupted tone-test method should be extended to the later stages of the transient.

Shorter's work concentrated on the decay of the transient. He consequently succeeded in refining the method to a stage where decay spectra could be presented in three dimensional displays representing amplitude, frequency, and time. FIGURE 2 shows the relationship between the energy vs. time, energy vs. frequency, and energy vs. frequency vs. time of a loudspeaker's resonance.

THE BIRTH OF MODERN ANALYSIS

During World War II, R.K. Potter at Bell Labs was working on a revolutionary new frequency analyzer that gave a continuous analysis of speech. It was called "visible speech" (10). In his book Potter describes his device; "One speaks into a microphone and the oscillations of his speech are then passed through 12 electrical filters...When amplified, each filtered set of oscillations lights a tiny grain-of-wheat lamp; there are twelve lamps, arranged vertically. The fundamental tone of the speech lights one lamp, the second harmonic another farther up, and so on. The lamps that light in response to the speaker indicate the frequencies present in his speech."

Referring to FIGURE 3, Potter then explains how he produced the display; "...the light from the lamps falls on a horizontal moving belt made of a phosphorescent material, so arranged that each lighted lamp traces a separate luminous line on the belt. The result is a characteristic pattern for each vowel and consonant, defined by lines of varying frequency and duration." FIGURE 4 shows a typical display of the visible speech process.

In the forties and early fifties, researchers working at RCA's Princeton lab were refining RCA loudspeakers in production at the time. Olson, Preston, and May of RCA (11) reported in their historic paper that, "One of the common methods of testing the transient response of a loudspeaker is by observing the response to a tone

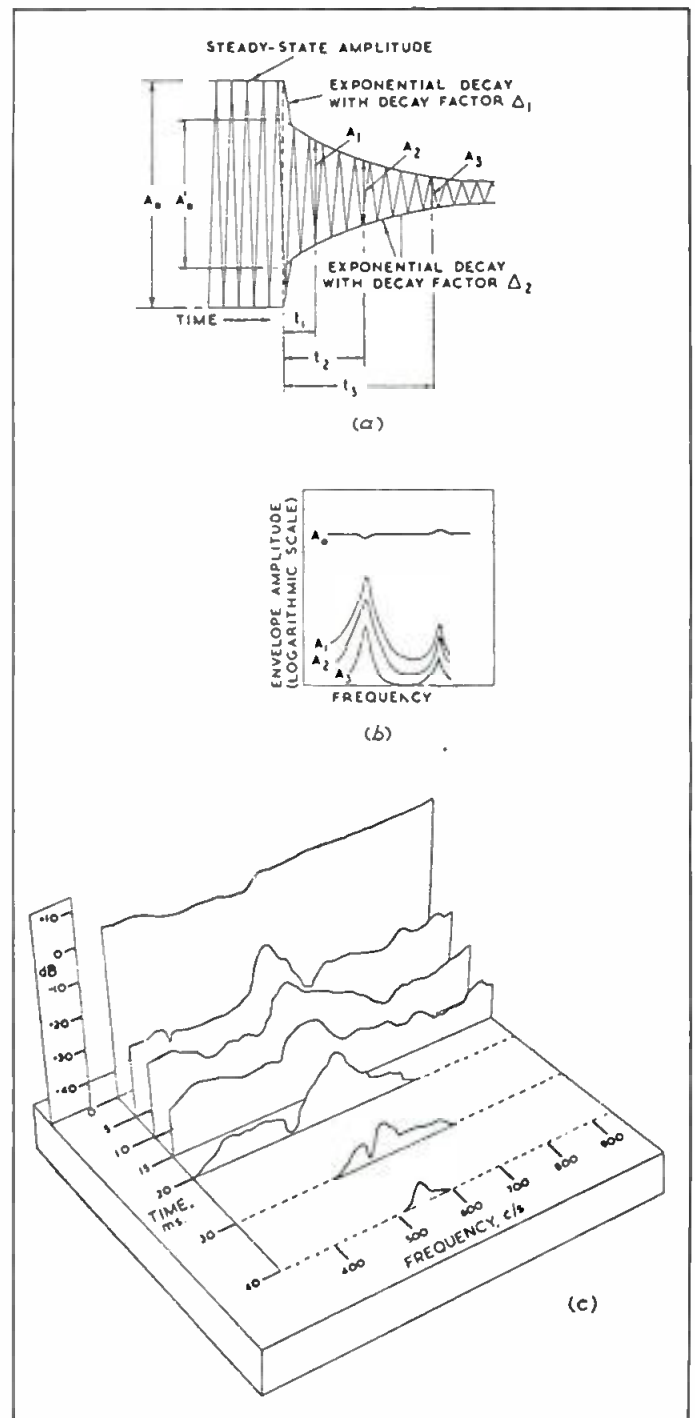

Figure 2. Example of Shorter's representation of a transient decay: a) energy vs. time. b) energy vs. frequency. c) energy vs. frequency vs. time.

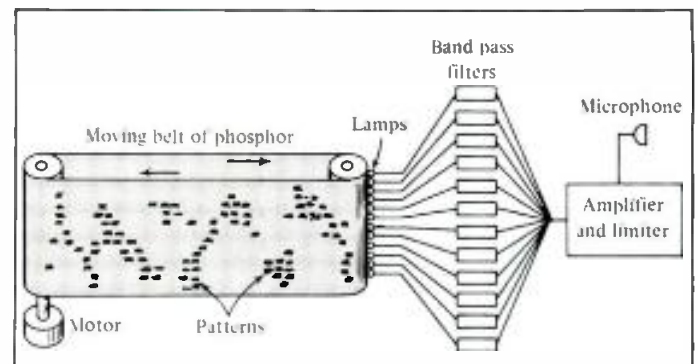

Figure 3. Potter's visible speech system.

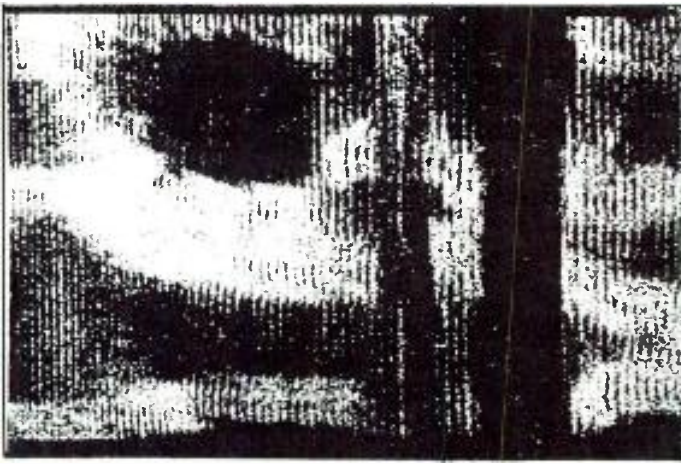

Figure 4. Typical display of Potter's visible speech process of the spoken phrase, "Four score and seven years ago...."

burst... Any loudspeaker passing this test will handle any transients encountered in speech and music without distortion." They then stated, "From the foregoing it will be seen that the growth and decay characteristics of speech and music will not be reproduced unless the system exhibits good response to transients."

At about the same time, working at RCA's Camden lab, Corrington (12) showed the connection between various modes of cone resonance, tone-burst decay patterns, and corresponding fluctuations in the amplitude-frequency response characteristics. As a result of Corrington's work, Kidd (13) designed an electronic device to interrupt the test tone at intervals corresponding to a given number of cycles, and to record, as a function of frequency, the sound output of the loudspeaker while the tone was shut off. FIGURE 5 is the block diagram of the tone burst generator and transient recorder as described in Kidd's paper and used by Corrington and Kidd.

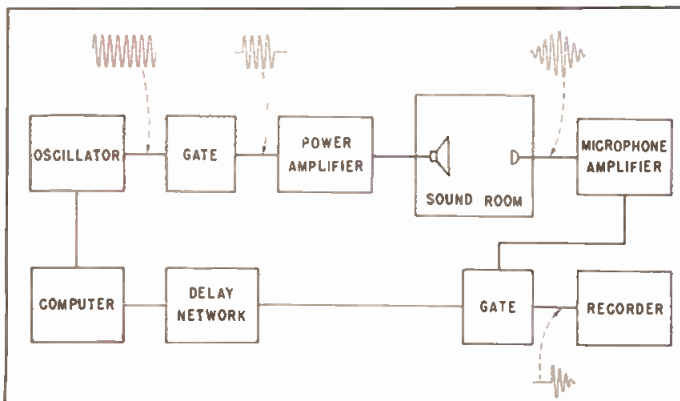

Figure 5. Block diagram of Kidd's transient recorder.

Corrington pointed out that the response to a unit impulse (or impulse response) "gives all of the (transient) behavior at one test, but is hard to interpret..." Corrington was lamenting a well-understood fact: because a loudspeaker is a very complex device, there is a great deal of information contained in its impulse response. While this information is a complete description of all the linear properties of a loudspeaker, the sum total can often become such a jumble that it is difficult to extract any of its single components by visual inspection.

Corrington continued: "The suddenly applied sine wave is more selective, since it emphasizes the behavior of the device at nearly the same frequency as the applied sine wave." Thus, the intention of tone-burst testing is to extract a spectrally limited part of the information describing the transient behavior of a loudspeaker; and by selecting a series of tone-burst frequencies and accumulating a set of such measurements, it might be hoped to build up a more or less complete picture of the transient behavior, indexed by frequency for easy interpretation.

HMMM...NOW WE'RE BEGINNING TO SEE THE LIGHT!

Problems of instrumentation nevertheless dominated the situation until quite recently. Earlier methods suffered from poor signal-to-noise ratio and were tedious and time-consuming. The results were also difficult to interpret and none of the techniques described came into general use.

If a loudspeaker is assumed to be a linear device, the steady-state frequency response—in terms of both amplitude and phase, as well as the transient response—can all be derived from its response to a short duration impulse. In fact, with an accurate record of a loudspeaker's impulse response, one can predict its response to any other signal, whether it is transient or steady-state. A loudspeaker's performance could very well be shown by its frequency response alone—that is if it were a minimum phase-shift device. Unfortunately, loudspeakers like this are rarely found (fortunately for the test equipment manufacturers). Therefore, phase information is of equal importance.

Investigations into phase distortion of loudspeakers were carried out by Wiener (14) as early as 1940, but he was unable to eliminate the effects of the linear phase-shift induced by the transient time of the signal from the loudspeaker to the test microphone. Subsequently, Ewaskio and Mawardi (15) measured group delay and succeeded in eliminating linear phase-shift. Still later, Stroh (16) used a delay line for the same purpose.

JPL TO THE RESCUE

The problems of phase-shift in loudspeaker measurement were solved in elegant fashion using analog methods by Richard C. Heyser of Jet Propulsion Laboratory at California Institute of Technology (17). Heyser described this "new acoustic testing technique" in his landmark paper, "Acoustical Measurements by Time Delay Spectrometry."

This new technique can be implemented in its most basic form with a swept sine-wave spectrum analyzer and an external oscillator (equipment found in most labs even to this day). The technique of "TDS" (as implemented with a spectrum analyzer and oscillator) can be simply described: the external oscillator introduces a time offset equal to the transit time of the test signal (the time it takes the signal to travel through the air from the loudspeaker to the test microphone), and delays the tracking filter in the spectrum analyzer proportionately, thus eliminating the linear phase-shift distortion problems encountered in previous methods. This method also eliminates any extraneous signals (such as reflections), yields "anechoic" response curves, has an excellent signal-to-noise ratio, and also has a wide dynamic range.

Don Davis and Synergetic Audio Concepts recognized the potential of Heyser's work, and the company has since then been teaching the "TDS" technique in special seminars (they issued licenses through Cal Tech to

practice TDS for a limited time). Bruel & Kajer (whose test equipment can be found in a vast majority of laboratories) introduced a "Time Delay Spectrometry Control Unit" that enabled those who already owned a B&K heterodyne analyzer setup to measure with TDS.

Those who wished to have the capabilities of TDS quickly found themselves with a minimum investment of \$25,000 worth of test equipment and a cumbersome pile of equipment and patch cords. In view of these problems, Crown International, through Syn. Aud. Con., obtained licensing from JPL to manufacture a "dedicated" unit, the Tecron TEF System 10. This implementation of Heyser's techniques put all the TDS features in one portable unit for about \$15,000 (price depends on the options ordered).

MEANWHILE, THE BRITISH WERE COMING

In 1971, a research program concerned with the transient behavior of loudspeakers was initiated by KEF Electronics in conjunction with R.V. Leedham of the University of Bradford. An interim progress report was made in a paper presented to the AES in 1973 by L.R. Fincham of KEF and R.V. Leedham of University of Bradford: they centered their research on impulse testing. The techniques developed at KEF overcame all the disadvantages of previous attempts at impulse measurement systems: poor signal-to-noise ratio, slowness, and long, involved procedures. Signal averaging was used to obtain a wide dynamic range and good signal-to-noise ratio. Subsequent processing of the impulse response with a digital computer was used to provide other displays from the initial data.

In 1975 J.M. Berman presented a paper about the developments of KEF's impulse testing research at the AES convention in London. He stated, "From this one measurement alone (the impulse response) we are then able to derive the corresponding response to any test signal and, in addition, to present the total system information in ways which may communicate more visual information about its behavior." Berman made the point, "The steady-state and transient behavior may be derived from such an impulse response....In addition, digital processing techniques may be applied to the stored impulse response to reveal aspects of the system behavior quite inaccessible with traditional (analog) measuring techniques." Berman concluded, "At present, listening tests are still the only means of revealing many of the subtle differences between loudspeakers. There is now evidence that digital techniques may provide measured confirmation of these audible differences and so facilitate a more objective approach to loudspeaker design."

FIGURES 6 through 8 show the impulse response of a KEF 2-in. dome midrange loudspeaker, and how the impulse response can be manipulated to show its various properties. FIGURE 6 is an example of how the "tail" may be magnified to show in better detail the decay portion of the signal. As we discussed earlier, the steady-state frequency and phase response may be derived from the impulse response, as is displayed in FIGURE 7. Even further computer manipulation will give us a *cumulative spectra* display as shown in FIGURE 8. In this type of display we can easily see the build up and decay of all frequencies as displaced in time. It should be obvious that the cumulative spectra display shows far more information, is much cleaner, and easier to interpret than its predecessor, the tone-burst test.

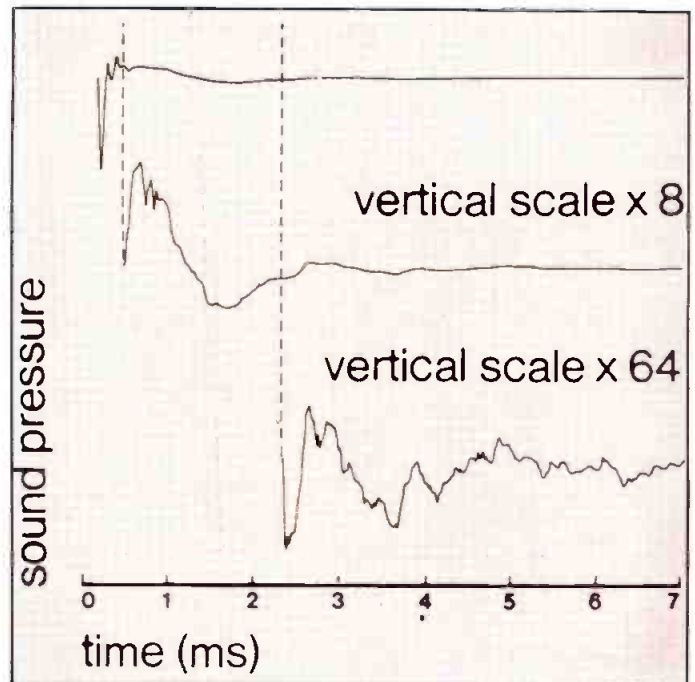

Figure 6. Impulse response of a 2-in. dome mid-range driver, showing the "tail" magnified. (KEF Electronics)

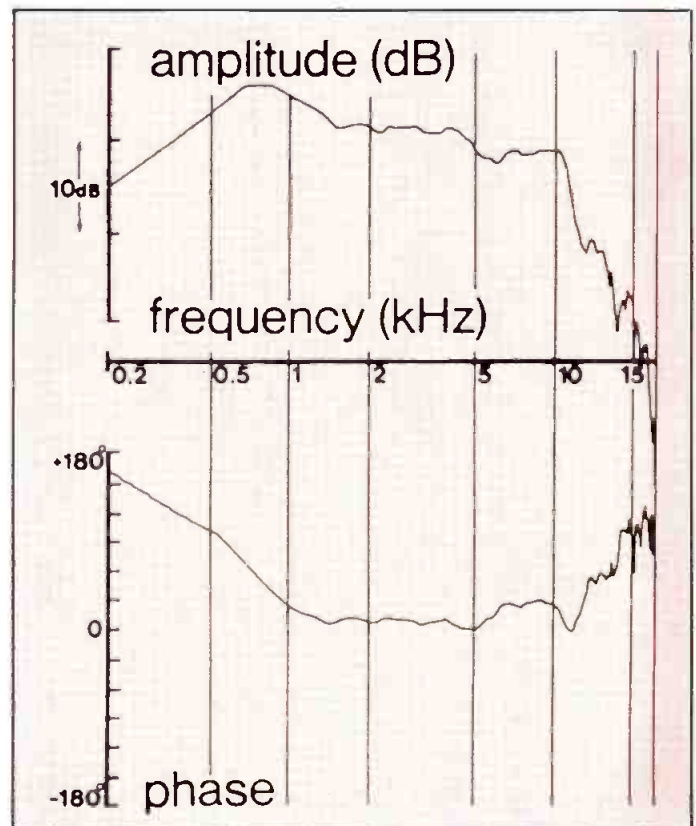

Figure 7. The steady state frequency and phase response of the 2-in. dome mid-range driver, as derived from the impulse response in Figure 6. (KEF Electronics)

AND IN THE REAL WORLD

At this time we will take a look at several different applications and techniques presently in use in the industry. At Community Light & Sound, John Wiggins has been using the Tecron TEF 10. In the past, in addition to using the traditional testing methods and equipment available, the people at Community had been resorting to subjective analysis as a final "tweak"; now they see a much better picture in a matter of minutes with the TEF

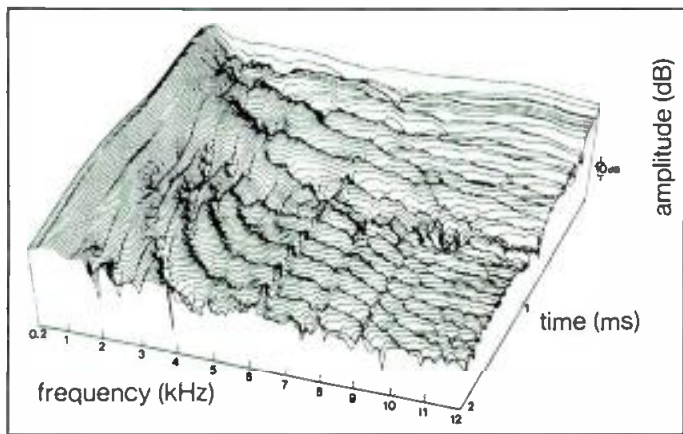

Figure 8. The cumulative spectra display of the 2-in. dome mid-range driver, as derived from the impulse response in Figure 7. (KEF Electronics)

machine. John has been able to refine their loudspeaker designs more efficiently and accurately. FIGURES 9 and 10 show the build up and decay characteristics of one of their current full-range loudspeaker systems. These curves show that this system will do a very good job of handling transients and will not “muddy up” the decay sound in musical reproduction applications.

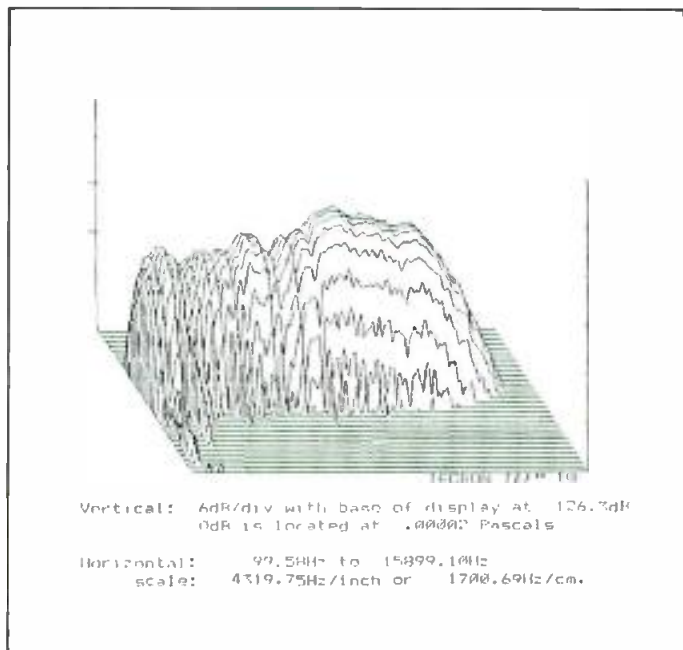

Figure 9. TDS swept sine wave response plot of a Community full range loudspeaker showing its “build-up characteristics.”

The People at Philips Research Labs in the Netherlands have taken a somewhat different approach. Called “Wigner Distribution,” it uses instrumentation techniques similar to the digital impulse testing method in use at KEF. As Janse and Kaizer (18) report in their paper, “...The Wigner distribution of a signal can be interpreted as a distribution of the signal energy in time and frequency. It is a basic time-frequency distribution...” FIGURES 11 and 12 show the response of a bandpass filter in cumulative spectra form and the Wigner Distribution display contour plot. The top view of the *mountain range* in the Wigner plot shows the effects of phase-shift or time-delay in this filter (about 0.5 msec. at 1 kHz).

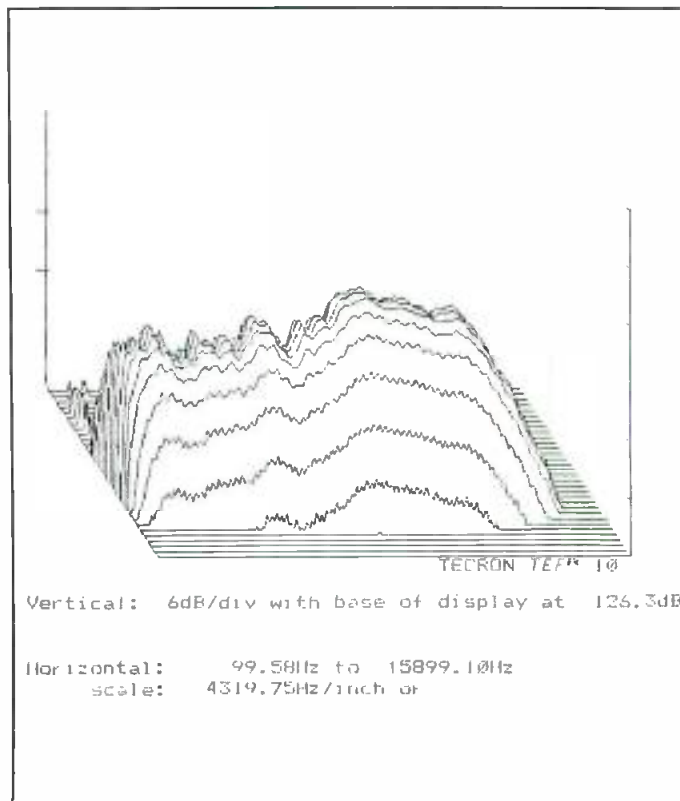

Figure 10. TDS swept sine wave response plot of a Community full range loudspeaker showing its “decay characteristics.”

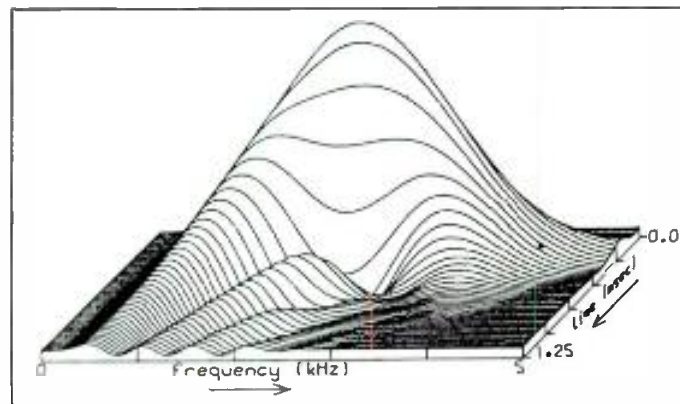

Figure 11. The cumulative spectra display of the response of a bandpass filter. (Philips)

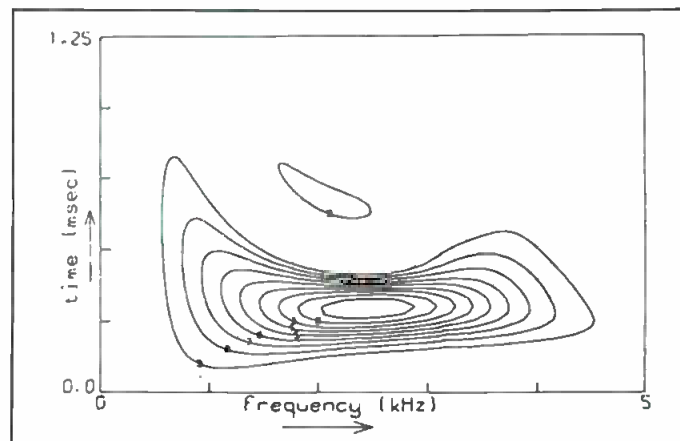

Figure 12. The Wigner Distribution display of the bandpass filter in Figure 11. (Philips)

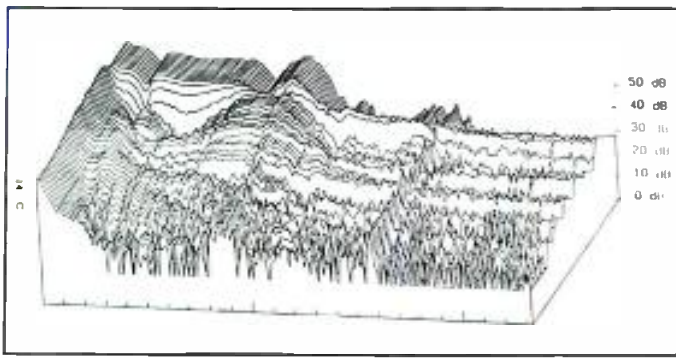

Figure 13. The Spectral Decay contour plot of a full range loudspeaker using a rectangular window.

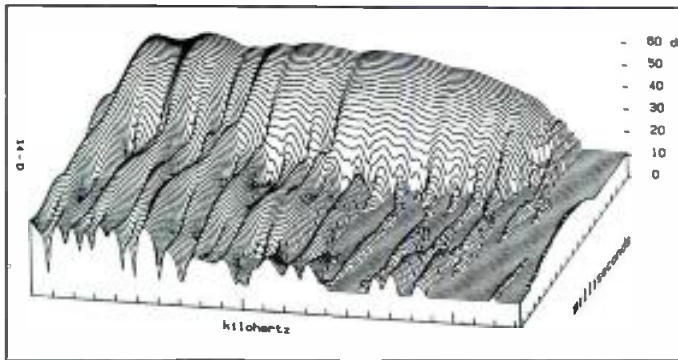

Figure 14. The Spectral Decay contour plot of the loudspeaker in Figure 13 using a cosine window.

APPLES AND MORE APPLES

“What about the IQS-401-L Analyzer?” I thought you’d never ask. Keeping in step with the rest of their software, IQS has certainly written some very nice programs for three-dimensional audio analysis. We will take a look at two different programs that are available for the 401-L at this time.

Similar to the traditional “waterfall” display style, IQS calls their display a *Spectral Decay* contour plot. FIGURES 13 and 14 are examples of spectral decay contours taken from the time data of a loudspeaker. The major differences between the two displays is a result of the “windowing” (weighting) used in the figure. FIGURE 13 used a “rectangular” window (flat or unity weighting), and the FFTs in FIGURE 14 were computed with a cosine function window.

When an FFT is computed, it is looking at a “window” of the time domain data—that is, a “slice” of the continuous “periodic” waveform. The FFT joins the beginning and end of this slice of time, forming an assumed periodic function. Tapering the ends of this slice of time by various “windowing” functions can thus reduce errors that would normally be introduced by joining ends that are continuous (since, after windowing, both the beginning and end would now have zero energy). Further, selecting various windowing functions allows control over the trade-off between frequency and time resolution, a consequence of the uncertainty principle. Phew!

This may all sound extremely involved and complicated, but once you have gathered test data (whether in memory or called up from disk), it is merely a matter of a half a dozen single keystroke responses to questions that the computer prompts you with.

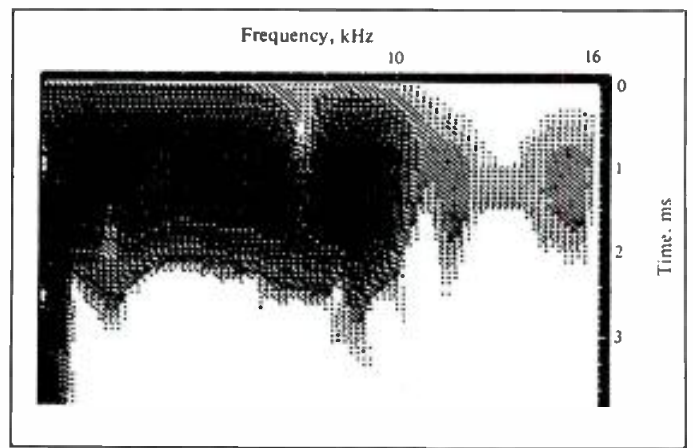

Figure 15. TimeSpectrum® display of the full range loudspeaker in Figure 13 where the darker areas of the display correspond to amplitude peaks.

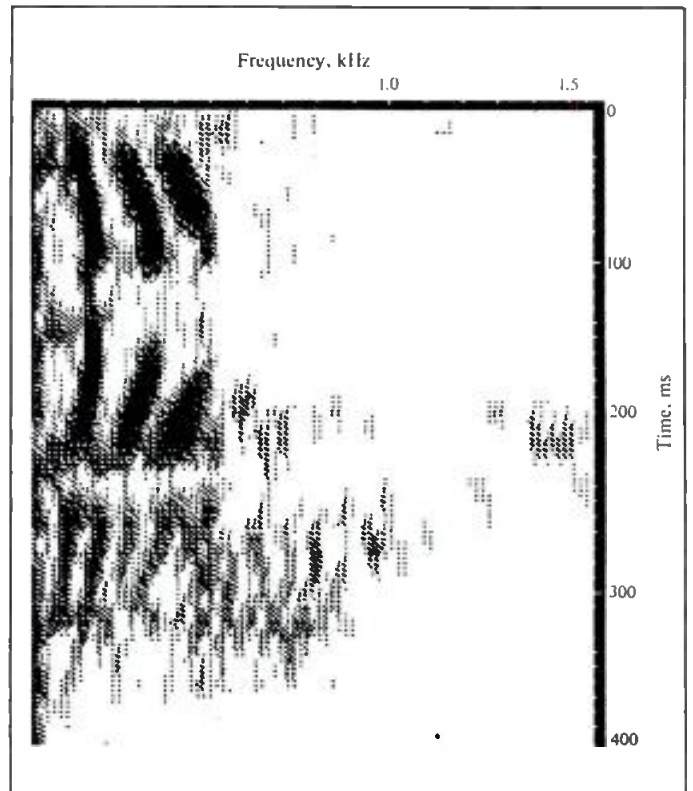

Figure 16. Time Spectrum display of a voiceprint.

OK, WHATS THE BIG DEAL?

The big deal is that once the time domain information is gathered, these or other programs may be run to display the information in many different views, giving us much more insight than was previously possible, in just a matter of minutes!

One of these views is the second program from IQS, called TimeSpectrum®. This new program (hot off the press) allows us to view frequency/time changes of physical systems in a unique and unprecedented way. The TimeSpectrum display eliminates the distortions normally encountered when isometrically displaying a three dimensional plot in a two dimensional graphics medium. TimeSpectrum does this by showing the energy amplitude with a greyscale intensity; the more energy, the darker the display point becomes. The frequency and time scales are now shown in the x and y axis without distortion, and “clumps” of frequency-defined “energy

packets." displaced in time, now form a crystal clear picture!

THE PIECE DE RESISTANCE

FIGURE 15 is the loudspeaker analyzed in FIGURES 13 and 14; the darker areas of the display correspond to the peaks in amplitude of the spectral decay plot. Comparing

the identical data in these two plots, one can easily see the build-up, steady-state and decay characteristics of the d.u.t. (device under test) all in one plot. This observation can be made without having to resort to the "front" and "rear" view of the more conventional "waterfall" plot.

FIGURE 16 is a "voiceprint" plot; three discrete "energy packets" can easily be displaced in time as a function of

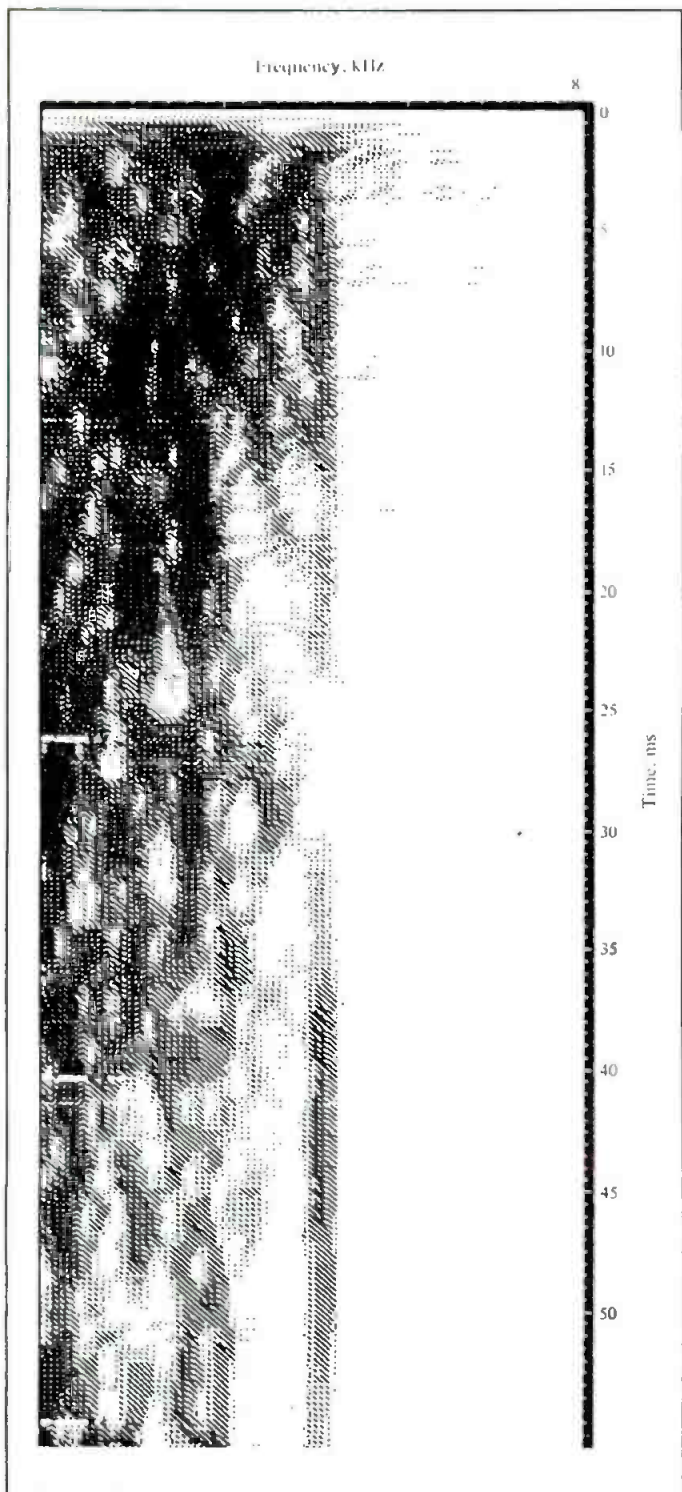

Figure 17. TimeSpectrum display of a single note played on a piano.

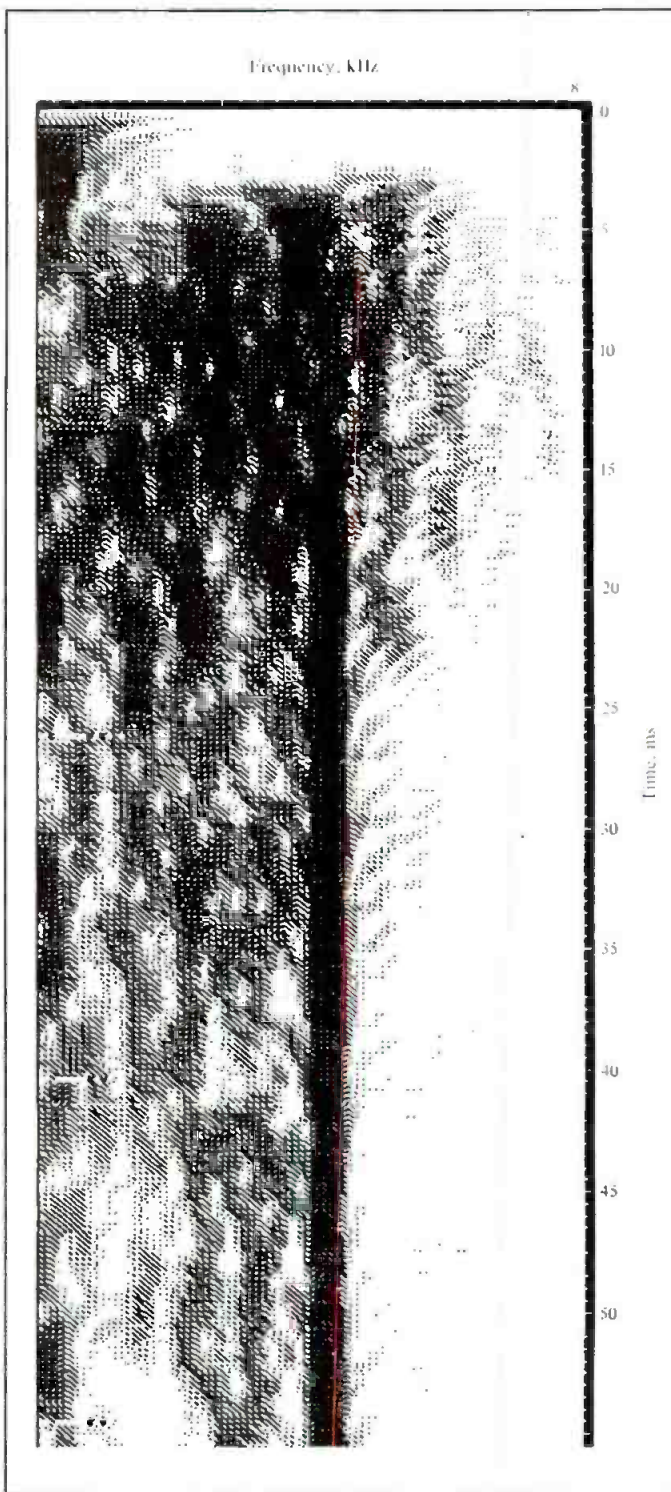

Figure 18. TimeSpectrum display of the same note played identically to the one in Figure 17, but on a different piano. The strong ridge is the actual note.

frequency. It is also interesting to observe in FIGURE 16 the "repetitiveness of these "energy-packets." In looking at this type of analysis, you don't need a wild imagination to see TimeSpectrum's application to architectural acoustics, structural and mechanical analysis, vibration study, loudspeaker and microphone development, and bio-medical instrumentation, just to drop a couple of names. Just think, a single picture showing a 1.6-second decay of an auditorium!

FIGURE 17 and 18 are plots of the same note played identically on two different pianos. The strong "ridge" in FIGURE 18 is the actual note being played, showing a piano with a much better "voicing." This application of TimeSpectrum demonstrates the enormous amount of information attainable for analysis of musical instruments.

Based on early practice, the application of computer technology has led us to a whole new view of loudspeaker evaluation. The current state of the art has given us

"cameras" to take "pictures" of electro-acoustical phenomena more efficiently and accurately than older methods. A good, working knowledge of the theories and physical laws of electro-acoustics is a fundamental tool in interpreting these "pictures."

More powerful computer hardware is rapidly becoming available. We are at the beginning of a new computer age. As we speak, those computer "freaks" are furiously hacking away. I wonder what the guys are working on in those backroom labs now! ■



There are more than 2,000 kinds of birth defects. Call your local chapter for the free booklet:

"Be Good to Your Baby Before it is Born"



REFERENCES

1. Egelson, H.W., & Egelson, O.W. "Identification of Musical Instruments When Heard Directly and Over a Public Address System," *JASA* (1947).
2. Wente, E.C. "Characteristics of Sound Transmission in Rooms. *JASA* #7 (1935).
3. Stumpf, C. *Die Sprachlante*. Berlin and New York: Springer-Verlag, (1926).
4. George, W.H. "A Sound Reversal Technique Applied to the Study of Tone Quality." *Acustica*, #4 (1954).
5. Schaeffer, P. "Traite Des Musicaux." Paris, 1966 (with three records of sound examples).
6. Olson, H.F. and Belar, H. "Electronic Music Synthesizer," *JASA* #27, (1955).
7. McLachlan, N.W. *Loudspeakers*, Oxford, 1934.
8. Helmbold, J.G. "Oszillographische Untersuchungen von Einschwingvorgängen bei Lautsprechern," *Akustische Zeitschrift*, #2 (1937).
9. Shorter, D.E.L. "Loudspeaker Transient Response, Its Measurement and Graphical Representation," *BBC Quarterly*, #1 (1946).
10. Potter, R.K. *Visible Speech*. Van Nostrand, 1948.
11. Olson, H.F., Preston, J., and May, E.G. "Recent Developments in Direct-Radiator High-Fidelity Loudspeakers," *JAES*, October, 1954.
12. Corrington, M.S. "Transient Testing of Loudspeakers," *Audio Engineering*, #34 (1950).
13. Kidd, M.C. "Tone-Burst Generator Checks A-F Transients," *Electronics*, #25 (1952).
14. Wiener, F.M. "Phase Distortion in Electroacoustic Systems," *JASA*, #22 (1950).
15. Ewaskio, C.A., and Mawardi, O.K. "Electroacoustic Phase-Shift in Loudspeakers," *JASA*, #22 (1950).
16. Stroh, R. "Phase Shift in Loudspeakers," *IRE Transactions on Audio*, Sept.-Oct., 1959.
17. Heyser, R.C. "Acoustical Measurements by Time Delay Spectrometry," *JAES*, #15 (1967).
18. Janse, C.P., and Kaizer, A.J.M. "Time-Frequency Distributions of Loudspeakers: The Application of the Wigner Distribution. #4 (1983).

WANTED

PREFERABLY ALIVE !!!

We are looking for you out there, you who may have developed computer programs or devices for the audio industry.

If you are a manufacturer who has developed a new idea or method of testing or producing using a computer—tell us! We want your idea in our new computer column.

If you are an audio engineer who has come up with an innovative way to use a computer in the recording, broadcast or sound reinforcement field—tell us! We want you to tell us and the world about it.

If you are a programmer or someone who has a special knowledge of computers in audio—tell us! We'll let everyone know about it.

This is your opportunity to tell the world about your brainchild—your innovations—your genius!

Tell us—here at db—The Sound Engineering Magazine.

Sagamore Publishing Co.
1120 Old Country Road
Plainview, NY. 11803
(516) 433-6530



PRESIDENTS MESSAGE

SPARS IS ELITIST!

*Jerry Barnes
United Western Studios*



The "President's message"... sounds a little ecclesiastical doesn't it. There is, however, a definite feeling that one chosen for this office must enjoy the compelling challenge to continuously espouse the concepts and values of this organization. In order to effectively do that, one must truly believe in the need to closely associate with every business that has anything to do with professional audio recording. Having been active in SPARS for only about half of its existence, I must say I have gained more than I could have possibly imagined from participating in the various gatherings such as regional meetings, seminars and board of director events. So... here I go, "espousing."

When SPARS was formed, a gallery of critics quickly surfaced with the presumptive attitude that our world needed another trade society about as much as it needed a good dose of the syrup of black drought. Well, time has not shown us to be the intimidating incubus once feared by some. Neither did we proceed to become a "chowder society," though tempting it has often been.

What SPARS started out to be, and is still becoming, is a true representative body for the entire professional audio recording community. It both complements and supplements similar trade groups. The present spirit of cooperation existing between SPARS, AES and SMPTE is a positive model and as we continue to grow our interface with other related entertainment associations will be a natural progression.

Although the earliest membership roster was made up primarily of studios whose services placed emphasis upon record company activity, today's rolls contain members specializing in every aspect of audio. The spectrum ranges from the very smallest one person shop to the largest facilities in the country. The pleasant climate of free and open exchange of ideas and the sharing of information between members who are in direct competition is a substantial benefit to our people and exists more effectively in SPARS than in any organization of its kind. A special, enviable by-product of membership occurs when studio executives, or employees, sense the value of picking up the telephone and consulting with their peers. Owners talking to owners, managers to managers, tech personnel discussing problems with other techs and even receptionists comparing thoughts. It is working and it's happening all the time because of the feeling that SPARS members have much in common and very little to fear from each other. These kinds of exchanges were unheard of in the '60's and '70's. In those days most of us were insecure to the extent of not wanting competing studios to know anything about our operational problems while making every effort to discover our opponents' weaknesses. Seems rather silly now. The first contribution SPARS made to this industry was to create the environment which has largely done away with such nonsense.

It's generally known that the genesis of SPARS goes back to a gathering of key studio executives at the invitation of "Jeep" Harned of MCI. This 1979 meeting, held at the MCI plant in Ft. Lauderdale, was to be a first of its kind search for the mythical "console to end all consoles." The unprecedented and well attended occasion soon revealed the perhaps not so startling fact that such an instrument, designed from the input of so venerable a collection of experts, would be wider than most buildings. So after a modicum of posturing and a tiny degree of pontificating by the famous guests, that august body repaired to the Harned family luxury boat to engage in an evening of frivolity and proper release. During some critical moment Mr. Harned produced a one hundred dollar bill and suggested that all present should sign the bill and that each signature represented a purchase order for the "super console" and that such signing carried no time limitation since all signings were on an open P.O. which the hundred dollar bill was then declared to be. Yes, it really happened. I now possess that

continued on next page

GOOD SOUND CAN BOOST VIDEO SALES

*By Murray R. Allen
UNIVERSAL RECORDING CORP.*

Excerpts from a speech made before Video Tape Producers and Duplicators. Originally printed in the ITA JOURNAL.

My talk, "Sound for Video—A Marriage Made On Tape," is a marriage that is going to work out. There won't be any divorce. We may need twin beds, but it's going to make it.

I was asked to keep this talk non-technical. This is easy for me because basically I am not a technician; I am a fundamentalist. However, nothing was said about keeping this talk non-emotional and that's good. When it comes to sound I become emotional because sound, more than anything else, has the power to evoke emotions.

I can't think of anything more frightening than to hear a group of fire trucks with their sirens screaming. You may not be able to see them, you don't know where the fire is, but your emotional juices start to flow.

When you are at the movies watching a science fiction thriller and a large spaceship is landing, you feel you are actually there because of the enormous sound that theatre speakers are putting out. The clanking of machinery, the low rumble of motors actually makes your body vibrate—emotional, indeed; it's scary.

Sound, because of its physical nature can evoke the human mind into emotional changes quicker than pictures. If any of you have ever been in an auto accident the moment of truth occurs when you hear that awful crashing explosion of metal meeting metal.

Sound also has a characteristic that pictures do not. Sound has rhythm. Our life is filled with these rhythms. We wake to the rhythm of the surf beating against the beach, the songs of birds, the flapping of wings as they fly past our balcony—all emotionally soothing. Then the tow truck wakes up. The rhythm of traffic overwhelms the quiet. Emotionally everyone is a little more nervous. *continued next page*

GOOD SOUND from previous page

All of us are in the "story telling" business. The better we tell the story, the better chance we have to beat the competition and the more profit we make. One of the best ways to improve the "telling of the story" is through the improved use of sound. Strange as it seems, this method is the most neglected. But it shouldn't be because economically speaking good sound can be used to increase your sales.

Let's look at the facts. In 1927, 60 million people went to the movies each week. Two years later, 9,000 theatres were wired for sound and 110 million people went to the movies each week. The record business began to improve; the LP was invented. For the last several years, dollar sales for phonograph records

have exceeded motion picture box-office receipts. Motion picture producers have realized the sales potential created by the audio market. Soundtrack albums are now released before the film debut. It is a proven fact that a successful soundtrack album can hype the box-office of a film.

Theatre owners realize that movie goers prefer to hear their movies in stereo. Given the same picture, stereo sound will bring in more customers than monaural. The fact is that you can tell the story better in stereo than you can in mono.

My end of the business has become very exciting. We work with record artists. We record soundtracks for films. We score commercials. We use digital equipment, computerized consoles, floppy disc memory and many more innovations.

I know somebody is going to ask me why we go to such lengths to get good sound when, in the case of commercials, it's only going to be heard over a 3-inch speaker.

Let me dispel one of the biggest myths in television. You can hear the difference over a 3-inch speaker. For the last 20 years, everything we record is mixed on 3-inch speakers. We only use big speakers for playback reference. The bulk of the work is on 3-inch speakers. The electronics in most modern TV sets are more than adequate to produce good quality sound. The problem is that if you put garbage in, you get garbage out.

True, the 3-inch speaker does not reproduce the low frequency tones we expect from our hi-fi systems. But then the picture on the screen does not have the resolution or the ratio of lighting contrast that we expect from our 35-mm SLR cameras. However, in the case of the 3-inch speaker we have a quick fix. For less than two dollars you can buy a connector that will go into the mini-earphone plug on your TV set and send the sound through your hi-fi system.

At home I have a separate audio-only receiver for TV sound so I can accurately check how our work is being broadcast. The quality of sound I get out of the TV set directly is quite comparable to the sound I get out of this unit. The point I am trying to make is that the sound produced by your TV set is in fact a rather true reproduction of what is put into it. On those rare occasions when really good sound is broadcast, your set will produce really good sound, even in hi-fidelity if you so wish. You are still stuck with that little picture, but that doesn't seem to bother anyone.

Let's discuss what makes video sound such a problem. First, there is a general apathy about sound. It just is not considered important. The reason for this is usually blamed once again on the TV set's reproduction capabilities. Once again this is a false assumption.

Another problem is that the video industry does not always attract the top audio technicians. These people prefer to work in the record industry where they have more state-of-the-art equipment to work with and where their work is more appreciated. At present, many modern recording studios are going into the business of video sound so this problem may eventually find its own resolution.

The biggest problem lies with the handling of video recorders and video tape. Video tape, as we know, was designed to record pictures. As a side feature, sound can also be recorded, not as well as on audio tape but, with loving care, sound can be recorded with accuracy on video tape. Video tape is a little more difficult to align for audio, so the technician that does the work should be a very patient and a highly qualified audio person. Audio

continued on next page

PRESIDENT'S MESSAGE from previous page

nfamous hundred dollar bill, encased in priceless lucite, and all the signatures are there though most of them are somewhat shaky . . . for some reason.

Seriously, along with all the fun and good times, a very significant thing had occurred. A major manufacturer, MCI, had generated a dialogue with end users before developing product. That the product did not become reality is irrelevant. Those studio representatives decided, on the spot, to form the organization we know as SPARS. Alright, so it's history and everyone is aware of how we began. Yes, but we need to constantly remind ourselves of one of our most vital opportunities. I refer to the fact that, for the first time in the life of the recording studio industry, there exists a formal, active line of communication between the manufacturer and the studio. That line is called SPARS. Now, along with MCI/Sony, most major equipment manufacturers serving the industry also belong to SPARS. They are more sensitive to the needs of recording studios than ever before. They talk to us and they listen to us and I'm convinced it's true, in no small part, to the fact that there is now a trade association to which manufacturers and end users can relate. Every recording facility in this country benefits from this relationship whether or not they belong to SPARS.

The present board of directors is the most effective we've had. After only two meetings these people have become what every good board should be . . . a focus group searching for meaningful ways to make the society more effective. They are supporting the efforts initiated by previous boards while establishing ambitious new programs. Programs that can produce positive results for the future. Board meetings, while seldom a mosaic, can often take on the appearance of being the last act of a Russian opera; but I am pleased to report that this bunch of guys really takes care of business.

The recent SPARS/University of Miami Digital Conference was a real success, thanks to the tireless efforts of our Executive Director—Gary Helmers, our Technical Consultant—John Woram and Regional Coordinators—Dannie Emerman and Dave Teig. We also enjoyed tremendous preconference press coverage from the trade press. Without their generosity, the whole affair probably would not have happened. And they didn't just give us a few lines of polite print, they came to the conference and covered it well. The panel participants delivered the goods and all who attended seemed gratified. Many good reactions are still coming in and we are now in the early stages of planning next year's conference. I want to also express deepest appreciation, on behalf of SPARS, to Dr. Ted Crager, Ken Pohlmann, and The University of Miami for jointly sponsoring the event and for providing the marvelous Gusman Concert Hall for the conference.

Well . . . I believe I have done enough "espousing." That I am sold on SPARS should now be fairly obvious. But I saved my real reason for being so excited about this group for the last. At the risk of causing some mild discomfort to my colleagues, I'm going to use that wonderful word—ELITE! That's it. I never really understood all the implied negative connotations attached to that good word by our early critics. Didn't they ever look up the definition of ELITE in the dictionary? It means "best, or choicest part" and who wouldn't want their studio to be a part of this ELITIST group? You see, it's about being proud of who you are and what you are accomplishing; it's about aligning your operation with a body totally committed to making what you do more profitable and longlasting. We're not perfect, but we're trying and the older we get the better we are. I don't know about you, but I had a choice and I chose to line up with the "choicest part." If you are not a member, join us! Whether your studio is in Cut & Shoot, Texas, or Upper Clyde, Wisconsin, or even L.A. or Dallas. You have the right to believe you're part of the best. It'll cost you about the same as you pay for three rolls of 2" tape. It's worth it. Yes, SPARS is ELITIST!

GOOD SOUND from previous page

alignments and frequency adjustments are required more often on video tape than on audio tape. In an audio studio, machines and tape are checked before each session.

One of our clients asked us to perform an experiment. We sent an audio tape to five major video production houses. We requested them to copy the audio program onto video tape, audio only, and return it to us. In all cases, I stressed I needed a very accurate copy. Only one copy came back meeting our specifications. The variations relative to hum on the tape were over 20dB. The variations relative to noise were 12dB. The variations relative to all-over level, 7dB. The best showed a variation of plus or minus 5dB at various frequencies.

The machines have the ability to reproduce accurately. The tape can also do the job if the machine is adjusted for that roll of tape. I guess the audio technicians in video houses are not given enough time to do their job correctly. One technician told me he has not had a chance to do a total audio check on his recorders in over two years.

Yes, you can record good sound on video tape. But sound on video tape falls apart quite fast as you go from generation to generation. Unlike the picture quality that will hold up quite well, the sound will not. This is due partially to the upkeep of equipment, partially to the design of video tape, and partially to the people doing the work.

People in the motion picture business had the same problem. When they exposed both picture and sound on the same film the quality was acceptable, but when they went to make copies the audio quality became very poor. To solve this problem, they devised a technique called the "double system," with the exposed picture on picture stock and audio on audio stock. They kept the two elements separate and only combined them on the release print.

We feel the one most contributing factor to bad video sound is the careless use of multiple generations of audio on video tape. With today's technology this need not happen.

When a modern recording studio does a commercial, it often offers the client the option of dubbing the sound onto his video release prints. Because the consoles are computerized, this gives the client a release print with audio only, one generation away from the original. The "on-the-air" tape will only be two generations away from the original.

The more typical way of doing it would result in six to 10 generations away from the original for "on-the-air" use. This also holds true in a similar fashion for video cassettes. Do what the film industry has done for decades: use picture stock for picture and audio stock for audio. Don't perform the marriage

continued on next page

SPARS INTERNSHIP PROGRAM REPORT

*Jaime Rudoff, Eric Erickson, Henry Rael
University of Colorado at Denver
Phase One Interns*

College students rarely have the opportunity to witness the daily routine of the audio recording industry. The SPARS Internship Program offers an overview of the recording studio industry as well as a chance to talk with seasoned professionals. During our five day visit to the Los Angeles/Hollywood area we visited The Record Plant, United Western Studios, Record Plant Scoring, Motown-Hitsville USA and A&M Recording Studios. In the course of the week, we had a chance to observe recording sessions, tape duplication, studio maintenance and repair and the opportunity to discuss studio management and administration.

This type of interaction is priceless to a student. With new insight, the student can plan future classes to prepare for the future. As a student, the view of a potential career is somewhat distorted. The SPARS Internship Program gives us a more realistic view of the industry and a more accurate view of the preparation required for a career in audio engineering. Observing professionals, in the working environment, illustrates the importance of attention to detail in every aspect of the recording process and encourages mastery of basic engineering skills.

We would like to thank all of the people at SPARS for hosting our visit. We hope the program continues to offer these opportunities to our fellow students and benefits the industry through better prepared employees.

*Rosie Rounseville
University of Miami - Phase Three Intern*

Three areas of study are stressed in the University of Miami Audio Engineering Program. Music courses are required each semester, to give the student an indepth knowledge of music theory. A minor in electrical engineering is required, providing a good foundation in electronics. Finally, there is an emphasis on the philosophy of recording; those general principles that furnish the rational explanation for recording practices. The importance of a philosophical basis may not be fully realized until you experience working in the recording industry. The 15 week internship offers exactly that; an opportunity to utilize skills and knowledge, and to comprehend the philosophical framework.

As one would expect, I have found a knowledge of music and music theory quite useful during my internship. I can-

not stress enough the importance of a good, solid foundation in electronics. This becomes more evident every day in the face of accelerating technological change. Most valuable to me, however has been the philosophical basis that provides the framework for continued learning.

When looking for an internship, there are several criteria to consider. For me it was important to find an intership that would provide a broad look at the variety of career options available in audic recording. United Western Studios, Los Angeles, was the perfect example. Not only does United Western host numerous record projects, but also film and television scoring and jingle work. This variety offered first hand observation of several career possibilities. It is also important to consider the match between your personality and the personality of the studio. The potential inter should ask, "Am I comfortable in this atmosphere, or would another studio or company offer an atmosphere better suited to my personality?" Again, United Western was a happy match for me. It is wise to consider these questions before committing to an internship. The answer can make the difference between a successful internship and a disastrous one.

I am currently in the eleventh week of my internship at United Western Studios. I would like to thank Jerry and Joar Barnes, as well as SPARS, for allowing me the opportunity to enjoy what, for me has been a valuable learning experience. I would also like to thank the entire staff at United Western for their patience, support and constant encouragement. The internship has met my expectations and needs; the people at United Western have made my time there positive, rewarding, and educational.

One definition of intern is "to imprison; to confine or detain." There may be times when this definition describe the experience quite accurately. There is another definition that I find to be more accurate and perhaps a bit more comforting. "An internship is a link between formal education and the 'real world.'" With a great deal of commitment and dedication, the right attitude and a little luck an internship can provide a comparatively painless transition from the sheltered life of a college classroom to the reality of the working world.

*Inquiries, regarding the SPARS Internship Program, should be directed to:
SPARS Internship Program
P.O. Box 11333
Beverly Hills, CA 90023*

GOOD SOUND from previous page

until the release print is made.

Although I am not in the video duplication business, let me tell you how an audio man would proceed to turn out Beta's and VHS's with outstanding audio.

First, when transferring the film to tape, I would make sure the audio source was the original magnetic master mix. A copy will not suffice, it must be the original. I would record the audio on audio tape. At the same time, I would record time-code on both video and audio. When it came time to duplicate I would playback the video off the video recorder and the audio off the audio recorder.

Good sound will improve sales when-

ever it is properly utilized. The video market is moving forward into video discs. One of the selling points of the video disc is improved audio. What bothers me is that video people are not using the audio technology available now, at inexpensive prices, that could vastly improve the quality of the product that is being produced today.

A new invention won't improve the product if the attitude toward audio doesn't change. If video discs are mastered from audio on video tape, their quality will not be as good as from a well-made audio cassette. Hopefully, the audio source master will be the original master mix and not copies from the audio on a release print, be it magnetic or optical.

If the people who master a video disc put as much loving care into their work as the people who master phonograph records, and if the producers supply them with the proper source material, the audio on the video disc will do its selling job correctly. But if any short-cuts are taken, the final results will not give the public what it expects.

Modern consumers know good audio. They have been raised in the rock-and-roll era. Sound is a big part of their lives. Don't try to fool the public with sound that is less than the best. The public will know and react accordingly.

Yes, perform that marriage of sound and sight, whether on disc or tape, but do it carefully. Everyone is listening.

SPARS DEVELOPING NATIONAL TEST FOR AUDIO RECORDING TECHNICIANS

SPARS will soon be adding to its growing list of accomplishments with the introduction of a new national examination for would-be audio recording technicians. Will such a test be of genuine value to the industry? All deliberations up to now have concluded that the answer is yes.

Job applicants are currently approaching the industry with widely differing levels of education and experience, not to mention diverse and often unrealistic expectations about the technician's job and the studio workplace.

As conceived, the test score will provide applicants and employers with diagnostic information about each applicant's strengths and weaknesses in areas that are demonstrably related to the technician's job. Test results will help individual applicants identify subject matter or skills in which they need to improve their level of preparation, and will give employers an opportunity to make an objective assessment of an applicant's qualifications.

But beyond these obvious uses of test results, there are other benefits to the recording studio industry overall. In support of SPARS' broad objectives in education, communication and innovation, the establishment of a national testing program will contribute to the development of performance standards in a field where up to now no systematic analysis has been undertaken. Studio owners and personnel share many common perceptions about the recording business, but they may also differ about the importance of certain aspects of operating a studio: Should the recording technician be competent to discuss financial matters with clients? Does the technician contribute to the client's artistic deliberations or just turn knobs as instructed? How musical does a technician need to be? Is technicians' burn-out in-

evitable or avoidable? Etc.

One of the first steps in developing the testing program will be to establish a clear and comprehensive job description for entry-level audio recording technician. Federal guidelines specify that tests and all other employment selection procedures must meet certain standards, must be job-relevant and non-discriminatory. Therefore, the abilities to be tested must be linked to actual job dimensions.

To assure that the tests meet these standards for validity and legal defensibility (fairness to test-takers, essentially), the specifications for the subject matter to be tested must be drawn from a systematic study of current job incumbents and supervisors. This Job Analysis, as it is called, will identify the knowledge, skills and abilities that an entry-level recording technician must possess to be able to perform adequately on the job.

The job analysis will provide valuable information about the common core of tasks and responsibilities belonging to the job, to the extent that uniformity and consensus exist throughout the industry. Not only will prerequisite knowledge, skills and abilities be identified, but their relative frequency and importance will be described.

The results of the job analysis may lead studio managers to restructure certain jobs, to develop new job descriptions, or to modify performance criteria for employees already on the job. The study will also provide a reliable basis for curriculum development or modification by private schools, community colleges, colleges and universities. Relationships between industry and educational institutions can be facilitated and enhanced by this kind of mutual focus of attention.

Once the actual tests have been devel-

oped (a joint undertaking by testing consultants, industry experts and other subject matter specialists), the test specifications can be used as a blueprint that potential job applicants can follow to prepare themselves for working in the recording studio business. Descriptive information about the test will be made readily available in the form of a Bulletin of Information for test-takers. Technicians already on the job may want to use the test specifications as a guide for self-assessment and self-improvement. More broadly, the dissemination of information about this test will contribute to interest in and demand for appropriate training and development opportunities in the recording studio field.

Test scores themselves can have many uses, above and beyond the diagnostic information they provide to the job applicant and employer. Aggregated test results can identify subject matter that is relatively easy or difficult for test-takers or groups of test-takers, suggesting that explanations for performance differences should be sought. Training programs may not be keeping up with changing technology in the studio, instructors may not be aware of the importance of certain subject matter.

Test results can point to other useful questions to ask, like what kind of educational background and experience correlate with the most able test-takers, how are test-takers from certain geographic areas performing on the test, etc. If schools are interested in monitoring their students' performances special reports can be prepared for this purpose. The process of answering such questions can further strengthen communication between the industry and its affiliates in other fields, and can help SPARS to promote guidance and placement programs for aspiring stu-

continued on next page

ECONOMIC ASPECTS OF OPERATING A RECORDING STUDIO

A seminar-discussion presented by
SPARS
at the

2nd AES International Conference
Disneyland Hotel
Anaheim, CA
Saturday, May 12, 7:00 P.M.

You are invited
to visit the SPARS Hospitality Suite
in the Disneyland Hotel during
the Conference.

Friday, May 11, 5:00 P.M.—7:00 P.M.
Sunday, May 13, 5:00 P.M.—7:00 P.M.

TEST from previous page
dio technicians.

The SPARS test is not intended to erect barriers to entering the recording studio industry, but is conceived as a measuring instrument to benefit potential new employees, their employers and the industry overall. It is not suggested that the test should be the sole criterion on which a job applicant should be evaluated, but it is hoped, for example, that the test will provide useful information around which a productive job interview might take place.

In the long run, recognized performance standards for the recording studio technician's job will enhance the professional image of the studio industry and the reputation of its multi-talented technical staff. Frequent updating of the job analysis is advisable in a field that is impacted by rapid technical innovation, and will support the reliability and credibility of the SPARS testing program. The diagnostic test could lead eventually to a SPARS certification program for recording technicians, which could become an even more useful tool for employers to use in evaluating applicants.

The audio recording studio business will never become standardized, there is too much artistic creativity, technical change, and diversity among clients for this to happen. But SPARS' commitment to excellence includes the willingness to look at problems in the industry that need resolving, and the uneven quality of job applicants is one of them. The development of a national test for audio recording technicians will encourage the best-prepared and best-qualified applicants to enter the business, and will notify all audiences that the industry is committed to excellence and working hard to achieve it.

DIGITAL AUDIO ON TRIAL!

a report by
Ken Pohlmann

The University of Miami and SPARS presented their much-heralded seminar on digital audio on March 8, 9, and 10 on the Coral Gables campus. Digital Audio On Trial invited a number of industry leaders to explain who they are and why they are saying so many wonderful/terrible things about digital audio. Panel discussions with ample time for audience participation attempted to impart some rational insight into an area currently filled with speculation, questionable explanations, confusion and terror. There has probably never been a topic like digital audio in the history of audio technology, which so completely challenged the status quo and promised/threatened to revolutionize the art of audio engineering. The University of Miami SPARS seminar was thus an opportunity for education and peace-making, in which a meeting of the minds, presentation of facts and discussion of opinions could prepare the participants for the future, which one way or another will be irrevocably influenced by digital technology. In general, the digitization of audio is accepted as fact; the only question remaining is simply—how soon? However even that simple question serves to conceal many difficult decisions and much debate which the audio community must digest as it undergoes this technological transformation.

To aid that digestion, the Digital Audio seminar presented five panel discussions, each with invited experts in their fields to present their views and insights on the state of digital audio. Panel members were selected to provide a balanced and objective presentation; in the case of the audibility of digital, pro and con participants squared off; when technical topics came under scrutiny, opposing manufacturers spoke to their company's position. In addition, the floor was periodically opened to the audience, so that other viewpoints could come under discussion, and questions could be asked. While such an open forum might suggest the inevitability of a brawl, it can be reported that the debate was in general very gentlemanly and the



Registration, Spars/University of Miami Digital Conference.

seminar's intent to provide education and insight was well served.

Prior to the panel discussion, a digital audio tutorial was presented to the seminar participants by this reporter. Before any discussion begins, it is necessary to establish a common ground of understanding and a framework of nomenclature. Thus the tutorial presented an overview of digital technology in two parts: The first part offered a step by step look at a digitization system, from input to output. The operation of hardware such as the anti-aliasing filter, sample and hold circuit, analog to digital converter, digital to analog converter, and anti-imaging filter and oversampling circuit were explained through the use of slides and signal processing such as modulation and demodulation, error detection and correction and storage with fixed and rotary head were illustrated. In the second part, the digital discussion switched from circuit to concepts. In any engineering endeavor every design decision affects the whole; early decisions tend to lock-in both the designer and user. This is perhaps especially true in digital design because there is less possibility for adapting and modifying a digital system to future needs. Questions such as sampling rate, quantization word length, use of dither, digitization architecture (PCM, CPDM, etc.) modulation scheme, and format are being decided now in laboratories—but will they best serve the future needs of the audio community? The tutorial attempted to answer many of these questions. The rapid pace of this tutorial left some participants breathless; they are referred to this reporter's forthcoming book on digital audio for further explanation. . . .

The first day's panel discussion included Bruce Botnick, Roger Nichols, Michael Tapes, and John Eargle and tackled the question, 'If digital audio is so good, why is it so bad?' This panel quickly targeted their discussion to the heart of the problem—is there something inherently wrong with digitally-encoded music, or are other aspects of the process responsible for the controversy which has been provoked in some circles? The consensus, I think, was a positive vote for digital audio, with the proviso that in the future lower cost and greater fidelity are expected. Several panelists pointed out the fact that a technology has reached its limit when refinement becomes costly—and postulated that analog has reached that limit. They presented digital as an alternative technology with tremendous growth possibilities, at a decreasing cost. Several comments were made regarding the present state of digital recordings. Production practices which have served us well for analog recording are perhaps not suitable for digital; com-

continued on next page

DIGITAL ON TRIAL from previous page

nsation and equalization are not necessary and spoil otherwise good digital sound; a learning curve must be participated in. Similarly, engineers have unconsciously modified their technique to best fit the analog medium—they too must evaluate their habits. Also of concern to the panel was the need to provide for improvements in standards, particularly in the ex post facto consumer standard—the Compact Disc. Hastily designed analog circuitry, cheaply built players and badly recorded discs can only hurt the public's opinion of digital music. On the other hand, the C.D. player was praised for its foolproof operation and ability to correct damaged discs. John Eargle reported on the C.D. player test kit which consists of a roll of 1/8 inch black tape; when applied radially on a disc, a good player will reproduce the signal without audible degradation. Is digital a valid format? The panel concluded that even one good C.D. validates the format; what is needed now is a method of communicating technical and methodological information to both the industry and the consumer. With a dissenting vote, Michael Tapes stated that he has yet to hear a good C.D.—his large collection of Compact Discs still deny him the aesthetic satisfaction available in analog recordings.

The afternoon session examined the role of the recording studio and the Compact Disc and included presentations from Bob Ludwig, Bill Foster, and Roger Nichols. They presented the production side of the Compact Disc and presented the studio's special requirements when preparing a C.D. recording. They shared some mutual horror stories of incompetent processing of digital masters in C.D. manufacturing plants in which illogic and refusal to listen had resulted in highly unsatisfactory pressings. Once again, the need for special awareness was stressed. The panelists agreed that if musical people were included in the evaluation of C.D. masters, all C.D.'s could sound good. Going on to specifics, the panel discussed the operation of the Sony 1610 recorder, the feeder machine to C.D. mastering. When set to 44.1 KHz sampling and with re-emphasis properly set, the processor and its U-matic tape laser cuts the C.D. master. Particular attention should be paid to the quality of the tape used; digitally certified tape is a necessity to insure quality. Phantom (nonrepeatable) dropouts, rogue particles, housing shavings, and dust were cited as problems, as was the possibility of oxidation of video heads. Other discussions centered around the need for lead-in and lead-out time code before and after a program, and the PQ (and RSTUV) code inherent in each frame of a C.D.—this information is contained at the head of a master tape. The panel concluded with the belief that greater awareness in the production process is required, and some special techniques can facilitate the pro-



Spars/University of Miami Digital Conference CD or NOT CD, was that the question? Panelists (left to right) Chris Stone (Record Plant, L.A.) Richard Elen (Studio Sound), and Len Feldman.

duction of C.D. masters.

The last panel of the day attacked the question of the bottom line with a discussion entitled Digital for Dollars. Hamilton Brosius, Chris Stone, Murray Allen, and Joe Tarsia presented the studio owner's view of digital—as being either an economic risk, or economic necessity. The question of exactly who pays for digital is a complex one. The studio is faced with the initial cost of incorporating digital recorders into its physical plant, and then must find ways to recoup its investment and commitment. Chris Stone spoke of the need for rental of equipment to better distribute costs, the important consideration of financing, and the underlying need to constantly evaluate the return on investment. He cited figures which supported the economic validity for digital equipment in the studio. In addition, Mr. Stone stressed the need to inform the client of the possibilities of digital audio; he discussed the recently completed film 'Digital Dream' which has been prepared to demonstrate the advantages of digital audio to the film industry. Murray Allen candidly disclosed many of the marketing strategies which have become increasingly important as the cost of audio equipment has increased. His highly successful advertising campaign of 'Analog Tape Forgets' prompted many Chicago clients to re-evaluate their tape libraries and future needs. The fear of obsolescence can be used to sell a product, as can buzz words. Digital recorders justify raised prices and lead to a synergism in a studio in which more excitement is generated as is overall quality; for example, properly trained technical support is required for digital hardware and this can lead to an overall elevation of a studio's quality. Joe Tarsia conceded the previously mentioned points, but stressed the need for the proper timing of the investment. Analog is still highly competitive and preferred by many clients, or is at least only affordable by them. Digital recorders might be a necessity in the near future, but meanwhile the rental fee of several thousand dollars a month for a digital multitrack must be reckoned with. These three views of economic reality coincided in agreement with the idea that digital can be affordable and profitable, but differed in exactly how that can be realized, and when.

The seminar adjourned and moved on to an evening at Criteria Recording Studios following an invitation by Mack Emerman and Paul Gallo. Entertainment was in order; however, the controversy didn't stop. One of the points of contention centered in the new cutting room atop Studio E. Peter McGrath demonstrated C.D. playback and an A/B comparison between simultaneous recordings made on a modified Studer 2 track, and a Sony PCM F1. Keen ears detected differences between the storage mediums however no consensus was reached. However one irrefutable point was not lost on anyone—that a \$2,000 digital recorder could challenge a \$25,000 analog recorder. Talk about digital for dollars!

The second day's morning session convened to discuss the advantages and disadvantages of standards—a question of great economic importance to manufacturers. Digitization architecture, sampling rate, word length, data codes, modulation codes, error detection and correction, mediums and formats form a network of potential incompatibility and will ultimately determine the winners and losers in digital audio—both for manufacturers and purchasers. This reporter moderated, and held at bay representatives from three various linear PCM formats, and one delta modulation format. Curtis Chan, Almon Clegg, Richard Molstad, Tore Nordhal, and Lance Korthals represented their company's interests. Heated discussion was provoked concerning the relative merits of the differing formats, for example the DASH format versus the Mitsubishi format, and linear PCM versus CPDM delta modulation. However, political differences were quelled and discussion shifted toward the general questions of standards. The necessity for a consumer format seems prerequisite for development of digital audio, and the C.D. (as well as current work on the D.A.C. Digital Audio Cassette) seem to have provided this. But is a standard really necessary in the professional field? It was estimated that only about 2,000 studios could initially afford a \$50,000 investment in digital two track recorders, and only a handful of those could afford digital multitracks. Would universality make any difference in such a monolithic studio environment? And how important is long term compatibility—perhaps technology will obsolete itself before that need arises. In addition, multiple standards could be viewed as good because they promote innovation and competition whereas standards could act as a restraint. If the marketplace makes the decision, perhaps the best justice has been done. The winning standard is thus that of the manufacturer which places the most machines—and that competitive spirit might ultimately act to benefit the new technology of digital audio. In an agreement to disagree, the manufacturers concluded that

continued on next page

DIGITAL ON TRIAL from previous page
free enterprise would probably decide the question of standards.

The final session of the seminar focused on the C.D. as the emerging consumer digital playback medium and asked, C.D. or not C.D.—is that the question? Panelists Chris Stone, Richard Elen, and Len Feldman presented views of the Compact Disc, and characterized it as representing the Emil Berliner stage of digital audio in which a great evolution will be forthcoming. Meanwhile, as Richard Elen put it, the consumer is hearing things he has

never heard before, such as air conditioners, street noise, and the string players putting down their magazines before letter G. For a modest investment a consumer can purchase playback equipment which offers higher fidelity than most recording studios can deliver. In addition, some consumer monitoring is better than professional monitoring. The C.D. is a driving force which could raise the standards of consumers and professionals alike and necessitates an upgrading of other audio equipment such as amplifiers and loudspeakers. Similarly, the professional-

ism of audiologists will have to be upgraded. Using C.D. playback to prove his point, Richard Elen demonstrated just how bad carelessness can sound on a C.D. On the other hand, both analog and digital masters can sound excellent on the new medium. In the midst of the C.D. speaking tour of the country, Len Feldman reported on the favorable consumer perception of the C.D. and called for better utilization of the 70 minute playing time of a C.D., wariness toward comparisons formerly done on analog master
continued on next page

HAVE A RECORDING STUDIO PROBLEM?

Call **DataLine**
(213) 651-4944

The Society of Professional Audio Recording Studios, a non-profit organization, offers SPARS members, and non-members referred by a SPARS member, a national telephone 'hot-line.'

Questions regarding any area of recording studio operations including business practices, audio engineering, and technical maintenance will be answered by SPARS-approved sources at no charge.

Want a problem solved?
Call SPARS—
(213) 651-4944



SPARS Board of Directors and Consultants

Murray R. Allen Universal Recording Corporation Chicago	Bob Lifon Regent Sound New York
Jerry Barnes United Western Studios Los Angeles	Lenard Pearlman Editor Chicago
Charles Benanty Soundworks Digital Audio-Video Studios New York	John Rosen Fanta Professional Services Nashville
Larry Boden JVC Cutting Center Los Angeles	Christopher Stone Record Plans, Inc. Los Angeles
Bruce Botnick Digital Magnetics Los Angeles	Joseph D. Tarsia Sigma Sound Studios Philadelphia
Nick Collieran Alpha Audio Richmond	David Teig New York
Mack Emerman Criteria Recording Miami	John Woram Woram Audio Associates New York

SPARS PROUDLY ANNOUNCES THE FOLLOWING NEW MEMBERS

ADVISORY

AUDIO & DESIGN/CALREC, INC.
P.O. Box 786
Bremerton, WA 98310
Contact: Nigel Branwell

FAIRLIGHT INSTRUMENTS, USA
2945 Westwood
Los Angeles, CA 90064
Contact: Kim Anderson

HARRISON SYSTEMS, INC.
P.O. Box 22964
Nashville, TN 37202
Contact: David Harrison

REGULAR

THE AUTOMATT
829 Folsom St.
San Francisco, CA 94107
Contact: David Rubinson

THE CASTLE RECORDING STUDIO, INC.
Rte. 11, Old Hillsboro Rd.
Franklin, TN 37064
Contact: Jozef Nuyens

CHICAGO AUDIO WORKS, INC.
1111 W. Webster Ave.
Chicago, IL 60614
Contact: Scott Smith

CRESCENDO RECORDERS, INC.
125 Simpson St., N.W.
Atlanta, GA 30313
Contact: William Kay

DALLAS SOUND LAB
6305 N. O'Conner
Irving, TX 75039
Contact: Russell Whitaker

KAMPO CULTURAL CENTER, INC.
31 Bond Street
New York, NY 10012
Contact: Hiroshi Harada

NEW AGE SIGHT & SOUND
3026 Hylle St.
Kalamazoo, MI 49007
Contact: William & Luanne Allgood

PEABODY RECORDING STUDIOS
One East Mt. Vernon Place
Baltimore, MD 21202
Contact: Alan Kefauver

TRES VIRGOS STUDIOS
1925 Francisco Blvd.
San Rafael, CA 94901
Contact: Jerry Jacob

TRIAD PRODUCTIONS, INC.
1910 Ingersoll
Des Moines, IA 50309
Contact: Richard F. Trump

ASSOCIATE

STUART ALLYN
ADR Studios, Inc.
325 West End Ave.
New York, NY 10023

JOHN R. FRENCH
JRF / Magnetic Services
101 Landing Road
Landing, NJ 07850

PETER McGRATH
Audiofon Records
2720 Ponce de Leon
Coral Gables, FL 33134

FRED J. MUNCH
Institute of A/V Engineering
1831 Hyperion Ave.
Hollywood, CA 90027

JAMES SMYTH
Optimus, Inc.
161 East Grand Ave.
Chicago, IL 60611

SID ZIMET
Audioforce, Inc.
147 West 24th St.
New York, NY 10011

APPLICATION FOR MEMBERSHIP TO SPARS

NAME	TITLE		
COMPANY	PHONE		
ADDRESS	CITY	STATE	ZIP
<input type="checkbox"/> REGULAR MEMBERSHIP	\$365	Any professional recording, mixing or mastering facility with gross billings under \$1 million.	
<input type="checkbox"/> SUSTAINING MEMBERSHIP	\$1000	Any professional recording, mixing, or mastering facility with gross billings over \$1 million, or other grossing under \$1 million who wish to contribute to our growth.	
<input type="checkbox"/> ADVISORY MEMBERSHIP	\$2500	Includes any company presently engaged in providing services and/or supplies for the recording industry, not qualified for membership in any of the preceding categories.	
<input type="checkbox"/> ASSOCIATE MEMBERSHIP	\$250	Includes any company or individual presently engaged in or utilizing the services of the recording industry, not qualified for membership in any of the preceding categories.	

Accompanying this application is a check in the amount of \$_____ covering membership dues for the fiscal year.

MAIL TO: SPARS, P.O. BOX 11333, BEVERLY HILLS, CA 90213

STOP...LOOK...LISTEN

By Guy Costa
Motown/Hitsville USA

The time seems right for us to pause for a moment in our technological evolution and consider the consequences of "being affected" rather than "affecting" the future of audio in the media.

Stereo and surround television, digital audio, Dolby theatres, video tapes, music videos, simulcasts, DBS, DAD, DOLBY, DBX, CX, etc., . . . all bombard us with such diverse representations of what we work so hard to create in our studios that it is no wonder the consumer oftentimes "turns-off" and "tunes-out" the very product we create for his enjoyment. We are killing the goose that lays the golden egg!!

Why?

Is the left ear myopic? Does the right

ear see what the left ear feels? Are we confused or just plain STUPID?

Obviously, none of the above.

In our creative rush to apply the latest techniques and technology we overlook the limitations of the audio delivery system.

The sound the theatre patron hears is not designed (without modification) to be effectively experienced as part of the home video system nor is the limited bandwidth of the typical television speaker intended to stimulate the pulse of our creative energies.

SPARS has a charter to "EDUCATE, COMMUNICATE & INNOVATE" and I propose we create a forum to "STOP. . . LOOK. . . LISTEN".

Let's work to make the entertainment industry "a better place to hear".

SPARS/UNIVERSITY OF MIAMI DIGITAL CONFERENCE

If you weren't there, what did you miss?
If you *were* there, what did you forget?

Order tapes and transcripts and find out!

- | | | |
|---|-------------------------------|-------------------------------------|
| Seminar 1. <i>Digital Audio On Trial</i> | Tape <input type="checkbox"/> | Transcript <input type="checkbox"/> |
| Seminar 2. <i>The Recording Studio and the Compact Disc</i> | Tape <input type="checkbox"/> | Transcript <input type="checkbox"/> |
| Seminar 3. <i>Digital for Dollars</i> | Tape <input type="checkbox"/> | Transcript <input type="checkbox"/> |
| Seminar 4. <i>Standardization: Is it Time?</i> | Tape <input type="checkbox"/> | Transcript <input type="checkbox"/> |
| Seminar 5. <i>CD or not CD, Was That the Question?</i> | Tape <input type="checkbox"/> | Transcript <input type="checkbox"/> |
| Seminars 1 - 5 <i>Entire Conference</i> | Tape <input type="checkbox"/> | Transcript <input type="checkbox"/> |

Cassette tapes \$6 per seminar Transcripts \$6 per seminar
Entire Conference tapes \$25 Transcript \$25

NAME _____

COMPANY _____

ADDRESS _____

TELEPHONE _____

AMOUNT ENCLOSED: _____

Make checks payable to SPARS
Return to: SPARS, P.O. Box 11333
Beverly Hills, CA 90213

DATA TRACK is published by
The Society of Professional Audio Recording Studios.
Editor: Gary Helmers

Please send all news and comments to Editor, SPARS, P.O. Box 11333, Beverly Hills, CA 90213

db April 1984

53

DIGITAL ON TRIAL from previous page

promotion of the notion that many analog master tapes are suitable for re-release on C.D., need for accurate labelling of recording, mastering, and release of L.P.'s and C.D.'s (as SPARS has previously proposed), and warned of the misstatements of the indestructibility of the C.D. by zealous stereo salesmen. The panel agreed that the C.D. offers a tremendous opportunity to revitalize the recording industry, and that its full potential is just becoming apparent.

The Digital Seminar concluded with a discussion of the entire venture; it was agreed that such seminars are crucial to provide a better understanding of the new technology and will enhance its advantages and minimize the chance for misrepresentation. While specific conclusions were not reached, and could not be forthcoming at this time, it was felt that digital audio had successfully entered the marketplace with a viable alternative to analog technology, and that its future development was assured. Appreciation was offered to SPARS, the University of Miami, and seminar organizers John Woram and Gary Helmers.



P.O. BOX 11333
BEVERLY HILLS, CA 90213
(310) 651-4944

400 MADISON AVENUE
ROOM 1211
NEW YORK, NY 10017
(212) 355-1008

Chairman of the Board
Clark Emerman
Meridian Recording
Miami

Chairman Emeritus
Joseph D. Tarsia
Sigma Sound Studios
Philadelphia

President
Gary Barnes
United Western Studios
Los Angeles

Ex Officio
Murray R. Allen
Universal Recording Corporation
Chicago

Secretary/Treasurer
Mark Collieran
HDA Audio
Hammond

Christopher Stone
Record Plant, Inc.
Los Angeles

1st Vice President
Bob Lipton
Lipton Sound
New York

Executive Director
Gary Helmers
Los Angeles

Regional Vice President
Charles Benanty
Soundworks Digital
Jai/Video Studios
New York

Eastern Coordinator
David Teig
New York

Regional Vice President
Gary Boden
Cutting Center
Los Angeles

Administrative Secretary
Dannie Emerman
Miami

Regional Vice President
George Botnick
Midi Magnetics
Los Angeles

Legal Counsel
Malcolm Pierce Rosenberg
Wolfs & Rosenberg
Philadelphia

Regional Vice President
Harold Pearlman
Metel Chicago

Technical Consultant
John Woram
Woram Audio Associates
New York

Regional Vice President
John Rosen
HDA Professional Services
Hillsville

The Shure FP31 ENG Mixer

THE SHURE FP31 is a portable electronic news gathering (ENG), electronic field production (EFP), or film production mixer that is especially useful in remote application work. The tiny mixer (it measures only $6\frac{5}{16} \times 1\frac{7}{8} \times 5\frac{5}{16}$ -in.) features three transformer coupled, 3-pin XLR input connectors—each switchable to low impedance microphone or line level. The entire mixer (less batteries) weighs only 2.2 lbs (1 kg.). It is supplied with a removable shoulder strap and a carrying case for convenience in transporting. The mixer carries a suggested retail price of \$830 Low-cut filters

are available at each input (separately) to reduce extraneous low-frequency interference. Phantom (simplex) or A-B powering for condenser mics is available at each of the microphone inputs. A built-in tone oscillator is incorporated for level checks or line tests. The tiny mixer even has a "slate" microphone with automatic gain control for identifying takes or for other uses that require an identification mic that's not part of the production mic setup. There's also a "slate" tone for identifying the start of takes—a feature that's extremely useful during post-production editing.

Two transformer-coupled 3-pin XLR-connector outputs are provided. Each of the outputs is switchable either to low-impedance balanced microphone or to 600-ohm balanced line level. A tape output connector is available for feeding a tape recorder input or any other unbalanced Aux-level input. A full-size $\frac{1}{4}$ -inch and a 3.5mm headphone jack will drive headphones or other devices having input impedances ranging from 8 ohms to 2000 ohms. Either or both of these jacks can also drive Aux or unbalanced line-level inputs.

Help bring
the world
together,
one friendship
at a time.



Be a host family.

Discover how you can become a volunteer host family in International Youth Exchange.

Write: YOUTH EXCHANGE
Pueblo, Colorado 81009

Ad The President's Council for International Youth Exchange and The Consortium for International Citizen Exchange.

CONTROLS AND INDICATORS

Active, feedback-type input gain controls permit direct input of high-level sources without requiring input attenuators. A built-in limiter with an adjustable threshold prevents output clipping of the mixer or input overload of associated amplifiers, phone lines or tape recorders. An LED indicator flashes to show when the limiter operates, or to signal the onset of signal overload when the limiter is defeated. A small VU meter is conveniently positioned on the front panel and is set so that a "0 VU" indication is equal to +4 dBm. The meter can be calibrated to other VU levels with an internal adjustment. For operation in low ambient light conditions, a VU meter lamp can be lit by means of a pushbutton. This lamp remains lit for five seconds after the button is released, providing adequate time for the

Len Feldman is a well-known writer on the audio scene and is a contributing editor to Modern Recording & Music Magazine.

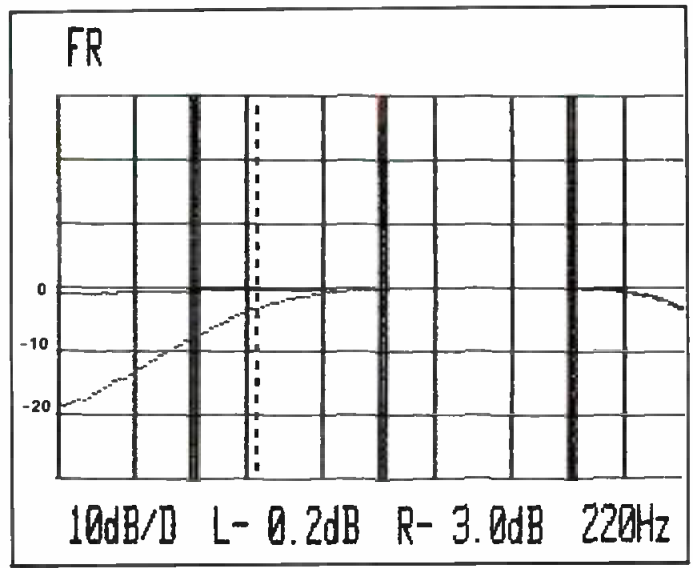
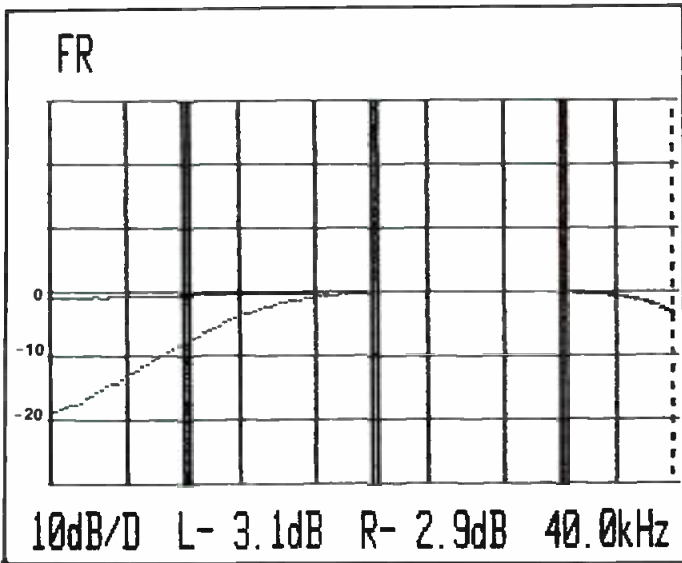

Figure 1. Frequency response with and without low-cut filter, with cursor set to high-end cut-off (A) and filter cut-off points (B).

operator to observe readings. A battery-check function will also read out on the VU meter. In addition to the individual input level controls, there is a master gain control which adjusts level at the Line/Mic and Tape outputs as well as tone oscillator level. A phones level control adjusts the output level at both headphone output jacks.

POWERING THE MIXER AND MICS

The Shure FP31 Mixer is powered by two standard 9-volt alkaline batteries, which also supply power for condenser microphones connected to the mixer. A third, separate 9-volt alkaline battery supplies A-B power for condenser mics. This third battery is not required if the alternative A-B type of power is not used. The mixer can also be powered from any 11- to 18-volt DC source such as a standard belt pack, automotive electrical system, video tape recorder, or an AC power converter/adaptor. Inside

the battery compartment, there are three 3-position switches. These are used to select the type of microphone powering required. The center position is for dynamic microphones (no power is applied to the mic inputs), while the other two positions are for A-B powering or simplex (phantom) powering. When the front panel slide switches are set to LINE (as opposed to MIC), no powering voltage is brought out to the input connectors.

LABORATORY PERFORMANCE MEASUREMENTS

With the low-cut filter deactivated, frequency response from input to output of the mixer was essentially flat from 20 Hz to 20 kHz, rolling off to about -3 dB at 40 kHz, as shown in FIGURES 1A and 1B. The lower traces in each of these plots depicts the response of the mixer when the low-cut filter is activated. The -3 dB point, using the filters, occurs at 220 Hz, and the slope is a gentle 6 dB per-

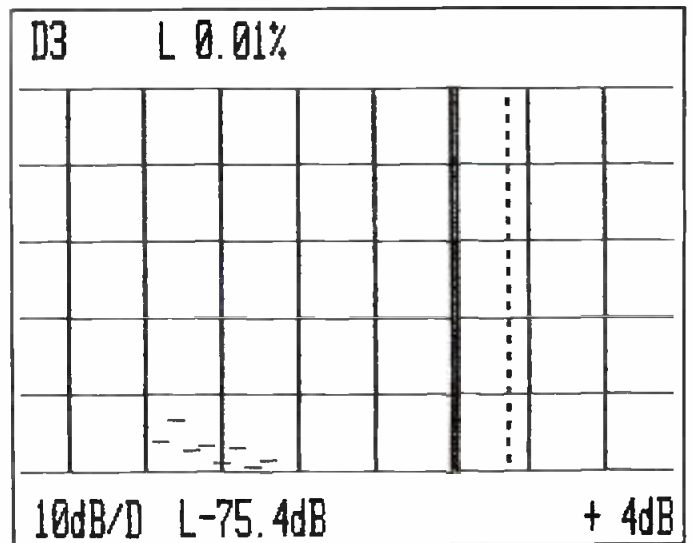
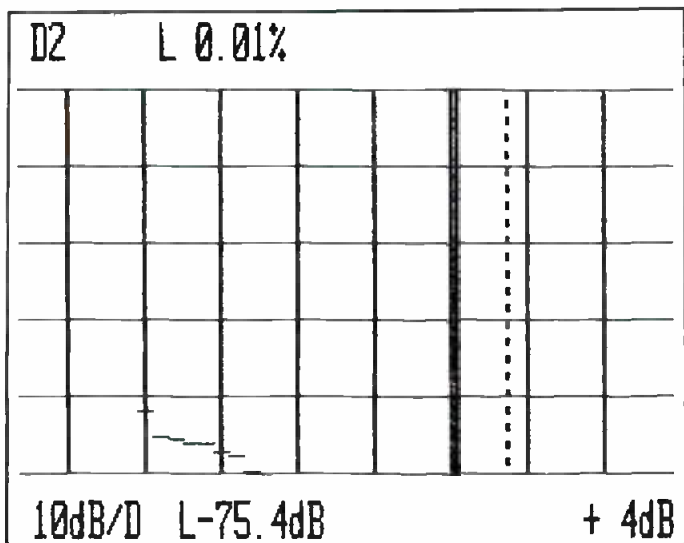

Figure 2. Second and third order harmonic distortion for -4 dBm output of FP31 mixer.

octave. Harmonic distortion, measured at a +4 dBm output level, was far lower than the 0.5 percent claimed by the manufacturer. As shown in FIGURES 2A and 2B, we measured only 0.01 percent second and third order distortion components at a +4 dB level, and in fact, distortion may well have been considerably lower than that, since 0.01 percent is about as low as our Sound Technology Test System can display on its video readout system.

With input and output controls fully opened, microphone input to output gain was a maximum of 40 dB. Mic input to Line output maximum gain measured just under 90 dB, while Mic input to Tape output measured 68 dB. Line-in to Line-out provided a maximum gain of 40 dB, while Line-in to Tape-out maximum gain measured 18 dB. Shure specifies a noise level for the system of -125 dBV equivalent input noise. This would have been rather difficult for us to measure, so we measured noise at the tape output with respect to the output level of +4 dB, with the system set for microphone operation. Under those circumstances, we obtained a reading of -64.6 dB, unweighted (see FIGURE 3). That adds up to approximately 63 dBV, to which must be added the 68 dB of gain from mic to tape outputs. That brings us to an equivalent input noise figure of 131 dB, or well above the 125 dB figure published by Shure.

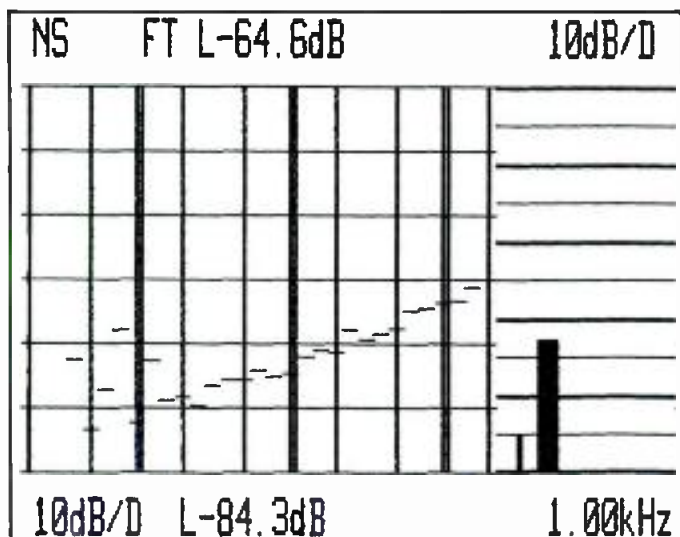

Figure 3. Signal-to-noise at tape output referenced to +4 dBm output. (Upper figure is overall S/N value, 64.6 dB.)

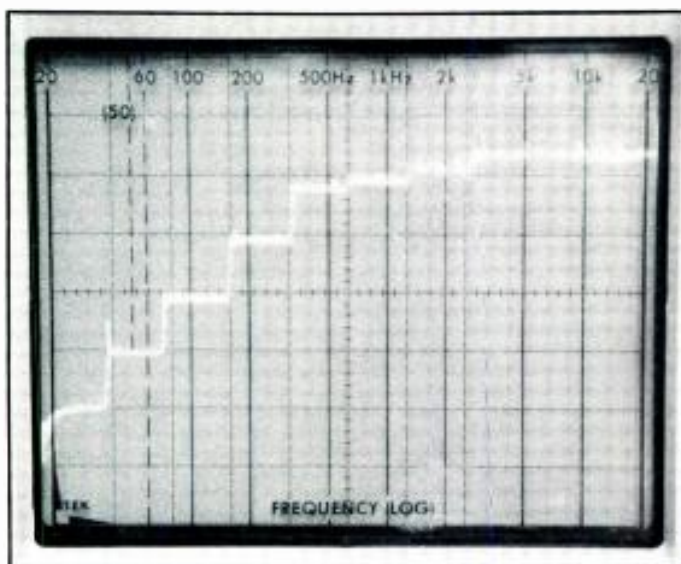

Figure 4. 'Scope photo shows action of built-in limiter.

As received, the limiter circuitry of the Shure FP31 mixer was set to a threshold level of approximately +14 dBm. The action of the limiter is best illustrated by the 'scope photo of FIGURE 4. In this photo, frequency notations should be ignored, as the spectrum analyzer was tuned to a single, fixed frequency of 1 kHz. As the sweep moved from left to right, we manually increased input levels in 10 dB steps. (The vertical scale in this presentation is 10 dB per-division). The first several "steps" measure precisely 10 dB each, but as the amplitude of the input signal reached a level near to and exceeding the threshold of the built-in limiter, further 10 dB increases resulted in only negligible increases in output level (for the last five increments shown at the right of the 'scope photo). We found that the threshold for this limiter could be reset from its factory-calibrated level down to approximately +3 dBm. Attack time for this limiter was stated by Shure as being 3 milliseconds, with a decay or recovery time of approximately 500 milliseconds.

Input clipping level for the microphones was found to vary from -45 dBV to -15 dBV (depending upon the individual channel gain control settings); for the line input mode of operation, clipping levels ranged from +3 to +35 dBV. At the Tape output, clipping level was approximately -5 dB. Maximum output level at the phone output jack before clipping or overload was 1.5 volts RMS into a 200-ohm impedance load.

We found the little Shure FP31 mixer to be amazingly versatile and effective during our brief experience with it. We were amazed at how many controls and features Shure was able to cram into what has to be the smallest three-input/two output mixer we have ever encountered. Although the slide switches used for activating the filter are extremely small, they seemed rugged enough to withstand repeated use. When the limiter was not in use, the red LED warning light began to flash when we were within approximately 6 dB of overload level. A green power-on LED, instead of just staying on, flashed at a rate of about once-per-second so long as power was applied to the unit. While we found this a bit disconcerting at first, we soon got used to it and, more than once, it served as a reminder that power was still on when we were through using the device.

The tiny pushbutton identified as SLATE not only turns on the built-in slate microphone (which remains on so long as you hold the button depressed), but also causes a 1-second 400 Hz tone to be inserted each time that button is depressed. The constant 1 kHz built-in tone oscillator, on the other hand, can be turned on by simply pulling out the Channel 1 gain control knob, thereby conserving panel space and eliminating the need for yet another switch in the limited space available.

Overall, the engineers at Shure who were responsible for this much-needed little mixer have done a superb job. Phantom powering of our AKG condenser mics during tests of the mixer worked perfectly and without introducing any additional noise. The VU meter was just about perfectly calibrated as claimed (+4 dBm output registered exactly "0 dB VU" on the meter) and all controls operated smoothly and noiselessly. Nomenclature was easy to read even in low ambient light conditions. We can think of several recent mic'ing and recording chores where this little mixer would have been most welcome, had it been available to us instead of the heavy, cumbersome gear we had to use. ■

ADVANCED FM INTERMEDIATE FREQUENCY SYSTEMS

• National Semiconductor's new series of advanced FM intermediate frequency (IF) systems, LM1865/1965/2065, has been developed for use in electronically and manually tuned radio applications. The series of FM IF systems reduces external component costs and improves performance. The LM1865 and LM2065 feature a stop detector for electronic tuning. All versions offer low distortion of 0.1 percent typical at 100 percent modulation with a single tuned quadrature coil and have a broad off-frequency distortion characteristic. If the radio or quadrature coil is mistuned, the total harmonic distortion (THD) isn't adversely affected. The LM1965 provides a deviation and signal level mute function in addition to a mute disable

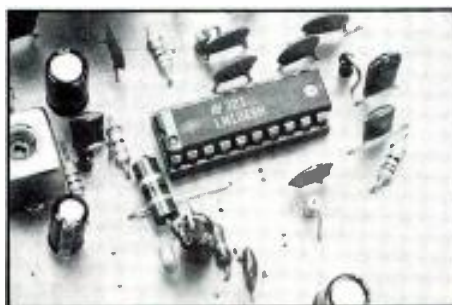

for use in manually tuned radios. The only difference between the LM1865 and LM2065 is the direction of the Automatic Gain Control (AGC) signals. The forward direction of the AGC on the LM2065 increases the

control voltage, which reduces the RF gain of the front end. All three units have a dual threshold AGC and eliminate the local/distance switch. With the LM1865/1965/2065 system, a low AGC threshold is achieved whenever there are strong out-of-band signals that might generate an interfering third-order intermodulation (IM3) product, and a high AGC threshold is achieved if there are no strong out-of-band signals. The high AGC threshold allows the receiver to obtain the best signal-to-noise performance when there is no possibility of an IM3 product. The LM1865/1965/2065 is available in a 20-pin plastic DIP (dual-in-line) package.

Mfr: National Semiconductor

*Price: For quantities of 100 and up,
\$2.45 each*

NEW SEQUENCER

• United Media's new Model 500 Sequencer is a digital, electronic programmer that activates up to 16 pieces of equipment; it is intended for post-production and technical television operations. The simplified, computer-controlled, solid-state sequencer can store 320 commands in internal memory. A built-in time-code reader enables the selection of either 24, 25, 30DF (Drop Frame), or 30NDF. The sequencer also works on a real-time clock at .01-second intervals and has built-in registers for start time, stop time, event channel, tape time display, and frame indicators. Timing accuracy is 1/100th of a second in real time and to the frame in other modes. Programming commands can be entered from the front panel, paper tape, RS-232 input equipment, or

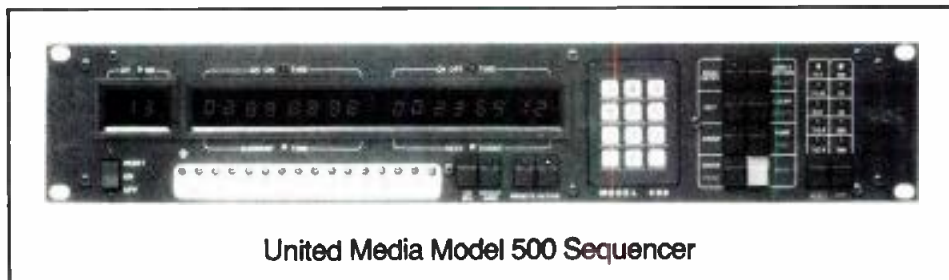

United Media Model 500 Sequencer

from United Media's Commander II video editing system. Each command can then be recalled via the front panel scroll controls, a printer, or an RS-232 disk drive with 5¼-inch diskette. The 3½-inch rack-height

sequencer also features event-stacking, editing look-ahead, and a full range of controls for external devices.

Mfr: United Media

DUBBING MACHINE FOR RADIO STATIONS

• Phase Audio's new dubbing machine, the Phase Audio Dubbing Center, allows stations to operate more efficiently without tying up their production rooms with dubbing carts. Features include a logic control unit that starts the turntable and the cart machine, and also operates an optional digital timer and any auxiliary equipment. The dubbing center can accept a phono preamp or a tape machine for dubbing from a disk or a tape, for either stereo or mono broadcasts. The dubbing center's monitor system comes with two buffered, true VU meters and a phase meter; it will simultaneously monitor playback while dubbing. Monitoring can be done through the broadcast studio speakers or with a set of headphones.

Mfr: Phase Audio, Inc.

Circle 37 on Reader Service Card



Q: The Department of Defense picked what sound effects library as the one to use in all their radio stations around the world?

A: The Production EFX Library. 5 stereo albums arranged by categories. Shouldn't you give a listen?

Stereo Sound Effects

PRODUCTION EFX LIBRARY

2325 Girard Ave. S.
Minneapolis, MN 55405

Circle 42 on Reader Service Card

SIX-BAND LIMITER ACCESSORY CHASSIS

• Orban Associates' Model 8100A/XT Six-band Limiter Accessory Chassis is designed to enhance the operation of the widely used Optimod-FM® 8100A/1 Audio Processing System. The new Orban unit has been created to provide more aggressive multiband processing for stations that demand bright, loud, "highly processed" audio. Derived from the Optimod-AM® (Model 9100A), the 8100A/XT consists of a six-band limiter cascaded with the exclusive Orban distortion-cancelled multiband clipping system. When added to the basic Optimod-FM® system via an accessory port, the unit creates a dense, consistent sound, free from pumping or other obvious processing side effects. The 8100A/XT

is particularly suited for highly competitive pop music formats such as AOR, CHR, AC, and Urban Contemporary. Because it has been specifically tuned to the Optimod-FM® system, it provides the most aggressive processing practical with a minimum of audible side effects when compared to less integrated processing systems. All existing 8100A series Optimod-FM® systems may be used with the new unit, which is also compatible with the Studio Accessory Chassis Model 8100A/ST. Model 8100A units must be upgraded to Model 8100A/1 using an inexpensive field-installable retrofit kit.

Mfr: Orban Associates, Inc.

Price: \$2,295.00 (suggested list)

Circle 38 on Reader Service Card

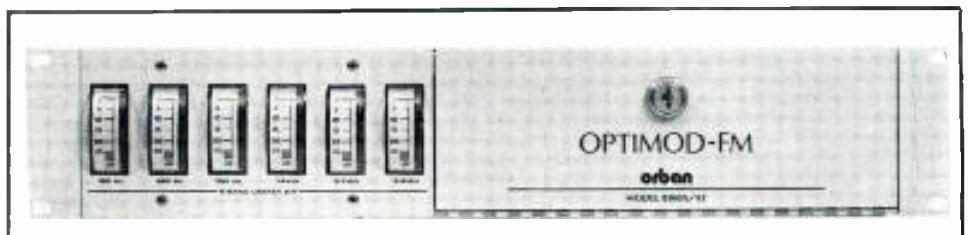

CORDLESS STEREO HEADPHONE SYSTEM

• Nady's new cordless stereo headphone system offers freedom from cords at an affordable price. The system works with any audio source (stereo systems, TVs, radios) and consists of a transmitter and stereo headphone receiver, or transmitter and stereo receiver for use with any headphones. Nady's components use infrared light to transmit audio information normally carried by wire. The transmitter, IRT-200, is easily installed—hookup is by phone plug, and adapters are included. With both headphones and receivers, range is about 35 feet. Stereo separation is excellent; the system can also be used in mono. The stereo headphones, model IRH-210, have full frequency response, 15 Hz to 15 kHz.

The infrared sensor is on top of the headphones for optimum reception. Any number of headphones can be used with the IRT-200 Transmitter. The IRSR-220 Infrared Stereo Receiver works with any stereo headphones. Two can listen at once with this unit, which can be placed up to 35 feet from the audio source/IRT-200 Transmitter hookup. Besides recreational uses, Nady's infrared system is ideal for the hearing-impaired, interpretation, language labs, and theatre applications.

Mfr: Nady Systems, Inc.

Circle 39 on Reader Service Card



64-CHANNEL FILTER SYSTEM

• Precision Filters' new System 64 is a 64-channel electronic filter system approximately the size of a 16-channel unit. The system is available in two models. A programmable mainframe version offers full front panel controls and readouts; a lower cost version, with blank front panel, can accommodate fixed frequency filters. Each is seven inches high, rack-mountable, and capable of holding 16 plug-in quad-filter cards. Both feature 64 inputs and outputs and can be equipped with a wide range of computer interfaces; both

offer extensive protection from digital equipment "noise." Available with the System 64 are sharp, fast-transition, elliptical high- and low-pass filters, and time delay filters. All are phase-matched to better than 1 degree. State-of-the-art bandpass, band reject, and anti-alias performance is available using filters in combination; programming is straightforward.

Mfr: Precision Filters, Inc.

Circle 40 on Reader Service Card

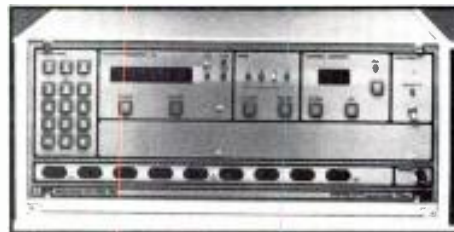

TRANSMISSION POWER REDUCER

• McMartin Industries' new Post Sunset Power Reducer is a "black box" enabling AM daytimers to take advantage of the new pending FCC rules permitting operation after sunset at reduced power. The Post Sunset Power Reducer is available in two models. The PS-1K takes a daytimer from 1 kilowatt down to any lower power; the PS-5K takes a daytimer from 5 kilowatts down to any lower power. The power reducers will automatically provide the proper power reduction and switching. The remote-controlled units employ the proper high power RF relay/resistive attenuator/RF output meter and transmitter control relays. The transmitter audio specifications are unaffected because only passive com-

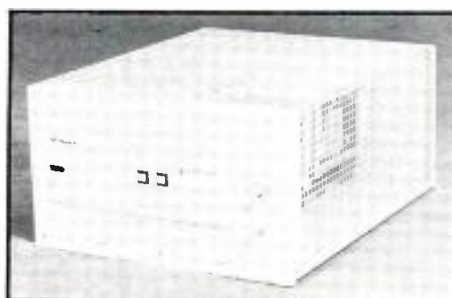

ponents are used. The size of the reducer is 12-in. high by 24-in. deep by 30-in. wide, and weighs 75 pounds.

Mfr: McMartin Industries, Inc.

Price: PS-1K, \$1,795.00

PS-5K, \$2,395.00

Circle 41 on Reader Service Card

Polyline Corp.
REELS & BOXES
FOR AUDIO AND VIDEO TAPE
PROFESSIONAL QUALITY
ALL SIZES
Shipped from Stock
(312) 297-0955
1233 Rand Road
Des Plaines, IL
60016

33

• **Fender Professional Sound Products**, a unit of Fender Musical Instruments, has announced the addition of three Pro Sound specialists who will function as market development managers. These specialists will be available to assist all district sales managers in serving Fender dealers with in-store demonstrations, seminars and other specialized services. They are also available for institutional sales consultations.

Responsible for the West Coast will be **Anthony (Toby) Sali**, who recently served as director of sales for the **Karl Video Corporation** and as national sales manager for **Interlake Audio**. Additionally, Sali has handled sales for the **Phase Linear Corporation**, **AKG Acoustics**, and other leading electronic and high fidelity companies.

Jerry Smith, who will cover the Mid-Central region, was formerly VP, Corporate Planning, for **Fostex**, where he was responsible for new product development and management of the **Electro Acoustic** division. He has also served as director of marketing for **Cerwin Vega**. Smith's consultant credits include the designing of studios or sound systems for **Kenny Loggins**, **Jackson Browne**, **Mick Fleetwood**, **Stevie Wonder** and **Ray Charles**, among others.

Handling the East will be **Bob French**, former professional sound products national sales manager at **Yamaha**. Prior to his work at Yamaha, French served as soundman/tour manager/coordinator for **Brighton Sound of Rochester**.

• **Leslie Rosen** has been appointed director/coordinator of the **Compact Disc Group**, as part of its reorganization as an independent, not-for-profit trade association. The announcement came from **Emiel N. Petrone**, chairman of the 30-member group of Compact Disc hardware, software and accessory manufacturers, and senior vice president—Compact Disc, **PolyGram Records**. Rosen, president of **Expose, Inc.**, a New York-based marketing communications firm, was formerly public relations director for **Mobile Fidelity Sound Lab**, and has spent several years in both the record and electronics fields. Rosen is joining the Compact Disc Group at "a most exciting and positive period of its development," said Petrone, "and all of us are looking forward to working with her in guiding the CDG in its many new promotional plans for 1984."

• **Motorola, Inc.** has announced that its C-QUAM® AM stereo broadcasting system has been selected for use by **Westinghouse Broadcasting and Cable Inc. (Group W)**. **Harrison Klein**, director of radio engineering for Group W, said Motorola's system was chosen after testing of the most popular systems available and

concluding that the C-QUAM system had a very high level of monophonic compatibility and excellent stereophonic performance. Klein also said Group W supports the concept of a single technical standard for AM stereo.

More than 150 radio stations have chosen the Motorola C-QUAM system. Ninety-three such stations are now on the air in the U.S. and Canada.

• **Bill Jasper**, president of **Dolby Laboratories Inc.**, and **Ioan Allen**, vice president, Marketing, have announced the appointment of **Robert M. Schein** as Director of Dolby Laboratories' Motion Picture Division. Allen continues in his role of overseeing all U.S. marketing functions for Dolby Laboratories Inc., with Schein as Director of the Motion Picture Division. Schein's first appointment was the promotion of **Clyde McKinney** to manager of the Motion Picture Division. McKinney's new responsibilities include overseeing all aspects of exhibitor and chain relations, as well as new market development.

According to Schein, more than one hundred feature films are currently scheduled for Dolby Stereo release in 1984, with over four thousand theatres already Dolby Stereo equipped. Upcoming titles include *Blame It on the Night*, *Corsican Brothers*, *Gremlins*, *Grey-stoke*, *Indiana Jones and the Temple of Doom*, and *Streets of Fire*.

• The Washington, D.C., headquarters of the **National Radio Broadcasters Association (NRBA)** has a new address. The new address is 2033 M Street, N.W., Suite 506, Washington, DC 20036. The NRBA phone number will remain (202) 466-2030. In announcing the move, NRBA president **Bernie Mann** said, "We're planning the new NRBA office with our members in mind. A special members' room will be set up at the Washington office, which

A SINGER'S DREAM!



REMOVES VOCALS FROM RECORDS!

Our **VOCAL ELIMINATOR** can remove most or virtually all of a lead vocal from a standard stereo record and leave most of the background untouched! Record with your voice or perform live with the backgrounds. Used in Professional Performance yet connects easily to a home component stereo system. Not an equalizer! We can prove it works over the phone. Write or call for a free brochure and demo record.

Listen..



Before You Buy!

• Time Delay	• Compressor/Limiters
• Reverbation	• Expanders
• Crossovers	• Spectrum Analyzers
• Noise Reduction	• Parametric EQ

Don't have regrets about paying too much for a lesser product. In demos and comparisons, we'll show you why we're Better! Our Factory Direct sales allow us to produce a Superior product and offer it to you at a Lower price. Call or write for a free full length Demo Album and 24 page brochure. Write to: **LT Sound, Dept. D-3, PO Box 330 Stone Mountain, GA 30086**
In Georgia Call (404)493-1258

TOLL FREE: 1-800-241-3005 - Ext. 3-A

members will be able to use as an 'office away from home' when they are in town."

Celebrating its 25th year in 1984, NRBA represents over 2,000 AM and FM radio stations and firms servicing the radio industry.

- **Oberheim Electronics, Inc.** has announced a MIDI Interface for their OB-8 Polyphonic Synthesizer. The optional package, which can be installed into any OB-8, provides MIDI IN, OUT, and THRU connections enabling communication with any other MIDI equipped electronic musical instrument.

MIDI (Musical Instrument Digital Interface) enables one MIDI equipped keyboard, guitar, or computer to play notes, control the sound, as well as perform pitch bending and vibrato on another MIDI equipped instrument. When used with its companion DSX Digital Polyphonic Sequencer, the Oberheim OB-8 will also transmit notes programmed by the sequencer to the MIDI OUT connector, allowing the powerful DSX Sequencer to control other synthesizers.

The OB-8 MIDI implementation provides two MIDI modes, MIDI channel selection, as well as split channel transmission. Notes played below the split point on the OB-8 can be sent to one MIDI channel, while notes played above the split point can be sent to a second MIDI channel.

The MIDI interface package, which is available from any authorized Oberheim Service Center, costs \$150, including installation.

- Since last year's installation of a Neve console and Studer tape machines, Skyline Studios, NY, has continued with major renovations to the premises and extensive acquisitions of control room equipment and musical instruments. In the control room, Skyline has added a Lexicon 224x Digital Reverb, a Marshall Time Modulator and Tape Eliminator, a rack of API equalizers and an Effectron II. In addition, Skyline has upgraded its available musical instruments and equipment with the purchase of a completely restored 1896 Steinway B grand piano, an Oberheim OB-8 synthesizer, Linn-Drums, a Roland jazz chorus amp, a custom built Macintosh/Alembic bass amplifier and a new set of Yamaha Recording Series drums and Zildjian cymbals.

- **Bart O. Williams** has joined **Sprague Magnetics Inc.** as marketing director. He recently retired after 20 years from **Ampex Corporation**, where he was senior sales engineer and most recently national audio sales manager for the Professional Audio Products. According to **Dorothy Sprague**, president, **Sprague Magnetics** (formerly Restoration) has expanded its audio head refurbishing operation and now offers several complete lines of replacement audio heads, accessories, parts and other related items.

- The dream of funding the educational efforts of outstanding students in the audio engineering discipline has become a reality. In February 1984, the government approved the non-profit status of the **Audio Engineering Society's Education Foundation**. The Foundation concept was started with two gifts of consequence in the last two years from two individual members of the AES. Plans for the foundation have been implemented over the past 24 months by an organizing committee originally chaired by **Norman C. Pickering**. When Mr. Pickering left the post of chairman due to other commitments, **Emil Torick** completed the work started by the original committee, of which Mr. Torick was also a member. Officers of the foundation are: **Emil Torick**, president; **Dr. Duane Cooper**, vice president; **Walter O. Stanton**, Treasurer; **Donald J. Plunkett**, Secretary; **Julius Fouts**, assistant secretary, and **G. Allan Ballantine**, director.

In the Fall of 1984, the Foundation plans to start funding (3) outstanding graduate students in their pursuit of further graduate studies in audio engineering. The board of the foundation has voted that funding of \$1,500. per awardee can be made in the academic year 1984-85. The changing technology in audio seems a fit time for the inauguration of this society effort. Under the tax classification 501(C)(3), all gifts to the Audio Engineering Society's Educational Foundation are considered tax deductible under U.S. Federal Tax law. The Society thanks the generosity of the original contributors and encourages others to enhance the Foundation's efforts with their own contributions to it.

For more complete details on the Foundation, including an application for consideration by the Foundation,

students are advised to contact the Foundation Secretary, **Donald J. Plunkett**, at 60 East 42nd Street, Room 2520. Applications will be accepted until May 1, 1984.

- **Brian Gary Wachner**, president of **BGW Systems, Inc.** and **Yas Yamazaki**, president of **Nakamichi USA Corporation** have announced a joint venture. Under the terms of the venture, **BGW Systems, Inc.** will provide expertise in design, development, and marketing of Professional, Commercial, and Musical Instrument products, as well as certain manufacturing capabilities. **Nakamichi** will provide R & D funding, tape recording technology, and volume manufacturing capabilities from its various plants in Japan. The first joint effort will be (**BGW**) marketing the **Nakamichi** professional digital audio processor, Model **DMP100**, to a select group of top studio and broadcast dealers. Numerous products have been proposed for joint development and manufacture; among them, professional cassette tape recorders to be distributed by **BGW Systems, Inc.** In addition, **Nakamichi** will assist **BGW** in the International Marketing of its products.

- **20th Century Fox**, noted film production studios in Los Angeles, California, has selected the new **Harrison PP-1** sound console for post production use in their new studios. The new console, which is 18.5 feet long and has 216 inputs with three mixing engineer positions, is to be installed by April and will first be used for post production work on the new movie *Rhinestone*, which stars **Dolly Parton** and **Sylvester Stallone**.



Seems Like Old Times

• At the unique Archeological Park in Xanten, West Germany, visitors can not only view its historical monuments, they can also become involved in a practical way. One of the monuments, a Roman amphitheatre from around 120 AD, has been brought right up-to-date with the aid of modern technological equipment; but this has been done in such a way as not to detract from the natural splendor. The new installation includes a range of sound reinforcement, public address, communication and control equipment from the local Philips organization Audio-Video-System (AVS). Today the arena, with its partially reconstructed auditorium accommodating up to 3000 spectators, will function as an open-air theatre where plays, ballets and concerts will be performed.

A special feature of the equipment installed by AVS is that it allows complete mobility. All equipment used for performance, such as microphones, loudspeakers or telephone extensions, simply have to be plugged into six weatherproof junction boxes

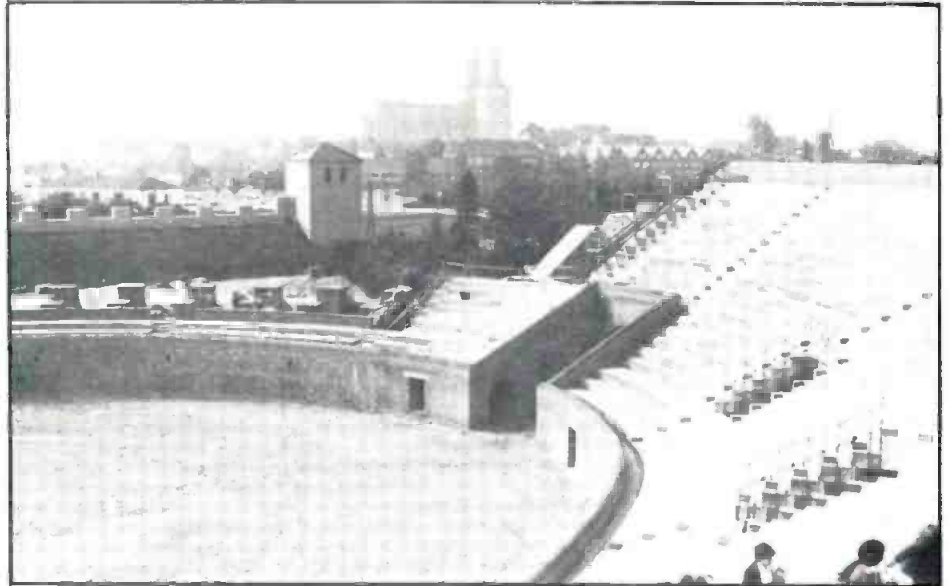

What do you mean there are no lions left?

located either underground or in vaults under the auditorium. The audio control center is mounted in a special container (as are the lighting controls and light towers) which only needs to be brought onto the stage

when needed for a performance. At all other times these modern technological aids can be discreetly hidden away, allowing visitors to enjoy the beauty of this amphitheatre in its natural state.

Welcome to Our House

• Studer Revox America and Cramer Audio/Video Inc., Studer's newly appointed New England dealer, recently held a joint two-day Open House at the new Westin Hotel in Boston. Studer was represented by Hans Batschelet, president of Studer Revox America, Inc.; by Doug Beard, national service manager; and Nick Balsamo, Peter Kehoe, and by Nancy Byers of Studer's New York office. Cramer was represented by Bill Lewis, vice president; Mark Parsons, manager of Professional Audio; and by Henry Ordway and Tom Giovanniello. Attendees included dozens of broadcast and recording engineers from all parts of New England.

On display was most of the equipment typically found at Studer's trade show exhibits, including several A810 recorders (one with center-channel time-code), an A800 24-track recorder, a TLS2000 synchronizer, an A710 cassette recorder, the Telehybrid, the A68 amplifier, 900 and 169 mixing consoles, and a Revox PR99 recorder. The A800 was displayed locked to video. Cramer's Service Department highlighted an A810's performance by using Cramer's Sound Technology tape recorder test system.



What happens if I press this button?

Classified

Closing date is the fifteenth of the second month preceding the date of issue.

Send copies to: Classified Ad Dept.
db THE SOUND ENGINEERING MAGAZINE
1120 Old Country Road, Plainview, New York 11803

Minimum order accepted: \$25.00
Rates: \$1.00 a word
Boxed Ads: \$40.00 per column inch
db Box Number: \$8.50 for wording "Dept. XX," etc.
Plus \$1.50 to cover postage

Frequency Discounts: 6 times, 15%; 12 times, 30%

ALL CLASSIFIED ADS MUST BE PREPAID.

FOR SALE

AGFA CHROME and normal bias BLANK CASSETTES CUSTOM LOADING to the length you need Your music deserves the best—your budget deserves a bargain GRD P.O. Box 13054, Phoenix, AZ 85002. (602) 252-0077.

FREE 32pg Catalog & 50 Audio/Video Applic.



Stereo Mono Pwr Ampl
PHONO, MIC
TRANS, ACM
TAPE, VIDEO
LINE, OSC

8-in 2-out, 12-in 4-out, 16-in 4-out
TV Audio & Recd Prod Consoles

OPAMP LABS INC (213) 934-3566
1033 N Sycamore Av LOS ANGELES CA, 90038

MICROPHONES. Immediate delivery via UPS. All popular models in stock. Best prices you'll see in '83; PLUS we pay freight. UAR Professional Systems, 8535 Fairhaven, San Antonio, TX 78229. (512) 690-8888.

FOR SALE: AKG-BX-20 w/remote exc. condition \$2250.00. Neumann Tube U-47 w/power supply, exc. condition \$1550.00. Contact Clay (212) 762-2295.

BLANK AUDIO AND VIDEO CASSETTES direct from manufacturer, below wholesale, any length cassettes: 4 different qualities to choose from. AMPEX and AGFA mastertape—from 1/4-inch to 2-inch. Cassette duplication also available. VHS T-120's \$6.00. Brochure. Andol Audio Products, Inc., Dept. db, 42-12 14th Ave., Brooklyn, NY 11219. Toll free 1-800-221-6578, ext. 1. NY residents (212) 435-7322.

THE MOST COMPLETE SELECTION OF

AUDIO TEST TAPES

All formats including cassettes
Write or phone for free catalog



STANDARD TAPE LABORATORY, INC.
26120 Eden Landing Road #5, Hayward, CA 94545
(415) 786-3546

AMPEX REEL TO REEL/CASSETTE TAPE. Grandmaster/High Performance. Pro Stereo/Mono Duplication. Volume Wholesale Pricing. MSC "The Cassette Works," 806 W. 7th, Amarillo, TX 79101. (806) 373-8473.

Electro-Voice microphones in stock plus Sentry monitors, CD35 speakers, speaker components, EV/Tapco mixers, equalizers and reverb. Low prices, personal service. Call Rick Marder at (201) 561-8123.

THE LIBRARY Sound effects recorded in STEREO using Dolby throughout. Over 350 effects on ten discs. \$100.00. Write The Library, P.O. Box 18145, Denver, CO 80218.

Quality audio equipment, supplies, low prices, any quantity, custom records, on-location recordings, cassette duplicating, printed labels, blank cassettes any length, recording tape. Our twentieth year. FREE CATALOG. Stith Recording Services, 8 Redwood Lane, Ithaca, NY 14850 (607) 273-2309.

(20) MELCOR EQs modified to 12k: \$125 each. (15) FLICKINGER parametric EQs: Best offer. API 440 faders: \$30 each. Dan: (415) 441-8912 or 441-4789.

TECHNICS TURNTABLES IN STOCK! AKG, Neumann, UREI, Orban Eventide, dbx, Lexicon Best pro-audio equipment. Lowest prices IMMEDIATE DELIVERY UAR Professional Systems. (512) 690-8888.

FOR SALE: White 1/6 octave equalizers. Like new—Sound Workshop Vocal Doubler. Good condition. Call 10am to 10pm (401) 467-9362.

FOR SALE—AKG C-24 and other tube type condenser mics. (415) 441-8934 or 527-4789.

SERVICES

HEADACHES?
FOR PROFESSIONAL
MAGNETIC AUDIO HEAD
RECONDITIONING AND PRECISION
OPTICAL ALIGNMENT OF
THEIR HOUSINGS AND ASSEMBLIES
CALL THE SPECIALISTS:
AUTERI ASSOCIATES, INC.
9 Henearty Dr.
Miller Place, NY 11764
24 Hr. Ans. Srv. (516) 331-5022

ACOUSTIC CONSULTATION—Specializing in studios, control rooms, discos. Qualified personnel, reasonable rates. Acoustilog, Bruel & Kjaer, HP, Tektronix, Ivie equipment calibrated on premises. Reverberation timer and RTA rentals. Acoustilog, 19 Mercer Street, New York, NY 10013. (212) 925-1365.

SONGWRITERS RESOURCES and SERVICES is a non-profit organization dedicated to the education and protection of songwriters. For free information, write or all SRS, 6772 Hollywood Blvd., Hollywood, CA 90028; (213) 463-7178.

PCM-F1 USERS! Starting an international newsletter of applications, modifications, theory, who's doing what, etc. If interested please send your name, address, ideas and \$2 to: DIGITAL AUDIO, c/o Mediatech, P.O. Box 335, Natick, MA 01760, U.S.A.

New York Technical Support, Ltd

IS SERVICE

"We provide the support necessary for today's recording technology. Our work is guaranteed."

CALL
GREG HANKS
914-776-2112

1440 MIDLAND AVE., SUITE-1D
BRONXVILLE, NY 10708

EMPLOYMENT

EXPERIENCED TECHNICIAN

We are currently expanding our Customer Service Department and we are seeking a top flight technician experienced in analog tape recording or high speed tape duplication. Send resume with salary history to Customer Service, Electro Sound, 160 San Gabriel, Sunnysvale, CA 94086.

MOVING?

Keep **db** coming without interruption!

Send in your new address *promptly*.

Enclose your old **db** mailing label, too.

Write to:

Eloise Beach, *Circ. Mgr.*
db Magazine
1120 Old Country Rd.
Plainview, N.Y. 11803



Have you misplaced your **db** again? Our high quality, royal blue vinyl binders keep 12 copies of **db** neat and handy for ready reference.

Just \$9.95, available in North America only. (Payable in U.S. currency drawn on U.S. banks.) **ORDER YOURS NOW!!**

Sagamore Publishing Co., Inc.
1120 Old Country Road
Plainview, NY 11803

YES! Please send _____ **db** binders @ \$9.95 each, plus applicable sales tax. Total amount enclosed \$ _____

Name _____

Company _____

Address _____

City _____

State/Zip _____

How important is microphone phase response?

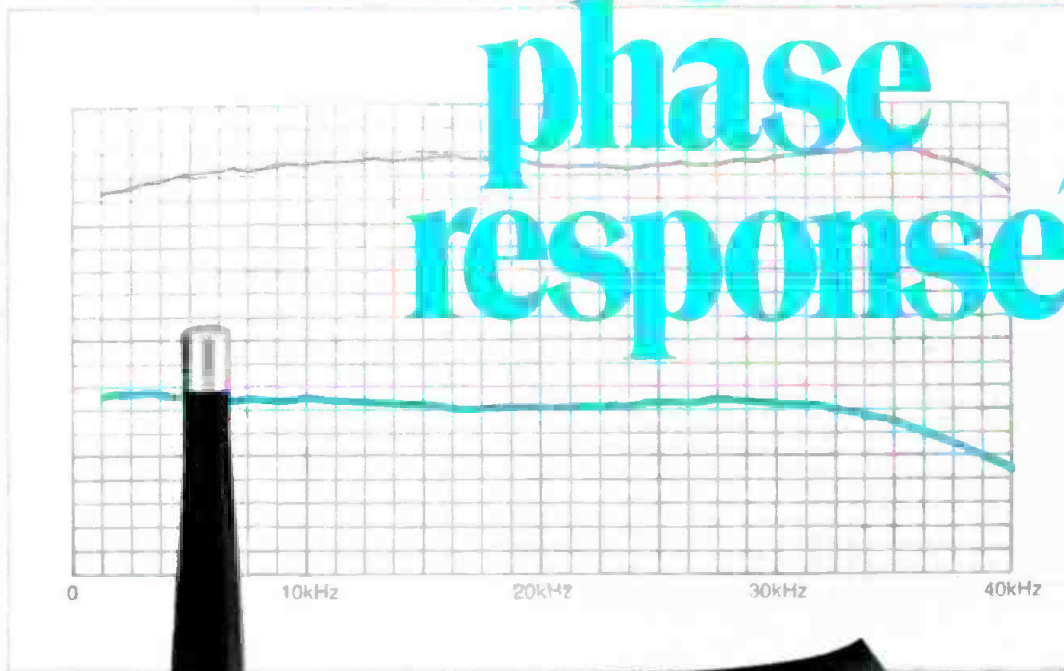

The ability of a microphone to reproduce transients without smearing is directly proportional to the uniformity of its phase response. Yet, few manufacturers measure the phase performance of their microphones, and fewer still publish these data.

Bruel & Kjaer designed its 4000 series to exhibit uniform phase response across the entire audio spectrum not only on-axis but off-axis. These phase response characteristics are matched within 10° (5° on some models) to assure a stable, undistorted image when you work in stereo. And we publish them in our brochure so you know what you're getting before you purchase.

If you like to read response curves, request our literature. If you like to hear clean transients, call us for a demonstration of B&K 4000 series microphones in your space.



Bruel & Kjaer Instruments, Inc.

185 Forest Street, Marlborough, Massachusetts 01752 • (617) 481-7000 • TWX 710-347-1187
World headquarters: Naerum, Denmark. Sales and service in principal US cities and 55 countries around the world

Circle 11 on Reader Service Card

INTRODUCING THE SMART MIC* SYSTEM



Actual Size

The most troublesome audio conditions can only be solved by today's most trouble free microphone system. The Shure Automatic Microphone System.

Total integration is the key.

For the first time ever, Shure has combined microphone, mixer and logic technology in a dedicated, totally integrated system—so advanced, its conception marks the beginning of a sound revolution in conference rooms, teleconferencing, churches, legislative chambers, courtrooms—anywhere speech related multi-microphone systems are employed.



At the heart of Shure's Automatic Microphone System (AMS) are revolutionary, angle-sensitive microphones that turn on automatically *only* when addressed within their own 120° "window of acceptance." In addition, each microphone continuously samples its own local acoustic environment, and compensates for changing room audio conditions—automatically.

The Shure AMS incorporates advanced signal processing circuitry—turning on to the sound source quickly, quietly, and automatically—and turning off with a smooth whisper. From

beginning to end—no clicks, pops, noise "pumping," or missed syllables.

Logic terminals on the rear panel of every AMS mixer offer unprecedented flexibility for advancing the system's capabilities. For example, when connected with Shure's Video Switcher Interface, the AMS will control commercially available video switchers. And for large gatherings, AMS mixers (both 4 and 8 channel models available) can easily be combined to effectively control over 200 individual microphones.

Since the AMS operates as an integrated system, many adjustments and controls have been eliminated. As a result, no other unit sets up as quickly. And operation is so easy and automatic, the only adjustments necessary are individual volume controls.

For more information on the revolutionary new Automatic Microphone System, call or write Shure Brothers Inc., 222 Hartrey Ave., Evanston, IL 60204, (312) 866-2553.

*Microphones and Intelligent Circuitry

SHURE®

THE SOUND OF THE PROFESSIONALS®...WORLDWIDE

Circle 12 on Reader Service Card

www.americanradiohistory.com



PATENTS
PENDING

SBI-1086A