

db



A98105KUOWA3Z5COMI 0184
KUOW RADIO
D S 50 UNIV OF WASH
325 COMMUNICATIONS BLDG
WA 98105
SEATTLE

WHY IT'S OTARI FOR MORE POST-PRODUCTION PROS.

Today's hot topic is audio post-production. At Otari, it was a hot topic years ago—and still is.

In 1979, we introduced the MTR-90 multi-track recorder which featured our new pinchrollerless tape drive system. It was quickly accepted as a superior performer under synchronizer control—with faster search and lock-up for quicker, easier sessions.

In 1980, we introduced the MTR-10/12 1/4-inch and 1/2-inch machines—the industry's first with microprocessor-controlled transports.

In 1981, the Series II MTR-90 provided even faster, more accurate tape handling, and was the first audio machine to offer

a serial port for computer control of the transport functions.

Along the way, we've worked with every major synchronizer and video editor manufacturer to provide our customers with the interfaces they require. Synchronizer interface connectors are now standard equipment on all MTR Series recorders.

Our commitment to audio post-production continues.

In 1983, we adopted the IEC standard for center-track SMPTE/EBU time code recording on 1/4-inch tape. We also developed a 1-inch C format audio layback recorder conversion kit for the MTR-90, and an RS232C Serial control port for the MTR-10/12.

Now, we're introducing the EC-400

Series, an advanced tape speed resolver capable of phase lock over a $\pm 30\%$ frequency range.

These are just a few of the ways we've delivered on our commitment to the audio post-production professional. To get the complete picture, contact your nearest authorized Otari dealer.

Otari Corporation
2 Davis Drive
Belmont, California 94002
(415) 592-8311 Telex 910-376-4890



The EC-401 Resolver: A precision speed controller with Widelok™—everything necessary to lock a tape machine's speed control track to any internal or external time base reference. Available as a compact, rack mount package, or for the MTR-10/12, as a plug-in module.



Post Sound, Los Angeles

Technology you can trust.

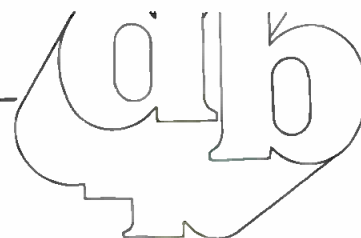

Editor/Publisher
Larry Zide

Associate Publisher
Elaine Zide

Managing Editor
Mark B. Waldstein

Associate Editor
Ricki Zide

Technical Editor
Linda Cortese

European Editor
John Borwick

Technical Advisor
John M. Woram

Layout & Design
Kathi Lippe

Advertising Coordinator
Karen Cohn

Book Sales
Lydia Calogrides

Circulation Manager
Eloise Beach

Graphics
K & S Graphics

Typography
Spartan Phototype Co.

FEATURES	
THE VIRGINIA CENTER FOR THE PERFORMING ARTS: THE ACOUSTICAL DESIGN 26	<i>Larry King</i>
THE INSTALLER'S VIEWPOINT 31	<i>Nick Colletta</i>
RECORDING STUDIO CONSOLES AND FILM PRODUCTION, PART II 34	<i>Gregory Hawks</i>
SEEING WHAT YOU HEAR, PART II 42	<i>Jesse Klapholz</i>
VCA TELETRONICS MAKES A SPECIAL DELIVERY 46	<i>Mark Trust</i>
db TEST REPORT: THE URSA MAJOR 8X32 PROGRAMMABLE DIGITAL REVERBERATION UNIT 54	<i>Leslie Shapiro and Marco Fratnik</i>
1983 INDEX 62	

COLUMNS	
THEORY AND PRACTICE 6	<i>Ken Pohlmann</i>
SOUND REINFORCEMENT 12	<i>John Eargle</i>
DIGITAL AUDIO 18	<i>Barry Blesser</i>

DEPARTMENTS		
LETTERS 2	EDITORIAL 25	CLASSIFIED 60
NEW PRODUCTS AND SERVICES 49		
PEOPLE, PLACES, HAPPENINGS 57		

db, the Sound Engineering Magazine (ISSN 0011-7145) is published monthly by Sagamore Publishing Company, Inc. Entire contents copyright © 1984 by Sagamore Publishing Co., 1120 Old Country Road, Plainview, L.I., N.Y. 11803. Telephone (516) 433 6530. db is published for those individuals and firms in professional audio-recording, broadcast, audio-visual, sound reinforcement, consultants, video recording, film sound, etc. Application should be made on the subscription form in the rear of each issue. Subscriptions are \$15.00 per year (\$28.00 per year outside U.S. Possessions, \$16.00 per year Canada) in U.S. funds. Single copies are \$1.95 each. Editorial, Publishing and Sales Offices: 1120 Old Country Road, Plainview, New York 11803. Controlled circulation postage paid at Plainview, NY 11803 and an additional mailing office.

**THE BEST
VALUE IN
PROFESSIONAL
POWER
AMPLIFIERS ...
HAFLER.**

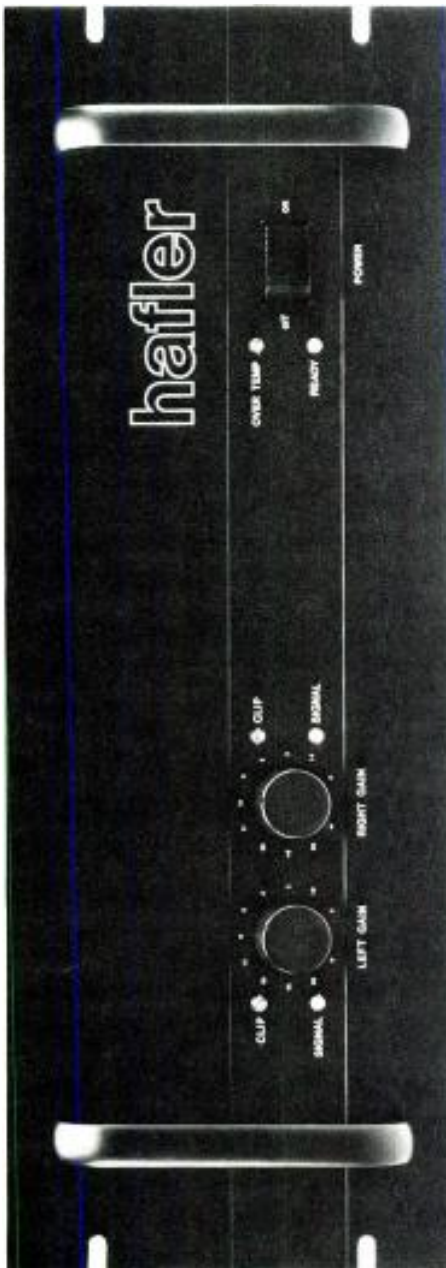

hafler
The David Hafler Company
Department DJ
5910 Crescent Boulevard
Pennsauken, N.J. 08109

Circle 13 on Reader Service Card

Letters

SOME REMINISCING

TO THE EDITOR:

After plodding through details of resonant boxes intended for bass reproduction in large halls in your July/August issue (and wearying at the futility of such schemes), I was pleasantly surprised with William Gelow's article on compression drivers, which brought back memories of true sound projection.

Notably, German and British acoustic engineers preceded the US efforts of 1915. Sir Oliver Lodge produced a thirty-foot-long exponential horn and driver unit around 1890 that was driven by either a carbon microphone with up to ten capsules or a large Reiss microphone energized with up to 90 volts. Parallel efforts were being made at that time to modulate the exciter generator used for a spark transmitter. Some microphones were water-cooled and received signals that were readable but had no relationship to the original voice. Sir Oliver Lodge's loudspeaker is used daily for PA announcements in the London Museum of Modern Sciences. Tube type amplifiers were used with curled exponentials during World War I in the trenches, hurling invectives at the Huns. The Tannoy Company got its start during that time. I used 8-foot long square, straight exponential horns in the early thirties for PA with Marconi rubber diaphragmed drivers and later, duralium diaphragms.

The W.E. 555 driver (pictured on page 47 of July/August's *db*) was intended for a booth monitor; I have never seen it used elsewhere. Figure 4 in Mr. Gelow's article shows a LF droop of 1 dB at 200 Hz for the 555 driver on the short horn. I believe that this roll-off was the driver mounted on the W.E. 12-foot curled exponential horn that was a common stage setup from 1926. A 3000 seat house was adequately served by two of these driver/horn assemblies fed by a 42A amplifier having only 3.3 watts output. A 43 amplifier using 211/242B triodes with 950 volts in strictly class A operation provided a smooth installation still unsurpassed for dialogue.

Later W.E. installations showed obvious tinkering with the original Bell Labs thinking. A horrible, short non-cellular HF horn mounted on top of a LF folded horn fitted with a Jensen

Index of Advertisers

Alpha Audio	22
Amber	29
Audio-Technica	21
Bruel & Kjaer	13
Crown	3, 19
David Hafler Co.	2
Electro-Voice	17
Garner	51
Klark-Teknik	4
Knowles	5
Lexicon	Cover III
Orban	16
Otari	Cover II
Polyline	58
Publison	10
Shure Bros.	Cover IV
Sony/MCI	11
Sound Ideas	19
Tektronix	14-15

About The Cover

- This month's cover features the Virginia Center for the Performing Arts. For the complete stories on this restored Loew's theatre, see page 26.

“For two years we’ve heard it all.”



“Choosing the Delta Omega™ was a simple matter of knowing its capabilities.

This amplifier exercises unique voice coil control, employing a principal without precedent—delivering more punch, clarity and headroom than we’ve ever heard.

After two years with Delta Omega™ not a single acoustic detail has been missed. Only after you experience it will you know more than we could ever tell you.”

Tres Virgos Studio
San Rafael, CA



CROWN

1718 W. Mishawaka Road, Elkhart, IN 46517
(219) 294-5571

Call or write for details.

M20 14-inch driver was added to the 12-foot 555 driver/horn assembly. Because of design faults, the LF horn trailed off sharply below 150 Hz, while the original 555 setup kept on pumping it out to 100 Hz or better. I wonder how many people have opened the back pressure vent cover on a 555 and examined the fine golden lamb's wool damper or operated a 555 on a 12-foot horn without back pressure loading. Once heard, any resonant speaker box is laughable.

The last W.E. stage system that was publicized was the Mirrophonic installation, using one or more cellular HF horns with 555C or 594 drivers and up to six folded LF horns 8-feet across the mouth, each fitted with two 14-inch or 18-inch "Loudspeaking Telephones" drivers, originally designed by Jensen. Although the LF droop still persisted, the demo film of the eruption of the Island of Karakatoa, with greatly enhanced low frequency, was about the best ever from a single optical track. Later, when installing four track magnetic systems, I obtained a quantity of 555A drivers and made up acoustic adaptors that would fit Vitavox multicell horns—a very demanding job, but with results well worth the effort in sound cleanliness and efficiency. Par-

ticular care had to be given to the 7.5 volt field supply so that the energisation would not modulate the acoustic output. At the time, I experimented with the panel positions inside the W.E. LF folded horns and obtained a loaded response down to 30 Hz with little or no visible cone excursion. Smoke test patterns revealed most of the faults in the original. I wondered why W.E. chose such a relatively high roll off until we received Perspecta prints some years later; everything below 50 Hz had to be sharply taken out.

Thank you Mr. Gelow for pleasant memories.

ALAN L. ROYCROFT

HEY MAN, WHERE'S THE QUIET RIOT?

TO THE EDITOR:

Record the London Symphony Orchestra with B&K studio mics through a Neotek console on to a Sony digital two-track, map that on to a digital audio disc, pushing Crown amps pushing JBL monitors playing in an acoustically transparent room, and out of one hundred consumer audio customers, 82 will ask if you have any Van Halen,

12 will ask to turn it up, and one guy will play with the remote controls. Only four or five will be genuinely interested, and a sale among them unlikely.

Come on, folks. We'll never get consumer digital off the ground like this. Mass-market wise, who cares if a digital audio disc is the approximate spec of the highest quality analog pressings? How many of your friends or clients have superb analog recordings? Not many of mine do. The point is that worst case for digital is near best case for analog. The durability and lifetime of a digital audio disc should also give them a good edge.

In addition, there needs to be accommodation of the music buyer's impulse for current music more than thirty to fifty percent higher in price than the comparable LPs. (This is the range of price mentioned by those asked how much they would want to pay for a disc.) Most of these people were not cognizant of the actual price.

Digital audio is a major step forward. Ultimately, the ledger will rule the digital audio disc's future. It can be a good one.

Thanks for a fine magazine.

—DAVE FISH
Electronic Fish Music
Denton, Texas

The measure of success

Whether you need to prove or improve system performance and auditorium response ... Klark-Teknik's DN60 measures sound levels with almost laboratory accuracy right across the audio spectrum. The result is graphically displayed on 30 LED columns exactly matching the frequencies of the Series 300 equalisers. Features of this outstanding instrument include a clear LED display, three memories, peak hold function and built-in pink noise source.

To round-off we also offer the RT60, an ingeniously inexpensive plug-in unit that converts the DN60 to a graphically displayed reverberation analyser.

Specification includes:

Frequency response 15Hz to 22kHz

Input sensitivity

Microphone, 120 dBspl to 50 dBspl

Line, +20 dBm to -50 dBm

Pink noise output Digitally generated.

The Klark-Teknik promise — a bigger investment in the future with:

1. Greater R&D investment, with 12% of all company personnel directly involved in new product development.
2. Consistent attention to production economies for professional performance at 'breakthrough' prices.
3. Effective 'Reliability Control' during manufacture.

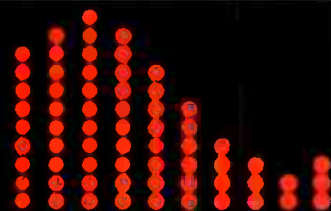

KLARK TEKNIK



British designed, British made

For full colour 'DN60 Analysers' brochure contact:

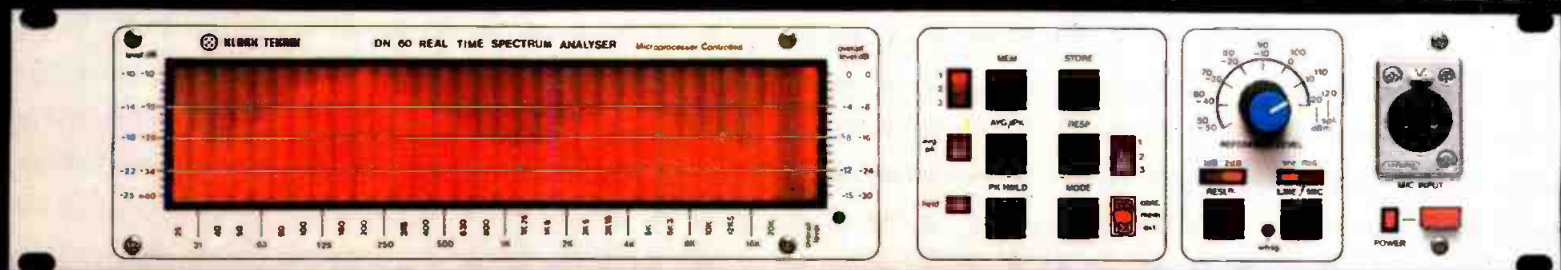

Manufactured by Klark-Teknik Research Limited
Coppice Trading Estate, Kidderminster DY11 7HJ,
England. Telephone: (0562) 741515 Telex: 339821

Klark-Teknik Electronics Inc.
262a Eastern Parkway, Farmingdale,
NY 11735, USA. Telephone: (516) 249-3660

Omnimedia Corporation Limited
9653 Côte de Liesse/Dorval, Quebec H9P 1A3,
Canada. Telephone: (514) 636 9971

Circle 14 on Reader Service Card

The VOICE-MATIC™ Automatic Microphone Mixer

**JUST GOT
EVEN
BETTER**

**WORKS WITH ALL
MICROPHONES**

Introducing the LEVEL-MATIC™ module option

The Voice-Matic Model DE-4013 has received wide acceptance in sound reinforcement, broadcasting and teleconferencing applications by eliminating feedback and fading sound levels. With the NEW LEVEL-MATIC master module option, the Voice-Matic is totally automatic.

- Soft talkers receive added gain.
- Loud talkers and background sounds are attenuated.
- A smooth, uniform output level is the result.
- Retrofits all existing DE-4013 mixers.

Once you hear it, you won't want your sound system without one.

Call or write today for more information on how the Voice-Matic mixer with the Level-Matic option can improve your sound installation...automatically!

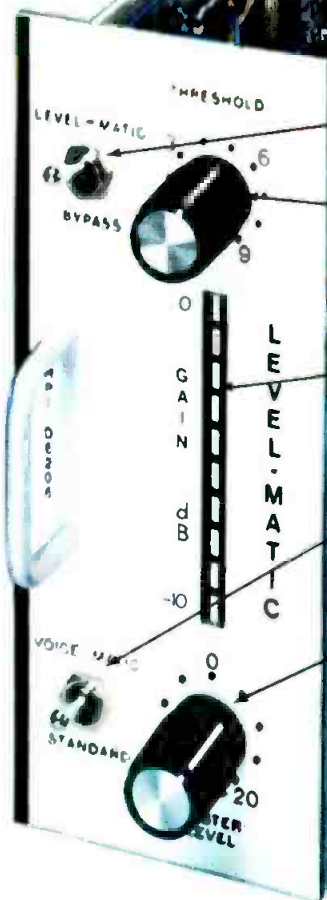

LEVEL-MATIC
OR OPTIONAL
BY-PASS

VARIABLE
THRESHOLD

10dB AUTOMATIC
GAIN RANGE

VOICE-MATIC MODE
OR STANDARD MIXER

MASTER
SYSTEM GAIN

Videotape
demonstration
of LEVEL-MATIC
available upon
request

VOICE-MATIC™
automatic microphone mixer

INDUSTRIAL
RESEARCH
PRODUCTS,
INC.

A Knowles COMPANY

321 Bond Street • Elk Grove Village, IL 60007
(312) 439-3600

Circle 17 on Reader Service Card



Jolly Roger Recording

• It's a little-known fact, but a mere two days after the commercial introduction of the Edison Cylinder, a man in New Jersey bought a recording of "Stars and Stripes Forever," set up two recorder/players in a warehouse and, using toilet paper tubes dipped in paraffin, began making the first pirate recordings. He undercut his legitimate competition by 20¢ per cylinder and netted \$37.20 in profit before his alarming demand for toilet paper alerted the authorities and his operation was flushed out. Believe it...or not.

SOME NUMBERS

From those humble origins, pirating has flourished. Today, clandestine duplicating facilities are in operation throughout the country, cleverly disguised as home stereo systems. The problem is home taping of records—that innocuous practice of borrowing an album from a friend (or renting one from a store, or taping from the radio) and making a cassette copy for yourself. Well, maybe it's not so innocuous. Seemingly innocent people are in fact

putting the record companies out of business. For example, in 1982 1,540 fewer albums were produced than in 1978—a decrease of 37 percent; in addition, the industry now employs 7,000 fewer people than it did in 1978—a decrease of 34 percent in the work force. Do you think you might lose your job, or have you already lost it? At the rate things are going, there may not be any job security for any of us. In 1982, 564 million albums-worth of music was taped at home, or, to put it another way, 20 percent more music than was purchased.

And it's not just a few nasty teenagers. Statistics show a broad involvement in terms of age: 10-17, 31 percent; 18-34, 39 percent; 35-54, 25 percent; 55-79, 5 percent. Blank tape is a big business, and a full 84 percent of all blank tape purchased by consumers is used to tape copyrighted music. Economist Alan Greenspan estimates that the recording industry as a whole lost over 1.4 billion dollars in sales in 1982 due to home taping. For every 100 recordings sold, an additional 75 were taped.

And it's getting worse. The annual volume of taping has grown by 24 percent since 1980, while record sales have decreased by 16 percent. People are taping more, and on an individual basis; the more a person tapes, the less records he owns. Is the trend to continue until the point where the record companies release one copy each of a few albums, and everyone in the country passes it around and tapes it like some gigantic chain letter? Well, you say, that record would wear out pretty quickly. What if it were a Compact Disc?

Sure, you can question the validity of the statistics. These particular ones were the result of a study done by Audits & Surveys, commissioned by RIAA. Maybe the numbers, such as the 84 percent figure, were biased upward, since RIAA probably takes a pretty dim view of home taping. But on the other hand, a 1981 survey commissioned by EIA (Electronics Industries Association), which probably likes the idea of people buying cassette machines and blank tape, showed that 48 percent of blank tape was used to record copyrighted music. There's a big difference between the two numbers, and in both cases there are some gray areas. For example, a certain percentage of taping is relatively harmless, say by people who have already purchased the record. If someone buys a record, doesn't he have the right to do what he wants with it? To re-record it? To let people borrow it? To rent it out? To get a warehouse and go into business? And as far as the numbers go, it's difficult to be precise about something like lost record sales—something that exists because it isn't there. But the magnitude of the problem is clearly evident. The Spanish galleons aren't making it back to the Queen. They are going under, and the pirates are taking a lot of the loot.

WHAT'S GOING ON?

Is it a question of economics or convenience? Probably a little of both. It is certainly cheaper to buy a blank cassette than an album. The old adage that a good album cover can sell 50 percent more albums might not be true anymore. Obviously, at least for the consumer pirate, the sound of the music is more important than the visuals. For the minority who still buy albums, who knows, maybe they just read the liner notes (maybe they don't even own record players). Taping is cheap. Blank tape is cheap and it can be erased and used for another album. On the

Exquisite
Sound

Modest Cost

GRD

AMERICA'S MOST
EXPERIENCED
REAL TIME DUPLICATOR

HIGH QUALITY PRINTING
AND ASSEMBLY

CUSTOM LOADED BLANK
AGFA CASSETTES, CHROME

(602) 252-0077
P.O. BOX 13054
PHX., AZ 85002
Canada Division
(403) 283-8068

THE RECORDERS Quartz-lock Auto Bias,
30-20,000 HZ, 025% w/ f.m.s. Dolby B -
more than 67 db S/N ratio

Circle 15 on Reader Service Card

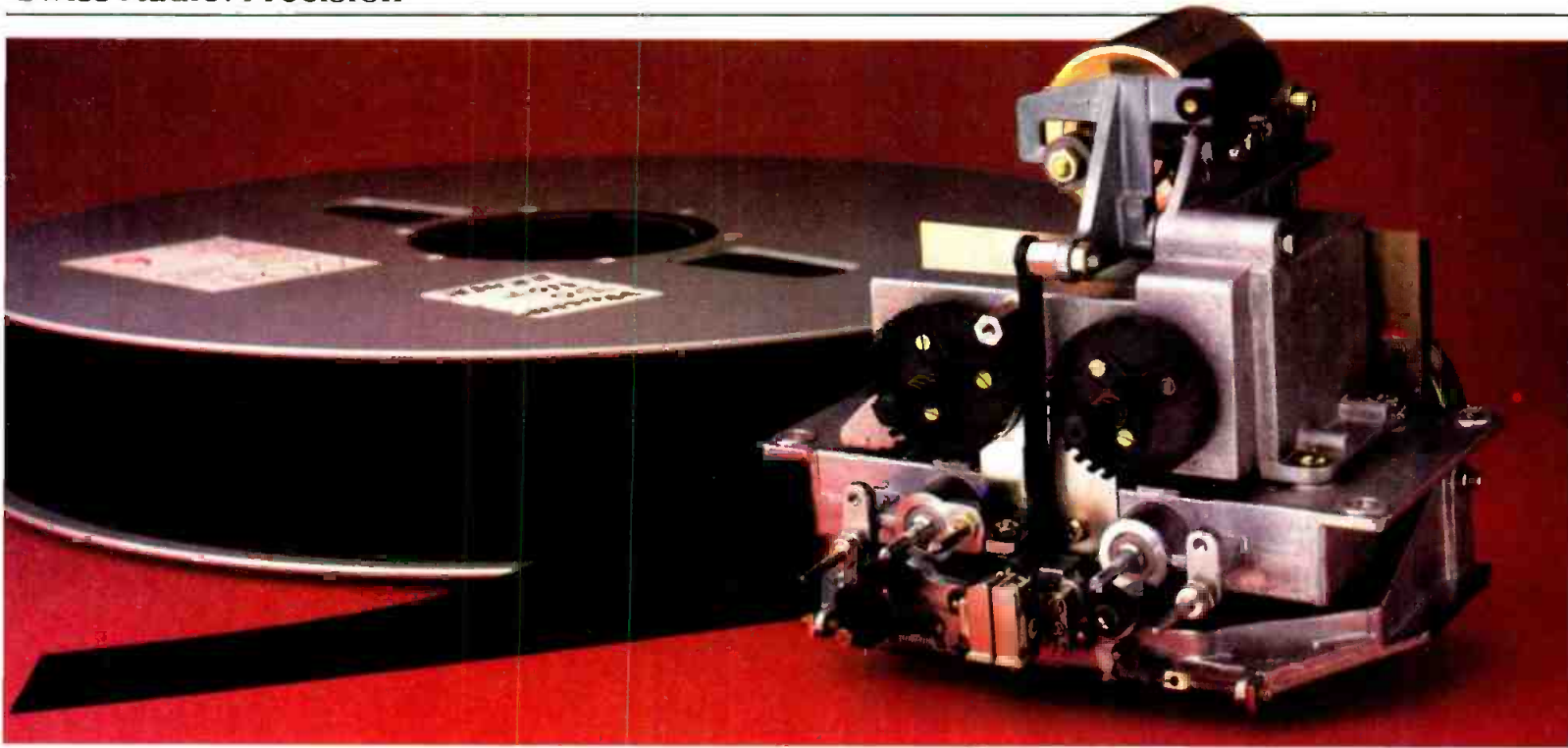

On designing a cassette transport to meet 2" mastering standards.

As an audio professional, you probably work with several tape formats. But your demands for reliability and performance are always the same.

In designing a transport for the Studer A710 and the Revox B710 MKII cassette decks, our engineers worked with the same principles established for our professional open reel decks. No cost-cutting compromises were permitted. For example, the Studer Revox cassette transport is built on a die-cast aluminum alloy chassis, not on stamped metal. This is the only way to assure precision machining and long term stability.

Four direct drive motors handle your cassettes smoothly and gently. Two quartz-locked, Hall effect capstan motors keep wow-and-flutter down to a conservatively rated 0.05% (DIN weighted). Two additional DC reel motors, both servo regulated and microprocessor controlled, provide constant speed fast winding, automatic start-of-oxide cueing, and motion sensing for positive tape protection.

No sleds allowed. Most other cassette decks use a sled mechanism to insert the heads into the cassette shell. The free play inherent in this design often contributes to azimuth misalignment.

In the Studer Revox design, a die-cast headblock pivots upward on two precision (0.001 mm tolerance) conical bearings and

locks into a solid 3-point mount. Because the headblock always locks into exactly the same position, absolute azimuth stability is assured.

One transport, two decks. This remarkable transport can be found in only two tape decks, the Revox B710 MKII and the Studer A710. Features shared by both units include 3 head design, internal 24 hour clock for programmable operation, tape type sensor, Dolby™ B and C noise reduction, plug-in modular PC boards, optional remote control, and adjustable headphone output with ample amplification.

A710: The Studer Version. This deck offers professional line level inputs and outputs, with output levels adjustable from -3 to +14 dBu. It also has calibrated input and output levels, XLR connectors, and a rack mount flange standard.

B710 MKII: The Revox Version. The lower priced B710 MKII has front panel mike inputs, mike/line mixing, and an optional infrared remote control.

For the long run. The Studer A710 and Revox B710 MKII are built for consistent, dependable performance. Hour after hour. Year after year. The kind of performance you expect from the world's most respected name in audio recording.

For more information on Studer Revox cassette decks, contact: Studer Revox America, 1425 Elm Hill Pike, Nashville, TN 37210, (615) 254-5651.

STUDER REVOX



Revox B710 MKII

Studer A710

Circle 18 on Reader Service Card

MICROPHONES!

At long last, all the questions you ever asked...all the problems you ever grappled with...are answered clearly and definitively!

The Microphone Handbook

In 256 fact-filled pages, liberally sprinkled with over 500 illuminating photographs, drawings and diagrams, John Eargle covers virtually every practical aspect of microphone design and usage.

Completely up to date, this vital new handbook is a must for any professional whose work involves microphones. Here are just a few of the topics that are thoroughly covered:

- Directional characteristics—the basic patterns.
- Using patterns effectively.
- Microphone sensitivity ratings.
- Remote powering of capacitors.
- Proximity and distance effects.
- Multi-microphone interference problems.
- Stereo microphone techniques.
- Speech and music reinforcement.
- Studio microphone techniques.
- Microphone accessories.
- And much, much more!

THE MICROPHONE HANDBOOK. You'll find yourself reaching for it every time a new or unusual problem crops up. Order your copy now!



JOHN EARGLE,

noted author, lecturer and audio expert, is vice-president, market planning for James B. Lansing Sound. He has also served as chief engineer with Mercury Records, and is a member of SMPTE, IEEE and AES, for which he served as president in 1974-75. Listed in *Engineers of Distinction*, he has over 30 published articles and record reviews to his credit, and is the author of another important book, *Sound Recording*.

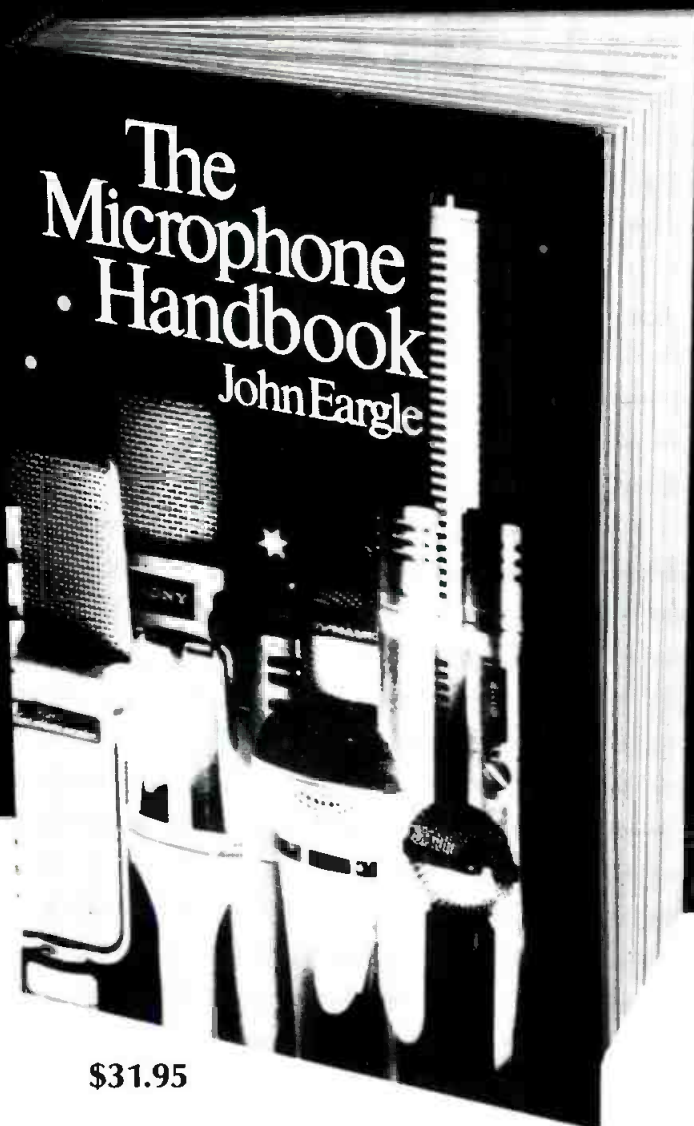

\$31.95

ELAR PUBLISHING CO., INC.

1120 Old Country Road, Plainview, NY 11803

Yes! Please send _____ copies of **The Microphone Handbook @ \$31.95** per copy. (New York State residents add appropriate sales tax.)

Payment enclosed.
Or charge my MasterCard Visa

Acct. # _____ Exp. Date _____

Name _____
(please print)

Address _____

City _____

State/Zip _____

Signature _____

Outside U.S.A. add \$2.00 for postage. Checks must be in U.S. funds drawn on a U.S. bank.

If you aren't completely satisfied, you may return your copy in good condition within 15 days for full refund or credit.

Updated Recording Studio Handbook

A must for every working professional... student... audio enthusiast

Features latest state-of-the-art technology of creative sound recording.

21 Fact-Filled Chapters

- I. The Basics**
 - 1. The Decibel
 - 2. Sound
- II. Transducers: Microphones and Loudspeakers**
 - 3. Microphone Design
 - 4. Microphone Technique
 - 5. Loudspeakers
- III. Signal Processing Devices**
 - 6. Echo and Reverberation
 - 7. Equalizers
 - 8. Compressors, Limiters and Expanders
 - 9. Flanging and Phasing
- IV. Magnetic Recording**
 - 10. Tape and Tape Recorder Fundamentals
 - 11. Magnetic Recording Tape
 - 12. The Tape Recorder
- V. Noise and Noise Reduction**
 - 13. Tape Recorder Alignment
 - 14. Noise and Noise Reduction Principles
- 15. Studio Noise Reduction Systems
- VI. Recording Consoles**
 - 16. The Modern Recording Studio Console
- VII. Recording Techniques**
 - 17. The Recording Session
 - 18. The Mixdown Session
- Three all-new Chapters**
 - 19. The In-Line Recording Studio Console (The I/O Module, The Basic In-line Recording Console, Signal flow details.)
 - 20. An Introduction to Digital Audio (Digital Design, Basics, Digital Recording and Playback, Error Detection and Correction, Editing Digital Tapes.)
 - 21. Time Code Implementation (The SMPTE Time Code, Time-Code Structure, Time-Code Hardware.)



\$39.50

Recording Studio Handbook is an indispensable guide with something in it for everybody. It covers the basics beautifully. It provides insight into common situations and problems encountered by the professional engineer. It offers clear, practical explanations on a proliferation of new devices. **And now it has been expanded with three new chapters . . . chapters on the in-line recording studio console, digital audio and time code implementation.**

With printing of industry's "first" complete handbook *Recording Studio Handbook* has been so widely read that we've had to go into a sixth printing to keep up with demand (over 30,000 copies now in print). Because it contains a wealth of data on every major facet of recording technology, it is invaluable for anyone interested in the current state of the recording art. (It has been selected a textbook by several universities for their audio training program.)

Widely Acclaimed

Naturally, we love our book. But don't take our word for it. Here's what others have to say:

"John Woram has filled a gaping hole in the audio literature. This is a very fine book . . . I recommend it highly." *High Fidelity*
 "A very useful guide for anyone seriously concerned with the magnetic recording of sound." *Journal of the Audio Engineering Society*

30-Day Money-Back Guarantee

When you order *The Recording Studio Handbook* there's absolutely no risk involved. Check it out for 15 days. If you decide it doesn't measure up to your expectations, simply send it back and we'll gladly refund your money.

Easy to Order

You can enclose a check with your order or charge it to Master Charge or BankAmericard/Visa. Use the coupon below to order your copies of the new updated *Recording Studio Handbook* (\$39.50).

ELAR PUBLISHING COMPANY, INC.

1120 Old Country Road, Plainview, N.Y. 11803

Yes! Please send _____ copies of THE RECORDING STUDIO HANDBOOK. \$39.50. On 15-day approval.

Name _____

Address _____

City/State/Zip _____

Total payment enclosed \$ _____
 (In N.Y.S. add appropriate sales tax)

Please charge my Master Charge
 BankAmericard/Visa

Account # _____ Exp. date _____

Signature _____

(changes not valid unless signed)

**Outside U.S.A. add \$2.00 for postage.
 Checks must be in U.S. funds drawn on a U.S. bank.**

other hand, most home recordists live in above-average income households. There is perhaps a reason more important than money. A cassette is convenient. It plays at home, or in the car, or at the beach, or while exercising. Anyone who carries a turntable while jogging is considered to be eccentric. A cassette is longer-lived and more maintenance-free; it is more compact and less breakable. It also sounds almost as good as a new L.P. So why haven't prerecorded cassettes displaced L.P.s and held pirates at bay? Generally, they don't sound as good as a home cassette. The industry has been too slow in adapting to premium tape. Also, prerecorded tapes are expensive. It's cheaper to tape at home with premium blank tape that can yield a better copy. In fact, a full 91 percent of premium blank tape goes to pirates. Free enterprise at work—a cheaper and better product. If it's illegal—so what? Don't kid yourself, America was built on that premise.

Unfortunately, free enterprise sometimes involves shoddy merchandise and the record industry isn't entirely blameless in this respect. The quality of pressings is so poor that the serious listener can count on returning several pressings to the store before an acceptable one is obtained. That frustration, and the suspicion that one is being gyped, certainly has contributed to the rise of home taping. A totally logical response to a big problem. Could the record companies effectively compete by lowering retail prices, negotiating more sensible royalties for artists, and improving quality? A competitive spirit would be the best way to combat the problem, but that task wouldn't be easy. The home recordist contributes his equipment cost and labor for free. The company has to pay for both, as well as items such as royalties....

WHO'S HURTING?

Who is being hurt by pirating? The record companies are being hurt because they sell fewer records. The recording industry as a whole is being hurt—fewer albums, less business. Recording artists are being hurt because they sell fewer records and lose royalties on pirated records. Record buyers are being hurt because they must help cover the companies' losses by paying more for albums. And the pirates themselves are being hurt because companies can afford fewer albums—the number of available recordings, the selection of music, and the number of new bands appearing on labels is less. In the worst case, all record companies would go out of business and the pirates could only pirate from each other. Is anyone helped from pirates? Cassette machine and tape manufacturers are benefitted in the short run—until the record companies fold, or the government slaps a tax on machines and tape....

BLAME IT ON THE CASSETTE

The culprit is the cassette. Originally designed as a low fidelity, high convenience recording medium, it has outgrown its sonic shortcomings to displace open reels as the most popular recording medium. Its ability to record from L.P.s logically places it as the ideal pirate medium. Although the fidelity of cassettes is now quite high, a curious kind of destruction has taken place. Consumer perception of high fidelity has been altered; the expectation has been lowered because people accept both a generation loss and the inherent lower fidelity of the cassette in place of the theoretically much higher fidelity of an L.P. record. Tape hiss, wow and flutter, and other specification problems which abound, especially in low-priced cassette recorders, have become the norm. Thus the standard for high fidelity has actually been lowered since the days when the L.P. reigned supreme. The next question, of course, is to consider the impact of the Compact Disc. It is possible to suppose that the introduction of a medium with higher fidelity, durability, portability and convenience will awaken a consumer dissatisfaction for their cassette copies. Perhaps that will signal a return to the record stores and the legitimate purchase of music software. Furthermore, any attempts to copy from a Compact Disc would reveal the shortcomings of the cassette, which would scarcely handle the dynamic range, etc. Of course, the problem of cost still remains. As long as a Compact Disc retails for 20 dollars, many consumers will remain content with slightly inferior duplicates costing much less.

THE BIG QUESTION

So, what is to be done? Everyone generally agrees that pirating is bad, and ultimately will result in a weakened music industry. But the solution is elusive; pirating probably cannot be prevented. Various methods to provide copyguarded L.P.s have proved unsatisfactory, and probably could be circumvented anyway. Exhaustive research into the development of a spoiler system, undertaken or encouraged by the RIAA and other organizations, has produced only false hopes. Similarly, video tapes suffer the same dilemma; sync pulses can be attenuated so that re-recording is made impossible, but playback of the original tape is sometimes impossible also. Of course, for \$50 you can purchase an anti-copy device. Similarly, the Compact Disc is a copyable medium because no matter how much you scramble and unscramble, filter and defilter, at some point all of that digital complexity must appear as a simple analog line level signal ready to be applied to an amplifier or a cassette machine input.

The only really attractive possibility

for a solution is an economic response devised in the marketplace—new enthusiasm on the record companies' part to produce good quality L.P.s at a cheap price, a Compact Disc which has all of the advantages of the cassette, but at a lower price. Two days after the introduction of either of those products pirating would begin to disappear. Of course, those attractive solutions might not be attractive to the record companies. In that case there is always the cowardly economic solution, government style. Rather than find a solution to home taping, we would legalize it and put a tax on it. One idea is to sell a license for home taping, available for anyone wishing to copy records for private use; however, this solution succeeds only on the assumption that lawbreakers are honest people.... Meanwhile, in the Senate judiciary copyright subcommittee, several bills are under scrutiny, each designed to resolve the issue of home taping of audio and video. There is probably no question that a copyright exemption will be enacted such that non-commercial home taping will become legal. The second problem is stickier. Someone must pay compensation—and that will be the consumer, perhaps in the form of a royalty to be placed on audio and video tape machines and blank tape. Exactly how much the royalty should be is a question of approximation because we will never know exactly how much money is being lost to home taping. One thing is for sure, the tax will have to be high enough to cover all of its internal administrative costs and show a fat profit. Therefore, it will be high, maybe so high that a blank cassette will cost as much as an

L.P. More likely (I hope), it will be as high as the record companies and music publishers can make it because they will receive any distributed money, and as low as the manufacturers can make it because they don't want to be the toll booths for the record industry. I suppose that in all fairness, since the manufacturers will be losing money in reduced sales, we should also put a tax on records and distribute that money to manufacturers.

The point is that any royalty raises tough questions. For example, counterfeiters (who duplicate cassette music as well as their covers) would increase their sale price to match the increased cost of taxed cassettes, and make even bigger illegal profits. And what about us poor journalists and authors? How about a tax on blank photocopy paper so we're covered anytime someone copies any of our material? Clearly, a royalty presents a lot of problems. One thing is for sure. Under the bills now in the Senate subcommittee, pirating would become completely legal, and most likely you and I would pay for it. Fifteen men on a dead man's chest, yo ho ho and a case of C-90s. ■

JH-618-10-GO/VU

JH-800

INSIDE. OUTSIDE. OR BOTH.

MCI's years of experience building the world's finest recording consoles have led us to the development of two new mixers designed to maximize audio capability in small spaces. In the studio or editing suite, make creative production possible with our JH-618 console in any one of a number of configurations. On the road, take studio

performance with you in the new JH-800 compact console with user programmable signal flow, built-in communications functions and 12 mic or line inputs.

Inside and outside, Sony Professional Audio has the answer with equipment from MCI...the choice of today's professionals.

SONY

Professional Audio Products
Sony Communications Products Company
Sony Drive, Park Ridge, New Jersey 07656.



Automatic Microphone Mixers

• Multiple microphones are a part of most sound reinforcement systems. For example, in a system designed for a house of worship, there will be microphones at the pulpit, lectern, altar, and possibly one or two used for congregational participation. A reinforcement system for a large board room will, of course, have a microphone for each position; the total number may well reach 15 to 25.

It has long been known that excess open microphones diminish the gain capability of a reinforcement system, since they provide numerous possible feedback paths. Since one microphone is normally in use at a given time, earlier systems required skilled operators to shut down, or lower, unused microphones—and to raise them on cue with nothing missed in the process!

While voice-operated gates have been used for many years for special applications, their general use in sound reinforcement dates from the mid-seventies as an ingredient in what are generally called automatic microphone mixers.

THE GATING FUNCTION

The basic flow diagram of a signal-operated gate is shown in FIGURE 1A. Essentially, it is an amplifier followed by a multiplier, with a side channel that detects the presence of a signal in excess of a given threshold setting. When the signal reaches the threshold, a DC signal goes to the multiplier and opens the signal path. Added functions include attack and release times for the gating function. Generally, the attack time should be quite rapid, but the release, or decay time should be on the order of one or two seconds so that normal pauses in speech do not turn off the input channel.

Older designs often turned on the signal at some predetermined time, t_0 , dictated by the threshold setting. If the turn-on occurs at some point in the wave form removed from the zero axis, then the turn-on will be quite abrupt, and a click may be heard. This is shown in FIGURE 1B.

Some more recent designs make use of a "zero crossing detector," a circuit that does not turn on on cue, but waits until the next point at which the signal crosses the zero axis. This is shown in FIGURE 1C. The audibility of an instant turn-on of this sort is quite negligible, and the gating action will be a natural one.

THE SYSTEM GAIN STABILIZING FUNCTION

All automatic microphone mixers provide a gain stabilizing function. The overall system gain is adjusted downward, depending on the Number of

Open Microphones (NOM). The assumption is made (not necessarily an accurate one) that all open microphone channels will contribute equally to feedback potential. Thus, the rule for lowering system gain is given by the following equation:

$$\text{Gain reduction} = 10 \log (\text{NOM}).$$

The table below gives the values for gain reduction for values of NOM from 1 to 24:

NOM	Gain Reduction
1	0
2	3
3	4.8
4	6
5	7
6	7.8
7	8.5
8	9
9	9.5
10	10
11	10.4
12	10.8
13	11.1
14	11.5
15	11.8
16	12
17	12.3
18	12.6
19	12.8
20	13
21	13.2
22	13.4
23	13.6
24	13.8

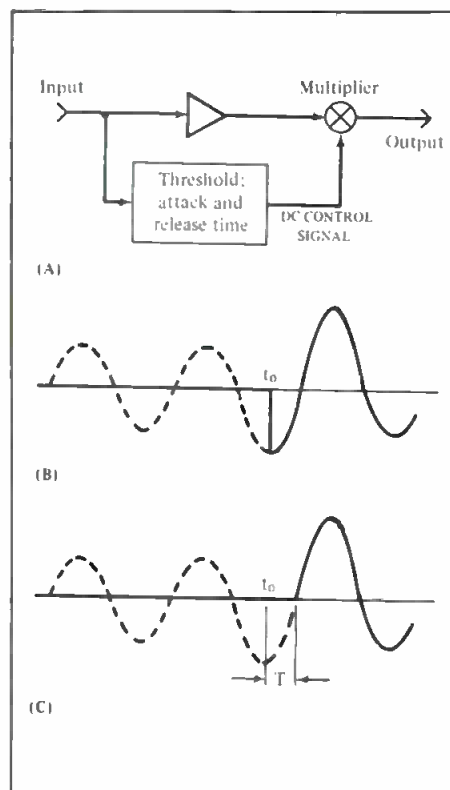

Figure 1. The Gated Input. A) flow diagram; B) gating control—signal turns on at t_0 ; C) gating control—zero crossing detector turns on signal at next zero crossing following t_0 , after a delay, T .

There are several important things to note. The first few microphones to be opened have the greatest effect on overall system gain; later microphones have a lesser effect. Calculated values of gain reduction have been carried out to .1 dB. In actuality, this degree of precision is not necessary, since it is not possible to determine the actual gain contribution of each channel with much accuracy. It is important, however, that the gain control function be quite free of drift.

FIGURE 2 shows the flow diagram for a number of individual inputs with NOM output control. Each open micro-

A few words on microphone accuracy

from the people who
specialize in it



The major contributor to a microphone's fidelity to the original acoustical event is the uniformity of its amplitude response over frequency. Indeed, the anomalies that give most popular microphones their characteristic coloration show themselves upon careful analysis to be variations from flat amplitude and phase response, especially those occurring in the middle and high frequencies.

Believing the best microphone must be an accurate one, Bruel & Kjaer designed the 4000 series of professional condensers to virtually ruler-flat response through the middle frequencies, worst-case deviation of ± 2 dB from 10 Hz to 40 kHz. amplitude and phase response uniform on-axis, but uniform even off-axis.

have
and
Not only are the
they remain remarkably

The result of this insistence
response is a microphone you can

upon accuracy in both amplitude and phase
place before any sound source knowing
you'll preserve timbre without coloration.

If you like performance curves, request our literature. If you'd like a demonstration in your space, call your B&K field applications engineer or contact:



Bruel & Kjaer Instruments, Inc.

185 Forest Street, Marlborough, Massachusetts 01752 • (617) 481-7000 • TWX 710/347-1187
World headquarters: Naerum, Denmark. Sales and service in principal US cities and 55 countries around the world

Circle 21 on Reader Service Card

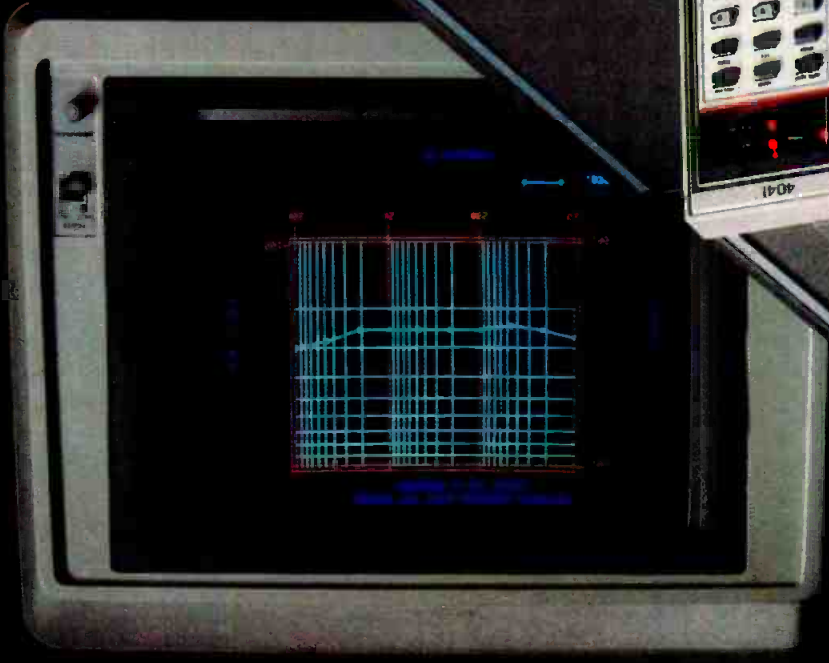
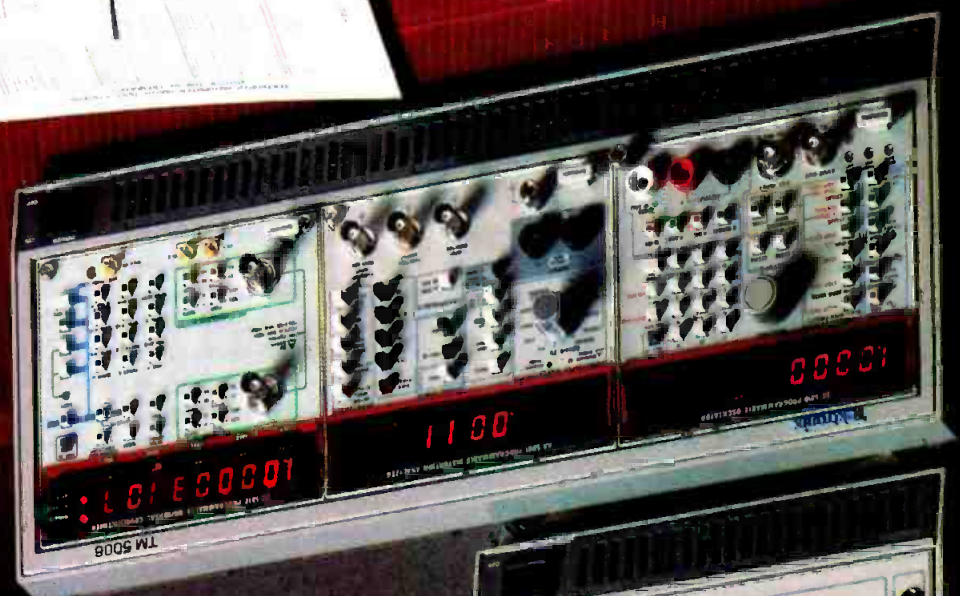
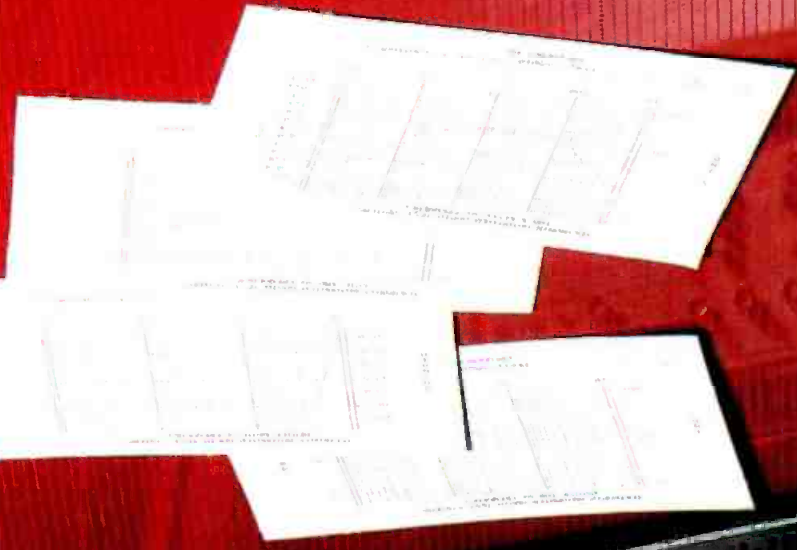

Tektronix automated audio test systems: built to test the best.

Tek's new SG5010/AA5001 Programmable Audio Oscillator and Distortion Analyzer System lets you test the finest professional audio and communications equipment, with uncompromisingly high-quality measurements.

Finally, you can count on computer-controlled audio test equipment that's better than the products you're testing. Coupled with an IEEE-488 controller, the SG5010/AA5001 completes most audio tests quickly, automatically, even unattended.

The new Tek system features extremely low residual noise (less than 3 microvolts) and low distortion (typically 0.0012% at midband when using the audio bandpass filter). It allows you to make all standard audio tests—including THD, IMD (SMPTE, DIN, CCIF difference tone), gain/loss, and signal-to-noise ratio.

Perform most audio production tests up to ten times faster than manually.

Tek's Programmable Audio Test System will help your technicians achieve both faster throughput and more comprehensive testing. And because one Tek automated system can do the work of five to ten fully equipped benches, your investment will pay for itself several times over.

Eliminate most slow, repetitive performance testing involved in audio design. Use the new Tek test system to automate measurements, then display the results via graphics for quickest interpretation. Free up design engineers for more creative tasks.

Detect broadcast signal degradation promptly, before equipment failure. The Tek audio test system can help cut downtime by accurately measuring and documenting increases in noise or distortion, or other trends affecting signal quality. Thorough audio proof reports can be generated automatically, every day if desired.

Test with the best. Highly accurate results, made quickly

and automatically, add up to savings in the audio field. Even if you're not ready for full automation, Tek also makes the fastest, easiest-to-use manual audio test equipment. Our AA501/SG505 package offers performance equivalent to our new programmable system.

Find out more about how Tek instruments can pay off in your audio application.

Call your nearest Tektronix Sales Office, or contact: U.S.A., Asia, Australia, Central & South America, Japan Tektronix, Inc.

P.O. Box 1700
Beaverton, OR 97075

Phone: 800/547-1512

Oregon only: 800/452-1877

Europe, Africa, Middle East

Tektronix Europe B.V.

Postbox 827

1180 AV Amstelveen

The Netherlands

Telex: 18312-18328

Canada

Tektronix Canada Inc.

P.O. Box 6500

Barrie, Ontario L4M 4V3

Phone 705/737-2700

Tektronix
COMMITTED TO EXCELLENCE

phone gate produces a voltage (or some other kind of signal) which are then combined. The resulting control signal is then used to diminish the gain at the output according to the 10 log NOM function.

GENERAL COMMENTS

While the above comments apply generally to all commercially available automatic microphone mixers, there are significant differences between them in terms of features.

Some models offer access to each gated input individually, so that the device can be used in recording studios as a noise gate. The gating control signal itself can be accessed in some models so that it can be used for some auxiliary function, such as turning off a loudspeaker immediately overhead. This could be a very useful function in a board room system, where it could be used to further control feedback.

Many models have the capability of being coupled together so that they

operate as one large unit, accommodating as many input channels as desired.

Some models offer a "priority control," which allows an assigned input to mute all others when it is actuated. In using this function, the priority would typically be given to the chairman's input. Each time the chairman spoke, all other inputs would be muted, give him greater control over the proceedings.

Models differ in how they react to high levels of ambient noise. Obviously, we would like random noise entering all microphone inputs not to turn on microphone channels indiscriminately. In a house of worship, specifically, organ music entering all microphones should not turn on any of the inputs. The control functions which ensure that this will not happen can be fairly complex, and manufacturers have handled this requirement in different ways and with different degrees of success.

In general, automatic microphone mixers, properly specified and installed, allow a wide variety of sound reinforcement systems to operate virtually unattended. More and more designers are availing themselves of this advantage. ■

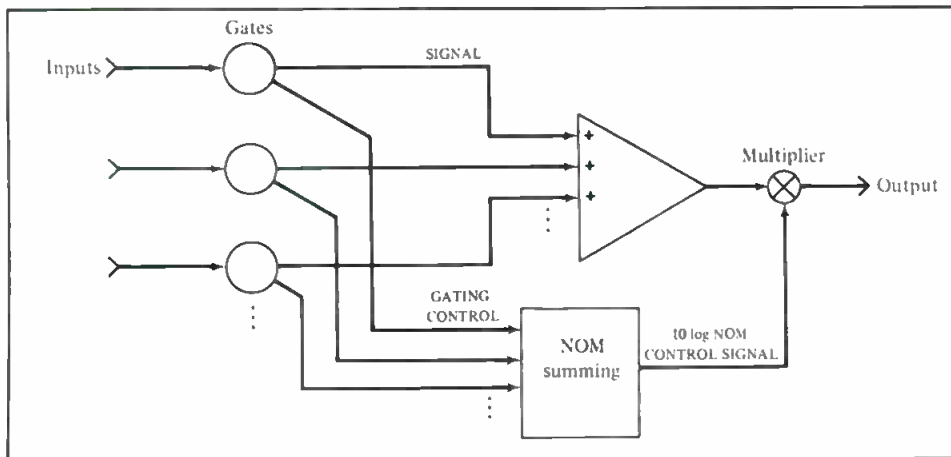

Figure 2. Implementation of the 10 log NOM function.



It proves its worth.

While others have introduced more expensive reverbs that don't sound like they're worth it, or lower-cost units that don't deliver quality, Orban's 111B Dual Spring Reverb continues to prove its worth.

Why? Because the Orban 111B offers good, clean sound that most studios and production rooms demand at a fair price. Our proprietary "floating threshold peak limiter" protects the springs from being overdriven on transients. So the 111B doesn't sound "twangy"—just bright and clean, with a sound that complements tracks instead of muddying them. And flexible EQ lets you contour the echo return for any application.

So check out the 111B Dual Spring Reverb: A proven performer with the right sound at a fair price.

orban Orban Associates, Inc.
645 Bryant St. San Francisco, CA 94107
(415) 957-1067 TLX: 17-1480

EVM™ Pro-Line Speakers

As a working musician or sound-pro, you constantly work to improve and refine your performance. And we at EV know that today's performance demands a wider dynamic range and clean, clear sound. It requires higher instrument or monitor levels on stage and more punch out front. But raising your performance standards has been expensive, until now.

That's why we designed the EVM PRO-LINE Series of extra heavy-duty sound reinforcement loudspeakers. The 15" and 18" models can handle 400 continuous watts of "real world" power (not just laboratory sine waves) and an incredible 1600 watts of peak music power. The 12" models will take 300 watts continuous and 1200 watts peak under the same grueling power tests.

They're the newest genera-

tion of maximum efficiency, low-frequency speakers designed for cost effective, high-level performance. The EVM PRO-LINE can give you the extra punch you need with freedom from fear of failure—even when pushed to their limits.

All of this power handling capacity comes with the same EVM efficiency and reliability as our industry standard EVM Series II music speakers.

Couple that with EVM's 5-year loudspeaker guarantee, and our fast, efficient repair service, and you won't find a better high-powered value than the EVM PRO-LINE Series.

RAISE YOUR STANDARDS.

So raise your sound standards. See your EVM dealer or write for more information to: Greg Hockman, Director of Marketing, Music Products, Electro-Voice, Inc., 600 Cecil Street, Buchanan, MI 49107.

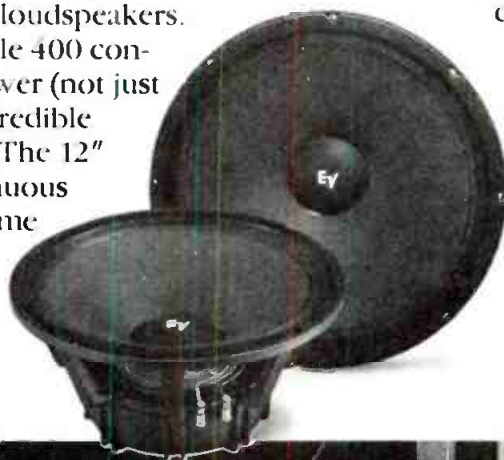

EV Electro-Voice
SOUND IN ACTION™

a gulton company



Circle 24 on Reader Service Card

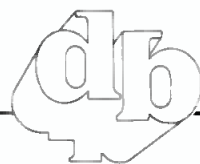

• Several months ago we mentioned the topic of phase-locked loops in the context of creating a new clock frequency out of an old clock frequency. This introduces us to a very unpleasant class of digital engineering. Clock and control logic is the area of a design that is most likely to have bugs, and these bugs can produce very strange effects. Distributing audio data is relatively simple because the meaning of the digital word is clear-cut. With clocks and control we often do not have a natural language and each of the circuits has a very ill-defined functionality. There are, however, a few topics in control logic which can be described in a coherent fashion. For the next few months we will consider this subject.

The first topic we will consider is that of clock interval generation. Consider the case where we have a master system clock for the entire studio running at 50 kHz. (I will continue to use 50 kHz as a standard for discussion even though 48 kHz would now be a better choice. The numbers are easier to consider with a 20 μ sec period compared to a 20.83333 μ sec period.) This external clock gives the equipment information every 20 μ sec. However, if the equipment must perform many operations in that 20 μ secs, it would be useful to have finer gradations. The act of cutting the basic cycle-time into finer units requires us to have "multiple phases" of the basic clock. With 10 operations per main cycle, we would need information every 2 μ sec. In theory, one could have a master high frequency clock for the entire studio, but this would be impractical since different equipment would require a different number of phases.

The problem we are now addressing is that of creating an internal high frequency clock system that is synchronous with the external reference clock. To get 10 phases, we would need a 500 kHz internal clock. Although this is easy if we use a local crystal, the result will not be synchronous with the external clock. If the 500 kHz were

actually 500.001 kHz, then 10 phases would not be complete in 20 μ sec but rather in 19.99996 μ sec. After some time, the two clocks would "slip" with regard to each other. Even if the frequencies were exact, there would be no way to control the phases of the two clock systems. For example, suppose the input data was to be made available on the third phase of the equipment clock. How would the equipment become time aligned? The act of synchronizing the two systems thus reduces to two separate issues: identical frequency and phase alignment.

FREQUENCY AND PHASE

Let us take a moment to digress on the general subject of phase and frequency. We all think that we understand these concepts, but they are actually more complex than we think. After the following discussion, you should become convinced that frequency is the derivative of phase or phase is the integral of frequency. To see how this works, let us begin with the concept of a sinewave. We may write this as

$$y = \sin(\omega t)$$

$$\text{where: } \omega = 2\pi f$$

$$t = \text{time.}$$

Or, we may simply say that

$$y = \sin(\theta)$$

where θ is phase. Notice that the first equation is a function which changes with time, whereas $y = \sin(\theta)$ is simply a nonlinear relationship between two variables, y and θ . For the purposes of this discussion we will stay with the second equation. This equation is static in that each value of θ produces a value of y ; it may or may not be time varying. θ is the phase variable. To create a sinewave we need to make θ be a function of time:

$$\theta = \omega t.$$

It is interesting to plot this as shown in FIGURE 1. Although the graph is very simple, it shows that a sinewave can be described by a linearly increasing phase for all time. The slope of the

curve is frequency. In this way of thinking, we do not consider the fact that the sine function repeats every 360 degrees. That would be an artifact of $y = \sin(\theta)$, not a property of phase. In some mathematics, it is useful to make a distinction between 360 and 720 degrees.

To understand frequency, we can say that a 1 kHz signal is really a signal which increases its phase 360 degrees every 1 msec. This is the slope of the curve. (Most mathematics uses

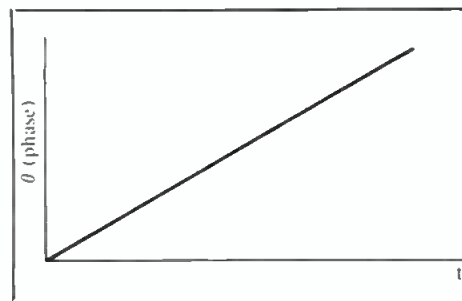

Figure 1. Phase as a function of time for a sinewave.

radians for phase rather than degrees. We then say that a 1 kHz signal has a phase which increases at the rate of 2π radians/msec.)

We can keep track of large phase numbers if we paint a red dot on one cycle of a periodic signal. Using this dot, we can count the number of cycles, number of radians, or the number of degrees which have been accumulated after a certain time. The application of this idea is shown in FIGURE 2. The top curve shows a plot of phase vs time for some signal; the bottom curve shows the result if phase is mapped to voltage with a sine function. This figure illustrates several different ideas. The time curve up to "a" is a linearly increasing phase that corresponds to a sinewave. At point "a" the phase stops changing, resulting in DC. For example, if the phase stops at 405 degrees, the DC will be 0.707. Since the phase does not change between "a" and "b," we get

We Didn't Believe it Either.

Our introduction to the Pressure Zone Microphone® broke our previous record for skepticism. But the hardware converted us. Like Orville Wright's gas powered kite, it outperformed its appearance. The rest, as they say, is history. In the 3 years since we began production, sales

have mushroomed and the best recording studios use PZM®. So do a whole lot of other people on a whole lot of stages, church podiums, and conference room tables.

Success has changed us. One of these days we'll probably start telling you we knew it would work all along.

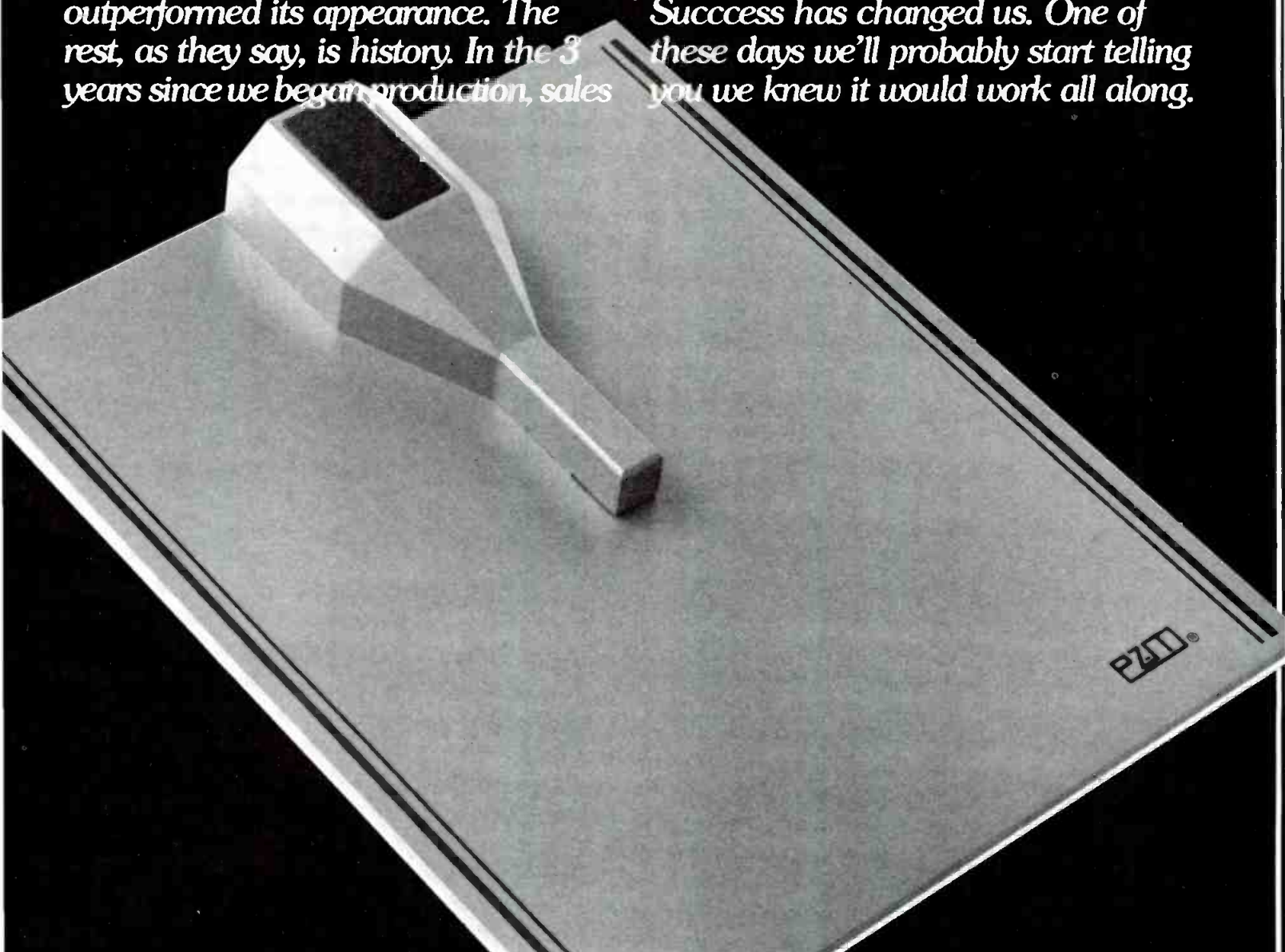

CROWN

1718 W. Mainwaka Road, Elkhart, IN 46517
(219)294-5571

Call or write for details

Circle 25 on Reader Service Card

www.americanradiohistory.com

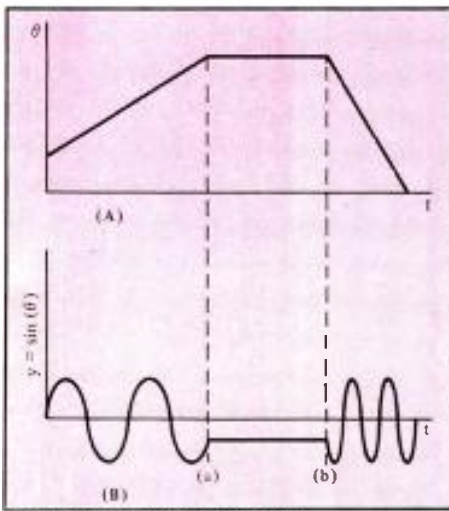

Figure 2. A specific phase vs. time signal (top) and the resulting voltage with a sine function mapping.

constant DC. Once we get to "b," the phase now decreases with a linear slope. This again gives us a sinewave at a new frequency. A finer examination shows us that the time waveform is a function of the sign of the rate of phase change. If the signal at "b" had been a linearly increasing phase instead of a linear decreasing phase, we would have gotten a different result. At "b," the sinewave is running backward—retracing the signal leading up to "a," but at a different rate. By keeping track of absolute phase, we can actually tell the difference between positive and negative phase change.

you write it

Many readers do not realize that they can also be writers for **db**. We are always seeking meaningful articles of any length. The subject matter can cover almost anything of interest and value to audio professionals.

You don't have to be an experienced writer to be published. But you do need the ability to express your idea fully, with adequate detail and information. Our editors will polish the story for you. We suggest you first submit an outline so that we can work with you in the development of the article.

You also don't have to be an artist, we'll re-do all drawings. This means we do need sufficient detail in your rough drawing or schematic so that our artists will understand what you want.

It can be prestigious to be published and it can be profitable too. All articles accepted for publication are purchased. You won't retire on our scale, but it can make a nice extra sum for that special occasion.

This information will be needed when we discuss the phase locked loop since this system element uses the phase variable for feedback. We have considered the y variable to be signal voltage that can be measured directly with electronic equipment. Phase is a "parameter" of the signal. This introduces the concept of parametric processing. Any system element that extracts a parameter may be thought of as parametric. When a sound engineer adjusts the level of a music signal, he is adjusting a parameter of the signal. If he was adjusting the pitch by changing the speed of a tape recorder, he would be adjusting another parameter. With a sinewave function, there are two parameters that are relevant: phase and amplitude. Specialized systems have been designed which operate on a parameter of the signal and not the signal itself. A compressor is such an example.

With a phase locked loop, the system extracts phase and ignores all other parameters of the signal.

PHASE DEMODULATION

We begin the discussion of phase locked loops with the introduction of a specialized module called a *phase detector*. This element accepts a signal and outputs a voltage corresponding to the phase of the input; it is converting

the technology for the phase subtractor-demodulator, it will have either a large or small dynamic range at the output. This means that the maximum phase difference that can be represented must be limited to some upper value. The restriction is similar to that of an amplifier that also has a maximum value above which the output cannot go. FIGURE 3 shows the model of a phase subtractor-demodulator.

FIGURE 3B represents the inputs as two signals, y_1 and y_2 , whereas FIGURE 3A represents the parameter of the two signals' phases as inputs. Notationally, we are saying that the two real voltages, y_1 and y_2 , enter a complex module. This module ignores all properties of the two signals except their phase; hence, the model can just show the phase parameters.

The demodulator takes two sinewaves at the same frequency and produces a DC output proportional to the difference in the phases of the inputs. If we had the following case:

$$y_1 = \sin(\omega t + 10^\circ) \text{ and}$$

$$y_2 = \sin(\omega t + 30^\circ),$$

then we would have

$$v_o = -20^\circ \text{ as DC.}$$

In contrast to the above, if we had two different input frequencies with

$$y_1 = \sin(\omega_1 t) \text{ and}$$

$$y_2 = \sin(\omega_2 t),$$

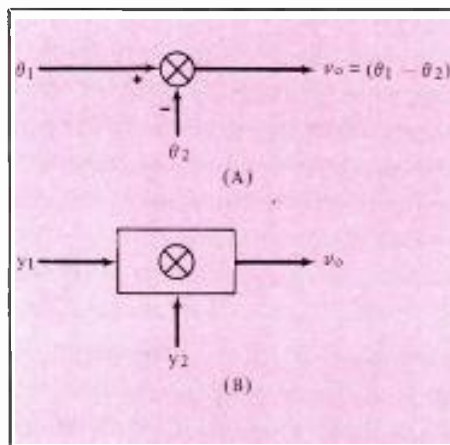

Figure 3. Phase subtractor demodulator (A) and actual inputs to demodulator (B).

(like a microphone) from one domain to another. In an idealized sense, if the input signal was that shown at the bottom of FIGURE 2, the output would be that shown at the top of FIGURE 2. The phase demodulator described is a conceptual idea, one that could not be built. Notice that if the input were a sinewave, the output would be a ramp that would go on forever. It would reach infinity. Clearly, this is not possible. But the inability to build a pure phase demodulator does not detract from our conceptualization.

An element that *can* be built is a phase demodulator with an input subtraction. This element accepts two inputs, and the output is the difference in phase between them. Depending on

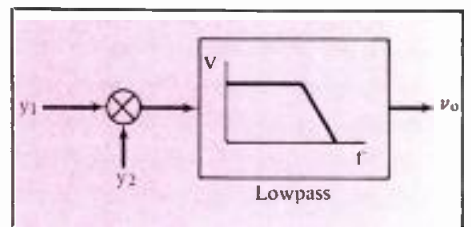

Figure 4. Example of demodulator with sinewave inputs.

then we would have

$$v_o = (\omega_1 - \omega_2)t, \text{ which is a ramp.}$$

This ramp would have a limited dynamic range, so a typical demodulator would follow the last equation for only a limited time. Let us ignore this limitation for the time being. Later we will see that it is not relevant.

EXAMPLE OF A DEMODULATOR

It is now time for an example of a demodulator. There are many different ways of building them and each type has different properties. To illustrate a simple one, we assume that the two input signals, y_1 and y_2 , have a normalized amplitude of 1 (other demodulators do not require this limitation). Our demodulator now consists of a multiplier and a low-pass filter, as shown in FIGURE 4. To illustrate this we need the simple trigonometric function which gives the result of multiplying two sinewaves. We will do the mathematics under the assumption

When you'd give
an arm and a leg
for an extra foot...

A-T
gives you
a hand!

The new AT835.

Now there's a new way to reach out and hear. The Audio-Technica AT835 Condenser Line + Gradient Microphone. It's barely longer than a legal pad, but it zeroes in on the sound you want to hear, while blocking out noise from the sides and rear.

Baby Brother

The new AT835 is 4 inches shorter than our famed AT815a and its remote-powered brother, the AT815R. Yet its performance in the field is remarkably close. The major difference is a slightly wider (60°) acceptance angle at higher frequencies. Credit a sophisticated "Fixed-Charge" element for the truly impressive sound and excellent directional control. The AT835 short "shotgun" fits in whether you are recording "actualities" for the evening news, picking up dialogue for film or A/V, or eavesdropping from the sidelines.

With Guts

Our FET impedance converter is super quiet, and runs for months on a single "AA" flashlight cell. The balanced, phased output matches any remote or studio input from 150 to 1000 Ohms without problems. And the AT835, like all A-T condensers, is built to take real punishment. Even so, it weighs just 7½ ounces for easy fishpoling or extended hand-held use.

If your goal is better control of your sound at moderate cost, your Audio-Technica sound specialist has a brand new answer. The AT835.

audio-technica®

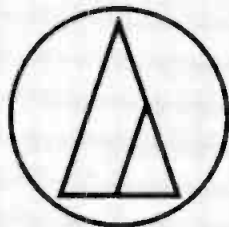

AUDIO-TECHNICA U.S., INC., 1221 Commerce Dr., Stow, OH 44224 • 216/686-2600

Circle 26 on Reader Service Card

www.americanradiohistory.com

that the two inputs are approximately the same frequency:

$$y_1 = \sin(\omega t + \theta_1) \text{ and}$$

$$y_2 = \sin(\omega t + \theta_2).$$

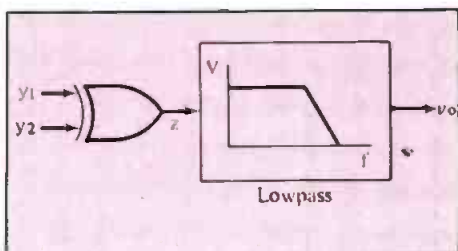

Figure 5. A demodulator similar to that shown in Figure 4 with digital square wave inputs.

To make these two signals be at different frequencies, we only need to make one of the θ s be a ramp. This allows us to use a common ω variable, yet still have the freedom to represent different frequencies. For example, if $\theta = 0$ and $\theta_2 = 2\pi t$, then y_2 will be 1 Hz higher in frequency than y_1 . The result of multiplying the two sinewaves gives us:

$$y_1 \times y_2 = 0.5 \sin(\theta_1 - \theta_2 + 90^\circ)$$

$$- 0.5 \cos(2\omega t + \theta_1 + \theta_2).$$

We assume that the lowpass filter will remove the second term. Furthermore, the 90 degree term becomes an offset

that we also ignore until later. For small differences in $\theta_1 - \theta_2$, the sine function is linear. Therefore we are left with the approximation:

$$y_1 \times y_2 = 0.5 \sin(\theta_1 - \theta_2) = 0.5(\theta_1 - \theta_2).$$

We include the 90 degree offset in θ_2 . We can restate this in simple terms. When the two signals have approximately the same frequency and the phase difference is approximately 90 degrees, the multiplier-lowpass filter combination produces an output which is proportional to the phase difference. For larger phase differences there is a nonlinearity, like harmonic distortion of an amplifier, which effects the demodulation.

Another kind of phase demodulator is shown in FIGURE 5. Here we assume square wave inputs instead of sinewave inputs. When we think of square waves, we can think in terms of a digital representation. Notice that a square wave has the same basic phase as a sinewave in that for any given phase we can determine the output. By applying both signals to a simple XOR (exclusive OR) gate we have created the equivalent of a digital 1 bit multiplication. When both inputs are high or low, the output is low; when only one input is high and one input low, the output is high. FIGURE 6 shows two examples of inputs and outputs for the

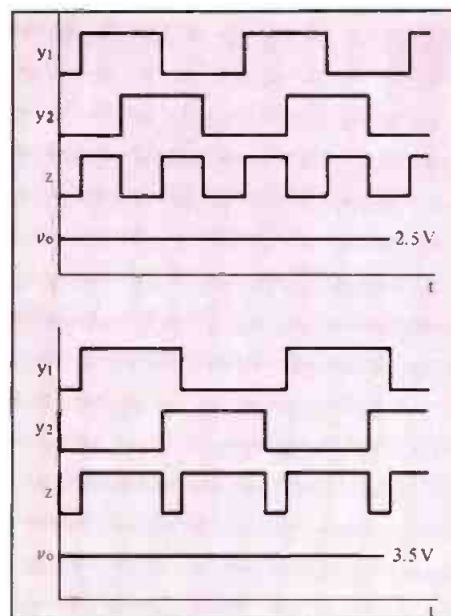

Figure 6. Two examples of inputs and outputs for the digital phase demodulator.

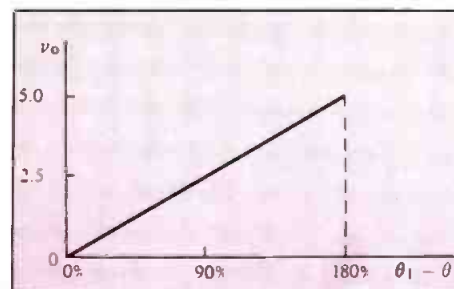

Figure 7. Output resulting from circuit in Figure 5.

digital phase demodulator. In the upper example, the two signals differ by exactly 90 degrees. The XOR result is a square wave and the DC output after lowpass filtering is halfway between +5 and 0 volts. In the lower example, the phase difference is approximately 135 degrees, rather than 90 degrees. Now the result shows a higher DC value, e.g., 3.5 volts. With a little playing, you can see that the percentage of overlap determines the output voltage. This percentage is a function of the phase difference.

Unlike the linear multiplier, there is no approximation in this case. We have a perfect subtraction over the range of 0 to 180 degrees. If we think of 2.5 volts and 90 degrees as the nominal center, we have an ideal model. Outside of the 0 to 180 degree range, the demodulator does not work.

Unfortunately, we don't have the space to continue the full phase-locked loop so please, dear reader, save this month's article until next month, when we will continue the saga of the phase locked loop. In the meantime, try thinking about everyday signals in terms of parameters and not in terms of the signals themselves. Believe it or not, this method is so powerful that it can predict the distortion in a sine-wave oscillator, control power plants, and give answers to very difficult problems. ■



SONEX kills VTR noise.

SONEX not only improves audio quality, inexpensively, but also quiets annoying background noise when you need to concentrate: noise from Quad VTR head blowers and head wheels; from mechanical tape transports; even from computer disk drives and fans. SONEX is the art of shaping sound... and the workhorse of killing noise.

Get the facts today.

SONEX is manufactured by Illbruck/usa and distributed exclusively to the pro sound and A/V industries by Alpha Audio.

Alpha Audio

2049 West Broad Street
Richmond, Virginia 23220 (804) 358-3852
Acoustic Products for the Audio Industry.

Circle 27 on Reader Service Card

PEAK
WATTS/8Ω

● CLIP

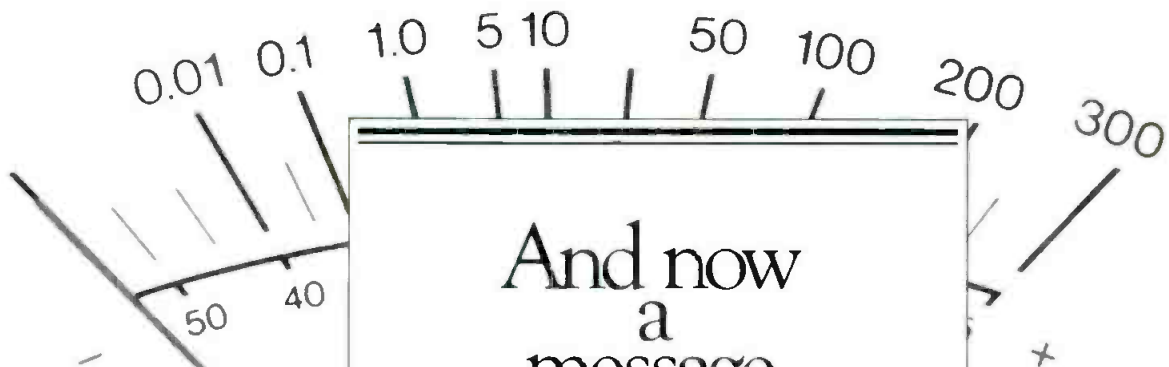

And now
a
message
on
Yamaha's new
PC2002M
power amp.

CHANNEL A

CHANNEL B



-dB



PC2002M

SPECIFICATIONS

		PC2002/PC2002M	
POWER OUTPUT LEVEL	Continuous average sine wave power with less than 0.05% THD. 20 Hz to 20 kHz	Stereo, 8 ohms 240W + 240W Stereo, 4 ohms 350W + 350W Mono, 16 ohms 480W Mono, 8 ohms 700W	
FREQUENCY RESPONSE	10 Hz to 50 kHz, 8 ohms, 1W	+0dB -0.5dB	
TOTAL HARMONIC DISTORTION	Stereo 8 ohms 120W Mono 16 ohms 240W Mono 8 ohms 350W	1 kHz 20 to 20 kHz 20 to 20 kHz	Less than 0.003% Less than 0.007% Less than 0.01%
INTERMODULATION DISTORTION	70 Hz and 7 kHz mixed 4:1	Stereo 8 ohms, 120W Mono 16 ohms, 240W	Less than 0.01% Less than 0.01%
INPUT SENSITIVITY	Input level which produces 100W output into 8 ohms.		0 dB (0.775 V rms)
INPUT IMPEDANCE	Balanced and unbalanced inputs, maximum attenuator setting.		25 k ohms
8 OHM DAMPING FACTOR		1 kHz 20 to 20 kHz	Greater than 350 Greater than 200
S/N RATIO	Input shorted at 12.47 kHz Input shorted at IHFA		110dB 115dB
SLEW RATE		Stereo 8 ohms Mono 16 ohms	60V/μsec 90 V/μsec
CHANNEL SEPARATION	8 ohms 120W 8 ohms 120W	1 kHz 20 to 20 kHz	95dB 80dB
DIMENSIONS (W×D×H)		18-7/8×16-1/4×7-1/4" (480×413×183 mm)	
WEIGHT		PC2002 44 pounds (20 kg) PC2002M 45 pounds (20.5 kg)	

All specifications subject to change without notice.

The performance of the PC2002M speaks for itself. So does its sound, with exceptional low end response. And you can count on its superior performance over the long haul. We use massive side-mounted heat sinks, extensive convective cooling paths and heavy gauge steel, box-type chassis reinforced by heavy gauge aluminum braces and thick aluminum front panels. Yamaha's reliability is legendary, and with the PC2002M and PC2002 (same amp without meters), the legend lives on. For more complete information write: Yamaha International Corporation, P.O. Box 6600, Buena Park, CA 90622. In Canada, Yamaha Canada Music Ltd., 135 Milner Ave., Scarborough, Ont. M1S 3R1.



Circle 28 on Reader Service Card

A Question of Standards

IT'S HARDLY NEWS that several digital tape deck manufacturers have joined together to create a kind of de facto standard. Specifically, Sony/MCI, Studer, and now Matsushita (Technics/Panasonic) have agreed to a single type of digital machine built around a stationary head principle. DASH, standing for Digital Audio Stationary Head, is what they have announced. Unquestionably, this goes a long way toward making sense out of the present total non-compatibility problem. But is it the solution that the promotion at the recent AES Convention seemed to insist it is?

We don't think so. DASH does offer, for the first time, inter-manufacturer compatibility. And there is no question but that the three manufacturers are industry heavyweights. But the fact remains that *none* of the DASH-standard machines are commercially available and that several non-DASH machines, using stationary heads (we're not counting the digital recorders built around helical-scan video recorders), *are* available.

A digital recorder must presently be considered as a closed-loop system. That is, you master on it, and you sweeten on it. If you are ending up on a CD, your master will either conform or have to be made to conform. In fact, the time is approaching that black-box converters will be made available that will convert any digital tape to almost any playback standard. This is already happening in the computer field—how long will it take to get to audio? We won't guess what this means for the DASH concept. If, as we said earlier, it is a strong step in the right direction, is now or sometime in the coming months the time to create industry standards? Each month brings news of newer, more versatile digital storage media. Will we someday be storing our programs in non-moving solid-state domains?

What is clear, we think, is that digital storage *is* here to stay. You should be storing in that domain now. Anything you have in digital now will likely be convertible to any newer (read that as better) future system.

What do all of you think? We want to hear from you.

SPARS has recently announced that it is talking merger with its English counterpart, APRS (Association of Professional Recording Studios). We think this is an excellent idea for a number of reasons. APRS has several decades of experience in general organization and its excellent management of the annual APRS Show and Convention held each June in England. SPARS, in its five years of existence, has managed to grow fast and well. Today, it is a significant factor in the recording industry. Tomorrow, it will be even stronger.

The recording studio business is certainly international in both its hardware and software. It makes sense for there to be a truly international association. SPARS and APRS have a lot to give to each other. We certainly wish them success in their merger talks.

Finally, we at db are pleased to announce that the SPARS Board of Directors has confirmed that we will be carrying, in the appropriate issues during 1984, the quarterly SPARS DATA TRACK (the first of the DATA TRACKS ran in our September issue). L.Z.

The Virginia Center for the Performing Arts: The Acoustical Design

The following articles detail the conversion of Richmond's 1928 Loew's Grace Street Theatre into a modern, multi-functional auditorium.

IMAGINE THE THRILL of hearing the magnificent voice of Leontyne Price successfully test the acoustical behavior of a new concert hall! Such was the occasion on May 5, 1983, when Miss Price performed with the Richmond Symphony Orchestra as part of a three-evening gala opening designed to display every facet of the Loew's \$8,000,000 renovation. The gala opening celebrated the culmination of five years of work by the Richmond Symphony, its architects, engineers, acoustical and theatrical consultants, technical and administrative staff, contractors, and supportive Richmond citizens to convert the Loew's movie theatre into a suitable performing venue for symphony and chamber orchestras. (Richmond boasts one of each, and hosts visiting orchestras), opera (Virginia Opera, based in Norfolk, plans to perform in the new auditorium), touring and locally produced "Broadway" shows, ballet, drama, soloists, and virtually any event that can be contained on the compact (30 x 75-ft) stage that will attract an audience to fill the auditorium's 2,030 seats.

ACOUSTICAL REQUIREMENTS

The Loew's Theatre was actually only one of several downtown assembly places surveyed as candidates for renovation. Initially, the Richmond Symphony was looking for a suitable rehearsal hall away from its home at the time, the venerable Richmond Mosque—a flat-floor auditorium and exhibition facility with less than ideal acoustics (too reverberant when empty, during rehearsals). After surveying the Loew's, the idea of adapting it into a permanent performing home for the orchestra was born and subsequently adopted.

The Loew's possessed the audience seating capacity and stage floor area required by the Richmond Symphony, and theatre's lobby and backstage areas served adequately as foundations for the renovation scheme. Acoustically significant, the old theatre's interior surfaces were intricately ornate, uniformly constructed of plaster, wood and concrete, and favorably shaped to project and distribute sound throughout the seating area. This Loew's was one of John Eberson's "atmospheric" theatres, conceived as the "roofless" courtyard of a mythical Moorish Palace (see FIGURE 1), and equipped with the latest (for 1928) in fantasy visual effects such as twinkling electric stars and projected moving cloud patterns in the ceiling to simulate the passage

from twilight to evening as the house lights were gradually extinguished at curtain time. The renovation plan called for retaining and refurbishing all of the "atmospheric" effects and, therefore, imposed strict architectural constraints which limited acoustically related interior modifications to the stage area. Nevertheless, the converted theatre would require acoustics suitable to the various planned uses. Accommodations for acoustical adjustability were provided by designing an unusual mechanical orchestra stage enclosure and a comprehensive state-of-the-art sound reinforcement system.

AMBIENT NOISE

Modern multi-purpose auditoria should have virtually inaudible levels of ambient noise. Air handling and conditioning equipment must be silent, and exterior noises (vehicular and aircraft traffic, pedestrians, etc.) must not penetrate audibly. Ambient noise levels at the NC-25 criteria are barely audible (i.e., they do not seriously interfere with speech intelligibility or mask musical overtones). Therefore, the renovation design efforts were directed toward meeting or bettering the NC-25 criteria. Attempting to meet the more desirable and more expensive-to-obtain NC-15 to NC-20 criteria was deemed unfeasible because certain portions of the existing air handling ductwork were to be reused in an effort to keep renovation costs within a specific budget. The renovation provided new air conditioning equipment including cooling towers, fans, interconnecting ductwork, and silencers. Fans and cooling towers were remotely located, although the space limitations did not allow optimum physical separation of these noisy devices. Hence, double-construction techniques and duct silencers were employed where necessary to reduce, as far as possible, equipment noise. Unusual noise sources encountered on this project were a result of the compressors and pumps used for powering the hydraulic system that operates the stage rigging, the orchestra enclosure, the pit lift, the loudspeaker cluster lift, and the operable ceiling doors for the cluster and ceiling light bridge. The pumps and compressors were remotely located and in-line resonant silencers, tuned to the system resonant frequency, were installed by the hydraulic system contractor.

SOUND & COMMUNICATIONS SYSTEMS

The theatre's sound system provides a degree of acoustical adjustability by, at minimum, improving the direct-to-reverberant ratio of sound originating at the stage and pit. The sound system was designed after establishing with the

Larry King is a partner in Klepper Marshall King Associates, Ltd., the acoustical consultants for the Virginia Center for the Performing Arts project.



Figure 1. The seating area of the Virginia Center for the Performing Arts.

owner specific functional and performance requirements, which are listed below.

FUNCTIONAL REQUIREMENTS

A. Main Sound Reinforcement System:

1. Monophonic reinforcement of live speech and music from the stage or pit area, with intelligible, natural-sounding, directionally realistic coverage of entire seating area.
2. Archival recording, separate or simultaneous with reinforcement.
3. Controls for foldback/sound effects system combined with controls of main system.

B. Foldback/Sound Effects System:

1. Foldback (on-stage monitoring) for on-stage coverage of performers who need to better hear themselves or hear specific instruments or groups of instruments during accompaniment.
2. Playback of sound effects tapes, recorded music or speech tapes, or motion picture sound tracks, with amplified sound localized anywhere on stage, in pit, or behind sound-transparent motion picture screen.
3. Dubbing from stereo disk to stereo tape; dubbing from tape to tape.

C. Program Monitoring and Paging System:

1. Pickup of live activities inside the theatre proper and sound distribution to front-of-house areas: main lobby, mezzanine lobby, and box office.
2. Similar pick-up and distribution to backstage areas: two mezzanine dressing rooms, four basement dressing rooms, sound, light, and projection booths, and dimmer-bank room; override by paging from Stage Manager's microphone.

D. Infra-Red Hard-of-Hearing System:

1. Uses signal from main reinforcement system to enable hard-of-hearing listeners to hear anywhere in the

seating area by the use of portable, easy-to-wear, headsets or earphone couplers—with no wiring to headsets or earphone couplers and no interference by RF signals.

E. Production Communications System:

1. Simultaneous listen and talk intercommunications for Stage Manager, Sound, Light, and Projection booths, center of ceiling lighting catwalk, grid, loading and operating galleries, and dimmer bank in basement.

REVERBERATION TIME

The initial acoustical survey of the Loew's Theatre indicated a rather low reverberation time of 1.0 sec. at mid-frequencies. Reverberation time in the range of 1.6 to 1.8 seconds is considered more appropriate to good concert halls, so initial plans called for incorporating an electro-acoustical reverberation system that would employ digital delay and reverberation devices, and distributed loudspeakers concealed within the theatre's architecturally ornate perimeter (see FIGURE 2). The reverberation system was specified as an add-alternate but, due to budgetary constraints, was not purchased. However, conduit was provided to the loudspeaker locations to facilitate a future installation. Not surprisingly, the measured reverberation time increased (even without the reverberation system) as a result of the cleaning and painting of the theatre's interior sound-reflecting surfaces and the installation of the stage enclosure with its sound-reflecting and diffusing surfaces which are tightly-coupled acoustically to the auditorium. The measured reverberation times are shown in FIGURE 3.

EARLY-TO-REVERBERANT RATIOS & LATERAL REFLECTIONS

Analysis of the architectural drawings indicated that the Loew's, with a properly designed stage enclosure, would



Figure 2. A view of the auditorium with the house curtain down. The central loudspeaker is retracted into the ceiling (note arrow).

provide both strong lateral and overhead early reflections to many seats—but in varying proportions depending upon seat location. The Grand Tier and lower Balcony seats experience strong overhead reflections from the smooth plaster ceiling,

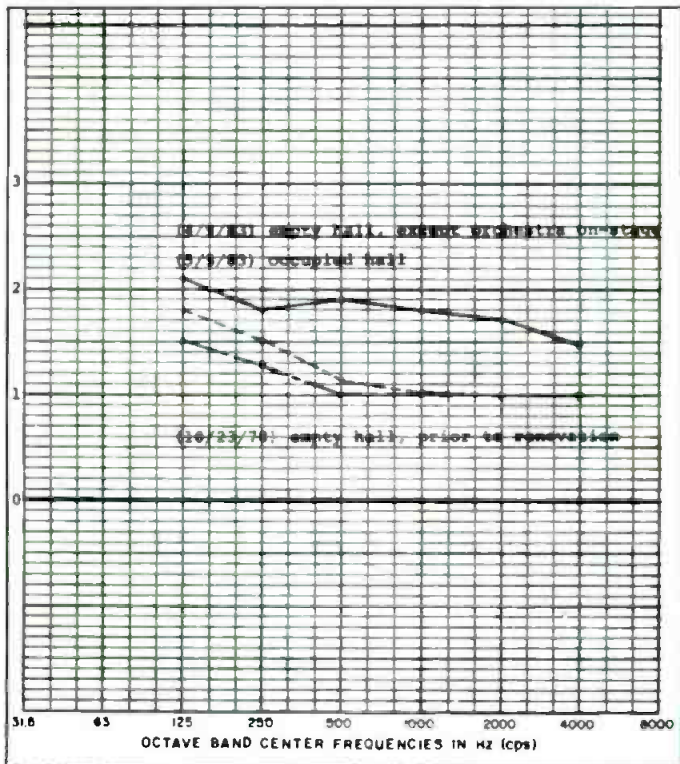

Figure 3. Measured reverberation time characteristics for the Center.

but these seats also receive long-delayed reflections of significant strength from the upper side and rear walls. Our hearing facilities integrate these early and longer-delayed reflections along with the direct sounds and interpret them subjectively (so science tells us) as musical-acoustical qualities of weight or strength, yet with both clarity and warmth. These are highly desirable acoustical characteristics for symphonic music. The main floor has a relatively deep underbalcony with a low (13-foot average) soffit, which is typical for theatre designs of that period. In effect, the underbalcony speaker is an "acoustic pocket" that "looks" at the stage through a relatively small-area slot. This underbalcony "pocket" has a lower-than-optimum volume-to-seat area ratio, hence lower audible reverberation. Yet strong lateral reflections occur here from the side and rear walls, and overhead reflections are provided by the plaster soffit. Therefore, clarity and warmth are preserved, but strength is diminished in comparison with the seats in the front balcony and front main floor.

STAGE ENCLOSURE

The purpose of the orchestra stage enclosure (see FIGURE 4) is to project the full orchestral sound, balanced properly throughout the musical frequency spectrum, into the seating area and to provide properly blended on-stage communication among the various instrumental sections so that the musicians can hear themselves—a necessity in achieving precise ensemble playing. The stage enclosure at the Virginia Center incorporates both adjustable inner and outer wall sections, as well as typical adjustable ceiling sections. The ten adjustable 17-foot high inner wall units and four 5-foot wide ceiling sections are made of steel-braced 3/4-inch painted plywood. The inner units are stored high in the stagehouse, out of the way of other stage scenery; when

Looking for a Distortion Measurement System?

The Amber model 3501 is quite simply the highest performance, most featured, yet lowest cost audio distortion and noise measurement system available.

It offers state-of-the-art performance with THD measurements to below 0.0008% (-102dB), maximum output level to +30dBm and noise measurements to below -120dBm.

It has features like automatic operation, optional balanced input/output and powerful IMD measurement capability. It includes comprehensive noise weighting with four user changeable filters. Unique features like manual spectrum analysis and selectable bandwidth signal-to-noise measurements.

The 3501 is fast, easy to use and its light weight and small size make it very portable. It can even be battery powered.

And the best part is that it is 20% to 50% below what you would pay elsewhere for less performance. The Amber 3501 starts at \$2100. Send for full technical details.



amber

Amber Electro Design Inc.
4810 Jean Talon West
Montreal Canada H4P 2N5
Telephone (514) 735 4105

Circle 29 on Reader Service Card

lowered on stage, they are moved easily on built-in dollies to form various perimeter configurations according to the size of the performing ensemble. The enclosure's outer wall section is composed of a fixed up-stage (rear stagehouse) wall of 2 layers of 5/8-inch drywall and two vertically-tracked side walls of 3/4-inch steel-braced painted plywood. The enclosure's outer wall air diffuser grilles are connected to the stage air handling system via detachable, flexible ducts.

The enclosure ceiling and outer walls provide a large sound-reflecting volume coupled to the main theatre volume for added on-stage warmth, and the adjustable inner wall units provide reflections to aid on-stage communications and projection of sound into the theatre.



Figure 4. The mechanized stage enclosure in the symphony orchestra configuration.

PERFORMANCE REQUIREMENTS

A. Frequency Response:

1. Reinforcement System: acoustical response within ± 3 dB of flat from 80 to 2,000 Hz, followed by slope of 2 dB/octave from 2,000 to 10,000 Hz, with no peaks outside this range.
2. Foldback/Sound Effects System: acoustical response within ± 3 dB of flat from 100 to 2,000 Hz, followed by slope of 3 dB/octave from 2,000 to 8,000 Hz, with no peaks outside this range.
3. Program Monitoring and Paging, and Production Communications Systems: tested for speech intelligibility and naturalness subjectively with no formal frequency response limits to be met.

B. Sound Output Capability:

1. System capable of producing peak levels of 105 dB in the fixed seating area and 100 dB on the stage without objectionable distortion, buzz, or rattles. Similarly, 85 dB in dressing rooms and other enclosed spaces covered by program monitoring/paging system.

C. Noise:

1. Hum and noise of systems must be inaudible at normal gain settings.

D. Coverage:

1. Uses main loudspeaker cluster and all supplementary loudspeakers for high-frequency coverage of areas not completely covered by main loudspeaker cluster, in fixed seating only within ± 3 dB, using an octave band of filtered pink noise centered at 4,000 Hz. Foldback/sound effects coverage depends on number of loudspeakers employed and their location and orientation, as does program monitoring and paging.

DESCRIPTIONS OF SYSTEMS

Except for certain items (such as the Sennheiser Infrared earphone system), the specifications stated two or more

acceptable alternative manufacturers' equipment models for each major component in the sound system. Equipment performance specifications were stated as well as overall system performance specifications to give the bidders performance guidelines to meet if they desired to substitute a manufacturer's product which was not one of the stated acceptable alternates. A summary of the installed system components is described below:

Microphones and Associated Equipment

AKG C-452EB	10
Electro-Voice RE-16	6
Beyer M-101C	3
AKG D-109E	3
Electro-Voice 602FL	3
AKG KM-201A Floor Stands	10
Atlas MS-12C	5
Electro-Voice 411 Floor Mounts	10

Recording and Playback Equipment

Otari 5050B	2
Technics SL-1700MKII/Shure V15-IV	1
UREI 1122	1

Control and Signal Processing Equipment

AudioArts	1
Shure M67	3
UREI LA-4	1
UREI 539A	4
Industrial Research Products DF-4015	2
Biamp M2/V	1

Power Amplifiers and Associated Equipment

BGW 250E	5
JBL 6022	3
JBL 6012	2
Soundolier 100-77	3

Loudspeakers and Associated Equipment

Altec MR42/288-16G	2
Altec MR64/288-16G	4
Altec 817A	1
Altec 515B	2
Altec 1221	4
Altec 9842B	2
Altec 409-8D/15065	59
Soundolier Q408/F64-8	59
Altec 405-8H/15074	31
Soundolier E410/T710-4	31
Soundolier AT-10	6

Production Cue Equipment

Clear-Com MS-200	1
Clear-Com RS-100A	12
Clear-Com MR-102	6
Clear-Com CC-75B	9
Clear-Com CC-240B	4

Infrared Hard-of-Hearing Equipment

Sennheiser (SA) 210 transmitter	1
Sennheiser (SA) 111 emitters	6
Sennheiser HDI-406S headsets	30

CREDITS

Architect: Marcellus Wright Cox & Smith, Richmond, Virginia

Theatre Consultant: Frink and Beuchat, Philadelphia

Acoustical Consultant: Klepper Marshall King Associates, Ltd., White Plains, New York

Mechanical/Electrical Engineers: Norman Harris Giles, Richmond

General Contractor: Conquest Moncure Dunn, Richmond

Sound System Contractors: Jarvis Sound Corp. in collaboration with Alpha Audio, both of Richmond

Hydraulic Contractors: Gagnon LaForest, Montreal, PQ, Canada

Photographs: Amir Pishdad, Whitney Cox

The Virginia Center for the Performing Arts: The Installer's Viewpoint

IN THE WORLD OF P.A., price is all too often the primary concern. The consideration, "Will it work well?" may at best, be an optional bonus.

It is therefore refreshing to receive a specification such as the one provided by Klepper Marshall King Associates, Ltd. for the renovation of the Loew's Theater to the Virginia Center for the Performing Arts. An equipment list that starts with 10 Neumann KM84 or AKG C451 microphones and ends with a cluster of JBL or Altec bi-radial horns holds promise. It almost has to sound good!

While there is very little we can presume to add to the system description provided by Larry King, Alpha Audio was allowed the privilege of suggesting changes in the execution of the control room design. These, no doubt, will be considered minor or obvious to many db readers. We have found that what may be standard practice in one part of our industry, professional sound, often takes some time to filter into other areas.

This is due to the way systems proceed. In sound reinforcement, design has traditionally been more formal and the installation has been completed before any interface with the user. In recording studios, the process of design, implementation and use occur simultaneously. Also, the client is more often the persons who actually use the gear.

Alpha Audio was chosen by Jarvis Sound Corp., sound contractor for the project, to implement the signal processing and recording system to the point of amplifica-

tion, at which point Jarvis completed the work. This setup was due not only to Alpha's access to equipment lines more closely associated with recording, in addition to reinforcement, but also their experience as an end user of such systems.

Having operated several recording facilities and installed many more over the past twelve years, Alpha Audio's engineers are very sensitive to potential operating failures.

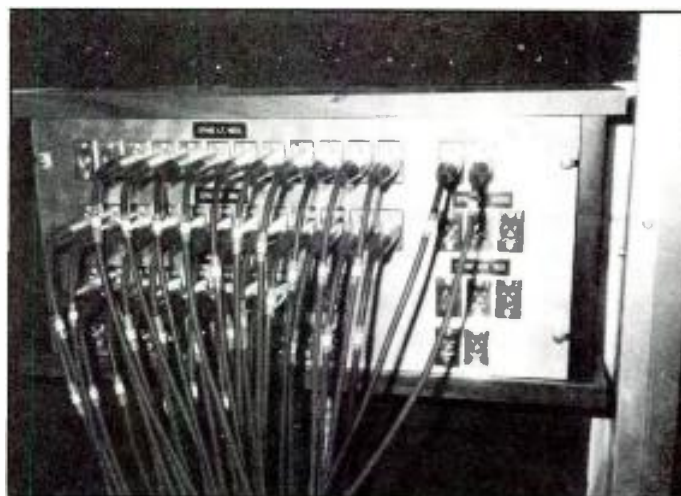

Figure 1. A close-up of the microphone patching system/console connection.

Nick Colleran is president of Alpha Recording Corporation, which operates Alpha Audio's sales and installation service in Richmond, VA.

Knowing that the installer may be called upon to act as sound mixer at a later date provides all the incentive needed to do things right.

SMOKE FILLED ROOMS AREN'T FOUND ONLY AT POLITICAL CONVENTIONS

Most routine control room failures can be attributed to dirt and contaminants. Equipment failures are minimal since newer electronic gear either dies on the launch pad or works forever. A typical contaminant is cigarette film on patch bays. With line level signals, a few twists of the patch cord are often all that is needed. With microphone patches, however, substantially less signal is present. A small amount of film on the contacts can easily block the signal.

For this reason, Alpha recommended that microphone patches be accomplished with standard three pin "XL" type audio connectors. This provides the secondary benefit of allowing microphones and other mic level devices such as direct boxes to be connected in the control room without adapter cables. At the suggestion of David Klepper, this was taken a step further. The entire microphone patching system was included in the console installation. All microphone lines from the stage terminate to a box composed of appropriately labeled, male 3-pin "XL" connectors. From there a harness of individual mic lines connect to the AudioArts mixing console, as shown in FIGURE 1. Besides reducing the problems associated with tip, ring, sleeve microphone patching, the arrangement proposed by Mr. Klepper allows relatively easy substitution of another console should an artist prefer to use his own. Another side benefit of this concept is the elimination of mic level input patch points in the same rack with line levels or higher signals. There is no opportunity to mis-patch line and mic level signals or for feedback from an inductive loop.

TO REDUCE CONTACT PROBLEMS, REDUCE THE NUMBER OF CONTACTS

To further reduce the possibility of patching errors, a low density, full sized patch bay was used (see FIGURE 2). There is no place for miniaturization in a dynamic situation such as live theater, where you must find the right hole in a hurry. There is no "take two"!

Patch bay layouts as provided in most sound system specifications we have seen have normalling contacts on both outputs and inputs. At the suggestion of Alpha Audio, this was changed to a multi-normal configuration. That is, jacks

associated with equipment outputs have no normalling contacts. The signal is taken from the feed to the output patch point and fed to the normalling contacts of the input jack for the next piece of gear in the chain. Besides the obvious cost savings of using a non-normalling jack, there are performance benefits. One more set of contacts which may become dirty or oxidized has been eliminated. Additionally, an output may feed recorders or side-chain processors without disturbing normal signal flow. Test instruments can be used as well during performances. No doubt, the double normals are a holdover from the days when outputs and inputs really were 600 ohms and matching was a reality. Today, everything is designed to work with/from/to (pick one) 600 ohms—but almost nothing is. With input



Figure 3. The Virginia Center's control room set up in the Alpha basement.

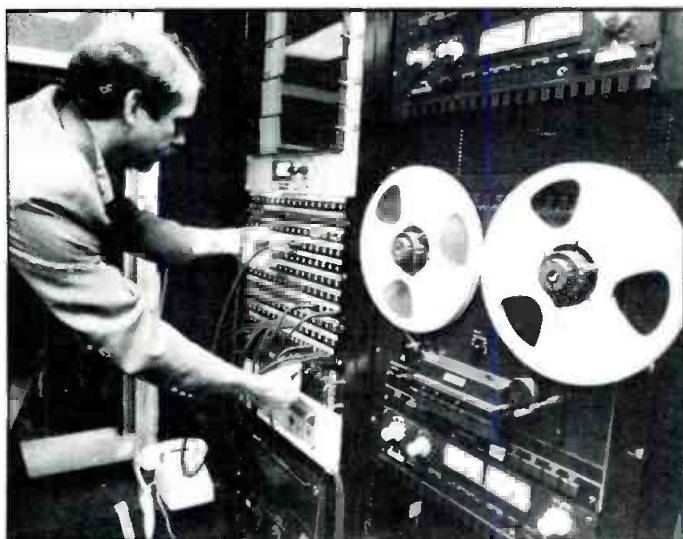

Figure 2. The patch bay at the Virginia Center is 176 points, but only 16 across the 19-in. panel. Here, Alpha Audio's Joe Horner makes a connection.

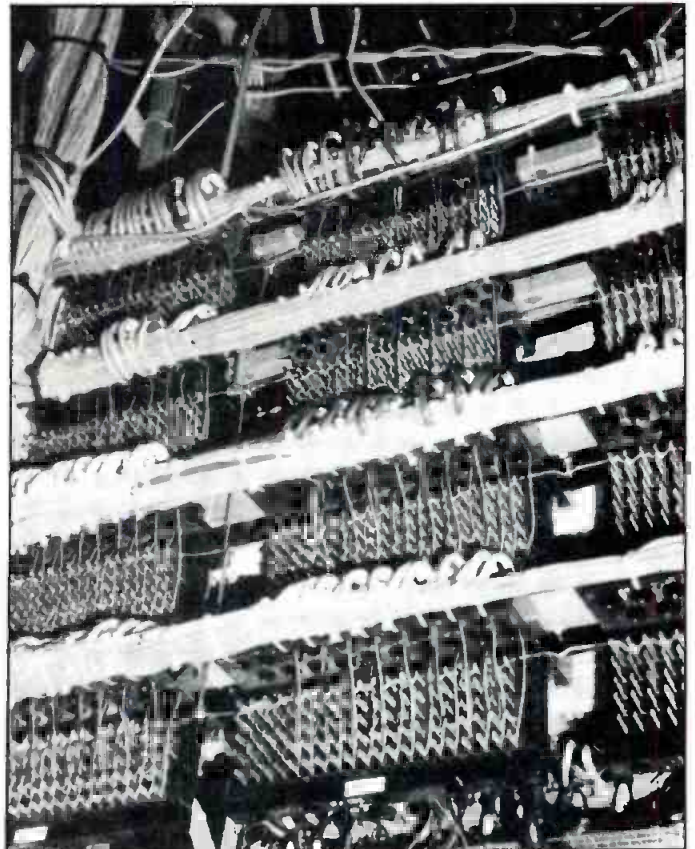

Figure 4. Christmas trees (ADC variety) handle interface of racks to the rest of the sound system.



Figure 5. Alpha Audio mixing engineer Joe Horner recording television spots for the Richmond Symphony (barely visible through the control room window). Note microphone patch panel in upper center of photo.

impedances in the 50K-and-up range and outputs at 100 ohms or lower, bridging is the norm and multi-normals the most logical way to go.

While the preceding practices may be obvious to many, their importance in system reliability cannot be over-emphasized. For the latest improvements in sound processing to be experienced, the signal must get through the chain. While everyone in the audience may not have a golden ear, it's a safe bet they all can tell you when the sound isn't there at all, or worse is intermittent.

With the exception of these minor changes to improve reliability and function, the system was installed exactly as specified. There was, of course, the obligatory last minute change of the microphone complement, adding three Shure SM58's to accommodate Helen Reddy's backup group. (No matter how good the sound, will the pictures look right without "ball mics" on the group's stands?) Set-up and delivery were a bit unusual, however.

GETTING IT DOWN UPTOWN BEFORE SETTING IT UP DOWNTOWN

The control room for the Virginia Center is located at the uppermost part of the rear of the theatre. It is a nice, isolated area to mix a recording with a good view of the symphony; it is not a place you want to climb to a dozen times a day to get the one connector you left or the wire-ties you forgot.

For this reason, the entire system was assembled and wired at Alpha Audio (see FIGURE 3). A plywood replica of the control room floor was placed in the basement. All equipment was set in position, and the racks wired to Christmas tree (ADC) blocks, as shown in FIGURE 4. Harnessing was done prior to having the entire system transferred by professional movers to its permanent home at the Virginia Center. Equipment was transferred mounted in its racks. Connecting the console and mic lines with the previously made and color-coded harnesses took relatively little time at the job site (and fewer trips up and down the stairs, thankfully!).

Installation in this manner, besides being somewhat necessary given the location, allowed a controlled environment for assembly and testing prior to delivery. The risk of loss (read theft) of gear inherent in high traffic situations during construction was eliminated.

USE OF THE SYSTEM

As we suspected, it wasn't long before our engineers were called in to mix sound, in this case for television spots promoting the symphony (FIGURE 5). In the course of doing this, we found the acoustics to be superb. The spots were recorded with a single source microphone for the most part. This is a real tribute to the acoustic design of Klepper Marshall King Associates, Ltd. ■

Recording Studio Consoles and Film Production, Part II

The following article offers a step-by-step description of the changes made to an MCI 248 B and Neve A665 in converting them for use in film mixing.

THIS IS THE second of a series dedicated to the art of film mixing, an understanding of the tools used, and ways to utilize some equipment that was never intended for film studio use! Part 2 will feature a case study of the modification of two different consoles that are currently in use in a very busy film studio. In Part 1 (September, '83) we touched briefly on the console requirements. Now we will discuss some of the auxiliary requirements in a little more depth.

Film mixing is a complex task involving a large number of steps that require many movements, and they should all be easily repeatable. What this means is that the commonly used controls should be within easy reach, and automatically identified by function. For these reasons the monitor controls are most often grouped with the machine remotes and the record controls.

The first console that we will examine is an MCI 428 B

series console. This was the first time that this author had ever been involved in anything associated with actual re-recording technology. When we were approached, our impression of what was involved consisted of the simple wiring of an M24 rack. When we got down to discussing the actual details of the work, we found we had to block out three months instead of the three days that we had scheduled for the work! The first step of the construction process was the gleaning of the information presented in the two parts of this article. The next part of the process was to determine how to make a pre-existing MCI console conform to the requirements outlined by the Dolby stereo film format while retaining the ability to do mono film work at other times. Upon examination, it was determined that the vast majority of change to be made to the board would be done in three major areas. These were: The I/O module in the panning area, the Monitor module, which is where the majority of the work

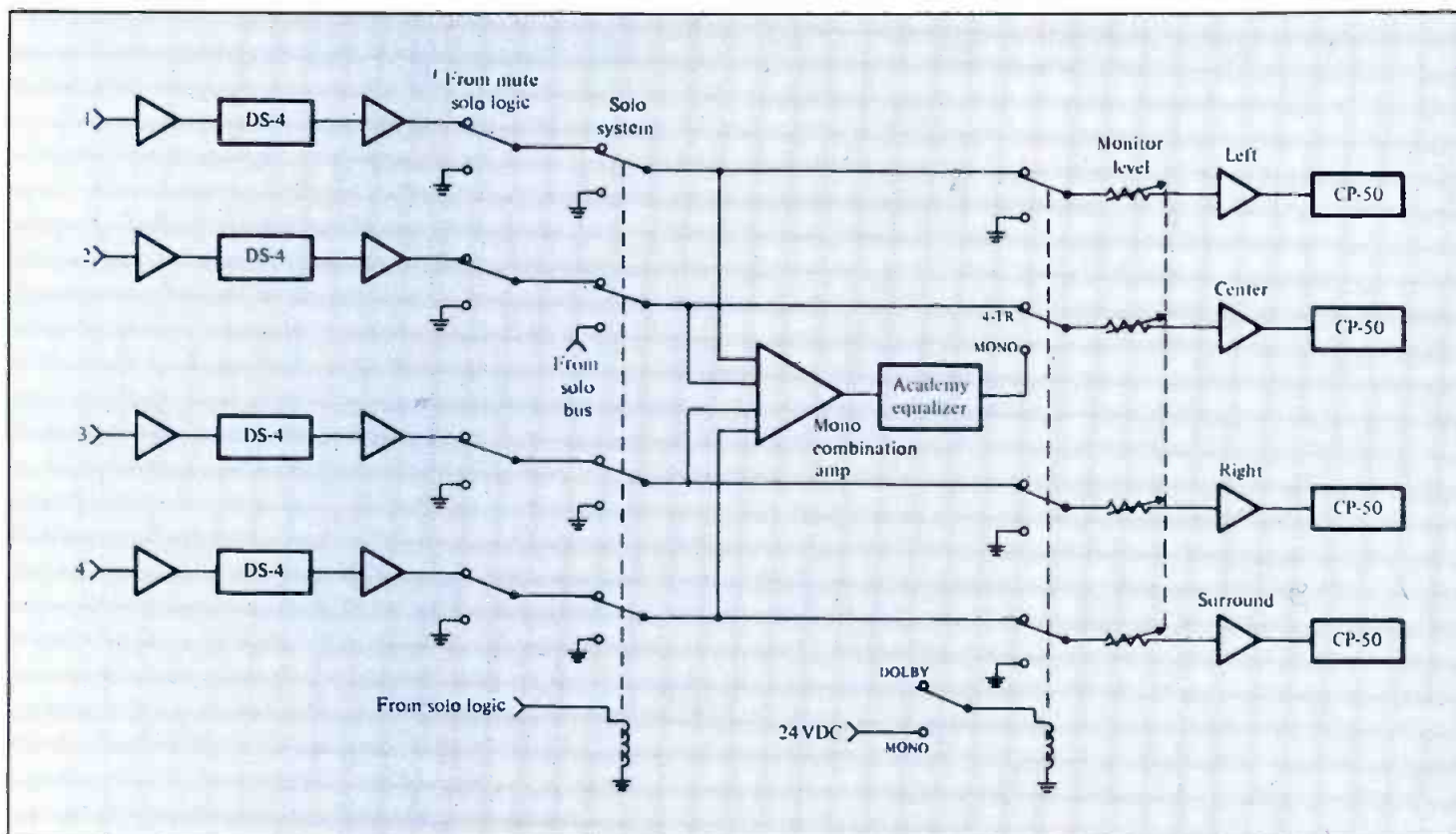

Greg Hanks, formerly service manager at Audiotechniques, Inc., formed New York Technical Support Ltd., which specializes in studio installation and service.

Ed. note. This monitor system detail drawing appeared in incomplete form in Part I of this series (Sept. '83). Our apologies to our readers and author Greg Hanks for any confusion this may have caused.

occurred, and the Patch bay, which also required extensive modification. The details of the work performed are as follows.

I/O MODULES

We determined that the console would work in one of the three modes that were part of its original design. The chosen mode is "mix." When doing Dolby stereo mixing, the monitor buses are, in fact, the output buses. This is a common situation in any in-line console. The quad buses of the console are used for this purpose, and the pan pots access this bus. The sends in this mode are post EQ and pre-pan driver. For mono work, the first four assignable buses are used, with the bus outputs patched to the DS-4 inputs in the patch bay (to be detailed later). The output assign drivers are accessible in the mix mode with no modification. The only changes required in the I/O module for the use described above are:

1) the addition of a Mic/Line switch across contact pair 'D' of the Remix relay (K2) (see FIGURE 1A). This was done because the room is also used for Live Mixing as well. Otherwise, the mic preamps could simply be removed and the line inputs hard wired to the fader inputs. We also included a line trim in between each line input and mic/line switch (see FIGURE 1B).

2) the rewiring of the pan network so as to pan from the "Left/Right" pan pair to either "Center" or "Surround" (which is switch selected) as shown in FIGURE 1C. It was also necessary to change the swamping resistors for a -3-dB center. The only real custom work required for this task was the fabrication of dress plates of the appropriate color to identify the added functions, and the inclusion of the selector switch and mode identifying LED.

MONITOR MODULE

Because of the vast difference in functional requirements between record and film recording, the monitor module was the subject of the majority of the changes required in the console. When the decision was made to add mag motion and record controls to the console, we figured it made sense to incorporate the monitor control as part of the same package and completely isolate it from the board. The fabrication effort involved building and mounting a box of the same shape and size as an MCI Autolocator. This was done so as to enable the mounting of the whole package on a Glide Mount assembly under the front bolster of the console. Within this framework, we designed and built a system that contained a motion controller with record function control, and a bus/mag selector system integrated with a monitor solo function of our own devising. The design goal was to keep the controlling electronics outside of the console, while maintaining all of the audio circuitry on the monitor module itself. All of the lines to and from the remote control were to remain isolated from the audio signal and grounds. This was done primarily because the record control and motion control circuits were referenced to a common signal that was over 200 feet away from the console. (We were concerned with minimizing the number of changes that had to be made to the mother board of the console.) We also worked with the philosophy that a chassis connection is a screen or shield connection that is brought to ground at one point only. In keeping the audio out of the remote control box, we were also able to keep RF interference to an absolute minimum (as well as minimizing the number of wires that we had to run from the monitor module itself). We decided to use the quad bus monitor and quad tape return monitor positions as our main insert points. We rewired the selector switch so as to allow selection between bus and mag, using four SPDT reed relays. Reed relays perform all of the added audio switching in the monitor circuit. These are driven by a transistor that is driven by a logic low from the monitor box. The bus/mag outputs are then taken to the input of the monitor circuit through a four-pole double-throw selector switch. The other

input of the switch is the output of the original monitor selector switch. This was done to accommodate all the other monitor selections that come with the console. The output is then buffered by four op-amps and taken to the patch bay to drive the input of the DS-4. The DS-4 outputs are then returned through the patch bay, back down to the monitor PCB, and brought back into the monitor circuit via four differential op-amps. The outputs of the four differential amps then feed the remaining monitor circuitry. Following these monitor selector buffer amplifiers are another four reed relays to be used for our monitor solo system. Again these are driven by a transistor that is driven by the remote control box with a logic low (open collector).

At this point in the original circuit, we encountered the mono switch. This function required in our current design scheme. However, the original operation was a bit different than what we now needed. Originally, the switch inter-tied all of the summing junctions with a mono combine of the quad bus. What was now required was a mono signal composed of the quad buses, feeding only channel two (the hard center) and muting the other three monitors. Also to be included in this mode of operation was an academy equalizer inserted in series with the output. The equalizer may be bypassed with a switch, but is only accessible in the mono monitor mode. A warning indicator is incorporated to indicate the use of this mode. These functions were accomplished by rewiring the switch and including another four reed relays in the input circuit of the line output buffer. The academy equalizer was realized using an op amp with an appropriate R-C-L input network. FIGURE 2 illustrates in block form the changes that we made.

PATCH BAY

The changes made in the patch bay were primarily those of addition. We added four rows of patching to allow access to an M24 Rack (remember the M24 discussed earlier!). We had to include additional monitor patching to allow for the inclusion of the Dolby DS-4, and for four mag recorders—one of them six track, and the other three four tracks each. We also had to bring out the monitor input patches to allow patch bay access to the monitor selector.

OTHER CHANGES

Highly desirable (read necessary) features soon to be added to the console to facilitate efficient use in film production include: the inclusion of four linear faders inserted between the output of the channel combining amplifier(s) on the I/O module and the output transformer so as to accommodate fades in the mono mode, and the addition of switch-selectable low pass and high pass filters in series with the abovementioned faders so as to easily record mono tracks with academy equalization. In addition, two quad panning joysticks that are accessed in the patch bay, buffered, and fed directly to the quad buses have been added to the console.

The following is a summary of the changes that were made to the MCI JH428-B to allow it to function in the world of Dolby Film Re-recording:

I/O MODULES

- 1) Add Mic/Line switch.
- 2) Add Panning selector switch.
- 3) Rewire panning network.
- 4) Add dress escutcheon to identify the above!

MONITOR MODULE

- 1) Remove quad tape return switch and wiring.
- 2) Install Bus/Mag select relays in the Quad Bus monitor position.
- 3) Insert buffer amp(s) on output of monitor selector switch (post relays).
- 4) Take output(s) of buffer to patch bay.
- 5) Install four differential input amp buffers (fed from the patch bay).

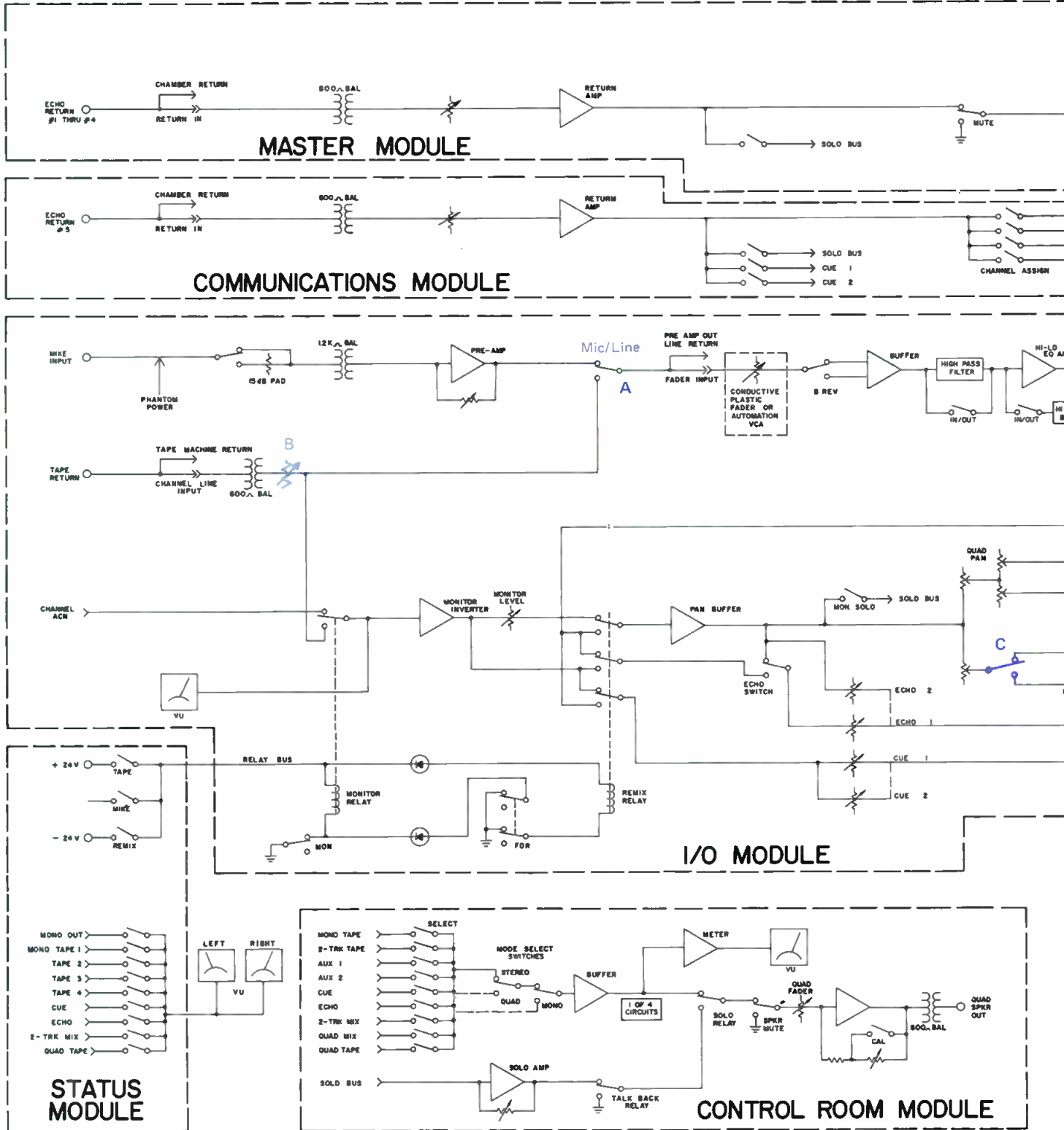

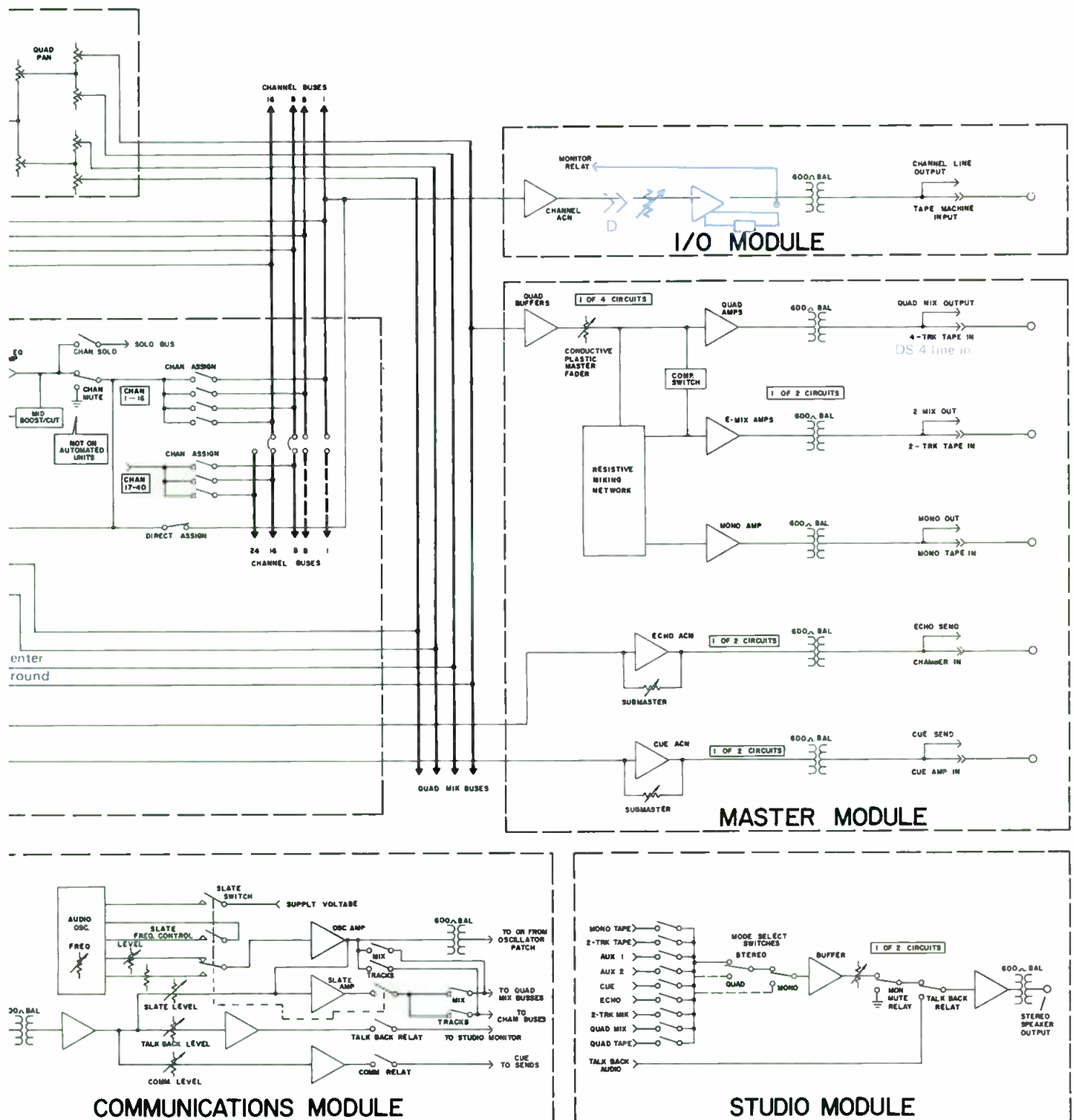

Figure 1. Signal flow diagram of the MCI JH-400B console, with modifications.

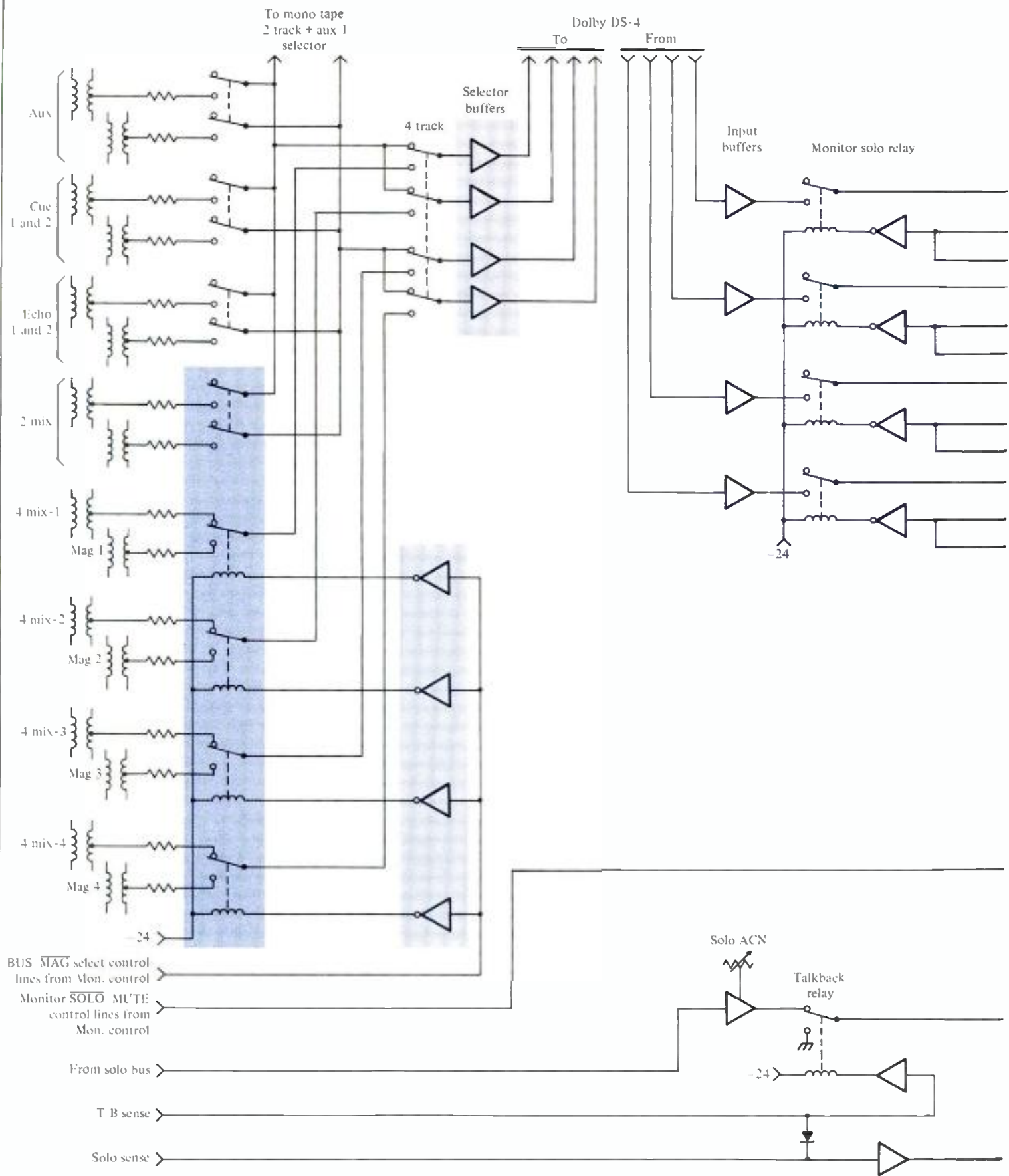
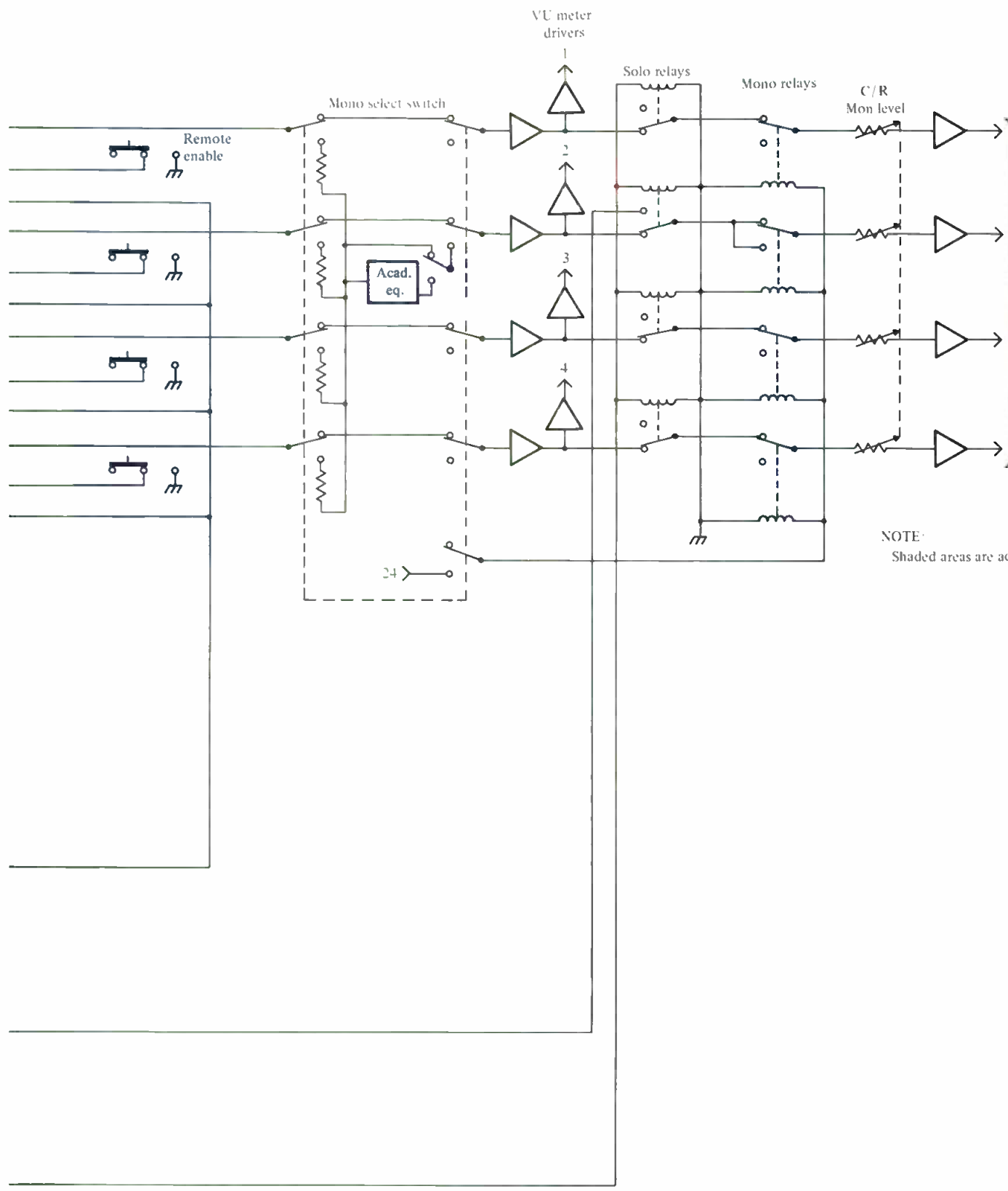

Figure 2. Block diagram denoting modifications made to the monitor module.



NOTE:
Shaded areas are added circuitry.

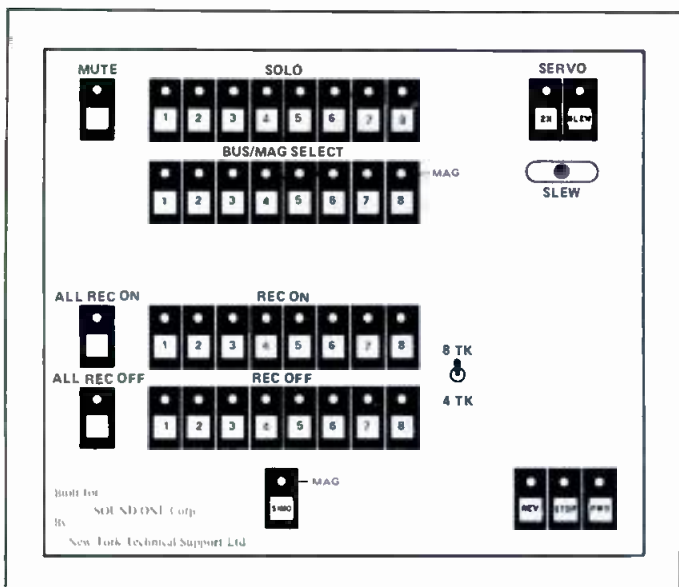

Figure 3. Monitor selector/mute/solo assembly utilized in modification of the Neve A665 console.

- 6) Install monitor Solo/Mute relay circuitry. (This was installed using the already present mute switches on the module, through the normally "on" contacts.)
- 7) Rewire Mono switch.
- 8) Install mono select relays.
- 9) Install academy equalizer in mono side chain.

PATCH BAY

- 1) Install DS-4 patch points within the monitor circuit.
- 2) Add monitor input patching (with appropriate corresponding normals).
- 3) Add required additional rows of patching for outboard equipment.

Changing the JH428 over to a film console was a very rewarding project in terms of both economy (a standard film console usually costs over \$150,000) and flexibility.

THE NEVE A665

Modifying this older custom console for operation in the film realm was in some ways an easier task, yet in others much more difficult. Originally, this board was a 32 in by 16 out by 24 monitor. Based around the older class A 1073 channel amplifier, this console offers some of the finest examples of Neve custom hand work anywhere. Part of the original design included four limiters, which could be inserted in the middle of any of the 16 output group amps. Concurrent with this were two sets of re-routing switch banks allowing for any output to be sub-grouped into any other group. These facilities came from some far-sighted thinking for use in a standard recording facility, and are almost essential to the desires of the film format. This console was to serve many more purposes than the MCI. The studio management intended to have a room wherein it would be possible to work in some of the more non-standard multitrack film formats that are currently in use. Some of these formats would be: four channel Dolby; six channel Dolby; six channel Discrete; eight track Discrete; eight channel Dolby with low frequency side fills; six and eight channel 'IMAX'; client designed multitrack. These possibilities necessitate having up to eight separate monitors throughout the studio. The capability of assigning various buses to these monitor channels while controlling Bus/Mag selection and maintaining a single monitor fader was essential. This situation led to the decision to construct a separately enclosed monitor selector/mute/solo assembly that utilized the eight-track monitor position on the presently available monitor matrix assembly (see FIGURE 3). Once again we decided to put the monitor and recorder controls in a common chassis mounted on a Glide Mount assembly. As before, the main work necessary was in the monitor section.

The older Neve consoles are built on a building block concept. The input channels consist of two separate modules—an input module that incorporates the preamplifier, fader, and equalizer in one chassis, and the output assign module, which consists of an output assignment switch bank and a buffer amplifier. The channel amplifiers are of the modular 1272 type. The monitor circuit (for the multitrack section) consists of, a mixer and a group of relay contacts that select the source desired. In the film environment this translates to a situation whereby the configuration that you desire is achieved by simply re-connecting the wires that constitute the system. Some of the advantages afforded us were based upon the fact that the pan pot was switched in or out of circuit by the original design. Therefore, if the studio was being utilized in the Dolby stereo mode, the pan pot was engaged to pan between any two buses. If the console was being used in the mono mode, the pan pot was simply not engaged, and the first four buses were used as in any mono film console. Bus faders were also provided as part of the original design. In the time that Rupert Neve Ltd. constructed this monument to the custom art, -3 dB pan centers were standard design. Originally, -3 dB pan pots were used so that mono information did not build up in the mono playback mode. Later, high fidelity systems in the home presented a much greater coherency so that mono information played back on a two-channel system proved to add in 4½ to 5 dB increments, which has prompted the adaptation of the 4½ dB pan center norm. The necessary modifications included:

- 1) Removing the 24 track monitor section, and converting it to an auxiliary 24 by 4 mixer with separate sends.
- 2) Removing the 24 track monitor selector position.
- 3) Rewiring the patch bay to accommodate the Dolby DS-4 Network. It was also necessary to provide patch points for the monitor inputs and outputs so that the various monitoring environments could be accommodated.
- 4) Designing and fabrication new monitor and control circuitry for an eight track monitoring environment that would allow mixing in 6-track mag and 8 track 'IMAX' formats, as well as the more conventional Dolby 4 track format. (Mono mixing must also be accommodated.)
- 5) Rewiring the monitor selector relay matrix to accommodate the new monitor assembly.
- 6) Designing and constructing a new mono combine network that would allow for the use of the monitor solo network while allowing for single speaker monitor.
- 7) Rewiring the re-assign network so as to allow re-assignment to buses 1 through 4.
- 8) Modifying the internal intercom facilities so as to interface with our custom monitor system.

With the sub-system modular design of this console we were freed from the constraints of placing our additional circuitry on a pre-existing printed circuit board (as with the MCI 428 discussed earlier).

The additional monitor circuitry is shown in FIGURE 4. The monitor system conversion of existing circuitry consisted of re-routing wire and removing what had become unnecessary functions. With our modifications to the monitor, we constructed an additional sub-rack of amplifiers that embodied the additional circuitry in the forms of a 10-channel VCA group, nine transformer-coupled line drivers for the monitor outputs, and many buffer amplifiers to drive the mono and solo circuitry. We chose to use VCAs for the monitor so as to maintain very close tracking on all eight monitor channels at different attenuator settings. A benefit that was realized by using VCAs was the ability to perform mutes with a single DC line rather than a collection of relays. This benefit was used in the monitor solo system by driving the mutes directly with TTL level logic. We used optoisolators throughout the interface between logic controls and audio circuitry so as to eliminate any ground loops in the system.

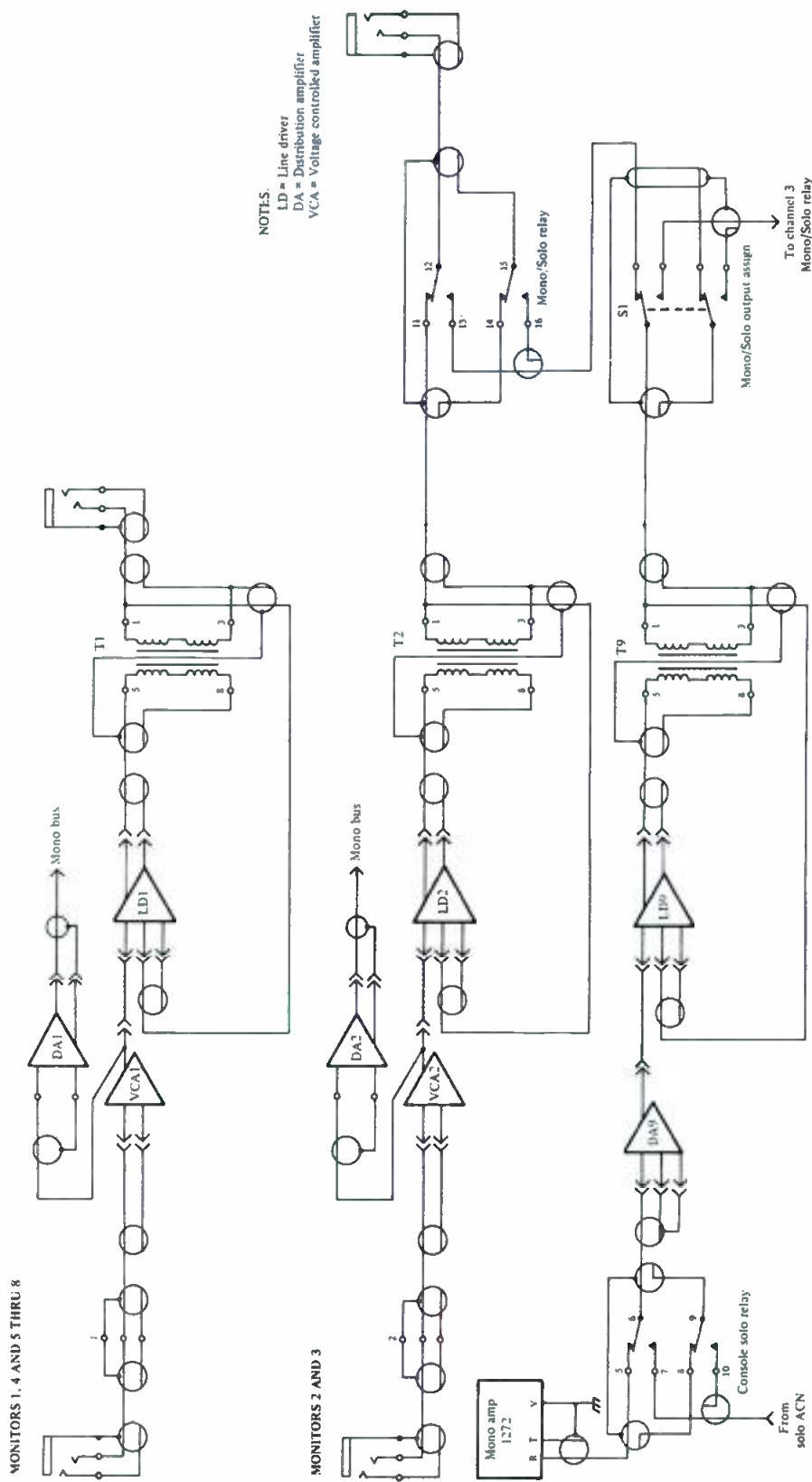

Figure 4. Additional monitor circuitry for the A665.

IN CONCLUSION

It was deemed desirable to maintain the original design concepts as much as possible in the modification procedure. To this end we solicited the assistance of Rupert Neve of England. They provided us with the very able assistance of one of their servicemen, David Close. He proved very helpful in divining the intentions of the original engineer when

reading the drawings that were provided with the console and interpreting them so as to identify the individual wires inside the console. The time scheduled for this project made all of Neve's assistance invaluable. In addition, the author wishes to acknowledge Mel Zelniker, whose assistance in the preparation of this article proved invaluable. ■

Seeing What You Hear, Part II

In Part II, author Klapholz puts the IQS FFT Analyzer through its paces, performing some 'real world' measurements.

HISTORICALLY, THE "BUSINESS" of audio analysis has often been misleading in terms of its information. Compounding the "information gap" problem has been the degree of complexity and expense normally involved with analysis systems. In Part I of this article, I discussed the IQS FFT Analyzer used with the Apple II micro-computer as one solution to this dilemma. In Part II, I will be using the FFT analyzer to make some "real world" measurements and analysis.

The system we will be looking at is a standard 2-way loudspeaker system, consisting of a 15-in. woofer in a 5 cubic ft. reflex enclosure, and a 1-in. compression driver mounted on a wide angle constant coverage horn with a passive 12 dB/octave 800 Hz crossover.

The room that we are looking at is 17-ft. x 15-ft. with a 7-ft. ceiling. It has thick pile carpeting with heavy padding, largely heavily padded furniture, acoustical ceiling tile and fairly reflective wall paneling. With a total volume of 1,785 cubic ft. and a total surface area of 958 square ft., the room has minimal reverberation characteristics.

There are some discrete reflection patterns and standing waves, as would be expected in a room of this type. Subjectively, however, listening to music in this room is quite pleasant. I would consider it to be an average listening (real world) environment.

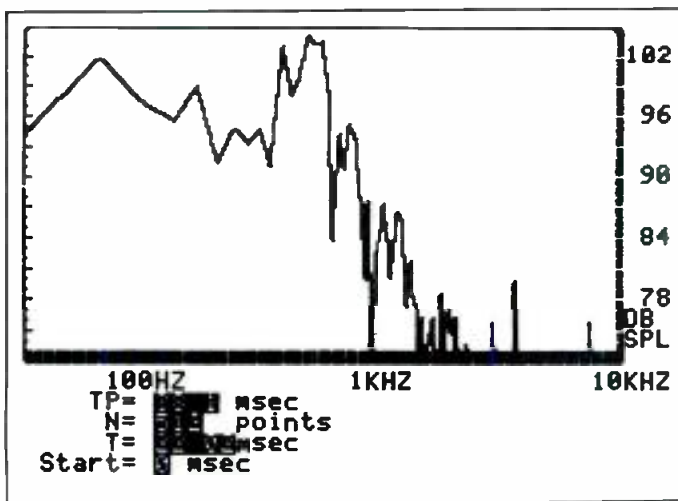

Figure 1. On axis frequency response of the woofer.

Jesse Klapholz runs an audio consulting firm specializing in acoustical analysis and design in the Philadelphia area.

With this background information, let us begin our investigation. First let's select a sampling rate of 23 kHz. Performing 512 point FFTs will give us a measurement "time window" of 22 milliseconds. This will allow us to see, in one display, good frequency resolution (11 kHz bandwidth) and the early sound field simultaneously.

MEASUREMENTS

In FIGURE 1, we see the on axis frequency response of the woofer and crossover. The 22 millisecond time window shows us not only the anechoic response of the woofer, it additionally tells us what the room is doing to our loudspeaker. FIGURE 2 is the on axis frequency response of our test driver/horn combination, measured with the same conditions and test parameters as our woofer.

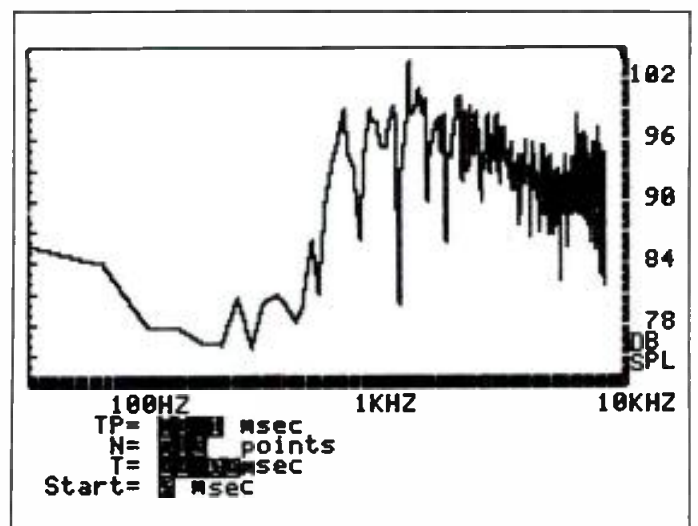

Figure 2. On axis frequency response of the driver and horn.

In FIGURE 3 we see what happens when we combine our woofer and driver/horn in the room. Various effects of the room on the system include: acoustic loading; early reflections, which introduce comb-filtering; pressure cancellations, which introduce geometrically related notches in the response; and low frequency coupling, which raises the free space sensitivity. We also see the result of the crossover combining the two loudspeakers' individual responses, both coherently and non-coherently.

Keeping in mind that the system response in FIGURE 3 is measured on axis, let's take a look at it off axis in FIGURE 4. Looking at the 1 kHz to 4 kHz band, there is virtually no difference between the on and off axis frequency response.

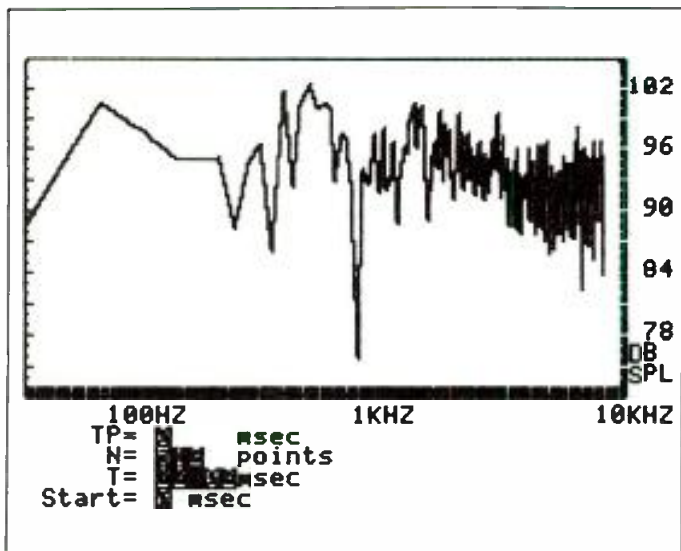

Figure 3. On axis frequency response of system.

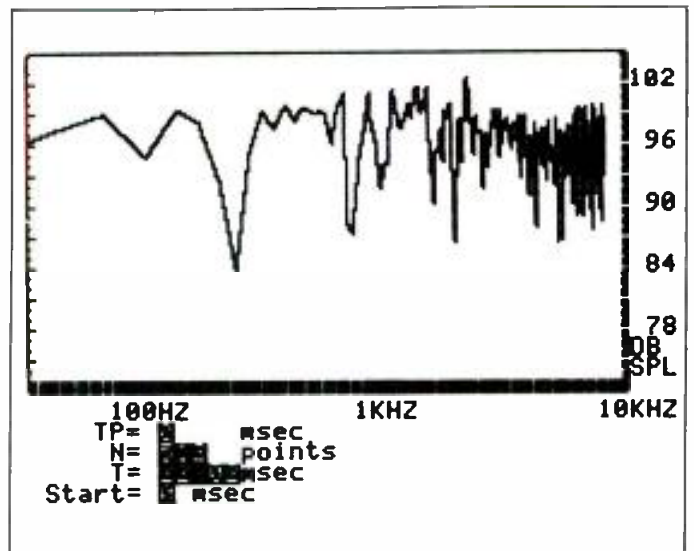

Figure 5. On axis frequency response of system as tuned by the third-octave equalizer.

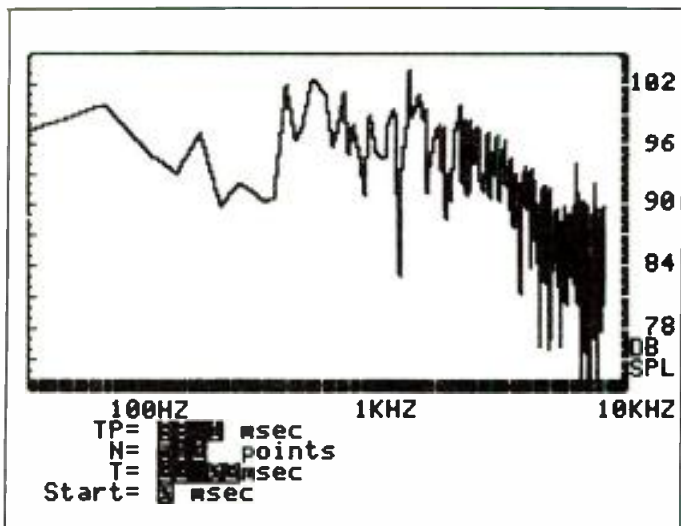

Figure 4. Off axis frequency response of system.

While the off axis response is down about 6 dB at 10 kHz in relation to 3 kHz, the on axis response is fairly linear, exhibiting considerably more energy in the region of 7 kHz to 10 kHz than the off axis response.

The response from 500 Hz to 1 kHz, on and off axis, show the same characteristics. At approximately 300 Hz and 500 Hz, there are notches in both measurements. A moderate peak shows up a little over 200 Hz, off axis only. Down to 90 Hz, both measurements closely track each other again. The on axis response is down about 6 dB at 50 Hz (when compared to the off axis response).

At this point we know what the response of the loudspeaker is in the room, so let's take some steps to see if we can correct some of the problems that we have objectively uncovered. Normally, we would use a real-time analyzer, pink-noise generator and a third-octave equalizer to equalize the loudspeaker.

PROBLEM SOLVING

OK, let's do a classic third-octave tuning. This procedure usually takes about fifteen to twenty minutes, and in this case used sixteen filters out of a twenty seven band third-octave filter set. According to the real-time analyzer, we solved all of our problems.

Measuring the frequency response of the system now with the FFT analyzer will demonstrate exactly what the third-octave/RTA is doing. FIGURE 5 clearly reveals that the response is not as perfect as the RTA led us to believe.

Now let's try inserting a four-band parametric equalizer into the signal path and see what we come up with. FIGURE 6 is the result of about fifteen minutes of tuning and only three filters! The filters were set to attenuate at the low, low-midrange and mid-range frequency bands. None of the filters were attenuated more than 4.5 dB, and the bandwidth of all three filters were set to approximately a third of an octave.

What we have uncovered so far is that the power response of this system is fairly smooth and that our problem is the room, which we cannot seem to affect with any equalization. We have demonstrated that we can only effectively equalize the response of the loudspeaker, not the room.

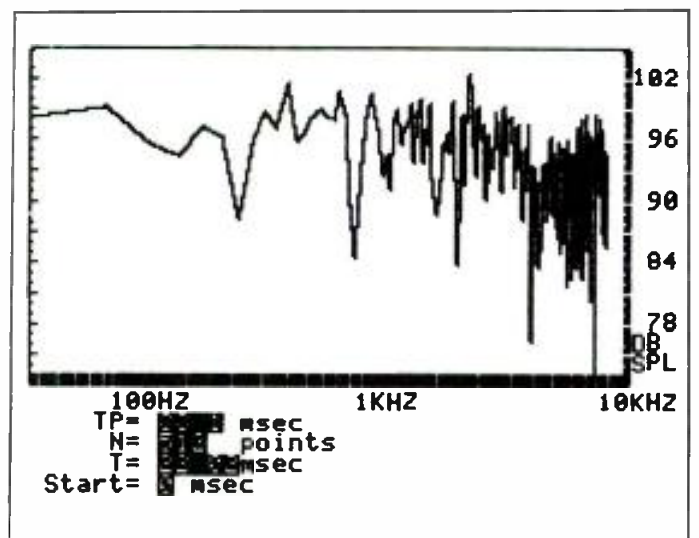

Figure 6. On axis frequency response of system as tuned by the parametric equalizer.

WHY?

One may ask, "Why should we bother to change the way we have been measuring systems?" I was afraid you were going to ask that. To answer this question let's dig a little further. Figures seven through ten show the phase response and group delay of the system, with the third-octave equalizer and the parametric equalizer, respectively.

The phase and group delay plots show the time dispersive distortions inherent in the equalizers. While both systems show phase aberrations through the crossover region, the third-octave phase and group delay plots illustrate the classic "ringing" of filters.

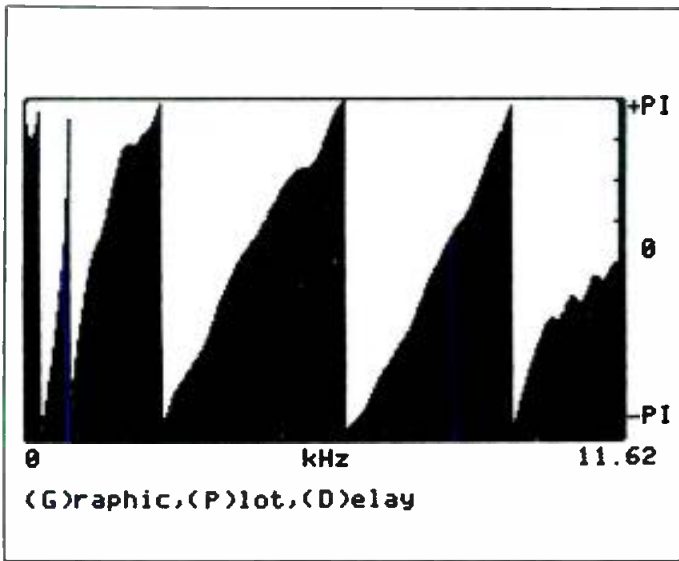

Figure 7. Phase response of system as tuned by the third-octave equalizer (+PI = +180°, -PI = -180°).



Figure 8. Group delay plot of system (measured in msec) as tuned by the third-octave equalizer.

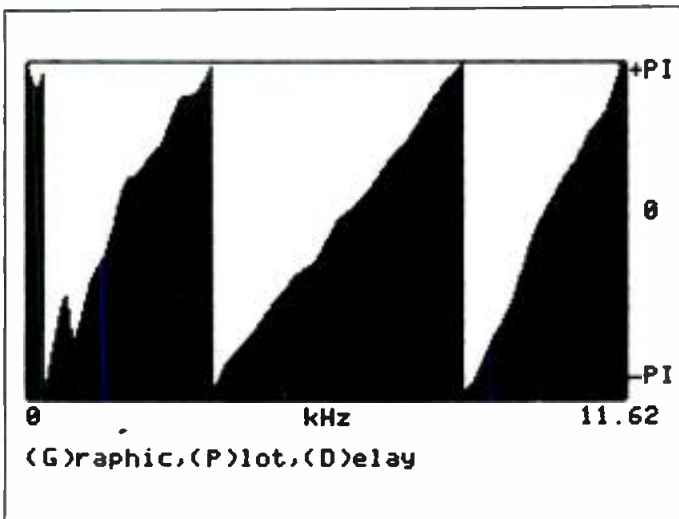

Figure 9. Phase response of system as tuned by the parametric equalizer (+PI = +180°, -PI = -180°).

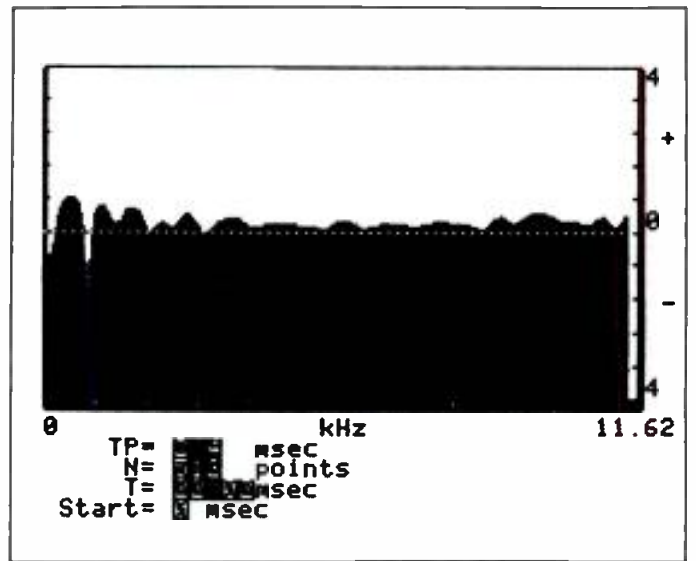

Figure 10. Group delay plot of system (measured in msec) as tuned by the parametric equalizer.

As was discussed in Part I, phase shift at any given frequency may be directly expressed as a group delay function. Figures eleven through thirteen illustrate the relationship between the frequency response, phase response, and group delay of a perfect pulse. The phase plot of a minimum phase device/system would be a straight line(s) from -180 to +180 degrees; this would exhibit a linear phase change with increase of frequency.

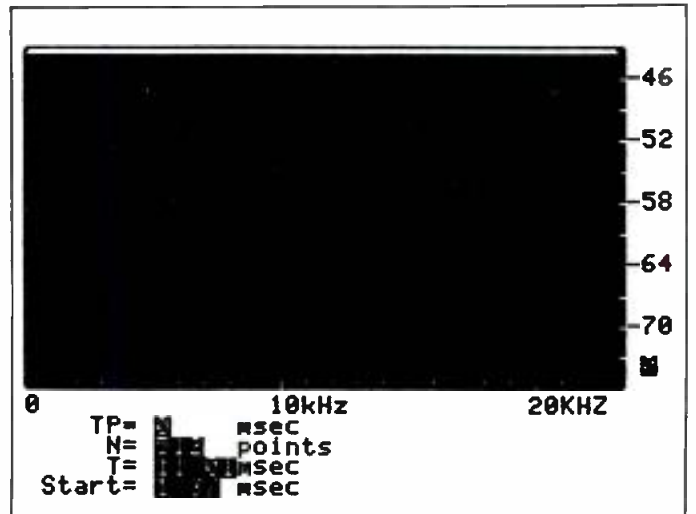

Figure 11. Frequency response of a perfect pulse.

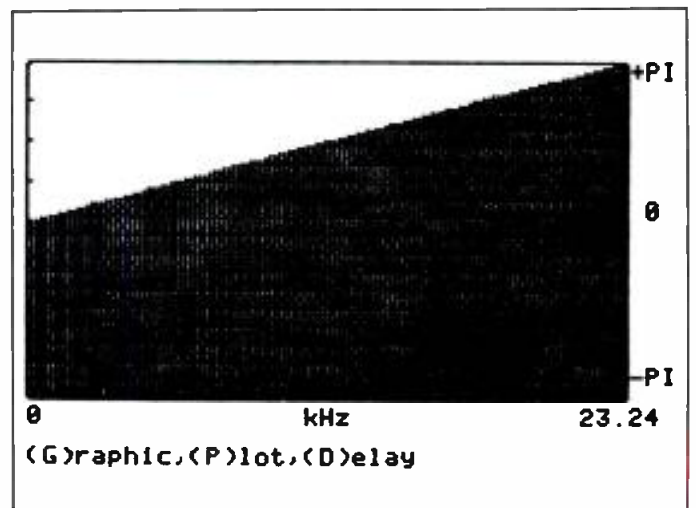

Figure 12. Phase response of a perfect pulse (+PI = +180°, -PI = -180°).

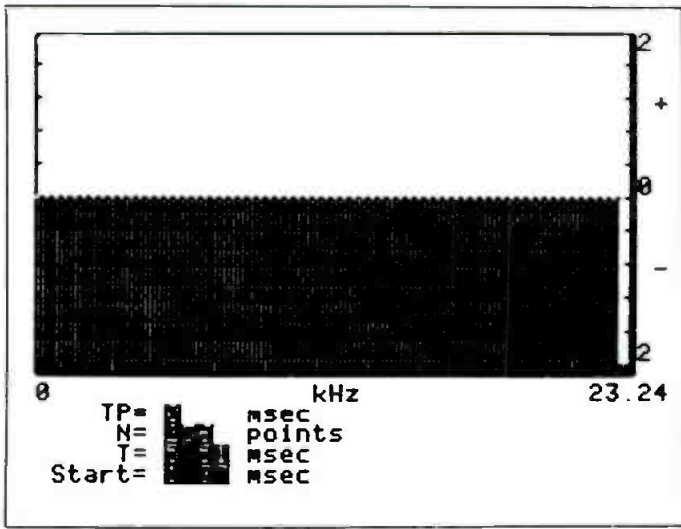

Figure 13. Group delay plot (measured in msec) of a perfect pulse.

WHAT'S ON THE MENU?

Aside from the objective measurements, the key question is, "What does it sound like?" If the proof is in the pudding, then the difference was like going from twinkies to chocolate mousse! When A/B listening was done with the two equalizers, it was immediately apparent that there was a dramatic difference. When switching from the third-octave equalizer to the parametric, it sounded as if a PA loudspeaker was transformed into a studio monitor!

Subjectively, the three bands of parametric equalization had a more open sound, improved transient response, more perceived depth, and an apparent increase in dynamic range. When listening to music, the parametric equalization seemed to decrease the amount of coloring, and the instruments just didn't appear to get lost in the mix.

IN SUMMATION

We have learned that the real-time analysis methods of measuring loudspeakers can be very misleading. We have seen a typical example of over-compensation through excessive equalization. The RTA led us to believe that there were no problems with the test loudspeaker in the room; this is not what one finds when using the FFT analyzer.

The manner in which we perceive music and sound is the most complex system we possess. Consider that we have been programming our hearing/perceiving system from the time we were born! When the system just doesn't sound quite as good as it should, trust your ears that something may be rotten in Denmark. Don't just look to the RTA for the answer. There is no substitution for an inquisitive mind and the right tools used judiciously. For any given subjective description of a physical phenomenon, there is a scientific (objective) explanation as well. The field of sound is artistic as well as scientific; to disregard one or the other is a mistake. Just as you would not learn how to fly a jet by just using the flight instrument gauges, simply measuring loudspeakers does not tell the whole story, either.

The combination of a good understanding of the principles involved and the power of the FFT analyzer will enable us to solve many problems and perhaps remove some of the mystique associated with the "business" of audio analysis. Its opinion is unbiased; it hasn't been programmed to "like" one sound over another. The FFT analyzer is not affected by colds or medicines, and it does not need a blindfold to give an honest answer.

In this article we have explored only one of many applications of FFT analysis. As we continue to apply the FFT analyzer in the multi-dimensional world of audio, we will begin to see how the micro-computer enhances the power of FFT analysis. ■



UNCOMPROMISING WIRELESS MICROPHONES

Finally, you can choose a wireless mic to fit the application. The Telex WHM-300, the electret wireless transmitter mic for uncompromising speech clarity. Or a Telex WHM-400 dynamic wireless transmitting mic for vocal entertainment with rich, full bodied audio quality. Both elegantly tapered and without trailing antenna wires. Or select the miniature electret WLM-100 lavalier mic (or any standard dynamic mic) with our belt-pack transmitter.

Combined with the superb Telex dual diversity* FM receiver, you'll have a wireless system that is as good as any hard wired mic, and at a reasonable price. Write us today for full details.



Quality products for the Audio Professional





TELEX COMMUNICATIONS, INC.

9600 Aldrich Ave. So. Minneapolis, MN 55420 U.S.A.
 Europe: Le Bonaparte - Office 711, Centre Affaires Paris-Nord, 93153 Le Blanc-Mesnil, France

*U.S. Patent No. 4293955. Other patents applied for.

Circle 33 on Reader Service Card

VCA Teletronics Makes a Special Delivery

Quick, what do audio/video technicians have in common with U.S. mail carriers? Stumped? Well, read on.

THE MAILMAN'S CREDO could well apply to the men and women of New York's VCA Teletronics. With the exception of snow, the VCA technicians overcame rain, gloom of night and problems the U.S. Postal Service would never encounter, including a complex logistical maze and production schedule with no room for error. VCA Teletronics' mission was to deliver, worldwide, the tape-delay stereo simulcast of last summer's Diana Ross concert from New York City's Central Park.

VCA had been retained for this task by Showtime, the pay cable network. Showtime was the primary television outlet for the Diana Ross extravaganza, which was also carried in the U.S. by the ON-TV and Select-TV subscription television services, and by some 60 radio stations across the U.S.

By utilizing one of VCA Teletronics' SatCenter complexes as the tape broadcast's focal point, VCA successfully delivered the unique event to three pay tv networks, six satellite transponders and over 60 radio stations, as well as to the Intelsat international satellite system for overseas broadcast. This accomplishment was made even more noteworthy when the company was unexpectedly asked to do it twice...in less than 24 hours!

"Diana Ross World-wide From New York: For One and For All" was supposed to be a once-in-a-lifetime affair. Showtime and the other subscription TV systems had scheduled same day live and tape delayed airings for Thursday, July 21st from the Great Lawn in Central Park. The 6 p.m. live broadcast of the twilight concert attracted nearly 500,000 New Yorkers to Central Park and millions of cable and subscription TV viewers at home. The two-hour show was then to be repeated four hours later on tape as a stereo video simulcast, using the broadcast origination facilities of VCA Teletronics, a Manhattan-based division of Video Corporation of America. The East Coast was to get the tape-delay feed from 10 p.m. to midnight (Eastern Time); at midnight, VCA would broadcast the show again for the West Coast.

While an elaborate logistical undertaking, VCA Teletronics was not unfamiliar with the requirements of such a satellite transmission. For a year and a half, the company had served as Showtime's broadcast origination and post-production center for the network's West Coast feeds. The facility had also performed broadcast origination for Showtime's two previous stereo concerts, which featured Crosby, Stills & Nash and Rick Springfield. One of the VCA Teletronics SatCenters is also currently the origination site for all Cable Health Network broadcasts.

Yet, even with VCA Teletronics' extensive background in satellite and stereo video services, Bruce Blackwell (now Executive Assistant to the President of Video Corporation of America, but at the time of the broadcast Director of Satellite Services for VCA's Teletronics division), realized

the Showtime/Diana Ross production would be a difficult assignment.

"It certainly was among the most intricate projects we had ever been asked to perform," he said. "Almost all of our other satellite broadcasting experience, including the stereo simulcasts, had been with programs that were shot and edited well in advance of transmission. The Diana Ross show was to be sent out only hours after it was performed, so there were no rehearsals, and no logs to go by. It was much like a live broadcast, which left little time for anything to go wrong, and even less time to fix it if it did. We had to be thoroughly prepared for all possible contingencies."

HERE'S THE PLAN

Upon receiving the assignment in early July, the VCA Teletronics Satellite Services group, led by Blackwell and comprised of Walter Neidel (Satellite Operations Manager), Keith Andoos (Technical Services Manager), and Peter Harris (Assistant Satellite Manager), began formulating their plan of action. VCA audio expert Frank Lanzer was assigned the duty of setting up the simulcast's audio operation.

For the basic replay of the tapes, the group decided to employ a hardware roster built around four on-line Sony BVH 1100A one-inch VTRs with on board Dolby noise reduction. At any given time, two consecutive reels would be on the machines, each with a back-up copy rolling in sync on the other two video recorders. A fifth machine was standing by in case of recorder malfunction. Each VTR featured a time base corrector, vectorscope, waveform monitor and audio monitor for individual signal monitoring. A schematic showing the overall wiring configuration is shown in FIGURE 1.

The Sony recorders would all be operated from the SatCenter I control room (see FIGURE 2) where a technical director and assistant would cue-up the tapes. Other equipment included an Image Video Routing Switcher, which was patched to serve as a backup for the Grass Valley 1600 broadcast switcher, a Neve model 542 broadcast audio console, and a Studer A80VU 2 track tape deck. Also available in the control room was a Chyron IV character generator, and a CMX 340X computerized editing system in case emergency editing or a last minute message was called for.

Before the tapes were loaded onto the playback decks, the SatCenter team made end to end quality control (QC) checks of each videotape, with the facility's audio lab standing by in case the QC process revealed something amiss on the reels.

To accommodate the stereo simulcast, a pair of dual-channel audio feeds would be taken from the on-air audio console, with one pair earmarked for broadcast, the second for backup. Both stereo audio feeds would then be sent by VCA's 15 kHz audio terrestrial signal delivery system to WNYC, a National Public Radio outlet, which would uplink the stereo sound to the Westar IV satellite for pick-up by all radio stations slated to carry the concert. This configuration is shown in FIGURE 3A.

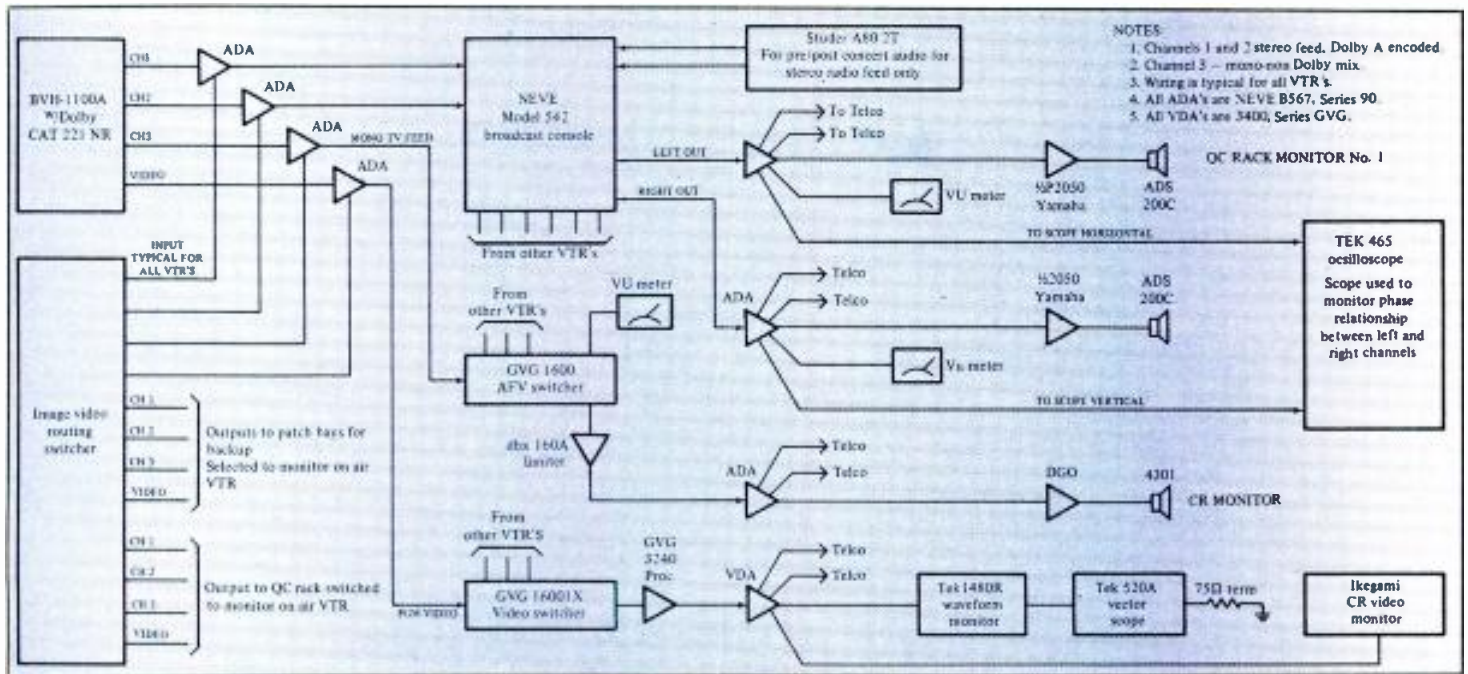

Figure 1. Overall wiring configuration for the Diana Ross stereo simulcast.



Figure 2. The SatCenter I control room.

For the video feed, a pair of mono audio/video signals, again, one for air, the second for back-up, would be transmitted through the VCA Teletronics' audio and video terrestrial system to AT&T's Network Radio facility, a mid-Manhattan switching center, which would split and send the signal to three different satellite uplinks (see FIGURE 3B). The uplink sites were at Cablevision, on Long Island, to service Compstar D4, for transmission to Oak Communications' ON-TV subscription stations; to RCA's center in Vernon Valley, N.J., for transmission to Satcom IIIR, Showtime's satellite; and to the Wold Communications uplink in Little Falls, N.J., for transmission to Westar IV for servicing Select TV subscribers. The Wold Company also sent the transmission to a second Wold uplink, which relayed the signals to a Pacific Intelsat satellite for transmission overseas.

Along with setting up the video equipment and terrestrial system, the SatCenter executives drew up a list of eight people to be involved with the actual operation. Aside from Andoos, Lanzer, and Harris, who supervised the actual broadcasts, the roster included technicians to operate the hardware and maintenance crews to handle any equipment malfunctions.

With VCA's state-of-the-art broadcast system ready to go, the rather pedestrian problem of actually getting the tapes in from Central Park to VCA Teletronics as fast as possible was

still to be solved. Showtime set up a series of messengers, who would be timed to arrive at VCA Teletronics' East 55th Street headquarters every twenty minutes with the just-recorded reels ready for the Quality Control process.

Confident that they had covered all the bases, Andoos and Company stood at ease, believing everything would go pretty much according to the plans formulated by themselves, by Showtime, and by Paramount, which was producing the live event at Central Park.

STOP, IN THE NAME OF RAIN

Unfortunately, Mother Nature doesn't always work on the same schedule as cable networks and video facilities. About 40 minutes into Miss Ross's show, the skies opened, deluging Central Park. The singer immediately broke into a rendition of "Stop, In The Name of Love" while the crowds scurried for cover. Within a few minutes, much of the on-location video gear was under water, and the concert came to an abrupt end.

"Nobody really knew what to expect at that point," says Andoos. "We had already gone through final system check-outs when the concert simply stopped. We didn't know if Showtime was going to schedule a tape delay broadcast that night or not."

Up to that time, the tapes received at VCA were flawless. "With the crowds in the foreground, Ross in the center, and the Manhattan skyline illuminated by lightning, the footage was exceptionally dramatic and exciting."

Although the concert was telecast live, and Ross performed in the rain, the deluge eventually forced a cancellation. Showtime's operations and programming executives then quickly debated the merits of re-broadcasting a two-hour concert which had lasted less than half of its scheduled time.

However, once it was revealed that the material which had been shot was excellent, with Miss Ross providing a powerful, even inspirational performance, the decision was made to rebroadcast the abbreviated concert to the East Coast, but not the West Coast. Miss Ross, Paramount, Showtime, and VCA Teletronics would try again the following night.

The decision made, a massive effort was undertaken to notify all radio and television affiliates of the new plan, and to

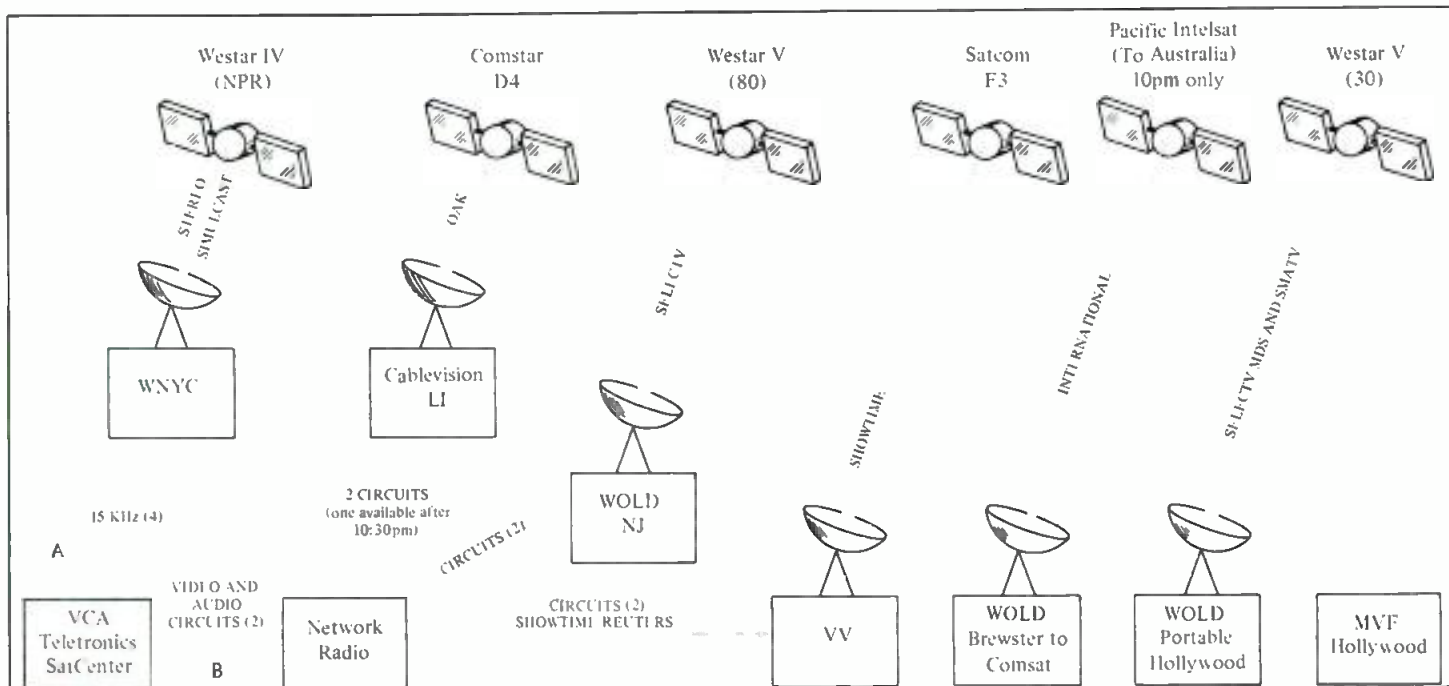

Figure 3. The stereo audio feeds (A) and the audio and video feed (B) for the tape/simulcasts of the concert.



Figure 4. Audio projects specialist Ira Kemp in the VCA Teletronics sound studio.

make arrangements for satellite transmission facilities for the next night.

To alert the concert's viewers that the full concert would take place on Friday night, the SatCenter's Chyron character generator was used to print a message across the TV screen.

Weather aside, the first night's re-broadcast went off flawlessly. In fact, audio engineer Frank Lanzer found it to be a perfect rehearsal. "By the time the second night had rolled around, it was pretty routine," he said. "We knew that everything worked as it was supposed to, and that everyone was aware of what they had to do. So we all thought we were in for a relatively easy time of it."

LET'S DO IT AGAIN

But again, fate seemed to conspire against the spirited VCA Teletronics crew. "The second night's concert came off exactly as planned," says Andoos. "There wasn't a cloud in the sky, but there was a buzz on the first reel we received from Paramount."

As the first completed reel came in, the Quality Control check had discovered a buzz, which was believed to have been caused by electrical interference. Lanzer brought the tape down to the VCA audio lab in an attempt to filter out the interference.

"It's the kind of thing that sometimes happens at live shoots," says Lanzer. "We attempted to eliminate the buzz through notch filtering. In our sound studio, designed by a team led by VCA's audio projects specialist Ira Kemp, we have everything you'd need to do that."

The VCA Teletronics sound studio (see FIGURE 4) includes an SSL mixing console, Studer A800 multi-track tape machines, and a full complement of the latest (and some of the best vintage) outboard signal processing equipment. Also featured are UREI equalizers, limiters, and notch filters, Pultec tube-type equalizers, and Dolby noise reduction.

"Although the buzz wasn't very serious," said Lanzer, "we did want to get it out, because we wanted this broadcast to be absolutely perfect."

As Lanzer worked in the audio lab, another unexpected development popped up, in the person of Diana Ross. "No one had expected that after such a grueling and high spirited performance, Miss Ross would want to come here to review the completed concert before the tape delay broadcast went out," says Andoos.

"So, in short order, we set up a screening room with a VTR, 30-inch Sony monitor, and UREI 813B studio monitor system. Apparently, Miss Ross liked what she saw and heard, since she stayed in there for three hours."

In the meantime, Lanzer was still in the audio lab. "Up to 15 minutes before air-time, Frank was still trying to get the buzz out of the tape," Andoos said.

"As things turned out," he continued, "Frank couldn't totally eliminate the buzz without seriously affecting the frequency response of the material, but I don't think it was all that noticeable."

Despite the obstacles, the VCA staff overcame them. Both the 10 p.m. East Coast and midnight West Coast transmissions went out problem-free. Noted Blackwell, "To handle a job like this required the type of equipment, technical expertise and staff dedication that only a company which had made a major commitment to both post-production and satellite broadcast origination could provide."

Keith Andoos summed it all up, saying "In a situation like this, you have to be flexible. With all the last minute changes, we stretched the crew to the absolute limit. They responded by giving 110 percent. This was an extremely challenging and exciting project, and we're proud of the contribution that VCA Teletronics was able to make toward its success."

Indeed, like the mailman, VCA Teletronics delivered. ■

MULTITRACK MIXING CONSOLE

• Interface Electronics' new series of mixing consoles, the Series 324, incorporates all of the mixer functions in each module so that, for example, a 28-in-by-24-out console requires only 28 input modules in the standard frame. Each module incorporates a track output master with LED VU indicator, along with input module features such as track assign, four equalizers, and four Cue/Effects sends. Also included is the Model NA Monitor Module, which allows three stereo mixdowns from the Monitor Send section of each module that can be used for control room, studio, and phones in a recording system or house mix. The NA Module also includes talkback and echo returns. For recording, the system can be set up for 24 tracks and provides a simultaneous stereo mixdown—one for control room with solo, and the other for studio without solo. For sound reinforcement systems, the mixer provides up to 24 submixes each panned into the stereo house output, with another stereo output with solo functions for the operator. Many points in the mixer can be soloed into the monitor. The Series 324 mixers are fully modular and permit a dynamic range approaching 120 dB under most conditions.

Mfr: Interface Electronics

Circle 40 on Reader Service Card



FOREGROUND MUSIC SYSTEM

• JBL's Industrial Series 8216 Foreground Music System is a compact two-way design suited for installation in a variety of commercial locations such as retail stores, restaurants, and lounges. Equipped with a one-inch dome high frequency loudspeaker and 6½-inch bass driver, the 8216 offers wide, smooth response, high efficiency and power capacity, and low distortion. The quality of this system's performance is derived from the use of technological features found in JBL's studio monitor and high-fidelity product lines. These include flat wire voice coils, SFG (Symmetrical Field Geometry) magnetic structures in the low frequency component, and a high resolution dividing network with bypass capacitors wired in parallel with the larger



active capacitor valves. This technique reduces hysteresis effects on the signal for improved resolution of complex transient waveforms. Built with damage-resistant materials chosen to ensure long-term reliability, the

system's enclosure is constructed of dense, compressed wood. The panels are covered in black vinyl, complemented by a black cloth grille.

Mfr: JBL

Circle 41 on Reader Service Card

MODERN RECORDING & MUSIC

**The magazine
for**



Rindy and Mary Foss of Quarterflash. (Photo by Denny Anderson.)

**people
who create
music**

I wish to subscribe renew today
 \$15.00 for 12 issues \$26.00 for 24 issues
 Check money order enclosed for the amount of \$ _____

My account number is: Visa Mastercharge

Name _____ Exp. Date: ___/___/___

Address _____

City _____ State _____ Zip _____

(Foreign subscribers add \$3 for each year. Foreign subscriptions payable ONLY in U.S. funds by international draft or money order.)

SPECIAL TEST TAPES

• Standard Tape Laboratory's new line of special test tapes and films is for use with the Sound Technology 1500 Series test instruments, models 1500A and 1510A. These multi-purpose tapes are available in all popular widths and speeds for reel-to-reel, broadcast cart, cassette, and film formats. Used in conjunction with the Sound Technology

system, these tapes provide measurement of level, azimuth, and frequency response of any tape or film machine. Flutter/Speed test tapes are also available for use with the system. This special line of test tapes is available in addition to the conventional line of STL test tapes.

Mfr: Standard Tape Laboratory, Inc.

Circle 42 on Reader Service Card

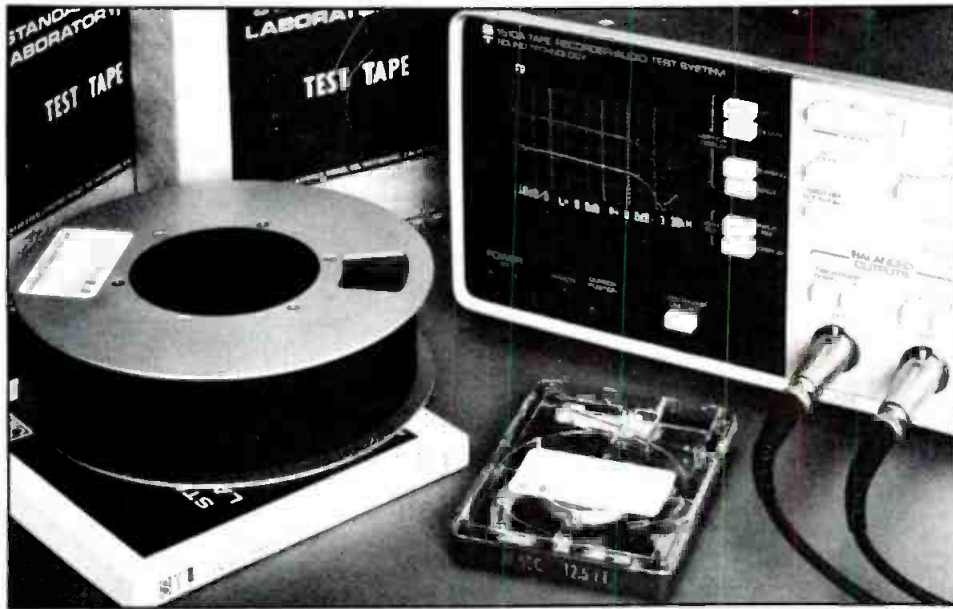

NEW AMPLIFIERS

• Edecor's GLA series is a newly released line of packaged mixer and power amplifiers. New circuit technology and a special digital sensing circuit is employed to make the units reliable. The new GLA (Great Little Amp) series has many features such as precedence control and voice gate operation. Full voice coil and constant voltage line outputs are standard.

Mfr: Edecor

Circle 43 on Reader Service Card



ONE PASS

The Only Four-Second Tape Erasers

That's Garner... The Quality Eraser

You're recording on a machine that costs hundreds or thousands of dollars, and you're reording on recycled tape. Can you guarantee that tape is absolutely clean? You can if you're using a Garner Audio Tape Degausser.

Garner is the standard of the industry...designed to the specifications of leading tape manufacturers. Garner is a conveyor-belt tape eraser. It can erase in less than five seconds what most degaussers take up to a minute to erase, and Garner erasers do a better job.

Time savings, ease of operation, quality of erasure, and rugged construction make Garner the most cost-effective eraser available.

Garner has established a reputation as the "Eraser People" because we manufacture a complete line of both audio and video erasers. Call and let us show you what a Garner eraser can do for you.

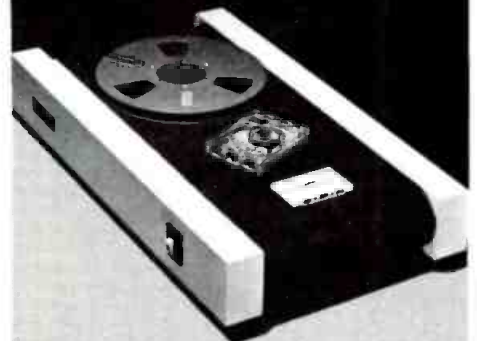

Dependability...Guaranteed



4200 N. 48th Street Lincoln, NE 68504
Phone: (402) 464-5911 Telex: 438068

db January-February 1984 51

TIME CODE READER/REGENERATOR

• Audio + Design's TCR 1 Portable SMPTE/EBU Time Code Reader and Regenerator is completely portable; operating for up to 2000 hours from one set of internal batteries, the unit will read time code from serial time code outputs. Apart from reading SMPTE/EBU time code, the unit will display "user bit" code at the flip of a switch. Drop Frame and Color Frame are indicated below the frame count digits. The TCR 1 also has an output through which time code can be accessed "cleaned up." This function is useful where the source tape is not the master and where time code may have degenerated. The LCD display may be illuminated for 20 seconds by pressing the illumination button. Alternatively, when the TCR 1 is AC-powered, the LCD display will be continuously illuminated. The TCR 1 measures 7½-in. long by 5⅝-in. wide by 1¾-in. high.

Mfr: Audio + Design

Price: \$495.00 (Suggested retail)

Circle 44 on Reader Service Card



DIFFERENTIAL INPUT AMPLIFIERS

• Benchmark Sound Company's new Differential Input Amplifiers are designed to retrofit into existing equipment such as monitor amps, recording consoles, limiters, and a host of semi-pro devices. Outboard balancing systems with their attendant wiring, space, and mounting problems are eliminated. The DIA-1 is a DC-coupled device intended for use with split supplies from ± 9 to ± 42 VDC. The DIA-2 is an AC-coupled version intended for use with a single positive supply from +18 to +58 VDC. Included among the features are a true differential balanced input which eliminates ground loops, 90 dB of trimmed common mode rejection (70 dB at 20 kHz) typical, bridging 100 kilohm differential input impedance, an FET input op-amp and ferrite beads to eliminate RF interference, 13 V/sec slew rate to insure SID and TIM free operation, and various gain options available from -14 dB to +20 dB.

Mfr: Benchmark Sound Company

Price: \$24 each, in quantity

Circle 45 on Reader Service Card

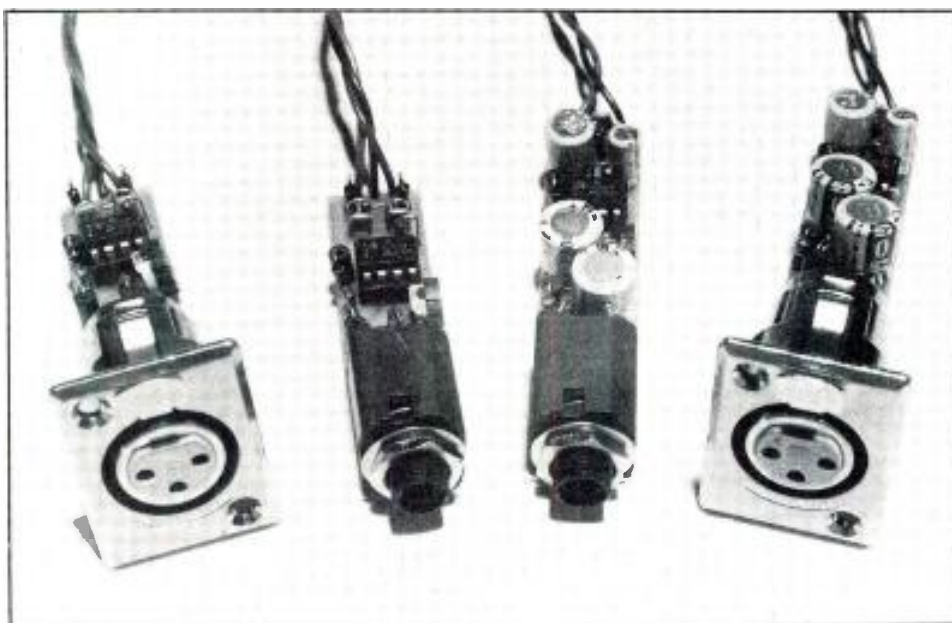

WANTED

PREFERABLY ALIVE !!!

We are looking for you out there, you who may have developed computer programs or devices for the audio industry.

If you are a manufacturer who has developed a new idea or method of testing or producing using a computer—tell us! We want your idea in our new computer column.

If you are an audio engineer who has come up with an innovative way to use a computer in the recording, broadcast or sound reinforcement field—tell us! We want you to tell us and the world about it.

If you are a programmer or someone who has a special knowledge of computers in audio—tell us! We'll let everyone know about it.

This is your opportunity to tell the world about your brainchild—your innovations—your genius!

Tell us—here at **db**—The Sound Engineering Magazine.

Sagamore Publishing Co.
1120 Old Country Road
Plainview, NY. 11803
(516) 433-6530

The Ursa Major 8X32 Programmable Digital Reverberation Unit



THE URSA MAJOR 8X32 is a programmable digital reverberation unit (3.5 × 15.5 × 19-in. rack mount). An optional remote control unit duplicating all the front panel controls is also available. Four basic, pre-programmed settings (labelled PLATE 1, PLATE 2, HALL, and SPACE) simulate a wide range of reverberation responses, from a small plate to a concert hall. For special effects, unnatural responses can be obtained with the SPACE program (decay time up to 20 seconds!). The parameters on these four programs—early reflections, initial reverberation and decay time—can be adjusted by the user. A RAM allows you to store 64 of your favorite programs.

PROGRAMS AND SETTINGS

Reverberation can be accurately represented with three sets of parameters: early reflections (discrete echoes), initial reverberation (a cluster formed by closely spaced echoes), and decay (high density echoes of exponentially decreasing amplitude). Different reverberating fields can be simulated by varying the time delay, amplitude, and the number of echoes (the density) on each of these three parameters.

Ursa Major proposes a set of four programs with fixed initial parameters. The user can modify the initial settings by varying the amplitude and/or incrementing the time delays. The amplitude of early reflections and initial reverberation is variable within a relative scale from 1 to 8. In the same fashion, the delay times appearing on the LED display do not represent the total delay time of the early reflections or initial reverberation, but the amount of

Leslie Shapiro is an assistant engineer at Music Market productions, Coral Gables, FL; Marco Fratnik is studio manager at Gusman Recording Studio, also in Coral Gables.

incremental time beyond the value preset by the program used. Decay time, on the other hand, is indicated in seconds, and this value actually corresponds to the RT60. The program selected limits the maximum decay time (6, 8, 10, or 20 seconds). While at first it may seem confusing, it turns out to be very easy to use.

PLATE 1 simulates a fast-diffusing, small-sized plate reverberation (diffusion describes the property of a reverberator to produce a high density of echoes). In this program, initial delays are practically eliminated in order to rapidly obtain a high density of echoes. Fast diffusion is necessary to successfully reverberate short duration signals (plate reverberations usually produce a minimum of one thousand echoes per second). If this characteristic makes the program suitable for material containing transient signals, it also tends to increase coloration—that is, the acoustical impression of an unnatural frequency response. The amount of coloration is inversely proportional to the dimensions of the simulated room; this first program will thus create the most coloration. PLATE 1 is best applied to drums, percussion, or any other material with fast attacks. The effect is that of adding “body” to the musical program without destroying its clarity and definition. One might expect that fast attacks will create audible discrete clicking, but, due to the very high density of echoes, this problem doesn’t occur unless the HALL or SPACE programs are used.

PLATE 2 also has the smooth characteristic response of a plate. However, the slower diffusion and the longer initial delay times makes it more appropriate for vocals or any program containing melodic lines. Because of the increased delay on the early reflections, the reverberation “opens” the sound, and coloration is reduced.

The HALL program simulates the characteristic reverbera-

tion of a concert hall. High frequencies decay much faster than lows in any natural reverberant field. This phenomenon becomes even more noticeable with long decay times. It is partially explained by a property common to all materials: the absorption coefficient increases with frequency. Other losses at high frequencies are due to air absorption. The Ursa Major digital reverberator provides both a low-pass and a high-pass filter to band-limit the decay of the reverberation (the filters aren't active on either the early reflections or the initial reverberation). The corner frequencies of both filters are selectable: 20, 50, 100 and 200 Hz for the hi-pass filter and 1, 2, 5 and 8 kHz for the low-pass. The reason the spectrum of natural reverberation is limited to approximately 8 kHz is to eliminate the need for the usual 20-22 kHz "Hi-Fi" bandwidth.

The SPACE setting can be used for special effects. The build-up of the reverberation is very slow and uneven, and the initial time delays are large. This accounts for the absence of coloration. However, due to the very low density of echoes, signals with fast transients will produce a discrete audible clicking. There is always a trade-off between coloration and clarity. While the SPACE setting is free of coloration, it is inappropriate for most musical programs because it tends to blur the fine details. This compromise situation is not a characteristic of digital reverberation units; rather it is a phenomenon inherent to any reverberant field, whether the source is a digital unit, a plate, a spring, or a live chamber.

At first glance, this unit may seem to be limited in its flexibility. For example, you cannot select the number of early reflections or the specific resonance of each reflection. However, to be practical, a digital reverberation unit must be pre-programmed, and thus is limited in its simulations by the manufacturer. In theory, a digital processor could simulate almost any reverberant field (given enough RAM and the correct algorithm), but recording studios do not hire computer wizards capable of instantaneously programming a specific reverberant field... yet! Plates, spring reverberation units and, moreover, reverberation chambers, are far more limited by their own physical characteristics (torsional characteristics of a spring or a plate, mechanical damping, and resonant frequencies are some of the numerous limitations of mechanical systems). A digital processor is potentially free of these limitations. In other words, the quality of a digital processor depends on the quality of the software. A trade-off must be made between flexibility and practicality. A third factor must be taken into consideration: any alteration of the pre-programmed software should not allow the user to implement an error condition in the system. This further limits the number and range of the parameters accessible to the user. We believe that Ursa Major has found a balanced solution to this dilemma: the four programs are immediately useful, and reasonable variations can be further programmed in a short time. In a recording studio—where time is money—expediency is sometimes the most important criterion.

THE ALGORITHM

Digital reverberation is obtained with a fairly simple algorithm. The original signal is first filtered, sampled and quantized. As we already know, the bandwidth of this unit is 8 kHz. In order to satisfy the Nyquist theorem—and thus eliminate any source of error from the sampling process—the sampling frequency must be at least twice the highest frequency passed by the anti-aliasing filter; the 8X32 uses a sampling frequency of 20 kHz. The delay is obtained by circulating the digitized signal through a RAM. The CPU increments the addresses of the RAM each time, and writes the digitized signal. The address at which the data is read determines the time delay; in other words, the time delay is proportional to the amount of memory used (see FIGURE 1). The Ursa Major can be used as a delay unit by setting the decay time at zero. To obtain the reverberation effect, the

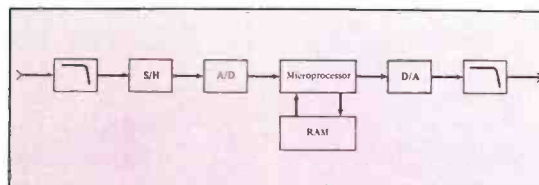

Figure 1. Block diagram of a digital processor.

stored signal must be read at different addresses (different time delays), multiplied by a number smaller than unity to simulate the decay and, finally, added to the present input signal in order to be recirculated in the RAM (see FIGURE 2). This concept is easy to understand, but the software needed to obtain this result is very complex due to the enormous amount of variables involved.

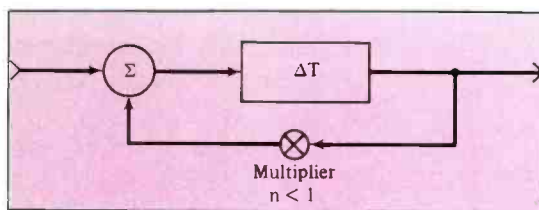

Figure 2. Reverberation is obtained by feeding back part of the delayed signal.

Reverberation according to the diagram in FIGURE 2 is not only a question of time delays. The relative amplitude of the reverberation parameters greatly influences the impression of depth (front-back perspective). The output level of the decay section is set at a fixed level while the amplitude of the early reflections and initial reverberation can be adjusted by the user to obtain the desired balance.

A last consideration of the algorithm is the stereo image. One of the characteristics of the reverberation decay is to have an incoherent stereo image. At the last stage of the reverberation process, sound comes from all directions simultaneously, with different angles, time delays, amplitudes, and phases; all directional information is lost. For this reason, most reverberation units have a single input and a stereo output. The Ursa Major 8X32 uses the same procedure: left and right inputs are added together to form a single input to the processor. Left and right outputs are derived at each stage (early reflections, initial delay, and decay) and added to form a stereo output.

SPECIAL FEATURES

An Input Mute function permits the user to stop the flow of signal into the unit. This allows the previously stored material to decay naturally without being masked by a new input. The reverse operation is also possible: input mute can be released at the specific moment when reverberation is needed, leaving the preceding material dry.

A logical complement to the input mute function is the Reverb Clear. While the Reverb Clear is pressed, the decay time is set to 0.2 seconds, which is similar to clearing or resetting the reverberator. This phenomenon can be compared with the damping of the spring in a spring reverberator: the energy fed to the spring produces early reflections but is absorbed by the dampers before a natural decay can occur. When the Reverb Clear key is released, the normal decay curve is produced.

Two LED displays indicate both the input level and the relative amplitude of the decay in the reverberator. Both Peak and Overflow are indicated with red LEDs. Peak indicates that the maximum input level has been reached; this can be compared to the peak indication of any analog

unit. Overflow, on the other hand, is strictly a digital measurement: it indicates that the analog-to-digital converter has run out of bits and thus cannot quantize the signal properly. The result is severe audible distortion. In analog systems, the distortion is present at all times and the only requirement is to keep it below a certain percentage so that the acoustical effect cannot be perceived by the listener. In digital systems, the distortion appears at low input levels, specifically when the input level is smaller than one least significant quantization bit. Another type of distortion, which is much worse, appears when input levels exceed the maximum quantization level. This last type of distortion (indicated by the Overflow LED), however, can easily be eliminated by trimming the input level of the processor. A touch of class: both LED displays are duplicated on the remote control.

The Ursa Major 8X32 has 64 non-volatile memory locations available to store your favorite programs. All the user-variable parameters are kept in memory: program, amplitudes and delays, and decay time and corner frequencies of both filters. Storing, retrieving, or editing your programs is simple: select a memory location (00 to 63) and depress Reverb Clear and Store simultaneously. The program is stored. To retrieve or edit the program, punch up a memory location and press Recall. Special key combinations allow the user to compare settings, protect the programs against involuntary erasure, or even reset the microprocessor if it ever latches-up. The ease of program retrieval allows the use of presets. For example, while using reverberation program #7 on lead vocals, you can ask for program #13, and the display flashes to indicate that it is waiting. Then when the flute solo appears, simply punch in Recall and the reverberation characteristic changes to program #13 without a click or pop.

INTERFACING

A remote control connector is located on the back panel as are two line input and two line output XLR connectors. A trimmer allows adjustment of the input sensitivity from -10 to +4 dBm. A balanced, transformerless input is obtained with op-amps used in a differential configuration (differential input). The owner's manual explains in great detail the possible interfacing techniques.

THE FUTURE

As we mentioned previously, a digital processor is a programmable unit that can perform a multitude of tasks without changing the hardware involved. The potential of diversifying the type of processing by merely altering a program is one of the strong points of digital technology, and the 8X32 is no exception. All the software is contained in a few PROMs (programmable-read-only-memory). To update the system with new software becomes a question of replacing a couple of chips, and Ursa Major provides the updated software at no charge.

Ursa Major also plans to prepare software for remote computer control of the 8X32. The computer, through the standard RS232C interface, will control all user-variable parameters as well as operations of the 64 memories.

COMMENTS

The 8X32 is an extremely versatile product that allows the user to obtain a very wide range of reverberation characteristics. The design of this unit is user-oriented. It is easy to install and operate. Perhaps this emphasis on simplification went a little too far in regard to the owner's manual. It is vague in its description of the unit, and this leads to uncertainty when initially using the reverb. For example, the displayed time delay represents incremental time, and the amplitude display is not referenced to any absolute scale. This creates confusion that could have been circumvented through either a better manual or better labels on the displays. However, these criticisms do not affect the excellent performance of the unit.

With the optional remote control unit, using the reverberator is a breeze. The controls are easy to reach and adjust, and the LEDs are large and brightly lit (no more fumbling with miniscule knobs and squinting to see the result!).

Many studios could find advantages in owning this kind of digital reverberator. It can offer a reasonable substitute for plates, digital delays, and large sound chambers for a studio that can't afford, or doesn't have the room for, these units separately.

In all, we found the Ursa Major 8X32 to be a very satisfactory digital reverberation unit. The effects are all practical, useful, and easily variable. Most important, it sounds good to the ear. ■



Don't be
in the
dark about
birth defects.
Call your
local chapter.

Support
March of Dimes
BIRTH DEFECTS FOUNDATION



**People
Power**
helps
prevent
birth
defects

Support
March of Dimes



• **Leland Wayne Oliver**, vice president of ITT and group general manager of Components-North America and Cannon Worldwide, announced that **George H. Ashmore**, general manager of ITT Cannon Phoenix, has been elected president of ITT Cannon-North America. As president of this division of ITT Corporation, Mr. Ashmore will be responsible for Cannon plants in Fountain Valley and Santa Ana, CA, Phoenix, AZ, and Whitby, Ontario, Canada. Mr. Oliver, formerly president of Cannon-North America, continued to act in this capacity following his appointment as vice president of ITT and group general manager in March of this year. **Heinz Juenthner**, president of ITT Cannon-International, will continue to head international operations. Mr. Juenthner and Mr. Ashmore will report directly to Mr. Oliver, as well as heads of other companies making up Components-North America.

• **Nimbus Nine Recording, Inc.** of New York City, formerly a private studio, has announced that its doors are now open to outside clients. While the studio continues to enjoy the support of in-house music projects as well as **Messina Enterprises'** production of jingles for major ad campaigns, many new and diverse outside projects have already been completed, including work on **E Street Band** member **Clarence Clemons'** first solo album; a new EP by **Julie Budd**; a new country single produced by songwriting ace **Randy Goodrun** (who penned "You Needed Me" among many other hits); new rock EPs produced by **Rascals** rock group members **Gene Cornish** and **Dino Danelli**; additional music mixing for the soundtrack of the **No-Nuke** film. *In Our Hands*, as well as editing of performance tapes for international ballet star, **Alexander Godunov**. Featured equipment includes a **Trident Series 80** console. **MCI JH-24** multitrack, **JBL 4430** monitors, **EMT** tube stereo reverb, **AKG** two channel

reverb, **Lexicon PCM-42s**, **Pultec** equalizers, **API** compressors, **A&D** compressor/limiters. **Ursa Major Space Station**, **Kepex IIs**, **Gain Brain IIs** and **SMPTE** synchronization for interlocking the multitrack to any other audio or video equipment.

• **Juergen Wahl** has been appointed Applications engineer, **JBL** and **UREI** Professional Products, it was announced by **Ron Means**, vice president of Marketing and Sales for the **JBL** Professional Division. In his new position at **JBL**, Mr. Wahl will provide technical support to the **JBL/UREI** sales and marketing organization, including product training sessions and consultations with **JBL** representatives, dealer personnel, sound contractors and other end-users.

In other **JBL** Professional Division news, **Debra Watson** has been appointed Marketing Services manager for **JBL** Incorporated's Professional Division. Ms. Watson's responsibilities include creation and implementation of brochures and other promotional materials; planning for all trade shows; media budgeting; and serving as staff liaison with the division's advertising agency, **Smith and Meyers**. Previously, she held positions with **Cochrane, Chase, Livingston and Company, Inc.**, and with **American Savings**, where she most recently served as Marketing Project coordinator.

• **RKO Radio Networks** has successfully utilized two **dbx 700** Digital Audio Processors in a coast to coast transmission of a **Little River Band** concert—a broadcasting first.

Supervised in New York by chief engineer **Dave Pollard** and **Joe Maguire**, V.P. and director of Engineering for **RKO**, the transmission of the **Little River Band** performance from the **Universal Amphitheater** in Los Angeles took place on October 23. Digital bit stream information from one **dbx 700** was relayed via satellite to New York where another **dbx 700**

performed the digital to analog conversion for broadcast from **RKO** affiliate stations throughout the country. **RKO Networks** was very impressed with the performance of the **dbx** units. Said **Pollard**, "They performed flawlessly and with exceptional audio quality."

The audio processors were provided by **dbx** and **Martin Audio**, the New York **dbx** Digital dealer.

• **ABC News-Washington** recently used the **Shure Automatic Microphone System** to facilitate the taping of "Voting for Democracy," a news special which documents an important symposium co-sponsored by **ABC** and **Harvard University's Kennedy Institute of Government**.

The symposium brought 47 dignitaries together in the Caucus Room of Washington's **Russell Senate Office Building**, including former Presidents **Gerald R. Ford** and **Jimmy Carter**. Panelists presented papers and discussed at length the various problems of participatory democracy. **ABC** taped 15 hours of discussion, which are being edited down to a one-hour TV special.

Because of the program's format and the large number of participants, the audio portion of the taping presented considerable problems. Those problems, said **Marc Drazin**, **ABC's** technical coordinator for the project, were solved by the **Shure Automatic Microphone System**.

The **Shure AMS** was chosen for the project for several reasons. First, the number of participants and the possibility of quick verbal exchanges ruled out the possibility of standard manual mixing. Second, the system used had to be capable of producing sound reinforcement audio as well as high-quality broadcast audio. Finally, the **AMS's** direction sensitive gating (patent pending) eliminated the need for time-consuming threshold adjustments.

Each participant seated at the table spoke into his or her own **AMS26** Microphone, mounted on a **Shure S33B**

Q: The Department of Defense picked what sound effects library as the one to use in all their radio stations around the world?

The Production EFX Library. 5 stereo albums arranged by categories. Shouldn't you give a listen?

A:



PRODUCTION EFX LIBRARY
2325 Girard Ave. S.
Minneapolis, MN 55405

Circle 46 on Reader Service Card

<p>CONNECTORS AND MICROPHONE CABLES</p>	<p>BLANK-LOADED AUDIO CASSETTES</p>
<p>TAPES & CASSETTES from AMPEX AGFA BASF MAXELL TDK 3M</p>	<p>EMPTY REELS AND BOXES</p>
<p>NAB BROADCAST CARTRIDGES</p>	<p>CASSETTE BOXES, LABELS, ALBUMS</p>
<p>ACCESSORIES</p>	

Ask for our
44 PAGE CATALOG
of
PROFESSIONAL SOUND RECORDING & DUPLICATING SUPPLIES

Recording Supply Div. of Polyline Corp
1233 Rand Road, Des Plaines IL 60016
(312) 298 - 5300

35

Circle 47 on Reader Service Card

Desk Stand. The 47 microphones were divided into three sub-groups, each of which was sent to one of three separate mix locations. At each location, two Shure AMS8000 Mixers were linked together to control the microphones, with the combined output feeding to a multi-channel mixing console. For redundancy, the direct output of each AMS channel fed a Shure A95U Transformer, which in turn fed an individual console channel. Two of the mixing consoles fed a third master console, which also controlled a sub-group of AMS microphones. The output of this master console fed the videotape recording equipment and microwave transmitter located outside the building.

According to the ABC production staff, the project was both simplified and enhanced by the Shure AMS's smooth automatic gating functions and excellent audio quality.

• SMPTE elected a new slate of officers and governors for the 1984-1985 term. Three national officers, Engineering vice president, Financial vice president, and Sections vice president were elected, as were nine new governors. The newly elected Engineering vice president is **Richard G. Streeter**, director of Advanced Development, CBS Broadcast. **Blaine Baker**, president of Motion Picture Laboratories, was elected Financial vice president. Baker was the incumbent. **Sherwin H. Becker**, vice president and director of Engineering, Allied Film Laboratory, was elected Sections vice president. The newly elected governors are: *Canadian Region:* Leonard A. Green, National Film Board of Canada; *Central Region:* John P. Rushe, Sandy Corp.; *Eastern Region:* K. Gerald Evans, WHEC-TV, and Frederick R. Nobbs, Jr., Eastman Kodak Co.; *Hollywood Region:* Donald C. McCroskey, American Broadcasting Co. and Howard T. LaZare, Consolidated Film Industries; *New York Region:* Edward J. Messina, Jr., ABC-TV; *Southern Region:* John D. Wayne Caluger, J. Wayne Caluger & Assoc.; *Western Region:* Stephen D. Kerman, Tektronix, Inc.

• **Criteria Recording Company, Inc.** of Miami, Florida, and **Fanta Professional Services** of Nashville, Tennessee, have entered into a joint venture agreement to market the Criteria mobile recording truck. The 26-ft. GMC transmode, equipped with an MCI 636 console, will be based at Fanta's Nashville headquarters, according to Criteria vice president, **Richard Lee**. Fully equipped for the road, the Criteria truck will be a positive addition of Fanta's extensive mobile recording services.

• **Gene Perry** has been appointed general manager of **Audiotechniques**, New York, it was announced by Audiotechniques president, **Hamilton H. Brosious**. Perry comes to Audiotechniques after eight years with **Harvey Radio** in New York City where he was general manager of the Professional Audio/Video department for the past five years. At Audiotechniques, Perry will direct an expansion program which will include enlarging the sales department, remodeling the New York headquarters at 1619 Broadway, the establishment of a major MCI/Sony parts department and construction of a digital audio editing and transfer suite.

• **William L. Brydia**, president of **Leader Instruments Corporation**, announced that **James S. Mortellaro** has been named director of Marketing, a new position. Mr. Mortellaro will report to Mr. Brydia. Prior to his appointment, Mr. Mortellaro spent the previous year directing the marketing activities of **Tampa Technical Corporation** of which he is a principal. Before becoming actively involved at Tampa Technical, Mr. Mortellaro was staff Marketing manager for **AVX Corporation**, a manufacturer of multi-layer ceramic capacitors.

• **Roy F. Schaub** has rejoined **Audiotronics** as director of Marketing, Audio/CCTV Products. He is responsible for directing Audiotronics national and international audio, CCTV and special product line marketing. Schaub has an extensive background in audio and video products marketing. He was with **Singer Educational and Training Products/GPL CCTV** for 17 years. Before joining Audiotronics in 1978 as Audio Division Marketing director, he was responsible for western region marketing of **Scientific-Atlanta's Cable TV** products. Most recently, Schaub was with **Avicom International**, where he was responsible for marketing video and audio products in the Americas and Far East.

In other promotion news, **Michael J. English** has been promoted to Marketing manager, International/Special Products, reporting to Schaub. In this newly created capacity of combined domestic and international marketing, English will continue to manage the marketing and sales activities of Audiotronics International, Inc. In addition, he will develop sales of audio-visual, CCTV and related products to new categories of customers that often involve a combination of Audiotronics product technologies.

The AKG Studio Sound Award

• In keeping with the AKG tradition of involvement with all that's new in electronic and acoustic engineering, AKG has announced the AKG Studio Sound Award.

The AKG Studio Sound Award is designed to discover and give recognition to those people who are using their personal skills in technical design and sound recording techniques, in order to devise new equipment or produce recordings featuring innovative and original material.

Submissions will be invited from the widest possible spectrum of designers, engineers and students. There will be three categories:

1. *Professional Recording* with entries drawn from recording studios and associated areas.
2. *Broadcast*, radio and T.V. industry.
3. *Non-Professional* aimed at students, semi-professionals and amateurs with an interest in sound recording techniques and equipment.

Reeling in the Gold

• Country music group Alabama has earned their third prestigious Ampex Golden Reel Award for their album, *The Closer You Get*. The LP was mixed and mastered on Ampex tape at Music Recording Studio in Nashville, TN. Ampex Golden Reel Awards are presented to artists and groups who make their master recordings on Ampex tape, and whose sales success of the record exceed 500,000 units for albums and 1,000,000 units for singles, as certified by RIAA, U.S.A. To date, over 400 such awards have been presented worldwide. *The Closer You Get*

The award will go to the person who produces the material or product chosen by a panel of judges as being the most original, innovative entry, and may be given as the result of a new concept in technology or in the original use of existing technology.

It may be given as a result of a totally unique way of using the sound console, microphones and remote sound processing and other equipment, at any stage of the production process from the very first recorded sound to the final production techniques and may be for a pop single or classical recording, a live concert or a drama production. Or, it may be a completely new conceptual approach to equipment design or a new way of using existing equipment creatively. It is not aimed at musical compositions themselves. It is designed for those people who have thought to present the music, the speech, the sound itself in a new, dramatic and innovative way.

Entry forms with conditions of entry are available from AKG Acoustics Limited, 191 The Vale, London W3 7QS.

is Alabama's third album to receive the Ampex Golden Reel Award, and was voted "Album of the Year" at the 17th Annual Country Music Association Awards show.

Alabama selected the June Jam II fund to receive the \$1,000 Ampex Golden Reel Award charity donation. The June Jam II, which raised over \$560,000 for local charities, was a second annual concert sponsored by Alabama which featured themselves, Janie Fricke and William Lee Greenwood of the Oak Ridge Boys.



I'd like to thank my mother, my agent....

She's Winning Her Fight For Independence



Stephanie is 8 years old.

A spinal defect at birth left her paralyzed below the hips.

She walks with the aid of braces and crutches and has the fighting spirit to achieve a bright future.

Thousands of children like Stephanie... and adults, too... get the help they need from Easter Seals to carry on their fight for an independent life.

Your help is needed, too.

**Back a
Fighter
with
Easter
Seals**



Classified

BLANK AUDIO AND VIDEO CASSETTES direct from manufacturer, below wholesale, any length cassettes: 4 different qualities to choose from. AMPEX and AGFA mastertape—from 1/4-inch to 2-inch. Cassette duplication also available. VHS T-120's \$6.00. Brochure. **Andol Audio Products, Inc., Dept. db, 42-12 14th Ave., Brooklyn, NY 11219. Toll free 1-800-221-6578, ext. 1, NY residents (212) 435-7322.**

SOLID STATE LOGIC 4000B series console 40/32/4 fully updated including latest computer soft/hardware. For full details contact **Rod Vickery, Virgin Holdings Ltd, 95-99 Ladbroke Grove, London W11, England. Tel: 01-229-1282 or Telex 8954617.**

(20) MELCOR EQs modified to 12k: \$125 each. (15) FLICKINGER parametric EQs: Best offer. API 440 faders: \$30 each. **Dan: (415) 441-8912 or 441-4789.**

AMPEX REEL TO REEL/CASSETTE TAPE. Grandmaster/High Performance. Pro Stereo/Mono Duplication. Volume Wholesale Pricing. **MSC "The Cassette Works," 806 W. 7th, Amarillo, TX 79101. (806) 373-8473.**

FOR SALE: Scully 280 eight track head stack plus all guides. Best Offer. Looking for 288 Scully electronics four card. **Mike (201) 423-4625 or (201) 423-0815.**

MICROPHONES Immediate delivery via UPS. All popular models in stock Best prices you'll see in '83: PLUS we pay freight **UAR Professional Systems, 8535 Fairhaven, San Antonio, TX 78229. (512) 690-8888.**



MODEL X-700RPS
Stereo Record-Play
Tape Cartridge Machine
Net Price \$1000.00
TAPECASTER TCM, INC.
BOX 662
ROCKVILLE, MARYLAND 20851
800 638-0977



FREQUENCY SHIFTING STILL THE SAFEST WAY TO DEFEAT FEEDBACK HOWL DUE TO STANDING WAVES • FIND OUT ABOUT OUR FEEDBACK STABILIZERS MOD. 741XR & 742XR.

BODE SOUND CO.
1344 ABINGTON PL.
NO. TONAWANDA, N. Y. 14120
716-692-1670

DIRECT FROM BROADWAY

USED SOUND EQUIPMENT SALE

PETER PAN • FIDDLER • CAMELOT KING & I • CHORUS LINE • DOLLY
Wireless Microphones
Used By The Stars
AMPS • MIXERS • RECORDERS
all guaranteed

 **SOUND ASSOCIATES, INC.**
424 WEST 45 ST. • N.Y. NY 10036
TELEPHONE 212 757-5679

PACHBURN AUDIO NOISE SUPPRESSOR
For all recorded sound media

The choice of recording industry, archives and collectors around the world.

Three processors for reduction of transient and steady-state noises Plus special features for optimum reproduction of old records, lateral or vertical

Mono model \$1,950; Mono/Stereo \$2,450

Write for literature to
P. O. Box 335 Dewitt NY USA 13214-0335

FOR SALE: (1) MCI JH428B console and (1) MCI JH100 24-track with A/L II. Excellent Condition. Best Offer. (212) 362-8100.

FREE 32pg Catalog & 50 Audio/Video Applic.

PHONO, MIC, TRANS, ACN, TAPE, VIDEO, LINE, OSC

Stereo/Mono Pwr Ampl.  

Video & Audio Dist Amps. 8-in./2-out, 12-in./4-out, 18-in./4-out
TV Audio & Recd Prod Console

OPAMP LABS INC (213) 934-3566
1033 N Sycamore Av LOS ANGELES CA, 90038

THE MOST COMPLETE SELECTION OF

AUDIO TEST TAPES

All formats including cassettes
Write or phone for free catalog

STL

STANDARD TAPE LABORATORY, INC.
26120 Eden Landing Road #5, Hayward, CA 94545
(415) 786-3546

FOR SALE
Stephens 40 Track Model 811, excellent condition, and Stephens 24 Track Recorder Model 821, excellent condition. Cleanest and quietest transformerless design. Comes fully equipped with microprocessor based auto locator, 10 commands and cycle function, reads locations in feet or seconds. VSO with speed readout in tenths of seconds. Full function remote control included. Interested parties please reply to **Dept. 65, db Magazine, 1120 Old Country Rd., Plainview, NY 11803.**

- 1 3M M79/16 TRACK, W/SELECTAKE II. WIRED FOR 16, 10 1/2" REELS, 15 & 30 IPS, WITH LESS THAN 50 HRS USE \$15,000
 - 2 JBL 4343 WX STUDIO MONITORS \$750/ea
 - 4 YAMAHA P2200 AMPLIFIERS \$600/ea
 - 2 UREI 525 CROSSOVERS .. \$400/ea
 - 1 AMPEX ATR 700 LESS THAN 100 HOURS OF USE \$1,100
- ALL OF THE ABOVE IN MINT CONDITION. FOR MORE INFORMATION CALL: (305) 538-2281.

Stephen's 820-B-24, 2-inch, 16-track (24 Ready) Recorder/Reproducer in like new condition and (1) Sound Workshop Series 1600 (20 x 16 x 2) Automated—Ready Recording Console. For specifications call the **University of Delaware telephone (302) 738-2168.**

CONCERT SOUND CO. selling one of two complete concert sound systems, modular design will do from 1000 to 15,000 seat venues. 4-way JBL spk system, complete 20 x 8 monitor system, snake/splitter system, Crown power, U.R.E.I. electronics (system does not include mics or house console). Will sell house. or mon. systems separately. Also Prime Time and Roland SRE-555 chorus/echo. **Call (715) 483-9315.**

PERSONAL STUDIO FOR SALE: MCI 8 track w/dbx Noise Reduction. Quantum 12 in—8 out console. 2 dbx compressor/limiters. AKG BX 10 Reverb. Excellent condition. (316) 264-5210.

2 TELEFUNKEN 251-E mikes in original wood boxes. 2 power supplies, 100 ft. cable for each mike. Good working condition. \$2000 each. Gerald Lewis Recording, Arlington, VA. (703) 521-1871.

AGFA CHROME and normal bias BLANK CASSETTES. CUSTOM LOADING to the length you need. Your music deserves the best—your budget deserves a bargain. GRD P.O. Box 13054, Phoenix, AZ 85002. (602) 252-0077.

FOR SALE: Scully 280—8 track. Good Condition. Best offer. Reason for selling—gone 16 track. Birch Recording Studio (301) 943-8141.

SENSURROUND LOW FREQUENCY ENCLOSURES with 18" CER-VEG 300 watt die-cast 96 oz. magnet driver. \$195.00. Empirical Sound, 1234 East 26th Street, Cleveland, OH 44114. (216) 241-0668.

THE LIBRARY. Sound effects recorded in STEREO using Dolby throughout. Over 350 effects on ten discs. \$100.00. Write The Library, P.O. Box 18145, Denver, CO 80218.

TECHNICS TURNTABLES IN STOCK! AKG. Neumann. UREI. Orban Eventide. dbx. Lexicon. Best pro-audio equipment. Lowest prices. IMMEDIATE DELIVERY. UAR Professional Systems. (512) 690-8888.

FOR SALE—AKG C-24 and other tube type condenser mics. (415) 441-8934 or 527-4789.

BUSINESS OPPORTUNITIES

YOUR OWN RECORDING SCHOOL/STUDIO

National audio educational franchises now available for private ownership! Operate fully equip school/studio in your community. State approved courses developed over a 14 year period. Turnkey business including studio construction, equipment, pretraining, marketing, advertising, grand opening and ongoing assistance. Low initial investment! Dawn Audio, 756 Main St., Farmingdale, NY 11735. (516) 454-8999.

SERVICES

REAL TIME CASSETTE DUPLICATION. Custom Length B.A.S.F. Chrome Tape. Use your inserts or ours...Labels by Computer of Print. Norelco Boxes and Shrink Wrapped. Short Runs O.K. Low Cost-Fast Service. Call John—Boyd COLLECT for Cost. MUSICOL, INC. Columbus, OH (614) 267-3133.

New York Technical Support, Ltd

IS SERVICE

*"We provide the
support necessary
for today's recording
technology. Our
work is guaranteed."*

CALL
GREG HANKS
914-776-2112

1440 MIDLAND AVE., SUITE-1D
BRONXVILLE, NY 10708

CASSETTE DUPLICATION IN real time from 10-10,000. Nakamichi cassette decks used for optimum quality. Best rates. Labels, inserts and shrink wrap available. Fast turn around. Audiohouse (303) 751-2268.

PCM-F1 USERS! Starting an international newsletter of applications, modifications, theory, who's doing what, etc. If interested please send your name, address, ideas and \$2 to: DIGITAL AUDIO, c/o Mediatech, P.O. Box 335, Natick, MA 01760, U.S.A.

ACOUSTIC CONSULTATION—Specializing in studios, control rooms, discos. Qualified personnel, reasonable rates. Acoustilog, Bruel & Kjaer, HP, Tektronix. Irvie equipment calibrated on premises. Reverberation timer and RTA rentals. Acoustilog, 19 Mercer Street, New York, NY 10013. (212) 925-1365.

EMPLOYMENT

INSTRUCTORS—AUDIO TECHNOLOGY, VIDEO TECHNOLOGY, ELECTRONICS Full-time and part-time faculty openings to teach basic and advanced technology at leading proprietary technical institute. Industry experience and/or teaching experience required. Professional, satisfying atmosphere. Dynamic Greenwich Village location. Send resume and salary history to Philip Stein, Director, INSTITUTE OF AUDIO RESEARCH, 64 University Place, New York, NY 10003.

RECORDING SERVICES ENGINEER

The Eastman School of Music Department of Recording Services is currently seeking a Maintenance Engineer with responsibilities to include: maintenance of professional recording, sound re-enforcement and tape duplication; closed circuit television and tape-to-disc transfer systems; design of control systems and special audio circuitry and equipment requirements. Proficiency is required in the use of all types of test equipment. Digital technology is required. Prefer five years experience in professional studio maintenance operations. Send resume to: Personnel Department, University of Rochester, Box 636D, 260 Crittenden Blvd., Rochester, NY 14642. Equal Opportunity Employer. M/F.

AUDIO EQUIPMENT MAINTENANCE ENGINEER

New York City 24-track recording facility has opening for qualified person. Minimum three years studio experience. Excellent growth opportunity. Salary commensurate with qualifications. Resume to: Right Track Recording, 168 W. 48th St., New York, NY 10036. Attn: Simon Andrews. (212) 944-5770.

AUDIO TECHNICIAN

Top salary and profit sharing for qualified candidate. Sound Company specializing in installation of hotel systems nationwide seeks audio technician with following qualifications:

- Minimum three years experience and proficiency in installation and servicing of hotel sound systems.
- Technical knowledge of sound products including JBL, Crown and Altec.
- Experience working with blueprints and electrical contractors.
- Ability to design layouts for 70 volt and entertainment systems.
- Able to travel extensively and relocate to Florida.

Send resume to Mr. Jary Rea, London Town Associates, Inc., 2101 S.W. 27th Ave., Miami, FL 33143. (305) 858-7000 collect.

1983 Index

INDEX BY AUTHOR

- Alexandrovich, George.** Sound Recording and Sound Processing Technology—16 Years Later. Nov., 1983, p. 41.
- Anthony, Bob.** House Sound Reinforcement at the US Festival. Sept., 1983, p. 52.
- Borwick, John.** 73rd AES Convention: Eindhoven. April, 1983, p. 42.
- Brewster, Robert C., Jr.** Montreal Sound Studio. May, 1983, p. 29.
- Carr, Beau.** Audio Installation at the Fort Worth Museum of Science and History. July/August, 1983, p. 29.
- Coddington, R. H.** Some Noise About Noise. June, 1983, p. 43.
- Colleran, Nicholas.** The Virginia Center for the Performing Arts: The Installer's Viewpoint. Dec., 1983, p. xx.
- Collins, Diane.** A Journey Through Time. Oct., 1983, p. 32.
- Crowhurst, Norman.** Patents, Copyrights, and "Pirating": Some Perspective. Oct., 1983, p. 6.
- Davis, Carole, B.** The Music Goes Round and Round. Oct., 1983, p. 28.
- Delantoni, John.** The National Association of Professional Audio Manufacturers (NAPAM). Nov., 1983, p. 6.
- Eargle, John.** JBL's Central Array Design Program (CADP). July/August, 1983, p. 41.
- Eargle, John.** Sound Reinforcement—The State of the Art—16 Years Later. Nov., 1983, p. 47.
- Gelow, William J.** Compression Drivers Old and New. July/August, 1983, p. 46.
- Gizzi, Vin.** Designing Audio for Video. March, 1983, p. 44.
- Goode, J. Mark.** The Gold Line 30 Real-Time Analyzer. Feb., 1983, p. 35.
- Goode, J. Mark.** The Shure AMS8000 Automatic Mixer. June, 1983, p. 35.
- Hanks, Gregory.** Recording Studio Consoles and Film Production. Sept., 1983, p. 42.
- Hanks, Gregory.** Recording Studio Consoles and Film Production, Part II. Dec., 1983, p. xx.
- Hansen, John C. and White, Philip S.** The Creation of a New Studio Microphone. June, 1983, p. 27.
- Hay, Thomas.** A Postscript on Grounding. April, 1983, p. 37.
- Hockman, Gregory M.** You Can't Just Listen to a Microphone. June, 1983, p. 32.
- Hughes, Richard L. and Johnson, Milton F.** Acoustic Designs in Natatoriums. April, 1983, p. 34.
- Kaplowitz, Matthew.** The Creative Process in Audio-for-Video. May, 1983, p. 39.
- Keene, Sherman.** The Tale of the Telearte Recording Studio. Feb., 1983, p. 38.
- King, Larry.** The Virginia Center for the Performing Arts: The Acoustical Design. Dec., 1983, p. xx.
- Klapholz, Jesse.** Seeing What You Here, Part II. Dec., 1983, p. xx.
- Landmann, Christopher.** Landesstudio Steiermark. April, 1983, p. 26.
- McKenna, Mark.** Bearsville's Control Room B—Remodelling for the 80's. Nov., 1983, p. 22.
- McLaughlin, David L. and Bolles, Robert F.** Superjam '82. April, 1983, p. 26.
- Metzler, Bob.** Automated Audio Test Systems for Professional Audio Requirements. March, 1983, p. 39.
- Monforte, John.** The Bruel & Kjaer Studio Microphones. Sept., 1983, p. 46.
- Monforte, John.** The Orban 422A/424A Gated Compressor/Limiter/De-esser. July/August, 1983, p. 38.
- Morrison, Robert K.** Boundary Displacement Recording. May, 1983, p. 50.
- Mullin, John T.** Long Players—Long Gone. Sept., 1983, p. 48.
- Nikanorov, Vladimir.** Digital Broadcasting: Upcoming Revolution. March, 1983, p. 29.
- Pizzi, Skip.** Tips on Recording From the Telephone. March, 1983, p. 50.
- Pohlmann, Ken.** The Analog-to-Digital Transition: Development of a Consumer Clarification Code. Jan., 1983, p. 34.
- Pohlmann, Ken.** Halls for Music: Two Decades of Experience. April, 1983, p. 40.
- Pohlmann, Ken.** The MCI JH-800 Console: A Survival Report. March, 1983, p. 55.
- Pohlmann, Ken.** The 74th AES Convention. Oct., 1983, p. 36.
- Rupert, James F. and Roberts, Michael.** Keep on Tracking: Barry Ainsworth and Mobile One. Feb., 1983, p. 31.
- Schafer, Curtiss.** The Cortical Hearing Aid. May, 1983, p. 35.
- Silver, Sidney L.** Electronic Devices With the Power of Speech. Feb., 1983, p. 42.
- Simmons, Warren.** Analog Mastering Tape vs Digital Mastering Tape. Jan., 1983, p. 26.
- Tapes, Michael.** Compact Disc Analysis. Sept., 1983, p. 56.
- Trost, Mark.** VCA Teletronics Makes a Special Delivery. Dec., 1983, p. xx.
- Wells, Jim.** Audio/Musical Design for Animated Shows. Nov., 1983, p. 28.
- Woram, John M.** National Association of Broadcaster's Annual Convention and Exposition. May, 1983, p. 45.
- Woram, John M.** Orion Reference Guides. April, 1983, p. 38.
- Woram, John M.** The 72nd AES Convention, Part II. Jan., 1983, p. 44.
- Woram, John M.** Time Code Implementation. Jan., 1983, p. 40.

INDEX BY TITLE

- Acoustic Designs in Natatoriums.** Richard L. Hughes and Milton F. Johnson. April, 1983, p. 34.
- Analog Mastering Tape vs Digital Mastering Tape.** Warren Simmons. Jan., 1983, p. 26.
- Analog-to-Digital Transition, The: Development of a Consumer Clarification Code.** Ken Pohlmann. Jan., 1983, p. 34.
- Audio Installation at the Fort Worth Museum of Science and History.** Beau Carr. July/August, 1983, p. 29.
- Audio/Musical Design for Animated Shows.** Jim Wells. Nov., 1983, p. 28.
- Automated Audio Test Systems for Professional Audio Performance Requirements.** Bob Metzler. Nov., 1983, p. 28.
- Requirements.** Nov., 1983, p. 28.
- Bearsville's Control Room B—Remodelling for the 80's.** Mark McKenna. Nov., 1983, p. 22.
- Boundary Displacement Recording.** Robert K. Morrison. May, 1983, p. 50.
- Bruel & Kjaer Studio Microphones, The.** John Monforte. Sept., 1983, p. 46.
- Compact Disc Analysis.** Michael Tapes. Sept., 1983, p. 56.
- Compression Drivers Old and New.** William Gelow. July/August, 1983, p. 46.
- Cortical Hearing Aid, The.** Curtiss Schafer. May, 1983, p. 35.
- Creation of a New Studio Microphone, The.** John C. Hansen and Philip S. White. June, 1983, p. 27.
- Creative Process in Audio-for-Video, The.** Matthew Kaplowitz. May, 1983, p. 39.
- Designing Audio for Video.** Vin Gizzi. March, 1983, p. 44.
- Digital Broadcasting: Upcoming Revolution.** Vladimir Nikanorov. March, 1983, p. 44.
- Electronic Devices With the Power of Speech.** Sidney L. Silver. Feb., 1983, p. 42.
- Gold Line Real-Time Analyzer, The.** J. Mark Goode. Feb., 1983, p. 35.
- Halls for Music: Two Decades of Experience.** Ken Pohlmann. April, 1983, p. 40.
- House Sound Reinforcement at the US Festival.** Bob Anthony. Sept., 1983, p. 52.
- JBL's Central Array Design Program (CADP).** John Eargle. July/August, 1983, p. 41.

Journey Through Time. A. Diane Collins. Oct., 1983. p. 32.

Keep on Tracking: Barry Ainsworth and Mobile One. James F. Rupert and Michael Roberts. Feb., 1983. p. 31.

Landesstudio Steiermark. Christopher Landmann. April, 1983. p. 26.

Long Players—Long Gone. John T. Mullin. Sept., 1983. p. 48.

MCI JH-800 Console, The: A Survival Report. Ken Pohlmann. March, 1983. p. 55.

Montreal Sound Studio. Robert C. Brewster, Jr. May, 1983. p. 29.

Music Goes Round and Round, The. Carole B. Davis. Oct., 1983. p. 28.

National Association of Broadcaster's Annual Convention and Exposition. John M. Woram. May, 1983. p. 45.

National Association of Professional Audio Manufacturers (NAPAM), The. John Delantoni. Nov., 1983. p. 6.

Orban 422A/424A Gated Compressor/Limiter/De-esser. John Monforte. July/August, 1983. p. 38.

Orion Reference Guides. John M. Woram. April, 1983. p. 38.

Patents, Copyrights, and "Pirating": Some Perspective. Norman Crowhurst. Oct., 1983. p. 6.

Postscript on Grounding. A. Thomas Hay. April, 1983. p. 37.

Recording Studio Consoles and Film Production. Gregory Hanks. Sept., 1983. p. 42.

Recording Studio Consoles and Film Production. Part II. Gregory Hanks. Dec., 1983. p. xx.

Seeing What You Here. Jesse Klapholz. Nov., 1983. p. 33.

Seeing What You Here. Part II. Jesse Klapholz. Dec., 1983. p. xx.

72nd AES Convention. The: Part II. John M. Woram. Jan., 1983. p. 44.

73rd AES Convention, The: Eindhoven. John Borwick. April, 1983. p. 42.

74th AES Convention. The. Ken Pohlmann. Oct., 1983. p. 36.

Shure AMS8000 Automatic Mixer, The. J. Mark Goode. June, 1983. p. 35.

Some Noise About Noise. R. H. Coddington. June, 1983. p. 43.

Sound Recording and Sound Processing Technology—16 Years Later. George Alexandrovich. Nov., 1983. p. 41.

Sound Reinforcement—The State of the Art—16 Years Later. John Eargle. Nov., 1983. p. 47.

Superjam '82. David L. McLaughlin and Robert F. Bolles. April, 1983. p. 30.

Tale of the Telearte Recording Studio, The. Sherman Keene. Feb., 1983. p. 38.

Time Code Implementation. John M. Woram. Jan., 1983. p. 40.

Tips on Recording From the Telephone. Skip Pizzi. March, 1983. p. 50.

VCA Teletronics Makes a Special Delivery. Mark Trost. Dec., 1983. p. xx.

Virginia Center for the Performing Arts: The Acoustical Design. Larry King. Dec., 1983. p. xx.

Virginia Center for the Performing Arts: The Installer's Viewpoint. Nicholas Colleran. Dec., 1983. p. xx.

You Can't Just Listen to a Microphone. Gregory Hockman. June, 1983. p. 32.

INDEX BY COLUMNIST

BARRY BLESSER

Applications of Re-sampling. Oct., 1983. p. 25.

Clock Generation. Dec., 1983. p. xx.

Digital Filters, Part V. Jan., 1983. p. 11.

End of Digital Filtering, The. Feb., 1983. p. 8.

Modulation Controls, Continued. April, 1983. p. 20.

Re-sampling. July/August, 1983. p. 18.

Re-sampling the Re-sampling Idea. Sept., 1983. p. 28.

Talking to Each Other. June, 1983. p. 22.

Transmission and Distribution. March, 1983. p. 16.

Upconverting D/A. Nov., 1983. p. 16.

Wires and Busing. May, 1983. p. 14.

JOHN EARGLE

Automatic Microphone Mixers. Dec., 1983. p. xx.

Environmental Effects in Sound Reinforcement. April, 1983. p. 16.

Equalization in Sound Reinforcement Systems, Part I. May, 1983. p. 26.

Equalization in Sound Reinforcement Systems: Control Room Monitors. June, 1983. p. 18.

Equalization in Sound Reinforcement Systems: Motion Picture Theatre Systems. July/August, 1983. p. 22.

Extending Power Bandwidth at Low Frequencies: Mutual Coupling. March, 1983. p. 20.

Incompatibility Dilemma, The. Feb., 1983. p. 14.

Line Distribution Systems. Jan., 1983. p. 14.

Microphones in Sound Reinforcement. Oct., 1983. p. 19.

Microphones in Sound Reinforcement, Part II. Nov., 1983. p. 8.

Microphones in Sound Reinforcement, Part III: Calculating and Measuring the Gain of a Sound Reinforcement System. Sept., 1983. p. 37.

LEN FELDMAN

Audio and Video Standards for 8mm Video Tape. June, 1983. p. 10.

Betamovie Cuts the Umbilical Cord. July/August, 1983. p. 12.

Colored Sound. Feb., 1983. p. 18.

Digital TV Video and Audio. April, 1983. p. 8.

Good Sound Ideas Never Die. May, 1983. p. 10.

More "Bits" and Pieces in the Quest for Better Audio. Jan., 1983. p. 16.

Stereo and High Definition TV Update. Oct., 1983. p. 22.

VHS Plays Audio "Catch-Up" With Beta. Sept., 1983. p. 19.

Worthy Competitor for Digital Audio, A. March, 1983. p. 22.

KEN POHLMANN

Case of the Resonating Restaurant. The. June, 1983. p. 14.

Compatibility Solution, The. April, 1983. p. 12.

Floppy Tutorial, A. May, 1983. p. 22.

Incompatibility, Dilemma, The. Feb., 1983. p. 14.

Night at the Opera, A. Jan., 1983. p. 20.

Other Digital Revolution, The. Nov., 1983. p. 12.

Roll Over Helmholtz. Sept., 1983. p. 10.

Secret of Flux Reversal, The. Oct., 1983. p. 10.

SPARS Meets Students. March, 1983. p. 20.

Waiting for Godot. July/August, 1983. p. 24.

INDEX BY SUBJECT

ACOUSTICS

Acoustic Designs in Natatoriums. Richard L. Hughes and Milton F. Johnson. April, 1983. p. 34.

JBL's Central Array Design Program (CADP). John Eargle. July/August, 1983. p. 41.

Virginia Center for the Performing Arts: The Acoustical Design. Larry King. Dec., 1983. p. xx.

AUDIO/VISUAL

Audio/Musical Design for Animated Shows. Jim Wells. Nov., 1983. p. 28.

Creative Process in Audio-for-Video, The. Matthew Kaplowitz. May, 1983. p. 39.

Designing Audio for Video. Vin Gizzi. March, 1983. p. 44.

Recording Studio Consoles and Film Production. Gregory Hanks. Sept., 1983. p. 42.

Recording Studio Consoles and Film Production, Part II. Gregory Hanks. Dec., 1983. p. xx.

VCA Teletronics Makes a Special Delivery. Mark Trost. Dec., 1983. p. xx.

BOOK REVIEWS

Halls for Music: Two Decades of Experience. Ken Pohlmann. April, 1983. p. 40.

Orion Reference Guides. John M. Woram. April, 1983. p. 37.

BROADCAST

- Digital Broadcasting: Upcoming Revolution.** Vladimir Nikanorov. March, 1983, p. 29.
- Tips on Recording From the Telephone.** Skip Pizzi. March, 1983, p. 50.
- VCA Teletronics Makes a Special Delivery.** Mark Trost. Dec., 1983, p. xx.

CONVENTION REPORTS

- National Association of Broadcaster's Annual Convention and Exposition.** John M. Woram. May, 1983, p. 45.
- 72nd AES Convention, Part 2.** John M. Woram. Jan., 1983, p. 44.
- 73rd AES Convention: Eindhoven.** John Borwick. April, 1983, p. 42.
- 74th AES Convention.** Ken Pohlmann. Oct., 1983, p. 36.

CONSOLES

- MCI JH-800 Console, The: A Survival Report.** Ken Pohlmann. Oct., 1983, p. 36.
- Recording Studio Consoles and Film Production.** Gregory Hanks. Sept., 1983, p. 42.
- Recording Studio Consoles and Film Production, Part II.** Gregory Hockman. Dec., 1983, p. xx.

DIGITAL AUDIO

- Analog Mastering Tape vs Digital Mastering Tape.** Warren Simmons. Jan., 1983, p. 26.
- Analog-to-Digital Transition, The: Development of a Consumer Clarification Code.** Ken Pohlmann. Jan., 1983, p. 34.
- Compact Disc Analysis.** Michael Tapes. Sept., 1983, p. 56.
- Digital Broadcasting: Upcoming Revolution.** Vladimir Nikanorov. March, 1983, p. 29.

HISTORICAL

- Compression Drivers Old and New.** William Gelow. July/August, 1983, p. 46.
- Long Players—Long Gone.** John T. Mullin. Sept., 1983, p. 48.
- Music Goes Round and Round, The.** Carole B. Davis. Oct., 1983, p. 28.
- Sound Recording and Sound Processing Technology—16 Years Later.** George Alexandrovich. Nov., 1983, p. 41.

INTERNATIONAL AUDIO

- Keep on Tracking: Barry Ainsworth and Mobile One.** James F. Rupert and Michael Roberts. Feb., 1983, p. 31.
- Landesstudio Steiermark.** Christopher Landmann. April, 1983, p. 26.
- Montreal Sound Studio.** Robert C. Brewster, Jr. May, 1983, p. 29.
- Tale of the Telearte Recording Studio.** Sherman Keene. Feb., 1983, p. 38.

MICROPHONES

- Bruel & Kjaer Studio Microphones.** The. John Monforte. Sept., 1983, p. 46.
- Creation of a New Studio Microphone.** The. John C. Hansen and Philip S. White. June, 1983, p. 27.
- New Microphone Products.** June, 1983, p. 38.
- Shure AMS8000 Automatic Mixer.** The. J. Mark Goode. June, 1983, p. 35.
- Some Noise About Noise.** R. H. Coddington. June, 1983, p. 43.
- You Can't Just Listen to a Microphone.** Gregory Hockman. June, 1983, p. 32.

MISCELLANEOUS

- Cortical Hearing Aid.** The. Curtiss Schafer. May, 1983, p. 35.
- Electronic Devices With the Power of Speech.** Sidney L. Silver. Feb., 1983, p. 42.
- Journey Through Time.** A. Diane Collins. Oct., 1983, p. 32.
- Postscript on Grounding.** A. Thomas Hay. April, 1983, p. 37.

RECORDING TECHNOLOGY

- Boundary Displacement Recording.** Robert K. Morrison. May, 1983, p. 50.
- Sound Recording and Sound Processing Technology—16 Years Later.** George Alexandrovich. Nov., 1983, p. 41.
- Time Code Implementation.** John M. Woram. Jan., 1983, p. 40.
- Tips on Recording From the Telephone.** Skip Pizzi. March, 1983, p. 50.

SOUND REINFORCEMENT

- Audio Installation at the Fort Worth Museum of Science and History.** Beau Carr. July/August, 1983, p. 29.
- House Sound Reinforcement at the US Festival.** Bob Anthony. Sept., 1983, p. 52.
- Sound Reinforcement—The State of the Art—16 Years Later.** John Eargle. Nov., 1983, p. 47.
- Superjam '82.** David L. McLaughlin and Robert F. Bolles. April, 1983, p. 30.
- Virginia Center for the Performing Arts: The Installer's Viewpoint.** Nicholas Collier. Dec., 1983, p. xx.

STUDIOS

- Bearsville's Control Room B—Remodelling for the 80's.** Mark McKenna. Nov., 1983, p. 22.
- Designing Audio for Video.** Vin Gizzi. March, 1983, p. 44.
- Keep on Tracking: Barry Ainsworth and Mobile One.** James F. Rupert and Michael Roberts. Feb., 1983, p. 31.
- Landesstudio Steiermark.** Christopher Landmann. April, 1983, p. 26.
- Montreal Sound Studio.** Robert C. Brewster, Jr. May, 1983, p. 29.

- Tale of the Telearte Recording Studio.** The. Sherman Keene. Feb., 1983, p. 38.

TEST REPORTS

- Bruel & Kjaer Studio Microphones.** The. John Monforte. Sept., 1983, p. 46.
- Gold Line Real-Time Analyzer.** The. J. Mark Goode. Feb., 1983, p. 35.
- MCI JH-800 Console, The: A Survival Report.** Ken Pohlmann. March, 1983, p. 55.
- Orban 422A/424A Gated Compressor/Limiter/De-esser.** John Monforte. July/August, 1983, p. 38.

TESTS & MEASUREMENTS

- Automated Audio Test Systems for Professional Audio Performance Requirements.** Bob Metzler. March, 1983, p. 39.
- Seeing What You Here.** Jesse Klapholz. Nov., 1983, p. 33.
- Seeing What You Here, Part II.** Jesse Klapholz. Dec., 1983, p. xx.
- Some Noise About Noise.** R. H. Coddington. June, 1983, p. 43.
- You Can't Just Listen to a Microphone.** Gregory Hockman. June, 1983, p. 32.

HAVE A RECORDING STUDIO PROBLEM? Call DataLine (213) 651-4944

The Society of Professional Audio Recording Studios, a non-profit organization, offers SPARS members, and non-members referred by a SPARS member, a national telephone 'hot-line.'

Questions regarding any area of recording studio operations including business practices, audio engineering, and technical maintenance will be answered by SPARS-approved sources at no charge.

Want a problem solved?
Call SPARS—
(213) 651-4944



SPARS Board of Directors and Consultants

Murray R. Allen
Universal Recording
Corporation, Chicago

Jerry Barnes
United Western Studios
Los Angeles

Charles Benantsy
Soundworks Digital
Audio Video Studios
New York

Larry Boden
jvc Cutting Center
Los Angeles

Bruce Bounck
Digital Magnetics
Los Angeles

Black Emerman
Criterion Recording
Miami

Bob Lifan
Regent Sound
New York

Lenard Pearlman
Eitel Chicago

John Rosen
Papa Professional
Services, Nashville

Malcolm Pearce Rosenberg
Wala & Rosenberg
Philadelphia

Christopher Stone
Record Point, Inc.
Los Angeles

Joseph D. Tarsia
Sigma Sound Studios
Philadelphia

David Teig
New York

John Woram
Woram Audio Associates
New York

Satisfying, pure digital reverb at an affordable price.

If you think that's impossible, you haven't heard the Model 200—Lexicon's latest.

The 200 is the first economical general-purpose digital reverberator designed for recording studios, musicians, film/video production houses, and broadcasters. Its versatility and high quality are matched only by its low price.

The 200's advanced technology brings you:

Hall, Plate, and Chamber programs — each with 10 preset variations — all in full stereo

Size control — from a closet to the Taj Mahal — dramatically increasing the versatility of each program

Adjustable predelay and reverb time

Programmable nonvolatile memory for storing up to 10 user setups with instant recall

Selectable diffusion, reverb time contour, rolloff, and early echoes

Affordable, natural-sounding digital reverb is not impossible—call your Lexicon dealer today.

Remote control functions for stage performances

Human-engineered panel controls for easy, intuitive operation

On-board mixing

Input level switch to accommodate a wide range of instruments and input sources

Balanced input and output connections with a maximum signal level of +24 dBm



lexicon

60 Turner Street
Waltham, MA 02154 USA
(617) 891-6790
Telex 923468

Export:
Gotham Export
Corporation,
New York, NY 10014

Circle 11 on Reader Service Card

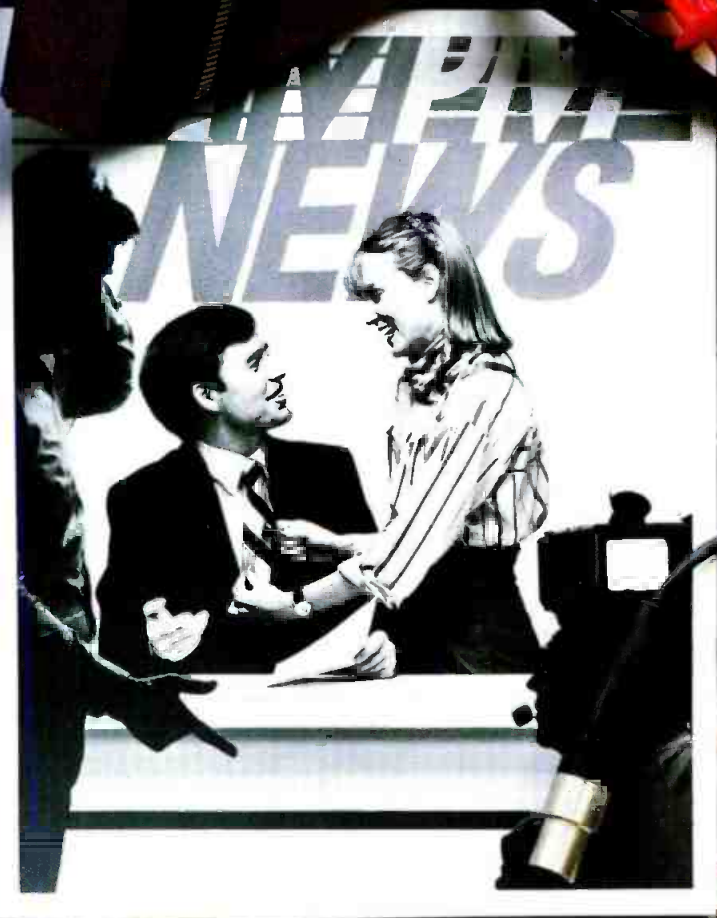

Our new lavalier mic makes everyone look good. Introducing the SM83.

People in news broadcasting have been using the same lavalier mic for a long time. But our new Shure SM83 is out to change all that. It's just what everyone has been asking for in an omnidirectional condenser microphone.

On-camera talent like the SM83 because its electronics provide for a dip in the mid-range, giving both male and female voices a smoother, more natural sound. And unlike its Japanese counterpart, the SM83 unplugs from the battery pack for easy storage.

Sound engineers appreciate the SM83 because its tailored frequency response requires less equalization. They like its low-frequency rolloff too, which quiets on-air rumbling and mechanical and clothing noise.

Set directors are impressed with the SM83's neat appearance on camera. The cord exits from the side and disappears from view, running down behind a tie, shirt or blouse.

Production assistants enjoy the SM83's mounting versatility. It comes with a single clip that works either vertically or horizontally, a double clip that holds two mics, and a universal mount that can be sewed, pinned or taped to clothing.

Repair technicians love the SM83's easy maintenance. The cartridge is easily accessible by unscrewing the end cap. And cable replacement requires only a screwdriver and tweezers; no soldering is necessary.

Field crews are also big fans of the SM83 because its electronic pack is powered by a standard 9-volt battery or by a mixer's phantom supply.

For more information on the Shure SM83, the little mic with big advantages, call or write Shure Brothers Inc., 222 Hartrey Ave., Evanston, IL 60204. (312) 866-2553.

SHURE®

THE SOUND OF THE PROFESSIONALS®...WORLDWIDE

Circle 12 on Reader Service Card