

10155 10th Avenue NE  
Seattle, WA 98108  
206 762-2200  
206 762-2201  
206 762-2202  
206 762-2203  
206 762-2204  
206 762-2205  
206 762-2206  
206 762-2207  
206 762-2208  
206 762-2209  
206 762-2210  
206 762-2211  
206 762-2212  
206 762-2213  
206 762-2214  
206 762-2215  
206 762-2216  
206 762-2217  
206 762-2218  
206 762-2219  
206 762-2220  
206 762-2221  
206 762-2222  
206 762-2223  
206 762-2224  
206 762-2225  
206 762-2226  
206 762-2227  
206 762-2228  
206 762-2229  
206 762-2230  
206 762-2231  
206 762-2232  
206 762-2233  
206 762-2234  
206 762-2235  
206 762-2236  
206 762-2237  
206 762-2238  
206 762-2239  
206 762-2240  
206 762-2241  
206 762-2242  
206 762-2243  
206 762-2244  
206 762-2245  
206 762-2246  
206 762-2247  
206 762-2248  
206 762-2249  
206 762-2250

COMBINED ANALOG AND DIGITAL PRODUCTION

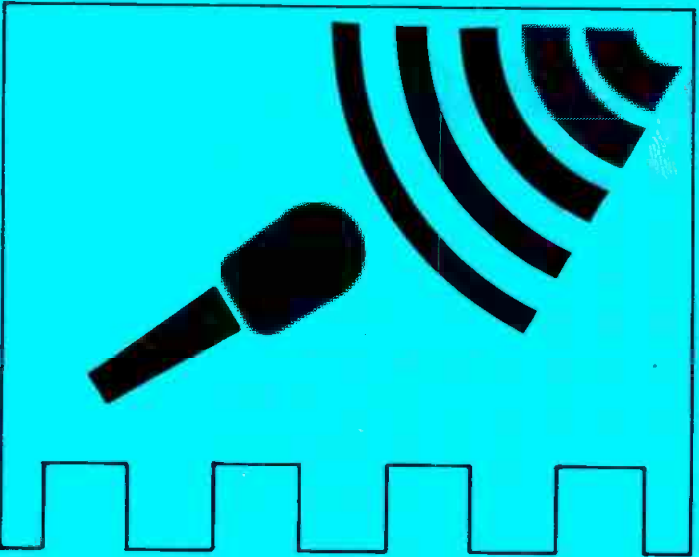

DIGITAL RECORDING

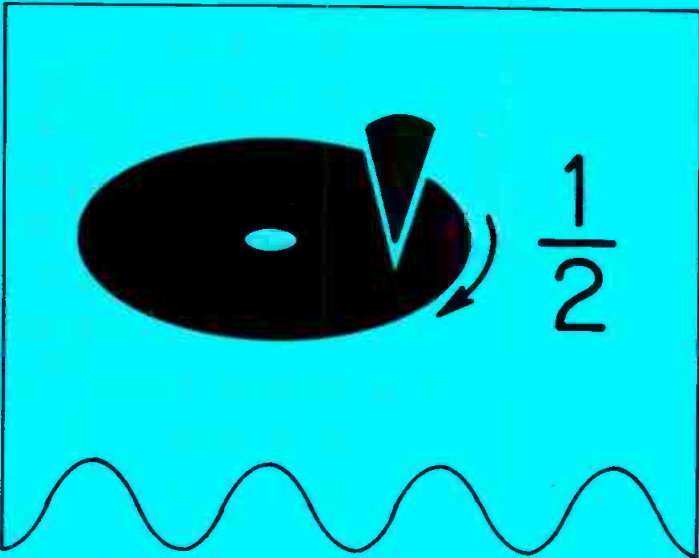

HALF SPEED MASTERING

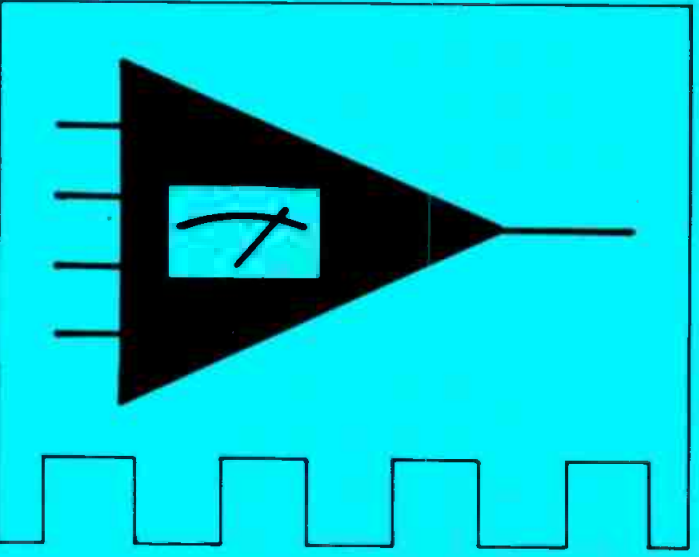

DIGITAL MIXING/PROCESSING

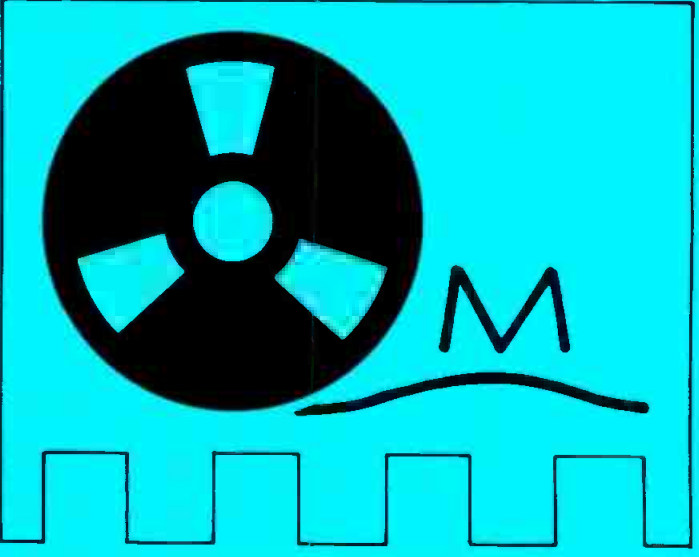

DIGITAL MASTERING

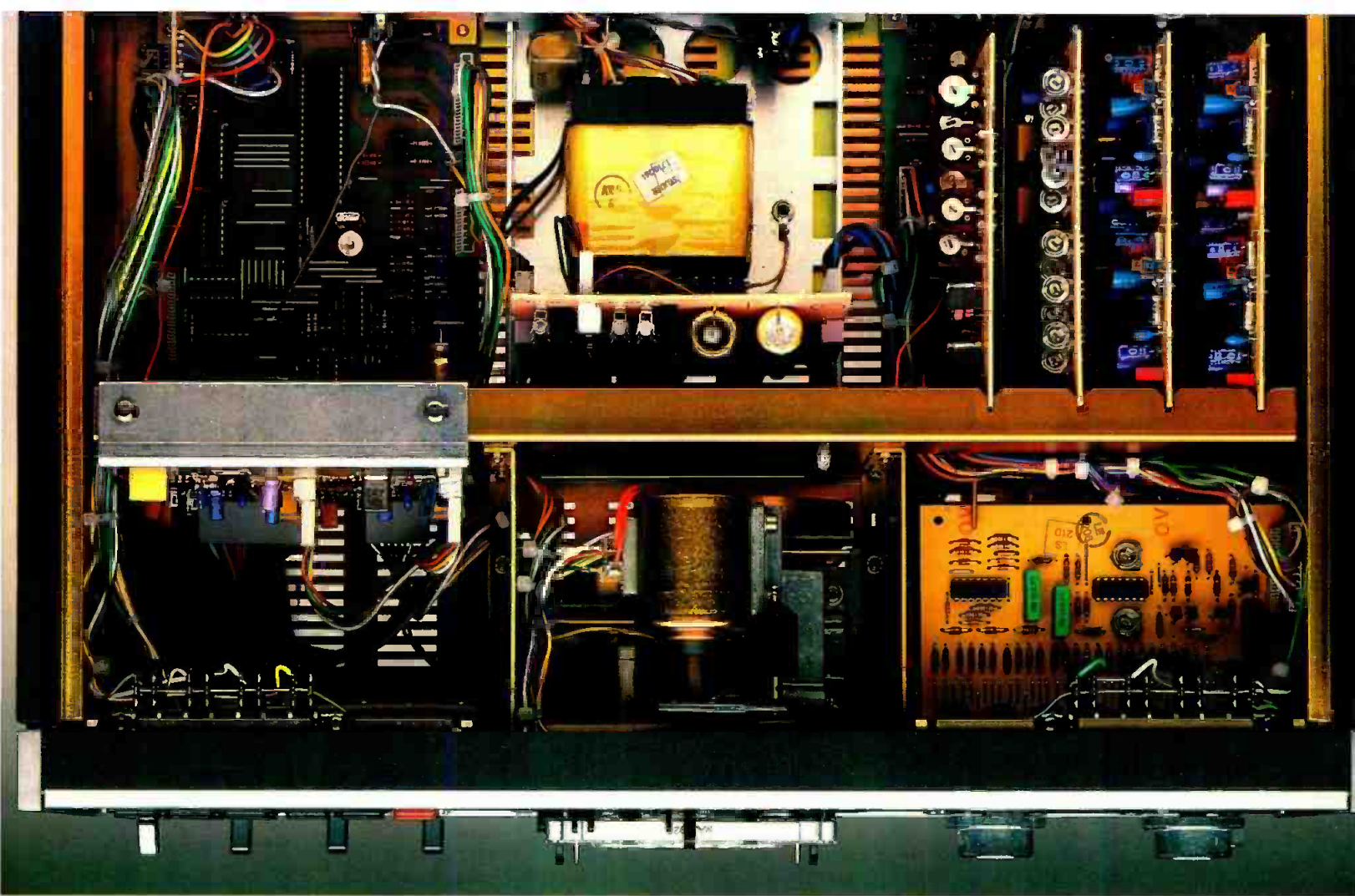

## Revox B710 MKII: Shamelessly Professional.

**The Naked Cassette Deck**—At Studer Revox, we're not ashamed to be bare all. What you see above is an unretouched photo looking down inside a new B710 MKII cassette deck. If you compare what you see here to any other deck, you'll find that the B710 MKII is more professional where it counts—on the inside. This is the first cassette deck built to the exacting Studer Revox standards for craftsmanship, mechanical precision, long-term transport stability, and uncompromising quality control.

The performance follows suit. A B710 MKII not only makes recordings and dubs of unprecedented accuracy, but it also guarantees consistently repeatable results from one B710 to the next. And, thanks to total microprocessor control, production work with this deck is fast and foolproof.

**Engineering Fundamentals**—The B710 MKII utilizes a die-cast aluminum alloy

chassis as a solid base for the four direct-drive motors. (Rubber belts, pulleys, and clutches—which can degrade long-term performance—will not be found here.) The two Hall-effect capstan motors are quartz regulated for exact speed and synchronization; and the two DC spooling motors are microprocessor controlled for constant-speed fast wind, controlled tape tension, and gentle electronic braking.

Revox has also developed a unique pivoting headblock system to assure absolute azimuth stability. Instead of sliding



into the cassette shell on the usual "sled" mechanism, the B710 MKII headblock pivots upward on two precision conical bearings and locks into a stable three-point mount.

Finally, because every part is made to professional specifications, you can depend on superior performance long after other cassette decks have succumbed to early retirement.

**Features in Summary**—Three head design • Automatic start-of-oxide cueing • Dolby B and C NR • Modular plug-in PC boards • Mic/line mixing • Internal timer for programmable start/stop in record or play • Precise 4-digit LED counter • Headphone volume control • Optional remote • Full microprocessor control of transport modes and audio switching • Adapts to external computer control.

**Look and Listen**—Examine and audition the unabashedly professional Revox B710 MKII today at your nearest Revox dealer.

# STUDER REVOX

Studer Revox America, Inc.  
1425 Elm Hill Pike • Nashville, Tennessee 37210 • (615) 254-5651

Circle 10 on Reader Service Card





JANUARY 1983 VOLUME 17, NO. 1

Publisher  
Larry Zide

Editor  
John M. Woram

European Editor  
John Borwick

Associate Editor  
Mark B. Waldstein

Production & Layout  
KATHI LIPPE

Advertising Coordinator  
Karen Cohn

Classified Advertising  
Carol Vitelli

Book Sales  
Lydia Calogrides

Circulation Manager  
Eloise Beach

Graphics  
K&S Graphics

Typography  
Spartan Phototype Co.

sales offices

**Roy McDonald Associates, Inc.**  
Dallas, Texas 75207

First Continental Bank Bldg.  
5801 Marvin D. Love Freeway  
Suite 303  
(214) 941-4461

**Denver, Colorado Area**  
Englewood, Colorado 80112

14 Inverness Dr. East  
Bldg. 1—Penthouse  
(303) 771-8181

**Houston, Texas 77036**  
6901 Corporate Drive

Suite 210  
(713) 988-5005

**Los Angeles Area**  
Glendale, California 91204

424 West Colorado Street  
Suite 201  
(213) 244-8176

**Portland Area**  
Hillsboro, Oregon 97123

510 South First  
P.O. Box 696  
(503) 640-2011

**San Francisco Area**  
Emeryville, California 94608

265 Baybridge Office Plaza  
5801 Christie Avenue  
(415) 653-2122

**Sagamore Publishing Co.**  
New York

Plainview, NY 11803  
1120 Old Country Rd.

(516) 433-6530

## About The Cover

• This month's cover features an artist's representation of various schemes for identifying the digital content of a recording. The method was proposed by Jeff Phillips. For more information, see Ken Pohlmann's article on page 34.

### FEATURES

ANALOG MASTERING TAPE vs DIGITAL MASTERING TAPE Warren Simmons

26

THE ANALOG-TO-DIGITAL TRANSITION: DEVELOPMENT OF A CONSUMER CLARIFICATION CODE Ken Pohlmann

34

TIME CODE IMPLEMENTATION John M. Woram

40

THE 72nd AES CONVENTION: PART 2 John M. Woram

44

### DEPARTMENTS

LETTERS CALENDAR EDITORIAL CLASSIFIED

6

8

25

53

DIGITAL AUDIO Barry Blesser

11

SOUND REINFORCEMENT John Eargle

14

SOUND WITH IMAGES Len Feldman

16

THEORY AND PRACTICE Ken Pohlmann

20

NEW PRODUCTS AND SERVICES

48

NEW LITERATURE

51

PEOPLE, PLACES, HAPPENINGS

55

db, the Sound Engineering Magazine (ISSN 0011-7145) is published monthly by Sagamore Publishing Company, Inc. Entire contents copyright © 1983 by Sagamore Publishing Co., 1120 Old Country Road, Plainview, N.Y., 11803. Telephone (516) 433-6530. db is published for those individuals and firms in professional audio-recording, broadcast, audio-visual, sound reinforcement, consultants, video recording, film sound, etc. Application should be made on the subscription form in the rear of each issue. Subscriptions are \$15.00 per year (\$28.00 per year outside U.S. Possessions, \$16.00 per year Canada) in U.S. funds. Single copies are \$1.95 each. Editorial, Publishing and Sales Offices: 1120 Old Country Road, Plainview, New York 11803. Controlled circulation postage paid at Plainview, NY 11803 and an additional mailing office.



## EL-15 Woofer

- 25-5000 Hz
- 200 Watts
- 100 dB M/W
- 4" Voice Coil



For complete information:

(714) 632-8500

(800) 854-7181

**EMILAR CORPORATION**

1365 N. McCan St.,  
Anaheim, CA 92806

Circle 16 on Reader Service Card

## Audio Tape for professionals



### REEL TO REEL TAPE

Ampex, 3M. All grades.  
On reels or hubs.

### CASSETTES, C-10—C-90

With Agfa, TDK tape.

### LEADER & SPLICING TAPE

### EMPTY REELS & BOXES

All widths, sizes.

**Competitive!**  
**Shipped from Stock!**

Ask for our recording supplies catalog.

**Polyline**  
Corp. 312/298-5300

1233 Rand Rd. • Des Plaines, IL 60016

15

Circle 13 on Reader Service Card

# Letters

## TELL-HARMONIUM WHAT YOU KNOW

TO THE EDITOR:

For a book, and possibly a film, on Thaddeus Cahill and his Telharmonium (1892-1911), I would appreciate any information on letters, recordings, or other materials. I would also like to hear from any digital experts interested in reconstructing the sound of the Telharmonium, using its schematics and the written descriptions of earwitnesses.

REYNOLD WEIDENBAAR  
5 Jones St., Apt. 4  
New York, N. Y. 10014

## A HEARING BREAKTHROUGH

TO THE EDITOR:

We would like to comment on Chris Landmann's letter as published in *db* October 1982, page 8.

We have developed and tested a Cortical Hearing Aid that enables about 75 percent of the profoundly deaf (90 dB or more hearing loss, or no measurable hearing at all) to discriminate speech and enjoy music. This aid, in part, is based upon digital audio techniques.

Now, we have found that most of our profoundly deaf patients can tell the difference between a 50 kHz sampling rate and a 150 kHz rate, and indicate their preference for the higher rate. We have found none, however, who can differentiate between a 150 kHz rate and a 200 kHz rate.

Our Cortical Hearing Aid, incidentally, is not of the usual acoustic or bone conduction types, but introduces a properly encoded audio signal directly into the auditory cortex in either temporal lobe of the brain. No implanted electrodes or other surgical techniques are used: only a small metal disc lightly held against the appropriate spot on the head.

CURTISS R. SCHAFER  
Director of R & D  
Biophysical Research, Inc.

# Index of Advertisers

Ampex .....	Cover III, 37
Audio-Technica .....	9
Cetec Gauss .....	13
Center for the Media Arts .....	43
Emilar .....	6
JBL .....	7
Kimball .....	52
Klark-Teknik .....	24
Knowles .....	39
Orban .....	15
Otari .....	Cover IV
PAIA .....	50
Polyline .....	6
Quad Eight .....	8
Renkus-Heinz .....	16
Shure Bros. ....	21
SIL .....	41
Studer Revox .....	Cover II
Tektronix .....	23
Telex .....	17
IOA .....	30-31
Westlake Audio .....	29
White .....	8

## Coming Next Month

### COMING NEXT MONTH

• In February the topic is International Audio. Sherman Keene travelled to Caracas, Venezuela to report on the Telearte Recording Studio, while Jim Rupert made his way to London for an article on Mobile One, Europe's largest mobile recording facility. In addition, the U.N.'s Sidney Silver checks in with a piece on electronic devices that speak, and J. Mark Goode brings us a *db* test report on the Gold Line 30 Real Time Analyzer. All this and more, coming in February's *db*—The Sound Engineering Magazine.



At JBL, we design professional products with just one application in mind...

Whether you're designing sound systems for 20,000 seat concert halls or 20 seat boardrooms, one thing remains constant—the need for quality, high performance audio products. Yet the very performance characteristics that make an audio component ideal for one application can make it only marginally acceptable for another. And that can make component selection a real headache for you.

At JBL, we have a solution. We tailor each product in our extensive line to meet the demands of a specific application. So no matter what kind of system you have in mind, you'll find a JBL component that offers a perfect match.

If this approach makes sense to you, ask the audio specialists at your JBL professional products dealer for the details. They can help you get the exact performance you need without guesswork or compromise.

Yours.

**JBL** Professional Products Division

JBL/harman international

Circle 19 on Reader Service Card

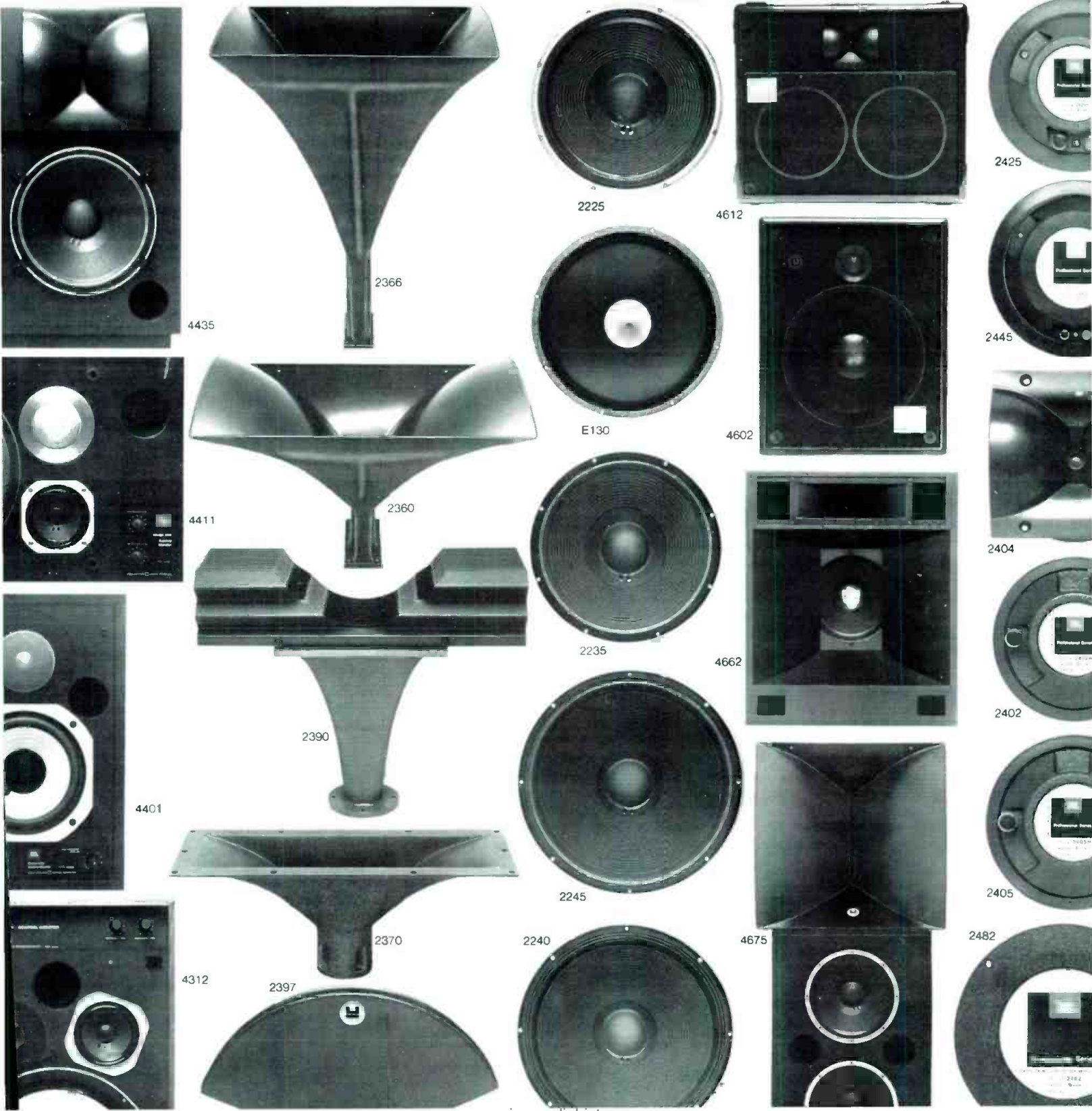

# THE EXPANDABLE SYSTEM 200

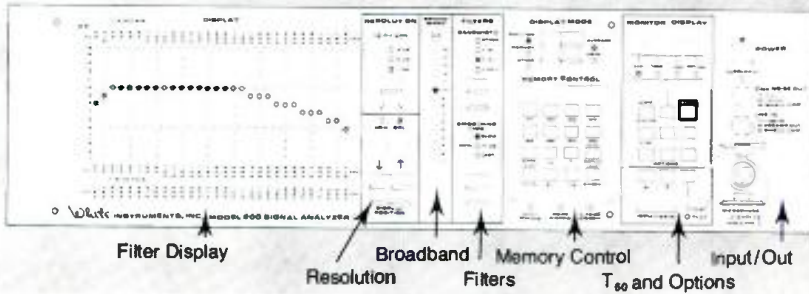

## Advanced Microprocessor Controlled Real Time Analyzer.

### Featuring:

- Interchangeable Filters
- 45 dB Dynamic Range
- 16 x 31 High Intensity LED Display
- 8 Non-volatile Memories
- 3 Smoothing Time Constants
- Simultaneous Peak and Average Processing
- 0.5 dB Precision
- T<sub>60</sub> Measurements
- 3 dB, 2 dB or 1 dB Resolution
- Built-in Pink Noise Generator
- 15 V Microphone Power
- Oscilloscope and Plotter Drive
- Optional Function Generator

All Functions  
Microprocessor  
Controlled,  
Plug-in Options  
Available



**White**

**instruments, inc.**

P. O. Box 698, Austin, Texas 78767 • 512/892-0752 • TELEX 776409 WHITE INST AUS

Circle 35 on Reader Service Card

# 20 YEARS IN THE MAKING!



## 248 Component Series

For 20 years, **Quad/Eight** has been known for its Academy Technical

Achievement Award winning console designs. Now, all of that performance and engineering excellence have been combined into the new, cost efficient **248 Component Series**.

- As many inputs as you need, and 2, 4 or 8 mixing buses.
- Resetttable, detented 3-band parametric EQ with peaking shelving and 'Q' select.
- Variable Hi-Pass and Lo-Pass filters.
- Full stereo/mono capability.
- Exclusive building block housing system.

Check the features, check the price. **Quad/Eight** does it again.



**quad/eight electronics**

*For the artist in every engineer.*

11929 Vose Street

Telephone: (213) 764-1516

North Hollywood, CA 91605

Telex: 662-446 Quadfather LSA

Circle 14 on Reader Service Card

# Calendar

## FEBRUARY

- 4-5 **SMPTE Television Conference.** Hotel St. Francis, San Francisco, CA. For more information contact: SMPTE, 862 Scarsdale Ave., Scarsdale, NY 10583. Tel: (914) 472-6606.
- 15-17 **Microphone Applications Workshop.** Sponsored by Shure Bros., Inc. and HM Electronics. Syn-Aud-Con Seminar Center, San Juan Capistrano, CA. For more information contact: Synergetic Audio Concepts, P.O. Box 669, San Juan Capistrano, CA 92693. Tel.: (800) 854-6201.
- 15-17 **Western Educational Society for Telecommunications Annual Conference.** Civic Auditorium, San Francisco, CA. For more information contact: Dr. Donel Price, Media Production Services, California State University - Los Angeles, 5151 State University Drive, Los Angeles, CA 90032.

## MARCH

- 3-6 **Concert Hall Acoustics and TEF Workshop.** In cooperation with V.M.A. Peutz. For more information contact: Don Davis, P.O. Box 669, San Juan Capistrano, CA 92693. Tel.: (714) 496-9599.

## APRIL

- 23 **MAC 83—Midwest Acoustic Conference.** Hermann Hall, Illinois Institute of Technology, Chicago, IL. The topic will be Audio Signal Processing. For more information contact: Ted Staniec, Knowles Electronics, Inc., 3100 N. Mannheim Rd., Franklin Park, IL 60131. Tel.: (312) 445-3600.



# In search of the ideal mixer.

In demonstrating our microphones throughout the country, we've found a serious limitation in most stage mixers. They are unable to handle wide range microphones on stage. And they just can't cut it when it comes to making demo tapes. Which means that the musicians need TWO mixers and perhaps TWO sets of microphones to get the sound they want on stage as well as on tape. It's a luxury not everyone can afford!

So, to solve your problem — and ours — we set out to create a "double threat" mixer which would be a great stage mixer, yet still give you the sound and control you need while taping. A mixer designed to take full advantage of every mike you own, including phantom-powered models.

Our standards (like yours) were high. Everything had to be rugged, reliable, and very clean. With wide basic frequency response, plenty of headroom, and very low distortion and noise. And the mixer had to be very natural to use. Finally, the price had to be right. We invite you to examine the new Audio-Technica ATC820 and ATC1220 stereo mixing consoles to see how well we have accomplished our goal.

Our prototypes have done a lot of traveling. Users were impressed with the features, the flexibility, and the sound. They liked the 3-band EQ on every input. And the 7-band stereo graphic program equalizers, plus another graphic equalizer for the monitor output. But most appreciated were the variable high-pass filters for each output. They permit you to use wide-range recording microphones on the stage, while exactly limiting bass response to suit acoustics and to keep from overloading your speakers. Yet during recording you can go all the way down to 20 Hz if you wish.

There's a long list of very practical features. Phantom power is available at each of the transformer-isolated mike inputs. Two 20 dB mike input pads plus an LED to warn of clipping on each input. A SOLO button to check any input with headphones without affecting the mix. "Stackable" design when 8 or 12 inputs aren't enough. Even an assignable talk-back input. And all the logical controls for the transformer balanced MONITOR, EFFECTS, SOLO, PHONES, and OUTPUT

busses. In short, very flexible, and quite complete.

With a very modest investment, you can do almost everything the single-purpose boards can do... and do it very well. And get the benefit of phantom-powered recording mikes on stage as well as during recording. The more you learn about the ATC820 and ATC1220 the more impressed we think you'll be. Ask your Audio-Technica sound specialist for a hands-on tour of this brand new breed of mixer. Or write for literature. We may have the ideal answer to your mixer requirements.



audio-technica®



AUDIO-TECHNICA U.S., INC., 1221 Commerce Drive, Stow, Ohio 44224 • (216) 686-2600  
Circle 18 on Reader Service Card



# MODERN RECORDING & MUSIC

**The magazine for people  
who create music**



**MODERN  
RECORDING  
& MUSIC**

1120 Old Country Road  
Plainview, NY 11803

- \$26.00 for 24 Issues—save \$20.80
- \$15 for 12 issues—save \$8.40  
(\$1.95 to subscribers)

Charge to my  Mastercharge  Visa acct  
My account number is \_\_\_\_\_ Exp Date   /  /  

Signature \_\_\_\_\_

## Subscribe Now!

Payment enclosed (Put form in envelope)

\$ \_\_\_\_\_

Signature \_\_\_\_\_

Name \_\_\_\_\_

Address \_\_\_\_\_

City \_\_\_\_\_

State \_\_\_\_\_ Zip \_\_\_\_\_

Outside U.S. add \$3.00; U.S. funds ONLY 207c



# Digital Audio

## Digital Filters, Part V

• Last month we presented the calculator programs necessary to generate a tapped delay line filter which had either an impulse input or a step input. Those are the two classical forms of transient input. The next most important input is that of a sinewave. So in this article we will add to our collection of programs a new subroutine D that will generate a sinewave input.

This presents certain special issues. Unlike the step or impulse, the sinewave requires us to keep track of the time index. The other two required us only to keep track of the fact that  $t = 0$  or  $t \neq 0$ . For this reason, we need to dedicate a new register for the equivalent of real-time index. Let us take Reg 5 for this. Our next problem is that of frequency. We normally like to think of a sinewave as having so many cycles per second or so many radians per second (there are  $2\pi$  radians per cycle).

The problem is that our digital filter does not know anything about seconds. It only computes outputs on a sequence of input data. We can get around this problem by defining a hypothetical sampling rate as if it were an A/D converter. Or we can use the simpler approach and redefine the nature of frequency. Suppose we define frequency as cycles-per-sample or radians-per-sample. This is the number of cycles or degrees that the sinewave has advanced between samples. If a certain sinewave frequency is sampled every 45 degrees, it takes 8 samples period. A frequency which is one octave lower would be sampled every 22.5 degrees, or 16 samples period. This entirely avoids the question of absolute time. In all of the following discussions we will use the notation of phase increment per sample. The Nyquist frequency is thus  $180^\circ$  sample and the Nyquist rate is  $360^\circ$  sample. This last term is equivalent to a full cycle sample. Notice that this sampling would always be the same value; that is, our aliasing of the sampled frequency would be a DC value.

### SINE GENERATOR

The computation of the sinewave is simple because we have a calculator key function SIN which computes the sinewave value for us. Moreover, we will take the amplitude as being 1. The only com-

putational issue is the angle, or argument, of the sinewave. We might wish to have it in the form  $\text{sine}(n \cdot a)$  where  $n$  is the sample number and  $a$  is the phase sample. Alternatively, we could define a phase register and add the phase increment each sample. We will use the latter method because it illustrates that phase is a ramp function which always gets larger. Our Reg 5 now becomes the current phase register. We also need a register to hold the phase increment; let us use Reg 6 for this purpose. The program becomes the following:

```
LBL D    $ name of subroutine
RC 5    $ get current phase value
        $ from last sample
+       $ add
RC 6    $ phase increment
=       $ compute result
ST 5    $ store new phase for next
        $ iteration
SIN     $ compute sine result
RTN    $ return to calling routine
        $ location
```

The TI calculator key entries for this program segment, and the one below, are given at the end of this month's column (FIGURES 3 and 4). To finish the program, we need to do two things. First, Reg 5 needs to be cleared or initialized when the program is first started; second, we need a way of easily entering the phase increment into Reg 6. If we were only doing the sine generation a few times, we might enter it by hand. Alternatively, we could provide the increment before running the program and have the program store it. The initialization routine is clearly the place for both of these activities. Since we are no longer using Flag 1, this new code can go in that place. Because it is larger, the remaining program will get pushed down. This is not a problem since we showed that the program is position independent. The new initialization routine begins with the following:

```
LBL A    $ name of beginning
ST 6    $ assuming phase increment
        $ was presented before
        $ running, it will be stored in
        $ Reg 6
```

```
0       $ initial phase value
ST 5    $ initialize phase register.
. . . .
. . . .
```

### TEST CASE

It is now time to test the program. Simple tests are better until we have some confidence. The simplest test is to make one coefficient 1 and all the others zero; the output should be a sinewave. By selecting which coefficient is 1, we can vary the delay in the sinewave. Again for simplicity, let us select a phase increment factor of 45 degrees so that we can easily recognize the correctness of the results.

Place 1 in Reg 39, clear Regs 30 through 38, enter 45 (frequency) into display. Press Go/Lo A, Press R/S and observe the results. You should observe the following as output:

```
.707
1.00
.707
0
-.707
1.00
.707
0
etc.
```

This is our sinewave. We notice a small "bug" since the initial result is .707, not 0. After some investigation, we observe that the sine generation program in Subroutine D adds the increment factor before computing the sinewave. Hence, although the current phase is 0 when entering for the first time, it will be 45 degrees when the sine is computed. There are several ways to solve this problem. One obvious possibility is to initialize the phase register to the negative increment rather than to 0. Therefore we modify the initialization routine to be the following:

```
LBL A    $ name of beginning
ST 6    $ store phase increment
        $ factor
+       $ change sign of increment
        $ factor
ST 5    $ store negative as initial
        $ value in phase register.
```

Now we get the correct results. The first data point from the output is 0 as we expected.

**A**

```

      -0.05
- .1366025404
- .1866025404
- .1866025404
- .1366025404
      -0.05
       0.05
. 1366025404
. 1866025404
. 1866025404
. 1366025404
       0.05
      -0.05
- .1366025404
- .1866025404
- .1866025404
- .1366025404

```

**B**

```

      0.
      0.05
. 1366025404
. 2366025404
. 3232050808
. 3732050808
. 3732050808
. 3232050808
. 2366025404
. 1366025404
      0.05

```

Figure 1. Response for  $f = 30^\circ$ : (A) initial transient response (B) steady-state output.

We continue our test cases by making a delay of 2 units—making the coefficient in Reg 39 a 0 and the coefficient in Reg 37 a 0.5. In addition to the extra delay, the output should be half as great. The results should be the following:

```

0
0
0
0.35355
0.5
0.35355
0
0.35355
-0.5
0.35355
0
etc.

```

By checking the results manually, we can confirm that they are correct.

### A LOW-PASS FILTER

Now it's time to make a real filter. Let us set the 10 coefficients to a value of 0.1 each, and examine the frequency response. The basic characteristic of this filter is that higher frequencies are attenuated. One can see why: As a sine-wave fills the delay line, we are summing (or averaging) all of the values of a sine. Since some are positive and some negative, the amplitude is reduced. With DC, however, all of the coefficients add in

the same direction: The gain for DC is 1.

This example suddenly becomes very interesting if we use a 36-degree increment factor for frequency. The results below show a complex output for the first 10 samples—but then the result is always 0! Why? The results are as follows:

```

0
.05877
.15388
.24898
.30776
.24898
.15388
.05877
0 (0 is actually a small number
   like  $6 \times 10^{-14}$ )
0
0

```

The fact that the results become 0 after the first ten samples is understandable since one full cycle of the sine wave fits into the delay line. Ten taps of 36 degree increments is 360 degrees. The average value of a single cycle is 0. This part makes sense. Why does the initial part contain such a complex signal? The answer is that our input signal is not actually a "real" sine wave, it is a "truncated" sine wave. A sine wave is defined to exist for all time. The act of turning it on creates new spectral components. These components come through the filter because the filter has a finite gain at these frequencies. Once the delay line is filled, the transient part has passed. In other words, when the initial part of the sine wave has entered the delay line, how does the delay line know what frequency will be there? In fact, after the first sample has entered, the filter *cannot* tell the difference between our input sine ( $n36$  degrees) and a step of amplitude 0.5877 or an impulse of 0.5877. These three cases are identical. Once the sine has completed itself, the filter can know the input.

Thus we see that all filters respond to the input in two parts: the steady state and the transient part. The former is defined as the case when the transient has decreased to 0. This situation is, unfortunately, filter dependent. For analog filters with poles or digital IIR filters, the transient decreases con-

tinuously and approaches 0, but never actually gets there. For FIR filters of the type being discussed, the transient is as long as the delay line. Once every tap has some input signal, knowledge of the signal's beginning is lost.

We can now begin our experiments with a real frequency response. This requires us to redo the above type situation with different input frequencies (or phase increment factors). A full plot of the frequency response requires a large number of runs. For example, if we wish to plot the response at 10 degree increments, we would need to run 18 such responses from 0 to 180 degrees [above 180 is beyond the Nyquist frequency].

The results for  $f = 30$  degrees are shown in FIGURE 1. Again we see the transient and the steady-state parts. In the steady state, we see the repetition corresponding to the periodicity of the input. The output repeats every 12 samples, just as the input does. The amplitude of the response is a bit harder to see. Although the peak value is 0.1866, that is not the sine response peak. Don't forget that this is sampled. To convert from sampling back to a continuous sine wave we need a low-pass filter. Although we could build such a program, we can sidestep this by asking: What is the sine wave amplitude and phase shift for which this is the result after sampling? The answer is 0.1873153318 amplitude and 15 degree phase shift. It is not obvious that this is true, but you can confirm it.

We can continue with other input frequencies. If you try  $f = 29$  degrees, another interesting result appears: The output is apparently not periodic! This makes it even harder to observe the peak from the raw output data. Actually, it is periodic, but it takes 29 periods of the input before repeating, or 360 samples. If we could low-pass filter the result, we would see the sine wave clearly. Remember that in the digital domain, the input frequency and its aliasing frequency both yield the same result: the 29 degree frequency and the 151 degree frequency both exist simultaneously. The low-pass filter separates them. 29 degrees and 151 degrees are relative primes and therefore it takes a very long time for an output to repeat.

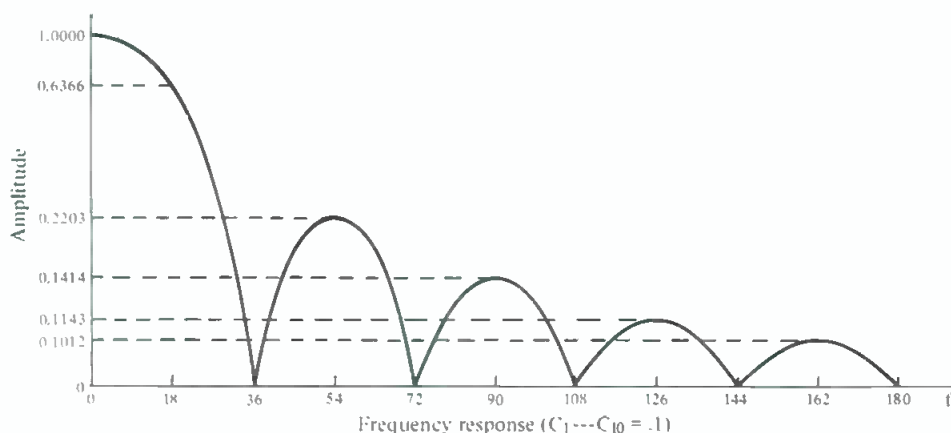

Figure 2. An FIR Filter's frequency response for  $f = 30^\circ$ .



```

107 76 LBL
108 14 D
109 43 RCL
110 05 05
111 85 +
112 43 RCL
113 06 06
114 95 =
115 42 STD
116 05 05
117 38 SIN
118 92 RTN
119 00 0
120 00 0
121 00 0

```

Figure 3. New signal generation subroutine to generate sinewave inputs. It replaces the impulse and step generators of last month.

```

000 76 LBL
001 11 A
002 42 STD
003 06 06
004 94 +/-
005 42 STD
006 05 05
007 01 1
008 00 0
009 42 STD
010 00 00
011 76 LBL
012 23 LNX
013 00 0
014 72 ST#
015 00 00
016 69 DP
017 20 20
018 00 0
019 71 SBR
020 15 E
021 01 1
022 00 0
023 32 X!T
024 43 RCL
025 00 00
026 22 INV
027 67 EQ
028 23 LNX
029 09 9
030 42 STD
031 00 00

```

Figure 4. New initialization routine to replace the one presented in last month's column. Because it is three instructions longer, all of the remaining code must be pushed down.

In contrast, the 30 degree frequency has an alias of 150 degrees which repeats at the same rate. The practical limitations of many frequencies makes the empirical approach to frequency response methods very difficult. You, the reader, can try other frequencies to get a feel for the filter. It is not too difficult to do this in steps of 10 degrees. After inferring the peak value, we could create the plot seen in FIGURE 2.

Many things can be noticed. The response goes to 0 at frequencies which are multiples of 36 degrees, i.e. 36, 72, 108, 144 and 180. The response peaks are at 54, 90, 126, and 162. The amplitude of the peaks decreases at approximately a  $1/f$  rate. The minimums are at fre-

quencies which have a full-integer number of periods in the delay line, and the peaks are when there is an odd half cycle in the delay line. The 3 dB point is at approximately  $f = 18$  degrees (actually 4 dB). The filter is very sharp for the number of taps used; that is, the transition from pass band (high gain) to stop band (low gain) is very rapid. However, the stop band has high ripples.

In general, we would not say that this is a particularly good low-pass filter. We would be better to sacrifice some of the transition interval by making the filter decrease more slowly in exchange for suppressing the ripples in the stop band. Next month, we will examine this class of trade-offs. ■

**Hear them.** Write for your nearest dealer.

**Cetec Gauss**

9130 Glenoaks Blvd.  
Sun Valley, CA 91352

Circle 20 on Reader Service Card

# Sound Reinforcement

## Line Distribution Systems

• In typical paging and background music systems, many loudspeakers may be placed across the output of a single amplifier, with each loudspeaker driven at only a fraction of the amplifier's total output capability. If the amplifier's maximum output rating is specified for a particular load impedance, then we must keep track of all the individual parallel loads across the input. This is cumbersome and requires numerous calculations.

What actually interests us, however, is not the impedances of the individual loads, but rather the power supplied to each loudspeaker. Line distribution systems were devised many years ago to facilitate the specification and layout of distributed systems, and in these systems, the engineer or installer merely has to keep track of power—literally, he only has to count watts in order to load the amplifier properly.

### THE 70-VOLT SYSTEM

In the 70-volt distribution system, the maximum output power of an amplifier

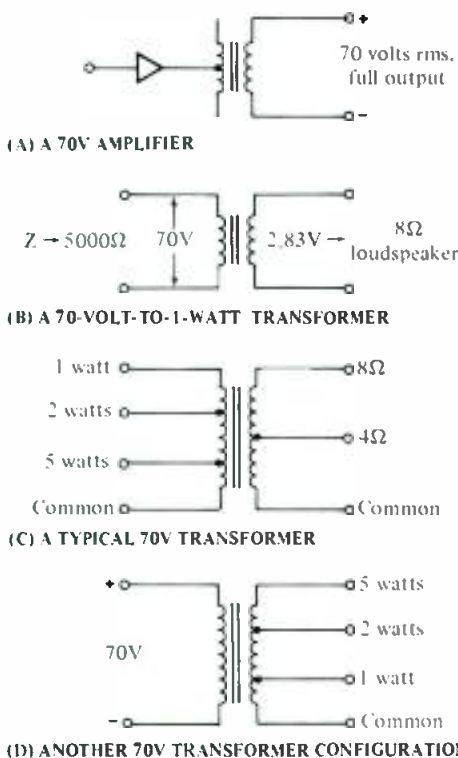

Figure 1. The 70-volt Distribution System.

exists at an output voltage of 70 volts rms. This is true regardless of the power rating of the amplifier. With a known voltage existing at the primary winding, it is possible to construct a family of transformers, called line distribution transformers, that will always deliver a known power into a known load under maximum drive conditions. In FIGURE 1A, we show a 70-volt amplifier operating at full output. Its actual power rating is irrelevant. If we place the transformer shown at B across the output of the amplifier, there will be a voltage transformation from 70 volts down to 2.83 volts, and one watt ( $2.83^2 / 8$ ) will be delivered to the 8-ohm loudspeaker.

Other versions of distribution transformers are shown at C and D. The version shown at C has multiple impedance taps on the secondary winding, with various power taps existing on the primary side. The version shown at D has a fixed primary winding with multiple wattage taps on the secondary designed to work only into 8 ohms. For equivalent settings, both versions will have the same transformer turns ratio. The choice of one over the other is simply a matter of convenience or availability.

### SPECIFICATION OF A 70-VOLT SYSTEM

In laying out a 70-volt system, the designer takes into account the total number of loudspeakers which are to be zoned together. He then notes the ambient noise levels in the individual areas where each loudspeaker is to work, and, working with the sensitivity of the loudspeakers, determines the maximum power each speaker would receive. The next step is to add up all the powers in the loads, and, finally, to specify an amplifier whose output power rating is equal to, or slightly higher, than the load. Under maximum drive conditions, the amplifier will see a safe load, and each loudspeaker will be driven at the power indicated by its operating tap on the transformer. Details of this are shown in FIGURE 2.

### LINE LOSSES

While transformer losses are generally

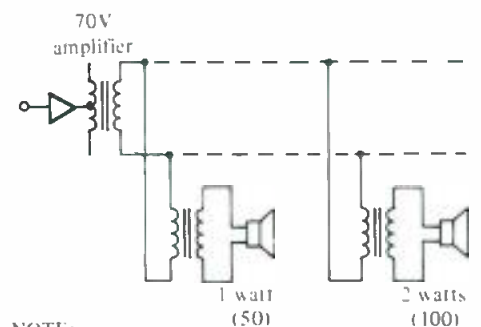

NOTE:  
Total watts in load =  $50 \times 1 + 100 \times 2 = 250$  watts.  
Therefore, amplifier should be 250 watts (minimum);  
300 watts is a better choice.

Figure 2. Specification of a 70-volt System.

AWG WIRE LOSSES (copper)	
GAUGE	LOSS PER 300 METERS (single run)
10	1.0Ω
12	1.6Ω
14	2.5Ω
16	4.0Ω
18	6.3Ω
20	10.0Ω

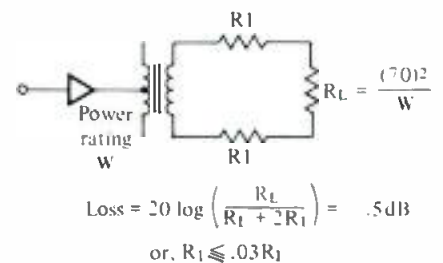

Example: Let  $W = 100$  watts and let total double wire run = 100 meters.

$$\text{Then, } R_1 = \frac{(70)^2}{100} = 50\Omega$$

$$\text{and } R_1 \leq .03R_1 = .03(50) = 1.5\Omega$$

$$\frac{300 \text{ meters}}{100 \text{ meters}} \times 1.5\Omega = 4.5\Omega$$

Therefore, AWG #16 or larger will work.

Figure 3. Calculating Wire Losses.

negligible (0.5 dB or so), wire losses may be considerable—especially for long runs. Larger wire gauges are more expensive than smaller ones, and the designer



must make a value analysis based on the trade-off between the lower cost of thinner wire and the higher cost of a larger amplifier to make up for the losses. Performance considerations favor larger wire gauges, those that will keep line losses to 0.5 dB or less. FIGURE 3 gives details of line-loss calculations and shows

how to calculate the minimum gauge that will allow no more than 0.5 dB loss.

### OTHER LINE DISTRIBUTION VOLTAGE STANDARDS

In Europe, a 100-volt line distribution standard is common, and in the United

States, there is a 25-volt standard used in some school systems. The specifications of these alternate standards are related to local wiring codes and the cost of conduit necessary for the higher voltages.

Line losses are of course minimized with higher voltages, since higher voltages require lesser currents for a given power in the load. Less current in the line means that the IR drop in the line will be less. When Altec designed special amplifiers for the large reinforcement installation at the Ontario Motor Speedway in the early seventies, they constructed a family of transformers to work with a 240-volt distribution system!

Many companies in the sound reinforcement business manufacture auto-transformers. These are usually large, hefty devices that can be used to transform impedances from low to high, and back again. FIGURE 4A shows details of a typical autoformer, and a typical application in power distribution is shown at B. Some years ago, this would have been the logical solution to line losses. Today, we would favor locating power amplifiers close to the load, sending only the voltage drive signal up to the amplifiers. ■

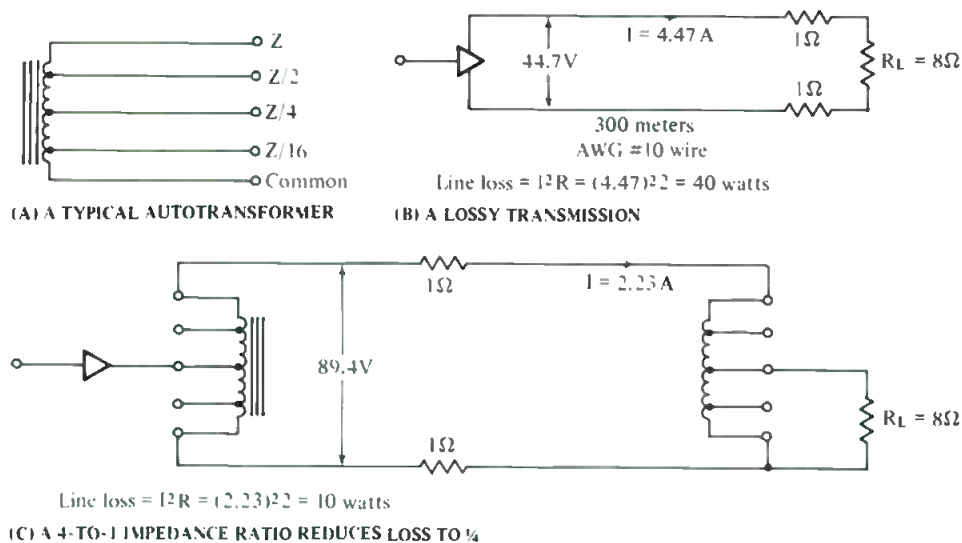
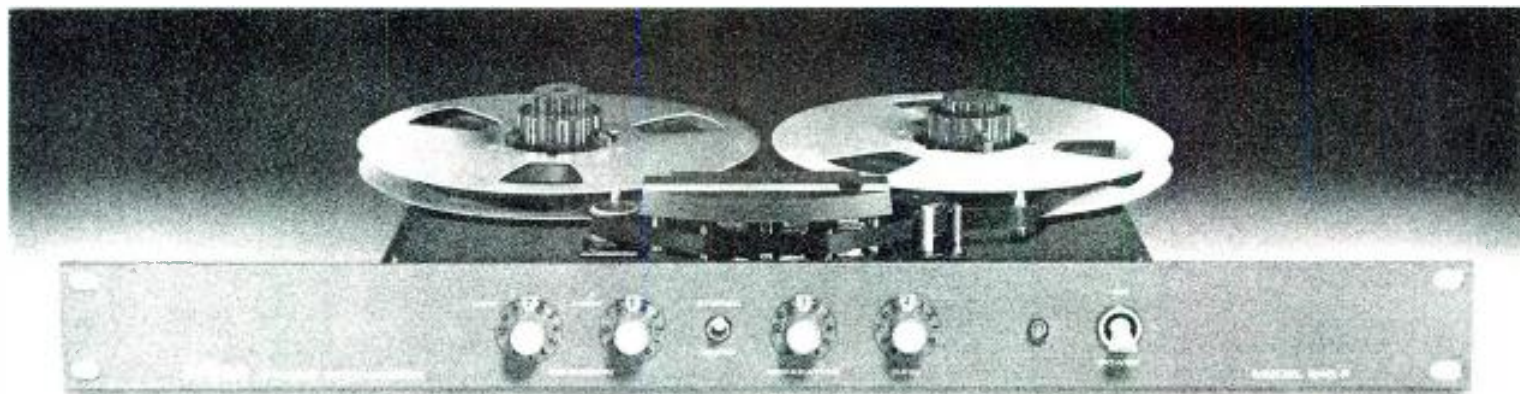

Figure 4. Details of the Autotransformer (Autoformer).



## Introducing the 5th (9th, 17th, or 25th) track.

Orban makes an amazing little device that greatly expands your multitrack capabilities. Our new 245F Stereo Synthesizer uses a patented technique for processing mono tracks into pseudo-stereo during mixdown. So you can save tracks by recording instruments like drums, strings, synthesizer, organ, horns, or electric guitar in mono, and then expanding them into convincing pseudo-stereo during the mix rather than taking two tracks.

The 245F is particularly useful in processing *intrinsically* mono sources—like many electric and electronic instruments. And unlike many other ambience-generating techniques, our stereo synthesis is completely mono-compatible: There's no phase cancellation or comb-filtering when the stereo channels are summed.

For \$399, you won't find a better, more cost-effective way to save tracks and get more on your master. Call or write for details.

**orban** Orban Associates Inc. 645 Bryant St.  
San Francisco, CA 94107 (415) 957-1067  
Telex: 17-1480

Circle 21 on Reader Service Card

# Sound With Images

## More "Bits" and Pieces In The Quest For Better Audio

• I really lucked out when the editor of *db* asked me to take over the "Sound With Images" column. My assignment is to come up with video-related audio subjects, and almost everywhere I turn there seems to be something happening in this area. Recent examples of this have occurred in such diverse locations as the recently-concluded AES Convention in Anaheim, California, in Danvers, Massachusetts and at the Harumi Fair

Grounds in Tokyo, Japan. As a well-known sportscaster on one of my local TV stations is fond of saying all the time: "Let's go to the video tape!"

### dbx ENTERS THE DIGITAL WORLD

dbx, Inc., the firm best known in consumer audio circles for their linear companding noise reduction system for tapes and dbx-encoded analog records, has come up with a new kind of digital

audio processor that will interface well with a 1/4-inch VCR format such as U-matic. It is scheduled to sell to professional audio studios for under \$5000.00, a fraction of the cost of the other professional PCM digital processor. The dbx Model 700, pictured in FIGURE 1, is totally unlike any currently available digital audio processor in that it does not employ PCM (Pulse Code Modulation) at all. Rather, it uses an improved version of an alternative method of digitizing audio signals called Delta Modulation.

In the conventional PCM approach, each sampled level of audio signal amplitude is represented by a binary number, produced by an analog-to-digital (A/D) converter. In a Delta Modulation digital audio encoding system, the numbers produced by the A/D converter represent the *difference* between successive sampled signal amplitudes rather than the total instantaneous amplitudes themselves. Delta modulation has been known for years to be a low-cost means of analog-to-digital data conversion. Some of you may remember the Audio Pulse Digital Time Delay unit which was marketed a few years ago; it too used delta modulation to convert signals to digital form which were stored for brief periods and then reconverted to analog audio after suitable time delay. In its simplest form, however, delta modulation yields a dynamic range of only around 55 dB; hardly as good as the best analog records or tapes are capable of providing.

A variation of the delta modulation idea is called Adaptive Delta Modulation, or ADM. In the ADM process, digital numbers produced by the A/D converter are allowed to represent *varying* differences or step sizes between successive audio amplitude samples. When the input signal level is changing quickly, the step-size becomes large, producing a digital output which tracks the input. When the input signal changes



setting new standards for excellence and value in Sound

### RENKUS-HEINZ PROFESSIONAL SSD1801 EXTENDED RANGE COMPRESSION DRIVER

**Now! A 1" throat driver for high power handling with crystal-clear performance to 25 KHz**

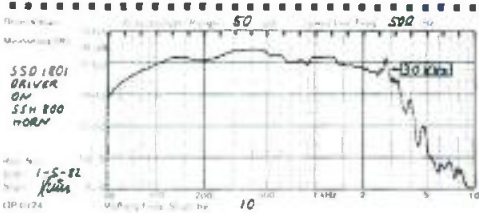

Unequalized response 4' on axis in anechoic environment



Another **R-H** driver, offering a unique combination of extended frequency range, full power handling capability and clean natural tone quality. Compact, efficient, affordable—in a class by itself—here is an ideal professional all-purpose driver.

**ASK YOUR DEALER FOR A DEMO OR WRITE US**



**RENKUS-HEINZ, INC.** • DRIVERS • HORNS • SPEAKER SYSTEMS  
17851AB Sky Park Circle • Irvine CA 92714 • (714) 540-3154

Circle 24 on Reader Service Card



slowly, the step size is adjusted or adapted to be smaller, so as to more accurately reproduce these waveforms. ADM extends the dynamic range of ordinary delta modulation to around 90 dB (about the same dynamic range which is now achieved by 16-bit PCM digital systems, in practice). While ADM represents a significant improvement over ordinary Delta Modulation as far as dynamic range is concerned and is far less expensive to implement than PCM, it

does exhibit other problems.

Because the introduction of a random noise floor (known as "dither noise" in PCM) would be hard to implement in an ADM system, such noise is not used. As a result, the ADM noise floor may exhibit a definite tonality and low-level signals may be highly distorted. Furthermore, with typical real-world circuits, the step size referred to earlier can be adjusted only over a range of about 500 to 1, reducing the practical dynamic range

capability of the system. ADM also tends to produce a shifting noise floor as the quantization error of an ADM system changes with signal level. If this shifting noise floor is not far enough below signal levels, some noise "breathing" may become audible. Finally, when the input to an ADM system becomes very small in amplitude (during quiet musical passages), the converter may be asked to compare two values that differ by very small amounts. An actual comparator circuit may have trouble doing this, and the result may be a limit on minimum step size and a consequent raising of the noise floor.

**COMPANDED PREDICTIVE DELTA MODULATION**

That's what dbx is calling its answer to the problems of Adaptive Delta Modulation just enumerated. CPDM (you need an acronym for that mouthful) differs from ADM in two major respects. First, while in ADM step-size is varied to follow the signal, the dbx 700's converter uses a precision compander in which the signal itself is varied with a voltage-controlled-amplifier to avoid overloading a fixed delta modulator. Secondly, the dbx delta modulator uses a "linear-prediction filter," which analyzes the past history of the audio signal to predict its future.

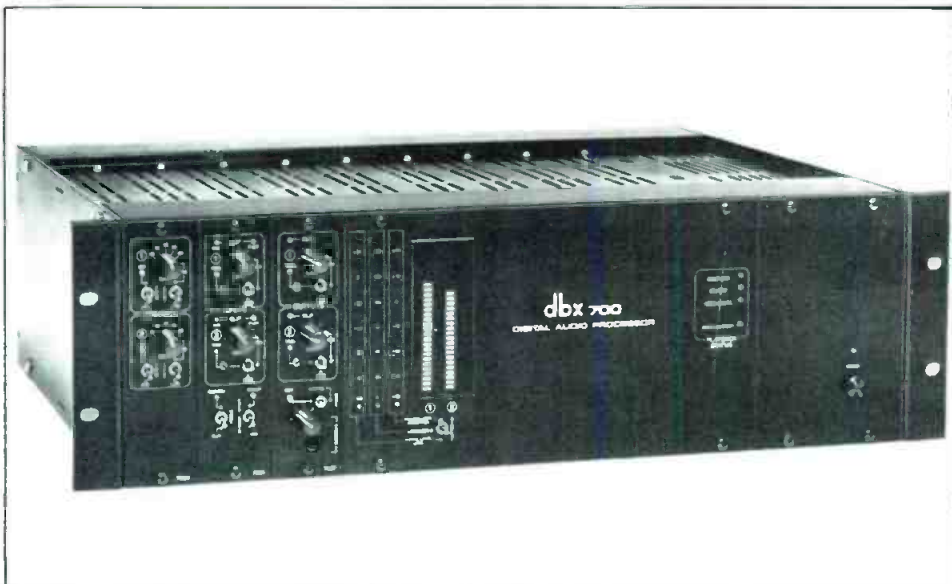
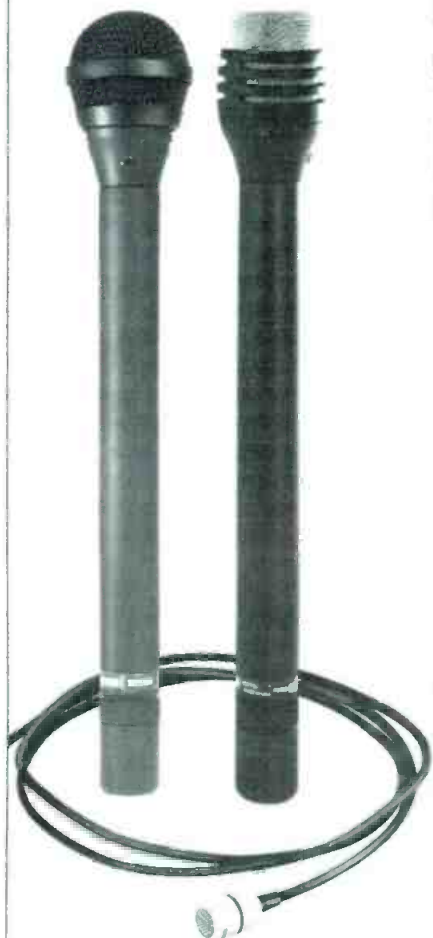

Figure 1. The new dbx digital audio processor uses a combination of modified delta modulation plus linear precision companding.

**UNCOMPROMISING WIRELESS MICROPHONES**

Finally, you can choose a wireless mic to fit the application. The Telex WHM-300, the electret wireless transmitter mic for uncompromising speech clarity. Or a Telex WHM-400 dynamic wireless transmitting mic for vocal entertainment with rich, full bodied audio quality. Both elegantly tapered and without trailing antenna wires. Or select the miniature electret WLM-100 lavalier mic (or any standard dynamic mic) with our belt-pack transmitter.

Combined with the superb Telex dual diversity\* FM receiver, you'll have a wireless system that is as good as any hard wired mic, and at a reasonable price. Write us today for full details.



Quality products for the Audio Professional

**TELEX**

TELEX COMMUNICATIONS, INC.

9600 Aldrich Ave. So. Minneapolis, MN 55420 U.S.A.  
Europe: Le Bonaparte Office 711 Centre Affaires Paris Nord 93153 Le Blanc-Mesnil, France

\*U.S. Patent No. 4293955. Other patents applied for.

Circle 22 on Reader Service Card

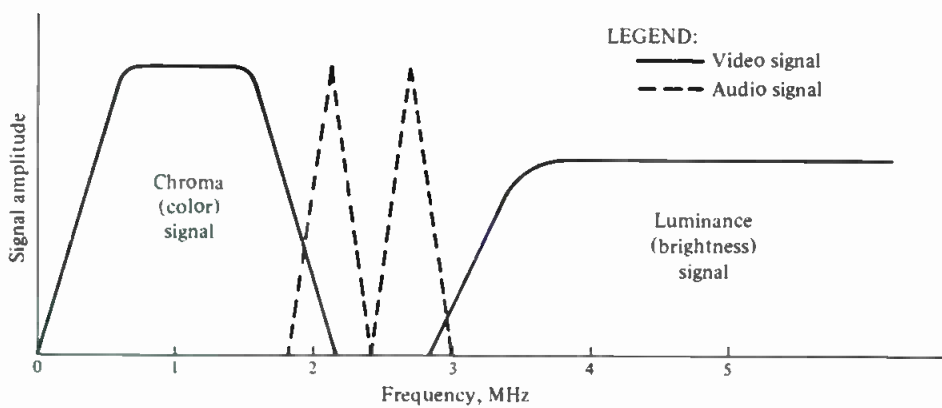

Figure 2. Separate FM carriers are inserted between luminance and chroma signal in the proposed Beta hi-fi audio format.

While the term companding has been associated by many audio enthusiasts with some form of "breathing" or "pumping," dbx feels that such effects are not really the fault of any companding circuit, but rather are the fault of a non-linear intermediate storage medium (such as tape in analog noise reduction systems). In the case of the CPDM processor, the level-sensing circuit of its compander obtains its information directly from the digital bit stream in both encode (record) and decode (play) modes. Since these bit streams are identical, mis-tracking of the system cannot occur.

As for the Linear Prediction circuit, it estimates a signal's future by monitoring its recent past history. This is done 700,000 times per second. The dbx Linear Prediction circuit increases the dynamic range of a basic delta modulator from 55 dB to 70 dB. The companding circuit further increases the dynamic range of the CPDM system to more than 100 dB - actually some 20 dB higher than the dynamic range achieved by conventional 16-bit PCM professional and consumer digital systems.

### THE QUESTION OF COMPATIBILITY

Since the dbx CPDM system is totally incompatible with other digital audio processors, the question of whether or not professional studios would want to adopt the dbx system loomed large at the AES convention. Company spokesmen felt that, for the small recording studio, it mattered little whether or not a given digital system was compatible with other competing systems in other studios. The important point they made was that now, with such a low-cost system available, smaller studios would be able to add to the store of software which is so desperately needed to get consumer

versions of digital audio (such as the digital disc player) off the ground next year.

### ON TO TOKYO

As for audio-for-video developments in Tokyo, Sony, at the recently held audio exhibition there, leaked a bit more about their much talked about Beta hi-fi system; a system that has the capability of improving sound reproduction from Beta-format VCRs such that it will rival the sound quality obtainable from top-of-the-line reel-to-reel tape decks. In this new system, the sound tracks (as many as three, but more often two for stereo) are frequency modulated and inserted in the picture track. In the case of the Beta format, as shown in FIGURE 2, the existing layout of chroma (color) and luminance (brightness) video signals are spaced apart by a sufficient frequency difference so as to accommodate the new sound carriers. Even though the sound carriers appear to be partially superimposed upon the color and brightness signals, the arrangement does not lead to cross-talk. Furthermore, with a maximum capacity of three audio channels, the system could accommodate stereo plus a second language in mono, two or three language sound tracks or, if need be, three-channel stereo.

Industry sources indicate that dynamic range of this system is of the order of 80 dB or more, while frequency response can be made flat from 20 Hz to 20 kHz, with unmeasurable wow-and-flutter. A high order of wow-and-flutter is another obvious deficiency of the more conventional, currently used system for recording audio on VCRs. Distortion in the Beta hi-fi system of sound recording is said to be one-tenth as great as in conventional systems.

Not long after we began to hear about this Beta hi-fi audio system, the pundits

started telling us why the VHS system could not support a system similar to that developed by Sony for Beta. So, as you might have guessed, along came Matsushita Electric at that very same Tokyo show to exhibit and demonstrate a "hi-fi" version of the VHS system after all. According to reports that filtered out of Tokyo, the VHS "better audio" approach is similar in concept to the Beta hi-fi approach, in that FM carriers are used and are applied to, and read by, the helical-track tape heads (the spinning drum) of the VCR. Dynamic range claimed for this system is 90 dB! Asked to comment on earlier statements that an FM carrier for audio on the VHS system simply couldn't be done, those same pundits now said that what they really meant was that it would be difficult to apply such a system to PAL-based VCRs (the video system used in most of Europe), but much easier in the case of NTSC, the color TV system used in both the U.S. and Japan. If that is so, it's the first kind thing I've heard anyone say about our NTSC color TV standard in a long time!

### AND THEN THERE IS DANVERS, MASSACHUSETTS

As for Danvers, Massachusetts and its relationship to better audio for video, that's the site of a conference which I'm about to attend. Along with several colleagues, I'm going to serve as a conference leader at a three-day seminar series entitled "Integration Of High Fidelity Audio and Video." A listing of some of the session titles will give you some idea of how keenly the industry has become aware of the need for better audio for video. These include, among others, sessions dealing with:

1. The major implications of high-quality audio and video marriage.
2. Improvement of television sound.
3. EIA activities in multi-channel TV sound.
4. Technical implications of multi-channel TV sound for the broadcasting industry.
5. The need for uniform standards in the coming integration of audio and video. (That's my session.)
6. Technical implications of multi-channel sound for the cable TV industry.
7. Stereo cable TV today.
8. Video programming for the emerging audio-video systems.
9. A TV set manufacturer's approach to the marriage of audio and video.
10. The role of the laser optical disc and player in the marriage of high-quality video and high fidelity audio.
11. Audio and VHS: now and future.
12. High definition TV: an overview.

As you can see, the seminars will explore the whole question of improved audio for video in great depth, and if the discussion yields material that will be useful to readers of *db*, I'll summarize the highlights of the conference in a future column. ■



# 30,000 copies in print

## The Recording Studio Handbook



### 21 INFORMATION PACKED-CHAPTERS

#### Three all-new Chapters

#### Chapter 19. The In-Line Recording Studio Console

The I/O Module.  
The Basic In-Line Recording Console.  
Signal flow details.

#### Chapter 20. An Introduction to Digital Audio

Digital Design Basics.  
Digital Recording and Playback.  
Error Detection and Correction.  
Editing Digital Tapes.

#### Chapter 21. Time Code Implementation

The SMPTE Time Code.  
Time-Code Structure.  
Time-Code Hardware.

**Use the coupon to order your copies today at \$39.50 each. And there's a 15-day money-back guarantee.**

### Sixth big printing of the definitive manual of recording technology!

"John Woram has filled a gaping hole in the audio literature. This is a very fine book . . . I recommend it highly."  
— *High Fidelity*. And the *Journal of the Audio Engineering Society* said, "A very useful guide for anyone seriously concerned with the magnetic recording of sound."

So widely read . . . so much in demand . . . that we've had to go into a sixth printing of this all-encompassing guide to every important aspect of recording technology. An indispensable guide with something in it for everybody to learn, it is the audio industry's first complete handbook on the subject. It is a clear, practical, and often witty approach to understanding what makes a recording studio work. In covering all aspects, Woram, editor of *db Magazine*, has provided an excellent basics section, as well as more in-depth explanations of common situations and problems encountered by the professional engineer. It's a "must" for every working professional . . . for every student . . . for every audio enthusiast.

#### ELAR PUBLISHING COMPANY, INC.

1120 Old Country Road, Plainview, N.Y. 11803

Yes! Please send \_\_\_\_\_ copies of THE RECORDING STUDIO HANDBOOK. \$39.50. On 15-day approval.

Name \_\_\_\_\_

Address \_\_\_\_\_

City/State/Zip \_\_\_\_\_

Total payment enclosed \$ \_\_\_\_\_  
(In N.Y.S. add appropriate sales tax)

Please charge my  Master Charge  
 BankAmericard/Visa

Account # \_\_\_\_\_ Exp. date \_\_\_\_\_

Signature \_\_\_\_\_  
(charges not valid unless signed)

Outside U.S.A. add \$2.00 for postage.  
Checks must be in U.S. funds drawn on a U.S. bank.

## A Night at the Opera

• We're all a little nervous tonight. Even worse, none of us are hiding it very well. My assistants, Steve Shrewsbury and John Stancil, have each added a year's wear to the tape heads by scrubbing them furiously with alcohol and cotton swabs for the last hour. Even the Norwegian stoicism of my friend Tore Skille is showing stress: he has tightly rolled up his score of *Tosca* and looks ready to jump into a fjord (which in Miami isn't easy). Meanwhile, I am huddled in a corner of the control room, absolutely convinced that at least one of the marlin-sized fishing lines holding my orchestra stereo pair will snap, leaving my microphones dangling. It's about ten minutes to curtain, and we're waiting for something to go wrong.

Something does. Suddenly there is a bad hum on the left outrigger, a U-47. It's a dependable microphone—we've never had any trouble with it—and there's absolutely no reason for it to fail. However, the hum is undeniably registering -4 VU on my left meter. Steve grabs the spare U-47 and heads for the ladder to the catwalks. John starts opening XLRs. Tore checks the wiring harness behind the console. I am turned to stone in the corner—something horrible had to happen, it *had* to. We had two shots at recording Neblett and Pavarotti. The first performance had been pretty routine for us, and for the artists too. Tonight was our second and last chance for a good tape—and we wanted something good for the radio broadcast. Now, of

course, the equipment fails.

Steve is climbing down the ladder, having switched microphones. Naturally, the hum is still there. It's only moments before the opera begins. For no explainable, logical or earthly reasons, I turn the phantom power off, and then back on. The hum is gone, the house lights dim, and the audience's applause greets the conductor. We start the tape machine. With crashing orchestral chords the curtain goes up, and we all shrug.

### ACT ONE

Tore takes the stool behind the console. I've given him the opportunity and obligation of mixing. Tonight we need the best engineering possible, and I've rationalized that since he's from Europe, he must have better ears than the rest of us. Someone flicks the tape switch to repro, the score is uncurled and opened across the console, and we settle down to business. Tore is reading the score and mixing. John is watching levels and the action on stage for any signs of trouble. Steve has manned the tape machines. I am merely contemplative.

This is about the 24th opera recording I've made in this house, and about all of them have had problems identifiable to me. Sure—they were all good clean recordings, but none of them produced the kind of artistic and sonic spectacular a recording engineer always hopes for. There exists an ideal in the mind's ear in which every note of a recording per-

petually lives to impossibly recreate a perfect event again and again. Each time that I have recorded in this opera house, I have wanted to roll tape for three hours and walk away satisfied. It hasn't ever happened. There was always something I didn't like, or wished I had done differently. It was more than a phony perfection trip—the opera recordings had proved to be a real challenge. Thus, no two recordings had even been made the same way—some other manufacturer's microphones, a stereo pair a couple of feet lower than last time, near-coincident instead of coincident—not to mention different tape machines, consoles, and so on. I cock my ears towards the monitors—Pavarotti has just fallen in love with his *Tosca* for probably the thousandth time in his operatic career, yet the guy sounds like he really *is* filled with passion. It's a good night; even the orchestra has agreed to share the same measures.

Our work was cut out for us even before we saw the opera house. The opera's general manager had firmly stipulated that no microphones were to be visible to anyone in the audience. I could almost see his point of view. In a world of lip-syncing and reinforcement, in a world where I was once forced to run P.A. for the vocal soloists in a Beethoven Ninth, opera lovers want their music straight—no speakers, no amps, no mics, nothing. Besides, the Opera was spending a ton of money to perfect its display of





## Now getting the hot story live is as easy as calling home. The SM82.

Sometimes a story breaks so fast there's practically no time to set up lines of communication. Knowing that, Shure has developed a microphone to keep both you and the story well covered.

The Shure SM82 Cardioid Condenser Microphone. It's the only line-level microphone tough enough for the rigors of day to day remote ENG broadcast assignments. And all your crew has to do is just patch it straight into the transmitter connection of the nearest telephone... call your station, and they're home free. Or, it can be connected directly across a dialed-up phone line. No separate amplifiers, limiters, or line-level adapters are necessary.

Just as important, the SM82 is ideal for assignments involving very long cable runs (up to one mile without equalization) typically encountered when covering sporting events, parades, and political rallies.

While electronic news journalists will appreciate the SM82's extended reach and exceptional balance in hand-held situations, you'll love its low mechanical handling noise, rugged construction and reliable operation over a

variety of temperature, humidity and wind conditions.

Its built-in limiter kicks in at 100 dB SPL, preventing overload of the microphone's internal line amplifiers.

The SM82 utilizes an internal battery or it can be externally powered by an optional PS1 power supply or equivalent. For added security, it automatically switches to battery power if its simplex source should ever fail.

If you're in the broadcast operations ENG/EFP business, you know there are lots of ways to get a live story—even more ways to miss one. Now, with the SM82 on the scene, it is simply a matter of calling home.

For more information on the complete line of professional broadcast products, call or write Shure Brothers Inc., 222

Hartrey Ave.,  
Evanston, IL  
60204, (312)  
866-2553.

# SHURE

THE SOUND OF THE PROFESSIONALS®... WORLDWIDE

Circle 23 on Reader Service Card

visual fantasy—it didn't want that degraded in any way. No visible mics.

Now, hearing grand opera is quite an experience, and recording it is even more of an experience. Consider the problems involved: an enormous stage filled with acoustically treacherous scenery and effects equipment, and overhead a gigantic stagehouse, equally treacherous. People sing or speak on the stage, but sometimes they walk or run around, too. Sometimes they face sideways and sing at each other, sometimes they're forward, or backward to the audience. Sometimes there is one person on the stage, sometimes there are a hundred. They are all vocalizing (sometimes very loudly) and you can see the taut neck muscles and red faces. But sometimes you can't hear them, because there is also an orchestra with a hundred players hidden in a pit, drowning them out. What acoustical mayhem! For example, a minute ago a boy's chorus was at the back of the stage whispering something while the orchestra was playing *fortissimo*, and now the little brats are at the front, declaiming something while the orchestra has inexplicably fallen silent. Of course, the recording engineer can easily balance all of that at all times and make every scene sound both acoustically balanced and intelligible *and* in sonic agreement with the physical actions. Sure, of course.

The act one finale mayhem is now in high gear, and Tore balances it all superbly without a bead of sweat. The act is over. So far, so good. We talk it over and, for an unexplained reason, agree to put the original microphone back, as if there was any difference between perfectly identical U-47s.

## ACT TWO

Act two begins, and the cruel and lustful Baron Scarpia is interrogating Cavaradossi. Of course, it is the beautiful Tosca who he's really after. A bit player muffs a line and everyone on stage smiles faintly. John looks up from the score, surprised, but probably no one in the audience even noticed. We could splice from the first evening's recording, but is that right? This is a human performance—and a live recording—not a studio, not a synthesized version. The muff will stay, radio broadcast notwithstanding.

Earlier, we determined that the best place for a stereo pair would be above the pit, about thirty feet above the floor—not a very good hiding place. There were two other possibilities. Above the stage, a series of pipes is available for hanging scenery and lights. The first pipe is about thirty feet up and twenty feet in from the pit. We have an AKG 451 near-coincident stereo pair there tonight. It is nestled among stagelights, patches into an anticipated house microphone line, travels three hundred feet, and reaches us perfectly clean—no filament noise, no induced hum, nothing. The sound is

bright, patterns over most of the usable stage, gives a fair stereo image, but because of placement problems, gives the world's worst off-axis orchestra sound. Our second hiding place is back in the house, in a light bay across the ceiling over row 20. We have a near-coincident stereo pair there. Sony C-500s tonight, for orchestra sound. It is a wooly sound, with only fair imaging because of the proximity of the hard ceiling which gives undesirable reflections. In both pairs, the sound is incredibly dry, and a dry opera sound is incredibly horrible.

It's essential to have a little ambience in an opera recording and therein lies another dilemma. With its diversity of musical contexts—from recitative to full orchestra and chorus, from Monteverdi to Wagner, it's absolutely impossible to acoustically design an opera house with optimum reverberation time. A big volume of a million cubic feet with a long reverberation time of 2 seconds might be great for *Gotterdammerung*, but would obliterate the intelligibility required for the recitatives in *Orfeo*. Of course, recording engineers understand that Monteverdi is always performed in reverberant barns and Wagner in sponge closets. In any case, that question is academic in this opera house, which has the distinctly crisp non-sound of an anechoic chamber.

Our mobile truck houses neither plate nor spring not bucket brigade—actually we don't even have a truck. The BX-20 in the studio does a remarkable job in post production, but we rely on ambience microphones in the house to add the real thing. Thus, to either side of the Sony orchestra pair are U-47 outrigger microphones for house ambience. Between the two near-coincident pairs and the spaced-apart pair, we have our basic tools to achieve a balance. We have worked out path lengths from the various parts of the performing forces to the various microphones, and the disagreements are not serious. Because PBS radio broadcasts are the end result of the project, monaural compatibility is crucial. Miraculously, our three-pair placement gives excellent compatibility. It's not a microphone placement scheme you'll see in a textbook, but that is perfectly understandable. As I've noted before, sometimes its theory *versus* practice in this business. Tosca places a gold crucifix on the stricken Scarpia's chest, and the curtain falls.

## ACT THREE

Steve thought he heard some induced radio station during a quiet part of the act, so we rewind during the intermission and listen—no one hears it, but we are all edgy as act three begins. This opera house has the Act Three Curse, it never fails. Once a staghand walking along a catwalk gave us a great recording of footsteps. One time a microphone covering an offstage brass ensemble went dead.

During another act three, the Bee Gees suddenly joined in via a local radio station, cruelly startling my old assistants, Curt Taipale and Dave Apelt. (I wonder what has happened to them?) Now I remember the strain of opera recordings had been too much, and they retreated back to the tranquility of rock 'n' roll. We are nervous again, waiting for the Act Three Curse to befall us. I move my chair over to the window, and hope that by prayer alone I can guide the performance to a happy ending. Out on stage the reason for all of this progresses with familiar inevitability. Earlier, Mario Cavaradossi the painter confused his enthusiasm for his portrait of the Virgin Mary with his lust for the raven-haired diva Flora Tosca. A cannon shot signalled the escape of the political prisoner whose name isn't important, and some choir boys sang a rousing *Te Deum*. Back in the Farnese Palace, chief of the secret police Baron Scarpia anticipated the sadistic pleasure of bending the beautiful Tosca to his will. Meanwhile, Napoleon wins the battle of Marengo. So Tosca stabbed Scarpia with a butcher knife (or scissors, letter-opener, or what-have-you), and placed a candelabra at his outstretched hands and a crucifix on his chest. All of which brings us to act three. Cavaradossi will be killed by a make-believe firing squad because Scarpia's treachery transcends the grave and Tosca will run up to the top of the fortress and jump off. It is a tragic story. No humor, none at all.

Pavarotti steps up for his big aria, *E lucevan le stelle*. We are breathless, it's the tune the audience has paid for, and waited all evening to hear. If there was ever a time for The Recording Curse to fall, this is it. I cross my fingers for the five of us, and all of us take a deep breath. He throws open his mouth, ready to put an earful into four thousand ears out there. And something in him responds to the task. He opens up. What a voice extraordinary. The orchestra joins in—a beautiful zero on our meters. Again and again—hitting that zero. As if we had all found the perfect moment, we are plugged right in, our microphones condensing, preamps gaining, tape fluxing: perfection—a kind of ecstasy—a moment that engineers covet, a moment in which every engineer dissatisfied with making mere reproductions suddenly realizes that he has at last captured *reality*. Then it is over: the crowd goes wild. I breathe a sigh of relief, we are going to make it. The meters jump at the startlingly loud, ugly shots of the firing squad, and Tosca's frightened exclamations. The tape is almost to its end, another in a countless succession in the modulated reels of a recordist's career, the means to his paycheck, his satisfaction. Tosca runs to the battlement's heights and leaps to her death and we all shake hands, and power-down. Another night at the opera. ■



# Now! A balanced high-level output oscillator with the lowest distortion.

**This is oscillator performance that's totally advanced, totally Tektronix!** Depend on the new SG 505 Option 2 for balanced, high level output in the studio or at a transmitter site. It outputs a sine wave with less than 0.0008% THD, the lowest residual distortion of any oscillator on the market today.

Complex measurements are made automatically in tandem with the AA 501 Distortion Analyzer. These two TM 500 plug-ins can be mounted in the same or separate mainframes, or transferred to a portable mainframe for use in the field.

No other manufacturer offers this kind of flexibility; two separate devices that make one powerful package, side-by-side or miles apart. Still fully automatic, even when separated.

**New state-of-the-art performance, by every measure!** The SG 505 Option 2 features a completely balanced output configuration for compatibility with highest-performance audio systems. Source impedances are selectable among 600, 150 and 50 ohms. And when you're testing for clipping



margin or headroom, the SG 505 generates high level output of +28 dBm into a 600 ohm load and +30 dBm into a 150 ohm load.

Answers come quickly with the AA 501. No level setting, tuning or nulling required. Measurements are precalculated via digital processing and displayed on the LED readout automatically.

**Part of the family: TM 500.** These two plug-ins share the configurability that TM 500

is famous for: over 35 different plug-ins for a host of test and measurement requirements. Six mainframes provide bench, rackmount and portable packaging, each with built-in power supply.

**Call the Tektronix National Marketing Center today for specifications, pricing and applications information.** Technical personnel can answer your questions, accept your order and expedite delivery. Direct orders

include operating manuals, 15-day return policy, full Tektronix warranty and service back-up.

**Order toll free:  
1-800-426-2200  
Extension 38**

In Oregon call collect:  
(503) 627-9000 Ext. 38

**The Answer  
By Any  
Measure**

**Tektronix**  
COMMITTED TO EXCELLENCE

# "No noise, nor silence, but one equal music."

John Donne, 1571-1631.

The new Klark-Teknik high-performance DN30/30 graphic equaliser offers much more than just a quiet ability to balance channels right across the audio spectrum. Thoughtful ergonomics are backed by a new circuit design breakthrough using ultra-stable microelectronic filter networks to set performance standards comparable with Klark-Teknik's 'golden oldie' the DN27A. The DN30/30 is the equaliser to boost a studio's reputation, meet broadcasting specs in less rackspace, cut costs and equipment failures on the road — because ...

It fits two matched high specification graphic channels into a single unit, each providing  $\frac{1}{3}$  octave equalisation over a full 30 ISO centre frequencies.

It gives fine fingertip low-frequency control covering the subwoofer range down to 25Hz — with touch-sensed centre detents, selectable cut boost level range and fail-safe design giving extra certainty during live events.

Its advanced design, tough construction, stringent testing and long burn-in exceed even Klark-Teknik's previously high standards for reliability and consistent performance on the road.

For technical information ask for:  
Our DN60/RT60 Data Sheet.  
Our DN30/30 Data Sheet.  
Our Application Notes on equalisation.



**KLARK TEKNIK**  
*sound science*

**Klark-Teknik Electronics Inc.**

262a Eastern Parkway, Farmingdale, NY 11735, USA.  
Telephone: (516) 249-3660

**Omnimedia Corporation Limited**

9653 Côte de Liesse/Dorval, Quebec H9P 1A3, Canada.  
Telephone: (514) 636 9971

Manufactured by Klark-Teknik Research Limited, England.



**SOME MORE  
EQUAL THAN OTHERS**

The microprocessor-based DN60 Spectrum Analyser and RT60 Reverberation Analysers provide LED matrix display of system, performer and studio response at 30 frequencies identical with those of the DN30/30.

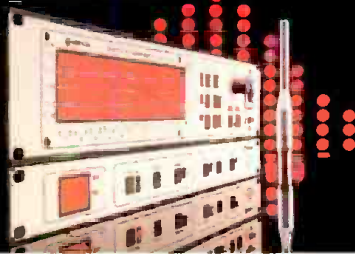

Circle 26 on Reader Service Card



## Let's Hear it for "Dull"

AS THIS PAGE is being written, the new year is fast approaching (no doubt fast receding by the time this gets to your mail box). It's time for everyone, except us, to be hard at work making New Year's Resolutions. Long ago, we made a solemn resolution to make no more resolutions. Even predictions are out, and as for forecasts, they should be regarded with deep suspicion (especially if they are editorial forecasts).

This makes life a lot easier. And these days we can certainly use all the "easy" we can get. For example, we have wisely not resolved to do better this year. So, if we don't, no one can accuse us of breaking our resolution. It's quite simple really, once you get the hang of it. Of course, we'll try—and all that—but trying and resolving are entirely different matters.

This year, we're going to resol...oops, *try* to make these pages an even better buy than they were in 1982. After all, money's tight. (We have this from no less an authority than The Publisher, who so informed us when we suggested an in-depth personal study of Tahitian recording studios.) As we recall, his point was that we should try to offer the public something more for *their* money or there wouldn't be any more money for *us*. (Publishers have a way of quickly getting to the heart of even the most abstract concepts.)

Now, although we have very simple tastes, and rarely think about personal comfort, the villa in Capri does need a little sprucing up, and the yacht could use another coat of varnish. So perhaps we might pay just a bit more attention to what our readers want, and then maybe hit them with a subscription increase while they're off-guard (varnish is so expensive).

A quick peek in the mailbag was of no help whatsoever. Some said we were getting a little too technical lately; others said we weren't technical enough. Some wanted more studio stories; others asked us to skip the studio stories and get down to business.

Apparently, we shall have to work this one out ourselves and then hope that you folks will go along with us. So, for whatever it's worth, here's how we see it for 1983. But remember, this is no prediction.

The world of pro audio is not getting any simpler (remember, you read it here first). If you're busy making a living (or busy trying to make a living) in audio, then you are...busy. You could probably use a hand in keeping up with what's new in our industry. And if you could only sneak a little time off for some R & R, you probably wouldn't spend it reading this little magazine (well, at least we wouldn't).

You can see where this is leading. We look to our authors to help us with our work, and then go and look somewhere else when it's time to play. If we work hard enough, and are good enough at it, maybe we'll be fortunate enough to get some more time off for play. But if we play at working, maybe we'll wind up with nothing *but* time off.

So, **db** will remain aimed at the audio professional who is looking for help with the work part of life. All work and no play? Not at all—at least for us. It's just that for our work, there's **db**. For our play time, there's (deleted on orders of The Publisher).

So next time someone tells us that **db** is a little, uh...dull, we'll say "we know—it was carefully planned that way." It keeps the magazine out of the reception room, and you won't find spare copies lying all around the studio. In fact, you probably won't find it at all, except for this copy. (It is yours, isn't it? If not, stop reading immediately, and turn to the subscription form.)

Keeping **db** hidden from idle eyes was not really our idea—at first. At first, the (in)visibility worried us, until we finally realized we were on to something big. We weren't really invisible at all; you just had to know where to look. If you're looking on the coffee table, you're not even close. (You'll get no more hints from us!)

To help keep us invisible, we have a few new features planned. First of all, equipment reviews. What!? After all these years? Why now? (Or, if you like, Well, it's about time!)

In the past, we've stayed away from reviews, mostly because we didn't know how to handle them. Those detailed descriptions of where to find the power switch, how many LEDs are in the lower left-hand corner, and how do the specs really measure up were just a little too dull—even for us! What we needed was a studio environment in which the equipment could be placed and subjected to all the indignities of the real world.

Well, we've got the studio now. (Actually, the University of Miami has it, but that's just a minor technicality.) Your editor, aided and abetted by faculty member Ken Pohlmann, who doubles as a **db** columnist, have actually convinced a handful of unwary manufacturers to part with samples of their prized merchandise for a semester or so. We'll have a preview review, and more details, next month.

Of course, we haven't Resolved to Do Reviews in 1983. We're just going to try it out, and see if it works. If it does, maybe we'll get even more invisible. In these difficult times, what more could a Publisher want? JMW

# Analog Mastering Tape vs Digital Mastering Tape

*The following is a detailed comparison of analog and digital tape, along with a discussion of common magnetic tape elements.*

**M**AGNETIC TAPES for digital mastering present unique design requirements that are quite different from those intrinsic to the formulation of tapes for analog mastering. Therefore, an important part of any discussion about analog and digital mastering tapes should include an analysis of the ways in which the two designs differ. Only then can a serious comparison be made; only then can progress be defined and, ultimately, future developments predicted.

First, let's examine each of the basic elements of *all* magnetic tapes and consider these elements as building blocks, which in themselves may be modified in a myriad of ways. The magnetic tape architect can then select the proper combination of building blocks, fitting them together in specific arrangements to achieve the appropriate tape design goals.

## COMMON MAGNETIC TAPE ELEMENTS

**Base Film.** The foundation of all magnetic tape is the base film. Today's design requirements dictate that a polyester film be used, since polyester's unique properties make it ideally suited for all types of magnetic tape.

Polyester film possesses high-tensile strength, low elongation at working loads and excellent dimensional stability through a wide range of temperature and humidity. It can be cast efficiently in thicknesses as thin as 0.20 mil (0.00020 inch) and as thick as 5.0 mil (0.00500 inch). Its tensile properties may be varied, producing films of high-tensile strength in the longitudinal direction or balanced ones where longitudinal and transverse tensile strengths are similar. Surface smoothness also may be varied to fit specific needs.

Polyester is a generic term, chemically known as polyethylene

terphthlate. Familiar trade names are Mylar, manufactured by DuPont; Celanar, from American Hoechst; Hostophan, from Kalle, and Melinex, from ICI.

**The Magnetic Particle.** The magnetic particle of a tape is the element which undergoes the widest design modification to suit the unique criteria of different tape formulations. In its most widely used form, the magnetic particle is an oxide of iron, needle-like in its physical form and some 10 to 25 microinches in length and 3 to 5 microinches in diameter. Chemically, it is known as gamma ferric oxide ( $Fe_2O_3$ ), or just plain "iron oxide."

Iron oxide is a crystalline material, the construction of which can be modified by the chemical addition of other materials. In magnetic particle chemistry, the other material most often used is cobalt. By modifying the crystalline structure with the addition of cobalt, the magnetic properties of iron oxide can be changed dramatically.

For example, the most important characteristics of a magnetic particle are coercivity—measured in oersteds—and retentivity—measured in gauss. Gamma ferric or iron oxide particles have coercivity levels of 260 to 380 oersteds, and retentivity levels of 900 to 1500 gauss. Cobalt modification of those particles can produce coercivity levels varying from 350 to 2000 oersteds, and retentivity levels of 1500 to 2500 gauss.

Other magnetic particles are also available to the tape architect. Chromium dioxide is one such particle, with coercivity in the 400 to 600 oersted range, and retentivity ranging from 800 to 2000 gauss. Also, the most recent and glamorous addition to the magnetic-particle building blocks is that of pure iron or metallic particle, with coercivity levels varying from 800 to 2000 oersteds, and retentivity levels as high as 3600 gauss.

It is the tape architect's responsibility to select the proper particle to achieve his design goal, whether it be standard-bias cassette tape, high-bias cassette tape, metal-particle cassette tape, analog mastering, digital mastering, video, instrumentation or computer tape applications.

---

Warren Simmons is the Product Manager, Audio Magnetic Tape Division, at Ampex.



**Backcoating.** In all current magnetic tape technology, a conductive backcoating has become standard design practice, and electrical conductivity is a major concern. By maintaining a minimum conductivity level through the use of carbonous materials, electrostatic generation can be minimized. Magnetic surface conductivity levels can be shifted to backcoat conductivity, thereby maximizing magnetic surface performance while still retaining overall adequate tape conductivity levels. A minimum conductivity level is essential to minimize electrostatic buildup, which, in turn, reduces pickup of contaminating particles and provides cleaner running tape.

Yet another consideration in the design of backcoatings is that of surface roughness. In this case, design tradeoffs are important. As backcoat roughness is increased, high-speed winding uniformity is enhanced. However, the tradeoff penalty is an increase in modulation noise, a most important consideration in all high-quality mastering tape designs.

Once again, the building blocks available to the tape architect in the category of backcoatings are many, and the proper selection is vital to the ultimate performance level of a given tape.

**Binder Systems.** In magnetic tape design, the selection of the proper binder system is also essential to tape performance. Consider audio mastering applications where two-inch tapes might be required to perform reliably for more than 2000 passes during mixdown, re-mix or overdub sessions at 15 or 30 ips. Compare these requirements with instrumentation tapes that must operate at 120 ips in airborne applications or surveillance logging tapes and medical body-function monitoring applications which must perform at speeds less than 0.2 inches per second. Durability and frictional properties have become prime considerations, and binder systems which include surface lubricating characteristics must also change—yet another set of building blocks from which to choose.

**Tape Accumulation/Reels.** In the majority of current recording devices, magnetic tape is presented to the recorder by winding on reels. The reel design and physical tolerances of the reel have become critical to the overall recorder performance. Increasing accuracy of all reel dimensions has been recognized as desirable to meet the higher performance requirements of current analog recording, not to mention the requirements of digital recording, where narrower track widths make more precise tape guiding essential.

## MAGNETIC TAPE MANUFACTURING CONSIDERATIONS

**Magnetic Particle Dispersion:** By selecting different manufacturing processes, the uniformity of dispersion or positioning of the magnetic particle throughout the surface of the magnetic tape can be modified. Both electrical noise and dropout activity can be affected by such dispersion. Agglomerates, or particle groupings, can cause increases in noise levels in analog recordings, while particle voids can cause dropouts or bit errors in digital (PCM) recording.

**Calendering:** After a magnetic tape is coated and dried, it undergoes an operation called calendering, or surface smoothing. The calendering operation performs two basic functions: 1) It compacts the magnetic coating, resulting in an increase in magnetic activity, and 2) it imparts a design surface smoothness and gloss dependent on the selection of calendering media and calendering pressures and temperatures. Higher

gloss levels, in general, provide more intimate tape-to-head contact and can improve short wavelength (high frequency) response in analog recording as well as reduce bit error rate in digital recording.

**Slitting:** In the initial manufacturing stages, magnetic tape processing is carried out in a "web" form with widths of 26 inches or more. After coating, drying and calendering operations, the wide webs of coated material are moved to the slitting operation where they are cut or slit into the appropriate tape widths ranging from 0.150 inch for audio cassette tape applications up to two inches for audio mastering, quadruplex video and rotary instrumentation applications.

Demands for tape-width uniformity are intense. Current applications require tolerances of 0.002 inch or less, and future requirements are already searching for manufacturing methods that can perform reliably within width tolerances no greater than 0.0004 inch to accommodate digital audio track widths of as little as 0.006 inch.

## COMPARING ANALOG AND DIGITAL TAPES

Now, after defining the basic elements of all magnetic tapes, we can identify systematically, element by element, the differences between the design requirements for both analog mastering and digital (PCM) mastering tapes. FIGURE 1 is a comparison of analog and digital tape characteristics, and these characteristics are discussed in detail below.

### Base Film

**Analog Requirements:** A thick base is important to minimize print-through. Base film thicknesses from 1.15 mil (0.00115 inch) to 1.45 mil (0.00145 inch) are in general use for high-quality analog mastering. Recorder geometry allows up to 14-inch reels holding 5000 feet, while play speeds not exceeding 30 ips permit 33 minutes of play time.

**Digital Requirement:** Due to higher track densities resulting in narrower track widths (37 tracks on one-inch tape in the Mitsubishi X-800 recorder), intimate tape-to-head contact is essential, and greater tape flexibility helps meet this need. Since print-through is no longer a consideration, lower film thicknesses from 0.83 to 0.88 mil can be used. In some hardware geometry, linear speeds are higher (45 ips for the 3M systems), and thinner tapes will permit reasonable play time at these higher speeds (32 minutes, using 7200 feet on a 1½-inch reel).

### The Magnetic Particle

**Analog Requirements:** In analog mastering, magnetic particles are always gamma ferric oxide. Because of recorder bias current characteristics, particles must fall into the range of 290 to 380 oersteds. Particles must be selected for bias noise characteristics, print-through, distortion and saturation characteristics.

**Digital Requirements:** In digital recording, the new term "packing density" becomes an important consideration. Packing density can be considered the number of bits of information which must be handled in any given area of tape. Packing densities are usually described as the number of kilobits per inch of tape. In analog recording at 15 ips, looking at a 20 kHz signal, packing densities would be 1.33 kilobits per inch. If we look at a typical professional digital recorder, operating at a 48 kHz sampling rate and a 16-bit format, the packing density at 30 ips jumps to 25.6 kilobits per inch.

Obviously, substantially higher recording density now is in effect, and in order to accommodate these higher recording densities, magnetic energy levels must also increase. The higher energy levels can be realized by increasing the coercivity level of the magnetic particle. As previously discussed, through the use of cobalt, iron oxide particles can be modified to achieve coercivity levels anywhere between 350 and 2000 oersteds. Current tapes for digital audio applications are being designed with magnetic particle coercivity in the 600 to 700 oersted range.

contact, are not extreme for analog requirements.

*Digital Requirements:* Because of higher packing densities and narrower track widths, it is necessary that tape for digital use be manufactured to higher gloss levels to accommodate more intimate tape-to-head contact. Modifications in binder systems are required in order to enhance the achievement of these higher gloss levels.

### COMPARISON CHART: ANALOG VS DIGITAL MASTERING TAPES

Characteristic	Analog	Digital
<i>Base Film</i>		
Composition	Polyester	Polyester
Thickness (mils)	1.15 to 1.45	0.80 to 0.88
<i>Magnetic Particle</i>		
Composition	Gamma Ferric Oxide	Cobalt-Modified Gamma Ferric
Coercivity (Oersteds)	290-380	600-750
Retentivity (Gauss)	1050-1450	950-1250
<i>Back Coating</i>		
Resistivity (Ohms square)	$1 \times 10^4$ to $6 \times 10^4$	$1 \times 10^4$ to $6 \times 10^4$
Smoothness ( $\mu$ in peak to valley)	20	20
<i>Binder Systems</i>		
Durability	Highest Level	High Level
Shed	Low Level	Lowest Level
Magnetic Particle Dispersion	Highest Level	High Level
<i>Calendering</i>		
Gloss Level (units of reflectance)	90-110	110-120
<i>Slitting</i>		
Width (maximum allowable variation—inches)	0.002	Less than 0.002

Figure 1. A comparison of analog and digital tape characteristics.

#### Backcoating

*Analog vs. Digital Requirements:* In both analog and digital tape, the smoothness of the backcoating is an important factor. In the case of analog recording, modulation noise is deteriorated by surface roughness; in digital recording, the same surface roughness can increase error rate levels. In addition, conductivity to minimize airborne dirt becomes extremely important in digital recording in order to minimize error rate levels.

#### Binder Systems

*Analog Requirements:* Binder systems for analog tapes must demonstrate extremely high levels of durability to withstand multiple mixdown passes, re-mix activity and overdubs. Surface gloss levels, which promote intimate tape-to-head

#### Magnetic Particle Dispersion

*Analog vs. Digital Requirements:* In both tapes, a high level of dispersion is required, but for different reasons. In analog recording, poor dispersion causes bias noise buildup and an increase in modulation noise. In digital recording, poor dispersion can cause loss of digital information and an increase in error rates.

#### Calendering

*Analog vs. Digital Requirements:* Because of higher packing densities, digital recording requires greater tape-to-head contact, which can be achieved through higher gloss levels. By modifying temperatures, pressures and calendering media, gloss levels can be increased to provide a higher level of tape-to-head contact.



# WHY OUR SHELVES ARE LOADED WITH AMPEX TAPE, ALWAYS HAVE BEEN, AND PROBABLY ALWAYS WILL BE.

## Consistency. Consistency. Consistency.

Three beautiful words that keep car doors from slamming in our parking lot, phone calls from becoming abusive, and mail from growing hostile.

Words we hear about Ampex tape. Consistently.



Words we hear from extremely reliable sources — our customers.

Time and again.

The professional recording world has a blizzard of tapes to choose from. All with similar base film, magnetic material, binder system and backcoating.

Looking at the specs, it's hard to tell one brand from another. So price and availability make the sale more often than data sheets.

A big mistake.

They're all pretty much the same, but they're not all pretty much consistent.

We've heard too many horror tales about some track on a master tape having to be doctored ever so carefully back to life. Sure he should have been paying attention. But in the middle of a recording, with 24 tracks going, who really has time to reach over and adjust a needle that's suddenly making funny with the VU meter.

With Ampex tape you decide the levels, not the tape. It's consistent.

It has been for years.

It would be nice if a lot more things were.



from acoustic design  
to down beat...

**Westlake  
Audio**

Professional Audio Sales Group  
7265 Santa Monica Boulevard  
Los Angeles, California 90046  
(213) 851-9800 Telex: 698645

Circle 27 on Reader Service Card

**AMPEX**

# THE CONSOLE THAT REDEFINES "POWERED MIXER."

## INTRODUCING THE RXA SERIES PROFESSIONAL, POWERED CONSOLES FROM TOA.

### WE'LL BET YOU'VE OUTGROWN YOUR "MIXER."

Until now, self-powered mixers have had some serious shortcomings. Like inadequate power amplification, limited input channel capability, a serious lack of signal processing and most of all—not enough thought (or care) put into the construction.

The new TOA RXA Series self-powered consoles are engineered to solve all these problems. They're built rugged. They're amazingly compact. And, they're designed around the specifications and performance that an audio professional needs.

An RXA board is the logical next step.

### OUR SMALL CONSOLES HAVE SOME BIG DIFFERENCES.

There are two models of RXA consoles: The 16 input console has four built-in power amps of 120 watts each into 8 ohms. The 12 input has two, 120 watt assemblies. These amplifiers are totally accessible for whatever use you may have for them, including bi-amplification.

Both consoles feature dual, 9-band graphic equalizers that are switchable to either the program or foldback outputs. Both equalizers and the power amps are assignable with panel mounted switches. Signal input is a choice of either +4 or +20 dBm sensitivity.

Every channel input is balanced, transformer isolated with an input level switch and trim control. These inputs are XLR type, while unbalanced operation appears on normal plug-in jacks. There's four band equalization for more flexibility. All the faders are log-linear type with 60mm travel. The inputs also have peak indicating L.E.D.'s, cue switch, stereo input, Aux echo input, program output, foldback output and echo send.

The metering is solid-state, high intensity fluorescent bargraphs for monitoring the program L&R and foldback 1 and 2. Both

consoles give you additional stereo inputs for connecting a stereo playback deck, disk player or any other auxiliary equipment. There's even a built-in, electronic analog echo unit.

### OUR SMALL CONSOLES ARE BUILT TO TAKE YOUR WORST.

When you get your hands on our new RXA Series you'll discover the big difference is inside too. All critical components are modular, including our exclusive PowerBlok™ amplifier assemblies. The sensitive input electronics are grouped into units of two and have extensive shielding to keep out interference, and hold to an ultra-low noise spec.

Both consoles are wrapped into a rugged chassis that's lightweight, easily transportable and attractive. Our 16 input model is only 2'9" wide.

Our new RXA consoles are engineered for where you're going, not

where you've been. Check out these specs and you'll see what we mean.

### SPECS:

Frequency Response:	20Hz-30kHz
THD:	less than .05%
Equivalent Input Noise:	-126dB
Crosstalk:	-63dB @ 1kHz

Contact us now for more information on a series of powered mixers that are designed to be high performance consoles.



TOA Electronics, Inc., 480 Carlton Court  
South San Francisco, California 94080 (415) 588-2538

In Canada:  
TOA Electronics, Inc., 10712-181 Street  
Edmonton, Alberta T5S 1K8 (403) 489-5511

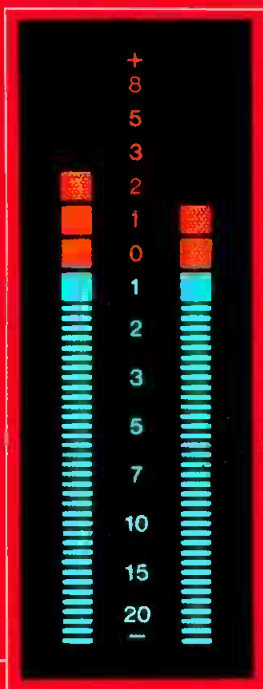

Large, fluorescent, high intensity bargraph peak meters.

8 1/16"

29 5/8"



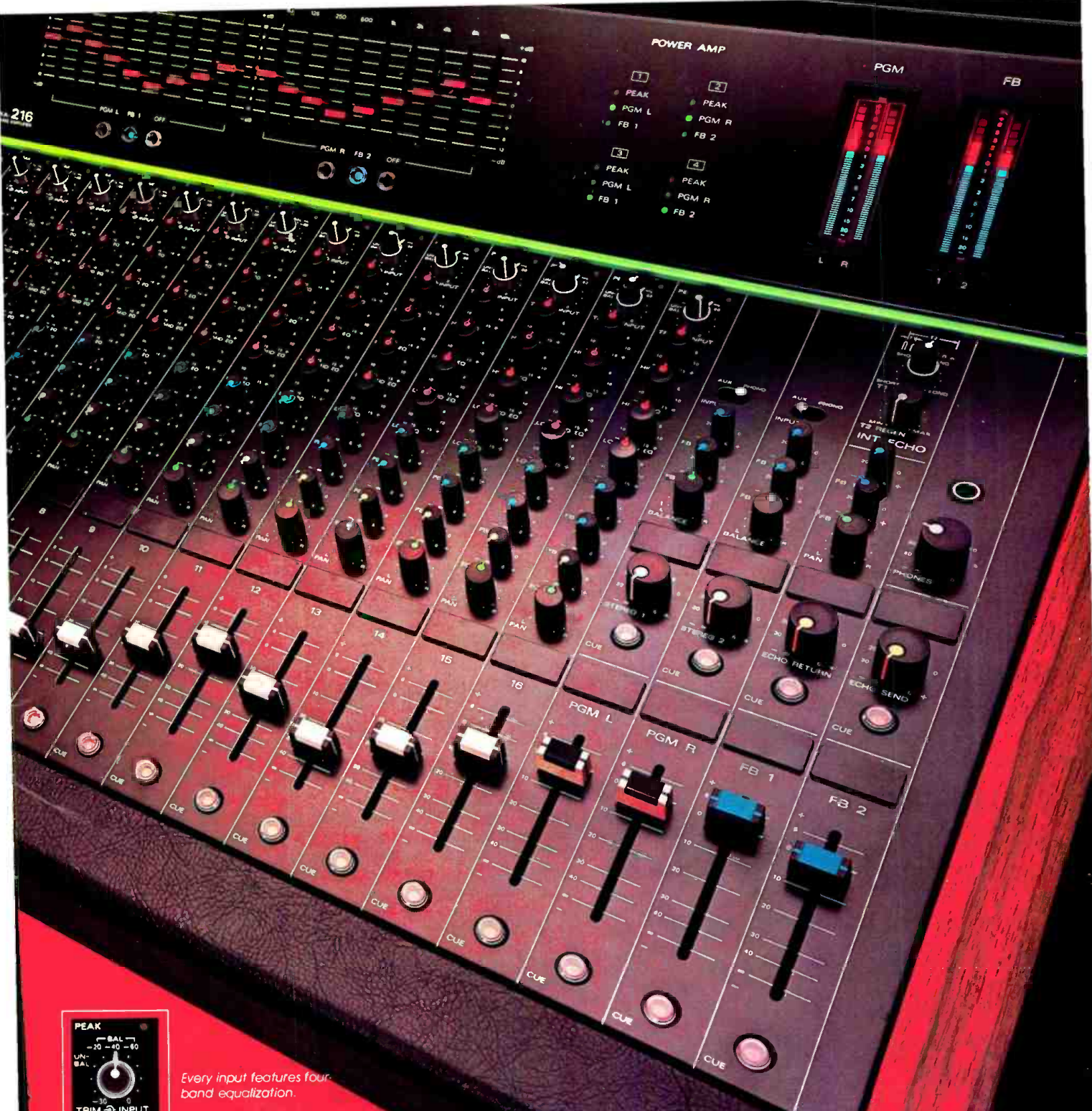

216

POWER AMP

PGM

FB

- 1 PEAK
- 2 PEAK
- 3 PGM L
- 4 PGM R
- 5 FB 1
- 6 FB 2



Every input features four-band equalization.

Exclusive, built-in electronic analog echo device.

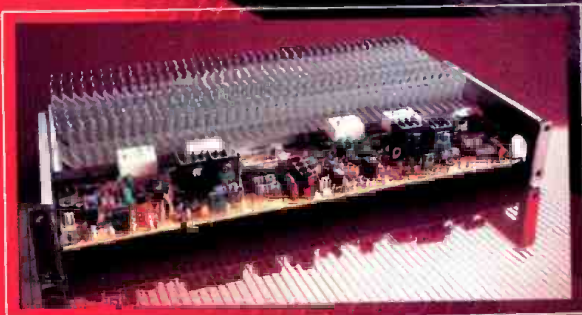

Exclusive, integral PowerBlok™ power amplifiers rated at 120 watts into 8 ohms.

© 1982 TOA Electronics, Inc.

Circle 28 on Reader Service Card





Figure 2. These electron scanning microscope photographs, processed at a diameter magnification of 10,000 and a viewing angle of 45 degrees to the surface, show differences between the Ampex 456 analog (left) and the Ampex 466 high-energy digital tapes. At this magnification, the surface roughness is directly related to the gloss level under standard viewing—the lower the surface porosity, the higher the gloss, as seen in the 466 photograph on the right.

### Slitting

*Analog vs. Digital Requirements:* In general, narrower track widths (currently standard recorder design practice) require lower levels of slitting error. In analog recording, tolerances of 2.0 mils (0.002 inch) have allowed totally acceptable performance, even up to 24-track, two-inch widths. In digital recording, where track widths of 6 mils (0.006 inch) are not uncommon, more precise slitting has been recognized as highly desirable, and tolerances of 0.4 mil are being sought after as standard slitting practice. In addition, tape edge weave—or skew—takes on new importance in digital recording because of the narrow track widths in multi-track recording.

### PROGRESS IN MAGNETIC TAPE DEVELOPMENT

The earliest magnetic tapes in the late 1940s were produced on acetate-backed material having relatively low strength and a high degree of sensitivity to dimensional change through temperature and humidity changes. As multi-track recording came into being, a much greater degree of dimensional stability was required as tape widths increased from ¼ inch, to ½, one and finally two inches.

The DuPont Corporation made polyester base film available in the mid-1950s, providing a new, high level of strength and dimensional stability and also making multi-track recording practical from a tape point of view.

Continued development in base film technology has increased the overall accuracy of manufacturing in magnetic tape with improved slitting tolerances and better tape surfaces. Oxide development has taken tape from a coercivity level of 240

oersteds (with retentivity levels less than 800 gauss with signal-to-noise ratios possible of only about 50.0 dB) up to coercivity levels of 380 oersteds, retentivity levels of 1500 gauss, and with a great improvement in particle size, allowing a significant reduction in noise levels. Magnetic particle chemical modification through the use of cobalt has provided an even wider selection of particle energy levels for meeting the needs of applications such as digital recording. The advances in binder system chemistry have provided increases in durability as have been described in analog mastering for multiple mixdown passes. Surfaces today are tougher and more durable than in the original magnetic tapes. Backcoating of magnetic tape to improve winding properties, tape pack information and cleanliness of running is a relatively recent design improvement and has allowed tape performance to improve, particularly from a dropout and overall cleanliness point of view.

### THE APPEARANCE OF DIGITAL AUDIO TAPE

The first digital audio tape presented to the marketplace was Ampex Corporation's 460 Series, formally introduced at the AES Show in New York in 1977. Hardware requirements at that time were operating at relatively low packing densities and wide track widths. The Ampex 460 Series was a 300 oersted tape which performed satisfactorily on the first generation of digital audio recorders.

When multi-track recorders (the 3M one-inch 32-track, the Mitsubishi one-inch 32-track and the more recent Sony ½-inch



# Digital Audio Recording Tape Specifications

MANUFACTURER <i>Tape Type</i>	AMPEX		3M	
	460	466	265	
<b>Physical Properties</b>				
Base film thickness	1.00	0.88	0.79	(mils)
Oxide thickness	0.20	0.20	0.16	(mils)
Backcoat thickness	0.04	0.04	0.10	(mils)
Total thickness	1.26	1.12	1.05	(mils)
Width ¼"	n/a	247	n/a	(mils)
Width ½"	498	498	498	(mils, nominal)
Width 1"	997	997	998	(mils, nominal)
Yield strength	n/a	n/a	13	(lbs, per inch)
Breaking strength	n/a	n/a	21	(lbs, per inch)
<b>Magnetic Properties</b>				
Retentivity	1000	1300	1350	(gauss)
Coercivity	310	650	720	(oersteds)
Erasure field	1000	n/a	n/a	(oersteds, for 60 dB erasure)
<b>Performance Specifications</b>				
Sensitivity	0, +/ 1	n/a	n/a	(dB)
Wavelength response	0, +/ 1	n/a	n/a	(dB, 1-0.10 mil)
	0, +/ 1.5	n/a	n/a	(dB, @ 0.08 mil)
	0, +/ 2.0	n/a	n/a	(dB, @ 0.06 mil)
1.5 MHz Slot S/N	>46	n/a	n/a	(dB)
Uniformity	2.0	n/a	n/a	(dB max, 1 MHz signal)
<b>Environment</b>				
Operating	40-120	n/a	55-85	(degrees, F.)
	25-95	n/a	25-75	(%, rel. hum.)
Storage	10-120	n/a	50-90	(degrees, F.)
	10-95	n/a	25-75	(%, rel. hum.)

n/a = Information not provided on Specification Sheet.

24-track) made their appearance, low coercivity levels were no longer acceptable. Gloss levels likewise were too low for intimate tape-to-head contact and acceptable dropout activity.

At the AFS Show in Los Angeles in May of 1981, the Ampex 466 Series of digital audio tape was introduced. Design criteria for digital audio tape now had shifted, and a different set of building blocks was selected. Magnetic particle coercivity was increased to 650 oersteds, and a cobalt-modified gamma ferric oxide was used. The binder system was also modified, allowing for a higher degree of calendaring and for higher gloss levels for better tape-to-head contact. With higher packing densities, dropout activity became a far more important consideration.

## MAGNETIC TAPE: ITS FUTURE AND ITS VARIOUS APPLICATIONS

Most experts agree that analog mastering will continue to flourish. Because of an extremely large installed population of analog recorders, efforts will continue to improve the overall quality of analog recording. The current move from ¼-inch mixdown to ½-inch mixdown, providing about a 5.0 dB improvement in signal-to-noise, is one such example of application improvement.

Tape manufacturers also will continue their efforts to locate oxides having lower noise, higher output, lower distortion and lower print-through.

The move to multi-track digital mastering will place extremely stringent requirements on tape manufacturers. Tape surfaces will become ever more important as packing densities increase, and tape manufacturers will have to improve the overall cleanliness of the recording surface to meet both the high packing-density requirements in digital audio and the desire for lower dropout levels in all video applications.

As cassette recording in the Philips audio format moves into digital configurations, even higher particle energy levels will be required to accommodate the high-packing densities of this narrow-track application. One of the current experimental Philips digital audio configurations requires a coercivity level of approximately 1250 oersteds - higher than any other current recording application.

Miniaturization of recording devices such as the micro-cassette for high-fidelity audio applications and digital audio cassette recording systems, plus continued movements toward higher packing densities as a result of lower linear tape speeds, will accelerate development efforts in all areas of magnetic tape.

To keep up with such developments, industry research activities, like those of Ampex Corporation's Magnetic Tape Division Laboratory, will carry on their work, dedicated to supplying the ever-changing recording industry with high-performance tapes that can meet these challenging needs. ■

# The Analog-to-Digital Transition: Development of a Consumer Clarification Code

*The question of how to accomplish the A/D transition in the marketplace is a thought-provoking one which, unfortunately, provides no easy answer.*

SOMETIME IN THE FUTURE, when the long-playing record joins its ancestors the wax cylinder and the 78 RPM disc in the family vault, when analog consoles and analog microphones have been retired to audio museums—when digital audio finally reigns supreme—we shall think back on these days...and chuckle. Everything from toasters to newspapers is digital now. Why did we ever worry that music recordings might have a hard time making the transition?

Of course, our prediction is paradoxical—while we may anticipate such future fond memories, here in the present we must carefully consider and calculate for that future. For if those chuckles are to come later on, we must now address the issue of consumer reactions during the transition period from analog to digital recording technology. If we don't, the road to that transition may turn out to be very rough.

Presently, when the consumer buys what appears to be a conventional record album with a "Digital Recording!!" banner on it, a subtle fraud is being perpetrated. The master tape may indeed have been digital, but that vinyl disc of grooves certainly is not.

As digital technology enters the record-production chain, it becomes increasingly important to correctly identify precisely which aspects were accomplished digitally, and which were not. Failure to provide consumer clarification would conceivably lead to a marketing debacle (or, at least, to a lot of confusion). Thus, during the transition period in which we convert from an all-analog to an all-digital recording-reproduction chain,

engineers and marketers alike will be faced with questions of honesty and ethics, and—for some, perhaps—survival.

## A TRICKY RELATIONSHIP

The consumer is a demanding and capricious force, and must be carefully dealt with in an open and understanding bedside manner. If the implicit trade agreement between consumer and supplier is violated, suppliers can expect confusion, suspicion, resentment, resistance, or, even worse, rejection. While the audio industry has been reasonably successful over its first hundred years, it has experienced more than a few disasters and, in my opinion, has sometimes skated on dangerously-thin ethical ice with its partner and patron, the consumer. In the audio hardware industry, as with any competitive business, great pressure is placed on engineering departments to perform, and on advertising agencies to sell. For example, it is essential to imply (at *least* once every few years) that a new product represents the ultimate in recording or reproducing, and that once that item is purchased, the owner shall never again be bothered by obsolescence.

Of course, the recording business depends on the eventual repudiation of that idea by the very consumer who initially believed it, much in the same way that Detroit depends on rust. On the other hand, the recording business incorporates an almost magical entity—the music business. Because music is never really obsolete, and yet is eternally replenishable, new audio recordings can be constantly produced and added to the existing software library. There is no need to proclaim "state-of-the-art," or "technological breakthrough," or "this is the last tuner you will ever have to buy." The music software business must simply state: "it's available, and you'll enjoy it."

Between audio hardware and software a curious relationship has developed. Precisely which one (if either) takes advantage

---

*Ken Pohlmann is the assistant director of the Music Engineering Program at the University of Miami and is a regular db columnist.*



of the other is an interesting question. The hardware manufacturer must sell new gear each year both to new customers and to those wishing to upgrade. At one time or another he has stated these truisms (or their opposites): "solid state is better than tube; stereo is better than monaural; integrated is better than transistor; quadraphony is better than stereo; FFT is better than bipolar, etc." His success depends on how well-believed his claims are. From all of his various appeals, the manufacturer essentially consolidates his strategy to one which appeals to everybody by stating: "This new hardware makes music sound better than ever before." That's a clever ploy, because few consumers buy hardware for its aesthetic value alone. It isn't the performance of the instrument per se which interests the consumer, but the improvements it brings to music listening. Thus the music hardware is only a means to an end—the music software. The hardware manufacturer innocently pretends that he labors solely to make your music sound better; thus, hardware manufacturers take advantage of the software suppliers.

Or is it the other way 'round? The software suppliers believe that the ends cannot be sold without promoting the means. Their album-covers variously state: "long play is better than 78 RPM; full-fidelity response is better than low-fidelity response; stereo is better than monaural, quadraphony is better than stereo; direct-to-disc is better than mixed, etc." Perhaps the impact of technology claims on record sales is not clearly perceivable. Certainly, a tremendously popular and eccentric performing group could sell platinum records released on acetate 78s. But for most other sales, those technology claims on the album cover might make just that little difference between a profit margin, or none. Therefore, the music software business takes advantage of the hardware business. One hand washes the other, while historically both hands have grabbed a piece of the pie.

## TRANSITIONS

In our society, new technology is introduced for the pursuit of the pie. That motive tends to treat us to an incredibly rapid pace of development in many facets of our lives, and canned music listening has been no exception. Transitions from old to new elicit our excitement and our will to buy, and the audio industry works hard to maintain state-of-the-art. In the early 1950s, the long-play record quickly pushed aside the 78 RPM record. In the late 1950s, stereo suddenly obsoleted monaural. There was some consternation when perfectly clean monaural recordings began reappearing as "electronically re-channelled stereo," but that irritant could never have put the stereo transition in jeopardy. Solid-state equipment soon replaced vacuum tube types and we all learned to like the sound of bipolar transistors. Even direct-to-disc was successfully (re-)introduced and gained a small but adamant market share.

But there have been some transition debacles. No doubt the most glorious and costly death-wish in recent technology was quadraphony. Perhaps it was doomed from the start; no one could agree on anything, the different matrix schemes created confusion in the consumer and led to the ultimate death-knell—consumer indifference. That disaster occurred during some enormously profitable years for the recording business—the losses were absorbed as tax write-offs. But what if the quad disaster was taking place right now, when record sales are steadily decreasing each year? Given the useless choice and needless confusion between SQ and QS quad, would today's record buyer instead change his ten dollar bill for quarters, and never return?

## ANALOG-TO-DIGITAL

Now we enter another transition period with incredible potential for unprecedented sales growth, as well as for confusion, suspicion, resentment, resistance and rejection. That transition is, of course, analog-to-digital. While electrical engineers have devised ingenious ways to convert analog information into digital information for efficient processing and storage, the audio industry might find that A/D conversion in the marketplace requires even greater ingenuity. Consider the

potential complications: the consumer, accustomed to buying digital records released on vinyl-groove long-play discs, is suddenly confronted with other digital records, perhaps in the form of a compact disc; he does not understand the price increase for apparently comparable products—he rejects the compact disc. Or, after buying his vinyl digital record, the consumer hears all the same clicks and pops and observes the usual steady-usage degradation; he decides that digital is just another gimmick, the word is soon passe and no interest is generated when the "true digital" medium is introduced. Or, a consumer buys a compact disc because he has heard of the incredible fidelity it offers; but after investing in a new player, he plays a digital compact disc which is a reissue of an old analog recording; the consumer isn't impressed, and tells his friends it's not worth the extra money. Another consumer goes to the video-cassette store and is confronted by albums proclaiming "16-bit linear PCM" or "14-bit floating point," or "delta modulation"; the consumer doesn't know which of these discs will work on his player, so he leaves empty-handed. Still another consumer goes to the record store and sees albums featuring "digitally-recorded," or "digitally-mixed," or "digitally-mastered," or "digitally-released," or "all-digital," or "true-digital"; unable to understand just what he's paying for, and thus unable to evaluate its worth, he goes to the video arcade instead, where he knows what he's getting for his quarters.

Considering all the analog or digital choices in the recording and reproducing chain (and all the possible ways of accomplishing any of them), and then calculating the permutations, we might conclude that the conversion to quad was kid-stuff compared to the transition to digital. Clearly, if hardware manufacturers and software suppliers want the transition to succeed, then some forethought and restraint must be applied to the matter, from all interested parties.

## ENTER SPARS

The Society of Professional Audio Recording Studios (SPARS) is a singular organization, uniquely placed at the juxtaposition of these interests. Like the consumer, its studio-owner members are watching the digital dilemma with interest. But unlike the consumer, who at least has the choice of buying old or new technology to listen to old or new software, the recording studio owner (SPARS or otherwise) must buy new technology to produce new software. For the present transition, the risk is enormous because of the great investment required to convert the facilities to handle any or all of the digital formats. If the transition is delayed, or incompletely implemented, or proves calamitous, the loss is tremendous. Thus, out of prudent self-interest, the issue of the analog-to-digital transition was raised at a recent meeting of the SPARS Board of Directors. I imagine that a great concern was consumer perception of the transition.

After all, it is the consumer who ultimately determines whether a studio's investment in digital hardware was money well spent. Since advertising plays a key role in consumer education, the marketing practices employed will help shape consumer reactions. The marketing confusion experienced by the quad hardware and software manufacturers was reflected into the recording studio, with the inevitable result. Anticipating another such episode, SPARS has addressed itself to the problem, and is examining the need for an explicit designation scheme showing analog or digital techniques employed in the recording, processing, and manufacturing of music software. Clearly, that explicit designation must be prominently displayed on the field of battle where the consumer will both learn of his choices and make his own choices—on the album cover itself. *When the means of producing a product is being used to sell a product*, the consumer must be made aware of exactly what means were employed in producing the product.

In other words, to eliminate confusion and promote honesty, a clear explanation of any claim must be provided. For example, when a consumer buys a vinyl disc derived from a digitally-recorded master, is it unfair to advertise it as a "digital

record" because it is an analog release of a digital recording? Even the words "digitally-recorded" incompletely describe the process and obviously omit the information that the microphones and console were surely analog devices. Or, consider that when the consumer buys a digital compact disc which contains a re-issue of an analog recording, it certainly is a "digital disc," but it certainly is *not* a "digital recording." Strictly speaking, the unqualified use of the word "digital" should only be permitted when the entire chain from microphone to release is digitally accomplished.

In the interest of long-term self-preservation, everyone in the recording industry should recognize the importance of playing fair with this matter. Something I'll call a *clarification code* must be developed. But the implementation of a clear and understandable, fair and honest scheme will not be easy. First, how much information can the consumer actually absorb, without becoming hopelessly confused? The amount of information which might be conveyed is quite large—e.g. should differentiation between processes such as recording and remixing, or mastering and pressing be explained? And what about technical differences between, for example, 16-bit linear and 14-bit floating-point? Third, what about the intuitive prejudice (deserved or not) which exists between analog and digital? Digital has been equated with "good" and analog with—if not "bad"—then at least with being "inferior by comparison." The temptation to arbitrarily assume that a record with four out of five digital production or manufacturing steps is "better" than one with only three out of five digital steps would obviously be unfair. Finally, that prejudice could create trouble between some codes and some manufacturers. What record label would care to advertise a release as being "half-digital," thereby apparently confessing to it being a "half-quality" product? (No doubt some critics will argue about which half of such a record contains the quality—Ed.)

The solution will require an impartial, complete, and self-explanatory representation of the analog and digital aspects of the complete recording manufacturing chain. The good bad judgement should be left to the consumer—who will make that decision anyway. However, said consumer must not have his good bad reflexes pre-conditioned by misleading phrases incorporating the word "digital."

Since words are inherently dangerous, at least when applied to matters of propaganda and selling, perhaps symbols could provide a better scheme. Each album might bear a composite symbol, or a series of symbols, showing the chain which led to the end product.

Before going on with this epic—a little background information. It turns out that our editor was present at that SPARS meeting mentioned earlier. No doubt in an effort to show off, he volunteered to do a little research into the problem. Next, in an effort to advance the cause of scholarship (and possibly get out of doing the work himself), he turned the research project into a class project for the music engineering students at the University of Miami.

Presumably, the music engineering students are keenly interested in every detail of recording technology (at least that's what they tell their instructors). However, the other music students are more interested in hearing the finished product than in learning of the means by which it was realized. Still other students outside the School of Music want little more than the assurance that they are not buying "half-quality" merchandise.

If a code could be devised that would simultaneously satisfy these three levels of interest, it might go a long way towards minimizing overall consumer confusion if it was adopted by the recording industry. The remainder of this report summarizes our "first draft" efforts to come up with something useful.

It might be instructive to further explore the nature of the problem by working our way through some of the possibilities, to see where this leads us.

## SOME POSSIBILITIES

If recordings could be equated to restaurants, we could use the star code familiar to gastronomes everywhere. For example, \* \* \* \* could denote a more digitally-complete recording than \* \* . Obviously, this simple scheme fails; it is not self-explanatory, it is an incomplete representation of the entire chain, and it contains an implicit quality judgement.

First, it seems that we must designate which segment of the chain is digital, and which is analog. We could sub-divide the chain into say, three parts, and place an A or D in the appropriate box: Thus, 

D	D	A
---	---	---

 would denote digital recording, digital mastering, and analog release. This is reasonably self-explanatory, and does not imply a quality judgement. But it also does not completely represent the signal chain. We would like to include more boxes for microphones, console, multi-track tape, signal processing, sub-master tapes, cutting, duplication and release. A typical code could get to look like 

A	A	D	D	D	A	A
---	---	---	---	---	---	---

. This code meets our criteria, yet omits much pertinent information, such as digital format (16-bit linear PCM, 14-bit floating point, delta modulation, sampling rate), half-speed mastering, direct-to-disc, etc. Also, we should think about other pertinent release information, such as analog speed, tape type, cassette format (VHS, Beta, U-matic), digital disc type (capacitive, laser), and so on. Obviously, the truly-complete code quickly becomes exhaustively informative and exhaustively complicated.

At this point, we must back up for a moment. To what extent is it advisable to divulge the recording process? How much explanation will a consumer understand? How far should we expect consumer education to develop consumer understanding? How much does the consumer care about all of these fine points?

When stereo was introduced, large portions of the album covers were devoted to explanations of the new process in the correct belief that consumer awareness would benefit sales. Today, consumer awareness of digital has aided sales. However, the digital transition is much more complex and piecemeal than the stereo transition of a quarter of a century ago. Information overload at the consumer level could raise misunderstandings and myths—and concerns about compatibility. And during this transition, perhaps the consumer's overriding concern will again be that of compatibility. Thus, even an occasional uncertainty could snowball into untold lost sales.

We return to an early premise that the clarification code must be simply expressed and not overly informative. The recording chain must be simply sub-divided and designated analog or digital. The code must appear as universally-understood symbols, perhaps most effectively drawn as pictographs—that is, as diagrams representing both the recording sub-processes. A single log might appear too abstract—we might best be served by a signal-flow pictograph. Initially, we might consider three sub-processes, with appropriate crenallations designating analog or digital. Such a scheme has been proposed by student Jeff Phillips, who suggests the format symbols shown in FIGURE 1.

While these schemes might serve present needs, future innovations should perhaps be considered and included in our code to forestall obsolescence. For example, the eventuality of digital microphones and digital consoles would modify what is presently regarded as a digital recording process, and would call for additional symbols. In a more complete system, microphones, console, and all subsequent steps would have to be illustrated.

But now, put yourself in the layman's position. What if you had to decipher cinematography to see a movie, or debug microprocessor systems to play a video game? The way to the product must not become obscured! It now appears that the definitive CCC could become unwieldy to implement. If it presented all the information discussed here, it would take up a lot of space and probably go a long way towards confusing.



# Better Than A Guarantee

You only check a guarantee after something goes wrong.

You can check the strip chart in every box of Ampex 2" Grand Master® 456 as our assurance that nothing will.

Which is why we test every reel of 2" Ampex 456 end-to-end and edge-to-edge. The strip chart of the test results tells you that you'll get a rock-solid readout with virtually no tape-induced level

variations from one reel of 456 to another or within a single reel.

No other brand of tape undergoes such rigorous testing. And as a result no other brand offers you the consistency of Ampex Tape. A consistency that lets you forget the tape and concentrate on the job.

## AMPEX

Ampex Corporation • One of The Signal Companies

Ampex Corporation, Magnetic Tape Division  
401 Broadway, Redwood City, CA 94063  
(415) 367-4463

**4 out of 5 Professionals Master  
on Ampex Tape.\***



\*1981-1982 Billboard Magazine  
Brand Usage Survey

Circle 29 on Reader Service Card

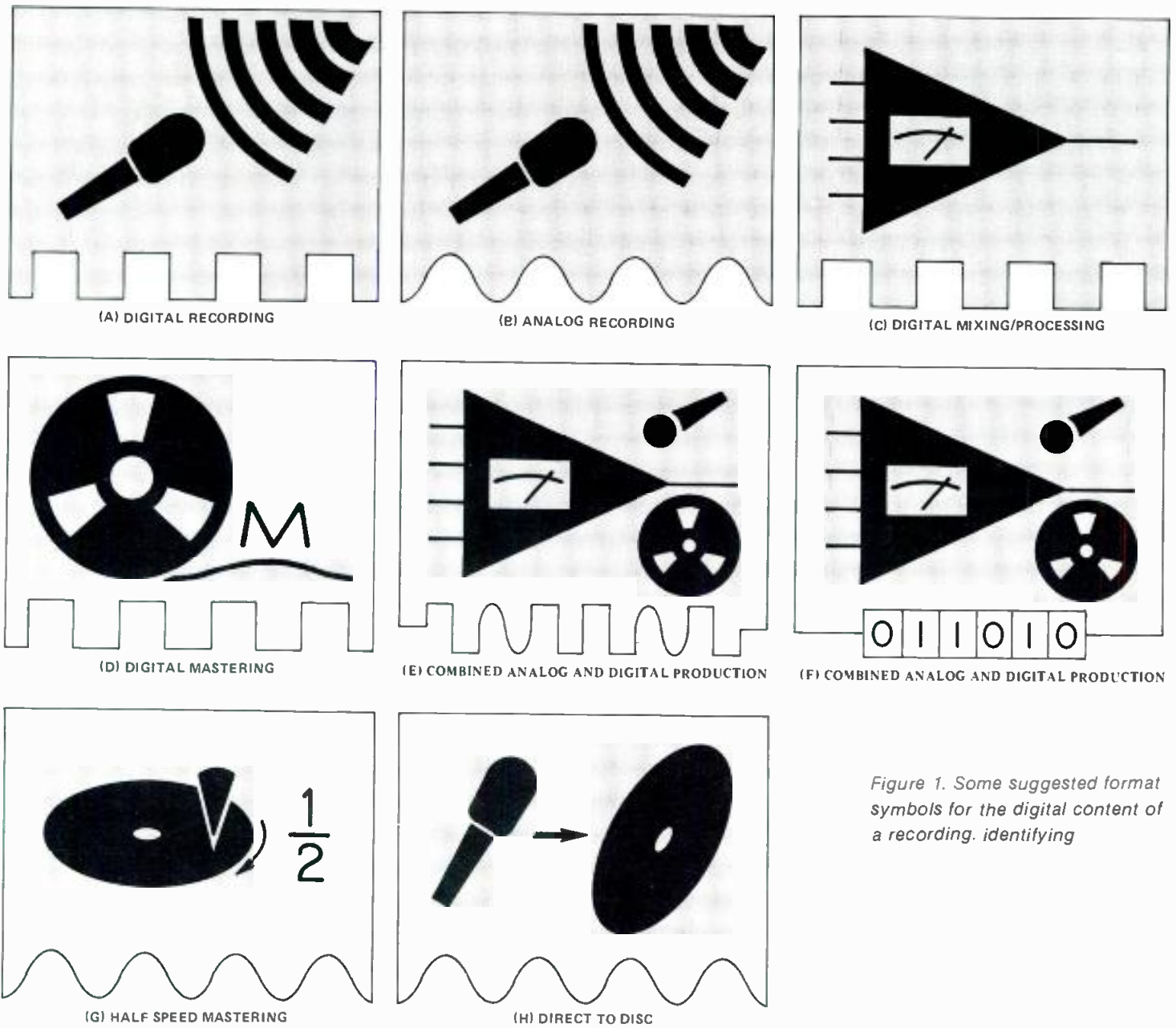

Figure 1. Some suggested format symbols for the digital content of a recording, identifying

rather than enlightening, the record buyer.

Perhaps a solution is to devise a simple digital logo which would clearly identify the recording as one that makes use of digital technology. The logo might include a bar-like code, an alternating sine wave square wave border, or perhaps a sequence of binary digits that would unobtrusively indicate which of many steps in the chain were digital (1) and which were analog (0). For example, a string of 1s and 0s would provide three levels of information.

The record buyer with little interest in the finer points of digital production would note the digital logo, and no doubt ignore the binary word, which would convey no implied quality rating.

The more interested consumer might note the 1s and 0s which would simply indicate how many steps were digital and how many were analog.

For the serious audiophile consumer, a series of articles in the hi-fi press could describe the complete code in detail. The reader would learn that when the most-significant bit was 1, the

recording was made with digital microphones (!). The next most-significant bit would reveal the console type, and so on.

Presumably, the same information could be printed as an album insert by those record labels that wished to do so. And, an informative "What is Digital?" booklet could be made available to the consumer—perhaps as a promotional handout.

The current attempt by SPARS to study and possibly formulate a consumer clarification code deserves our careful attention and the support of interested hardware and software suppliers. With some forethought and consensus, the rate of the analog-to-digital transition might be limited by hardware software availability, and not by marketplace confusion.

If the consumer is not subjected to partial truths, and thus if the well is not poisoned, everyone should benefit from the new technology. However, if short-term gain is attempted, or chaotic marketing is promulgated...

What started out as a "simple" project has turned out to be a rather-complex issue. Let's hope the solution turns out to be a little more satisfactory than quad. ■



# The VOICE-MATIC™ Automatic Microphone Mixer

**JUST GOT  
EVEN  
BETTER**

## Introducing the LEVEL-MATIC™ module option

The Voice-Matic Model DE-4013 has received wide acceptance in sound reinforcement, broadcasting and teleconferencing applications by eliminating feedback and fading sound levels. With the NEW LEVEL-MATIC master module option, the Voice-Matic is totally automatic.

- Soft talkers receive added gain.
- Loud talkers and background sounds are attenuated.
- A smooth, uniform output level is the result.
- Retrofits all existing DE-4013 mixers.

Once you hear it, you won't want your sound system without one.

Call or write today for more information on how the Voice-Matic mixer with the Level-Matic option can improve your sound installation...automatically!

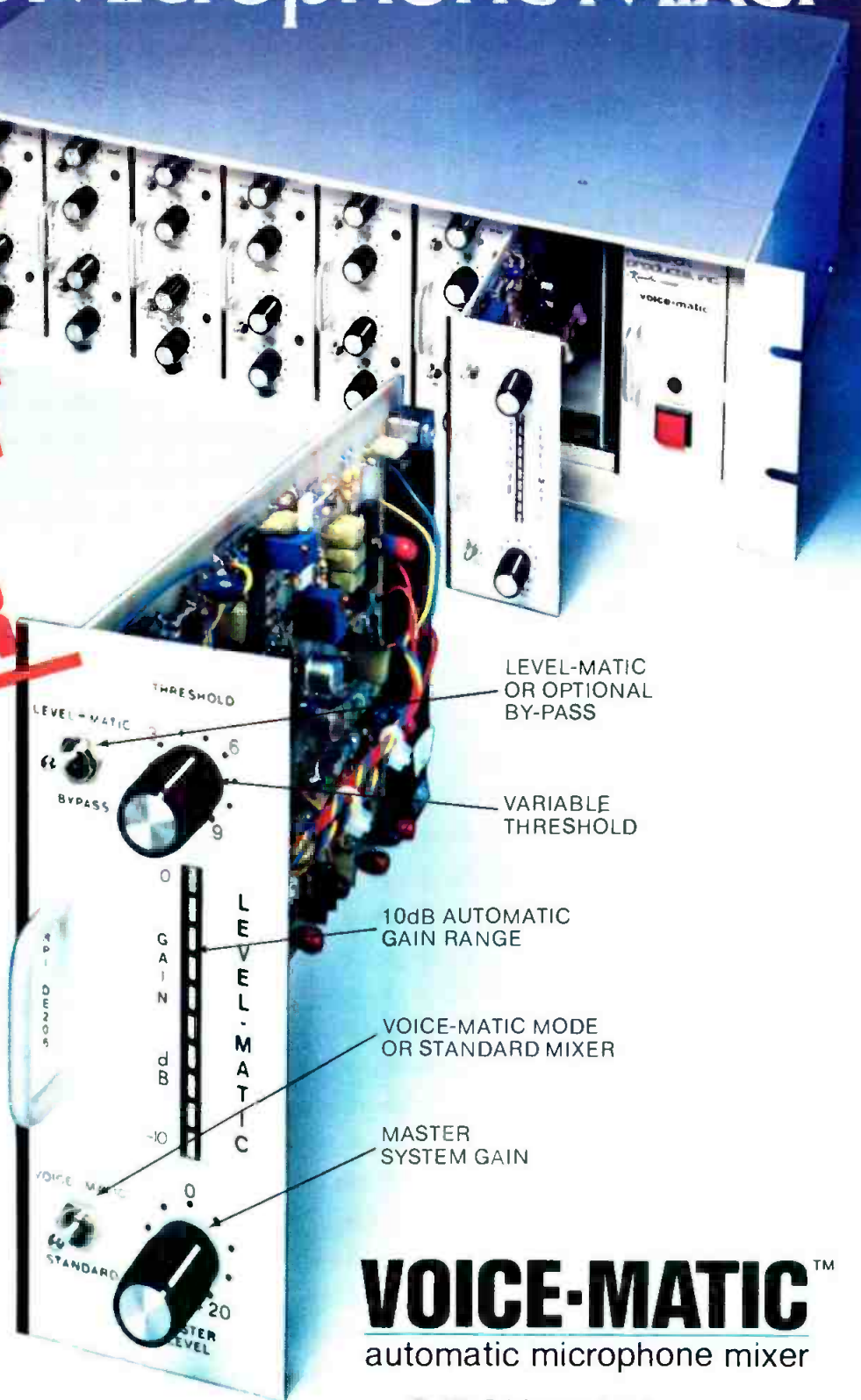

**VOICE-MATIC™**  
automatic microphone mixer

INDUSTRIAL  
RESEARCH  
PRODUCTS,  
INC.

A Knowles COMPANY

321 Bond Street • Elk Grove Village, IL 60007  
(312) 439-3600

Circle 30 on Reader Service Card



# Time Code Implementation

*The following is a (brilliant?) excerpt from the author's updated **Recording Studio Handbook**.*

**S**INCE THE EARLIEST DAYS of multi-track recording, studio engineers have felt the need for an efficient, reliable means of monitoring time-related data. The most obvious requirement—as well as the one easiest to implement—is to establish a means of noting the playing time of the finished recording. Obviously, if this was all we needed to know, a conventional stop-watch would be more than sufficient.

The requirements for more sophistication within the time domain may have begun with the introduction of the sel-sync recording techniques. The engineer now needed a way to return, again and again, to the same location on the tape, as the artist rehearsed and then recorded at the punch-in point. While this point was usually musically apparent, a slight change in phrasing could carry the punch-in recording too far if the engineer was paying more attention to the new material than to the old.

Obviously, a non-ambiguous method of noting, and returning to, the required points was needed. The earliest technique—still used on many consumer tape decks—made use of a counter which generally indicated the number of revolutions of the recorder's supply reel. Directly linked to the reel motor, the system could be quite accurate. However, practical considerations prevented it from gaining wide-spread acceptance.

The first drawback to a revolutions counter is that it has little or no relationship to the real-time world. Neither artist nor engineer can be comfortable with a recording that begins at say, 7680, and ends at 8309, since these numbers convey absolutely no information about starting or ending time, or about the

duration of the interval between them. Worse yet, documentation for future reference is of little use, since if the tape segment gets transferred to another reel with more, or less, tape on it, both the numbers and their mathematical difference will be changed. This makes intelligent record-keeping virtually impossible.

A more satisfactory system would provide a time-based readout, typically derived from tape travel across an idler wheel placed in the tape path. Although such a system is certainly much easier to read and interpret by the operator, it may be less accurate due to tape slippage, especially if the tape is pulled away from the idler from time to time, as, for example, during editing.

In either case, the systems just described will be of little practical value in the synchronization of two or more machines. Furthermore, when the reel of tape is removed from the machine, all time or revolutions data is lost.

## RECORDED TIME DATA

A far more accurate and reliable system would record the time information as a coded signal on one of the tracks of the multi-track tape. Once recorded, this time code would of course remain in perfect synchronization with the program material, and its future accuracy would not deteriorate, due to various mechanical factors. For example, as the tape is shuttled back and forth, so is the time code. When the tape resumes playing, the time-code readout resumes as well.

Like any other "stopwatch," the code usually does not tell the actual time of day. Instead, it indicates the running time of the recorded program. This may have been keyed to the actual time of day at which the recording was made, or to the elapsed time since the recording began. Thus, after 2 minutes and 37 seconds, on a 9:15 am recording session that began 31 seconds late, the time code might read 09:18:08 or simply, 2:37.

---

*John Woram is the author of the **Recording Studio Handbook** and the editor of **db Magazine**.*

## THE SMPTE TIME CODE

Today, the time code that is in almost universal use conforms to a standard developed by the Society of Motion Picture and Television Engineers (SMPTE), and subsequently adopted by the European Broadcast Union (EBU). The complete standard is published as ANSI V98.12M-1981; The American National Standard Time and Control Code for Video and Audio Tape for 525 Line 60 Field Television Systems. The standard was approved by the SMPTE in January 1981, and is generally referred to as the SMPTE EBU Longitudinal Time Code, or simply, SMPTE Time Code.

The code was originally developed as an electronic alternative to the mechanical visual sprocket-and-frame-count system used in the film industry. In motion picture work, the sprocket system can be used to keep two or more machines in sync; while editing is easily accomplished by simply viewing the film frames. Needless to say, videotape has neither sprockets nor visible frames, nor does the frame rate match that used in film work. Nevertheless, the SMPTE time code provides a readout in hours, minutes, seconds and frames, to give the operator film-like frame editing accuracy. Thus, a readout of

23:59:32:21 indicates 23 hours, 59 minutes, 32 seconds and 21 frames.

There are several frame rates in use today, and these are tabulated here:

Frame Rate (frames per sec)	Application
24	used in motion picture film work
25	EBU standard, compatible with European television
29.97	NTSC color videotape standard
30	NTSC monochrome (B & W) standard

### Description of the Code

Simply stated, the SMPTE time code is a longitudinally-recorded signal. The code provides an 80-bit digital word for each video frame. Unlike the coding schemes described earlier, a zero is defined whenever there is no transition within a bit cell, as shown in FIGURE 1A. In other words, there is only one

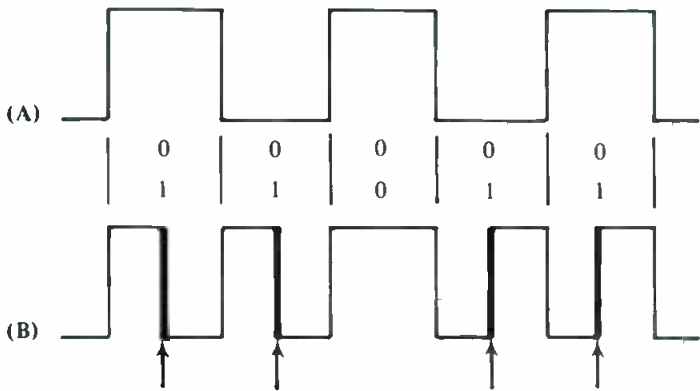

Note transition in the middle of these bit cells, which defines a 1.

Figure 1. In the SMPTE time code, a zero is defined whenever there is no transition within a bit cell (A), while a transition within the bit cell (B) defines a one.

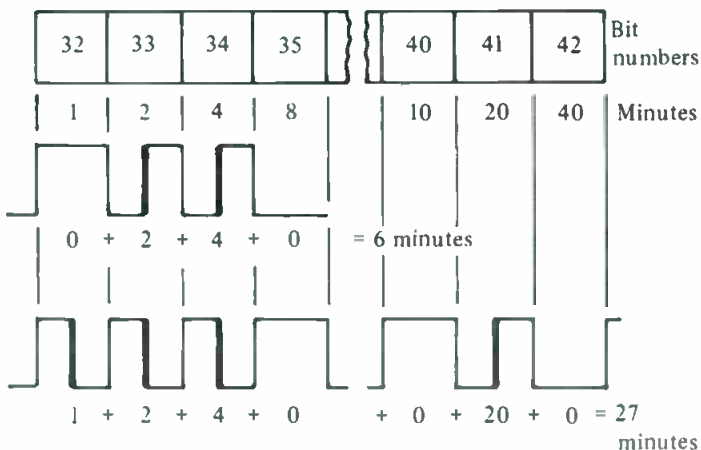

Figure 2. In each frame, bit groups 32-36 and 40-42 define minutes (units + tens).

## STL Offers The Most Complete Selection Of Test Tapes Available Anywhere

STL can serve all your needs with precision test tapes for frequency alignment, level set, azimuth set, flutter & speed tests, sweep frequency tests and pink noise analysis. Also available is the Standard Tape Manual & the Magnetic Tape Reproducer Calibrator.

Phone for fast delivery or free catalog

**STL**

**STANDARD TAPE LABORATORY, INC.**

26120 EDEN LANDING ROAD #5 HAYWARD, CALIFORNIA 94545 • (415) 786-1536



transition per bit, and this occurs at the beginning of each bit. At 30 frames-per-second, 80 bits-per-frame, and 1 transition-per-bit, a continuous stream of digital zeroes will produce a square wave of  $30 \times 80 \times 2 = 4800$  transitions-per-second, or 2400 Hz.

### SMPTE-ASSIGNED ADDRESS BITS

Within the 80-bit digital word assigned to each frame, certain bit groups have been assigned to various time, sync, and user-defined functions as described below.

#### Time-code Address Bits

The time code assigns specific bit groups to indicate hours, minutes, seconds and frames. For example, FIGURE 2 illustrates bit groups 32-35, and 40-42, which indicate minutes(units) and minutes(tens) respectively. Using a binary-coded decimal (BCD) system, bits 32-35 indicate 1, 2, 4 and 8 minutes, while bits 40-42 are 10, 20 and 40 minutes. Thus, 6 minutes is defined by a one in bits 33 and 34. If bits 32, 33, 34 and 41 are one, then the time is  $1 + 2 + 4 + 20 = 27$  minutes.

Note that the units group is used to define minutes 0-9, and the tens group defines minutes 10-59. Therefore, 12 minutes is indicated by  $2 + 10$ , and never as  $4 + 8$ . Similarly, 60 minutes is indicated by a one in the hours (units) group — not illustrated here — and not as  $20 + 40$  or  $2 + 8 + 10 + 40$  within the bit groups presently under discussion.

A summary of bit groups assigned to time follow:

Bit Group	Time Function
0-3	Frames (units)
8-9	Frames (tens)
16-19	Seconds (units)
24-26	Seconds (tens)
32-35	Minutes (units)
40-42	Minutes (tens)
48-51	Hours (units)
56-57	Hours (tens)

#### Frame-Rate Errors

As described so far, we have made the assumption that the black-and-white videotape frame rate of 30 frames-per-second is being used. However, it should be noted that the NTSC (National Television Standards Committee) frame rate for color is 29.97 frames-per-second. This means that a one-hour black-and-white program will contain 108 more frames than a one-hour color program.

Therefore, if a color program is clocked by a system calibrated to the black-and-white standard, it will take an additional 3.6 seconds until the readout indicates an elapsed time of one hour ( $108 \text{ frames} \div 30 \text{ frames-per-second} = 3.6 \text{ seconds}$ ).

#### Drop-Frame Code Bit

To compensate for this discrepancy, a drop-frame system is used, in which certain frames are discarded, for a total of 108

frames during each hour. To accomplish this, the drop-frame time code omits the first two frame numbers at the beginning of each minute, except for the six minutes which start at 00, 10, 20, 30, 40 and 50 ( $2 \times 60 - 2 \times 6 = 108$  frames). Thus the following sequences will be seen:

#### H:M:S:F

09:18:49:29 followed by  
 09:18:50:02 (not 09:18:50:00)  
 and—  
 09:19:59:29 followed by  
 09:20:00:00

To implement the drop-frame code, bit 10 in each 80-bit word is defined as a drop-frame flag. When drop-frame time code is being used, a one is assigned to this bit. Otherwise, bit 10 remains a zero.

#### Color-Frame Code Bit

Due to the nature of the color video signal, edits must be made between frame pairs, rather than between any two adjacent frames. If even-number frames (0, 2, 4, ...) are labelled 'A' frames and odd-number frames (1, 3, 5, ...) are 'B' frames, then edits must preserve the AB, AB, AB sequence, if momentary picture shifts at the edit points are to be avoided.

Bit 11 in each frame is the color-frame flag, and is encoded as a one to indicate color frame identification. This signifies that all even-number frames are 'A' frames and odd-number frames are 'B' frames, for electronic editing purposes. Otherwise, bit 11 is recorded as a zero.

#### Sync-Word Bits

As with the digital pulse streams described in the previous chapter, the beginning and end of each digital word must be clearly identified. In the SMPTE time code, a permanently-assigned sync word occupies bits 64-79. The word consists of 2 zeros, 12 ones, 1 zero and 1 one (0011 1111 1111 1101). This sequence, or its mirror image, cannot possibly be duplicated by any combination of bits elsewhere within the frame word, and so it is immediately recognized, regardless of the direction in which the tape is moving.

#### Plus-One Frame

Note that the 16-bit sync word just described appears at the end of the frame. When the sync word is detected, the code will be updated to display the time data contained in the word that was just completed. This means that the time data is always displayed one frame late. The Plus-One frame function automatically adds one frame to the count to correct for this built-in error.

#### User-Assigned Bits

Within each code word, 32 bits, in 8 groups of 4 bits each, have been reserved as "User bits," to meet whatever unique requirements the user may have for encoding information. The

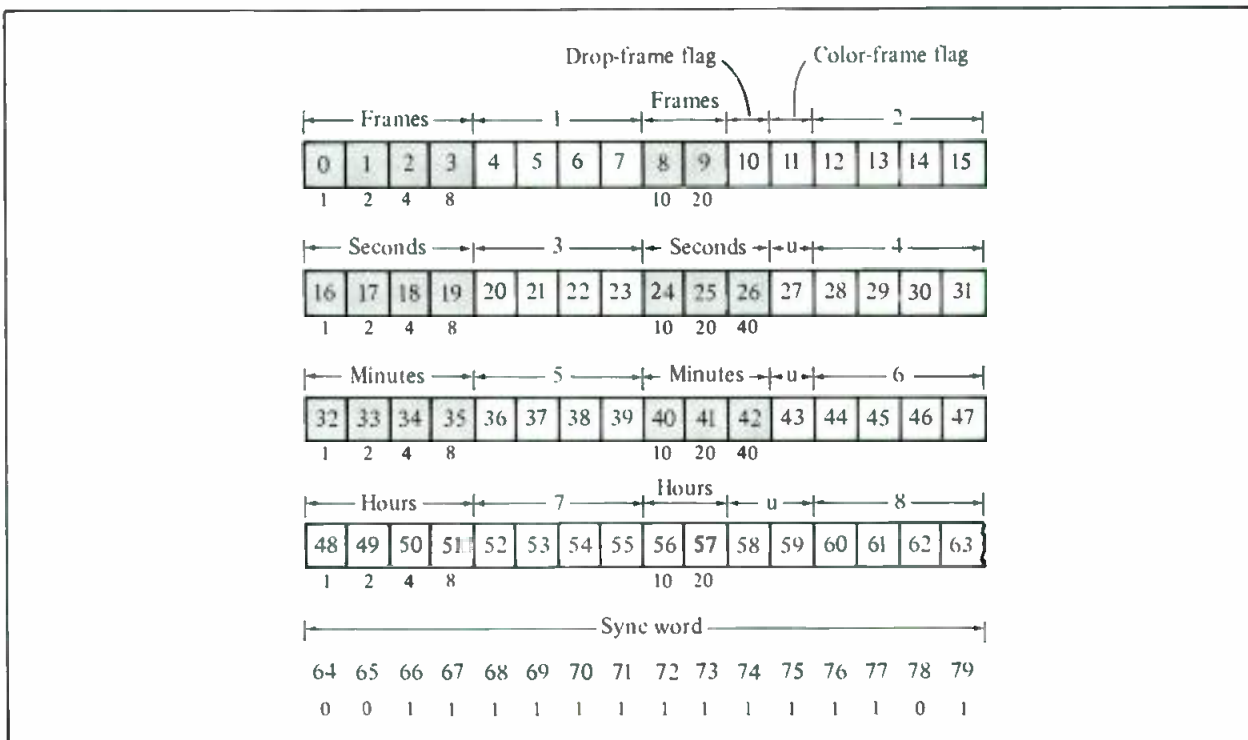

Figure 3. The complete SMPTE Time Code Structure. Each frame has a unique 80-bit digital word assigned to it, which identifies the frame number and the time (hour: minutes: seconds). Also included are eight binary groups (1-8) for user-assigned functions, as well as drop-frame and color-frame flags, and four unassigned bits (u). Each word is concluded with the 16-bit sync word shown here.

user bits are bit groups 4-7, 12-15, 20-23, 28-31, 36-39, 44-47, 52-55 and 60-63. They are frequently referred to as binary spare bits, or binary groups.

#### Unassigned Address Bits

Bits 27, 43, 58 and 59 have been defined as permanent zeros, until otherwise assigned by the SMPTE. Formerly, bits 10 and 11 were also unassigned, until being defined as drop-frame and color-frame code bits, as described above.

#### Bi-Phase Modulation

In the practical application of the SMPTE time code, there will never be a continuous stream of either ones or zeros. So although the code may superficially resemble a square wave whose frequency is continually varying between 1200 Hz and 2400 Hz, it is correctly identified as a waveform with bi-phase modulation; in other words, square wave-like in appearance, but not in name.

#### SUMMARY OF THE SMPTE TIME CODE FORMAT

The SMPTE time code is a bi-phase digitally-encoded data stream, in which each recorded frame is identified by an 80-bit word. The word contains 26 time-code address bits, 2 other assigned bits (drop-frame and color-frame), 16 sync-word bits, 32 user-assigned bits, and 4 unassigned bits.

The code is longitudinally recorded on one channel of a multi-channel tape recorder.

FIGURE 3 illustrates the complete time-code data structure.

## CAREERS IN AUDIO ARTS



# "I MIX SOUND MAGIC"

**NEW, HANDS-ON  
PROFESSIONAL  
CAREER PROGRAM**

- 24 Track Studio Console
- State-of-The Art Equipment
- Multi-Track Editing & Mixing
- Audio for Film & TV
- Individual Work Stations
- Music Recording Sessions
- Digital Technology

**Audio & Recording  
Arts Division**  
Classes Forming Now!  
**(212) 807-6670**  
Grants and Loans  
Available for Eligible Students  
Use this coupon or call

Please send me your Careers Manual and Catalog of courses in Audio and Recording Arts.

Name \_\_\_\_\_

Address \_\_\_\_\_ Tel. \_\_\_\_\_

City/State/Zip \_\_\_\_\_

226 WEST 26 ST NYC 10001 (212) 807-6670

Circle 32 on Reader Service Card



## The 72nd AES Convention: Part 2

### MORE TAPE RECORDERS

**N**AGRA'S NEWEST T-Audio recorder is the very-big brother in the company's well-known family of compact open-reel tape recorders. Its twin-capstan system is servo-controlled by a tape-tension sensor placed between the tape heads, with additional "tensiometers" located in the tape path on either side of the head block. Reel size is almost instantly changed to accommodate 7½ or 14-inch reels by simply grasping the two reel-support turntables, lifting them off the machine, and quickly reinstalling them as required to suit the reel size. A detachable keyboard is loaded with user-function controls, and includes a two-level (!) warning system. At first, a warning light comes on to advise that, although the particular function is still operating within tolerance, a parameter change has been noted, and an out-of-tolerance condition may be expected in the near future. If you ignore the warning, eventually a second warning light may come on to inform you that the machine is now operating out-of-tolerance. Not content with minding its own internal business, the warning system also keeps an eye on the external power and lets you know if it isn't behaving properly.

The Studer booth at the convention was billed as "...the largest exhibition of Studer Revox products ever held in the Western Hemisphere." That's all very nice for Studer, but it makes it a tough job to home in on a single item for this report (and all the time you thought this was an easy job). Perhaps the big news for the recording industry is the 24-track A800 MKIII, which offers transformerless balanced and floating line inputs and outputs. The A800 now includes standard interfaces for Solid-State Logic and Neve Necam automated mixing systems, as well as for the Audio-Kinetics Q-LOCK sync system. There's also an input for a 9.6 kHz capstan-control reference frequency, as used by EECO and BTX sync systems. For \$69,500, it's yours.

To keep your analog machines behaving, BASF has introduced a full line of open-reel and cassette calibration tapes. These include ¼-, 1- and 2-inch widths, with NAB frequency



Figure 1. Studer's 24-track A800 MKIII tape recorder.



Figure 2. The BASF line of open-reel and cassette calibration tapes.

responses to 18 kHz. They vary in price from \$88 to \$577.50. The cassette tapes include reference level, azimuth alignment, and frequency response sections. Dolby-B and wow-and-flutter test cassettes are also available.

#### LOUDSPEAKERS

UREI's new 813B monitor uses the company's 801B coaxial loudspeaker and provides a maximum sound output that is 6 dB greater than the older model 813A; high-frequency response has also been improved, by one-third octave.

Electro-Voice introduced its new Sentry 500 Studio Monitor, a two-way, Thiele-aligned, time coherent system intended for broadcast recording studio applications. The speaker is a big brother to the company's popular Sentry 100A, and it is said that the same program material may be mixed on either speaker with no surprises. A companion SEQ Step-Down Kit for the Sentry 500 extends its low-frequency response by one-half octave.



Figure 3. The model 813B Coaxial loudspeaker used in the company's time-aligned monitor system.



Figure 4. The new Electro-Voice Sentry 500 Studio Monitor.

JBL has added the model 4612 to its Cabaret series of sound reinforcement speaker systems. The 4612 contains a miniature bi-radial horn and two 8-inch woofers. Both woofers operate at low frequencies, while only one of them covers the mid-



Figure 5. The model 4612 is the latest addition to the JBL Cabaret series.

frequency range. According to a JBL press release, this improves dispersion definition and eliminates the need for external equalization.

In a move towards the sound contracting and motion picture industries, JBL is re-equipping several of its 4000 series of speaker systems with new bi-radial horns and high-power compression drivers. In addition, two new direct-radiator low-frequency enclosures are being introduced.



Altec Lansing introduced a new generation of Mantaray constant-directivity horns, which are about half the size of the first Mantaray series. The Mantaray II series features horns with vertical horizontal coverage patterns of 40 20, 60 40, 90 40 and 120 40 degrees. Unlike the earlier generation, which were made from two pieces of sheet metal, the Mantaray II series are on one-piece fiberglass construction.

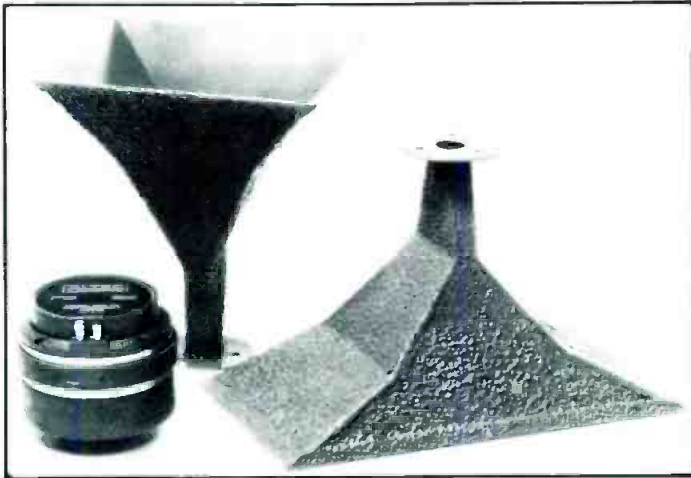

Figure 6. Altec Lansing's new Mantaray II series of constant-directivity horns.

Community Light & Sound announced that it will be the exclusive distributor for The Cluster Computer System. This includes room-plotting computer software and accessories for projecting loudspeaker coverage patterns onto a room model. In addition, two-dimensional hard copy of a completed design can be generated. In the future, Community expects to provide loudspeaker overlays for popular horns from other professional sound manufacturers.



Figure 7. Anchor Systems' "Roadies."

The program has been designed to run on a Hewlett-Packard 41C programmable calculator, and a CP/M computer BASIC program will also be made available. John Prohs, the System's inventor, described the Cluster Computer in his AES paper, "An Accurate and Easily-Implemented Method of Modelling Loudspeaker Array Coverage." (Prohs' AES pre-print 1941 was reviewed in Ken Pohlmann's AES Convention Report.)

Anchor Systems, Inc. introduced its "Roadie" series of self-powered compact speaker systems, which are built into their own carrying cases. Each "Roadie" contains microphone, line and phono inputs, input-selector switch, volume control and speech/music equalization. The Anchor 100 has a single 4½ inch speaker, while the 200 has two 4½ inch speakers plus a 1-inch high-frequency dome speaker. Optional mic-stand and wall mounts are also available.

For making acoustical measurements of sound systems, HM Electronics announced its PAL (Precision Audio Link) System. The PAL serves as a wireless link between sound measurement points and the measurement hardware, which may be located up to 1000 feet away. The system's transmitter is compatible with most sound level meters, and also provides a separate balanced microphone input for use in audio measurements or as a communications link. The receiver offers microphone and line-level outputs for interfacing with recorders, test equipment and loudspeakers.

Spectra Sonics' 404 series of power supplies were developed



Figure 8. HM Electronics' Precision Audio Link (PAL) System.

for sound reinforcement systems designed around the company's model 701 power amplifier. The 701 is a modular system, with each module providing 80 watts continuous power. Depending on user requirements, the 404 power supply may be purchased in versions supplying 8, 16 or 32 amperes,  $\pm 12$  VDC.

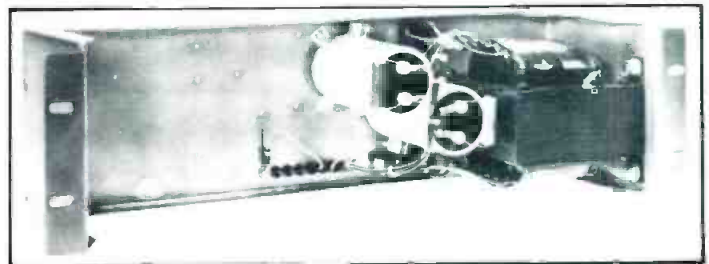

Figure 9. The Spectra Sonics 404 series power supply.

## TESTS AND MEASUREMENTS

The model 510 Bandpass Filter, also from Spectra Sonics, allows the user to make accurate unweighted noise measurements with a standard AC voltmeter. The filter gain is set at 60 dB within the audio bandwidth (20 Hz to 20 kHz), and employs two 18 dB-per-octave Butterworth filters.

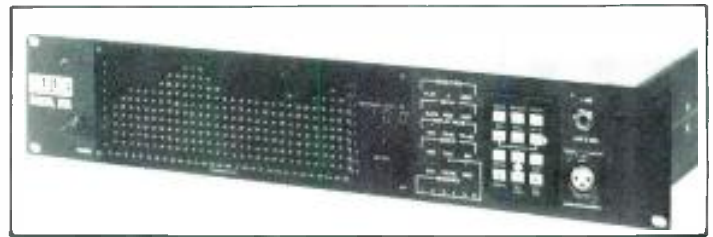
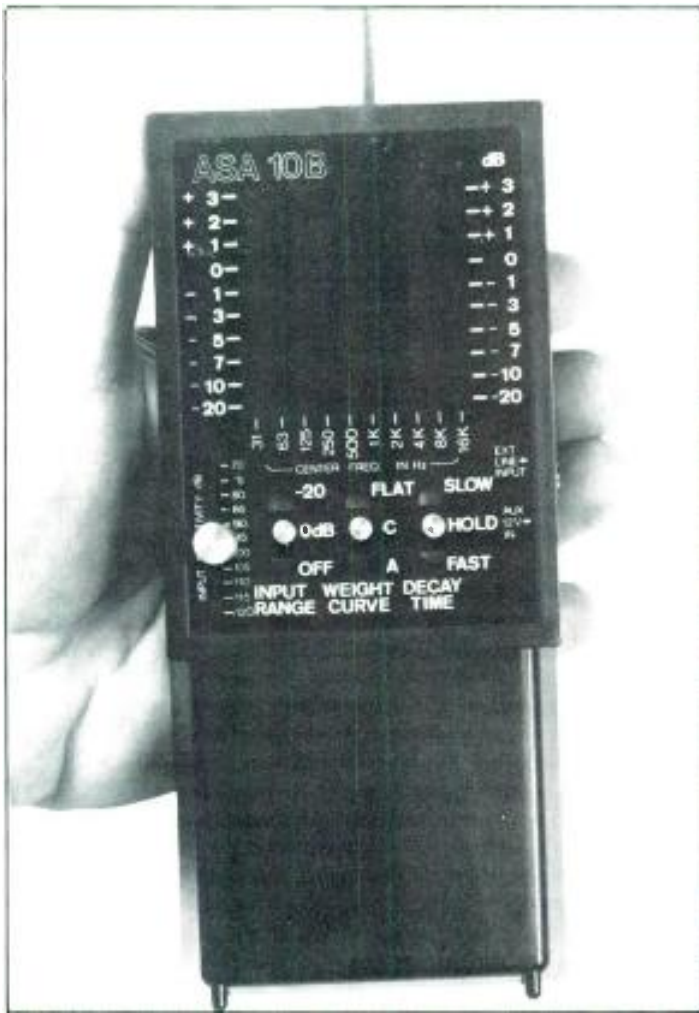

Figure 10. Gold Line's model 30 Real-Time Analyzer, and the ASA-10B hand-held Audio Spectrum Analyzer.

The Gold Line model 30 digital Real-Time Analyzer uses a quartz-controlled "switched capacitive" filtering system with six memories. A 30-band LFD matrix will display a flat, A-, or user-weighted curve, and the "Auto level" feature will maintain the LFD display normalized about the zero line of LFDs. Three expansion ports and an extra PROM location are provided, so that the user may add RT60 options, non-volatile memory, computer plotter and CRT interfaces, etc. The model 30 costs \$1695.

Gold Line's ASA-10B is a hand-held Audio Spectrum Analysis System whose input sensitivity may be varied in 5 dB steps from 70 to 120 dB. For SPLs below 70 dB, a -20 dB gain switch increases the sensitivity to 50 dB. Flat, A-, and C-weighting curves are switch-selectable, and fast or slow decay times may be selected as well. For CRT interface, Sync and Vertical outputs are provided. An accessory PN-2 pink white noise generator is also available. Saving the best news for last, the ASA-10B carries a list price of \$339.95 (!). ■

## Convention Report Manufacturers

Altec Lansing  
1515 South Manchester Avenue  
Anaheim, California 92803  
(714) 774-2900

Anchor Systems, Inc.  
4510 Federal Blvd.  
San Diego, California 92102  
(714) 262-9901

BASF Systems  
Crosby Drive  
Bedford, Massachusetts 01730  
(617) 271-4000

Community Light & Sound  
333 East 5th Street  
Chester, Pennsylvania 19013  
(215) 876-3400

Electro-Voice, Inc.  
600 Cecil Street  
Buchanan, Michigan 49107  
(616) 695-6831

Gold Line  
P.O. Box 115  
West Redding, Connecticut 06896  
(203) 938-2588

HM Electronics, Inc.  
6151 Fairmount Ave.  
San Diego, California 92120  
(714) 280-6050

JBL, Inc.  
8500 Balboa Blvd.  
Northridge, California 91329  
(213) 893-8411

Nagra Magnetic Recorders, Inc.  
1147 N. Vine Street  
Hollywood, California 90038  
(213) 469-6391

Nagra Magnetic Recorders, Inc.  
19 West 44th Street, Room 715  
New York, New York 10036  
(212) 840-0999

Spectra Sonics  
3750 Airport Road  
Ogden, Utah 84403  
(801) 392-7531

Studer Revox America, Inc.  
1425 Elm Hill Pike  
Nashville, Tennessee 37210  
(615) 254-4453

UREI  
8460 San Fernando Road  
Sun Valley, California 91352  
(213) 767-1000



# New Products

## CORRECTION

• In our November New Products Section we inadvertently reported that the cost of the model 3501 audio distortion and measuring unit from Amber was \$21,000.00 and up. The actual cost of the unit is \$2,100.00 and up.

## WOOD RACK

• The Runaround is a multi-purpose, 19-inch wood rack pivoted on a wheeled pedestal. The Runaround will house any variety of standard rack-mount equipment up to 12 inches deep. Its special design feature, a 360 degree tilt adjustment, allows the rack to be fixed at any angle, providing easy access to equipment and flexibility of operation. Specifications include: outside cabinet dimensions 20½-in. W x 26-in. H x 10-in. D; rack space 19-in. W x 24½-in. H x 10-in. D; height 32½-in. when horizontal, 42-in. when vertical.

*Mfr: Midsummer Sound Co., Inc.*

*Circle 35 on Reader Service Card*

## OPEN REEL RECORDER

• The Revox B77 MKII is an updated version of the B77 open reel recorder. The new version incorporates a variable speed control as a standard feature. When activated by a push button switch, the vari-speed knob adjusts the tape speed as much as two musical half-tones above or below the fixed speed. This feature facilitates pitch matching with off-speed tapes, as well as other creative special effects. For easier editing, the front record head shield remains in the down (open) position when the edit switch is engaged, regardless of the transport operating mode. Also, the B77 MKII's updated transport control logic utilizes four separate starting pulses for smooth tape acceleration regardless of tape speed or reel size. All the features of the former B77 are retained on the new MKII, including a die-cast transport chassis, servo-controlled capstan motor, ASA standard VU meters with peak reading LED's multiple mode input and monitor switching, 10½-in. reel capacity, and universal power supply.

*Mfr: Studer Revox*

*Price: \$1,799.00*

*Circle 36 on Reader Service Card*

## CONFERENCE ROOM FLOOR BOX



• The F1-100 electrical floor box, designed specifically for conference rooms, auditoriums and lecture halls, conceals the microphone, speaker, control and ac power cables. The brass carpet flange is all that shows when cables are not being used, allowing traffic to walk freely over the area. Constructed of heavy steel, the F1-100 measures 10-in. x 12-in. x 3-in. deep.

*Mfr: FSR, Inc.*

*Price: \$325.00*

*Circle 37 on Reader Service Card*



## REVERBERATION UNIT

- The model 3180 2-channel Reverberation Unit features a multiple spring design and a delay matrix. There is a built-in delay before the signal reaches the spring transducer. This delayed dry signal is then added to the reverberated signal at the output via a matrix system. The distinguishing sound that results from this design is a minimum 24 msec. delay at high frequencies. Because of the matrix system, each channel of the 3180 is capable of producing a stereo effect from a mono source. Additional features include an LED overload indicator located just before the drive circuit, built-in limiter, independent reverb and dry mix controls, remote jack for foot-switch operation, and both front and rear panel inputs/outputs.

*Mfr: Foxtex Corp. of America*

*Price: \$400.00*

*Circle 38 on Reader Service Card*



## MONITOR SPEAKER



## STEREO SYNTHESIZER



- The 245F Stereo Synthesizer is said by the manufacturer to be an improvement of the 245E version, adding balanced input, output transformer option, RF filtering on the audio inputs and outputs, and ac line filtering. The patented stereo synthesis technique incorporated in the 245F allows any mono source to be converted to pseudo-stereo with no phase cancellation in the mono original.

*Mfr: Orban*

*Price: \$399.00*

*Circle 39 on Reader Service Card*

## AUTO AUDIO RECORDING DEVICE



- Designed especially for documentary-type producers, IDI's Nagra to Cassette Auto Audio Recording Device automatically starts an audio cassette recorder. When you roll quarter-inch tape, the cassette starts; it stops when the Nagra stops. The device includes an accessory jack to replace the one used to power and connect it to the recorder.

*Mfr: Image Devices International*

*Price: \$275.00*

*Circle 40 on Reader Service Card*

- Delivering 20 watts RMS, the Producer Series MS10 Monitor Speaker weighs just 8½ lbs., and measures only 6¼-in. by 6½-in. by 11-in. Front panel controls include volume, bass and treble, providing a degree of tonal variation not available on many larger "self-powered" speaker systems. In addition to monitoring line-level signals from mixers, tape decks, etc., the MS10 input will also accept the signal from electronic keyboards or electric guitars and basses. In rehearsal or low volume situations, an MS10 provides enough power for effective on-stage monitoring of a multi-keyboard system.

*Mfr: Yamaha*

*Circle 41 on Reader Service Card*



## BROADCAST MIXER

• The model 5990 broadcast mixer has three independent and modular input sections which each accept a phono and a line level input. Each input section has its own three band equalizer and volume control; on the back panel are separate stereo send-and-receive jacks. While one section is being used to supply program material, either of the other two can be cued without disturbing the program. Two separate microphone sections are provided with individual three band equalizer and volume controls, as well as individual pan switches (left, right, and left and right). In the center of the mixer are two twenty-section LEDs that can be adjusted to indicate an overload condition in the driven device (such as an amplifier). By pressing a button, the twenty-section LEDs assume a new function: indicating the heat of the cued music (left LED display), and the heat of the program music (right LED display). The phono, auxiliary and microphone inputs all have a frequency response of 20 Hz to 20,000 Hz,  $\pm 0.25$  dB, with distortion (both IM and harmonic) less than .01 percent. The unweighted signal-to-noise ratio is 80 dB for the phono and microphone sections, and 90 dB for the auxiliary input sections.

Mfr: Integrated Sound Systems

Price: \$1,095.00

Circle 42 on Reader Service Card



## MASTER OUTPUT MODULE

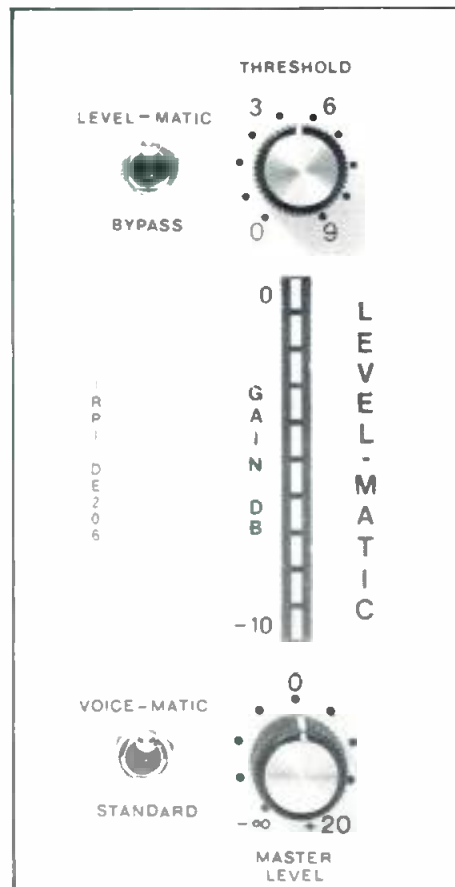

## MICROPHONE PREAMPLIFIER

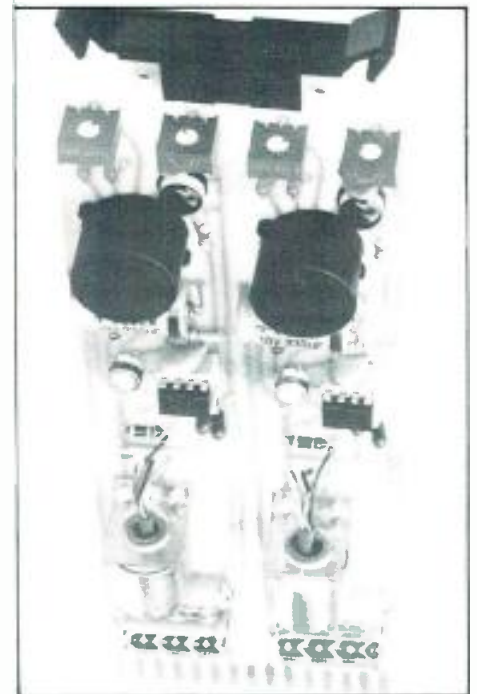

In general, spring reverbs don't have the best reputation in the world. Their bassy twang is only a rough approximation of natural room acoustics. That's a pity because it means that many people will dismiss this exceptional product as just another spring reverb. And it's not. In this extraordinary design, Craig Anderton uses double springs, but much more importantly, 'hot rod's' the transducers so that the muddy sound typical of most springs is replaced with the bright clarity associated with expensive studio plate systems.

Kit consists of circuit board, instructions, all electronic parts and two reverb spring units. User must provide power ( $\pm 9$  to 15 v) and mounting (reverb units are typically mounted away from the console).

CHARGE TO VISA OR MC TOLL-FREE  
1-800-654-8657 9AM to 5PM CST MON-FRI

DIRECT INQUIRIES TO:  
**PAIA Electronics, Inc.**  
Dept. HD, 1020 W. Wilshire Bv. Oklahoma City, OK 73116 (405) 843-9626

Send the 6740 REVERB KIT \$59.95 plus shipping (\$3 enclosed or charged).

Send Free Catalog

name \_\_\_\_\_

address \_\_\_\_\_

city \_\_\_\_\_ state \_\_\_\_\_ zip \_\_\_\_\_

Circle 33 on Reader Service Card

• The model DE-4013 Voice-Matic automatic microphone mixer, designed for use in multiple microphone sound systems, is now available with the new Level-Matic master output module. The DE-206 Level-Matic makes the DE-4013 totally automatic. It senses signal variations between soft and loud talkers or variations in distance between talker and microphone. The level is then automatically controlled. The DE-206 retrofits all existing DE-4013 mixers and can replace the standard DE-201 master module in all new production. Features include a 10 dB gain range, no audible noise gain pumping and both feed-forward gain control and feedback peak control.

Mfr: Industrial Research Products, Inc.

Circle 43 on Reader Service Card

• ProTech Audio has announced the addition of a new dual channel microphone preamplifier with built-in compression or limiting. According to the manufacturer, this configuration virtually eliminates first stage overload. Designated the model 72509, the new unit features two independent channels with built-in mic input transformers, adjustable gain and threshold settings, and offset trim. The amplifier circuitry is built around low noise, fast slewing op-amps, with all decoupling and reverse polarity protection components built-in. Specifications include a frequency response of  $\pm 2$  dB—20 Hz to 20 kHz—and a maximum output of +20 dBm.

Mfr: ProTech Audio Corp.

Circle 44 on Reader Service Card

# New Literature

## PZM® LITERATURE

• Extensive information about the PZM® microphone is available in a new two-color, 120 page brochure. The new brochure includes general specifications for Crown's full line of PZM® microphones. Several application suggestions are also included and highlighted with accompanying photography. The new brochure also features an explanation of the pressure recording process invented by Ed Long and Ron Wickersham, and comes complete with a full complement of accessory information on the back page. The brochure is available via: **Crown International, 1718 W. Mishawaka Rd., Elkhart, IN 46517.**

## STUDIO PRODUCTION GUIDE

• A 12-page illustrated guide to studio production techniques has been published by MCI Sony as part of that company's expanded thrust into the broadcast market. The booklet, titled "The Guide to Profitable In-House Production," introduces broadcasters to MCI Sony equipment. It also discusses studio recording techniques that apply to broadcast commercial and program production and on-air work. The booklet details the new MCI Sony Broadcast Audio Production System; text and diagrams illustrate each machine's technical features and explains how they function in broadcast production work. Also explained are basic techniques of multi-track production such as recording from microphones, overdubbing, punch-ins and line mic mixing. The free guide is available by writing to: **Broadcast Production Guide, MCI/Sony, 1400 West Commercial Blvd., Fort Lauderdale, FL 33309.**

## INFORMATION KIT

• A new information kit from Ferrofluidics Corporation provides all the information necessary to evaluate FerroSound™ ferrofluids for loudspeaker applications. Topics discussed in the new FerroSound information kit include technical, economic, marketing, manufacturing and applications aspects of using ferrofluids in loudspeakers. Copies of the new Ferrofluidic FerroSound information kit are available via: **Ferrofluidics Corporation, 40 Simon St., Nashua, New Hampshire 03061.**

## UNITED STATES FREQUENCY ALLOCATION CHART

• An updated "Varian United States Frequency Allocation Chart" is now available free of charge. The four-color chart includes radio, television, point-to-point, microwave, satellite communications to millimeter wave frequency allocations. The chart features a ledger guide and is both color and line coded for easy reference. Frequency allocations from 3 kHz to 300 GHz are divided into eight one-order-of-magnitude divisions. These divisions are color coded to illustrate frequency uses of government exclusive, non-government only, and government and non-government shared frequencies. Line coding is then used for the demarcation of 31 specific frequency categories. The guide is available via: **Varian Associates, Electron Device Group Marketing, 301 Industrial Way, San Carlos, CA 94070.**

## STANDARD LINE CATALOG

• An expanded 286-page Standard Line Connectors Catalog from ITT Cannon details microminiature, hermetically sealed, filter, printed circuit, circular, rack/panel connectors and more. The new edition offers illustrations and full specifications on the complete line of Cannon electrical and fiber optic connectors. The free catalog is available via: **ITT Cannon, Marketing Department, 10550 Talbert Ave., Fountain Valley, CA 92708.**



The PROFESSIONAL MOTION PICTURE EQUIPMENT ASSOCIATION has developed a computer compilation of stolen, missing and misappropriated motion picture production equipment. This computer listing reflects an accurate and continually updated reference of equipment of questionable origin, including serial number, manufacturer and product category.

These listings will protect filmmakers from inadvertently purchasing lost or stolen equipment, and can aid in the recovery of equipment. One may also report lost or stolen equipment to be included in these reports at no charge.

To receive a free copy of the missing equipment listings or to report lost equipment, contact your nearest PMPEA member, or respond directly to the International PMPEA Office, Ten Thousand Riverside Drive, Suite 6, Toluca Lake, California 91602, USA (213)761-6690.



## SOUND SYSTEM DESIGN REFERENCE MANUAL

- The "Sound System Design Reference Manual" is a guide for all professionals in the sound reinforcement field. Based on JBL's earlier "Sound Workshop Manual," prepared by George Augspurger in 1976, the new volume has been edited and revised by John Eargle, JBL's senior director of product development and application, and a noted author on sound and its related equipment. Beginning with an explanation of the basic physics of sound, the manual offers a series of how-to approaches to solving both common and complex sound reinforcement problems. The text culminates in examples of technology applied to specific needs, including theatrical installations, paging systems and churches. The manual is priced at \$15.00 and is available via: **Pro Products Sales Department, JBL, 8500 Balboa Blvd., Northridge, CA 91329.**

## BOOK ON FUTURE OF CABLE AUDIO

- *Listening to the Future: Cable Audio in the Eighties* is the title of a new book recently published by National Public Radio. Based on NPR's cable project, called ASCOT (Audio Services through Cable and Other Technologies), the book explores the potential of audio program services on cable and analyzes the past, present and future market conditions affecting this new programming medium. Copies of the book are \$10.00 and are available via: **Barbara Hoyman, NPR, 2025 M Street, N.W., Washington, D.C. 20036.**

## NOISE CONTROL HANDBOOK

- The latest B & K handbook, "Noise Control Principles and Practice," is designed to provide practical instruction on tackling noise problems. After an introduction of acoustical concepts and measurement methods, the handbook explains the principles of noise control. Two-thirds of this 156-page book is devoted to a wide range of specific noise problems and their solutions. The principle of each case is illustrated and a practical solution is offered. Copies of the handbook are \$6.00 and are available via: **Bruel & Kjaer Instruments, Inc., 185 Forest St., Marlborough, MA 01752.**

## ACOUSTICAL CONSULTANTS DIRECTORY

- The National Council of Acoustical Consultants (NCAC) has published their 1982-83 Directory. In addition to listing the 85 members of the NCAC, the booklet gives practical advice on how to select an acoustical consultant and explains the broad categories of acoustics its members provide. These services include architectural and industrial acoustics, environmental impact assessment and community noise studies, testing and management, seminars, and product development. Copies of the \$5.00 Directory are available via: **NCAC, 66 Morris Ave., Springfield, NJ 07081.**

## TELECONFERENCING GUIDE

- The Tele-Commandments is a compendium of essential information for facilities planners, architects, engineers, meeting planners and telecommunication managers. It begins with ten criteria for a successful meeting room communication system, then elaborates on each "commandment" at length. The new book incorporates specific recommendations with understandable acoustical theories; charts and graphs are included. The Tele-Commandments costs \$25.00 and is available by mail order via: **The Tele-Commandments, Darome, Inc., Suite 780, 5725 East River Rd., Chicago, IL 60631.**

## More and more recording studios are discovering the great sound of the Kimball Professional Grand.

### Here's why:

The Kimball 6'7" Professional Grand derives its heritage of greatness from the world's finest piano—the Bosendorfer. The scale and plate design are derived from the Bosendorfer Model 200, and the plate is extra thick to assure maximum sustain and to avoid plate noise from hammer strikes. The Bosendorfer-derived scale and non-duplexed trebles enhance tonal depth, clarity, and pitch perception. The Kimball Professional Grand is specifically designed for clear, pure tonality, free of spurious noise and false harmonics. It also offers superior durability and tuning stability. Its entire structure, including the soundboard, is of precision-laminated woods, greatly reducing differential expansion in changes of temperature and humidity.



**kimball**

"The Key to sounding great!"  
1549 Royal St. Box 460  
Jasper, IN 47546



For more information  
about the Kimball  
Professional Grand,  
contact Wade Bray at  
(812) 482-1600.

Circle 15 on Reader Service Card

# Classified

**Closing date is the fifteenth of the second month preceding the date of issue.**

**Send copies to: Classified Ad Dept.  
db THE SOUND ENGINEERING MAGAZINE  
1120 Old Country Road, Plainview, New York 11803**

**Minimum order accepted: \$25.00**

**Rates: \$1.00 a word**

**Boxed Ads: \$40.00 per column inch**

**db Box Number: \$8.50 for wording "Dept. XX," etc.**

**Plus \$1.50 to cover postage**

**Frequency Discounts: 6 times, 15%; 12 times, 30%**

**ALL CLASSIFIED ADS MUST BE PREPAID.**

---

## FOR SALE

---

**BLANK AUDIO AND VIDEO CASSETTES** direct from manufacturer, below wholesale, any length cassettes: 4 different qualities to choose from. Ampex and Agfa mastertape—from 1/4-inch to 2-inch. Cassette duplication also available. Brochure. **Andol Audio Products, Inc., Dept. db, 42-12 14th Ave., Brooklyn, NY 11219. Toll free 1-800-221-6578, ext. 1, NY residents (212) 435-7322.**

**ORBAN and LEXICON.** All products in stock. **FOR IMMEDIATE DELIVERY. UAR Professional Systems, 8535 Fairhaven, San Antonio, TX 78229. (512) 690-8888.**

**RECORDING EQUIPMENT FOR SALE:** TEAC 80-8—New—\$3,311.00. TEAC model 15-16—New—\$6,000. OTARI 8 track w/remote—New. YAMAHA PM2000-32 Mixer—New. **CALL FOR PRICES. SPECIALIZED AUDIO, INC. (518) 885-8966.**

**NEOTEK 16x 16 Series III console** with custom base, \$12,500. MCI JH-110A 8-track with RTZ/remote, \$6,950. (512) 472-8975, 345-5255. Joel.

**ALTEC 1584A POWER AMP,** rack mountable, excellent condition. Revox A-700 in excellent condition for \$800.00 or best offer. Other equipment available. Call for list. (212) 575-9412.

**PRO AUDIO IN STOCK**—ready to ship. Top lines, top dollar trade-ins, clearance specials. Call or write for our prices. **Professional Audio Video Corporation, 384 Grand Street, Paterson, NJ 07575 (201) 523-3333.**

**FOR SALE**—AKG C-24 and other tube type condenser mics. (415) 441-8934 or 527-6167.

**THE RECORDING BOOK** that is rocking the music industry. "Practical Techniques for the Recording Engineer" by Sherman Keene is endorsed by major colleges, universities, recording schools, studios, musicians and our correspondence students around the world. Recommended by reviewers of the MIX, Re/P, Guitar Player and other top publications. The book—hard cover, 380 pages, 28 chapters (4 on computer assisted mixing), illustrations. \$29.75 (\$31.69 in Calif.) + \$2.50 shipping. The Correspondence Course—certificate course using two textbooks, corrected and graded homework, cassette dialog with the author via cassette, Basic, Intermediate and Advanced Levels. The Curriculum—for schools only, Teacher's Manual (lesson plans for two textbooks, charts, suggested session content), Student's Workbook, Final Exams. For information or to order contact **S. K. P. 1626 N. Wilcox No. D-677, Hollywood, CA 90028.** Order by phone using Visa or MasterCard by calling (213) 708-2933.

**REELS AND BOXES** 5" and 7" large and small hubs, heavy duty white boxes. **W-M Sales, 1118 Dula Circle, Duncanville, Texas 75116 (214) 296-2773.**

**THE LIBRARY...** Sound effects recorded in STEREO using Dolby throughout. Over 350 effects on ten discs. \$100.00. Write **The Library, P.O. Box 18145, Denver, CO 80218.**

Would you believe **REAL-TIME** cassette copies for \$1.03 each? Exquisite sound, modest cost. Denon DR-F8 Recorders, AGFA Tape. Full-color printing and assembly available. America's most experienced Real-Time Duplicators. **Contact GRD (602) 252-0077, P.O. Box 13054, Phoenix, AZ 85002.**

**USED RECORDING** equipment for sale. **Dan (415) 441-8934.**

**FREE 32pg Catalog & 50 Audio/Video Applic.**



**Stereo Mono Pre Ampl**  
**PWR SUPP. EQ**  
**PHONO, MIC,**  
**TRANS. ACN,**  
**TAPE, VIDEO,**  
**LINE, OSC**

**8-in 3-out, 12-in 4-out, 18-in 4-out**  
**TV Audio & Recd Prod Consoles**

**OPAMP LABS INC (213) 934-3566**  
**1033 N Sycamore Av LOS ANGELES CA, 90038**



---

**WANTED**

---

WANTED: TRANSCRIPTION discs, any size, speed. Radio shows, music. P.O. Box 724-db, Redmond, WA 98052.

---

---

**EMPLOYMENT**

---

MAINTENANCE TECHNICIAN wanted for New York recording studio. Call. ELDO (212) 279-2000.

---

---

**SERVICES**

---

ACOUSTIC CONSULTATION—Specializing in studios, control rooms, discos. Qualified personnel, reasonable rates. Acoustilog, Bruel & Kjaer, HP, Tektronix, Ivie equipment calibrated on premises. Reverberation timer and RTA rentals. Acoustilog, 19 Mercer Street, New York, NY 10013. (212) 925-1365.

---

MAGNETIC HEAD relapping—24 hour service. Replacement heads for professional recorders. IEM, 350 N. Eric Drive, Palatine, IL 60067. (312) 358-4622.

AMPEX FACTORY SERVICE: Complete service and parts for Ampex equipment. Professional audio, helical-scan video systems and professional audio motor and head assembly rebuilding. AMPEX SERVICE CENTER, 719 W. Algonquin Road, Arlington Heights, IL 60005, 1-800-323-0692 or (312) 593-6000.

---

**MOVING?**

Keep **db** coming without interruption!

Send in your new address *promptly*.

Enclose your old **db** mailing label, too.

Write to:

Eloise Beach, *Circ. Mgr.*  
**db** Magazine  
1120 Old Country Rd.  
Plainview, N.Y. 11803

**you write it**

Many readers do not realize that they can also be writers for **db**. We are always seeking meaningful articles of any length. The subject matter can cover almost anything of interest and value to audio professionals.

You don't have to be an experienced writer to be published. But you do need the ability to express your idea fully, with adequate detail and information. Our editors will polish the story for you. We suggest you first submit an outline so that we can work with you in the development of the article.

You also don't have to be an artist, we'll re-do all drawings. This means we do need sufficient detail in your rough drawing or schematic so that our artists will understand what you want.

It can be prestigious to be published and it can be profitable too. All articles accepted for publication are purchased. You won't retire on our scale, but it can make a nice extra sum for that special occasion.

# Do You Know Where?

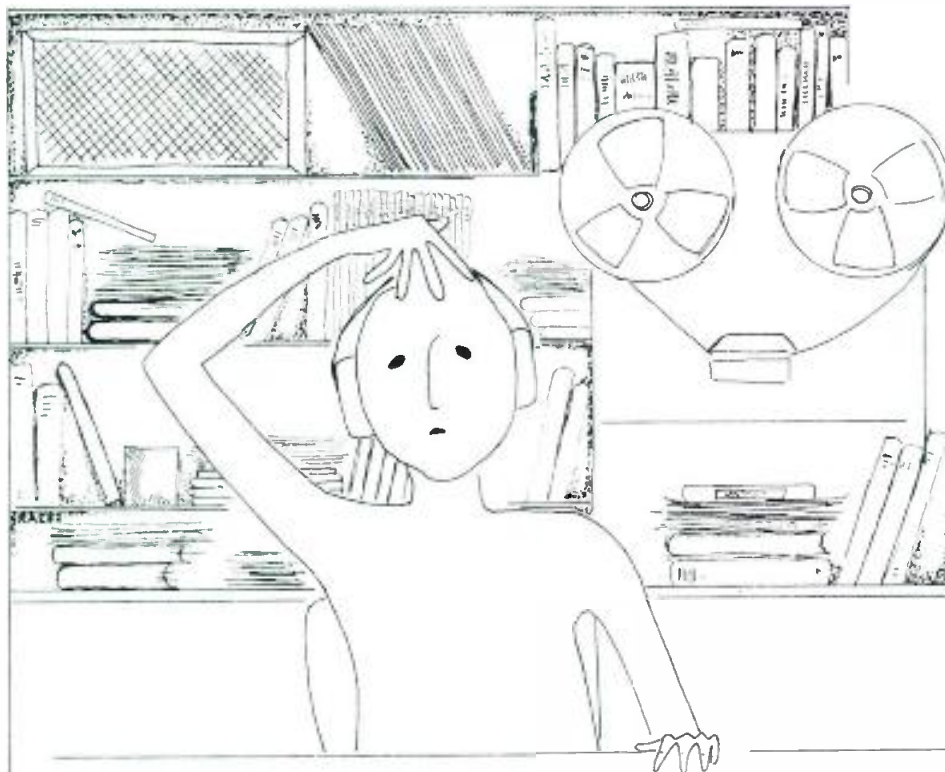

Have you misplaced your **db** again? Our high quality, royal blue vinyl binders keep 12 copies of **db** neat and handy for ready reference.

Just \$9.95, available in North America only. (Payable in U.S. currency drawn on U.S. banks.) ORDER YOURS NOW!!

**Sagamore Publishing Co., Inc.**  
1120 Old Country Road  
Plainview, NY 11803

**YES!** Please send \_\_\_\_\_ **db** binders @ \$9.95 each, plus applicable sales tax. Total amount enclosed \$ \_\_\_\_\_.

Name \_\_\_\_\_

Company \_\_\_\_\_

Address \_\_\_\_\_

City \_\_\_\_\_

State / Zip \_\_\_\_\_

# People, Places

• **R. Dennis Fraser**, Corporate vice president and general manager of the Broadcast Equipment Division of **NEC America, Inc.**, has announced that a new multi-million dollar contract has been signed with **NBC-TV** for the expansion of the network's **NFC Model TKA-105 Routing Switcher**.

Already the largest switcher in the world, featuring 150 inputs x 270 outputs (for a total of 40,500 crosspoints) with 270 controllers, the **TKA-105 Routing Switcher** was delivered to **NBC** in time for the 1980 Olympics, and was subsequently installed at **NBC's** Burbank headquarters. Under the terms of the new contract, the existing system will be expanded by more than 85 percent and will consist of 210 outputs x 360 outputs (for a total of 75,600 crosspoints) and 360 controllers.

The **NFC Model TKA-105 Routing Switcher** provides digitization of all audio signals, with up to four discrete audio channels for each video input (2 channels are standard), and **LSI** devices in all critical circuits for greater stability and reliability in performance, as well as lower power consumption. Full micro-processor logic in every controller verifies the operation of each crosspoint associated with its output bus, and presets takes to occur only during blanking intervals. **NFC-7** vertical interval test signals added synchronously to each input provide a basis for automatic verification of signal performance throughout the system. The system is capable of behind-the-scene

operation in virtually any application—from fixed station to Olympic coverage—in any television standard.

The planned expansion of **NBC's TKA-105 Routing Switcher** in Burbank is scheduled for completion by mid-1983.

• **Mitsubishi Electric Sales America (MESA)**, which markets in the U.S. audio and video products and a variety of industrial controllers and compressors, has opened expanded office and warehouse facilities for the central region at **Mt. Prospect, IL**. More than 102,000 square feet of space is afforded to the new quarters, located at 799 North Bierman Circle, **Mt. Prospect, IL**, 60056, (312) 298-9223 or 1-(800) 323-4216. The site is headquarters for **MESA's** car audio division, directed by general manager **Mike Hyde**. The location houses a warranty and service department, as well as a parts department, for car audio. The building is **Midwest** regional headquarters for **Mitsubishi Electronics America (MEIA)**, which markets computers, semiconductors and computer peripherals, **MESA's** industrial division which markets precise, computer-type numerical controllers, compressors and magnetic contactors, also is headquartered in the **Mt. Prospect** facility. **Steve Saake**, executive vice president of **MESA**, said the new quarters brings to 10 the number of offices and warehouses which **MESA** operates in the U.S., plus its projection TV assembly plant in Santa

Ana, CA, and a Canadian facility in Montreal.

• The **International Council of the National Academy of Television Arts and Sciences (NAITAS)** has presented its Directorate Award for 1982 to **Akio Morita**, chairman and co-founder of **Sony Corporation**. The Directorate Award recognizes individuals and organizations responsible for "outstanding contributions to the advancement of international television." Each year the Council presents the **International Emmy Awards** for programming as well as a **Founder's Award** and the **Directorate Award**.

Past recipients of the Directorate Award have included **Dr. Frank Stanton**, former president and vice chairman of **CBS Inc.**; **Sir Huw Wheldon**, former director of programs for the **BBC**; **Charles Curran** on behalf of the **European Broadcasting Union**; **Dr. Joseph Charyk** on behalf of **Intelstat Satellite Corporation** and to **Lord Grade of Elstree**, chairman and chief executive officer of **England's Associated Communications Corporation, Ltd.**

The Directorate Award was presented to **Mr. Morita** for his leadership of **Sony** and its contributions to the broadcast industry over the past three decades.

**Sony Corporation** is the recipient of three previous Emmys. In 1973, **Sony** won recognition from **NAITAS** for the



Trinitron color television system. In 1976, the company was awarded an Emmy for the U-matic videocassette system, and an additional Emmy in 1979 for its engineering achievement in the development of the professional one-inch type C videotape format.

- **Tom Bush** has joined **Reeves Sound Shop** as a sound mixer and audio consultant. His past experience includes spending time with **Editel** in their video music mixing facility; acting as musical director for **RCA** recording group, **805**; working as the staff recording engineer for **Electric Lady Studios and Productions**, and as recording engineer with **A&R Recording**.

- **Altec Lansing Commercial Sales** vp **Gary Rilling** recently announced the hiring of **Mr. Gordon Hawks** as new Altec district manager for Central Eastern Territory #6. Coming to Altec with extensive sound products sales experience, Hawks' background includes sales manager positions with **BGW Systems** and **N. Browning & Co.** As DM for Territory #6, Hawks will be working with Altec contractors and dealers in Michigan, Indiana, Ohio, Kentucky, West Virginia, western Pennsylvania and western New York.

- **Dove and Note Recording Company** of Houston, Texas provided the microphone technology for the recording of George Fredrick Handel's "Messiah," aired in a nationwide **PBS** broadcast on Christmas Day, 1982. The **Concert Chorale of Houston** and the **Texas Chamber Orchestra** combined forces to present a baroque rendition of a complete "Messiah" in Jones Hall for the Performing Arts on December 9. Dove and Note provided consultation on microphone placement and fabricated a custom-designed near-coincident microphone array for this performance. This array provided the main stereo pickup, was designed to provide natural stereo imagery, and utilized **Crown PZM**® transducers. This was the first national broadcast to take advantage of this proprietary design developed by Dove and Note Recording. The performance

was conducted by **Dr. David A. Wehr** and featured nationally known soloists. Remote recording facilities were furnished by **Omega Audio and Productions, Inc.** of Dallas, Texas. The producer was **John L. Meeks, KUHT-TV, Channel 8, Houston**; **Phillip Byrd** of New York City was director. Executive producer was **Lawrence R. Bell** of Houston, Texas.

- **Steve Armstrong** has been named Western Regional sales manager for **JBL Incorporated's Professional Products Division**. The announcement was made by **Ken Lopez**, National sales manager for the Division. Armstrong will supervise all sales of JBL's professional products in thirteen Western states, including Alaska and Hawaii. Prior to joining JBL, Armstrong held positions in sales and sales management for a Northwest pro audio and musical instrument retail firm.

- **Raymond E. Cooke**, managing director and founder of **KEF Electronics Limited**, has been elected president of **The Audio Engineering Society (AES)** for the year 1983-84. Mr. Cooke was elected following a polling of the worldwide membership of the AES, now estimated at over 10,000 members, at the 1982 AES Convention. Mr. Cooke has been a member of the AES since 1956 and has served the society on the British Section Executive Committee for over ten years. He has served as chairman of the British Committee from 1974 through 1976 during which time the first London convention took place at the Cunard Hotel. Mr. Cooke served as governor in 1976 and subsequently became vice president of the European Region in 1977. He served in that capacity until 1979 at which time he became vice president of the International Region. Mr. Cooke's election to the Presidency marks the first for an Englishman and the second for any European since the Society was founded thirty years ago.

## It's **UN-BEAR-ABLE**

to know you  
haven't subscribed  
to db yet!



Our rate for new subscribers is  
only \$10.00 and a free  
sample is available  
upon request.  
See coupon on  
reader service card.

## The Ampex ATR-800 is built to last.

Others talk about audio "workhorses". But only Ampex has been manufacturing reliable professional audio recorders since 1947. Recorders that can take everything you can dish out day after day.

The Ampex ATR-800 continues our tradition by offering you unmatched editing ease, complete interfacing capabilities with a variety of peripherals (synchronizers, editors, etc.), a rugged cast transport that maintains tape path alignment, standard built-in features without an accompanying

premium price tag, and a full range of accessories for all kinds of applications. And, as with all Ampex audio recorders, you get our worldwide sales and service support to keep your workhorse racing along. Try the ATR-800. Another winning audio workhorse from Ampex.

For details, contact your nearest Ampex dealer, or write Willie Scullion, National Sales Mgr., Ampex Corporation, Audio-Video Systems Division, 401 Broadway, Redwood City, CA 94063.

# OUR WORKHORSES DON'T DIE YOUNG.

## AMPEX

Ampex Corporation • One of The Signal Companies



Circle 11 on Reader Service Card



# INDUSTRY STANDARD CHAPTER II

*The New Otari 1/4" Two Channel 5050B-II*

*The best selling professional two track audio recorder has finally been improved. We've added the refinements you asked for: The inputs and outputs of the new B-II are transformerless, balanced. The elapsed time indicator is a real-time hours/minutes/seconds L.E.D. display—tape accurate at all speeds. The built-in oscillator provides both 1kHz and 10kHz calibration tones. And we added a low frequency adjustment to the reproduce equalizers.*

*Behind the clean, new look of the B-II are the same features, performance and reliability you expect from our famous 5050B. We didn't change the rugged quarter-inch thick deckplate or the cast aluminum frame. We kept the switch selectable NAB/IEC equalization, +4dBm/-10dBv output levels, half-track and quarter-track playback heads and three standard reference fluxivity levels. And, of course, the B-II still features three tape speeds, XL type connectors, front panel record equalization and bias adjustments, variable speed, "dump edit" function, and an integral splicing block.*

*The 5050B-II has been engineered like no other tape machine in the world. When you check out the specifications you'll know why we say it's the best \$5,000.00 tape recorder available for under \$2,500.00. When you work with it, you'll know that we've just raised the industry standard.*

**OTARI** Technology You Can Touch.

Otari Corporation, 2 Davis Drive, Belmont, CA 94002  
Tel: (415) 592-8311 Telex: 910-376-4890



Circle 11 on Reader Service Card

© 1982 Otari Corp