

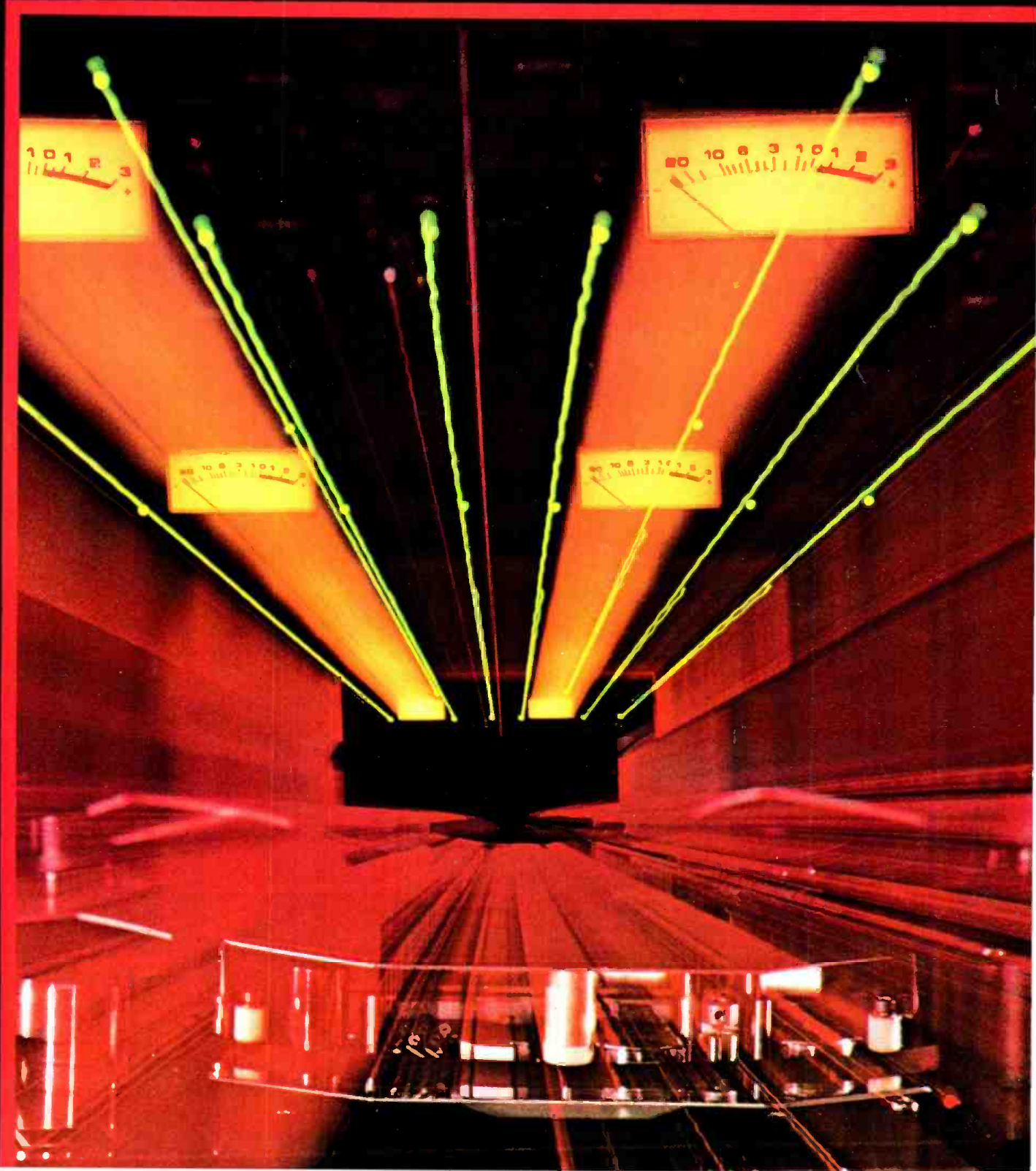

49910SKU0MVA325C0M11 02
KU0W RABID
U S 00 UOIV DE WASH
325 C0MMUNICATI0NS
SEATTLE



Take Us For Granted

With 24 tracks going, you don't have time to reach over and adjust for tape-induced level variation. You want to be able to forget about the tape.

Which is why we test every reel of our 2" Grand Master® 456 Studio Mastering Tape end-to-end and edge-to-edge. To make certain you get a rock-solid readout with virtually no tape-induced level variation from one reel of 456 to

another or within a single reel.

No other brand of tape undergoes such rigorous testing. As a result, no other brand offers the consistency of Ampex Tape. The consistency that lets you forget our tape and concentrate on the job.

AMPEX

Ampex Corporation • One of The Signal Companies 

Ampex Corporation, Magnetic Tape Division
401 Broadway, Redwood City, CA 94063
(415) 367-4463

**4 out of 5 Professionals Master
on Ampex Tape.***



*1981-1982 Billboard Magazine
Brand Usage Survey

Circle 10 on Reader Service Card

www.americanradiohistory.com

Publisher
Larry Zide

Editor
John M. Woram

European Editor
John Borwick

Associate Editor
Mark B. Waldstein

Advertising Production & Layout
Karen Cohn

Classified Advertising
Carol Vitelli

Book Sales
Lydia Calogrides

Circulation Manager
Eloise Beach

Art Director
Bob Laurie

Graphics
K & S Graphics

Typography
Spartan Phototype Co.

sales offices

Roy McDonald Associates, Inc.
Dallas, Texas 75207
First Continental Bank Bldg.
5801 Marvin D. Love Freeway
Suite 303
(214) 941-4461

Denver, Colorado Area
Englewood, Colorado 80112
14 Inverness Dr. East
Bldg. 1—Penthouse
(303) 771-8181

Houston, Texas 77036
6901 Corporate Drive
Suite 210
(713) 988-5005

Los Angeles Area
Glendale, California 91204
424 West Colorado Street
Suite 201
(213) 244-8176

Portland Area
Hillsboro, Oregon 97123
510 South First
P.O. Box 696
(503) 640-2011

San Francisco Area
Emeryville, California 94608
265 Baybridge Office Plaza
5801 Christie Avenue
(415) 653-2122

Sagamore Publishing Co.
New York
Plainview, NY 11803
1120 Old Country Rd.
(516) 433-6530



MAY 1982 VOLUME 16, NO. 5

DEPARTMENTS

LETTERS

6

EDITORIAL

24

CLASSIFIED

53

SOUND WITH IMAGES

8

Len Feldman

THEORY AND PRACTICE

12

Ken Pohlmann

DIGITAL AUDIO

16

Barry Blesser

SOUND REINFORCEMENT

20

John Fargle

NEW PRODUCTS AND SERVICES

51

FEATURES

A REGIONAL STUDIO ON THE RISE: NORMANDY SOUND

26

Howard Sherman

CRITERIA RECORDING STUDIOS: THE NEW EAST WING

32

Ken Pohlmann

THE CONSTRUCTION OF SELECT SOUND STUDIO

40

Bill Kothen and Dick Bauerle

THE SONY PCM-3324 DIGITAL RECORDING SYSTEM

46

Curtis Chan

About The Cover

• This month's cover comes courtesy of Huston Edwards of the Ampex Photography Department. This image of the Ampex ATR-800 audio recorder was created with a series of zoom time exposures.

db, the Sound Engineering Magazine (ISSN 0011-7145) is published monthly by Sagamore Publishing Company, Inc. Entire contents copyright © 1982 by Sagamore Publishing Co., 1120 Old Country Road, Plainview, L.I., N.Y. 11803. Telephone (516) 433-6530. db is published for those individuals and firms in professional audio-recording, broadcast, audio-visual, sound reinforcement, consultants, video recording, film sound, etc. Application should be made on the subscription form in the rear of each issue. Subscriptions are \$15.00 per year (\$28.00 per year outside U.S. Possessions; \$16.00 per year Canada) in U.S. funds. Single copies are \$1.95 each. Editorial, Publishing and Sales Offices: 1120 Old Country Road, Plainview, New York 11803. Controlled circulation postage paid at Plainview, NY 11803 and an additional mailing office.

Alpha Audio	25
Altec	39
Ampex	Cover II
Aspen Music Festival	23
Audio-Technica	19
Beyer	51
Bose	35
Datatronix	21
Kimball	8
Klark-teknik	7
Maxell	17
MCI	15
Milab	29
Modular Audio Devices	10
Orban	14
Otari	9, 30-31
Polyline	10
Sescom	52
Shure Bros	13
Sound Technology	11
Standard Tape Labs	43
Teac	Cover III
Telex	45
UREI	Cover IV

CALCULATING ROOM MODES

TO THE EDITOR:

In the October 1981 issue of *db* Magazine I have found several interesting articles about studio acoustic design. But the article concerning room mode resonances ("Calculating Room Modes") is based on empirical criteria which are today considered scarcely successful.

I enclose herewith a copy of my paper "A New Criterion for the Distribution of Normal Room Modes" that states the advantage of using the Density of Modes Concept. The practical calculations are very easy and, with the aid of a programmable pocket calculator, the readers of *db* could design the best dimensions of a studio in a really scientific way.

If you need some other explanation about my method, please don't hesitate to contact me.

OSCAR J. BONELLO

db replies:

Sr. Bonello's excellent paper (AES preprint 1530) appeared in the September, 1981 Journal of the Audio Engineering Society. We've asked the author to consider writing an applications-oriented version for us, which we hope to publish in a future issue of db.

Meanwhile, our Applications Note on Calculating Room Modes was certainly not intended to be the last word on the state-of-the-art of acoustic design. It merely allows the reader to compare studio dimensions with various ratios that have been recommended over the years, and to identify potentially troublesome room modes.

THE WELL-TEMPERED WHO?

TO THE EDITOR:

Please, don't pull my leg! On page 55 of the February issue, I noted with interest David McLey's Electronic Music System and the illustrations for same. Extraordinary—but why is that music so familiar?

Well, I can tell you because I used to play it before David McLey was born. He *can't* copyright it, because it is a Prelude in C Sharp from the well-known *Well-Tempered Clavier* by the very well-known Johann Sebastian Bach—who else?

Seriously, I'd like to take the opportunity to tell you how much I have enjoyed each issue of *db* these last years. Even though I am no engineer, I find a large part of the contents easily understandable and useful. The Sound Reinforcement issue is really excellent and I got many chuckles out of Bob Ashley's piece on getting rid of *all* the P.A.

Some years ago I went to the famous Paris Cathedral of Notre Dame on Christmas day. The sound—and sight—was more than could be believed. Vast batteries of floodlights (TV??) and spots on every priest; dozens of mikes, and each time a priest opened his mouth a sound like fifty jet planes came forth. Absolutely unintelligible. The choir was, predictably, even worse: close-up mikes, enormous amplification.

Do you realize that the Cathedral of Notre Dame is over 800 years old? It's a wonder it didn't come tumbling down under the acoustic strain.

EDWARD TAINALL CANBY

Coming Next Month

• June is Microphone Month at *db* and we'll be featuring a number of Application Notes on, appropriately enough, microphones. In addition, there will be a photo essay on Bob Paquette's Microphone Museum and a special New Products section devoted entirely to mics. All this, plus an NAB Convention report, European Editor John Borwick's Montreux AES Convention wrap-up, and more—coming in June's *db*—**The Sound Engineering Magazine.**

It will discourage most eloquent music.

(William Shakespeare 1564-1616)

Our considerable experience in the field of equalisation coupled with a philosophy of continual research and development has enabled the realisation of a range of high quality Graphic Equalisers which have become standard tools for correcting room acoustics and offer the solution to tricky equalisation problems.

The latest Klark-Teknik equalisers incorporate scale switching which facilitates a fine resolution for small adjustments and yet retains full boost and cut when required. Construction is to the highest standard using selected components and all units are rigorously bench-tested and aligned before a burn-in period and final music test.

DN22 GRAPHIC EQUALISER



The DN22 is a dual-channel Graphic Equaliser, each channel having 11 filters providing up to 12dB boost or cut at 11 centre frequencies, covering the entire audio spectrum. Separate low and high pass filters are provided on each channel giving 12dB per octave attenuation above and below their respective turnover frequencies.

The DN22 offers an extremely wide dynamic range and negligible channel-to-channel crosstalk.

DN27A GRAPHIC EQUALISER



The DN27A is the successor to the widely acclaimed DN27. It is a 1/3rd Octave Graphic Equaliser, providing boost or cut of up to 12dB at 27 I.S.O. centre frequencies covering the entire audio spectrum.

The equaliser filters are of computer-aided design and consist of actively-coupled L.C. networks of the 'minimum phase' type. The inductors have precision-ground ferrite cores and coils wound to extremely tight tolerances.

DN30/30 GRAPHIC EQUALISER



The DN30/30 Stereo Graphic Equaliser represents a breakthrough in equaliser design, giving two channels of full 1/3rd octave equalisation in one compact unit. In addition to saving on rack space the DN30/30 also means a considerable financial saving for anyone requiring stereo system equalisation.

All-new circuitry developed specifically for the DN30/30 uses ultra-stable N.I.C. minimum phase, combining filter networks to give unequalled performance.

For further information on our complete range of professional audio equipment and application details telephone (516) 249-3660

Klark-Teknik Electronics Inc.
262a Eastern Parkway, Farmingdale,
NY 11735, USA. Telephone: (516) 249-3660

Klark-Teknik Research Limited
Coppice Trading Estate, Kidderminster, DY11 7HL,
England. Telephone: (0562) 741515 Telex: 339821

Omnimedia Corporation Limited
9653 Côte de Liesse/Dorval, Quebec H9P 1A3, Canada.
Telephone: (514) 636 9971

Circle 14 on Reader Service Card



KLARK TEKNIK
sound science

db Sound With Images

Audio for Video — A Period of Transition

• Were you aware of the fact that 84 percent of all the TV we see these days is shot on film? I certainly wasn't, until I attended a recent New York Section meeting of the AES, where four experts involved in sound production and post-production for video enlightened a large audience regarding the intricacies of post-production audio for video. Before I tell you about who they were and what they had to say, let me quickly explain that when I say that 84 percent of all video is shot on film, that doesn't mean that it *ends up* on film for final showing over the air. Most of it ends up, as you might guess, on videotape. That being the case, why would so many studios and producers start out on film when videotape offers the single-medium advantage of being able to record a sound-track plus a picture, all at the same time, in perfect synchronism? Shooting picture

on film, using a separate Nagra or other audio recording device, means having to sync the recorder to the film camera (usually done by means of a crystal reference frequency in the camera which provides the reference for the tape transport drive). That brings us back to the subject of the meeting, which was "Audio for Video" but which could just as well have had the title "Post-production Audio for Video," because that's what was really at the heart of the matter.

The meeting was chaired by C. Robert Fine, a seasoned expert in the field of sound recording for both film and video. Bob Fine was responsible for the development of the well known Vidimag, which is used by many sound studios and about which we'll have more to say presently. His guests included Robert Liftin of Regent Sound Studios. Seeing Bob Liftin brought back fond memories

of a time when he and I were both somewhat younger and when I used his studios for some experimental matrix quadraphonic recording work in which I was then heavily involved. Vin Gizzi was the second panelist, and he was, until recently, associated with Teletronics, one of the best known video audio studios in New York City. Michael Kletter of Parkson Advertising was there to represent the ultimate "customer" who engages the services of the video audio studio (and whose purpose at the meeting was to keep the engineering types from going too far off the technical deep end which might confuse the audience). Dick Mack of National Video Center, another prestigious production studio, was the fourth panelist.

Bob Liftin quickly got to the heart of the matter when he explained that synchronizing as many film strips as you want (whether they contain pictures, sound tracks, or what have you) is relatively simple in the post-production editing and mixing process. Ask a camera supply shop for a film synchronizer and what you will get is a mechanical contraption with a series of sprocket holes arranged side by side. It doesn't really matter whether you operate the synchronizer at correct absolute speed or not, so long as *all* the film strips remain synchronized to each other. And they will, so long as those common sprocket holes run all the strips simultaneously.

In videotaping, the videotape speed is controlled and maintained by a control track, whose frequency is derived either from an internal crystal or from an external source known as a sync generator. In the U.S., a frequency of 3.58 MHz is used, largely because it is the frequency of the NTSC color carrier. Audio recording speed, of course, is determined by the usual capstan/pinch roller arrangement familiar to all of us. The key here is to use a common "house" sync generator to lock *all* machines to each other—audio as well as video recorders.

The panelists also introduced us to another system of synchronization and control which is based upon the so-called SMPTE Time Code. SMPTE stands for the Society of Motion Picture and Television Engineers, and the SMPTE time code is a bi-polar 80-bit system or method of addressing videotape and identifying or labelling every single frame of that tape with a number and

More and more recording studios are discovering the great sound of the Kimball Professional Grand.

Here's why:

The Kimball 6'7" Professional Grand derives its heritage of greatness from the world's finest piano—the Bosendorfer. The scale and plate design are derived from the Bosendorfer Model 200, and the plate is extra thick to assure maximum sustain and to avoid plate noise from hammer strikes. The Bosendorfer-derived scale and non-duplexed trebles enhance tonal depth, clarity, and pitch perception. The Kimball Professional Grand is specifically designed for clear, pure tonality, free of spurious noise and false harmonics. It also offers superior durability and tuning stability. Its entire structure, including the soundboard, is of precision-laminated woods, greatly reducing differential expansion in changes of temperature and humidity.



For more information about the Kimball Professional Grand, contact Wade Bray at (812) 482-1600.



kimball

"The key to sounding great!"
1349 Royal St. Box #50
Gasper, IN 47546

With An Otari Duplicating System, You Can Duplicate The Success Of These Duplicators.

When it comes time to make the decision to expand your business capabilities in high-speed duplicating, it's also time to seriously consider the OTARI DP-7000 High-Speed system. It's an endless loop, 64:1/32:1 system that's specifically engineered for the tough environments and continuous-duty operation that's demanded in the professional facility.

Here's two testimonials from DP-7000 users that tell this story best:

Frank Gspann, Sound Arts Co., New Jersey:

"We're a recording studio and duplicating company. In the studio we've worked with a pair of Otari 5050's for over four years and they have literally been Workhorses. So, we decided to invest in the DP-7000 High-Speed system when we wanted to expand our cassette duplication operation to a high-speed, high-output line. We duplicate a variety of materials from spoken word to computer program cassettes, which are much more demanding than music cassettes. The quality has been so consistently high that we violate all the rules and use the DP-7000 for some of our short runs because we know the product will be better. In this competitive business, you've got to sell a better product or you won't make it. The Otari DP-7000 lets us do that... and profitably!"

Leonard Gross, Custom Duplication Inc., Los Angeles:

"Custom has been in the high-speed duplication business for a number of years and we had to add another line. In this business reliability and performance are number one... but, in today's economy, price is a close second. When we checked around, we discovered that our money could buy two OTARI systems for close to the cost of a single system from the nearest competitor. The Otari is already putting-out almost half our total volume of four to five million cassettes a year... and that includes everything from spoken word Bibles to game and program cassettes for one of the largest game/computer manufacturers."

Let Otari's over 15 years of experience as a world leader in tape duplication systems go to work for you as it has for Frank and Leonard. Find out how an Otari DP-7000 can be a profitable, economical addition to your company. Call Michael Pappas at OTARI (415) 592-8311. He'll tell you how you can duplicate the success of the duplicators.

OTARI®
The New Workhorse

Otari Corporation
Industrial Products Division
2 Davis Drive Belmont, CA 94002
(415) 592-8311 Telex: 910-376-4890

Please send me more information on the Otari DP-7000.
Name _____ State _____
Address _____
City _____
Zip _____
Phone _____
Mail to: Otari
2 Davis Dr., Belmont, CA 94002



Circle 20 on Reader Service Card

www.americanradiohistory.com

MAP 3550 EQUALIZER
(5 1/4" x 1 1/2")

EUPHONIOUS "MAP a good sound future"
MODULAR AUDIO PRODUCTS
A UNIT OF MODULAR DEVICES, INC.
50 O'ville Drive ■ Airport International Plaza ■ Bohemia, New York 11716 ■ 516-567-9620

Circle 22 on Reader Service Card

Audio Tape

for professionals

REEL TO REEL TAPE
Ampex, 3M. All grades.
On reels or hubs.

CASSETTES, C-10—C-90
With Agfa, TDK tape.

LEADER & SPLICING TAPE

EMPTY REELS & BOXES
All widths, sizes.

Competitive!
Shipped from Stock!

Ask for our recording supplies catalog.

Polyline Corp. 312/298-5300
1233 Rand Rd. • Des Plaines, IL 60016
15

Circle 24 on Reader Service Card

with a good deal of other data, if desired. (For more details, see "SMPTE Time Code Comes to Audio" in the November, 1978 db, and "Electronic Synchronization in the Recording Studio" in the December, 1981 issue—Ed.)

Another frequency which *might* have been used for synchronizing sight and sound in the U.S. was 60 Hz. This would have been a lovely frequency to use since it corresponds to our line voltage frequency. In the era of black and white TV, standards called for 30 frames per second which, with two fields per frame, worked out to a nice, even 60 fields per second. Unfortunately, when color came along, for reasons of reduced chroma-to-luminance interference, the 3.58 MHz color carrier frequency carrier was established and since it could not be evenly divided by 60, the field rate was changed to approximately 59.94 frames (or a frame rate of 29.97) per second. This rules out the possibility of using the frame field rate crystal generator as a real-time clock. Therefore, a complex system called "drop frame" was developed, in which 2 frame numbers are dropped every minute, except at the 10-minute marks on the clock, and everything works out OK.

During his talk, Dick Mack pointed out that motion pictures, over the 50-odd years since they have included sound, have developed sophisticated techniques for achieving all kinds of post-production audio effects. Those involved in sound production in the motion picture business are not anxious to abandon familiar techniques that have a high productivity rate and that produce the desired results. A single audio video medium such as videotape would at first seem to be an ideal and easy one with which to work. However, the moment the sound engineer is called upon to do some post-production editing, dubbing, adding of effects, music and the like, it's still simpler to take the original sound track *off* the videotape, and lay it down on another medium. Then, it becomes possible to do things that would be difficult for the inexperienced audio specialist who had not worked with computer coding, SMPTE time code, clock synchronization and the like to do efficiently.

It is probably for that reason that the Vidimag, mentioned earlier, enjoys such widespread use. The Vidimag is simply an intermediate videotape medium that is equipped with sprocket holes! Once you transfer your original videotape to Vidimag, you have the kind of control and easy mechanical synchronization that you have with film. In other words, Vidimag relies upon well established film sound editing principles, even though it is a tape medium.

In yet another hybrid system known as Q-lock, also discussed by the panelists, it is possible to interlock a VTR with one or more multitrack tape recorders,

such as a 24-track deck or a 4-track mastering deck. This method is especially useful for elaborate live-performance shows in which multi-track might have been used for the audio recording in the first place. This method has also been found useful, according to Dick Mack, with pre-recorded video programs (such as sit-coms and soaps) to which you want to add sound effects, laugh tracks, music or whatever in the post-production phase of the project.

If all of these electronic, mechanical and hybrid means of adding or editing sound in video production seem complicated and confusing, Bob Fine summed up the situation in a few words at the end of the discussion. He pointed out that there are two reasons why so many producers stick to film and resist working directly with videotape. The first reason stems from the feeling that the "sprocket hole" is almost an international standard. To be sure, it is a 24-frame per second standard, and often U.S. films are shown in Europe at a 25-frame rate because that's half of their 50 Hz line frequency. That causes a slight upward shift in pitch, but nobody seems to care. It is, as we said, an "almost-international standard."

The second reason is, as might be expected, economic. With so much on-location production going on, producers may need to add more and more tracks in their post-production sound editing: ten or fifteen sound effect tracks, three or four music tracks, and even lip-sync overdub in many cases. With a simple Moviola machine (which can be rented for as little as \$25.00 per hour and operated by a single editor in a small room), it's easy to build up as many individual sound tracks as are needed in a short time at very low cost. Despite the great strides made in videotape sound editing and post production work directly onto videotape, electronic editing is still fairly expensive and requires people with experience and an understanding of some of the electronic synchronization techniques which were described by the panelists.

Still, all agreed that there was a definite trend developing towards videotape post-production sound editing and away from the more traditional film makers' approach. There were indications too that computerized electronic editing would soon be a lot simpler than it is today—and a lot less expensive. Bob Fine rightly pointed out that while the AES has largely catered to those audio engineers involved in records and audio for broadcasting, everyone involved in audio today will find that his or her operation will change significantly within five years or so. The voracious appetite of the burgeoning cable TV industry for more and more programming—much of it musical in nature—is likely to involve *all of us* in audio-for-video—and very soon at that. ■

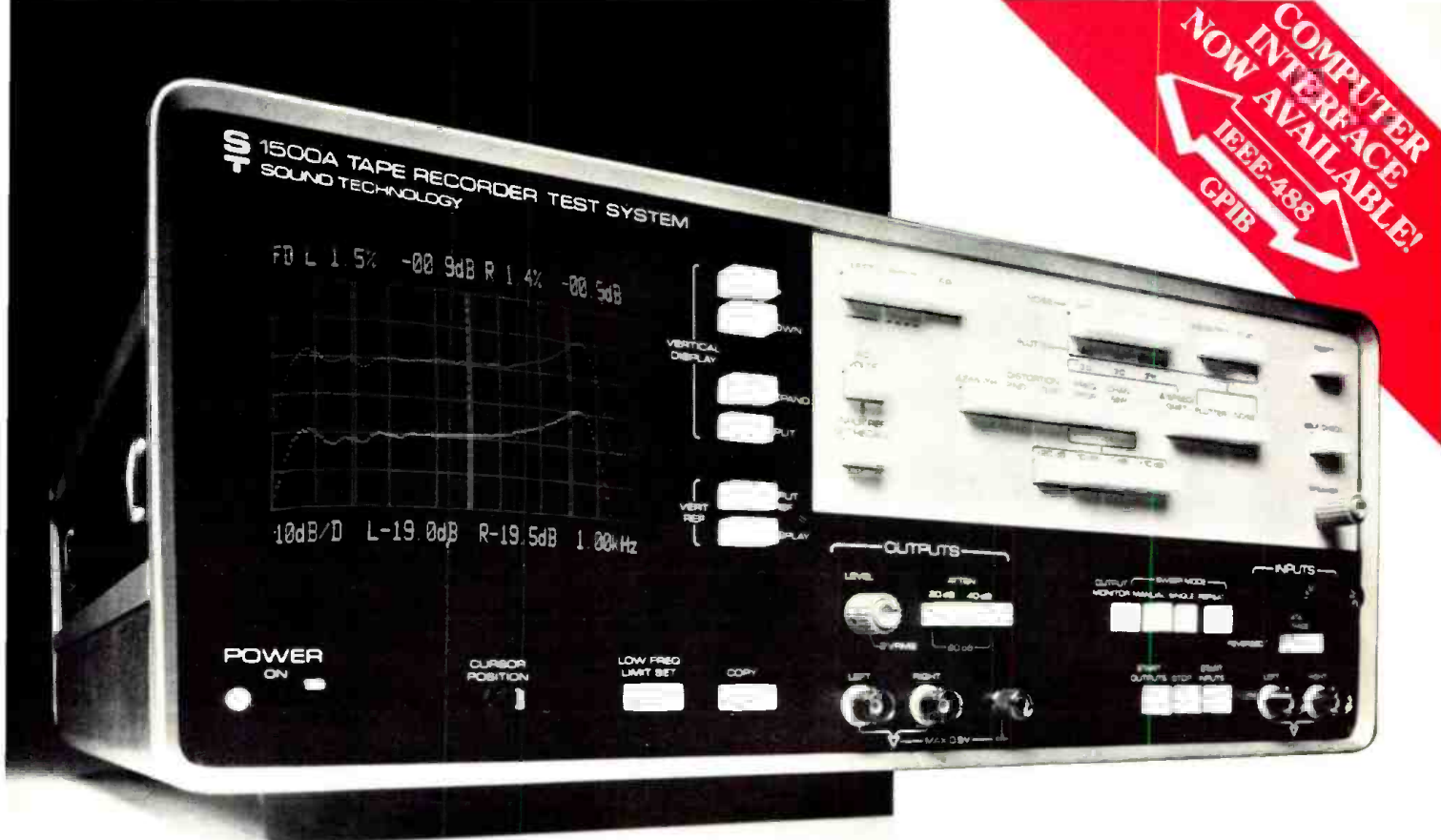

THE INTELLIGENT TEST SET THAT CLEANS UP YOUR ACT.

The Sound Technology 1500A

It's the first microprocessor controlled audio measurement test system. It can do in minutes what used to take hours with more conventional and ordinary test set-ups. And, it can show you things you've never seen before.

Designed around the most advanced microprocessor hardware, the 1500A will show you the whole story on an integral CRT with adjustable cursor. Push a "Copy" button, and it delivers a hard-copy printout from the optional VP-150 Video Printer.

What Will It Do?

Conceived to be the ultimate precision test instrument for tape recorder analysis, the 1500A evolved into a comprehensive audio test system for many applications. Here's just a small sample of the varied jobs it will do:

- Complete tape recorder mechanical and electronic performance checks
- Thorough phono cartridge analysis
- One-third octave spectral analysis

- Evaluation of audio quality for VTR's
- Acoustical room analysis including microphone and loudspeaker measurements
- Quality control for high speed tape duplication systems
- Semi-automated production testing
- Research and development for the audio tape manufacturer
- Quality assurance for the audio distribution network
- Exclusive asynchronous inputs and outputs for remote location testing (satellite, transmitter, studios, etc.)

Here's the kind of data you can get:

- Frequency Response
- Azimuth at 4 discrete frequencies
- 2nd and 3rd Harmonic Distortion Vs. Level
- Wow & Flutter; noise; weighted or flat
- Channel Separation 20Hz - 20k
- Delta Speed & Drift

Because of the modular plug-in design, the 1500A is designed to grow with you. Many accessories are now available which include a 1/3 octave spectrum analyzer card (noise: 20Hz-20kHz, Wow & Flutter, .5Hz-200Hz) that easily plugs into the mainframe; a hard copy printer; a comprehensive test record that lets you test cartridges, tonearms and turntables; a balancing system that will allow you to interface balanced I/O test applications; and a heavy-duty transport case. There's even a kit for rack mounting.

Add to the above the powerful new GPIB, IEEE interface for computers, and you have an extremely broad range of functions and applications that the advanced 1500A can tackle.

Who Can Use It?

Broadcaster. Recording studio. Film sound studio. Audio manufacturer. Audio dealer. Service technician. Researcher. Virtually anyone whose job requires accurate evaluation of audio equipment performance. Wherever you are in the audio spectrum, it can make life a whole lot easier.

Clean up your act with the 1500A. It's intelligent. And so is a phone call to Sound Technology. We'll be pleased to send full information on the 1500A and our other industry standard test equipment.

**S SOUND
T TECHNOLOGY**

1400 Dell Avenue, Campbell, CA 95008
(408) 378-6540 Telex: 357445

© Sound Technology, 1982

Circle 25 on Reader Service Card

Doppelgangers

• Monaural recordings are great—a few weeks ago half of my power amplifier folded and I spent the evening recreating the good old days. A point source isn't all that bad—certainly all of the criteria of frequency response, dynamic range, and clarity are fulfilled and the room still faithfully couples with the sound source to provide some live ambience. There is also no question that a recording of a Beethoven piano sonata sounds a lot like someone playing a Beethoven piano sonata. And yet, the question of realism is where the trouble begins. A nine-foot piano sounds funny from a foot-wide cabinet, and an orchestra sounds even funnier. Two speakers ten feet apart makes the piano sound more like it's there—right there—between the speakers. Exactly why it doesn't bother me to listen to a forty-foot-wide orchestra from two speakers ten feet apart, I can't say. On the other hand, I've listened to orchestral recordings from speakers forty feet apart and it sounds even better—but on still another hand, a piano recording was way too big. Well, let's look at the problem.

Monaural recordings are great, but stereo is more than twice as good. Those two point sources allow us to create a panorama of images, phantom images, which obviously don't exist literally, yet they sound as if they do. The ear-brain interface is incredibly sophisticated yet easily fooled. Although live sound usually contains sound cues from many directions, two sources can deliver enough cues to the ear-brain interface to provide realism to our perception of direction.

EAR-BRAIN

As near as we can tell, the ear-brain uses four main cues to localize sound: relative intensity, time of incidence, phase, and complexity of waveform. Provided that two ears are available (and two are needed to perceive direction), the

intensity difference is perhaps the most important cue. A sound from one side will have greater intensity at the near ear because of the inverse-square law and the acoustic shadow cast by the head itself. This is insignificant at lower frequencies because they tend to bend around the head, but is quite significant at frequencies above 1000 Hz. The second cue, time of incidence, is very important—the brain rapidly calculates time differences of less than a few ten-thousandths of a second between one ear and the other. The other two cues are derivatives of these first two. For continuous tones, the brain compares the phase between the two ears. Obviously, this too is frequency dependent—the effect is only good for frequencies where the path length between the two ears is a wavelength or less; at higher frequencies different phases are superimposed, and that information is lost. Finally, the complexity of the waveform plays a part—the head attenuates high-frequency components and not lower ones, and the brain perceives the resulting timbre difference between the ears—the further ear has less high frequencies. Thus, lower frequencies are localized primarily by time of incidence, or phase, between the two ears, and higher frequencies by amplitude difference.

The frequent mention of the ear-brain should perhaps be explained. While some simple cues are fairly well understood, the mechanism itself is still virtually imponderable. The left and right ears do not differ physiologically in their capacity for detecting sound, but their respective right and left brain halves certainly do. Each of us has one brain (sometimes debatable), but the brain has two halves which loosely divide the brain's functions. Interestingly enough, and also mysteriously enough, the connections from the ears to the brain halves are crossed; in other words, the right ear is connected to the left brain

half, and the left ear to the right brain half. There is some overlap in the connections, but the primary links are crossed. And that leads to an interesting question. It has been found that the left cerebral hemisphere processes most of our speech information. Thus, the right ear is perceptually superior for spoken words. And now listen to this: it's mainly the right temporal lobe which processes melodic information. Therefore, we are better at perceiving the melodies heard by the left ear. Got that? The left ear is better at nonverbal things like melodies and the right ear is better at verbal things like words. Whether or not that means the lead vocals should be panned to the right channel, I don't know.

PHANTOM IMAGES

Now—let's get back to the question of phantom images. Two loudspeakers generating equivalent in-phase signals will produce not two, but one image located between them for a listener seated on-axis in front of them, given an arc of about 60 degrees. That is because for the four reasons stated above, and for other more subtle reasons, the ear-brain has been supplied with enough information for it to make that perception decision. In other words, it has been fooled into localizing an image which is not really there. And that phenomenon is what makes stereo twice as good as monaural—because by varying our cues, we can shift that phantom image along a line between the loudspeakers. That lateral image is an important part of realism.

Consider the typical pan pot on a console: it's a potentiometer varying the amplitude of the signal. By varying the proportion of a signal between two loudspeakers, we make use of amplitude cues to shift the phantom image along the line between the speakers. And the result, especially convincing for higher frequencies, is a solid phantom image. An

Special microphones for special sound requirements



As an audio specialist, you know making do with "utility" microphones isn't good enough. You need a complete assortment of microphones, each suited for specific applications.

Microphones that not only sound superb but are built to withstand the abuse of session to session punishment.

Shure SM line professional microphones offer built-in ruggedness and reliability and are designed to give you the optimum performance you need in every circumstance, whether it be for • a bass drum (SM7); • an acoustic stringed instrument (SM17); • percussion instruments (SM56 and SM57); • snare drum or acoustic guitar (SM81); • amplified instruments (SM53 and SM54); • studio quality vocals inside the studio (SM59); • studio quality vocals outside the studio (SM85); • stand-up interviews (SM61 and SM63); • desk-top applications (SM33) ... or *whatever* your needs.

...under one cover

For all the facts on Shure's full line of professional microphones, fill out and return the coupon below for your **FREE** copy of our new 72 page catalog describing over 150 microphones. No matter what your sonic requirements, there's a Shure microphone that fills the bill.



The Sound of the Professionals®

Shure Brothers Inc., Dept. 63, 222 Hartrey Ave., Evanston, IL 60204
In Canada: A.C. Simmonds & Sons Limited
Manufacturer of high fidelity components, microphones,
loudspeakers, sound systems and related circuitry.

PLEASE PRINT

Yes, send me your new Full Line Microphone/Circuitry Catalog, AL700. (Outside the U.S., enclose \$2.00 for postage and handling.)

Name _____

Address _____

City _____ State _____ Zip _____

db 0582

Circle 26 on Reader Service Card

amplitude difference of about 20 dB places the image firmly in the louder loudspeaker; anything less than that falls somewhere between them. Obviously the stability of the placement is dependent on the pitch and timbre of the waveform, the interaction with other signals present in the loudspeakers, the effects of the listening room acoustics, and listener placement. And as you might expect, the effect of straight amplitude panning is best for a multitrack mix, which has independence between the original signals. For stereo microphone techniques, that cue information must be properly encoded at the microphone itself, but that comes later.

AMPLITUDE AND TIME CUES

Let's set up the pair of loudspeakers again. Given an equal input signal and holding relative amplitudes constant, we can shift the lateral image with time delays, using the Haas effect. It's easy—the ear-brain is a sucker for this one. If a slight time delay is introduced to one loudspeaker, the ear-brain tends to localize toward the earlier loudspeaker using the time of incidence cue we discussed earlier—for example, a time-delay of three-quarters of the way toward the left speaker. A 2 millisecond delay would put the image firmly in the left speaker altogether, even though equal amplitudes still exist between them, and that cue by itself should still place the

image in the center of the loudspeaker's arc. The question of time delays illustrates the extremely touchy nature of stereo. If the listener moves off-axis by a foot or so, he sets up a 2 millisecond delay from the far loudspeaker, and suddenly all of those careful panning images that the producer was so proud of shift to one speaker. Instant monaural. In fact, it's probably worse than mono. But if you sit on-axis and never turn your head, the cues work. And time delay works well, up to about 40 milliseconds, at which time the ear-brain has time to figure out the trick and begin to calculate for a discrete echo effect.

The logical extension of these amplitude and time cues is to use them simultaneously. For example, a 2 millisecond delay in the right loudspeaker would place the image in the left channel, but then by attenuating the left loudspeaker by 20 dB, the image would shift back, centered between the loudspeakers. It appears simple, but exactly how linear that trade-off is, is probably still a research question. Under conditions as complex as music signals, the balancing of those two cues would be a tricky question, the solution of which would also surely result in better placed and more suitable phantom images.

Let's get back to the console and its pan pots. Multitrack panning works well and the images are aligned between

the loudspeakers. However, with only amplitude cues to work with, we are restricted to a line between the speakers, and it's a flat line at that; there can be no depth information in the mix. And that's why solo instruments can sound unnaturally highlighted in such a mix. They can only sound louder—not closer. Clearly there is more to localization accuracy than just relative loudness. We could try some DDL from the peripheral rack but we've seen that even time cues can still only shift us along that same flat line. Given that dilemma, even the most hardened multitrack engineer involuntarily remembers some stereo pair recording he once heard—it wasn't flat, it had depth, it had life.

Yes, well, those two microphones provided some special information that no number of individual microphones ever could. It was genuine information, not artificial, and it had cues from all 360 degrees of the recorded sound field. No, we don't have to junk our multitracks, but the stereo pair technique can provide some tricks to put some life into a tired mix: images between the loudspeakers, in front of, and behind them, and even outside of the speaker's pan. When was the last time you listened to stereo playback and heard the lead guitar come from across your left shoulder? Next month, that secret is revealed. ■

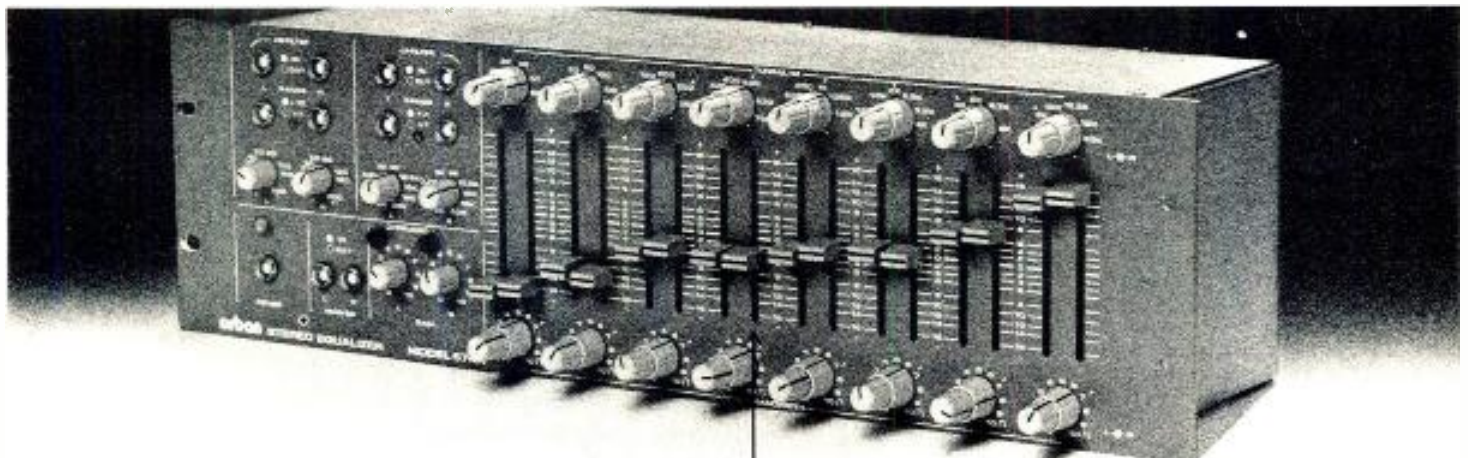

The Dream Equalizer: Now Mono Or Stereo

When we introduced our 672A "dream equalizer" in 1979, we had an instant hit. Audio professionals loved its versatility and clean sound. Eight parametric EQ bands (with reciprocal curves) were combined with wide-range tunable 12 dB/octave highpass and lowpass filters. The result: an amazingly powerful and useful machine. A cost-saving one too, because the outputs of both filters are available to perform a full electronic crossover function.

The 672A now has a stereo twin—the new 674A, with all the power of two 672A's in a space-saving 5¼" rackmount package. Naturally, both equalizers are built to full Orban professional standards. That means industrial-quality construction and components, RFI suppression, a heavy-duty roadworthy chassis, and comprehensive backup support.

For complete information on the popular 672A and the brand new stereo 674A, contact your nearest Orban dealer.

orban Orban Associates Inc. 645 Bryant St.
San Francisco, Ca. 94107 (415) 957-1067

Circle 15 on Reader Service Card

Another cold, hard fact.

As broadcast quality becomes more and more demanding, MCI makes more and more sense.

When we built the JH-110 Series, we took a fresh look at professional recorder design and developed a radically new transport system. Today, this cool running Total Servo Transport has made MCI the most accepted line of studio recorders. Now this proven system is available in versions specially designed for broadcasters' needs. MCI's new JH-110B and JH-110BX.

These recorder/reproducers offer smooth tape handling, unmatched editing capabilities, controlled tape tension, and

quartz locked speed accuracy. A digital spot timer/locator is included at no extra cost, and their transports have been designed from the ground up for use in synchronized systems with video or other audio recorders. We even make a SMPTE/EBU synchronizing unit, the JH-45. If you're thinking about upgrading or a new installation, take a good look

at MCI. You can buy a stereo JH-110BX for \$4800 FOB Fort Lauderdale, Florida. MCI, not always the most expensive, but always the best.

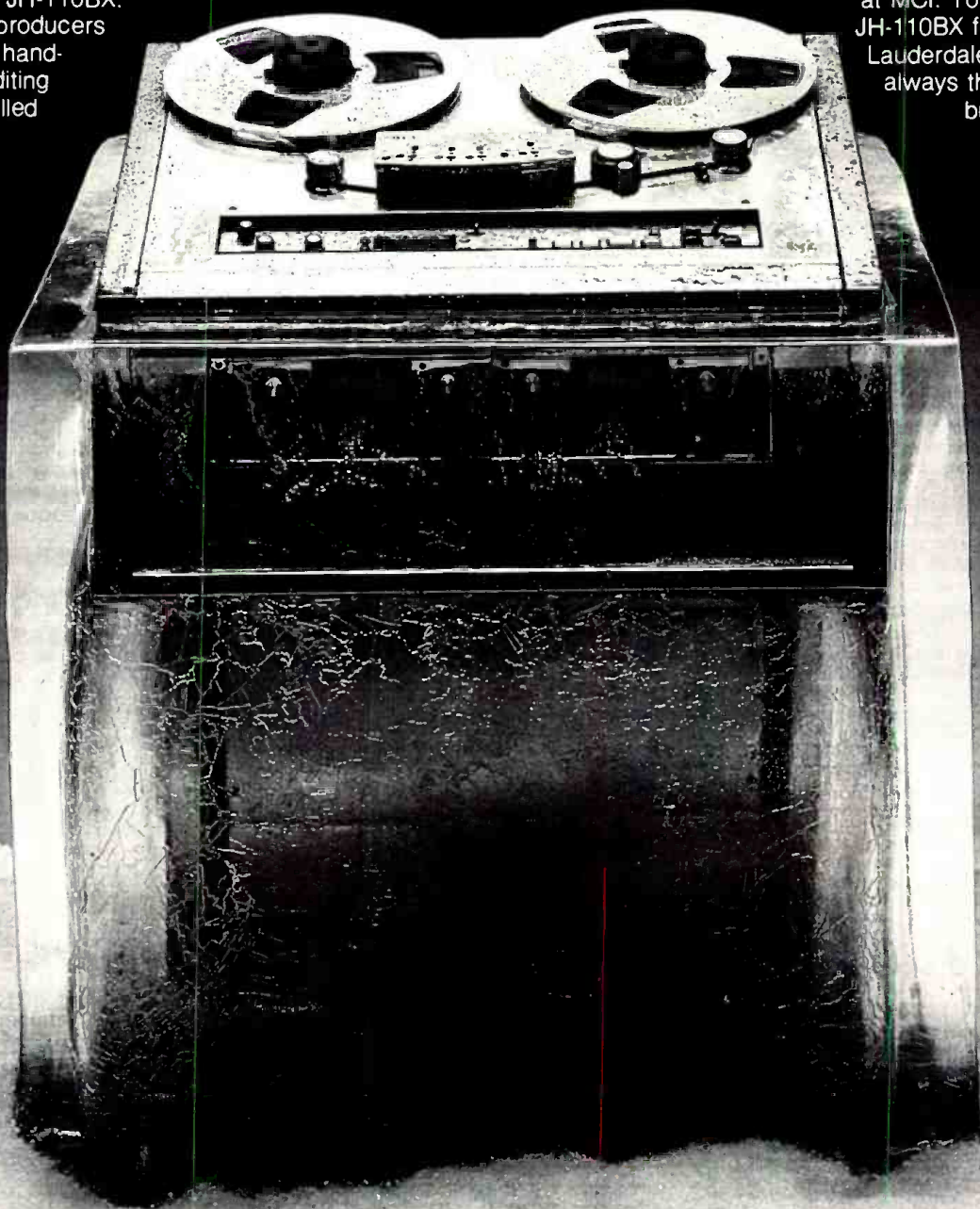

For more information, contact your local MCI dealer or write MCI, Inc.,
1400 West Commercial Boulevard, Fort Lauderdale, Florida 33309 USA. Telephone: (305) 491-0825. Telex: 514362 MCI FTL.

Circle 28 on Reader Service Card

TWA1100-0005-81

www.americanradiohistory.com

Building an Audio Processor

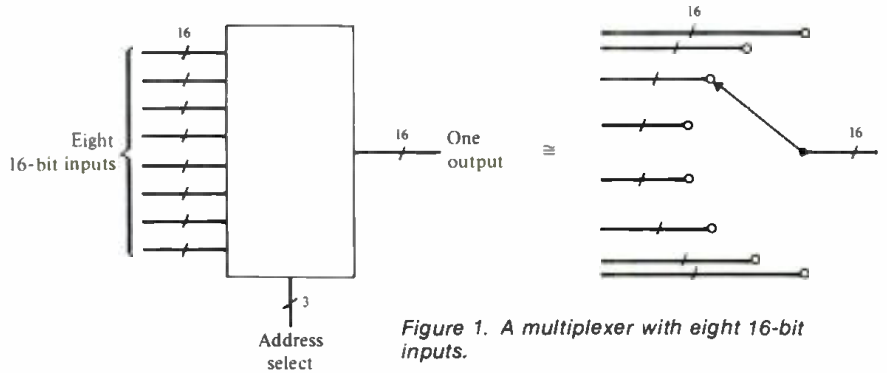

Figure 1. A multiplexer with eight 16-bit inputs.

• In last month's column, we introduced the concept of the digital audio processor. The basic concept of such a device is the interconnection of various functional elements which do different kinds of tasks. The program determines which tasks are to be done and the sequence in which they are done. Let's build such a machine. However, before we begin we need to consider a compact notation because the actual number of wires is very large. Our data words will be 16 bits, but we do not wish to actually draw all 16 lines. Rather, we will just mark a single wire in terms of the number of bits, or we will understand that audio data information is always 16 bits.

In contrast to audio data, there is a

class of control information which determines the function. These control lines are generally named, and they are single bits. Multiple-wire address functions are also considered as control information, since they specify which path will be used for the audio data.

BASIC ELEMENTS

To build such a processor we need a set of basic elements. One of the primary switching elements is a multiplexer (MUX) which allows N (8, for example) 16-bit inputs to be selected. You can think of this as an 8-position switch (remember that there will be 16 bits

associated with such a multiplexer). FIGURE 1 shows a multiplexer with eight 16-bit inputs.

The choice of which input is to be selected is determined by the address select input (3 bits for 8 positions). A multiplexer is the name of a particular class of IC as well as the name of a function. It can also be built out of tri-state logic. (Tri-state means that the output will be HI, LOW or disconnected. We can wire 8 such outputs together if all but one are always in the disconnected state. State selection is thus equivalent to address selection.)

FIGURE 2 shows the audio data flow (and memory address) connections for a possible audio processor. Notice the

Figure 2. The audio data flow and memory address connections for a digital audio processor.

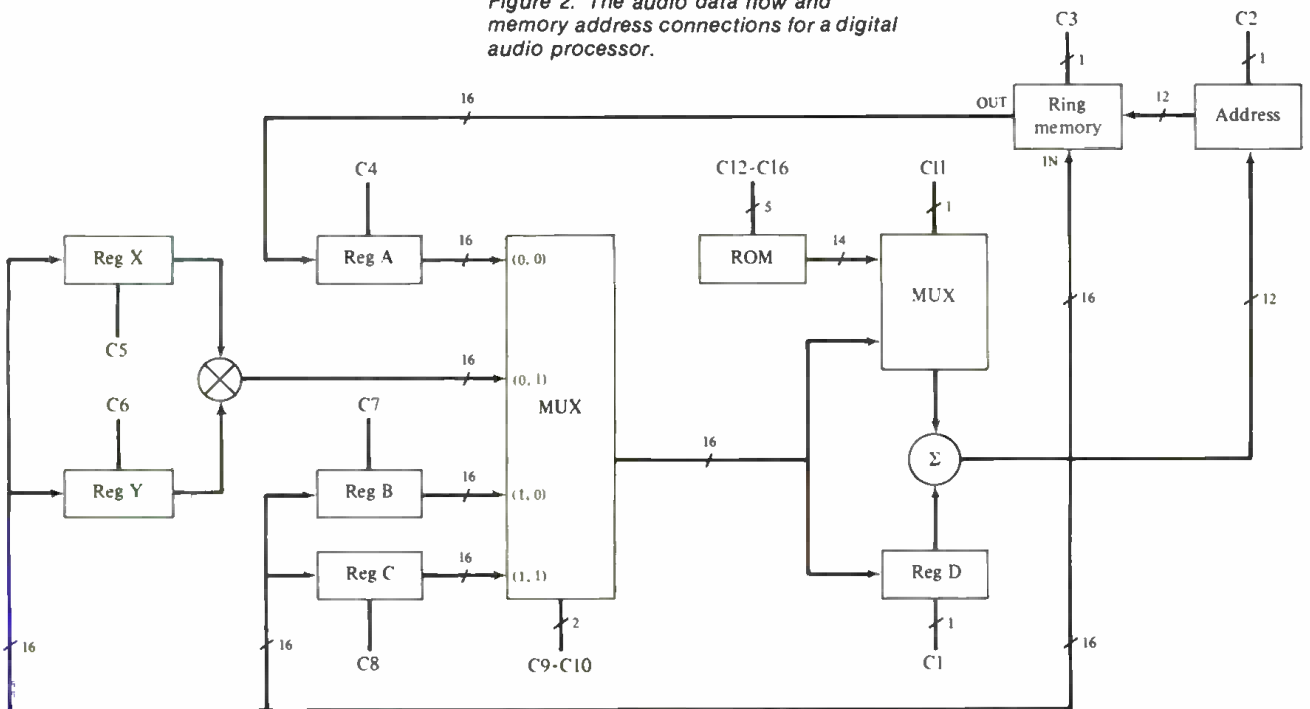

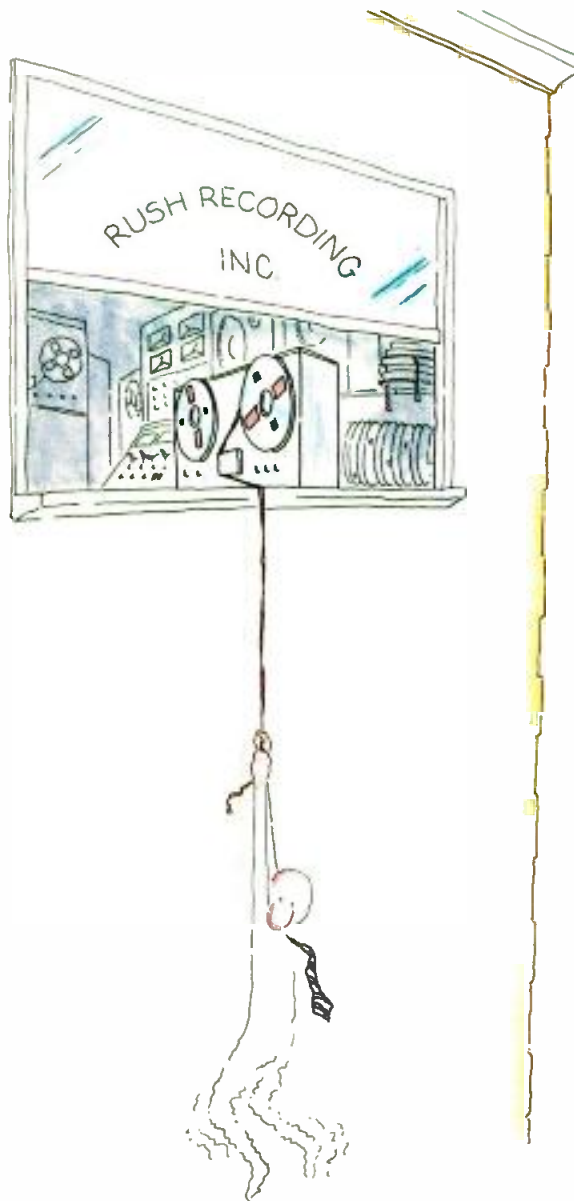

Audio engineers who try Maxell won't let go.

Maxell quality saves a lot of recording situations. Maxell meets your 1/4" open reel and audio cassette needs, no matter how demanding you are. Because we're more demanding. We've developed a name that means unique quality all around the world. For example, Maxell cassettes give you a productivity boosting four-function leader with A/B side indications, directional arrows, non-abrasive head cleaner and five-second cue to set timing and level.

You can see Maxell excellence in the cassette construction and on the scope or meter. The physical construction is strong enough to meet all professional requirements. Maxell open reel tape and cassettes give you quality you can hear. And your clients can hear as well.

We'll give you all the technical information you need to form your own opinions. But if you're like just about every audio professional that tries Maxell, you won't let go. Remember, we warned you!



maxell[®]

PROFESSIONAL / INDUSTRIAL DIVISION

Our success is magnetic.

Maxell Corporation of America, 60 Oxford Dr., Moonachie, N.J. 07074 (201) 440-8020

Circle 30 on Reader Service Card

www.americanradiohistory.com

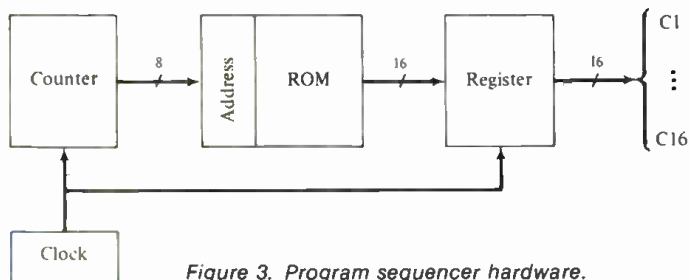

Figure 3. Program sequencer hardware.

operation appears to be extremely complex because of all the possible activities which could happen. The decision as to which activities happen is governed by the actual control bits, C_1 through C_{16} . Since these effect the clocking of all registers, nothing will happen unless these bits are active. Thus, if our program contains NOP (No Operations) with all bits inactive, none of the registers will change value. The registers' outputs remains fixed until the clock line makes a transition.

Before we can make the processor do something, we need to consider the way in which the control bits are generated. At a given time, there are 16 such bits and we call them the *Instruction Word*. When we give a name to a particular instruction word it is called a program step. FIGURE 3 shows the hardware for generating such a sequence of program steps. Hence, sometimes it is referred to as a program sequencer. The sequencer is composed of a ROM which contains all of the needed instruction words and a counter which sequences through them in order.

Now, let's try to make the processor do something simple. Suppose we wish to move the audio data word in Register C to Register D. This requires that the MUX-Select bits (C_9, C_{10}) be set such that the MUX output is Register C; it also requires that we generate a clock for Register D (C_1). This might be represented as the instruction word, 0,000,001,100,000,001 for $C_9 = 1, C_{10} = 1,$ and $C_1 = 1$. All other control bits are 0. Semantically we would say "Register C Select-to-Register D."

Now, suppose we wish to add this audio data word to that of Register B, and then place the result into Register Y. The MUX control bits (C_9, C_{10}) must now be 1,0 instead of 1,1 to select the 3rd (B) inputs instead of the 4th (C) input. The other MUX feeding the adder-module must be set for the main MUX output instead of the ROM ($C_{11} = 1$), and the Register Y clock must be issued ($C_8 = 1$). This program step corresponds to 0,000,010, 100,100,000.

Notice that these two operations could not happen at the same time because the main MUX can select *either* Register C *or* Register B. On the other hand, Register D could transfer its information to the memory address register at the

time that either of the other two operations were taking place.

A complex program can be written to do sophisticated processing using processors of this class. This particular processor is probably not that interesting because it was not designed for any particular task. Nevertheless, it could implement many functions such as primitive reverberation, phasing, filtering, etc.

PROGRAMMING

The fact that we have demonstrated that such a processor can create interesting audio signal processing should not imply that the creation of such a program is easy or straightforward. The design task of making a particular function has just been split into two pieces: the hardware and the software. The relationship between them is not clearcut if one allows the designer to change the hardware in order to implement a program. Usually, programming thinks in terms of a fixed hardware structure.

Programming itself must be divided into two classes of design activity: algorithm development and program coding. The former deals with the questions of what algorithm is needed for a filter structure, analogous to choosing the type of analog filter: Butterworth, Bessel, All-pass etc. with pole-zero specifications. Program coding corresponds to that of picking the circuit type with component values.

When we actually think about doing such a task, we quickly realize that the complexity is beyond a normal human mortal, unless certain developmental aids are provided. This is especially true if one considers that large-array processors may have 32, 48, 64 or more bits in each instruction word. The core of most large computers is designed in the same way as this audio processor, but the instruction word might be 128 bits long. Think about writing a program where you had to specify each of 128 bits, just to create one instruction word! Even a short program might require 1000-4000 program steps. The number of possibilities frizzles the mind. To keep programmers and software designers from going crazy, we may develop a more-compact notation. Certain combinations of bits are given names, such as MULX

for control bit 5. These symbols are converted to their binary values by a software program called an Assembler.

However, even this kind of programming is difficult, and we need to generate a higher-level language. In a large computer, a symbol such as FMUL for floating-point multiply will turn-on a fixed sequence of program instructions using many cycles to implement the instruction.

When the class of programming is restricted to a particular category, such as FORTRAN (*formula[equation] translation*), one can write another software tool called a Compiler. This can turn the equation $A = B \sin C$ into a sequence of program steps which contain a sequence of (operation) codes which in themselves contain a sequence of microcode. The simple equation example might actually result in the specification of thousands of bits within the deepest part of the machine. Currently there is a move to go to still-higher-level languages. One might consider a software system which would allow programming to be done in the form: Solve[x], ($A = B \sin A$) where the "Solve" command would itself decompose in a series of equations to implement an algorithm such as Newton's iteration. The user would not need to concern himself with the details.

Such a high-level language for audio might allow the user to program reverberation by specifying room size, construction materials, number of people in the room, etc. This kind of higher-level language is nice except for the enormous development effort to write these compilers, interpreters, assemblers, etc. It is not uncommon for a good developmental software tool such as a compiler to take 5 man-years of development. Currently people are working on the Compilers' Compiler. The user would enter the characteristics of the machine and the Compilers' Compiler would create a compiler for, say, FORTRAN. If one then changed the hardware by adding an extra multiplier, the Compilers' Compiler would be re-run and a new FORTRAN compiler would result. The user writing in FORTRAN would not have to change the FORTRAN inputs but the compiler would create a new microcode to run.

This is why the DEC family of PDP-11 computers can, in general, all run the same programs. The hardware is very different but the internal microcode uses the same symbols. A program on an 11 02 will run on an 11 34. The program will not run on a Data General machine. However, since they both have a FORTRAN compiler, the user can generate different code by entering the same equations into the FORTRAN compiler. There is, unfortunately, no such example in audio. Even if it were possible, there is no software which would allow a reverberation program to be generated that would run on an EMI 251 as well as a Lexicon 241. ■

GO AHEAD. STOMP YOUR FEET!

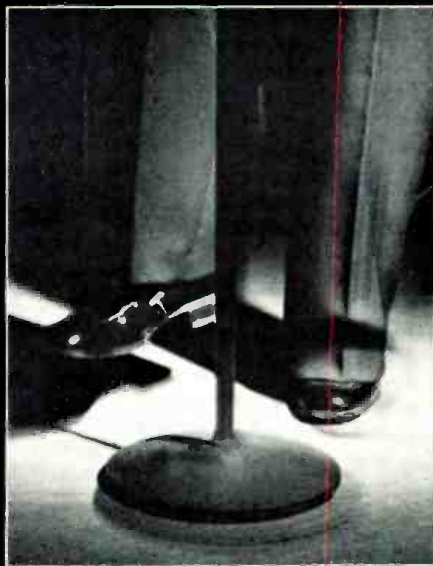

You've got an ATM Instrument Microphone System.

 You're on stage to make music, not noise. But most microphones will respond to everything that hits them. Including noise coming through the mike stand. Except these new ATM microphone systems. Because each of these specially-designed instrument mikes includes a *very* effective shock mount and a windscreen.

Even if you're on a "bouncy" stage, you needn't tiptoe when an ATM microphone system is at work. Distracting noises are reduced... not amplified. Including floor resonances from speakers nearby. Or the clunks when you raise or lower the mike. All the audience hears is your chops.

But a great microphone system is not just a shock mount or a piece of foam. At the heart of our systems are

three superb studio-quality microphones: a unidirectional dynamic, a unidirectional condenser and an omni condenser. Road tough? Of course. But with response specially tailored with uncanny accuracy for instrument reproduction.

With these ATM microphones a trumpet is bright, not strident. Trombone is dark but not murky. Reeds are full but not thick. And drums are crisp and clean, not fuzzy or thumpy. For two important reasons.

First, frequency response is smooth and peak-free and extends well beyond the limits of your instrument. So the balance between overtones and fundamental isn't distorted. And one part of your range isn't favored over another.

Second, and equally important is our wide dynamic range... designed

to capture and amplify all of yours. It's almost impossible to overblow our ATM dynamic, for instance. And our electrets will handle up to 130 dB with ease. So your *fff* crescendo won't come out just *ff*.

Great sound and no distractions. The best possible way to start your sound system working *for* you. ATM Instrument Microphone Systems are waiting for you at leading pro music dealers everywhere. Kick up your heels! AUDIO-TECHNICA U.S., INC., 1221 Commerce Drive, Dept. 11BD, Stow, Ohio 44224. In Canada: Audio Specialists, Inc., Montreal, P.Q.

audio-technica

Great sound right from the start!



Model ATM10SM
Omnidirectional
Fixed-Charge
Condenser



Model ATM11SM
Unidirectional
Fixed-Charge
Condenser



Model ATM21SM
Unidirectional
Moving Coil
Dynamic



All systems include
microphone, stand mount,
shock mount, foam windscreen,
and carrying case.

Circle 32 on Reader Service Card

High-Frequency Horns and Acoustic Lenses—Part II

Figure 1A. Perforated plate acoustic lens.

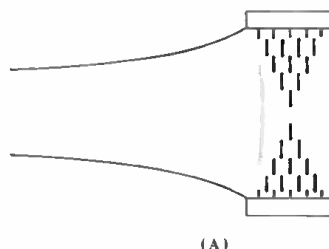

Figure 1B. Slant plate acoustic lens, side view.

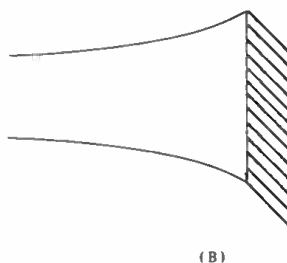
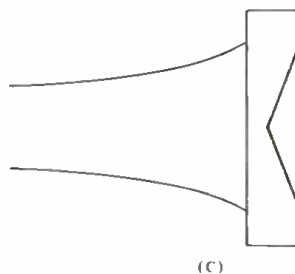

Figure 1C. Slant plate acoustic lens, top view.



• The acoustic lens was described by Kock and Harvey of Bell Telephone Laboratories in the forties. Later studies were undertaken by Frane and Locanthi. There are two basic types of lenses, slant-plate and perforated-plate, and they are shown in FIGURE 1. By either action, there is a shorter path through the center of the lens than its edges. Thus, waves exiting at the center (which are ahead of those exiting at the sides) tend to fan out, offering greater coverage.

The perforated-plate lens is normally circular, producing a symmetrical pattern about the horn's axis. The slant-plate lens will always have distinctly different horizontal and vertical patterns.

FIGURE 2 shows beamwidth data on a typical slant-plate lens. Because there is no lens action in the vertical plane, the coverage pattern of the horn without the lens closely resembles the vertical pattern with the lens in place. Note that the lens provides a near ideal horizontal coverage pattern at high frequencies.

Lenses are manufactured by only a few companies, and they are used most often in music reinforcement or monitoring systems. Since the lens is used as a diverging element, it is not uncommon to see them used in providing wide coverage, typically 90 to 120 degrees in the horizontal plane. Thus, they are best specified for fairly short-throw applica-

tions. In the view of many users, acoustic lenses are "soft-edged"; that is, they do not fall off as rapidly beyond the nominal coverage angles as do other types of horns. Again, this may favor them for musical applications as opposed to speech coverage.

DIFFRACTION HORNS

The diffraction horn has a mouth which is very narrow in one plane and fairly wide in the other. In the plane perpendicular to the small mouth opening, the coverage angle will be quite wide for those frequencies for which the mouth opening is small compared to a wavelength. Above that frequency range,

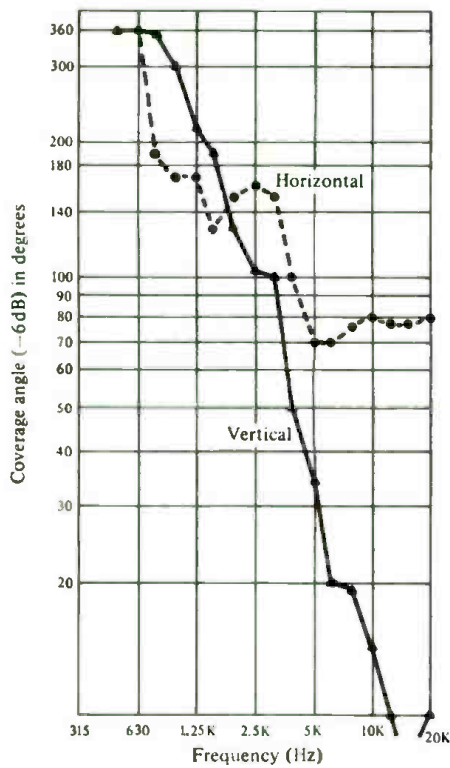
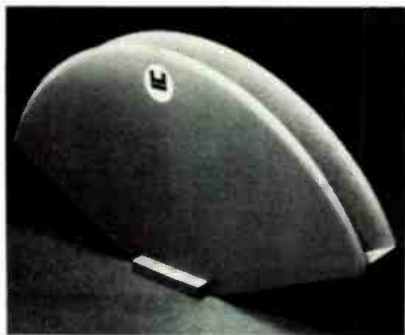

Figure 2. Beamwidth data for a slant plate acoustic lens.



(A)

Figure 3A. A diffraction horn (JBL photo).

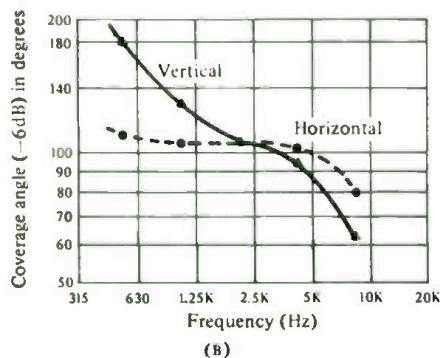

Figure 3B. Beamwidth data for the diffraction horn shown in Figure 3A.

the coverage narrows. Coverage in the other plane may be wide or narrow, as the designer wishes. In the model shown in FIGURE 3A, the horizontal angle is about 130 degrees. Fins located near the throat distribute power, much the same way as in a multicellular horn, helping to keep the high-frequency coverage wide. The typical coverage angles for this horn are shown in FIGURE 3B. As with all other wide-coverage devices, diffraction horns are most useful for music reproduction systems indoors, or in other close quarters where narrow coverage is not desired.

CONSTANT COVERAGE HORNS

Departing from the simple theory of exponential horns, and borrowing from

the practice of wave guide design, several families of constant coverage horns have been designed and introduced during the last six or seven years. While most conventional horns have "nominal" horizontal and vertical coverage angles which they may satisfy only over a fairly narrow band of frequencies, the constant coverage horns maintain their nominal coverage angles over a wide band of frequencies, typically, from the 800 Hz range up to 12.5 kHz and beyond. Presently, such devices are manufactured by Electro-Voice, Altec, JBL and the Ramsa division of Matsushita.

In FIGURE 4, we show the nominal coverage angles versus frequency for the 20-by-40-degree versions of these horns, as manufactured by the four suppliers



With an API totally modular console by Datatronix, you have unlimited flexibility in size and function. Each console is custom designed . . . each component individually selected by you. After all, the choice is yours . . . you design the console to fit your needs today *and* tomorrow. □ For example, you can choose from five different, interchangeable, plug-in EQ modules and an array of input and auxiliary modules—all assembled into a mainframe designed to your requirements. As your needs change, so can the modular components. Plus . . . each console may be prewired for expansion, so that you can easily expand your capability at minimum cost! □ The API console by Datatronix offers you the quality of sound, performance, *and* flexibility you demand as a professional recording engineer. So call us today . . . and remember the choice is yours.

With an API modular console, the choice is yours.

Performance you can count on

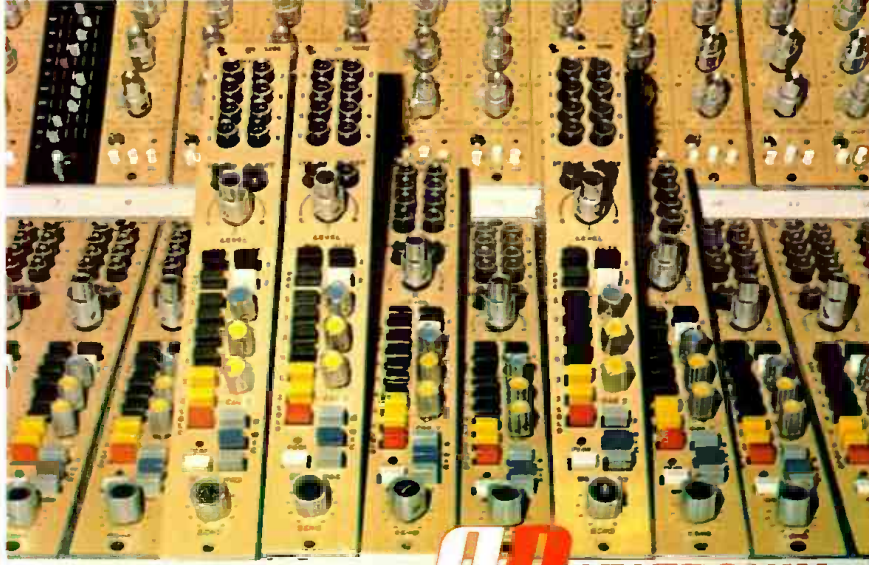



DATATRONIX INC
A subsidiary of ATLANTIC RESEARCH CORPORATION

2100 Reston Ave., Reston, VA 22091 (703) 620-5300 TWX 710 833 0365

Circle 13 on Reader Service Card

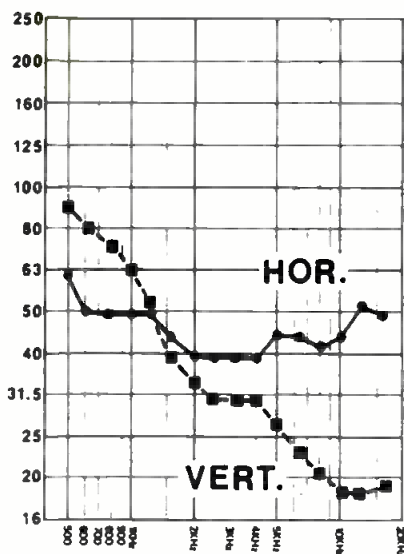

(A) ELECTRO-VOICE DATA

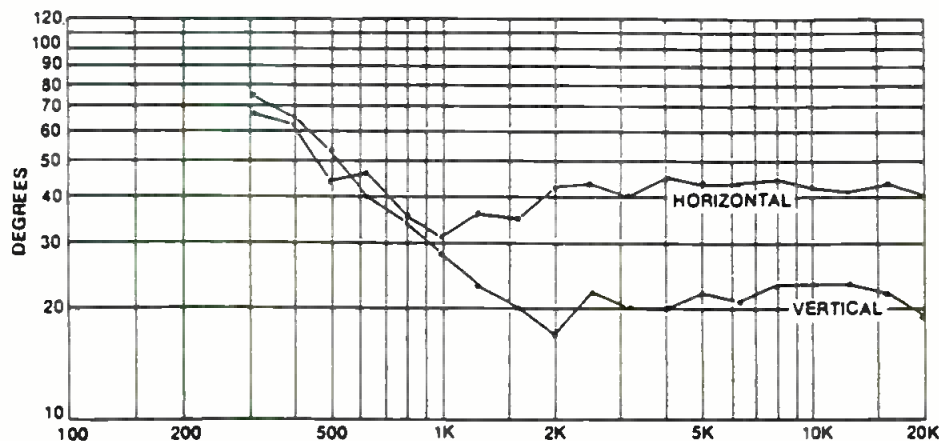

(B) ALTEC DATA

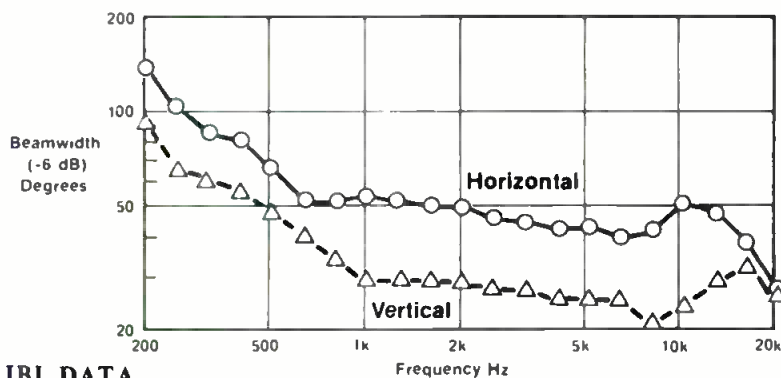

(C) JBL DATA

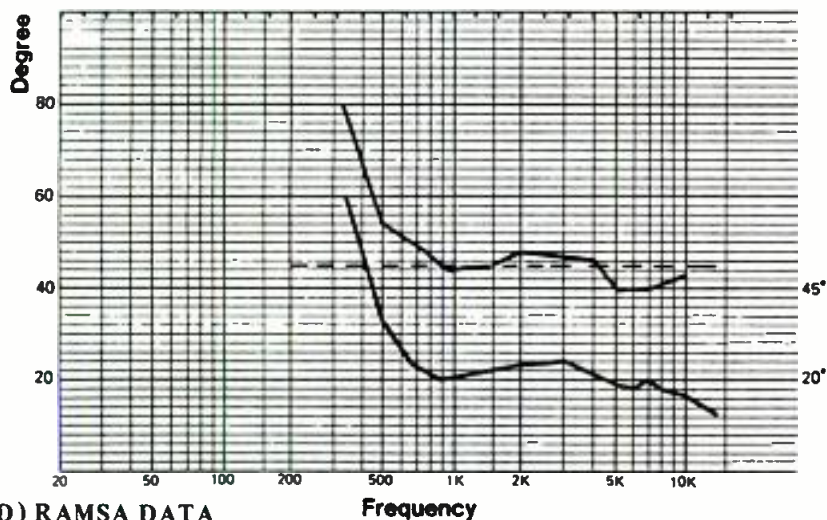

(D) RAMSA DATA

listed above. Note that they all succeed, within relatively broad limits, in doing what they set out to do.

The great virtue of this type of horn is that smooth response may be realized both on- and off-axis. But in order to do this, the power response of the high-frequency driver must be equalized for flat response above about 3 kHz. FIGURE 5A shows the on- and off-axis frequency response for the JBL model 2360 90-by-40-degree constant-coverage horn with a driver so equalized. FIGURE 5B shows what typically happens with a radial horn (in this case a JBL 2350), when the on-axis response is equalized flat. Note that the high end falls off for even small off-axis horizontal angles.

Constant coverage horns have effectively supplanted all other types in high-quality systems for speech and music reinforcement. Only where there are space constraints will a designer favor any of the older devices.

DISTORTION IN HORN SYSTEMS

Over normal operating ranges, the second-harmonic distortion to be expected from a horn system may be found from the equation,

$$HD_2 = 1.73 (f/f_c) \sqrt{I_1} (10^{-2}),$$

where HD_2 = percent 2nd harmonic distortion,
 f = frequency of input signal,
 f_c = horn's nominal cut-off frequency, and
 I_1 = intensity, in watts/m², at the diaphragm/phasing plug interface.

Note that the distortion is proportional to the driving frequency and inversely proportional to the cut-off frequency. Thus, horns with more rapid flare rates (higher cut-off frequencies) will generally produce less distortion than the longer, lower cut-off horns. The moving system of the compression driver itself is rarely a source of distortion, but the intensity, I_1 , at the phasing plug is dependent on the driver. The larger, 10-cm (4-in.) diaphragm drivers have more than four times the slit area at the phasing plug than do the smaller 4.4 cm (1.75-in.) diaphragm devices. Thus, the larger drivers will produce about 6 dB less second-harmonic distortion for a given output level than will the smaller drivers, since second-harmonic distortion is proportional to the square root of the intensity. Further, each doubling of the output level will produce a 3 dB increase in second-harmonic distortion, relative to the fundamental, and raising the input frequency by one octave, keeping all else the same, will raise the second harmonic distortion by 6 dB relative to the fundamental. FIGURE 6 shows a set of on-axis distortion curves for a high-quality 2-way system with a horn high-frequency section. Nominal power input is

Figure 4. Beamwidth data for four 40 degree-by-20 degree constant coverage horns.

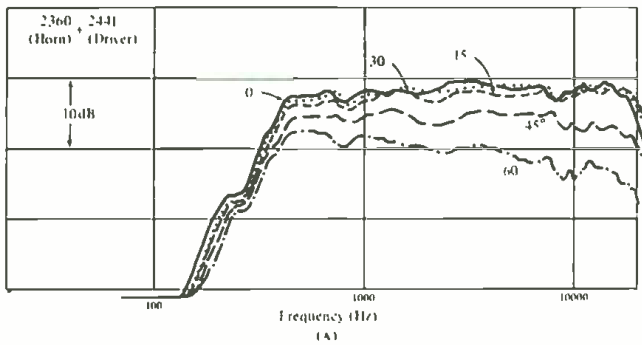

Figure 5A. On-axis and off-axis response of a 90 degree-by-40 degree constant coverage horn with equalized HF driver. (Data courtesy of JBL and D. B. Keele.)

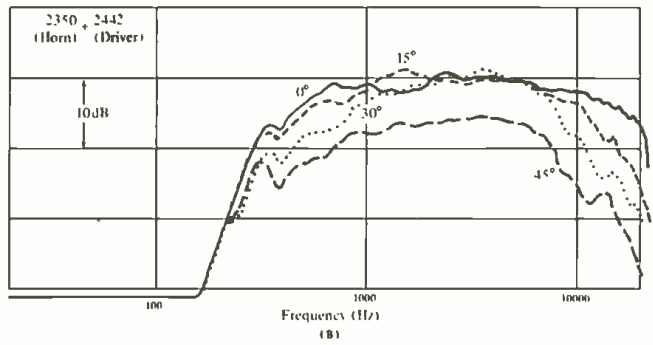

Figure 5B. On-axis and off-axis response of a 90 degree-by-40 degree radial horn.

10 watts, and the cut-off flare of the horn is 350 Hz. The driver has a diaphragm diameter of approximately 5 cm (2-in.), and the loading factor is 10. We calculate the percent second harmonic distortion below:

1. 2.54 cm Plane Wave Tube data: at 10 kHz, 5 mw produces 114 dB-SPL
2. At 10 watts, the level is 33 dB higher, or 147 dB-SPL
3. 147 dB-SPL in a 2.54 cm PWT represents 0.25 acoustical watt
4. Area of phasing plug slits: $(2.54)^2 / 10 \text{ cm}^2$, or $6.45 \times 10^{-4} \text{ m}^2$
5. Therefore, $I_T = (.25) / 6.45 \times 10^{-4} \text{ watts/m}^2$, and $\sqrt{I_T} = 20$
6. Percent 2nd harmonic = $1.73 \times \left(\frac{10,000}{350}\right) \times 20 \times 10^{-3} = 9.9\%$

This figure agrees fairly well with the observed distortion in the neighborhood of 10 kHz of roughly -20 dB relative to the fundamental, or about 10 percent. In this specific example, the slight dip in measured distortion at 10 kHz cannot be explained, but such effects have been observed many times before. We further made the assumption in these distortion calculations that the difference in high-frequency directivity between 10 and 20 kHz was negligible. In any event, the published distortion data on this system is typical of its class.

In general, field distortion measurements are difficult to make, due to ambient noise levels. If such measurements are made, then proper allowance must be made for differences in directivity between a fundamental and its harmonics. Except for the most raucous rock systems, distortion in a well-designed reinforcement system with horn high-frequency components will not normally be a problem, due to the natural high-frequency roll-off of most program material. ■

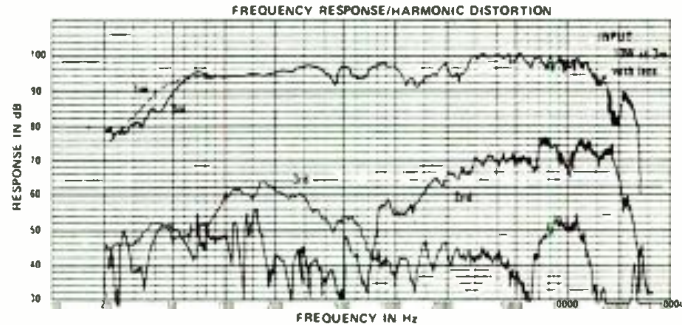

Figure 6. On-axis, 2nd and 3rd harmonic distortion curves for Pioneer LS-1 2-way loudspeaker system.



GORDON HARDY
President & Dean
JORGE MESTER
Music Director
announce



AUDIO-RECORDING INSTITUTE

HAROLD BOXER - Director

Three three-week sessions offering experience in recording live symphony, opera, and chamber music with world-renowned artists.

June 21-August 22, 1982
Aspen, Colorado

"The Aspen Audio-Recording Institute has something no other recording studio-oriented course has—the Aspen Music Festival."
BILLBOARD MAGAZINE

Address all inquiries to: Aspen Music Festival, 1860 Broadway, New York, NY 10023 (212) 581-2196 After June 1st: Box AA, Aspen, Colorado 81612 (303) 925-3254

The Aspen Music School admits students of any race, color, and national or ethnic origin.

Circle 34 on Reader Service Card

QUICK—NAME THE TOP three recording centers in the United States. Did you say Miami, Buffalo and Providence? Probably not. All right, what about the top *ten* centers?

Maybe Miami made it this time, but we'll bet the other two still aren't on your list. It's not surprising of course: most high-speed recording types think in terms of life in the Big Apple, splitting for the coast, or bopping down to Music City. Miami, Buffalo and Providence are places where people come from, and certainly don't go *to*—especially to record.

But, we know at least three studio owners who feel there's something to be said for life outside the big city—especially recording life. As you may suspect by now, this Recording Studio Update issue looks in on studios in—where else? Miami, Buffalo and Providence.

Why? Well, why not? Years ago, the world of recording was a small one, consisting mostly of New York, Los Angeles and Nashville. These were the oases of audio, isolated from each other by a great sonic desert in which there were few sounds—and certainly none of which got recorded. Eventually, the beautiful people grew weary of life in the big city, and set forth to discover Nederland, Morin Heights, Montserrat and other far-away places with strange-sounding names.

Meanwhile, out there in middle America, a potentially profitable clientele was being largely ignored, while the big cities (and some of those far-away places) attracted all the action. Finally, some small-town entrepreneurs

came along who were savvy enough to realize that not every recording act has the time, money and inclination to go to Metropolis every time it needs to record.

Studios—some good ones too—began springing up in small-town markets. (Perhaps we should change that to small-market towns.) More often than not, at least in the beginning, the studio was the only one in town—a concept which a big-apple studio manager can't even begin to comprehend.

However, being the only game in town may be somewhat of a mixed blessing. One more studio opening in Metropolis may go almost unnoticed; one more studio opening in South Succotash means your business could be cut in half—or worse! In other words, you've got to really stay on your toes when you're the number-1-*and*-only.

Sometimes the town grows up. That's certainly happened in Miami, although Mack Emerman's Criteria Studios have more-than kept pace with the sun belt boom. Even in say, Los Angeles, his facility would be a spectacular addition to the local scene.

Buffalo and Providence? OK, so they're not really small towns either, although they're still reasonably far removed from the mainstream of contemporary recording. Maybe neither venue is quite ready for a Megabuck Production Center on every street corner, but both are more than able to support a profitable local recording industry. Certainly there are more such areas around the country, ready to be discovered by a recording pioneer. It's something to think about before moving to Metropolis. JMW



SONEX

FOR CLEAN SOUND

After WLEE installed SONEX, people called about the "clean, new sound!" Was it new equipment?

No. The answer is simple and inexpensive:

SONEX kills all the stray reflections, so the mike processes a clean signal of the announcer's voice. The announcer hears himself in a warm environment, and there's

less clutter to waste watts. The result is a noiseless, clear signal and greater market penetration.

Get the facts today. SONEX is available in five colors, in three thicknesses, and in standard four-ft. square panels. Use it in broadcasting, recording, videotaping or performing areas for really pure, clean sound.

**Alpha
Audio**

2049 West Broad Street
Richmond, Virginia 23220 (804) 358-3852
Acoustic Products for the Audio Industry

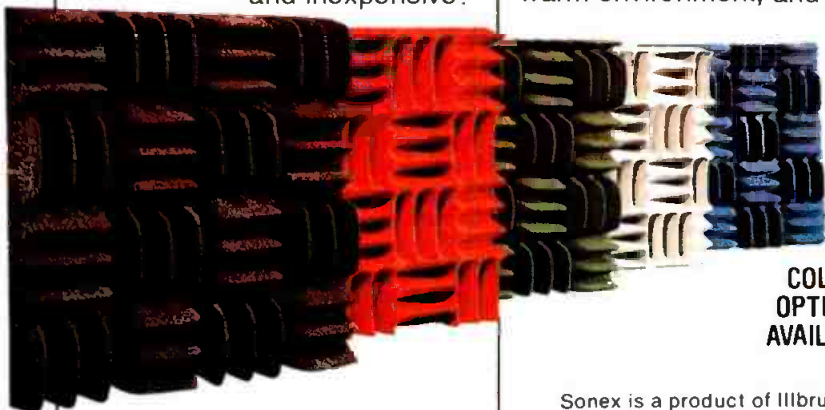

**COLOR
OPTIONS
AVAILABLE**

Sonex is a product of Illbruck/USA

Circle 35 on Reader Service Card

A Regional Studio on the

In existence for just over a year, the new Normandy Sound is making a name for itself on the east coast and elsewhere.



Rise: Normandy Sound

EARLY THIS YEAR, celebrated drummer Billy Cobham traveled to Warren, Rhode Island for a series of recording and mixing sessions at Normandy Sound, Rhode Island's only 24-track recording studio. Cobham, an American currently living in Zurich, Switzerland, had heard good things about Normandy and its co-owner/engineer Phil Greene from Boston-born bass player Timmy Landers and guitarist Mike Stern—musicians whom Cobham greatly respects.

Based on their recommendation, Cobham selected Normandy, site unseen, to record and mix the music for what would eventually become two lps: *Observations*, released in late April to coincide with the group's spring and summer European tour and *Reflections*, scheduled to be in stores this fall in time for the group's stateside tour. Both albums are on Electra Musician, a new label from WEA Records.

"The Normandy environment was highly conducive for the kind of music we play [jazz fusion]," Cobham explained. "We [Landers, Cobham, keyboardist Gil Golstein and guitarist Dean Brown] had plenty of quiet and lots of cooperation. And, of course, there's Phil Greene, a sensible, intelligent guy who knows how to listen and is willing to work with you."

Phil Greene's reputation as a first-rate engineer and producer has grown in direct proportion to the success of Normandy Sound. Beginning with his productions of local hit singles by regional groups in the late 70s, and progressing to label projects for CBS International, Casablanca, Polygram International and JVC Records, Greene and his partners at Normandy have combined creative management with sheer hard work to turn what began as a lark into a thriving regional facility.

POINTS OF ORIGIN

The original Normandy Sound was the brainchild of Robert Shuman, a young Boston law student with a passion for music. While in school, Shuman played guitar and keyboards on weekends with a rock-and-roll band, simultaneously collecting sundry low-level recording equipment for home experimentation.

Living at the time on Normandy Drive in Norwood, Massachusetts, the young lawyer/musician decided to dub his home "Normandy Sound," thereby qualifying the "facility" to receive a wide range of complimentary music and audio-related publications. The year was 1973, and Shuman was on his way to realizing his dream: a small, quality recording setup in his basement sanctuary.

ENTER FREEDMAN

Two years later, Shuman was introduced to Arnold Freedman, a full-time accountant and part-time musician. "Music is the love of my life," Freedman explained. "and I'd always been interested in learning more about the recording process."

Sharing the common bond of music, Freedman and Shuman became quick friends, spending hours in the budding basement studio experimenting with the small 8-track recording console,

limited collection of microphones and other hardware Shuman had acquired with the aide of a small bank loan. To defray some of the expenses, Shuman employed the studio for an introductory recording-technology course which met Saturday mornings for a series of three-hour sessions. The class was an immediate success, attracting local audio buffs and semi-pro musicians interested in learning more about the recording process.

The following year (1976), the enterprising duo purchased an old laundry van which they customized to accommodate Shuman's recording equipment. Thus was born Normandy I, a mobile recording studio. Advertising in nearby Providence papers, and plastering handbills all over town, Freedman and Shuman earned up to \$125 a night recording live performances of rock bands in local clubs and providing them with professional quality demo tapes of the gigs.

Though still not a formal business, "It was a tremendous experience that couldn't help but fuel our enthusiasm," comments Freedman. "Soon after, we outgrew our equipment (as all true audiophiles do) and—unlike the typical audiophile—agreed to look into the possibility of opening a *real* recording studio." Late in 1967, Shuman and Freedman officially became partners and took over an old 3,000 square foot furniture store in Warren, Rhode Island that today is the home of Normandy Sound. Soon after, Phil Greene came aboard.

CONSTRUCTION

Twelve minutes from downtown Providence and smack on the Rhode Island/Massachusetts border, the Warren site is convenient to nearby Newport and Boston, with Block Island, Martha's Vineyard and Nantucket easily reached by ferry or plane.

Besides their outside activities, the Normandy team spent an additional 30-40 hours a week renovating the building, with the help of relatives and friends, most notably Beaver Brown, a six-piece rock and roll band currently managed by Coastline Productions, an off-shoot of Normandy Sound.

"None of us had any specific knowledge of studio construction, and we were all 'Sunday' carpenters," says Freedman. "but Greene knew what he wanted, and in a true family effort, the facility was born."

NORMANDY ARRIVES

Late in the summer of 1976, Normandy Sound, equipped with a Teac/Tascam 8-track machine and an APS1 console, opened its doors to local groups. "Even though we were only an 8-track facility," Freedman recalls, "we worked hard at establishing Normandy as the best studio for local ad agencies to record their jingles, and *the* place in which to cut quality demos."

THE ROAD TO "PERFECTION"

From 1977-79, Normandy continued to update its equipment, going 16-track and then, inevitably, moving to its present automated, transformerless MCI JH 24-track master recorder. In collaboration with recording studio designer Dan Zellman, Greene and Freedman supervised a number of studio transformations each time major equipment was installed.

Mr. Sherman is president of Howard Sherman Public Relations.

Freedman recalls the anxiety of ripping out a wall or ceiling, only to replace it six months later to satisfy the requirements of the new hardware.

Finally, buoyed by the continued flow of repeat business, due in large part to their growing association with Phil Greene, the partners decided to go the limit. In the spring of 1981, designer Zellman was again commissioned to rework Normandy's studio and control room, this time planning and supervising construction of an innovative LEDE-style (Live-End/Dead-End) control room as the major part of his assignment.

LEDE™ CONTROL ROOM

LEDE™'s design (developed by Syn-Aud-Con) employs sound-deadening material at the front end of the room (eliminating abnormality in frequency response, early reflections and cancellation of sound) and live, or hard surfaces, at the back end to enhance stereo definition and create ambience. According to LEDE proponents, the result is a listening environment that eliminates control room acoustics as a source of listening error. This affords the engineer and clients the peace of mind that what they hear in the control room is compatible with what they'll hear in most listening environments.

Freedman believes that LEDE is the truest sounding room available today. "We were particularly impressed with the precise methods of measuring, analyzing, predicting and controlling virtually all sound in the listening environment.

"It made sense to invest in a room that would remain compatible with current and future equipment, one that would provide consistently clean and undistorted sound and reference

well with the 'real' world. Although the room itself is extremely handsome, our real expenditures are behind the fabric and wood. It's loud, if you want it loud, with a minimum of distortion to dramatically reduce listener fatigue.

"Almost everybody in the industry can recall a horror story of a musician's distress with a disappointing recording: 'I loved the sound I heard in the studio; but when I took the copy home and played it, something was missing. It didn't sound the same.'

"This happens in our business far too frequently, but it *can* be avoided. We have a room that offers accuracy and, therefore, peace of mind to the client *and* engineer, staff or visiting."

THE STUDIO AND ITS EQUIPMENT

Normandy's studio room is 1,000 square feet of open space featuring both hard and soft easily-isolated surfaces. Theater curtains can instantly deaden a particular wall or open to expose floor-to-ceiling convex wood, allowing the artist environmental acoustic control. Adjacent to the studio area is a unique 2,000 cubic foot geodesic drum booth. Designed by Dan Zellman, the booth's hard, non-parallel surfaces produce natural, bright sounds which may also be muted with the addition of absorptive hanging baffles.

As one would expect of a first-class recording facility, Normandy Sound boasts an extensive equipment package, including a fully automated MCI JH-636 Console; the aforementioned transformerless MCI JH-24 Master Recorder; a wide range of microphones (Neumann, AKG and Sennheiser, to name a few); UREI, JBL and Altec monitors; a Hammond A-100 Console Organ and a Yamaha Conservatory Grand Piano.

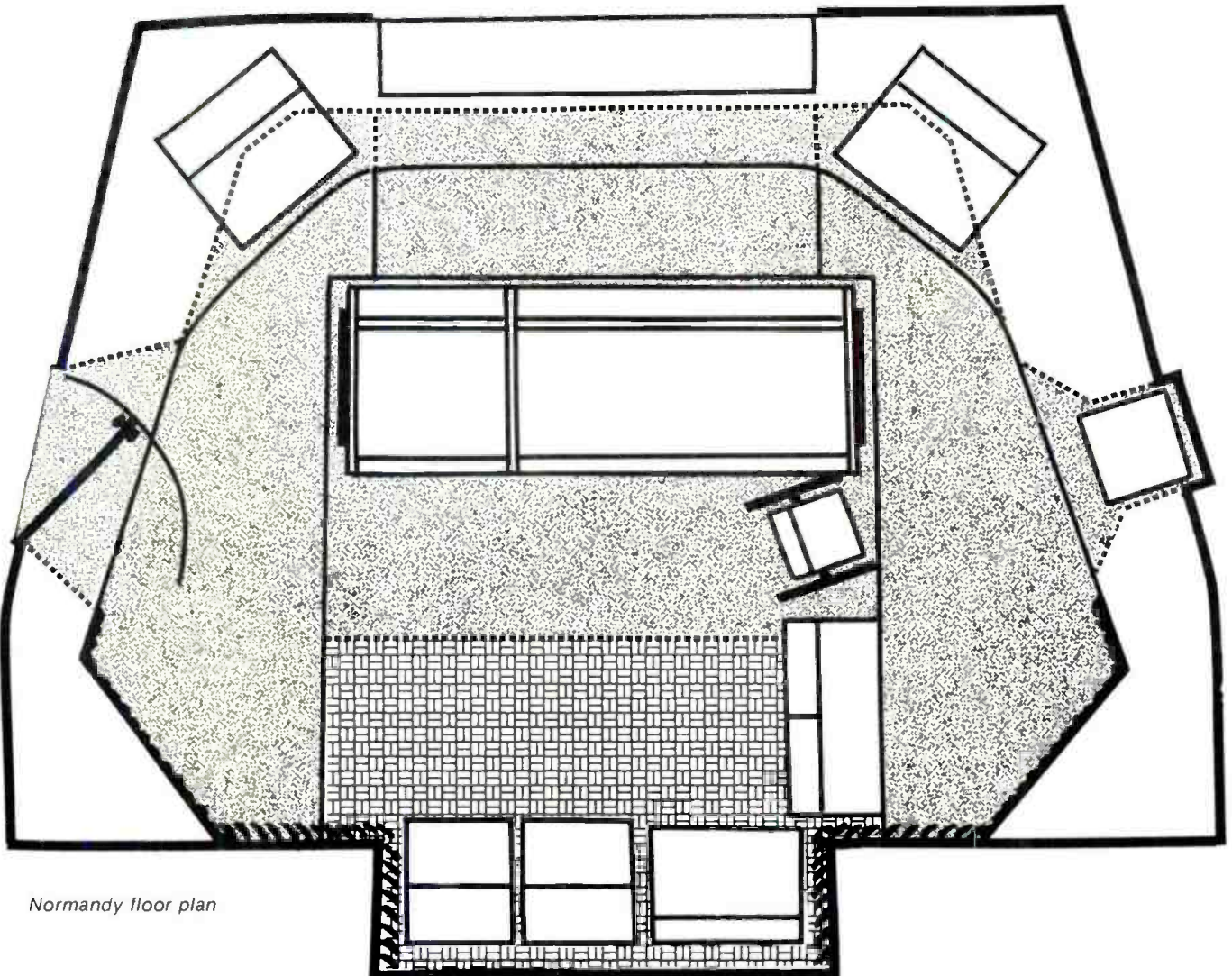

Normandy floor plan



Taking a break at Normandy Sound, are from left to right, drummer Billy Cobham; Normandy principal/engineer Phil Greene, and Timmy Landers on electric guitar.

NORMANDY TAKES OFF

Though the new Normandy Sound has been in operation for less than a year, it's growing reputation has already attracted album projects for some top labels, as well as repeat work from some of New England's major advertising agencies.

"We continue to cut demos for local talent, and also arrange mastering and pressing for many area labels," Freedman states. "And then, of course, we've been making some solid in-roads in the world of jazz and fusion.

"Unlike rock and roll, jazz fusion groups are generally composed of itinerant musicians who move around from group to group and from project to project. Word of mouth is extremely important, as the recent Cobham gig has proven."

BILLY COBHAM

"This was the first time I'd worked in an LEDE room," mentioned Cobham, "and I liked what I heard. In Europe, we travel everywhere by train and spend a lot of time listening to our tapes and discussing them. So by the time we got here, we all agreed on how we wanted our performance to sound. There have been no surprises: at Normandy, we were able to record back to front, and complete 85 percent of all the overdubs in a few days."

Overall, Cobham believes in Normandy Sound. "Lower production costs permit the artist the luxury of spending the time needed to get things right," Cobham concluded. "Normandy can produce top quality sound at a reasonable rate. They're going to be in business for a long time."

AMENITIES

During Cobham's sessions, he and his musicians were housed in guest quarters above the studio. The space comfortably accommodates six and comes complete with kitchen facilities. A lounge with pinball machines and computerized video diversissements is a great way to help musicians unwind, and nearby Providence offers several fine restaurants. Normandy also provides limousine service to and from local airports.

THE FUTURE

Freedman and Greene are optimistic about Normandy Sound's future. Excitement runs high when they consider how far they've come in a relatively short six years. Their management company, Coastline Productions, has signed some promising new talent and is in the process of coordinating bookings and signing a number of record deals. The Cobham/Landers sessions have made lots of noise in the industry, and Freedman is in New York several times a month to court international talent.

To echo Billy Cobham, it seems like Normandy Sound is going to be around for a long time to come. ■

THE CONVERTIBLE.

Omni, cardioid, bi-directional or something in between. Flat or low cut, highly sensitive or with a 12 dB pad. The DC 63 turns into anything you please, but it will always be true to its sources.

MILAB™
PROFESSIONAL MICROPHONES

Manufactured by CTAB, S-265 00 Åstorp, Sweden

BELGIUM Trans European Music 02 569 18 23 · FINLAND Studiotec 90 556 252 · FRANCE MCI France 1 227 25 95 · GERMANY EMT-Franz 07823 1011 · HONG KONG Studer Revox 5-412050 · JAPAN Continental Far East 03 583 8451 · NEW ZEALAND General Video 4-872-574 · NORWAY Pro-Technic 02-460554 · SPAIN Singleton Production 2283800 · SWITZERLAND Audio Bauer 01 64 32 30 · UNITED KINGDOM AVM Audio Video Marketing 0632 893092 · USA west Cara International 213 821 7898 · USA south Swedeks 404 881 9981 · USA east Facel 212 370 0032

Circle 36 on Reader Service Card

**The Performance
a Broadcaster Expects,
The Features and
Reliability He Demands.**



THE NEW OTARI MTR-10 SERIES PRODUCTION RECORDERS

We engineered them to be the ultimate in broadcast production. They embody the innovative technology and the highest reliability that has made us The New Workhorse in audio production.

THE ULTIMATE IN PRODUCTION EFFICIENCY

- Three speeds: 3¾, 7½, 15 or 7½, 15, 30 ips.
- Full, two and four track formats.
- Flexibility in cabinet choice: desk type, overbridge or rack mount for custom installation.
- Full servo, D.C. PLL transport governed by an on-board microprocessor—an industry first.
- ±20% vari-speed with ips or percentage display.
- Built-in, no overshoot return-to-zero with optional 10 memory/one stroke and keyboard access autolocator.
- Internal multi-frequency square/sine wave generator.
- Preset master bias switching.
- Electronically balanced I/O with direct-coupled, high current outputs.
- Automatic reel size sensing with single hand, bi-directional tape rocking.
- Cue control with lifter defeat and controlled wind.
- Dump edit and shuttle edit control.
- Integral, precision splicing block.
- Cue speaker and headphone monitoring.
- Direct access playback head.
- Modular, single card electronics with high slew-rate integrated circuits.

THE ULTIMATE IN ANALOG AUDIO

- Dynamic Range: > 75dB measured from noise floor to 3% THD (30 ips, =226 tape).
- Frequency Response: 0 VU (+4) 35Hz-29kHz, +1.0, -3.0dB @ 30 ips.

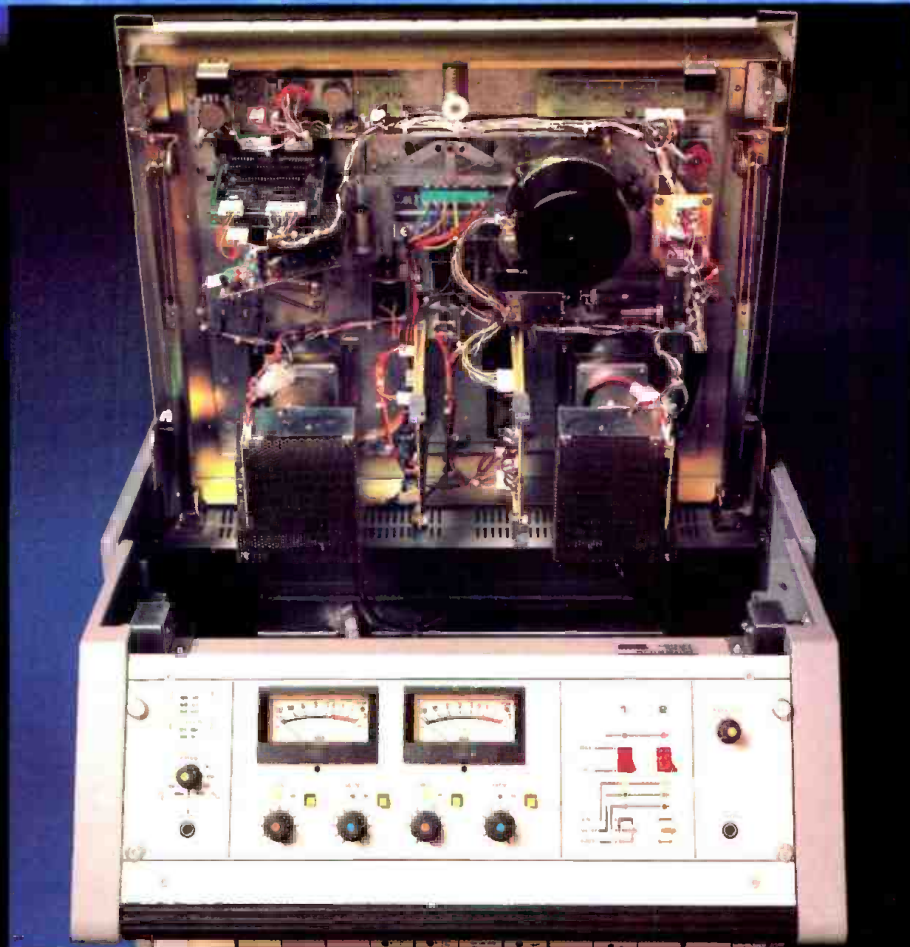
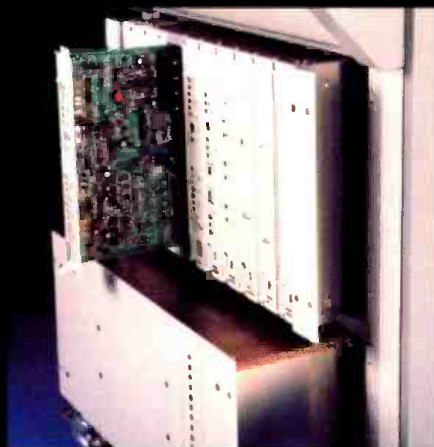

- Wow & Flutter: Less than 0.04%, DIN 45507
- Distortion: Less than 0.1% @ 1kHz, 250nWb/m.
- Maximum Output: +28 dBm.
- Adjustable record phase compensation.

These features and more will allow you to do your job faster while delivering every last dB of performance. It's the productive and efficient solution to the demanding new realities of the contemporary broadcast facility.

ENGINEERED TO BE EASILY SERVICED

Access to all components makes maintenance straightforward. The audio, transport, master CPU and power supply electronics are all of modular, card frame design; the entire transport assembly is top-hinged to allow wide-open access while the deck is in operation.

ENGINEERED TO THE HIGHEST STANDARD OF RELIABILITY

Reliability is paramount in Otari's approach to doing business. We've earned an enviable reputation for quality and value that has made us the

world leader in broadcast automation (Model ARS-1000) and compact production recorders (the 5050 Series). With the new MTR-10, we have successfully bridged the gap between the new technology and reliability.

Evaluate the MTR-10 recorder for yourself by contacting your authorized Otari Series professional audio dealer. It will become evident that Otari is several steps ahead of the competition—again. Audition the performance, features and engineered reliability that will meet the needs of all broadcasters for years to come.

If you're really thinking of buying broadcast precision, there's only one logical decision.

THE NEW WORKHORSE

OTARI

2 Davis Drive
Belmont, California 94002
(415) 592-8311
Telex: 910-376-4890

© 1982, Otari Corp.

Criteria Recording Studios:

Here, author Pohlmann provides us with a detailed look at Criteria Studios' latest addition—a state-of-the-art million dollar-plus new wing.

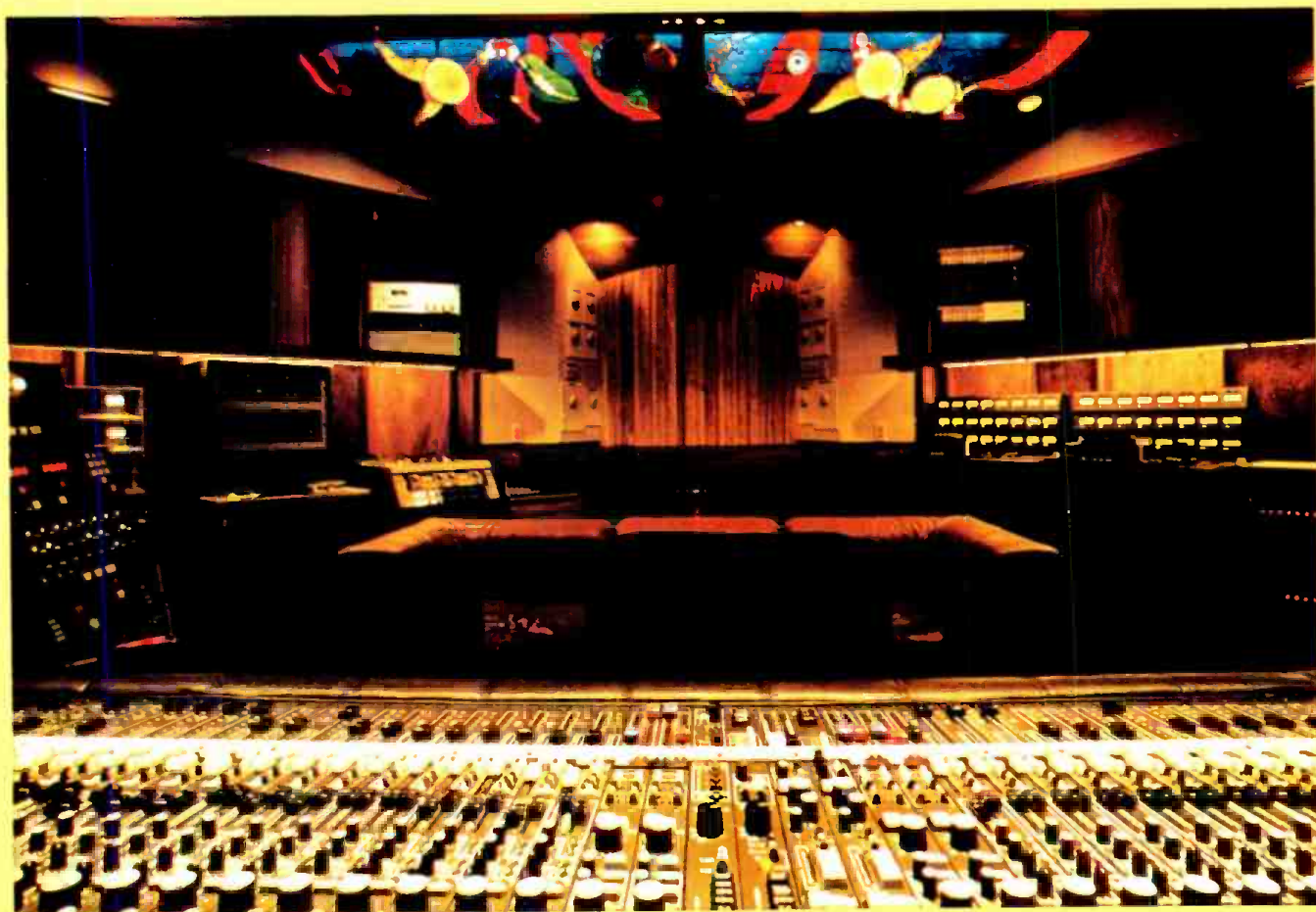

The control room of Studio E.

The New East Wing

IN A TIME OF SUSTAINED uncertainty and ever-encroaching compromise for many studios, Criteria Recording Studios has chosen to emphatically restate its long-held belief that only the best will do. Under the direction of Mack Emerman, Criteria has added a new wing to its recording and post production facilities in North Miami, bringing to five its number of recording rooms. The new two-story addition contains a studio and control room, a cutting room, twin reverberation chambers, as well as amenities such as four private living rooms, lounges, and an atrium complete with waterfall. At a cost of a million dollars-plus, the creation of the east wing is a significant expansion to an already extensive facility and by all accounts from both acousticians and musicians alike, a successful bid to build a flagship studio for the audio industry.

In its twenty-nine year history, Criteria has placed a premium on its own evolution. Through its never-questioned philosophy to pursue the hypothetical status of state-of-the-art, it has always enjoyed a remarkable degree of currency. New studios have been added, and old ones periodically rebuilt acoustically to take advantage of contemporary design innovations and have been re-fitted electronically with a steady supply of MCI's newest equipment—usually before it is offered to the public in general. There has probably never been a time when a construction project or equipment up-date was not under way. Indeed, carpenters and designers are part of the Criteria staff.

In 1979 it was recognized that cumulative advances in technology and acoustical thinking necessitated the con-

struction of a new studio, designed from the ground up. Plans were begun for a room which was to incorporate new acoustical and technical ideas—a summing place for all of Criteria's years of experience and development. John Storyk was called on for the design of the new facility. From the beginning a large building, with complete structural isolation from the existing building, was envisioned. It was to contain a studio and control room, and a cutting room. To house its facilities, the wing was to have two stories, with a total floor area of 8,000 square feet. The original design objective called for large rooms—a large studio able to handle high sound-pressure levels, and a large control room which could accommodate the many people involved in complex production work.

The studio is irregularly shaped and contains two isolation booths, drum platform, and a live area with parquet floor, and a dead carpeted area with low overhead soffits. The dimensions of the completed room border on the enormous. The studio has an interior floor area of approximately two thousand square feet and high ceilings, a feature which is already a Criteria trademark. The studio ceiling rises to twenty-seven feet, providing adequate space for traps, resonators and splays, and then stairsteps down to an eight-foot height. This yields a visible and implied room volume of approximately 40,000 cubic feet. Given the estimation of specific volume needed for satisfactory recordings of 1,000 cubic feet per instrument, the room could hold forty musicians, with specific floor area of fifty square feet per artist. Clearly the studio is amply suited for big bands, which have already recorded there, as well as the high pressure levels of amplified music.

CONTROL ROOM TWINS

The control room is enclosed in a separate shell housed within the rectangular main structure. It is bilaterally sym-

Ken Pohlmann is the assistant director of the Music Engineering Program at the University of Miami and db's newest columnist.



Patchable microphone input panel with digital display of console I/O assignment.

metrical with its own impressive dimensions—a volume of 8,000 cubic feet—making it twice as large as the average control room and as big as some studios. To accommodate that volume the room was designed to be more efficient than is typical, using Criteria-modified IEDE acoustics and an efficient monitoring system—a custom designed three-way bi-amped Ed Long Time-Aligned™ monitor system using TAD and CSI components, with three auxiliary monitor systems available. The control room incorporates nine walls in its design with a large window of over 125 square feet of glass in the front. The acoustic ceiling is an expansion ceiling which slopes upward to a point over the console, then contours downward to the rear wall with sloping cylindrical baffles of alternating fabric and wood. The side walls are faced with fabric and acoustic foam, and the rear wall contains alcoves for audio racks. The control room is equipped with an MCI JH-556/48 automated console with 48 microphone inputs, 96 mix inputs, center group faders, and plasma display PPM and VU meters. The room has 48-track capability using 24-track transformerless machines in conjunction with an MCI JH-45 autolock. Atop the control room on the second story is its duplicate—a cutting control room made in every detail to be a twin to the downstairs room. Identical dimensions, acoustic and monitoring design, decor, even an identical glass window looking not into the studio but instead toward a surreal view offers the supreme advantage of disc mastering in the same environment used for laying tracks and mixing. Adjacent to the cutting control room is an electronically-cleaned lathe room equipped with tandem Scully LS-76 lathes. Ortofon 741 cutter amps drive the 731 and 732 cutter heads. The cutting console contains Sontec MES 430-B equalizers and DRC-200 controllers, four-band parametric automated equalizers, and is custom automated with floppy disk storage for all equalization, limiting, level changes, and special lathe commands for permanent documentation and duplication of cutting parameters. Video monitors display console status information as well as groove pictures. The tape-to-disk transfer is accomplished through an MCI JH-110-B ¼ inch or ½ inch machine. However, tie lines allow for direct-to-disc from any of Criteria's studios, or twenty-four track mix-to-disc from any of the control rooms.

The success of the architectural concept and constructional detail has made the east wing rooms acoustic and aesthetic masterpieces. And the outcome they represent is all the more admirable in the light of the difficulty of the undertaking. In the words of John Storyk, "This was not an easy building to build; they are extremely ambitious rooms. Perhaps the layout was the hardest thing; what with the exceptional height of the studio. Designing its interior geometry was like fitting together a puzzle. Yet the construction, miraculously enough, went according to the plans. The local architect and builders did a good job on a building of great complexity."

CONSTRUCTION

In accordance with the strict south Florida building codes, the east wing is thoroughly hurricane-proof. The exterior walls are reinforced concrete block construction laid on poured concrete footings. Similar solidity is evident everywhere in the structure, providing rigidity and acoustic isolation. Isolation is perhaps the primary concern in a recording studio—the rooms must be free from extraneous sounds—they must be quiet. The emergence of more stringent digital recording standards call for even lower noise criteria. Also, where time and space are money, simultaneous usage of adjoining facilities is an economic necessity. The air and structure-borne transmission of vibrations must be minimized. The solution to that problem is one of mass-per-area, for which one predicts a transmission loss of 6 dB-per-octave. However, a disappointing phenomenon known as wave coincidence occurs when the incident sound wavelength equals the internal blending wavelength of the material and the barrier becomes a secondary resonator with a flat transmission loss plateau for a characteristic frequency bandwidth. The coincidence effect and other phenomena thus dictate that not only mass, but also stiffness and internal damping determine a material's isolation efficiency. Very thick and very heavy homogeneous walls and ceilings are not the only answer—typically compound partitions such as double and triple walls independently constructed from each other provide effective isolation.

The control room ceiling and front wall are typical interior partition constructions. A ten-inch thick poured concrete slab, and a floated five-inch poured slab, isolate the control room from the cutting room overhead. The control room and the studio are built on separate concrete slabs isolated by machine rubber and a triple wall structure partitions them. The control room is roofed by a ten-inch structural slab. The inner ceiling is hung by a ten-inch structural slab. The inner ceiling is hung from isolators and is comprised of two ⅝-inch gypsum board layers. The upper airspace is lined with three inches of R-41 insulation. The perimeter of the ceiling is isolated from the inner wall by a metal channel lined with felt. The floor of the overhead cutting room is designed to minimize both structural-borne and impact noise. It incorporates a five-inch slab of lightweight concrete in 12-by-12 wire mesh reinforced under the inner wall by #4 iron rods. The slab is floated on two 1-inch layers of Owens-Corning type 703 and ½-inch of celotex. The floating layers are surfaced with ½-inch plywood and the entire inner layer structure is sandwiched top and bottom by a 1-mil vapor barrier.

The control room and studio floors are also floated. One-inch high Neoprene isolators are placed at one-foot intervals on the structural slab, and the remaining space is filled with Vermiculite. Two sheets of plywood, ¼- and ½-inch, are laid on top of



Criteria's first state-of-the-art console in 1957, a 3-track tube console.

Introducing the Bose® 402 Loudspeaker.

Now Bose brings the advanced technology of the Articulated Array™ system to a speaker designed specifically for high-quality reinforcement of vocals and acoustic instruments. The 402 Professional Loudspeaker. An affordable and truly portable alternative to the traditional small-group P.A. speaker.

Each 402 enclosure contains four 4½" high-sensitivity drivers mounted on a faceted 3-dimensional baffle. This unique Articulated Array™ system works together with a special Acoustic Diffractor and built-in Directivity Control circuitry to deliver exceptionally uniform room coverage, without the penetrating shrillness of horns or the muffled sound of columns.

Tuned Reactive Radiator slots allow the 402 speaker to produce surprisingly high output levels with low distortion. The matched 402-E Active Equalizer assures smooth, accurate spectral response across the entire operating range of the system. And the TK-4 Transit Kit lets you clamp a pair of 402 speakers (with equalizer) together into a compact unit light enough to carry in one hand!

The 402 Loudspeaker makes it easy for anyone to



obtain the outstanding performance of Bose's Articulated Array™ system. Ask for a live demonstration at your authorized Bose Professional Products dealer.

402 Speaker on SS-4 Speaker Stand.

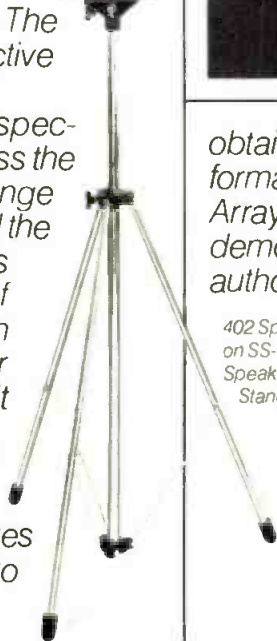

402 System Set in TK-4 Transit Kit.



Bose Corporation, Dept. SE
The Mountain
Framingham, Massachusetts 01701

Please send me the Bose Professional Products Catalog and your technical data.

Name _____

Firm _____

Address _____

City _____

State _____ Zip _____

Telephone () _____

BOSE
Better sound through research.

Covered by patent rights, issued and/or pending.
402 speaker design is a trademark of Bose Corporation.
© Copyright 1982 Bose Corporation.

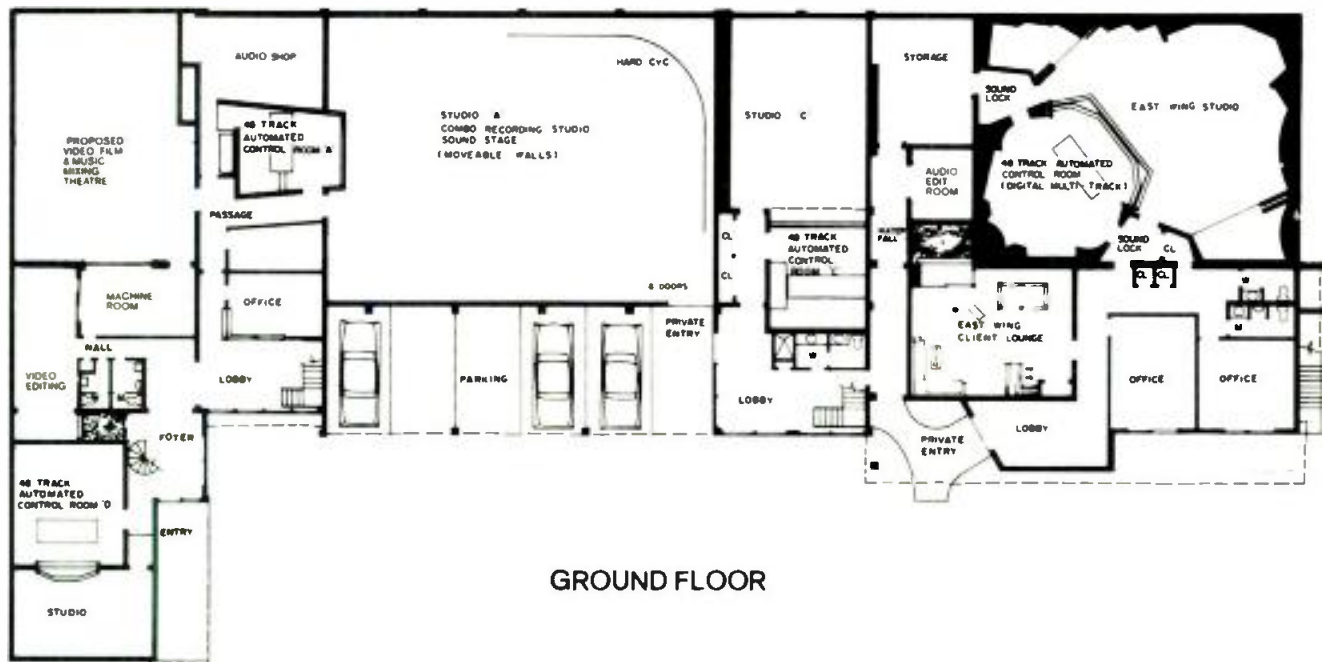

GROUND FLOOR

the isolators in opposite directions. Felt lines the floor perimeters to isolate it from the walls.

The partition separating the second story cutting room and the studio is of triple construction. These walls are built on 2-by-4 studs isolated from the slabs by ¼-inch felt. The inner cutting room wall is floated off the 5-inch concrete slab and consists of two ⅝-inch gypsum boards with a ½-inch sound board between them. They are glued and nailed to 2-by-4 studs and the interior space is stuffed with 3½-inch R-41 insulation. A 1-inch airspace separates the inner wall from the middle wall, which is floated off the 10-inch concrete slab. The middle wall consists of double layers of ⅝-inch gypsum and ½-inch sound boards built on either side of 2 by 4 studs on 12-inch centers stuffed with 3½-inch R-41 insulation. The outer wall is offset from the middle wall by a 1-inch airspace and is identical in construction to the inner wall. However it is bolted to the face of the 10-inch slab and isolated by 1-inch of machine rubber. All joints are caulked to maintain the isolation integrity of the triple wall against airborne transmission.

The lower part of the wall, separating the control room from the studio, is identical to that in the cutting room. The five-sided window uses two panes of laminated glass of differing thicknesses angled at 14 degrees on the control room side and 8 degrees on the studio side. Layers of gypsum and sound board and insulation similar to that used in the walls forms upper mounts for the glass. The two mounts are isolated from each other by a ¼-inch space stuffed with felt. The lower mounts are layers of gypsum board and felt resting on raised portions of the concrete slabs comprising the floor, isolated from each other with machine rubber—with open cavities stuffed with insulation.

The twin reverberation chambers are housed within a concrete block room which is structurally independent from the rest of the building. It contains two concrete slab floors floating on Neoprene and lined with ½-inch machine rubber on the perimeter walls and the gap separating the two chambers. Walls are made of 2-by-4 studs, stuffed with insulation, and faced with ⅝-inch gypsum board and ½ soundboard, and rest on the floating concrete slabs. The walls are carefully caulked and covered with multiple layers of hard plaster. The total volume enclosed in the chamber is 6,000 cubic feet, which is twice that of typical chambers. The volume is achieved with the smallest possible interior surface area to maximize reverberation times, and the fundamental and multiples of the dimensions of any non-parallel but opposing surfaces are made unequal. Careful attention to the rigidity of the surfaces, isolation, proper dimensioning and angling, plastering, and large volume has yielded exceptionally smooth reverberation characteristics for the matched chambers.

ACOUSTICS

Both the studio and control room utilize a diversity of treatment constructions to create a mosaic of reflective and absorptive surfaces providing uniform reverberation response as well as uniformity in the sound pressure field. The reverberation characteristic of a room reveals its temporal absorption and reflection of the sound as the room processes the sound at different rates, as different frequencies occur. Only a totally live room could theoretically offer a totally uniform reverberant sound field. The problem becomes acute in studios where desired reverberation time is usually less than half a second and the resulting need for absorption aggravates nonlinearities in the reverberant response time of the room. Nevertheless, a good approximation of linear reverberation response is an important feature of a good room and it can be achieved by careful treatment techniques. As a general rule, lightweight porous materials absorb high frequencies and lightweight rigid membranes absorb low frequencies. Those absorption characteristics can be tuned and the absorbing bandwidth varied; for example, by increasing the air space behind a panel resonator, its response is more broadband. While it is relatively easy to obtain a uniform response at higher frequencies, it becomes progressively more difficult at low frequencies. Thus, special attention must be paid to low frequency trapping. In addition to reverberation characteristics, spatiality (or distribution of sound pressure levels) plays a major role in the quality of the acoustics of a room. The two are nonlinearly related. For example, a room could have an energy peak at the frequency where reverberation time is the shortest; the two must be considered separately. Fundamentally, every enclosure exhibits resonance frequencies—and that is a fortunate phenomenon because many acoustical musical instruments rely on the predictability of its existence. However in the case of rooms, such standing waves create an uneven low frequency transfer characteristic because of the low density of the resonant low frequencies, and that can lead to problems. Pressure nodes and antinodes, and every pressure in between, establish themselves as stationary properties of the room as a sort of three-dimensional graphic equalizer stretched across the space. Control rooms, because of the inherent need for symmetry in stereo mixing, encourage mode structures and thus are often distribution culprits—the engineer hears something different from the producer because their listening positions are physically different and thus acoustically unequal. The theoretical case of random sound energy flow and uniform sound pressure over the entire volume occurs only in a room perfectly diffuse at all frequencies but, once again, can be approximated by modifying normal room modes with diffusers

and constructing absorbers to handle low frequencies. The design goal is to force every surface to encounter sound from every possible angle to provide mid- and high-frequency diffusion, and to absorb low frequency reflections.

The central part of the studio ceiling where the maximum height is attained uses three primary types of surfaces on an irregularly configured, nine-step staircase. Three angled sections of cypress provide reflection and some scattering; they constitute the smallest ceiling surface area. Three more sections are comprised of fabric stretched over wide openings which lead to a large low-frequency trap inside the ceiling. This volume is hung with baffles of varying sizes constructed from ½-inch soundboard double-faced with 3½ inches of insulation stapled to the board. The boards are hung with wire hangers from the upper isolation ceiling which in turn is covered by 3½ inches of insulation, and is isolated from the structural ceiling. Three more sections consist of stretched fabric. However, they are faced by parallel wood strips laid over open frames. The cypress strips vary from 1 to 3 inches in face width and from ¼ to 2 inches in depth. The separation between strips varies from 1 to 2 inches, and each of the strips has a different face angle—all of which is carefully considered for maximum diffusion. Light coves framed in finished oak are placed in the three fabric sections.

Soffits descending to as low as 8-foot heights are constructed around the perimeter of the studio. Their ceilings are made of stretched fabric which open into extensive traps with hung baffles identical in construction to those above the central ceiling. However, their size is much larger—some are as big as 50 square feet. The total absorptive surface area contributed by the soffit baffles is approximately 750 square feet. The result is to effectively form areas of intimate acoustics within the larger room volume, and in turn aid in its acoustic control. The vertical sides of the soffits are formed of irregularly-shaped sections of cypress, fabric, and wood strip diffusers on fabric. In addition, adjustable cylindrical baffles are mounted on horizontal pivots set into the soffits.

The lower studio walls are faced with a variety of surfaces. Reflection is provided by flat surfaces of pecky cypress, as well as constructions of curved wood and tile. Other surfaces consist of fabric stretched over an inner insulated wall set at a varying depth. Other fabric facings conceal acoustic panels mounted over ¼-inch pegboard, which is backed by 6 inches of insulation. Vertical resonators are constructed on 2 by 4 studs faced with ¾-inch wood of random widths from ½ to 3 inches, backed by a 1-inch duct liner. The studio has carpeting as well as a large teak parquet floor to create more possibilities for live and dead spaces within the room.

The nine-sided control room and its acoustic twin, the

upstairs cutting room, are bilaterally symmetrical to provide a correct bass panorama in the monitors. The engineer is seated close to the geometric center of the room. Because of the potential danger of bass deficiency at that central point, careful attention was given to low frequency absorption—almost 1,500 cubic feet are devoted to bass trapping in the control room ceiling. In addition, a polycylindrical wood resonator is located on the rear wall. As a result, low end response at the console is strong and smooth through the bottom musical octave. Also, bass distribution throughout the room is uniformly excellent.

The control room, and cutting room, also contain a diversity of wood and fabric treatments. The expansion ceiling is made of layers of plywood laid across rigid framing and the expansion ceiling, as well as the entire area surrounding the monitors, is faced with a 4-inch layer of Sonex acoustic foam covered by grillcloth. Hanging baffles, identical to those in the studio ceiling, are located in the cavity above the control room ceiling. The plane surfaces in the near neighborhood of the monitors are carefully angled to minimize unfortunate reflections which would cause coloration, and yet reinforce the pressure levels to more efficiently drive the large room volume. From the point over the console, the ceiling slopes downward to the rear wall with alternating cylindrically curved wood diffusers and fabric traps with acoustic windows leading to additional hanging baffles. The central rear wall, concave in shape, contains a large convex hardwood resonator flanked by fabric traps concealing hung baffles.

The side walls at the room's widest point are faced with acoustic foam and covered by grillcloth, while the rear inward sloping walls contain specially-made alcoves for tape machines and recessed rack space. These units consolidate the clutter of audio equipment and provide more-controlled scattering in the rear of the room. The control room floor is carpeted, except for a centrally located 12- by 12-foot teak parquet floor. The doors to the control room, located on either side wall, are prefaced by sound locks with concrete block walls. An array of monitors are located above the window and are directed to a point one foot behind the engineer's head, at a height of four feet. The monitors subtend an angle of precisely 60 degrees horizontal and 18 degrees vertical from the engineer's chair.

The same kind of careful consideration which achieved the acoustic excellence of the rooms is also evident in the design of its appointments. The studio is equipped with standard and unique features—all designed with the question of ergonomics in mind—with the result that the studio, unlike all too many studios, is a pleasure to work in. The look of studied complex, and meticulous finishing is evident everywhere, and a simple-but-important aspect is the visual layout of the rooms. Eye

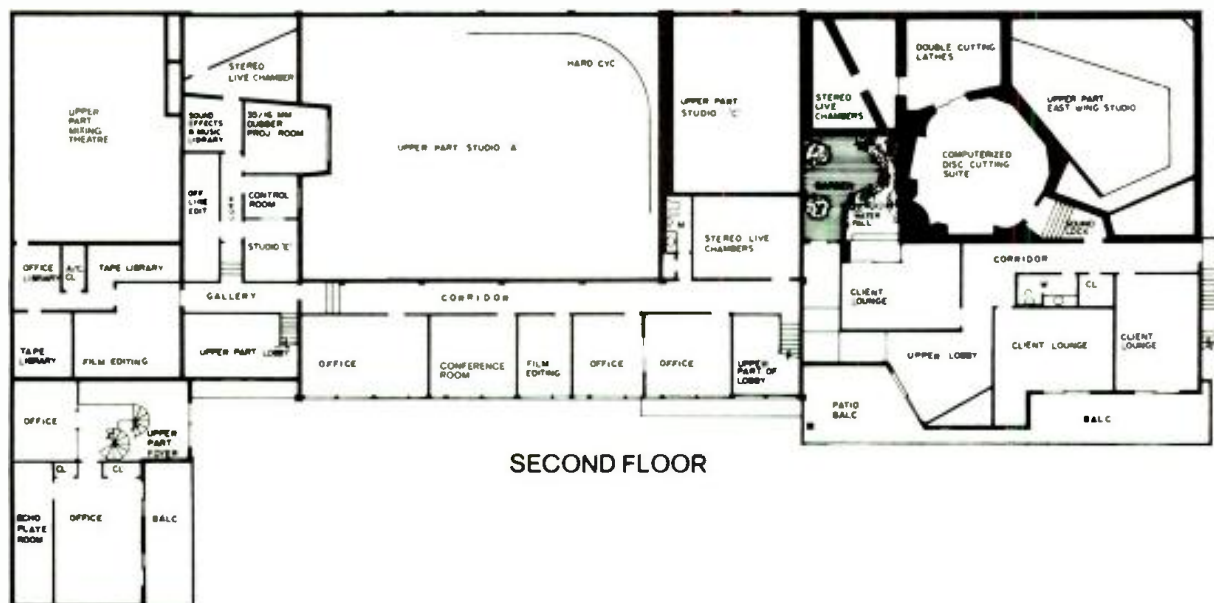

contact from the control room to the drum platform to the isolation booths to the studio as a whole is easily maintained. The window between the control room and the studio is large for that very important functional reason. People like to look, and the extremely large amount of glass encourages that.

The two isolation booths are located at far ends of the studio, yet there is visual contact between them and the rest of the room. Triple sliding glass doors provide isolation and motorized curtain tracks on either side of the doors vary the relative reflection from the glass. Each booth is spacious, with 75 square feet of floor area, one with a carpeted floor and the other with teak. Each contains a variety of absorbers and diffusers as well as traps.

The acoustic and claustrophobic problems associated with most drum booths have been eliminated by using an open drum platform instead. The platform is isolated from the studio floor and is located in the central corner of the studio beneath a soffit 8 feet in height which opens to extensive baffling. The overhead baffling, and the surrounding dead acoustics of that part of the studio, combine to offer most of the advantages of a booth, with none of its disadvantages. Again, visual contact is maintained to the control room, isolation booths, and all other parts of the studio.

A unique feature of the studio is its variable microphone line system. Line groups may be switched between the control room and any of five different input panels in the studio from a master control board located in a sound lock. Each line on the wall panels contains an LED display showing which console input it has been assigned to. All lines appear twice at the switching panel so a console input may be distributed to different studio panel locations simultaneously. The switching is done manually in groups of six lines using Alco connector patch cables. However, programmable assignments will later be incorporated into the system. Typically, microphone inputs are routed to the high-order inputs on the split console, and tape machine returns sent to the low-order inputs to facilitate the recording process—engineer on the right, producer on the left.

Any discussion of room dimensions, architectural isolation, and acoustical treatment must conclude with the bottom line question—one of profit and loss—how do the rooms sound? The new Criteria rooms show a fat profit on that ledger. The studio, control room, and monitoring system achieve an excellent synthesis of precision and transparency. In point of fact, some clients initially dislike the sound—distrusting its sonic appeal. Sometimes it isn't until later, when the mix is auditioned over various loudspeakers, in various rooms, that it becomes apparent that the significantly better sound heard in the control room was real—because not only does the room sound good, but the mix sounds good too. Whereas some rooms sound too good and thus mislead the ears, the Criteria room is objective, with sensitivity in which a knob change on the console, or a microphone placement change in the studio is

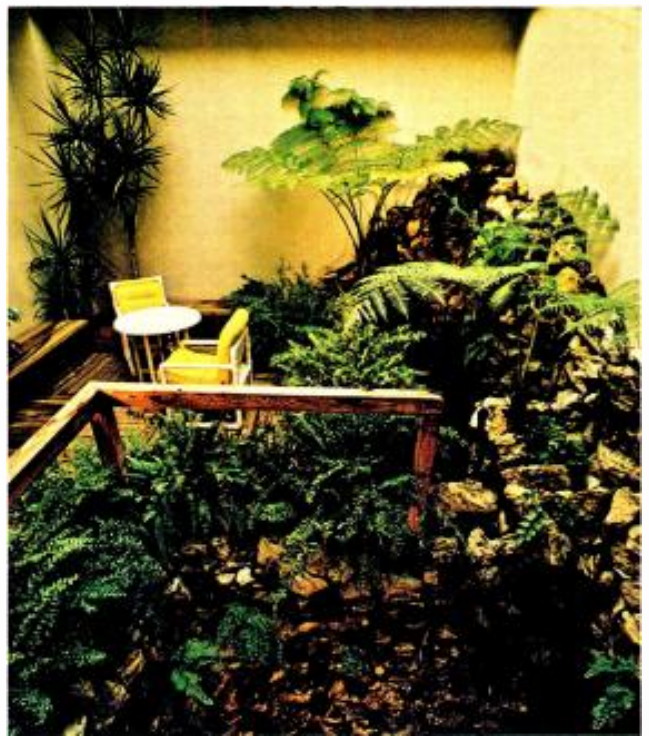

The top floor of Criteria's 2 story stone waterfall surrounded by tropical plants.

readily perceived. That creates a simple advantage: because everything can be heard, the options available to the recording engineer and producer are greatly increased. Thus their work is facilitated, and the resulting mix is better.

CONCLUSION

The desire to build an honest room was probably the underlying motivation for the entire project. As Mack Emerman states, "Ever since we started, Jeep (Harned) and I dreamed about open, transparent sound that would eliminate the hype and deception once and for all. We wanted an entire studio electronically and acoustically to sound as transparent as possible, with the kind of accuracy later achieved with electrostatic loudspeakers." Whether any recording studio can ever find that ideal is a matter for philosophic debate, but the innovations incorporated in the new Criteria rooms have provided them with an acoustic environment which is significantly better than that encountered in most facilities. The sound is uncolored, dispersion is excellent, there is a lack of fatigue, there is no boosted bottom end and no bottom end mud. There was no need to electrically tune the control room monitors. As constructed, the room achieves quantitative results remarkably close to Ed Long's free-field measurements. The new studio closely approaches its designed ideal of transparent, honest sound.

There is no reasonable way to summarize a description of a studio complex such as the Criteria East Wing in which the design and construction pooled the combined expertise of acousticians, architects, engineers and builders in a project which required three years and a million dollars to complete. No words or photographs can hope to convey the minor miracle which this studio represents, and that is perhaps rightful because no matter how well designed a studio is, no matter how impressive its finished forms appear, a studio's ultimate achievement is to be an anonymous, unheard component in the recording chain. There is only the recorded music which it creates—through which it documents its success in simply being a place where musicians can give their best performance. ■



Criteria's first custom-made 4-track console designed for Criteria by Jeep Harned of MCI.

The Altec Lansing 9813 High Accuracy Recording Monitor. The truth never sounded so good.



Loudspeaker accuracy. It's a highly controversial subject. And for good reason. The most prized result of a recording session is an accurate sonic illustration of what is going on in the heads of the producer, musicians, arrangers, and composers. Recording is a process of fusion, and the monitor is responsible for an accurate painting of the completed sonic picture.

Enter our new 9813. We developed it to play its highly critical part in the fusion process with great accuracy. We did it by putting nearly half a century of audio alchemy into it.

The 9813 has an all new high-frequency compression driver that uses our famous Tangerine® radial phase plug.



There's a brand new network design the patent office is already looking at, and the smooth, accurate highs are controlled by an asymmetrical Manta-ray® horn.

The 9813 handles power like no small monitor you've ever experienced. It takes on big amplifiers as though it were addicted to watts. And if you should push it to the limit, there's a built-in system we call automatic power control, which *lowers the power* (never shuts the speaker completely off) and lights a red indicator on the front panel at the same time.

The new 9813 does everything

a great monitor should: It sounds super (accuracy need not be unpleasant), handles power extremely well, mids and highs adjust through very wide amplitude ranges, and its great-looking hand-rubbed oak cabinet is small enough for even mobile recording vans (25½ H x 15½ W x 13½ D).

Next time you're visiting your favorite pro audio dealer, ask to hear the new 9813. What you'll hear will be the honest truth.



Altec Lansing International
1515 South Manchester
Anaheim, California 92803

The Construction of

Select Sound's President and GM team up to share their story of the troubles and joys encountered in turning their studio into Buffalo's only 24-tracker.



Studio A's control room.

Select Sound Studio

SELECT SOUND STUDIO was born in the basement of a Tonawanda, New York home in 1974. Tonawanda is a residential area located just north of the city of Buffalo. Our basement studio was typical of many which have recently become quite popular among musicians. The studio area consisted of insulated walls covered with ported sound board and curtains. We used a very standard acoustically tiled ceiling with a carpeted floor. Despite the cramped quarters, we did find just enough space for a windowed drum booth, which afforded us enough isolation to cut some surprisingly clean tracks. Our control room, housing our Scully 280 8-track and Stevenson-Interface console, had paneled walls with ceiling trapping concealed beneath a grille cloth finish.

The basement studio's income was based mainly on group demos. However, in 1977 we did a series of demonstration tapes for Moog Synthesizers which were distributed world-wide. Business continued to boom and the basement studio could no longer handle the load, both from a technical as well as a professional standpoint. Our growing pains necessitated a move which culminated in our opening a larger studio with additional office space in a commercial building in Kenmore, also a suburb of Buffalo.

*Bill Kothen is the president of Select Sound Studio.
Dick Bauerle is the general manager of Select
Sound Studio.*

This upgrading brought us in contact with Carl Yanchar, president of Lakeside Associates (then vice-president of Sierra Audio), who upon hearing of our move, flew in to town to see if we required design assistance. Unfortunately, our need to re-open quickly coupled with budget restrictions killed the notion of a world-class design at that time.

Therefore, we designed and built our Kenmore Studio with its 15-ft. x 18-ft. control room and 25-ft. x 27-ft. studio. What it lacked in acoustical perfection was made up for by the comfort and intimacy afforded to the client. Our business continued to grow and in the fall of 1979 we expanded from 8 track to our current 24 track format, purchasing a new MCI JH-114-24 track, JH-110-2 track, and Syncon Series A 28 x 28 console, along with some miscellaneous signal processing equipment. After a year and a half of being Buffalo's only 24 track studio, we found ourselves in a very familiar situation. Once again we had outgrown the physical and technical confines of our working environment and it was time for the ultimate move.

CHOOSING A SITE

Much has been written about the traumas that recording people have gone through while trying to find the "perfect" location to build a state-of-the-art studio. After extensive investigation, with many disappointments, we failed to find the perfect shell for a studio. When we were ready to give up and resign ourselves to our present location, our new site, more or



The gutted shell as seen facing the future site of the control room.

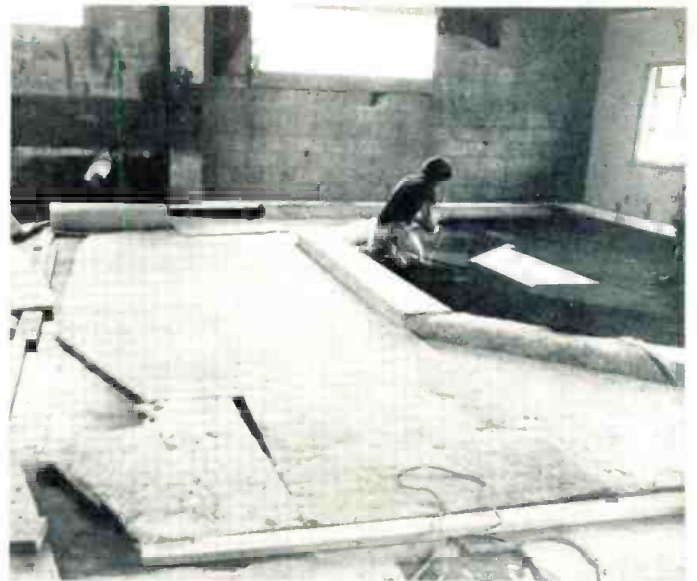

Constructing the isolation pad and wire troughs for the floated control room floor.

less, found *us!* While returning from lunch one day we saw a building with a "For Sale" sign out front. Just because of the size of it, we thought it merited looking into. Our hunch was correct. One half of the building was devoted to office space, more in fact, than we felt we really needed, while the other half was a Godsend; the "perfect" shell for a studio: cinder block walls, a pre-existing 7-in. concrete slab, and a 16-ft. ceiling height. There were still some modifications we would have to contend with such as some demolition and the blocking in of some windows and a garage door, but the overall size of the potential studio (32 x 57), presented a very appealing possibility. Still another attractive aspect of this Elmwood Avenue site was that it was only a five minute walk from our Kenmore Avenue location (this convenience, once construction began, cannot be understated)!! At any rate, purchase arrangements were made and our new location was officially procured in November 1980.

DESIGN DECISIONS

Now that we had the perfect shell, the question that presented itself was how to build the perfect studio. This is a question that occupied our thoughts for months after picking up our building keys. Influenced by an article in *db* Magazine (July 1979) written by Michael S. Dilley of Producers Studio in Eugene, Oregon, our initial thoughts centered on designing our own studio, since our two previous efforts had been so successful. However, a trip to New York and subsequent visits to studios such as Sound Mixers and Soul Sound, quickly showed us the

importance of a professional, world class design. After all, Rick James and Spyro Gyra, both with strong Buffalo roots, proved to us that Buffalo's musicians were finally being recognized throughout the world and the city's multi-faceted talents were ready, willing, and able to support a world class facility.

With this goal in mind, we contacted most of the "name" studio designers, and received varying responses. We received some interesting proposals, but felt that the designs that we really liked were over-priced. In addition, the designers seemed unwilling to give us the kind of personalized attention and reassurance that any customer likes to receive. We became a little discouraged, to say the least. However, our final investigative phase put us back in touch with Carl Yanchar, who had left Sierra Audio and started his own design company, Lakeside Associates, along with Steve Fouce, another former Sierra employee. Carl's conception of a possible studio contained the magic that the other proposals lacked. Carl's package also was cost-effective and he did not object to the fact that we planned to build this new studio with our own labor force, instead of his own turnkey crew that's usually required to build a studio of this detail. Our entire staff viewed the prospectus and the opinion was unanimous—Lakeside would design our new room.

Carl flew into Buffalo in June, 1981, to inspect the site and to further confirm our choice of a new location as a good one. During Carl's first visit he patiently answered all of our questions, and thoroughly examined the studio area in order to gather the information needed to do the design. The personal



The concrete for the floated control room floor.



Facing the control room during framing and isolation stages.

Floor plan of Select Sound Studio.

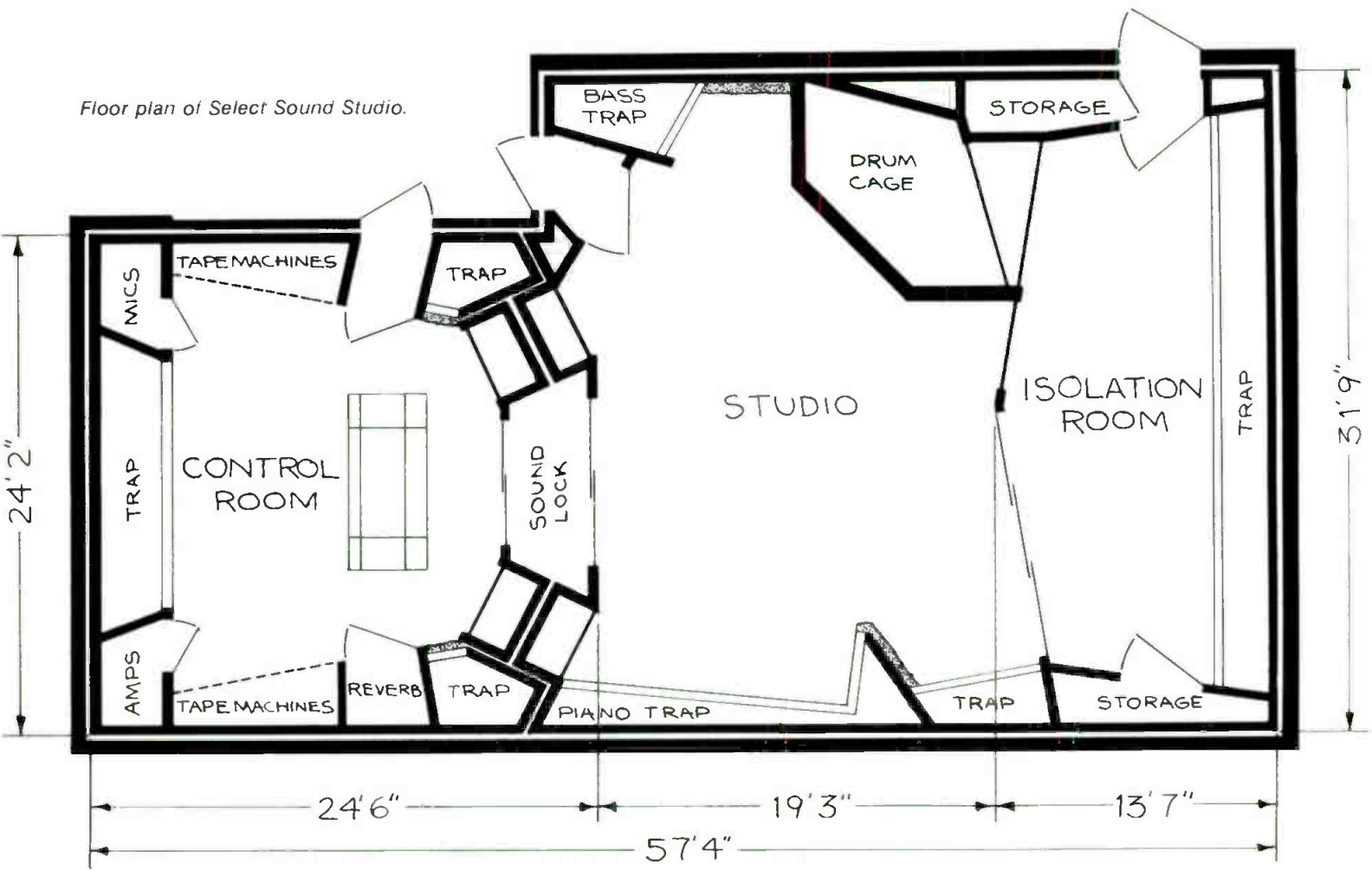

touch that we had desired had now been established (this would prove vital as our construction reached certain critical stages) and the initial prints arrived a mere 10 days from Carl's visit.

CONSTRUCTION

While waiting for the plans, the shell was gutted. Five dumptrucks and a thirty-yard dumpster later, the room was ready for construction.

When the plans arrived, we found them to be very extensive, leaving nothing undescribed, except for some of the decor decisions. Material lists were sent to various local suppliers for quotes while we studied the plans.

The first thing to be constructed was the control room floor. The floor consists of 2 layers of 1/2-in. sound board separated by 1-in. insulation. The isolation pad was then blanketed by a 6 mil vapor barrier and topped with 7-ins. of concrete. The floor has a maze of wire troughs built in the slab. These troughs were made



The studio under construction as viewed from the isolation room.

**Get Aligned
Stay Aligned
with STL precision
magnetic test tapes**

These dependable tapes are used by broadcasters, recording studios, equipment manufacturers, governments and educators throughout the world. Widest variety...Alignment, Sweep, Pink Noise, Level Set, Azimuth and Flutter/Speed. Available on reels, in cartridges and in cassettes. Also, the Standard Tape Manual & the Magnetic Tape Reproducer Calibrator.

Phone for fast delivery or free catalog.



STANDARD TAPE LABORATORY, INC.

26120 EDEN LANDING ROAD #5, HAYWARD, CALIFORNIA 94545 • (415) 786-3546

db May 1982

43

Circle 33 on Reader Service Card

from 1/2-in. plywood and have openings in two of the three control room closets and two tape machine soffits. No wires, other than console patch cords, are seen in the new room. This made equipment interfacing very efficient for Joe Puma, the studio technician.

After letting the floor cure for the weekend, we were ready to complete the initial isolation stages. All existing windows and unnecessary door-openings were enclosed with 8-in. concrete block. A block wall was also built between the control room and the reception area so that Peggy Kothen, Select Sound's receptionist, would not hear any sound leakage from production.

The wall construction consists of hemlock fir 2 x 4 studs, 16-ins. off center. The isolation ceiling is made up of Douglas fir 2 x 12 joists placed 12-ins. off center. It should be noted that only the highest quality lumber was used throughout our project in order to avoid any future problems such as warping or other problems caused by lower grade timbers. All studs and plates were glued and nailed. The plates rest on sound board to maximize vibration isolation. Ceilings and walls do not touch the existing structure. The wall plates rest on 1/2-in. sound



Interfacing during the finishing stages of the control room.

board, isolating the walls from the floor. In fact, the control room and studio do not touch each other at any point and are connected only for cosmetic purposes with grille cloth.

ELECTRICAL

After the isolation framing was finished, the basic electrical circuits were installed. Shielded 12-gauge cable was used to eliminate electrical interference. Cables were siliconed at each stud to eliminate the chance of rattles and there is a separate circuit for each main piece of equipment.

Recessed lighting is used in the control room, drum cage and closets. Lumilines, and incandescent tube light, provide diffused lighting for the tape machine soffits. Track lighting is used throughout the rest of the studio.

Completing the isolation was next. All hollow wall cavities were filled with 3 1/2-in. fiberglass insulation and the ceiling with two layers of 6-in. insulation. Framework was then faced with 1/2-in. sound board then 1/2-in. sheetrock. All of the layers were glued and nailed. The seams were overlapped and caulked. Wherever there were hardwoods, a fourth layer of chipboard would be added totaling 5 1/2-in. layers.

Chipboard was also added to the ceiling in order that sound absorbers had rigid anchor points from which to hang.

HEATING, VENTILATION AND AIR CONDITIONING SYSTEMS

The HVAC Systems were installed between isolation stages and acoustical treatment.



The studio under construction as viewed from the bass cage.

Our facilities required two systems; a 2 1/2 ton air conditioning unit for the control room which is cooled all year round, and a 3 1/2 ton heating and air conditioning system for the studio. Both systems have economizers to take advantage of the outside air when it is cold enough to cool the production areas.

The air conditioners rest on spring vibration isolators to stop the transmission of low frequencies into the studio. To stop airborne transmissions, the ducts are insulated and have a minimum of four 90 degree bends for sound attenuation. 16-in. diameter ducts were used to prevent noise caused by a high velocity, yet maintain a reasonable rate of cubic feet per minute. To keep the control room fresh and very comfortable, the system recirculates the air at 1000 cubic feet per minute.

Air-returns are strategically located by the tape machine soffits and amplifier rooms to exhaust equipment-heat out of the control room.

ACOUSTICAL TRAPPING

All of our control room traps are lined with 1-in. insulation and the trap cavities are consumed by absorbers.

We were especially careful with this aspect of the project, since room-symmetry and accurate trapping will yield the required acoustics.

MONITOR SYSTEMS

Monitor selection is as important as the design itself, so it was important to evaluate many speakers. After auditioning several systems, the Lakeside Monitors were chosen.

The monitors were designed by Carl. They consist of speaker-boxes made from 1-in. plywood with solid oak horns.



Carl (left), Bill (foreground) and Dick (right) discuss interfacing.



Select Sound's staff: from left to right—Bob Napieralski, Dick Bauerle, Nick Kothen, Peggy Kothen, Bill Kothen, Joe Puma and Frank Cascino.

These boxes were fastened into wall cavities lined with ½-in. Neoprene. Each monitor has two 15-in. low frequency drivers and a high frequency compression driver.

A column of rock is adjacent to the monitors to enhance high frequency dispersion.

Powering the system we have a Crown PSA-2 for the low end and a DC-300 for the highs. Equalizing the room are two White 4001s with the 800 Hz crossover cards.

Audio cables were installed after most of the isolation was finished, because they run through the trap walls. We are presently using 28 mic lines. However, we have incorporated systems for future equipment. For instance, 40 mic jacks are duplicated at three different room locations, along with

auxiliary mic jacks in the control room, sound locks and lounge.

Microphones are hidden in ceiling traps to improve communications. Also in the ceiling traps are stereo speakers which are placed throughout the studio for talkback and playbacks. Six selectable headphone cues are still another feature of our new facility.

SUMMARY

We are extremely proud of our new studio and all of the features that Carl has incorporated. We are equally pleased that our initial plan of building it with a local labor force has worked. It should also be mentioned that building a studio in this manner is not recommended for everyone. There can be problems. For example, three different construction crews were auditioned during certain non-critical stages of the construction before we found the crew which met our requirements. Not only is our crew of carpenters, electricians, and masons highly skilled, but also possess a great deal of pride and conscientiousness which they have applied to our project.

Our full-time staff also helped out by assuming many carpentry tasks which kept our momentum alive during the tedious layering process. Construction progress was expedited by Frank Cascino, project-coordinator, and Bob Napieralski, supply-procurer.

Another major aid in bringing the construction to a successful conclusion were the occasional visits by Carl and many, many telephone calls to Los Angeles during certain crucial phases. These calls helped us constantly maintain the rigid specifications required in carrying out the design to the last detail.

The obvious benefit of having built the new studio ourselves is the amount of money we were able to save in labor. Although this method takes a bit longer as opposed to a turnkey crew, the workmanship and precision we have achieved have made any delays well worth the wait. ■

TELEX
AUDIOCOM
For Communications Behind The Scene

AUDIOCOM. The closed circuit intercom for small, large, portable or fixed installations at concerts, stage productions, film or TV studios, stadiums or race tracks, industrial or public safety applications. AUDIOCOM belt packs or wall mount stations can be "daisy-chained" by the dozens over five miles without degradation in signal quality or strength. AUDIOCOM interfaces with other sound systems and telephone circuits. AUDIOCOM includes headsets, mics, cables, switchboards, signalling kits, even battery packs for remote locations; the complete intercom system for communications behind the scene.

Quality products for the audio professional.

TELEX
 TELEX COMMUNICATIONS, INC
 9600 Aldrich Ave. So. Minneapolis, MN 55420 U.S.A.
 Europe 22, rue de la Légion-d'Honneur, 93200 St. Denis, France

The Sony PCM-3324

The following article offers a step-by-step look at the PCM-3324 digital recording system.

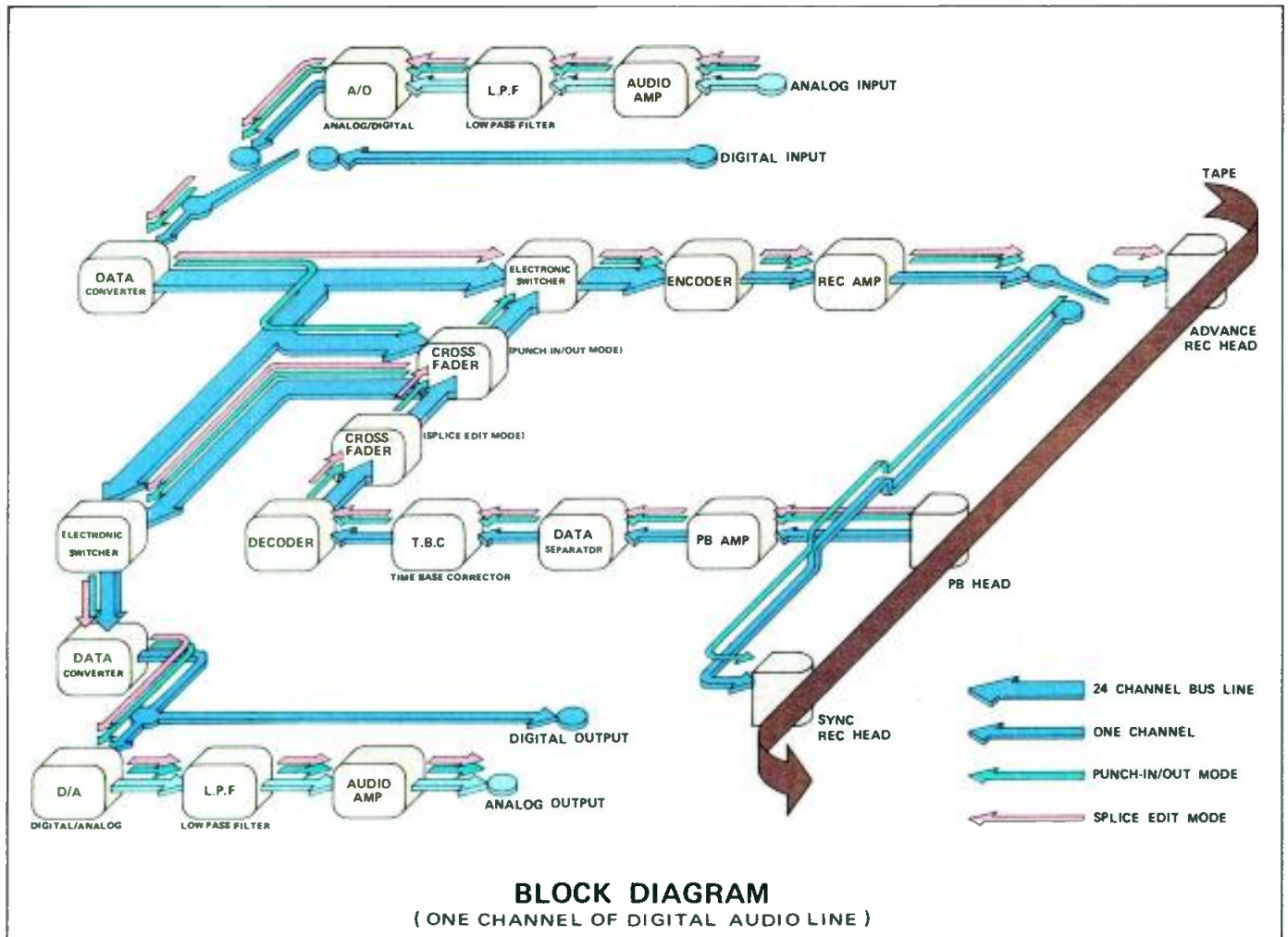

Figure 1. Block diagram of the PCM-3324 record/play-back system.

Digital Recording System



The Sony PCM-3324 digital audio multi-channel recorder.

SONY HAS BEEN ACTIVE in digital audio technology for more than ten years, and has recently expanded its professional product line to include the PCM-3324 Digital Multi-track Tape Recorder. The new recorder provides the standard features of conventional multi-

track recorders (such as splice editing) as well as many new features that only a digital system is capable of providing.

A block diagram of the PCM-3324's record/playback system is given in FIGURE 1. Note that there are two digital record heads and one digital playback head. The ADVANCE RECORD HEAD is used for most recording purposes, thus allowing tape monitoring from the playback head in the conventional manner. However, for sync recording, including punch-in/-out, the SYNC RECORD HEAD (located *after* the playback head) is used.

Curtis Chan is the National engineering manager of the Sony Professional Audio, Digital Audio division.

PUNCH-IN/PUNCH-OUT RECORDING

FIGURE 2 is a much-simplified block diagram, omitting many details in order to better illustrate the two recording modes. The heavy solid line indicates the signal path for conventional recording. The dashed lines indicate the signal path for sync recording. At the moment of the punch-in, the crossfader inserts a crossfade (1.33-341 ms at 48 kHz sampling rate) between the old (playback head) signal and the new (input) signal. There is a suitable delay in entering the record mode, until the signal at the playback head reaches the record head. At the encoder block, the signal to be recorded is also delayed so that it is recorded in-sync with any material previously recorded on the tape.

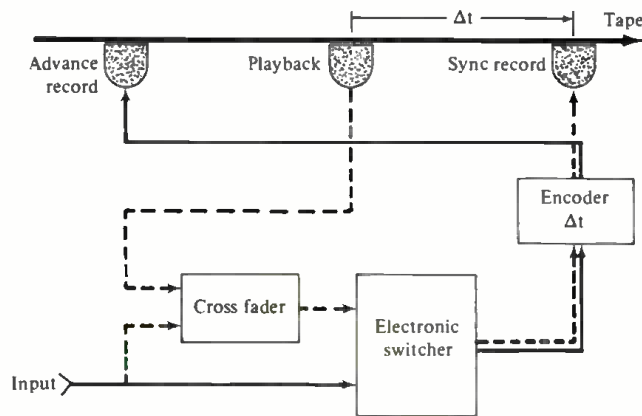

Figure 2. Simplified block diagram. The heavy solid line indicates the signal path for conventional recording. The dashed lines indicate the path for sync recording.

		CONVENTIONAL	HIGH DENSITY	HDM - 1	UNITS
Sampling rate	f_s	48	48	48	kHz
Tape speed	V	72.381	72.381	72.381	cm/sec
Wavelength	λ_s	$1.507 \cdot 10^{-3}$	$1.507 \cdot 10^{-3}$	$1.507 \cdot 10^{-3}$	cm
Bit length	$BL = \lambda/16$	$.0942 \cdot 10^{-3}$	$.0628 \cdot 10^{-3}$	$.0628 \cdot 10^{-3}$	cm/bit
Packing density	$1/BL$	10.611 (26,951)	15.916 (40,426)	15.916 (40,426)	bits/cm (bits/in)
Bit rate	V/BL	768.365	1152.548	1152.548	kbits/sec
f_{MAX}	$BR/2$	384.182	576.274	384.182	kHz
λ_{MIN}	V/f_{MAX}	1.884	1.256	1.884	μm
T_{MIN}	$1/f_{MAX}$	2.603	1.735	2.603	μsec

Figure 3. Conventional, high-density, and HDM-1 recording parameters.

SPLICE EDITING

For traditional razor-blade editing, an analog mix of the appropriate digital tracks may be recorded on one or both of the analog tracks provided for this purpose. The editor may now listen to these tracks in order to find the desired splice point. Afterwards, when the spliced tape is played back over the digital playback head, the decoder block senses the level discontinuity at the splice point. Then as this point approaches the splice-edit crossfader (seen in FIGURE 1), a pre- and post-splice crossfade smooths out the level across the edit point.

RECORDING FORMAT

The HDM-1 (High Density Modulation) channel coding scheme used in the PCM-3324 digital tape recorder was developed in order to improve reliability at high packing densities. The format allows a bit-packing density that is 1.5 times greater than in older channel coding systems.

FIGURE 3 is a comparison of conventional, theoretical high-density, and actual HDM-1 parameters, while FIGURE 4 is a graph of block error rate versus recorded wavelength. Theoretically, it is desirable to have a wavelength in the range between $1.5 \mu m$ and $2.5 \mu m$. At wavelengths below $1.5 \mu m$, the error rate is dangerously high, while wavelengths greater than $2.0 \mu m$ offer only a minimal further improvement in error rate.

Note that although the wavelength of the conventional format ($1.884 \mu m$) is acceptable, the high-density wavelength is small enough ($1.256 \mu m$) to be potentially dangerous.

HDM-1 CHANNEL CODING

The HDM-1 system employs coding rules that are briefly summarized in FIGURE 5A-D, and these rules again place the recorded wavelength at $1.884 \mu m$. (A complete listing of HDM-1 coding rules is given in AES Preprint 1856, "Channel Codings for Digital Audio Recordings"—Ed.) Note that when a

1 follows a 0, there is a transition at the center of the 1 bit cell (A). For consecutive 1s, there is a transition at the edge of each pair of bit cells, but no transition if there is to be one more 1, followed by a 0 (B). In this case, the transition occurs between that 1 and the 0 which follows it. In the case of consecutive 0s, a transition occurs between the third and fourth 0 (C). As before, a 0, 1 sequence places the transition in the middle of the 1 bit cell (D).

Therefore, if T is the length of one bit of conventional data, then $T_{MIN} = 1.5T$, and $T_{MAX} = 4.5T$. From FIGURE 5, we may observe that the HDM-1 coding format gives us a T_{MIN} of $1.5 \times 1.735 \mu sec = 2.603 \mu sec$. This gives us a maximum recorded frequency of 384.182 kHz, or a minimum wavelength of $1.884 \mu m$, as before.

In comparing HDM-1 to the 3PM (Three-Position Modulation) system used in earlier prototype digital tape recorders,

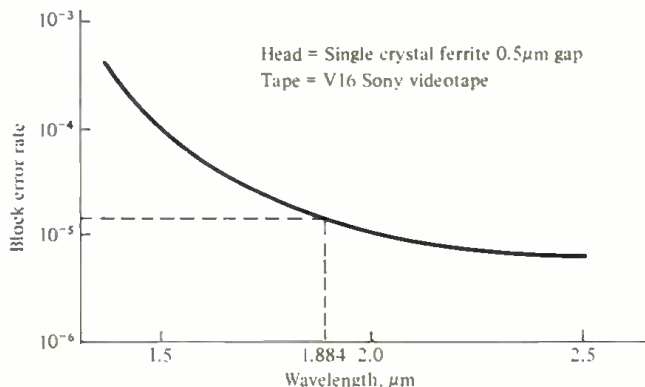

Figure 4. Block error rate versus recorded wavelength.

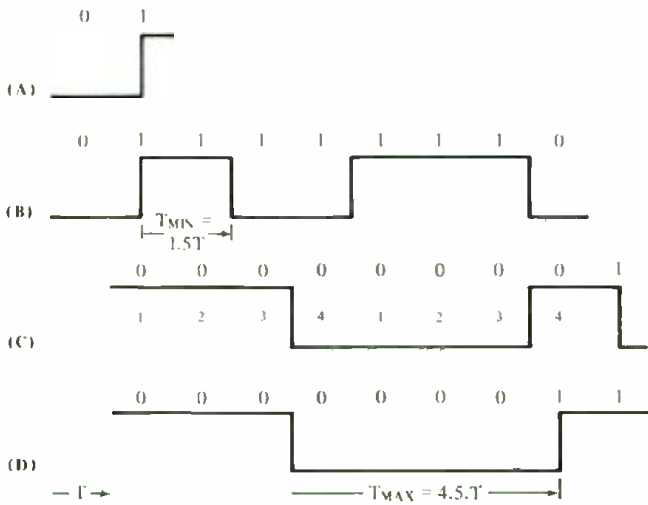

Figure 5. A summary of HDM-1 channel coding rules.

several improvements are noticed. In order to attain maximum accuracy during self-locking, the phase should be corrected at the transition point. Hence, the smaller T_{MAX} is, the better. T_{MAX} is important in order to keep good clock recovery at splice edits, auto punch-in/-out points, and long burst errors.

The constraint length, L_C , is the length of previous bits which affect the determination of the present modulated channel bit. If L_C is long, an error propagation may occur in which one channel bit will cause an error of many bits at the decoding stage.

In the HDM-1 format, T_{MAX} is improved from $6T$ to $4.5T$, and L_C is improved from $9T$ to $5.5T$, which makes hardware implementation simpler.

ERROR CODING FORMAT

The recorded block structure is shown in FIGURE 6, and FIGURE 7 shows the word array sequences of the error correcting code. The word sequence is divided into odd and even

	WORD NUMBER	NUMBER OF BITS
Synchronization		11
Block address	1	3
Flag bits		2
Data words	12	192
Parity words for error correction	4	64
Parity word for error detection	1	16
TOTAL	18	288
REDUNDANCY		33.3%
EFFICIENCY		66.7%

Figure 6. The HDM-1 recorded block structure.

numbers and a cross-interleave code is independently applied to each odd and even sequence. Each block of error correction consists of six words from each sequence, plus two parity words (P and Q). In the medium- and slow-speed formats, words are distributed into two and four tracks, and error concealment varies due to the decreasing distance between odd and even sequences.

FIGURE 8 is a summary of the burst error correctability and other parameters of the HDM-1 channel coding format.

BURST ERROR CORRECTION

The HDM-1 error correction codes allow for good concealment of lost data. If as much as 89 percent of the data is lost, a data-interpolation scheme will still provide reasonable data correction. For example, in FIGURE 9 a nine-word sequence is shown, and we will assume that the six words in parentheses have been lost. The values of these words may be interpolated by using the equations shown next to each of the missing words. The multiplication coefficients 0.5 and 0.25 may be realized

(1) HIGH SPEED VERSION



(2) MEDIUM SPEED VERSION

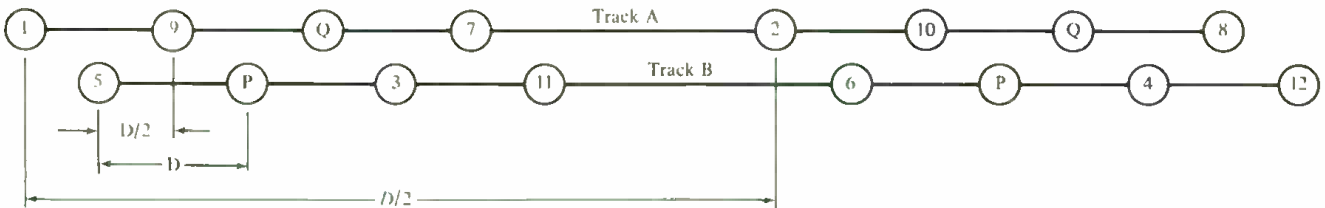

(3) LOW SPEED VERSION

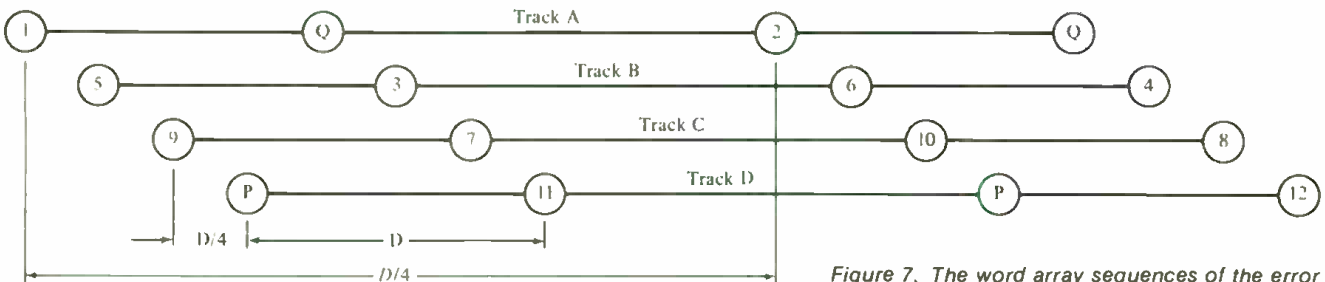

Figure 7. The word array sequences of the error correcting code.

Packing density and burst error correctability of the HDM-1 format

VERSION		FAST SPEED			MEDIUM SPEED			SLOW SPEED		
Sampling rate (kHz)		48.00	44.1	32.0	48.00	44.1	32.0	48.00	44.10	32.00
Tape speed (cm/s)		72.38	66.5	48.25	36.19	33.25	24.13	18.10	16.63	12.06
Bit rate/TRK (kb/s)		1152.08	1,058.4	768.0	576.04	529.2	384.0	288.10	264.60	192.00
Maximum frequency to be recorded (kHz)		384.0	352.8	256.0	192.00	176.4	128.0	96.00	88.20	64.00
Burst error correction	Length (mm)	5.427*			3.075			3.075		
	Time (msec)	7.50	8.161*	11.25*	8.50	9.252	12.75	17.00	18.50	25.50
	Bits corrected	8,640*			4,896			4,896		
Burst error protection (good concealment)	Length (mm)	21.35			15.20 x 1/2 tape width			12.12 x 1/4 tape width		
	Time (msec)	29.49	32.10	44.24	42.0	45.71	63.00	67.00	72.29	100.50
	Bits corrected	33,984			24,192			19,296		
Burst error protection (normal concealment)	Length (mm)	36.90			24.60 x 1/2 tape width					
	Time (msec)	50.99	55.49	76.48	33.99	37.00	50.99			
	Bits corrected	58,752			39,168					
Burst error protection (marginal concealment)	Length (mm)	52.28			26.14			13.07		
	Time (msec)	72.25	78.64	108.38	72.25	78.64	108.38	72.25	78.64	108.38
	Bits corrected	83,232			41,616			20,808		

NOTE:

* These values are theoretical limit by multiple decoder, while other values can be obtained by single decoder.

Figure 8. Packing density and burst error correctability of the HDM-1 format.

simply by shifting the indicated word by one or two bits. The coefficient of 0.75 is obviously the sum of 0.5 and 0.25.

In conclusion, the HDM-1 Channel Coding Format improves reliability at high packing density. The cross-interleave code results in strong error correctability with low redundancy. The structure is a combination of two sets of codes with different interleaves for punching-in and punching-out. Therefore, blocks lost by switching between playback and record modes are designed to belong to one error correction series, and the correctability of single erasure corrections is always maintained, regardless of the loss of many blocks.

WORD	VALUE	EQUATION	INTERPOLATED VALUE
1	0100		
2	(0101)	$.75W_1 + .25W_5 = 0011 + 0010 =$	0101
3	(0110)	$.50W_1 + .50W_5 = 0010 + 0100 =$	0110
4	(0111)	$.25W_1 + .75W_5 = 0001 + 0110 =$	0111
5	1000		
6	(1001)	$.75W_5 + .25W_9 = 0110 + 0011 =$	1001
7	(1010)	$.50W_5 + .50W_9 = 0100 + 0110 =$	1010
8	(1011)	$.25W_5 + .75W_9 = 0010 + 1001 =$	1011
9	1100		

Figure 9. A nine-word sequence, in which the six words in parentheses are assumed to be lost. As shown in the figure, the missing values may be interpolated from the equations given next to each "missing" word.

ADDITIONAL FEATURES AND FUNCTIONS

Specific features of the PCM-3324 system include a pinch-rollerless tape transport system controlled by the capstan motor in which tape speed is variable in 0.1 percent increments over a range of ± 12.5 percent of tape speed. The tape speed may also be varied in half-tone steps, which are displayed in cents. The tape timer indicates either absolute or relative tape time. Incremental adjustment is possible with four cue store/recall registers.

A fingertip shuttle control allows 1/15 to 15 times play speed. For either manual or automatic punch-in/-out, a RECORD REHEARSE mode allows punch-in/-out operations to be rehearsed and modified if necessary prior to actual execution.

An "intelligent" control panel allows the 24 digital audio channels, the 2 analog channels, the control and external data tracks to be individually assigned for REPRO and INPUT. Selected channels may be grouped in any combination, and four such groups may be stored in memory.

The PCM-3324 has been designed to be fully tape-compatible with comparable 24-channel systems, such as Studer and MCI. In addition, it will also follow the standardized 44.1 kHz sampling rate of the Compact Disc format.

The system is geared to interface with video hardware, and a synchronization interface may be added to the remote editor to enable the PCM-3324 to operate with videotape recorders. Capabilities of this configuration include digital memory cue search for easier editing accuracy, multiple auto locate points, and synchronized multiple punch-in and punch-out and rehearsal functions. Optional synchronization interface boards make the system compatible with PAL, SECAM and film industry standards. ■

REMOTE MICROPHONE SWITCHING CARD

DELAY LINE/FLANGER



• The Loft 450 Delay Line/Flanger has a maximum bandwidth of 18 kHz and comes standard with up to 160 milliseconds of delay. The addition of the EM-450 extender module will provide delay up to 320 milliseconds. The unit has a signal to noise ratio of -90 dB. The Loft 450 features excellent control and flexibility in creating special effects such as flanging, chorusing, double-tracking, slapback echo and other types of effects. Other features include a musical instrument input (with up to 20 dB of gain) and a rear panel foot pedal jack. Both 1/4-in. phone jacks and XLR connectors are utilized on the inputs and outputs. Level controls are calibrated and there are three LED headroom indicators on the front panel. The model 450 is a steel encased 19-in. rack-mount unit which occupies 1 1/4-ins. of rack space.
Mfr: Phoenix Audio Laboratory, Inc.
Circle 43 on Reader Service Card

LIMITER



• The Superdynamic Limiter has been designed for the digital era. As a mastering limiter for recording applications, front ending PCM units, satellite links, and broadcast transmitters, it offers a 100 dB dynamic range (threshold—noise) and 100 percent transient control. Features of the Superdynamic include: precision stepped attenuators and controls; 20 dB make-up gain; side-chain pre-emphasis; a music-voice ratio control (VO) system; transient clipper; symmetrical/asymmetrical (AM) output; output filtering (AM/FM) option; logic function tamper-proof "inhibit" and dual function metering. Inputs and outputs are electronically balanced (with provisions for transformer option). Audio connections are via PCM mounted XLR connectors.
Mfr: Audio + Design Recording, Inc.
Price: \$990.00
Circle 45 on Reader Service Card

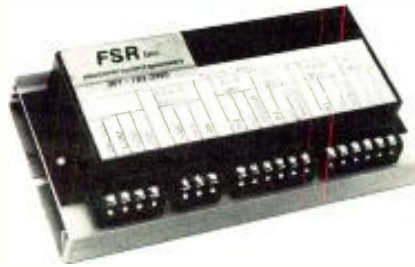

• The MIC-1 microphone control unit allows the user to switch from lectern mic to lavalier mic with the touch of a button which illuminates when the lavalier is selected. The MIC-1 features terminal strips, accepts balanced line audio cables, operates on 24VDC power, and is track mounted for easy installation in lectern or control room rack. The MIC-1 will also work with phantom powered microphones.

Mfr: FSR, Inc.

Price: \$45.00

Circle 44 on Reader Service Card

SOUND UNSEEN

THE BEYER MCE 5

Voice and appearance are key to a news announcer's success. Beyer benefits both with its MCE 5 electret condenser mic. A matte-black omni so tiny it's virtually invisible. Full 20-20,000Hz range projects the vital presence of the speaker, uncolored, undistorted. Unique floating element eliminates clothing noise. Removable windscreen for outdoors. 62dB S/N. 116dB overload. 700-ohm balanced output for professional performance. Phantom or self-powered, also available in a variety of connector configurations to meet every application requirement, including wireless.

Visit your local Beyer dealer today.



beyerdynamic

BEYER DYNAMIC, INC.
5-05 Burns Avenue, Hicksville,
NY 11801 • (516) 935-8000

Circle 23 on Reader Service Card



- The Model E51 five-band parametric equalizer is designed for a variety of musical instrument and sound reinforcement applications. A key feature of the unit is the option of switchable peak or shelf response on bands One and Five. In addition, the E51 offers automatic balanced unbalanced XLR ¼-inch phone inputs outputs; +20 dB system gain for low level sources; overall Level Control and Bypass switch with LED; Signal Present, Power Ready and System Overload LEDs; output relay control, and line drivers.

Mfr: Phase Linear

Price: \$549.00

Circle 46 on Reader Service Card

FOR LIVE PERFORMANCE

★ **Three Band Parametric Equalizer**

PM-1

FOR RECORDING

★ **Three Band Tone Equalizer**

TE-1

FOR PA

★ **Adjustable Active Crossover**

AC-1

Send For Your Free Copy Of Our Catalog



SESCOM, INC.
Professional Sound Division
111 Las Vegas Blvd. North
Las Vegas, NV 89101 U.S.A.

(702)384-0993
(800) 634-3457
TWX 910-397-6996

Circle 47 on Reader Service Card

db Featured Equipment

NORMANDY EQUIPMENT (Pages 26-29)

CONSOLE

MCI JH-636

TAPE MACHINE

MCI JH-24 master recorder

MONITORS

JBL, UREI, Altec

MICROPHONES

Neumann, AKG, Sennheiser

ORGAN & PIANO

Hammond A-100 Console organ; Yamaha Conservatory grand piano

EAST WING EQUIPMENT (Pages 32-38)

CONSOLE

MCI JH-556-48—automated console with plasma display peak and VU meters, center group faders, 48 mic inputs, 96 mix inputs

TAPE MACHINES

MCI JH-110B—2-track transformerless machines

MCI JH-24—24-track transformerless machine

48-track capability in all rooms utilizing MCI JH-45 Autolock

Dolby and dbx noise reduction

MONITOR SYSTEMS

Custom designed 3 way bi-amped Ed Long Time-Aligned monitor system using TAD and CSI components (with three auxiliary monitor systems available)

PIANOS

Baldwin 9-ft. concert grand pianos

SELECT SOUND EQUIPMENT (Pages 40-45)

CONSOLE

Allen and Heath Brennell Ltd. Syncon A 28 x 28 with parametric equalization and fourteen stereo subgroups.

TAPE MACHINES

MCI JH-114-24—24 track w/ Autolocator III

MCI JH-110B—2 track

Ampex ATR-700—2 track

Sansui SC-3330—cassette deck

MONITOR SYSTEMS

Speakers—Lakeside Monitors w/ 2 15" TAD low frequency driver and TAD high frequency compression drivers

Amplifiers—Crown PSA

Equalizers—White 4001 1, 3 octave with the 800 Hz crossover cards

SIGNAL PROCESSING

EMT 240 gold foil reverberation system

Lexicon primetime digital delays

Valley People, Kepex II—noise gates

UREI 1176 peak limiters

UREI LA-4 compressor limiters

Pandora LM-402 peak limiters

MICROPHONES

AKG 451

AKG 224

Neumann U87

Sennheiser MD 441

Sennheiser MD 421

Sony C37P

Closing date is the fifteenth of the second month preceding the date of issue.

Send copies to: Classified Ad Dept.
db THE SOUND ENGINEERING MAGAZINE
 1120 Old Country Road, Plainview, New York 11803

Minimum order accepted: \$25.00
 Rates: \$1.00 a word
 Boxed Ads: \$40.00 per column inch
 db Box Number: \$8.50 for wording "Dept. XX," etc.
 Plus \$1.50 to cover postage

Frequency Discounts: 6 times, 15%; 12 times, 30%

ALL CLASSIFIED ADS MUST BE PREPAID.

FREE 32pg Catalog & 50 Audio/Video Applic.



Stereo Mono Per Ampl
 PWR SUPP EQ
 PHONO MIC
 TRANS. ACN
 TAPE, VIDEO
 LINE, OSC

8-in 2-out, 12-in 4-out, 16-in 4-out
 Video & Audio Dist Amps TV Audio & Recd Prod Consoles

OPAMP LABS INC (213) 934-3566
 1033 N Sycamore Av LOS ANGELES CA, 90038

THE LIBRARY... Sound effects recorded in STEREO using Dolby throughout. Over 350 effects on ten discs. \$100.00. Write **The Library, P.O. Box 18145, Denver, Colo. 80218.**

LEXICON, dbx, & UREI. Most items for immediate delivery. **UAR Professional Systems, 8535 Fairhaven, San Antonio, TX 78229. (512) 690-8888.**

AUDIOHOUSE SELLS, Ecoplate, Valley People, MicMix, Symetrix, (303) 751-2268.

MASTER THE RECORDING SCIENCE. Sherman Keene's "Practical Techniques for the Recording Engineer" is a book about the real world of studio recording. Acclaimed by magazines, reviewers, college teachers, studio owners and engineers. 381 pages, 28 chapters (4 on computer mixing). To order send \$29.75 plus \$2.25 shipping plus 6% (Calif.) to: **Opamp Books, 1033 N. Sycamore, Suite D, L.A., CA 90038. Order by phone (213) 464-4322.**

FOR SALE

AMPEX, OTARI, SCULLY—In stock, all major professional lines; top dollar tradelins; write or call for prices. **Professional Audio Video Corporation, 384 Grand Street, Paterson, New Jersey 07505. (201) 523-3333.**

AUDIO SERVICES—Best prices on EV, Tapco, dbx, Lexicon, Ampex Tape, Symetrix, Audioarts, White, Revox, more. Write for specific quotes. **P.O. Box 8220, Greensboro, NC 27419.**

REELS AND BOXES 5" and 7" large and small hubs, heavy duty white boxes. **W-M Sales, 1118 Dula Circle, Duncanville, Texas 75116 (214) 296-2773.**

FOR SALE AKG C-24 and other tube type condenser mics. **(415) 441-8934 or 527-6167.**

PROFESSIONAL AUDIO EQUIPMENT

Shop for pro audio from N.Y.'s leader, no matter where you live! Use the Harvey Pro Hot Line (800) 223-2642 (except N.Y., Ak. & Hi.). Expert advice, in-depth parts dept., ¾" video systems available. Broadest selection such as Otari, Quad Eight, Soundcraft, Tascam and more. Write or call for price or product info:

Harvey Professional Products Division
 25 W. 45th Street
 New York, NY 10036
 (212) 921-5920



ACOUSTIC TEST INSTRUMENTS
 USE TO ADJUST EQUALIZERS, OPTIMIZE SPEAKER PLACEMENT, ETC

Complete Test Set	\$449
Calibrated Sound Level Meter	\$199
Fractional Octave Pink Noise Generator	\$339
Handbook on Acoustic Testing	\$10

Free broch HALL ENGINEERING Dept E5
 P.O. Box 506 Mansfield NJ 08836
 (201) 647-0377

ORBAN and LEXICON. All products in stock. FOR IMMEDIATE DELIVERY. **UAR Professional Systems, 8535 Fairhaven, San Antonio, TX 78229. 512-690-8888.**

QUALITY STEREO CASSETTE duplication in real time. **G.G. Productions, Box 24164, Denver, CO 80231. (303) 751-2268.**

USED RECORDING equipment for sale. **Dan (415) 441-8934.**

BLANK AUDIO AND VIDEO CASSETTES direct from manufacturer, below wholesale, any length cassettes: 4 different qualities to choose from. Bulk and reel mastertape—from ¼-inch to 2-inch. Cassette duplication also available. Brochure. **Andol Audio Products, Inc., Dept. db, 42-12 14th Ave., Brooklyn, NY 11219. Toll free 1-800-221-6578, ext. 1, NY residents (212) 435-7322.**



Special binders now available.

All you regular **db** readers who, smartly enough, keep all your back issues, can now get our special binders to hold a whole year's worth of **db** magazines in neat order. No more torn-off covers, loose pages, mixed-up sequence. Twelve copies, January to December, can be maintained in proper order and good condition, so you can easily refer to any issue you need, any time, with no trouble.

They look great, too!

Made of fine quality royal blue vinyl, with a clear plastic pocket on the spine for indexing information, they make a handsome looking addition to your professional bookshelf.

Just \$7.95 each, available in North America only. (Payable in U.S. currency drawn on U.S. banks.)

Sagamore Publishing Co., Inc.
 1120 Old Country Road
 Plainview, NY 11803

YES! Please send _____ **db** binders @ \$7.95 each, plus applicable sales tax. Total amount enclosed \$ _____

Name _____

Company _____

Address _____

City _____

State/Zip _____

MICROPHONES BY UPS. Quicker. You'll save more with us. All popular models for immediate delivery. **UAR Professional Systems.** (512) 690-8888.

REMANUFACTURED ORIGINAL equipment capstan motors for all Ampex and Scully direct drive recorders, priced at \$250., available for immediate delivery from **VIF International, P.O. Box 1555, Mtn View, CA 94042, phone (408) 739-9740.**

SURPLUS JBL TWEETERS. NEW. Ideal for disco tweeter arrays or improving sound reinforcement and home loud-speaker systems. Specify choice of bullet or slot lens type. \$80 plus \$2 shipping each. Add sales tax if in NY. **Rosner Custom Sound, 11-38 31 Ave., L.I. City, NY 11106. (212) 726-5600.**

SALE: HEWLETT PACKARD 333A Distortion Analyzer, \$1,000. Marconi Instruments monitored output, ultra precision audio frequency Signal Generator in rack mount, \$600. Both excellent condition. **(301) 585-1118.**

TECHNICS, BGW, EVENTIDE, AKG, Scully, and many more IN STOCK. FOR IMMEDIATE DELIVERY: **UAR Professional Systems, 8535 Fairhaven, San Antonio, TX 78229. (512) 690-8888.**

INSTRUCTION

SHERMAN KEENE CORRESPONDENCE course. Author of acclaimed textbook "Practical Techniques for the Recording Engineer" invites you to study recording at home. Course includes reading and homework assignments in two textbooks with personal dialog via cassette. Eight lessons per level, 3 levels. \$250 per level. For info write: **Correspondence Course, 1626 N. Wilcox No. 677D, Hollywood, CA 90028.**

WANTED

WANTED: TRANSCRIPTION discs, any size, speed. Radio shows, music. **P.O. BOX 724—db, Redmond, WA 98052.**

SERVICES

JBL AND GAUSS
SPEAKER WARRANTY CENTER
 Fast emergency service. Speaker re-coning and repair. Compression driver diaphragms for immediate shipment. **NEWCOME SOUND, 4684 Indianola Avenue, Columbus, OH 43214. (614) 268-5605.**

MAGNETIC HEAD relapping—24 hour service. Replacement heads for professional recorders. **IEM, 350 N. Eric Drive, Palatine, IL 60067. (312) 358-4622.**

CUTTERHEAD REPAIR SERVICE for all models Westrex, HAECO, Grampian. Modifications done on Westrex. Quick turnaround. New and used cutterheads for sale. Send for free brochure: **International Cutterhead Repair, 194 Kings Ct., Teaneck, N.J. 07666. (201) 837-1289.**

CUSTOM RECORDING SERVICE: Tapes, discs and cassettes; stereo and mono; live recording and copies; editing, masters. High quality at reasonable rates. **Audio-Tech Laboratories, 1158 Stewart Avenue, Bethpage, NY 11714. (516) 433-0171.**

ACOUSTIC CONSULTATION—Specializing in studios, control rooms, discos. Qualified personnel, reasonable rates. Acoustilog, Bruel & Kjaer, HP, Tektronix, lvie, equipment calibrated on premises. Reverberation timer and RTA rentals. **Acoustilog, 19 Mercer Street, New York, NY 10013 (212) 925-1365.**

EMPLOYMENT

FACULTY POSITION. The American University invites applications for a position in the Audio Technology program, beginning in September, 1982. Candidates must have a PhD or MS degree in Electrical/Electronic Engineering. A knowledge of music is preferred. Please send resume and three letters of reference to **Physics Department, The American University, Washington, DC 20016.** Closing date is June 15th, 1982. The American University is an Affirmative Action/Equal Opportunity Employer.

TO AN ENTERPRISING E.E.

We are audio products producers located in the Northeast and are looking for an Electronic Engineer with a demonstrable track record in the design of components for the professional user and an entrepreneur at heart. Initially, this position entails the design of audio products and systems but will phase into company management, leading to control and ownership.

Compensation includes salary, profit sharing, and stock bonuses. If you are an aggressive, talented designer, unafraid of work and challenges and are looking for a future under your own control, you should answer this ad. Please give sufficient detail on education, work experience, accomplishment and objectives to permit us to go to the next step, a personal interview. Reply to:

Dept. 52
db Magazine
1120 Old Country Road
Plainview, New York 11803

MICROPHONES!

At long last, all the questions you ever asked...all the problems you ever grappled with...are answered clearly and definitively!

The Microphone Handbook

In 256 fact-filled pages, liberally sprinkled with over 500 illuminating photographs, drawings and diagrams, John Eargle covers virtually every practical aspect of microphone design and usage.

Completely up to date, this vital new handbook is a must for any professional whose work involves microphones. Here are just a few of the topics that are thoroughly covered:

- Directional characteristics—the basic patterns.
- Using patterns effectively.
- Microphone sensitivity ratings.
- Remote powering of capacitors.
- Proximity and distance effects.
- Multi-microphone interference problems.
- Stereo microphone techniques.
- Speech and music reinforcement.
- Studio microphone techniques.
- Microphone accessories.
- And much, much more!

THE MICROPHONE HANDBOOK. You'll find yourself reaching for it every time a new or unusual problem crops up. Order your copy now!



JOHN EARGLE,

noted author, lecturer and audio expert, is vice-president, market planning for James B. Lansing Sound. He has also served as chief engineer with Mercury Records, and is a member of SMPTE, IEEE and AES, for which he served as president in 1974-75. Listed in *Engineers of Distinction*, he has over 30 published articles and record reviews to his credit, and is the author of another important book, *Sound Recording*.

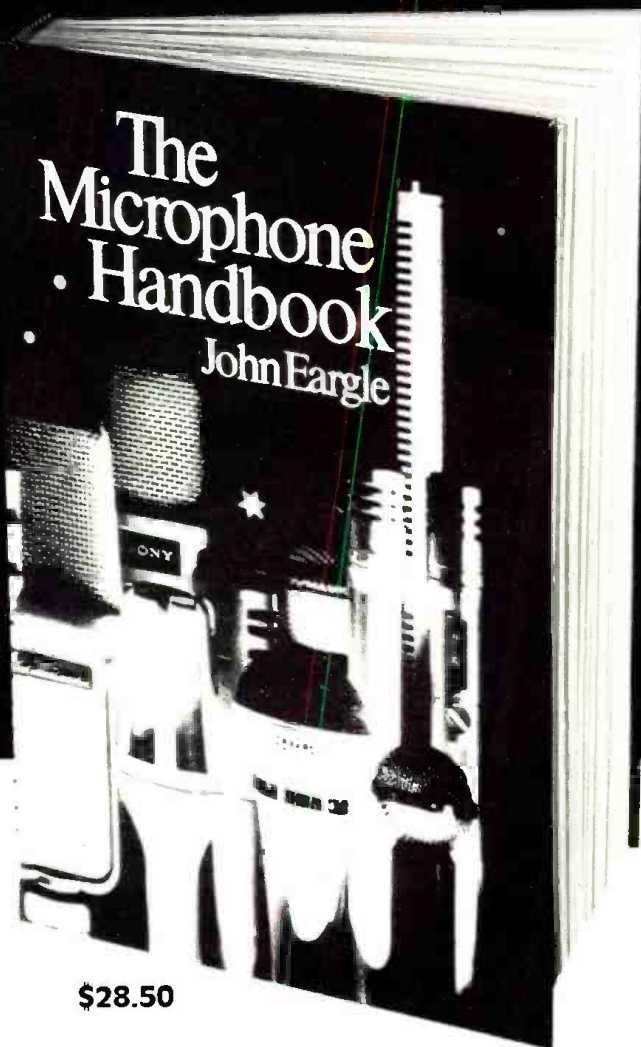

\$28.50

ELAR PUBLISHING CO., INC.

1120 Old Country Road, Plainview, NY 11803

Yes! Please send _____ copies of **The Microphone Handbook** @ \$28.50 per copy. (New York State residents add appropriate sales tax.)

Payment enclosed.
Or charge my MasterCard Visa

Acct. # _____ Exp. Date _____

Name _____
(please print)

Address _____

City _____

State/Zip _____

Signature _____

Outside U.S.A. add \$2.00 for postage. Checks must be in U.S. funds drawn on a U.S. bank.

If you aren't completely satisfied, you may return your copy in good condition within 15 days for full refund or credit.

In Memoriam



Dr. Harry F. Olson, a pioneer in acoustics and electronic sound recording who was associated with RCA for nearly 40 years, died on April 1 at the Princeton Medical Center. He was 81 years old.

Dr. Olson was Staff Vice President, Acoustical and Electromechanical Research for RCA Laboratories here when he retired in 1967.

The scientist held over 100 U.S. patents on devices and systems in the acoustical field.

During his career with RCA, Dr. Olson developed several types of microphones for broadcasting and recording, high-fidelity loudspeakers, improved phonograph pickup and recording equipment, underwater sound equipment, sound motion picture and public address systems.

He also guided and contributed substantially to the development of the RCA magnetic tape recorder for television and the RCA music synthesizer. His other developments included the phonetic typewriter and a speech processing system.

Born in Mt. Pleasant, Iowa, in 1901, Dr. Olson attended the University of Iowa, where he received his B.S. degree in 1924, his Ph.D. degree in 1928, and the degree of Electrical Engineer in 1932.

In 1928, he joined RCA as a member of the Research Department. Except for a two year period, 1930-32, when he was associated with the Engineering Department of RCA Photophone, Dr. Olson was continuously associated with the RCA research organization. In 1934, he was placed in charge of acoustical research for the RCA Manufacturing Company and subsequently became Director of the Acoustical and Electromechanical Laboratory at RCA Laboratories in Princeton. He was appointed Staff Vice President of Acoustical and Electromechanical Research in 1966.

Dr. Olson was the author of numerous acoustical studies and contributed to more than 130 articles and professional papers. He wrote several books, including "Applied Acoustics," "Elements of Acoustical Engineering" and "Musical Engineering."

He was elected to the National Academy of Science in 1959. He also was a Fellow of the American Physical Society, the Institute of Electrical and Electronics Engineers, the Audio Engineering Society, the Society of Motion Picture and Television Engineers and the Acoustical Society of America, of which he was a past President.

Dr. Olson received numerous awards for his contributions to the field of audio engineering, among them the John H. Potts Medal of the Audio Engineering Society in 1949 and the John Ericsson Medal of the American Society of Swedish Engineers in 1964. He received three awards from the IEEE: the Mervin J. Kelly Award in 1967, the Consumer Electronics Award in 1969 and the Lamme Medal in 1970. Dr. Olson was awarded the first Silver Medal in Engineering Acoustics of the Acoustical Society of America in 1974 and the Society's Gold Medal Award in 1981.

Dr. Olson is survived by his wife, Lorene, and a sister, Lillian.



Harold W. Lindsay, 72, whose development of the first practical audio recorder in America revolutionized the recording industry and established Ampex Corporation as a high technology leader, died April 1st in his Los Altos Hills, California home following a brief illness.

"Harold Lindsay made many lasting contributions to audio technology and Ampex during his career," said Arthur H. Hausman, chairman of the board, president and chief executive officer of Ampex.

Mr. Lindsay played a major role in turning Ampex, a small subcontractor of electric motors during World War II, into a major high technology company after he became a full-time employee December 10, 1946.

He was lured to the firm by Alexander M. Poniatoff, the founder of Ampex, to advise in the selection of a post-war product. This occurred about six months after Mr. Lindsay witnessed a demonstration of the German Magnetophon tape recorder.

Mr. Lindsay's enthusiasm over the exciting possibilities of the new recording medium was an important force in the acceptance of his recommendation that Ampex develop and manufacture a professional magnetic audio recorder.

He became project engineer and chief designer of the Model 200, the first professional high fidelity magnetic tape recorder produced in the United States.

The Model 200 was first demonstrated in October of 1947, and the ABC Radio Network subsequently purchased the first 20 production units. By April of 1948, the recorder was being used nationally to broadcast the Bing Crosby Show, as well as for network daylight savings time-delays. During the following 22 weeks, less than 3 minutes of broadcast time was lost in 2,618 hours of broadcast recording.

The Model 200 established tape as a professional recording medium in America, and made Ampex the leader in audio recording technology. After the introduction of the Model 200, Mr. Lindsay directed development of later generations of Ampex audio recorders, and set up the first quality control and industrial design departments at Ampex. During his involvement in the latter project, Mr. Lindsay developed the industrial design for the VR-1000, the first videotape recorder introduced by Ampex in 1956.

He was honored for his pioneering work in audio technology in 1958 when he was made a fellow of the Audio Engineering Society, and became a life member in 1977. He presented a number of papers before the society, as well as the Institute of Radio Engineers, the American Institute of Electrical Engineers, and the American Society of Tool Engineers.

Mr. Lindsay held many patents on instrument design, control and equipment circuits, and on magnetic tape recording equipment. His design for the Ampex Model 300 audio recorder won the 1950 design award of *Electrical Manufacturing* magazine.

He is survived by his wife, Margery, three children, and seven grandchildren. The family requests that contributions in lieu of flowers be made to the American Cancer Society or charity of the donor's choice.

16 TRACKS OF NUMBER ONE SOUND

TASCAM'S FASTEST 16-TRACK PRODUCTION BOARD.

- 4-band parametric EQ plus high and low pass filters
- 24 Input x 8 Master Out & 4 AUX Out x 16 Track Monitor
- 72-point stereo solo in place for instant audition of any signal location
- Discrete 16-track monitor
- Fully wired back panel. Installation is quick. No time consuming, costly connector or terminal block wiring. From out of the crate to up-and-running in as little as an hour.
- Reliability—The TASCAM reliability that makes all our equipment industry standard. We make the world's broadest, toughest, most flexible system of multitrack production equipment. From the Portastudio and the MM-20, to the M-16, TASCAM means business. Multitrack, video-post, broadcast production and much more.

Circle 11 on Reader Service Card

TASCAM
TEAC PRODUCTION PRODUCTS

COPYRIGHT 1982, TEAC CORP. OF AMERICA, 7733 TELEGRAPH ROAD, MONTEBELLO, CA 90640

The new UREI Series "A" Time-Aligned™ monitor systems and their equals, the UREI Listening Amplifiers.

For the purest sounds you've ever heard, audition the critically engineered and listener proven UREI professional monitoring systems.

UREI: The NEW Monitoring Standard

Now available with your choice of three accurate Time-Aligned™ monitors and four sonically superb power amplifiers.

From small intimate listening situations to the most spacious environments... from studio control rooms to massive sound reinforcement, the solution to critical music reproduction for the audio professional is awaiting your evaluation at your authorized UREI dealer.

Evaluate the combined technology of a total UREI monitoring system and you will know and appreciate why your peers have made UREI the *new monitoring standard*.

Time-Align is a Trademark of E.M. Long Assoc., Oakland, CA.
All referenced Trademarks are property of, or licensed by,
United Recording Electronics Industries, a URC Company.

UREI From One Pro To Another

United Recording Electronics Industries, a URC Company
8460 San Fernando Road, Sun Valley, California 91352
(213) 767-1000 Telex: 65-1389 UREI SNVY
Worldwide: Gotham Export Corporation, New York
Canada: E. S. Gould Marketing, Montreal

See your professional audio products dealer for full technical information.

