

de



WA 98407
9999

X-80

2-Channel
Digital Audio Recorder



Experience the 3rd dimension of sound... Presence.

Record with the Mitsubishi X-80 2-channel digital recorder. Then sit back, close your eyes and listen. You'll swear you're right in there with the players. You'll feel the depth. The presence. The true existence of the sounds you've captured. You'll experience three dimensional sound. No hiss. No print through. No drop-cuts. No deterioration through generations.

It's as simple to use as a standard analog recorder. It's the only digital recorder that requires no special editing equipment. It's the culmination of

years of refining and perfection. The X-80 is available now. (Also available in console model: X-80A)

Above and beyond our warranty. We stand behind every unit with a 1 year parts and labor warranty. We've also established a service line, designed to put our staff to work for you any time you need us. For any reason. We guarantee 24 hour reaction time to any problem.

Experience the X-80. Come to our rooms, 697 and 699, at the AES Show, New York City, October 31—November 3, 1980. Talk to Kunimaro Tanaka, the Chief

Designer of this incredible machine. Be there for the unveiling of the X-800, 32-channel digital recorder. If you can't be there, call us at 800-323-4216 (outside Illinois), or 312-982-9282 (within Illinois) for more information on Mitsubishi Digital Audio Recording Systems.

Experience the
3rd dimension of sound.

 **MITSUBISHI**
DIGITAL AUDIO SYSTEMS

Circle 10 on Reader Service Card

Coming Next Month

• In December, the transducer is our featured subject. We'll have a look at what's going on at both ends of the signal path, and try to figure out what happens when various polar patterns get combined. Until next month, we leave you with a little quiz:

Two cardioid mics are placed at right angles:

One of the mic cables has a polarity reversal:

What is the resultant polar pattern when the mic outputs are combined?

For a complementary subscription, send us your answers before the appearance of next month's **db**.



THE SOUND ENGINEERING MAGAZINE
NOVEMBER 1980 NUMBER 14, VOLUME 11

	EDITORIAL	44
	A db SPECIAL REPORT—	47
	GOOD ENGINEERING PRACTICES—SPARS	
	RECORDING CONFERENCE III	
	MAGNETIC REFERENCE LABORATORY AND THE	52
	STATE OF REPRODUCER CALIBRATION TAPES	
	Ralph Hodges	
	JAY McKNIGHT AND MRL	56
	THE OTARI MTR-90	59
	John M. Woram	
	CORRECTING TAPE ERRORS IN	62
	DIGITAL MAGNETIC RECORDING	
	Sidney L. Silver	
	ON RMS: KELLEY'S CONSTANT TO THE RESCUE	66
	Almon H. Clegg	
	LETTERS	6
	DIGITAL AUDIO	14
	Barry Blesser	
	SOUND WITH IMAGES	20
	N. I. Weinstock	
	THEORY AND PRACTICE	24
	Norman H. Crowhurst	
	NEW PRODUCTS AND SERVICES	30
	CLASSIFIED	69
	PEOPLE, PLACES, HAPPENINGS	72



is listed in **Current Contents: Engineering and Technology**

Larry Zide
PUBLISHER

John M. Woram
EDITOR

Mark B. Waldstein
ASSOCIATE EDITOR

Kathy Lee
ADVERTISING PRODUCTION

Eloise Beach
CIRCULATION MANAGER

Lydia Anderson
BOOK SALES

Bob Laurie
ART DIRECTOR

Crescent Art Service GRAPHICS AND LAYOUT

About The Cover

• At 25 West 56th Street in Manhattan, you will find Regent Sound Studios, whose Bob Liftin tells us that the MCI board feeds dual Ampex 24-track machines that are computer interfaced with video. Regent Sound Studios are members of SPARS. See our article on page 47.

db, the Sound Engineering Magazine (ISSN 0011-7145) is published monthly by Sagamore Publishing Company, Inc. Entire contents copyright © 1980 by Sagamore Publishing Co., 1120 Old Country Road, Plainview, L.I., N.Y. 11803. Telephone (516) 433-6530. db is published for those individuals and firms in professional audio-recording, broadcast, audio-visual, sound reinforcement, consultants, video recording, film sound, etc. Application should be made on the subscription form in the rear of each issue. Subscriptions are \$12.00 per year (\$24.00 per year outside U.S. Possessions and Mexico; \$13.00 per year Canada) in U.S. funds. Single copies are \$1.95 each. Editorial, Publishing and Sales Offices: 1120 Old Country Road, Plainview, New York 11803. Controlled circulation postage paid at Old Saybrook, Connecticut 06475.

PRO AUDIO SEATTLE

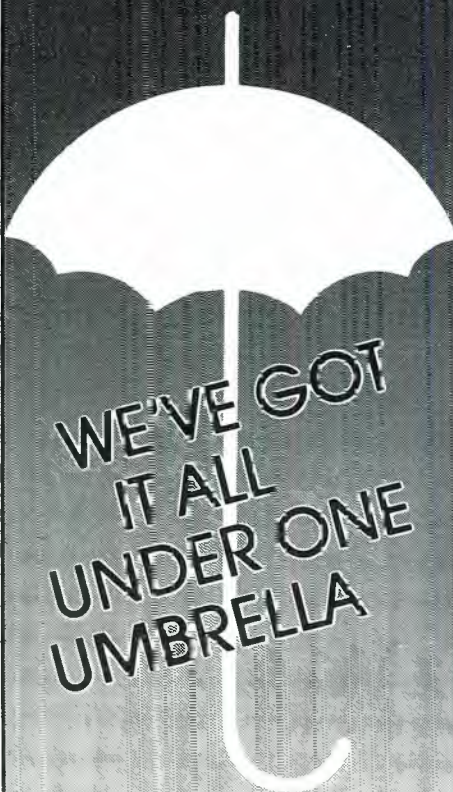

MCI Recorders

MCI Consoles

MCI SMPTE

MCI Automation

And over 55 lines including:

AKG, Ampex, Annis, Auratone, Beyer, BGW, DBX, Deltalab, ElectroVoice, Eventide, Gauss, Ivie, JBL, Klipsch, Koss, Leader, Lexicon, Master Room, MRL, Neumann, Orban, Otari, Revox, Roland, Sequential Circuits, Scotch, Sennheiser, Shure, Sony, Sound Workshop, Stanton, STL, Tangent, Tapco, Tascam, Teac, Technics, UREI, Vega

PROAUDIOSEATTLE

Professional Audio Equipment and Services

(206) 367-6800

11057 8th NE, Seattle, WA 98125

db Letters

DAVIS, on Rettinger

TO THE EDITOR:

Mr. Rettinger's article on control rooms in your June 1980 issue contains a number of mis-statements of fact that should be corrected. ("A Live-End Environment for Control Room Loudspeakers.")

Mr. Rettinger states, "The shorter the time interval between the individual reflections and the direct sound, the less is the ear able to detect acoustic comb filter effects."

Unfortunately, just the opposite is correct, as the shorter the time difference the broader in bandwidth the comb filter, hence its markedly increased effect on hearing as whole octaves of energy are cancelled.

I have given three papers relative to LEDE™ control rooms at AES Conventions, all of which were preprinted. It's a shame Mr. Rettinger is unaware of them, as they clearly state that the main objective of an LEDE™ control room is to provide an initial time delay gap in the control room that is longer than the initial time delay gap in the studio. The removal of spectrum cancelling early reflections is incidental to this objective.

I am surprised that Mr. Rettinger treats low frequencies as if they were geometric frequencies in his article, as his other published work does not make this error. His window discussion is meaningless once this fundamental acoustic fact is faced.

Mr. Rettinger admitted to me that at the time he dashed off these comments (at the request, he stated, of some editor) he had never seen or heard an LEDE™ control room or witnessed TEF™ measurements. I submit that his article has foundations built on sand.

Finally, to read on your editorial page, "Which is it to be then; live end or dead end? Rettinger knows, and so will you" suggests to me that you have displayed, to be charitable, questionable editorial integrity.

DON DAVIS
President
Synergetic Audio Concepts

Index of Advertisers

Alpha Audio	31
Ampex	13
Andrews Audio	49
Aphex	54
Astatic Corp.	57
Atlas Sound	51
Audio Environments	16
Audio Technica	11
Beyer Dynamics	35
Bose	19, 40
BTX	24
Community Light & Sound	42, 43
Crown International	9
Dolby	27
Electro-Voice	21
ESE	55
Garner Industries	20
Harrison Systems	Cover IV
JBL	25
Mike Shop	22
Mitsubishi	Cover II
R. K. Morrison Illust. Mat.	34
Neptune	15
Neve	17
Orban Associates	28
Panasonic	53
Polyline Corporation	34
Pro Audio Seattle	6
Sescom	32
Shure Brothers	7
Sony	29
Soundcraftsmen	12
Standard Tape Lab	14
Studer Revox	37
Swintek	32
Teac	33
Telex	8
Telex Audiocom	10
Tentel	57
3M	41
3M Mincom	Cover III
Universal Studios	26
UREI	39
Valley People	23
Viz Manufacturing	18



sales offices

THE SOUND ENGINEERING MAGAZINE

New York

1120 Old Country Rd.
Plainview, N.Y. 11803 516-433-6530

Roy McDonald Associates, Inc.

Dallas

1949 Stemmons Freeway—Suite 670
Dallas, Texas 75207 214-742-2066

Denver

14 Inverness Drive E., Bldg. 1—Penthouse
Englewood, Colo. 80112 303-771-8181

Houston

6901 Corporate Drive, Suite 210
Houston, Texas 77036 713-988-5005

Los Angeles

424 West Colorado St., Suite 201
Glendale, Cal. 91204 213-244-8176

Portland

P.O. Box 696
510 South First
Portland, Oregon 97123 503-640-2011

San Francisco

265 Baybridge Office Plaza,
5801 Christie Avenue
Emeryville, Cal. 94608 415-653-2122

Karaban/Labiner Inc.

New York

25 West 43rd Street
New York, N.Y. 10036 (212) 840-0660

Chicago

333 N. Michigan Ave.
Chicago, Ill. 60601 (312) 236-6345

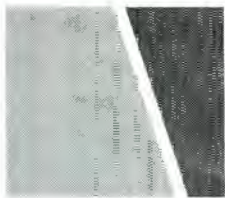

fact: you can choose your microphone to enhance your sound system.

Shure makes microphones for every imaginable use. Like musical instruments, each different type of Shure microphone has a distinctive "sound," or physical characteristic that optimizes it for particular applications, voices, or effects. Take, for example, the Shure SM58 and SM59 microphones:



SM59

**Mellow, smooth,
silent...**

The SM59 is a relatively new, dynamic cardioid microphone. Yet it is already widely accepted as a standard for distinguished studio productions. In fact, you'll often see it on TV . . . especially on musical shows where perfection of sound quality is a major consideration. This revolutionary cardioid microphone has an exceptionally flat frequency response and neutral sound that reproduces exactly what it hears. It's designed to give good bass response when miking at a distance. Remarkably rugged — it's built to shrug off rough handling. And, it is superb in rejecting mechanical stand noise such as floor and desk vibrations because of a unique, patented built-in shock mount. It also features a special hum-bucking coil for superior noise reduction!

Some like it essentially flat...

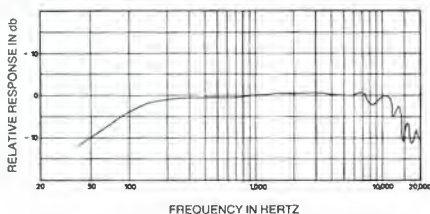

SM58

**Crisp, bright
"abuse proof"**

Probably the most widely used on-stage, hand-held cardioid dynamic microphone. The SM58 dynamic microphone is preferred for its punch in live vocal applications . . . especially where close-up miking is important. It is THE world-standard professional stage microphone with the distinctive Shure upper mid-range presence peak for an intelligible, lively sound. World-renowned for its ability to withstand the kind of abuse that would destroy many other microphones. Designed to minimize the boominess you'd expect from close miking. Rugged, efficient spherical windscreen eliminates pops. Lightweight (15 ounces!) hand-sized. The first choice among rock, pop, R & B, country, gospel, and jazz vocalists.

...some like a "presence" peak.

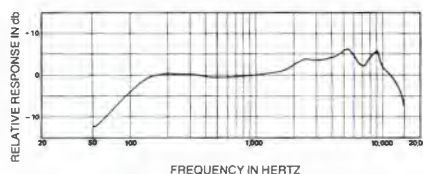

professional microphones...by



Shure Brothers Inc., 222 Hartrey Ave., Evanston, IL 60204, In Canada: A. C. Simmonds & Son Limited
Manufacturers of high fidelity components, microphones, sound systems and related circuitry.

Circle 13 on Reader Service Card

Desk Paging?



Turner has More!

Turner desk paging microphones allow the audio professional more flexibility in choosing the right microphone for each installation. A minimum amount of electronic modification is required because Turner has engineered its products to meet virtually all applications. Twelve distinctly different microphones in two desk-top case styles. There is a quality Turner desk paging microphone with features to meet the following applications requirements:

- Omnidirectional • Low Impedance • Normally Open Switching
- Normally Closed Switching • High Impedance • Zone Paging
- Cardioid • Noise Cancelling • Press-To-Talk • Lift-To-Talk
- Amplified.

And, that's only the beginning. Turner has 13 other paging microphones in gooseneck, handheld and wall mount versions, as well as a full line of sound reinforcement microphones. Turner *does* have more, and now, with the additional product development strength of Telex Communications, Inc. there will be even more to come.

Quality Products for The Audio Professional



TELEX **TURNER**

TELEX COMMUNICATIONS, INC.

9600 ALDRICH AVE. SO., MINNEAPOLIS, MN 55420 U.S.A.
EUROPE: 22, rue de la Legion-d'Honneur, 93200 St. Denis, France.

RETTINGER, on Davis

TO THE EDITOR:

This is in reply to Mr. Davis' letter regarding my article, "A Live-End Environment for Control Room Loudspeakers" in the June 1980 issue of *db*.

When Mr. Davis states that I had not been in an LEDE control room, he refers to a telephone conversation which I had with him prior to the publication of another article on the subject which appeared in the April issue of *Recording Engineer/Producer*. I felt at the time that the published comments from several recording engineers and a violin virtuoso would lend enough credence to my belief as to the bad listening conditions of such a control room, without my own reaction. Nevertheless, I did listen in such a room, and felt in accord with their response. But all this was long before I had submitted the above article to *db*.

His technical questions are difficult to discuss. What, for instance, is a geometric frequency? He also makes no distinction between what the ear is able to hear and what a comb filter analysis is able to detect. It is the qualitative effect on the ear with which we are concerned, because in Lord Rayleigh's dictum "Directly or indirectly, all questions connected with this subject (of sound) come for decision to the ear, as the organ of hearing; and from it there can be no appeal." That was also why I solicited the comments of outstandingly qualified musicians in regard to the listening quality of a LEDE control room.

A shoemaker should stick to his last.
M. RETTINGER

And on, ANON

TO THE EDITOR:

I am concerned with several allegations made in Don & Carolyn Davis' article, "Time, Energy and Frequency Measurements for Sound Definition." If the Davis's are to be interpreted correctly, their instrumentation setup's main function is to produce the same type of echograms that have been in use by acousticians for over a quarter of a century, along with the type of frequency response data that can be obtained with the B&K Gating System. The Davis' claim that a 10,000-fold reduction in analysis time can be achieved with this equipment. Are they really serious about this, or is this some kind of play on words? A large number of acoustical consultants, using the typical spectrometer, oscilloscope, preamplifier, etc., find an eight hour measurement session sufficient for a pre-

Introducing the Crown PZM,TM the second major advance in microphones in 100 years.

In 1876, Bell invented the first microphone.

Crown now announces the second microphone – the PZM.TM

During the last century, microphones have been much improved, but they still employ Bell's basic concept: a movable diaphragm connected to a transducer, the whole assembly intended to be stuck out in the air somewhere near the sound source.

Comb filtering is a side effect of that design that cannot be eliminated.

Every Bell-design microphone demonstrates frequency response anomalies because of an inability to satisfactorily combine direct and reflected signals. Phase-induced amplitude cancellation and reinforcement are the inevitable result.

Crown PZM microphones eliminate comb filtering from the primary boundary because they detect sound according to a new principle, the Pressure Recording Process.TM As a sound wave approaches a boundary (wall, table, floor) a pressure field four or five millimeters deep forms at the boundary, within which the direct signal and its reflection from the boundary add coherently and remain in phase.

The Crown PZMTM places a small pressure transducer into the primary boundary pressure zone, eliminating the possibility of phase-induced interference. The PZM concept thus provides a significant improvement in signal quality. Its small profile also improves microphone aesthetics.

The PZM pickup pattern is hemispheric, with no "off-axis" position.

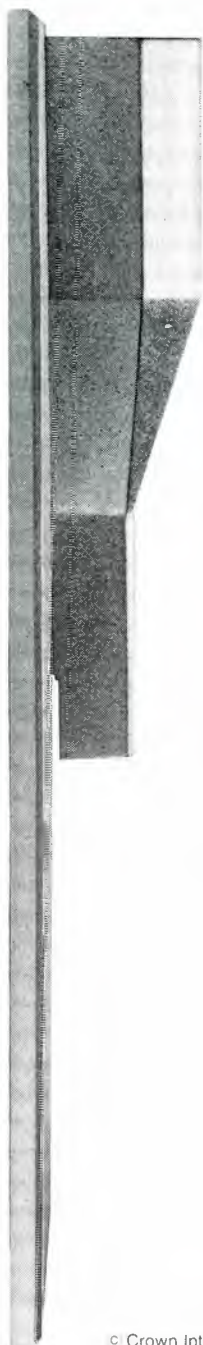

Singers and speakers can move more freely around the PZM. Gain related to distance will change, but not tonal quality.

The PZM responds accurately to SPL up to 150dB. You can put it right inside a drum, a bass fiddle, or a piano. The PZM hears whispered conversations in an ordinary room at thirty feet. In certain situations where undesired ambient noise can't be eliminated, or in halls with poor acoustics, the PZM probably should not be used – it will pick up everything.

Singers, orchestra conductors, pianists, percussionists, broadcasters have all tried – and praised – the PZM.

Recording engineers find that the PZM suggests new miking techniques. For small groups it now seems that the best place for a PZM is on the floor! Recording and reinforcement may well require fewer PZM mikes.

Several PZM models are now available, including a clip-on and recessed model for permanent installation.

The PZM is changing ideas about how a microphone ought to sound, look and be used. Find out for yourself how it might improve your own recording or reinforcement systems.

*Write for information on the PZM.
Or call us at 219/294-5571.*



© Crown International. 1980



1718 W. Mishawaka Road, Elkhart, Indiana 46517

Innovation. High Technology. American. That's Crown.

PZM. PZMicrophone and Pressure Zone Microphone are trademarks of Crown International.

CROWN INTERNATIONAL

1718 W. Mishawaka Road, Elkhart, IN 46517

(Mail this coupon to Crown.) Send PZM info. Hurry!

Name _____

Company _____

Address _____

City _____ State _____ Zip _____

Phone _____

Circle 49 on Reader Service Card

TELEX®

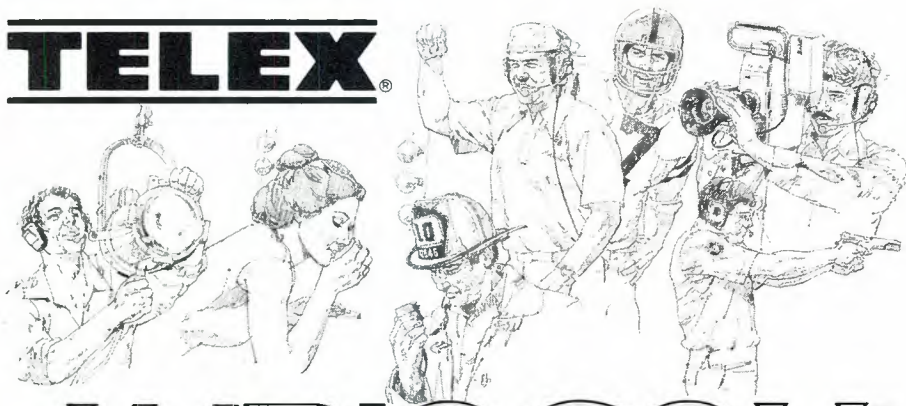

AUDIOCOM™

THE INTERCOM SYSTEM

A closed circuit headset intercom system for small, large, portable or fixed installations. AUDIOCOM, for concerts, stage productions, film or TV studios, sports stadium or race track, industrial, military or public safety applications.

AUDIOCOM, for short or long distance (over five miles), requires only simple wiring and readily interfaces with other sound systems including telephone circuits. Options include tone or light signaling, paging, program feed and rechargeable battery packs in case of power failure.

AUDIOCOM Switchboard, portable or rack mount, segregates six external intercom lines into three separate non-interfacing circuits. For example, stage, lighting and sound crews can communicate independently, jointly, or may be mixed. Contains 24 Vdc power supply with optional, rechargeable battery pack. Smaller power supplies also available.

AUDIOCOM Intercom Stations, belt pack or wall mount, can be "daisy-chained" by the dozens without degradation in signal quality or strength. Listening control and mike switch included. Unused inputs mute automatically to prevent system noise.

AUDIOCOM Paging Speakers, portable or wall mount, feature volume level switch. Also serves as a paging station.

AUDIOCOM accessories include noise cancelling boom-mike-headsets or hand mikes, suitable even for high noise environments. An Interface unit adapts to 2, 3 or 4 wire systems with balanced or unbalanced circuitry. Cables, extension cords and "T" connectors for convenient, virtually limitless system layout.

Quality products for the audio professional



TELEX®

TELEX COMMUNICATIONS, INC.
9600 ALDRICH AVE. SO., MINNEAPOLIS, MN 55420 U.S.A.
EUROPE: 22, rue de la Legion-d'Honneur, 93200 St. Denis, France.

Circle 48 on Reader Service Card

liminary diagnosis. This usually consists of two hours of set-up and take-down, without even so much as powering up the equipment mains. I am skeptical that the Davis' can accomplish the same job in 2.88 seconds. If they are referring to some small part of the measurement process, I believe they should state which part of the process is speeded up.

The article states that TEF has 100 techniques superior to current ones. I am familiar with Heyser's articles in JAES, and one significant disadvantage of the TDS process is its linear frequency axis. And like all classical measurement methods, the lower frequency limitation on a TDS measurement is often determined by the size of the room. The article implies no such limitations when it states, "Truly TDS-ETC is an instrumentation system limited only by the wit of the user to apply it and interpret the results."

The very specific quantitative parameters listed under "The Ideal ETC Response" imply these to be accepted or proven scientific requirements. Although based on a few selected quotes by knowledgeable authorities, no carefully controlled scientific studies have been cited proving their criteria superior or preferred by listening tests. The large amounts of technical data immediately preceding these "criteria" imply that the recommended early reflection times are mathematical axioms, rather than being the authors interpreted opinions.

However, I must strenuously object to the abstract which is apparently pulled from the last paragraph. A typographical error makes it unclear whether the authors meant to say, "Utilizing equipment already used by most acoustical consultants," or "competent acoustical consultants." Surely, most acoustical consultants throughout the world do not use the \$17,000 package of FFT analyzer, frequency synthesizer, or the particular wave analyzer that the authors picture. I would hope that, in future articles, the authors refrain from any judgement of their colleagues.

Name and Address withheld

db gets in the last word

db replies:

As Mr. Rettinger's letter makes clear, his recent db article was written after seeing and hearing an LEDE control room.

As for us here at db, if "QEI" is defined as printing both sides of a story, then we're delighted to plead guilty. To re-cap, our editorial question was: "Which is it to be then; live-end or dead-end? Rettinger

GO AHEAD. STOMP YOUR FEET!



You've got an ATM Instrument Microphone System.

 You're on stage to make music, not noise. But most microphones will respond to everything that hits them. Including noise coming through the mike stand. Except these new ATM microphone systems. Because each of these specially-designed instrument mikes includes a *very* effective shock mount and a windscreen.

Even if you're on a "bouncy" stage, you needn't tiptoe when an ATM microphone system is at work. Distracting noises are reduced... not amplified. Including floor resonances from speakers nearby. Or the clunks when you raise or lower the mike. All the audience hears is your chops.

But a great microphone system is not just a shock mount or a piece of foam. At the heart of our systems are

three superb studio-quality microphones: a unidirectional dynamic, a unidirectional condenser and an omnidirectional condenser. Road tough? Of course. But with response specially tailored with uncanny accuracy for instrument reproduction.

With these ATM microphones a trumpet is bright, not strident. Trombone is dark but not murky. Reeds are full but not thick. And drums are crisp and clean, not fuzzy or thumpy. For two important reasons.

First, frequency response is smooth and peak-free and extends well beyond the limits of your instrument. So the balance between overtones and fundamental isn't distorted. And one part of your range isn't favored over another.

Second, and equally important is our wide dynamic range... designed

to capture and amplify all of yours. It's almost impossible to overblow our ATM dynamic, for instance. And our electrets will handle up to 130 dB with ease. So your *fff* crescendo won't come out just *ff*.

Great sound and no distractions. The best possible way to start your sound system working *for* you. ATM Instrument Microphone Systems are waiting for you at leading pro music dealers everywhere. Kick up your heels! AUDIO-TECHNICA U.S., INC., 1221 Commerce Drive, Dept. 110BD, Stow, Ohio 44224. In Canada: Audio Specialists, Inc., Montreal, P. Q.

audio-technica®

Great sound right from the start!



Model ATM10SM
Omnidirectional
Fixed-Charge
Condenser

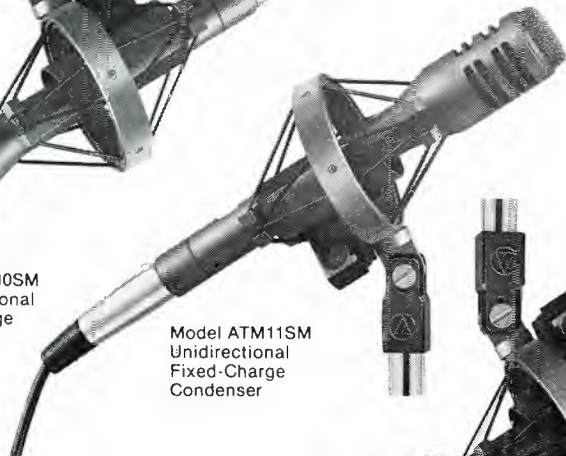

Model ATM11SM
Unidirectional
Fixed-Charge
Condenser



Model ATM21SM
Unidirectional
Moving Coil
Dynamic



All systems include
microphone, stand mount,
shock mount, foam windscreen,
and carrying case.

Circle 47 on Reader Service Card

knows" (that "some will prefer...reflecting surfaces. Others will choose an absorptive treatment").

Rettinger concludes by saying, "...there is no disputing personal taste." And we conclude by saying the same thing, even if some will therefore dispute our editorial integrity.

Some further notes:

Don Davis is co-author of "Sound Systems Engineering," which was reviewed in the February 1976 Sync Track column. Michael Rettinger's "Acoustic Design and Noise Control" was reviewed

in February, 1974 (2nd edition) and again in June, 1980 (3rd edition). The Davis and Rettinger books are available from db (see our book page for the details.)

Lord J.W.S. Rayleigh is the author of "The Theory of Sound" which is available in a two-volume paperback reprint from Dover Publications, New York.

TO THE EDITOR:

Just a note of thanks for the prominent mention of NCAC in your article on architectural acoustics in the June, 1980 issue of db. You covered the pertinent points relating to services rendered by

NCAC members in the area of architectural acoustics and I know our members appreciate it.

I would like to request that if you publish a Directory of Studio Construction Services again, that you consider a footnote which would indicate that there are architectural acoustics consultants available for design services rather than for complete design and construction turnkey type services.

Our Directory 1980-81 Supplement is just off the press. The Supplement, which updates the bi-annual Directory, is being sent free to all holders of the Directory.

Again, thanks for your interest in our organization.

VINCENT J. MILLER
Executive Director,
National Council of
Acoustical Consultants

db replies:

Thanks for the footnote, and the kind words about db. NCAC's Directory Supplement lists eight new member companies, plus some address changes, list of officers, etc.



GUARANTEED to improve - and enhance - any fine stereo component system!

The Patent-Pending DIFFERENTIAL COMPARATOR circuitry of the "SCAN-ALYZER"/EQUALIZER IS THE KEY TO HIGH PRECISION ACCURATE EQ analysis. The basic simplicity of the DIFFERENTIAL COMPARATOR circuitry makes it possible for even a novice to accurately EQ his room and his system, yet that same circuitry is so highly accurate it can actually be used for 0.1 dB laboratory measurements in EQ analysis. This combination of

equalizer and analyzer creates a functional component that should be an integral part of every high quality home stereo system. The "SCAN-ALYZER"/EQUALIZER with its accompanying COMPUTONE CHARTS, can be used in a home stereo system for so many important functions we can't begin to list them here. See your nearest Soundcraftsmen Dealer, or circle Reader Card, for complete information.

5 EQUALIZERS
from \$249 to \$550



SE450—SILVER OR BLACK \$249



RP2201-R \$299



RP2215-R \$370



TG3044-R \$550

3 STATE-OF-THE-ART
PREAMPS, \$399 to \$699



SP4001 \$549



SP4002 \$699

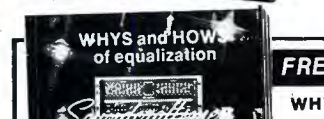

SP4003 \$399 (not shown)

3 CLASS H 250w AMPS
from \$649 to \$949



EA5003 \$949



MAS002—\$799
PAS001—\$649 (Not Shown) Ⓢ

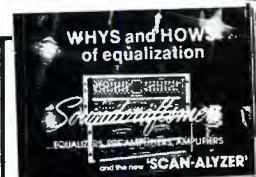

FREE! 16-page Full-Color Brochure

WHYS and HOWS OF EQUALIZATION

Includes TEST REPORTS, complete specifications, Class "H" amplifier ENGINEERING REPORT, EQ COMPARISON CHART, and the "WHY'S & HOW'S" of equalization—an easy-to-understand explanation of the relationship of acoustics to your environment. Also contains many unique IDEAS on "How the Soundcraftsmen Equalizer can measurably enhance your listening pleasures," "How typical room problems can be eliminated by Equalization," and a 10-POINT "DO-IT-YOURSELF" EQ evaluation checklist so you can FIND OUT FOR YOURSELF WHAT EQ CAN DO FOR YOU!

this publication is available in microform

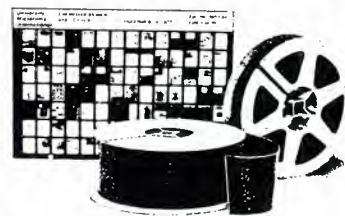

Please send me additional information.
University Microfilms

International
300 North Zeeb Road
Dept. P.R.
Ann Arbor, MI 48106
U.S.A.

18 Bedford Row
Dept. P.R.
London, WC1R 4EJ
England

Name _____
Institution _____
Street _____
City _____
State _____ Zip _____

SEND \$6.00 FOR EQUALIZER-EVALUATION KIT: 1-12" LP TEST RECORD, 1 SET OF CHARTS, 1 CONNECTOR, 1 INSTRUCTION FOLDER
Made in U.S.A. by SOUNDCRAFTSMEN INC. • 2200 South Ritchey • Santa Ana, CA 92705 U.S.A.

Circle 23 on Reader Service Card

AIM HIGH FOR MORE HITS. DEPEND ON AMPEX TAPE.

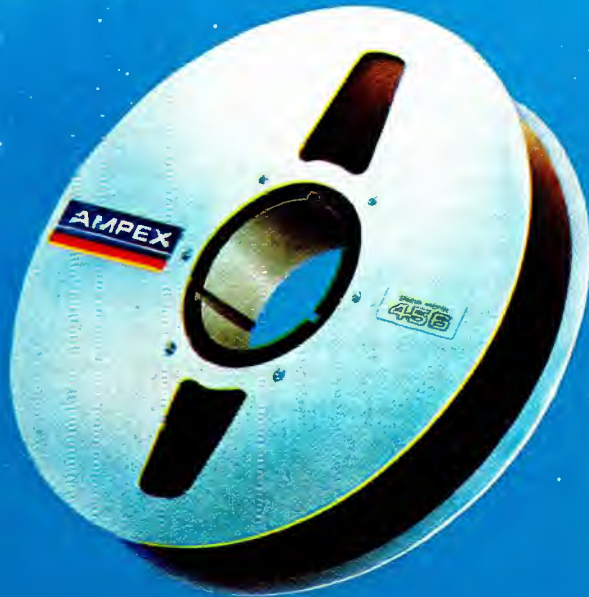

3 OUT OF 4 RECORDING STUDIOS DO.

In just 7 short years, Ampex Grand Master 456 Professional Recording Tape has become the unquestioned leader. And it is now used by 3 out of 4 recording studios in America. Ampex professional tape is used to master more hit albums than all other brands combined. Impressive facts. But, so are the reasons.

For one thing, Ampex 456 has a wider dynamic range than any other professional recording tape. It's bias compatible, so you won't have to waste valuable studio time adjusting bias. And it's a "hotter" tape—the kind that professionals demand.

Naturally, Ampex 456 has all the other characteristics you'd expect from a professional recording tape. Like the highest possible signal-to-noise ratio and a saturation capability that's the best in the business. It also has the industry's lowest distortion, unwavering physical stability, high durability, and the ability to perform perfectly after the most prolonged or adverse storage conditions.

If you still can't decide which tape to use for your next session, here's a simple test. Ask 4 studios. Ask 40. Odds are they'll recommend Ampex 456.

AMPEX

**REFLECTIONS OF REALITY.
AND BEYOND.**

Ampex Corporation, Magnetic Tape Division,
401 Broadway, Redwood City, CA 94063 415/367-4463

Circle 29 on Reader Service Card

GRAND MASTER
456

Implementation of the Analog-to-Digital Conversion

• The ADC (analog-to-digital converter) can be built in several different ways, depending on the nature of the signal to be converted. To begin our discussion, let's consider the most direct implementation, even though it is useless for audio. Since the ADC must determine which pair of quantization levels bracket the analog signal, there is a need for a special device called a comparator. This compares the sign of the difference between the analog signal and a fixed threshold. It is like an amplifier with very high gain on a differential input and very high bandwidth. The major difference between a comparator and an OP amplifier is that the comparator is designed to operate without feedback and its normal output state is one of the two saturation voltages. Typical saturation limits are

0 volts and +5 volts, depending on the sign of the difference. These saturation voltages correspond to the nominal TTL digital levels. A comparator is generally very fast: with a switching time on the order of 100 nsec or less, it goes from one saturation level to the next whenever the input crosses the threshold.

The basic ADC architecture is thus a comparator at each quantization level. FIGURE 1 shows the circuit for a three-bit converter using eight comparators with thresholds set at -3.5 , -2.5 , -1.5 , -0.5 , $+0.5$, $+1.5$, $+2.5$, and $+3.5$. The input signal appears simultaneously on all of the comparator "+" inputs. Clearly, those comparators which have thresholds above the input level will produce 0 as outputs, and those below will produce 1 as outputs.

Notice that this group of comparators does the conversion since the analog input (continuum) is transformed to a set of digital outputs (1 and 0). However, the format of the comparator outputs is not that of a binary word. Consider an input of +1 volt, which is between the third and fourth quantization levels; the eight digital outputs from the comparators are 0,0,0,1,1,1,1,1. These eight lines of digital information can be converted to the usual binary *word* format with a "priority encoder." This is a digital circuit that produces a three-bit word which specifies the number of the input line which has a different value than its neighbor. In this example, the encoder's output would be the digital word 4 (100) to indicate that the input was between the quantization levels +0.5 and +1.5 volts.

This implementation is instantaneous in that a change in the input signal will immediately result in a change in the digital word, assuming high speed logic and comparators. The sampling process is added by a clock which loads a digital storage register with the encoder's output at a periodic rate. The encoder can change its state whenever the input crosses a threshold of one of the comparators, but the register will only change to that value at the clock (sampling) time.

Because this type of conversion is direct and rapid, it is called a "flash" converter. Although conceptually simple and easy to build, it suffers from the impossible burden of requiring 2^n comparators, since each quantization level needs one. Even a model 10-bit ADC for audio would result in 1024 comparators. A 16-bit system would result in an absurd 65,536 comparators.

Since this is out of the question, the flash converter is only used where extremely high speed is required with a few numbers of bits, such as video digitization. An eight-bit flash converter

Figure 1. A 3-bit Flash converter using 8 comparators, a priority encoder, and a clocked output register.

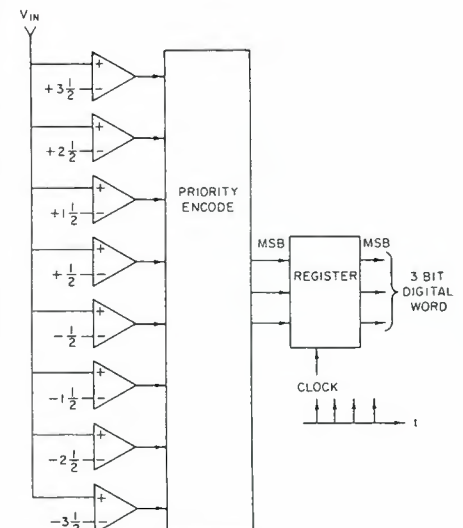

Get Aligned Stay Aligned

with STL precision magnetic test tapes

These dependable tapes are used by broadcasters, recording studios, equipment manufacturers, governments and educators throughout the world.

STL offers the most accurate reference in the widest variety... Alignment, Sweep, Pink Noise, Level Set, Azimuth and Flutter/Speed. Available on reels, in broadcast carts, in home carts and in cassettes...2" to 150 mil tape widths. Also available is the Standard Tape Manual and the Magnetic Tape Reproducer Calibrator.

Write or phone for fast delivery or free catalog.

STL
STANDARD TAPE LABORATORY, INC.
26120 EDEN LANDING ROAD #5, HAYWARD, CALIFORNIA 94545 • (415) 786-3546

Circle 20 on Reader Service Card

NEI Your Profound People

We believe in continuously incorporating the very latest proven electronic advancements into our equipment. NEI engineering refinement yields configurations that are simple and clean. Sophisticated analyzers, crossovers, equalizers and mixers at affordable prices. Design your sound with NEI.

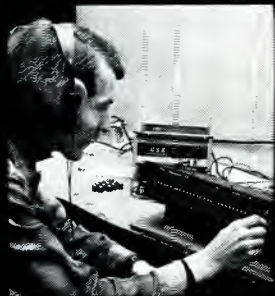

Circle 14 on Reader Service Card

NEPTUNE ELECTRONICS, INC.
934 N.E. 25th Avenue

Portland, Oregon 97232
503/232-4445

module is at the limits of today's technology. However, such a converter can digitize signals at a 20 MHz rate.

SUCCESSIVE APPROXIMATION

An alternative configuration must be used for audio since these signals require a large number of bits, but the sampling rate is relatively low. The basic element of this technique is the use of a DAC to create the quantization levels and one comparator. Consider a digital n-bit counter with the n bits connected to a DAC, as shown in FIGURE 2. For a given state of the counter, the DAC produces the corresponding analog voltage which can then be compared to the input. At

each clock, the counter advances, and the DAC produces a voltage corresponding to the next quantization level. At some point, the DAC's output will be greater than the input. The comparator then opens the switch to stop counting. The digital word in the counter thus corresponds to the first quantization level which is above the input. Hence, this is the best approximation to the input. By analogy to normal circuit design, we can say that the DAC is operating in a feedback mode to create an ADC. The counter-switch logic is effectively trying to determine the best digital word, which when converted to an analog signal, will give the best approximation to the input.

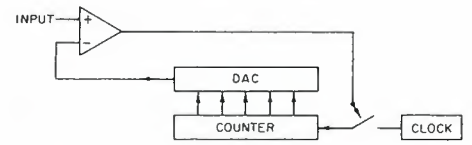

Figure 2. A sequential ADC using a counter and DAC to compare against the input sample. The counter is stopped when the DAC's output is greater than the input.

We can also say that the comparator is being multiplexed in time to be used 2^n times with different thresholds. This architecture would not be very good for audio if we had 16 bits, since it would take 65,536 clock cycles to do a complete conversion. If we had only 20 μ sec (50 kHz sampling rate) to determine one of 65,636 levels, the master clock would have to be 3 GHz.

We can, however, modify the above design so that there need only be 16 threshold tests for 16 bits instead of 65,536 tests. This is done by replacing the counter of FIGURE 2 with the special circuit seen in FIGURE 3, called a successive approximation register (SAR). This functions like the game of twenty questions. Consider the operation of a five-bit ADC having a maximum range of ± 1 volt and a quantization interval of $1/16$ volt between levels. We illustrate the operation with an input of $+13/32$ volts. The first cycle of the SAR places a digital 0 onto the DAC and the comparator can compare the unknown input to 0 volts. The comparator can now determine if the input is positive (greater than 0) or negative (less than 0). Our "unknown" input of $+13/32$ is of course positive and the comparator puts out +5 (high) to so indicate. Notice that all of the negative quantization levels no longer need be tested, since we know that the input is positive.

On the next cycle of the SAR, it places the digital word 01000 ($+16/32$ volts) on the DAC. The comparator compares this value with the unknown input, and and it outputs a 0 to indicate that the

Figure 3. Classical successive-approximation type ADC using a special successive approximation register to speed up the convergence.

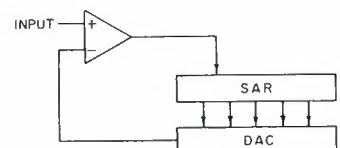

BIGGER PROFITS PROVEN PRODUCT VAST MARKET

AEI Foreground Music offers substantial new opportunities for increasing your sound contracting business and your cash profits. Our program combines high-profit equipment sales, continuing monthly music residuals, warrantied equipment, and satisfied customers. We've got the whole package — and the best one. Just send us the coupon for our free literature on how easy it is to become a well-paid AEI dealer.

Audio Environments Inc.
619 East Pine Street Seattle, Washington 98122 206/329-1400

I want to know more about the AEI Foreground Music program.

name _____

address _____

city _____

state _____

zip _____



Circle 31 on Reader Service Card

THE NEVE 8108

The most advanced audio console ever!

The 8108 Range.

Just introduced to the world at the AES Exhibition in Los Angeles in May 1979, this thoroughly new console range received much praise for the quantum leap in sound recording technology it represents. Building on their computer/digital experience earned through the successful NECAM Computer Mixing System, Neve engineers have developed the technically superior 8108 range. The console is in production and early deliveries are now being made to several West Coast top name studios. The 8108 Range is available in 56/48, 48/32 or 32/24. Join the Neve world of excellence. Please call or write for our beautiful 8108 brochure.



Neve

Robert Neve Incorporated - Barksdale Industrial Park, Bethel, Connecticut 06801 Tel: (203) 744-6230 Telex: 969638

Robert Neve Incorporated - Suite 609, 6255 Sunset Blvd., Hollywood, California 90028 Tel: (213) 465-4822

Robert Neve of Canada, Ltd. - 2721 Reza Road, Malton, Ontario L4T 3K1, Canada Tel: (416) 677-6611 Telex: 983502

Neve Electronics International, Ltd. - Cambridge House, Melbourn, Royston, Hertfordshire, SG8 6AU England Tel: (0763) 60776

Robert Neve GmbH - 6100 Darmstadt Bismarckstrasse 114, West Germany Tel: (06151) 81764

Circle 38 on Reader Service Card

unknown is less than $+16/32$. From the previous test, we also know that the input is greater than 0. Hence, it is between 0 and $+16/32$. On the next cycle of the SAR, the DAC has the digital word 00100, corresponding to $+8/32$. This time the comparator says that it is greater than this value. The range of possible inputs has now been restricted to between $+8/32$ and $+16/32$. The next cycle of the SAR places 00110, corresponding to $+12/32$, on the comparator. Again, the comparator indicates that the input is larger, so that the next test will be $14/32$. This test on the comparator shows that the input is less than this value. The process has now been completed and the

SAR has determined that the input is between $14/32$ and $12/32$ volts. This is the best possible approximation for a five-bit conversion. Notice that the number of cycles is equal to the number of bits in the word. A 16-bit conversion thus requires only 16 comparisons to determine which pair of the 65,536 possible quantization intervals bracket the input signal. The reason that there are so few comparisons is that a comparison at a given part of the cycle is a function of the information which was gained on the previous cycles. Just like the game of twenty questions, the choice of each new question is a function of the previous answers.

We should also note that the critical component for implementing the ADC is the same DAC which we described in the previous article. It is for this reason that the DAC is so critical, since it is the key element in both analog-to-digital and digital-to-analog conversions. One of the major differences between them, however, is the speed of response. In the digital-to-analog conversion, there is one digital data word to be converted per audio sample. With the successive approximation technique for analog-to-digital conversion, the DAC is used 16 times per audio sample. Hence, in the ADC, it must be at least 16 times faster. In many situations, the speed difference is very critical.

In the first cycle of the SAR, the DAC places a 0 volts on the comparator threshold. The DAC and comparator must come to the right decision in about $1 \mu\text{sec}$, since the next cycle of the SAR will then begin. Moreover, this decision must be accurate to within the same tolerances as the DAC itself. A specification of $1/2$ LSB (least-significant bit) error for a 16-bit ADC having a maximum signal of ± 10 volts, is only 3 millivolts. A 10-volt step change in the DAC, in going from the first to the second cycle, must settle to within 0.001 percent during this $1 \mu\text{sec}$. This corresponds to about ten time constants, or, the time constant must be 100 nsec. This is high speed indeed for analog signals.

SAMPLE-HOLD

In an earlier article we described the sampling process which extracts a single analog voltage from the time-continuous audio signal. With an understanding of the successive approximation ADC, we can now see that this sample must be held for $t_{\text{c}} \mu\text{sec}$ the duration of the successive approximation. The game of twenty questions would never culminate in an answer if the object could change in the middle of the questioning. Similarly, the input voltage must be held absolutely constant for each of the 16 comparator tests.

We should note that the requirement of an input sample-hold is really two different issues. The sampler extracts a single value from the input audio: this is a theoretical requirement. The hold of that sample is required only by virtue of the particular implementation of the ADC. A flash converter would not require a hold function.

The specifications on the sample-hold function are also quite strict. The held value should stay constant to within a fraction of the quantization interval. In our example of a ± 10 -volt range and 16 bits, the sample hold should stay constant to within 1 millivolt after having sampled the signal. This turns out to be difficult, since limitations of switches and capacitors are such that the signal tends to move during the hold interval.

We will examine the consequences of the various non-idealness in subsequent articles. ■

Pick your signal

VIZ means value... DC to 40 MHz —



More magic from the Wizard of VIZ



Pulse Generator WR-549A \$130

- Ideal for logic design or digital circuit trouble shooting
- Output 5 Hz to 5 MHz $\pm 5\%$, 0-15 V into 600Ω , 0-6 V into 50Ω
- Pulse width adj. 100 ns to 0.1 sec., rise and fall time 20 ns
- TTL and CMOS compatible, on and off time independently adj.



Function Generator WR-550B \$150

- Sine, sawtooth and square wave output, 1Hz to 1MHz
- Output 0-20 V peak to peak at 600Ω plus 10 V adj. offset
- 10 to 1 freq. sweep with ext. sweep voltage of any wave form
- Freq. stability 200 ppm/ $^{\circ}\text{C}$
- Accuracy to 100 kHz $\pm 5\%$ of dial. Above 100 kHz, $\pm 8\%$
- Separate fixed 4 VDC square/sawtooth wave outputs compatible with TTL and CMOS.



Audio Generator WA-504B/44D \$139

- Switch selectable sine or square wave output
- Output 20 Hz to 200 kHz in 4 ranges
- Stability better than $\pm 0.5\%$
- Voltage output 4 ranges .01 to 10 V at 600Ω
- Sine wave harmonic distortion 0.15%
- Square wave rise and fall 150 nsec. Tilt 2%



RF Generator WR-50C \$130

- RF output tunable 85 kHz to 40 MHz in 6 ranges
- Special sweep output at 455 kHz and 10.7 MHz, plus external xtal
- RF output .05 V rms, 2 step 10 to 1 plus fine adj. attenuator
- Internal modulating freq. 600 Hz adj. to 80%
- Audio output 6 V rms across $15\text{ k}\Omega$ load
- FET amplifier for rugged stability

See your VIZ distributor



VIZ Mfg. Co., 335 E. Price St., Philadelphia, PA 19144
Over 70 test instruments in the line

Circle 46 on Reader Service Card

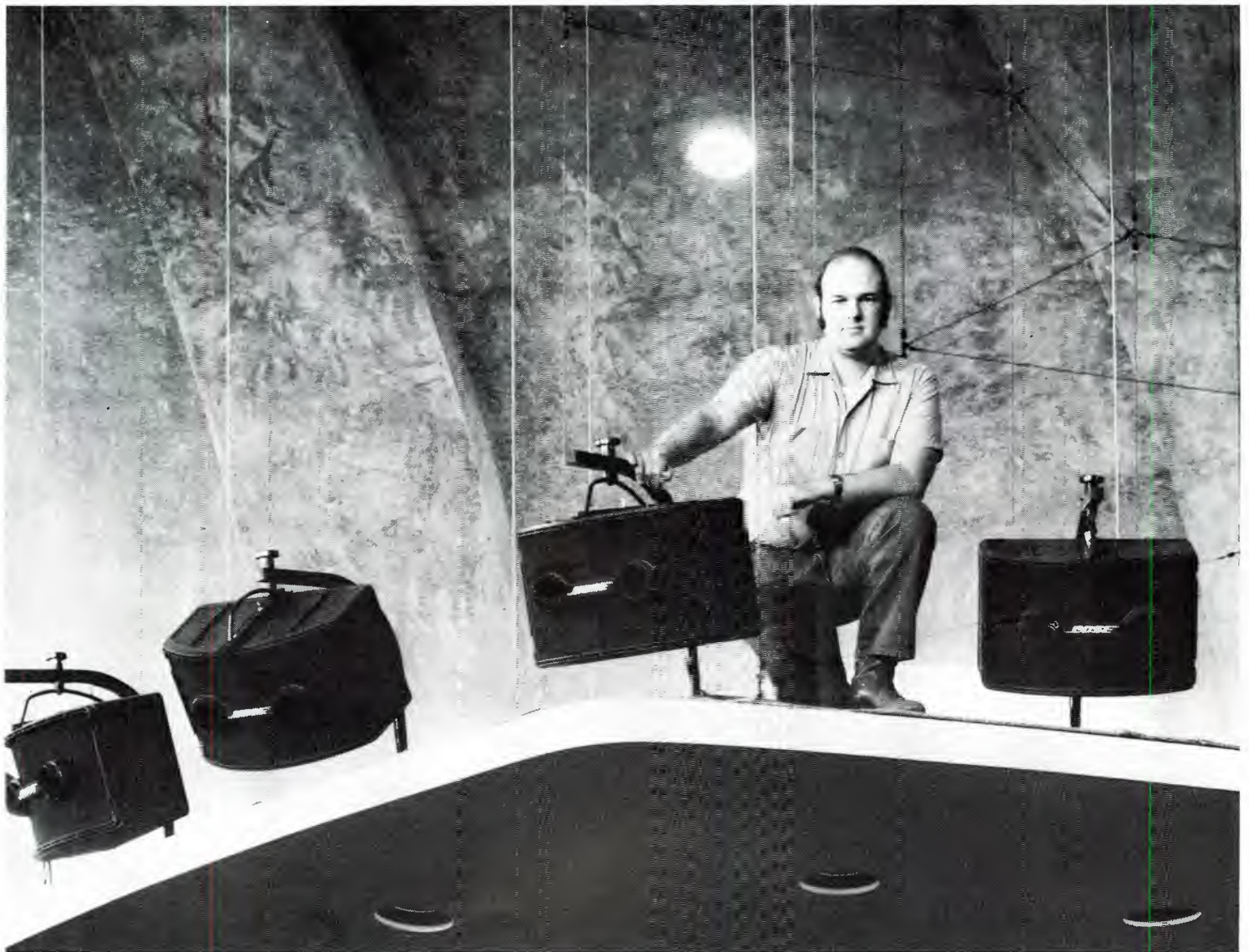

“...a clarity that was not there before.”

Fifty-eight hundred seats. Two million cubic feet. The Auditorium, World Headquarters of the Reorganized Church of Jesus Christ of Latter Day Saints, is the largest domed auditorium in the United States not used for athletic events. Its 92-foot dome and elliptical geometry could make it an acoustical nightmare. But it isn't.

The original sound system, of nine multicell horns and six bass cabinets, has been replaced by just eight Bose® Model 802 speaker systems. Even more startling is that the entire system is powered by just 200 watts total. This new sound system is used for speech and music reinforcement and playback of recorded material. For conference and convention use it is operated with up to 16 open microphones.

The most authoritative judge of the system is RLDS Church audio engineer Robert Haworth. He speaks from nine years of intimate knowledge of the hall, including almost a full year with the Bose system.

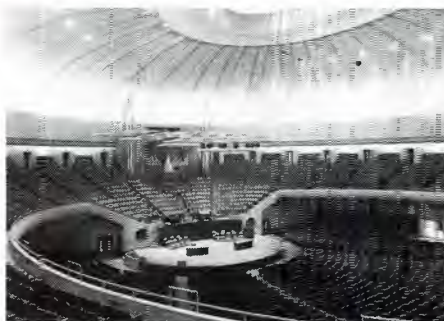

Haworth says, "There is a clarity to this system that was not there before. The old system had that narrow, hornlike sound. The Bose system has given us a large improvement in intelligibility, especially in the farthest areas of the room. It has also eliminated the dead regions we had with the old system, providing very even coverage of the room."

BOSE®

Better sound through research.

Perhaps the Bose Model 802 can help a sound system job that you're involved with. Write for our new Engineers' and Architects' Design Guide to get complete specifications.

Bose Corporation, Dept. SE
The Mountain
Framingham, MA 01701

- Please send me the 802 Engineering Bulletin and the complete Bose Professional Products Catalog.
- Please have your representative contact me.

Name: _____

Firm: _____

Street: _____

City: _____ State: _____ Zip: _____

Tel. () _____

Patent rights issued and/or pending.
© Copyright 1980 Bose Corporation

Corrective Devices

• The helical scan video cassette recorders in use today—for all professional purposes but network broadcasting—were originally meant for amateurs. A few years ago no one really expected professional quality out of helical scan. But today, many people assume that ¾-inch machines have improved enough over the last few years to allow us to make a living with them. That assumption would be, to a great extent, wrong. There have not been many inherent improvements in the helical scan process at all, and certainly not enough to produce recordings measurably better than ones of ten years ago.

There have been a great many changes in the recorder itself, but most affect the signal *after* it is on tape. The improvements that have allowed helical scan to produce a quality image are all of a regulating, correcting variety; the most important part of this process goes on outside the recording deck. This is embodied in processing amps, time base correctors, and test equipment that line up in an image-fixing chain that brings the helical scan hardware package up to broadcast quality.

Looking back over the textbooks that I taught from only a couple of years ago—not to mention the ones that I learned

from just before that—is instructive in a way those books were never meant to be. Outdated technical material is not merely a measure of how far we've come (in so short a time), but how our view of some of the very same material has changed.

Back a couple of years ago, it was anticipated that fundamental changes in the recording process would contribute to an increased availability of video. But then the videodisc slipped into the consumer playback bracket instead. It's just now coming to market—some ten years after it was supposed to be “right around the corner.” Some (electronic video recording) may never get much

Dub a dub, dub a dub, dub.



The Garner 1056 High Speed Professional Tape Duplicator.

The Garner 1056 delivers perfect dubs time after time, with unmatched precision and accuracy. We challenge you to find a superior unit.

Never before has a duplicator combined such precise performance characteristics for such a reasonable price. The compact design and convenient control panel make operation and installation the easiest you'll find. The Garner 1056 High Speed Professional Tape Duplicator...perfect duplication plus a lot more.

- Fast 60 ips duplicating speed
- Two-minute tape loading
- Glass bonded ferrite heads
- Three-year mechanical warranty
- Common capstan eliminates speed variance between master and slaves
- Compact, self-contained console
- 100% solid-state integrated circuitry

Look to Garner for quality electronic audio and video products. For more information, write or call: **GARNER INDUSTRIES**

4200 N. 48th St., Dept. DB-11 Lincoln, NE 68504 • Phone 402-464-5911



Circle 24 on Reader Service Card

con·stant di·rec·tiv·i·ty

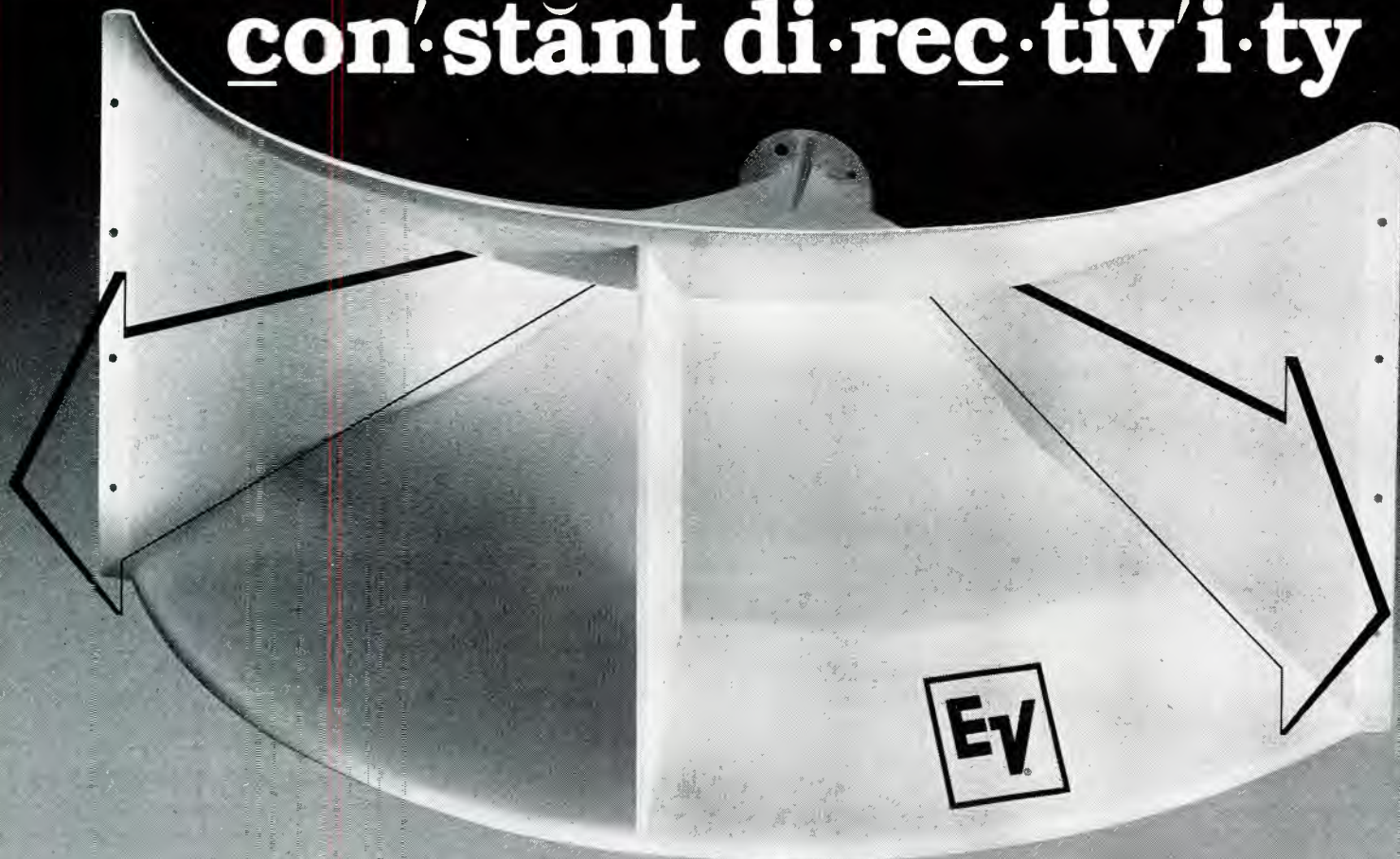

The characteristic of a horn that directs all of the frequencies where you want them to go.

Most horns offer some control of the sound pattern they produce. The problem is that frequencies at the center of the pattern are different from those at the edges.

Unless you use **HR Constant Directivity horns**, that's the problem you'll have. To the audience this means unintelligible, too bright, too dull, and sometimes just plain bad sound at many seats.

These patented **HR Constant Directivity horns** from Electro-Voice provide full-range frequency coverage and effectiveness of pattern control

unheard of before E-V engineers developed this unique design concept.

Demand for the "white horns" has grown dramatically—almost completely by word-of-mouth. Once a sound engineer, musician or facility owner hears the difference **HR Constant Directivity** makes, a new demand is created.

Ask someone who has used or heard them, or buy a pair and try them yourself. You'll probably hear that HR horns are so clearly superior that other choices are obsolete.

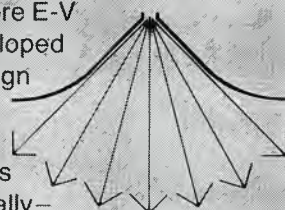

Write to Electro-Voice for more information. We'll send you a complete set of Engineering Data Sheets and a paper comparing the today performance of HR constant directivity horns with yesterday's promises. Include \$1 with your request, and we will put you on the mailing list for the E-V "PA Bible," a down-to-earth series of papers on the selection and application of professional PA products and concepts!

¹U.S. Patent Number 4071112.

E-V Electro-Voice
a gulton company

600 Cecil Street, Buchanan, Michigan 49107

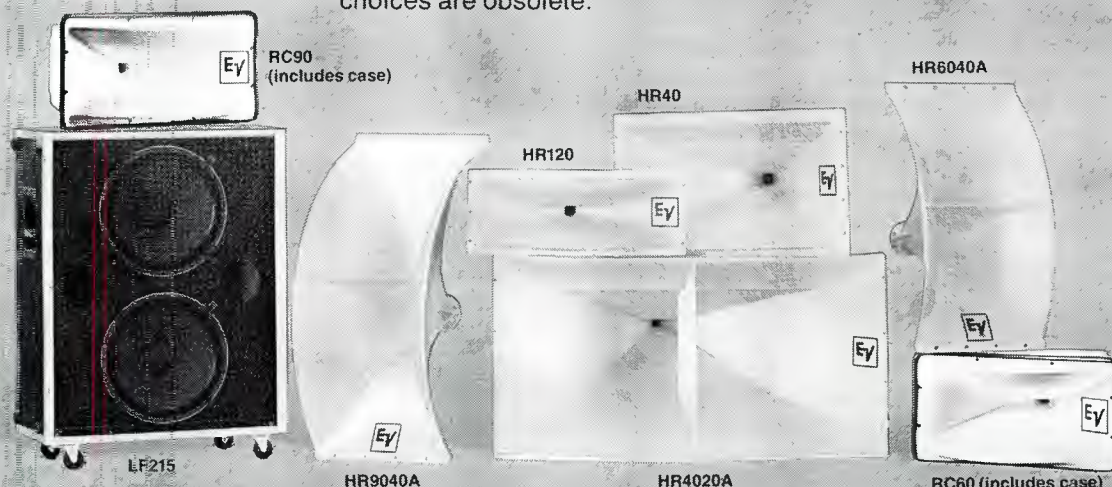

Circle 28 on Reader Service Card

www.americanradiohistory.com

beyond the experimental stage, but still, their development has helped the research on other processes currently used. So, instead of fundamental changes, it's an ongoing refining process that has brought helical scan, the amateur's medium, to a professional level.

THE PROCESSING AMP

How does this chain of image improvement work? A processing amplifier (proc amp) has a few less uses than generally reputed; it is not quite the total cure-all video newcomers think it is. But the fact that it appears to be, certainly points out its effectiveness at what it does, which is to clamp the signal, as well as generate and replace proper sync.

The "clamp amp" function eliminates low frequency modulation. In the picture this looks like alternately lighter-and-darker horizontal bars, and is caused by a 60 Hz disturbance in the baseline, viewed at a vertical rate. Typically, the trouble may be due to a difference in ground potential between each end of the cable. Since the cable shield carries the video signal, it can add to it the 60 Hz AC difference between ground points, developed across the reactance of the cable shield, ground and connector. The amp works by clamping or returning each sync pulse tip to the same DC potential. Usually, only a very long line will produce such low frequency modulation, and the clamp amp was developed

to cure it. In some clamp amps, horizontal blanking is returned to a pre-determined DC potential, determined by sampling the front porch pulse level. (The "front porch" is the time interval between the start of the blanking signal and the start of the sync signal.)

The proc amp developed out of being merely a clamp amp by adding the function of sync pulse generator. Helical scan units have inherently distorted and noisy sync pulses, so the proc amp found its way to becoming so ubiquitous. Together the two functions perform a third, replacing gaps of several lines in the video, where one head leaves one edge of the tape and the other head enters the other side. The interval varies in width and position in different recorders—even in different units of the same model. Most often, the lines are dropped somewhere at the bottom of the picture, before the vertical interval. The monitor may interpret this gap as vertical sync, causing a jittery picture (only one of a few causes of jitter, hence the overbelief in the power of the proc amp). So the proc amp should be used whenever dubbing between two helical VTRs, when going from 1/2-inch to 3/4-inch, and must be used when moving up to quad.

While the proc amp corrects the total number of lines, the TBC (time base corrector) corrects the length of each

line. Ideal line length should be 63.5 μ secs, and the first and most accurate TBCs correct each line, "line by line." A correction window is designated, say 5 μ secs, so that it will correct any line within 5 μ secs of 63.5 μ secs. If the error is greater, it will not be able to correct it. The first analog TBCs had narrow correction windows (the first manufactured in quantity was Television Microtime's in the mid '70s), while the present digital models have wider windows. Sometimes they employ a PLL to determine the time between sync pulses and speed up the process; if the sync changes quickly, the PLL will miss a few lines.

Most of helical scan's problems are caused by varying line length ("flag waving," or bending at either edge of the picture, and jitter are the symptoms). The difficulties of proper tension control and perfect stability of all the associated moving parts are incredible and apparently, always inherent. To cut down on as much of this as possible—so that even a wide-window TBC can handle the input, the VTR feeding into it must have a capstan servo—it must be an editing deck.

Among the various manufacturers of TBCs, slightly different means are employed to correct line length. Analog systems may use electronically controlled delay lines, which alter delay time with an external control signal. Or, a switchable delay line may switch sections, or "lumps," in or out to change the length of several lines at once, the video remaining at baseband frequencies for both.

Digital TBCs convert the video signal to digital, then store it in a revolving three-memory process. One memory stores a line, while another is holding the previously-stored line, while the third is transferring the next line advanced into a digital-to-analog converter. In the middle phase, while a line is stored, the digital TBC adds or subtracts from it to bring every line (within its window) to 63.5 μ secs.

Color TBCs will correct chroma phase errors within each line by velocity error circuitry that works in basically the same digital way. There are now many TBCs that can work so fast as to operate directly between a 3/4-inch helical deck and broadcast. This is exactly the type of refining advance that was not deemed possible at all a few years ago—except for those with a gleam in the eye.

Although the first TBC was analog, since then most have been digital in some sense. It seems to me that the function of the TBC, even when not performed digitally, is a situation of digital thinking. So, in a real sense, the ability to produce high-quality video from helical scan at all is one of the first fruits of digital correction. Such a basically messy system as helical scan screams out for digital techniques, and has spurred the onset of a digital age in all things video. ■

**mikes by mail? for less?
why not!™**

and much more!

**The Mike Shop™ now sells audio equipment
as well as mikes by mail! for less!**

Write or call us with your requirements or for our price sheet.



The Mike Shop™

PO Box 366A, Elmont, NY 11003 (516) 437-7925

A Division of Omnisound Ltd.

Circle 21 on Reader Service Card

GAIN BRAIN II

Now...a limiter/compressor and *ducker* that understands MUSIC

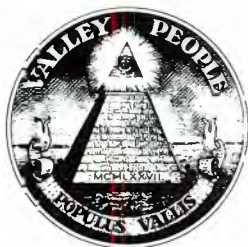
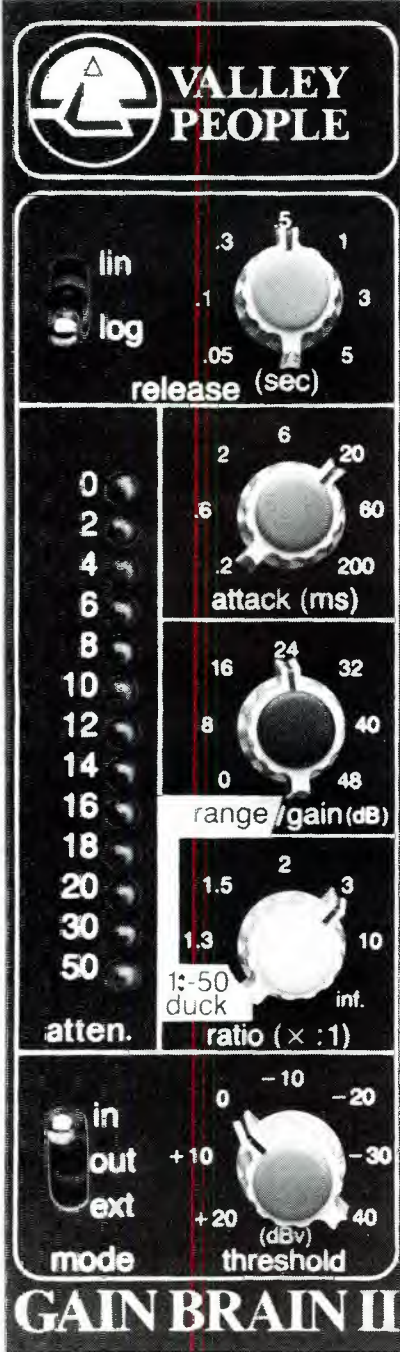

VALLEY PEOPLE, INC.
a merger of ALLISON RESEARCH & VALLEY AUDIO
P.O. Box 40306/2820 Erica Place
Nashville, Tennessee 37204
615-383-4737
TELEX 558610 VAL PEOPLE NAS

Strong words? We're prepared to back them up. Just listen to **GAIN BRAIN II** and you'll agree it's the only real advancement in dynamics control in nearly a decade.

GAIN BRAIN II is fundamentally different from any other limiter/compressor device, including our own Allison **GAIN BRAIN I**. The others struggle along with Peak and RMS detection methods that squash and flatten the life out of music, as if it were a laboratory test signal. **GAIN BRAIN II** treats music waveforms with greater respect and understanding. It does this by means of exclusive circuitry: Linear Integration Detection, Log Domain Processing, Peak Reversion Detector Correction, and the most transparent VCA ever created by man—namely our own EGC 101.

Sure, these are new words; we invented them. Just like we invented the technology that goes with them. Audibly effective technology that allows **GAIN BRAIN II** to solve the great limiter paradox: tight control vs. musical integrity.

GAIN BRAIN II can give you the *flattest VU meter output of any limiter/compressor device in existence*, while maintaining an *unheard of degree of integrity to the subtle dynamics of music and speech*. And it's a ducker, too.

And the **GAIN BRAIN II** phenomenon is just the beginning. Get your copy of our **GAIN BRAIN II** literature package. Once you've read it, you'll understand the full implications of our new technology. Better yet, get yourself a **GAIN BRAIN II**. Your ears will tell you all you need to know.



KEPEX II Our original KEPEX® is credited as the most successful signal processing device of the 70's. We're flattered by the imitators who widely advertise claims that they have "improved" on our design.

One fact remains: More studios buy KEPEX than *all* of the imitations combined, yet we seldom advertise the equipment. Does that tell you anything?

There does, however, exist a genuine "improved KEPEX". It's not a copy though, it's an original in its own right. We call it KEPEX II®. New technology from the ground up. New capabilities for the 80's: new controls, new functions, and best of all, dramatic new levels of audio transparency thanks to our EGC 101 VCA.

Today, more people buy KEPEX II than all of the others. Find out why this is true.

Travelling Goodies New for the 80's ... the TR-804 Processing package. It holds KEPEX II®, GAIN BRAIN II, and the host of unique processing equipment now under development at VALLEY PEOPLE. TR-804

combines all of the advantages of a portable "goodie box" for the freelance engineer/producer, with the benefits of multiple device rack mounting for the serious studio. Ample connections and powering assure its ability to accept future products.



Circle 15 on Reader Service Card

www.americanradiohistory.com

Information Theory

• If digital technology is to improve what can be done in audio, we need to learn to think in terms of information theory. This is a science that quantizes the "amount" of information that can be conveyed in a specified form, or through a specified medium. In digital terms, it is specified in terms of "bits."

A bit is a single element in information theory that can exist in one of two states, on or off, yes or no, 1 or 0. Thus, it closely relates to the binary system. If a system can handle so many millions, or billions of bits per second, that is a measure of its capacity in information theory.

Assume that we want to accurately register the contour of a waveform by giving its amplitude at intervals of 50

microseconds. That is a full period at a frequency of 20 kilohertz, which we assume to be above the upper limit of human hearing for most individuals. Now, if our information system has a capacity of a million bits per second, each amplitude registered can have 50 bits. Suppose we reduce that to 40, to allow for an interval of separation between each piece of coded "information."

If we think of that in binary, we can register the amplitude at each 50-microsecond instant with an accuracy of 2^{40} ($= 1.09 \times 10^{12}$), which is a little more than 10^{12} . That would be a better replication of any waveform than anyone ever dreamed possible. But now, two questions: (a) Is that degree of accuracy, or that application of it, really

necessary or meaningful? And (b), is it applying the available capacity for information in the best possible way?

To answer the first question, it would appear not. Perhaps this approach is not applying the technology to its best advantage. Plenty of research has shown that the precise shape of a waveform is not that important in certain respects. A waveform that consists of a precise combination of fundamental and harmonics can take a variety of shapes without changing that precise combination. And, if in fact it does so, our hearing cannot detect any change.

What this says is that such relatively large changes in waveform shape are inaudible to the human ear. However, much smaller changes, if they are caused by the introduction of spurious fre-

4600 SMPTE Tape Controller

Before you do another multi-track session, call us for a personal introduction to electronic audio editing.





Cherokee Studios, Hollywood, California.

JBL 4313 Studio Monitor. It flattens the competition.



Introducing the 4313.

Flat frequency response. It means accuracy. Naturalness. Reality.

JBL gives it to you without the bigger box that you'd expect along with it, since the 4313 only measures about 23" x 14" x 10"!

This new, compact professional monitor produces deep, distortion-free bass. And does it with a newly developed 10" driver. Its massive magnet structure and

voice coil are equivalent to most 12" or 15" speakers. Yet it delivers heavy-duty power handling and a smoother transition to the midrange than most larger-cone speakers.

The 4313's edge-wound voice coil midrange accurately reproduces strong, natural vocals and powerful transients.

Up top, a dome radiator provides high acoustic output with extreme clarity and wide disper-

sion. A large 1" voice coil gives it the ruggedness needed in professional use.

Working together, these precision matched speakers offer superb stereo imaging, powerful sound levels and wide dynamic range.

Audition the 4313 soon.

We think you'll agree that its combination of flat response, power and moderate size flattens the competition.

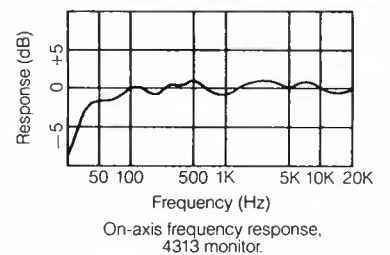

James B. Lansing Sound, Inc.,
8500 Balboa Blvd.,
Northridge, California 91329.

JBL First with the pros.

Circle 37 on Reader Service Card

quency elements, will be quite audible. This then would seem to argue that expending all that information capacity to accurately reproduce a waveform's exact shape is basically useless. What is far more important is the precise frequency content of the waveform.

How are we going to go about digitizing frequency content? How many frequencies in our system do we want information about? We have determined that human hearing, in one respect at least, behaves as a very sophisticated wave analyzer, or measurer of frequency content. So how accurately does human hearing register the frequency content of sounds we hear?

Throughout the musical scale, we hear semitone intervals quite reliably. There are 12 of them to an octave, and the range from 20 hertz to 20,000 hertz contains ten octaves, or 120 discrete frequencies. Musicologists can define smaller changes than that as being flat and sharp of designated discrete frequencies. They divide each semitone into 100 cents, and the smallest interval the average person can hear is about 5 cents.

This means that the whole range of frequencies audible to the human ear could be represented with about 2,400 frequencies, distributed 5 cents apart, from 20 hertz to 20,000 hertz. Obviously a system could get by with less, but it certainly would never need more.

When we talk about amplitude, we are talking about the amplitude of each frequency component as measured at some instant in time. The smallest change in amplitude of an individual signal, barely discernible with very careful listening, is 1 dB. The full range, from threshold of hearing to threshold of pain, at maximum, is 120 dB. In binary, 7 bits will cover a range of more than 120 whatever—in this case, dB.

So, if each frequency of the 2,400 is registered for its level, within 1 dB, over a 120 dB range, which again is being generous with the needs, that requires 16,800 bits.

Finally, how often do the bits need to be taken and how often should the frequency content be analyzed? The smallest interval between sounds, such as a percussive tap, that can be heard as two distinct sounds, is about 5 milliseconds, maybe a little more. Therefore, we should have about 200 per second, to put them at 5 millisecond intervals.

This would require over 3 million bits per second. But we have been somewhat extreme in our definition of requirements. There is only a 120 dB range of hearing over a much smaller range of frequencies than from 20 to 20,000 hertz, just a range from about 1,000 to 3,000 hertz. That is only about an octave and a half, or 360 frequencies out of the 2,400, beyond which a smaller intensity range

will be enough.

Also, 1 dB change in level can be heard only by very critical listening. Obviously, by making compromises in areas where the ear could not hear the difference, the information requirement could come down considerably. But there is one more area which demands serious thought: the interval question. We based that on 5 millisecond intervals, because that was the smallest interval at which two sounds of a percussive nature could be heard at separate entities.

If a percussive sound, such as a tap, continued to be produced at regular 5 millisecond intervals, it would sound like a rather-rough 200 hertz tone, because 5 milliseconds is the interval between periods at 200 hertz. This means that occasionally the ear can distinguish sounds 5 milliseconds apart as separate, but that when that interval is repeated, it becomes a frequency.

Actually, thinking of it that way, we already counted a decade of frequencies, or about 720 of them, between 20 hertz and 200 hertz in our first calculation of information requirements. So we have an overlap that we are accommodating in two ways at once. That should be unnecessary.

So, assume that we apply information theory to minimize redundancy and have a nice streamlined system that will replicate any sound our ears might

THANKS!

FOR LETTING US SERVE ALL YOUR AUDIO NEEDS



MURRAY
ALLEN
President

FOOTE
KIRKPATRICK
Studio Mgr.



UNIVERSAL RECORDING CORPORATION

46 E. Walton Street Chicago, Illinois 60611 • 312/642-6465

3M DIGITAL • NEVE NECAM • VIDEO SWEETENING

DOLBY CAT. NO. 155

A TWO-CHANNEL AUDIO NOISE REDUCTION UNIT



FOR THE SONY BVH-1000/1100

Dolby noise reduction has been applied to videotape recorder sound tracks for many years by using external noise reduction units, such as the highly successful Dolby Laboratories' 360 series. The new Cat. No. 155 has been designed specifically to incorporate Dolby A-type noise reduction within the Sony BVH-1000/1100 videotape recorder. Like other professional Dolby noise reduction units, it provides 10 dB of noise reduction, from 20 Hz upwards, rising to 15 dB at 9kHz and above.

Two fully independent channels are provided in the Cat. No. 155, which plugs into an existing unused circuit card location in the BVH-1000/1100, with minor changes to the backplane. The front panel meters and gain controls on the BVH-1000/1100 are used in the normal manner; a bypass switch allows for instant removal of the noise reduction card from the signal path, restoring the videotape recorder to its unmodified state.

Today, with wide audio bandwidth and low noise becoming the norm in many parts of the television origination/transmission chain, the improvement in

the S/N ratio on the audio tracks of VTRs is a significant step in the quest for improved television sound. When applied to those tracks, the Dolby System's 10 dB of noise reduction results in VTR audio performance which is in line with professional audio tape recorders. The Dolby system uses a complementary technique which applies compression and expansion to low level signals only, in four independent bands. The result is noise reduction with none of the audible side effects, such as noise modulation and overshoot distortion, associated with more conventional noise reduction techniques. Since its introduction in 1966, the Dolby system of noise reduction has become widely accepted throughout the world for high quality tape recording and in other audio transmission and storage media. The new Dolby Cat. No. 155 brings the benefits of the Dolby system to television audio in a form particularly suited to the purpose.

The Cat. No. 155 is now in quantity production and will be displayed at SMPTE by Dolby Laboratories in booth 120-121.

DOLBY LABORATORIES, INC., 731 Sansome Street, San Francisco CA 94111, Phone (415) 392-0300, Telex 34409 • 346 Clapham Road, London SW9, Phone 01-720 1111, Telex 919109. Dolby and the double-D symbol are trademarks of Dolby Laboratories Licensing Corp.

Dolby[®]

normally hear. To make it binaural, we have a similar information system to replicate what each ear would normally hear.

What we then have is a system that would replicate a stereo—or more accurately, binaural—program that would convey to our ears an illusion of the sound it represented that would be indistinguishable from the original. For purposes of sound reproduction, it would be as good or better than anything we have on the market today. In most audio engineers' view, it would be more complicated than anything we now have, but with modern digital technology, it might be produced more cheaply than anything we have today, and thus from the business point of view, would be considered a competitive system.

In today's multitrack systems, whether analog or digital, each track carries a recording of a separate source of sound which can be blended together, using the mixer's art, to produce two channels of stereo or binaural, or perhaps four of quadraphonic. But, given any of those final outputs, today's technology would be hard put to regenerate the multitrack, individual sound source tracks, from which they were produced. Unmixing poses problems.

Yet the human hearing faculty seems to have a remarkable capability for unmixing, provided it receives signals

that are amenable to that process, by having the necessary low distortion in various already-determined aspects. An information system, such as we have outlined, could at least do as well in that respect by providing our hearing faculty with the "inputs" necessary to achieve that internal unmixing.

Can information theory be extended to achieve some of what the human hearing faculty can do? This really gets into a different field; data processing. But information theory could put the data into a form suitable for such processing. No way can an accurately reproduced waveform of the sounds delivered to each ear be directly processed to enable individual instruments or other sources of sound to be identified and separated. But the information theory analysis we pursued earlier could be a step toward doing that.

The important thing is to recognize that what human hearing receives is not the analog waveform that enters each ear, but a digitized analysis of it, after a form of frequency analysis.

At each step in such a sequence, the prospective designer must ask himself, "How good does this need to be?" This is not a new question, just an old one in a new context. We remember when the question was; how much distortion is audible to the human ear? Carefully-made measurements determined that

human hearing could not hear harmonic distortion of less than five percent.

How could such measurements have been so far off? In past days, loudspeakers with less than five percent distortion would have been hard to find, so reducing amplifier distortion to less than that meant that what the ear then heard was the loudspeaker distortion. Also, hearing is definitely educable. We are learning to listen from the moment we are born.

This means that sounds that are indistinguishable to us at one time may become quite distinguishable with a little more listening practice. This has been demonstrated many times with linguists. Every nationality has its own set of pronunciation. For instance, when an Englishman tries to learn French, he finds that Frenchmen distinguish vowel sounds between which, at first, the Englishman cannot hear any difference.

Another example is the oriental confusion between the "r" and "l" sounds. They sound quite different to our ears, because we have always distinguished between them. But they are sounds the Oriental finds strange, so he has difficulty learning to tell the difference.

Applied to our problem, it means that we will continue learning to listen and, as better equipment is developed to reproduce and perhaps eventually to unmix the way our hearing does, we will go on learning to listen more critically. ■

The Orban 672A: A Dream Equalizer at a Practical Price



The 672A is a single-channel equalizer offering astonishing control and versatility. There are eight non-interacting parametric bands with reciprocal curves and the convenience of graphic-style controls. Highpass and lowpass filters with 12dB/octave slopes that tune continuously over a 100:1 frequency range. And, separate outputs that let you use the 672A as an eight-band parametric cascaded with an electronic crossover in reinforcement and monitor tuning applications.

The dream equalizer is usable practically *everywhere* in professional and semi-professional sound: recording studios, cinema, theater, reinforcement, broadcasting, disco — you name it! Yet its price is down-to-earth. And, it's built to full professional standards.

Check it out at your Orban pro-audio dealer.

orban

Orban Associates Inc.
645 Bryant Street
San Francisco, CA 94107
(415) 957-1067

THE NEW SONY DAE-1100 IS THE WORLD'S MOST ADVANCED DIGITAL AUDIO EDITOR. IT'S ALSO THE EASIEST.

Rounding the corner at the AES, you'll come face-to-face with a revolution: the Sony DAE-1100 digital audio editor. It's the best, it's the easiest, and it's on sale now.

The Sony DAE-1100 gives you unheard-of editing accuracy. Unheard-of because its unique "search dial" locates your edit point with a precision closer than the width of a razor blade. A precision far past the threshold of audible discrimination.

But equally important, lighted buttons flashing in sequence guide your fingers, making the DAE-1100 virtually mistake-proof. In fact, the DAE-1100 frees you so completely from technical demands, that for the first time, purely musical considerations will shape your editing. Meanwhile, the remote-control key-

board goes where your studio needs it, while the "guts" get stashed away.

Best yet, you can start using the DAE-1100 right away because it interfaces with the Sony PCM-100, PCM-1600 and PCM-1610 Processors. And it will be right at home with other revolutionary Sony digital audio products scheduled for imminent delivery.

**AFTER YOU VISIT THE DAE-1100,
THE DAE-1100 WILL VISIT YOU.**

Sony will bring the DAE-1100 to your studio and cemo it—even if you're not yet equipped with digital audio. See Sony's Roger Pryor at AES, between October 31st and November 3rd, in the Sony suite, room 600k. Or call him now at **SONY** Digital Audio (415) 467-4900.



© 1980 Sony Corp. of America, 9 West 57th St., NY, NY 10019. Sony is a registered trademark of Sony Corp.

Circle 27 on Reader Service Card

(from page 30)

Communicator



MARK 200 FULL-DUPLEX

COMMUNICATOR FEATURES:

- Compatible with many hard wire PL systems including RCA, RTS, Clear-Com, etc.
- True Hands Off Operation
- One-half mile usable range, typical
- Push To Talk for system expansion
- Data information input
- Compatible with many popular headsets including PLANTRONICS MS50, BEYER DT109, SHURE SM12, ROANWELL, ASTROLITE, MINILITE, TELEX, etc.
- Dimensions and Weight - 7.5" L x 4.7" W x 1.9" D, 2 lbs.
- Fast change "SNAP-IN" NICAD battery Pack
- A MARK 200 System consists of two MARK 200 transceivers, antennas, batteries and carrying case, headsets

swintek ENTERPRISES INC. 1180 ASTER AVENUE
SUNNYVALE, CA 94086
(408) 249-5594

Circle 39 on Reader Service Card

INTERFACING DIRECT BOXES FOR GUITARS & KEYBOARDS



SM-4
Simple Passive Direct Box

SM-1A
Deluxe Passive Direct Box

SM-2
Simple Active Direct Box

SM-3
Deluxe Active Direct Box

Send For Your Free Copy Of Our Catalog

SESCOM, INC. (702)384-0993
Professional Sound Division (800) 634-3457
1111 Las Vegas Blvd. North TWX 910-397-6996
Las Vegas, NV 89101 U.S.A.

Circle 33 on Reader Service Card

P.A. SPEAKER SYSTEM

• Cerwin-Vega's new V-30X full-range, portable P.A. speaker system is based on a line of second-generation compression drivers and a new high-power 15-in. woofer. The 153EV 15-in. driver utilizes a high flux density 6-in. magnet and high-temperature, voice-coil construction. The high-output, H-25 compression driver operates above 2.5 kHz and features a copper-clad, aluminum wire voice-coil, driving a cross-hatch linen dome. A rigid ABS horn flare with internal damping serves to tailor the horizontal dispersion for audience coverage. The V-30X crossover features an auto resetting circuit breaker on the high-frequency horn unit for protection at high-power. The input panel has a pair of paralleled 1/4-in. phone jacks, enabling the user to connect two 8-ohm units on a single amplifier channel.

Mfr: Cerwin-Vega

Price: \$400.00

Circle 81 on Reader Service Card



DUAL LIMITER

• The Dual Limiter functions like two independent limiters that can be strapped together via front panel switches for stereo-limiting applications. Each channel has an in-out switch, slope switch, input, output, attack and release controls, as well as an LED meter displaying the amount of gain reduction. Its ability to drive 600-ohm loads, +19 dBm input and output capability and standard rack dimensions of 19-in. long x 1 3/4-in. high x 6-in. deep, allow it to be employed in any professional system.

Mfr: MXR

Circle 82 on Reader Service Card



TRANSIENT LIMITER

• The EMT 266 is an audio frequency limiter using feed-forward and variable pre-emphasis techniques to control signal transients in FM broadcast transmitters and disk cutting systems. By employing a 300 microsecond analog delay line in the signal path, the limiter's control circuitry is able to calculate the gain reduction required for each transient before it arrives. The "adaptive pre-emphasis" circuit of the EMT 266 further processes this limited signal via a variable time constant filter. The EMT 266 is a rack-mountable unit intended for hands-off operation.

Mfr: Gotham Audio Corp.

Circle 83 on Reader Service Card



(continued on page 34)

The Tascam 16-Track System.



Chair not included.

All this for the price of a 2-inch recorder.

If you don't need 2-inch compatibility or 24 tracks, you don't have to pay the price for expensive 2-inch hardware.

Instead, you can own the heart of a 16-track studio.

The Tascam Model 15 Mixer. 24-in 8-out 16-track monitor with a comprehensive cue system that can be fed simultaneously by 48 signals.

The Tascam 85-16 Recorder/Reproducer. A 1-inch transport with 16-track integral dbx.*

And the Tascam 35-2B Mastering Recorder. A 1/4-inch 2-track with integral dbx.

With this Tascam 16-track system, you'll get professional sound at an affordable price. And because it's all new equipment, you save even more with tax credit potentials.

Write to us today for the name of your nearest authorized Tascam dealer. He'll show you how a Tascam 16-track system can fit your studio needs and your budget.

TASCAM

TEAC Production Products Group

*dbx is a registered trademark of dbx inc.

©1980 TEAC Corporation of America, 7733 Telegraph Road, Montebello, CA 90640

Circle 36 on Reader Service Card

STANDARD TAPE MANUAL



This valuable data book is for the AUDIO recordist, engineer or designer. Offered at \$45.00 you may order direct from publisher.

MAGNETIC REPRODUCER CALIBRATOR



This is induction loop equipment of laboratory quality for primary standardization of tape recorders and tapes. Send for detailed information, prices and formats.

R. K. MORRISON ILLUSTRATIVE MATERIALS

819 Coventry Road
Kensington, CA 94707

Circle 50 on Reader Service Card

Audio Connectors Jacks, Plugs Patch Cords SWITCHCRAFT BRAND

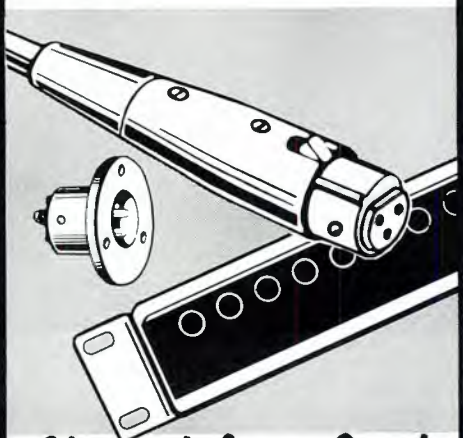

Shipped from Stock

ASK FOR OUR CATALOG
OF PRO-AUDIO SPECIALTIES

Polyline Corp. 312/298-5300

1233 Rand Rd. • Des Plaines, IL 60016

18

Circle 52 on Reader Service Card

(from page 32)

DIGITAL EDITOR

- The DAE-1100 incorporates an SMPTE time code generator/reader, allowing any chosen point to be memorized and quickly located at a later time by the automatic locator. Digital LED display counters for both recorder and player(s) are capable of displaying up to 23 hours, 59 minutes, 59 seconds and 29 frames. The DAE-1100 features a "search dial" that can locate an edit point with greater precision than the width of a razor blade and insures smooth edits by the use of a gain offset fader to equalize the edit-in and edit-out points. A range of cross-fade times from one millisecond to 99 milliseconds assures audio continuity, and provides highly flexible fade-in and fade-out effects. With the use of the preview feature, the edit can be monitored, then adjusted for varying volumes, cross-fade characteristics, and exact edit points. Once the edit is chosen, the operation is completely automatic.

Mfr: Sony Industries

Price: \$45,000.00

Circle 71 on Reader Service Card



MIXER

- The AD 049 Mixette is a new, lightweight, professional mixer for sound recording on location. Its four microphone input channels have 80 dB, 60 dB and 40 dB gain setting. Input levels of 10 dB can be handled in the 40 dB position. Each channel has a high pass filter to reduce wind noise problems. Measuring 10½-in. x 8-in. x 3½-in. and weighing 6½ lbs., the unit can be powered by a clip-on battery pack or from a regulated d.c. power source (12-24 d.c.)

Mfr: Audio Developments

Circle 72 on Reader Service Card



PROFESSIONAL TAPE RECORDER

- The TSR professional 24-track tape recorder features compact remote and autolocate, transformerless input and output, common capstan frequency for interlocking tape machines, 14-in. reel capacity and 2-in. cast and machined aluminum deck plate. The company claims that the record/replay electronics design provides 5 to 6 dB savings in signal-to-noise ratio over comparable machines. The unit is 44.5-in. high x 30-in. wide x 25-in. deep and weighs 250 lbs.

Mfr: Trident Audio

Circle 73 on Reader Service Card



(continued on page 36)

Beyer. We make the best broadcast mics, too.

In recording studios, concert halls and theatres worldwide, Beyer is the premier name in microphones. Loved by performers and respected by engineers.

Now that same Beyer quality is available in a full line of innovative broadcast microphones, to meet every need and solve every problem.

The Beyer MCE 5 is the world's smallest electret condenser and provides true broadcast-quality audio from a 7 x 23 mm. cylinder weighing just 6.5 grams. It has wide frequency response, but is immune to most body noises. And you can hide it almost anywhere and connect it to a cable or a wireless transmitter.

If you can't get the mic near the sound source, try our Beyer MC 717 shotgun. It has a directional gain of at least 20 dB and a 40-20K frequency response.

The MC 717 is part of a modular condenser mic system consisting of six different transducer capsules plus amplifiers and phantom power supplies that can be perfectly tailored for a wide range of broadcast situations. They're all ruggedly built to handle ENG as well as studio work and can accept temperatures up to 160° and 99% humidity.

Other mics include: the M 55 – an omni-directional dynamic mic that is especially suited for reporters and field interviews; the M 69 – a uni-directional hypercardioid dynamic mic that is perfect for announcers on TV and a studio mic in radio stations; the M 88 – a uni-directional cardioid dynamic mic with warm and full bass response that is ideal for booth or radio announce. This is easily one of the best mics in the business – with a special suspension that eliminates transmitted noise if hand held. Our M 201 is another microphone with excellent vocal characteristics that is favored by singers and reporters alike.

There are many more mics in the Beyer line, plus stands, booms, headsets and accessories. Visit your local Beyer distributor for more information and specs.



MCE 5



MC 717



M 55



M 201



M 88



M 69

Beyer
Dynamic

BEYER DYNAMIC, INC.

5-05 Burns Avenue, Hicksville, NY 11801 • (516) 935-8000
In Canada, H. Roy Gray, Ltd.

Circle 44 on Reader Service Card

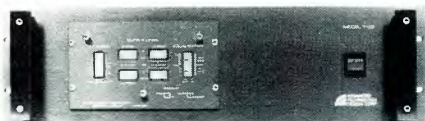

BIAMPLIFIER POWER SYSTEM

• The Model 7132 delivers 450 watts low frequency and 150 watts from each of two high frequency channels into 4-ohm loads. The dip-switch control system employed in the 7132 eliminates inaccuracies in the control of amplifier gains, crossover settings, filters and equalizers. High frequency, providing up to 15 dB boost and 20 kHz, may be independently selected for each of two high frequency channels. High-pass filters with 18 dB per octave slope at either 40 Hz or 80 Hz may be selected, and up to seven dB of band reject in one-dB steps, centered at either 100 Hz or 200 Hz, is available to tailor the signal to the performance capabilities of the low frequency loud-speaker system.

*Mfr: Advanced Technology Design Corp.
Circle 74 on Reader Service Card*

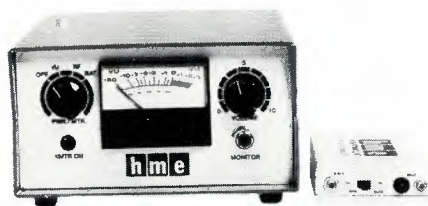

WIRELESS MICROPHONE SYSTEMS

• Four new UHF wireless microphone systems are now available from HM Electronics, Inc. These systems operate on 400-470 MHz, thereby offering the user additional open channels of use as compared to VHF radio bands alone. The Dynamic Expansion design concept reproduces the input signal linearly to over 100 dB. Both the 24E "Body Pac" and the 27E "Handheld" UHF systems are available with standard receivers as well as portable receivers for ENG/EFP usage.

*Mfr: HM Electronics, Inc.
Price: \$2,825.00-\$3,075.00
Circle 75 on Reader Service Card*



MICROPHONE ISOLATORS

• Tensimount universal microphone isolators are a simple yet effective way to eliminate floor vibration, shock and mechanical feedback that is transmitted through your microphone stands. These devices accept any microphone up to 1 3/8-inches diameter (Tensimount I), or up to 2 3/8-inches (Tensimount II), and provide more than 20 dB of mechanical isolation. Tensimounts also adapt any microphone to fit a standard 3/4-inch stand, making interchanging of microphones much easier.

*Mfr: Brewer Industries
Circle 76 on Reader Service Card*

1981 WINTER CONSUMER ELECTRONICS SHOW

Las Vegas, Nevada — January 8-11, 1981

*Largest Allotment of Lowest Price Airline Seats to the Show!!
Largest Selection of Hotel Rooms!!*

**CAESARS PALACE • DUNES HOTEL AND COUNTRY CLUB
FRONTIER HOTEL • HILTON INTERNATIONAL • ROYAL INN**

AIRLINE SERVICE FROM ALL U.S. GATEWAYS

Call Our Convention Center:

NATIONWIDE — 800 645 2182

NEW YORK — 212 347 0058

Ask for Debbie

Our full computerized Convention Center will be ready to serve your every travel need. We have a United Airlines APOLLO System which is fully interfaced with all airlines, hotels and car rental companies. We will give you instant confirmation and rate quotation! In addition we can make your seat requests and special meal requests when required. Instant printing of your tickets, itineraries and invoices—and prompt attention to any pre or post convention trips you may desire by travel experts. KARSON TRAVEL serves all major conventions—both domestic and worldwide....

KARSON TRAVEL

3185 Long Beach Road

Oceanside, New York 11572

212 347-0058 516 764-5300 800 645-2182



MICROPHONE MIXERS

• The Model 1674 (4-input) and 1678 (8-input) Automatic Microphone Mixers are two new additions to Altec Lansing's Industrial/Professional line. Both models feature balanced microphone or line level inputs with phantom power for condenser microphones, TTL compatible logic outputs for custom applications, switchable 200 Hz high-pass filters and auto/direct bypassing in each channel, and complete international selection of power standards. In addition, analog computer circuits look at the level of each input channel, compare that level to the total of all inputs, and adjust the gain of each input in a manner which holds the overall mixer gain constant. The 1674 may be used as an extension of the Model 1678, or separately for systems requiring four channels or less.

*Mfr: Altec Lansing
Circle 77 on Reader Service Card*

(continued on page 38)



THE A80VU MARK III... ANOTHER UNAPPROACHABLE STUDER!

No other multitrack recording system has ever neared the degree of perfection attained by STUDER, and the new A80VU Mark III represents one more milestone in the decade-long production of this classic machine. As always, STUDER sets and maintains the standard for the industry.

This newest A80 from STUDER has been outfitted with a completely redesigned, "close proximity" headblock for virtually undetectable drop-in/drop-out operations and totally reliable performance in the most demanding situations. Actually, the repositioning of the erase/record/playback heads is one of the few modifications made since the A80's inception, the original design being so advanced that a revision would be meaningless.

The new A80VU Mark III system includes a 20-address memory, micro-processor controlled, programmable autolocator with channel remote, which enables all tape deck functions to be operated within easy reach of the engineer at console position. The autolocator remote control is packaged as a fully-adjustable, freestanding unit.

As with all A80 models, the Mark III functions flawlessly and with satin smoothness—a machine worthy of its name and the absolute confidence professionals place in it.

STUDER A80VJ Mk III
Shown with 20-address memory
autolocator and channel remote

Circle 26 on Reader Service Card

STUDER REVOX

Studer Revox America, Inc./1425 Elm Hill Pike, Nashville, TN 37210/(615) 254-5651
Offices: Los Angeles (213) 780-4234/New York (212) 255-4462/Canada: Studer Revox Canada, Ltd.

Talk is cheap.

It's time we stopped talking about child abuse and did something. Here are some of the actions your company can take to prevent the suffering caused by child abuse and also give your community a better business environment.

We want to stop the hurt.

- We are enclosing a tax-deductible donation in the name of our company.
- We want to help. Please call our company and tell us what you're doing to stop the hurt of child abuse in our community.
- We want to make our employees more aware. We will carry an article about child abuse in our company publication.
- We will volunteer our employees' time and talent to community child abuse prevention programs.
- We will plan a day for employees' children to visit our place of work to learn what we do and why.
- I don't spend enough time with my children. Tonight I am going home early to find out who my children are.
- Please send us _____ copies of the pamphlet "Prevent Child Abuse" at 10¢ a copy for 100 copies or more.

Name _____

Company _____

Address _____

City, State, Zip _____



prevent child abuse.

write: Box 2844, CH, IL 60690
National Committee for Prevention of Child Abuse

COMMUNICATORS

• The Mark 300-S Series of communicators are designed to provide continuous closed-circuit wireless headset intercommunication for industrial or reinforcement applications. Unlike a conventional walkie-talkie, no transmit buttons have to be depressed to establish communications between two remote stations. This mode of operation limits false triggering of the transceiver system, thus blocking interfering signals. Any break in communications is immediately apparent at all stations due to loss of voice sidetone information. Other features include compatibility with many dynamic headsets, push to talk for system expansion, one-half mile range, low level input and 600 ohm output, external 12 VDC input at 100 mA, and a frequency range of 140 MHz to 230 MHz.

Mfr: Swintek Telecommunications Division

Price: \$2,850.

Circle 78 on Reader Service Card



DIGITAL DELAY PROCESSOR

• The PCM 41 (Baby Prime Time), based on the technology developed for larger systems, employs studio quality pulse code modulation (PCM) encoding for all delayed audio signals. Bandwidth is 20 Hz to 16 kHz with less than 0.1% distortion at all frequency and delay settings. Musical effects provided by the PCM 41 include double tracking, flanging, vibrato/tremolo, arpeggio, doppler pitch shift, slap echo and infinite repeat. The system contains 400 ms of delay in X1 Mode (full bandwidth) and 800 ms in X2 Mode. All major functions can be foot-switched controlled.

Mfr: Lexicon

Price: \$1,095.00

Circle 79 on Reader Service Card



IN-LINE CONSOLE

• Featuring four-band parametric equalizers and two filters, digitally-controlled status-switching of major functions with local override; conductive plastic faders; interchangeable microphone amplifiers with remote capability and optional automation; The Britannia is the newest series of in-line consoles from Raindirk Limited.

Mfr: Raindirk Limited

Circle 80 on Reader Service Card



(continued on page 40)

To the audio professional, when a compressor or limiter is needed to tame the potentially disastrous consequences of uncontrolled level or to create special effects, one name stands out as the best: UREI.

Studio Standards for more than a decade, the compressors and limiters from UREI have earned their way into thousands of recording, mastering, and broadcast installations around the world.

Because we built our reputation for unparalleled professional performance and quality with our compressors and limiters, we have continuously advanced their engineering and technology to offer more reliability, features and performance. When you need the fastest, quietest and most flexible gain control instruments available, you can be totally assured that these products will prove to you why they've earned the title — Studio Standard:

The Model LA-4

A single channel, half-rack unit with patented electro-optical attenuator. Featuring smooth, natural sounding RMS action, it offers selectable compression ratios, a large VU meter, adjustable output and threshold levels and stereo coupling.

The Model 1176LN

A peak limiter which features adjustable input and output levels; individual attack and release time controls; selectable compression ratios; switchable metering; and

stereo coupling. The 1176LN is the most widely used limiter in the world.

The Model 1178

A two channel version of the 1176LN in a compact (3-1/2) rack mounting design. Featuring perfect tracking in the selectable stereo mode, it additionally offers selectable VU or Peak reading meter ballistics.

From One Pro To Another — trust all your toughest signal processing needs to UREI.

The UREI Compressor/Limiters



UREI From One Pro To Another

United Recording Electronics Industries
8460 San Fernando Road, Sun Valley, California 91352 (213) 767-1000 Telex: 65-1389 UREI SNVY
Worldwide: Gotham Export Corporation, New York; Canada: E. S. Gould Marketing, Montreal

Circle 17 on Reader Service Card

See your professional audio products dealer for full technical information.

this publication is available in microform

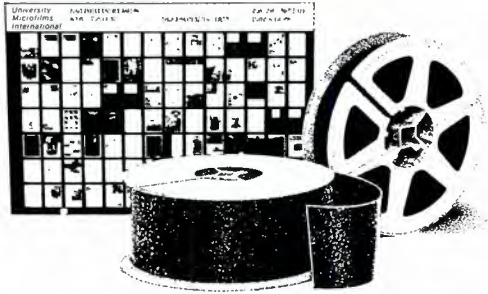

Please send me additional information.

University Microfilms International

300 North Zeeb Road
Dept. P.R.
Ann Arbor, MI 48106
U.S.A.

18 Bedford Row
Dept. P.R.
London, WC1R 4EJ
England

Name _____
Institution _____
Street _____
City _____
State _____ Zip _____

(from page 38)



PORTABLE BROADCAST AUDIO MIXING CONSOLES

• Tangent Systems, Inc. has announced their entry into high-quality portable broadcast audio mixing consoles with the new Model BC-I. Powered with an external power supply or an optional Ni-Cad Battery Pack, the carrying case-ready mixer is available from 8 to 32 inputs on a modular input channel configuration. The BC-I also features three-band EQ, three sends, conductive plastic faders, fully balanced inputs and outputs and PFL/Mute and flexible monitoring on each input. On the stereo output module, a switchable LED PPM meter is provided along with options like: RTS intercom talkback, IFB systems and down-cue switching.

Mfr: Tangent Systems, Inc.

Price: \$5400 (8 input stereo)

Circle 84 on Reader Service Card

PRODUCT LINE MANAGER

Further expansion of our professional marketing team has created an immediate opening for a Product Line Manager. Responsibilities include identifying and exploring new product ideas, evaluating product need and monitoring product introduction and development. The position involves continuous interaction with a variety of functional areas and disciplines and demands constant attention to existing products and markets.

The ideal candidate will possess a solid technical background and working knowledge of high fidelity with significant experience in the field of product management and/or marketing preferred. You must have demonstrable understanding of market conditions, retail opportunities, the constraints of design and manufacture, and the managerial talent and energy to thrive in an industrial environment committed to excellence.

We offer an attractive package of salary and extensive personal benefits in a convenient location 30 minutes west of Boston.

For confidential consideration, please send resume with salary history and requirements, to Gary LaFave, (Dept. DB), Bose Corporation, 100 Mountain Road, Framingham, MA 01701.

BOSE®

An Equal Opportunity Employer



CARDIOID MICROPHONE

• The PL91A dynamic cardioid vocal microphone is a new, refined version of Electro-Voice's PL91. Utilizing a shock suspension design that reduces handling and cable noise, the 91A, like the PL91, features a carrying case and a dent-resistant Memraflex grille.

Mfr: Electro-Voice

Price: \$115.50

Circle 85 on Reader Service Card

Jim is one of the good ol' boys of Nashville. His engineering career stretches back some 18 years to the days of mono mixing. He's done everything from pop to R&B to disco—and, of course, country. The aviation industry gave Jim his technical background. But he's also prepared himself by playing four or five different instruments. Some of the names on the other side of the glass from him include Bob Dylan; Simon and Garfunkel; Peter, Paul and Mary; Loretta Lynn; Johnny Cash; Don Williams; Marty Robbins; Conway Twitty; Ray Price; and Roy Clark.

ON SPECIALISTS

"Let me say that I have sympathy for them, because they're missing the rest of the world of music. They're locked into one thing and I got it all. I have done four different styles of music in one day. I did a disco record that got to number six on the Billboard charts, 'Dance With You.' In the same day, I did a number one country record. You don't listen to the same kind of music all the time. And I don't want to listen to the same kind of music all the time, either."

ON OVERPRODUCTION

"'Swarm.' That's my term for overproduction. I've had producers who have turned and said, 'Well, how many tracks have we got left?' You may look at the chart and say, 'Well, we've got nine tracks left.' He'll say, 'Great.' And he looks into the window of the studio. 'Hey, let's put an electric piano on.' Not because the electric piano fits the song and has a place or meaning

in the rhythm or in the feel of the song, but it's because he sees one in the room and we've got nine tracks to go. And that's overproduction, abuse of multitrack recording. And that I don't condone."

ON PLAYBACKS

"I actually mix. I don't load tape. I like to sit down at the console, set my monitor levels equal and put the band together and get a monitor mix in the control room that sounds as close as I can make it to the record, so that the producer and the artist and the musicians can hear and understand what they're doing and correct their mistakes. I'm an old mono mixer. And that's what built mono mixing."

ON TAPE

"A competitor of 3M has stated that 3M has a greater print-through than their product. It's my opinion that there is no greater print-through on the Scotch[®] 250. It's just not masked with modulation noise. There also was a comment that the competitor's tape was brighter, when in fact, there was just more third harmonic distortion in the 10 to 12 kc range. I am very stringent on monitoring in the control room. And when I hear a signal off the floor, I want it to come back off the tape the same way. I don't want it to be embellished with third harmonic distortion to make it brighter, or modulation noise to confuse the bass line."

SCOTCH 250
WHEN YOU LISTEN FOR A LIVING.

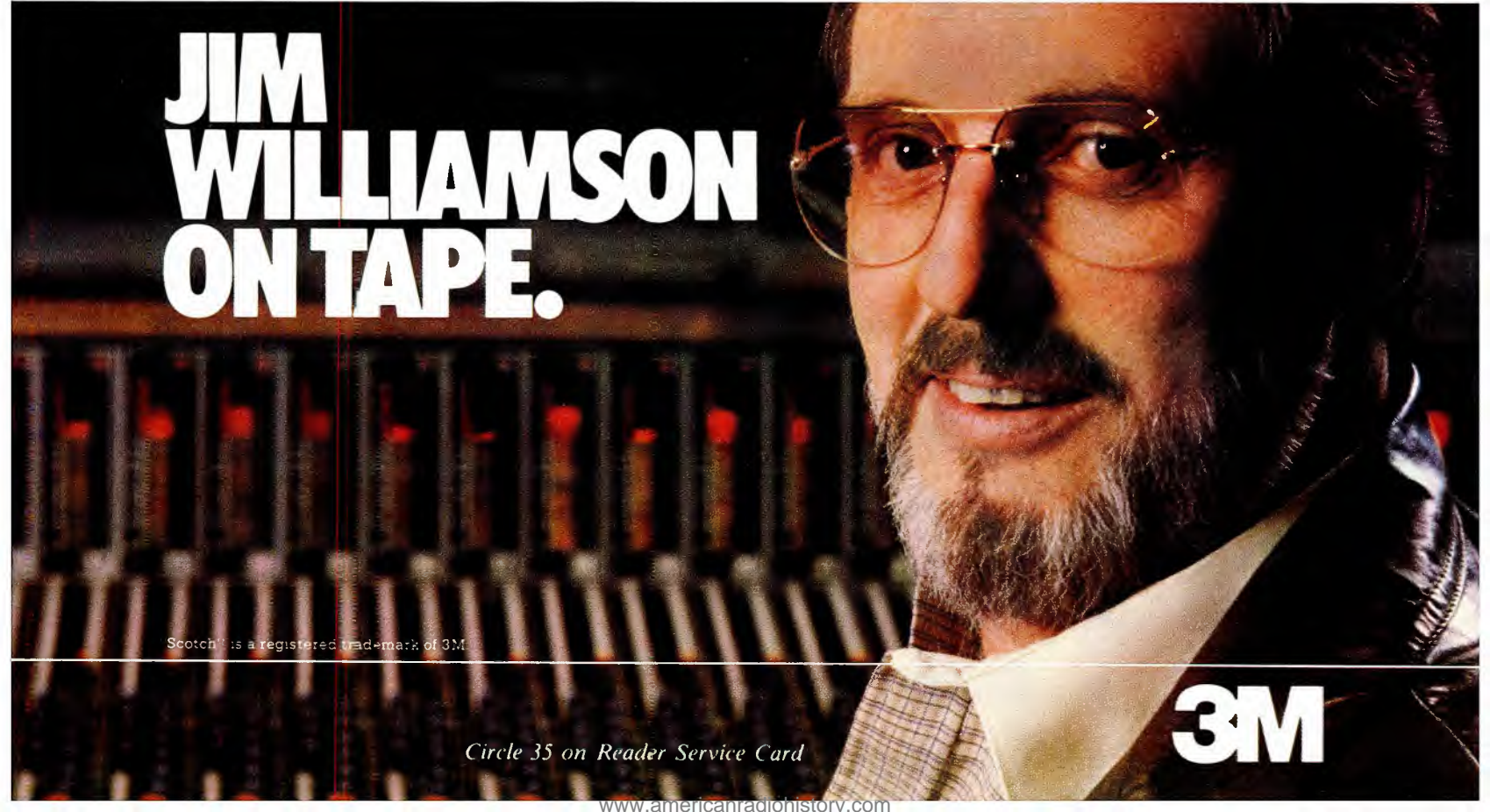

**JIM
WILLIAMSON
ON TAPE.**

Scotch[®] is a registered trademark of 3M.

Circle 35 on Reader Service Card

3M

**NOW
HEAR
THIS
AMERICA:**





The best professional sound equipment in the world is made by Community.
Listen to a demonstration at your professional sound equipment dealer.

Community

Community Light & Sound, Inc.
5701 Grays Avenue, Philadelphia, PA 19143
215/727-0900 Telex: 834649

ONCE AGAIN, the convention season is upon us. We're just back from the NRBA's in Los Angeles, and getting ready to attend the SPARS Recording Conference, followed immediately by the AES's 65th.

What with all the papers, conferences and workshops being presented, it seems like as good a time as any for us to review Education and Audio Basics once again. And since we meet so many new readers at convention time (new to us, and often, new to the industry as well), we often have to do a little head scratching about what to include in an "education" issue.

"Meet Danny Decibel" doesn't quite make it, but neither does "A New (and terribly boring) Assembly Language Program for Calculating Bessel Functions." Chances are, either of these would turn off at least some of our readers. (Relax; neither is in this issue!)

Well, what then? How about a little education in good engineering practices? This ought to do nicely, since the particular brand of good engineering is as practiced by the member-studios of SPARS—the Society of Professional Audio Recording Studios. These guys appear to be serious about their profession, and are definitely not in the "dedicated amateur" league. In fact, the studio of Spars vice president Robert Liftin (Regent Sound) shows up on our cover this month.

Our Special Report is really nothing more than a tabulation of current practices in SPARS studios, with an emphasis on the care and feeding of tape recorders. The SPARS survey is understandably concerned about machine alignment, so we thought it would be a good idea to review test tape procedures as well; if only to help convince the new-comer that this is definitely not a do-it-yourself project for a slow day in the studio. And so we asked Ralph Hodges to look in on Jay McKnight's

Magnetic Reference Laboratory, to find out just what it takes to put a test tape together. And, we've inserted a quick-reference guide to a handful (well, four anyway) of what's available. Note the different reference fluxivities. If your studio is using several test tapes interchangeably, it might be worth it to verify which is which. Hopefully, a 6 dB discrepancy will be spotted (at least on a good day), but those less-than-half dB changes may be causing a lot of needless knob-tweaking.

On a recent trip to California, we dropped in on Otari's US headquarters for a quick look at the company's series of two-inch tape recorders. Our picture story will give you an idea of what to expect from this recent entry into the multi-track market.

As part of our continuing education in digital audio, Sidney L. Silver teaches us how a digital tape recorder corrects tape errors. This sort of self-analysis capability strikes us as a powerful argument on the side of digital technology, although others will be quick to point out that if the system wasn't so complex, it wouldn't need the correction circuits in the first place.

But even if digital error correction is—for the moment, anyway—an expensive solution to a more-expensive problem, it does offer us a glimpse into the signal processing capabilities in store for us in tomorrow's digital studio (maybe the day *after* tomorrow).

Concluding our educational offerings for this month, Almon Clegg answers all your questions about RMS measurements. You say you never had any questions about RMS? Oh come on, didn't you once wonder why it was .707 times the peak value, and not, say, .75? You may not get a better drum sound by brushing up on RMS, but it may help you sort out the differences between different metering devices while monitoring those drums. ■

20,000 copies in print

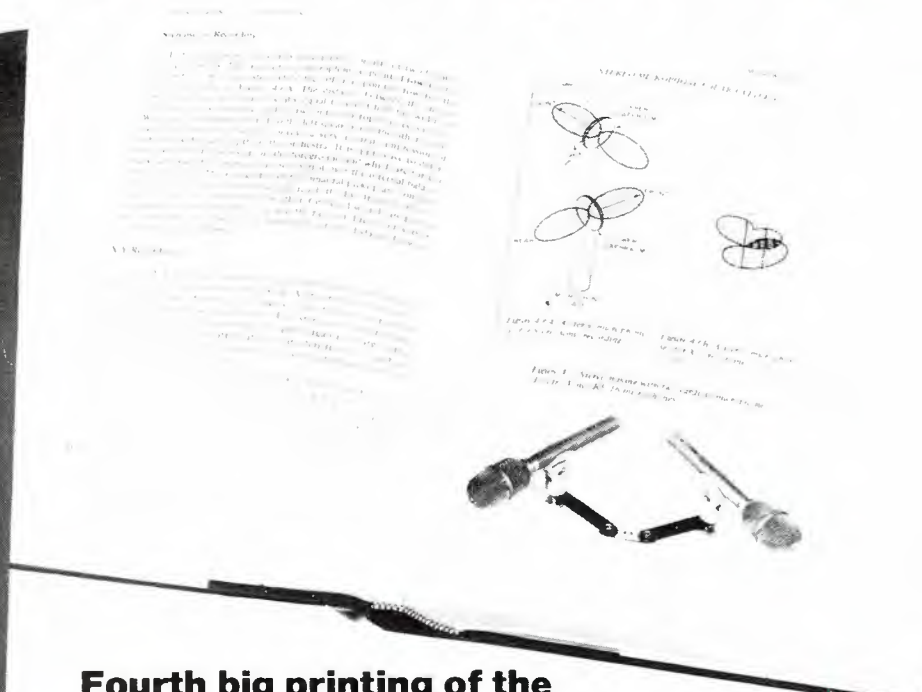
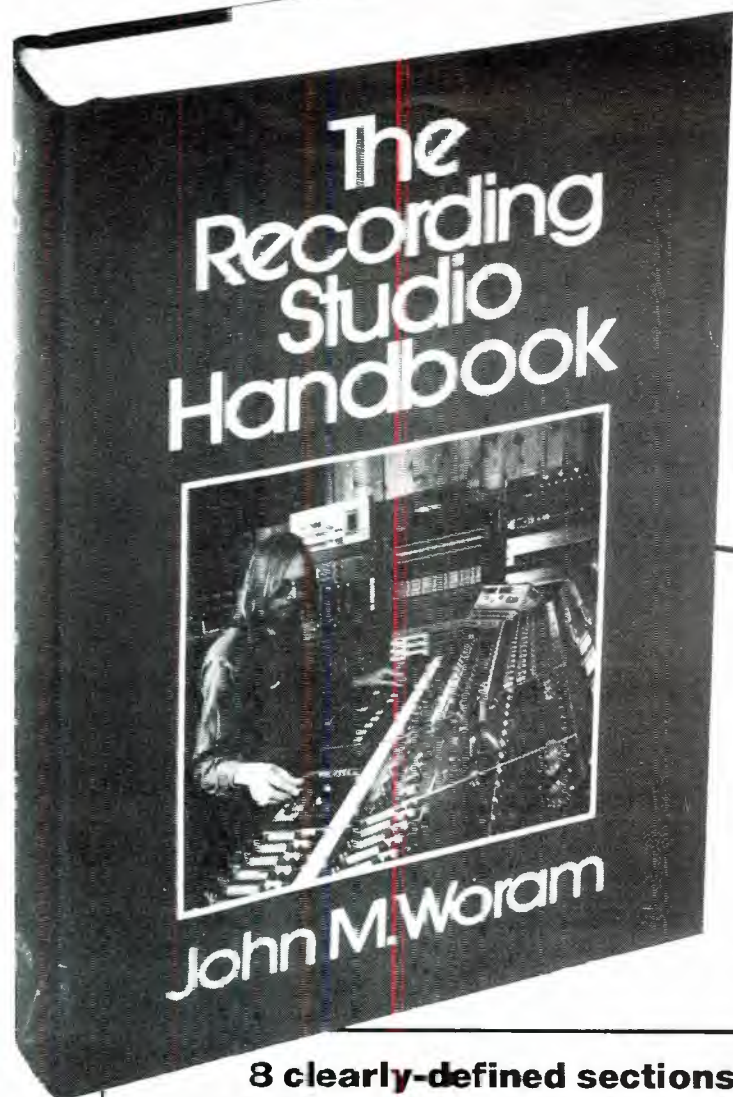

Fourth big printing of the definitive manual of recording technology!

"John Woram has filled a gaping hole in the audio literature. This is a very fine book . . . I recommend it highly. —*High Fidelity*. And the *Journal of the Audio Engineering Society* said, "A very useful guide for anyone seriously concerned with the magnetic recording of sound."

So widely read . . . so much in demand . . . that we've had to go into a fourth printing of this all-encompassing guide to every important aspect of recording technology. An indispensable guide with something in it for everybody to learn, it is the audio industry's first complete handbook on the subject. It is a clear, practical, and often witty approach to understanding what makes a recording studio work. In covering all aspects, Woram, editor of *db Magazine*, has provided an excellent basics section, as well as more in-depth explanations of common situations and problems encountered by the professional engineer.

It's a "must" for every working professional . . . for every student . . . for every audio enthusiast.

8 clearly-defined sections 18 information-packed chapters

I. The Basics

The Decibel Sound

II. Transducers: Microphones and Loudspeakers

Microphone Design
Microphone Technique
Loudspeakers

III. Signal Processing Devices

Echo and Reverberation
Equalizers
Compressors, Limiters and Expanders
Flanging and Phasing

IV. Magnetic Recording

Tape and Tape Recorder
Fundamentals
Magnetic Recording Tape
The Tape Recorder

V. Noise and Noise Reduction

Noise and Noise Reduction Principles
Studio Noise Reduction Systems

VI. Recording Consoles

The Modern Recording Studio Console

VII. Recording Techniques

The Recording Session
The Mixdown Session

VIII. Appendices

Table of Logarithms
Power, Voltage, Ratios and Decibels
Frequency, Period and Wavelength of Sound
Conversion Factors
NAB Standard
Bibliography
Glossary

Use the coupon to order your copies today at \$37.50 each. And there's a 15-day money-back guarantee.

SAGAMORE PUBLISHING COMPANY, INC. 1120 Old Country Road, Plainview, N.Y. 11803

Yes! Please send _____ copies of THE RECORDING STUDIO HANDBOOK. \$37.50. On 15-day approval.

Name _____

Address _____

City/State/Zip _____

Total payment enclosed \$ _____
(In N.Y.S. add appropriate sales tax)

Please charge my Master Charge
 BankAmericard/Visa

Account # _____ Exp. date _____

Signature _____
(charges not valid unless signed)

Outside U.S.A. add \$2.00 for postage.
Checks must be in U.S. funds drawn on a U.S. bank.



If something shows up in the mail that you didn't order, you can keep it for free.

If anything is mailed to you without your permission — books, records, stockings, or something more unusual — you can keep it for free.

If the company sends you a bill,

you still don't have to pay. The law's on your side.

For more information, write the Federal Trade Commission, Washington, D.C. 20580.



A public service of this magazine.

Good Engineering Practices : SPARS Recording Conference III

ONCE AGAIN, SPARS (Society of Professional Audio Recording Studios) will hold its Recording Conference on the day before the start of the Audio Engineering Society convention October 30, at the Doral Inn in the Big Apple).

Conference III consists of three seminars covering the business, technical and engineering aspects of recording studios. The seminars are:

STUDIO MARKETING PRACTICES

A panel led by Murray Allen (Universal Recording) will examine marketing techniques that have been successfully employed to keep studios productive—in spite of today's economy.

TECHNICAL DOWNTIME: THE INVISIBLE THIEF

Robert Liftin (Regent Sound) will chair a panel of technical experts who will delve into one of the most profit-draining aspects of any recording studio—technical downtime.

GOOD ENGINEERING PRACTICES

This seminar will range from azimuth-to-zenith, and present the conclusions of a comprehensive SPARS survey of recommended audio recording practices. Guy Costa (Motown/Hitsville, USA) will chair the panel.

The SPARS survey consisted of almost 70 questions presented to member studios. We present here a somewhat-abbreviated summary of the results. The question numbers do not necessarily match the original survey, since we've omitted some and combined others. Out numbers are simply a guide to our own editorial comments, which follow at the end of the survey, thus sparing our readers (*and us*) from having to wade through the questions twice.



At Chicago's Universal Recording, SPARS vp Murray Allen describes "The Backroom" as his "...newest/hottest/ electronic music/video/sweetening/overdub/ mix-down/original recording studio."

The SPARS Survey

TEST TONES

1. *On quarter-inch masters, do you provide tones: on one reel only; on every reel; on a separate master tone reel?*

This one's easy: 57% provide tones on one reel only, 35% put them on every reel, and 7% supply a separate tone reel.

2. *On 15 (and 30) ips masters, what tones do you provide, and in what order?*

This one's not-so-easy! 1 kHz and 10 kHz tones are provided by every studio but one (that one gives 700 Hz and 14 kHz), but that's where the similarity ends. For 50% of the studios, the lowest frequency is 50 Hz. For 29%, it's at 100 Hz. The other 21% vary between 40 and 60 Hz.

At the other end, the highest frequency was; 35% at 10 kHz, 35% at 15 kHz, with the rest divided between 12, 14 and 18 kHz.

3. *Approximately how long are your tones?*

43% preferred 30-second tones, 21% supplied 60 seconds, and the rest varied from 10 seconds to 3 minutes.

4. *Are the tones leaded when provided?*

Almost 80% provide leaded test tones.

5. *Are tones stored at the head or tail?*

86% store the tones at the head of the tape.

6. *On wide-width tapes, do you use an alignment tape that is compensated for fringe effect?*

30% do, 70% don't.

7. *Do you provide a record "pad"? (i.e., blank tape for alignment)*

Almost 60% do. 20% don't, and the others do "sometimes" or only on 2-inch tape.

8. *How long a pad do you provide?*

There was no consensus here, with pads varying from one to ten minutes. 70% of those providing pads kept them between 1 and 2 minutes long.

9. *Is the pad leaded?*

60% of the studios answered "yes."

10. *Is the pad stored at the head or the tail?*

Here, there was a 50-50 split between head and tail.

11. *Do you provide a short length of blank tape at the head and tail, to facilitate loading?*

100% of the studios do so.

OPERATING LEVEL

12. *Do you specify operating level: in nWb/m; in dB relative to standard level (185 nWb/m); other?*

36% of the studios don't specify operating level in any way (too bad). 21% specify in nWb/m, and the others give a dB value relative to 185 nWb/m.

13. What level, relative to 185 nWb/m, is your in-house standard?

80% answered +3, 7% said +4 and 14% were at 0-to-1 dB.

AZIMUTH

14. How do you check azimuth?

64% look for the peak reading when two channels are combined. 7% look for a null, when two channels are combined with a polarity reversal in one of the lines. 7% do both. 21% use a 'scope instead; However, of those who take peak/null readings, about 70% also use a 'scope. Only 20% use a phase meter.

15. On multi-track masters, what channels are compared when evaluating azimuth?

36% choose tracks 2 and 23 as their first choice. 18% use 3 and 22, and 9% use either 4 and 20, or 1 and 24. 27% use other combinations, including 9 and 10, 1 and 12, and the sum of all the tracks.

16. What degree of azimuth error (and at what frequency) do you allow?

Only 50% of the studios specified a tolerance in degrees, and this varied between 5 and 15° at 10 or 15 kHz.

17. How often do you check machine alignment?

Every studio checks alignment before every session.

18. How often do you demagnetize your machine heads?

41% do it daily, 25% weekly, 17% do it bi-weekly and 17% demagnetize before each session.

19. After how many minutes of running time do you clean heads?

There was no consensus here at all. Studios were about evenly divided between: every 30 minutes, every few hours, several times daily, and, as needed.

20. What percentage of outside-generated client tapes fall within your normal house-aligned specifications?

The average here was 45%, with a low of 5% and a high of 80%.

LEADER

21. Do you use paper or plastic leader on quarter-inch tape?

42% use paper, 29% use plastic, and the others use both.

22. Do you use paper or plastic leader on two-inch tape?

38% use paper, 46% use plastic, and 15% use both.

23. Do you use colored head or tail leader on tape?

There is a 50-50 split on this one also.

24. What color do you use to indicate heads-out? tails-out?

Everyone uses red for heads-out and blue for tails out.

25. Do you use white leader to indicate virgin tape?

93% do not make the distinction that white leader signifies virgin tape.

26. Do you have an extended cutting angle on your quarter-inch splicing block for tail ends (to "feather" the noise-to-leader transition)?

Only 14% did.

27. What cutting angle do you use most on 2-inch tape?

50% use a 15° splice, 33% prefer 7.5°, and 16% use 30°.

28. Do you indicate tape reel time on legends?

71% of the studios do.

29. Do you indicate tune or tape timings on legends?

All studios answered "yes."

30. When marking wide width tapes for cue, what do you use?

8% use splicing tape, 83% use a white crayon and 8% use a yellow crayon.

31. How are your master tapes stored?

57% specify a temperature-controlled environment, and about 40% of these also specify controlled humidity. The temperature specified is 65-to-72 degrees Fahrenheit, and the humidity is 50-to-60%. 36% of the tapes are stored on hubs, and 86% are stored tails-out.

32. Are masters slow-wound prior to storage or shipping?

100% answered "yes."

33. Are two-inch masters stored on hubs or reels?

Over 90% of the studios store their masters on reels.

NOISE REDUCTION

34. What percentage of sessions use noise reduction?

dbx noise reduction is used on 3% of the 15 ips sessions, and 1% of the 30 ips work. Dolby is used on 51% of the 15 ips tapes and 27% of those at 30 ips. Telecon is used on 7% of the 15 ips tapes and also on 7% of those at 30 ips. These figures are averages of total studio usage of noise reduction. Individual studio usage varied from zero to 98%.

35. Do you Dolby-encode the tones? (i.e., noise reduction "in")

Only one studio does. The rest conform with the Dolby recommendation to leave the noise reduction out when recording test tones.

36. How are computer program information and set-up sheets stored?

75% store this data with the master tape, and 16% use a separate box. 9% store the information in a different location.

37. How do you record console set-up data?

About 70% use a custom-designed data sheet.

38. Do you have a preferred track layout?

60% said yes, 40% answered no.

PRESSURE ZONE MICROPHONES

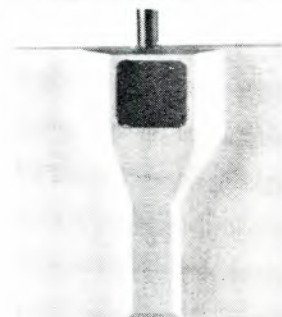

A fundamental advance in the art and science of microphones.

- Cleaner sound without distortion.
- Rugged, unobtrusive mounting.
- Minimum phase, phase coherent.

Available through

ANDREWS AUDIO CONSULTANTS
451 West 54th Street
New York, N.Y. 10019
(212) 674-6934

DAVID ANDREWS

39. *What is your normal or preferred track assignment?*

Of the studios responding to this question, all put the drums and bass on tracks 1-through-(5-to-9). After that, it's "anything goes." There is a general tendency to follow the drums with other percussion, then guitars, keyboards, strings, backgrounds, lead vocal, and finally, sync, code, data, etc.

SMPTTE

40. *Do you have facilities for adding SMPTE time code on multi-track masters?*

85% of the studios have SMPTE facilities, and most record the code about 5-to-15 dB down. Most studios prefer to record code on the last track (16, 24 or 32), although one specified any track, and another, any non-edge track.

41. *How many seconds pre-roll do you use when adding SMPTE time code?*

40% use 5-to-15 seconds, 20% prefer 15-to-30 seconds, 30% use 30 seconds, and 10% add 45 seconds.

42. *How many seconds post-roll do you use?*

80% use 5-to-15 seconds, 10% are at 30 seconds, and 10% use 120 seconds.

43. *When adding time code, do you use a pre-roll to start 00:00:00 at the downbeat?*

90% answered no.

44. *When the SMPTE time code is placed on the last track, do you record 59.94 Hz sync on the next-to-last track?*

Another 50-50 split on this question.

45. *After adding time code to a master, how do you check for valid data?*

100% do it by playing back through a code reader. 90% also use test tapes for lockup, and 30% use their console automation system.

In Universal's studio A control room, Jim Scheffler prepares for a NECAM mix, using three 24-track machines (MCI and Ampex).

46. *When copying multi-track masters with SMPTE time code, how do you process the code?*

90% regenerate the code, and 10% use a simple shaper (clipper).

47. *What percentage of your multi-track masters require the use of audio interlock of two machines?*

For 70% of the studios, audio interlock is required on less than 25% of the masters. 20% of the studios required it on more than 75% of their masters.

48. *Where do you use peak reading meters?*

54% use them on the console's stereo bus, and 40% use them on all console output buses. 30% use peak reading meters in tape copy rooms, and 80% use them in disc mastering work.

db SURVEYS THE SURVEY

2. It's interesting to note that none of the studios match all of their tones to the "preferred frequencies" listed in ANSI and ISO standards. (These are; 31.5, 63, 125, 250, 500 Hz and 1, 2, 4, 8, 10, 12.5, 16 and 20 kHz.) MRL test tapes use the preferred frequency list, while STL tapes do not.

Of course, on a studio signal generator, it certainly is easier to find 50 Hz and 100 Hz (STL frequencies) rather than 31.5 Hz, 63 Hz and 125 Hz (MRL), but in these days of automated everything, maybe its time for someone to market a push-button signal generator using a standardized list of audio frequencies.

We'd also suggest that frequencies be recorded in ascending order (maybe even including an up-sweep run). This would make azimuth and high-end check-up and adjustment just a bit easier.

5. Most studios store tones at the head of the tape. However, when there is only one set of tones, and several master tapes, wouldn't it be better to put the tones at the end of the reel, instead? That way, it would not be necessary to wind through an entire reel just to gain access to the tones.



10. It's probably safer to put the pad at the end of the reel. That way, when you forget to come out of record, you don't erase the master. (Yes, we know *you* wouldn't do such a thing, but what about all the others?)

12 and 13. There may be a little ambiguity here. 3 dB above 185 nWb/m is 261.3 nWb/m (nano-webers per meter). STL's EL-3 series of test tapes use a reference fluxivity of 261 nWb/m, while MRL's high level tapes are at 250 nWb/m. Although there's less than 0.5 dB difference between them, it would be more accurate to specify output level in nWb/m, not in dB above standard operating level.

15. Hopefully, once azimuth is aligned, all tracks will be within spec. In the real world though, no matter which track pair is used for alignment, other pairs will be out-of-alignment. To keep things interesting, each head has its own internal variations, so on a slow day it may be a good idea to check various combinations, in order to locate potential troublesome pairs. However, checking the sum of all the tracks could turn out to be a lifetime occupation.

16. Without a phase meter calibrated in degrees, a calculation of phase angle is probably more trouble than its worth, since a scope or meter reading is usually a reliable indication of "go" or "no-go" conditions.

39. Obviously, there will never be a standard track layout, even within a single studio. However, it's interesting to note that in some studios, drums are routinely placed on as many as seven separate tracks.

40-46. An SMPTE "standard" seems to be evolving, in which the time code is placed on the last track, thus keeping leakage to a minimum. However, one studio makes a point of keeping its code *away* from the tape edges, perhaps suggesting it is too valuable to risk on an edge track.

A standard pre- and post-roll might make things a trifle easier for master tapes travelling between studios. And, note that no studio attempts to make a direct I-to-I copy of SMPTE code, with most preferring to re-generate the code.

MASTER TAPE PROFILE

After studying the raw data collected in the survey, a typical profile of a two-inch master tape comes out looking like this:

The tape is wound tails-out on a two-inch reel. The reel begins with a few turns of scrap tape, followed by a sequence of 30-second test tones and some blank tape for making record adjustments. The tones are recorded at a reference fluxivity of 250 or 261 nWb/m, and are separated from the blank tape and the master itself by leader tape, which may be either paper or plastic. Red leader indicates the beginning, and blue, the end of the reel. White leader has no particular significance.

Azimuth alignment has been optimized using tracks 2 and 23, or 3 and 22. There's about a 50 percent chance the tape will fall within your own studio's in-house standards. (If it doesn't, you might want to review your own standards at the next opportunity.)

A custom-designed information sheet, on, or inside the tape box, will provide the necessary timing information, as well as specifying the reference fluxivity of the recording.

If it is a 15 ips recording, there's a 50 percent likelihood that it was recorded using Dolby noise reduction. Dolby tones were recorded with the noise reduction switched off.

Rhythm tracks are most likely to start at track 1, followed by everything else. Lead and background vocals are on the opposite side, just before the sync tone and time code, if any.

Crayon marks (usually white) indicate cue points, although SMPTE time code is probably also on the tape. 00:00:00 indicates the start of the tape, with the downbeat coming up to 30 seconds later.

SUMMING UP

A study of this master tape profile suggests that a de facto standard is emerging out of the day-to-day practice of SPARS studios. Perhaps a SPARS working group will take this one step further, and propose an official SPARS standard. We'll keep you posted. ■

PROVEN PERFORMERS FOR STAGE AND STUDIO

SB-36W

The preference for recording studios. Triangular cast-iron base with rubber casters for heavy duty stability. Adjustable counterweight, gyromatic swivel for microphone positioning. Boom length: 62". Height range: 48"-72".



MS-12S

The favorite of professional entertainers. Automatic clutch with touch-control sleeve action makes it possible to position microphone height to any level without the usual rotary adjustment. Low silhouette, charcoal finish, 10-lb. cast-iron base for maximum stability. Height range: 39"-62".

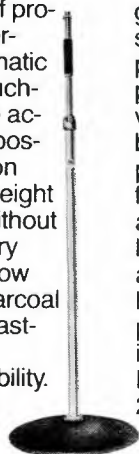

PS-C3

The ideal for music groups. Instant set-up, and compactness for transportation. Base and vertical tube combine in a single portable unit and feature spring-action telescoping legs. Extra low adjustment flexibility for seated performer or instrument-miking. Height Range: 26"-66".

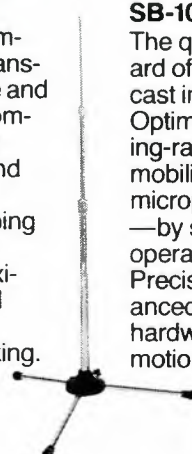

SB-100W

The quality standard of the broadcast industry. Optimum positioning-range and mobility. 350° radius microphone-follower —by single knob operator-control. Precision balanced, oversized hardware for motion-functions,

heavy duty wheels. Boom length: 110" —Height range: 61.5"-92.5".



ATLAS SOUND, DIVISION OF AMERICAN TRADING AND PRODUCTION CORPORATION
10 POMEROY ROAD, PARSIPPANY, NJ 07054 (201) 887-7800

Magnetic Reference Laboratory and the State of Reproducer Calibration

If you are a total recluse or a permanent resident of the moon, you may never need a calibration tape. But if not...

IN THE SMALL FRAME STRUCTURE at 229 Polaris Avenue, Mountain View, California, some of the most technically-sophisticated recordings are made daily; but nobody ever listens to them if they can help it. In terms of entertainment value, they couldn't be drabber, being lengthy series of test tones and noise signals, relieved only by periodic voice announcements (dubbed from a broadcast-type tape-cartridge player, not sophisticated in any sense). Their intended audience is meters, scopes, and chart recorders, and their ultimate objective is to establish accurate and informative communications between tape machines. These recordings are the only truly practical means of accomplishing this.

Mountain View's Magnetic Reference Laboratory, founded in 1972 under the guidance of president Jay McKnight, is one of the few vendors of professional-quality reproducer calibration tapes extant, with significant competition in the U.S. coming only from Ampex and Standard Tape Laboratories. The current MRL catalog lists over 160 calibration tapes, some of them special-order items. The average ¼-inch tape plays for 6 minutes and sells for around \$40. The average 2-inch tape is 15 minutes and costs somewhat over \$400. In between are ½- and

1-inch formats, likewise available in all widely-employed tape speeds and equalization characteristics (most relevantly, NAB 1965, IEC 1968, and AES 1971). The wider tapes play longer because it takes more time to set up 24 tracks than 2. And yet, the MRL tapes do not have separate tracks; They are all recorded full width—the result of one of many conscious design decisions that must go into a product of this type.

As MRL creates it, the basic workhorse reproducer calibration tape is divided into three parts: a reference signal for adjusting operating level; coarse and fine azimuth adjustment tones; and finally, frequency response. This last part consists of ascending spot frequencies at octave intervals from 31.5 Hz to 8 kHz, and then at 1/3-octave spacings up to at least 16 kHz. Tapes other than the basic ones offer slow and fast frequency sweeps (for use with chart recorders and oscilloscopes, respectively), and broad-band noise signals for examination with spectrum analyzers.

The reference signal is a 1 kHz tone recorded at a precisely-defined fluxivity ($\pm 1/2$ dB tolerance) to permit the setting of machine gain and the referencing of it to a known recorded fluxivity. Most useful for the U.S. user will be tapes with



Honeycomb
speakers
inspired by
today's
recording
technology.

To hear the full potential of today's digital tape and direct-to-disc recordings, our Professional Audio Division presents a speaker that's just as advanced, just as accurate. The Technics R&B Series Honeycomb Disc Speakers.

The special diaphragm is constructed like a flat, rigid honeycomb disc to eliminate the traditional acoustical problems of cone-shaped diaphragms. Best of all, phase linearity occurs automatically because the acoustic centers are distinctly aligned on the flat diaphragm surface.

The axially symmetric "nodal driver" is designed to vibrate in a more accurate pistonic motion. This provides an extremely wide flat frequency response, broad dynamic range and extremely low distortion.

And the flat leaf tweeter in the SB-7 and SB-10 is much lighter than many dome tweeters for incredible high frequency response, up to 125 kHz.

The Technics R&B Series is available at select locations. Call our Professional Audio Division at 800-447-4700 (in Ill. 800-322-4400) to hear the entire line of Honeycombs—the speakers that don't hold back today's recording technology.

Technics
R&B series

Circle 19 on Reader Service Card

MOVING?

Keep **db** coming
without interruption!

Send in your
new address *promptly*.

Enclose your old
db mailing label, too.



Write to:

Eloise Beach, *Circ. Mgr.*
db Magazine
1120 Old Country Rd.
Plainview, N.Y. 11803

recorded fluxivities of 200 and 250 nanowebers per meter (nWb/m), corresponding to standard operating levels for general purpose (200) and high-output (250) tapes. Tapes with fluxivity levels suited to European standards are also available. In addition to the obvious benefits, a true calibration tape provides you with an "absolute": a recorded level that is precisely defined. This gets a little tricky. For example, how does a manufacturer of a calibration tape determine exactly what fluxivity he has recorded? One way might be to play the tape with a calibrated flux-measuring playback head. But how then does he calibrate this head? Well, maybe by playing a tape with a known fluxivity. But how does he determine the fluxivity recorded...? And so forth. This chicken-and-egg conundrum has exasperated experts on magnetism for decades, and it remains the case that there is a 10 percent difference between the German (ein) flux measurement and the US measurement. Still, small differences in absolute fluxivity of calibration tapes—even from different manufacturers—are unlikely to be a serious handicap to normal studio operation. If they are, the obvious answer is to reference all machines involved in a production operation (no matter how far apart they are located) to tapes from the same manufacturer, which in MRL's view should provide agreement within a dB, at the very worst.

Azimuth alignment involves adjusting the geometry of the tape-to-head interface so that the head gaps are perfectly perpendicular to the edge of the tape, and therefore perfectly lined up with the flux pattern recorded on a properly-made tape. Needless to say, a calibration tape must therefore be very carefully made. As the calibration tape is recorded, any weaving as it passes over the recording head makes it useless (and any serious weaving of the tape as it passes over your playback head makes it unsuitable on your machine). Weaving can result from poor slitting of the tape edges; from worn or tilted head faces; and from imprecise tape guidance, referring generally to the accuracy with which guides, capstans, and pinch rollers route the tape across the head contours. What the manufacturer of a calibration tape does—or should—guarantee is that the tape is slit in a straight line, the tape stock is uniform, and the recording machine he uses always provides near-perfect tape guidance and alignment. If he fails to ensure any of these conditions, wide fluctuations of the meters as you attempt to use the azimuth-adjustment tones—or any of the other higher frequency tones on the tape, for that matter—will be the giveaway. Of course, the same sort of fluctuations will occur if it is *your* machine that is introducing the weave.

The spot frequencies for playback response adjustment comprise the lengthiest section of the calibration tape. As a rule, a regularly maintained machine will not have to be subjected to a check-out on the whole sequence of tones very often; a quick run-through of the azimuth-adjustment tones is usually enough to verify that a machine is maintaining its high-frequency response. But if it is not, and the reason is not readily apparent (worn heads, for example), then the spot frequencies will help in the hunt for serious anomalies.

As noted earlier, calibration tapes are usually recorded full width in all formats. There are several reasons for this, the most obvious being that different tapes need not be offered for every conceivable track format. (Reflect that 1/4-inch tape can be full-track, 1/2-track, 1/3-track, 1/4-track, or 1/8-track, with variations in track widths and positionings to boot.) Furthermore, with a full-width format, one needn't struggle to ensure identical performance from as many as 24 tracks of a master recorder, including identical azimuths for 24 gaps in a head stack—an as-yet-unrealizable goal in tape-head manufacture. But there is one serious drawback to the full-width calibration tape: on playback, it creates a rise in low frequencies, due to fringing effects.

Actually, for 1/4-inch 2-track tape especially, fringing effects could not be completely avoided even with an ideal calibration tape, because there are too many non-standard details of head construction that can influence the situation. According to McKnight, the best way to adjust the *low*-frequency performance of a recorder is to work on its record-play response



GET YOUR SOUND OUT OF THE MUD

Customize your sound system
around the world's top performers
of stereo music. APHEX Audio Systems
already know. APHEX—introducing
azimuth.

For more information contact
your local APHEX office or

ApheX Systems, Ltd.
7801 Melrose Avenue
Los Angeles, CA 90048
(213) 655-1411 TWX: 310-321-5762



WITH APHEX



with tapes you make yourself from an audio-generator source. An alternative way is to pre-compensate the calibration tapes as they are recorded to anticipate the low-frequency rise. Still another alternative is to provide a table that lists the response errors to be expected when a full-track calibration tape is used with various multi-track formats. MRL has embraced both alternatives to a certain extent. Its wider calibration tapes are recorded with pre-compensation (which is also being considered for 1/4-inch tapes, pending a bit more research into non-standard track winding and spacings). It provides tables that can be used when pre-compensation is not present, and also works hard at thinking about ways to eliminate the problem entirely. The problem is, of course, immensely complicated by the so-called head-contour or head-bump effects that introduce regular undulations in the low-frequency response of a tape machine. Because of these, spot frequencies, unless very closely spaced, cannot be relied upon to document the long-wavelength performance of a recorder. The best solution remains a record-play check.

OTHER CALIBRATION TAPES

The basic calibration tape discussed so far is certainly adequate for the studio with basic test instruments and a typical maintenance schedule. But, for more demanding applications, or when a cornucopia of test gear is at hand, there are calibration tapes that can make adjustments more accurately, more rapidly, or both. Both pink and white broadband-noise tapes are available, and can be used with a spectrum analyzer to make any response anomalies instantly apparent. If the outputs of multiple tracks are summed, these tapes will also point up serious gap-scatter problems in the playback head with a characteristic comb-filter display on the CRT. Swept-frequency tapes with low- and high-speed sweeps can be used with chart recorders (low-speed 50-second sweep) or oscilloscopes (high-speed repetitive 1/10-second sweeps with scope-triggering pulses). The high-speed sweeps will display the upper audio spectrum (500 to 20 kHz) on a scope screen, enabling you to verify the response of each track of a multitrack tape machine in a fraction of a second. Graticules that calibrate the scope face for frequency and levels when they are applied to the face of the CRT are also available.

For mono tape reproducers, a "difference-method" azimuth-adjustment tape can be used. This is recorded with alternating equal azimuth errors in opposite directions, so that equal output from both signals is a positive assurance of correct azimuth. Because long recorded wavelengths can be used for this test, it is possible to turn the tape over and play it through its backing for a confirmation of the azimuth adjustment tape. Finally, there are tapes recorded with a single frequency, at defined fluxivity, that play for up to 30 minutes.

For any professional tape recordist, the ultimate question is not whether he needs a reproducer calibration tape, but "who do you trust"? As a way of getting in touch with the rest of the recording world, a good test tape is indispensable. But if the rest of the world is playing to a different calibration tape than the one you're using, there may be problems in communication. Elsewhere in this article, Jay McKnight makes the case for accuracy; but it is still a fact that accuracy is one thing and standardization another. A calibration tape that is both standard and accurate is the obvious goal, and the way to approach it is to keep aware of the state of calibration tapes and the ways in which they might be improved.

As a way of getting in touch with the rest of the recording world, reproducer-calibration tapes are indispensable to the professional recordist. The characteristics of an ideal calibration tape are absolute accuracy and sample-to-sample consistency. If, in a less than ideal world, it proves to be impossible to get both, a typical recordist should probably place the greater emphasis on consistency—provided the other studios with which he (she) does business adhere to that same consistent standard. But, given the state of calibration tapes today, there is no compelling reason why one shouldn't be able to get both, executed to a high degree of precision. ■

Perfect Timing

If You've Wanted To Put Time Code On Your Tape, But Can't Afford The High Cost Of SMPTE:

The ES 280 TIME CODE GENERATOR/READER Is For You!

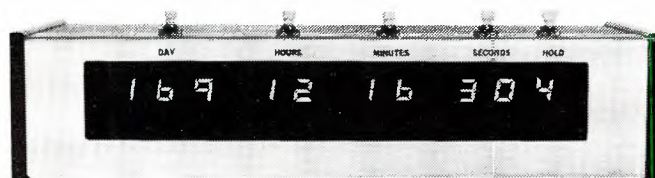

The new, low-cost way to provide time information on all your tapes, ES 280 generates a time code which includes DAYS, HOURS, MINUTES, SECONDS AND TENTHS OF SECONDS.

With the flip of a switch, ES 280 becomes a reader, to locate that certain place on the tape.

An Amplitude Control knob is located on the rear, so that you can use the 280 with any recorder, Video or Audio.

The 280 uses tones that are compatible with the cue tones used in cartridge recording.

ES 280 COSTS \$500.00

ES 281 (READER ONLY) \$375.00

Contact us or one of our dealers, and we'll tell you how you can get your own 280.



(213) 322-2136
142 SIERRA STREET • EL SEGUNDO, CA 90245

Circle 18 on Reader Service Card

Jay McKnight and MRL

WITH MORE THAN fifty publishing credits to his name in the *Journal of the AM Audio Engineering Society*, and a reputation that extends far beyond that, MRL president Jay McKnight can justifiably claim to be a reasonably knowledgeable man in the field of tape recording. What follows is the distillation of a long interview with him, freely excerpted and paraphrased.

ON MANUFACTURING CALIBRATION TAPES:

Recording calibration tapes is pretty straight-forward. You just have to be careful, adjust bias, record level, and equalization for each roll of blank tape. A fixed-calibrated reproducing system is frequently cross-checked with an in-house reference-standard tape used to permit cross checks, and we feel confident that this "cross-check standard" lets us know where we are at all times. For care, we go over the reproducing system at the beginning and end of each production day, or whenever the calibration tape type is changed. We check azimuth, sensitivity at 1 kHz and high frequency response and wear on tape guides and heads, relapping parts as necessary. Although the tapes are recorded full track, we monitor on a multi-track playback head. One track drives a chart recorder to provide a plot of the response, but any significant deviation from correct response on other tracks is automatically sensed, resulting in a shutdown of the system until the problem is located and corrected. We estimate that we are well within our specified tolerances on all tapes that leave the house, and even further within the tolerances that can be expected from recorders/reproducers in the field.

ON HAZARDS:

The keys to a good calibration tape are (besides suitable tape stock) a mechanically-stable transport and tape heads with a known and stable gap length, plus amplifiers that are similarly reliable. Without these, everything becomes a hazard. Beyond that, there is the constant possibility of oxide shed building up on the tape heads. You could ride gain as you produce a tape, turning the level up when you see the output dropping. If the output drop is caused by contamination of the playback head, you wind up with too much flux on the tape. If the contamination is on the record head, you might be all right for a mono reproducer. And what if the tape is intended for a multi-track reproducer, and one or two tracks are troubled while the rest are fine? We prefer to shut down and look around when any anomalies turn up.

Tape guidance is a horrendous problem; we just do the best we can. For our 1/4-inch tapes we use edge-loading tape guides—a carefully chosen weight pressing on the upper edge of the tape to position it accurately. For wider tapes, we modify the guides to very close tolerances. If the tape jams, we throw it out. The loss is not significant; audio oscillators are cheap talent.

ON CHOOSING TAPE STOCK:

From the user's point of view, the tape stock used for a calibration tape should make no difference, provided there are

no mechanical hang-ups ("sticktion," etc.) when he runs it through his machine. In practice, we use stock from three suppliers: Agfa (PEM 468), Ampex (456), and 3M (250). These are widely-used tapes, and most of our customers prefer to use a tape stock they're familiar with. We don't specify the tape type on the packaging in any obvious way, but we don't deliberately make a secret of it either. Agfa is marked by a white dot on the box, Ampex with a blue, and 3M with a red. Tape varies from batch to batch, and there are times when one supplier is doing well and another poorly. We maintain supplies from all three vendors so that our production can keep going despite the occasional difficulties that one or another vendor might get into.

The final criterion we apply to raw tape stock is uniformity. It must be properly slit, regular throughout its length in magnetic performance, and free of drop-outs and other effects of asperities. A tape used in a music studio can exhibit variations in output up to 0.4 dB and still be fine, but that is not good enough for our purposes.

ON PACKAGING AND SHIPPING:

No evident problems. We use four-in. hub plastic reels for 1/4-inch tape and precision aluminum reels for the wider tapes. We have seen no evidence of erasure as a result of airport security devices, or even proximity to powerful permanent magnets like loudspeaker assemblies. Erasure fields have to be about 20 percent of the tape coercivity in order to have a perceptible effect, and that involves something like 5k per meter passing through any erasing device. It's not likely this would occur by accident. In any case, our warranty provides for verification of a tape's accuracy if any damage is suspected to have occurred before it reaches the customer.

Sometimes we are asked about heat, but in general, any temperature you can comfortably live in will be comfortable for the tape as well. Although higher temperatures will encourage print-through, this will not necessarily affect accuracy of the recorded signal. It will simply implant ghostly additional recordings on adjacent layers of tape.

ON USE:

Properly used, a calibration tape will last until it becomes so limp that you're sorry for it. But, even one pass through a machine that is magnetically or physically hostile can end its usefulness in a moment. The magnetic threat is residual field from the guides or other tape-contacting surfaces. The physical threat is anything that might rub against the tape (reel flanges, guides) to cause ripples at the edges, making it worthless for the evaluation of outside tracks, and chancy for the inner ones as well. You can recognize physical troubles by variations in the output of the outermost tracks, but you can't do anything about it once it has occurred. If you suspect magnetic damage, you can check your tape against a known calibration tape. But with reasonable care, none of these steps should be necessary.

One other thing: some tape transports start and stop with violent jerks that may cause damage to the calibration tapes.

Others have chronic circuit-switching problems that will mysteriously leave record and erase heads active when you want them to be dead. For caution's sake, a calibration tape should be played with all recording circuits thoroughly out of the way, and it should be played all the way through without stops or rewinds. It should also be stored tails out.

ON FOLLIES:

Calibration tapes are costly, so some users decide to dub them onto another tape and use that, keeping the calibration tape in storage. All this does is perpetuate the errors that the tape recorder is making in the first place. The purpose of a calibration tape is to define the relationship between it and the gaps of the playback head. This relationship is crucial, and only the touch of a precision-made calibration tape on the actual surface of the playback head can evaluate it. Substitutes may be convenient for rough checks, but they are no substitute for an absolute standard.

In time, any calibration tape will begin to show poor results because of the aging (through use) of the tape, your machine, or both. At that time you'll begin worrying about the accuracy of your calibration tape, and you might be inclined to buy a new one, only to find that its results do not agree with former ones. Which is right? The new tape? The old tape? The machine, despite what any of the tapes say? You can't know immediately, and pressures of session schedules may keep you from poking into the situation later. But if you had bought *two* calibration tapes—one for general use and the other for storage—you'd have a reference dating back to your first alignment. If discrepancies are still present, chuck the tape you've been using for routine set-up (or at least have it checked for accuracy), bring in the calibration tape that's been in storage, and buy a new calibration tape for back-up. The process seems expensive at first glance, but it pays off down the road. ■

HOW DO YOU MEASURE TAPE TENSION?

If something SOUNDS FISHY it may be your fish scale approach to measuring tension.



The Tentele Tape Tension Gage is designed to diagnose problems in your magnetic tape equipment. Virtually all recorder manufacturers use and recommend the TENTELOMETER® for use with their equipment.

The TENTELOMETER® measures tape tension while your transport is in operation, so you can "see" how your transport is handling your tape; high tension causing premature head and tape wear, low tension causing loss of high frequencies, or oscillations causing wow and flutter. Send for the Tentele "Tape Tips Guide". The T2-H20-ML sells for \$245 - complete.



50 CURTNER AVENUE
CAMPBELL, CALIF 95008
(408) 377-6588

Circle 41 on Reader Service Card

Astatic Delivers Sound Performance

Whatever your installation, Astatic delivers a full range of microphones to meet your demand for quality, performance and styling.

Since 1932, Astatic products have been meeting the

needs of installations ranging from the routine to severe environmental.

When the call goes out for quality, Astatic answers with a value-engineered product.



For complete information write for our Commercial Sound Brochure #CSD-80

THE ASTATIC CORPORATION

Commercial Sound Division
CONNEAUT, OHIO 44030 (216) 593-1111 TLX 980712

In Canada: Canadian Astatic Ltd., 1830 Ellesmere Rd., Scarborough, Ontario M1H 2V5.



Circle 40 on Reader Service Card

TEST TAPE QUICK-REFERENCE GUIDE
 1/4-inch, 15 ips, except TDK

AMPEX	STL	MRL	TDK
Alignment Tones			
700 Hz 15 kHz	15 kHz 700 Hz	1 kHz 500 Hz 8 kHz 16 kHz	315 Hz
Frequency Response			
12 kHz 10 kHz 7.5kHz 5 kHz 2.5kHz 1 kHz 500 Hz 250 Hz 100 Hz	15 kHz 12 kHz 10 kHz 7.5kHz 5 kHz 2.5kHz 1 kHz 500 Hz 250 Hz 100 Hz	31.5Hz 63 Hz 125 Hz 250 Hz 500 Hz 1 kHz 2 kHz 4 kHz 8 kHz 10 kHz 12.5kHz 16 kHz 20 kHz 1 kHz	63 Hz 125 Hz 250 Hz 500 Hz 1 kHz 2 kHz 4 kHz 6.3kHz 8 kHz
reference fluxivities available			
185 nWb/m (0 dB)	185 nWb/m (0 dB) 261 nWb/m (+3 dB) 369 nWb/m (+6 dB)	200 nWb/m (+0.67 dB) 250 nWb/m (+2.6 dB) 320 nWb/m (+4.76 dB)	250 nWb/m (+2.6 dB) and 79 nWb/m (-7.4 dB)

NOTES:

MRL 320 nWb/m tape is IEC, others are NAB.
 TDK is cassette test tape, 315 Hz at 250 nWb/m, all other frequencies are 10 dB down (79 nWb/m).
 (N dB) indicates reference level, with respect to 185 nWb/m.

The Otari MTR-90

Presenting a once-over-lightly of the MTR-90.

THE JAPANESE ELECTRONICS INDUSTRY is, of course, well-established in the world of consumer audio. And on the pro/digital scene, Sony, JVC, Mitsubishi and others are familiar names. In analog audio, Yamaha is prominent in sound reinforcement, and Technics is well-known in broadcast audio. Also, the TAD (Technical Audio Devices) line of compression drivers and loudspeakers are being seen and heard.

However, in the control rooms of most big-buck recording studios, Japanese hardware is still hard to find. As for multi-track tape recorders, the rest of the world has seen little competition (yet). But all that could change now with the introduction of Otari's MTR-90 two-inch tape recorder, in 16- and 24-track formats. Looking at the bottom line first, the 24-track machine costs \$35,040, as compared to MCI's \$37,464 (JH-24/24) and Ampex's \$38,500 (MM-1200/24).

Otari is named after the small Japanese town in which the company's president, Masayuki Hosada, was raised. Mr. Hosada started the company in 1965, and in the early years, Otari's focus was on the design and manufacture of high-speed tape duplicating systems. Several years later, the company opened offices in the United States.

The first reel-to-reel recorders were designed as mastering machines for the duplicator systems, and later the line was expanded to include normal-speed (i.e., real-time) machines. In the US, these became popular in the high-end consumer market, although Otari itself is geared more towards broadcast and other pro areas. In fact, sales of the MX-5050 quarter- and half-inch machines are now 50 percent recording, 40 percent broadcast, and 10 percent audio/visual.



Figure 1. Otari's MTR-90 is available in three formats: a full 24-track; 16-track, pre-wired for 24; and 16-track only, with no additional wiring installed.



Figure 2. Note that the servo capstan drives the back coating side of the tape, minimizing slippage and oxide abrasion.

THE MTR-90 TRANSPORT

In overall principle, the MTR-90 transport is similar to the Ampex ATR series machines, with an oversize capstan and no pinch roller. However, the MTR-90 capstan drives the tape backing, rather than the oxide side of the tape. Otari special projects engineer Tom Sharples notes that, by driving the backing, the capstan mechanism is less affected by variations in tape, which tend to show up more on the oxide. Also, tapes with slippery oxide coatings are less susceptible to abrasion during acceleration and deceleration, and, whatever abrasion may occur, does not cause wear to the oxide. As a further point, problems related to tape slippage in the play mode may be

minimized by keeping the drive system and the oxide on opposite sides of the tape.

The capstan is a mixture of poly-urethane and cork, and controls tape speed during both fast modes, as well as in the play mode. The reel motors merely "follow" the capstan, to maintain constant tape tension. The capstan motor is capable of winding a 10-inch reel (2500 feet) of tape in 30 seconds, although it is calibrated for a rewind time of 120 seconds, maximum.

The transport system does require a stable AC mains supply; as a "fix" against AC voltage variations, the gain of the capstan servo systems may be reduced, although this reduces the acceleration time.

Figure 3. The tape guides on either side of the heads are an integral part of the head block assembly, thus minimizing tape path alignment problems when changing between 16- and 24-track head stacks.

Figure 4. A single plug-in card for each track contains record, sync and repro electronics. At the bottom is the power supply, and plug-in cards for the transport servo, master bias and test input patch point.



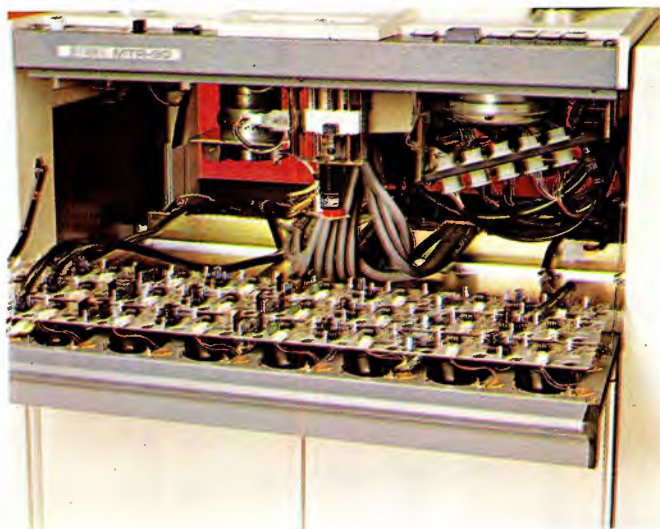

Figure 5. VU and other panels are hinged to facilitate access to the transport system. Note wide-scale use of molex plugs to minimize replacement time.

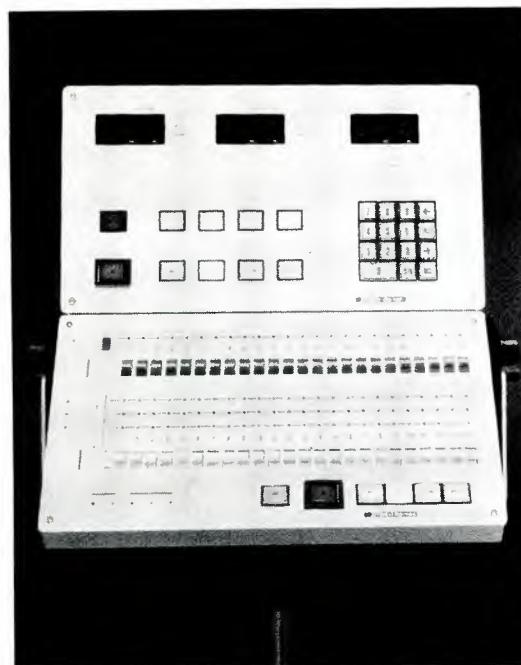

Figure 6. The CB-107 Auto Locator (top panel) has ten memory locations and, in the upper right-hand corner, an independent stop-watch. The lower panel is the CB-104 Remote Control Box, containing channel mode selector switches and transport controls.

THE ELECTRONICS

On many late-model tape recorders, tight punch-ins are now possible, due to various timing circuits in the erase and record lines. However, these are optimized for only one tape speed, or may not vary during VSO operations.

The MTR-90's record system logic uses a digital timing scheme to establish punch-in and punch-out timing. The timing pulse into a shift register varies according to the transport's tape speed, even with the VSO activated. At 15 ips, it takes 180 msecs (2.7 inches of tape travel) for the bias to turn completely on. During this interval, the erase current is ramped up, and the record head relay closes. When coming out of record, the sequence is reversed, and at 30 ips, the timing interval takes half as long (90 msecs).

Otari uses its own record and play heads, and a Woelke erase head. The record head contains two identical windings for each audio track. These are connected in parallel for record, to provide the record head driver with a low-impedance load for increased bias current capability. In the sync-repro mode, the windings are in series, to provide a higher-voltage output to the sync-repro amp.

Audio switching between test, play, sync, and input modes is done mostly through FETs. The test mode allows a single test input signal to feed all 16 (or 24) input amps, while the normal audio inputs are blocked by FETs located just after the input transformers. (For those who don't like transformers, the input transformers are easily bypassed.) ■

Figure 7. A typical audio channel. The FETs in each line are used for audio switching. Note series/parallel switching of the windings in the record head.

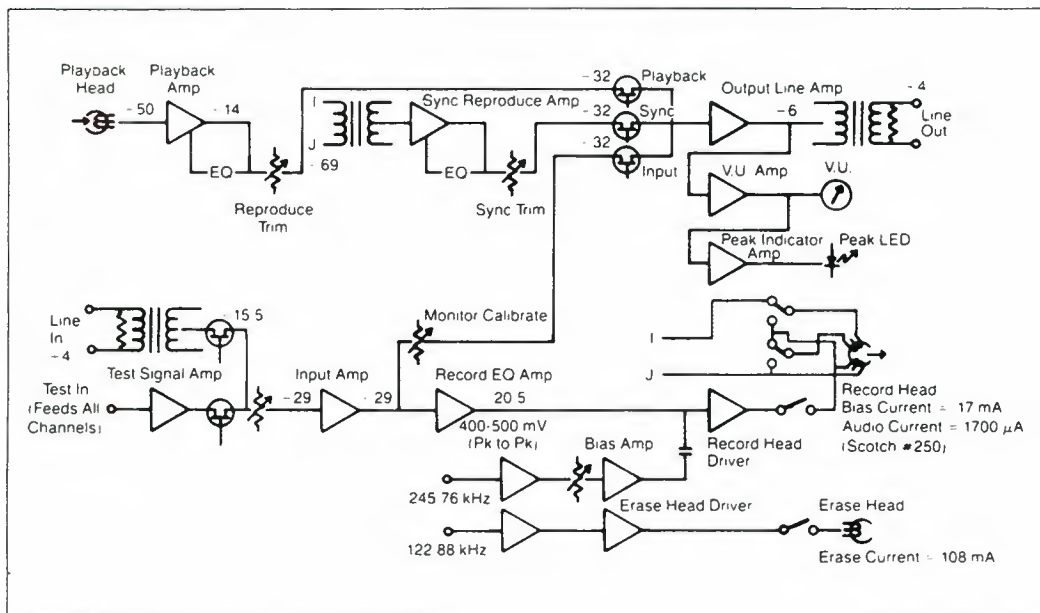

Correcting Tape Errors in Digital Magnetic Recording

Error-correcting techniques permit the digital tape recorder to recover information that was lost during a dropout.

WHEN USING DIGITAL TECHNIQUES such as PCM recording, the reconstruction of the original audio information depends on reproducing the original sequence of coded pulses accurately. But, owing to the high density of the pulse stream, digital errors are apt to occur, resulting in differing logic states between the input and output of the system. Nearly all of these errors are attributed to dropouts caused by tape imperfections and mechanical problems at the tape/head interface. The result is that recorded data bits fail to be reproduced with sufficient amplitude to trigger the digital decoding circuitry. In situations where digital words are severely impaired, special means must be provided to locate the position of these errors precisely. Generally, this involves the insertion of additional bits into the pulse stream prior to recording the data. These redundant bits are then used during playback to detect and correct the errors.

THE NATURE OF THE PROBLEM

Despite all of the precautions in the manufacture of digital magnetic tape, the surface finish may not be completely smooth, and surface defects of various types will occur. These permanent "bad spots" are mainly clusters of tiny oxide particles which protrude above the tape surface and prevent the coating from being properly magnetized. As a result, intimate head-to-tape contact cannot be maintained and spacing losses become a problem. Almost the same thing happens when foreign particles, such as dust and lint, cling to the tape as it passes the record head. But, in this case, the "soft" errors sometimes shift in position, or even disappear when the tape is run through the machine a second time. Other error sources include wrinkled tape and ruffled edges induced by improper handling.

In addition to these dropout effects, there is a smaller problem, referred to as a drop-in, which adds spurious data bits to the system. Drop-ins are caused when fragments of magnetic coating from a damaged tape are deposited elsewhere on the tape, or by noise pickup from an improperly-erased track.

Usually, these tape irregularities are much larger than the space required to store a single digit, so that dropout errors tend to occur in bursts. Some of the larger dropouts may continue for several hundred microseconds, obliterating a whole group of consecutive bits. Minor burst lengths, however, will audibly affect only about 12 or so bits over a 10 μ sec period. In a

Sidney L. Silver is on the supervisory staff of the Telecommunications Section of the United Nations, where he is in charge of sound and recording. As a contributing author to db, he has written several articles on digital audio including, Digital Modulation for High Quality Audio, June, 1978 and Digitizing Audio with Delta Modulation, April, 1979.

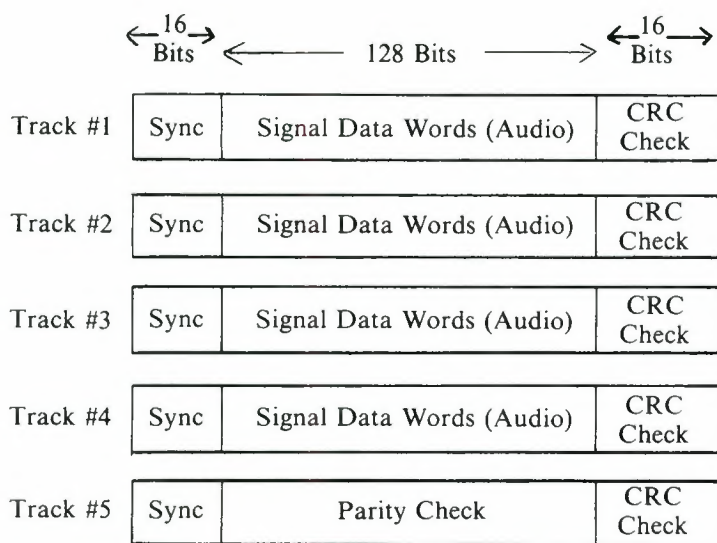

Figure 1. Five track per channel error correction system.

conventional analog tape recorder, a 10- μ sec loss of information would not be detected by the listener, since the human ear tends to smooth out, or integrate, such brief dropout periods. In a PCM system however, the loss of the most significant digit of a binary word will produce an annoying pop similar to the click caused by a deep scratch in a phonograph record. Errors occurring in digits of lower significance will make the disturbance much less audible. In order to realize high-quality recording and playback, these burst errors must be compensated for by a suitable error correction mode.

TAPE-PATTERN FORMAT

In analog magnetic recording, it has been customary to use the terms "audio channel" and "tape track" interchangeably. But, with the introduction of digital recording, it becomes necessary to make a clear distinction between the two terms, since they no longer mean the same thing. For example, at normal tape speed it would not be expected to record a serial PCM signal on a single track, because of the high data rate involved. Therefore, it would be desirable to divide the PCM signal in such a way that the information is recorded on several tracks in parallel, aligned across the width of the tape. Accordingly, it is appropriate to think of a digital recording in terms of "(data) tracks per (audio) channel."

Figure 3. Division of the signal data word by the generator character yields a remainder which is the CRC code.

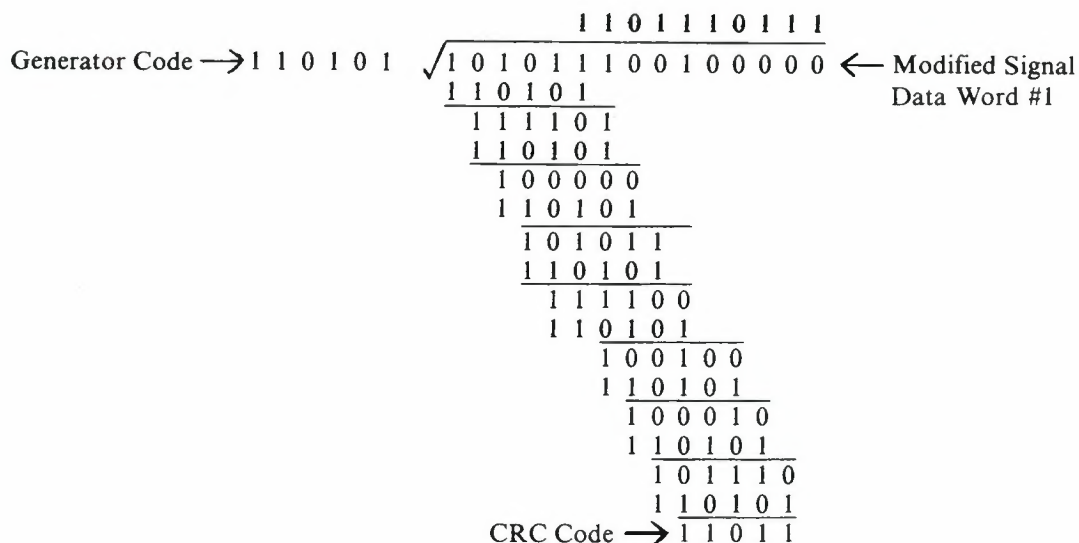

	Signal Data Word (Audio Information)	CRC Check Bits
Block #1	1 0 1 0 1 1 1 0 0 1	1 1 1 0 1 1
Block #2	1 1 1 0 1 1 0 0 1 1	1 1 1 1 1 1
Block #3	0 1 0 0 1 1 0 0 0 1	0 0 1 1 1 0
Block #4	1 1 0 0 1 0 0 0 1 1	1 1 1 0 1 0
Column Parity Block	0 0 1 1 1 0 0 1 1 1	1 0 0 1 1 1

Figure 2. Simplified version of encoded data block format.

Consider a digital recording system which handles 16-bit words at a sampling rate of 50 kHz. The basic audio data rate will be 800 kilobits/sec. If we add redundant data to this format to allow for error detection, error correction, and synchronization, the composite data will come to about 1.5 Megabits/sec. Now suppose we select 15 ips as our recording speed, in order to achieve conventional recording time per reel of tape. With a data rate of 1.5 Megabits/sec, and a tape speed of 15 ips, the recorded bit density is 100 kilobits/in, or a bit-to-bit spacing of 10 μ in. But, it has been shown experimentally that the recorded bit density in a PCM system should not exceed 25 kilobits/in, using the precision digital tape and tape heads available today. Therefore, to effectively reduce that data rate, we must allocate the bit stream of 1.5 Megabits/sec to four tracks in parallel, thus achieving a data rate per track of 375 kilobits/sec. Recording 375 kilobits/sec at 15 ips corresponds to a bit density of 25 kilobits/in per track. This is in accordance with the maximum allowable recorded bit density. (For a similar approach, see *A Proposed Digital Audio Format* in our November 1978 issue—**Ed.**)

FIGURE 1 shows the track distribution of a multi-track PCM system. Here, each block, or frame, is laid out in the order of one 16-bit sync word, eight sampled 16-bit signal words (comprising 128 bits), and a 16-bit cyclic redundancy check (CRC) word for error detection. Synchronizing data is included in each block because of the possibility of the recorder losing synchronism with the tape format after the occurrence of a major dropout. Also included is a parity block recorded on track five which works with the CRC code to achieve error correction.

During playback, the signal data words are examined for accuracy, and when error correction is completed, the four parallel tracks containing the audio data are reconstructed into one serial PCM signal.

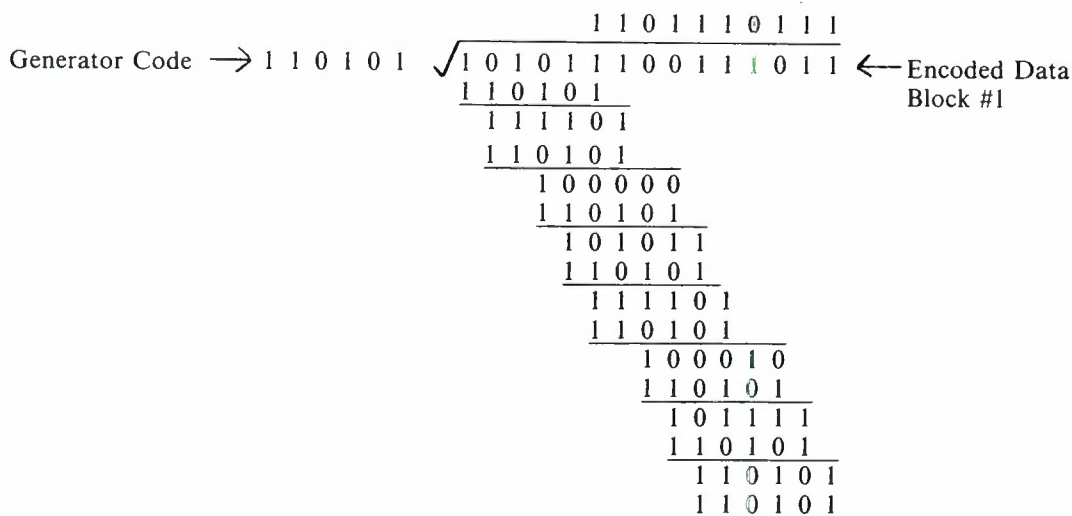

Figure 4. Encoded data block consisting of the signal data word followed by the CRC is recorded on tape. During playback, a zero remainder signifies that the encoded signal data is error-free.

ERROR DETECTION AND CORRECTION

In general, error compensating codes utilize cyclic redundancy checking along the length of the tape for error *detection*, and parity checking across the width of the tape for error *correction*. The combination is designed to correct any number of errors in a block, provided these errors occur in the same track on the tape. Experience has shown that stray dust and oxide particles tend to be much smaller than the distance between tape tracks, so that single-track errors are by far the most prevalent. To correct a massive error burst occurring over adjacent tracks would require a more-powerful error correcting code.

The CRC technique uses an error detection code that allows the digits to be manipulated, or shifted in some fashion, without losing the identity of the code. These codes are often described in mathematical terms, where the data bits are treated as the coefficients of a binary polynomial. In this article, however, we shall attempt to gain an understanding of error-compensating codes, using a minimal mathematical background which, hopefully, will lead to practical insight.

In the CRC scheme, the signal data word (continuing audio information) may be considered as a long number, say, P, which is divided by another number, say, G, yielding a quotient Q, and a remainder R, so that: $P/G = Q + R/G$. An equivalent expression is: $P = QG + R$. The quotient from this operation is discarded, but the remainder (which is the CRC word) is appended to the signal data word, P, and recorded on tape. During playback, the same operation is performed on the reproduced version of P, using the same value of G, to see if the remainder, R, agrees with the locally generated check bits. If it does, the reproduced word is assumed to be error-free. If there is an error, the CRC word will detect the erroneous word regardless of whether the error occurs in P or in R or in both.

As a basis for understanding this procedure, let us refer to the group of encoded data blocks illustrated in FIGURE 2. For the sake of simplicity, each block has been reduced to 10

information bits and five CRC bits. Each block has been constructed by dividing the signal data bits by a fixed sequence of pulses, 110101, which we will refer to as the generator code, G. The choice of this divisor is directly related to the anticipated error patterns. Using block #1 as an example, FIGURE 3 shows how this division is performed. Note that five zeroes have been appended to the 10 information bits; this series is one digit less than the number of bits in the generator code. The remainder from this operation, 11011, becomes the CRC word that is appended to the original signal data word. Block #1 now consists of the encoded 15-bit word, 101011100111011, and this sequence is recorded on tape. Later on, to check the validity of this block, the reproduced encoded data is divided by the same sequence of bits comprising the generator code (FIGURE 4). Since the remainder is zero, none of the bits are in error. A similar procedure is followed to check the accuracy of the other encoded data blocks. (The construction of the parity block will be discussed later.)

Referring now to the group of data blocks shown in FIGURE 5, let us assume that the signal data bits recorded on track #1 are almost completely mutilated by errors. As a result, the division operation will produce a different sequence of pulses composing the CRC word. During playback, a division of the new data bits by the local generator code will yield a remainder, thereby signifying that block #1 is in error. Obviously, to obtain a high degree of error detection capability, each detectable error pattern per block must give a different remainder. From this, it is clear that the choice of the generator code is critical to the effectiveness of the CRC word.

It should be pointed out that digital codes satisfying error detection and error correction properties, require that arithmetic operations be performed "modulo-2." In modulo-2 arithmetic, digital pulses may be multiplied and divided as though they were ordinary integers, but any bit added to a bit of the same value equals 0. Moreover, addition and subtraction produce the same results, because modulo-2 has no carries and

Figure 5. Encoded bits in block #1 are degraded by tape errors. During playback, the block in error is detected by the CRC code when division operation yields a non-zero remainder. Note that the column parity reflects the parity of the group of data blocks prior to recording the data.

Block #1	0 0 0 0 0 0 0 1 1 1 0 0 0 0 1	← Defective Block
Block #2	1 1 1 0 1 1 0 0 1 1 1 1 1 1 1	
Block #3	0 1 0 0 1 1 0 0 0 1 0 0 1 1 0	
Block #4	1 1 0 0 1 0 0 0 1 1 1 1 0 1 0	
Column Parity Block	0 0 1 1 1 0 0 1 1 1 1 0 1 0 0	

Block #1	0 0 0 0 0 0 0 1 1 1 0 0 0 0 1	← Erroneous Block
Block #2	1 1 1 0 1 1 0 0 1 1 1 1 1 1 1	
Block #3	0 1 0 0 1 1 0 0 0 1 0 0 1 1 0	
Block #4	1 1 0 0 1 0 0 0 1 1 1 1 0 1 0	
Old Parity Block, P ₁	0 0 1 1 1 0 0 1 1 1 0 0 1 1 1	
New Parity Block, P ₂	1 0 1 0 1 1 1 1 1 0 1 1 0 1 0	
Erroneous Block	0 0 0 0 0 0 0 1 1 1 0 0 0 0 1	} Add Modulo-2
New Parity Block, P ₂	1 0 1 0 1 1 1 1 1 0 1 1 0 1 1	
Restored Block	1 0 1 0 1 1 1 0 0 1 1 1 0 1 0	Sum

Figure 6. Parity check of all column bits (including CRC bits) locates position of errors in defective block #1. Modulo-2 addition of the defective block and new parity block corrects these errors. Note that the old parity block checks column parity of original blocks #1-4 in Figure 2.

borrows. Modulo-2 is also equivalent to the exclusive-OR function, which implements the hardware in error correcting circuitry. Thus, if two inputs have the same polarity, a 0 is produced; if the inputs are different, a 1 output is produced. (The exclusive-OR function is described in *Anatomy of Digital Logic: Part II*, in our May 1978 issue—Ed.)

ERROR CORRECTION

In order to determine precisely which bits in the defective block are in error, an extra bit is assigned to each column of corresponding bit locations, so that a "parity block" is formed. Parity bits are generated by counting the number of 1's in each column and then allocating a 1 or a 0 value to the parity bit, so that the total number of 1's is always an odd number. It is also possible to select parity as even, in which case, the parity bit would be encoded to give an even number of 1's in each column. However, the convention of odd parity will be used here for the purpose of illustration.

After parity determination, the encoded data blocks are recorded on tape. Of course, the track that records the parity block cannot be used for audio information. During playback, a parity checking arrangement monitors the bits in each column to ensure that parity is maintained. Here, an error-control circuit calculates a new parity bit per column based on the accessible blocks, and compares these bits with the previously stored version. If the parity bit in any column differs, a single-bit error has probably occurred in that column, either in the signal data word, the CRC word, or the parity bit itself.

To illustrate this method of error detection and correction, let us refer to the group of encoded data blocks in FIGURE 6. Note that block #1 has been "tagged" by the CRC word as a defective block. Consequently, a brand new parity block, P₂, is constructed from the corresponding bit positions in each column, now including those in the old parity block, P₁. A value of 1 in any location of the new parity block indicates an error in the corresponding column. To correct these errors, the corrupted block is added, modulo-2, to the new parity block, the sum of which yields the restored block. The restored block,

now in error-free form, is reread into the memory location containing the erroneous block, thereby providing the correct audio information.

Although the chances are remote, the possibility exists that a disastrous dropout extends over two adjacent tracks. Under these conditions, a parity check will fail to detect double-bit errors in each column because the 1's count will remain the same. It is feasible, however, to expand the parity checking concept to provide a more substantial protection against error bursts. One way to do this is to incorporate two parity tracks with the encoded data tracks to form a six track-per-channel system. This is the basis for the interlaced parity scheme shown in FIGURE 7. Here, two parity bits per column are required; the first parity block formed, P₁, provides odd parity for the corresponding bit positions in blocks #1 and #3, and the second parity block, P₂, accomplishes the same thing for blocks #2 and #4. The error correcting procedure is similar to that shown in FIGURE 6, except that parity blocks Q₁ and Q₂ are utilized independently to correct the odd-and even-numbered blocks, respectively.

ERROR CONCEALMENT

On the extremely rare occasions when the error correcting mechanism cannot deal with a catastrophic dropout, some form of error concealment is usually brought into use. This situation may arise when the errors are too numerous to be corrected by the interlaced parity scheme, even though they are detected by the CRC check. In the case where the uncorrected error samples are confined to one block, they are discarded and replaced by new sample values. These new values are derived by interpolation; that is, by calculating the average value of sampled signals immediately preceding and following the error sample. Where there are continuous uncorrected errors extending over more than one block, the preceding good data is held until the next error-free sample. An alternative to the latter procedure is muting during the period of uncorrected errors. Interpolation noise introduced by these methods will, for the most part, be barely perceptible. ■

Figure 7. Interlaced parity checking scheme offers further protection against burst errors.

Block #1	0 0 0 0 0 0 0 1 1 1 0 0 0 0 1	← Erroneous Block
Block #2	0 0 0 0 0 0 1 1 1 1 1 0 1 1 1	← Erroneous Block
Block #3	0 1 0 0 1 1 0 0 0 1 0 0 1 1 0	
Block #4	1 1 0 0 1 0 0 0 1 1 1 1 0 1 0	
Old Parity Block P ₁	0 0 0 1 1 1 0 1 1 1 1 0 0 0 1 0	
Old Parity Block Q ₁	1 1 0 1 1 0 1 1 1 1 1 1 0 1 0	
New Parity Block P ₂	1 0 1 0 1 1 1 1 1 0 1 1 0 1 0	
New Parity Block Q ₂	1 1 1 0 1 1 1 1 1 0 0 0 1 0 0 0	
Erroneous Block #1	0 0 0 0 0 0 0 1 1 1 0 0 0 0 1	} Add Modulo-2
New Parity Block P ₂	1 0 1 0 1 1 1 1 1 0 1 1 0 1 0	
Restored Block #1	1 0 1 0 1 1 1 0 0 1 1 1 0 1 1	Sum
Erroneous Block #2	0 0 0 0 0 0 1 1 1 1 1 0 1 1 1	} Add Modulo-2
New Parity Block Q ₂	1 1 1 0 1 1 1 1 0 0 0 1 0 0 0	
Restored Block #2	1 1 1 0 1 1 0 0 1 1 1 1 1 1 1	Sum

On RMS: Kelly's Constant to the Rescue

In which we discover that, when it comes to "RMS power," there isn't any!

ONE OF THE BEST-KNOWN mathematical values to engineering students is Kelly's Constant. This is the number by which you multiply your answer, in order to yield the correct answer. Edsel Murphy teaches us that, "When it comes to constants, Kelly's isn't." Nevertheless, we may express it mathematically as; $A_Y \cdot K = A_{EE}$

where A_Y = Answer (yours)
 A_{EE} = Answer (everyone else's)
 K = Kelly's Constant

It just so happens that this sort of higher mathematics may be directly applied to an analysis of "RMS"—that much-abused term which everyone uses, and *almost* everyone *misuses*. As it turns out, the RMS value of a sine wave, is the peak value multiplied by Kelly's Constant. This gives a final value that, when used in power calculations, yields the right answer. And,

since most of us deal with power calculations (remember the dB?), a clear understanding of what RMS is, and is not, may be in order.

The RMS value of a current or voltage is also known as the "effective" value, since it produces the same heating effect as a DC current or voltage of the same value. In other words, a direct current of say, 10 amps, will produce the same heating effect as an alternating current whose RMS is 10 amps. (Or as Kelly might put it, "Find out how much alternating current will do the same damage, and call it 10 amps RMS.")

Before going any further, let's look at electrical power; then, we'll come back to look at three ways of arriving at the RMS value of a sine wave.

In a simple DC circuit, the power dissipated in a resistor is given by the well-known equation: $P = IE$. The power dissipated in the resistor causes its temperature to rise and, if left alone long enough, the temperature stabilizes at some specific point.

Almon H. Clegg is the manager of the Audio Engineering Department, Product-Engineering Division at Technics, Secaucus, New Jersey.

Relating electrical and mechanical power

A side note about electrical power and its relation to mechanical power might be in order. The units of current are coulombs-per-second, while the units of voltage are joules-per-coulomb. The product therefore is joules-per-second, which is defined as watts.

Since a joule represents force-times-distance, it should be possible to convert watts to an equivalent horsepower whose units are foot-pounds-per-second. A table of conversion will show that a joule is equal to 0.7376 foot-pounds. And, since one horsepower is equal to 550 foot-pounds-per-second, it takes only some simple arithmetic to show that it takes 746 watts to equal one horsepower.

$$P = IE = \frac{\text{coulombs}}{\text{second}} \cdot \frac{\text{joules}}{\text{coulomb}} = \frac{\text{joules}}{\text{second}} = \text{watts}$$

$$\begin{aligned} 1 \text{ hp} &= \frac{550 \text{ foot-pounds}}{\text{second}} \cdot \frac{1 \text{ joule}}{.7376 \text{ foot-pounds}} \\ &= \frac{746 \text{ joules}}{\text{second}} = 746 \text{ watts} \end{aligned}$$

Now, before proceeding with the development of RMS values, take a quick look at AC power. As before, power equals current-times-voltage. But, instead of $P = IE$, we write $p = ie$: the small letters signify instantaneous values, for—unlike direct current—the current and voltage are constantly varying. The value at any instant is: $e = E \sin \omega t$, and, $i = I \sin \omega t$. The capital I and E are the peak values.

The alternating current and voltage cause the power dissipated in the resistor to vary between some maximum and zero, as the AC generator goes from its maximum value to zero. If we let the mathematics lead us along, we find that the power equation is a cosine wave at twice the frequency of the current and voltage.

For those who care about such things, the math is:

$$p = ie = (I \sin \omega t)(E \sin \omega t) = IE \sin^2 \omega t = IE(0.5 - 0.5 \cos 2 \omega t).$$

Or, think of it in a practical sense. At any instant in time, the power is the product of the current and voltage ($p = ie$). During the positive half of the current-voltage cycle, the product starts from zero, increases to a peak value, and then falls back to zero. During the negative half of the cycle, the same thing takes place, since the product of two negative values is positive.

The average power over many cycles is merely half the peak power. Thus, the same temperature rise in a resistor would be created by an alternating current with a peak value of X, or by a direct current of X/2. It is also intuitively obvious that negative power could not result from this circuit.

And now we get to the definition of RMS: The RMS value of a current and voltage sine wave is merely that value which, when used to calculate power, gives the average power. In other words, $I_{\text{RMS}}E_{\text{RMS}} = P_{\text{AV}}$ (*not* P_{RMS}). This average power produces the same heating effect as a direct-current power would. Now, we must come up with a Kelly's Constant with which we may multiply any peak current and peak voltage in order to find this average power. It should be noted that although most ammeters and voltmeters are peak-reading instruments, the meter scale is usually calibrated to give the RMS value.

Here are three methods which may be used to create our Kelly's Constant.

METHOD 1: IN THE LABORATORY

It would be possible to set up a precision oscilloscope or peak-reading meter, and place a thermocouple on the resistor under test. Then, we could set an AC source such that it gives the same temperature rise as some DC source, and therefore must be producing the same effective power. This type of laboratory experiment would yield the same result as we find in Methods 2 and 3: the effective, or RMS, values of current and voltage are both 0.707 times the peak values.

METHOD 2: A MATHEMATICAL APPROACH

If the average power dissipated in the load is half the peak power, we can do a little manipulating to come up with a constant that will give us the proper RMS values of current and voltage. We start with:

$$P_{AV} = 0.5P_{PEAK} = 0.5 (I_{PEAK}) (E_{PEAK})$$

Now, Kelly's Constant says that $I_{RMS} = I_{PEAK} \cdot K$. Therefore, $I_{PEAK} = I_{RMS}/K$ and, $E_{PEAK} = E_{RMS}/K$. This means that:

$$P_{AV} = 0.5 \left(\frac{I_{RMS}}{K} \right) \left(\frac{E_{RMS}}{K} \right) = \frac{0.5}{K^2} (I_{RMS})(E_{RMS})$$

But earlier, we said that $I_{RMS} E_{RMS} = P_{AV}$, which means that $0.5/K^2$ must be equal to 1. And that means that $K^2 = 0.5$, and $K = 0.707$, just as we found in the lab.

METHOD 3: THE TEXTBOOK APPROACH

This is the classical approach which is often found in the textbooks. Since the power is a function of the square of the current and voltage, and over the full cycle would have an average value, let's make a table of a sine wave for every 10 degrees, and see what results we get. (You calculator/computer freaks out there can generate this table in a flash.)

Since the sine wave is symmetrical, we will do the exercise for only 180 degrees, but the results will be the same for a full 360 degrees.

Angle θ	Sin θ	Sin ² θ
10	.17364818	.03015369
20	.34202014	.11697778
30	.50000000	.25000000
40	.64278761	.41317591
50	.76604444	.58682409
60	.86602540	.75000000
70	.93969262	.88302222
80	.98480775	.96984631
90	1.00000000	1.00000000
100	.98480775	.96984631
110	.93969262	.88302222
120	.86602540	.75000000
130	.76604444	.58682409
140	.64278761	.41317591
150	.50000000	.25000000
160	.34202014	.11697778
170	.17364818	.03015369
180	.00000000	.00000000
	Total	9.00000000
	Average	0.500
	RMS	0.707

The term RMS, which means root-mean-square, comes from this approach, simply indicating a value which is the square root (0.707) of the average, or mean (0.500) of the sum-of-square(s) (9). This type of mathematical analysis is more appropriate when we want the RMS value of a non-sinusoidal waveform. For a simple sine wave, it's certainly easier to simply remember that $RMS = 0.707$ Peak.

CONCLUSION

The RMS value of a current or voltage is merely a contrived number, used to compute the average power produced in a resistive load. It does not have any particular physical significance.

Perhaps this little tutorial has brought back some fond memories (and some, not-so-fond) to all you electronics students out there. And to all the spec-writers out there, remember the true meaning of the phrase "RMS watts" is a misnomer for what should really be called average power. The RMS label should be applied *only* to the current and voltage values used in the power calculations, which in turn give average power (*not* RMS power).

A FOOTNOTE OR TWO (possibly three)

1. The electrical power industry has standardized on specifying line voltages by their RMS value. Hence, all AC voltmeters are calibrated to read in RMS.
2. The IHF 202 Standard on Audio Amplifiers of 1978, and the FTC rule of 1974, do not use RMS power terminology. Rather, they use the correct term, which is continuous average power output, in watts. (The author has been waiting for some time now to see amplifier power quoted in milli-horsepower. A 100-watt amplifier could be rated at 134 mhp. If we stretch this far enough, we might be able to convert the ratings to an equivalent cubic-inch-displacement. With a little more conversion, we could be talking about the speed of an amplifier in peak mph in the standing quarter-mile.)
3. We have some crazy terms in our electronics dialogue. For instance, what is a "DC current"? Why, its a direct current current. Does that mean its a "direct current squared"? ■

A Simple BASIC program for Computing RMS

```

10 FOR A = 10 TO 180 STEP 10
20 AN = .01745*A
30 K = K + 1
40 S = (SIN(AN))^2
50 T = S + T
60 PRINT A,S
70 NEXT A
80 PRINT "TOTAL = ";T
90 PRINT " AVER = ";T/K
100 PRINT " RMS = ";(T/K)^.5
110 END
    
```

Remarks:

- 10 Steps (in 10-degree increments) through 180 degrees.
- 20 Converts the angle, A, into radians, as required for most personal computers.
- 30 Simply a counter, to keep track of how many computations have been made.
- 40 Calculates the sine-squared of each angle.
- 50 The total (so far) equals the sine-squared just computed, plus the previous total.
- 60 Prints the angle, and its sine-squared.
- 70 Returns to 10, for another run through the calculations.
- 80 Prints the final total.
- 90 Prints the average.
- 100 Prints the RMS value.

If all's well, your computer read-out should match columns 1 and 3 in the text (Method 3: The Textbook Approach).

Closing date is the fifteenth of the second month preceding the date of issue.

Send copies to: Classified Ad Dept.
db THE SOUND ENGINEERING MAGAZINE
 1120 Old Country Road, Plainview, New York 11803

Minimum order accepted \$10.00.

Rates: 50¢ a word.

Boxed Ads: \$25.00 per column inch.

db Box Number: \$1.00 per issue.

Frequency Discounts: 3 times, 10%; 6 times, 20%; 12 times, 33%.

ALL CLASSIFIED ADS MUST BE PREPAID.

FOR SALE

LEXICON 224 Digital Reverberation. FOR IMMEDIATE DELIVERY. **UAR Professional Systems, 8535 Fairhaven, San Antonio, TX 78229. 512-690-8888.**

THE LIBRARY... Sound effects recorded in STEREO using Dolby throughout. Over 350 effects on ten discs. \$100.00. Write **The Library, P.O. Box 18145, Denver, Colo. 80218.**

101 RECORDING SECRETS MOST ENGINEERS WON'T TELL, \$7.95 **Tune-tronics, P.O. Box 55, Edgewater, N.J. 07020.**

UREI: FOR IMMEDIATE DELIVERY most items. **UAR Professional Systems, 8535 Fairhaven, San Antonio, TX 78229. 512-690-8888.**

FREE CATALOG & AUDIO APPLICATIONS



CONSOLES
 KITS & WIRED
 AMPLIFIERS
 MIC, EQ, ACN LINE
 TAPE, DISC, POWER
 OSCILLATORS
 AUDIO TAPE BIAS
 POWER SUPPLIES

OPAMP LABS INC.
 1033 N. SYCAMORE AVE.
 LOS ANGELES, CA. 90038
 (213) 934-3566

REELS AND BOXES 5" and 7" large and small hubs, heavy duty white boxes. **W-M Sales, 1118 Dula Circle, Duncanville, Texas 75116 (214) 296-2773.**

SOUNDWORKSHOP 1280B Console, 12 in-12-out, Super EQ, meter bridge, 16-track monitor, freestanding desk, 3 patch panels—wired. \$4,000.00. **Tandem Recording, (703) 466-8675.**

AKG, E/V, Sennheiser Shure, Neuman; FOR IMMEDIATE DELIVERY most models. **UAR Professional Systems, 8535 Fairhaven, San Antonio, TX 78229. 512-690-8888.**

BEST PRICE—IMMEDIATE DELIVERY & FREE consultation on TEAC Tascam, Ampex, Sennheiser, Eventide, Studio Master, UREI, BGW, EV, Lexicon, ADR, Orban, JBL, Beyer, AKG, Technics, MXR & more. **Paul Kadair's Inc., Baton Rouge, Louisiana, (504) 924-1001.**

¼-INCH TAPE duplicating system. Six Crown 800 transports. New 4-channel heads. Solid state. Mint. \$4,200.00. **(215) 338-1682.**

PROFESSIONAL AUDIO EQUIPMENT

Shop for pro audio from N.Y.'s leader, no matter where you live! Use the Harvey Pro Hot-Line. (800) 223-2642 (except NY, AK, & HI) Expert advice, broadest selection such as: Otari, EXR, Ampex, Tascam and more. Write or call for price or product info:

Harvey Professional Products Division
 2 W. 45th Street
 New York, NY 10036
 (212) 921-5920

GUARANTEED LOWEST PRICES!
\$50 CASH OFFER!

We will beat any legitimate advertised price or price quote on any 3M PRO audio product, or we will give you \$50 CASH! Call now. Dealers excluded.

AUDIO PRO SHOP WHOLESALE DISTRIBUTORS
 8628 HORNWOOD
 HOUSTON, TX. 77074
 (713) 772-1153

SEND FOR OUR AUDIO PRO SHOP CATALOG.

CANADIANS!

Interested in semi-pro multitrack recording?

Headquarters for **OTARI** **MIE**
SOUNDRAFT **dbx** **TEAC TASCAM**
DeltaLab **JBL**
 and many more!
 Write or call

RICHARD AUDIO INC.
 6078 Sherbrooke St. W. Montreal, Quebec H4A 1Y1
 (514) 487-9951

FOR SALE: MCI RECORDING desk model 636 with light meters, Parametric Equalizer option, 36 x 36 in and out—4 EXTRA Wild VCA faders. Option for 2-24 track tape meter housing and 2 custom made producers tables—\$75,000.00. **Criteria Recording Studios, 1755 N E 149 St., Miami, FL 33181. (305) 947-5611.**

ELECTRODYNE 1608 CONSOLE (20x8/16tkMon) \$9,500; 3M M69 8tk Tape Recorder \$6,500; DBX 158 8ch Noise Reduction \$2,300; Ampex 300/350/351s-Mono/2tks. Call for Used Equipment List & quotes on new equipment. **Audio International (201) 322-4466.**

AMPEX, OTARI, SCULLY—In stock, all major professional lines, top dollar trade-ins; 15 minutes George Washington Bridge. **Professional Audio Video Corporation, 384 Grand Street, Paterson, New Jersey 07505. (201) 523-3333.**

BGW: FOR IMMEDIATE DELIVERY. **UAR Professional Systems, 8535 Fairhaven, San Antonio, TX 78229. 512-690-8888.**

ELECTRO-VOICE SENTRY III, Sentry IV-B, and Sentry V studio monitor speakers. E-V raw speakers and pro-music products. Otari professional recorders. Best prices—immediate shipment. **East: (305) 462-1976, West: (213) 467-5725.**

TEST RECORD for equalizing stereo systems: Helps you sell equalizers and installation services; Pink noise in 1/3-octave bands, type QR-2011-1 @ \$38.00. Used with various B & K Sound Level Meters. **Bruel & Kjaer Instruments, Inc., 185 Forest Street, Marlborough, Mass., 01752.**

NAB ALUMINUM FLANGES. We manufacture 8", 10½", 12½", and 14". Also large flanges and special reels to order. Stock delivery of assembly screws & nuts & most aluminum audio, video, & computer reels. For pricing, call or write **Records Reserve Corp., 56 Harvester Ave., Batavia, N.Y. 14020. (716) 343-2600.**

SCULLY, NEW and used: FOR IMMEDIATE DELIVERY. **UAR Professional Systems, 8535 Fairhaven, San Antonio, TX 78229. 512-690-8888.**

THE PA BIBLE from Electro-Voice, a professional guide addressing sound reinforcement and public address applications, specifications from the club, church, school level up through auditoriums, outside stadiums, road system situations. To receive your copy of this highly regarded tool, including all existing supplements, and to be put on the distribution list for future additions, send \$2.00 to **Electro-Voice, Box No. 122, 600 Cecil Street, Buchanan, Michigan 49107.**

BX20 AND BX10 AKG reverberation systems. FOR IMMEDIATE DELIVERY. **UAR Professional Systems, 8535 Fairhaven, San Antonio, TX 78229. 512-690-8888.**

COMPLETE 16 TRACK STUDIO for sale. All or individual pieces. Ampex MM-1100-16, 440-C 2-track, ElectroSound 2-track w/variable speed, plus lots of outboard pieces. Call for details. **(Dale), (303) 473-1114.**

AMPEX AG-350-2: consoled, \$1300.00; unmounted, \$1100.00. Crown 800 transports-quad heads, \$500.00; with electronics, \$650.00. Magnecord 1028-2 \$225.00; no electronics \$75.00. **(215) 338-1682.**

IVIE 10E REAL TIME Analyzer and 20B Noise Generator \$600/obo, like new condition. Call **Mike (213) 570-0938. (Los Angeles, CA)**

ORBAN. All products in stock. FOR IMMEDIATE DELIVERY. **UAR Professional Systems, 8535 Fairhaven, San Antonio, TX 78229. 512-690-8888.**

LEXICON 224 DIGITAL Reverberation System. In stock, immediate delivery, (special sale price). **Sonics Associates, Inc. (205) 942-9631.**

USED NEVE 24TK. CONSOLES

Model 8058 MK. II

Customer upgraded to larger console before he took delivery. This 28 in/24tk console is in brand new condition. Used by L.A. studio for 60 days. New price \$125,000. Offered for sale at \$99,900 FOB Los Angeles.

Model 8058 Custom

3 year old trade-in console. Fully reconditioned by Neve engineers. Sold with new warranty. \$59,900 FOB Bethel, Conn.

Lyrec 24 Track Tape Machine

6 month old demo machine with latest appearance and sophisticated ATC remote control. Run less than 100 hours. New warranty. Current list price \$45,000. Offered for sale at \$34,900 FOB Bethel, Conn.

Financing Available

Above equipment available through Neve 70% financing plan, subject to qualifying. Sales taxes, if any, are extra. Subject to prior sale.

East Coast (203) 744-6230
Nashville (615) 385-2090
West Coast (213) 874-8124
Canada (416) 677-6611

 **Neve**

AMPEX, OTARI & SCULLY recorders in stock for immediate delivery; new and rebuilt, **RCI, 8550 2nd Ave., Silver Spring, MD 20910.** Write for complete product list.

PROFESSIONAL AUDIO IN TUCSON—Crown, Otari, Altec, Sound Workshop, AKG, MXR-Pro, dbx & more. Sales, design, service and demonstration showroom. **Autograph Pro Audio, 601 E. Blacklidge Dr., Tucson, AZ, (602) 882-9016.**

Lexicon Prime Time: FOR IMMEDIATE DELIVERY. **UAR Professional Systems, 8535 Fairhaven, San Antonio, TX 78229. 512-690-8888.**

dbx 155: FOR IMMEDIATE DELIVERY. **UAR Professional Systems, 8535 Fairhaven, San Antonio, TX 78229. 512-690-8888.**

JFET TUBE REPLACEMENTS for first playback stages in most Ampex Professional audio tape recorders/reproducers available from **VIF International, Box 1555, Mountain View, CA 94042. (408) 739-9740.**

PRO-SOUND equipment. Specializing in phone and mail orders. Free discount catalog. Write or call **Sonix Co., Dept. D, P.O. Box 58, Indian Head, MD 20640 (301) 753-6432.**

FOR SALE: 3M-M-56, 16 tr w/remote. Excellent condition. \$12,000. **Warren (901) 458-4496.**

FOR SALE: EVENTIDE 910 harmonizer (all option), Eventide 1745 DDL; as packaged. **RPM Sound Studios, 12 E. 12th St., N.Y.C., NY 10003, call (212) 242-2100.**

SERVICES

VIF INTERNATIONAL will remanufacture your Ampex or Scully (Ashland/Bodine) direct drive capstan motor for \$175. Average turn around time—2-3 weeks. For details write **PO Box 1555, Mtn. View, CA 94042, or phone (408) 739-9740.**

JBL AND GAUSS SPEAKER WARRANTY CENTER

Fast emergency service. Speaker reconing and repair. Compression driver diaphragms for immediate shipment. **NEWCOME SOUND, 4684 Indianola Avenue, Columbus, OH 43214. (614) 268-5605.**

CUTTERHEAD REPAIR SERVICE for all models Westrex, HAECO, Grampian. Modifications done on Westrex. Quick turnaround. New and used cutterheads for sale. Send for free brochure: **International Cutterhead Repair, 194 Kings Ct., Teaneck, N.J. 07666. (201) 837-1289.**

ACOUSTIC CONSULTATION—Specializing in studios, control rooms, discos. Qualified personnel, reasonable rates. Acoustilog, Bruel & Kjaer, HP, Tektronix, Ivie, equipment calibrated on premises. Reverberation timer and RTA rentals. **Acoustilog, 19 Mercer Street, New York, NY 10013 (212) 925-1365.**

HIGHEST QUALITY SAME SPEED (one to one) cassette duplication with half track, A/V format from your 7½ or 15 ips masters. **Toby's Tunes, Inc., 2325 Girard Ave. S., Minneapolis, Minn. (612) 377-0690.**

MAGNETIC HEAD relapping—24 hour service. Replacement heads for professional recorders. **IEM, 350 N. Eric Drive, Palatine, IL 60067. (312) 358-4622.**

WANTED

SITUATION WANTED experienced recording engineer/producer with complete 8-track studio gear, clientele & ambition looking for individual in NE or upper-MW US to furnish physical studio, share work & future growth. **Michael, (317) 259-4853. Dept. 110, db Magazine, 1120 Old Country Rd., Plainview, NY 11803.**

EMPLOYMENT

WANTED: POSITION as a 1st or 2nd recording engineer, or position with a good professional sound company or professional audio equipment company—sales. Experience in studio recording, live sound reinforcement, video work and audio installations. Good, hard, efficient worker. **Eddie—(205) 263-6353.**

MAJOR NEW YORK CITY recording studio needs additional maintenance men. **Dept. 111, db Magazine, 1120 Old Country Road, Plainview, New York 11803.**

SITUATION WANTED: TV broadcast technician wants to break into professional audio recording business. Willing to learn mixing, dubbing, disk mastering; nearly everything in the technical end of recording. Over 8 years broadcast experience w/ASET Degree. If you're willing to show me the way, I want to learn. Write to **Bob Carr, 2307 6th Ave. N., Apt. #1-2, Great Falls, Montana 59401, or call (406) 727-8696, Thurs. & Fri., or Mon. & Tues. before 4 PM mountain time.**

PRO-AUDIO FLOOR SALESMEN WANTED Familiar with professional products of Altec, JBL, UREI, Yamaha, BGW, Shure, Electro-Voice, for new 3,000 square foot showroom in San Diego's oldest commercial sound engineering firm. Please send resume including either current salary or starting salary expected. Need someone who produces, accepts responsibility and wants to advance to a management position. Send resume to: **Victor M. Hall Communications Company, Inc., 3490 Noell Street, San Diego, CA 92110.**

SALES MANAGER for expanding, innovative pro-audio manufacturer in New York; distribution world wide. Send resume in confidence to: **Dept. 112, db Magazine, 1120 Old Country Road, Plainview, New York 11803.**

ENGINEERED SOUND SPECIALIST

Our expanding efforts in the installed sound system field have created a need for an exceptional individual to spearhead our activities.

Responsibilities include training our sales force, dealers and contractors in the application of our products, assisting dealers and customers with sound system design and acting as a liaison with acoustical consultants. The position is based in Framingham, Mass., reporting to our professional products sales manager and requires 50% national travel.

You should have a solid understanding of the principles of sound reinforcement, acoustics and audio. Strong oral and written communications skills and experience in making sales presentations a must.

BOSE offers a modern and attractive working, compensation and benefits package. Make your next career step with a leader of today and tomorrow. Send resume, in confidence, to **Gary LaFave, Dept. PDB, BOSE Corporation, 100 Mountain Road, Framingham, MA 01701.**

BOSE

An Equal Opportunity Employer M/F

Copies of db

Copies of all issues of **db—The Sound Engineering Magazine** starting with the November 1967 issue are now available on 35 mm. microfilm. For further information or to place your order please write directly to:

**University Microfilm, Inc.
300 North Zeeb Road
Ann Arbor, Michigan 48106**



Special binders now available.

All you regular **db** readers who, smartly enough, keep all your back issues, can now get our special binders to hold a whole year's worth of **db** magazines in neat order. No more torn-off covers, loose pages, mixed-up sequence. Twelve copies, January to December, can be maintained in proper order and good condition, so you can easily refer to any issue you need, any time, with no trouble.

They look great, too!

Made of fine quality royal blue vinyl, with a clear plastic pocket on the spine for indexing information, they make a handsome looking addition to your professional bookshelf.

Just \$7.95 each, available in North America only. (Payable in U.S. currency drawn on U.S. banks.)

Sagamore Publishing Co., Inc.

1120 Old Country Road
Plainview, NY 11803

YES! Please send _____ **db** binders @ \$7.95 each, plus applicable sales tax. Total amount enclosed \$ _____

Name _____

Company _____

Address _____

City _____

State/Zip _____

- **Servisound Inc.**, one of New York City's largest A-V and multimedia sound recording services, has added to its facilities a projection room dedicated solely to the programming and synchronization of A-V presentations. Occupying two floors at West 45th Street, Servisound now has available three recording studios, six mixing rooms with 2, 4, 8 and 16-track capability, four film scoring and editing rooms, a current music library with more than 25,000 music cues and a staff of 24.

- **Francesca Crupi** has joined the operations department at **Devlin Productions**. Ms. Crupi comes to Devlin with extensive video background, having served for over four years as operations manager at **National Video** and for two years before that as a coordinator at **Winkler Video**.

- Four hit albums from **Direct Disk Labs** are being released as **dbx** Encoded Disks, according to **Jerome E. Ruzica**, vice-president of dbx and director of the dbx Encoded Disc program. The four albums being released under the Direct-Disk Labs label are: *Blood, Sweat and Tears*, *Neil Diamond: His Greatest Hits*, *the Who's Who Are You* and *Loggins and Messina's Full Sail*.

- **Scharff Communications Inc.** (SCI) demonstrated the new **Technics** recording and broadcast digital equipment to members of the administration of the **Lincoln Center for the Performing Arts** during the **New York Philharmonic's** September 24th telecast from **Avery Fisher Hall**. **Zubin Mehta** was the conductor and **Itzhak Pearlman**, **Isaac Stern** and **Pinchas Zuckerman** were the featured soloists. SCI will be demonstrating the complete line of **Technics R & B** professional recording equipment, along with the **Neotek** console, as part of their presentation at **AES**.

- **C A Audio Systems**, manufacturers of the **Cadac Audio** range of studio mixing consoles, have appointed **Richard Swettenham** as Design and Marketing Consultant. Swettenham started his career at **EMI Abbey Road Studios**. In 1962, as technical director of **Olympic Sound Studios**, he designed the first all-solid-state studio console to be installed in London. As a founder of **Helios Electronics**, he supplied custom-built consoles to rock groups such as the **Beatles** and the **Who**, in addition to designing the **Rolling Stones** first large multi-track mobile studio.

- **Paramount Sound Studio** in Hollywood, California (not affiliated with **Paramount Pictures**) recently completed construction of a \$1.2 million dollar studio "C" recording and control room facility. The control room playback system features a pair of **Cerwin-Vega** 189SC 18-in. Stroker dual spider woofers and a pair of time-aligned **UREI** monitors. Each **UREI** 815 is driven by a bridged **Cerwin-Vega A-400** power amp (800 watts RMS into 8 ohms.)

- **The American Forces Radio and Television Services** (AFRTS) facility in Los Angeles will be updated this year with a new audio switching system supplied by **3M**. The Los Angeles AFRTS facility supplies more than 750 American broadcasting facilities with radio and television entertainment programs, special video information programs and current recordings for radio music libraries. In the new system, expected to be operational at the end of 1980, 80 audio tape units will be switched automatically, using a **3M AX** audio switching system and a **3M 6500** microprocessor machine-control system. The tape units serve variously as program sources and as recording devices.

- **Wayne Hetrich** of **National Public Radio** (NPR) has been honored with a special **Armstrong Award** for "significant research toward the implementation of major developments in state-of-the-art broadcast electronics technology." Hetrich, senior engineer for research and development at NPR, received the award for technical achievement in broadcasting in Los Angeles on October sixth. The judges cited Hetrich as a "pioneer in radio technology." He has been instrumental in the design and implementation of a cost-effective, high quality, multiple-channel satellite distribution system, the first ever created for a radio network. Hetrich's work also includes the development of a noise reduction system based on extensive research on the human ear and its reception of sound.

- **James B. Lansing Sound, Inc.** has appointed new firms to represent its professional series products in three domestic sales territories. Joining the **JBL** marketing organization are **Market-ration**, with its main office in Baltimore, Maryland; **RM Associates Ltd.**, headquartered in St. Louis, Mo.; and **Woburn**, Massachusetts-based, **Richard Dean and Associates, Inc.**

- **Martin Audio Video Corp.** announced that it has installed a 36-input **Amek M3000** mixing console with automated mixdown in **Aura Recording's** all new Studio D in New York City. Studio D's control room is equipped with a 24-track **Ampex MM 1200**, an **Audio Kinetics** Interlocator and an **Ampex ATR-102** 2-track mastering machine.

- At **Sigma Sound Studios**/New York, **David Byrne** and **Brian Eno**, who just completed working with Byrne and the rock group, **Talking Heads**, are back in the studio again, this time producing an album featuring themselves as the main artists. Working with them is engineer **John Potoker**.



IF YOU THINK DIGITAL IS JUST AROUND THE CORNER, YOU'RE ALREADY A STEP BEHIND.

These days, most people agree that digital is the recording technology of the future. Unfortunately they're also under the impression that it won't be available until then.

There are, however, some notable exceptions to that philosophy. Like Warner Bros. Records, Record Plant, Westlake Audio, A/V Rents and Sound Ideas. Along with some of the most successful studios in England, Germany, Japan and France. You see, they've all installed the multi-track digital system that's available right now.

3M's 30-channel Digital Mastering System.

Already, it's been instrumental in the production of more than 60 records. Because digital captures all the pure, full-range highs and lows and surrounds them with clean, no-hiss silence. The result is transparent, distortion-free sound itself. Whether it's the first generation or the twentieth. All of which adds up to the real reason why these and other outstanding studios are using 3M Digital equipment. Whether it's our 4, 15, or 30-channel recorders, or our sophisticated electronic-editing and digital preview units.

They like to stay a step ahead.

Write: Digital Mastering/3M, Building 223-5E/3M Center, St. Paul, MN 55144.

3M DIGITAL MASTERING. WE DIDN'T INVENT SOUND. JUST THE PUREST WAY TO RECREATE IT.

Circle 11 on Reader Service Card

3M



if we had known in advance the economic and technical needs of 1980...

if we had chosen to develop a recording console that would precisely meet those needs...

we couldn't have done better than this...

now more than ever **32C** from

Harrison

HARRISON SYSTEMS, INCORPORATED

P.O. Box 22964, Nashville, Tennessee 37202
(615) 834-1184, Telex 555133

Circle 12 on Reader Service Card