

ISSN0011-7145

# dB

THE SOUND ENGINEERING MAGAZINE

JUNE 1974 \$1.00



HAL SYR  
RUOW-EM  
UNIV OF  
SEATTLE WA



# We repeat.

Being the best in duplicating equipment isn't easy.

That's why we at Electro Sound design our professional tape duplicating system to be both durable and versatile. Long lasting hardware.

Sure we use state-of-the-art techniques. A unique servo constant tension system, electronic cue tone injector and a 2,000' capacity vertical loop bin that guards against tape edge curl are examples of our skills.

Plug-in heads let operators change tape width or formats in seconds. Speeds of 120, 240 or 60 ips means production flexibility. Endless loop or auto rewind handles any duplicating job. But so what?

It's the ability to efficiently produce a finished tape of unquestioned high quality that pays off in operating profits for our customers.

But that's not all. We are the only single source manufacturer of duplicators, loading racks, quality control reproducers, mastering recorders, cartridge and cassette winders and splicers. And we provide on-site engineers for equipment installation and employee training.

Whether you duplicate retail music, broadcast syndications or "spoken word" formats, Electro Sound has a system for you. After all, the giants who pioneered the industry, as well as those just joining it, are using Electro Sound systems.

## ELECTRO SOUND®

### ELECTRO SOUND, INC.

725 Kifer Road, Sunnyvale, CA 94086  
(408) 245-6600 Telex: 34-6324 LECTROSND SUVL

Exclusive International Distribution By:

### AUDIOMATIC CORPORATION

1290 Avenue of the Americas, New York, NY 10019  
(212) 582-4870. Cable: AUDIOMATIC. Telex: 12-6419  
European Office and Showroom  
4, rue Ficatier, 92400 Courbevoie, France (Paris).  
333.30.90 Cable: AUDIOMATIC. Telex: 62282

Circle 10 on Reader Service Card

# COMING NEXT MONTH

● Marshall King returns to our pages with a major feature article on the relationship that must exist between a t.v. sound man and the sound reinforcement specialist at a live show that is also being televised. To do this, the author takes us to Las Vegas where he has had plenty of experience trying to get good sound out to the video chain while staying friendly and indeed working with, the house sound man. It's fascinating and useful reading for every broadcast and recording engineer, as well as Las Vegas-type sound men.

John Woram is preparing a detailed examination of the just concluded Los Angeles AES Convention. It will appear in the feature section. There will be plenty of pictures of products and such, and there will also be a separate NEW PRODUCTS AND SERVICES section.

And there will be our regular columnists: Norman H. Crowhurst, Martin Dickstein, and John Woram. Coming next month in *db*, *The Sound Engineering Magazine*.

# ABOUT THE COVER

● This painting of a concert by P. Longhi, an 18th century Italian painter. Could it be that the dog in the corner is the forerunner of Nipper, the famous RCA dog?



THE SOUND ENGINEERING MAGAZINE

JUNE 1974 VOLUME 8, NUMBER 6

32	OPAMPS FOR MIXING Roy H. Trumbull
35	A MIC PREAMP/MIXER Ting Barrow
37	A VISIT TO ORTOFON Larry Zide
2	LETTERS
6	THE SYNC TRACK John Woram
12	THEORY AND PRACTICE Norman H. Crowhurst
19	NEW PRODUCTS AND SERVICES
28	SOUND WITH IMAGES Martin Dickstein
40	CLASSIFIED
42	PEOPLE, PLACES, HAPPENINGS

**db** is listed in **Current Contents: Engineering and Technology**,

<b>Robert Bach</b> PUBLISHER	<b>Larry Zide</b> EDITOR
<b>Bob Laurie</b> ART DIRECTOR	<b>John Woram</b> ASSOCIATE EDITOR
<b>A. F. Gordon</b> CIRCULATION MANAGER	<b>Hazel Krantz</b> COPY EDITOR
<b>Eloise Beach</b> ASST. CIRCULATION MGR.	<b>Richard L. Lerner</b> ASSISTANT EDITOR
<b>GRAPHICS Crescent Art Service</b>	

db, the Sound Engineering Magazine is published monthly by Sagamore Publishing Company, Inc. Entire contents copyright © 1974 by Sagamore Publishing Co., Inc., 980 Old Country Road, Plainview, L.I., N.Y. 11803. Telephone (516) 433 6530. db is published for those individuals and firms in professional audio-recording, broadcast, audio-visual, sound reinforcement, consultants, video recording, film sound, etc. Application should be made on the subscription form in the rear of each issue. Subscriptions are \$6.00 per year (\$12.00 per year outside U. S. Possessions, Canada, and Mexico) in U. S. funds. Single copies are \$1.00 each. Controlled Circulation postage paid at Harrisburg, Pa. 17105. Editorial, Publishing, and Sales Offices: 980 Old Country Road, Plainview, New York 11803. Postmaster: Form 3579 should be sent to above address.



the new standard in  
**professional  
audio design**

**amplifiers**



**DX, TAX  
SERIES  
70 TO 250  
WATTS RMS**

**INCOMPARABLE** solid-state amplifiers for continuous-duty performance, available in a broad selection to meet professional audio amplification requirements.

**mixer-amplifiers**



**SPECTRUM  
SERIES  
40, 80, 120  
WATTS RMS**

**SUPERIOR** mixer-amplifiers with less than 1.5% THD and program equalization provisions. Flexible, advanced design; professional in every sense of the word—for the most demanding applications.

**input equipment**



**4907 R  
PREAMP  
  
4908  
MIXER-  
EXPANDER**

**OPTIMUM** mixing performance in maximum flexibility input equipment. Ideal for broadcast and recording use, theaters, auditoriums, and churches. Distinguished for ultra-low distortion and wide-range performance.

**for equalization**



**6101  
SPECTRUM  
MASTER**

**PRECISE** professional acoustical analysis and system correction in minimum time is now at your command with this all-new 1/2 Octave Active Filter Test and Correction Instrument-System.

**WRITE FOR TECHNICAL BULLETINS**

**RAULAND-BORG CORPORATION**  
3535 W. Addison St., Dept. N, Chicago, Ill. 60618

**letters**

**THE EDITOR:**

I read with interest the two part article by A. Oscar Burke on **THE DECIBEL**. It touched on many important areas.

One important area of concern which Mr. Burke did not cover deals with the use of the decibel and volume units in the measurement of relative noise levels, particularly wherein telephone line transmission is involved. The audio and broadcasting industries use references which differ significantly from those employed generally by the telephone system (Bell System) and the telephone companies do not always understand the problems of audio

**advertisers  
index**

AKG . . . . .	3
Analog & Digital Systems . . . . .	5
Audio Designs . . . . .	21, 22, 23, 24
Audio-Technica . . . . .	8
Bang & Olufsen . . . . .	13
Bose . . . . .	20
Broadcast Electronics . . . . .	25
CBS Labs . . . . .	29
David Clark . . . . .	16
Electro-Sound . . . . .	cover 2
Garner . . . . .	31
Gately . . . . .	27
Gotham Audio . . . . .	19
Heil Sound . . . . .	29
Inovonics . . . . .	14
London Company . . . . .	39
Lumiere . . . . .	30
Miller-Stephenson . . . . .	39
Neumann . . . . .	19
N.V. Philips . . . . .	7, 15
P.C.E. . . . .	36
Ramko . . . . .	4
Rauland-Borg . . . . .	2
ReVox . . . . .	28
Russco . . . . .	12
Sagamore Pub. Co. . . . .	14, cover 4
Scott Instrument . . . . .	30
Sennheiser . . . . .	33
Spectra-Sonics . . . . .	8
STL . . . . .	10
Systron-Donner . . . . .	28
Tascam . . . . .	9, cover 3
Timekeeper . . . . .	10, facing page 1
Waters . . . . .	11
Westlake Audio . . . . .	17, 18
Woram Audio . . . . .	20

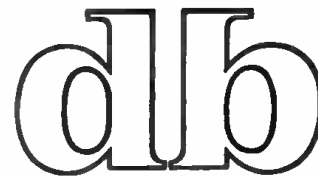

**THE SOUND ENGINEERING MAGAZINE**

**SALES OFFICES**

**New York**  
980 Old Country Road  
Plainview, N.Y. 11803  
516-433-6530

**Dallas**  
Roy McDonald Associates, Inc.  
Stemmons Tower West  
Suite 714  
Dallas, Texas 75207  
214-637-2444

**Denver**  
Roy McDonald Associates, Inc.  
3540 South Poplar Street  
Denver, Colorado 80237  
303-758-3325

**Houston**  
Roy McDonald Associates, Inc.  
3130 Southwest Freeway  
Houston, Texas 77006  
713-529-6711

**Los Angeles**  
Roy McDonald Associates, Inc.  
500 S. Virgil  
Suite 360  
Los Angeles, California 90020  
213-381-6106

**Portland**  
Roy McDonald Associates, Inc.  
2035 S. W. 58th Avenue  
Portland, Oregon 97221  
503-292-8521

**San Francisco**  
Roy McDonald Associates, Inc.  
Baybridge Office Plaza, Suite 265  
5801 Christie Avenue  
Emeryville, California 94608  
415-653-2122

The same perfectionist attitude that's in our most expensive microphones sets the pace for all AKG mikes. Some of them are so unique they're patented. Like the special AKG "two-way" dynamic microphones. They combine two microphone elements in one housing. You get improved highs and lows without the "booming" proximity effect. And virtually no feedback.

Another is the C-451 condenser microphone system. It is the only interchangeable component microphone system in the world. You can attach six different microphone modules for different recording functions on one compact preamplifier. You save on costs. You get versatility and high performance.

AKG even makes a condenser microphone—the C-24.

This single microphone can record an entire symphony orchestra in stereo.

Rock mikes? We have a range and variety that every artist will find palatable. Home recording, P.A., country and folk music, special purposes—there's even an AKG guitar pickup . . . and they all capture the exact sound any given situation generates.

Expect a lot from AKG microphones. They have the family reputation to live up to. See your professional equipment supplier. Or write to us directly for details.

**AKG MICROPHONES • HEADPHONES**

Distributed by  
NORTH AMERICAN PHILIPS CORPORATION  
100 East 42 St., New York, N.Y. 10017



## Between \$50 and \$1,295 AKG has everything for pop, rock and Bach.



# Buy the best at any cost— even if it costs you less!

Broadcast and audio engineers around the nation have chosen Ramko products on performance specs alone. Then were pleasantly surprised at our low, low prices.

Compare Ramko performance yourself. Free 10-day evaluation period and 2-year warranty guarantee you get the best.



### TURNTABLE PREAMPS MP-8 \$72 (Mono) SP-8 \$114 (Stereo)

Outstanding sensitivity and incomparable reproduction. RIAA/NAB equalized  $\pm 1$ db. 0.5mv sensitivity (internally adjustable) at 1kHz for  $-4$ dbm out.  $+20$ dbm out max. Balanced 125/600 ohm outputs.  $-73$ db S/N referenced to 10mv @ 1kHz. 0.075% or less distortion. External terminals for brilliance, rolloff or RIAA equalization. 140mv @ 1kHz headroom. Internal power supply. MP-8 Mono, SP-8 Stereo. Tabletop or bracket mount. Shipping weight 4½ lbs.



### DISTRIBUTION AMPLIFIERS DA-6 \$109 (Rack Mount Available)

Individual output amps provide maximum isolation.  $\pm 0.5$ db response. 10Hz to 20kHz. 26db gain. Balanced bridging or matching input. Six balanced 600 ohm outputs.  $+20$ dbm out max. Output level control. 0.1% or less distortion. Internal power supply. Tabletop or bracket mount. Shipping weight 4 lbs. Other models feature output metering and up to 32 outputs. \$138 to \$425.



### AUTOMATIC CART & CASSETTE LOADERS ACL-25 \$159

(Spec & Tone Sense Options Available)

At least automatic precision winding at a price you can afford! Eliminates guesswork because dials set tape length to the second. The exact amount of tape is fed onto the cart or cassette, then it is shut off automatically. Exclusive tension control for proper tape pack and winding of various hub sizes. TTL digital control circuitry. With speed or tone sense options. \$266 to \$350. Shipping weight 30 lbs.



### STUDIO MONITOR AMPLIFIERS SMA-50 \$105

(Rack Mount, Mono & Stereo Options)

Exceptional reproduction! Internal muting.  $\pm 1$ db response. 20Hz to 40kHz. 25w music power. 50w instantaneous peak power. 15w rms. Hum and noise.  $-55$ db below rated output. Distortion less than 1% at 15w rms; typically below 0.25% at less than full power. Load impedance, 4, 8, 16 ohms; input balanced bridging, 100kohms. Variable base contour. Internal overload protection. Internal power supply. Tabletop or bracket mount. Rack units. \$126 to \$169. Shipping wt. 6 lbs.



### MIC/LINE AMPLIFIERS MLA-1 \$84 (Mono) MLA-2 \$112 (Stereo or Dual Mono)

Dual function utility amps. Inputs for mic and/or line.  $\pm 0.5$ db response. 10Hz to 20kHz. Mic input  $-65$ db for  $+4$ dbm out. Balanced inputs on high-level and mic channels. Balanced 600 ohm out.  $+20$ dbm out max. 0.1% or less distortion. Internal power supply. Tabletop or bracket mount. Shipping weight 4 lbs.



### COLLIMETERS (Precision Tape Head & Guide Alignment) Standard. C-II \$15 Multi-Cart, C-IV \$19

A Ramko exclusive! Designed by Ramko to speed up tape head and guide alignment on all cart machines. Now used by more than 5,000 engineers. Unique combination of optical and electro-sensing elements allows you to precisely adjust Height, Zenith, and Azimuth on all cartridge machines.

ORDER TODAY FOR 10-DAY TRIAL PERIOD.  
Compare Ramko performance yourself.



**Ramko Research** Professional Audio Products

3516-B LaGrande Blvd., P.O. Box 6031  
Sacramento, California 95860 (916) 392-2100

transmission over the equipment and lines of the telephone company. It is high time that this problem area was duly researched and documented.

When the telephone company states that they have measured a facility and found it to meet their noise figure specifications, written in "dBRN" (decibels-reference noise) it is often difficult or impossible to translate these numbers into dBm or vu. For example, for f.m. broadcasting, FCC requires a noise figure of  $-60$  dB, referenced to program level of 100 percent modulation. If your telephone company-furnished program line limits your system to  $-57$  or  $-58$  dB because of telephone line noise, the telephone company often disputes the deficiency because of differences in references and terms. Usually routine maintenance improves the noise figure 15 or 20 dB, allowing the specification of the FCC to be met, but it is often difficult to get the telephone company to act to perform this maintenance if they are convinced that no problem exists to be corrected.

*James F. Pinkham,  
Technical Director  
Potomac Broadcasting Corp.  
Alexandria, Virginia*

## Copies of db on Microfilm

Copies of all issues of db—The Sound Engineering Magazine starting with the November 1967 issue are now available on 35 mm. microfilm. For further information or to place your order please write directly to:

University Microfilm, Inc.  
300 North Zeeb Road  
Ann Arbor, Michigan 48106  
A subsidiary of Xerox Corporation

In addition to Microfilm Copies available through University Microfilm, we have a limited number of regular back issues available. You may order these copies at \$1.00 each from:

Circulation Department  
db—The Sound Engineering Magazine  
980 Old Country Road  
Plainview, New York 11803

# INVISIBLE SOUND



For the first time in your life, you can hear music precisely as it was recorded. Down to the last incredible detail.

Until now, the very best high fidelity loudspeakers have been described as transparent. Now, innovative design and precision engineering have made it possible to take a giant step beyond transparency—to the Invisible Sound of Braun speakers.

Music passes through Braun speakers with such natural clarity the speakers seem to disappear. Only the music is real. Once you experience the Invisible Sound of Braun speakers—the ear-opening sound of live music in your living room—you'll never be satisfied with conventional speakers again.

We'll be happy to explain to you how and why Braun, and only Braun, is able to achieve Invisible Sound. We'll also describe our complete line of speakers in detail, and send you the names of the selected group of Braun dealers in your city.

Write: Braun Loudspeakers, 377 Putnam Avenue, Cambridge, Massachusetts 02139. Phone: 617/492-0970.

THE

SOUND OF **BRAUN**

Circle 24 on Reader Service Card

[www.americanradiohistory.com](http://www.americanradiohistory.com)

# To hear... perchance to speak...



Why there's the rub. Or at least it used to be.

For now Beyer has come up with a headphone/microphone combination that's been designed never to rub you the wrong way.

Created to meet the stringent requirements of the broadcast industry, the Beyer DT 109 combines a hypercardioid microphone with wide, flat frequency response and a two channel high quality headphone that offers the kind of performance that has made Beyer the overwhelming choice of professionals the world over.

Together they provide excellent isolation from ambient noise, superb intelligibility, unfettered, hands-free operation and unexampled comfort.

Equally at home in the studio or the field, the DT 109 is built to withstand the rigors of hard, constant use. And in the unlikely event any part is broken or wears out, its modular construction permits on-the-spot replacement.

As for the price, it won't rub you the wrong way either. The Beyer DT 109 only \$78.50.

**Another innovation  
from Beyer Dynamic,  
the microphone people**

**Revex Corporation  
155 Michael Drive  
Syosset, N.Y. 11791**

Circle 28 on Reader Service Card

John M. Woram

## THE SYNC TRACK

• Here's a letter recently received—

*Dear Sirs—or Lou (Burroughs)*

*I finally received my book, "Microphones: Design and Application" by Lou Burroughs, and what a disappointment. I confess to have built up what I thought it should be. Judging by the cover, I felt the book would deal with individual brands and not the three or four general types. I realize there's a certain amount of risk and prejudice involved, but that would have made a hell of a lot more practical sense. If Lou had shown patterns of individual mics (brands) I could apply what he wrote. But basically he beefed up what I already knew of the basic types and nothing more.*

*Also, here again I felt on the application part I was greatly let down. I thought I was going to read about miking techniques on drums, bass, piano, vocals and everything else but instead found out about room noise and phase relations. At the price demanded I for one feel cheated. Although I realize it's too late for my refund, I hope next time says what you expect from its author. (sic)*

Oh well, you can't please everyone.

I suppose it's not terribly clever to print letters like this when Sagamore Publishing Company is trying to break into the big time book publishing business. It's not what I'd call your standard testimonial letter.

However, it is symptomatic of some sort of anti-learning syndrome that seems to be all too noticeable among would-be recording engineers. I fully expect to see a letter any day now that says:

"Dear Sirs:

Never mind this education crap; just tell me what I want to hear!"

I should hope that by the time the writer had cleared third grade, he would have figured it out that education comes out of books, and out of personal experience. The books can prepare you to deal with the personal experience, but they cannot become a substitute for it.

On the first page of the first chapter of Lou's book he says, "The audio engineer and his microphone may be compared to the artist and his paint brush. Microphones and paint brushes are both tools used in the creation of a work of art—the one aural, the other visual. We have all seen the same subject interpreted differently by two great painters. The difference in interpretation does not make one superior to the other, except perhaps in the eye of its creator. The same is not less true of reproduced sound and explains why there is rarely, if ever, a uniquely "correct" way to place a microphone. (My italics)

Now if you can't figure out what that means, try this:

Imagine you are an art student, and Leonardo Da Vinci himself appears to you in a dream and says, "Go ahead kid, ask me anything."

"Leo sweetheart," you say, "what kind of brush did you use on the Mona Lisa?"

Leo tells you, and when you wake up, you run around to the art shop and buy one. But somehow, it doesn't seem to work for you the way it did for him.

What did you expect? You've got to know more about painting than what kind of brush Leonardo used. And you've got to know more about recording than you can learn from comparison shopping with polar patterns. I'd bet there are few engineers who could recognize the polar pattern of a favorite microphone in a stack of unmarked patterns. And what if they could? The engineer who selects a microphone because he admires its polar pattern should seriously consider retiring.

Any beginner who thinks he can apply such knowledge as he can get by matching up microphone specifications should send for this book before touching his first microphone. The trouble is, this reader already bought the book, apparently read it, and *still* doesn't get the message.

There's a very tired cliché around that warns against judging a book by its cover. Lou's book has an attractive dust cover with a collection of microphones on it. It keeps the book from getting scratched, and points out that



# Flexibility en route.

The Philips MP4 portable 4 channel mixing unit has been specially designed for flexible operation on location.

If you are looking for studio quality and a reasonably-priced, small flexible unit that complies with professional specifications, then the MP4 is what you need.

Not only can the MP4 be used as a portable unit but it can also be integrated in existing studio-installations.

You need more information? Contact Mr. Jan Gerrits or Mr. Bram Potappel, N.V. Philips' Gloeilampenfabrieken Electro-Acoustics (ELA) Division, Broadcast Equipment, Building SAQ II, Eindhoven - The Netherlands.

Tel. 040-733793 or 732646, Telex 51121.



## PHILIPS

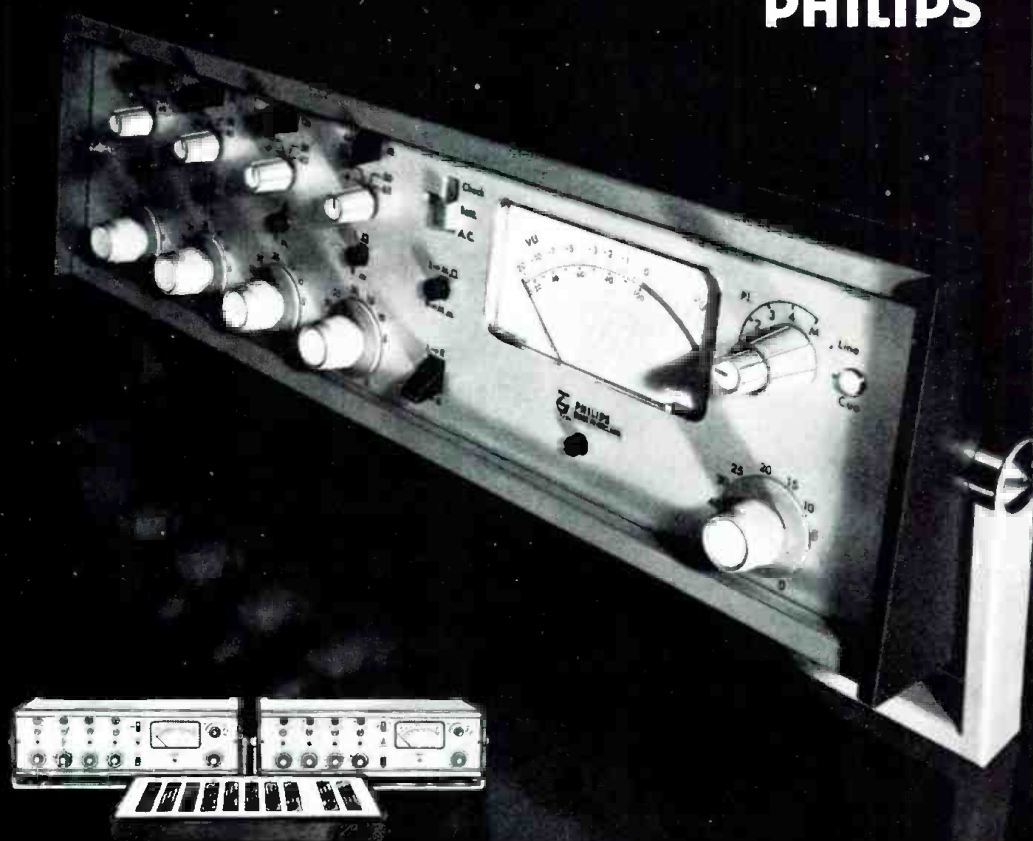

Circle 26 on Reader Service Card

## The Discrete Cartridge of Choice with CD-4 Record Manufacturers:

# audio-technica®

Whether listening to reference lacquers or checking metal "mothers" for quality, you'll find more Audio-Technica built cartridges in use than any other make.



Illustrated: Model AT14S with Shibata stylus, \$75.00, mounted in AT-1009 Tone Arm, \$139.95.

AUDIO-TECHNICA U.S., INC., Dept. 64BD, 1655 W. Market St., Fairlawn, Ohio 44313

Circle 15 on Reader Service Card

The reason is simple: Our consistent performance is essential to their quality control standards. Whether your CD-4 cartridge is for home or studio...if you've built up a tolerance for nothing but the finest, come to us.

# COMPLIMETER™



MODEL 610

Used in recording studios; disc mastering studios; sound reinforcement systems; TV, AM, FM broadcast stations to maintain a sustained average signal at a level significantly higher than that possible in conventional limiters, and with performance that is seldom attained by most linear amplifiers. Rack mounted, solid state, functional styling, the Model 610 is in stock for immediate shipment.

Specifications are available from:

## SPECTRA SONICS

770 WALL AVENUE, OGDEN, UTAH 84404  
(801) 392-7531



Circle 41 on Reader Service Card

the subject is microphones. In a bookshop, the art work may catch your eye, and get you to pick the book up. But, you're supposed to examine the *inside* to tell you what the book is really all about.

On the side of crass commercialism (horrors!) Sagamore Publishing Company hopes its entry into the book publishing business will be reasonably profitable. Now, there is no future, or profit, in releasing documents from which important information has been withheld. (Unless you're the President, of course.) If there was anything to say about miking technique on drums, bass, piano, etc., you can be sure it would have been said. But there isn't. No more than Leonardo can tell you what brush is best for you to use.

When you find a book or brochure that tells you how to mic the drums, or, which microphone to use for the guitar, you can be sure you are being *had*, either by a sales pitch or by someone trying to take advantage of the beginner.

Recording happens to be a lot of fun (sometimes). Even after years in the control room, tomorrow's session can still be an exciting experience. But the talent you bring to the session has got to be your own; copying someone else just won't work.

Your talent can be developed—by experience and education. Which brings us back to books. But not to "Dick & Jane Freak Out on Polar Patterns." A good book will tell you something of what you should know. Presumably, the author has picked up a little knowledge over the years, and is in a good position to teach you something, if you will give him your attention. If you won't, you're only cheating yourself.

Of course, this letter writer is not the only one of his kind. There are many students who have made up their minds what they want to be taught, and will fight like hell if anyone tries to put any of that education stuff over on them.

This letter writer seems to have successfully resisted any efforts to teach him spelling or sentence structure. (Your editor unscrambled most of the letter but surrendered at the sight of the last sentence.)

That's not a very kind remark, and I suppose it has little to do with audio and may not belong in a column which is supposed to be talking about the recording scene. But I see an awful lot of letters like this from people who really expect that some sort of divine revelation from the stars will transform them into instant geniuses and spare them all that business about studying.

Well gang, at the risk of offending



## Series 70 Recorder/Reproducers

# When you've got more talent than money

TASCAM Series 70 recorder/reproducers were designed for people who've outgrown high-end consumer audio products but can't afford full professional studio gear.

Whether you need single, two or four channels, you define the Series 70...it doesn't define you. Your choices are expanded instead of restricted without paying a performance penalty.

The versatile Series 70 electronics come in two versions, one for direct recording and one for use with a mixing console like our Model 10. Either way you'll find uncommon quality and reliability.

Series 70 recorder/reproducers. When you've got more talent than money.

 **TASCAM CORPORATION**



5440 McConnell Avenue  
Los Angeles, Calif. 90066

Circle 18 on Reader Service Card  
[www.americanradiohistory.com](http://www.americanradiohistory.com)

# Simply

## STL Test Tapes Are The Most Dependable And Accurate You Can Buy

These precision tapes are produced on precision equipment using exclusive production techniques to provide the most accurate reference possible. They are widely accepted by major manufacturers, governments and all who need a precision reference tool. Available in 1" and 2" sizes as well as flutter tapes and all other formats. Order STL test tapes and find out where your system really is. Write for a free brochure and the dealer in your area. Distributed exclusively by Taber Manufacturing & Engineering Co.



STL STANDARD TAPE LABORATORY, Inc.  
2081 Edison Avenue  
San Leandro, CA 94577  
(415) 635-3805

Circle 13 on Reader Service Card



## TIMEKEEPER Tape Timers

Due to the unavailability of a continuing supply, we are closing out our inventory of Professional Tape Timers. Here is a fabulous opportunity to purchase one of these excellent units at a considerable saving. The Professional Tape Timer is calibrated for 7.5 and 15 ips and normally sold for \$119.95. Our price is now only \$77.00 including shipping charges.

We have only a limited supply of units left so please order soon.

Send check to:  
TIMEKEEPER  
P.O. Box 35  
Great Neck, N.Y. 11021  
*N.Y.S. residents add 7% sales tax*

all of you, the stars won't, and can't do your thinking for you. So, get your heads out of the clouds and start *learning* before you get old and senile and have to make your living writing monthly columns.

*Why?* I'm glad you asked. The recording business is not getting any simpler. And, jobs are not exactly going begging. These days, the chief engineer can afford to shop around for someone with a little apparent potential. He may expect the applicant to have a few basic skills beyond being able to dress himself and tie his own shoes without assistance. He will certainly not be impressed with someone who thinks he knows how to mic drums because he read all about it in a book somewhere.

So, if you want to make your living playing in the recording studio with all the pretty knobs and switches, do yourself a favor and learn what you can, when you can. Try to learn how to read and write. Who knows, you may have to leave a note for the maintenance crew someday. ■

## you write it

Many readers do not realize that they can also be writers for *db*. We are always seeking good, meaningful articles of any length. The subject matter can cover almost anything of interest and value to audio professionals.

Are you doing something original or unusual in your work? Your fellow audio pros might want to know about it. (It's easy to tell your story in *db*.)

You don't have to be an experienced writer to be published. But you do need the ability to express your idea fully, with adequate detail and information. Our editors will polish the story for you. We suggest you first submit an outline so that we can work with you in the development of the article.

You also don't have to be an artist, we'll re-do all drawings. This means we do need sufficient detail in your rough drawing or schematic so that our artists will understand what you want.

It can be prestigious to be published and it can be profitable too. All articles accepted for publication are purchased. You won't retire on our scale, but it can make a nice extra sum for that special occasion.

# Waters Attenuators

key to trouble-free mixing



With a complete line of professional audio attenuators, Waters Manufacturing has solved the noise problems usually encountered in conventional fader controls.

The answer is MystR®—Waters' proprietary conductive plastic resistance element. MystR's glass-hard, smooth wiping surface achieves noise levels below 20  $\mu\text{V}$  (at least 100 db down) over a trouble-free life of at least ten million operations. Precision engineered to provide professional "feel," Waters' attenuators also feature adjustable damping. Zero to 90 db of truly "stepless"

attenuation is achieved with Waters' computer-controlled curve-shaping technique which actually tailors the attenuator resistance element assuring superior tracking accuracy.

For your key to trouble-free mixing send for Waters' Audio Attenuator brochure which describes their complete line of linear and rotary attenuators and pan pots. Use the coupon provided, or better yet, phone 617-358-2777 for immediate service.

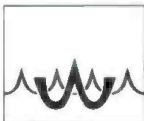

**WATERS MANUFACTURING, INC.**  
Boston Post Road  
Wayland, Ma. 01778

I'd like further information on Waters attenuators and MystR® conductive plastic elements.

Send me your attenuator brochure and "The MystR Story"

I need additional information:

\_\_\_\_\_

\_\_\_\_\_

Name \_\_\_\_\_

Position \_\_\_\_\_

Company \_\_\_\_\_ Phone \_\_\_\_\_

Street \_\_\_\_\_ City \_\_\_\_\_

State \_\_\_\_\_ Zip \_\_\_\_\_

Circle 25 on Reader Service Card

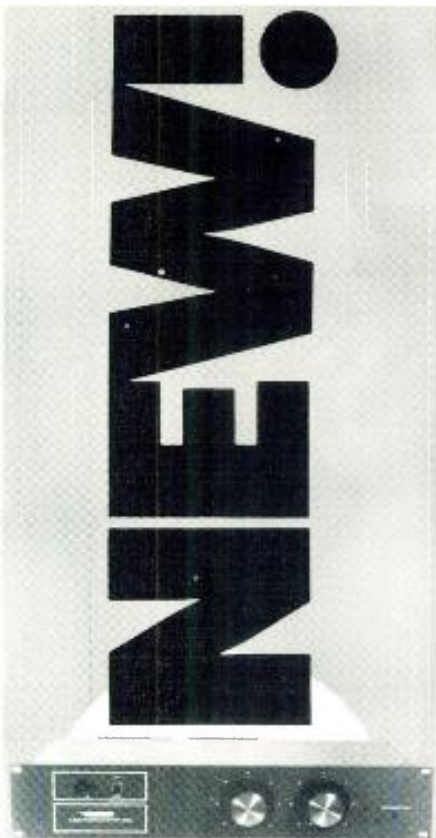

## TOUGH!

### MONITOR/MASTER 260

All Solid State, the New MONITOR/MASTER 260 Audio Amplifier produces 60 Watts RMS through each of its Dual Channels. Low distortion and high damping provide you with clean sound at full output. Balanced or unbalanced bridging inputs without transformers are featured, along with overload protection. The 260 is RUSSCO-Rugged and Economically priced!



## SMART!

### STUDIO/MASTER 505

RUSSCO's compact 5 channel monaural Audio Mixer is truly a Bargain! Packed with Quality features like 4 channels with built-in preamps, Channel 5 has 5 hi-level balanced inputs! The 505 includes a monitor amp, cue speaker and head set amplifier, FET monitor muting, Push-button switching, long-life "Mod Pots" and More! It's a Smart Buy at \$650!



**ELECTRONICS INCORPORATED**

1070 Brookhaven, Clovis, Calif. 93612

Phone (209) 299-2167

Norman H. Crowhurst

# THEORY AND PRACTICE

● What is distortion? It seems I have spent much of my life talking about this subject, but it keeps coming up. And a frequent overtone in the questioning implies that the asker is a perfectionist, who believes that the ideal is to eliminate all distortion, whatever it is, and that the closer one comes to perfect elimination of distortion, the better must the result be.

Long long ago, some enthusiasts believed that perfect reproduction would perfectly reproduce the input waveform at the output. If the input waveform was obtained from a microphone, which is the only direct way to convert a sound wave into an electrical one, then it is relatively easy to show that just moving the microphone a few inches in space will change a waveform.

If you mix together a fundamental and some known harmonics, say second or third, you can produce a variety of waveforms. For example, fundamental with third can either be pointy or flat-topped. The difference is phase. If you move the mike so it picks up fundamental at quarter-wave difference in phase, the third will be  $\frac{3}{4}$  wave different, and thus will be phase reversed, relative to the fundamental. The pointy wave will become flat topped, or vice versa.

This is equally true of every complex waveform. The precise wave shape is different at every point in acoustic space. This explains what has been repeatedly observed: phase relationship is not important to fidelity of sound. The pointy waveform and the flat topped waveform are audibly indistinguishable, if their content is identical, and if it varies identically, over time. So we do not need to bother getting wave shapes identical, provided we get their content identical.

Perhaps the most easily identified distortion in the early days was due to reproducing the various frequencies disproportionately. For example, before f.m. came into being, we only had a.m., with pretty sharply tuned

receivers, so the bandwidth was only a few kiloHertz. Accurately tuned, all the highs disappeared, or were drastically reduced, while off-tuning a little would bring back the highs, but at the expense of that "lovely bass."

Those changes were quite audible forms of distortion. Back there, feedback had not been "invented," and the tubes, transformers and other devices used to amplify were extremely primitive, so there were lots of other distortions beside, which became more evident once we had succeeded in increasing band width so we could hear them all!

The first of the modern types of distortion to be recognized, still used as a primary reference for the amount of distortion [although the figures have changed, tremendously], was harmonic distortion.

If a pure tone is applied to the input of an amplifier, or any part of an audio system, harmonic distortion results in overtones of that pure tone appearing at the output, along with it. That, in itself, would not be very important if all the system reproduced was individual tones, one at a time. But music consists of a great many tones, put together to be reproduced at the same time. The same distortion device that produces overtones of single notes produces all kinds of spurious, unwanted tones when the system handles a number of notes at once.

This was one reason why the term "intermodulation distortion," called IM or IMD for short, and all kinds of measurement for it, was introduced. There was another area where this was evident. When talking pictures first made the scene, using optical sound tracks [magnetic recording had not got beyond the wire variety then], they were particularly prone to a completely different form of intermodulation distortion. This happened because the bass tones were, quite literally, big waves, while the higher tones were very tiny, riding on the big ones.

Because of this, the little waves would often get modulated as they

## Bang & Olufsen™ has developed an extraordinary new CD-4 cartridge.



Before you listen to it there are a few things we think you should know.

**It is an integrated system.** The MMC 6000 cartridge leaves the factory as a sealed unit, a nonreplaceable stylus assembly integrated with the coils, magnet, and output terminals. This significant departure from traditional "two piece" cartridge construction allowed Bang & Olufsen engineers to meet performance standards previously unattainable, but definitely required for optimum CD-4 high frequency reproduction. Most important, this integration of the stylus assembly let Bang & Olufsen engineers greatly reduce the effective tip mass (ETM), the size and mass of the cantilever. Moving Micro Cross (Bang & Olufsen's patented device for superb stereo separation), and transducing elements of the MMC 6000. In other words then, the manufacture of the MMC 6000 as an integrated unit represents an absolute, no-compromise approach to cartridge design.

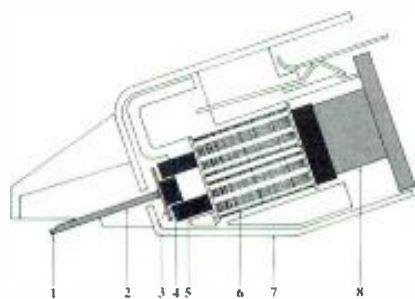

1. Nude Pramanik diamond\*
2. Low mass beryllium cantilever
3. Moving Micro Cross
4. Block suspension
5. Pole pieces (4)
6. Induction coils
7. Mu-metal screen
8. Hycomax magnet

The effective tip mass is .22mg. Extensive testing has shown that the effective tip mass (ETM) of a cartridge is the factor most directly related to record and stylus wear. It has also been demonstrated that record wear due to high ETM is most severe in the high frequencies; obviously then, a high ETM is a substantial problem with CD-4 high frequency modulations. The integrated manufacturing method used to produce the MMC 6000 contributes to the extremely low ETM of .22mg, and a tip resonance point of over 50,000 Hz.

**It tracks at 1 gram.** The MMC 6000's low vertical tracking force (VTF), greatly reduced ETM, and compliance rating of  $30 \times 10^{-6}$ , create an optimum relationship between those factors of a cartridge which have the greatest effect on performance. VTF, effective tip mass, and compliance should never be evaluated singly; the most critical task within cartridge design is establishing their ideal interrelationship. Therefore you should consider the 1 gram tracking force of the MMC 6000 as just one result of a superior cartridge design. While VTF is often a reliable parameter of overall quality, its relationship to record wear is secondary when compared to the ETM. It should be understood that at high frequency modulation the forces applied to the groove walls are several hundred times as great as the VTF. And to a large extent then, these forces determine record wear and are directly related to effective tip mass.

**It features a Pramanik stylus.\*** The MMC 6000 utilizes a multi-radial diamond developed by cartridge engineer, S. K. Pramanik of Bang & Olufsen. The unique shape of the diamond was developed to obtain maximum contact with the groove walls along its vertical axis and minimum contact along its horizontal axis. The increased contact along the vertical axis reduces record and stylus wear by significantly lowering the amount of force applied

Multi-radial Pramanik diamond\*

Improved surface contact along the vertical axis ↓



Improved point contact on the horizontal axis →

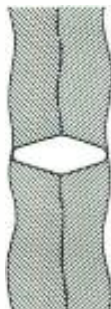

per unit of surface. The minimum contact along the horizontal axis guarantees the extremely accurate tracing of the CD-4 high frequency modulations between 20,000 and 45,000 Hz. As opposed to normal diamond styli, only the very tip of the Pramanik diamond is mounted on the can-

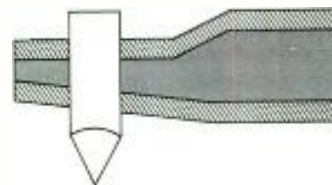

Usual pressed-through mounting of shanked naked diamond ↑

Pramanik diamond\* tip mounted to beryllium cantilever. ↓

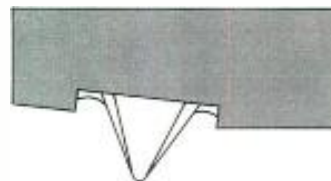

tiler. This procedure and the beryllium cantilever, stiffer and lighter than commonly used aluminum, further reduces the ETM of the MMC 6000.

**It meets the Class A criteria.**

The RCA/JVC rating system for CD-4 cartridges. Every MMC 6000 has a Class A rating.

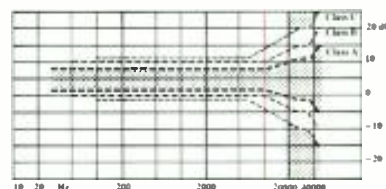

Discrete 4-channel sound became a reality through the work of the RCA/JVC joint development team. Accordingly, RCA/JVC engineers established criteria by which the performance and 4-channel capabilities of cartridges could be evaluated. Their rating system includes four classes: A, B, C, and D, class A being the highest and class D considered as unacceptable. The class A rating is given to only those cartridges with a frequency response varying no more than  $\pm 10$ dB between 20,000 and 40,000 Hz, with channel separation better than 14dB at 30,000 Hz, and more than 1mV output. Every MMC 6000 cartridge meets or exceeds these specifications. As proof of each unit's level of performance, the MMC 6000 comes with its own calibration card and frequency response curve. The calibration card states the output voltage, channel separation, and the balance between channels. The frequency response curve is produced for each channel on a Bruel and Kjaer level recorder and shows the performance levels from 20 to 45,000 Hz.

## Bang & Olufsen

Bang & Olufsen of America  
2271 Devon Ave.  
Elk Grove Village, Ill. 60007

Circle 39 on Reader Service Card

## SPLIT PERSONALITY

Ever hear of a schizophrenic limiter? Take a look at our Model 210. Half of it is limiting broadband program peaks while the other half is controlling high-frequency program energy. Independently. Simultaneously. It's enough to make you lose your paranoia about limiters.

### INOVONICS MODEL 210 FREQUENCY SELECTIVE/BROADBAND PEAK LIMITER

\$490



For FM Broadcasting, TV Audio, and Mastering applications where high-frequency overload is a potential problem.

- Fast peak limiter with variable control of Peak Ceiling, Attack, and Release.
- Unique ripple-cancelling circuits assure very low distortion, even at low frequencies.
- Separate frequency selective limiter with plug-in inserts to complement a variety of high-frequency overload characteristics.
- Panel indicators display peak limiting and high-frequency gain reduction instantly.
- Input isolation transformer and remote-mounting gain reduction meter optional.

**i** INOVONICS  
INCORPORATED

1630 Dell Ave., Campbell, CA 95008 Phone: (408) 374-8300

Circle 27 on Reader Service Card

# Our Directory.

The 1974 issue of *The Directory of Professional Audio Products* is now available. Subscribers to *db The Sound Engineering Magazine* have received a copy as a bonus.

This is the first industry compilation of manufacturers, their distributors, and suppliers of pro audio equipment, plus a separate listing by product category. In addition, we have included a special listing of professional audio consultants.

If you are in any phase of the pro audio world, you will find *The Directory* an indispensable tool.

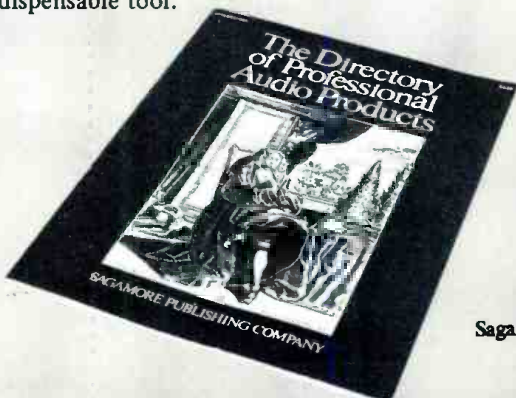

To order copies of the first **Directory of Professional Audio Products**, please send your check for \$3.00 per copy to:

**DIRECTORY**  
Sagamore Publishing Co., Inc.  
980 Old Country Road  
Plainview, N.Y. 11803

rode over the big ones, producing a sort of gargling effect in musical programs. Even today, to give the illusion of an early "talkie" sound track, all you have to do is introduce a good healthy hunk of this kind of inter-modulation!

The big question has always been "How much (or perhaps more relevantly, how little) distortion can you hear?" This has always been a difficult question to answer, reliably. Back in the early days, tests were run that suggested that any distortion less than 5 percent harmonic, or its equivalent in other forms, was completely inaudible.

What those experiments failed to note, however, was the fact that the loudspeakers or headphones used for the tests produced far more than 5 percent distortion. So although you might get amplifier and other system distortion well below the 5 percent figure, there was no way to hear it, without adding more than 5 percent in the way you listened. The amplifier or system distortion was drowned by the reproducer distortion.

To an extent, this is still true, but the figures are much smaller. Then of course, records, radio channels, everything in the system, had its own quota of distortion, all of which had to be reduced before you could begin to tell how little distortion was really audible. And the lower we get distortion in some of these elements of the system, the more readily do our ears pick up what is left in other elements of the system.

So now let us turn to ways to measure distortion. Harmonic distortion remains about the easiest to measure—quite simple equipment will do it. The main differences in harmonic measuring equipment, like the equipment it is used to measure, lies in improved precision. And the same kind of problems remain, again changed mainly in order, or magnitude.

The method consists of using an oscillator with the purest waveform you can get, applying this to the input of the system, then using a frequency selective bridge at the output, first to measure the output at that frequency, then to null the measurement frequency and find out what else is left.

Suppose you use 1,000 Hz as the measurement frequency. You first measure your output, to find you have, say, 10 volts across the output load. Then you null out the 1000 Hz by carefully setting the bridge, and read that you have, say 0.3 volts of something else. That would be 3 percent distortion. In the old days, that would have been good. Today we would not consider permitting it to remain twice!



# It needn't break the bank.

The Philips MD is a range of high performance standard mixing desks at realistic prices.

They have been used all over the world for years and years, which just proves their reliability and excellent quality.

A kind of all risks insurance. So keep it in mind.

You need more information? Contact Mr. Jan Gerrits or Mr. Bram Potappel, N.V. Philips' Gloeilampenfabrieken Electro-Acoustics (ELA) Division, Broadcast Equipment, Building SAQ II, Eindhoven - The Netherlands. Tel. 040-733793 or 732646, Telex 51121.

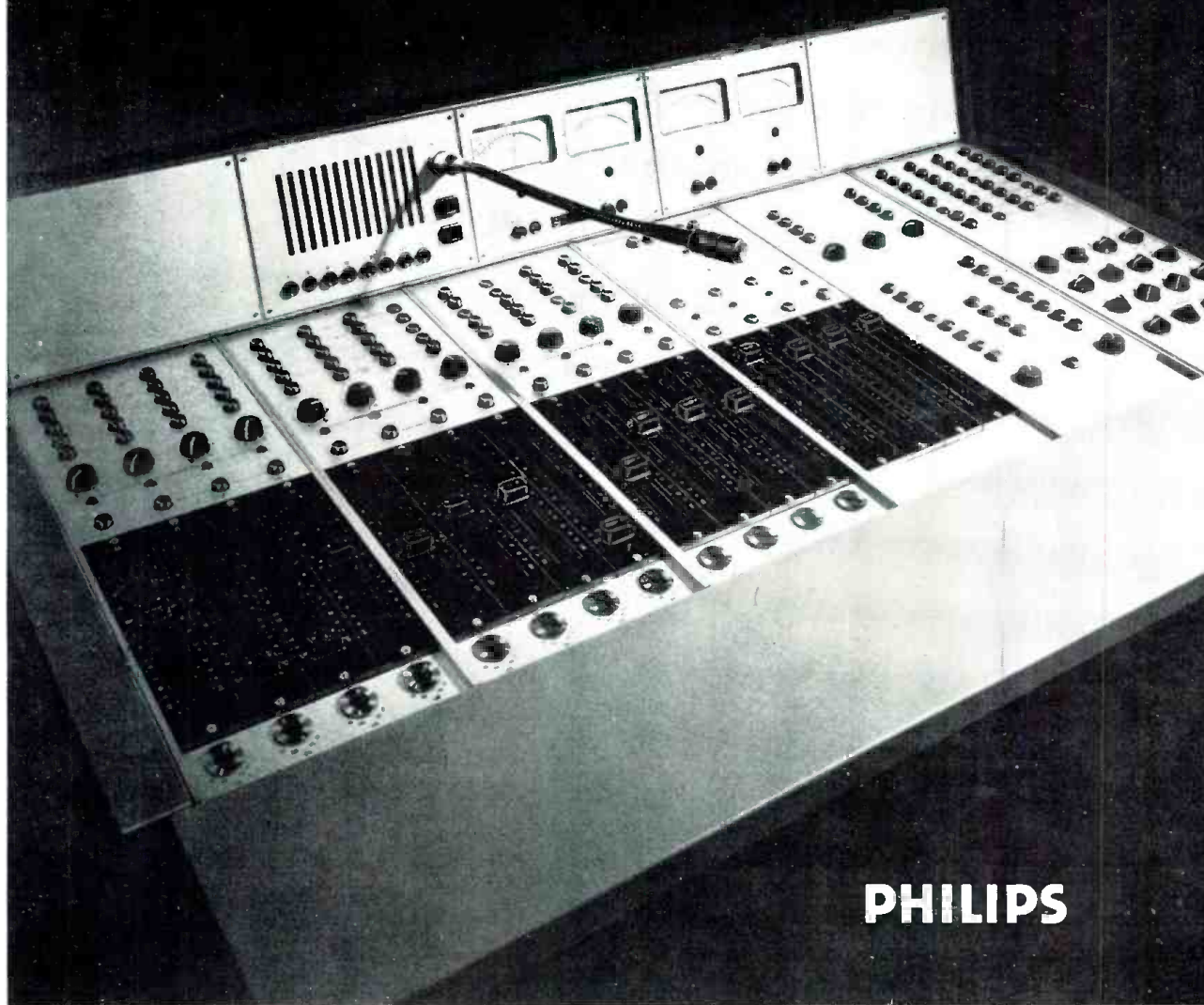

**PHILIPS**

Circle 29 on Reader Service Card

# WHEN IT'S NOISY

## Are You Getting Your Message Through?

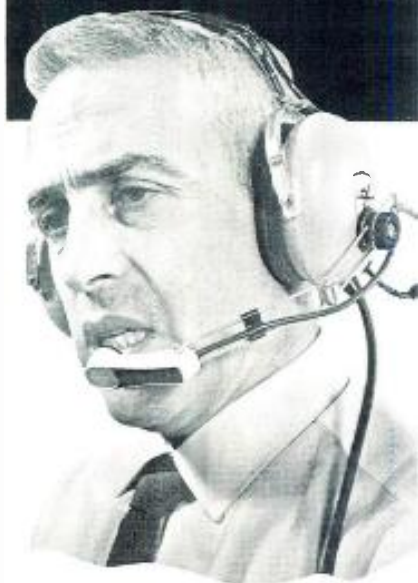

David Clark Company's Communications Systems overcome noise, distance and isolation. Solve your on-the-job communications problems, whatever they may be. If voice communications and job noise are on a collision course David Clark Company has an answer. We'll get your message through — everytime — with one of our efficient Communications Systems: (1) Sound Power; (2) Dynamic (low impedance); and (3) Carbon (high impedance). Used by U.S.A.F., U.S. Navy and NASA.

Send for a FREE Communications Systems Buyer's Guide.

From "the quiet people" at

**David Clark COMPANY**  
INCORPORATED  
360 Franklin St., Worcester, Mass., 01604

Circle 19 on Reader Service Card

In the old days, for one thing, you would have been lucky to find an oscillator that would give less than 5 percent harmonic in its output waveform. If you measured the oscillator output, and found 5 percent harmonic in it, how could you know what the system did? It would be virtually impossible, using this method, to measure distortion figures, even down to 5 percent with any reliability, much less to make measurements of lower levels of distortion.

Of course, since better oscillators have come into being—much better, those figures look a little ridiculous today! But the same principle applies. Back in those days, amplifier and equipment designers wanted to produce better performance, and they found themselves fussing with measuring equipment when what they really wanted was better products.

Another thing about this nulling method: it is very critical of frequency. And the lower you are trying to measure distortion, the more critical it gets. If you were measuring at 1000 Hz, and frequency shifted on you, as it was very likely to do with those old BFOs, you could be reading a higher figure because the null had drifted off tune instead of picking up harmonic products.

Of course, the advent of function generator type oscillators, as well as introducing much lower harmonic content figures for the output, also improved frequency stability, so neither of these problems is nearly so bad as they once were. Now it is easily possible to measure down to small fractions of 1 percent. But the method still possesses the same deficiency.

The method that some manufacturers discovered back there, to get much better, more reliable, readings much more easily was to use a totally different kind of bridge. It takes very little in the way of components, which may be the main reason why no instrument maker seems to have put one on the market.

Basically, the bridge consists of a phase splitter at the input, so a voltage of either phase, approximately equal to the output voltage, is available. One of these is provided with attenuation to cut it down to the needed input level. Then a resistance bridge—virtually no more than a simple potentiometer—is connected between the output voltage and the side of the phase split input that is opposite in polarity.

Adjusting the pot finds a place where the two voltages balance out. Now, if each of them contains fundamental with 5 percent harmonic, when

the fundamental is perfectly balanced, the harmonic will be very nearly balanced too. What will not be balanced is any harmonic produced in the system that is present in the output but not in the input.

This means that the method can use an oscillator with, say 5 percent harmonic in its waveform, to measure distortion figures down to fractions of 1 percent. Correspondingly, if your function generator oscillator has a harmonic content of 0.1 percent, the method will measure down to very much lower than that. And the adjustment is much less critical. It does require one more feature: some adjustment for phase difference, but that is relatively simple to add.

In a later column, we will pursue other forms of distortion and methods of measuring them, each of which have their drawbacks. To finish this off, we need to distinguish between the forms, assuming each to do what it is intended to do.

The SMPE [now SMPTE] form was devised by the Society of Motion Picture Engineers [before they included Television] and consisted of a low frequency and a high frequency, which could vary. The low one might be 70 Hz and the high one several thousand Hz. The low one was usually of 4 times the amplitude of the high one. The test was to determine whether the high one possessed any modulation in amplitude by the low one.

The CCIF method was developed in Europe and consists of using two higher frequencies that differ by a predetermined lower frequency. Typical test frequencies might be 5,000 Hz and 5,100 Hz. The test is to determine whether the system produces any 100 Hz signal not present at the input.

The point to note here, before we get into more detail later, is that each of these measurements is related to its own kind of distortion, which it will detect with more or less reliability. The SMPTE method determines the modulation of a higher frequency by a much lower one of bigger amplitude. The CCIF method determines whether two higher frequencies will produce a spurious "buzz" tone due to intermodulation between themselves.

A system that would produce one form might not produce the other; they are quite different types of distortion. What has introduced confusion is the fact that they have both used the same name, "intermodulation distortion." So many have assumed that they are two ways of measuring the same distortion. The first thing to get clear is that we are talking about two distinct types of intermodulation distortion. ■

Circle 20 on Reader Service Card ➔

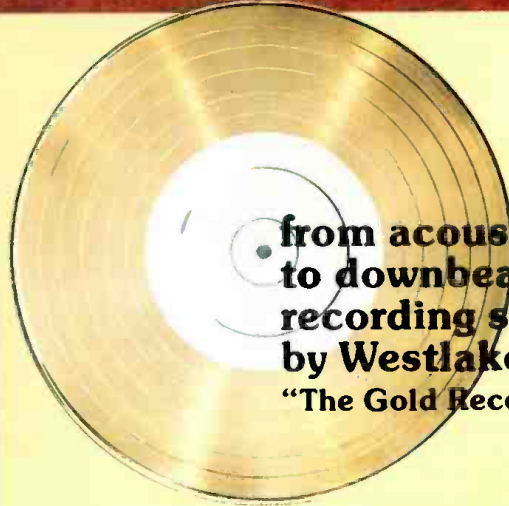

**from acoustic design  
to downbeat...  
recording studios  
by Westlake Audio  
"The Gold Record People"**



from acoustic design  
to down beat...

**Westlake  
Audio**



Kendun Recorders, Burbank, California

## services available to our package and turn-key clients

**Pre-Planning:** Which markets are you going after? One studio or two? What is the sound character desired? How much multi-track separation? Your budget? Future expansion? These are just a few of the questions discussed at this stage. From the answers, we'll provide you with a comprehensive proposal covering our recommendations and the cost for the entire project.

**Site Evaluation:** If you're planning to build from the ground up or within an existing shell, we'll help you to select the best building or location in terms of size, demolition and construction costs, zoning, noise transmission problems and those "hidden" costs. Remodeling an existing studio? We can show you how to get the best results from your space.

**Design:** Acoustical design is the key to the success of a studio. Westlake Audio's geometric and acoustic designs will provide you with a winning "sound." **Prior to construction**, we will guarantee the performance of your studio and control room with respect to isolation, response, decay time in various frequency bands and dispersion.

**Equipment Selection:** We have carefully evaluated the many products on the professional audio market to provide our clients with a broad selection of the finest recording equipment available. From consoles, automation and tape machines to monitors, microphones and support equipment, we have the lines to satisfy your requirements and budget.

**Financing:** We work closely with several companies whose specialty is providing clients with a lease or conditional sales plan tailored to your needs.

**Construction:** As the proper implementation and execution of the geometric and acoustic designs requires unique construction techniques, Westlake Audio will provide a construction foreman to oversee and work with your local construction crew and electrical and air-conditioning subcontractors.

**Wiring:** Our technical crew will install all the audio wiring throughout the studio complex and tie down the wiring to the microphone, headphone and tape machine panels, echo chambers, console, amplifier room and monitors.

**System Interface:** Our engineers will install all the recording equipment and interface the entire system to the console. A total system checkout is performed from microphone phasing to monitor equalization and balancing.

**Training:** Technical and mixing engineers will train your personnel in the operation and maintenance of the studio and equipment.

**Studio Management:** Upon request, Westlake Audio will offer guidelines and suggestions for all facets of studio management including rates, booking procedures and controls, personnel requirements, wages, work orders, tape legends, library systems and credit.

**No other professional audio dealer can offer these unique services and the experience gained from building over 50 major facilities.**

From a splicing block to an automated console, a home studio to an extravaganza.

*Write or call and we'll show you how to earn a 50% return on your investment.*



from acoustic design  
to down beat...

**Westlake  
Audio**

6311 Wilshire Boulevard  
Los Angeles, California 90048  
(213) 655-0303

# NEW PRODUCTS AND SERVICES

## TRANSISTOR OVERHEATING CONTROL



● A tiny device, known as Moxie, when attached to a power transistor, will prevent it from overheating. Moxie works by reducing power transistor drive in direct proportion to overheating, either through negative feedback or shunt attenuation. Resistance changes smoothly from greater than 100,000 ohms to less than 100 ohms whenever the device exceeds a specified transition temperature. Four Moxie types, with transitions at 57, 65, 75, and 85 degrees centigrade, are available.

Mfr: Multi-State Devices, Ltd.  
Price: 40¢ (1,000 quantity)

Circle 46 on Reader Service Card

## INTEGRATED CD-4 PICKUP CARTRIDGE

● MMC-6000 is the first of a series of cartridges based on this manufacturer's patented Moving Micro Cross principle. The effective tip mass of the stylus is an extremely low 0.22 mg., which permits tracking a CD-4 record with a vertical tracking force of one gram. To achieve this very low tip mass, the manufacturer has used only the very tip of the naked diamond. Instead of the conventional aluminum cantilever, they have designed one of beryllium, which is both stiffer and lighter than aluminum. In addition, all critical components of the system have been reduced in size. Another unusual aspect of the cartridge is the multi-radial shape of the diamond, designed by S. K. Pramanik, which offers greatly improved groove contact and will follow CD-4 high frequency modulations with greater fidelity than ordinary bi-radial or elliptical styli. Designed primarily for use with the integrated Beogram 4002 record player (soon to be available), the MMC-



6000 can be supplied with a standard 1/2 inch mounting kit for use with arms that are designed for any high compliance cartridge. Since the unit is integrated, the stylus is not user-replaceable; the entire balanced unit must be replaced with another balanced unit. The company claims that only in this way can they guarantee the high performance of their product.

Mfr: Bang & Olufsen  
Price: \$85.00

Circle 45 on Reader Service Card

## PROFESSIONAL TAPE RECORDER

● For those who demand a versatile tape recorder intended for rugged constant use and as a tool for professional creativity, Super 7 combines a number of wanted features. It offers three speeds on the standard model, 7 1/2, 3 3/4, and 1 7/8 inches-per-second and electronic editing utilizing a delay device which it is claimed eliminates clicks and pops as material is inserted. The unit contains three heads and operates on three motors, a hysteresis-synchronous capstan motor and two separate high torque induction motors for variable speed wind and rewind. Instant slur-free starts in record or playback are accomplished by minimizing the distance the pressure roller must travel to engage the tape to the capstan spindle. There are three outputs per channel and independent monitoring facilities for each channel, through vu meters. The unit has a remote control and automatic timer which permits recording without an operator at set times. Other features include pushbutton tape/source comparison, pushbutton bias readings, and echo, sound-on-sound, sound-with-sound, multiplay, and re-record capabilities. Dolby™ noise reduction system is optional.

Mfr: Ferrograph (Elpa Marketing)  
Circle 47 on Reader Service Card



← Circle 20 on Reader Service Card

## WE HAVE ALL THE RIGHT CONNECTIONS.

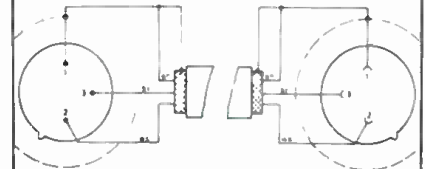

A "simple" microphone extension cable isn't so simple. Not if it's going to match today's phase accuracy and continuity requirements!

At Gotham, we start with double RF shielded, 3-conductor cables made to Neumann's tight specifications. And we attach Switchcraft "Q-G" (XLR compatible) connectors with a special technique, so the connector shell is grounded.

Our price? Practically what you'd pay for cable and plugs alone. Twenty-five feet, \$8.65. Fifty feet, \$13.20. One hundred feet, \$22.30. In small quantities.

Order through your Neumann Microphone Dealer. Or from Gotham directly.

**GOTHAM**  
AUDIO CORPORATION

741 Washington Street, New York, NY 10014  
(Tel: 212-741-7411)  
1710 N. La Brea Ave., Hollywood, CA 90046  
(Tel: 213-874-4444)



### WORAM AUDIO ASSOCIATES

Consultants in Studio Systems  
Engineering, Design and Installation

—offering—

A COMPLETE CONSULTATION  
SERVICE FOR STUDIO  
PLANNING AND  
CONSTRUCTION

FREE-LANCE RECORDING  
SERVICE IN THE  
NEW YORK AREA

212 673-9110  
64 University Place  
New York, N.Y. 10003

### PORTABLE STEREO MIXING DESK

● Portable stereo mixing desk HM 88 provides eight low- or high-impedance inputs, one submaster input, 500 Hz electronic crossover, and drives three volts into 600ohm load. There are separate bass and treble e.q. controls, monitor send, echo send, pre- or post-echo, 10 dB and 20 dB input attenuation. The unit contains five outputs: full range, high, low, monitor, and echo. Any combination can be used at once.

Mfr: Heil Sound, Ltd.

Price: \$1,100

Circle 51 on Reader Service Card



### LIGHTWEIGHT ACOUSTIC FOAM

● Useful for situations where appearance as well as function is important, Coustifoam 3-D is designed to control middle to high frequency sound. The material, made of fibrous glass, can be installed with scissors and an adhesive or can be die-cut, and is light enough to conform to curved surfaces. Standard thicknesses are 1/2 and one inch, available in 200 and 100 foot rolls, 54 inches wide untrimmed. Nominal foam density is two pounds/cubic foot, offering thermal insulation as well as soundproofing. The material can be glued, taped, heat-sealed, nailed, stapled, or wire-hung. Pressure-reactive self adhesive backing is optionally available.

Mfr: Ferro Corporation

Circle 52 on Reader Service Card

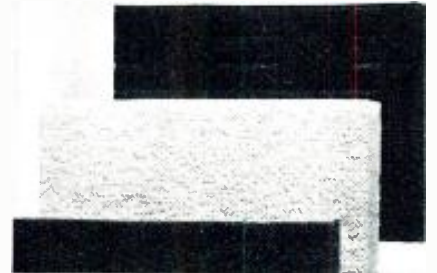

### MICROPHONE SUBSTITUTION DEVICE

● A resistive network that pads the high level of a musical instrument amplifier down to microphone levels enables the Direct Box™ to "mic" without a transducer. The device plugs into an extra speaker on an amp or can be used with a "Y" cord. Although it does not affect the loudness of the amplifier, the Direct Box controls the flexibility of the output level over a range of 50 dB in six steps. It uses an XL-type three-pin male connector that provides a 200 ohm balanced output. Ambient sound isolation is 100 per cent. Frequency response is ± 1 dB from 20 Hz to 20,000 Hz. The Direct Box can be used to create special effects, picking up electronic variations, such as fuzz and wha wha. For solving tricky cross-stage monitoring problems or power doubling, two amps can be connected via the Direct Box.

Mfr: Courage Enterprises

Price: \$29.95

Circle 53 on Reader Service Card

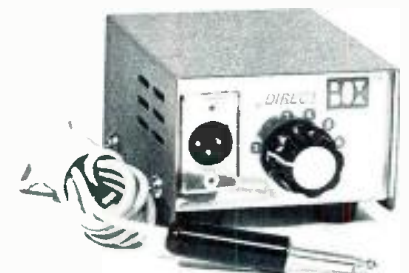

**BOSE 800™**  
professional  
loudspeaker

no  
sound  
of its  
own

With the BOSE 800, the sound  
the audience hears is the music  
the performers play...pure and simple.

□ CLEAR, NATURAL SOUND  
□ RUGGED, PORTABLE PACKAGE

BOSE 800... The  
Professional Performer  
For Professional Performers

Please send complete information on  
the BOSE 800 to:

Name \_\_\_\_\_

Address \_\_\_\_\_

City \_\_\_\_\_ State \_\_\_\_\_ Zip \_\_\_\_\_

Return to BOSE Corp. The Mountain,  
Framingham, Mass. 01701 Dept. BD



**You never  
lose a  
hemidemisemiquaver  
with Audio Designs  
Consoles and Components**

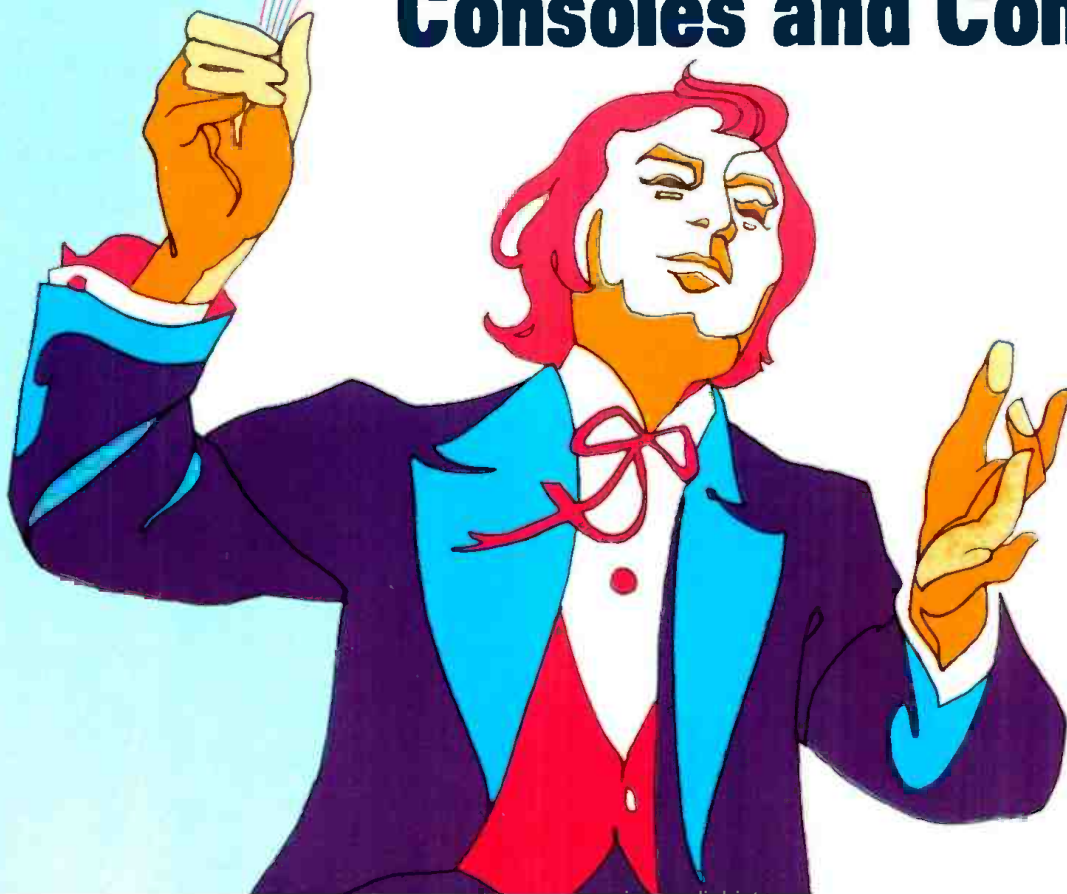

# ADM NRC SERIES CONSOLES

## hit a high note in Quality . . . Versatility

## . . . Performance

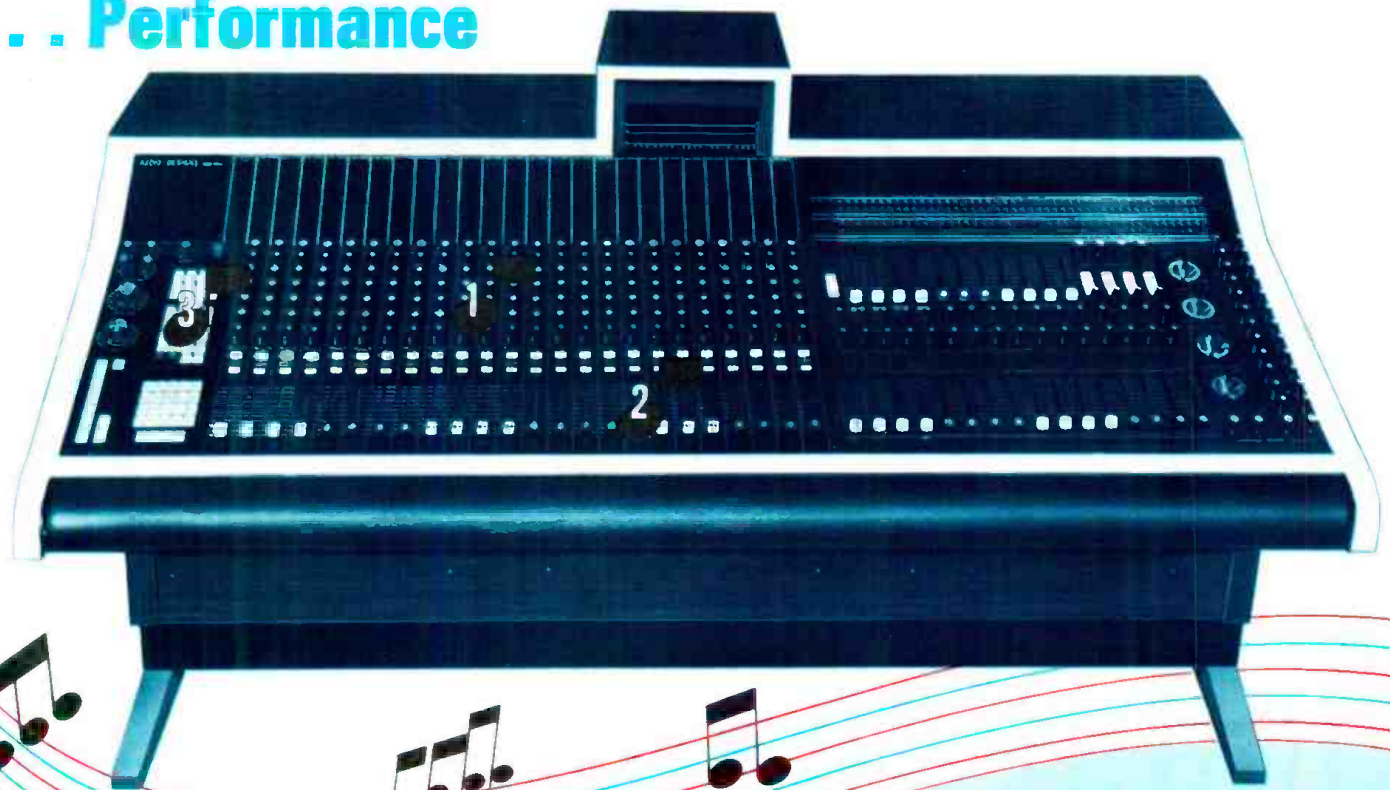

### Full-featured 8-16-24 Channel models at amazingly low prices

No one gives you more for your money than ADM. All ADM NRC Series Consoles are professionally engineered with such precise controls that you never miss or mess up a note. Yet we have held prices down through use of trouble-free "Mother Board" construction that eliminates literally miles of costly wiring . . . without sacrifice of quality, performance or "state-of-the-art" specifications.

You get high reliability features that ADM engineers into its custom consoles, including Slidex, Audex, four Cue Busses, two Solo Systems, complete Sync System, complete Tip, Ring and Sleeve Patching, Full Quadraphonic Capabilities including four Joy Sticks. And you get the flexibility and convenience of interchangeable plug-in modules, which make it easy to expand your console for future needs.

Chances are that one of our NRC models will meet your needs nicely. If not, we will be glad to work with you to integrate our components into your existing system, or in designing a custom console to your exact requirements.

### Interchangeable Plug-in Modules for complete flexibility

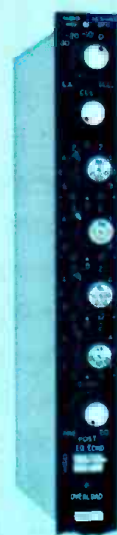

**1 INPUT MODULES**  
Versatile input strip features op-amp circuitry and four-section equalization. Input overload light and Solo button are also included. Everything required at an input is in one convenient plug-in module.



#### 2 SLIDEX

Unique, noise-free attenuator uses sealed elements. No contacts to clean. Even spilled coffee won't cause noise problems. Guaranteed free from noise or other defects for five years.



#### 3 AUDEX

Ultra-reliable switching system uses magnetic reeds governed by this compact control panel. Switch modules, mounted above inputs, include illuminated readouts for instant reference.





**ADM  
VUE-SCAN**  
Sweet music for frustrated  
"head swivelers"

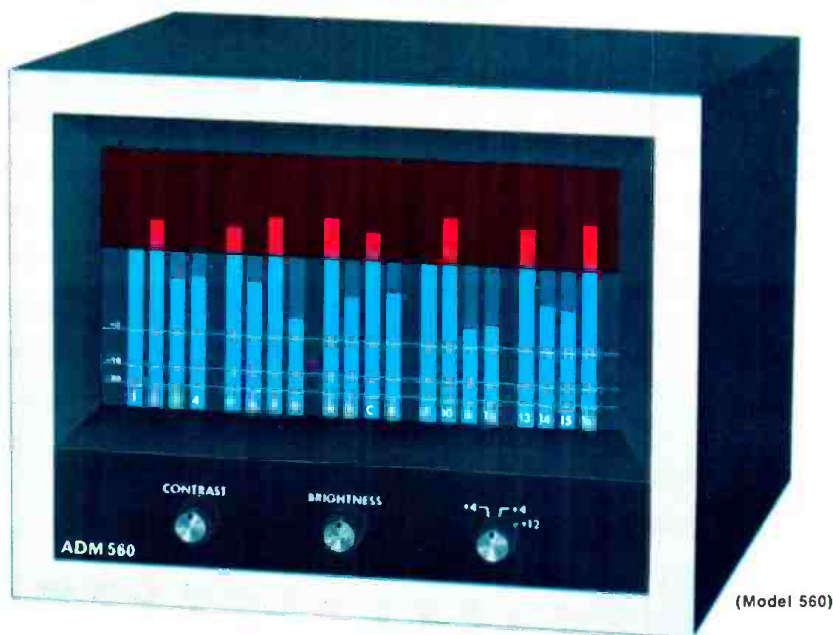

**Replaces up to 28 VU meters  
with an easy-to-read  
bar graph monitor**

ADM's new Vue-Scan solves one of the most troublesome and annoying problems of multi-channel recording . . . visual monitoring of the recording channels.

Vue-Scan takes up to 28 channels of audio information, and displays each channel as an easy-to-read bar graph on a TV monitor screen.

Each illuminated bar represents one analog channel. The vertical bars are always present as a background hue—the lower two-thirds in blue and the upper one-third in red. As the level of a channel increases, the bars representing that channel increase in height and intensity—making it almost impossible to overlook an overloaded channel.

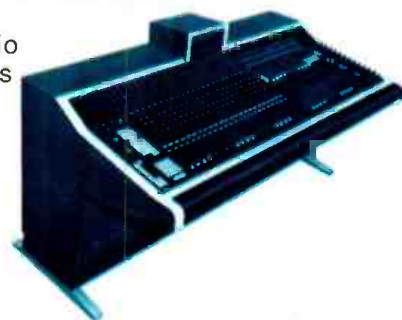

Vue-Scan is standard on all NRC Series Consoles, replacing VU meters, and is also available as an option on Custom Consoles. In addition, it can be used as a self-contained accessory with any ADM or competitive console.

# More sound ideas from ADM

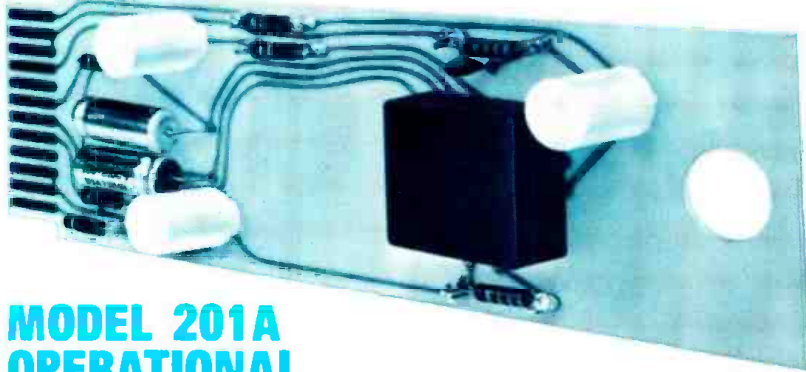

## MODEL 201A OPERATIONAL AMPLIFIER CARD

An audio operational amplifier designed on a 2.5" x 7.5" plug-in card, which can serve as a pre-amp, line amp or booster amp. Feedback stabilization is provided by "state-of-the-art" feedforward technique, providing the fastest possible response, and extending the frequency at which maximum feedback is available. Specially designed for low noise, and includes short circuit protection in the output stage.



## MODEL 301 NOISE SUPPRESSOR

A new, fast gain expander that puts silence where previously there was noise. It will turn on from dead silence with a cymbal crash and not miss a single cycle of sound. Because it is a true gain expander, with a continuously varying gain, there are no threshold clicks, nor is the ear aware of the threshold. Extremely fast attack time, and smooth operational characteristics. Packaged on a 4" x 7 1/2" card.



## MODEL 1500/1501 EQUALIZER

A unity gain equalizer, designed to provide EQ anywhere in an audio system. Features ADM's exclusive four band equalizer, providing reciprocal EQ functions in low frequency (LF), low mid frequency (LMF), high mid frequency (HMF), and high frequency (HF) bands. Four bands and reciprocal functions provide absolute control over the entire frequency spectrum. Model 1500 is designed for vertical mounting in a console; the 1501 mounts horizontally in the CH15 Frame.

**COMPONENTS  
& CONSOLES**  
for audio control

**AUDIO  
DESIGNS**  
and Manufacturing, Inc.

16005 Sturgeon  
Roseville (Detroit), Michigan 48066  
Phone: (313) 778-8400

## KNITTED WIRE MESH

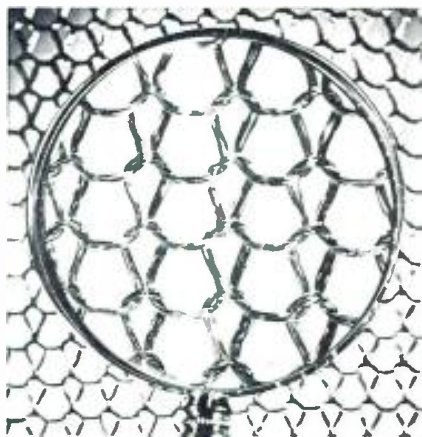

● This substance has a number of useful applications. These include compressed mesh units as air and liquid filters, flame and spark arrestors, noise suppressors, vibration and shock mount cushions, mesh covered refractory ropes and insulating blanket coverings, and cores for high temperature gaskets. The material comes in varying forms, diameters, opening sizes and widths and can also be used for electronic shielding, resilient mesh supports and separators, heat transfer materials, and a variety of chemical processing units.

*Mfr: Metex Corporation*

*Circle 48 on Reader Service Card*

## REVERBERATION UNIT

● It is possible to reverberate such instruments as drums or guitar with model 106C spring reverb. The reverb automatically becomes a standard fixed-threshold limiter above around -4 dBm input, protecting the reverberation driver output from overload distortion regardless of input level; a front panel switch permits the operation of the limiter in the fixed-threshold mode for any input level. The device has an adjustable midrange peaking equalizer for flexibility of the echo return, which blends with direct sound to cover pops. Flutter is controlled by the use of the four springs, longer than customary and, according to the manufacturer, therefore more effective than those found in the usual spring system reverb. Noise is kept below audibility through the use of a low noise transistor and true constant-current drive of the spring driver coil permits the use of deemphasis in the preamp, reducing that distortion and noise. Specific treatment of uneven frequency response is offered by a treble roll-off, a dip filter to remove metallic sound in the lower midrange, and a bass boost for warmth. For convenience in portability, the springs may be locked with a lever.

*Mfr: Parasound*

*Circle 49 on Reader Service Card*



## SOUND MEASURING SET

● Measuring set 4521 includes a model 456 precision acoustic calibrator, which can be used to calibrate the instrument to within  $\pm \frac{1}{4}$  dB in the field, a carrying case, and extra batteries. Features include a plug-in microphone for remote placement up to 200 feet away from the instrument, output jack to connect recorders, analyzers, headphones, a.c. adapter, all-metal case, broad sound level range of 35 to 140 dB for checking background levels as well as primary sounds of interest. The set is built around the company's model 452 sound level instrument, which meets ANSI type 2 as well as OSHA and U.S. Bureau of Mines requirements.

*Mfr: Scott Instruments*

*Price: \$398*

*Circle 50 on Reader Service Card*



← *Circle 23 on Reader Service Card*

*Spotmaster*®



### 100 SERIES STEREO CONSOLES

- All inputs switchable for mono or stereo sources, and high or low level
- Modular, plug-in electronics
- Quiet FET audio switching
- Muting on any channel
- Usable in remote control applications
- Optional matrix for separate composite mono from stereo input

FULL LINE INCLUDING 12  
OTHER MODELS AVAILABLE  
CALL OR WRITE



**BROADCAST ELECTRONICS**  
8810 Brookville Road  
Silver Spring, Maryland 20910  
Phone: 301-588-4983

*Circle 16 on Reader Service Card*

## PORTABLE STEREO RECORDER



● Certain sophisticated features, such as a Dolby™ noise reduction system, keep TC-152SD portable cassette recorder in the professional class. The unit also contains a long-lasting F & F (ferrite and ferrite) head, and a peak limiter which automatically monitors and holds input below the saturation level to prevent distortion. Automatic shutoff operates at the end-of-tape in record and play modes. The tape select switch selects the proper record equalization when using either standard or chromium dioxide tape. TC-152SD features line in/line facilities for stereo deck operation; mono can also be heard on playback. There are separate playback volume and tone controls. Other features include two vu meters with illuminated on/off switch, straight-line record level controls, light-touch lever action function selectors, battery check switch, and an input selector switch. The unit has a three-digit tape counter, locking pause control, stereo headphone jack and two front panel microphone inputs.

*Mfr: Superscope (Sony)*

*Price: \$299.95*

*Circle 54 on Reader Service Card*

## SOUND LEVEL METER



● All requirements are met for Type II Sound Level Meter ANSI S1.4-1971 with this compact hand-held device. The unit has a range of 40 to 140 dB in nine steps, combined with a selectable A, B, C, weighting response. The band "C" weighting scales detect interior noise, such as the faulty functioning of machinery. The meter has a three-inch face; meter speed is selectable "slow" per OSHA or "fast" for noise blasts. The instrument is powered by 9-volt transistor radio batteries and features a built-in pushbutton battery check.

*Mfr: Tracor Medical Instruments*

*Circle 56 on Reader Service Card*

## MIXER-AMPLIFIERS

The 4400 Spectrum series of mixer-amplifiers includes 40-, 80-, and 120-watt rms units. All include five convertible inputs for use with optional plug-in accessories, as well as a high level auxiliary input. The unit features a self-compensating mix bus which permits expansion of the mixing facilities and provides the ability to "split" the pre-amp and power-amp stages to accommodate program equalization. A program equalization network permits the adjustment of low- and high-frequency amplifier response at either 6 or 12 dB per octave at selected frequency rolloff. All three models operate at less than 1.5 percent THD, with a noise reading of 87 dB below RPO with an input clipping level of -11.5 dB. Options include vu meter, plug-in accessories for low-impedance balanced microphones, RIAA inputs and high-level auxiliary inputs.

*Mfr: Rauland-Borg*

*Circle 55 on Reader Service Card*

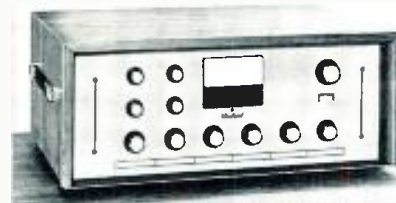

## RACK-MOUNTED INTERCOM STATION

● The main station electronics of this closed-circuit intercom system is housed in a rack-mounted cabinet with a 19 inch x 3½ inch enclosure. Sufficient power is supplied to allow up to two additional headsets to be connected to the main station. The system will power up to thirty lightweight remote belt-pack stations with headsets. Single or double earpiece headsets, equipped with dynamic high-intensity noise-cancelling microphones, are available. Shielded two-conductor microphone cables connect stations to the rack-mount main station or to other remote stations. Call lights back up the audio system to cue operators who have removed headphones. Auxiliary input and gain allow the operator at the main station to input additional signals to all stations.

*Mfr: Clear-Com Lumiere*

*Circle 58 on Reader Service Card*



## PHONO PREAMPLIFIER

● Magnetic phono cartridge signals are amplified by model ATD-25 laboratory reference phono preamplifier to a level which will drive the high level inputs of any stereo preamplifier, integrated amplifier, or receiver. All preamplifier modules are fully encapsulated. The circuit employs sixteen low noise silicon planar transistors. Frequency response range is  $\pm .5$  dB of RIAA curve, 20-20 kHz. Input impedance is 47k ohm  $\pm 5$  percent. Gain is 36 dB at 1 kHz.

*Mfr: All-Test Devices Corp.*

*Circle 57 on Reader Service Card*



## SEMICONDUCTOR CURVE TRACER UNIT



● Used with an oscilloscope, IT-1121 semi-conductor curve tracer displays operating parameters of virtually all types of semiconductors such as bipolar transistors, diodes, SCRs, triacs, fets, etc. Extra leads are provided for tests of larger devices or for in-circuit tests. The tracer can be used for selecting devices for specific applications, or for sorting, inspecting, and testing. It can be used for identifying unknown semiconductors. With the aid of the manual, the device can be used to teach the fundamentals of operating parameters. All major controls are stepped in a 1, 2, 5 sequence for maximum parameter resolution.

*Mfr: Heath Company*

*Price: \$89.95*

*Circle 59 on Reader Service Card*

## AUDIO ADAPTERS

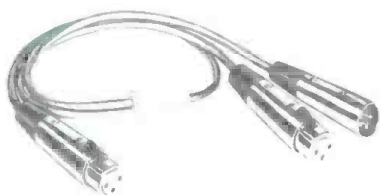

● Used for adapting and connecting audio circuitry and components, 391Q "Q-G" (quick ground) Y adapters can be used for interconnecting mixers, amplifiers, p.a.s, lecterns, microphones, phonographs, tape decks, cassette recorder/players, tuners, and test equipment. 3-pin male and 3-pin contact female plugs can be supplied in any combination for high quality, shielded audio connections. The adapters are two feet long with a molded Y-junction at the center point; cabling is two-conductor, shielded with an outer jacket.

*Mfr: Switchcraft*

*Price: \$16.10*

*Circle 60 on Reader Service Card*

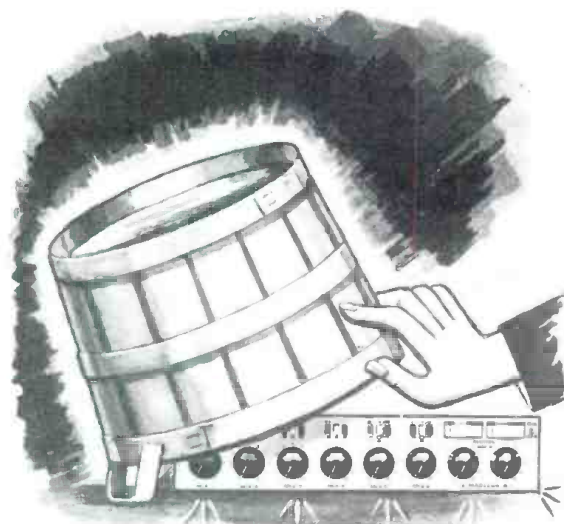

## We've been hiding our light under a bushel —

### ● C1616/C2424 CONSOLE

A year ago we studied the other two low cost recording consoles and we built a unit without their shortcomings. We also put in a few extra goodies, like semi-parametric equalizers on each input. We have installations in Atlanta, Washington, Wilkes-Barre, Denver, Lancaster, and more coming. Compare before you buy your new console. Circle 15 on Reader Service Card.

### ● MOM'S WHOLESOME AUDIO MICROMIXER

If you're into PA or stereo recording requiring lots of inputs with EQ and reverb, you might want to look into our MicroMixer. Circle 16 on Reader Service Card.

### ● ORTOFON DISC CUTTING EQUIPMENT

With installations in Nashville and Chicago, Ortofon has really got their thing together. Write or call for more information.

### ● SCHOEPS MICROPHONES

We've got some new hand held condenser microphones — both cardioid and omni patterns — that are absolutely pop free. Circle 17 on Reader Service Card.



**GATELY ELECTRONICS, Inc.**

57 West Hillcrest Ave.  
Havertown, Penna. 19083  
215-449-6400

1907 Division St.  
Nashville, Tenn. 37203  
615-327-1746

*Circle 17 on Reader Service Card*

Martin Dickstein

## SOUND WITH IMAGES

### A Film Projector-Recorder Unit

● In the recent past, we have discussed film projectors and some of the things that can and should be done to protect them and to keep them in good working order. This time we thought it might be interesting to discuss one particular model of a 16mm sound projector which may prove valuable in either a present or future audio/visual project—the Siemens 2000. It is a double-system unit which is in fairly wide use in film production and editing houses as well as advertising agencies, and in some educational institutions.

This double system permits the

playing of a standard 16mm film (with either magnetic stripe or optical sound track) or a separate full-width magnetic film. The projector incorporates, however, the capability to record onto either of the magnetic surfaces or to dub from the optical or either magnetic stripe to the other magnetic sound track. Although the fully coated magnetic film runs on a separate set of reels, it is interlocked with the optical film and will remain in perfect sync. With the addition of the recording preamplifier, which plugs into the rear of the amplifier, the projector is given a variety of in-

teresting functions which are helpful in the production of in-house sound tracks for industrial, educational or training films.

The amplifier, which is separate from the projector but acts as a base for the film unit, has a switching control for selection of the proper mode of operation, separate controls for film sound output level, bass and treble, and input level for turntable and microphone feeds. There is also an input for a tape recorder, but no level control. Regulation of input volume is controlled at the tape recorder itself. Since the projector and amplifier are made in Europe, there is also a line voltage selector switch, and the unit uses European connectors. Markings on the controls are symbols identifying the function or purpose of the control. Speaker output (there is no speaker in the unit) is 15 ohms and the amplifier is rated at 15 watts. Inputs are provided for a turntable, a tape recorder, and a high impedance microphone, although low Z mics can also be used but with cable transformers for impedance matching.

In order to ensure that the magnetic film will move smoothly and evenly over the head, a movement filter assembly is provided which consists of pressure roller before the film enters the head assembly, a rotating drum with flywheel, a loop stabilizer, and a filter roller lever with air damping as the film leaves the head. To isolate the magnetic head, a mumetal cover is used. The magnetic film side is not used, of course, when an optional or magnetic stripe sound track is played.

The preamp unit, which is used only for sound recording or transferring, is plugged into a multi-pin connector and has on it a magic-eye type of recording level indicator, an on/off switch for the erase head, a record lockout button which also sets up the recording eye, and a bias control. By manipulation of these controls—proper setting of the selector switches on the amplifier, and properly adjusting level settings of the inputs—several recording procedures can take place. An interesting feature of this recording setup is that the tone controls, which control bass and treble on playback, are also effective in the recording process and will operate with any audio input. During recording, there are two ways in which the sound can be monitored. A high impedance headphone can be plugged into either the speaker output jack or into the tape input receptacle (which also functions as an output), or a speaker can be plugged into the normal output jack.

# Look what \$450 buys!

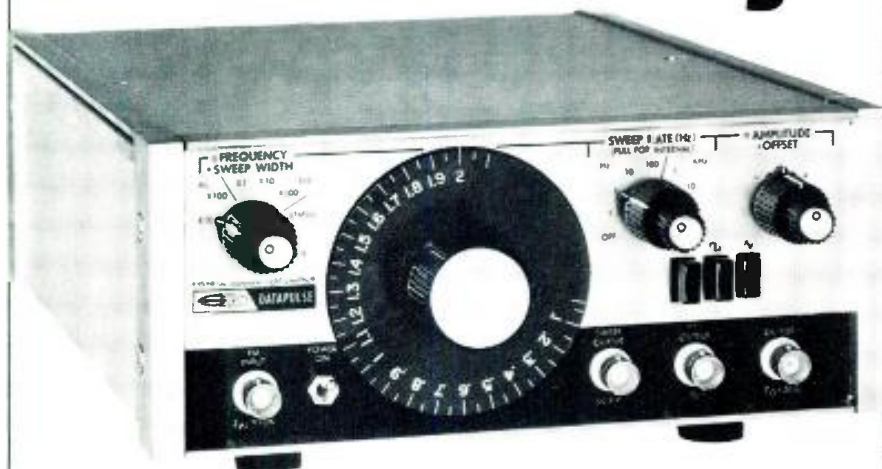

#### New 2 MHz sweep function generator

It's the only one at that price... Systron-Donner's Model 411 sweep function generator. Check these features: **Frequency** in 6 decade ranges from 0.02 Hz to 2 MHz—Dial accuracy 2% of full scale typical—**Waveform outputs**: sine, square, triangle, ramp and a T2L compatible sync pulse square wave. **Plus**: Model 411 is the only low cost sweep function generator which allows the operator to set the upper frequency limit to dial accuracy. **Contact**: your nearest Scientific Devices office or Systron-Donner at 10 Systron Drive, Concord, CA 94518. For immediate details call our Quick Reaction line (415) 682-6471 collect.

SYSTRON  DONNER

Circle 30 on Reader Service Card

www.americanradiohistory.com

The primary function of the recording system is to put incoming audio on the full-coat magnetic film. By setting up for magnetic recording, adjusting level controls for individual sources, marking cue indicators on both film and sprocketed magnetic film and aligning precisely (film mark in aperture and magnetic film mark on the head), setting tone controls, and making sure sources and monitoring equipment are plugged, the record amp. can be set up. It is necessary to check that the connecting cables between the preamp and the magnetic heads are plugged into the proper receptacles, the erase head switch is on, the bias control is set to the right for full on, and the record button is pushed in. With the eye lit up, the recording is set to go. One further suggestion. A headphone should be used for monitoring purposes instead of a speaker if a live microphone is used for recording to prevent feedback.

With the projector turned on, the recording can take place and at its conclusion the projector can be reversed, the optical film and magnetic film rerun to the start marks, and re-played. The recording can then be checked against the film immediately. The entire process can be repeated if necessary.

If there is already a recording on the magnetic film it is possible to erase a portion of it for elimination or correction. This is done in a manner similar to the recording, but with no sources plugged in and with the level controls at *off*, the film and full-coat set to play from a point in advance of the portion to be wiped, and the bias control set at full off. The erase head should be on and the recording button in. At the point where the erasure is to start, the bias control is turned full on, and then turned off at the end of the section. The magnetic wipe can be checked out immediately.

It is now possible to insert a new piece of material in the erased spot. This is accomplished by a combination of the original recording process, and the erase procedure. With the equipment set for magnetic recording, the source is plugged in but the bias is off. At the insert point, the level is turned up to the proper position, and the bias is turned full on. Both controls are then turned off when insertion has been completed.

There is one more process possible, in which the incoming sound can be balanced to superimpose itself over the previous material on the magnetic film and mix with it, rather than to supersede it completely. By setting up for magnetic recording, but keeping



## the HM 1200 Portable Mixing System

12-in, 4-out, Stereo 3 way electronic crossover. 2 submasters. Pre-Post Echo. Pan Pots. Variable input pad w/meter. 3 section EQ,  $\pm 22$ db! Monitor sends. Balanced transformer inputs. Line drivers. Your choice, rotary or slider controls.



INTRODUCING the greatest concept in audio mixing consoles for your traveling Sound System, small studio, or portable recording needs. Those days of paying for ginger bread you really didn't want, but were forced by the manufacturer to buy, are GONE! NOW, you be the designer... set up just those type channels and controls YOU need. HEIL SOUND allows you to plug them together to form the most incredible mixing system available today... The HEIL HM 1200 QUAD MIXING SYSTEM! Professional Net from \$2200.00. (8-in, 4-out)

**HEIL SOUND SYSTEM,** Heil Industrial Blvd.,  
Marissa, Illinois 62257

Circle 34 on Reader Service Card



Send only  
the best.

Only the best is good enough. And that's exactly what you get with CBS Laboratories power twins, Audimax and Volumax. Audimax delivers a distortion free signal by eliminating thumping, background "swish-up" and audio "holes." And Volumax prevents overmodulation and permits maximum per-watt coverage power. The power twins! From CBS Laboratories, of course.

**CBS LABORATORIES**

A Division of Columbia Broadcasting System, Inc.  
227 High Ridge Road, Stamford, Connecticut 06905

Circle 38 on Reader Service Card

# new pocket sized professional sound level meter for under \$100



The new Scott 451C sound level meter is the first truly professional instrument that fits in your pocket and costs only pocket money.

It gives instant readings at the touch of a button to ANSI type S3C accuracy with industry standard "C" weighting for flat response. Its range of 45 to 130dB SPL lets you check ambient background levels as well as the signals of interest. It measures the complete range of sounds likely to be encountered by the audio engineer or the advanced audiophile.

It's got a handsome, rugged all metal case and a big meter face that's easy to read. It's also a lot of fun to use. Its battery lasts all year. It lasts indefinitely and it's fully guaranteed for two years. It costs only \$98.00. It's available from distributors whose names we'll send you with full product specifications.

**Scott  
Instrument  
Laboratories**  
Division of Eastern Air Devices  
30 Cross Street  
Cambridge, MA 02139



Circle 35 on Reader Service Card

# Before you write a 'Help Wanted' ad, read ours.

## "Rock Talk"

Used by the Professionals: Leon Russell, Boz Scaggs, WAR, Uriah Heep, Osibisa, Alman Brothers, Doobie Brothers, Herbie Hancock, Pointer Sisters, Sha-Na-Na, Neil Young.



### CLEAR-COM PORTABLE INTERCOM SYSTEM

Exceptionally clear voice intercommunication for lighting, mixing, and sound reinforcement crews at concerts and recording remotes. Reliability and performance proven by constant professional use. Clear-Com is a wired system using standard 2-conductor, shielded microphone cable to connect all stations. One main station powers up to 30 remote belt-pack stations. All stations are equipped with headphones and dynamic high-intensity noise-canceling microphones.

Custom features for concert and recording groups include:

- Individual volume control at each station
- Call light signaling to back up audio system
- Complete portability
- Rugged all-metal construction for total reliability

Full one-year warranty guarantees all components. Write or call today for the dealer nearest you:

**CLEAR-COM**

DIVISION OF LUMIERE PRODUCTIONS, INC.  
759 Harrison Street, San Francisco, CA 94107 (415) 989-1130

## EMPLOYERS WANTED

Applications being accepted from industry, manufacturing, publishing, educational institutions, every business—large and small. Needed to employ disabled individuals skilled in many fields: accounting, secretarial, managerial, technical, sales, design, clerical, teaching, etc. All are highly trained, industrious and fully rehabilitated. We follow-up on every employee we place. Write: Director, State Department of Vocational Rehabilitation in your state. His office is in your state capital.

WRITE YOUR STATE  
DIRECTOR OF VOCATIONAL  
REHABILITATION.  
HIS OFFICE IS IN YOUR  
STATE CAPITAL.



The U.S. Department of Health,  
Education, and Welfare.

A Public Service of This Magazine & The Advertising Council



Circle 37 on Reader Service Card



the erase head off, the machine is run forward and at the point where the mix is to take place, the bias is turned up from full off to a desired position. If the bias were left at off, the new recording would not take place. If the bias were turned full on, the previous material would be wiped or at too low a level to balance properly with the new incoming audio signal. The level of the old recording can be controlled while the new material is being put on the tape by setting the bias control to some point between the two extremes. It takes a bit of practice to be sure: you have to get it right the first time.

The other functions possible with the machine include transfer of magnetic stripe to magnetic film, optical to magnetic film, and fullcoat magnetic film to magnetic stripe. (Assuming, of course, that the magnetic recording preamp is plugged in and that the machine is outfitted with a magnetic stripe head.)

To set up for transfer from magnetic film to magnetic stripe or from magnetic stripe to magnetic film, the controls and the preamp must be set for magnetic recording, and the cables have to be plugged in properly. The direction of feeding sound will determine the proper way to plug the cables. The output volume control, used to adjust levels during normal playback, is now used for controlling input recording level. Mixing input sources is also possible as during normal recording.

A procedure similar to this is also used for transferring optical to magnetic sound. The only difference is that the mode switch on the amplifier has to be set for optical/magnetic transfer. Mixing can also be accomplished.

There are also special features of the projector which can lend themselves to several interesting applications. For example, the projector amplifier can be used for public address, provision is made for variable running speed from below silent speed to above normal sound speed (the speed of movement can be read on a strobe disc mounted right on the projector), and the brightness of the projection lamp can be adjusted from a very dim to extra bright. The switch for starting the motor is on a rotary control which is then used to turn on the lamp and control the brightness. The current to the lamp is read on an ammeter mounted on the projector, and the normal setting for proper illumination on the screen is marked off.

The machine can be quite useful when it is necessary to edit film and then put sound tracks on match. Threading has to be done carefully

when using the double-system to be sure of correct synchronization. The optical film should be set first, with the cue mark in the aperture. To see this, the lens should be removed and the cue observed visually. The magnetic film can then be set up with the cue mark on the head. Both sides will then track if the loops are set properly. Both forward and reverse runs will remain in sync, as the drives are directly linked.

Although the machine is quite heavy, it is portable. The projector

and amplifier come in separate units and plug together for normal operation. They can be unhooked easily and carried individually.

Perhaps some of our readers have had experience with this or some other interesting unit and would like to share this information with others. This is the place. We would also like to hear if there is any special piece of equipment about which you might be interested. Tell us about it. We'll do what we can to get you the information you might need. ■

## After you use the 1056, we'll know one thing about your dub quality: it just got better.

Professional studios that make lots of dubs for radio, welcome the speed and quality they get using the Garner 1056. It offers a whole new set of advantages for producers of reel-to-reel duplicates for radio, AV, or educational needs. Some of those are: • Single capstan drives the master and all five copies. • Solid-state electronics and special heads provide outstanding frequency response. • Two-speed drive allows either 30 or 60 i.p.s. duplicating. • Extra-fast rewind of master tape speeds production. • Unique forward tilt of transport mechanism aids threading. • Conveniently located controls feature push button operation.

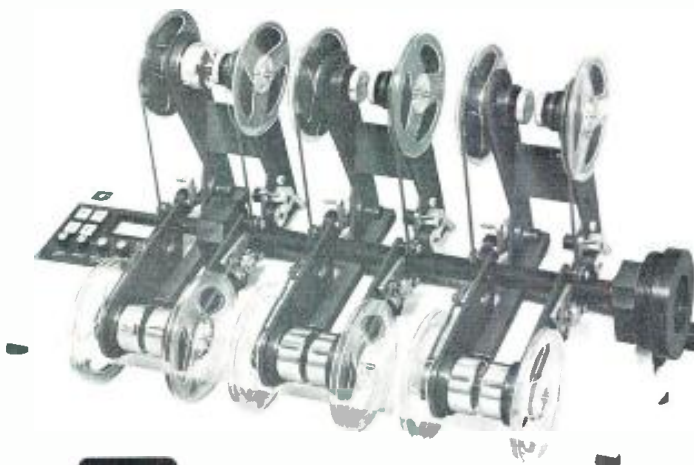

**GARNER ELECTRONICS**

1200 NORTH 48TH STREET  
LINCOLN NEBRASKA 68504

Circle 33 on Reader Service Card

# Opamps for Mixing

*The author tells us that the potentiometer has come a long way and he proceeds to describe a mixer circuit that shows how far.*

**T**HE USE OF variable constant impedance loss networks (attenuators) dates back to the earliest recording consoles. To this very day, the 2dB-per-step attenuator can be found in the majority of consoles extant. But this attenuator has some basic problems as viewed from the current state of equipment utilization.

First of all, in broadcasting, disc jockeys like all their levels to run between 11 and 2 o'clock. This is because it is easiest to flip a control knob from 7 to noon when you are bringing in a selection. The technique usually involves having the index finger riding on the knob pointer. Now on fades, only half the attenuator is available as a result, meaning you duck the level a mere 20dB before going to infinity. An acid rock jock can be moved to tears just talking about hearing such an effect on his 80 watt headsets.

The inline attenuator solves some of these problems, but you are still stuck with the discrete steps which can be heard when dealing with any sustained sound. The light dependent resistive attenuators take out the lumps and pops but they happen to be quite expensive.

There has been a good deal of interest, economic and otherwise, toward the elimination of the attenuator altogether, at least in some of the common bread and butter production equipment.

This means making use of pots, those dirty noisy old volume controls everyone hates. Now wait just a minute! The composition control has come a long way. It's much more reliable now and the ones we intend to use are sealed. They won't last forever, but nothing prevents you from mounting them with quick disconnect lugs for easy replacement. The real beauty of it is that you can replace

Figure 1. Two signals connected to the high sides of two pots. This creates problems!

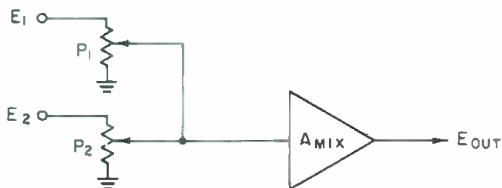
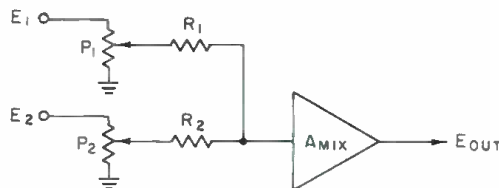

Figure 2. Build out resistors can reduce interaction.



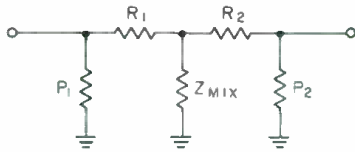
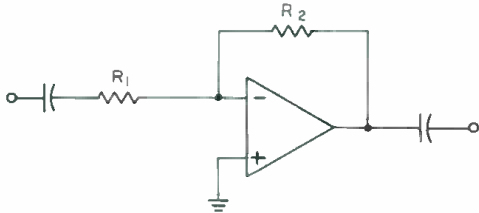

Figure 3. In this example the amplifier input impedance becomes a shunt element between input isolation resistors.

Figure 4. The use of an opamp can overcome both mixer loss and high circuit impedance.



all the high quality pots in a console for less than the cost of one attenuator.

Let's look at some of the problems brought on by using non-constant impedance devices in a mixer. In FIGURE 1 we have two signals connected to the high sides of two pots. Their wipers are tied together and connected to a booster amp. Now, first off you can see a real problem; the two wipers shunt each other and the input of the booster amp. They will interact like crazy.

In FIGURE 2 we have provided isolation resistors  $R_1$  and  $R_2$  (more commonly called "build out" resistors). Their values are such that the voltage from one source, present at the input of the booster amp., will not be shunted to a lower value regardless of the position of any other mixer pot. If  $P_1$  and  $P_2$  are 10k pots.,  $R_1$  and  $R_2$  would be over 100k to prevent interaction.

The nature of the booster amp. is the result of compromise. The higher its input impedance, the less loss there will be in the mixer. However, the higher the input impedance, the greater the noise pickup and the greater the chance that inputs will crosstalk to one another. As noted in FIGURE 3, the amplifier input impedance forms a shunt element between input isolation resistors.

Mixing bus impedances in some current consoles, even with attenuators, run up to 240k at the booster cards. This makes for great reception of f.m. broadcasts and radar.

Through the use of op amps we can overcome both mixer loss and high circuit impedances. FIGURE 4 shows a typical op amp employing negative feedback. The input impedance, in this case, is essentially  $R_1$ . However, the op

Figure 5. The opamp is connected as a mixer permitting the gain for each mixer channel to have a different value depending on the selection of  $R_1$ .

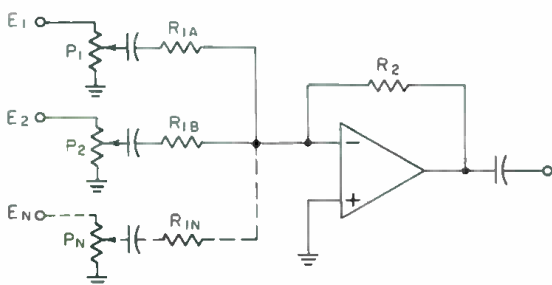

Response curve made with five random-selected MD 421 microphones.

## ALL 5 OF THEM!

### UNUSUAL? Not for Sennheiser.

The fact that the response curves of the five microphones are almost identical is commonplace for our engineers. And the individually-plotted curve we provide with each unit will confirm the fact. For besides the rigorous check of a response curve, each and every Sennheiser professional microphone undergoes numerous other inspections, to insure its absolute acoustical, electrical and mechanical integrity.

Perhaps this uniformity and unusual performance influenced the major recording companies in choosing Sennheiser microphones for both field and studio use (and made ours the 'standard' microphones of the continent).

You may think this kind of quality control is unusual for a production instrument. However, we are very particular about the kind of equipment bearing our name. Shouldn't this kind of 'insured performance' be built into your audio facilities, or those you install?

For further details, including full technical specifications, and a list of microphone accessories available for the MD 421, please write or call.



# SENNHEISER

## ELECTRONIC CORPORATION

10 West 37th Street, New York, N.Y. 10018 (212) 239-0190  
 Manufacturing Plant: Bissendorf, Hannover, West Germany

db June 1974

33

Circle 14 on Reader Service Card

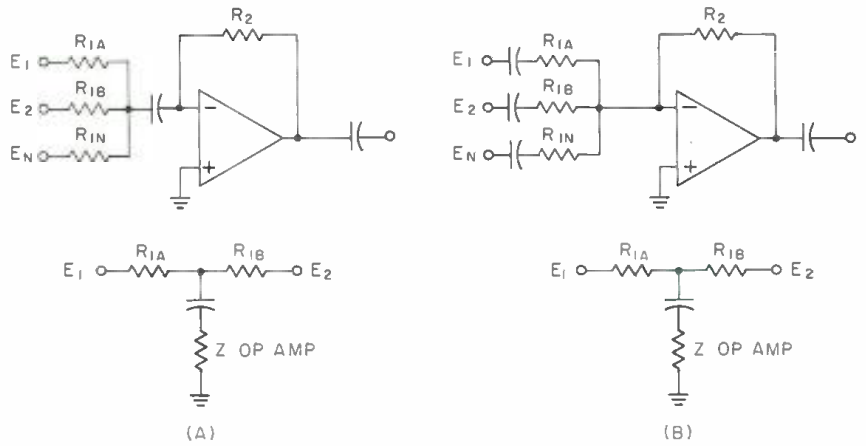

Figure 6. The difference between a common capacitor A) and individual ones B).

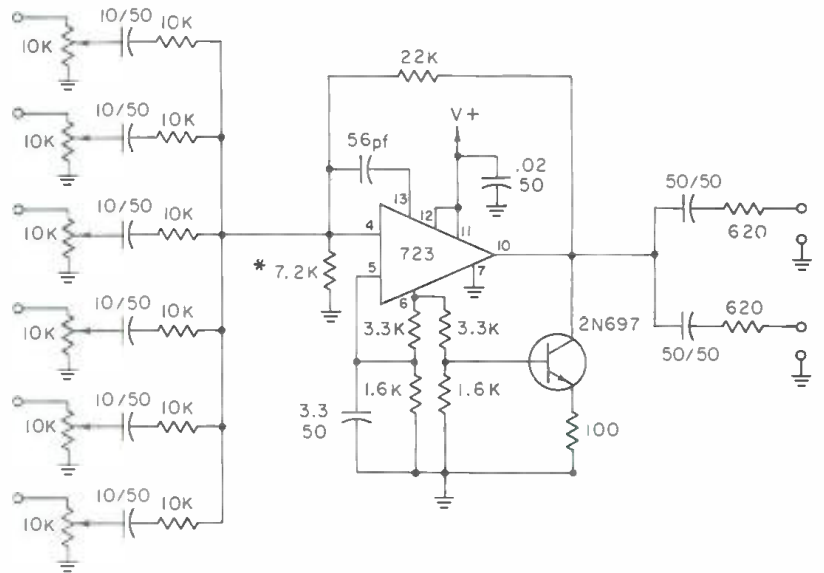

Figure 7. A complete mixer circuit. \*Selected to set the voltage at pin 10 equal to  $\frac{1}{2} V+$ .

amp does have a small input impedance in addition to  $R_1$ . In the circuit we are going to deal with this comes to around 25 ohms.

Looking at FIGURE 5 with the op amp connected as a mixer, you will note that the gain for each mixer channel may be made a different value depending on the selection of  $R_1$  for each input since the channel voltage gain is  $R_2/R_1$ . In addition, since the input impedance is low at the op amp, there will be very little interaction, given a sufficient minimum value for  $R_1$  in each case.

The worst likelihood for interaction is with one pot on and all other pots off. In this case, the input impedance of the op amp proper is shunted by all remaining  $R_1$ s in parallel to ground (The pots being at ground.). If we assume  $Z$  op amp to be 25 ohms, and all  $R_1$ s to be 10k, then the combined shunting effect to lower the level, by 1 dB of the pot in use at the amp input, would be about 246 ohms. How many  $R_1$ s at 10k each to ground does it take to get such a value? Would you believe 40?

What I am saying is that you could have a 40 input mixer using pots and experience only 1 dB of interaction. What's more, using a  $R_2/R_1$  ratio of one to give you unity gain, you get fine distortion and noise figures as well. Cutting down on the number of inputs allows you to increase the ratio for additional gain on selected inputs.

I have used 25 ohms for  $Z$  op amp to illustrate a point. In practice you will encounter lower values than that and of course the lower  $Z$  op amp is the less interaction there is between inputs.

Looking at FIGURE 5, you will note that each input has its own capacitor. FIGURE 6 details the reason for that. If inputs are combined through one common capacitor, the shunting action of the op amp input impedance is reduced at low frequencies and this results in reduced isolation from input to input. When separate capacitors are used, the isolation at low frequencies actually increases.

FIGURE 7 shows a mixer circuit with six inputs and two outputs, which makes use of a 723 voltage regulator i.e. With a few changes, the i.c. portion of the circuit is similar to the circuit described by Walter G. Jung in his September, 1970 db article. An I.C. LINE AMP . . . OR Is It? It just so happened I was breadboarding his circuit at the time the mixer idea struck me so I just altered it to fit my new objective.

The basic differences are that Mr. Jung was using a TO 5 723 and I used an inline 723; also, the feedback resistors and the output loading circuit have some changes. Aside from the pin numbers being different, the main difference between the TO 5 and the inline packages is that you can add a radiator to the former and draw a bit more current through it. I was forced to reduce the loading of the output in order to reduce the current being drawn. This resulted in a somewhat higher distortion.

My main message to you is not that this particular circuit is the most fantastic thing whatever, but rather, that the use of op amps for mixing allows you to make fairly inexpensive utility circuits which are worthy of your consideration. ■

# A Mic Preamp/Limiter

*Here's a simple but effective device that will be of value to both broadcast and recording engineers. The unit is built around Opamp Labs concepts.*

EARLY IN EACH of our careers, I suppose, each of us discovered the annoying habit performers have of giving us a higher level during a take than in rehearsal—often driving the tape, and us, into saturation. As the anti-engineer ire and studio bills rise, it is clear that something must be done. Limiting springs to mind. Conventional external limiters, good as they are, however, have a flaw. If you need a large amount of gain from your mic preamps most of the time, and yet there are occasional large signals, you may find, as I did, that the preamps distort by clipping, even though the output signal is held within reason. And you may not choose to sacrifice signal-to-noise on 98 percent of a take on the small chance that in 2 percent there may be a high peak. What you need, then, is a limiter on the preamp itself.

The limiter design to be discussed controls signal level at some late point in a console by reducing the gain of some earlier stage, be it mic preamp or what have you. It can be built for a total cost of about \$15 per channel, so if you like it, there's no reason not to have one on every channel. The essential points of the design here came originally from Opamp Labs, 172 S. Alta Vista Blvd., Los Angeles, Calif. 90036, from whom one can get the led unit needed.

In the Opamps 360BM mic preamps I use, as with most other opamps of whatever use, gain is set by a feedback resistor (or pot)  $R_f$ . If an ldr is paralleled across this resistor and optically coupled to an led driven by the signal output, excess signal can serve to reduce the ldr

resistance and the gain of the opamp. Thus we achieve limiting by increasing negative feedback—a generally desirable operation.

Driving the led, unfortunately, requires some power (in the circuit here about +8 dBm). It was the realization that the circuit could not be driven directly from the mic preamp which led to the discovery that it was more useful downstream anyway—say, after the eq. amp. Use of the ldr in this manner isn't feedback in the normal sense of the word, of course, so it doesn't matter how many stages you feed around. It would make sense not to feed around an assignment switch, however, or you may wind

Figure 1. The complete system as described in the text.

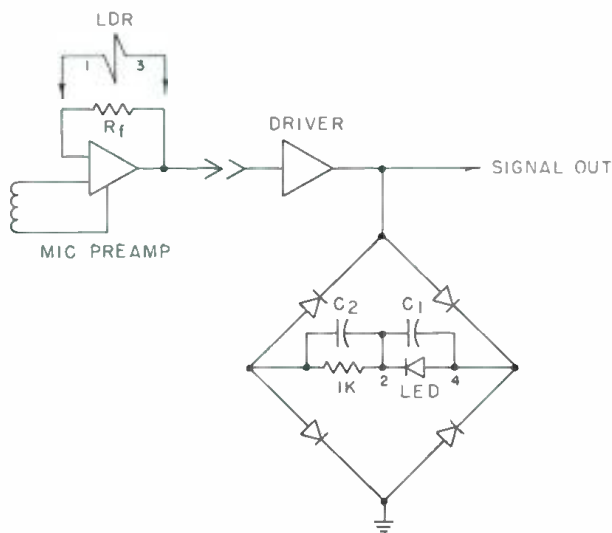

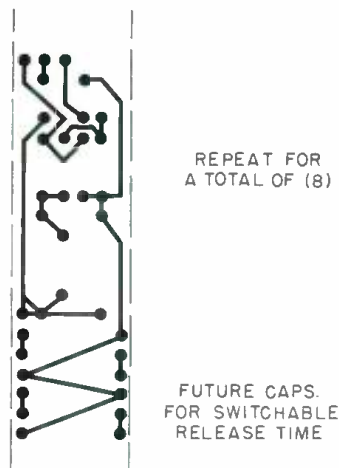

Figure 2. The mic limiter module ML4 foil side view (exact size).

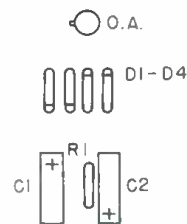

Figure 3. The component side view of the board shown in Figure 2. Again, scale is full sized. Note: O. A.—Vactec VTL-2C2; D1 to D4—1N4001; C1—1 $\mu$ F-500 $\mu$ F (see text) 3V d.c.; C2—50 $\mu$ F 6 V d.c.; R1—1k.

up limiting the wrong preamp. If your console isn't set up so that audio power can be tapped at this point, it shouldn't be hard to add a driver stage of one or two transistors to the pc board shown here and power it from the console.

Referring to FIGURE 1, the circuit consists very simply of a full-wave bridge driving d.c. through the led and a current-limiting resistor. Capacitor C<sub>1</sub> controls release time according to the relationship  $T = C/2$ , where T is in msec. and C is in  $\mu$ F. The ldr, while shown across R<sub>f</sub> as is cor-

rect, is physically in the same case with the led in the VTL-2C2. So keep the board as close to the mic preamp as possible and be sure that the leads from the ldr are well shielded. All other wiring is pretty non-critical. The pc board shown was developed to fit within the horizontal space of one channel in my console (where there are actually many by repeating this pattern on a single board) but you can squeeze it around for other shapes as you wish. Note the spaces at the bottom for extra release-time capacitors and holes for connection to a switch for selection. If you do this, make C<sub>1</sub> something small, like 1  $\mu$ F. with the other values say, 10, 50, 200, and 500  $\mu$ F. Or, you could stick with one release time and omit this section of the board to fit it into a smaller space.

In the VTL-2C2 the nominal resistance of the ldr is over 100k. At the threshold of +4 dBm, it has dropped slightly to about 100k; above this, the resistance drops off in a gradually flattening curve to about 1k at +24 dBm. The threshold of limiting will, of course, be at the point at which the ldr has dropped to a value equal to R<sub>f</sub>; that is, if R<sub>f</sub> is 100k, limiting would begin at approximately +4 dBm, whereas if R<sub>f</sub> were 1k, limiting would begin at roughly +24 dBm (although in the latter case little limiting action could really be expected, since at 1k the ldr is on the flat part of its curve and cannot drop much further). With the 360BM preamps, R<sub>f</sub> is an open circuit for full 60 dB gain, 15k for 50 dB gain, and 3.3k for 40 dB gain. Thus the VTL unit gives me limiting near +4 dBm only on the two high gain positions. To overcome this, one might, if designing a separate driver, incorporate a gain setting switch for it in the mic preamp gain setting switch; thus one could increase the drive slightly as R<sub>f</sub> was lowered in an attempt to keep limiting at +4. The driver in this case would not serve as a signal output, of course. Also, the ldr would not be operating on the steepest part of its curve, so this procedure would be most effective for values of R<sub>f</sub> above, say, 5k. Alternatively, one can simply pull down the channel master fader slightly to account for the higher threshold of limiting.

If you want an indicator of limiting action, another bridge circuit can be paralleled with the first, incorporating a regular led display of some kind on the console. This circuit should have a large value of C<sub>1</sub> to prevent flickering. A different value of current limiting resistor might be useful also. And make sure that sufficient drive is available to power both units without degrading the signal. ■

# get loaded

at a price you'll like

At last a professional cassette loader that does not cost a King's ransom

Vacuum splicing block complete with internal pump

Automatically winds loop into cassette with take-up switch after splicing

Set tape length directly in minutes

Safe 120 ips loading

Digital integrated circuitry for dependable accuracy

Easy loading from 10½ inch reels or pancakes

Designed for heavy-duty professional use

Produces 500 to 700 cassettes per 8-hour shift

Models start at \$950

Models available with: Convenient, automatic tape cutting

Cue-tone loading

Dealer inquiries invited.

Telephone 213 / 829-2282 or write for brochure today.



**PCE**

**Professional Cassette Equipment Co.**

1660 20TH STREET • SANTA MONICA, CA 90404

Circle 31 on Reader Service Card

LARRY ZIDE

# A Visit to Ortofon

**T**HIS VISIT to Ortofon was made during the time of the Audio Engineering Society's 47th Convention held this past March in Copenhagen, Denmark.

The visit to Ortofon was accomplished on one of the nice days that Denmark bestowed on visitors during the Convention.

I first visited the production facility that is responsible for the professional products which are the backbone of this company's long reputation. Ortofon is a supplier of disc recording (and playback) equipment. The recording equipment they make does not include the all-important lathe, unfortunately, but you can have excellent amplifiers for both power and control as well as a line of cutter heads, including one that can produce CD-4 masters at half speed. I met T. Vestegaard, who created the design for (and produced a paper given at the 43rd Convention) a new high-power cutting amplifier that is gaining wide attention in the industry—along with the cutter heads, of course.

I also met with and had a discussion with the present principals of the company, both Americans, David Hafner and Newton Chanin. Ortofon is, and will continue to be a part of the U.S. pro audio scene. (Gately Electronics is the exclusive distributor of their pro audio equipment in the U.S.)

Ortofon also is well known to the audiophile-hobbyist for their line of phono cartridges and tonearms. Many of these have also found their way into pro-audio usage, of course.

Cartridges are manufactured in a separate plant which I visited via a delightful small-plane flight of a quarter of an hour. In the U.S., Ortofon is primarily known for its moving-coil designs, but I saw lower-cost other types also being made for domestic usage.

The manufacturing policy here is a modification of standard assembly-line procedure. The airy plant is populated by workers who are highly skilled at specialized jobs of sub-assembly, but there is no long line on which a product proceeds. Rather, there is a group approach that results in a greater individual responsibility to the product.

It should be noted that this concept is carried to its extreme in Ortofon's pro-audio line. Amplifiers and cutter heads are made in the labs, not in a separate factory, and are assembled by engineers and technicians and then individually given their proof of performance under actual use conditions.

## ORTOFON HISTORY

This is no new company—it has been in existence since 1918. In that year, two young engineers, Axel Petersen and Arnold Poulsen, founded the firm, Electrical Fonofilm Company A/S. Their aim was to explore the possibility of high-class recording and reproducing of sound films—and they carried this into effect. Up to that time, sound could only be produced for film with semi-synchronized discs. By 1923, this group produced the first real sound on film, recorded according to the variable-area method. The method of realization was to put a picture on one film, and sound on the second, and synchronize the two.

Other motion-picture products followed, including cameras and recording heads that are still in use today. Products expanded into condenser microphones, compressors, amplifiers, mixing tables, and editing tables.

A new system of disc cutterhead design was developed in secret during the Second World War, and at the end of 1945 the Danish disc recording company "Tonno" was able to cut records, using the new system. No existing pickup system was able to reproduce this high sound quality at the time, so a pioneering mono pickup head and arm was developed and achieved world wide fame.

In 1946 the original company name was changed to Fonofilm Industri A/S and in 1951 Ortofon A/S was founded as a trading company attached to it. The word Ortofon was registered as a trademark for all the products of the firm.

My visit to their modern facilities near Copenhagen and elsewhere in Denmark convinced me that this heritage is an ongoing, one well respected by the present staff and ownership. It is reasonable to expect that Ortofon will continue to be the world leader it always has been. ■

*This corner of the lab is set up with a functioning lathe and is used for both the test of new designs of cutter head, but also for the proof of performance of each manufactured head.*





*Another corner of the lab is used for the assembly of electronic components such as this finished regulated filter here undergoing tests.*



*The lab boasts the most sophisticated test and evaluation gear, mostly from Bruel and Kjaer and all of which is used in the production testing of pro audio gear.*



*A view in the cartridge manufacturing facility. Note the high use of skilled women in this work. We were told that this is not sex discrimination—they receive equal pay for equal work with men.*



*The shadow spectrograph is a useful tool in many areas of Ortofon's production. Here it is being used as a proof of correctness check on the stylus assembly of phono cartridge.*



## Complete Audio Distortion and Frequency Response ...Automatically

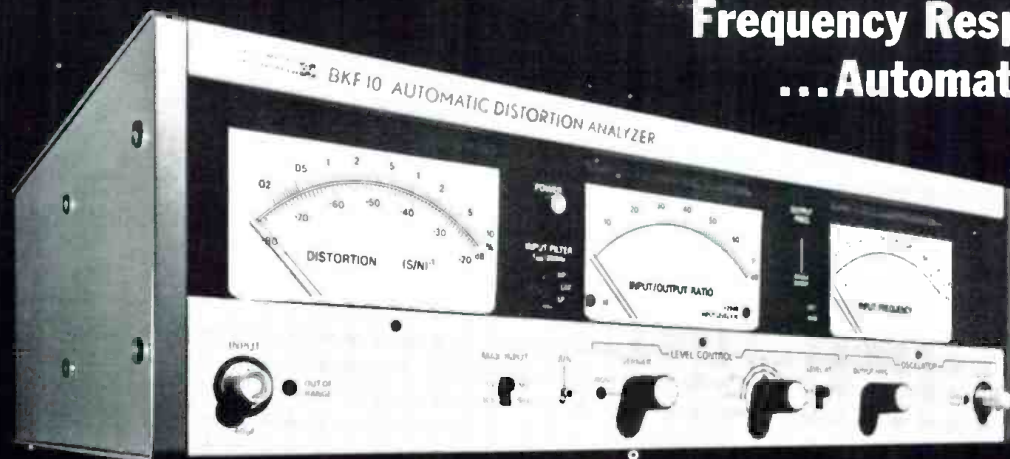

**RADIOMETER**  
**COPENHAGEN** 

Comprehensive distortion and frequency response measurements are easily performed with the BKF10 Automatic Distortion Analyzer. This unique instrument combines a distortion meter, a low distortion audio sweep oscillator (<0.01% t.h.d.) and an input/output ratio meter. Operation is totally automatic... No balancing, nulling or level setting is required. Addition of a recorder provides complete distortion and frequency response curves. Send for complete information.



THE LONDON COMPANY / 811 SHARON DRIVE / CLEVELAND, OHIO 44145 / (216) 871-8900

Circle 32 on Reader Service Card

# Why let oxide dust destroy your tape head?



MS-200 Magnetic Tape Head Cleaner quickly flushes away oxide build-up on heads and capstans. It can even be applied while deck is running.

Gone are the days of the cotton swab and bottle of cleaner. MS-200 with its "Cobra" brush sprays away your tape head troubles quickly and safely.

Recommended by leading tape recorder manufacturers. U.S. & Foreign Patents

"Two-Product Trial Unit" includes:

- MS-200 Magnetic Tape Head Cleaner
- MS-226 "Cobra" Extension & Brush



**miller-stephenson  
chemical co., inc.**

Danbury, Connecticut 06810 (203) 743-4447

SE

- Enclosed is \$5.00, please send my "Two-Product Trial Unit" (MS-200 & MS-226)
- Please send FREE literature and prices.

NAME \_\_\_\_\_ TITLE \_\_\_\_\_

DEPT. \_\_\_\_\_

COMPANY \_\_\_\_\_

ADDRESS \_\_\_\_\_

CITY \_\_\_\_\_ STATE \_\_\_\_\_ ZIP \_\_\_\_\_

CHICAGO • LOS ANGELES • TORONTO  Dist. in ITALY • GERMANY • FRANCE • ENGLAND • SCOTLAND • SPAIN • NETHERLANDS • LEBANON

Circle 36 on Reader Service Card

www.americanradiohistory.com

# CLASSIFIED

Closing date is the fifteenth of the second month preceding the date of issue. Send copy to: Classified Ad Dept.  
db THE SOUND ENGINEERING MAGAZINE  
980 Old Country Road, Plainview, New York 11803

Rates are 50¢ a word for commercial advertisements. Non-commercial and employment offered or wanted placements are accepted at 25¢ per word. Frequency discounts: 3 times, 10%; 6 times, 20%; 12 times, 33%.

## FOR SALE

FOR SALE: MCI JH-416 CONSOLES, 24 x 24, \$19,000; 16 x 16, \$13,500; JH-16 16-track w/auto locator, \$13,000, two months old. Sound 80, 2709 E. 25th St., Minneapolis, Minn. 55406. (612) 721-6341.

LOWEST PRICES, fastest delivery on Scotch recording tapes, all widths. We will not be undersold. Amboy Audio Associates, 236 Walnut Street, South Amboy, N.J. 08879. (201) 721-5121.

AMPEX AG-500-2, 7½ & 15 i.p.s. 2-track stereo w/extra 4-track play head in portable case in immaculate condition. Complete with new remote control unit, and operating/service manual. Price \$1,200. Jim Stemke, 3749 N. Sayre Ave., Chicago, Ill. 60634. (312) 545-0393.

FOR SALE BELOW COST, one set new Nortronic 2-inch 24-track heads for a Scully 288-16. HAECO, 14110 Aetna St., Van Nuys, Ca. 91401. (213) 787-7733.

TWO PRESTO 8DG LATHES with cutting heads and amplifiers; 45 and 33½. \$900.00 each. (615) 227-5027.

NEW YORK'S LEADING PRO AUDIO/VIDEO DISTRIBUTOR for audio, video, broadcast, public address, and hi-fi systems; representing over 130 audio/video manufacturers, featuring such names as Ampex, Scully, Tascam, Sony, J. B. Lansing, Neumann, Altec, McIntosh, AKG, Dynair, T.V. Microtime, UREI, 3M, and other major brands; the largest "in stock" inventory of equipment, accessories, and parts; competitive discount prices; factory authorized sales, service, parts, systems design, installation. Write for free catalog! Martin Audio/Video Corporation, 320 W. 46th St., New York, N.Y. 10036. (212) 541-5900.

SOLID STATE for MX-10 and MX-35. Specially designed fet tube replacements are now available to make the MX-10/35 completely solid state; improved gain, snr, and stability is obtained by simply replacing all tubes with the direct plug in fet tube substitutes; replacements also available for other professional audio equipment. Write for information and application notes to: Audio Applications, Box 3691, Hayward, Ca. 94545.

NEW MODEL AMPEX AG440C 2-track; servo capstan motor; in console; immediate delivery from stock. Used AG440B demo machines also. Malaco Recording, Jackson, Miss. (601) 982-4522.

HAECO ANNOUNCES complete repair service and overhaul for all Westrex cutterheads. Conversions of 3D-11 and older models to higher performance standards and reliability. Helium cooling systems and hi-temp coils can protect your investment. Repair insurance program available. Rapid service. Lower cost. HAECO, 14110 Aetna, Van Nuys, California 91401.

## ORTOFON

DYNAMIC MOTIONAL FEEDBACK mono disc cutting system. Complete amplifier system: drive, feedback, and feedback-playback monitor preamp; rebuilt, original factory parts. Guaranteed. Albert B. Grundy, 64 University Place, New York, N.Y. 10003. (212) 929-8364.

WHATEVER YOUR EQUIPMENT NEEDS—new or used—check us first. We specialize in broadcast equipment. Write for our complete listings. Broadcast Equipment & Supply Co., Box 3141, Bristol, Tenn. 37620.

NEW YORK STUDIO AVAILABLE to commercial engineer with own clientele. Superbly equipped and attractive four-track studio, sharing space and enormous sound effects and music library with successful radio studio. Ideal for educational, radio, and film work. Great chance to branch out on your own. Clack, Inc., 701 Seventh Ave., New York, N.Y. (212) 245-6770.

AMPEX, SCULLY, TASCAM; all major professional audio lines. Service, experience, integrity. 15 minutes George Washington Bridge. Professional Audio Video Corporation, 342 Main St., Paterson, N.J. 07505. (201) 523-3333.

MINI-MOOG, \$950. Schober echo, \$495; Senn SRO 4-12, \$450; Tandberg TCD 310, \$395; dbx 157, \$395; three AKG mikes, \$150. Charlie, (215) 363-7855.

**REPAIR**

SCHOEPS (TELEFUNKEN) VACUUM TUBE  
CONDENSER MICROPHONES REPAIRED.  
Original factory parts & factory calibration of capsules.  
Models CM51, 61, 66; M201, 221; MK24, 26 etc.

ALBERT B. GRUNDY  
64 University Pl., N.Y., N.Y. 10003  
(212) 929-8364

NEW 14-INCH NAB Ampex aluminum flanges; have never been removed from original box. Package of 10, \$8.15. Sound Investment, P.O. Box 338, Dunwoody, Georgia 30338.

NORTHWEST AREA, professional audio equipment and systems design. R. E. Munger Co., Seattle, Washington, (206) 365-1999. An Altec Acousa-Voice contractor.

CUSTOM CROSSOVER NETWORKS to your specifications: 1 or 1000. Power capacities to 1,000 watts. Networks duplicated. High tolerance air and iron core inductors. Outline your needs for rapid quotation. TSR ENGINEERING, 3673 W. 113th St., Inglewood, Ca. 90303. (213) 678-1979.

FREE ROOM EQUALIZATION with purchase of ⅓-octave filter sets. This is not a misprint. Music & Sound, Ltd., 11½ Old York Rd., Willow Grove, Pa. 19090. (215) 659-9251.

REEL SPECIALISTS; 10.5 inch reels, NAB \$2.00 each; Precision, \$5.00 each; other sizes available; NAB flanges, \$.75 each. Add 5 per cent postage. P.O. Box 338, Dunwoody, Ga. 30338.

3-SIXTY SOUND REINFORCEMENT SYSTEMS, including touring systems. Division of Brandy Brook Sound. Contact Concertour, P.O. Box 284, Wilton, Conn. 06897. (203) 966-3113.

TASCAM REVERBS; Tascam Mixing Consoles—\$1,890; Tascam ½ inch recorders—\$1,950; Tascam 8-track recorders—\$3,970. All shipped prepaid/insured, including free alignment/equalization/bias/calibration. Music & Sound, Ltd., 11½ Old York Rd., Willow Grove, Pa. 19090. (215) 659-9251.

STOP KIDDING YOURSELF . . . about Head Degaussing! Use a full power degausser and then measure the results with a magnetometer. The Annis Hand-Mag measures over 400 Oersteds . . . more than 5½ times as powerful as the head degausser you're probably using now. Then check the results with the Annis Magnetometer, included in the Hand-Mag kit for \$29.75. Prepaid any place in the U.S. from Audiotechniques, Inc. Send your check or money order to: Audiotechniques, Inc. 142 Hamilton Ave., Stamford, Ct. 06902. Tel: (203) 359-2312.



**CATV—MATV PRODUCTS**

- CONNECTORS
- SPLITTERS

- WALLPLATES
- AMPLIFIERS



AVA ELECTRONICS CORP.  
242 Pembroke Avenue, Lansdowne, Pa. 19050  
(215) 284-2500

AMPEX SPARE PARTS; technical support; updating kits, for *discontinued* professional audio models; available from **VIF International, Box 1555, Mountain View, Ca. 94042. (408) 739-9740.**

FOR SALE: SCULLY 8-TRACK 280 SERIES; excellent condition; price open. MCI; still under warranty; 8-track configuration; capable of 24-in/24-out; price open. Call mornings, **(212) 224-7813.**

THE LIBRARY . . . Sound effects recorded in STEREO using Dolby™ throughout. Over 350 effects on ten discs, \$150.00. Write, **The Library, P.O. Box 18145, Denver, Colorado 80218.**

CUSTOM RECORD PRODUCTION (100 & up) from your tapes; also Scully-Westrex precision cut masters and acetate demos (stereo or mono). Request literature, **Trutone Records, Dept. D, 6411 Bergenwood Ave., North Bergen, N.J. 07047. (201) 868-9332.**

FOR SALE OR TRADE: New 7 inch reels and boxes. Will trade for 5 inch reels and boxes. Several thousand available. **Magnetic Sound, Inc. 1105 Maple, W. Des Moines, Iowa 50265.**

B.B.C. REFERENCE MONITORS; pre-equalized J.B.L./Altec/I.M.F. monitors; Eventide phasors/omnipressors/digital delays; McIntosh 16 ½ power amps; dbx compressors; Little Dipper hum/buzz notch filters; Cooper Time Cube echo delay; Ortofon and B. & O. ultra-track cartridges; Schöeps & A.K.G. condensers; Beyer ribbons; U.R.E.I. comp/limiters; Gately Pro-Kits; Infinity electrostatics; Crown amplifiers/recorders; Tascam, Community Light & Sound fiberglass horns; Q.R.K.; 100's more, plus class "A" warranty service station. **Music & Sound, Ltd., 11½ Old York Rd., Willow Grove, Pa., 19090. (215) 659-9251.**

**All Shipped Prepaid/Insured**

CUSTOM TAPE DUPLICATION, 8-track and cassette; top quality at competitive prices. **Dick Walen, Custom Audio Sound Service, 4226 Robert St., Red Wing, Minn. 55066.**

SPLICE FASTER, BETTER, BY SHEARING; replaces razor; attached splicing tape dispenser; quality workmanship; reasonably priced; endorsed by professionals. \$24.95 prepaid. Guaranteed. Distributors wanted. **NRP, Box 289, McLean, Virginia 22101.**

AUDIO EQUIPMENT, new and used; custom consoles built to your specifications using the components of your choice. Whether you're building a new studio or remodeling your present one, check us first for a package price. **Amboy Audio Associates, 236 Walnut St., South Amboy, N.J. 08879. (201) 721-5121.**

FOR SALE: ONE COMPLETE RECORDING STUDIO including 24-track equipment. Price: Approximately \$70,000. **Box 61, db Magazine, 980 Old Country Rd., Plainview, N.Y. 11803.**

**ONE STOP  
FOR ALL YOUR PROFESSIONAL  
AUDIO REQUIREMENTS  
BOTTOM LINE ORIENTED  
F. T. C. BREWER CO.  
P.O. Box 8057, Pensacola, Fla. 32505**

SOLID-STATE AUDIO MODULES. Console kits, power amplifier kits, power supplies. Octal plug-ins—mic. eq., line, disc, tape play, tape record, amplifiers, Audio and tape bias oscillators. Over 50 audio products; send for free catalog and applications. **Opamp Labs, Inc., 1033 N. Sycamore Ave., Los Angeles, Ca. 90038.**

FOR SALE: TWO AMPEX AG 350-1 IN/CONSOLES, very good condition, \$1,250 each; two Ampex MR-70 four-track in/consoles, good condition, \$2,000 each, consider offer. **Bruce Collier, Pams. Inc., 4141 Office Pkwy., Dallas, Texas 75204. (214) 827-0901.**

ONE WAY NOISE REDUCTION for cutting rooms/tape copies; retains highs, rids hiss/surface noise by a full 10 dB and costs \$300 per channel! **Music & Sound, Ltd., 11½ Old York Rd., Willow Grove, Pa. 19090. (215) 659-9251.**

REVOX A700 — CROWN — TASCAM — AMPEX — SCULLY — UREI. New and used pro recorders and mixers. Write for latest listings. **RPB SOUND CO., 339 Park Avenue So., Winter Park, Florida. (305) 647-4762.**

CUSTOM RECORDING CONSOLE, 20 input, 8 output with 4 echo send and receive channels, with 16-track mixdown facilities; simultaneous 8-track, 4-track, 2-track, and mono record; contains 42 Altec 9475A amps, 4 Altec e.q.'s; one 7 ft. rack with 8 rows of jacks; one 30 inch rack with 20 rows of jacks; 3 cue systems, talkback monitor switching; \$6,000.00. One 15/30 8-track 3M/Stephens tape recorder; \$6,000.00. One 300 ft. 19 pair multiconductor mic cable in shipping crate on wheels, Cannon connectors, ideal for remotes, \$450.00. Any reasonable offer will be considered on the following: 4 Altec 612 utility speaker cabinets; 3 Ampex 350/2 electronics; 3 Ampex 02-30512-01 mono playback electronics with power supply; two Ampex 300 "bathtub" electronics; one Ampex 351-2 electronics; one K&H graphic equalizer; one Altec dual channel compressor/limiter; two 7 ft. equipment racks; two 36 inch equipment racks; 3 theatrical road cases on wheels; 1. D. 25 inches x 40 inches. Contact **Don Frey or Irv Joel, A&R Recording, (212) JU 2-1070.**

## MULTI-TRACK

8 and 16

**TRACK RECORDING CONSOLES  
THE SOUNDEST DOLLAR SPENT  
IN PRO AUDIO TODAY**

1965 CHEREMOYA AVE.,  
HOLLYWOOD, CALIF. 90028  
P.O. Box 3187, Hollywood, CA. 90028  
(213) 467-7890

FOR SALE: CUSTOM 16-in/12-out record/remix console; full 16-track monitor with echo, etc.; auxiliary equipment; price negotiable; Scully 2-track head assembly; never used. Other miscellaneous studio equipment. Contact: **Harvey Hoffman, MZH. (212) 986-1084.**

TUNED ROCK P.A.s customized touring sound systems, including narrow band (5 Hz!) feedback suppression, detailed Acosta-Voicing/environmental equalization ( $\pm 1$  dB at your ears), room design/measurement/treatment; 100's of customized professional products (J.B.L. & Altec Pro, Tascam, dbx, U.R.E.I., Eventide, Gately, Schöeps, Beyer, Crown, Community Light & Sound, Mom's Audio, McIntosh, etc. etc.) All shipped prepaid/insured from **Music & Sound, Ltd., 11½ Old York Rd., Willow Grove, Pa. 19090. (215) 659-9251.**  
Inventors/Engineers.

TWO CHANNEL MONITOR EQUALIZERS for your Altecs and J.B.L.s are a steal at \$150. **Music & Sound, Ltd., 11½ Old York Rd., Willow Grove, Pa. 19090. (215) 659-9251.**

→ S.M.E. Damping Mods—\$30.00 ←

## EMPLOYMENT

AUDIO/FM ENGINEER desires part-time, steady, work in NYC area; design, installation, maintenance. First phone, A.B. degree; \$12 per hour. **Box 63, db Magazine, 980 Old Country Rd., Plainview, N.Y. 11803.**

RECORDING ENGINEERING INSTRUCTOR, experience in 16-track recording, mixdowns and outboard equipment, together with an appreciation of today's commercial record music industries' standards and demands. Must be able to manage a studio. MUSIC PRODUCTION INSTRUCTOR, experienced in organizing musicians and working on rehearsals, teaching the producer's role in the recording studio, the business between producer, record company, and publishing, the nature and content of contracts and the procedures of record pressing. Please submit applications to: **The Personnel Officer, Fanshawe College, P.O. Box 4005, Terminal C, London, Ontario N5W 5H1, Canada.**

Young executive with outstanding management accomplishments in general business field desires involvement in the audio recording or related field. BBA, 1966; AES member; presently owns small recording company specializing in remote recording/disc production and related media endeavors. Can lend dynamic management skills, plus practical recording experience, to your company. Please reply to **Box 62, db Magazine, 980 Old Country Rd., Plainview, N.Y. 11803.**

# PEOPLE, PLACES, HAPPENINGS

● The appointment of **R. Clifford Rogers** as eastern U.S. sales manager has been announced by **Rupert Neve, Inc.** Bethel, Connecticut. Prior to joining Neve, Mr. Rogers was product manager of audio products and systems with **Philips Broadcast Equipment Corporation**. He was also associated with **RCA Commercial Electronics Systems Division** and with **Altec, Inc.**

● Functioning as "a friend of the court," the **National Association of Broadcasters** has filed a brief asking the U.S. Supreme Court to affirm a finding by the Third Circuit Court of Appeals that news broadcasts of winning numbers in state-conducted lotteries, which the FCC has sought to prohibit, are protected by the First Amendment. The action was instituted to guard against the erosion of free speech through federal censorship, the brief enjoining the Supreme Court to prevent the Federal Communications Commission from "illegally and unconstitutionally tampering with the content of radio and television news broadcasts."

● A complete audio service is promised to Kansas City, Mo. customers at **Sound Recorder's** new facility, recently opened, under the same management as **Sound Recorders—Omaha**. The new studio will offer narration recording and production, remote recording of live performances and for film work, a complete film chain and film mixing capability, 16-track music recording facilities, music and sound effect libraries, tape duplicating, record mastering, and original music and other creative services.

● Another trendsetting step, pointing to increased acceptance of quadriphonic sound has been evidenced in the licensing of **N. V. Philips' Gloeilampenfabrieken**, of the Netherlands, for the manufacturing and sale of **SQ™** quadriphonic systems. The movement toward quadriphonic sound has been documented through an interesting research project of **Chase Econometric Associates, Inc.** a subsidiary of **Chase Manhattan Bank**. Their findings indicate a decided trend toward this form of sound system in the consumer field.

● **Benjamin B. Bauer**, vice president of **CBS Laboratories** acoustics and magnetics department has been elected a member of the **National Academy of Engineering**. According to **Dr. Robert C. Seamans, Jr.**, president of the Academy, Mr. Bauer has been honored for his contributions to the sciences of sound transmission, reception, measurement, recording, and reproduction. Mr. Bauer holds more than fifty patents and is an author of many papers in various areas of engineering and science, as well as a contributor to textbooks on physiological acoustics and on speech and hearing. Mr. Bauer is a Visiting Professor of Engineering Acoustics at **Pennsylvania State University** and a Fellow of the **IEEE**. In 1963, he received the Gold Medal Award from the **Audio Engineering Society**. He is a member of the **Institute of Noise Control Engineering**, and a Fellow and Associate editor of the **Acoustical Society of America**. Before joining **CBS**, Mr. Bauer was with **Shure Brothers**.

● **Richard Silvera** has been promoted to the position of chief engineer at Long Island, N.Y. radio station **WHLI**, replacing **Norman Sternberg**. Mr. Silvera has been at the station for 2½ years, coming from **Grumman Aerospace Corporation**.

● Prize-winning salesmen **Gerald Terdiman** and **John Didlock** of the **Scully/Metrotech Division of Dictaphone Company** were treated to holidays in Hawaii with their wives in recognition of achieving 110 percent of their sales quotas. Mr. Terdiman works out of Rye, N.Y. and Mr. Didlock is European Regional Manager.

● **Jesse D. Maxenchs** has joined **Belar Electronics Laboratory, Inc.** in the newly created position of marketing manager. Mr. Maxenchs will be responsible for product development, introduction, sales, and marketing in both the domestic and international fields. Prior to joining **Belar**, Mr. Maxenchs served in various marketing capacities with **Acrodyne Industries**, **American Electronic Labs**, and **Triangle Publications**.

● Nashville, Tennessee will be served by a new manufacturers' rep organization, **Sphere Audio Sales**, formed by **Wally Wilson**. The new company represents **Sphere Electronics** of California and **dbx** noise reduction systems. Mr. Wilson was formerly with **Electrodyne** and **Cetec**. The address of the new company is 478 Devens Drive, Brentwood, Tennessee 37027.

● The appointment of **Scotty Wallace** as central regional sales manager for **Switchcraft, Inc.** of Chicago, has been announced. Mr. Wallace will be responsible for coordinating sales and marketing programs of the firm's industrial product lines in the sixteen central states. Mr. Wallace was formerly sales manager of **TAB Books** and had previously been active in the publishing field with **Harcourt Brace Janovich** and **Howard W. Sams Co.**

● **Sound Measurements**, a new firm established by **Howard A. Roberson** in Pittsfield, Mass., will provide audio and acoustical evaluation of equipment and facilities for manufacturers, studios, and dealers. Tests for which the new facility is set up include swept frequency response, harmonic and intermodulation distortion, recorder flutter, one-third octave noise response, and room reverberation characteristics. Mr. Roberson, who will supervise the tests, is a registered professional engineer. The address of the new firm is 34 Easton Avenue.

● A patent for an electronic method of speeding up and slowing down recorded speech on ordinary audio cassettes has been granted to **Murray M. Schiffman**. The method, called **Variable Speech Control (VSC)** was developed by **Dr. Sanford D. Greenberg**, Mr. Schiffman, and **Cambridge Research and Development Group of Westport, Connecticut**. The process uses miniaturized circuits smaller than a cigarette lighter to alter the rate of speech for special applications, such as learning situations. It can be added to an ordinary cassette tape recorder at a cost of about \$50. Two manufacturers, **Sony** and **Matsushita (Panasonic)** have been licensed to produce the units.

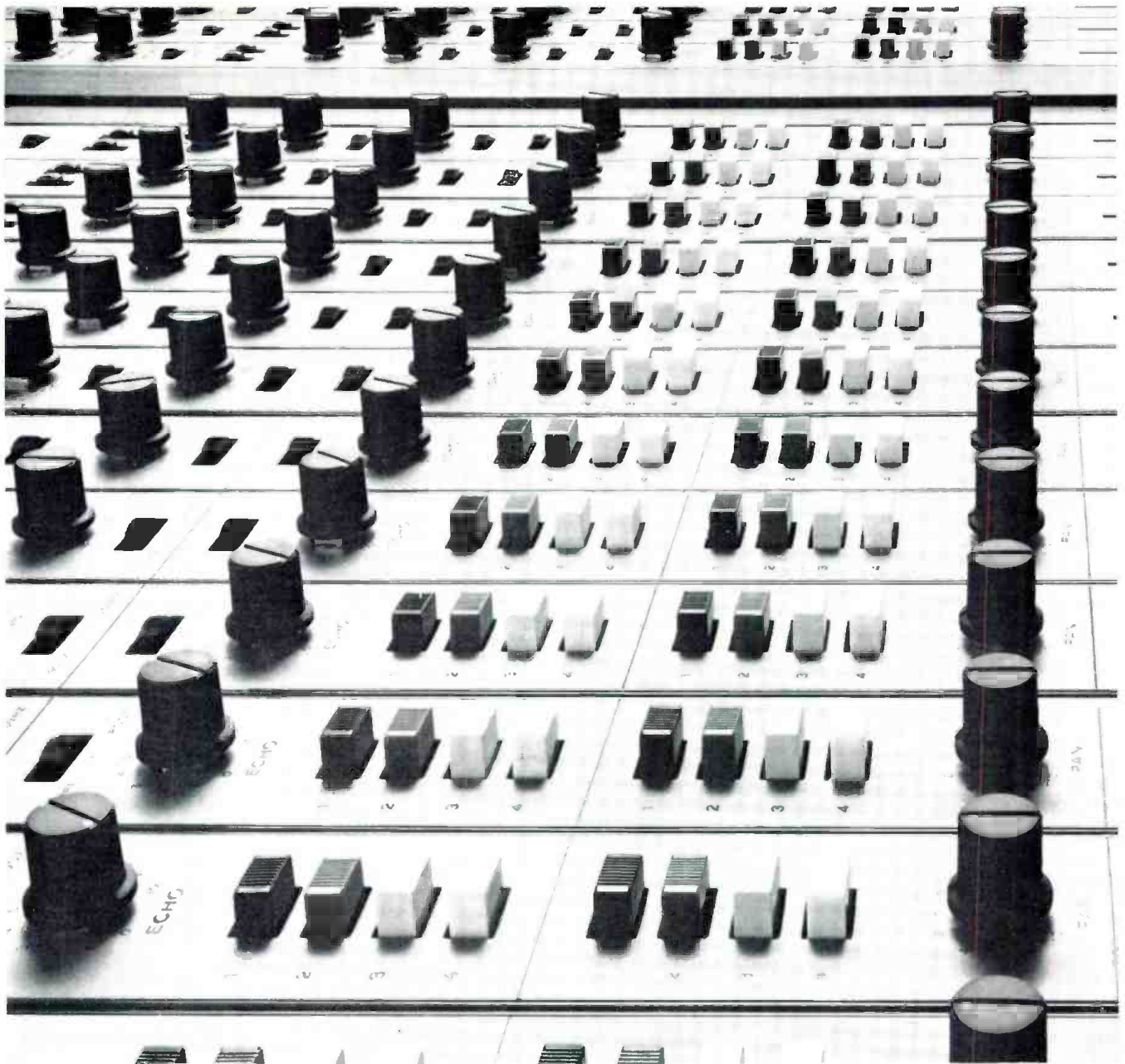

## The Model 10 Mixing Console

### When you've got more talent than money

Any mixing console is simply a creative tool. Getting the most out of it calls for imaginative insight into music and skill in the practical application of sound.

If you've got the talent but you don't have the money,



you're exactly who we built this board for. The basic 8-in, 4-out board starts at just \$1890. From there you can go to 24-in, with options and accessories enough to fill a studio.

The TASCAM Model 10. It gets your inside outside.

 **TASCAM CORPORATION**

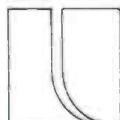

5440 McConnell Avenue  
Los Angeles, Calif. 90066

Circle 11 on Reader Service Card

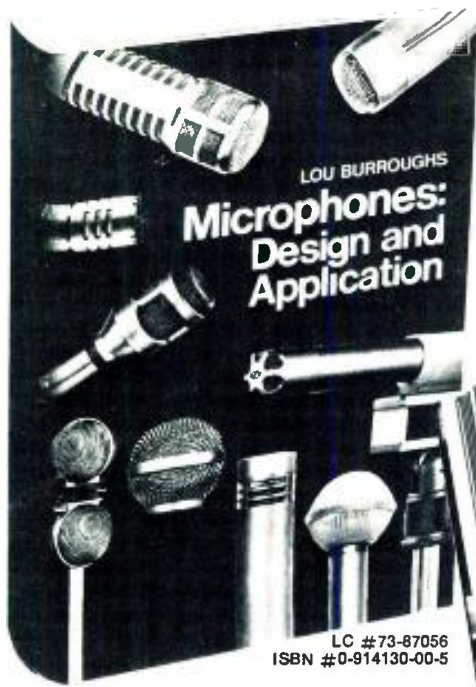

# If you work with microphones, you need this book!

## The most important microphone book ever published.

**COVERS EVERY SIGNIFICANT ASPECT OF THEORY AND USE FROM A TO Z!**

At last, the whole field of microphone design and application has been prepared and explained in one concise, fact-filled volume by one of audio's outstanding experts. This book is complete, up-to-the minute and so full of useful information, we think you'll use it every time you face a new or unusual microphone problem.

### Perfect for Reference or Trouble-shooting

The twenty-six fact-packed chapters in this indispensable volume cover the whole field of microphones from theory, physical limitations, electro-acoustic limitations, maintenance and evaluation to applications, accessories and associated equipment. Each section is crammed with experience-tested detailed information. Whatever your audio specialty — you need this book!

Along with down-to-earth advice on trouble-free microphone applications, author Lou Burroughs passes on dozens of invaluable secrets learned through his many years of experience.

He solves the practical problems you meet in day-to-day situations. For example:

- \* When would you choose a cardioid, omni-directional , or bi-directional mic?
- \* How are omni-directional mics used for orchestral pickup?
- \* How does dirt in the microphone rob you of response?
- \* How do you space your microphones to bring out the best in each performer?

This text is highly recommended as a teaching tool and reference for all those in the audio industry. *Price: \$20.00*

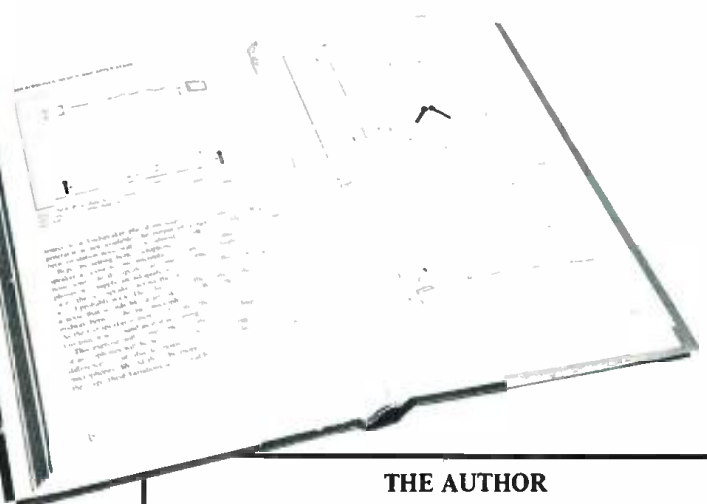

### THE AUTHOR

Holder of twenty-three patents on electro-acoustic products, Lou Burroughs has been responsible for extensive contributions in the development of the microphone. During World War II, he developed the first noise cancelling (differential) microphone, known as the model T-45. Used by the Army Signal Corps, this achievement was cited by the Secretary of War. Burroughs was the creator of *acoustalloy*, a non-metallic sheet from which dynamic diaphragms are molded. This material made it possible to produce the first wide-range uniform-response dynamic microphone. Burroughs participated in the design and development of a number of the microphones which have made modern broadcasting possible — the first one-inch diameter wide-range dynamic for tv use; the first lavalier; the first cardiline microphone (which ultimately won a Motion Picture Academy award) and the first variable-D dynamic cardioid microphone. He also developed the first wind screens to use polyester foam. Burroughs was one of the two original founders of Electro-Voice, Inc. He is a charter member of the Society of Broadcast Engineers and a Fellow member of the Audio Engineering Society.

### ORDER FORM

Sagamore Publishing Co., Inc.  
980 Old Country Road, Plainview, N.Y. 11803

Please send [ ] copies of MICROPHONES: DESIGN AND APPLICATION at \$20.00 each.

Name \_\_\_\_\_

Address \_\_\_\_\_

City \_\_\_\_\_ State \_\_\_\_\_ Zip \_\_\_\_\_

Total amount \$ \_\_\_\_\_

N.Y.S. Residents add 7% Sales Tax \_\_\_\_\_

Enclosed is check for \$ \_\_\_\_\_

Foreign Orders add \$1 postage and handling