

dlb

THE SOUND ENGINEERING MAGAZINE

FEBRUARY 1968 60¢

Microphones:

Specifications,
Polar Patterns,
European Condensers

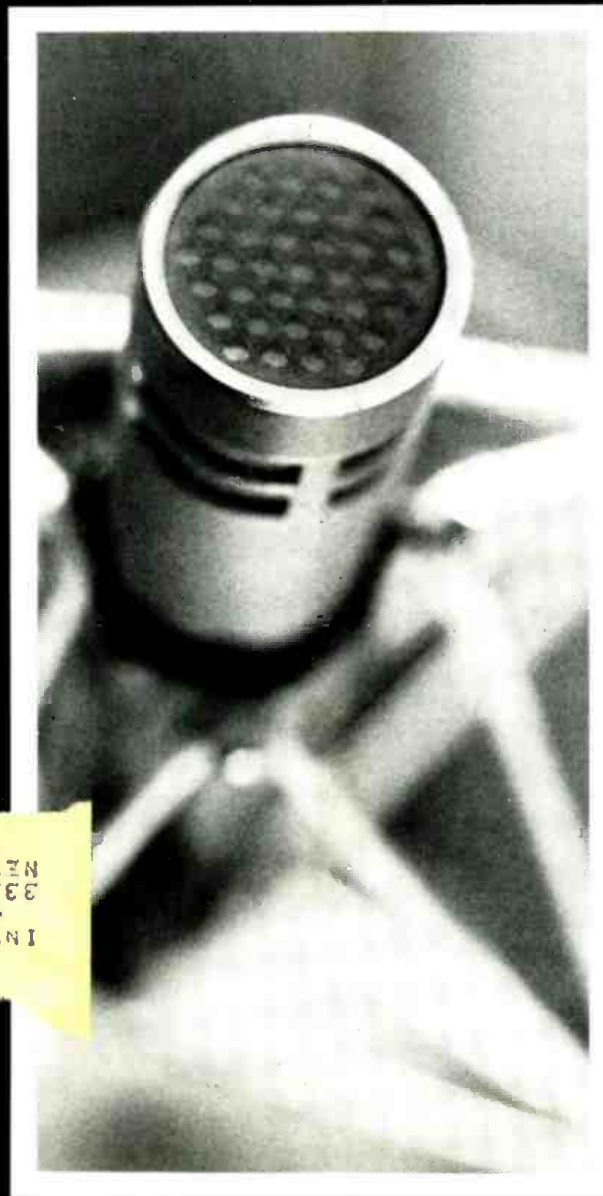

INTERNATIONAL
-ELECTROACOUSTICS INC
333 6TH AVE
NEW YORK N Y 10014

If you think Gotham Audio sells only one product



You're too close to the mike

We're famous as the sole U.S distributor of the world's finest microphone.

Maybe too famous.

Sometimes our unwary friends are so dazzled by Gotham's association with Neumann, that they overlook our other products and services.

And then they're missing a good thing. More than 300 good things, in fact. Including tape recording equipment and disk recording lathes. Disk cutting systems & control room equipment.

We select these products from such outstanding European companies as EMT and Beyer and Studer. As well as Neumann, of course. And as always, the basis of our selection is this: does it contribute significantly to the technical excellence of American audio?

That's our standard. A rigorous one, because we have a reputation to protect. And to keep building. If you do, too, maybe we can help.

Circle 10 on Reader Service Card

www.americanradiohistory.com

Coming
Next
Month

● David L. Klepper has prepared an article on Architectural Acoustics. The subject being what it is, this segment will start with Room Acoustics. Several future articles will cover Sound System Design, Room Noise Conditions, and Sound Isolation.

We will have a transcript of a recent New York AES meeting at which four experts discussed studio equipment servicing.

Two new monthly columns bow in March. THEORY AND PRACTICE will unite these two seemingly ununitable areas. Written by Norman H. Crowhurst, this pedagogic series will be a valuable addition to your library.

Martin Dickstein, who has appeared in these pages before, begins a monthly column titled, SOUND WITH IMAGES. His series will delve into that area known as audio/visual.

Plus the next installment of George Alexandrovich's HANDBOOK, John McCulloch's THE FEEDBACK LOOP, Philip C. Erhorn's SOUND REINFORCEMENT, NEW PRODUCTS AND SERVICES, PEOPLE, PLACES, HAPPENINGS—and more.

Next month in *db* The Sound Engineering Magazine.

About
the
Cover

● A microphone belongs at the head of every kind of sound system. This ultra-closeup of the working end of a broadcast mic might be called a view through the open mouth of the performer.

db

THE SOUND ENGINEERING MAGAZINE
February 1968 • Volume 2, Number 2

Table of Contents

FEATURE ARTICLES

- Microphone Level and Loading Specifications
Robert Schulein 12
- European Condenser Microphone Specs
Albert B. Grundy 18
- Acoustic Problems and Polar Patterns
John A. McCulloch 21

MONTHLY DEPARTMENTS

- Letters 2
- The Audio Engineer's Handbook
George Alexandrovich 4
- Sound Reinforcement
Philip C. Erhorn 8
- Editorial 11
- New Products and Services 26
- Classified 29
- People, Places, Happenings 31

EDITORIAL BOARD OF REVIEW

George Alexandrovich
Sherman Fairchild
Norman Anderson
Prof. Latif Jiji
Philip C. Erhorn
Daniel R. von Recklinghausen
Paul Weathers

db, the Sound Engineering Magazine is published monthly by Sagamore Publishing Co., Inc. Entire contents copyright © 1968 by Sagamore Publishing Co., Inc., 980 Old Country Road, Plainview, L. I., N.Y. 11803. Telephone: (516) 433-6530. Subscriptions are issued to qualified individuals and firms in professional audio. Application must be made on an official subscription form or on a company letterhead. Interested non-qualified readers may subscribe at \$5.00 per year (\$6.00 per year outside U.S. Possessions, Canada, and Mexico). Single copies are 60¢ each. Controlled circulation rates paid at N. Abington, Mass. 02351. Printed in U.S.A. at North Abington, Mass. Editorial, Publishing, and Sales Offices: 980 Old Country Road, Plainview, New York 11803. Postmaster: Form 3579 should be sent to above address.

Robert Bach
PUBLISHER

Larry Zide
EDITOR

Bob Laurie
ART DIRECTOR

Marilyn Gold
COPY EDITOR

Charles N. Wilson
ASSISTANT EDITOR

Richard L. Lerner
ASSISTANT EDITOR

A. F. Gordon
CIRCULATION MANAGER

David Pollens
ASST. CIRCULATION MGR.

SALES OFFICES

New York

980 Old Country Road
Plainview, N.Y. 11803
516-433-6530

Chicago

Gerald L. Taylor
333 N. Michigan Ave.
Chicago, Illinois 60601
203-332-7683

Denver

Roy McDonald Associates, Inc.
846 Lincoln Street
Denver, Colorado 80203
303-825-3325

Houston

Roy McDonald Associates, Inc.
3130 Southwest Freeway
Houston, Texas 77006
713-529-6711

Tulsa

Roy McDonald Associates, Inc.
2570 S. Harvard Ave.
Tulsa, Oklahoma 74114
918-742-9961

Dallas

Roy McDonald Associates, Inc.
Semmons Tower West
Suite 411
Dallas, Texas 75207
214-637-2444

San Francisco

Roy McDonald Associates, Inc.
625 Market Street
San Francisco, California 94105
415-397-5377

Los Angeles

Roy McDonald Associates, Inc.
1313 West 8th Street
Los Angeles, California 90017
213-483-1304

Portland

Roy McDonald Associates, Inc.
2035 S.W. 58th Avenue
Portland, Oregon 97221
503-292-8521

Letters

The Editor:

Your involvement in sound engineering and the profession cuts through the ad men's glowing terms and phrases, getting to what we want to know. Bench tests of home components are of some slight interest, but we need the very latest trends in operations, what the manufacturers are up to, all about Mod Monitors, FCC decisions (simplified), stereo technique, tape machines (and gimmicks), cutters, turntables, amplifiers, designs, useful ideas from other stations and studios; for if it's in use by a commercial establishment, I am curious.

The techniques of the larger studios are indeed useful. I may never have their facilities, but following their approach to a sound problem may often lead to a new idea for ourselves. I've been active in broadcasting and recording for over 25 years, and have always found *sound* an interesting and thrilling challenge. Every bit of the experience gained in one field has had some relation to the other — the two do overlap!

For instance, I have little patience with some of the miserable tv audio (mostly local) we are subjected to. There's no excuse for it. These plants have involved tremendous outlays of cash for good equipment, but they seem to feel that ownership of the equipment is all that is necessary to the end result. A station manager that I know will always buy something that someone somewhere else will recommend, never looking to see if it will fit his operation or not. ("If *they* say it's good, it is!") Then he can't understand why, after all that expense, he still doesn't get what he expected. (. . . and everyone else is afraid to tell him why.)

Good coverage in your magazine will go a long way in educating these people to make better and more considered judgments for themselves.

David L. Hubert
manager
KNDX
Yakima, Washington

The Editor:

Congratulations on *db* Magazine. I believe it to be the finest publication of its kind. Today the industry as a whole has turned its attention primarily to television, and radio has suffered a considerable defeat at the hands of the engineering editors.

I believe that your publication will be of great assistance to both the engineer desiring the best available material when making decisions regarding the repair of older equipment, or the engineer specifying and purchasing new equipment. Please keep up the good work.

I am particularly interested in the articles under the heading *A Handbook for the Audio Engineer*. This is informative and will make an excellent library item when kept on file.

Clyde E. Michael
chief engineer
Shoecraft Stations
KATO KIKO KINO
Miami, Arizona

Our interest is audio and we will cover video only from that point of view. Coverage of radio will end at the point of entry into the transmitter. There will be no rf in db. Ed.

The Editor:

Your December 1967 issue contained an article of particular interest to us at Acoustic Research. I refer to Dr. Harry Olson's contribution, *High-Quality Monitor Loudspeakers*.

This is written with such objectivity, and is so obviously based on a solid knowledge of loudspeakers, that it stands out in sharp contrast to the usual nonsense written on the subject. One might quibble on a detail here or there: for example, in a normal semi-reverberant environment, the off-axis response (or lack of it) affects what is heard even when the listener is on the loudspeaker axis. But the performance requirements specified by Dr. Olson are significant, inclusive, and reasonable; they all can be met by the best loudspeaker systems now available.

Perhaps just as important as its function in furnishing reliable guidelines for the selection of monitor loudspeakers is the fact that the article will help to make people realize that loudspeaker systems design now can be, and should be, more science than art.

Congratulations to *db*. If you continue to publish material of this caliber you deserve instant success.

Roy F. Allison
Vice President
Acoustic Research, Inc.
Cambridge, Mass.

Harvey's is selling stuff you may not know exists.

There's an information gap in the broadcast and recording fields today. Sometimes we find ourselves distributing an exciting new product that many professionals don't even know exists.

For example, did you know that there's a new boom headset with built-in microphone that's so light you can actually forget you're wearing it? It can pick up two different signals at once. It's interchangeable with any standard boom headset. And if you want one now, Harvey's is the only place you can get it.

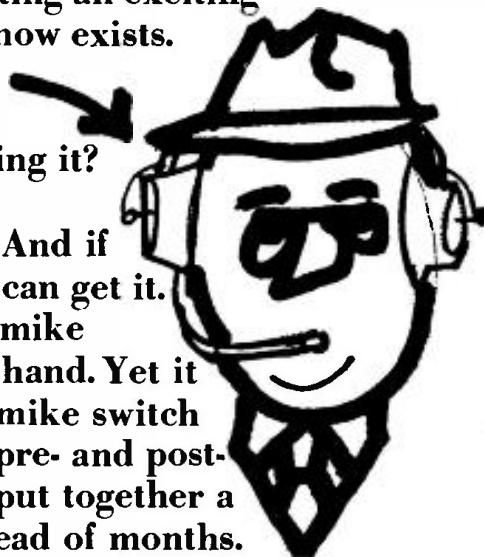

Also, there's now a complete console mike channel so small, you can hold it in your hand. Yet it includes a fader, program equalizer, line-mike switch with input pad, reverb-send channel and pre- and post-echo switch. With a few of them you can put together a complete console in a couple of days instead of months. It's revolutionary—yet, just about the only people who know of it are Harvey customers. Because just about the only place you can get it is Harvey's.



There's much more that's new. We have several new low-cost microphones that sound just as good as the most expensive mikes of a few years ago.

And so on. And so on.

Harvey's is in the habit of finding new equipment and distributing it before anyone else does. Often before anyone else knows about it, in fact. That's why almost every major sound studio and radio station already deals with Harvey's.

Help us close the information gap in the broadcast and recording fields. Call or write Harvey's regularly.

Open an account, if you want, and we'll start sending you our newsletter.

You don't necessarily have to buy anything.

We'll just feel a lot better if you, at least, know what exists.

Harvey Radio Co., Inc.

Professional A/V Division, 2 West 45th St., New York, N.Y. 10036 (212) JU 2-1500

The Editor:

I just finished a most absorbing time with the December issue of *db*. It was most informative and impressive. Your Editorial Board of Review bodes well for future issues.

In my estimation *db* falls into the category of first-hand reference material. May I therefore request, and hope to obtain, the November Volume 1, Number 1 issue? And get me on the subscription lists—but quick!

Philip Ross
WBNX
New York

We can supply a limited number of back issues, including Volume 1, Number 1 at a cost of sixty cents per copy, postpaid. Future issues, of course, will come to you at no cost. If you wish back issues, write to: Circulation Manager, db Magazine, 980 Old Country Road, Plainview, New York 11803. Include the appropriate remittance. Ed.

The Editor:

Your first issue of *db* was very interesting. The second issue was even better. I am anxious to see what you have in store for your readers in the succeeding installments of *db*.

I feel that the magazine is needed not only in the sound recording and sound reinforcement fields, but also in the audio-visual industry.

Robert A. Love, manager
Teaching Aids Center
Carnegie-Mellon University
Pittsburgh, Pennsylvania.

Many exciting things are in the wings. The audio-visual field will be served specifically beginning in March with a new monthly column by Martin Dickstein. Ed.

The Editor:

I was really delighted when I received your November copy of *db*. Our entire fraternity of sound people should be thankful to you for editing such a magazine. I'll be delighted to receive further copies of *db* as I have already found plenty of material necessary to the training I have to carry out with Lebanese technicians. In fact, even for me — an old fox in this field—there was new and useful information. Permit me to wish further prosperity and success to *db*.

G. H. Nieckau
chief engineer
FLEX Records and Magnetic Tape
Mfgs.
Byblos, Lebanon



● There are two systems for cutting stereo discs but both of them cut identical grooves. In one system, driving coils exert their forces upon the stylus armature at an angle of 45° with respect to the lacquer surface. This is the 45-45 system. In the lateral-vertical system, a combination of two forces from both coils produces a vector force directed at a 45° angle to the disc. This second system uses a matrixing network consisting of two transformers with double secondaries to convert left- and right-channel information into the sum of vectors for each of the channels (lateral and vertical). This information, when fed into the cutter and converted into groove excursions, becomes identical to grooves cut with the 45-45 system.

The practical significance of the difference between the systems is in the alignment procedure. While separation between channels in the 45-45 system is a fixed parameter depending on the construction of the cutter, in lateral-vertical systems this parameter is a function of the balance of the respective gain between the two amplifiers driving the cutter. Where the response of the 45-45 system is adjusted individually for each channel, the lateral-vertical system has only one adjustment for both channels. It is also impossible to unbalance two channels in terms of gain in lateral-vertical systems because gain has been determined and fixed by the matrixing network.

Since a lateral-vertical system cut depends on two vector forces produced simultaneously by the lateral and vertical coils, varying the amplitude of one of them will change the direction of the resultant force — changing the crosstalk between channels. Therefore, the individual gain of vertical and lateral channels must be adjusted so that the cutter will produce maximum separation between channels. Any variation in the response between the lateral and vertical channels is equivalent to a change of gain at certain frequencies. This will, of course, produce changes in the crosstalk between channels.

There is still another factor affecting alignment for maximum separation. This is the phase relationship between the lateral and vertical channels. Two

vector forces are additive only if they are applied at exactly the same time. If one of them is delayed or applied in advance, the resultant force will be directed in any other direction but a 45° angle.

Westrex, Neumann, and Holtzer cutters are all of the 45-45 system. Fairchild and Ortofon cutters use the lateral-vertical system.

To align a lateral-vertical system, adjust the gain of both channels at 1 kHz for maximum interchannel separation. Then adjust both channels for flat response and separation simultaneously by adjusting the controls for frequency response.

Over-all System Response

Once the frequency response of the system has been properly adjusted, the next step is a quality checkout of the entire system from tape machine to disc. At times, support equipment such as equalizers, limiters, amplifiers, and jack bays can be part of the audio chain between tape machine and cutting amplifier. Each may degrade a portion of the frequency response as little as 0.5 dB. But the additive effects can produce an unsatisfactory result, making this check very important.

If there are many transformers in the chain, look at the response in the 20-100 Hz and 10-15 kHz ranges. Correct any discrepancies with equalizers or specially-built networks. Use this additional equalization for all work.

Equalizers are commonly used in the recording chain to make the sound of records louder (depending on the program material). This is achieved by boosting the lower part of the spectrum and the region between 2 and 4 kHz. Most of the 45 rpm popular discs are doctored to make them sound boomier, louder, and fuzzier (to our regret), thus increasing frequency imbalance. Nevertheless, no matter what we like to hear, we should be able to record the levels and equalization that producers desire. Therefore, the studio must be equipped to do all this.

A limiter in the final chain is vital since it protects the groove from overmodulation. One instant of overmodulation and the master can be discarded.

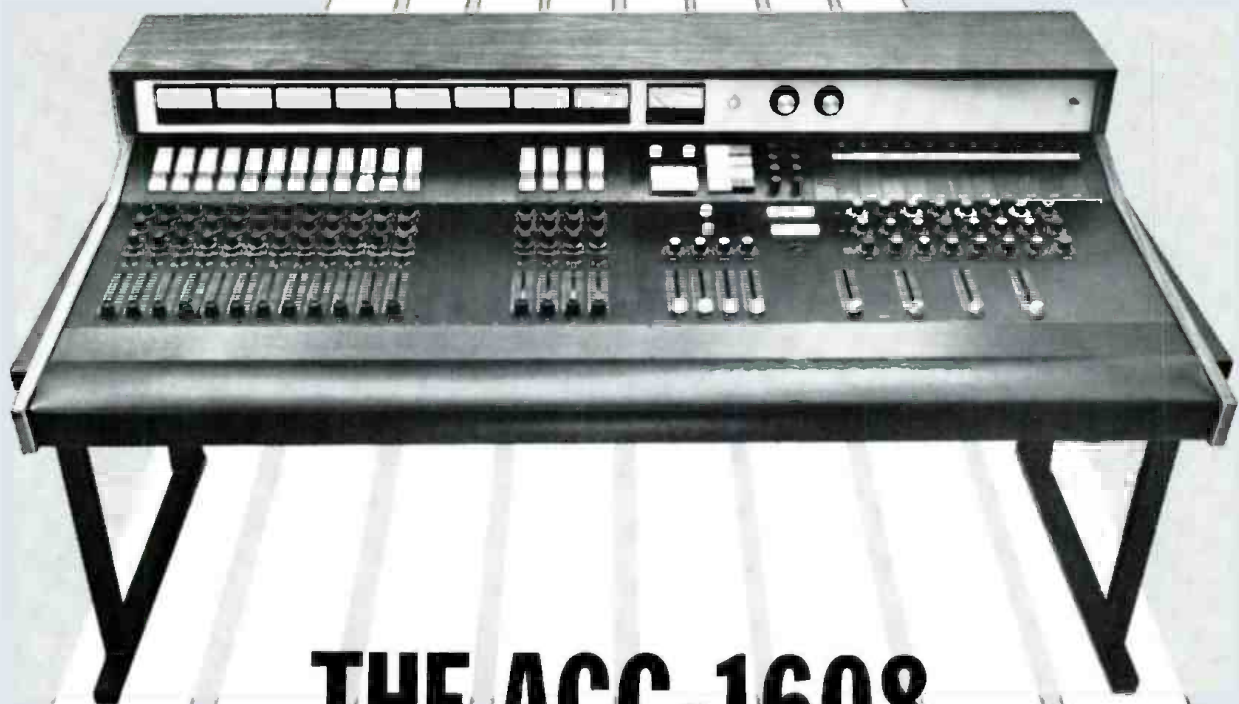

THE ACC-1608 "ON THE RIGHT TRACK"

DO AWAY WITH "TEMPORARY, HALF-FUNCTIONAL" SYSTEMS... THIS 8-TRACK AUDIO CONTROL CONSOLE DOES THE WHOLE JOB!

Up till now you 8-track people have had to make do with baling wire and chewing gum imitations of professional audio control console equipment. *No longer.* Electrodyne has specifically designed the ACC-1608 for your use. The same Electrodyne engineering and quality has been used in the ACC-1608 along with that *little bit more* that continually creeps into our products. For starters we designed the ACC-1608 to completely handle your 8-track recording. There are 16 microphone or line inputs, expandable to 20.

Complete 6 position equalization with echo send and cue on each channel is provided along with independent outputs for 8 channel, 2 channel and monaural. There are 2 stereo pan pots, illuminated pushbutton switches and complete monitor switching and level controls. Wrapping things up are the optional features. You name it, and you can have it! Sure, for a price you say... Try us on price, you'll find *baling wire and chewing gum* are much higher. Let the ACC-1608 get you *on the right track*, all eight of them.

Write or phone for complete literature on the ACC-1608 as well as the complete Electrodyne console and audio components line. Quotations on 12, 16 and 24 track consoles available on request.



ELECTRODYNE

10747 Chandler Blvd., North Hollywood, Calif. 91601
Telephone: area code 213/766-5602 or 213/877-3141
Cable Address: "ELECTRODYNE" North Hollywood, Calif.

Build Your Own Multi-Channel Custom Control Audio Console in Less Than One Day



with FAIRCHILD INTEGRATED CONTROL MODULES!

Now at last your audio control problems are solved with FAIRCHILD INTEGRATED CONTROL MODULES. Not only can you have the most complete compact single channel audio control system at a low cost but you can now assemble individual FICM's into one custom audio control console in literally a few hours. In addition the power handling capability of each individual FICM permits it to be used as a console output channel as well as a mike input channel.

Only the advanced design FAIRCHILD INTEGRATED CONTROL MODULE comes with integrated compressor in addition to program equalizer and unique metering circuit. And each FICM is a completely shielded plug-in unit.

Complete mounting shells and accessories are also available and the front panel is available in your choice from the many popular colors offered.

If you are expanding your audio control system or stepping up to more sophisticated audio control equipment consult FAIRCHILD before you take your next step.

FICM FEATURES:

- Input and output amplifiers
- Input level selector
- 8-channel delegation switch (with echo)

Write to FAIRCHILD—the pacemaker in professional audio products—for complete details.

FAIRCHILD

RECORDING EQUIPMENT CORPORATION
10-40 45th Ave., Long Island City 1, N. Y.

AUDIO ENGINEER'S HANDBOOK *continued*

A fast-acting limiter allows the application of higher average levels on the disc. It will trigger on every excessively high peak, however, reducing the level of the entire program material. So, although a limiter can help considerably, it is not the most effective way to achieve louder records with peak protection.

There are several volume-control devices on the market—the Gates *Top Level*, Fairchild *CONAX*, and the similar acting CBS Labs' *Recording Volumax*. Using the *CONAX* as an example, you can reduce high-level peaks by as much as 10-14 dB without apparent change in sound. It works as a clipper for troublesome peaks which would normally trigger a limiter. Its operation is based on the principle that instantaneous clipping of high-frequency peaks is not detectable by the ear, providing odd harmonics of this peak are filtered out after clipping.

Disc recording preemphasis is just in the range of frequencies controlled by the *CONAX*. This permits the

cutting of higher levels with less power required from the amplifier. At 10 kHz the third harmonic is 30 kHz—too high to be heard. But at 5 kHz the third harmonic is 15 kHz. This is about the lowest frequency at which sufficient *CONAX* action is present to produce any measurable harmonic at 15 kHz. Since it works with a precisely determined threshold, level fed into the *CONAX* has to be equally precise (a 4 dBm VU indication). Correct processing of the signal is dependent on this.

Such a control system should be used after the program equalizer—but before the limiter. This will prevent unnecessary triggering of the limiter on troublesome peaks.

When you make your test cuts (as described last month), record at the lower levels without limiter or *CONAX* action. If this gives you the sound you want, do not apply further equalization. Set the *CONAX* to position 3 (follow the manufacturers' literature on the other systems) and adjust the limiter to not more than 3-5 dB limiting on the highest passages. Then advance the level of the cut to the point where the following restrictions will force you to stop:

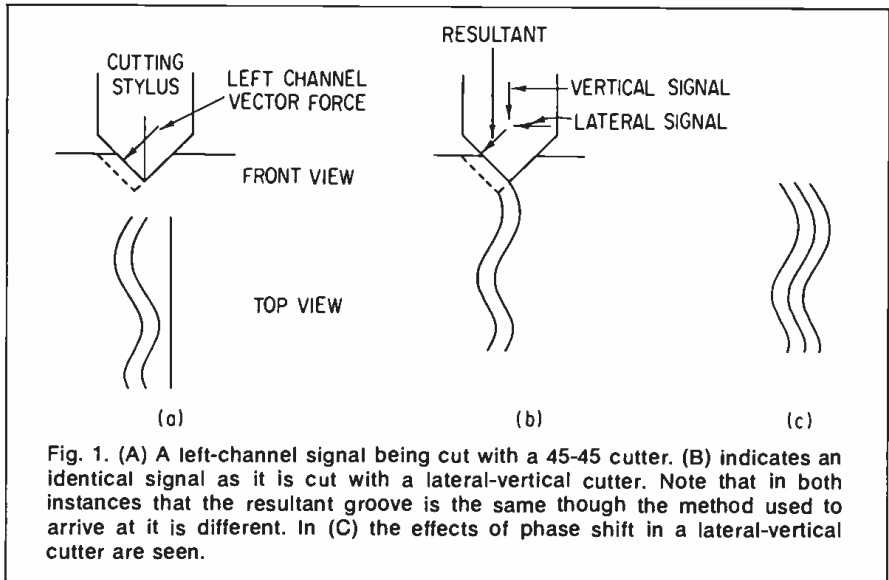

Fig. 1. (A) A left-channel signal being cut with a 45-45 cutter. (B) indicates an identical signal as it is cut with a lateral-vertical cutter. Note that in both instances that the resultant groove is the same though the method used to arrive at it is different. In (C) the effects of phase shift in a lateral-vertical cutter are seen.

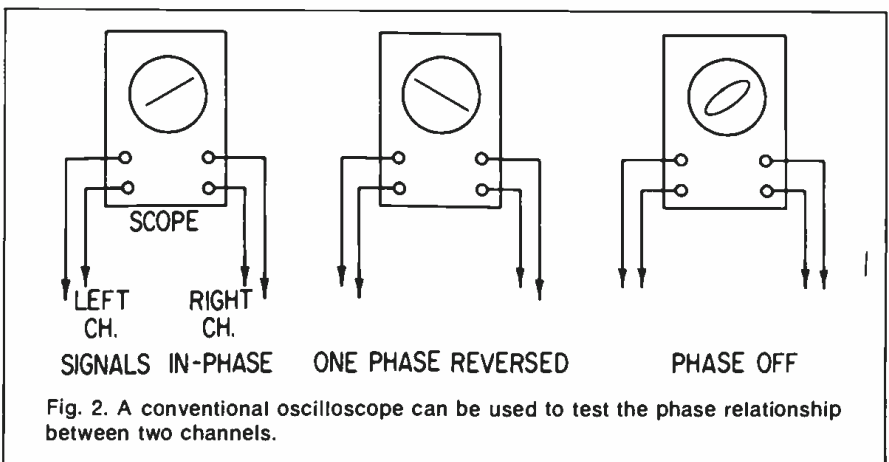
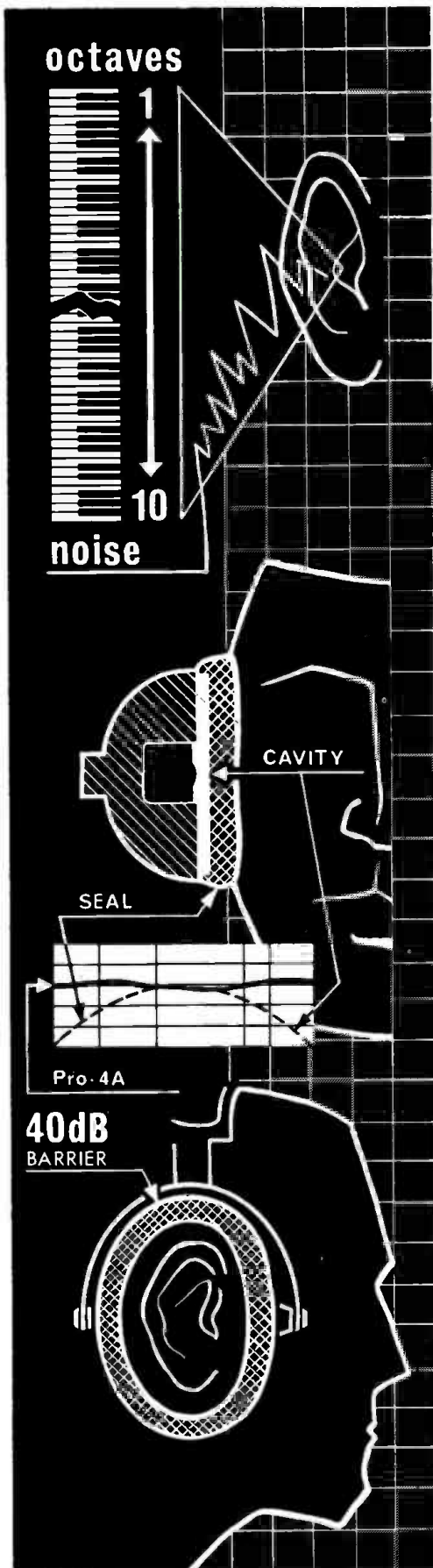

Fig. 2. A conventional oscilloscope can be used to test the phase relationship between two channels.



Pro.4A
\$50

the sound of **KOSS** **VIVID**

IMPROVEMENTS ON NATURE?

The premise that you cannot improve on nature has long since been discarded in the modern art of electro-acoustics. In everyday existence, the ear is subjected to ambient noise and the inherent crosstalk of the open environment. Here is the way Koss, through good design, improves on nature.

IMMEDIATE

CROSS TALK BANISHED

Koss confines all right and left sound to the respective ears to banish cross-talk with nearly perfect seal by comfortable, *liquid-filled* cushions. These cushions don't leak bass energy like ordinary headphones, so you get smooth, full low-end response. Koss top design makes the cavity between the driver and the inner-ear mechanism very small. This eliminates dull high-end caused by the shunt-capacitance of large cavities found in usual headphones. With Koss you get complete isolation and keep flat response.

COMPELLING

THE "TOTALITY" EFFECT

So nearly perfect are the liquid-filled cushions that a 40 db barrier is effected against outside noise. With only 1 part noise to 10,000 part signal and nearly 100% isolation of right and left sound, you get a new vital experience that Koss calls the "Totality" Effect. This allows critical monitoring available through no other means, and you get best sound quality with real comfort, too.

Hear the Koss PRO-4A Headset at your dealer today — or write the factory.



KOSS

KOSS ELECTRONICS INC 2227 NORTH 31ST. STREET. MILWAUKEE, WIS. 53208

Koss-Impetus / 2 Via Berna / Lugano, Switzerland / Export Cable: STEREOFONE
Circle 16 on Reader Service Card

db February 1968 7

The Editor:

I have just received and reviewed the December issue of *db*. One word — GREAT!

While other magazines cover broadcasting in general, there has been a need for a long time for audio-only coverage.

Thanks.

*William R. Graham,
chief engineer
CHYM
Kitchener, Ontario*

The Editor:

Congratulations on another fine issue of *db*. I feel that your magazine is filling an important gap that exists in the technical journals. The articles by Vorišek and Torick (December) were particularly interesting and provided the incentive for several changes in equipment and technique. I am looking forward to the next issue of *db* eagerly. Is it necessary to send a subscription application every month?

*B. Birnbach
Birnbach Recording Labs
New York, N.Y.*

*The subscription card bound into this issue need only be submitted once. You may now be getting *db* without having returned a card, but you must submit one if you wish to continue receiving copies. Once we receive your card, your subscription is confirmed.*

The Editor:

May I offer a correction to a statement made by the author of *Disc Mastering* pertaining to cutter head feedback. (This was in the November issue.) It is my understanding that the feedback system used by both Westrex and Neumann is not, as stated, amplitude sensitive. It is actually velocity sensitive, providing maximum feedback for high-level, high-frequency program material.

I believe that the Fairchild stereo cutter was the only generally available system using amplitude sensitive feedback. This type of feedback provides maximum correction with high-level, low-frequency program material.

May I compliment you on an excellent issue; keep up the good work.

*Charles Nairn,
operations manager
WDET
Wayne State University
Detroit, Mich.*

AUDIO ENGINEER'S
HANDBOOK *continued*

- ◆ Groove excursions too wide for the desired playing time for the side of the disc.
- ◆ Current checks of the cutter amplifier indicate a dangerous amount of power fed to the cutter.
- ◆ Level is higher than normally produced by the same studio, causing the record to be incompatible with standard production.

Compatible Stereo/Mono Discs

Since stereo/mono compatible records are supposedly today's rule, it may be a good idea to control the phase relationships at low frequencies between the channels. If the information stored on tape is badly out of phase it may pay to attempt reversal of the phase of one channel. Tapes recorded by amateurs may be made out of phase; cutting from these tape is painfully hard.

If phase reversal does not help, it may be necessary to limit the vertical component of the two-channel mix as it appears in the recording of the groove. This should be done only if the vertical excursions of the groove exceed the lateral excursions in amplitude. This precaution will produce a satisfactory cut even if played on monophonic equipment. It will not in any way adversely affect quality when the record is played with a stereo cartridge. When the groove is modulated with purely vertical or purely lateral signal, both channels will receive an equal share of the signal. In stereo reproduction this difference in phase will not be detected—while in mono reproduction vertical modulation will not be reproduced at all, creating a frequency-response droop.

If your studio work requires increased screening of the phase relationships on tape, it is worth your while to install a 'scope to monitor the output of the two channels. With the vertical input to the 'scope connected across one channel and the lateral (horizontal) input connected across the second, the 'scope will display the phase relationship of the two sound sources.

If the resultant 'scope display is in the form of a line inclined to the right at an angle of 45°, the signals are in perfect phase. If the line is inclined 45° to the left, phase is out by 180°. If the display is circular or elliptical, the channel phase relationships are somewhere between the 0° and 180° angle. Under such conditions of source defect, phase reversal of one channel will not help. Nor will anything else.

In the next two months we will deal with cutter care and cutting techniques and problems, plus some operational shortcuts.

Sound Re- inforce- ment

PHILIP C. ERHORN

*We are proud to add another valuable monthly column to our growing lineup. The subject — a practical approach to sound reinforcement. The author — Philip C. Erhorn, a member of *db*'s Editorial Board of Review and industry consultant on systems design and specification.*

● It is rather an odd circumstance that only two or three of the numerous companies manufacturing audio components for professional applications are also making a separate line for sound reinforcement use. To me this points up a couple of obvious conclusions. First, that the sound reinforcement market is being neglected by those people who can give it the most help. Second, that a woeful lack of adequate engineering know-how by many sound reinforcement (p.a.) contractors perpetuates the use of inexpensive, packaged components, or other systems, containing at best a shortcut approach to the desired result.

The initials *p.a.* have come to have such a poor reputation, immediately conjuring up mental images of feedback, limited quality, garbling echoes, and even hum, that we now label this neglected field *Sound Reinforcement* in an attempt to give it an aura of respectability. It is incredible that poor

CHECK THESE *ADVANCED FEATURES!*

ON THE GREAT **NEW** **Scully 280**

NEW "ADD-ON" MODULAR DESIGN CONSOLE . . . accommodates one, two or four amplifiers. Handsome cast metal covers on operations panel and head assembly give the 280 an entirely new look.

NEW BRAKING SYSTEM WITH EXCLUSIVE MOTION SENSING! Available previously only on the Scully one-inch tape transport, this unique system permits tape handling in any operation sequence without breaking worries. Optional on the Model 280.

NEW AUTOMATIC TAPE LIFTERS! This is an added bonus with the new motion sensing braking system. The automatic tape lifter keeps the tape off heads until tape transport has come to full stop.

SCULLY'S NEW SYNC/MASTER! Remote control your sync-sessions with Scully's exclusive Sync/Master control panel. Ask your Scully distributor about this new optional accessory for our 8-track units.

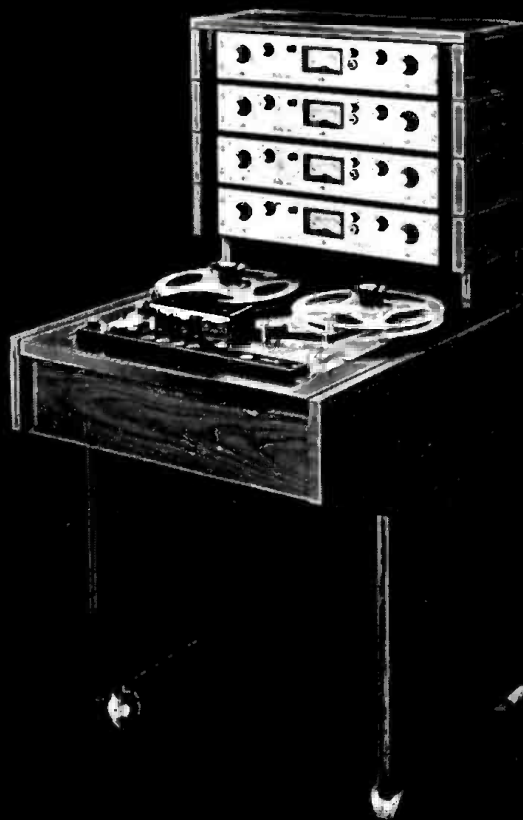

Scully engineering pioneered the plug-in head assemblies, plug-in amplifier cards, plug-in relays and solid-state electronics.

Now, once again, Scully sets the pace in great new features for the all-new 1968 model 280!

 **Scully**

RECORDING INSTRUMENTS COMPANY
A Division of DICTAPHONE CORPORATION

480 Bunnell Street
Bridgeport, Conn. 06607
(203) 335-5146

Makers of the renowned Scully lathe, since 1919
Symbol of Precision in the Recording Industry.

sound systems are allowed to exist, much less be perpetuated, in this day of impeccable amplifier specs, highly refined microphones and loudspeakers, and versatile equalizers, filters, compressors and other accessories.

To point up what can happen upon occasion, let me discuss a situation into which I was called as a consultant not too long ago. A large civic auditorium was under fire from numerous artists using its sound system. Distortion occurred at any level above a normal speaking voice level and feedback was rampant.

When I arrived on the scene, an attempt to alleviate feedback problems had already been made by replacing the inevitable center hanging cluster of multicellular horns and appended bass-boom boxes by some fifteen high-quality studio monitor speaker enclosures, grouped in three clusters over the stage proscenium. We later installed additional groups of columnar speakers to give better coverage to those seats on the flat floor immediately in front, and to both sides, of the stage. The proscenium speakers gave good coverage to the banked seat areas and preserved an illusion of a point source. Intelligibility was excellent. Any attempt to impose a multi-speaker, tape-delay, phase-shifting low-level system on the particular environment would have been virtually impossible.

Although some professional dynamic cardioid mics were being used, many of the mics were typical p.a. quality bi-directional ribbons. These were naturally raising havoc from a feedback standpoint. They were replaced with more dynamic cardioids, all of which were mounted on short stands along the footlights. Because hanging mics were not permitted in the case of several Broadway productions, the stars were equipped with r.f. transmitting microphones so that they could rove around at will onstage. (It was interesting to find that substituting dynamic "line" mics for the regular cardioids, increased feedback problems. Reflections from stage sets were aggravated through their increased directivity.) The controls for this system were in console format, located in a glassed-in control room, 400 feet from the stage, at the rear of the auditorium. Level monitoring was accomplished over a couple of small control room speakers. The system would easily go into feedback since it was impossible to determine what levels existed in the auditorium. The system was a 3-channel stereo, with some 15 mic inputs plus a few high-level inputs.

The console used a conventional

mixer approach and was very neatly and professionally executed from the viewpoint of appearance and wiring. However, it suffered from a large number of impossible engineering and operational problems. Let me enumerate some of them:

1. While modern vertical attenuators were used, they were spaced too far apart, arranged in three widely spaced groups which were related to the three program channels. In addition, the control panel was angled so steeply as to make forearm support impossible.

2. Because the console was flat on the floor, backed up to the control room front wall, the operator had to stand in order to see through the control room window to the stage, 400 feet away.

3. With a large stage and an enormous audience area, stereo sound reproduction was disappointing, and mono mixing was not possible except by patching, with no compensation for impedance matching of the lumped channels. The low-frequency response rolled off, as a result.

4. While considerable patching facilities were included, none of the jacks had normals, and it was necessary to patch up all sequences. Termination resistors were absent, and impedance matching was left to chance.

5. The wire pairs tying 100-watt power amplifiers to the stage speakers, were perhaps 600 feet long. The power amplifiers, as well as all other amplifiers and power supplies were located in racks in the control room. A measured power loss of about 50 per cent occurred in heating the wires between the power amplifiers and the stage speakers. (This was a so-called 70-volt system, with step-down transformers at the speakers).

6. Gain of the preamplifiers was far too high for their limited output capability, and distortion as high as 6 per cent at their outputs was measured with typical input levels. No boosters were being used to make up for mixer and pot setting losses, and the gain and output capability of the program amplifiers was too low. Distortion ran as high as 15 per cent at this point.

7. Over-all system gain was insufficient to drive the VU meters off their at-rest stop. This was why the meters had been bridged across the output of the power amplifiers!

8. Minimum-loss, unequal-impedance mixing networks were being used, with no attempt to match their approximate 200-ohm output to the 600-ohm inputs of the program amplifiers. Neither the networks nor the pots were

grounded, and leakage was severe.

9. The over-all system, through improper levels and lack of adequate ceiling capability, was constantly into distortion, with a rather high noise level, and the power amplifiers were operating at maximum gain, in order to overcome line losses.

10. Cueing and monitoring channels did incorporate a booster, which contributed so much uncontrollable gain, that these circuits were always distorted.

Now this array of problems (and more) came about through two basic errors, typical of the p.a. field. One was obviously improper system design. The other was even more insidious. The system had been designed by one of the contract bidders. Unfortunately, the contract was awarded to a different, low bidder. While the constructional quality of the successful bidder's components was on a par with those specified, their specs were not "or equal". Notably gain and output capability of the components up to line levels were not compatible with those normally used in professional systems.

We eventually resolved most of these mixer problems, primarily through re-design of the pre- and line amplifiers. This in turn required increased capabilities from the power supplies. By opening the control room windows and leaning out, it was possible to get some idea of the levels existing in the auditorium. As you can imagine, mixing while in such a position, was an impossibility. It was necessary to open the mic pots, and mix at best with the master gain controls, with one hand! Of course I recommended removing the console from the control room to a location in the center of the tiered seating area, so that the operator could see and hear properly. Ideally, the entire console needed redesigning, but the expense and work precluded that solution at the time.

This example shows that architects and their construction engineers are at the mercy of inadequate engineering and supervision normally supplied free by one of the bidders of the sound system. When this happens to a system as complex as that described, the results are very painful to all concerned. Because of the everyday pressure of public events using the sound system facilities, they cannot readily be torn out and replaced.

It will be the purpose of this series to examine a more professional approach to sound reinforcement. We will discuss typical problems, and examine suitable components and proper systems design.

Editorial

THE PROLIFERATION of multi-track tape equipment that goes far beyond the (nearly) commonplace four-track configuration is well under way. To meet this move to eight and sixteen tracks (and soon twenty-four), the sound engineer must solve many new technological problems.

Eight to twenty-four channels have an extremely valuable potential. Such equipment can provide a storage medium of considerable resource. It offers the opportunity to record segments of what ultimately will be a complete performance, expanding the artistic possibilities of the recording medium. This is particularly true in films where adding layers of sound to build a final track is economically and artistically important.

Commercial-music recording has already been transformed. It no longer mirrors a live performance; popular-music recording has used its new electronic flexibility to become an artistically creative medium in its own right.

With so many tracks on a tape, control is a major problem. Most professionals agree that these tracks should be relatively dry, with sonic control added during the dub-down. Since the console at this point tends to become minimal, there is some logic to a system whereby microphones are tied directly to the recorder.

One of the biggest questions is how to monitor the original session — what to do when the artistic director asks to hear an approximation of the final product. Certainly the answer is not to have twenty-four speakers in the control room. Aside from physical considerations, it is doubtful if any ear can discriminate under such conditions. Four or more speakers in the control room does not merit serious consideration either. Some engineers suggest that if a & r wants to monitor four (or more) channels, supply the full quantity of speakers, wired so each produces the same composite mono signal. This will answer the demand, although it will not produce the sound he really wants to hear.

More questions arise during mixing. What techniques will lead successfully back to one or two channels — and still satisfy the producer?

Some sound men are concerned with the issue of electronic fidelity to the composer's intention. This, we feel, is one problem that is *not* the recording engineer's problem. It lies firmly in the domain of the producer.

It is clear that a conflict of engineering and talent requirements is in the making. **db** asks its readers: how would you solve this dilemma? We look forward to a stimulating and provocative forum on the means of handling this enormous new technology.

L. Z.

Microphone Level and Loading Specifications

Robert Schulein

Typical A-Weighted Sound Levels		
AT A GIVEN DISTANCE FROM NOISE SOURCE	DECIBELS	ENVIRONMENTAL
	140	Pain Threshold
50 hp Siren (100')	130	
Jet Takeoff (200')	120	Discomfort Level
*Riveting Machine	110	Casting Shakeout Area
*Cut-off Saw, *Pneumatic Peen Hammer	100	Electric Furnace Area
*Textile Weaving Plant, Subway Train (20')	90	Boiler Room, Printing Press Plant
Pneumatic Drill (50')	80	Tabulating Room, Inside Sport Car (50 MPH)
Freight Train (100'), Vacuum Cleaner (10'), Speech (1')	70	
	60	Near Freeway (Auto Traffic) Large Store, Accounting Office
Large Transformer—200'	50	Private Business Office Light Traffic (100'), Average Residence
	40	Min Levels Residential Areas in Chicago at Night
Soft Whisper (5')	30	Studio (Speech)
	20	Studio for Sound Pictures
	10	
Threshold of Hearing: Youths—1000-4000 hz	0	
	(0.0002 microbar)	

*Operator's Position

The relationship of the threshold-of-hearing standard to typical environmental sound pressures, expressed in decibels. The conversion of s.p.1. from dB to *microbars* (the standard level specification for microphones) is detailed on page 18.

THE specification of microphone sensitivity or level, which would seem to be a simple specification, is often confusing to the microphone user. This results when incomplete specifications are given, or when comparisons are made between microphones which are specified by different methods. As an example, a nationally known electronics catalog describes three similarly priced unidirectional microphones in this manner:

Microphone No. 1: "Output -58 dB. Wired for Hi Z. Low Z available by moving one wire in connector."

Microphone No. 2: "Output level low-Imp., -57 dB; Hi-Imp., -55 dB."

Microphone No. 3: "Hi or 150 ohm impedance selected at cable connector; output level, -55 dB."

From these specifications, it is clear only that each microphone has both a high- and low-impedance output. A direct comparison of low- or high-impedance output level is not possible. If these microphones were being considered for a piece of equipment with a 50k ohm input impedance, it is not clear from this information which microphone will deliver the most voltage to the load for the same sound input. Even after the microphone level specification is made clear, the user is still faced with the question of how the level and frequency response is altered by the loading of the equipment. Hopefully, these microphone characteristics will not be changed, but this is not automatically true. It is the purpose of this article to explore these areas and present information to make it possible to answer such questions.

Three Commonly Used Microphone Level Specifications

All microphone level specifications describe the electrical output of a microphone for a specified sound pressure. The output may be measured in open circuit voltage ratios expressed in dB, or as a power ratio in dB. The sound pressure

must be stated to make the output numbers meaningful. Three things must be stated to completely specify level:

1. Output in voltage or power ratio.
2. The internal impedance of the microphone.
3. The sound pressure applied.

In the catalog example, the first specification is not clear because the low and high output impedances are not given, and it is not known whether the -58 dB refers to the high- or low-impedance connection. Also, the sound-pressure references are not given. The second specification is slightly more complete; however, the output impedances are not given as well as the sound-pressure references. In the third description, the high internal impedance value is missing, as well as the pressure references. Also, it is not clear whether the -55 dB specification is for a high- or low-impedance connection. Difficulty arises when any of this information is deleted.

The three level specifications that are in common use today are:

Open Circuit Voltage Specification. This form of specification describes the open circuit voltage obtainable from a microphone in decibels, based upon a reference voltage of one volt and sound pressure of one microbar. The formula is

$$\text{Level (Open Circuit) in dB} = 20 \log_{10} \frac{V_{\text{out}}}{V_{\text{ref}}}$$

Since V_{out} is much smaller than one volt, the level will be a negative number, typically between -55 dB and -60 dB. For this specification to be meaningful, the internal impedance of the microphone must also be stated, since the actual output voltage across the load is determined by the voltage divider action between the internal microphone impedance and the load impedance.

Maximum Power Output Specification. This form of specification gives the maximum power output in decibels available from the microphone for a given sound pressure and power reference. Such a specification can be calculated from the internal impedance and the open-circuit voltage of the microphone. This specification also indicates a microphone's ability to convert sound energy into electrical power.

The formula is

$$\text{Level (maximum power) in dB} = 10 \log_{10} \frac{(V_0)^2}{R_0} + 44 \text{ dB}$$

Robert Schulein is a Senior Engineer, Development Engineering Dept., Shure Brothers, Inc., Evanston, Illinois.

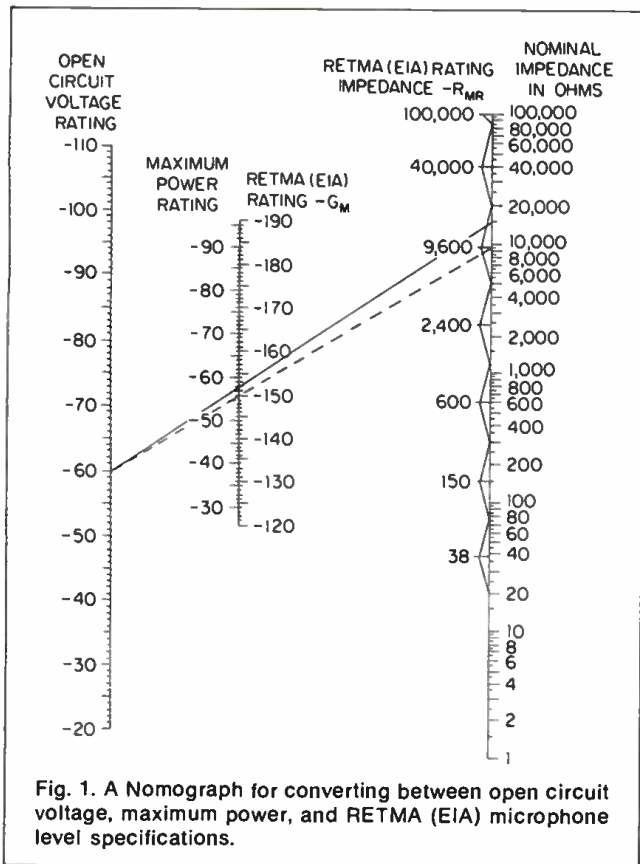

Fig. 1. A Nomogram for converting between open circuit voltage, maximum power, and RETMA (EIA) microphone level specifications.

The form of this specification is similar to the voltage specification, except that a power as opposed to a voltage reference is given with the pressure reference. A one-milliwatt power reference and a 10-microbar pressure reference are commonly used (as for the case above). In the above expression, V_o is the open circuit voltage that the microphone would produce for a one microbar sound pressure, and R_o is the internal impedance of the microphone. This form of microphone specification is quite meaningful because it takes into account both the voltage output and the internal impedance of the microphone.

RETMA (EIA) Output Specification. This output specification is essentially a maximum available power specification except that the reference sound pressure is 0.0002 microbars, and the internal impedance used in the equation depends upon the range in which the actual (nominal) internal impedance falls.

$$\text{Level (RETMA) in dB} = 10 \log_{10} \frac{(V_{out})^2}{R_{MR}} - 50 \text{ dB}$$

In the above expression, V_{out} is the open-circuit voltage that the microphone would produce for a one microbar sound pressure, the power reference is one milliwatt, and the RETMA impedance R_{MR} is given in the table.

Actual (Nominal) Internal Impedance	RETMA (EIA) Impedance R_{MR}
19 to 75 ohms	38 ohms
75 to 300 ohms	150 ohms
300 to 1200 ohms	600 ohms
1200 to 4800 ohms	2400 ohms
4800 to 20,000 ohms	9600 ohms
20,000 to 80,000 ohms	40,000 ohms
80,000 ohms or more	100,000 ohms

A nomogram is given in FIGURE 1 which facilitates the

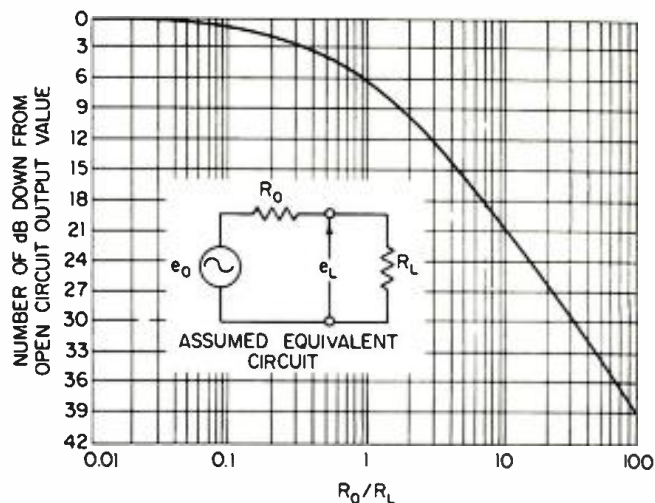

Fig. 2. Microphone level de-rating curve.

comparison of the level of various microphones on the basis of any of the three level specifications discussed. It shows that a microphone with a -60 dB open-circuit voltage specification and a 15,000 ohm internal impedance has a -58 dB maximum power rating and a -150 dB RETMA rating. An interesting observation that can be made from this nomogram is to pivot a straight edge about a specific maximum power specification and look at the variation between open-circuit voltage and internal impedance. Such a variation could be obtained with the use of a transformer between the microphone and load; i.e., as the open-circuit voltage increases, the output-impedance increases. To understand how this information may be used to match a microphone to a particular load, consider a microphone with a -55 dB re 1 mw/10 microbar maximum power-output specification, and a 150-ohm internal impedance which is to be connected to a 1500-ohm load. From FIGURE 1, the open circuit output voltage will be -78 dB re 1 volt/microbar. A microphone transformer with an impedance ratio of 150/1500 ohms will transform the output (and rotate the line) to 1500 ohms. The open-circuit voltage will then be -67 dB re 1 volt/microbar.

There is one aspect of the specification of level which has not as yet been discussed, and that deals with the selection of frequency at which the specification is made. If a microphone has a perfectly flat frequency response, the frequency at which the level specification is made is of no consequence; however, since most microphones do not have a perfectly flat frequency response, one might question the frequency at which such a measurement is made.

In an attempt to answer this question, numerous subjective experiments have been performed in the Shure laboratories with microphones having differences in response of as much as ± 10 dB over a 50 to 15 kHz band width. In such experiments, subjects were asked to adjust the level of a perfectly flat laboratory condenser microphone so that it sounded just as loud as a particular test microphone for voice and music sources. When the two microphones sounded equally loud, the level of the condenser microphone was said to be the *effective level* of the test microphone. The experiments were further refined by making similar comparisons with another laboratory condenser microphone whose response curve could be altered to produce peaks and roll-offs at any desired frequency. By making such comparisons, it was possible to determine the effect of a single peak or roll-off on the

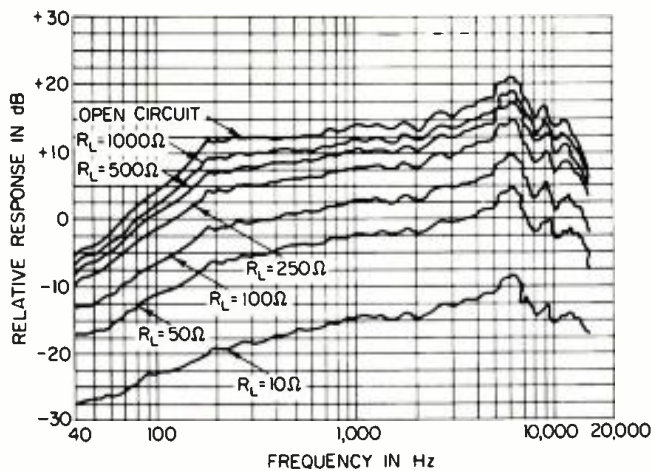

Fig. 3. The response versus resistive loading of a unidirectional dynamic microphone.

effective level of a microphone response curve.

As a result of these measurements, it was found, for example, that the effective level of a microphone whose response is flat except for a low frequency roll-off of 3 dB at 100 Hz was 2 dB below the flat portion of the curve. On the other hand, a gentle peak of 5 dB at 7 kHz from a flat response resulted in an effective level of about 1 dB above the flat portion of the curve. For the case of microphone response curves commonly encountered in practice, such deviations from the 1 kHz level tend to cancel each other and produce an effective level quite close to the 1 kHz level. Consequently, we feel that level measurement at 1 kHz accurately represents the effective level for practical situations.

Along with the previously described experiments, experiments were performed which dealt with the detection of total level variations among microphones with similar response curves. From the subjective tests made, it was found that most people cannot detect ± 1 dB differences in level among microphones when asked to switch between them while personally talking at the same time. Under more controlled conditions, such as one person talking and the other listening, ± 1 dB is just detectable. A ± 2 dB difference in level was, however, found to be quite detectable in the first instance. It should be pointed out that these experiments confirm earlier observations and "rules of thumb" which are often encountered in practice.

Microphone Loading Considerations

When a microphone is chosen for a particular application, its frequency response and output level are generally of prime concern. Preservation of the intended response and level are thus of equal concern when the microphone is connected to its intended load. In the process of connecting a microphone to an amplifier or tape recorder input, a shunting capacitance is placed across the microphone output terminals. This capacitance is due to the connectors, cables, and the amplifier used. A shunting resistance is also added as a result of cable resistance and the input impedance of the amplifier. Practically speaking, the capacitance is mainly that due to the cable, and the resistance is due to the input impedance of the amplifier. At audio frequencies, the inductance of cable and amplifier inputs is not significant and need not be considered. It is thus possible to consider a typical microphone loading situation as a parallel combination of resistance and capacitance. The effect of such loading upon the

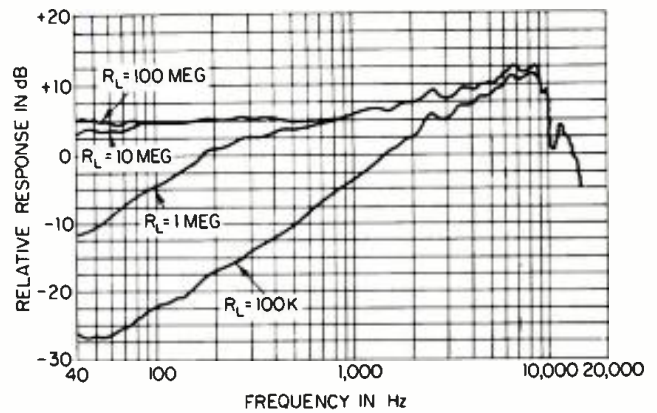

Fig. 4. The response versus resistive loading of an omnidirectional ceramic microphone.

response and level of a microphone is strongly dependent upon the microphone type and its internal impedance. The following list is given of various microphone types and the nature of their internal impedance:

Resistive Source Microphones

- Dynamic
- Ribbon
- Capacitor (after the impedance transformation preamp)
- Carbon
- Any microphone containing a preamplifier

Capacitive Source Microphones

- Ceramic
- Crystal
- Capacitor (before the impedance transformation preamp)

Inductive Source Microphones

- Controlled magnetic (variable reluctance)

Resistive Loading Effects

For microphones whose source impedance is primarily resistive, a resistance load generally has a minor effect upon frequency response, but a potentially major effect upon level as shown in FIGURE 2. In using this curve, one must know both the internal impedance of the microphone and the resistive component of the load impedance. By taking the ratio of these two values (R_0/R_L) the decrease in the open-circuit voltage value due to the connection of the load can be determined. As an example, consider a dynamic microphone with a 50k ohm internal impedance and a -55 dB re 1 volt/microbar open-circuit voltage specification connected to a 500k ohm load. In this case, $R_0/R_L = 0.1$. The loss is 1 dB and the level across the load is therefore -56 dB re 1 volt/1 microbar. If, however, this microphone was connected to a low-impedance load of 5k ohms ($R_0/R_L = 10$), the level as measured across the load would be -76 dB re 1 volt/1 microbar. As a good rule of thumb, it is desirable to use a microphone source impedance-load combination such that $R_L > 10 R_0$, preserving the open circuit output level of the microphone.

While the effect of resistive loading on the frequency response of resistive source microphones is generally small, there are exceptions, as shown in FIGURE 3. This figure shows a family of curves for various resistive loads across the output of a unidirectional low-impedance (250 ohms) dynamic microphone. The curves are quite parallel for load resistances greater than 250 ohms. For smaller valued loads, the

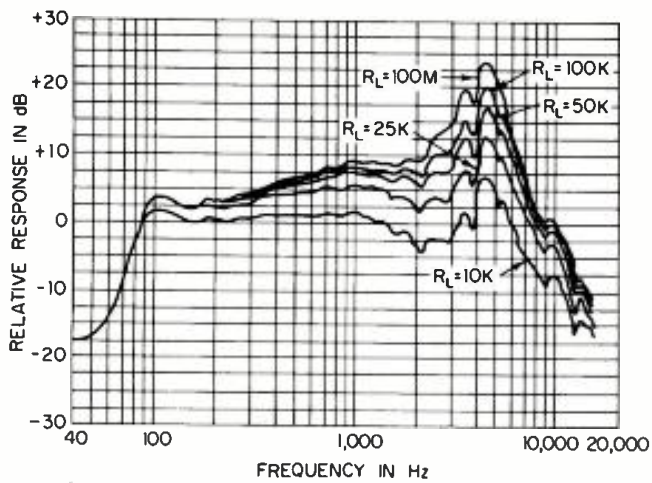

Fig. 5. The response versus resistive loading of a controlled-magnetic unidirectional microphone.

low-frequency response begins to roll off. This phenomenon is the result of a slight increase in internal impedance in the frequency range about diaphragm resonance of unidirectional dynamic microphones. In view of such phenomena, it is preferable not to load such microphones below rated internal impedance. Such an occurrence is not typical of omnidirectional dynamic microphones but is typical of bidirectional and unidirectional ribbon microphones where similar precautions should be taken. For the case of the capacitor microphone or a microphone with a preamplifier, there is no loading effect upon frequency response.

Resistive loading of capacitive source microphones primarily affects the frequency response as opposed to output level. A typical family of loading curves is shown in Figure 4 for an omnidirectional ceramic microphone. Due to the fact that the microphone source impedance is capacitive, a resistive load tends to roll off the low frequency response. The unloaded response will be 3 dB down at the frequency at which the internal capacitive reactance is equal to the load resistance. This sort of curve indicates why ceramic and crystal microphones have been associated with a *tinny* sound when connected to the majority of tape recorders and amplifiers whose input impedance is typically 500k ohms or less. The low-frequency response of such microphones could be greatly improved by loading them with 10 meg ohms or more.

The controlled-magnetic, or variable-reluctance microphone, as a consequence of its inductive internal impedance, exhibits still another form of loading when connected to a resistive load. FIGURE 5 demonstrates such loading for a microphone whose 1 kHz output impedance is 14k ohms (primarily inductive). Because of the inductive impedance, the internal impedance increases with frequency and consequently a resistive load results in a high frequency roll-off. The unloaded response curve will thus be 3 dB down at the frequency at which the microphone's internal inductive reactance is equal to the load resistance.

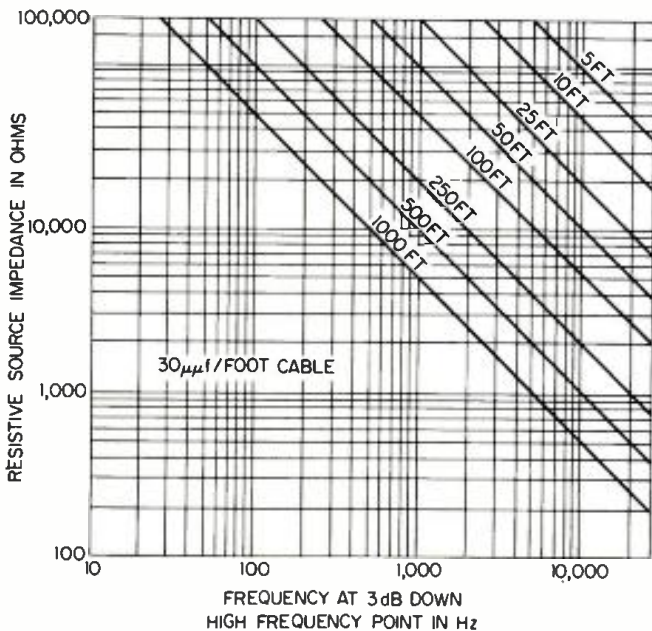

Fig. 6. The effects of capacitive loading of resistive sources with a cable of $30 \mu\text{f}/\text{foot}$ cable.

Capacitive Loading Effects

The primary source of capacitive loading of microphones is that of the microphone cable. Typical microphone cables range in capacitance from about $30 \mu\text{f}/\text{foot}$ to $100 \mu\text{f}/\text{foot}$, the higher values being for small diameter cables typically used for lavalier microphones. FIGURES 6, 7, and 8 describe the results of capacitive loading on resistive-source microphones. With a resistive source, a capacitive load tends to roll off the microphone's high-frequency response. The unloaded frequency-response curve will be rolled off by 3 dB at the frequency where the capacitive reactance of the cable is equal to the internal resistance. To use the graphs, it is necessary to know the approximate length and capacitance per foot of the microphone cable, as well as the internal resistance of the microphone. The curves then indicate the frequency at which the unloaded frequency-response curve will be 3 dB down. As an example, consider a high-impedance microphone whose source impedance is 40k ohms connected to an amplifier with 25 feet of $30 \mu\text{f}/\text{foot}$ cable. From FIGURE 6, it is noted that the cable will roll off the high-frequency response by 3 dB at 5 kHz. In comparison, consider a 250-ohm low-impedance microphone with 1000 feet of the same cable. For this combination, the same figure indicates a -3 dB alteration in frequency response at 20 kHz. This comparison serves to point out one of the desirable features of using low-impedance microphones where long cable runs are necessary.

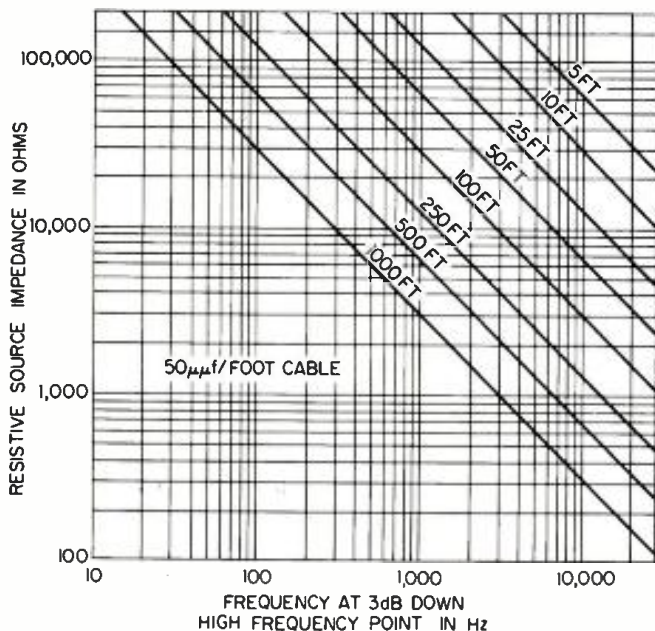

Fig. 7. As Figure 6, with a $50 \mu\text{f}/\text{foot}$ cable.

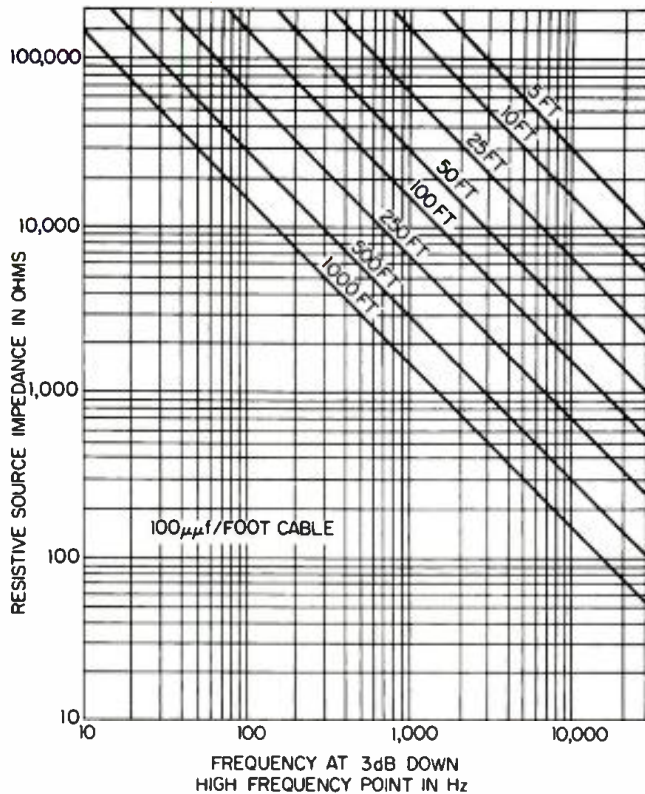

Fig. 8. As Figure 6, with a 100 μf /foot cable.

Capacitive loading of capacitive-source microphones is quite interesting in that there is no effect upon frequency response. Since a capacitive voltage divider is formed between the source and load, only level is affected. This effect is shown in FIGURE 9, where it is noted that the level is 6 dB down when loaded with a capacitance that is equal to its source capacitance.

Perhaps one of the most interesting capacitive loading effects is for the case of a microphone with an inductive internal impedance. Such loading is demonstrated in FIGURE 10 where two primary areas of loading are noted. The first is a rapid roll-off of high-frequency response due to the fact that the source impedance is increasing with frequency and the load impedance is decreasing with frequency. The second area is an increase in the unloaded output (for sufficiently high capacitance) due to a series resonance between the internal inductance and the load capacitance. The latter area of loading is occasionally introduced on purpose as a means of frequency-response adjustment.

In view of the previous discussion and with the proper level specifications, it is now possible to reconsider the original question of connecting microphones 1, 2 and 3 to a 50k ohm input impedance. The complete level specifications for each of the three microphones should have read:

- Microphone No. 1: "Output -58 dB re 1 volt/1 microbar for high impedance= 25k ohms.
Output -58 dB re 1 mw/10 microbar for low impedance= 150 ohm or -80.5 dB re 1 volt/1 microbar."

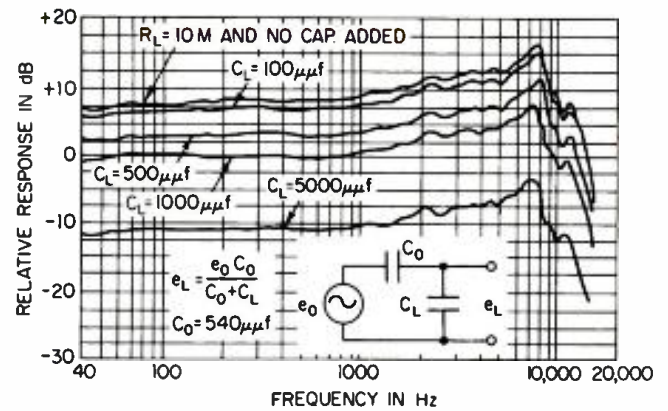

Fig. 9. The effects of capacitive loading on a capacitive source transducer.

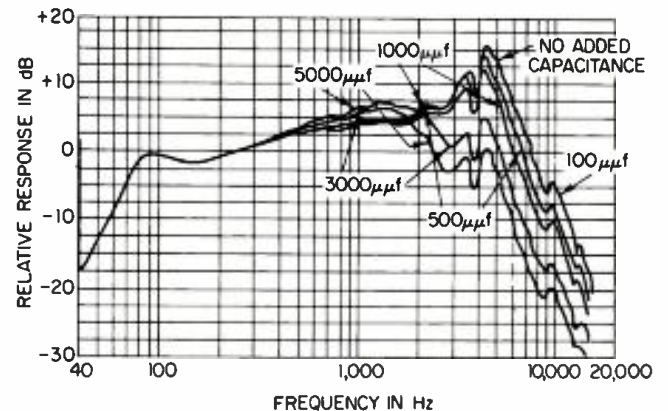

Fig. 10. The effects of capacitive loading on an inductive source transducer.

Microphone No. 2: "Output -55 dB re 1 volt/1 microbar for high impedance= 40k ohms, Output -57 dB re 1 mV/10 microbar for low impedance= 270 ohms or -77 dB re 1 V/1 microbar."

Microphone No. 3: "Output -55 dB re 1 V/1 microbar for high impedance= 40k ohms, Output -57 dB re 1 mw/10 microbars for low impedance= 150 ohms or -79.5 dB re 1 V/1 microbar."

In connecting these microphones to a 50k ohm input impedance, FIGURE 2 indicates the following voltage level specifications resulting across the load:

- Microphone No. 1: High impedance= -62 dB re 1 V/1 microbar
Microphone No. 2: High impedance= -61.5 dB re 1 V/1 microbar
Microphone No. 3: High impedance= -61.5 dB re 1 V/1 microbar

In view of these results and the previous discussion, the level variations among these three microphones loaded by 50 kil-ohms is negligible. This is an interesting conclusion since there appears to be a 3 dB level difference between microphones 1 and 3 in the level specifications given at the beginning of this article. As a further observation for the high-impedance connection, about 15 feet of 30 mmf/foot cable could be used with Microphones No. 2 and 3 with a 3 dB capacitive roll-off at 10 kHz and about 20 feet of the same cable with Microphone No. 1 for the same roll-off.

European Condenser Microphone Specs

Albert B. Grundy

European—notably German—specifications for condenser microphones have seemed inscrutable to many. This article defines and clarifies these specifications.

THE condenser microphone has always held a high position in any consideration of sound quality. The Western Electric 640 AA was used for broadcasting and recording in the 1940's but its single pattern, omnidirectional response limited its wide acceptance as a standard universal microphone.

In the early 1950's, the advent of microgroove recording techniques and the significant improvements in magnetic tape recording machines made possible the immediate acceptance of the multi-pattern condenser microphones manufactured by Neumann and Schoeps (introduced here in the U.S. by Telefunken) and those by AKG.

These microphones had confusing model numbers (U 47, CM 51, M 221, C 12, M 50, CM 61, etc.), unusual connectors, odd size fuses, strange impedances and other specifications in German that few people understood. But no one really cared because when the right adapters, etc., were made and the microphones plugged in, the results were noticeably better than most American types then in use.

The recent introduction of transistor condenser microphones has brought about considerable interest in the specifications of German condenser microphones; primarily so that these new transistor versions could be compared directly with the vacuum-tube types currently in use.

In general, there is fair agreement between companies as to which characteristics should be measured. These are:

*Mr. Grundy is affiliated with
International Electroacoustical, Inc.,
New York City.*



*Free field transmission factor or sensitivity at 1000 Hz.
Noise.*

Non-linear distortion factor.

There is great disparity among the methods and standards of measurement, especially on the units in which these measurements are reported. The significance of published data is often obscured when the standards of measurement are not specified and the units of measurement differ widely.

Measurements in Free Sound Fields in Anechoic Rooms. The free-field sound-pressure level in an anechoic room is usually established by measurement with a standard microphone of known calibration. Pressure is defined as force-per-unit-area and commonly stated in dynes-per-square-cm. Standard atmospheric pressure is one *bar* and this is equivalent to one million dynes per square cm. Therefore, one dyne per square cm. is identical to one *microbar*.

$$1 \text{ microbar} = 1 \text{ dyne/cm}^2$$

Sound-pressure level is also measured in decibels using the internationally accepted standard threshold of human hearing as the reference. This is 0.0002 dynes/cm² or microbar.

0.0002 microbar = 0 dB sound-pressure level
Using the formula:

$$dB_{spl} = 20 \log_{10} \frac{p}{P_0}$$

with $P_0 = 0.0002$ microbar we determine that one microbar is equal to 74 dB sound-pressure level.

$$1 \text{ microbar} = 74 \text{ dB}_{spl}$$

Ten microbar which is often the standard reference pressure here in the U.S. is therefore 94 dB_{spl}.

Measurements

Free Field Transmission Factor. This measurement is reported as either sensitivity or output level. In the U.S. the microphone is measured in volts *across a load* equal to the source impedance of the microphone. The results are specified in terms of power. The units are dBm, that is dB with one milliwatt zero reference. If the microphone has selectable impedances, the power-output level for each impedance is the same, assuming negligible transformer losses. If only one output level is stated, it can be assumed that it is the level at the impedance for which the microphone is connected when shipped. In Europe it is normal to measure the sensitivity in a sound field of *one microbar* instead of ten and report the results in *millivolts/microbar*. This is usually an *open circuit* measurement with a nominal source impedance of 200 ohms for professional microphones. To convert this to American standards a number of factors must be considered. European mixer preamplifiers have an input impedance of 1000-2000 ohms, a factor of at least 5 over the source impedance of the microphones. Some U.S. preamps, including a few of the new transistor types, have an internal impedance which is close to the nominal impedance stated in the input transformer strapping specifications. When these microphones are used with such preamplifiers, it may be necessary to strap the output transformer in the microphone itself for a source impedance of 50 ohms and to insert building-out resistors of approximately 60-75 ohms in the output lines. This provides the *microphone system* with a nominal source impedance of 150/250 ohms and it prevents the mixer preamp from loading the microphone with too low an impedance.

To convert from the European specification of *millivolts/microbar* open circuit with a 200-ohm source impedance to U.S. *dBm/10 microbar* loaded, the following steps are necessary:

Raise the voltage 20 dB to compensate for the increase from one to ten microbar sound-pressure level.

Reduce the voltage 6 dB because of the restrapping from 200 to 50 ohms.

Reduce the voltage another 6 dB because the specification states under load.

Reduce the voltage 2 dB because of the loss in the building-out resistors.

This results in a net gain of $20-6-6-2 = 6$ dB. For example, a microphone rated 2 mv/microbar would be 4 mv/10 microbar.

It should be mentioned that these changes for 50 ohms source impedance and the building-out network are now standard factory modifications for microphones delivered to the U.S. by most manufacturers.

Noise. Noise specifications are perhaps the most interesting today because of the expectation that they will differ for the new transistor types. In Europe, and particularly Germany, three different noise specifications are standard.

Fremdspannung: This is the unweighted, flat-response noise voltage measured over the frequency band 30 Hz to 20 kHz, with a 1000-ohm load and either an rms or peak-reading voltmeter. The meters that should be used are true peak and true or quasi-rms. A standard meter with average rectifier and sine-wave rms calibrated scale will not provide the same readings. The quasi-rms meter uses a multiple rectifier system and gives readings within 1 dB of a true thermal type rms meter over the indicated frequency band. This noise voltage is reported in microvolts and if no in-

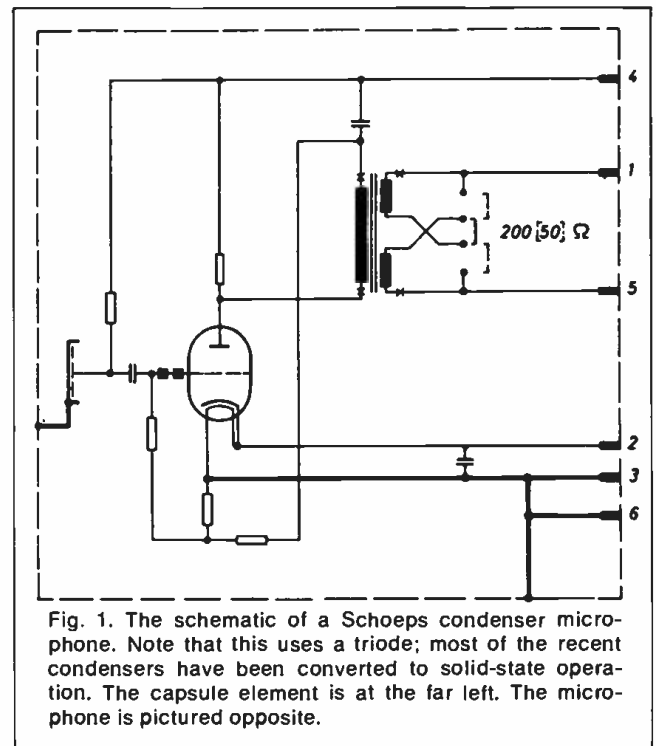

Fig. 1. The schematic of a Schoeps condenser microphone. Note that this uses a triode; most of the recent condensers have been converted to solid-state operation. The capsule element is at the far left. The microphone is pictured opposite.

dication is given it must be assumed to be rms.

Gerauschnspannung: This is the weighted noise level. There are many psophometric weighting curves for the measurement of weighted noise. Some are specified as DIN (Deutsche Industrie Normen) and some are international such as CCITT which is the old CCIF organization under a new name.

There have been changes in the DIN curves over the years but the DIN numbers have remained the same adding further to confusion unless the date of the DIN specification is indicated. When a new curve under the same standard is agreed upon it is supposed to supersede the old, but some manufacturers have a habit of holding the old curves if they happen to show their products in a better light.

The two curves, *DIN 5045* and *DIN 45 405*, in use today differ in the following ways. The older curve, *DIN 5045*, is based on the ears' equal loudness contours and it corresponds to the ASA sound-level meter specification A curve. This curve is used for measurement of noise in the very low range of approximately 30 phons. The *phon* is the unit of loudness level and at 1000 Hz phons are identical to decibels of sound-pressure level above 0.0002 microbar. At other frequencies, especially those in the low end, 100 Hz for example, the sound-pressure level must be raised 30 dB to approximately 70 dB_{spl} to be as loud as a 40 dB_{spl} at 1000 Hz. Therefore, 70 dB_{spl} at 100 Hz is 40 phons loudness level. *DIN 5045* specifies measurement with an rms meter. This noise level is normally reported in microvolts.

In March 1962 a new DIN specification, *Number 45 405* was introduced for the measurement of noise level in electroacoustical devices. This curve is based on an equal annoyance factor rather than an equal loudness factor. This new curve has approximately the same roll-off as the old one in the range below 500 Hz but it has a hump in the mid-frequency range between 1000 and 6000 Hz. Measurements with this new curve average approximately 4 dB higher than with the old curve due to this hump. In addition, the new *DIN 45 405* specifies that the measurement be made with a peak reading volt meter rather than rms. For

average noise spectrums, the peak reading is approximately 6 dB higher than the rms. Therefore, measurements with this new annoyance curve average approximately 10 dB higher than those with the old curve (based on equal loudness contours). It is obviously quite important that when the weighted noise of different microphones are compared, the system of measurement must be specified completely.

One further point that should be noted is that in the case of the new transistor condenser microphones, contrary to popular expectations, the noise level has been found to be in some instances less than that of vacuum-tube systems. To insure accuracy in measuring these low levels, compensation for the inherent noise level of conventional vacuum-tube volt meters must be made. The actual noise voltage of the microphone is the square root of the square of the total noise measured less the square of the inherent volt meter noise.

Erzataslautstaker: This term which has been translated in various ways (e.g. self noise level) is somewhat analogous to the U.S. *equivalent noise input level*, as applied to amplifiers. This is defined as that level of input signal that will produce the same output from an ideal amplifier with zero noise, as the internal noise level produces at the output of the real amplifier. This is desirable so that amplifiers of different gain can be compared directly for their noise properties.

For condenser microphones a better translation of *Erzataslautstaker* would be *equivalent noise loudness level*. *Erzataslautstaker* is therefore the loudness level of an acoustical signal at an ideal microphone of zero noise level that will produce the same output from this ideal microphone that the real noise level produces in the output of the real microphone. This specification, therefore, takes into account both the noise level and the sensitivity of the microphone so that microphones of different sensitivity can be directly compared. This equivalent-noise loudness level is computed from both the weighted noise level and the sensitivity.

Equivalent noise loudness level =

$$74 \text{ dB} - \frac{\text{sensitivity in mV/microbar}}{\text{noise level in microvolts}} \times 10^3 \text{ dB}$$

The factor 74 dB is from the sensitivity specification in mV/microbar. If the sensitivity is reported in mV/10 microbar this factor must be 94 dB. The factor 10^3 compensates for the fact that the sensitivity is in millivolts and the noise level is in microvolts.

The units of equivalent noise loudness level depend on the curve used to measure the noise level. If the *DIN 5045* is used with an rms meter, the phon is the proper unit of measurement. If the other curve (*DIN 45 405*) is used the specification is always in dB above 0.0002 microbar because this curve is not based on loudness-level phons.

One important factor to remember in computing equivalent noise loudness level is that the sensitivity is normally reported in mV/microbar with an *open circuit* while the noise level is reported in microvolts with a *1000-ohm load*. In the case of a microphone with 200-ohms source impedance (which is normal) the noise-level voltage must be increased by a factor of 20 per cent to compensate for this difference in loading.

Signal-to-noise ratio: The signal-to-noise ratio of condenser microphones is not normally stated when European specifications are given. It is easily computed and compared, provided the computations are based on the same system of measurements.

An arbitrary sound-pressure level can be chosen such as

100 microbar which corresponds to a level of 114 dB. The output level of the microphone can be computed from the sensitivity rating. It should be carefully noted whether this is a loaded or unloaded measurement to avoid the introduction of a 6-dB error. Also care must be taken when comparing variable-pattern microphones that the sensitivity rating for similar patterns is chosen. To find the signal-to-noise ratio, one can choose either the weighted or unweighted noise levels. (It should be noted whether these are peak or rms values.) As I stated, the choice of a 100 microbar sound-pressure level is arbitrary and since everyone is interested in evaluating products under conditions similar to those encountered in actual operation, perhaps some other value would be more realistic. It seems logical that a more valid specification of signal-to-noise ratio could be arrived at by choosing distortion as a parameter.

The signal-to-noise ratio should give a true indication of the useful dynamic range of the microphone. It is useless to consider the signal-to-noise ratio based on an arbitrary sound-pressure level if the distortion is so high as to make the microphone useless at that level.

Distortion: Until the advent of transistor condenser microphones, distortion had been specified as a per cent total harmonic distortion at the output of the microphone based on a given sound-pressure level in microbar or dB above 0.0002 microbar. Another method used has been to indicate the sound-pressure level in either dB or microbar for a specified percentage of total harmonic distortion factor. The two methods are equivalent; no conversion factors are necessary. One important condition must be remembered, however. This distortion factor measurement has always been made for the preamplifier alone under the assumption that the diaphragm assembly did not contribute significantly to the distortion factor. This is done by replacing the capsule assembly with a dummy measuring head and feeding a sine-wave signal from a low-distortion generator directly into the preamplifier.

Recent tests and measurements by the Deutsche Gramophon Gesellschaft have uncovered facts that require review of the above procedure. They have determined that the nominal distortion factors stated in manufacturer's literature do not account for audible differences in distortion between various types of microphones. Their research has uncovered the fact that it is possible for the diaphragm assembly to contribute to the distortion factor and that in the classical design the capsule distortion is an inverse function of the square of the polarizing voltage. This discovery has led to a review of the distortion-measuring techniques of all manufacturers and the results are eagerly awaited in all circles.

In the case of transistor condenser microphones, the frequency response can be measured with a measuring head containing varicap diodes. The non-linear distortion of these diodes is unfortunately so high that they cannot be used for distortion measurements.

An entirely new system utilizing actual acoustical excitation of the microphone with its diaphragm assembly in place has been developed. This involves the use of resonant tubes which can be excited to produce the necessary high sound-pressure levels required to evaluate the nonlinear distortion factors of these transistor condenser microphones.

It is hoped that these direct acoustic methods will be adopted by all manufacturers, so that evaluation of the actual total harmonic distortion factor of all microphones under normal operating conditions will be possible.

Acoustic Problems and Polar Patterns

John A. McCulloch

A microphone is not dead when the sound source is outside its acceptance pattern. An understanding of polar response will enable you to use your microphones to greater advantage.

WHEN a microphone is selected for purchase, one of the first considerations is usually the frequency response of the microphone. This characteristic of the microphone determines the sound we will obtain in the studio. Whether or not the response is flat or a deviation from the actual frequencies produced in the studio is not important, provided that the

John A. McCulloch is with Electro-Voice, Inc. in their microphone lab and as a field engineer. He also contributes db's monthly column THE FEEDBACK LOOP.

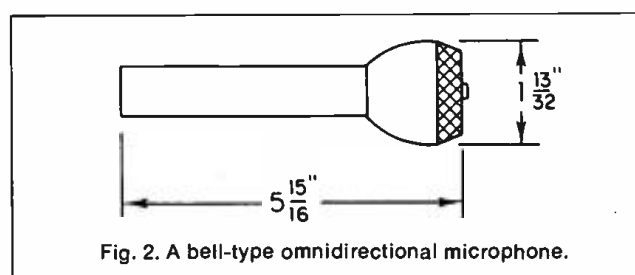
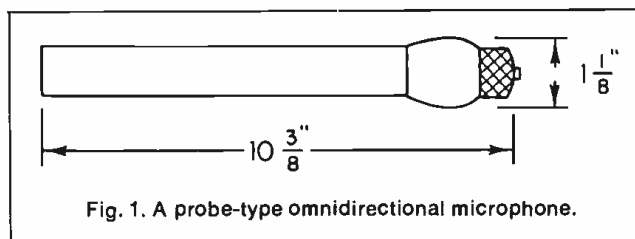



response received in the recording is the desired one. It is easiest, of course, to start with a flat microphone and add the desired amount of equalization in the console.

BUT... in judging a microphone's response characteristic, invariably only the front, or *on axis* curve is considered. True, we intend to utilize only this response, so off axis response is not really important. Correct? Not so... unless the recording is made in an anechoic chamber, and of a single instrument. The room sound comes in off the axis, as do the other instruments. Thus, depending upon the proximity and the directional pattern of the microphone, his off-axis reception may lead to serious acoustical phase distortion, unwanted equalization, and in general, an unacceptable sound.

A thorough understanding of all the characteristics of his microphones, particularly those which directly affect the frequency response can assist the recordist in obtaining a better sound, and in the creation of different effects without the use of external equalization.

Let's start by examining the basic pattern, the omnidirectional microphone. Supposedly, by its name, there should be no difference in response in any plane, nor should there be any over-all change in level from the on-axis position regardless of the orientation of the microphone. In a perfect omnidirectional microphone this would be true, but because the microphone has width and length, the body of the microphone affects the frequencies, and there is a change in response as the microphone is rotated from the on-axis position.

As an experiment, try taking a standard set-up, and closing all the microphones but a single omnidirectional. Have the performer using the remaining open microphone stop playing, while the rest of the ensemble continues. How much leakage is picked up, and at what sort of quality? If the leakage from the other instruments is greater than -20 dB referred to the level received from the instrument being picked up, the final sound mix is going to be compromised

by this leakage. How great this effect will be depends upon how much of the undesired sound is picked up, and how much equalization the microphone adds to this leakage.

Let's look at two different shapes of omnidirectional microphones and see how much the response changes off axis. FIGURE 1 shows the dimensions of a probe type omnidirectional together with its normal front curve. FIGURE 2, that of a bell type omnidirectional and its curve. FIGURE 3 shows the relative responses at 500 Hz, 1.5 kHz, 5 kHz, and 10 kHz, displayed in polar form. Notice the variations in response relative to 500 Hz, particularly at the 90° and 180° positions. How this effectively changes the frequency response is shown in FIGURE 4, for the probe type, and FIGURE 5, for the bell type. The deviation from the on axis response is shown for the 90° , 135° , and 180° positions of the microphone.

These characteristics represent the polar response typically found in an omnidirectional microphone. Under most conditions we do not desire this change, and so must take pains to avoid excessive leakage. But if a rolled-off top end is desired, or other sound balance is desired, simply try turning the microphone off axis until the sound is what you want. In essence you now have an additional equalizer, but one that does not consume level, nor degrade the signal-to-noise ratio. It is limited but effective. If you had sufficient separation before changing the position of the microphone, there should be little or no change as the 1.5 kHz level did not shift more than 2 dB. It is conceivable that a very strong high frequency signal that was towards the rear of the microphone is now stronger, but a slight repositioning of the microphone and stand or boom would eradicate or minimize the change in separation.

Should the leakage from the other instruments be much greater than a -20 dB (referred to the wanted signal), then a complete change of position or a change to a directional microphone is indicated. The time delay effect due to the different distances of the microphones with respect to the

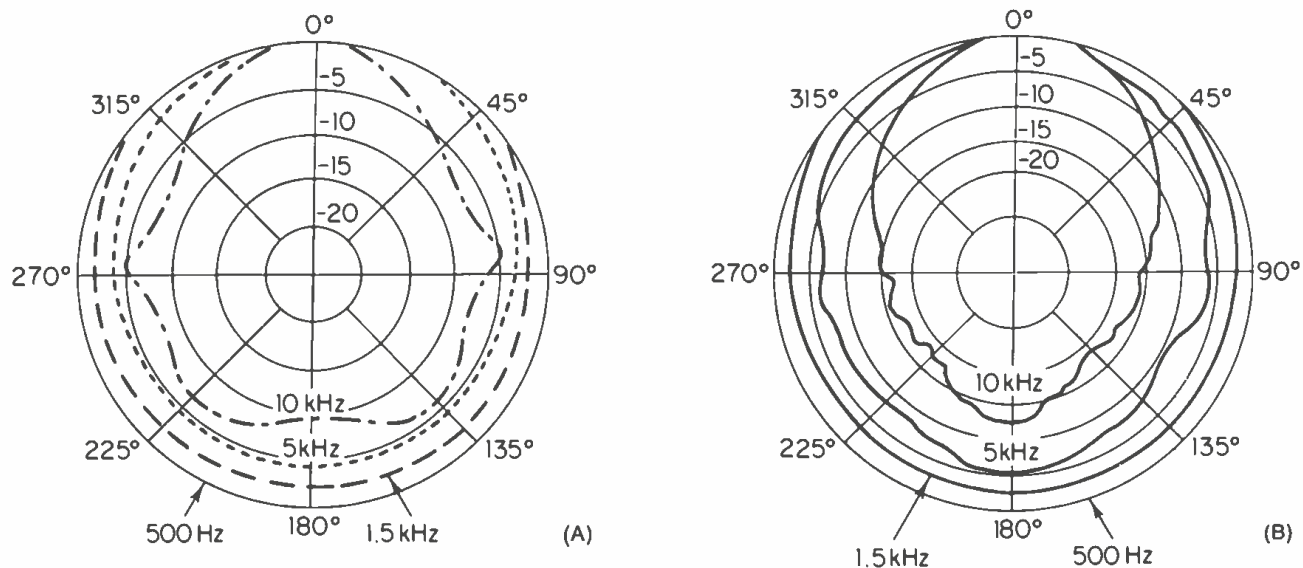

Fig. 3. (A) Polar response of a probe-type and (B) of a bell-type microphone.

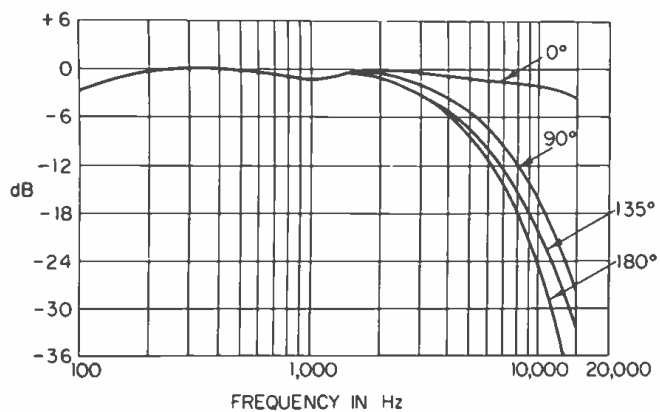

Fig. 4. Conversion of the probe-type mic. polar pattern into a conventional frequency response plot.

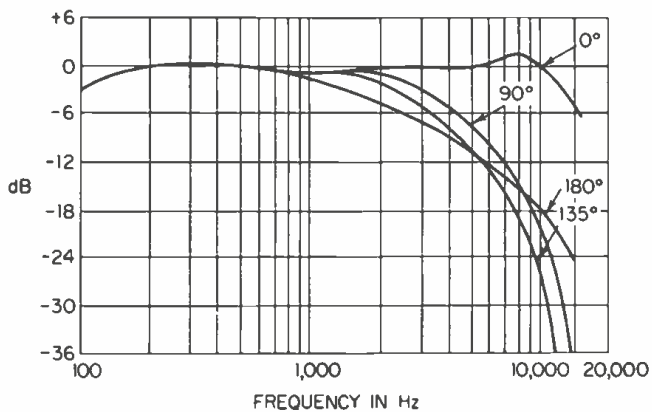

Fig. 5. As in Figure 4 but for the bell-type mic.

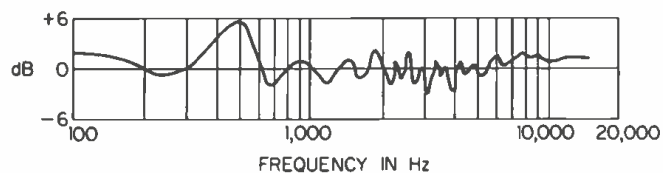

Fig. 6. The cancellation effect of closely spaced omnidirectional mics.

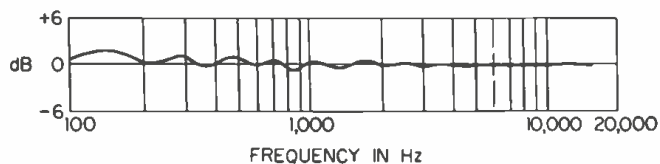

Fig. 7. As in Figure 6 but with increased spacing of the two mics.

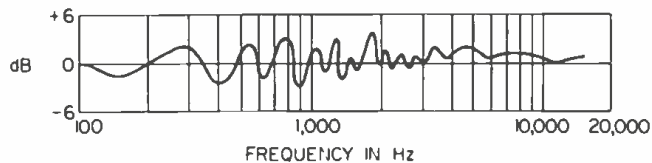

Fig. 8. Directional mics six feet apart.

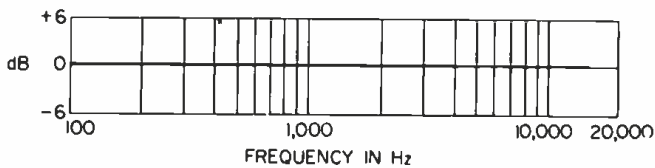

Fig. 9. Directional mics still at six feet but at 180° to each other.

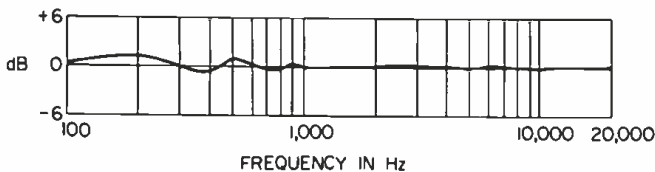

Fig. 10. Identical to Figure 9 but at a distance of 18 inches.

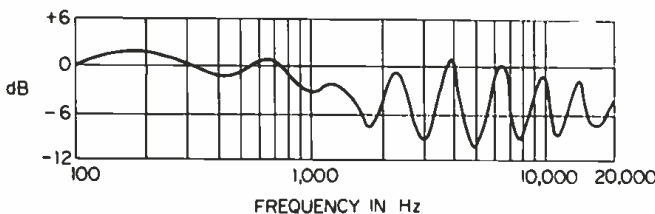

Fig. 11. Still at 18 inches, but turned to parallel direction.

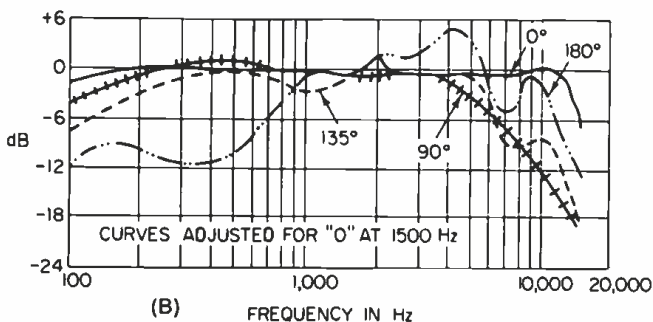
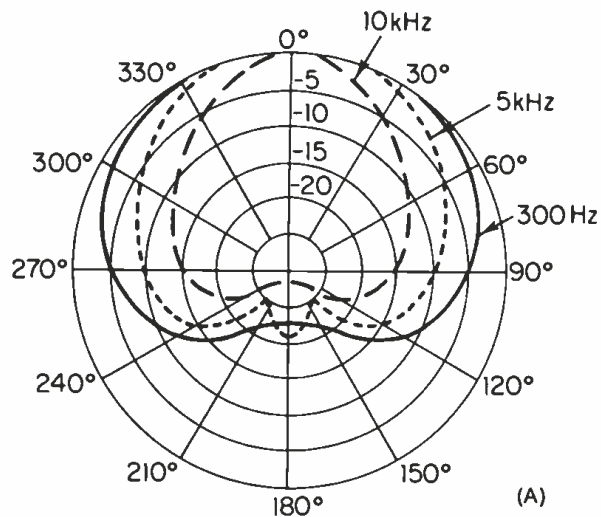

Fig. 12 (A) Polar pattern and (B) frequency-response curves for a directional mic.

same sound source, and the subsequent combination of their signals, produces partial or severe interference of the signals. Essentially this is what is done in a directional microphone, but within the microphone, and closely controlled with respect to frequency.

A typical cancellation effect shown in FIGURE 6 is the result of the combination of signals from two omnidirectional microphones spaced four feet apart, with the sound source located two feet directly in front of one of the microphones. Increasing the specification distance between the microphones to eight feet, or a ratio of 1 to 4, produced the results shown in FIGURE 7. At this distance, eight feet, the second microphone was receiving the source signal at about a -15 dB referred to the primary microphone. While some degradation of the signal is observed, it is less than 2 dB and is difficult to detect audibly.

In a directional microphone an acoustic labyrinth is utilized to phase and delay the signal as it enters a second opening towards the rear of the microphone. It is then applied to the back of the diaphragm to produce the directional effect. A signal arriving on axis will not be affected by the labyrinth, but an off-axis signal will be reduced in amplitude by a ratio according to its off-axis position. I have used the word *labyrinth* to indicate a 'black box' so to speak. It may consist of acoustic resistance, capacitance, or inductance. It may be a second diaphragm used acoustically, or electrically connected and phased. The exact method employed does not matter, but it is the amount of the reduction with respect to direction that determines the directionality of the micro-

phone. This pattern is displayed as the polar pattern; typical types being cardioid, super-cardioid, and bi-directional.

Again, ideally, there should be no discrimination with regard to frequencies, merely an over-all reduction in level. There are a few directional microphones that approach this ideal. Others are far from it. Each may be used to advantage, under different circumstances. In a large room, where no important information is being picked up other than on axis, the directional microphone with frequency discrimination from the rear may be used to apparently reduce the low-frequency component of the room. In this microphone, the rejection is well controlled at low frequencies, but suffers at higher frequencies. If the off axis were to be described, it might be termed *thin*. This is equalization from the microphone again.

The microphone that does not discriminate (to a noticeable extent) in off-axis frequency response is to be preferred where leakage can not be satisfactorily controlled, and a full response must be maintained. The ideal microphone (or its near approximation) has the same or greater rejection at the low frequencies as the one with frequency discrimination, but it maintains the ratio of rejection (or reasonably so) for all frequencies. In some cases where the leakage is severe, this leads to the sensation that it has less rejection than the one with frequency discrimination.

With a directional microphone the ratio of separation distance may be reduced when using multiple microphones from that of the omnidirectional established previously (1:4). With the microphones placed generally facing the

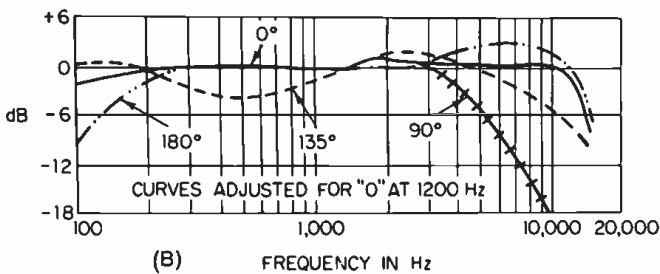
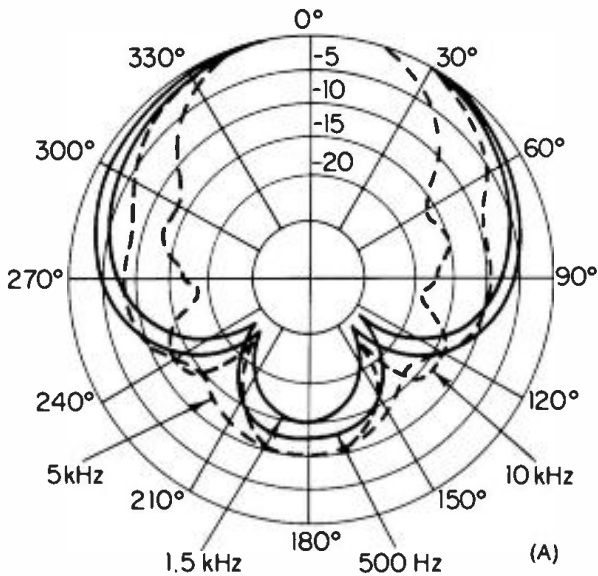

Fig. 13 (A) and (B) are as in Figure 12 but for a different directional microphone.

same direction; (the pick-up axes parallel) the reduction is minor. If we were to stagger the performers, or change their angles such that the microphones could be faced 135° to 180° axially, we may now realize a reduction in the distance separation ratio to almost 1:1, and if the microphones were not moved closer than the 1:4 ratio, an apparent gain in separation would be realized proportional to the reduction in level due to the polar pattern.

For example, taking the established ratio of 1:4, as in the omnidirectional, we observe no interference, reducing the distance to six feet (1:3) the result is FIGURE 8. Turning the microphone 180° the response is that in FIGURE 9. Next, the microphone is moved to 18 inches and the interference is represented in FIGURE 10. The microphone is now returned to face the source parallel to the primary unit, still 18 inches apart and also two feet from the source, and FIGURE 11 is the result.

If off-axis pickup must be tolerated, it should be as reduced in level as practical. Examine the polar patterns shown for two different directional microphones, (FIGURES 12 and 13) and their representative frequency responses taken at the 0°, 90°, 135°, and 180° positions. Regard each of the separate curves as main curves for that is exactly what the microphone sees for an instrument at that location.

A directional microphone does not have a dead side, merely a position with much lower, but still audible level. By selecting the microphone, and knowing its minimum points, (for best rejection), even crowded set-ups can be recorded with a minimum of acoustic phase distortion.

Best Value Meters Come From Heath!

Heathkit IM-25 Solid-State Volt-Ohm-Milliammeter

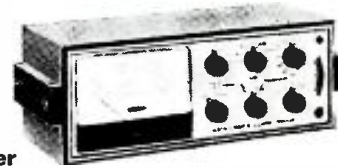

Kit \$80
Wired \$115

• 9 DC and AC volts ranges — 150 millivolts full scale to 1500 volts • 7 Resistance ranges measure from one ohm to 1000 megohms • 11 Current ranges — 15 uA full scale to 1.5 A. • Response to 100 kHz • 11 megohm DC input impedance, 10 megohm on AC • Battery or AC power

Heathkit IM-16 Solid-State Volt-Ohm-Meter



Kit \$44.95
Wired \$64.95

• 8 DC & AC volts ranges — 500 millivolts full scale to 1500 volts • 7 Resistance ranges measure from one ohm to 1000 megohms • 11 megohm DC input impedance, 1 megohm on AC • Battery or AC power

Heathkit IM-13 Bench Type VTVM

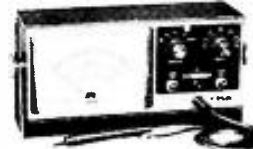

Kit \$34.95
Wired \$52.95

• 7 DC & AC volts ranges — 1.5 volts full scale to 1500 volts • 7 Resistance ranges measure from one ohm to 1000 megohms • Response 25 Hz to 1 MHz • 11 megohm DC input impedance, 1 megohm on AC • AC powered



Kit \$26.95
Wired \$44.95

Heathkit IM-11 Standard VTVM

• 7 DC & AC volts ranges from 1.5 volts full scale to 1500 volts • 7 Resistance ranges measure from one ohm to 1000 megohms • Response 25 Hz to 1 MHz • 11 megohm DC input impedance, 1 megohm on AC • AC powered



Kit \$37.50
Wired \$52.95

Heathkit IM-21 Lab AC VTVM

• 10 AC volt ranges measure from 0.01 to 300 volts RMS full scale • Decibel range —52 to +52 total in ten ranges • Response 10 Hz to 1 MHz • 10 megohm input impedance • AC powered



Kit \$29.95

Heathkit MM-1 Portable Volt-Ohm Milliammeter

• 7 DC & AC volts ranges from 1.5 volts full scale to 5000 volts • 5 Direct current ranges from 150 uA full scale to 15 A. • 3 Resistance ranges measure from 0.2 ohm to 20 megohms • 20,000 ohms per volt sensitivity



Kit \$19.95

Heathkit IM-17 Solid-State Volt-Ohm-Meter

• 4 AC & DC volts ranges from one volt full scale to 1000 volts • 4 Resistance ranges measure from 0.1 ohm to 1000 megohms • 11 megohm DC input impedance, 1 megohm AC • Response 10 Hz to 1 MHz • Battery powered • Includes all probes and portable case

HEATH COMPANY, Dept. 74-2
Benton Harbor, Mich. 49022
In Canada, Daystrom Ltd.



Please send my FREE 1968 Heathkit Catalog.

Enclosed is \$ _____, plus postage.

Please send model(s) _____

Name _____

Address _____

City _____ State _____ Zip _____

Prices & Specifications subject to change without notice.

TE-173

Circle 18 on Reader Service Card

db February 1968

25

New Products and Services



Mic Line RFI Filter

● This filter is designed to help in most situations where rfi is encountered. For sources ranging in frequency from am radio, through the citizens band, fm radio, and vhf and uhf television, the RFI Filter will provide a minimum guaranteed attenuation of 60 dB. From 1 to 10 gigahertz, attenuation will be at least 40 dB.

This unit will not help where the radio frequency carrier has already been detected and the audio modulation, whether a broadcast or just pure noise, has been put on the line *before* the filter. Rf detection can occur in the microphone, whether dynamic or condenser.

The filter may also be used, with some loss of effectiveness caused by the mismatch, in a 600-ohm line. Levels up to +30 dB will not harm the filter, but there may be some loss of audio level, also due to the mismatch.

Mfgr: Recording Equipment Company
Price: \$95.00

Circle 51 on Reader Service Card

New Literature

● A complete catalog of sound products available under the Geloso name lists industrial amplifiers, mobile amplifiers, paging systems, sound columns, portable and mobile sound systems, paging and trumpet speakers, musical instrument speakers, microphones, mixers, stands, and intercoms. The catalog contains sixteen pages of illustrations and specifications of the products.

Mfgr: American Geloso

Price: no charge

Circle 58 on Reader Service Card

26 db February 1968

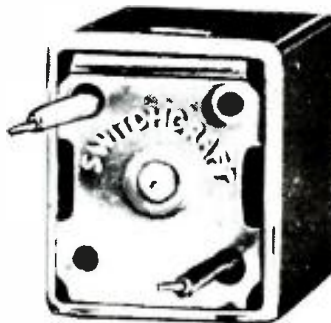

Color-Legend Annunciator

● A new electro-magnetically operated annunciator that provides a highly visible color-legend display without the use of lamps or other electrical illumination has been recently announced. The "Glo-Annunciator" Series GA has been designed for use in industrial and commercial equipment applications. Because no lamps are needed, power requirements are minimized, there is no lamp replacement problem or concern for heat build-up. Each standard unit has a matte-black display screen with a 3/16 x 3/8-in. display area. The display area appears to glow when a bright fluorescent material, carried on a magnet-operated indicator behind the display screen, is presented. The system consists of a coil, an associated magnetic circuit, and a magnetic indicator assembly. The magnetic indicator assembly is a permanent magnet with two color indicators attached. When the coil is energized, the permanent magnet maintains its original position or slides to the alternate position depending on the polarity of the applied voltage and induced poles. Whenever the magnet slides to an alternate position, a color change appears behind the display screen. The indicator will normally stay in the transferred position after the coil current is disconnected.

Mfgr: Switchcraft

Price: on request

Circle 59 on Reader Service Card



CCTV Camera Series

● The basic TC-177 camera is a self-contained, crystal-controlled, random-interlaced unit with 12 MHz bandwidth and 800-line resolution. It has 4000:1 automatic light compensation and adjustable aperture correction. Optional features include rf output, a high-resolution kit to produce 900 lines, and a 2:1 industrial interlace board. A TC-177RL model incorporates these features and also can be connected to a remote-control panel or a combination video processor remote control. The processor furnishes EIA-RS170 composite output when driven by an EIA sync generator. Two other models incorporate the features of the above units with the addition of a television viewfinder with optional rear-controlled zoom focus.

Mfg: Fairchild Space and Defense Systems

Price: \$995.00 (TC-177)

Circle 52 on Reader Service Card

Jerrold Catalog

● A new short-form catalog has capsule information on the entire range of rf test equipment, including sweep systems. Prices are included in the catalog.

Mfgr: Jerrold Electronics Corp.

Price: Free

Circle 56 on Reader Service Card

innovations in
components . . .

and consoles



including

**INPUT MODULES
LINE MODULES
LINE/BOOSTER AMPLIFIERS
SLATING OSCILLATORS
POWER SUPPLIES**

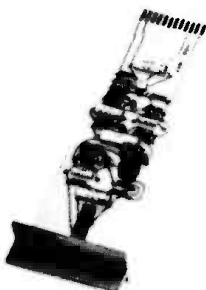
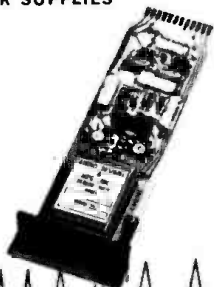

**UDIO DESIGNS
AND MANUFACTURING, INC.**
SYSTEMS BY INNOVATION

Write or call
for technical information
on our complete line

17510 WYOMING AVENUE
DETROIT, MICHIGAN 48221
PHONE (313) UN 3-7777

Circle 19 on Reader Service Card

Stereo Portable Recorder



● The 7050 model is a complete system designed for professional as well as the more elaborate home high-fidelity systems. This is a three-motor, four-track recorder that will play and record in forward and reverse directions. A reversible capstan-drive synchronous motor is used. Metal sensing strips are used to activate the reverse feature, which may be automatically programmed or controlled manually. All solid-state

construction includes two 15 watts-per-channel-power amplifiers. Modular in construction, this unit is readily adaptable to 50/60 Hz operation at 110/220-volt supplies. There is a deck-only version of the unit available as Model 7060.

Mfgr: *American Dokorder*
Price: \$399.50 (deck only: \$349.50)
Circle 53 on Reader Service Card

True RMS Meter Bulletin

● A new six-page bulletin describes the model 2409 portable voltmeter/amplifier which produces true rms measurements for signals from 2 Hz to 200 kHz, and measures a.c. voltages from 1 mV to 1000 volts. Measurements are indicated in true rms, average, or peak values. The bulletin also describes the unit with charts, tables, and simplified circuit diagrams that document such features as calibrated attenuation in 10 dB steps, precise frequency response, and high calibration stability.

Mfgr: *B & K Instruments, Inc.*

Price: free

Circle 63 on Reader Service Card

Amplifier Catalog

● The Challenger CHS series of solid-state public address amplifiers describes four new models; the CHS100, CHS50, CHS35, and the CHS20. Part of the six-page fold-out catalog is devoted to listing accessory items. All technical data and prices are given.

Mfgr: *Bogen Communications Division*

Price: free

Circle 64 on Reader Service Card.

Sound Column



● The Ampli-Vox S-1200A is a six-element unit with the speakers arranged in frequency-tapered array to provide excellent coverage and natural sound. The system has been equalized so that the throw is the same at all frequencies, providing even coverage anywhere in an auditorium. The column stands 30 inches high in a walnut veneer case with brown grille cloth and a side-mounted carrying handle. It is suitable for lecturn, background music, and high-fidelity systems. The sound is described as extremely natural, creating the illusion (when properly placed) of non-amplified sound. Frequency response is ± 5 dB from 150 to 8000 Hz; EIA sensitivity is greater than 48 dB.

Mfgr: Perma-Power Company
Price: \$59.95

Circle 60 on Reader Service Card

New Tape

● A new low-noise tape, Sound Track II, is now available. Major benefits are compatibility with leading low-noise tapes without bias changes to achieve equal performance levels. Improvements have been made in distortion re-

duction, frequency response, and print through. A sample 600 foot five-inch reel is available for \$1.00 directly from Northridge Magnetics, Inc., 19017 Parthenia St. Northridge, California 91325.

Circle 65 on Reader Service Card.

Disc Recording Stylus

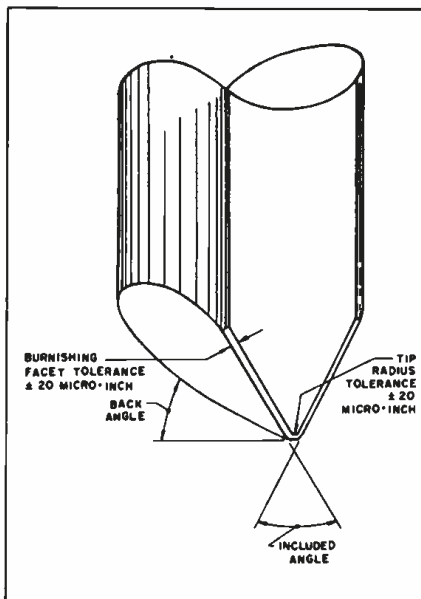

● Micro-Point recording styli are designed to respond to the most stringent demands of modern disc recording. Superfine cutting edges and surface finish guarantee optimum high-frequency cutter-head performance and low-noise groove surfaces. Critical facet and radius dimensions are maintained to within a 20 μ in. tolerance. Each stylus is critically inspected immediately before shipment to eliminate costly replacement of defective units by the user. Styli are wired at no extra cost and are available from stock. Each unit is individually boxed and foam-insert protected.

Mfgr: Micro-Point, Inc.
Price: Westrex 3B, 3C, Gramplan: \$12.00
Westrex 3D, Ortofon, Neumann: \$15.00

Circle 54 on Reader Service Card

Sine-Square Generator

● This solid-state instrument is a recent addition to the Knight-Kit line. All silicon semiconductors are used in the circuitry with a field-effect transis-

tor in the Sulzer oscillator circuit. Sine-wave output is available over the range of 20 Hz to 20 MHz—thus covering the entire am radio band. Five ranges are used, output voltage is adjustable from 0-7.5 volts rms into loads of more than 10k: ohms (0-6.5 V into 600 ohms).



Output level is ± 1 dB to 1 mHz; ± 2 dB to 2 mHz. Source impedance is 600 ohms nominal using step attenuators. Discrete 1 dB steps are available to 41 dB; a fine control operates to outputs as low as 0.5 mV. Distortion is stated to be 0.25 per cent or less over the audio range. The square-wave section offers 20 Hz to 200 kHz coverage at a maximum 10 volt p-p output. Source impedance is 200 ohms and rise time is less than 1 μ sec. at 20 kHz.

Mfgr: Knight-Kit (Allied Radio Corp.)

Price: kit only: \$75.00

Circle 55 on Reader Service Card

Department of (error) Amplification

In the December NEW PRODUCTS AND SERVICES listings, a Mu-formicro symbol was left out of the description of the Universal Audio 1176 limiting amplifier. Several readers were quick to point out that the unit is faster than the quoted attack time of 20 seconds. (We can see a studio engineer sitting with folded hands waiting for the limiting action to begin.) The fact is, of course, that the Universal Audio 1176 has an attack time of better than 20 μ sec. And that is fast indeed.

Sound-Track

Modern Stereo Magnetic Recording TAPES America's Finest at Amazingly Low Prices

TECHNICAL DATA

Signal to DC noise ratio minimum 65 db
High frequency sensitivity @ .5 mil wave length
..... + 2.0 db
Frequency response using NARTB equalization @ 7 1/2
IPS ± .5 db, 40-16,000 CPS
Frequency response using NARTB equalization @ 15
IPS ± .7 db, 30-20,000 CPS
Harmonic distortion 0.8% max @ 1000 CPS 8 db
below saturation
Print through @ 1000 CPS saturated signal 49 db
below signal
Erasing field for 60 db signal oersteds 800
Modulation noise approximately 60 db below signal
@ 1% distortion
Dropout none

Lubrication to decrease wear and reduce noise
..... silicones
Recommended operating temperature 40°F to 140°F
Recommended storage conditions ... 70°F @ 40-60%
RH
Base materials acetate or polyester film
Base thickness 0.5 mil, 1.0 mil or 1.5 mil
Tape width slit 0.246 ± .002
Lengths per standard reels
Coating ferric oxide
Coating thickness40 mil ± .05
Intrinsic coercivity 260 + 10 (HCl) oersteds
Retentivity (BRS) - GAUSS 900
Relative bias for maximum low frequency output
..... 5.0 ma
Low frequency sensitivity 0 db

Northridge Magnetics, Inc. 19017 Parthenia St., Northridge, Cal. 91325

Circle 19 on Reader Service Card

Classified

Looking for a qualified professional to fill a job opening?

Trying to sell some audio equipment privately?

Want to get an audio engineering position in another city?

USE **db** CLASSIFIED . . .

A UNIQUE NEW EMPLOYMENT AND EQUIPMENT EXCHANGE FOR THE WHOLE AUDIO INDUSTRY
db

THE SOUND ENGINEERING MAGAZINE now offers a classified advertising section to firms and individuals in all areas of audio—recording, commercial sound, broadcasting, manufacturing, film and tv sound, etc.

Rates are inexpensive: 25¢ per word for employment offerings, situations wanted and other non-commercial ads; 50¢ per word for commercial classified ads.

Closing date is the fifteenth of the second month preceding the date of issue. Send copy to:

Classified Ad Dept.

db

THE SOUND ENGINEERING MAGAZINE
980 Old Country Road
Plainview, New York 11803

FOR SALE

Scully Tape Recorders — One to twelve track. Two, four, and eight track models in stock for immediate delivery.

Scully Lathes — Previously owned and rebuilt. Variable or automatic pitch. Complete cutting systems with Westrex heads.

Mixing Consoles — Custom designed using Electrodyne, Fairchild, and Universal Audio modules. From \$4000.00.

Wiegand Audio Laboratories, 221 Carton Avenue, Neptune, N.J. 07751, Phone: 201 775 5403

Berlant BRX-1 Tape Recorder. Mono, full-track record and erase heads, half-track playback head. Provision for two additional heads. Heads and machine are nearly new, in excellent over-all condition. 7 1/2 and 15 in/sec. Cannon connectors in and out; mic and line level mixing. Accepts NAB and smaller reels. Includes reel locks for vertical operation. Transport and amplifier chassis both fit directly into standard 19-in. racks. Units are in portable carrying cases. This unit meets its original specifications and should provide long trouble-free sus-

tained service. Asking \$325 including shipment anywhere in the continental United States. Box D3 db Magazine, 980 Old Country Road, Plainview, N.Y. 11803

EQUIPMENT WANTED

Hewlett Packard Low Frequency 'Scope model 120B or 130C or equivalent. Box A3, db Magazine, 980 Old Country Road, Plainview, New York 11803

Rek-O-Kut CVS 12 Variable Speed Turntable in good condition. Box C3, db Magazine, 980 Old Country Road, Plainview, N.Y. 11803

Used recording lathe—must be in perfect condition and reasonable. Please send photo if possible. Box B3 db Magazine, 980 Old Country Rd. Plainview, NY 11803

PROFESSIONAL DIRECTORY

Phillip C. Erhorn
Systems Design and Specifications
Custom Consoles Technical Writing
P.O. Box 861
Stony Brook, New York 11790
Tel: 516 941-9159

db February 1968 29

Heath Catalog



● The 1968 Heath catalog describes their extensive line of electronic kits. More than 300 kits are listed in the 108-page volume, more than half illustrated in color. Test and lab instruments, cb radio, amateur radio equipment, stereo hi-fi components, photographic aids, color and b & w tv sets, electronic organs, and more are all detailed. Of particular note is the new line of test instruments. Included is a pair of solid-state vom units, high- and low-voltage power supplies, an fm-stereo generator, and a triggered 8 mHz 'scope.

Mfgr: Heath Company

Price: Free

Circle 57 on Reader Service Card

School-type Amplifiers

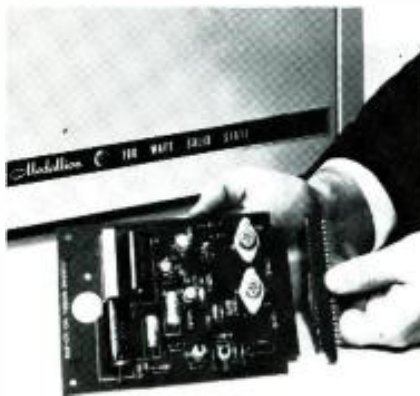

● Two new amplifiers have been marketed specifically for the school and
30 **db** February 1968

performing arts sound reinforcement market. The amplifiers are rated at 50 or 100 watts and are designed to offer wide-band sound output at less than one per cent distortion. Each amplifier offers five innovations that are designed to provide superior performance. The input stages use field-effect transistors and the output signal may be fed directly to the speaker network (transformers are available to match 70-volt lines). A current-measuring circuit protects against overload (short-circuit protection is built-in) and a thermal-sensing feedback circuit automatically compensates for temperature change protecting against the deteriorating effects of heat rise. All the active circuits except the power and output stages are mounted on a plug-in circuit board.

Mfgr: DuKane Corporation

Prices: 1A900 (50 watts) \$330.00

1A910 (100 watts) \$435.00

Circle 67 on Reader Service Card

Video Camera



● The new MTC-18 camera provides its own sync and operates as a sync generator for other MTC-18 cameras. It will also accept sync from an external generator such as the Concord SG-12. This sync-output feature allows video tape recorder users to simplify or expand their systems. Switching from camera to camera and sharp scene changes can be accomplished without loss or distortion of picture image. The all solid-state camera is designed for fixed 2 to 1 interlace cctv and recording systems. An additional feature is a light control selector on the camera which permits either totally

automatic or manual adjustment for varying light conditions. The lens supplied is a 25mm f 1.9 adjustable iris unit. Video resolution of the camera is 550 lines. An accessory item, the TCP-1 television control panel permits fades, titles, and superimposed images.

Mfgr: Concord Electronics Corp.

Price: \$450 (TCP-1 control: \$150)

Circle 66 on Reader Service Card

Audio Tape Recorder Series



● The venerable Japanese firm of TEAC is now distributing part of its professional products line in this country. Leading the group is the R-310 professional series of tape recorders. Units are in stock and available for delivery. Standard head configurations include full-track mono, half-track mono, quarter-track stereo, and half-track stereo. Console, rack mount, portable case, or chassis-only systems are available. The transport will accommodate up to four heads. Supplied TEAC heads have hyperbolic surfaces. Three speed capability is provided by a combination of two-speed motor and capstan sleeve techniques. The electronics feature two line, or mike and line input mixing. Plug-in transformers for microphone and line matching are available.

Mfgr: TEAC Corporation of America

Price: Mono—\$1275

Stereo—\$1575

Circle 61 on Reader Service Card

People, Places, Happenings



● **Rein Narma** has been named a vice president of **Ampex Corporation** and general manager of the company's consumer and educational products division in Elk Grove Village, Illinois. The announcement was made by **William E. Roberts**, president and chief executive officer. Mr. Narma was previously vice president (engineering and product planning) of the division. He succeeds **John N. Latter**, who has resigned. Rein Narma joined Ampex in 1959 as chief engineer for the company's professional audio products division. Since joining the consumer and educational products division in 1963, he has been responsible for development of the company's consumer audio tape recorder line. He also led the development of Ampex's compact closed-circuit videotape recorders, including the first low-cost color recorders.

Mr. Narma is a graduate of Technical University, Tallinn, Estonia, and a Fellow of the Audio Engineering Society.



● **Dr. Bradley Dewey, Jr.** has been appointed president of the **Reeves Soundcraft Division of Reeves Industries, Inc.**, it was recently announced by board chairman **Hazard E. Reeves**. Said Mr. Reeves: "Creation of this new position within the division, coupled with Dr. Dewey's extensive technical and business background, should enable Soundcraft to make further inroads in this growth industry." Mr. Reeves also noted that industry domestic sales of magnetic recording tape were \$135 million in 1966, and that this figure is expected to rise to more than \$200 million within three years.



● An exquisite sculpture-painting in the form of a brass and wood triptych has been awarded to artist **Herb Alpert** and his **Tijuana Brass** group. The basis for the award is a poll of stereo tape fans taken by **Ampex Stereo Tapes**. The award is given by Ampex for outstanding contributions to the field of recorded sound. The triptych's brass outer sculpture is in a Mexican motif, with an oil-on-wood portrait of Mr. Alpert in the center section. With Mr. Alpert (left) is **Donald V. Hall**, AST general manager (right).



● At **Greentree Electronics Corporation** **Sidney Brandt**, the company's president, announced the appointment of **Dan Kahan** as director of production. In his new post, Mr. Kahan will have complete charge of all production units in both Greentree plants. When the company moves into its new plant in April, it is expected that all manufacturing and processing will be done under one roof.

● In Woodstock, New York, **Paul M. Beard**, v.p. of **Rotron Manufacturing Company, Inc.**, has announced the appointment of **Richard Callaway** as an applications engineer. Mr. Callaway came to Rotron from the **L.J. Wing Company**, where he served as product manager for the firm's industrial heating and air-moving equipment. Prior to L.J. Wing, he was associated with **Hercules Filter Corp.** in sales engineering positions. His new duties will be to assist Rotron representatives and customers with applications engineering problems.

● **Sparta Electronic Corporation**, manufacturer of professional broadcast products, has merged with **Computer Equipment Corporation**. The merger was accomplished through an exchange of stock. The announcement by **William J. Overhouser**, Sparta president, also indicated that Sparta will now operate as a wholly-owned subsidiary of C.E.C.—a publicly held company with corporate headquarters in South E1 Monte, California. Sparta is in Sacramento. According to Mr. Overhouser there are no operational or personnel changes planned at Sparta.

"Our unique pattern for success is what attracted C.E.C. to us and the merger will provide us with greater corporate stability and the financial ability to gain additional growth," said Mr. Overhouser.

● People have been moved about at the top level of RCA. **Robert W. Sarnoff**, who was president is now chief executive officer. He announced that this new organization plan brings together RCA businesses which most closely relate to one another in four major operating areas: services, defense and commercial systems, consumer products and components, and information systems. The following changes were announced by Mr. Sarnoff: **Charles M. Odorizzi** becomes senior executive vice president, services. He will be responsible for the **RCA Service Company, RCA Communications, Inc., RCA Parts and Accessories, and the Hertz Corporation.**

W. Walter Watts becomes senior executive vice president, defense and commercial systems. He is responsible for **Defense Electronic Products and the Broadcast and Communications Products Division.** **Delbert L. Mills** becomes senior executive vice president, consumer products and components. He thus becomes responsible for the **RCA Victor Home Instruments Division and for Electronic Components and Devices.** He will also be responsible for the **RCA Sales Corporation, RCA Victor Distributing Corporation, Distributor and Commercial Relations, the RCA Victor Record Division, and the RCA Magnetic Products Division.** **John V. Farese** becomes an executive vice president, electronic components and devices, reporting to Mr. Mills.

James R. Bradburn is now executive vice president, information systems. His responsibility is for **Electronic Data Processing, EDP Service, and the Graphic Systems Division.**



Richard A. Kaplan

● At Microtran, **Richard A. Kaplan** has been appointed as the manager of industrial engineering, according to an announcement by Microtran president **Albert J. Eisenberg.** Mr. Kaplan has both a B.I.E. and Masters Degree in industrial engineering from the N.Y.U. College of Engineering. Prior to joining the company he was associated with **Jerry Le Boyer and Company** as a consulting industrial engineer. Earlier associations include **Westinghouse Electric Corp., Waldes Kohinoor, and the Technical Materials Corp.**

● Don't forget the NAB Convention to be held in the windy city at the end of March. Exact dates are Monday, March 31st through Wednesday, April 3rd. The place: the Conrad Hilton Hotel in Chicago. More details next month.

● Plans have been completed for the **1968 Midwest Acoustics Conference** to be held in Evanston, Illinois, on April 11, 1968. The conference will feature ten technical papers covering a variety of subjects in the field of acoustics by members of the staff at **Northwestern University.** A tour of the engineering laboratories will be included in the program. Following the technical session, a dinner program will be held at the **Orrington Hotel, Evanston, Illinois** (the evening of the 11th). The **Midwest Acoustics Conference** is sponsored by the **Midwest Section, Audio Engineering Society; Chicago Acoustical and Audio Group; and the Chicago Section of The Institute of Electrical and Electronic Engineers.** The objective of the conference is to enable the university to describe its work in acoustics to members of industry.

● Mark your calendars also for the period from April 29th through May 2nd. These are the dates for the **34th National Convention of the Audio Engineering Society** to be held in Hollywood, California. The place is the **Hollywood Roosevelt Hotel.** In addition to an extensive technical paper presentation program, a selected number of manufacturers will exhibit their latest professional audio equipment. **Don Davis of Altec-Lansing, 1515 South Manchester Anaheim, California 92803** is convention chairman. It has been reported to us that exhibit space for the Convention is completely sold out.



● Chicago is the scene of a smart new building recently occupied by **Jensen Manufacturing Division of the Muter Company** at 5655 West 73rd Street. The 174,000 square-foot plant more than doubles Jensen's previous facilities at 6601 S. Laramie Avenue. The corporate offices of the Muter Company will

be housed in the new building as well as Jensen's offices, engineering staff, and manufacturing operations. The plant incorporates advanced techniques for the production of loudspeakers as well as research and development facilities.

Sidney Frey, who almost single-handedly put the **Westrex**-system stereo disc before the public, has died, apparently of a heart attack. He was 47. As president of **Audio Fidelity Records** Mr. Frey was fascinated by the potential of the **Westrex** disc when it was demonstrated in 1957. His company pressed and distributed a **Westrex** cut master before there were cartridges available to play the records. Unplayable or not, the release started a rush by other companies to jump on the bandwagon. Cartridges soon appeared that could separate the information in the groove. By midsummer 1958 the stereo disc boom was on.

AR-2a^x speakers and AR^{INC.} turntables are used as laboratory measurement standards—

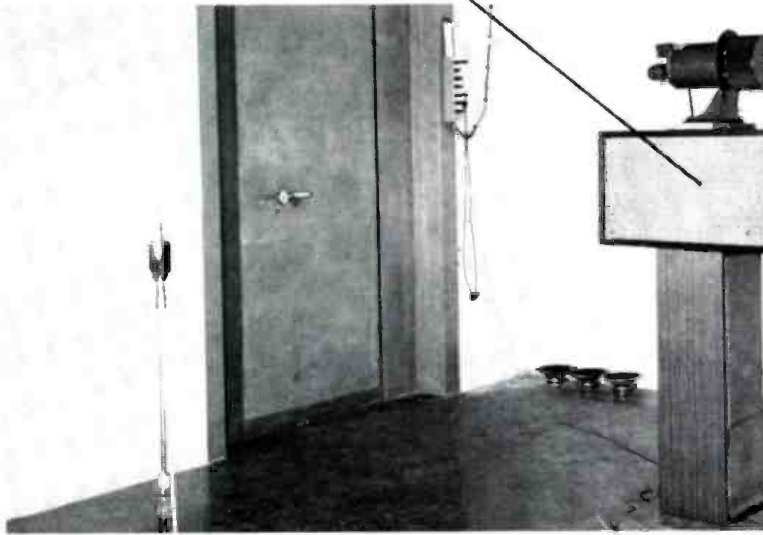

COURTESY PERMA-POWER CO.

Reverberant test chamber and associated laboratory test bench of the Perma-Power Company of Chicago, manufacturer of instrument amplifiers and sound-reinforcement systems. The AR-2a^x speaker on the pedestal is used as a distortion standard to calibrate chamber characteristics. This test facility, described in a recent paper by Daniel Queen in the *Journal of the AES*, employs only laboratory-grade equipment. (Note the AR turntable on the test bench.)



*but they
were designed
for music.*



COURTESY WABC-FM



Offices of the Vice President and General Manager, and of the Program Director of radio station WABC-FM in New York City. AR-2a^x speakers and AR turntables are used throughout WABC's offices to monitor broadcasts and to check records. WABC executives must hear an accurate version of their broadcast signal; they cannot afford to use reproducing equipment that adds coloration of its own.

ACOUSTIC RESEARCH, INC., 24 Thorndike Street, Cambridge, Massachusetts 02141

Circle 11 on Reader Service Card

This E-V driver has a hole in the back

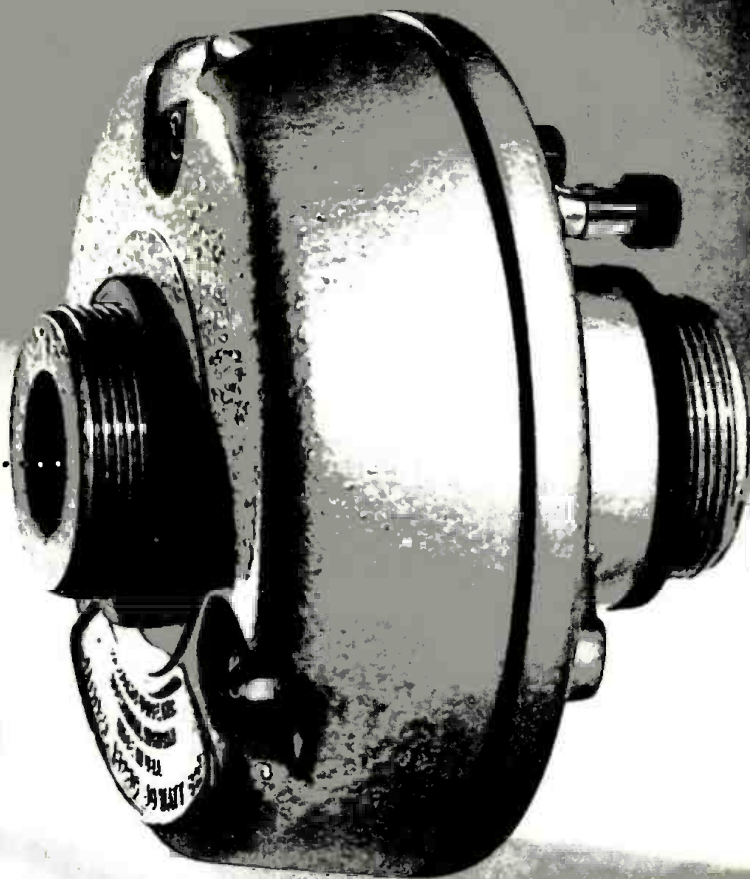

It's one of the ways Electro-Voice takes the holes out of P.A. system response!

Ey Too often, ragged frequency response starts at the P.A. driver. And all too often, there's a big hole in response from about 2 to 7kHz. But that's right where you need solid response for top-notch intelligibility. So E-V did something about it.

With these new P.A. drivers, E-V insured smooth, commanding high frequency response. How? By reducing the moving mass without reducing the strength of the diaphragm and voice coil. Special attention was also paid to internal sound paths—attention that paid off with unusually uniform response—and significantly improved articulation.

There are five versions of these new drivers.

The Model 1828R 30-watt driver fits any reentrant or other

conventional horn. When coupled to an E-V Model AR150, FR150 or HC400 reentrant horn, the wide-range performance belies the modest cost.

The 30-watt Model 1828C and the 60-watt Model 1829 are both compound drivers. Each has a hole in the back. While they can be used on reentrant or multicellular horns, they are specially designed to operate in exclusive E-V compound horns. The idea is simple: a big horn for lows is fed from the hole in the back of the driver, and a small horn for highs is attached to the front. You hear wider range and dramatically lower distortion. Choose the famous CDP® (FC100) wide-angle horn, or the fantas-

tic new AC100 concentrating horn.

The 30-watt Model 1828T and 60-watt Model 1829T also fit either reentrant or compound horns. An efficient 70.7 volt line transformer is built in. A transparent panel lets you see which tap has been selected, and you can change taps at any time—without disturbing the primary wiring.

There's much more to recommend this series of Electro-Voice PA drivers. Die-cast housings, spring-loaded terminals, improved weatherproofing, and the highest production standards in the industry. Get on-the-job proof today. Let an E-V hole-in-the-back driver keep you out of a hole!



MODEL 1828R



MODEL 1829



MODEL 1828T

ELECTRO-VOICE, INC., Dept. 28680,686 Cecil Street, Buchanan, Michigan 49107

microphones • public address loudspeakers • high fidelity components
• phonograph needles and cartridges • organs • space and defense electronics

Circle 12 on Reader Service Card

www.americanradiohistory.com

Electro-Voice
SETTING NEW STANDARDS IN SOUND