

Stereo Cartridges: 3 or 4 pins?

NOVEMBER 1958

50 CENTS

ICD

audiocraft

for the **HI-FI** hobbyist

How to solve rumble, hum, phase problems with stereo discs

Five most-used output circuits for hi-fi amplifiers

A photo construction feature: a stereo rig for perfectionists

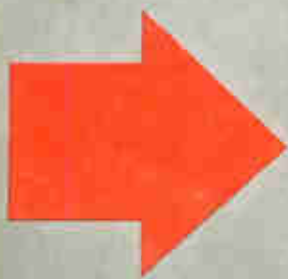
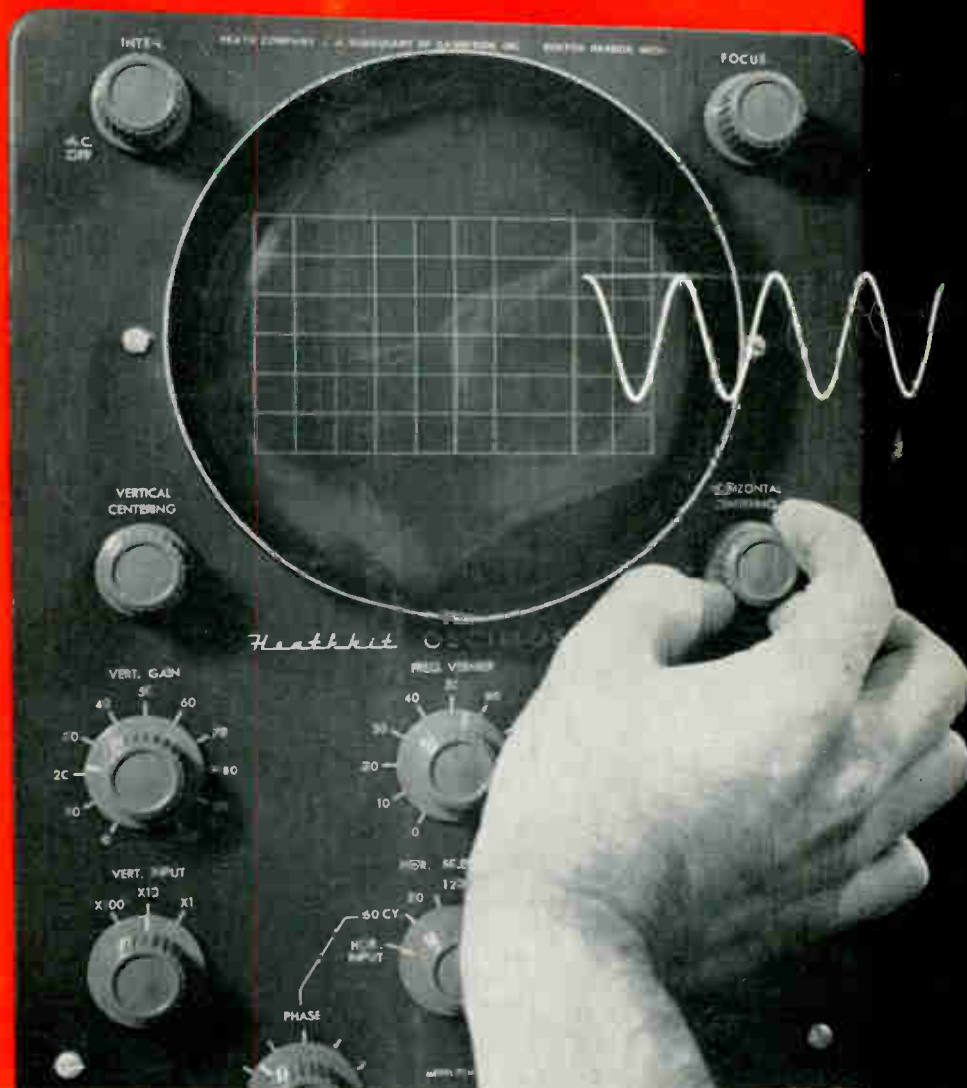

Plus: special reports on Telematic speakers, Sony mikes, Connoisseur turntable, Norelco cartridge

THE Garrard PAGE

Serving the owners of Garrard—
world's finest record playing equipment—
and other discriminating listeners.

Subject: A New Deluxe Garrard Player

Model **4HF**
(stereo-engineered and wired)

This new Garrard precision player is basically a four speed deluxe transcription turntable and transcription tone arm—combining in one unit the distinguishing qualities of both.

Already mounted on a single unit plate for simplest installation, the 4HF forms a superb instrument,

complete at only

\$59.50



Push-button system for auto-trip mechanism. A touch of the finger disengages the tone arm completely from the player mechanism, and arm becomes independent as if mounted separately.

Auxiliary stop mechanism built into tone arm rest. Unit shuts off when the arm is placed on rest.

Professional transcription tone arm newly designed with plug-in universal shell to take all stereo and monaural cartridges. Simple, accurate, weight adjustment.

Four speed unit with variable + or — speed adjustment on all four speeds.

Heavy duty turntable, 12 inch diameter; heavy weight steel with rubber traction mat.

New center spindle housing with pressure lubricating system, for long life and dead quiet operation.

There's a Garrard for every high fidelity system. Fully wired for Monaural and Stereo records.



RC98
Super
Changer
\$67.50



RC88
Deluxe
Changer
\$54.50



RC121/II
Intermix
Changer
\$42.50



TPA/12
Stereo
Tone Arm
\$19.50



501
Transcription
Turntable
\$89.00



4HF
Transcription
Manual Player
\$59.50



Model T/II
Manual
Player
\$32.50

GARRARD SALES CORPORATION, PORT WASHINGTON, N. Y.

Canadian Inquiries to Chas. W. Pointon, Ltd., 6 Alcino Ave., Toronto
Territories other than U.S.A. and Canada to Garrard Engineering & Mfg. Co., Ltd., Swindon, Wilts., England

New Comparator Guide — FREE

Garrard Sales Corporation, Dept. GS-98
Port Washington, New York.

Please send your new comparator guide
which compares all Garrard players and
their advanced features.

Name _____

Address _____

City _____

Zone _____ State _____

**you can convert
to stereo
without a
second woofer
or expensive
network**

IF YOUR WOOFER HAS FOUR TERMINALS



These four terminals lead to an exclusive University feature... THE DUAL VOICE COIL... two electrically separate voice coils on a single woofer that provide perfect bass from both stereo channels, without the need for expensive or complicated stereo adapter networks or "control" filters.

This means the tonal magnificence of University stereo adapted speaker systems can be perfectly matched for stereo with the sole addition of an inexpensive, compact stereo "add-on" speaker, or other suitable limited range speaker. This is possible because stereo effect is created largely by frequencies above the nominal bass range.

How University dual voice coil woofers work: Voice Coil A of the woofer receives the full bass from one stereo channel. Voice Coil B receives the full bass from the other channel. Then...exactly as done in two-woofer stereo systems...both bass signals are blended acoustically. Result: authentic, balanced, full-bodied bass that will give you the enduring satisfaction of superb stereophonic sound.

Thus, you save the expense and space of an additional woofer and its enclosure. Whether you are investing in a complete stereo system...or starting with a monaural system for later conversion...a University speaker system* featuring a dual voice coil woofer proves once again... *with University it pays to own the very finest!*

*University woofers having dual voice coils are models: C-15W, C-12SW, C-15HC and C-12HC. These are employed in speaker systems: Debonaire-12 S-3, S-3S; Senior S-5, S-5S; Master S-6, S-6S; Dean S-7, S-7S; Classic S-8, S-8S, S-9, S-9S; Ultra Linear S-10, S-10S, S-11, S-11S; Troubadour S-12, S-12S. (System models in light type are fully stereo adapted. System models in bold type can be easily and inexpensively prepared for stereo with kit SK-1. User net: \$5.95)



- **How to achieve your University stereo system**
- Select the stereo adapter speaker (s) that best suits your budget, decor and space requirements. Each of University's all-new stereo adapter speakers has been specially designed to provide a perfect stereo match by direct connection to your dual voice coil woofer, a stereo adapter network is available.) Stereoflex I is well suited for bookshelf installations. Stereoflex II, with its narrow silhouette, makes a fine end table. Model SLC can be affixed to a wall or "lite-pole," its decorative fibreglass housing blending smartly with modern furnishings.

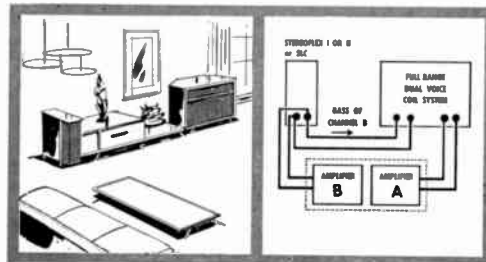

These illustrations are typical of how any of the University stereo adapter speakers may be used in 2-speaker and 3-speaker stereo system combinations. Above, is a Stereoflex II connected to a full-range speaker system. Below, are two Stereoflex I's used with just a dual voice coil woofer in a suitable enclosure.

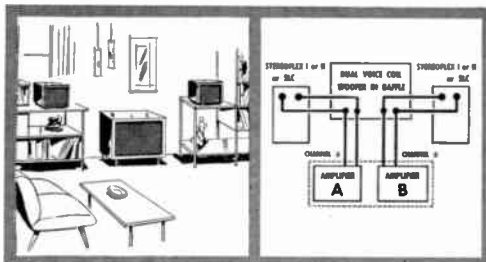

See your dealer for any desired additional information, or write to Desk V-4, Technical Service Department, University Loudspeakers, Inc., White Plains, N. Y.



STEREOFLEX I: Double horn-loaded, with 6" mid-range driver and 2000 cps crossover wide-angle tweeter. Response: 150-15,000 cps. Hardwood furniture finishes. 11½" h. x 12¼" w. x 10½" d. User net: Mahogany—\$54.90, Blond or Walnut—\$56.90.

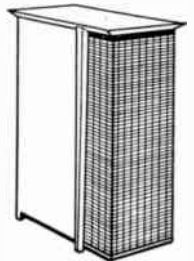

STEREOFLEX II: Double horn-loaded, using an extended air column mid-range with heavy duty compression driver and 3000 cps crossover wide-angle tweeter. Built-in BRILLIANCE control. Response: 150 cps to beyond audibility. Hardwood furniture finishes. 25¼" h. x 10" w. x 19½" d. User net: Mahogany—\$110.00, Blond or Walnut—\$113.00.

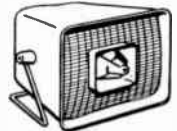

MODEL SLC: Same as Stereoflex I, but with decorator charcoal gray fibreglass housing and gold anodized front grille and adjustable tilting stand. 11½" h. x 12¾" w. x 10½" d. User net: \$43.90.

STEREO ADAPTER NETWORK A-1: Available for use with any brand of speaker system not having a dual voice coil woofer. Not needed with University speaker systems: Debonaire-12, Senior, Master, Troubadour, Dean, Classic, Ultra Linear-12 or -15. User net: \$30.00.

How to Think about Speaker Systems

by William Sherwood

Audiospeaker Laboratories
Pomona, California

We really mean how designers and manufacturers, as well as the ultimate consumer, should think about speaker systems. You may agree with our ideas. First, we are positive that the only valid approach to speaker system design assumes the finished product must provide the clearest and most faithful reproduction of music possible. Second, we believe that continued progress toward ultimate reproduction standards must use new thinking, new ideas, new methods, new designs and new materials.

How is the designer to know when he is reproducing music clearly and faithfully? Who is to tell him? Who is to judge? There are only two ways. One is by comparing the product with the sound of live instruments. The other is by listening to the product with musical score in hand, ascertaining if all the notes of the score can be heard in correct proportion and balance. These are things which can be done by trained eyes and ears. It is incumbent on the designer that once laboratory problems have been dutifully worked out by the use of test instruments the product then be subjected to listening tests by critical ears. Though many engineers dislike the idea, the fact remains that the best judge of clarinet reproduction is an experienced clarinetist. If a manufacturer were to market a system after having such a man tell him the system made a clarinet sound like an oboe, and other musicians offered similar comments, only one of two conclusions could be drawn. The manufacturer lacks integrity, or worse, perhaps, he is such an idiot as to decide that a critical musician doesn't know the sound of his own instrument.

How should the designer proceed toward the most nearly perfect musical reproduction? This leads to our second point about progress. We don't think that because something has been done a certain way for thirty years it has to be done that way. Consider something of the history of speakers and enclosures. The last significant new enclosure design occurred in 1934, twenty four years ago. The basic dynamic loudspeaker used today was patented by Rice and Kellogg in 1925, thirty three years ago. At the same time they developed such "modern" devices as variable density paper cones, multiple speakers, biflex cones, copper rings, etc. The most advanced contemporary system, then, will combine a 33-year old speaker and a 24-year old enclosure, with certain small modifications and refinements. This is progress? Furthermore, the most current enclosure, the bass reflex, is even older. And it booms today just like it did in 1932.

Taking an idea worked out three decades ago, cutting angles differently using more fiberglass, loosening the cone, adding speakers and crossovers, may create a somewhat different sound, but not necessarily better. Improvement requires real progress.

This is some of our thinking at Audiospeaker Laboratories. Always we seek out new ideas, new materials, and test them by relating them to one object — accurate reproduction of musical instruments. We don't produce booms and peaks and breakfast cereal cracks and pops. Such sounds have never been heard in a concert hall. We know we have to work with new materials and develop new

designs. We know our direction is right. Out of this attitude has emerged our Audiosonic Speaker System.

The system begins with the Anechoic Enclosure. As many of you know, this is the first fundamentally new enclosure design since Sandeman's 1934 corner horn. It employs a calculated configuration of air and damping materials, with new dimensional ratios, to achieve mass and resistive loading of the speaker. This unique principle insures optimum transient response, minimum distortion, good bass response, and elimination of midrange non-linearities due to standing wave interference found in conventional enclosures.

Completing the system is the new Custom 16 Co-Axial speaker. Here is a big rugged driver with two exclusive design features never before used. First is Dynamic Braking. A specially engineered sensing coil is integrated into the magnetic structure. By electromagnetic law this sensing coil dynamically brakes the voice coil whenever the cone wants to overshoot and create transient distortion. Overshoot and oscillation in the Custom 16 in response to a step-front square wave cannot even be observed on an oscilloscope.

Second, we have broken the paper cone barrier. The main cone of the Custom 16 Co-Axial is molded of very light, very rigid polystyrene foam plastic. All the books tell us about modal breakup of paper cones and the resulting non-linearities which inhibit musical quality. They are not talking about the Custom 16. The new foam plastic has only a fraction of the mass of paper and many times its rigidity.

This is what we mean by thinking about speaker systems. This is what we mean by suggesting that what was good enough for grandpa may very well be substandard for today.

The Audiosonic Speaker System is designed to be the finest reproducer of musical sound that can be made today. We think it has achieved this end. Three entirely new designs had to be perfected in order to turn the trick. Mind you, these are not refinements or modifications. They are new to the world of high fidelity. They have not existed before. Many of you heard the Audiosonic at the Chicago and New York high fidelity shows and were delighted. You will know precisely what this article is all about. For those of you who haven't yet had the experience of this sound in an extended listening test, we invite your attention. Listen, and we suspect that you will agree with our views on how to think about speaker systems.

Why no pictures? You have seen our Anechoic enclosure ads. This is the outer appearance of the Audiosonic, too. It is slender and gracefully styled, dignified, and takes up little floor space. Its eminent suitability for stereo is unprecedented. We will be happy to send literature on request. Meanwhile ask your dealer for a demonstration. The price for the complete system, in finished walnut, mahogany or birch, is only \$189.

Made by

Audiospeaker Laboratories

P.O. Box 1082

Pomona, California

Plant: 1114 E. Emporia St.

Ontario, California

audiocraft

Roy F. Allison
Editor

Eleanore B. Wright
Assistant to the Editor

Philip C. Geraci
Associate Editor,
Art Director

Weldon Bedell
Art Assistant

R. D. Darrell
Joel Ehrlich
J. Gordon Holt
Joseph Marshall
Contributing Editors

Charles Fowler
Publisher

Warren B. Syer
Associate Publisher

Claire Eddings
Advertising Sales Manager

Andrew J. Csida
Marketing and
Merchandising Manager

Lee Zhito
Western Manager

Joseph W. Pace
Circulation Fulfillment
Manager

THIS MONTH'S COVER: Since everybody knows what the cover shows, there's no real point in trying to explain it. So we won't.
Cover by Phil Geraci.



THE MAGAZINE FOR THE HI-FI HOBBYIST

NOVEMBER 1958

Volume 3 Number 11

The Grounded Ear <i>What's new in sound reproduction</i>	4	<i>Joseph Marshall</i>
Book Reviews	6	<i>Richard D. Keller</i>
Audionews	10	
Electronic Firsts <i>The Audion as an amplifier</i>	13	<i>Monroe Upton</i>
Readers' Forum	15	
Editorial <i>How to be unhappy with stereo</i>	15	
Are Stereo Discs Compatible? <i>Part III: Rumble, phase, and hum problems</i>	16	<i>Joel Ehrlich</i>
Perfectionist's Stereo Installation <i>An AUDIOCRAFT photo feature</i>	18	<i>David Beatty</i>
Using Test Instruments <i>The Signal Generator, Part V: Alignment of IF stages in tuners</i>	20	<i>Joseph Marshall</i>
Tape News and Views <i>A look at Sony mikes and the Reeves Magna-See kit</i>	22	<i>J. Gordon Holt</i>
Audiolab Test Reports <i>This issue: Connoisseur turntable; Norelco cartridge</i>	24	<i>Hirsch-Houck Laboratories</i>
The Trouble With Attenuators <i>And what to do about it</i>	26	<i>Paul W. Klipsch</i>
Sound-Fanciers' Guide <i>Reviews of exceptional tape and disc records</i>	28	<i>R. D. Darrell</i>
Rumble Seat <i>Still more on three-terminal cartridges</i>	30	
FM Line Maintenance <i>How to get the best from your antenna system</i>	33	<i>J. A. Bannister</i>
Puzzlements <i>Amplifier output circuits</i>	34	<i>Norman H. Crowhurst</i>
Audio Aids <i>Short cuts for the experimenter</i>	36	
Professional Directory	44	
Traders' Marketplace	44	
Advertising Index	48	



ADVERTISING

Main Office — Claire Eddings, The Publishing House, Great Barrington, Mass. Telephone: Great Barrington 1300.

New York — Andrew G. Spanberger, 1564 Broadway, New York 36. Telephone: Plaza 7-2800.

Chicago — John R. Rutherford & Associates, Inc., 230 East Ohio St., Chicago 11, Ill. Telephone: Whitehall 4-6715.

Los Angeles — George F. Kelley, 1520 North Gower, Hollywood 28. Telephone: Hollywood 9-6239.

Audiocraft Magazine is published monthly at Great Barrington, Mass., by Audiocom, Inc., a subsidiary of The Billboard Publishing Co., Publishers of The Billboard, Vend, Funspot, and The Billboard International. Telephone Great Barrington 1300. Editorial, publication, and circulation offices at: The Publishing House, Great Barrington, Mass. Subscriptions: \$5.00 per year in the United States and Canada. Single copies: 50 cents each. Editorial contributions will be welcomed by the editor. Payment for articles accepted will be arranged prior to publication. Unsolicited manuscripts should be accompanied by return postage. Entered as second-class matter October 1, 1955, at the post office, Great Barrington, Mass., under the act of March 3, 1879. Additional entry at the post office, Pittsfield, Mass. Printed in the U. S. A. by the Ben Franklin Press, Pittsfield, Mass. Copyright 1958 by Audiocom, Inc. The cover design and contents of Audiocraft Magazine are fully protected by copyrights and must not be reproduced in any manner.

**STEREO
STEREO
AND
MONAURAL**

the
experts
say...
in HI-FI
the best buys are

EICO[®]

World-famous
EICO advantages
guarantee your complete satisfaction:

- Advanced engineering • Finest quality components
- "Beginner-Tested," easy step-by-step instructions
- LIFETIME service & calibration guarantee
- IN STOCK — Compare, then take home any EICO equipment—right "off the shelf"—from 1900 neighborhood EICO dealers.



Stereo Preamplifier HF65



FM Tuner HFT90



Stereo Amplifier-Preamp HF81



Monaural Integrated Amplifiers:
50, 30, 20, and 12-Watt
(use 2 for Stereo)



Bookshelf Speaker System HFS1



Monaural Power Amp HFs:
50, 30, 20, and 12-Watt
(use 2 for Stereo)

Monaural Preamplifiers:
HF65, HF61
(stack 2 for Stereo)

Speaker System HFS2
36" H x 15 1/4" W x 11 1/2" D



Over 1 MILLION EICO instruments in use throughout the world.

NEW STEREOPHONIC EQUIPMENT

HF85: Stereo Dual Preamplifier is a complete stereo control system in "low silhouette" design adaptable to any type of installation. Selects, preamplifies, controls any stereo source—tape, discs, broadcasts. Superb-variable crossover, feedback tone controls driven by feedback amplifier pairs in each channel. Distortion borders on unmeasurable even at high output levels. Separate lo-level input in each channel for mag. phono, tape head, mike. Separate hi-level inputs for AM & FM tuners & FM Multiplex. One each auxiliary A & B input in each channel. Independent level, bass & treble controls in each channel may be operated together with built-in clutch. Switched-in loudness compensator. Function Selector permits hearing each stereo channel individually, and reversing them; also use of unit for stereo or monophonic play. Full-wave rectifier tube power supply. 5-12AX7/ECC83, 1-6X4. Works with any 2 high-quality power amplifiers such as EICO, HF14, HF22, HF30, HF35, HF50, HF60. Kit \$39.95. Wired \$64.95. Includes cover.

HF81: Stereo Dual Amplifier-Preamplifier selects, amplifies & controls any stereo source—tape, discs, broadcasts—and feeds it thru self-contained dual 14W amplifiers to a pair of speakers. Monophonically: 28 watts for your speakers; complete stereo preamp. Ganged level controls, separate focus (balance) control, independent full-range bass & treble controls for each channel. Identical Williamson-type, push-pull EL84 power amplifiers, excellent output transformers. "Service Selector" switch permits one preamp-control section to drive the internal power amplifiers while other preamp-control section is left free to drive your existing external amplifier. Kit \$69.95. Wired \$109.95. Incl. cover.

MONAURAL PREAMPLIFIERS (stack 2 for Stereo)
NEW HF65: superb new design. Inputs for tape head, microphone, mag-phono cartridge & hi-level sources. IM distortion 0.04% @ 2V out. Attractive "low silhouette" design. HF65A Kit \$29.95, Wired \$44.95. HF65 (with power supply) Kit \$33.95. Wired \$49.95.

HF61: "Rivals the most expensive preamps" — Marshall, AUDIOCRAFT. HF61A Kit \$24.95, Wired \$37.95, HF61 (with power supply) Kit \$29.95. Wired \$44.95.

MONAURAL POWER AMPLIFIERS (use 2 for STEREO)

HF60: 60-Watt Ultra Linear Power Amplifier with Acro TO-330 Output Xfmr.; "One of the best-performing amplifiers extant; an excellent buy." AUDIOCRAFT Kit Report. Kit \$72.95. Wired \$99.95. Cover E-2 \$4.50.

HF50: 50-Watt Ultra Linear Power Amplifier with extremely high quality Chicago Standard Output Transformer. Identical in every other respect to HF60, same specs at 50W. Kit \$57.95. Wired \$87.95. Cover E-2 \$4.50.

NEW HF35: 35-Watt Ultra-Linear Power Amplifier. Kit \$47.95. Wired \$72.95. Cover E-2 \$4.50.

HF30: 30-Watt Power Amplifier. Kit \$39.95. Wired \$62.95. Cover E-3 \$3.95.

NEW HF22: 22-Watt Power Amplifier. Kit \$38.95. Wired \$61.95. Cover E-2 \$4.50.

NEW HF14: 14-Watt Power Amplifier. Kit \$23.50. Wired \$41.50. Cover E-6 \$4.50.

MONAURAL INTEGRATED AMPLIFIERS (use 2 for STEREO)

HF52: 50-Watt Integrated Amplifier with complete "front end" facilities & Chicago Standard Output Transformer. "Excellent value"—Hirsch-Houck Labs. Kit \$69.95. Wired \$109.95. Cover E-1 \$4.50.

HF32: 30-Watt Integrated Amplifier. Kit \$57.95. Wired \$89.95. Both include cover.

HF20: 20-Watt Integrated Amplifier. "Well-engineered" — Stocklin, RADIO TV NEWS. Kit \$49.95. Wired \$79.95. Cover E-1 \$4.50.

HF12: 12-Watt Integrated Amplifier. "Packs a wallop"—POP. ELECTRONICS. Kit \$34.95. Wired \$57.95.

SPEAKER SYSTEMS (use 2 for STEREO)

HFS2: Natural bass 30-200 cps via slot-loaded 12-ft. split conical bass horn. Middles & lower highs: front radiation from 8 1/2" edge-damped cone. Distortionless spike-shaped super-tweeter radiates omni-directionally. Flat 45-20,000 cps, useful 30-40,000 cps. 16 ohms. HWD 36", 15 1/4", 11 1/2". "Eminently musical; would suggest unusual suitability for stereo."—Holt, HIGH FIDELITY. Completely factory-built: Walnut or Mahogany. \$139.95; Blende, \$144.95.

HFS1: Bookshelf Speaker System, complete with factory-built cabinet. Jensen 8" woofer, matching Jensen compression-driver exponential horn tweeter. Smooth clean bass; crisp extended highs. 70-12,000 cps range. Capacity 25 w. 8 ohms. HWD: 11" x 23" x 9". Wiring time 15 min. Price \$39.95.

FM TUNER

HFT90: surpasses wired tuners up to 3X its cost. Pre-wired, pre-aligned, temperature-compensated "front end"—drift-free. Precision "eye-tronic" tuning. Sensitivity 1.5 uv for 20 db quieting — 6X that of other kit tuners. Response 20-20,000 cps ±1 db. K-follower & multiplex outputs. "One of the best buys you can get in high fidelity kits." — AUDIOCRAFT KIT REPORT. Kit \$39.95*. Wired \$65.95*. Cover \$3.95.

EICO, 33-00 Northern Blvd., L.I.C. 1, N. Y. AC-11

SHOW ME HOW TO SAVE 50% on 60 models of top-quality equipment as checked below.

Hi-Fi
 Test Instruments Ham Gear.

Send FREE literature & name of neighborhood EICO dealer.

NAME.....
ADDRESS.....
CITY..... STATE.....

Copyright 1958 by Electronic Instr. Co., Inc. 33-00 N. Blvd., L.I.C. 1, N. Y.

Add 5% in the West.

* LECS COVER, F. G. T. INCL.

FOR

The Connoisseur, The Perfectionist, The Hi Fi Addict, The Jazz Buff or anyone from 9 to 90 interested in music on records or tapes

THE MUSIC BOX

offers the MOST PERSONAL MAIL ORDER RECORD SERVICE AVAILABLE IN THE COUNTRY.

THE MUSIC BOX

can supply you with ANY available long playing record, stereo disc or prerecorded monaural or stereo tape, on ANY label in the catalog.

Not just any old copy, pulled at random from stock, but a BRAND NEW, FACTORY FRESH, UNPLAYED PRES-SING.

Each one rigorously inspected for any visible imperfections.

Carefully dusted, cleaned and de-staticized, then enclosed and sealed in one of our own polyethylene envelopes.

Stoutly packed to reach you in PERFECT condition.

Mailed to you by Parcel Post. On orders of more than \$6.00 there is no charge for postage. On orders of less than \$6.00, please add 40¢ to cover postage and packing.

All records and tapes sold at manufacturer's suggested list prices only. No discounts.

To ensure prompt shipment, please list alternate choices. Occasionally we do run out of certain items. We do not make substitutions without the written permission of the customer.

We will gladly offer you our considered opinion of any recording in the catalog, and help you, when possible with any record or tape problem you may have.

We will be pleased to send you, on request, a list of worth while recordings likely to be swept into oblivion by the introduction of stereo discs.

Hundreds of already deleted 10 and 12-inch LP records in stock. If interested, please send us your want list. We do not issue any list of these items.

THE MUSIC BOX

Box 637
Great Barrington, Mass.



by RICHARD D. KELLER

book reviews

The McProud High Fidelity Omnibook

Ed. by C. G. McProud; pub. by Radio Magazines, Inc., Mineola, New York; 128 pages; \$2.50, paper-bound.

This volume of articles, originally published in *Audio Magazine*, is well chosen to represent writers in almost every phase of high fidelity.

There is quite a variety of material, with a few chuckles, some solid music information, and data on building speaker cabinets and enclosing entire hi-fi systems to harmonize with their surroundings in the home.

However, it was the humorous department which I enjoyed the most, particularly Charles Sinclair's "Hi-Fi-Manship" or "How to be an Audio Expert without knowing harmonic distortion from a harmonica," a bit of marvelously blatant paraphrasing (with full acknowledgment) of Stephen Potter's long-popular "Gamesmanship," "Lifemanship," and "Oneupmanship" volumes. If you've missed reading Sinclair's guiding ploys on "Audioship," "Musicship," "Old Hans'-manship," and "Counter-Hi-Fi-manship," *don't*, at least, not any longer.

Zygmunt Hof and George Augspurger also add deft touches to the serious art of hi fi, adding their mild humor to the more serious dissertations of veterans Paul Klipsch, Irving Greene, James R. Radcliffe, Milton Switzer, and others contained in this enjoyable anthology.

Electronic Puzzles and Games

Ed. by Matthew Mandl; pub. by Gernsback Library, Inc., New York; 128 pages; \$1.95, paper-bound.

This is a very unusual book, full of interesting projects for the home experimenter. Some of the puzzles are old classics brought up-to-date with batteries, switches, flashing lights, and buzzers.

Remember the river-crossing puzzle in which the farmer had a dog, a rabbit, and carrots to transport across the river, one at a time, with certain limitations and stipulations as to who could be left with what, etc? In this book, the author has added variety by making the game involve a policeman, a prisoner, a dog, and some food which must be transported across the river with certain stipu-

lations. The game board is quite simple and clever, and a red warning light flashes on instantly when a mistake is made.

There are games for two players as well, some similar to the old fascinating hunt-'em-down game of "Battleship," but brought up-to-date as "Jet Plane" with batteries and buzzers. Then there are games for several players that are reminiscent of Monopoly and advance-or-retreat-type games, but with unique variations involving chance combinations of the various players' peg positions which light up special instructions for the last player that help or hinder his progress.

Construction details are clear and complete so that even the rank newcomer to the soldering iron and double-throw switch can start right in building almost any one of the interesting projects. It should be pointed out, however, that the title is slightly misleading — there is no electronic circuitry involved anywhere in this book. It deals entirely with simple DC electrical circuits involving little more than flashlight bulbs and batteries, switches, and wire. Still, what can be done with these mundane and very inexpensive materials is remarkable.

Impedance Matching

Ed. by Alexander Schure; pub. by John F. Rider Publisher, Inc., New York; 120 pages; \$2.90, paper-bound.

All electronic equipment either uses, converts, or wastes electric power. When this power must be transferred from one stage to another, proper impedance matching between the stages involved becomes quite important if a reasonable degree of efficiency is desired in the process.

This book, the only one that I know of devoted exclusively to impedance matching, covers the entire subject in both theory and concrete applications, all the way from DC through 60-cps AC and audio to RF. There are diagrams and illustrative problems in abundance to help the layman, engineer, and technician in easy stages toward a thorough practical knowledge of the subject.

Each of the books in Rider's Electronic Technology Series is a gem, and this is no exception.

Easy-to-build



- style
- performance
- quality

costs you less!



MONAURAL-STEREO PREAMPLIFIER KIT (Two Channel Mixer)

MODEL SP-2 (stereo) **\$56.95** Shpg. Wt. 15 lbs.
 MODEL SP-1 (monaural) **\$37.95** Shpg. Wt. 13 lbs.
 MODEL C-SP-1 (converts SP-1 to SP-2) **\$21.95**
 Shpg. Wt. 5 lbs.

Special "building block" design allows you to purchase instrument in monaural version and add stereo or second channel later if desired. The SP-1 monaural preamplifier features six separate inputs with 4 input level controls. A function selector switch on the SP-2 provides two channel mixing. A 20' remote balance control is provided.



PROFESSIONAL STEREO-MONAURAL AM-FM TUNER KIT

MODEL PT-1 **\$89.95**

The 10-tube FM circuit features AFC (automatic frequency control) as well as AGC. An accurate tuning meter operates on both AM and FM while a 3-position switch selects meter functions without disturbing stereo or monaural listening. Individual flywheel tuning on both AM and FM. FM sensitivity is three microvolts for 30 db of quieting. The 3-tube FM front end is prewired and pre-aligned, and the entire AM circuit is on one printed circuit board for ease of construction. Shpg. Wt. 20 lbs.



STEREO EQUIPMENT CABINET KIT

MODEL SE-1 (center unit) **\$149.95**

Shpg. Wt. 162 lbs.

MODEL SC-1 (speaker enclosure) **\$39.95** each

Shpg. Wt. 42 lbs.

Superbly designed cabinetry to house your complete stereo system. Delivered with pre-cut panels to fit Heathkit AM-FM tuner (PT-1), stereo preamplifier (SP-1 & 2) and record changer (RP-3). Blank panels also supplied to cut out for any other equipment you may now own. Adequate space also provided for tape deck, speakers, record storage and amplifiers. Speaker wings will hold Heathkit SS-2 or other speaker units of similar size. Available in unfinished birch or mahogany plywood.

World's largest manufacturer of electronic instruments in kit form

HEATH COMPANY

Behton Harbor, 18, Michigan

 a subsidiary of Daystrom, Inc.



HIGH FIDELITY RECORD CHANGER KIT

MODEL RP-3 **\$64.95**

Turntable quality with fully automatic features! A unique "turntable pause" allows record to fall gently into place while turntable is stopped. The tone arm engages the motionless record, and a friction clutch assures smooth start. Automatic speed selector plays mixed 33 1/2 and 45 RPM records regardless of sequence. Four speeds available: 16, 33 1/2, 45 and 78 RPM. Changer complete with GE-VR-II cartridge with diamond LP and sapphire 78 stylus, changer base, stylus pressure gauge and 45 RPM spindle. Shpg. Wt. 19 lbs.

"EXTRA PERFORMANCE" 55 WATT HI-FI AMPLIFIER KIT

A real work horse packed with top quality features, this hi-fi amplifier represents a remarkable value at less than a dollar per watt. Full audio output at maximum damping is a true 55 watts from 20 CPS to 20 kc with less than 2% total harmonic distortion throughout the entire range. Featuring famous "bas-bal" circuit, push-pull EL34 tubes and new modern styling. Shpg. Wt. 28 lbs.



MODEL W7-M **\$54.95**



"BOOKSHELF" 12 WATT AMPLIFIER KIT
MODEL EA-2 \$28⁹⁵

There are many reasons why this attractive amplifier is such a tremendous dollar value. You get rich, full range, high fidelity sound reproduction with low distortion and noise . . . plus "modern styling". The many features include full range frequency response 20 to 20,000 CPS ± 1 db with less than 1% distortion over this range at full 12 watt output—its own built-in preamplifier with provision for three separate inputs, mag phono, crystal phono, and tuner—RIAA equalization—separate bass and treble tone controls—special hum control and it's easy-to-build. Complete instructions and pictorial diagrams show where every part goes. Cabinet shell has smooth leather texture in black with inlaid gold design. Shpg. Wt. 15 lbs.

"MASTER CONTROL" PREAMPLIFIER KIT
MODEL WA-P2 \$19⁷⁵

All the controls you need to master a complete high fidelity system are incorporated in this versatile instrument. Features 5 switch-selected inputs each with level control. Provides tape recorder and cathode-follower outputs. Full frequency response is obtained within $\pm 1\frac{1}{2}$ db from 15 to 35,000 CPS and will do full justice to the finest available program sources. Equalization is provided for LP, RIAA, AES, and early 78 records. Shpg. Wt. 7 lbs.



HIGH FIDELITY TAPE RECORDER KIT
MODEL TR-1A \$99⁹⁵

Includes tape deck assembly, pre-amplifier and roll of tape.

The model TR-1A provides monaural record/playback with fast forward and rewind functions. $7\frac{1}{2}$ and $3\frac{3}{4}$ IPS tape speeds are selected by changing belt drive. Flutter and wow are held to less than 0.35%. Frequency response at $7\frac{1}{2}$ IPS ± 2.0 db 50-10,000 CPS, at $3\frac{3}{4}$ IPS ± 2.0 db 50-6,500 CPS. The model TE-1 record/playback tape preamplifier, supplied with the mechanical assembly, provides NARTB playback equalization. A two-position selector switch provides for mike or line input. Separate record and playback gain controls. Cathode follower output. Complete instructions provided for easy assembly. Signal-to-noise ratio is better than 45 db below normal recording level with less than 1% total harmonic distortion. (Tape mechanism not sold separately). Shpg. Wt. 24 lbs.



MODEL TE-1 \$39⁹⁵
 Shpg. Wt. 10 lbs. (Tape Preamplifier Only)



HIGH FIDELITY AM TUNER KIT
MODEL BC-1A \$26⁹⁵

Designed especially for high fidelity applications this AM tuner will give you reception close to FM. A special detector is incorporated and the IF circuits are "broadbanded" for low signal distortion. Sensitivity and selectivity are excellent and quiet performance is assured by a high signal-to-noise ratio. All tunable components are prealigned before shipment. Your "best buy" in an AM tuner. Shpg. Wt. 9 lbs.



HIGH FIDELITY FM TUNER KIT
MODEL FM-3A \$26⁹⁵

For noise and static-free sound reception, this FM tuner is your least expensive source of high fidelity material. Efficient circuit design features stabilized oscillator circuit and broadband IF circuits for full fidelity with high sensitivity. All tunable components are prealigned before shipment. Edge-illuminated slide rule dial. Covers complete FM band from 88 to 108 mc. Shpg. Wt. 8 lbs.

"UNIVERSAL" 12 WATT AMPLIFIER KIT
MODEL UA-1 \$21⁹⁵

Ideal for stereo or monaural applications, this 12-watt power package features less than 2% total harmonic distortion throughout the entire audio range (20 to 20,000 CPS) at full 12-watt output. Use with preamplifier models WA-P2 or SP-1 & 2. Taps for 4, 8 and 16 ohm speakers. Shpg. Wt. 13 lbs.



YOU'RE NEVER OUT OF DATE WITH HEATHKITS

Heathkit hi-fi systems are designed for maximum flexibility. Simple conversion from basic to complex systems or from monaural to stereo is easily accomplished by adding to already existing units. Heathkit engineering skill is your guarantee against obsolescence. Expand your hi-fi as your budget permits . . . and, if you like, spread the payments over easy monthly installments with the Heath Time Payment Plan.

CONTEMPORARY
Model CE-1B Birch
Model CE-1M Mahogany



- No Woodworking Experience Required For Construction.
- All Parts Precut & Pre drilled For Ease of Assembly.
- Maximum Overall Dimensions: 18" W. x 24" H. x 35½" D.



TRADITIONAL
Model CE-1T Mahogany

CHAIRSIDE ENCLOSURE KIT

MODEL CE-1 **\$43⁹⁵** each

Control your complete home hi-fi system right from your easy chair with this handsome chairside enclosure in either traditional or contemporary models. It is designed to house the Heathkit AM and FM tuners (BC-1A and FM-3A) and the WA-P2 preamplifier, along with the RP-3 or majority of record changers which will fit in the space provided. Well ventilated space is provided in the rear of the enclosure for any of the Heathkit amplifiers designed to operate with the WA-P2. The tilt-out shelf can be installed on either right or left side as desired during the construction, and the lift-top lid in front can also be reversed. All parts are pre-cut and pre drilled for easy assembly. The contemporary cabinet is available in either mahogany or birch, and the traditional cabinet is available in mahogany suitable for the finish of your choice. All hardware supplied. Shpg. Wt. 46 lbs.

**IT'S EASY . . . IT'S FUN
AND YOU SAVE UP TO ½
WITH DO-IT-YOURSELF HEATHKITS**

Putting together your own Heathkit can be one of the most exciting hobbies you ever enjoyed. Simple step-by-step instructions and large pictorial diagrams show you where every part goes. You can't possibly go wrong. No previous electronic or kit building experience is required. You'll learn a lot about your equipment as you build it, and, of course, you will experience the pride and satisfaction of having done it yourself.



**DIAMOND STYLUS HI-FI
PICKUP CARTRIDGE**

MODEL MF-1 **\$26⁹⁵**

Replace your present pickup with the MF-1 and enjoy the fullest fidelity your library of LP's has to offer. Designed to Heath specifications to offer you one of the finest cartridges available today. Nominally flat response from 20 to 20,000 CPS. Shpg. Wt. 1 lb.

**"RANGE EXTENDING" HI-FI
SPEAKER SYSTEM KIT**

The SS-1B employs a 15" woofer and super tweeter to extend overall response of basic SS-2 speaker from 35 to 16,000 CPS ± 5 db. Crossover circuit is built in. Impedance is 16 ohms, power rating 35 watts. Constructed of ¾" veneer-surfaced plywood suitable for light or dark finish. Shpg. Wt. 80 lbs.

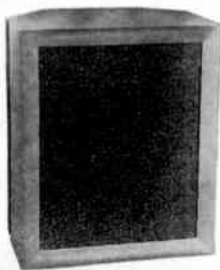

MODEL SS-1B
\$99⁹⁵



SEND FOR FREE CATALOG

Describing over 100 easy-to-build kits in hi-fi, test, marine and ham radio fields. Also contains complete specifications and schematics.

"BASIC RANGE" HI-FI SPEAKER SYSTEM KIT



MODEL SS-2 **\$39⁹⁵**

Legs: No. 91-26 Shpg. Wt. 3 lb. \$4.95

The modest cost of this basic speaker system makes it a spectacular buy for any hi-fi enthusiast. Uses an 8" mid-range woofer and a compression-type tweeter to cover the frequency range of 50 to 12,000 CPS. Crossover circuit is built in with balance control. Impedance is 16 ohms. Power rating 25 watts. Tweeter horn rotates so that the speaker may be used in either an upright or horizontal position. Cabinet is made of veneer-surfaced furniture-grade plywood suitable for light or dark finish. All wood parts are pre-cut and pre drilled for easy assembly. Shpg. Wt. 26 lbs.

LEGATO HI-FI SPEAKER SYSTEM KIT

MODEL HH-1 **\$299⁹⁵**

The startling realism of sound reproduction by the Legato is achieved through the use of two 15" Altec Lansing low frequency drivers and a specially designed exponential horn with high frequency driver. The special crossover network is built in. Covers 25 to 20,000 CPS within ± 5 db. Power rating 50 watts. Cabinet is constructed of ¾" veneer-surfaced plywood in either African mahogany or white birch suitable for the finish of your choice. All parts are pre-cut and pre drilled for easy assembly. Shpg. Wt. 195 lbs.



HEATH

pioneer in
"do-it-yourself"
electronics

COMPANY • BENTON HARBOR 18, MICH.

a subsidiary of Daystrom, Inc.

Please send the Free Heathkit catalog.

name _____

address _____

city & state _____

Enclosed find \$.....
Please enclose postage
for parcel post—express
orders are shipped de-
livery charges collect.
All prices F.O.B. Benton
Harbor, Mich. A 20% de-
posit is required on all
C.O.D. orders. Prices
subject to change with-
out notice.

QUANTITY	ITEM	MODEL NO.	PRICE



Audiobooks

CONVERSION KIT

Owners of recent Garrard record players may now obtain a kit for \$4.95 which will convert the players for stereo use. Included are a female connector wired with two leads for the tone arm, a complete audio cable with plug for the second amplifier, a stereo shell in which to mount the cartridge, hardware, and illustrated instructions. An ordinary screw driver will accomplish installation without the necessity of soldering. *Model SCK-1* will convert Garrard Models RC 88, 98, 121, and T mk II; *Model SCK-2* will convert the RC 121/II.

VALVO TUBES

Valvo tubes, manufactured in Europe and used extensively in many imported German radios and hi-fi equipment, are now available in the United States from Amperex Electronic Corporation, and are sold directly through Amperex distributors. Servicemen can replace tubes in foreign-made equipment with identical types, insuring the same continued operation from a set.

GE FM-AM TUNER

General Electric's latest high-fidelity product is an FM-AM tuner selling for about \$130. As *Model FA-11* it has a russet leather-vinyl finish, and as the *FA-12* it is finished in gray vinyl. All other details are the same. Features include an automatic frequency control

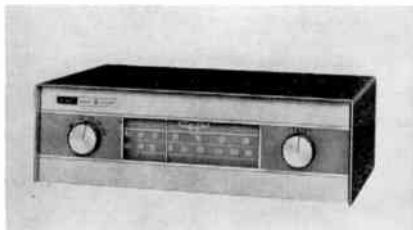

GE Model FA-11 FM-AM tuner.

(AFC), a multiplex jack, a folded-dipole FM antenna, and a built-in ferrite-rod AM antenna with tuned radio-frequency stage for increased sensitivity and low noise level. FM sensitivity is said to be $5 \mu\text{v}$ on the 300-ohm input for 30 db quieting, and AM sensitivity is stated as $200 \mu\text{v}$ per meter for 20 db signal-to-noise ratio. A maximum of $1\frac{1}{2}\%$ harmonic distortion at rated output and less than 2% IM are claimed. Dimen-

sions of the tuner are $15 \frac{1}{32}$ by $10\frac{1}{8}$ by $5\frac{1}{8}$ in.

MILLER CATALOGUES

Miller Radio Products has recently released two catalogues, *General Catalogue No. 59* and *TV Technician's Coil Replacement Guide No. 159*. No. 59 lists over 1,000 items such as RF chokes, line filters, IF transformers, and line-filter chokes. No. 159 contains Miller's coil-replacement numbers for more than 2,000 different chassis and 11,000 TV-model numbers.

ERIC TUNERS

Two tuners being offered by Eric Engineering are the *Model 357* FM-AM tuner and the *Model 457* FM tuner. Features of the 357 include self-powering, complete shielding, fly-wheel tuning, built-in antenna for local reception, and

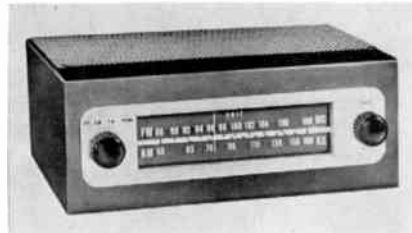

Eric Model 357 FM-AM tuner.

extended shafts for panel mounting. AM sensitivity is stated to be less than $40 \mu\text{v}$; FM sensitivity is said to be $5 \mu\text{v}$ for 20 db of quieting. Claimed frequency response is 20 to 6,000 cps on AM and 20 to 20,000 on FM. The cabinet measures 10 by $7\frac{1}{2}$ by 4 in.; audiophile net is \$71.95.

The size of the 457 is identical to that of the 357. Special features include: no antenna required for local reception, ground-grid RF amplifier, automatic frequency control and automatic gain control, neon-glow lamp to indicate station



Eric Model 457 FM tuner.

center, self-limiting discriminator, fly-wheel tuning, slide-rule dial, and shafts long enough for panel mounting. According to the manufacturer, sensitivity is $1.5 \mu\text{v}$ for 20 db of quieting, and frequency response is flat from 20 to 20,000 cps.

PENTRON STEREO RECORDER

Pentron has added a stereo tape-recorder/playback system, the *Emperor II Model NL-4*, to its line of recording equipment. It lists at \$450 and is housed in a contemporary, scuff-resistant, two-tone carrying case with two tape-storage compartments. Special features include an automatic microswitch end-of-reel shutoff, automatic idler disengagement,



Pentron's Emperor II stereo recorder.

instant automatic braking, and a tape-lift mechanism for fast forward and rewind operations. Frequency response is stated as 40 to 15,000 cps at $7\frac{1}{2}$ ips and 40 to 10,000 cps at $3\frac{3}{4}$ ips. Two small oval speakers are built in for monitoring, and two microphones are supplied for stereo recording. Optional accessories offered are a portable stereo speaker system, the *Model ES-2* listing at \$75, and a remote-control accessory, *Model RC-6* listing at \$15.

UNIVERSITY TECHNOLOG

The *Technilog*, a 64-page guide to sound planning, is being offered by University Loudspeakers for \$1.00. The subjects discussed include: how to apply driver-unit specs; overload protection; line-matching problems; correct phasing; best use of available power and effects of mismatch; adjusting power capacity and cutoff; how and which type of speaker to apply where; control of reverberations; using speakers as high-output microphones; and baffling cone speakers. Each section contains complete architects' and engineers' specifications.

FOUR-TRACK STEREO

Superscope's *Model 555-A* Stereorecorders may now be purchased as *Model 555-A4* with an extra playback head to reproduce the new four-track stereo tapes. The head is an optional feature, and may be added to a 555-A at any future time.

RCA TUBE

The *RCA-7199* is the first triode-pentode tube designed by RCA specifically for

audio use. It is a nine-pin low-hum miniature type, and it utilizes a 6.3-volt/450-ma heater. A controlled sharp-cutoff characteristic and high transconductance (7,000 micromhos) in the pentode unit are said to give high gain at low distortion; the triode unit has an amplification factor of 17. Other design features include: folded-coil (single helical) heaters in both pentode and triode sections; cage assembly mounted on short, stiff stem leads; reduced interelectronic coupling; an internal shield; and separate cathodes for each unit.

THORENS TURNTABLES

Thorens Company has recently announced two modestly priced versions of the TD-124 turntable. The TD-134 manual player, which lists at \$60, incorporates the same precision-machined, adjustable-speed drive that is used in the TD-124. It is provided with an integral tone arm, said to give fine tracking performance, and a plug-in adapter for standard stereo or monophonic cartridges. The unit measures 15 by 12 in., and extends 2½ in. below the panel and 3 in. above.

The TD-184 lists for \$75, and is identical to the TD-134 except for semi-automatic operation. A dial selects record size, starts the motor, and actuates the arm which lowers automatically into the first record groove. According to the manufacturer, there is no connection between arm and turntable during play. A manual-reject control permits shutoff, interruption, or manual operation. It is not a record changer.

LAFAYETTE CATALOGUE

Lafayette Radio's 1959 general catalogue (No. 590) is now ready. It is 260 pages thick, and has an 8-by-10-inch page format. Not only is Lafayette's own line of components and electronic parts listed, but also the latest products from other major high-fidelity manufacturers. A complete selection of all major-label stereophonic discs and prerecorded tapes is also included. The catalogue is free on request from the manufacturer.

For more information about any of the products mentioned in Audio-news, we suggest that you make use of the Product Information Cards bound in at the back of the magazine. Simply fill out the card, giving the name of the product in which you're interested, the manufacturer's name, and the page reference. Be sure to put down your name and address too. Send the cards to us and we'll send them along to the manufacturers. Make use of this special service; save postage and the trouble of making individual inquiries to a number of different addresses.

knight®

created by ALLIED RADIO

the Royalty of Value in **STEREO HI-FI**

money-saving hi-fi comparable to the very finest
advanced design, features, performance and styling
outstanding for superb musical quality
each unit guaranteed for one full year



knight KN734 deluxe 34-watt stereo amplifier

compare these "royalty of value" features:

only
\$12950
easy terms:
\$12.95 down

Full stereophonic and monophonic controls • 17 watts per stereo channel...34 watts monophonic • Separate bass and treble controls for each channel • 5 pairs of stereo inputs...input jack for accessory remote control • DC on all preamp heaters • Wide range balance control • 3-step loudness contour • Variable input loading control for any magnetic cartridge • May be used as 34 watt add-on with special preamp output • Mar-proof vinyl-clad metal case...solid aluminum anodized front panel.

knight KN120 deluxe stereo FM-AM tuner

compare these "royalty of value" features:

only
\$12950
easy terms:
\$12.95 down

Separate FM and AM sections for simultaneous or separate operation • Dynamic Sideband Regulation for minimum distortion of FM • Dual limiters on FM • Tuned RF stage on FM and AM • 3-position AM bandwidth switch • Cathode follower multiplex output jack • Four cathode follower main outputs • Dual "Microbeam" tuning indicators • Illuminated 9½" tuning scale; inertia tuning with advanced flywheel design • High-sensitivity AM ferrite antenna • Handsome solid aluminum front panel, gold anodized, with beige leathertone case.



FREE 1959 ALLIED CATALOG

Send for your complete, money-saving guide to the world's largest selection of hi-fi systems and components. See everything in thrilling stereo; all the new KNIGHT systems and components; every famous make line. For everything in hi-fi, for everything in Electronics, get the 452-page 1959 ALLIED Catalog. FREE—write for it today.

order from
America's
Hi-Fi Center



ALLIED RADIO

100 N. Western Ave., Dept. 89-18
Chicago 80, Illinois



Ralph Bellamy, starring in "Sunrise At Campobello", listens to stereo on his Collaro changer and Goodmans Triaxonal Speaker System.

Collaro—your silent partner for Stereo

Silence is the requirement — and *silent* performance is what you get when you select the new Collaro stereo changer for your stereo system. Collaro engineers have designed *the* high fidelity changer precision-engineered to meet stereo's rigid quality demands. Collaro's *silent* operation assures flawless reproduction of the exciting new stereo records every time. Here is why Collaro is your best buy.

Five-terminal plug-in head: Exclusive with Collaro. Provides two completely independent circuits thus guaranteeing the ultimate in noise-reduction circuitry.

Transcription-type tone arm: Another Collaro exclusive. As records pile up on a changer, tracking pressure tends to increase. Result may be damage to records or sensitive stereo cartridge. This can't happen with Collaro's counter-balanced arm, which varies less than 1 gram in pressure between the top and bottom of a stack of records. The arm accepts any standard stereo or monaural cartridge.

Velocity trip mechanism: Unique design of this sensitive mechanism insures that the Collaro changer will trip at extraordinarily light tracking pressures — a requirement of many stereo cartridges.

New Collaro changers include *all* of the best features which have made Collaro the largest manufacturer of record changers in the world — as well as important new features vital for superb stereo as well as monaural performance. There are three Collaro changers priced from \$38.50 to \$49.50. The changer illustrated here is the new Continental, Model TSC-840.

For full information on the new Collaro stereo changers, write to Dept. AC-11, Rockbar Corp., Mamaroneck, N. Y.



American sales representative for Collaro Ltd. and other fine companies. RC-7

DYNAKIT

STEREO or MONOPHONIC

Provides Complete Flexibility
and Control at Lowest Cost



Stereo control with two preamps

The Dynakit PREAMPLIFIER KIT

- ★ Finest Quality Available of Circuitry and Components
- ★ Lowest Distortion and Noise
- ★ Easiest Assembly Using Pre-Assembled Printed Circuit
- ★ Handsome Styling — Selected For Display at Brussels World's Fair
- ★ Only \$34.95* net

Power supply available for 2 preamplifiers PS-1 Kit \$8.95* net

The Dynakit STEREO CONTROL KIT

- ★ Adds Complete Stereo Control To Two Preamps Without Noise or Distortion
- ★ Unique Blend Control Fills in "Hole in Middle"
- ★ Level, Balance, Loudness, Channel Reverse, and Dual Tape Monitor Controls
- ★ Only \$12.95* Net

COMING SOON!
DYNACO—B&O
PHONO PICKUP
For Monophonic and
Stereo Discs

Available from leading Hi-Fi dealers everywhere.
Descriptive brochure available on request.

*Slightly higher in the West.

DYNACO INC.

Dept. AC, 617 N. 41st St., Phila. 4, Pa.
Export Division: 25 Warren St., New York, N.Y.

Electronic Firsts



by MONROE UPTON

Author of
"Electronics for Everyone"

LAST month we told of how the appeal of a vaudeville actor, Carl Anderson, for help in his mind-reading act, got Lee De Forest to thinking about his new Audion detector as a separate amplifier of audio frequencies. He was well aware of the telephone industry's desperate search for a repeater (amplifier) that would remove even the short long-distance calls from the realm of high adventure. But it was five years later, in 1912, when employed by the old Federal Telegraph Company in Palo Alto, California, before he found time to do anything about it.

With him in the lab were Herbert Van Etten, former telephone engineer, and Charles V. Logwood. Logwood, though he lacked formal training in engineering and math had, in De Forest's words, "a veritable genius for solving wireless and telephone problems." The two of them set about devising a circuit that would enable the little Audion to amplify telephone signals, with a skeptical Van Etten looking on.

The early Audion, with its gassiness, its coarse grid structure, and its limited electron emission, was far from an ideal amplifier. After three weeks of experiment, however, Van Etten grudgingly admitted that "the thing do boost." Next they tried a cascade connection of two Audions. Coupling was a problem here. Present-day amplifiers use either capacitive coupling, or direct coupling with the cathode held more positive than the positive plate-grid voltage so as to keep the grid negative with respect to the cathode. At Palo Alto they coupled the plate to the grid through a telephone company's repeater coil, a simple iron-core transformer with a ratio of 1:1.

Results were discouraging until a San Francisco X-ray tube manufacturer further exhausted their "soft" tubes. This enabled them to use as much as 120 volts on the plates. The output of the final tube was connected to a large telephone receiver with an attached horn sticking out of the window. De Forest then walked down the street to determine how far the sound carried. When he had achieved what he called a "three-block amplifier" he was satisfied. Today we have hi-fi enthusiasts who aren't happy with anything less than a ten-block amplifier. The world do move.



Joseph Szigeti
tapes his own recordings on

irish
BRAND
ferro-sheen
recording
tape

That alone is not the reason
why you should use

irish
BRAND
ferro-sheen
recording
tape

Here's why you should use

irish
BRAND
ferro-sheen
recording
tape:

It's the best-engineered tape
in the world...

...gives you better highs...better lows...
better sound all around! Saves your tape
recorder, too—because the **irish FERRO-SHEEN**
process results in smoother tape
...tape that can't sand down your mag-
netic heads or shed oxide powder into your
machine. Price? Same as ordinary tape!



Available wherever quality tape is sold.
ORRadio Industries, Inc., Opelika, Alabama
Export: Morhan Exporting Corp., New York, N. Y.
Canada: Atlas Radio Corp., Ltd., Toronto, Ontario

Only
THE FISHER

has all
of these features

400



THE "400"
STEREOPHONIC
MASTER
AUDIO
CONTROL

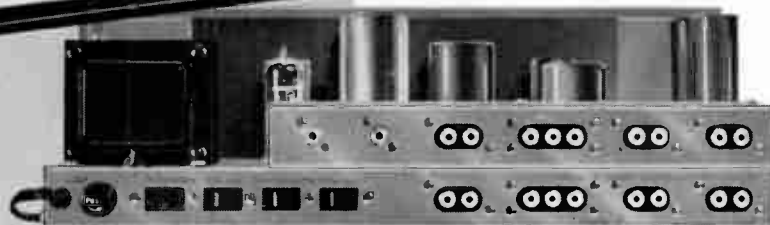

Your dealer will be happy to demonstrate
THE "400" for you. Compare **THE FISHER**
side-by-side with any other stereophonic audio
control system, regardless of price. In features, in
construction, and in ease-of-operation,
THE FISHER will prove itself to be the best!

- Eight pairs of stereo inputs, 4 pairs for low-level, 4 pairs for high-level.
- Seven pairs of permanent connections, 4 low-level, 3 high-level.
- High-gain microphone preamplifier.
- Push-button function and channel selection.
- Built-in crossover network, with complete use of the tone controls at all times.
- 3-position, lever-type Rumble Filter.
- 3-position, lever-type Loudness Contour Control.
- Special input for ceramic stereo cartridge.
- Channel indicator lamps.
- Power-on indicator lamp.
- Four auxiliary AC receptacles.
- Three cabinet finishes, for any room decor.

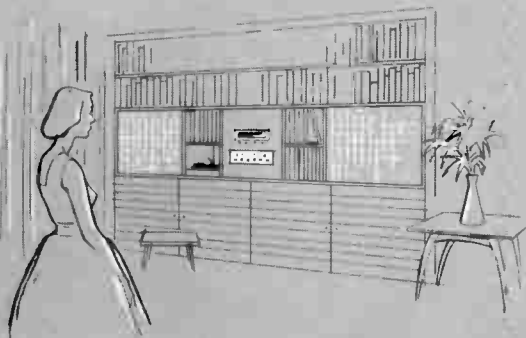

WRITE TODAY FOR COMPLETE SPECIFICATIONS



FISHER RADIO CORPORATION • 21-31 44th DRIVE • LONG ISLAND CITY I, N. Y.



How To Be Unhappy with Stereo

Gentlemen:

The printed-circuit oscillator ("Build a Printed-Circuit Oscillator") described in the September issue specifies a "1- μ fd, 200-volt DC metalized paper capacitor" as a plate-to-grid coupling entity. The use of a metalized paper capacitor for that circuitry is a perfect example of component misapplication.

The following conditions may be expected. 1) The low initial insulation resistance of the metalized unit will rapidly deteriorate and will thus allow a considerable positive voltage to be impressed on the grid of the 6U8 tube, thereby materially shortening its life, to say nothing about the severe distortion which will occur as a result of improper bias. 2) The internal short circuiting of this capacitor (i.e., its inherent "self-healing" characteristic) will be evidenced



as random spurious pulses and noise in the output. 3) Both the above effects are accelerated with time and with increased temperature condition. They are also a function of the ratio of the actual applied voltage to the voltage rating; it would therefore seem that the 200 v DC rating for this metalized capacitor is slightly inadequate. The fact that the physical location of the capacitor is right next to a tube would similarly aggravate the condition.

The use of metalized capacitors should be limited solely to power-supply filtering and bypass applications where their detrimental parameters are unimportant.

The old adage about not being able to get something for nothing still holds true. Metalized paper capacitors are much smaller than their straightforward foil and paper counterparts, but one must be ready to accept their much poorer electrical characteristics and, in the case of nonhermetically sealed construction, inherent short "shelf life" (due to moisture absorption).

Ed Glass
New York, N.Y

THERE are a great many things that can make you unhappy with a stereo system. A few of them are outside the range of practical control, but most are directly traceable to a fallacy that has been encouraged (if not first stated) by the manufacturers of mass-produced and marginal-fi phonograph equipment. The fallacy goes like this: stereo is an advancement in sound reproduction technique; therefore, it minimizes or eliminates the need for high fidelity. Nothing could be further from the truth.

In plain fact, stereo isn't a miraculous new sound medium in itself. It is, simply, one aspect of a sound transmission system's performance—like low noise and distortion, flat frequency response, and wide dynamic range—which together determine the fidelity of the system. If none of the other determinants of fidelity is sacrificed significantly in converting a system to stereo, that system most probably will be higher in fidelity than it was monophonically. But if converting to stereo involves a substantial increase in distortion, for example, you are merely exchanging one aspect of fidelity for another. Why bother? The system will be different but no better. After you become accustomed to the new dimension, and begin to listen critically again, we'll bet that you prefer low-distortion monophony to high-distortion or limited-range stereophony.

Consequently it is a mistake to assume that stereo replaces high fidelity. Two poor sound channels, or even one good and one poor channel, are *not* better than one good channel alone; they are worse. You have to be sensible, of course—neither space nor money may be available for duplication of a \$700 speaker system. It doesn't have to be duplicated exactly, so long as the second speaker system is of equivalent quality and similar sound coloration over its operating range; and you don't have to pay \$700 to achieve that. But it is ridiculous to expect a \$3.98 "hi-fi" speaker, and a six-watt bargain amplifier, to do anything but degrade a very good monophonic system if you try to add them as a second channel for stereo. That is poor economy indeed.

If you can't afford good components now for the second channel, you're better off to wait until you can. After all,

your monophonic system gave you good service before stereo came along; has the availability of stereo made your present system less satisfactory? Of course not.

A COROLLARY to the primary fallacy is that stereo makes flaws in reproducing equipment less obvious. That is true only so far as limited frequency range is concerned. It is true also, however, that (provided distortion is low in either case) a smooth extension of frequency range improves the realism of a stereo system as much as that of a monophonic system. And in other respects, flaws and misadjustments in equipment are even more noticeable with stereo—particularly disc stereo. Belief in the corollary, then, also can make you unhappy with stereo.

For example, you should use extreme care in setting up a stereo arm and cartridge. Tracking error produces more distortion than it does in a monophonic disc-record system, because of the more complex stylus motions. Not only must you adjust carefully the amount by which the stylus overhangs the turntable spindle, but you must set the arm height so that the stylus is at the correct angle with respect to the record when viewed from the side. (Usually this angle is vertical, and is obtained when the arm is parallel to the record in playing position). It is absolutely essential that the stylus be disposed vertically toward the record when seen from the front, as well; if it isn't, the stereo effect will be distorted dreadfully.

The subjectively magnified surface noise of stereo discs makes it more important than ever to have pickup cartridges and loudspeakers as peak-free as possible, because response irregularities in either serve to accentuate noise. Most stereo cartridges have lower output than their monophonic equivalents; consequently, preamplifiers must have even lower electrical noise and hum levels.

We don't want to discourage conversions to stereo, and we don't think our warning here will do so. Anyone who has heard a good stereo system knows it to be well worth the extra expense and care. Our purpose in this essay is to state emphatically that equipment quality is just as important in a stereo system as it is in a monophonic system—perhaps even more important. —R.A.

How compatible are

Part III: Rumble, phase, and hum problems

THERE is no question about rumble being a major problem in stereo-disc reproduction. While lateral turntable rumble has been reduced substantially in the ten years we have had LP's, more often than not the lateral rumble merely has been converted to vertical rumble. This "tuning" of the motor vibration was fine as long as we were dealing with conventional LP's. But the stereo record is played with a cartridge having vertical sensitivity as great as lateral sensitivity. Unless the vibration is absorbed by some material, the vertical motion is bound to cause trouble; in most record changers I tested, it did. This was true also of several lower-priced record players and turntables.

I do not mean to imply that *only* a high-priced turntable should be used for stereo; I have, in fact, found some good lower-priced ones. Whatever kind of record-rotating device you have or intend to buy, you can check its suitability for stereo by turning it on and resting your hand on the plate to which the turntable bearing is attached. There should be no noticeable vibration. This won't spot rumble caused by such things as idlers, pulleys, and turntable shafts, but it will, in most cases, give you a good indication of how much trouble you are likely to encounter.

A stereo record-playing system is more susceptible to acoustic feedback also — again, because either vertical or lateral motion produces an electrical output from a stereo cartridge. Don't mount the player on or close to a speaker system. You may find it necessary to isolate the deck or unit plate of the changer or

turntable from the base by springs or foam rubber, if such isolation isn't built in. And be careful when walking; you'd be surprised how little vibration it takes to create sound in the speaker.

Wow and flutter still have to be taken into account. Wow never sounded worse than it does in full dimension. Flutter is not accentuated—merely annoying. By and large, some pains taken with your unit will cure all these defects. But it is somewhat chastening to be forcefully thrown from your ivory tower. The important thing to realize is that stereo, contrary to a few early reports, doesn't cover up most defects in equipment. Since stereo sound brings us another step closer to potential perfection, equipment defects may be even more annoying.

Turntables in general are quieter and have fewer speed irregularities than the lighter changers and players. They should have; they generally cost more. And even they have their own stereo problems. Arm location is much more critical with a stereo record; less tracking error is tolerable. Consequently, accurate location of the center of the turntable and careful plotting of the correct arc for the center of the tone arm are more important than ever. The arm must be level in three ways. First, it must be parallel to the surface of the disc, to achieve good vertical tracking. Next, the arm must be balanced around its horizontal pivot, so that it doesn't roll. Lastly, it should be in dynamic balance so that it is not easily jarred.

Aside from the foregoing considerations for tone arms installed on turntables, the following must be carefully noted for all installations. The cartridge

stylus must be absolutely vertical with respect to the disc; it cannot be tilted. Severe tilt will ruin the record, the stylus, and the sound. This applies to the stylus as seen from the front. Unless otherwise noted as correct for the particular cartridge, it applies also to the side view. Unless you plan to use the cartridge in a changer for playing stacks of records, set the cartridge in such a manner that the correct stylus angle (viewed from the side) occurs on the first record. If you do plan to use it on stacks, adjust the cartridge for this condition on the fifth record. Doing so will permit the stylus to have a nearly optimum angle for most of the records.

Speaker phasing is another consideration worthy of note here. Originally, when setting up mikes for stereo, some engineers paid little attention to phase between the channels. Now the mikes are all in phase, the amplifiers are all in phase, and the master tape recorders are all in phase. In order to re-create as accurately as possible the sound originally recorded, your two speakers *must* be in phase. In monophonic two-speaker systems this was easy: you had only to wire the speakers so that they moved the same way when a battery was connected to the input terminals of the speaker system. But in stereo you have two separate sound systems to get in proper phase. Misphasing can occur in one of the preamplifiers, amplifiers, or speaker systems, or in the connections between them — particularly if units in the two chains are not identical.

One way of setting phase is to listen to stereo material and, with a double-pole double-throw switch, reverse connections to one of the speaker systems and determine which way the stereo sounds better. The in-phase connection will result in better sound: greater stereo spread and better localization. If the channels are out of phase, on the other hand, the sound will jump from one speaker to the other as you move across the room. Still an easier method is to

Some tips on solving three of the most worrisome problems with stereo discs

STEREO DISCS ?

by JOEL EHRLICH

play a monophonic disc on the stereo system, with the speakers placed close together. Balance the system and then reverse the phase on one speaker. If the low bass level increases, the speakers were out of phase and are now in phase. If the bass level drops, the speakers were in phase and are now out of phase; return to the original setting.

Channel reversal is also important in setting up. The easiest way to accomplish correct channel placement is to get one of the demonstration records (such as the Capitol) which identifies one channel. Simply connect the identified channel to the correct side. You'll be surprised to find that frequently, tapes and broadcasts do not correspond with this location. A channel reversal switch is very handy as an operating control.

Many cartridges do not have equal output level from both channels. This requires different level adjustments—simple on some preamps, which have dual level-setting pots, but more difficult on most sets. There is no simple cure for this condition except action by both cartridge and preamp manufacturers, especially the cartridge makers.

Hum, with stereo cartridges, can be a sticky problem. Usually it occurs mostly on one channel, which makes its elimination no simple task. Hum can stem from several sources, one of which is a ground loop. Aside from this, hum is usually the result of motor field pick-up by the cartridge or leads. Make sure the leads are dressed well away from the motor (and all transformers), and that all shield connections are secure. In addition, take care that the changer (or turntable and tone arm) is securely grounded to the chassis of the preamp (or one of the two chassis, when two preamps are used). If the hum results from motor radiation, and reorientation of the arm doesn't help, there is nothing to do but replace either the changer/turntable or cartridge.

The ground loop is probably the most common source of hum with stereo cartridges. This is created by improper grounding procedure. Properly, there should be but one ground point in the entire system. All points to be grounded should be connected directly to this point. In a high-gain, low-level circuit, very small potentials may be amplified enough to be troublesome. If there are two

ground returns between the cartridge and the preamps, one is bound to have slightly more resistance in it than the other. This means there will be a small difference in potential between the two grounds, at the output end. The very small 60-cps signal appearing between these two points will be picked up and amplified by the high-gain circuit. Since this hum may be only slightly lower in level than the output of the average magnetic stereo cartridge, it can be quite loud.

Stereo cartridges come with either three or four terminals on the output. Three-terminal units are usable in many systems, primarily those with single-chassis stereo preamps or preamp-amplifier

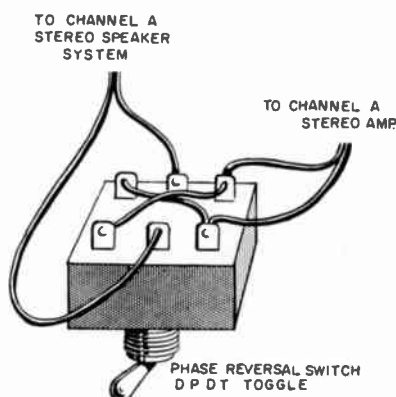

A simple phasing switch.

units. The single common ground is not then troublesome. With two separate preamps, joined at the amplifier, tape recorder, tuner, television set, or any other unit, where both channels have common controls, there will be two separate grounds being combined. No matter where this occurs, there is almost certain to be a difference in ground potentials.

Even with a single-chassis stereo preamp or amplifier, there can be hum troubles caused by ground loops. As an example, let me cite something that occurred during the test work for this article. A prototype of a stereo record changer was being tested. It had no plug-in shell, but rather a one-piece arm. Running through it were two coaxial leads; the shields were uninsulated from each other, but the setup was usable

with a four-terminal cartridge. The two grounds were joined at the muting switch, however, and they were joined at a number of places in the arm, each place the shields touched each other.

From the first, hum was noticeable. A four-terminal cartridge worked on only one channel and a three-terminal cartridge, aside from hum, seemed to cause the single-chassis amplifier to block and distort. The difficulty was finally traced to the multiple ground loops. Covering one of the coaxial leads with spaghetti and cutting it free of the ground at the muting switch cured all the troubles.

The last topic to be covered in full in this report is rather broad. It concerns general notes about stereo cartridges and stereo records. So far, I have had an opportunity to check some six stereo cartridges fully. With only one exception, they have been excellent—not quite so good as the best of the recent monophonic cartridges, but, taken by themselves, really very good.

Distortion was generally low, high-frequency response good, separation reasonable; the over-all sound was clear, not too badly colored, and pleasant to listen to. The records were technically more than adequate. So far I have been able to listen to RCA Victor, Capitol, Elektra, Vanguard, Counterpoint, London, and Decca records. In addition, a few labels such as Seeco, Hallmark, Audio Fidelity, and ABC Paramount were given brief study. Generally, recording technique wasn't always what I would have used (I am as opinionated as any other recording engineer), but all the discs were technically well recorded.

I did find that what had been predicted by many was true; you must *listen* to stereo. I was aware of this from listening to stereo tapes, and was not unprepared for it in stereo records. I doubt that stereo background music will ever be very successful. Still, a good stereo recording *can* be listened to even with the distraction of conversation in the background, which isn't often true of monophonic recordings.

PERFECTIONIST'S

by DAVID BEATTY



Here is the home of Dr. Lester Blender. Its appearance belying the mammoth hi-fi system housed within its slender walls.

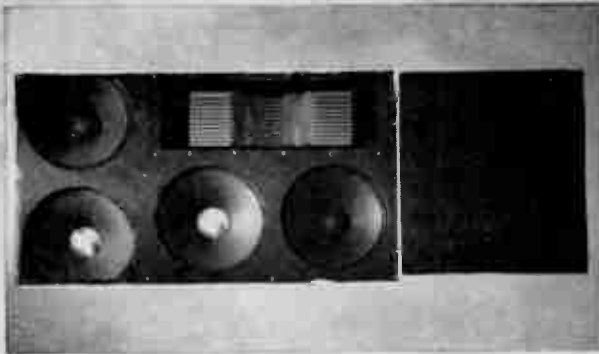

This was Dr. Blender's monophonic system, with its four woofers and JBL 375 tweeter.



To make way for stereo, the old panel was removed, and the wall opening enlarged.

Front view of the stereo system discloses eight woofers and two JBL high-frequency assemblies, spaced about six feet apart.

THE unpretentious white frame house of Dr. Lester Blender in suburban Roeland Park, Kansas City, is an outstanding example of the saying that wonderful things come in small packages.

The casual passerby would not suspect that it houses one of the most elaborate and powerful stereophonic high-fidelity systems in the Middle West, perhaps in the country. That is the opinion of the installer, David Beatty, the pioneer in Kansas City custom-music installations.

The system is even more unique in that it furnishes its owner a soothing companionship for long hours which might otherwise be dreary. Dr. Blender was forced to retire from his profession of dentistry because of the inroads of multiple sclerosis. For that reason alone the installation is more than worth the time and money involved.

Dr. Blender, who practiced dentistry for 29 years in Kansas City and served the nation in the United States Navy in World War II, came up through the "throes," as he calls it, of high fidelity. Long a music advocate, he studied the violin as a young man, embarked early on collecting records, and at present has more than 4,000 LP's and tapes in his extensive collection.

Shortly after his return from service in 1946 he purchased a \$1,600 commercial console radio-phonograph. This served until he heard a Beatty component system.

He immediately modified his console with a GE magnetic pickup, Newcomb 30-watt amplifier, and a 15-inch Altec-Lansing speaker built into the living-room wall. Next step was junking the console and going over completely to components and progressing gradually to a monophonic setup similar to his present one, in which he had four JBL (James B. Lansing) D130 15-inch woofers and a JBL Model 375-537-509 high-frequency driver-horn acoustical-lens assembly. This was driven by a Marantz 40-watt power amplifier and Marantz preamplifier using a Fairchild 225 diamond-point pickup, Gray viscous-damped arm, and transcription turntable.

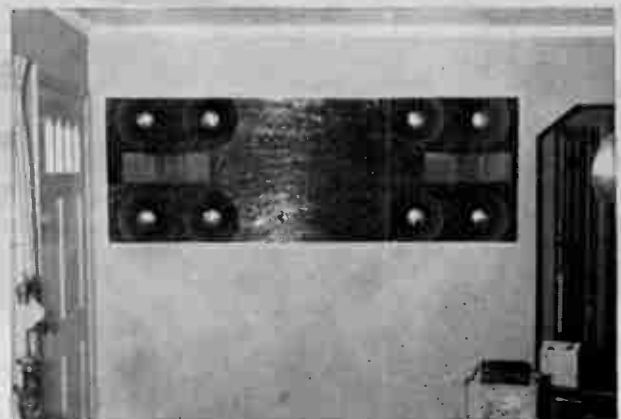

STEREO INSTALLATION

At the Kansas City Fall Hi-Fi Festival last year he heard a top-quality stereophonic system and again the bug took a nibble.

Consultation with Mr. Beatty resulted in a plan for doubling the speaker setup he had in the monophonic system. Thus he "arrived" at eight JBL 15-inch D130 speakers and two JBL Model 375-537-509 high-frequency assemblies, mounted six feet apart on centers, and built into the wall between the living room and his bedroom closets.

An Ampex 121 tape machine feeds stereo tapes into two Marantz preamplifiers, which drive two Marantz 40-watt power amplifiers. The latter are remotely mounted on a custom-crafted shelf under the floor, so that they get adequate ventilation and are easily accessible for service. Records are still played through one side of this system using his three-speed transcription turntable.

Installation of the speakers was a three-day job. The living-room wall was almost completely torn out. In order to reduce the possibility of resonances being induced, the wall cavity was filled with some 1,000 pounds of concrete, from speaker level to the subflooring the full width of the wall, and between the two speaker systems to the top of the installation. The floor was braced underneath with a steel jack.

Dr. Blender and his gracious wife took the easy way out on this. They took a three-day vacation, coming back to find the installation complete.

Speaker performance is often related to magnet weight. Dr. Blender's installation boasts no less than 42 pounds of Alnico 5 magnets in the ten speakers. Lows on the remarkable system are both

Continued on page 41



Completed, the attractive wall decorations conceal one of the most powerful home stereo systems in existence.



Here are the two Marantz 40-watters.

Ampex A series stereo tape machine and Marantz Audio Console were used in front end of stereo system.



Pouring concrete into the wall cavity between the two systems was a two-man job. The concrete added mass to the wall on which the speakers were mounted, thereby reducing resonances.

One-half of the stereo system is shown in this rear view. Wardrobe closet behind speakers provided infinite baffling. Celotex panels (and clothing hung in closet) damps interior.

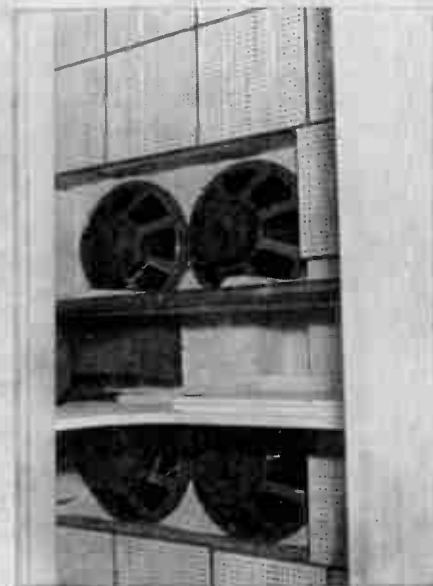

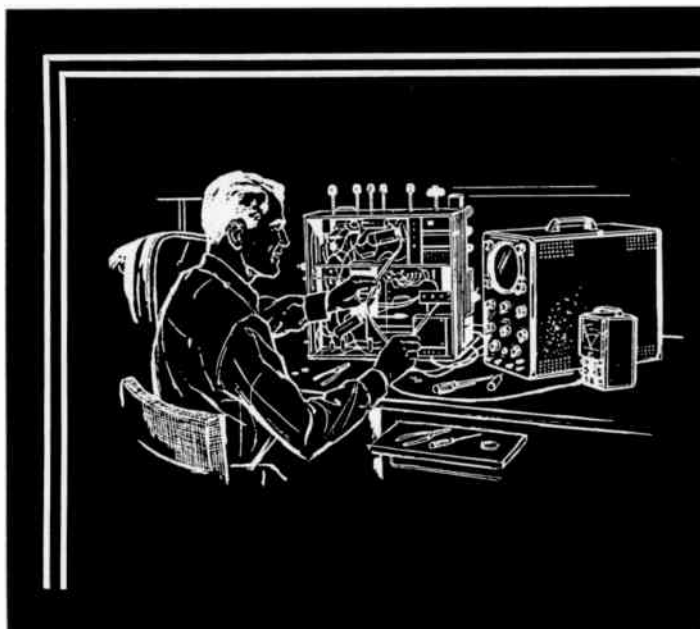

USING TEST INSTRUMENTS

by Joseph Marshall

Signal Generators, Part V

RECEIVERS and tuners can roughly be aligned with the signals from radio stations, but the use of a signal generator permits more exact alignment and is essential in obtaining optimum performance from the set.

The procedure of alignment is basically similar for all types of receivers or tuners, whether AM or FM. In the case of FM equipment, the detector circuits present some problems that do not arise in AM equipment. On the other hand, alignment of the RF sections of AM tuners, particularly those operating in the broadcast band, is more critical than it is for FM tuners. But by and large the technique is the same.

Besides the signal generator itself it is desirable to have an indicator capable of giving sensitive indication of proper alignment. The VTVM is ideal for this purpose. Some tuners have built-in tuning meters, however, and these will serve for most of the process.

AM IF Stages

There are two alternative places to connect the VTVM when aligning an AM tuner. AM tuners invariably have automatic-volume-control circuits, which may be any of several types. There is no need to bother about these variations, because the VTVM will give proper indication regardless of the method used to develop the AVC.

The AVC is usually applied to the grid of the first IF stage, and sometimes also to the converter or RF stage. Look over the wiring around these stages and you will find that in at least one, the bottom end of the grid winding of the IF or RF transformer is connected to a

high-value resistor (100 K or more), bypassed to ground by a capacitor of between .005 and 0.1 μ fd, as indicated in A of Fig. 1.

Sometimes the grid winding does not go directly to the grid, but is coupled through a small capacitor. In that case there is a grid resistor whose bottom end goes to the AVC bus line, as in Fig. 1B.

The VTVM can be connected between the top end of the filter resistor and ground, in the first case, or between the bottom end of the grid resistor and ground, in the second case, as indicated by the X marks in Fig. 1. The meter should be switched to a negative DC voltage range and will indicate the relative strength of any signal fed into the tuner. If the tuner has a tuning meter or magic eye, it also can be used as an indicator.

This method of measurement certainly is the simplest one, and is adequate for most cases. If the absolute maximum in selectivity and sensitivity is desired, it may be preferable to disable the AVC. This can be done by temporarily grounding the top end of the filter resistor, or the bottom end of the grid resistor, at the same point X to which the meter would be attached in the former case. The VTVM is then switched to AC and connected across the audio output, and resonance is indicated by the amplitude of the audio signal.

The first rule for optimum alignment is to give the signal generator at least a half hour to warm up and thus achieve good stability. Any significant drift in frequency during the alignment procedure will produce less precise results.

It is very helpful to disable the oscil-

lator in a superheterodyne tuner. If the oscillator tube is independent of the converter, it is simply pulled out of the socket. If the oscillator and converter sections are in the same tube it is simpler merely to tune the tuner or receiver to a place in its range at which there is no trace of any broadcast signal. Many servicemen have dummy tubes in which the plate pin of the oscillator section has been clipped off. This replaces the normal tube and disables the oscillator while keeping the converter operative.

The first step is to determine how extensive an alignment is needed. If the converter tube has a shield, pull it up until it is free of the grounding clips. Clip the hot end of the generator output cable to the shield. If the tube is not shielded, wrap a few turns of hookup wire around the glass envelope and clip the generator leads to the two ends of this coil. Or simply clip the hot lead to the grid terminal of the converter section of the tube.

Tune the generator around the nominal IF frequency (usually 455 Kc) with the internal modulation on, until you obtain a reading on the VTVM or hear the modulation. Check the frequency at which the meter indicates peak response. We assume that the calibration of the generator is reasonably exact at this point, as it should be. If the IF channel is tuned to within ± 5 Kc of the proper frequency, leave the generator cable clipped to the converter, tune the generator to exactly 455 Kc, and peak the IF transformers. Start with the secondary of the one closest to the detector and work backward to the front end. Keep reducing the generator output so that the

meter just barely shows an indication. This will produce the narrowest bandwidth and maximum weak-signal sensitivity. Stronger signals, which produce high AVC voltages, will widen the bandwidth slightly. If this procedure is followed there is no need to disable the AVC except possibly in communications receivers.

However, if the IF stages are off frequency by more than 5 Kc, apply the generator cable to the grid of the last IF stage and tune the transformer following it for maximum reading on the meter. Now move the generator to the grid of the preceding stage and, using just enough signal to produce movement of the meter, trim the secondary and primary of the next-to-last IF transformer. If there is still another stage, move the generator lead to the converter and peak the first transformer.

Many hi-fi AM tuners have broadband IF amplifiers, and some have switches to provide either sharp or broad bandwidth. The best way to align such tuners is with a sweep generator and an oscilloscope for a broad, flat-topped, symmetrical curve. An acceptable job can be done with careful use of a simple signal generator and VTVM. If the tuner has a sharp/broad switch, set the switch to the sharp position and align for optimum peaking as described above. Switch to the broad position and tune the generator for 10 Kc on each side of 455 Kc, observing the meter. The meter should trace a fairly symmetrical curve with a broad single peak or a reasonably flat top.

Audio response of a tuner can be estimated pretty accurately in this way. The center frequency of 455 Kc represents the low-frequency end of the audio range. As the signal generator is swept higher, 456 Kc will represent response at 1,000 cps, 457 at 2,000, 460 at 5,000, and so on. Most VTVM's have a db scale. If the generator input is adjusted so that the needle is at the 0-db point on the meter (at 455 Kc), the relative response at other frequencies will be indicated in db above or below zero. If the VTVM indicates 3 db down at 460 Kc and 10 db down at 465 Kc, the audio response will also be down 3 db at 5,000 cps and 10 db down at 10,000 cps. It is true that the audio section may contain compensation to correct for the slope in the IF amplifier, but this is rarely done. Therefore, this procedure gives a fair enough indication of audio high-frequency response.

In some instances the broad top of the IF curve, which is needed to assure good high-frequency response, is obtained by combining the response curves of one or two overcoupled transformers with that of a critically or undercoupled transformer, as indicated in Fig. 2. Such tuners are most easily aligned with the sweep-generator technique; but a good

job can be done also with the generator and VTVM. It is easy to determine which transformers are overcoupled because, as the trimmers on these are adjusted over a range of a turn or two, the meter will indicate two peaks separated by a small dip.

There are two ways to align an overcoupled stage. The simplest is to adjust the trimmers carefully to the point at which the meter is at the bottom of the small dip between the peaks. A more foolproof way is to shunt temporarily the winding opposite to that being adjusted, with a resistor of between 500 and 1,000 ohms, and then adjust for the single peak. Thus when peaking the secondary, shunt the primary; and when peaking the primary, shunt the secondary. When these adjustments are made, again it is a good idea to sweep the generator on each side of the center frequency and watch the VTVM needle as you do so. The desired result is a symmetrical broad response, with the meter reading remaining fairly uniform for 5 to 10 Kc on each side of 455 Kc. It may be necessary to repeat the process several times to obtain the best possible curve.

In local-transmitter areas, where highest fidelity is more desirable than high selectivity or sensitivity, even the simplest tuner can be aligned to produce a flat-top response by stagger-tuning the two or three IF transformers. Again, this is most accurately and easily done

Fig. 1. Connection points for AM tuner alignment. See text for full details.

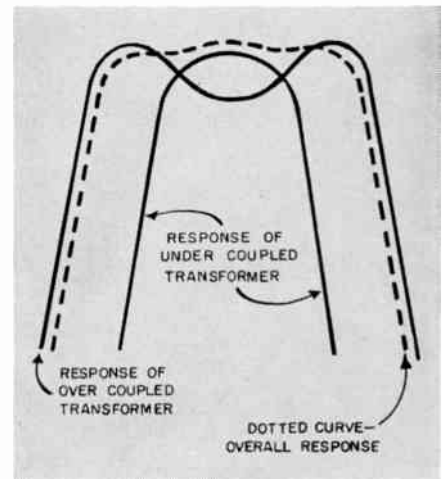
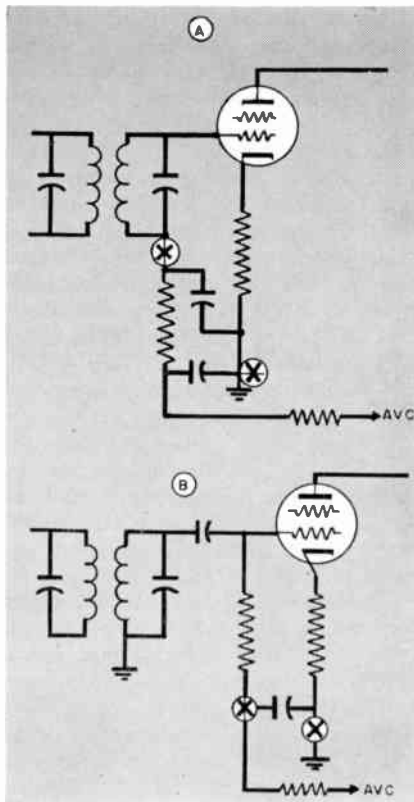

Fig. 2. Flat-topped IF curve is made by combining curves as shown above.

with a sweep generator, but the following technique should work well with the simpler equipment.

First, peak the IF amplifier to 455 Kc. Then increase generator output to obtain a reading of 1 or 2 v on the meter, or a reading of 0 db on the db scale. When this is done, carefully and slowly detune the generator toward the high side until the meter reading is about 70% of the previous reading, or 3 db down. Note the difference in frequency between this point and 455 Kc. It may be anything from 2 to 5 Kc. Now peak *one* of the transformers to *this* frequency. Retune the generator to a frequency the same number of kilocycles below 455. Thus if the first transformer was peaked at 458, move the generator to 452. Peak the other transformer to this frequency. Sweep the generator to see what kind of curve you have obtained. Again, the desired result is a wide curve with a fairly flat top, as indicated by minimum variation in meter reading for a number of kilocycles on each side of 455 Kc.

With two IF stages and three transformers, a very wide flat top can be achieved if selectivity can be sacrificed. If the top is made much broader than 12 or 15 Kc, however, you may be bothered by "monkey chatter" interference from stations on adjacent channels. This can be corrected if your control unit has a good sharp high-frequency-rolloff control to attenuate the interference without much affecting the response below about 7,500 cps. If you want to try such broad-banding, proceed as in the previous instructions but, in the second step, as you detune the generator, stop it at the frequency for which the meter reading is $\frac{1}{2}$ of the peak reading: 6 db down. Peak one transformer to this frequency, another to a frequency an equal number of kilocycles the other side of 455, and the third one to 455. You should get a very broad, fairly smooth flat-top IF curve.



The Sony Microphone

SEVERAL months ago, at a lunch-table discussion with audio consultant Joel Ehrlich, the topic of conversation gravitated toward the subject of microphones in general and the Sony condenser microphone in particular. Mr. Ehrlich said that while he had never actually used a Sony mike himself (he has, since then), he had heard some highly enthusiastic reports about it from people who *had* used it. This called to mind several rave reports I'd heard, and, since I could never recall having heard anyone criticize the mike, I decided then and there to try a couple of them myself.

Well sir, they're not easy to come by, as I found. Sony equipment is imported by Superscope, Incorporated, located in Sun Valley, California. This particular item is reportedly handmade by Japanese craftsmen (presumably the same kind of craftsmen that are giving the Germans a run for their money in the quality-camera field). Like most artisans of the old school, these Japanese take their own good time about what they're doing. Perhaps the situation has improved since I placed my order, but at that time I was obliged to stand in line while prior bidders from some of the leading recording studios had their orders filled. After about three months it was my turn, and since I had advance-scheduled some recording sessions with tenor Richard Dyer-Bennet (who specializes in spirited renditions of folk music ranging from bawdy Elizabethan ballads to Schubert leader), the mikes arrived none too soon.

I had previously blamed the extreme difficulty of realistically recording Mr. Dyer-Bennet's voice and guitar on such

things as room acoustics and the elusive timbre of his voice. The first thing that I noticed about the Sony mikes was that both the voice and guitar recorded naturally, regardless of microphone distance and direction, and almost regardless of the acoustics of the room in which we were recording. All we had to do from then on was to adjust the microphone distance for the desired amount of reverberation, and adjust the height for the proper balance between voice and guitar. The fact that we had previously spent almost a month of evenings trying to achieve comparable sound quality from the other mikes, and got what we wanted after a single evening's work with the Sonys, was the first thing that started me wondering about them. Other things which were immediately evident were their remarkable transient response and almost unbelievable high-frequency range and smoothness. Later experience confirmed these impressions.

Before getting into this any deeper, let's look at the Sony mike as a product. To begin with, I feel obliged to point out (with some embarrassment) that the Sony C-37A microphone system, including mike, power supply, 30 ft. of interconnecting cable, and a handsome carrying case, costs \$390. In short, this is not a big-deal bargain-counter item for the budget-minded recordist; it's a professional product, and is priced accordingly. It is, as a matter of fact, almost exactly the same price as the Telefunken U-47M condenser system.

The Sony is a low-impedance mike (200 ohms) and is not available with, or adaptable to, any other impedance.

It offers a choice of omnidirectional and cardioid pickup patterns, selectable by a screwdriver-adjustable switch on the microphone itself, and a second three-position switch on the power supply selects flat frequency response, slight bass cut (-6 db at 40 cps), or speech characteristic (-3 db at 200 cps, -17 db at 40 cps).

Rated frequency response is ± 2 db from 20 to 18,000 cps, output is about -17 dbv per dyne per square centimeter (equivalent to a RETMA sensitivity rating of -143 db), and noise is rated at -55 db relative to the signal created by a sound pressure of 1 dyne per square centimeter, at 1,000 cps.

The noise figure (which is set by hiss—hum is well below the Sony's hiss level) is the only one that could not be considered outstandingly good, and is apparently the only respect in which the Sony is inferior to other good mikes. On the other hand, 55 db is the signal-to-noise ratio of an excellent tape recorder, and only on one occasion did I find the Sony mikes producing hiss that was higher than the tape hiss from my Ampex 601-2 recorder. This was when I tried to record a speaking voice at a mike distance of 8 ft. The fact that this placement was acoustically unsatisfactory (because of excessive echo) ruled out use of the recording anyway.

In all other respects, the Sony was possibly the most natural sounding and uncolored microphone I have used to date. After having used it with voices, musical instruments, and natural sounds (including a thunderstorm), I am forced to conclude that there are very few things that it cannot record with a very high degree of fidelity. It is particularly good on strings, and its remarkable transient response brings out details in

complex sounds which were hitherto audible (from the best mikes I had used) but subtly colored. Its high-end response is evidently smoother than that of the best available loudspeaker systems, and the fact that both of the mikes I received (for stereo recording) were subjectively identical in this respect is a tribute to Sony's quality control.

As for the Sony's suitability for stereo recording, I'm not prepared to get into a hassle over whether omnidirectional, cardioid, or bidirectional mikes are best for stereo recording. All I'm willing to say is that I have made some excellent stereo tapes with these mikes, and have gotten cleaner and more transparent stereo tapes with them than are available commercially. Since commercial stereo tapes are bound to be inferior in these respects to the masters from which they were duplicated, I must admit that this is an unfair comparison, but it is an example of what the home recordist *can* achieve by using a top-caliber mike.

Readers who have stuck with this report this far may wonder where is the sense in my extolling the merits of a \$400 condenser microphone when only one out of a thousand tape recordists would consider spending that much money on a mike. Because it illustrates an important point, that's why. I had an opportunity to try a Sony mike with a \$100 Pentron recorder. The recorder's



Sony power supply and microphone.

speed regulation was nothing to brag about, but the sonic quality obtained from this machine (even with the inexpensive matching transformer that was used to couple the 200-ohm mike to the high-impedance mike input on the recorder) was better than that obtained from a \$545 Ampex using a moderately priced microphone. The economics here are obvious, if not overwhelmingly convincing. The fact is, though, that it is often a better idea, in terms of over-all results, to invest a little less money in the recorder and a little more in its microphone. Tape recorders in general have some sort of a quality breaking point, beyond which their increased cost goes into added flexibility and dependability rather than into improved sound. Despite some fantastic claims of frequency response to 20,000 cps and 60-db signal-to-noise ratio, a recorder that is within 2 db to 10,000 cps, has less than 0.2% wow or flutter, and 50 db of signal-to-noise ratio will record with very nearly

the fidelity of a machine going out to 15,000 cps, with 0.1% speed regulation and a 60-db s/n ratio. The difference in quality will not begin to parallel the difference in cost. Consequently, if a recordist can bring himself to forego the luxury and flexibility of a professional recorder he can get considerably better quality from his live recordings by purchasing a less expensive recorder and a better microphone.

As far as I'm concerned, anyone who has a reasonably decent recorder and is sincerely interested in getting the best possible sound from his live tapes, will be well advised to purchase a top-quality microphone. A second advantage of owning a fine mike is that it will never become a limiting factor should the owner decide to upgrade his machine later on. Every serious amateur recordist has on hand (or has been obliged to sell at a loss) moderate-quality microphones which failed to meet the performance standards of his upgraded tape machine. The Sony isn't likely to be outdone by any recorder I've heard about, regardless of price.

Soundcraft Magna-See

Most of us are willing to believe that, if we can get sound from a tape, it is magnetized. The fact that we can't see the recorded signals doesn't seem to worry the average magnetographer, because accurate editing of tapes can be done without recourse to anything more visual than a grease-pencil mark on the back of the tape.

There are times, however, when the lack of visibility of magnetic recordings can be positively frustrating: when, for instance, it is necessary to know whether multiple tracks are properly spaced across the width of the tape, or whether a case of fluctuating high-frequency response is originating in the electronic section, in the recording head, or in the playback head. Well, professional recordists have known about a way of seeing magnetic tracks for some time, but Soundcraft is the first company to put out a kit enabling the home user to apply this technique to his own tapes. The principle involved is almost ridiculously simple: magnetism attracts and holds ferrous metals; lack of magnetism does not. Thus if we apply metallic "dye" to the tape, the dye will be attracted to the areas of magnetism on the tape, and only those areas.

The dye (Magna-See) consists of a suspension of microscopic carbonyl iron particles in a highly volatile, nonpoisonous nonflammable liquid. You shake the Magna-See container to get the iron particles evenly dispersed, pour some of

the fluid into a small container supplied with the kit, and put a length of recorded tape into the bath. Then you agitate the tape back and forth until a pattern can be observed on the tape's surface. When the tape is lifted from the liquid, the tiny iron particles settle out of suspension onto the magnetized portions of the tape, leaving the unmagnetized areas clear. After the liquid evaporates, a clear image of the tape's magnetization is left along the treated length of tape. The resulting pattern will show placement of the recorded tracks across the width of the tape, and will also show any irregularities in track width that may be caused by poor head-to-tape contact.

The Magna-See kit includes a copious supply of the "developer" liquid, several glass slides and a roll of cellulose tape (for making permanent displays of unusually interesting "prints"), a small tray for holding the fluid, and a magnifying lens for close inspections. Instructions are comprehensive and clearly written, although Soundcraft's recommendation that the visible print be used for checking head azimuth alignment should be taken with a grain of salt. Azimuth alignment is far too critical a thing to check in this way without resort to a laboratory microscope and a precision hairline grid attachment. Alignment is still best carried out by means of a standard alignment tape.

Visible tracks produced by Magna-See can also be used for tape editing if the editor is convinced that he cannot learn to edit in the accepted manner—by ear. As far as I can see, the real value of the Magna-See kit is in checking lateral head alignment and tape-to-head contact, and there is nothing else I can think of offhand that will perform these functions as quickly and as easily. It takes some practice to produce the nice, clear images shown in Soundcraft's illustrations, but usable images can be obtained with the first try if you follow the instructions to the letter. The most important things to watch are the length of time during which the tape is left in the bath, and the state of suspension of the fluid itself. If it isn't properly stirred up, the pattern will be incomplete or blotchy; too short a developing time will give an indistinct image, while too long a developing period will cause smearing and saturation of the entire tape surface.

Incidentally, in case you're wondering about the permanent effects of this treatment on the tape, there aren't any. The iron particles can be wiped off the tape easily by means of a soft cloth, and they do not affect the recorded signal.

AUDIOLAB

Test Reports

*An objective analysis
of high-fidelity components*

AUDIOLAB TEST REPORT POLICY

These reports are prepared by an organization whose staff was responsible for the original Audio League Reports, and which has no connection directly or indirectly with any manufacturer or publisher in the high-fidelity field. The reports are published exactly as they are received from Hirsch-Houck Laboratories. Neither we nor manufacturers of the equipment tested are permitted to delete information from or add to the reports, to amend them in any way, or to withhold them from publication; manufacturers may add a short comment at the end of a report, however, if they wish to do so.

NORELCO MAGNETO-DYNAMIC CARTRIDGE

The Norelco Magneto-Dynamic Cartridge is manufactured by Philips in Holland and imported by North American Philips. It is a moving-magnet type, in which the magnet is a rod of ferrite about 1/2 in. long and 1/32 in. diameter. It is magnetized at right angles to its axis, with north and south poles on diametrically opposite surfaces of the cylinder along the length of the rod. This armature is located in the air gap of a horseshoe shaped mu-metal core. It is supported at both ends by neoprene bearings. At the lower end is a cantilever stylus shoe, which has a 1-mil diamond stylus at its other end. The stylus motion in the groove rotates the magnet and induces voltage in the two coils which are wound around the mu-metal core.

The lateral compliance of the Norelco cartridge is rather high, 5×10^{-4} cm/dyne. The manufacturer states that this high compliance will result in a resonance below 10 cps in most high-quality tone arms. The frequency response

Components 1109 test record, sweeping from 10 cps (left) to 200 cps (right).

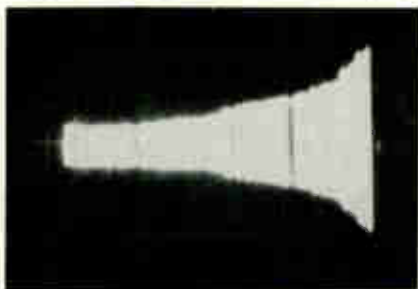

is rated at 10 to 20,000 cps within 2 db. The output of this cartridge is unusually high, rated at 35 mv for a stylus velocity of 10 cm/sec. The vertical tracking force is 5 grams. The recommended load resistance is 68 K. The cartridge has

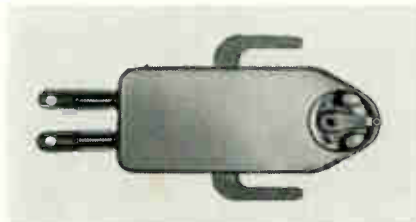

Norelco Magneto-Dynamic cartridge.

standard mounting centers and may be installed in any standard tone arm. The stylus and armature are replaceable as a unit by the user without the use of tools.

Test Results

The response of this cartridge to the Cook Series 10 and the Cook 10LP is similar in shape, with a tendency to peak in the 6- to 8-Kc region and a falloff of response at higher frequencies. The response at 78 rpm extends a little more than a half octave beyond the response at 33 rpm, but in both cases the response fell considerably short of the 20 Kc claimed. These curves were made with the cartridge mounted in a Fairchild 281 arm, tracking at 5 grams, and terminated in the recommended 68 K. The output was indeed high, being 26.5 mv on the 1-Kc band of the 10LP (5 cm/sec) and 44 mv on the Series 10 (9 cm/sec). The response to the Folkways FPX-100 (not plotted) was gen-

erally similar to that shown for the Cook 10.

The scope photo made from the Elektra 35 sweep record (33 rpm) confirms the falloff of highs above 10 Kc, but shows a notable freedom from peaks or resonances of any kind down to 200 cps. Continuing down the spectrum with the Components 1109, sweeping from 100 cps to 10 cps, there is no trace of a resonance down to 10 cps. This confirms the claim of a very high lateral compliance.

The Cook Series 60 record, which has very high recorded velocities at the low frequencies, was tracked all the way down to its last band (31 cps) at the rated 5-gram force, though a certain amount of buzzing could be heard on the last band. Increasing the tracking force to 7 grams cured this problem.

Listening Tests

The Norelco Magneto-Dynamic Cartridge sounds very clean and effortless. Despite the lack of flatness out to 20 Kc, we found its highs to be smooth and sharply defined. Needle talk was very

Elektra 35 test record, slow sweep, 200 cps (left) to 20 Kc. Sweep is smooth.

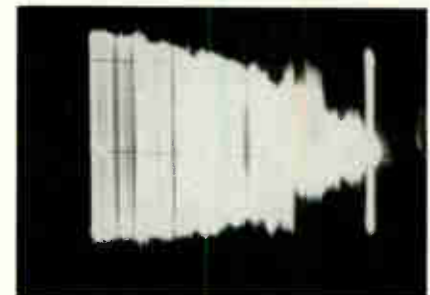

low, a natural by-product of the high stylus compliance. Hum pickup was negligible. The high output was immediately evident to our ears, and we would caution the user to be sure his preamplifier is of a type which will not overload with the peaks of over 100 mv which one will obtain from this cartridge on high-level passages. Judging from the output waveform viewed on a scope, distortion is very low at all frequencies.

Summary

The Norelco cartridge is an excellent cartridge, and would be a good buy even if it were priced considerably higher than its \$29.00. In our opinion, the slight

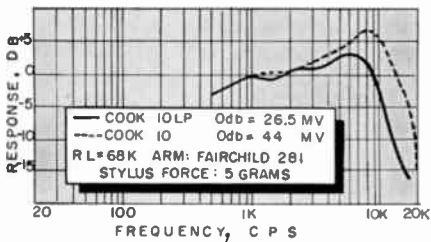

loss of extreme highs is more than compensated by the smoothness and freedom from resonance throughout the entire audio range, the high compliance which makes it easy on records and low on needle talk, and the audibly and visibly low distortion at all frequencies.

With some low-gain preamplifiers, the unusually high output of the Norelco cartridge can be an advantage; with other types it may lead to overloading of the input stage. Since the recommended load of 68 K is a value not commonly found in commercial preamplifiers, it may be desirable to modify the preamplifier to this value. If this is done, a simple resistive divider in the input circuit can also remove the danger of overload.

CONNOISSEUR TURNTABLE

The Connoisseur turntable, manufactured in England by A. R. Sugden & Company, has acquired a considerable reputation in this country since its introduction several years ago. It features



Connoisseur turntable.

three speeds, with an adjustment which provides approximately $\pm 2\%$ variation about each speed.

The turntable base plate is a heavy aluminum die casting $15\frac{3}{4}$ in. by $13\frac{1}{2}$

Continued on page 42

AUDIOLAB
Test Reports

NOW AVAILABLE

AUDIOLAB TEST REPORT REPRINTS

at low 15¢ per-copy cost (two for 25¢)

In answer to continuing requests, the publishers of AUDIOCRAFT have made available, at nominal cost, reprints of any or all of the famous Audiolab Test Reports published in AUDIOCRAFT since this exclusive service was started in April.

If you're a regular AUDIOCRAFT reader, you know about the value in these unique reports prepared by Hirsch-Houck Laboratories, the organization whose staff was responsible for the original Audio League Reports.

If you are not familiar with AUDIOCRAFT's Audiolab Test Reports, check the features in this issue. Note, especially, the pull-no-punches test policy . . . and you'll understand why audiophiles rave about these objective analyses of high fidelity components. There's nothing like them anywhere!

Use the coupon below to order any of these AUDIOLAB TEST REPORT reprints. Payment at 15¢ per copy (any two for 25¢), must accompany order.

REPRINT NUMBER	EQUIPMENT
101	McIntosh C-8 Audio Compensator
102	Eico HF 52 Control Amplifier
103	McIntosh MC-60 Power Amplifier
104	Weathers K-730D Turntable and Pickup
105	General Electric PA-20 Amplifier
106	Gray 212 Tone Arm
107	ESL C-60 Series Cartridge and Dust Bug
108	Thorens Model TD 124 Turntable
109	Shure Professional Dynetic Cartridge
110	Harman-Kardon Solo II, Model TA-12
111	Sargent-Raymont SR-570 Power Amplifier
112	Scott 330C FM-AM Tuner
113	Marantz 40-Watt Power Amplifier
114	Gray AM-3 Preamp-Control Unit
115	Marantz Audio Console
116	Chapman FM-AM-SW Tuner
117	Scott 310B FM Tuner
118	Peri-50 Power Amplifier
119	Connoisseur turntable
120	Norelco Magneto-Dynamic cartridge

Reader comments that typify the coast-to-coast sensational reaction to AUDIOCRAFT's Audiolab Test Reports

"Three cheers for the Audiolab reports, the first and only unbiased reports in any mag since the good old days of the Audio League!" (Detroit, Mich.)

"... the reports are superb . . . best aid an audiophile can have". (Great Neck, N.Y.)

"We need this rare kind of service." (Ottawa, Canada)

"Congratulations on the accuracy, objectiveness and general pull-no-punches attitude of your new equipment reports." (New Haven, Conn.)

"This sort of editorial courage has been needed in the audio field for a long time." (Encino, Calif.)

"At last the hi fi population has an opportunity to evaluate manufacturer specs from unbiased lab tests in your Audiolab Test Reports." (Rome, N. Y.)

"... fills a long felt need." (Lafayette, La.)

"... most enthusiastic about your publication . . . particularly since the inclusion of your Audiolab reports." (Montreal, Canada)

AUDIOCRAFT Reprint Service

The Publishing House
Great Barrington, Mass.

Please send me reprints of AUDIOLAB TEST REPORTS as checked here. I have indicated the quantity of each reprint I want in the space beside the reprint number.

Payment of 15¢ per copy (any two for 25¢) is enclosed.

Name

Address

City, State

- 101:
- 102:
- 103:
- 104:
- 105:
- 106:
- 107:
- 108:
- 109:
- 110:
- 111:
- 112:
- 113:
- 114:
- 115:
- 116:
- 117:
- 118:
- 119:
- 120:

Use This Order Coupon

—
All orders
shipped
prepaid

—
Payment must
accompany
order

The Trouble with Attenuators

MY BRIEF against pads is two-fold: (1) how can a layman adjust them, and (2) why degrade a low-impedance amplifier with inserted dissipation? The first point will be passed with only the comment that without thousands of dollars worth of test equipment and many years intimate experience in the field the layman is handicapped. The second seems to need some support beyond philosophy.*

Experiment

It was reasoned that if a step-down transformer were used, the speaker damping, if aided at all by the amplifier, will be benefited; the use of a pad will degrade it. In the case of heavily loaded horns, it might be assumed that the difference would be negligible. Yet the fact that no available speaker, horn or open type, has ever been made with a perfectly flat response over even a narrow frequency range, means that there remain resonances which are not completely damped.

Anyway, a middle-range speaker (horn type) was set up to be fed through a crossover network and either through a resistive pad or a transformer,

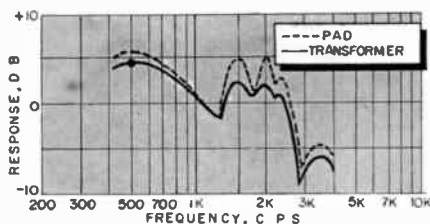

Fig. 1. Effect of pad and transformer.

the loss being adjusted to 6 db in each case and the network constants given values appropriate to the transformed or untransformed impedances.

It was found that the peak-to-trough ratio of output was 4 db in the frequency region of interest with the transformer, and 6.3 db with the pad. That is to say, the pad inserted its 6-db loss in the troughs, but only about 3.7-db loss on the peaks.

Fig. 1 illustrates the effect. The dotted curve shows the frequency response of a horn speaker unit with which a 6-db resistive pad was used to lower the level. The solid curve shows the response using a 2:1 turns ratio transformer.

*George L. Augspurger, "Loudspeakers and Enclosures," *AUDIOGRAFT*, Dec. 1956 (p. 25), rewords my opinion more forcefully than I would have expressed it: "Mr. Klipsch considers it rather simple-minded to spend money for an amplifier with a high damping factor, and throw away all the benefits . . . by inserting . . . a pad. . . ."

by PAUL W. KLIPSCH

Mr. Klipsch has, for many years, made no secret of his dislike for attenuator pads (level controls) on the individual drivers of multiway speaker systems. He has designed his famous Klipschorn and Shorthorn systems to produce measured balance among outputs of woofer, squawker, and tweeter, thereby eliminating the requirement for level controls under typical listening conditions. Despite sound-pressure measurements, however, recent comparisons with live and reproduced music convinced him that the middle-range output should be reduced for more natural balance. It was not feasible to replace the middle-range driver. The following describes in his own words how he avoided using an attenuator pad, and the measurable superiority of his alternative solution.

Although Mr. Klipsch writes specifically of his own speaker systems, we believe his findings to be of sufficient general interest as to warrant an exception to our rule of not publishing articles on commercial products written by manufacturers or their agents. — ED.

Note that the trough values are about the same for the two cases, but the peaks are higher with the pad. In other words, the response is smoother with the transformer than with the pad.

The explanation is assumed to be that the horn does not apply as much load as required to produce nearly critical damping, so that second-order resonances can show up on the response curve. The added damping of a low-impedance source, therefore, is evidently capable of helping the response even of a highly damped horn speaker.

Now, the 2.3-db error is not large; it is hardly discernible by aural comparison. But if each imperfect system could be compared with a perfect one, then the extra 2.3-db error could well be apparent, whereas the lesser error could pass undetected in many instances.

New Networks

Application of a transformer to a crossover network involves a lot of careful planning. The mere presence of an iron core can produce distortion if the primary inductance is too low.

The networks are shown in Fig. 2. As applied to the Klipschorn, the con-

stants follow fundamental design. The capacitor elements, particularly C2, depend on the actual speaker impedance and the transformation ratio. In the case of the Shorthorn the problem was aggravated by the fact that the woofer is a direct radiator over the upper-bass range, being horn-loaded for only a couple of octaves in the sub-bass range from about 40 to 160 cps, and the region above cone breakup (above 1,000 cps) produces a rising response. Also, the very short middle-range horn acted a little out of character. The C2 value for flattest response turned out to be a value appropriate to a 500-cps crossover frequency; response of the woofer alone suggested a 12-db section. But the values evolved from response adjustment resulted in the simple 6-db network with values shown in Table I.

Table I

	Klipschorn	Shorthorn	Remarks
C3	2 μ fd	2	oil
C2	5 μ fd	5	oil
L2	0.5 mh	0.5	not over 0.4 ohm DC
L1	5.0 mh	2.5	not over 1.2 ohms DC
T2		Special Autotransformer	

These networks have been evolved, as properly they should have been, as special devices fitted to the particular drive units and horns used. Obviously a substitution of drive unit, or of one of the horns, would probably result in imbal-

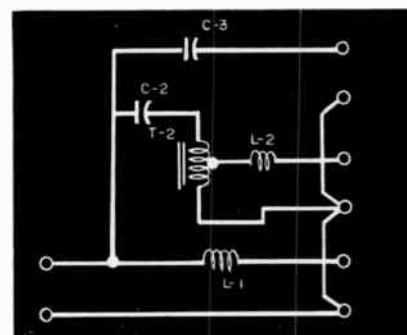
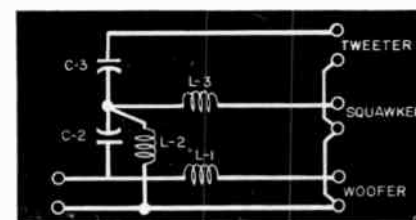

Fig. 2. The new network (above) used by Mr. Klipsch. Contrast this with the old network, which is diagrammed below.



ances. For example, the value of C2 for the Shorthorn network is 5.0 μ fd contrasted with a theoretical value of 2.0. The "design center" was used as a point of departure, and the sweep-frequency generator and microphone output used to indicate the direction in which to modify from the design-center values. Design-center and modified values were then given the acid test of hours of listening.

The results are empirical, but were evolved from years of experience, hours of experiment, months of engineering, and weeks of listening to both reproduced and original sound. The recording studio became a laboratory, and vice versa.

Special attention was given the adaptation of the networks for the Rebel series of speaker systems. Because the Rebel III and Shorthorn Model S are identical in acoustic size and function, nothing special was involved. But the less-than-2-cubic-foot size of the Rebel V presented problems.

From microphone-pressure indications it was found, as in the case of the Shorthorn Models S and T, that the capacitor C2 had to be about 2.5 times the calculated value.

The autotransformer is the same for all networks, which is a fortunate thing. The K-1000/5000 W2 network has been arranged to fit into the smallest of the Rebel boxes—hence the shape is trapezoidal, instead of rectangular.

Heretofore the networks involved no iron cores (except the first design of about 1940). In the absence of iron, there is no magnetic saturation and no power limit, except perhaps the kilowatt or so it might take to burn out the No. 17 wire in the inductors. With the introduction of the transformer's iron core, however, a power limit must be established.

Since the network design was specifically for horn speakers of fairly high efficiency, and since the networks would not likely be adaptable to other speaker types, the power requirements for horn speakers were given extended consideration. An extensive series of practical tests shows that 10 w is going to suffice for extremely loud sounds, and power levels exceeding 10 w would produce as much distortion in the ears as in the reproducing system. For sounds of gunfire and rivet hammers, the audiophobes may depend on ear overload before reproducing-system overload. The audiophile, on the other hand, will likely be content with actual volume-power levels of the order of 1 w or less.

The transformer is easily capable of handling its middle-range share of a total power well in excess of 10 system watts, with exciting currents low enough so distortion remains at levels difficult to measure. It is known that all speaker

Continued on page 39

First the fabulous TD-124



TD-124 \$99.75 net

NOW

two new "TD" Stereo-Monaural turntables



TD-134 \$60.00 net

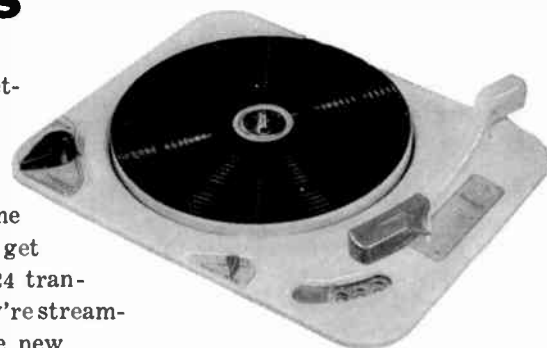

TD-184 \$75.00 net

Here's good news for budget-minded hi-fi aficionados. These two new Thorens turntables (with integral tone arm) give you the same basic drive mechanism you get in the ultra-precise TD-124 transcription turntable, but they're streamlined for economy. See the new TD-184 and TD-134 at your authorized Thorens hi-fi dealer's today.

TD-134 Manual Player. 4 speeds. It has the same precision-machined, adjustable-speed drive as the Thorens TD-124 transcription turntable for minimum wow, flutter and rumble. Turntable floats on nylon bearings. Integral tone arm equals tracking performance of separate arms costing as much as half the price of this entire unit. Plug in adapter for standard stereo or monaural cartridges. 15" x 12", extends 2½" below panel, 3" above.

TD-184. Same as TD-134 with semi-automatic operation: One dialing motion selects 7", 10" or 12" record size, starts motor. Arm literally floats down into first record groove on air; adjustable piston controls lowering speed. Absolutely no connection between arm and table during playing. Featherweight position trip shuts off player at end of record, idler disengages and arm lifts. Manual reject control permits shut-off, interruption or manual operation.



Thorens celebrates 75 years of progress in music reproduction

THORENS

SWISS MADE PRODUCTS
HI-FI COMPONENTS • LIGHTERS
SPRING-POWERED SHAVERS
MUSIC BOXES
NEW HYDE PARK, NEW YORK

Sound-Fanciers' Guide

by R. D. Darrell



Monophonic Consolations

Let's take a break! It's high time for a change — and to stop worrying, for at least a moment, about keeping up with the stereo-proud Joneses. If you're one of the few stubborn stereophobes, or just one of the many laggards who haven't yet gotten around to converting your home sound system for dual-channel operation, you're probably fed up with all the stereo hullabaloo anyway. If you weren't before, you're sure to be after having attended one of the stereo-disc-dominated high-fidelity shows, or — if you haven't been able to participate personally in those "Meetings at Pandemonium" — after having read about little else for several months in your favorite journals, including this one!

It's harder, of course, for anyone involved, even as commentator, in the business itself to tear himself even momentarily away from so absorbing and newsworthily "hot" a subject as stereo in general and the current floods of exciting stereo-disc releases in particular. Yet (partly conscience-stricken about the accumulation of neglected monophonic materials on hand, partly desirous of a change of pace and subject, and mostly just curious to discover whether my listening tastes have been significantly altered in any way), I've deliberately devoted the last week to an exclusive diet of "mono," as distinct from stereo, and — not without some surprise — have experienced no sense of deprivation. In fact, *both* my ears have been very busily and satisfactorily occupied. Moreover, I'm left with the strong sense that I've learned a great deal more about the shortcomings and advantages of stereo itself simply by weighing the aural evidence of what can and can't be achieved in monophony alone.

Enthusiastic as I am about stereo, I find myself wholeheartedly agreeing with the admittedly biased views of vested-interest record and equipment manufacturers that conventional LP's and monophonic sound systems are by no means obsolete or even faded in their sonic appeals. But I do vigorously contest the overinsistent claims that mono recordings sound "better than ever" when



reproduced with stereo pickups and spaced speaker systems. Out of laziness I have been playing LP's lately with my new stereo rather than old mono pickup, and while it does a quite competent job, I'm certainly not convinced that it does a better one. And while I usually start out with both speaker systems in operation, with most mono records I soon shut off, with a feeling of relief — and none of loss — the second channel entirely.

Now, it is only fair to note that this is definitely a minority, if not entirely idiosyncratic, point of view. Almost everybody else seems to find enhanced pleasure in single-channel recordings when they are fed into duplicate speaker systems. I agreed when I first tried it, yet before long the doubled projection of identical materials began to irritate me except where certain big choral or organ works were involved — and then I was much more conscious of the lack of true stereo spaciousness, which to my ears can only be suggested and never satisfactorily approximated in this way. If *you* don't have the same reaction (and

you probably won't), use both speakers for all they're worth! But if you should entertain the heretical notion that any sensed need for doubled speakers with monophonic sources is a sure indication of inadequacies in one or both of the speakers themselves, then at least you can have the comfort of knowing that one if no other maverick listener shares that heresy with you.

Some Modern Mono Masterpieces

Among many newer LP's I've been enjoying in my vacation from stereo, those which have given me the most profound rewards are several I've been replaying off and on for months now while I tried to find space (and with even more difficulty, the proper words) to discuss them in print. Finally I've given up the hope of doing them justice and will settle for the flat statement that nothing I've heard lately, in stereo or out of it, has more consistently stood up to the test of constant repetition and exploration. Sheerly as examples of current recording technology, they are hardly outstanding, strong and clean as they are, but this is almost beside the point; in their musical textures alone they are of inexhaustible sonic fascination even — or perhaps especially — when they are most difficult to grasp either intellectually or emotionally.

So I shan't even attempt to describe one of Stravinsky's least-known mid-period works, the ballet-cantata *Perséphone*, or two of the most recent creations of his tireless imagination and craftsmanship, the chamber ballet *Agon* and the austere tribute to St. Mark's Cathedral in Venice, the *Canticum Sacrum*. Music like this is either repellently alien to you, or it simultaneously baffles and invitingly tantalizes you to plumb its depths. To me, anyway, the *Canticum* already ranks with Stravinsky's mightiest achievements, but whether or not you share this opinion I can promise you that both Columbia ML 5196 (*Persephone*) and ML 5215 (*Agon* and the *Canticum*), all conducted by the composer, will provide experiences you will not soon forget and which will remain even after repeated hearings and intensive study a

perpetual challenge to both your ears and your mind.

And even more challenging, as well as perhaps the most impressive of all phonographic tributes to contemporary masters is the magnificent four-disc album which contains Anton Webern's complete works ably performed by various soloists, vocal and instrumental ensembles, and orchestras under Robert Craft's direction (Columbia K4L 232). Ordinarily I would hesitate to recommend (except to specialists) so expensive and extensive a purchase of what is undeniably, in considerable part at least, as difficult music as the present-day listener is ever likely to encounter. But in this case, the genuinely earnest sound fancier will find such sonically absorbing interplays of pure tone-color contrasts that even when his mind is baffled by what Webern is driving at, his ears will delight in some of the most striking sonority weaving available on or off records. Indeed the whole art of *Klangfarbenmelodie*, the distinctive technique of scoring different phrases of the same melodic line for piquantly varied timbres (as superbly exemplified here in familiar music — Webern's transcription of the Bach six-part Ricercare from the *Musical Offering* — as well as in many of his own compositions), is pre-eminently an audiophile's approach to abstract music making. No one seriously interested in either genuine modern masterpieces or present-day exploitations of sonic potentialities can afford to miss what is surely the supreme test of his aural sensibilities' full-range response!

Contents vs. Medium

Stereophony is a magical medium, whose possibilities and powers we have only begun to explore. But it, or any other means, must never be allowed to dwarf the true end of listening. Musical (or intellectual, if you will) content is and always will be the primary source of aural interest and substantial satisfaction.

Hence, masterpieces aside, it is only common sense which reminds us (and which actual experience will convincingly confirm) that certain types of program materials are not only perfectly suited for monophonic recording and reproduction, but that stereo in these cases would be either superfluous or distracting. Works of primarily didactic intent are particularly pertinent here — and a good example is one of the few monophonic tapes to come my way in a long time: a second "tapebook," sponsored by the Mooney-Rowan Publications, producers of the well-known *Hi-Fi Tape Recording Magazine*, which purports to answer the vital — to audiophiles in particular — question, *How's Your Hearing?* Prepared by the speech therapist James W. Laing, who has also written

Continued on page 40

the greatest achievement in **stereo** records

ffss

London *ffss* is the final triumph in the search for realistic sound reproduction. For over twelve years *ffrr* . . . full frequency range recording . . . has been the world's leader in high fidelity. Now, *ffss* . . . full frequency stereophonic sound . . . is the world's leader in stereo.

Music sounds better on London because it is recorded better. London *ffss* uses special microphones . . . the most sensitive ever engineered. They capture *all* the sounds that originate from the concert stage. When recreated in your home, these sounds seem to come to you from a *continuous* row of speakers. With *ffss*, live performance sound is yours—at home. You hear *separation of sound* or the *sweeping blend of sound* . . . exactly as performed on the concert stage.

Step-by-step *quality control* by renowned British craftsmen is another reason for the superiority of *ffss*. To these artisans record making is an art. Their dedication is part of the heritage of London Records . . . your assurance that *ffss* is the world's finest stereo.

Over 150 London *ffss* Recordings are now available at \$4.98 and \$5.98. WRITE FOR FREE CATALOG



CS 6050



CS 6052



CS 6054



CSA 1405



PS 139



PS 120



PS 121



PS 125



full frequency stereophonic sound

The RUMBLE Seat

A LETTER from Mr. Lawrence LeKashman of Electro-Voice, Incorporated, taking issue with a recent AUDIOCRAFT Editorial on three- and four-terminal cartridges, was published in this space last month. In order to present all sides of the question as fairly and as authoritatively as possible, we invited similar comments from other manufacturers of stereo cartridges. They appear below, in extracted form, together with a final reply from Mr. LeKashman.

Gentlemen:

The least of my intentions is to be drawn into a controversy with my good and long-time friend, Larry LeKashman of Electro-Voice. I cannot, however, avoid replying to his letter of last month as reprinted in this column. It is generally acknowledged that as of this date Electro-Voice and Pickering are leading manufacturers of ceramic and magnetic pickups respectively, and since the bulk of Mr. LeKashman's comments were directed against magnetic pickups, it is incumbent upon me to respond.

Unfortunately, although Mr. LeKashman was prompted by objections to the Editor's expression of preference for four-pin vs. three-pin pickups, his argument was obscured by drawing in the issue of ceramic vs. magnetic cartridges . . . the respective advantages of both are generally known. The fact that most of the statements contained in Mr. LeKashman's letter were liberally extracted from Electro-Voice sales literature causes me to wonder whether he objected to four pins and the Editor's preferences or the fact that magnetic pickups are recognized among the more sophisticated equipment users to have singular qualities not possessed by any other types. We at Pickering most certainly do not resent ceramic pickups. The advantage of their lower cost to both producer and user enables the general public to satisfy its universal desire for entertainment and, at the same time, helps to bring the price of the phonograph record within all its advantages within the reach of the consumer and high-fidelity enthusiast alike, to the benefit of all, and for this we must be grateful. However, it is an inescapable fact that for radio stations, recording studios, professional equipment users, and the intrepid enthusiast, none but the magnetic cartridge meets

their more stringent requirements. It is for these users that we provide a product.

Modern-day equipment — preamplifiers, turntables, and higher-quality record changers — are all intended for use with magnetic cartridges and provide the necessary gain and low noise content to complement the magnetic pickup. These facts cannot be contradicted by depreciatory and specious arguments loosely involving words like millivolts, decibels, etc. Moreover, our cartridges have true hum-bucking two-coil push-pull design in both channels.

All arguments notwithstanding, the ultimate choice lies with the user who must weigh cost on one hand vs. quality on the other, and while it is our conviction that the magnetic pickups provide

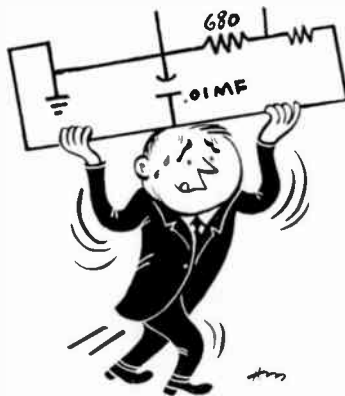

for the lowest record wear, the least amount of distortion, and the highest fidelity in reproduction, we also feel that nothing can be all things to all people.

Insofar as Pickering and Company is concerned on the question of four pins vs. three, suffice it to say that we chose four pins so as to provide maximum flexibility to the user (two of the four pins can be connected to form a three-wire system). Frankly, we did not consider the prospect that someone might be electrocuted until we read the Editor's remarks. As a practical matter the four-pin cartridge does not necessarily prevent this, should the user elect to employ three-wire connections. It is my opinion that anyone who gets in trouble in this fashion would be just as likely to unscrew a light bulb and stick his finger in the socket (unfortunately this occurs too). Seriously, we think the four-wire pickup may be required for some instal-

lations, so we provided for it, believing nonetheless that in general the three-wire system is to be preferred as a matter of convenience.

Walter O. Stanton

President

Pickering and Company, Inc.

Gentlemen:

From our experience we find that most original equipment manufacturers who are building the higher-priced merchandise prefer the use of only three leads whether they use a four-terminal or three-terminal cartridge. Where separate AC-DC-type amplifiers are employed most of these manufacturers must use four leads with four-terminal cartridges to prevent conflict with Underwriters requirements.

We feel that there is a great deal of confusion about the term "ground loop." Our tests show that with high-quality AC amplifiers (either separate amplifiers or both channels on one chassis) the use of three leads with a common grounding point results in lowest hum conditions. There is no necessity to provide an additional grounding point near the cartridge. Such an additional grounding point does create a "ground loop" and will cause hum regardless of whether four or three leads are used.

We expect our sales to continue with about an even split between the three- and four-terminal applications. . . .

In general, we pretty much agree with Mr. LeKashman; however, we would like to add emphatically that the entire issue at hand is somewhat of a "tempest in a teapot." We believe that the engineer doing the original equipment design knows best which arrangement of leads and terminals will give the proper performance and adequate shock protection.

S. Storch

President

Ronette Acoustical Corp.

Gentlemen:

It always makes it simpler for the assembler of a high-fidelity system if he does have a four-terminal pickup cartridge to work with. . . . The most difficult system to work with is a stereo system using two different types or makes of amplifiers connected together with a common stereo control unit. The problems can be aggravated to impossibility

if both a three-terminal pickup cartridge and a loudspeaker system requiring a common ground are used. Here, the user is almost assured of motorboating problems. Most motorboating problems might be eliminated by the use of a four-terminal pickup cartridge.

The situation is somewhat less critical if two identical complete amplifiers are used. . . . Still, considerable problems can exist. In all cases it is absolutely necessary that the ground loops in a stereo system be broken up as much as possible. This has been done in our type 135 Stereo-Daptor. If you examine the circuit diagram of this unit you will find a number of 18-ohm resistors which have been installed exactly for this purpose.

Even with this precaution it is still possible to have problems, particularly if a three-terminal cartridge and a loudspeaker system requiring a common connection are employed. . . . A four-terminal pickup cartridge is the best way of solving this particular problem. Alternately, two separate loudspeaker systems should be employed.

The situation becomes a lot less serious if a complete stereo amplifier or a stereo preamplifier and two power amplifiers are used as electronic components in the system. Here, design of these units has been such that ground loops are a lot less troublesome. Still, difficulties could exist. The amplifier and pickup and speaker system may not motorboat; however, the frequency-response characteristic of the system may show a very high peak at low frequencies. The rumble and other noises picked up by the pickup may then drive the amplifier very near overload and, in effect, reduced available power of the amplifier is the result. . . .

D. R. von Recklinghausen
Chief Research Engineer
H. H. Scott, Inc.

Gentlemen:

Your editorial, "Three-Terminal Troubles," in your September issue gave us something of a shock since we are producing not only three-terminal stereo phonograph cartridges, but a three-terminal arm as well.

When ESL stereo cartridges are used with the ESL TM100 transformers, and the arm and both preamplifiers are ground-strapped together, which is ordinary good practice, hum just isn't a problem. We at ESL have had trouble with hum caused by customers being provided with the wrong transformers

for use with their pickups. Our TM60 transformer, designed for use with our conventional C60 cartridge, is wired for unbalanced input and will, for this reason, produce hum. The TM100 transformer is properly wired and grounded for hum-free use with ESL stereo pickups.

The AC-DC shock hazard you describe can be completely and simply cleared up by proper grounding of the pickup arm in accordance with good practice. It is true that a fuse might then be blown if the AC-DC amplifier plug is inserted in the wrong direction. However, no one will be injured. Furthermore, we doubt very much if anyone would ever purchase an ESL stereo pickup for such an application. From an electrical standpoint, the TM100 input transformer completely isolates the cartridge from the AC-DC chassis except for the external arm ground. Whether this would enable the user to obtain useful operation from the system is something we don't know. There are so many long-standing practical reasons for not using AC-DC amplifiers in a high-quality system that it never occurred to us to try our pickups with them. . . .

Our pickups have two coils, and if we had thought a four-terminal arrangement was required, we would have used it.

John H. McConnell
Vice President
Electro-Sonic Laboratories, Inc.

Gentlemen:

Mr. LeKashman's statements regarding your editorial are almost as interesting as the editorial itself. Your own experience as related there confirms what every audio engineer knows: indiscriminate connection of ground wires in low-level circuits can produce a very bad hum situation, and often does. Just because it sometimes does not is small consolation to the poor experimenter who tries everything to get rid of system hum, not realizing that two ground leads so placed that a circulating current travels through part of this "loop" is the real offender.

Naturally such a situation, being purely electrical, is not particularly affected by the brand of cartridge used although it is true that the higher the audio level, the less conspicuous the effect is. Since high-level ceramic cartridges are most frequently used in less refined equipment it is even possible that any such

hum would be covered up by the residual hum of the system itself. (This may partially account for the truly impressive "no hum" record cited by Mr. LeKashman. Half a million of anything without a problem is an excellent record; in cartridges it is nearly incredible.)

Mr. LeKashman also raises again that ancient argument about equalization. Here his logic seems slightly elliptical since the reason for equalization in playback is simply that a converse equalization is used during recording in order to avoid overmodulation of grooves at low frequencies, and to improve the signal-to-noise ratio at high frequencies. Correct equalization in playback then restores a completely flat characteristic. This recording characteristic is of course *not* constant amplitude, as implied in his statement, although it does *approach* constant amplitude at two parts of the curve. Again it is true that a rough approximation to flat playback, satisfactory for some purposes, can be obtained with an unequalized amplitude-sensitive device. Since Mr. LeKashman indulged himself in various numerical tricks involving db and Kc in order to prove that his cartridge is superior to velocity devices perhaps we may be forgiven for quoting similarly, and quite as accurately.

Mr. LeKashman says that his cartridge is "naturally flat to the RIAA characteristic." We suppose he means by this it is amplitude-sensitive. An amplitude-sensitive device has a falling slope, compared to a velocity-sensitive device, of 6 db per octave. Since there are nine octaves between 30 cps and 15 Kc it will have 6×9 , or 54 db of this built-in equalization which makes it "naturally flat." Since Mr. LeKashman says the required equalization is 36.5 db, his cartridge has a "natural" error of 17.5 db over this range, which is anything but "flat."

This is theory, but actual practice is even worse. For example, our measurements of several ceramic stereo cartridges (which we assume to be typical) show an average capacity of 440 $\mu\mu\text{fd}$ per channel. In order to be down only 3 db at 50 cps to coincide with the RIAA playback curve, an input resistance of 7 megohms will be required, if cable capacity is neglected, and this is higher than any available preamp offers. In fact, a recent survey shows that of 28 stereo preamplifiers now or soon to be available, only two have input resistance as high as 1 megohm, the most common value being $\frac{1}{2}$ megohm.



With this typical 1/2-megohm input resistance, a shunt capacitance of 5,010 $\mu\mu\text{fd}$ will be required in order to have the "naturally flat" cartridge actually flat to the RIAA bass characteristic. This will result in a voltage loss of 23 db, which means a voltage at the grid of 35 mv rather than the claimed 500 mv. Not even Mr. LeKashman can have equalization without loss. What usually happens in actual practice is that no equalization is provided, but due to loss of bass through improper termination, and loss of highs because of cartridge deviation, the true errors are not apparent until the sound is compared with that from a precision cartridge, such as a moving-coil type, properly equalized.

His other statements could all be similarly answered, but space does not permit. . . .

The simple fact is that anyone wanting a first class installation should avoid ground loops no matter what the cause or what the cartridge. A four-pin construction makes possible a solution to the ground problem caused by using two preamplifiers with another common ground if it occurs, but a three-pin type precludes any solution except replacement of the cartridge or replacement of the amplifiers. It is not at all a matter of magnetic versus electrostatic circuits.

It may well be that your statement of the shock hazard was, for practical purposes, a little strong, but there is undeniably a hazard. We agree that very little AC-DC equipment is apt to be used with quality components, and hence that question for users of magnetic cartridges tends to become academic.

R. E. Carlson

Vice President

Fairchild Recording Equipment Corp.

Gentlemen:

(1) We agree completely with you that it is hazardous to operate an AC-DC amplifier as a part of a stereo phonograph system. Assuming that the shield on the cartridge cable must be connected to the chassis of a transformer-operated amplifier, the full line voltage would then be developed between this shield and the low potential wire for the AC-DC amplifier input circuit. I doubt very much if any of the conventional pickup cables, or for that matter, stereo cartridges are supplied with sufficient insulation to safely survive under this condition.

(2) At this stage of the art, it seems absurd to tie down the output of a cartridge by the use of three terminals. For example, we are now playing with several amplifier designs which require critical phasing of the outputs of the cartridge. This is particularly true if one attempts to play monaural records using a stereo cartridge.

(3) In high-quality stereo cartridges it is imperative to isolate the shield from

all of the coil terminals of the system in order to obtain the best signal-to-noise ratio. This applies not only to static but to magnetic fields and to induced shield currents or ground loops. You made this point in your original editorial, and we can only say that we agree completely.

Neal W. Turner

Merchandising Manager
Heath Company

Gentlemen:

Weathers Industries takes the view regarding three-wire versus four-wire cartridge connections that four wires offer greater freedom of application since a four-wire connection can be converted to three-wire by connecting two cartridge terminals together. In fact, Weathers uses five wires in order to totally shield the ceramic elements from electrostatic hum fields.

There are applications where three-wire cartridges are quieter than four-wire; however, if a metal case is used to house the ceramic elements, as is true with Weathers ceramic cartridges, the hum can be reduced to a very low value under both conditions by merely grounding the metal case separately. This makes



four-wire signal connections practical on AC-DC amplifiers and at the same time makes possible the safe grounding of the cartridge shield for minimum hum.

Paul Weathers

President

Weathers Industries

Gentlemen:

We do take issue with your proposal to make all stereo cartridges four-terminal devices, and are surprised that you would take such a stand, since it cannot be supported on technical grounds. In any electrical system, greatest safety and freedom from possibility of undesired voltage sources is achieved by having one basic ground to which all desired voltage sources may be referenced. Hiding the potential danger of interconnected AC-DC receivers which may have defective isolation capacitors by having four narrowly separated terminals does not appear to us to be a safe practice. With a three-terminal cartridge, two properly isolated AC-DC amplifiers may be used if the line cords are correctly phased. If they are not, or if the sets

are not properly isolated, the hum level will instantly inform the user of this fact and he will correct the situation. In any case, there will be no line voltage at the cartridge to endanger the user.

Erie Resistor's StERIEo cartridge was designed for three-terminal operation, for best performance, and for perfect safety. It has been thoroughly checked out for performance in both AC-DC (transformerless) and straight AC applications.

J. D. Heibel

Vice President

Research & Engineering
Erie Resistor Corp.

Gentlemen:

There are a great many excellent stereo phonograph sets on the market using three-terminal wiring based upon sound design principles that are, as their U.L. labels attest, as safe as (if not safer than) any electrical appliance found in the home. Condemnation of three-terminal types as proposed by AUDIOCRAFT's September editorial, "Three Terminal Troubles," therefore creates controversy.

The rebuttal appearing in the October issue uses the opportunity to claim superiority of ceramic cartridges over magnetic cartridges based upon the number of terminals! In actual fact there are excellent and poor cartridges available of both types. Whether the transducer be ceramic or magnetic (or one of other possible types), there are major problems of design and application in over-all systems in each case. Certainly the creation of a second controversy will not improve matters.

Finally, the italicized editorial conclusion following the rebuttal condemns the use of AC-DC sets as a second channel. There are phono inputs in many reliable, U.L. approved, name-brand radio and TV receivers which can be used for the second channel while the hobbyist acquires his second-channel equipment. After all, if he could use a monophonic phonograph this way without electrocuting himself, why not one channel of his stereo? More controversy.

Sonotone's position is completely straightforward. Based upon manufacturer's requirements for both three- and four-terminal cartridges in specific designs, Sonotone cartridges are manufactured with either three or four terminals. For replacement and over-the-counter-sales purposes, four-terminal types are distributed so that the user can replace either type of termination or can use either type of termination in his own system at his own discretion. In using AC-DC sets, extreme caution is recommended because with either three- or four-terminal cartridges (and two-terminal) line voltage can be present at the terminals. With four-terminal termina-

Continued on page 45

To enjoy peak FM reception,
don't neglect that all-important
link between tuner and antenna.

FM

by J. A. BANNISTER

Line Maintenance

DISTORTION and noise, the most common difficulties of FM reception in fringe and semifringe areas, are frequently caused by deterioration of the antenna system. If the FM tuner is a good, sensitive unit of recent vintage, the antenna system should be suspected if performance becomes degraded by loss of sensitivity or poor limiting.

Corroded, dirty, or loose connections at the antenna terminals are common sources of trouble. The connections should be cleaned, fastened securely, and coated with a good high-dielectric weatherproofing compound. Excellent aerosol-type sprays for the purpose are available from most parts supply houses.

Accumulations of dust and foreign materials on lightning arresters may bleed off a high percentage of the signal to ground, in humid weather or damp climates. Thorough cleaning of the arrester body and terminals, plus a heavy weatherproofing coat after reconnecting the twin line, will minimize signal losses at this point.

Another potential source of trouble is the practice of running twin line into the home beneath window frames. The insulation deteriorates rapidly at the entrance and conductors frequently break off inside the insulation. There is no substitute for a proper lead-in tube in quality installations.

Where corrosion is a problem, in coastal regions or industrial locations having a high amount of air-borne chemicals, it will be necessary to renew the antenna and twin line more frequently than in average inland locations. In my home area, for example, there is a substantial chemical factor, and I have found that antenna efficiency drops noticeably after a period of approximately three years. At the end of this period replacement of the twin line is helpful, together with disassembly, cleaning, and reassembly of all joints of the antenna. Sometimes the joints are so corroded that replacement of the antenna is necessary.

When new antennas are being installed, soldering terminal lugs to the twin line for antenna connections, and anchoring the lugs with lockwashers, is good insurance. This, coupled with thorough weathercoating of the entire array, careful installation and coating of the lightning arrester, and use of a lead-in bushing will assure the longest trouble-free operation obtainable. The usual precautions of twisting the twin line to minimize noise pickup, maintaining adequate clearance between the line and metal roof flashings, eaves troughs, and downspouts should be observed.

Antenna terminals should be cleaned periodically, the lead-in reconnected with lugs and lock washers, and the connections coated with plastic spray.

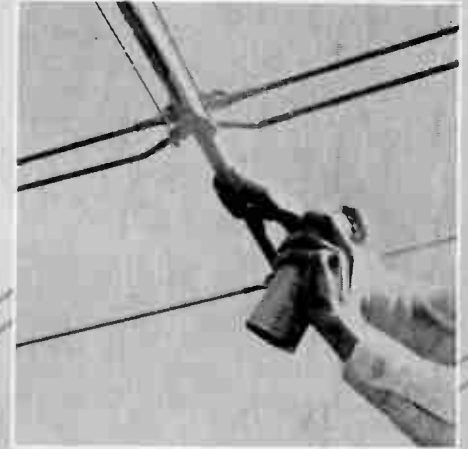

Lugs should be soldered to lead-in for continued positive contact. In photo (left) one lug has been soldered, the other crimped to stripped lead-in.

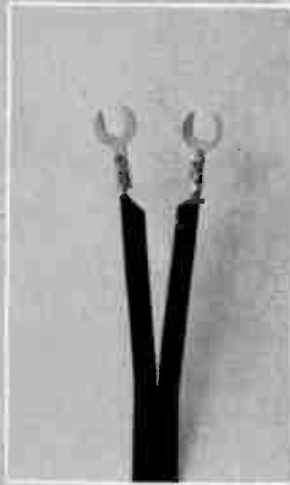

Lightning arresters require occasional cleaning to prevent bleeding of weak antenna signal. After reassembly, connections should be sprayed.



Although pushing lead-in under window is convenient, wires may become crushed as shown here, eventually breaking contact completely. The use of a special lead-in tube is recommended.

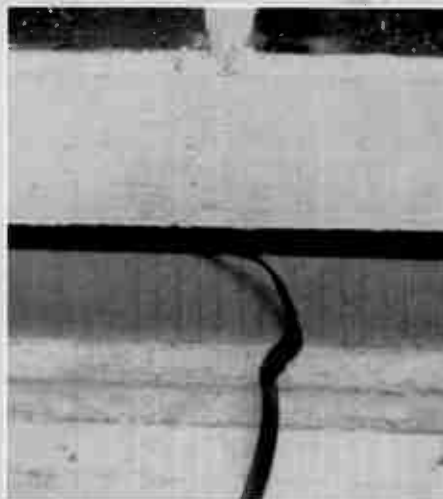



WE SEEM to be getting away, at long last, from that somewhat vague product, the "Williamson type" amplifier. A study of the schematics seems to show that one or the other of two features from the original Williamson justified using the term "Williamson-type"—either the use of a combination gain stage direct-coupled to a split-load phase inverter, or the use of a "step" network somewhere as part of the feedback stabilizing procedure. The rest of the circuit could be what it may.

Now we have a new crop of amplifier circuits, complete with fancy names. As a result one often hears a conversation between enthusiasts in which one will mention, say, the unity-coupled circuit, and another will say, "Oh, yes, that's the same as the Circlotron circuit, isn't it?" And neither of them seems quite sure if these are the same or different circuits.

These two circuits achieve the same objective by slightly different methods. Each of them operates the output tubes as pentodes in push-pull, in such a way that the tubes' plates and cathodes each deliver an equal part of the total output "swing" or power. This yields considerable tightly coupled degenerative feedback between the drive and output stage, so that the inherently high plate resist-

Fig. 1. Unity-coupled circuit.

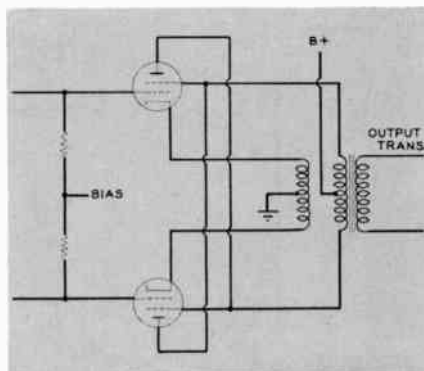

ance of pentodes is reduced to a convenient value in a circuit that is rock-stable. Then conventional over-all feedback can be applied without the severe conditional stability (or at least highly conditional frequency response) problems often encountered with pentode-type output stages.

An essential feature of such a circuit is sufficiently tight coupling of the output currents from the two tubes. The tubes individually still have their normal high plate resistance; it is only as a composite circuit that the effective plate resistance is drastically reduced. Conse-

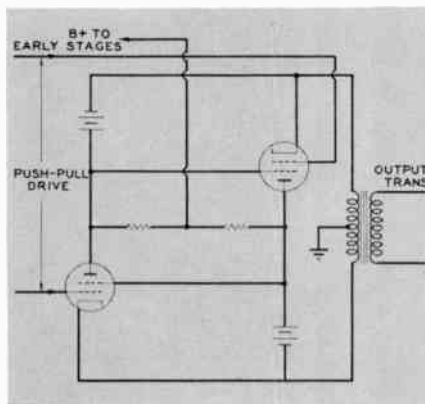

Fig. 2. The Circlotron circuit.

quently, failure to tightly couple the output currents together can result in the well-known "notch" distortion and other problems. And this is where the circuits differ.

The unity-coupled circuit (Fig. 1), used by McIntosh, has a bifilar-wound output transformer; the currents in the two sections of the winding, as well as the associated voltages, are tightly coupled together. The Circlotron circuit, formerly used by Electro-Voice (Fig. 2), couples the output tubes together through two identical high-voltage power supplies, and then has a simple

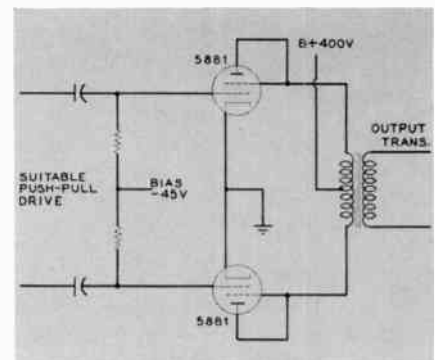
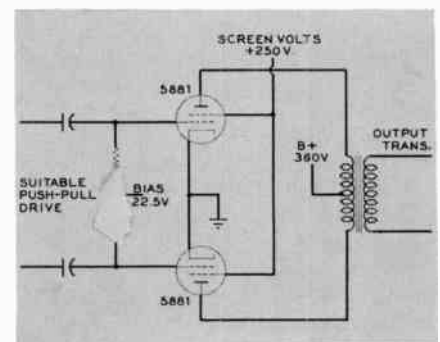

Fig. 3. Pentodes used as triodes.

output transformer, whose only function is to transform the output power to match the load. Over-all feedback is also taken from its secondary.

So one method uses a special output transformer and conventional power supply, while the other uses a conventional output transformer with a special power supply. There is a third possibility, which I recently introduced, and which may be called the poor man's unity-coupled circuit. Instead of using either an expensive output transformer or a complicated power supply, I use two inexpensive output transformers (two for less than the price of one super-duper) and a pair of inexpensive paper capacitors to provide the necessary cou-

Fig. 4. Standard pentode output circuit.



pling. This is called the twin-coupled circuit.

But there is another variety of unity coupling, formerly used in the National amplifiers. This has the output tubes working so that one has the load in its plate circuit while the other has it in the cathode circuit. The high-voltage supply is, of course, between one cathode and the other plate, while a fat electrolytic coupling capacitor links the other pair, at the "hot" end of the output-transformer primary. An auxiliary winding on the output transformer provides the screen voltage for the tube whose load is in its cathode. Otherwise, as in the Circlotron and twin-coupled circuits, the only purpose of the output transformer is to match the load.

Then there's another source of confusion in this area. Each of the four circuits we have discussed has degenerative feedback between the push-pull pentode output tubes and the drive stage. As well as reducing the composite plate resistance, this also operates to linearize the tube characteristics very considerably. Aware of this action, apparently, several have thought it entitled the circuit to the designation, "Ultra-Linear." But, in its accepted usage, that is yet another way of working output tubes.

As is well known, any pentode output tube can be connected to work as a triode (Fig. 3), merely by strapping the second, or screen, grid to the plate. If we assume that the same B supply is used directly for both plate and screen

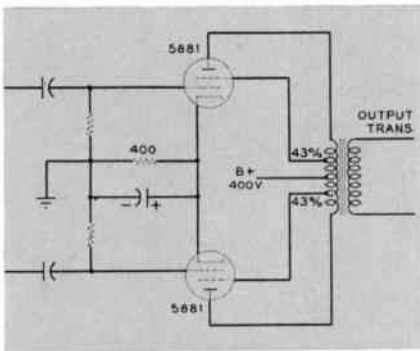

Fig. 5. Tapped-screen operation.

in the pentode circuit too—as it is in the circuits we have just discussed—the difference between pentode and triode operation is in what happens to the screen voltage when the plate voltage swings.

As a pentode (Fig. 4), the tube achieves maximum gain and efficiency, and the plate characteristic curves are nearly horizontal with a turnover at the left-hand end. As a triode, the AC voltage fed to the pentode's second grid is the full plate voltage direct-coupled to it. This changes the plate curves very dramatically, to the conventional triode type, in which the only curvature is at the bottom. It also reduces efficiency

Continued on page 38

Designed for Stereo
... by Weathers

Weathers has done it again—with components engineered specifically for the finest reproduction of stereophonic sound. These components are the ultimate in quality, reliability, and economy.

2 Superb Stereo Cartridges*

The Weathers Ceramic Stereo Cartridge (shown) outperforms any magnetic cartridge. Tracks at 2 grams . . . shielded against hum . . . 25 db channel separation . . . 15 to 30,000 cps frequency response. Comes complete with leads and connectors to fit all standard mountings . . . with diamond stylus \$17.50 . . . with sapphire stylus \$9.75.

The Weathers FM Stereo Cartridge for the Weathers FM Pickup. Universally acknowledged to be the finest ever made. Gives you the ultimate in channel separation (up to 35 db) and 10 to 30,000 cps flat response. **Tracks at 1 gram** . . . never causes record wear. Prices on request.

*Play both monaural and stereophonic records without damage.

The Weathers Turntable and FM Pickup

The lightest, quietest, and smoothest turntable ever produced. Noise level is 25 db less than that recorded on today's finest records. Isolated against outside vibrations. Rumble and acoustic feedback are practically eliminated. Maintains constant speed regardless of variations in line voltage or load. The Weathers FM Pickup and Micro Touch Tonearm show absolutely no intermodulation or harmonic distortion and no resonances over the complete audio spectrum. Prices on request.

Compatible Speaker Systems

Shown above at left is the Weathers Decorator . . . at right the Fiesta . . . both ideal for stereo.

	Mahogany each	Blonde each
Decorator	\$135.00	\$139.00
Fiesta	\$ 59.95	\$ 62.50

See your dealer or write for booklet number 658C.

Weathers Industries, 66 E. Gloucester Pike, Barrington, N. J.
DIVISION OF ADVANCE INDUSTRIES, INC.

Export: Joseph Plasencia, Inc., 401 Broadway, New York, N. Y.

WEATHERS TECHNICAL MAGIC IS SOUND



Crossover Coil Winding

The number of turns of wire in a coil used in making a crossover network determines the inductance of the coil and hence the crossover point. In winding such coils on a dowel with hardboard or plywood sides, the first layer or two usually go very well and counting is no problem. As the layers pile up, however, the wire will often become uneven, making it difficult to count turns. A simple way of keeping the winding neat and of keeping accurate count of the turns is to use a sheet of paper between each layer. Before starting to wind, cut several strips of ordinary bond writing paper the width of the winding area. As each layer is wound, cut a strip to a length slightly longer than the diameter of the last completed layer and wrap this around it. If reasonable care is used in the winding process each layer of the coil will remain neat and the turns will be much easier to count.

Edward T. Dell, Jr.
 Millis, Mass.

Easy Soldering

The following is a way of handling solder that is much more convenient than

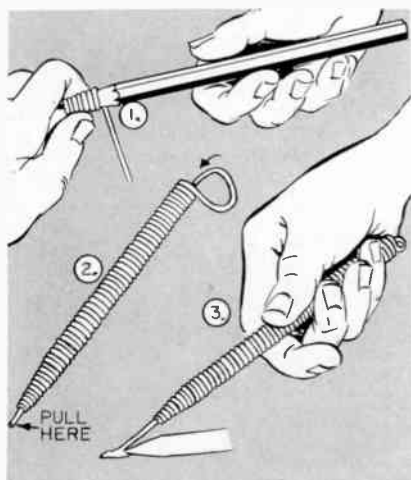

working with pound spools or haywire rolls. Simply wind rosin-core solder, preferably 1/16 inch in diameter, starting at the tip of a pencil and continuing its full length. Cut the solder about 8 or 10 in. longer, and feed the end down through the winding which has been re-

moved from the pencil. Pull the solder out to any length as needed (see diagram).

Louis Rick
 Lorain, Ohio

Temporary Housing

When experimental circuits such as filters and equalizers are added to an existing audio system, it is desirable to "live with" the new additions before permanently incorporating them into your setup in order to eliminate bugs, work out any necessary changes in the circuits, and, in fact, decide whether the additions are really wanted after all.

For example, I had occasion to add a set of low-pass and rumble filters, a presence equalizer, and switches between my preamp and power amplifier. While testing the individual circuits, I found it very convenient to use ordinary 1-pound candy boxes as temporary housing for the wired subassemblies. For shielding, aluminum foil was sometimes used as a lining.

The cardboard boxes are thin enough to allow very rapid mounting of controls and switches. While this won't win any prizes for interior decoration, it does eliminate the "home workshop" appearance of a den or living room while adjusting circuit values and the like.

H. Rosen
 Montreal, Que.

Improve FM Reception

Owners of FM tuners may profit from a gimmick used in many TV-antenna installations. A small piece of tinfoil (3 in. square seems to work well, although the size is not critical) wrapped around the 300-ohm twin lead can be used to compensate for antenna impedance mismatching and thereby improve reception of weak stations. The tinfoil is simply slid along the lead-in at the tuner end until maximum reception is attained. A second piece of tinfoil a few feet towards the antenna from the first may improve reception still further. In this case, adjustment of the two pieces is made alternately.

This procedure is worth while only when there is substantial mismatching, a common situation, however, when indoor dipoles have been laid under rugs, etc.

In my own case (I have an outdoor folded dipole), reception of weak stations was changed from very poor to excellent.

Note that the best position for the tinfoil depends on the frequency of the station, and if there are weak stations at both ends of the FM band a compromise setting may be necessary.

John Dukes
 Berkeley, Calif

Avoiding Wiring Errors

One of the most common pitfalls in the construction of electronic equipment is an error in wiring. The danger of making such an error may be decreased by marking on the circuit diagram with a pencil as each wire is soldered in place, but this defaces the diagram and makes it difficult to read. Copying the drawing is also unsatisfactory because of the possibility of errors.

These difficulties may be entirely eliminated by covering the circuit diagram with a piece of celluloid fastened in place with masking or drafting tape which may subsequently be removed without damage to the paper (ordinary cellophane tape is not satisfactory). The celluloid may then be marked with a grease pencil or crayon. If several colors are on hand, the color of the wire used may be duplicated. If the celluloid becomes greasy and will not take the crayon marks, ordinary cleaning fluid will take care of it. A further advantage is that the marks can be removed easily with a rag. After the circuit is completed, the record may be kept for future reference or simply wiped off and the celluloid used over and over again.

Thomas M. Green III
 Berkeley, Calif.

IMPORTANT NOTICE

Beginning with the December issue, **Audiocraft** will be consolidated with **High Fidelity Magazine**. Most features of each publication will be retained, and **Audiocraft** will be clearly a separate section, edited by the same staff it has now.

This will give to **Audiocraft** readers the editorial coverage of music and records, and to **High Fidelity** readers the practical audio coverage, that it has been impossible for them to find within the covers of any other magazine. We believe that the consolidation will be in the best interests of everyone concerned.

If you are a subscriber to **Audiocraft**, you will receive notification by mail of the arrangements being made to transfer the unexpired term of your subscription. If you buy **Audiocraft** from a newsstand, simply look for **High Fidelity** (including **Audiocraft**) beginning in December.



NATIONAL STRING QUARTET; VIOLINISTS, DAVID MONTAGU, HERBERT BORKIN; VIOLIST, MAX SERBIN; CELLIST, DANIEL VANDERSALL.

You are the Fifth man in this Quartet...

...when the instrument you are playing is the **Harman-Kardon Concerto**. Listen to Harman-Kardon stereo high fidelity and you are in the very midst of the music. Here is music in its fullest dimension: all of its depth and width and color — its infinite variety — reproduced for you perfectly every time.

There is a complete new line of stereo units by Harman-Kardon. All are sensibly designed to permit maximum performance with a minimum of complication. Each reflects the brilliant design which has won Harman-Kardon products the distinction of exhibition at the Milan Triennale and the Brussels World's Fair.

The range of control in these new instruments is such that your position in the room is uncritical. Virtually wherever you sit, the room is alive with music. Further, your present LP records are enhanced in performance when reproduced this wonderful new way.

The Concerto, Model TP200 (see below) is a complete stereo tuner and stereo control center. It incorporates a splendid stereo AM and FM tuner and superb stereo preamplifiers in one, handsome, compact unit. The Concerto connects easily and quickly to the new Model HK250 (not shown) dual power amplifier. The HK250 delivers 25 watts of hum-free, distortion-free power from each channel (a combined peak power of 100 watts). It is meant to be placed out of sight and is controlled by the TP200. Together, they provide a complete, flawless stereo electronic center.

The TP200 includes separate highly sensitive FM and AM tuners with a convenient stereo indexer which permits ready identification of six pairs of stations. The preamplifiers permit any monaural or stereo program material to be re-

produced. Operating controls include: ganged bass, treble and loudness; contour, rumble filter, scratch filter, equalization, balance control, mode switch, function selector and two tuning controls for AM and FM. The TP200, including its copper finished enclosure, is priced at \$189.95. The HK250, including its copper finished enclosure, is priced at \$99.95.

Other new Harman-Kardon models include complete stereophonic amplifiers priced as low as \$99.95 and new stereophonic tuners as low as \$114.95. Harman-Kardon also produces The Nocturne, Model AX20, the ideal instrument to convert any existing system (console or component) to superb stereo. The AX20 price is \$99.95. Prices of all units are slightly higher in the West.

For complete information on Harman-Kardon stereo write to Dept. AU-11, Harman-Kardon, Inc., Westbury, N. Y.



harman kardon



make the change to **GRAY**

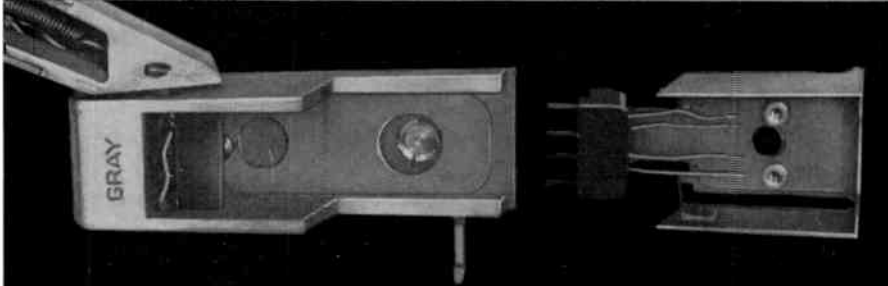
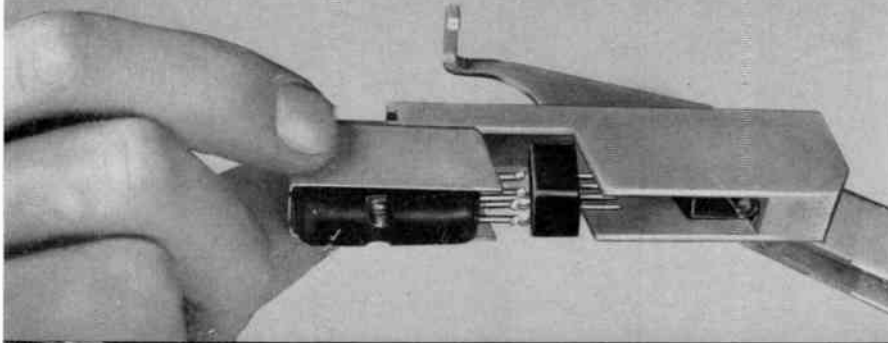

... make the complete change easier with **GRAY**

Exclusive GRAY slide-clip feature interchanges 2-wire monaural, 3 or 4 wire stereo cartridges easily, without rewiring!



all-new GRAY STEREO TONE ARM

Model 212-SP, 34.00. Model 216-SP, 36.50

Your cartridge will sound best in a GRAY tone arm. Dual viscous damping absorbs noise and vibration on widely separated vertical and lateral pivots, thus reducing tone arm resonance. Other features include static balance, stylus pressure control, slide-clip for quick cartridge switching, multiple wiring for monaural *and* stereo applications, simple installation, and overall precise metallurgy to insure freedom from distortion and life-long operation without wear. Get the "easy feel" and superior performance of a GRAY tone arm now at fine High Fidelity showrooms everywhere.

.....
 • Owners of GRAY 212 and 216
 • tone arms may switch easily
 • to SP series with new GRAY
 • STEREO CONVERSION KIT
 • ... Only 3.95.

For new literature on
 GRAY RECORD PLAYING EQUIPMENT
 write to:

GRAY High Fidelity Division

DEPT. H • 16 ARBOR STREET, HARTFORD 1, CONN.

PUZZLEMENTS

Continued from page 35

considerably, by taking away the area previously occupied by the pentode "knee." Plate current *and* plate voltage can no longer be made to swing as far, whatever the control-grid swing may be.

So it appears that the ideal tube would be some compromise between a triode and a pentode. This is what Ultra-Linear (Fig. 5) working means. Instead of keeping the screen volts constant, as in a pentode circuit, or swinging them all the way with the plate, as in the triode operation, they are connected to taps on the plate windings of the output transformer. This produces effective plate curves that are intermediate between the pentode and triode types. The efficiency is close to that of pentode operation, but the effective plate resistance and linearity — as well as tolerance of load deviation — are nearer that of a triode. It should be noted that Ultra-Linear is a registered trademark of the Acro Products Company, who devised the first transformer for this purpose. A general term for the circuit is "tapped-screen."

Having explained these differences between the circuits, there is the final inevitable question, "Well, which do you think is the best of all?"

Taking first the four circuits using pentode operation with degenerative feedback including the drive stage: they achieve the same objective by different means. There is no reason why one should do it any better than the others in any respect. The output tubes are operated in the same manner. Each circuit can be deteriorated by using circuit values other than optimum, or by using inferior components, particularly the output transformer.

The McIntosh version (unity-coupled) is dependent on the bifilar-wound output transformer. The Circlotron avoids this extreme dependence on the output transformer, but the power transformer and other parts of the twin B supplies can contribute to the audio performance in a way not usual among ordinary amplifiers. The National version must have the screen winding correctly coupled — a requirement that is admittedly easier than some output-transformer problems, but does have to be met.

In the twin-coupled circuit, the output transformers are completely noncritical of the circuit performance. But in the tapped-screen operation of output tubes, the output transformer is more critical than in any other output circuit. With a really good transformer the circuit is surely a good one. But with a poor transformer the circuit becomes quite inferior. It is far from being just as simple as inserting taps at the right percentage points.

Finally, someone usually calls attention to one of the popular brands of amplifier that uses a straight pentode push-pull output, with over-all feedback, and sounds very good. How does this compare? Often this question is asked in the tone, "This amplifier sounds very good — should it?"

Of course, when things sound good there is a reason. At least, there *must* be a reason when they don't! Let me present a hypothetical comparison (and please note, it *is* hypothetical—don't try to fit any actual products to it). One amplifier may consist of a good output stage (tapped-screen, say, with a good output transformer), but then the over-all feedback, including the front end, may not have been engineered to give solid performance to back it up. Another amplifier may use pentodes straight, with a relatively inexpensive output transformer, but a carefully tailored front end and feedback. And the second amplifier may finish up sounding the better of the two, at much lower cost.

What this implies is that you cannot dogmatize about the best output stage, drive stage, phase inverter, etc. A well-designed amplifier will perform better than a badly designed one, though the latter may include the "best" circuits.

ATTENUATORS

Continued from page 27

drive units so far tested here produce much more distortion at $\frac{1}{4}$ w input than the network would introduce at 25 w input.

While on the subject of power, a word should be said about high-fidelity expositions. It seems that every new speaker introduced and a lot of the old ones are demonstrated at hundreds of times as much power as the original sound. Many other exhibitors turn their volume up in self-defense. These loud demonstrations prove little except perhaps that loud playing obscures some of the defects of the reproducing systems. But even at power levels necessary to drown out a nearby dynamicist, electrical power to Klipsch speakers has never exceeded about $2\frac{1}{2}$ w, the gains being set on the tape-playback amplifiers so that this is the output for maximum playback gain setting.

In conclusion, it should be reiterated that the new networks are designed to supplement, fit, qualify, and compensate for a given driver-horn combination. As such, they are no longer of general application.

While it will continue to be company policy to sell these networks separately, it should be understood that they cannot be expected to work with any except driver and horn units of at least closely similar characteristics to the ones for which the network was designed.



Photo from Hi-Fi Music at Home (March, 1958)

LOUIS ARMSTRONG IN HIS DEN, EDITING TAPE

(Note his AR-2 loudspeaker at the left)

Where natural, musical quality is required, without pseudo-hi-fi exaggerations, AR-2 speaker systems are a logical choice. They are used in recording studios, in broadcast stations, and in the homes of leading figures of the musical world—including Louis Armstrong above, and John Hammond, director of the Newport Jazz Festival.

AR speaker systems, because of their patented acoustic suspension design, must use small cabinets. These small enclosures mean an advance rather than a compromise in quality, particularly of the bass range.

AR2's are \$89 to \$102, depending on cabinet finish (5% higher in the West and Deep South.) Literature is available for the asking.

AR-2

ACOUSTIC RESEARCH, INC. 24 Thorndike St., Cambridge 41, Mass.

COMING to your city HIGH FIDELITY MUSIC SHOWS

See and hear the latest in HIGH FIDELITY from leading high-fidelity manufacturers . . .

Don't miss these public showings of Hi-Fi Equipment . . . from the most economical units for the budget-minded to spectacular home music theatres . . . compare and enjoy them all. Components and complete systems will be displayed.

● 1958-1959 HIGH FIDELITY MUSIC SHOW SCHEDULE ●

OMAHA, NEBR. — Paxton Hotel
November 7, 8, 9, 1958

DENVER COLO. — Cosmopolitan Hotel
March 6, 7, 8, 1959

SEATTLE, WASH. — New Washington Hotel
November 21, 22, 23, 1958

BALTIMORE, MD. — Lord Baltimore Hotel
March 20, 21, 22, 1959

MINNEAPOLIS, MINN. — Leamington Hotel
January 16, 17, 18, 1959

PITTSBURGH, PA. — Penn-Sheraton Hotel
April 3, 4, 5, 1959

BUFFALO, N.Y. — Statler Hotel
April 10, 11, 12, 1959

Rigo Enterprises, Inc. 500 North Dearborn Street, Chicago 10, Illinois

? GOING STEREO

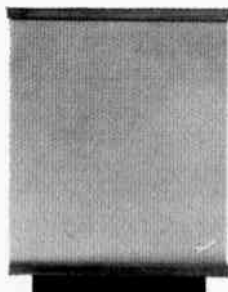

YOU'RE LUCKY IF YOU ALREADY HAVE A BOZAK!

Quality stereo demands matched speakers. To match your present Bozak, simply select a similar Bozak system at random or assemble a duplicate*. Presto! — your stereo team-mates are musical soul-mates, identical in their full-frequency response, natural balance, tonal consonance, room-wide coverage and broad-front sound. No need of special matching or balancing, no "hole-in-the-middle" or "ping-pong" effect with good program material — and no later regrets that you didn't start with the best! See a Bozak Franchised Dealer, write for literature.

* — E-300 Contemporary Kits with three-way B-302A systems are ideal for high-standard stereo on a low budget.

THE R. T. BOZAK SALES CO., DARIEN, CONN.

SOUND FANCIER

Continued from page 29

the informative 16-page accompanying booklet, the second track of this reel presents 33 sets of paired tones of different pitches (which tone is higher, or are they the same, in frequency?) and 75 paired words of similar sound but different meaning (can you distinguish each of them?). These are good aural tests, all right, although the former are mostly too easy, at least for an experienced listener, but unfortunately the other track is not devoted to similar checks of pitch, loudness, color, rhythm, discrimination, etc., but to a long batch of Lennie Herman pop pieces intended for recognition tests at various loudness levels and listening distances.

Much more valuable for one's aural education is the best single-volume guide to *The Instruments of the Orchestra* to appear on modern LP's (Vanguard VRS 1017-8, two 12-in.), played by first-desk men of the Vienna State Opera Orchestra, with businesslike verbal annotations and more extensive written notes by David Randolph. Happily the producers have ingeniously complemented and simplified, rather than imitated, the Vox "Spotlight"-series practices by sticking to the standard orchestral types, by including not only unaccompanied examples of the individual instruments but also full-orchestra excerpts, and by using only well-known musical illustrations. Excellently recorded in warmly attractive acoustics, this delightful lecture and demonstration is "must" listening for every musical novice, and should also appeal strongly to more experienced audiophiles for whom the complete Vox series may seem too expensive or farther ranging than their own interests demand.

The specialist, however, whose curiosity remains unslaked by Vanguard's limited representation of the reeds, will also want the extraordinarily diversified expositions of historic as well as modern instruments, in chronologically representative musical examples, in the final volume of the Vox series, *Spotlight on Wood Winds* (DL 312, two 12-in.). As with the earlier volumes, I have been too closely involved with this project to evaluate it objectively, and further biased as a onetime bassoon and clarinet player and still more than a little of a woodwind fanatic myself. But perhaps I may be permitted to whisper, *sotto voce*, that this set is my own favorite of the entire series, perhaps especially for the "old" bassoons, clarinets, and oboes; the singular timbres of the long-since-obsolete Cromorne and Ranket (or "sausage-bassoon"); and, not least, the eerie sounds of the most ancient of all wind instruments, the still-terrifying Bull Roarer or Thunderstick.

STEREO INSTALLATION

Continued from page 19

felt and heard. Power is such that Bob McKinney, installations expert with Mr. Beatty, guesses at full power the system could cause structural damage to the house.

The speaker system is on the narrow wall of the living room, backing into wardrobe and utility closets. There is over 250 cu. ft. of air space behind the speakers for an infinite-baffle system. Walls of the closets are completely lined with 1¼-inch Celotex. The ceiling and certain portions of the walls are also covered with 3-inch Gustin-Bacon Ultra-acoustic Fiberglas covered with cloth or plastic screen wire to prevent shedding. This material is available with a vinyl covering which would be even better for this use. This is probably the most absorptive material on the market today with an NRC rating of over 95.

All the woodworking was glued, screwed, and calked. The entire wall, upon completion, had the rigidity of a 6-inch-thick brick wall. This, combined with the extremely efficient JBL speakers, gives the system a most unusual combination of full bass response and an exceptional ability to handle transients.

"Some have questioned putting the two speaker systems in such proximity to each other," Dr. Blender remarked, "but I find that the effect is to distribute the sound throughout the wall. There is no conscious switching back and forth while listening, and yet the stereophonic effect is complete."

Stereophonic tapes have claimed more and more of his time since the installation of the new system, but he still collects records. "Too much of what I want to listen to still is available only on records," he says.

No less an authority than Hans Schweiger, conductor of the Kansas City Philharmonic Orchestra, has declared Dr. Blender's system to be virtually equivalent to a live concert. Schweiger is a frequent visitor and in fact makes use of the system to preview compositions the Kansas City orchestra programs.

Dr. Blender finds his music is keeping him as busy as his dental practice did. He writes excellent record reviews for a Kansas City magazine. He also now is finding time to read and study art, another favorite hobby.

In truth, music via hi-fi has become a soothing friend as he faces the uncertain future.



INTEGRITY IN MUSIC

PR-499:

STROMBERG-CARLSON PERFECTEMPO* MANUAL TURNTABLE

Designed for Stereo and Monaural Use • Incorporating every valid principle of turntable design that has been proven over the years . . . • belt drive • stroboscope speed indicator • high tolerance precision machining • weighted precision cast table • Precision motor • continuously variable cone drive . . . plus Stromberg-Carlson's own unique and original double-acting motor and table suspension system that effectively isolates the table and arm from all unwanted, extraneous noise.

Precision machining plus a high quality precision motor give constant speed at any RPM setting of the continuously variable drive with virtually no wow and flutter. The unique design of the cone drive and the accurately calibrated stroboscopic speed indicator permit fine adjustment to any speed from 14 to 80 RPM. Once set, the speed will never vary.

The result—professional performance with complete versatility. These are the contributions of the "Perfectempo" to your high fidelity system. Handsome styling in morocco red with aluminum trim. Specially designed hardwood base (PB-497) also available if you wish.

*TM



PR-499 SPECIFICATIONS:

SIZE: 15¾" wide, 14½" deep,
5½" below and 2" above mounting
base (not including tone arm).
WOW: 0.14% rms. FLUTTER:

0.09% rms. RUMBLE: -55 db re.
20 cm/sec @ 1 kc. MOTOR: four-
pole. PRICE: \$99.95*. (audiophile
net)

RA-498: TONE ARM

Designed for Stereo and Monaural Use • Single pivot point suspension, true viscous damping and high moment of inertia result in extremely low resonance (as low as 12 cycles, depending on cartridge used) and consequently yield flat response below the limits of audibility.

A calibrated counterweight is adjustable to provide any needed point force and is eccentric for fast, precise mass centering.
PRICE: \$24.95* (Audiophile Net). *Zone 1

"There is nothing finer than a Stromberg-Carlson"

STROMBERG-CARLSON

A DIVISION OF GENERAL DYNAMICS CORPORATION

1436C N. Goodman Street • Rochester 3, N. Y.

Electronic and communication products for home, industry and defense; including High Fidelity Consoles; School, Sound, Intercom and Public Address Systems.



HI-FI CABINETS of Philippine Mahogany



FULLY ASSEMBLED,
READY TO FINISH

ONLY
\$3988

TAX INCLUDED

Turntable Base
FREE!

Fits ALL Hi-Fi Components

2 Top compartments with drop doors, each 17" deep 19" across 11 1/2" high	2 Lower compartments with sliding doors, each 17" deep 19" across 14" high
---	--

OVERALL OUTSIDE DIMENSIONS:
18" deep, 40" wide, and 34" high

WEIGHT: 50 lbs.

FRONT PANELING
for AMPLIFIERS
and TUNERS
Included

F.O.B. Factory of
Chicago, Ill.
or Philadelphia, Pa.

These rich, luxurious looking cabinets are sanded satin smooth, ready to be custom finished in their natural state. Just apply lacquer, wax or varnish . . . they'll compare with the most expensive finished cabinets on the market . . . with the complete bottom half for record storage or speaker systems. Yes, here is your low-priced admission to the wonderful world of high fidelity.

Send Check or Money Order Now to;

ALFRAN DISTRIBUTORS
Suite 900, 22 W. Madison St.
CHICAGO 2, ILL.

PENTRON STEREO

HIGH FIDELITY
TAPE RECORDERS

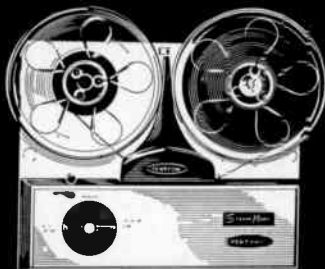

professional performance at popular prices

NOW YOU CAN RECORD STEREO, TOO!

Pentron's totally new TM-4 Stereo Tape Deck is the ideal addition to your custom high fidelity system: records and plays stereo . . . 4-track as well as 2-track tape, records and plays monaural and has all the exclusive Pentron stereo features which assure you matchless performance of a professional quality never before possible at popular prices.

Pentron tape mechanisms are precision engineered with full-range frequency response, Azmur-X head azimuth adjustment, single Finger-Flite rotary control, easy dual-speed control lever, four outputs plus two AC convenience outlets, self-energized braking, stereo or monaural erase, designed to operate at any mounting angle.

The Pentron TM-4 is priced at \$109.95 net and is available at professional high fidelity showrooms. For detailed information on Pentron high fidelity tape recorders, amplifiers, pre-amps, mike mixers, tape decks, and stereo conversion kits, write Dept. C-11 or see your yellow pages.

SEE THE NEW PENTRON-4 EMPEROF II . . .



THE ONLY COMPLETE POPULAR-PRICED
STEREO RECORDING SYSTEM

PENTRON

CORPORATION 777 South Tripp Avenue, Chicago 24, Illinois

CANADA: Atlas Radio Ltd., Toronto EXPORT: Raytheon Manufacturing Company, Waltham, Massachusetts

AUDIOLAB REPORTS

Continued from page 25

in. The motor is a hysteresis-synchronous type, dynamically balanced. It is appreciably smaller than most American hysteresis motors but seems to be quite adequate for its purpose. The main spindle is tapered and runs in phosphor bronze bearings. Unlike most other high-quality turntables, the Connoisseur spindle is a part of the motor and motor-board assembly. The 12-inch aluminum turntable is separate and slips over the spindle.

The speed-change and vernier variation is accomplished by a conical shaft on the motor. The idler wheel is moved up and down on the conical drive shaft by the speed-change knob, and the vernier control moves the idler up or down a small distance about each center position. The idler drives the inner surface of the turntable rim in the conventional manner.

An interesting feature of this turntable is the brake which stops the turntable almost instantly when the power is switched off. This is simply a small cork which is raised up through a hole under the rim of the turntable and presses against it in the OFF position. It works most effectively.

The turntable submitted to us for test was mounted on a finished wooden base which is available as an accessory. The motor board is normally furnished drilled for mounting a Connoisseur Mark II pickup (which we are reporting on separately) but may be drilled for most other arms which mount within 9 in. of the spindle. Sixteen-inch arms must be mounted off the motor board, on the wooden base.

Test Results

Wow and flutter were measured with a Components 1106 test record and a Donner 2800 Wow & Flutter Meter. The wow was approximately 0.1% RMS, and flutter was .07% RMS. These values are typical of the best professional standards and are certainly entirely negligible in home service.

Rumble is a much more difficult thing to measure with any degree of exactness, since it depends to a great extent on the characteristics of the pickup and on its mounting to the base or motor board. Our rumble measurements are referred to a level of 7 cm/sec stylus

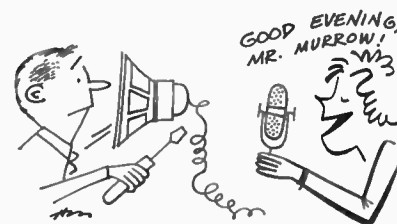

velocity at 1,000 cps, as obtained from the Components 1108 test record. The pickup is equalized by a Dynakit pre-amplifier set for RIAA equalization.

With the Connoisseur pickup mounted on the drilled motor board, we measured a rumble level of -38 db to -43 db. This was predominantly 20-cps, which is an unusual frequency (most turntables suffer from 30-cps rumble). The test of the pickup showed a pronounced resonance in the 20-cps region, which seemed like a probable cause. Unfortunately we were unable to mount our standard pickup (Fairchild 225A in a Fairchild 281 arm) on the turntable proper, so we located it on a separate base at the correct distance and rechecked rumble. This time it was -47 db, and mostly at sub-audible frequencies. It seems to us as though this figure is more truly representative of the turntable. In listening tests, rumble was completely inaudible under any conditions.

We encountered one idiosyncrasy of the Connoisseur turntable which we have not seen elsewhere. If the turntable is stopped or slowed down by hand while it is operating, the idler-wheel needle bearings slip from their pivots, and the turntable does not resume when the drag is removed. The cure consists of removing the platter and resetting the idler in its pivots by hand (a simple operation). This does not seem to be a likely occurrence under normal conditions of operation but could prove puzzling to the user.

We have adopted a procedure for measuring the relative hum fields surrounding turntables in the regions traversed by the cartridge. We use a magnetic cartridge, of a type noted for its susceptibility to induced hum, as a probe, and measure the output after it is RIAA-equalized by the Dynakit preamplifier. This is expressed in db relative to the output of the cartridge from a 7-cm/sec, 1,000-cps test band under identical equalization conditions. The cartridge is placed in the normal location it would assume, directly on the turntable surface, at radii of 2 in. and 6 in.

The hum figure we obtained for the Connoisseur turntable was -47 db at a 6-inch radius and -51 db at a 2-inch radius. It must be stressed that these are purely arbitrary figures and can be used only for comparison with other turntables tested under identical conditions. To provide a frame of reference, it can be said that the Connoisseur has a very low induced hum, and the readings obtained were comparable to the stray hum induced in the pickup from nearby power lines.

Summary

In its operating characteristics, the Connoisseur turntable meets or exceeds the
Continued on next page

The features that have long made JBL loudspeakers the most wanted in the world for monaural systems are doubly important for stereo reproduction:

BEST



HIGH EFFICIENCY is synonymous with JBL. The JBL 15" Model D130 with 4" voice coil is the most efficient extended range loudspeaker made. The high efficiency of all JBL precision transducers is largely responsible for their smooth, accurate response and unequalled transient reproduction. Now it is found to have great practical significance when you consider the power requirements for your stereo system.

FOR



WIDE ANGLE DISTRIBUTION with smooth coverage of equal intensity regardless of frequency is best achieved with a JBL acoustical lens. A pair of model 375 high frequency drivers fitted with exponential horns and serpentine lenses, the kind used in the JBL Hartsfield, will distribute "the stereo frequencies" evenly over a broad area.

STEREO



PROGRESSIVE PURCHASE extended range unit first, high frequency unit and dividing network later - makes it possible to build in logical steps to the ultimate in high fidelity sound—a JBL Signature two-way divided network system for each channel in your stereo system.

TOO!



And fundamentally, since you must in any case use twice the number of speakers as before, you will prefer JBL speakers for their clean, precision response. Write for your free copy of the complete JBL catalog and the name of the authorized JBL audio specialist in your community.

JAMES B. LANSING SOUND, INC. / 3249 CASITAS AVE., LOS ANGELES 39, CALIFORNIA

PROFESSIONAL DIRECTORY



ANTENNAE

Get more FM stations with the world's most powerful FM Yagi Antenna systems.



Send 25¢ for booklet "Theme And Variations" containing FM Station Directory.

APPARATUS DEVELOPMENT CO.
Wethersfield 9, Connecticut

the unique **ISOTONE** acoustical spiral system of music reproduction featuring the rugged Hartley polymerized cone speaker, among other top grade units, now available: to Dealers. Please inquire; to Audiophiles. Send for brochure.

Isotone Acoustic Spiralways, Inc.
3402 Third Avenue,
N.Y. 56
Phone: WY3-1821

SOUNDTASTIC!

That's what our customers are saying upon receiving our price sheets on our latest **HIGH FIDELITY, STEREO, MONAURAL AMPLIFIERS, TUNERS, TURNTABLES, SPEAKERS, TAPE RECORDERS, KITS, ALL BRAND NEW WITH FACTORY GUARANTEE.** Prompt in-stock service. Free selector and planning booklet #A, available on request.



2857 Coney Island Ave., B'klyn 23, N. Y.

ENJOY PLEASANT SURPRISES?

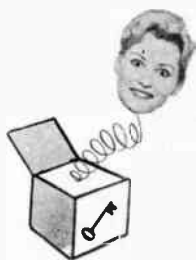

write us your hi-fi needs now, you'll be glad you did. Ask too, for our unusual free audio catalog.

KEY ELECTRONICS CO.
120 Liberty St.
N.Y. 6, N.Y.
EVergreen 4-6071

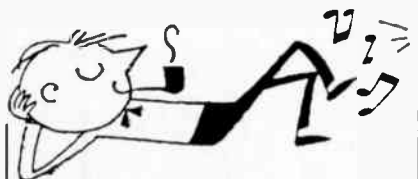

TAPE RECORDERS
EXCEPTIONAL VALUES
HI-FI COMPONENTS
NATIONAL BRANDS

WRITE FOR FREE CATALOGUE
CARSTON
215 VV E. 88 ST.
NEW YORK 28, N.Y.

LEONARD RADIO, INC.

69 Corlandt St., New York 7, N. Y., Corlandt 7-0315

ELECTRONICS for HOME and INDUSTRY
FREE . . . !

128 PAGE HiFi STEREO CATALOGUE

World Renowned
HARTLEY
Speakers

Few areas still open.
Moderate franchise requirements.

WRITE - WIRE - PHONE

HARTLEY PRODUCTS CO.
521 East 162nd Street, New York 51, N. Y.
LUdlow 5-4239

"BUCK STRETCHER" HI-FI VALUES!



Expand the buying power of your Hi-Fi dollar at Sun Radio on new and fully guaranteed name brand Hi-Fi components!

Send for our special price quotations and our Hi-Fi package specials! Dept. X8

SUN Radio & Electronics Co., Inc.
650 6th Ave., New York 11, N. Y.
Phone: ORegon 5-8600

AUDIOLAB REPORTS

Continued from preceding page

best professional standards. It has unusually low wow, flutter, and rumble. The variable speeds add extra flexibility, and a series of stroboscope markings on the rubber turntable mat assist in setting the speed exactly.

Mechanically it is ruggedly built. It is convenient to operate, and we found the brake to be a most desirable feature in bringing the turntable to a stop.

Mounting a pickup other than the Connoisseur on the motor board involves drilling holes through the 1/4-inch aluminum plate, which might prove inconvenient. If the turntable is used on the accessory base, it is necessary to use a relatively short arm, preferably one which mounts about 8 in. from the spindle. Such an arm might not be otherwise desirable, and if any 16-inch arm is used the base is too small and the user must provide his own base.

Manufacturer's Comment: In arriving at the specifications which are published for Connoisseur products and which are minimums, in every case attained, but more often exceeded, we use as a reference 7 cm/sec stylus velocity at 1,000 cps.

In view of the high opinions expressed by the Hirsch-Houck Laboratories of the Connoisseur braking system, we are amused by the reference which is termed an idiosyncrasy since we can scarcely see any cause for slowing the turntable by hand (the variable speed arrangement being readily available) and the brake being equally available and efficient.

It is quite true that the metal used in the motor board is difficult to drill, but the turntable is available predrilled to accept the Connoisseur arm, and with proper tools, the problem is certainly minor. Bases are available which will accept the 16-inch arm.

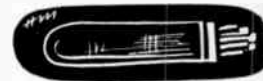

STATEMENT OF THE OWNERSHIP, MANAGEMENT, CIRCULATION, ETC., REQUIRED BY THE ACT OF CONGRESS OF AUGUST 24, 1912, AS AMENDED BY THE ACTS OF MARCH 3, 1933, AND JULY 2, 1946

Of Audiocraft, published monthly at Great Barrington, Massachusetts, for September 29, 1958

1. The names and addresses of the publisher, editor, and business manager are: Publisher, Charles Fowler, Egremont, Mass.; Editor, Roy F. Allison, North Egremont, Mass.; Business Manager, Warren B. Syer, New Marlboro, Mass.

2. The owner is: Audiocom, Inc., Great Barrington, Mass.; The Billboard Publishing Company, Cincinnati, Ohio.

3. The known bondholders, mortgagees, and other security holders owning or holding one percent or more of the total amount of bonds, mortgages, or other securities are: none.

4. Paragraphs 2 and 3 include, in cases where the stockholder or security holder appears upon the books of the company as trustee or in any other fiduciary relation, the name of the person or corporation for whom such trustee is acting; also the statements in the two paragraphs show the affiant's full knowledge and belief as to the circumstances and conditions under which stockholders and security holders who do not appear upon the books of the company as trustees, hold stock and securities in a capacity other than that of a bona fide owner.

(Signed) Charles Fowler
Sworn to and subscribed before me this twenty-ninth day of September, 1958.
(Seal) Lillian F. Bendross, Notary Public
Commission expires June 24, 1961.

TRADERS' MARKETPLACE

Here's the place to buy, swap, or sell audio equipment. Rates are only 20¢ a word (excluding name and address) and your advertisement will reach 30,000 to 35,000 readers. Remittance must accompany copy and insertion instructions. Copy must be received by the tenth of the second month preceding publication date.

TAPE RECORDERS: hi-fi components, tapes at wholesale prices! Free catalogue. Carston, 215-V, E. 88 St., N.Y.C. 28.

LOWEST QUOTES ON HI-FI components, tape recorders, tapes. Write to Dept. A, PROFESSIONAL

AL HI-FI, Box 62, Canal St. Station, New York 13, N. Y.

WILL BUILD all types of kits, hi-fi, etc. 30% above cost. Write for details, Howard's Radio Service, Box 528, Myrtle Creek, Oregon.

HI-FI HAVEN, New Jersey's finest sound center. Write for information on unique mail order plan that offers professional advice and low prices. A registered component dealer with the IHFM. 28 Easton Ave., New Brunswick, N. J.

STORAGE Problems? New design in racks and cabinets for record and tape collections. Direct from manufacturer. Write - A. G. PEPP, 209 Fremont Ave., Los Altos, California.

TAPE RECORDERS, hi-fi components, tapes. Unusual values. Free catalog. Dressner, 69-02D 174 St., Flushing 65, N. Y.

From
any Point of View,
more Experts choose
ACROSOUND
ULTRA-LINEAR II
60 watt amplifier

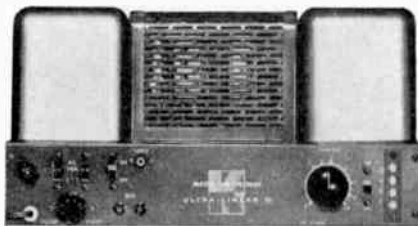

DESIGN The combination of patented ULTRA-LINEAR circuitry—plus new HYBRID FEEDBACK principle—VARIABLE DAMPING control, and ULTRA STABILITY, represents a new high in the art of amplifier design... an example of ACROSOUND'S latest achievement in AMERICAN Know-How. This superiority of design now enables anyone with or without any previous knowledge of electronics to assemble for himself or herself... (yes! it's that easy!)... the finest of amplifiers and at a most reasonable cost, in only two hours!

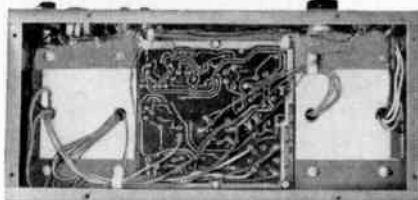

PERFORMANCE By listening test, or by instruments... second to none in clarity and frequency response. Normal level distortion is virtually unmeasurable—IM 1% or less at 60 watts, 120 watts peak. Completely stable... unaffected by loads, perfect square waves.

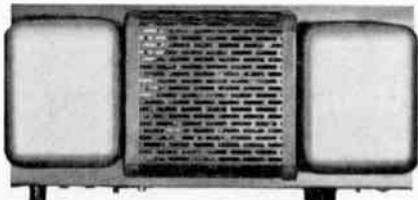

QUALITY Every part going into the assembly of critical and even non-critical circuitry is tested and checked to allow no more than $\pm 1/2\%$ variation from ACROSOUND'S standards. Specialized test equipment unavailable commercially was designed in ACROSOUND'S laboratories to achieve this result. Every printed circuit board is placed in trial operation on a laboratory amplifier. Output tubes are matched by trial and double checked.



COMPONENTS ACRO'S newest TO-600 output transformer with special hybrid winding—separates functions of output circuit and feedback circuit. Heavy duty, completely assembled, and thoroughly tested, printed circuit board assures uniformity of performance. Low distortion EL34 output tubes are operated well within their ratings ensuring long tube life and optimum performance.

PRICE In preassembled kit form so that you may save money, learn while doing, and have the proud satisfaction you built the best for only \$79.50 net... or if you feel you would prefer it laboratory assembled it still represents a bargain at \$109.50 net.

HEAR IT AT YOUR DEALER NOW!

BE READY FOR ACROSOUND DISTORTIONLESS PRE-AMP DESIGNED FOR THE STEREO-PHILE

*Experts know why ACRO is best!
Others... Learn why! Write to*

ACRO PRODUCTS
369 SHURS LANE
PHILA. 28, PA.

RUMBLE SEAT

Continued from page 32

tion and AC-DC sets for each channel, it is possible to find 220 v between the two low terminals in homes serviced with 220/110-v wiring.

In summary, there are good and valid reasons for the existence of both three- and four-terminal stereo cartridges...

Robert L. Lewis
Manager
Sonotone Corp.

Gentlemen:

Although the new General Electric stereo cartridge was designed for optimum performance using all four terminals, it can easily be converted into a three-terminal cartridge by connecting two terminals together with the grounding strap provided. Let the user decide for himself.

Fred P. Beguin
Audio Consultant
General Electric Co.

Gentlemen:

Lest the motivating reason for our original protest be completely obscured by the lengthy exchange of correspondence concerning the relative merits of ceramic cartridges versus magnetic, I want to state again in the most emphatic, unequivocal terms that a three-terminal phonograph cartridge and a four-terminal phonograph cartridge are equally safe for high-fidelity use. Neither should be employed without adequate safeguards if one of the channel sources is an AC-DC device.

By now, the reader who has had the patience to wade through the voluminous correspondence may be sight-reading, so I would like to minimize the length of my remarks and start by summarizing the salient points that I intend to make.

No one, not even ourselves, has bothered to point out a very important and fundamental fact. *There has never been a restrictive factor in the design of a ceramic cartridge which would impose a limitation on performance.*

To imply anything other is to hurl defiance at incontrovertible engineering fact. The obverse is true: their functional simplicity affords extreme latitude in design and allows tailoring of the performance to limits imposed in the mass-market by acoustic feedback, limiting bass, amplifier hash, limiting high end, speaker deficiencies, requiring peaked cartridge response.

The many millions of ceramic cartridges produced for the set industry were neither designed for nor intended to have the flat response and close tolerances of the present designs for stereo. As Mr. Stanton pointed out, the popular-

THE PERFECT GIFT FOR THE TAPE RECORDIST

TK-4STD

GIBSON GIRL ACCESSORY KIT

EVERYTHING YOU NEED FOR BETTER TAPE RECORDING AND EDITING

30 STICKUM

FOR TAPES

\$12.00 List

GIBSON GIRL® ACCESSORY KIT

Everything you need for better
TAPE RECORDING and EDITING

- ★ FOR MORE PLEASURE!
- ★ GET PROFESSIONAL RESULTS!
- ★ FOR BETTER RECORDINGS!

ROBINS' ACCESSORY KIT contains the famous GIBSON GIRL TAPE SPLICER, SPLICING TAPE, TAPE THREADER, HEAD CLEANER, TAPE CLEANER CLOTH, TAPE CLIPS, REEL LABELS and NEW TAPE EDITING BOOK!

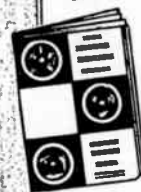

TAPE EDITING AND SPLICING FOR THE PROFESSIONAL AND AMATEUR TAPE RECORDIST
by N. M. HAYNES
24 Pages — illus. . . . 25¢

AT DEALERS EVERYWHERE!
Write for FREE Catalog of ROBINS' Phone and Tape Accessories!

ROBINS INDUSTRIES CORP.
FLUSHING 54 • NEW YORK

PURCHASING A HI-FI SYSTEM?

Send Us
Your
List Of
Components
For A
Package
Quotation

WE WON'T BE
UNDERSOLD!

All merchandise is
brand new, factory
fresh & guaranteed.

AIREX RADIO

CORPORATION

64-AC Cortlandt St., N. Y. 7, Co 7-2137

**PARTIAL LIST
OF BRANDS
IN STOCK**
Altec Lansing
Electrovoice
Jensen
Hartley
University
Acoustic Research
Janszen
Wharfedale
Karlson
Viking
Concertone
Bell • G. E.
Weathers
Harman • Kardon
Eico • Pilot
Sherwood
Acrosound
Fisher
Bogen • Leak
Dynakit
H. H. Scott
Pentron
Ampro • VM
Revere
Challenger
Wollensack
Garrard
Miracord
Glaser-Steers
Rok-O-Kit
Components
Norelco
Fairchild
Pickering • Gray
Audio Tape
Full Line of
Cabinets

RUMBLE SEAT

Continued from preceding page

priced monaural ceramic filled a necessary place in the business of music reproduction.

With the advent of stereo, Electro-Voice saw the necessary potential to warrant design of an entirely new breed of ceramic cartridge. From this effort came a true high-fidelity ceramic series, capable of comparison with the very best magnetics. For stereophonic reproduction the great advantage of ceramic in addition to design simplicity is in the fact that it is absolutely impervious to stray magnetic fields, giving us what we believe is a sharp, unassailable competitive advantage. No amount of correspondence can overcome this inherent strength of the EV ceramic cartridge. Indeed, the age of stereo is the age of ceramics.

Now, let us roll up our sleeves and answer some of the points raised by our erudite panel of magnetic partisans. Our friend, Mr. Stanton, is editorializing and, while we give full acknowledgment of his right to his own views, we do not feel that they have to be accepted without question. For example, most modern high-fidelity preamplifiers and amplifiers do provide a high-impedance input for ceramic cartridges. Admittedly, not all of them are of sufficiently high impedance to obtain optimum performance from the ceramic cartridge. But to spend any time on this point is to talk about a specious argument since Electro-Voice also manufactures a high-quality ceramic cartridge which de-equalizes the equalization required for magnetics; thus, it may be plugged directly into any magnetic input. A major advantage of a low-impedance ceramic cartridge is that both high- and low-frequency response is unaffected by the input resistor, insuring the user of optimum performance, insurance that he does not get when he uses a magnetic cartridge.

The question of record wear is determined principally by the mechanical impedance of a cartridge-stylus system, more commonly expressed in vertical and lateral compliance. The generating element has absolutely nothing whatsoever to do with these parameters; it is possible for any system to excel as a function of design and there are excellent ceramics and magnetics. Good or poor record wear is not confined to either type. Similarly, distortion is a function of good design and not dependent upon the type of generating element.

Mr. Von Recklinghausen has argued issues that are so esoteric and so far afield from the questions at hand that we would require a single issue to discuss them. Neither we nor any of our contemporaries have been able to duplicate the deplorable state of circumstances

POWERING 4 OUT OF 5

of the world's
greatest hi-fi
amplifiers

the
**Amperex®
6CA7/EL34**

HIGH-POWER
OUTPUT PENTODE



No other comparable tube combines to the same degree the 6CA7's exceptional linearity, high power dissipation and low drive-voltage requirements. It is a true pentode design, with a separate suppressor grid that controls the space charge, resulting in greater linearity on reactive speaker loads than is possible with competitive beam-power tetrodes. A single pair of 6CA7's in push-pull has been successfully used in power amplifiers delivering up to 100 watts undistorted output.

Ask your Amperex distributor about Amperex voltage amplifier, rectifier and output tubes for hi-fi circuits



Amperex
ELECTRONIC CORP.
230 Duffy Avenue
Hicksville, L. I., N. Y.

TRUE HI-FI
BEGINS
WITH

Sonotone® STEREO PHONO CARTRIDGES

50 manufacturers of over 417
phonograph models specify
SONOTONE.

When you buy or modernize
your record player, insist on
Sonotone Ceramic Phonograph
Cartridges.

**Winegard FM
Antennas Give You
Maximum Results
From Your FM Tuner**



The superior electrical characteristics of Winegard FM antennas exact the ultimate in hi-fi sound reproduction from your FM equipment. Without a doubt, these are the finest FM antennas made... permanently gold anodized to give you years of service.

Model FM3A
Non-directional, completely factory pre-assembled. You can install it yourself in just minutes on any antenna, mast, universal roof mount, fasteners, lead-in wire, set clip. \$17.95.

Model FMY8
A high gain 8-element directional yagi. Flat frequency response across entire FM band with 10.2 db. gain. Ideal for fringe areas and long distance reception. Users report reception up to 200 miles. \$22.95.

Write for Free complete list of FM stations and folder on Winegard FM and TV antennas.



copyright 1958

Winegard Co.

3003-11 Scotten Boulevard, Burlington, Iowa

*High priced speaker
a must?*



Made in England

Not with the new



Coxial 700 Series Mark III

Here is a speaker that brings you the luxury listening that is higher fidelity; yet its price is unbelievably lower than you would expect for such excellent performance. The new R & A speaker incorporates superb design details and is precision engineered to deliver a rare purity of sound — an experience that invites you to close your eyes and listen, and wonder how such a quality speaker can be offered at so low a price. (We won't tell you how little . . . you must hear the speaker first!)

8", 10" and 12" Models — all with Alcomax III Aniso-tropic Magnet systems of 12,000 Gauss Flux Densities. Buy it . . . try it . . . we back claims with a money back guarantee. At all hi-fi dealers.

ERCONA CORPORATION

(Electronic Div.)

16 West 46 St., Dept. 95, New York 36, N.Y.

In Canada: Astral Electric Co. Ltd.
44 Danforth Road, Toronto 13

HI-FI ACCESSORIES

MULTIPLE REMOTE SPEAKER SWITCH

Constant impedance switching device. Simplifies installation of one to six speakers in Hi-Fi or PA system. 42 combinations of operation.

For use with any size speaker and any speaker impedance. Gold embossed plate. MS-6. Complete with simple wiring instructions.



\$2.64

HI-FI CROSSOVER NETWORK

High pass filter network permits range of amplifier to be extended by addition of high frequency speaker. Prevents low frequencies from reaching the high frequency speaker, thereby eliminating the major source of distortion in a two speaker system. Universal can be used with 8 ohm or 16 ohm speaker systems. Facilitates the addition of a high frequency speaker. Model CN-5.



\$5.37

ORDER FROM YOUR DISTRIBUTOR

Vidaire

ELECTRONICS MANUFACTURING CORP.
BALDWIN • NEW YORK

he has conceived. I think we should be careful not to scare the consumer. Among the thousands who have returned our registration cards, virtually none has had any problem of installation and hookup with all types of electronics, including those units designed by Mr. Von Recklinghausen.

Mr. Carlson of Fairchild and ourselves unfortunately sit at different engineering tables. He continues to refer to records with an old standard of velocity characteristics in which the high end has been tipped up, the low end rolled off. The new RIAA standard which postulates this precise information to a specially conceived curve (which the entire world record industry has standardized upon) is what we use as our measure for flat. We resent his inference that we have to resort to tricks either verbally or mathematically. The unadulterated fact is that the EV ceramic when played on a modern stereo or monaural LP delivers a curve flat within $\pm 2\frac{1}{2}$ db from 20 to 16,000 cps. Many of Mr. Carlson's arguments should be directed not to us but to manufacturers of amplifiers.

We repeat, when played with the proper input impedance, the ceramic will do precisely as we claim and without equalization if our specified load resistor is used. In the event the proper impedance isn't available, then the audiophile may enjoy most of the natural advantages of the modern high-fidelity ceramic by using our low-impedance models. These magnetic series ceramic units retain freedom from hum and other advantages and incorporate an equalizer reducing the level exactly 36.5 db to match the velocity characteristic and low level of the magnetic cartridges. We don't want to split hairs with Mr. Carlson, but if it makes him feel better, we hasten to correct any impression he might have gathered that we have had not a single problem in turning out hundreds of thousands of stereo cartridges. The total now exceeds three-quarters of a million, but in line with our 25-year policy of guaranteeing product satisfaction, we do not know of one single dissatisfied consumer in the field.

Finally, we are happy to acknowledge that there are many excellent monaural and stereo magnetic cartridges being manufactured. Some of them are indeed a joy to listen to; this does not deter us from our argument that the EV high-fidelity ceramics have certain natural advantages which enable us to build a fine product at a reasonable price. For those that want even better performance — the last nuance — buy either a hand-selected ceramic or custom-crafted magnetic and pay the premium price. It's a free country.

Lawrence LeKashman
Vice President, Sales
Electro-Voice, Inc.

ADD HOLT STEREO!



MONAURAL THEN SOUNDS LIKE STEREO.

New encased model 6 tube converter and amplifier complements any hi fi system. It begins where hi fi leaves off. Connects in 2 minutes.

\$65.00 postpaid in U.S. Sold direct, only, on moneyback trial.

Order yours or send for folder. Read what customers and Hi-Fi magazines say.

NOW IN KITS, TOO

Kit, complete, \$45 postpaid (U.S.)

Encapsulated converter network
\$12 postpaid (U.S.)

STEREO by HOLT

4712 W. Magnolia Blvd.
Burbank, California

Dynaco Output Transformers



Featuring para-coupled windings, a new design principle (patents pending). These transformers use advanced pulse techniques to insure superior square wave performance and undistorted reproduction of transients. Dynaco transformers handle full rated power over the entire audio spectrum from 20 cps to 20 kc, without sharp rise in distortion at the ends of the band which characterizes most transformers. Conservatively rated and guaranteed to handle double nominal power from 30 cps to 15 kc without loss of performance capabilities.

Specifications:

Response: Plus or minus 1 db 6 cps to 60 kc. Power Curve: Within 1 db 20 cps to 20 kc. Square Wave Response: No ringing or distortion from 20 cps to 20 kc. Permissible Feedback: 30 db.

MODELS

A-410	15 watts	EL-84, 6V6, 6AQ5	14.95
A-420	30 watts	5881, EL-34, KT-66	19.95
A-430	60 watts	KT-88, EL-34	29.95
A-440	120 watts	KT-88, 6550	39.95
A-450	120 watts	PP par KT-88, EL-34	39.95

(all with tapped primaries except A-440 which has tertiary for screen or cathode feedback)

Additional data on Dynakit and Dynaco components available on request including circuit data for modernization of Williamson-type amplifiers to 50 watts of output and other applications of Dynaco transformers.

DYNACO INC.

Dept. AC, 617 N. 41st, Philadelphia 4, Pa.
Export Division: 25 Warren St., New York, N.Y.

New! Years Ahead!



Use it as a Binaural-Stereophonic FM-AM tuner
Use it as a Dual-Monaural FM-AM tuner
Use it as a straight Monaural FM or AM tuner

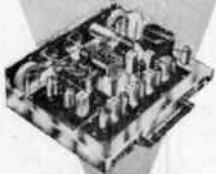

KT-500 IN KIT FORM
74.50
ONLY 7.45 DOWN
7.00 MONTHLY

LAFAYETTE STEREO TUNER KIT

THE MOST FLEXIBLE TUNER EVER DESIGNED

- Multiflex Output for New Stereo FM
- 11 Tubes (including 4 dual-purpose) + Tuning Eye + Selenium rectifier Provide 17 Tube Performance
- 10KC Whistle Filter ● Pre-aligned IF's
- Tuned Cascade FM ● 12 Tuned Circuits
- Dual Cathode Follower Output
- Separately Tuned FM and AM Sections
- Armstrong Circuit with FM/AFC and AFC Defeat
- Dual Double-Tuned Transformer Coupled Limiters.

More than a year of research, planning and engineering went into the making of the Lafayette Stereo Tuner. Its unique flexibility permits the reception of binaural broadcasting (simultaneous transmission on both FM and AM), the independent operation of both the FM and AM sections at the same time, and the ordinary reception of either FM or AM. The AM and FM sections are separately tuned, each with a separate 3-gang tuning condenser, separate flywheel tuning and separate volume control for proper balancing when used for binaural programs. Simplified accurate knife-edge tuning is provided by magic eye which operates independently on FM and AM. Automatic frequency control "locks in" FM signal permanently. Aside from its unique flexibility, this is, above all else, a quality high-fidelity tuner incorporating features found exclusively in the highest priced tuners.

FM specifications include grounded-grid triode low noise front end with triode mixer, double-tuned dual limiters with Foster-Seelye discriminator, less than 1% harmonic distortion, frequency response 20-20,000 cps \pm 1/2 db, full 200 kc bandwidth and sensitivity of 2 microvolts for 30 db quieting with full limiting at one microvolt. AM specifications include 3 stages of AVC, 10 kc whistle filter, built-in ferrite loop antenna, less than 1% harmonic distortion, sensitivity of 5 microvolts, 8 kc bandwidth and frequency response 20-5000 cps \pm 3 db.

The 5 controls of the KT-500 are FM Volume, AM Volume, FM Tuning, AM Tuning and 5-position Function Selector Switch. Tastefully styled with gold-brass escutcheon having dark maroon background plus matching maroon knobs with gold inserts. The Lafayette Stereo Tuner was designed with the builder in mind. Two separate printed circuit boards make construction and wiring simple, even for such a complex unit. Complete kit includes all parts and metal cover, a step-by-step instruction manual, schematic and pictorial diagrams. Size is 13 3/4" W x 10 3/4" D x 4 1/2" H. Shpg. wt., 22 1/2 lbs.

KT-500 Net **74.50**
LT-50 Same as above, completely factory wired and tested... Net **124.50**

NEW! LAFAYETTE PROFESSIONAL STEREO MASTER AUDIO CONTROL CENTER

Solves Every Stereo/Monaural Control Problem!

- UNIQUE STEREO & MONAURAL CONTROL FEATURES
- AMAZING NEW BRIDGE CIRCUITRY FOR VARIABLE 3d CHANNEL OUTPUT & CROSS-CHANNEL FEED
- PRECISE "NULL" BALANCING SYSTEM



KT-600
79.50
ONLY 7.95 DOWN
8.00 MONTHLY

A REVOLUTIONARY DEVELOPMENT IN STEREO HIGH FIDELITY. Provides such unusual features as a Bridge Control, for variable cross-channel signal feed for elimination of "ping-pong" (exaggerated separation) effects and for 3d channel output volume control for 3-speaker stereo systems; 3d channel output also serves for mixing stereo to produce excellent monaural recordings. Also has full input mixing of monaural program sources, special "null" stereo balancing and calibrating system (better than meters), 24 equalization positions, all-concentric controls, rumble and scratch filters, loudness switch. Clutch type volume controls for balancing or as 1 Master Volume Control. Has channel reverse, electronic phasing, input level controls. Sensitivity 1.78 millivolts for 1 volt out. Dual low-impedance outputs (plate followers), 1300 ohms. Response 10-25,000 cps \pm 0.5 db. Less than .03% 1M distortion. Uses 7 new 7025 low-noise dual triodes. Size 14" x 4 1/2" x 10 1/4". Shpg. wt., 16 lbs. Complete with printed circuit board, cage, profusely illustrated instructions, all necessary parts.

LAFAYETTE KT-600 - Stereo Preamp kit Net **79.50**

- RESPONSE 10-25,000 CPS \pm 0.5 DB
- 6 CONCENTRIC FRONT PANEL CONTROLS
- 4 CONCENTRIC REAR PANEL INPUT LEVEL CONTROLS
- 180° ELECTRONIC PHASE REVERSAL

NEW! LAFAYETTE STEREO/MONAURAL BASIC POWER AMPLIFIER KIT



KT-310
47.50
ONLY 4.75 DOWN
5.00 MONTHLY

- 36-WATT STEREO AMPLIFIER-18-WATTS EACH CHANNEL
- FOR OPTIONAL USE AS 36-WATT MONAURAL AMPLIFIER
- EMPLOYS 4 NEW PREMIUM-TYPE 7189 OUTPUT TUBES
- 2 PRINTED CIRCUIT BOARDS FOR NEAT, SIMPLIFIED WIRING
- RESPONSE BETTER THAN 35-30,000 CPS \pm 1/2 DB AT 18 WATTS
- LESS THAN 1% HARMONIC OR INTERMODULATION DISTORTION

A superbly-performing basic stereo amplifier, in easy-to-build kit form to save you lots of money and let you get into stereo now at minimum expense! Dual inputs are provided, each with individual volume control, and the unit may be used with a stereo preamplifier, for 2-18 watt stereo channels or, at the flick of a switch, as a fine 36-watt monaural amplifier - or, if desired, it may be used as 2 separate monaural 18-watt amplifiers! CONTROLS include 2 input volume controls, channel Reverse switch (AB-BA), Monaural-Stereo switch, DUAL OUTPUT IMPEDANCES are: 4, 8, 16 and 32 ohms (permitting parallel (monaural) operation of 2 speaker systems of up to 16 ohms. INPUT SENSITIVITY is 0.45 volts per channel for full output. TUBES are 2-6AN8, 4-7189, CZ-34 rectifier. SIZE 9-3/16" d (10-9/16" with controls) x 5 1/2" h x 13 1/4" w. Supplied complete with perforated metal cage, all necessary parts and detailed instructions. Shpg. wt., 22 1/2 lbs.

KT-310 Stereo Power Amplifier Kit Net **47.50**

Lafayette Radio

P. O. BOX 511
JAMAICA 31, N. Y.

Dept. ACK

Send FREE LAFAYETTE Catalog 690

Name

Address

City..... Zone.... State.....

CUT OUT
AND
PASTE ON
POSTCARD



ADVERTISING INDEX

Key No.	Advertiser	Page
1	Acoustic Research, Inc.	39
2	Acro Products Co.	45
3	Airex Radio Corp.	46
4	Alfran Distributors	42
5	Allied Radio Corp.	11
6	Amperex Electronic Corp.	46
7	Apparatus Development Co.	44
8	Audio Fidelity Records	Back Cover
9	Audiolab Test Report Reprints	25
10	Audiospeaker Laboratories	2
11	Audio World	44
12	Bozak, R. T., Sales Co.	40
13	British Industries Corp.	Inside Front Cover
14	Carston Studios	44
15	Collaro	12
16	Dynaco Inc.	13, 47
17	EICO	5
18	Ercona Corp.	47
19	Fisher Radio Corp.	14
13	Garrard Sales Corp.	Inside Front Cover
20	Gray Mfg. Co.	38
21	Harman-Kardon, Inc.	37
22	Hartley Products Co.	44
23	Heath Co.	7-9
24	Holt Stereo	47
25	Isotone Acoustic Spiralways, Inc.	44
26	Key Electronics Co.	44
27	Lafayette Radio	48
28	Lansing, James B., Sound, Inc.	43
29	Leonard Radio, Inc.	44
30	London Records	29
31	Music Box	6
32	ORRadio Industries, Inc.	13
33	Pentron Corp.	42
	Professional Directory	44
18	R&A speaker	47
34	Rigo Enterprises, Inc.	40
35	Robins Industries Corp.	45
15	Rockbar Corp.	12
36	Sonotone Corp.	46
24	Stereo by Holt	47
37	Stromberg Carlson	41
38	Sun Radio & Electronics Co., Inc.	44
39	Thorens Co.	27
	Traders' Marketplace	44
40	University Loudspeakers, Inc.	1
41	Vidaire Electronic Mfg. Corp.	47
42	Viking of Minneapolis	Inside Back Cover
43	Weathers Industries	35
44	Winegard Co.	46

Compatible **STEREO**

plus **BETTER TAPE RECORDING!**

Plan carefully . . . Plan Well . . . Select tape equipment that will fully exploit the capabilities of the best components in your high fidelity system. In no other way can you be sure of the playback and recording signal-to-noise ratio, the dynamic range and the frequency response that commercial quality tape equipment can provide.

See 'The Big Three' Viking decks at your high fidelity components dealer. You'll find tape equipment with an unmatched reputation for quality performance at sensible prices.

Most important, each of the Viking "Big Three" tape decks is designed and built with end use performance as a paramount objective. When you buy Viking, you buy honestly rated specifications. You buy engineered performance, not only in playback of recorded tapes, but in full-fidelity recording as well.

All models feature head configurations suited for the new four-track tapes as well as half-track stereo — fully compatible.

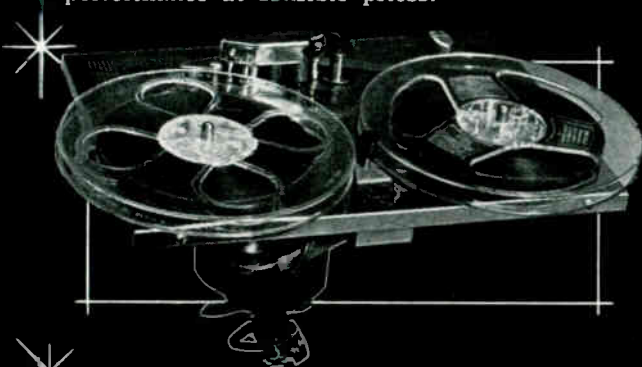

VIKING 75

The world's most used tape deck. The VIKING 75 has proven itself not only in countless thousands of music systems, but in training and teaching applications throughout the world—where dependability and minimum upkeep are of utmost importance.

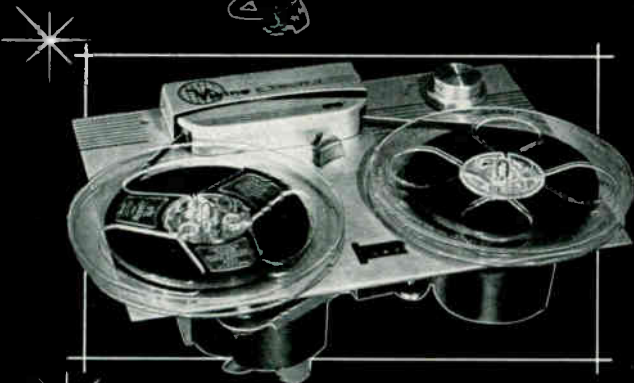

VIKING 85

This completely new 85 series tape deck offers fast forward, fast rewind and pause/edit operation. A rotary tape motion control provides spill proof, break proof operation under all conditions. Two motors and Viking's famed "flutter-filter" belt drive are standard. The 85 has room for five heads to meet any monaural or stereophonic requirement.



VIKING 95

Easily the outstanding new tape deck in the professional class. This superb new 95 series gives you dual-speed professional transport, hysteresis "flutter-filter" drive with three motors and a wide choice of head types. Available with 15-7½; 7½-3¾; or 3¾-1½ inches per second drive pulleys.



Write for Viking's new 1959 catalog covering decks, recording amplifiers, and tape accessories. Ask your dealer for help with integration of these tape components with your music system, or write direct to Viking's Customer Service Department

Viking OF MINNEAPOLIS, INC.

9600 Aldrich Avenue South • Minneapolis 20, Minnesota
EXPORT DIVISION: 23 Warren Street, New York City 7, New York • CABLE: SIMONTRICE, NEW YORK (All Codes)



Terrific, true swingin' Dixie in the finest New Orleans tradition! A Hi-Fi enthusiast's delight — a Jazz Collector's must! AFLP 1877*



Johnny and his gang create musical sounds on their new album making it difficult to believe one is listening to just harmonicas. AFLP 1859*

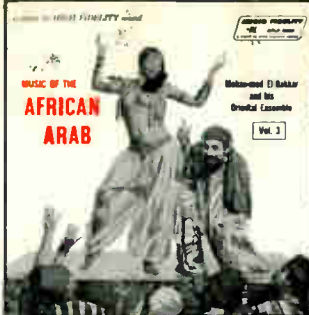

Sensuous, authentic, native music from the ancient Slave Markets of North Africa. Mohammed El-Bakkar and his Ensemble. AFLP 1858*



'Brilliant and exciting' best describe the new Johnny Puleo album of beautiful, easy-swinging, favorite Italian melodies. AFLP 1883*



Let's go back to College! Favorite Gridiron and College songs in the Dukes' unique styling converts the ordinary to the unusual. AFLP 1891*



Exciting, massive sounds — powerful earth-shaking dynamics from the world's largest Theatre Organ. All "pop" favorites. AFLP 1886*



Tango—the dance of love—torrid as a warm breeze, exciting as a new love! Lush arrangements recorded in Buenos Aires. AFLP 1880



A delightful array of scintillating tunes specially arranged for xylophone, glockenspiel, marimba, vibes. AFLP 1882*



Once again, Jo Basile weaves a magic musical carpet to transport you to the beautiful city of Rome. AFLP 1871*



Champagne and caviar moonlight, roof-top garden, and lush string arrangements. Mood music at its most intimate! AFLP 1873*

exciting new releases on the world's finest recordings...

AUDIO FIDELITY RECORDS

Here are some of the most exotic sounds and musical effects ever recorded! . . . and the Fi is fantastically high!

These are not just records . . . each is truly a wonderful emotional experience!

*also available on AUDIO FIDELITY STEREO DISC — \$6.95

recorded in brilliant High Fidelity . . . \$3.95 each 12 inch LP

Write for FREE Catalog — AUDIO FIDELITY, Inc. 770 Eleventh Ave., New York 19, N. Y.



Ace Harris and Buddy Charles really "rock" that piano with solid interpretations of old time standards. AFLP 1876*



A modern Jazz pianist with a distinctive captivating rhythmic style! Pat and her group play Blues, Ballads and Swing. AFLP 1875*



Gather 'round ye Shantymen — ye lovers of seafaring lore. Oscar Brand sings salty sea songs and spicy nautical ballads. AFLP 1884*



Leon Berry at the Giant in the Basement and an exciting session of pop favorites. Volume 3 AFLP 1844*



A wonderful new intense dramatic Jazz vocalist whose voice runs the gamut of musical expression. AFLP 1874*

THE NEW AUDIO FIDELITY STEREO DISC PACKAGE

All Audio Fidelity Stereodiscs are now available in this new super-deluxe four-color book-type jacket. Information about each album is contained on the inside front cover. As an extra feature, the inside back cover contains a non-technical, illustrated explanation of stereophonic sound. For added protection each record is packaged in a heavy polyethylene case.

each 12 inch Stereodisc — \$6.95



*reg. app.