

AUGUST 1958 • 35 CENTS

Data on all Stereo Cartridges

ICD

audiocraft

for the **HI-FI** hobbyist

The right way to put
up an FM antenna

Audiolab Test Reports:
Gray preamp, Marantz amplifier
Scott 330-C tuner

How to adjust bias
for least tape distortion



**perfect
match
for matchless
stereo!**

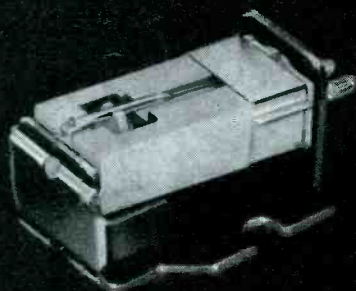

Collaro

STEREO RECORD CHANGER

Collaro Changers are designed to meet the rigid new demands of stereo. The transcription-type tone arm, exclusive with Collaro, is a counter-balanced unit designed to accept the Electro-Voice and other standard stereo cartridges. Arm resonance is below the level of audibility. Vertical and horizontal friction are reduced to a minimum. Tracking error and rumble are virtually eliminated. Between the top and bottom of a stack of records there is a difference of less than a gram in tracking pressure—insuring longer life for both stylus and records. Wow and flutter specifications are superior to any other changer. Collaro—Electro-Voice: the perfect match for matchless stereo.

ROCKBAR
Corporation

American sales representative for Collaro Ltd.

For complete information on the new Collaro stereo changers, write to
ROCKBAR CORPORATION
Dept. AC-8C, Mamaroneck, New York.

Electro-Voice®

STEREO CARTRIDGE

The Electro-Voice totally compatible stereo cartridge plays the new stereo discs superbly—LP's too—even better than existing cartridges. In breaking the stereo cartridge bottleneck, Electro-Voice has made popular-priced quality stereo a reality. EV's ceramic stereo cartridge (Model 21D with .7 mil diamond stylus) sells for only \$19.50 net.

Pickup from stray magnetic fields is non-existent; hum and rumble are below the level of even the most expensive magnetic cartridge. PZT ceramic elements deliver a precise RIAA curve. It's totally compatible—for brilliant stereo and monaural. Electro-Voice—the perfect stereo match for the Collaro stereo changer.

FOUR MODELS

- 21D Stereo Cartridge with diamond stylus \$19.50 net
- 21S Stereo Cartridge with Sapphire stylus \$ 9.90 net
- 26DS Stereo Turnover to 78 monaural, diamond and sapphire \$22.50 net
- 26ST Stereo Turnover to 78 monaural, two sapphires \$12.90 net



For further information on Electro-Voice compatible cartridges write:

ELECTRO-VOICE, INC.

Dept. AC-8C, Buchanan, Michigan

Save yourself time and trouble
by ordering your books directly from us.
Just fill in the coupon below.

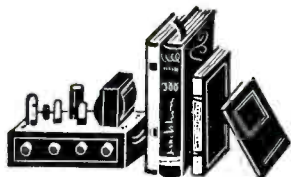

audiophile's bookshelf

MAINTAINING HI-FI EQUIPMENT

By JOSEPH MARSHALL. A much-needed book on the specialized approach necessary to service high-fidelity equipment. The author discusses not only electronic faults, but the mechanical and acoustical defects which cause a hi-fi system to function less than perfectly. Hard cover, \$5.00 **232** Soft cover, \$2.90 **233**

UNDERSTANDING HI-FI CIRCUITS

By NORMAN CROWHURST. Here the audiophile will find the answers to questions often confusing. The chapters are: special output stages, feedback, damping, inverter and driver stages, input stages, matching, equalization, speaker distribution and crossovers, loudness and volume controls, tone controls. Hard cover, \$5.00 **254** Soft cover, \$2.90 **255**

THE FORMS OF MUSIC

By SIR DONALD TOVEY. Written by one of the most literate and profound of modern interpreters of music, these essays are drawn from those articles which Tovey prepared for the *Encyclopaedia Britannica*. Paper, \$1.35 **239**

WHAT TO LISTEN FOR IN MUSIC

By AARON COPLAND. The revised edition of a book which made it possible for thousands to increase their enjoyment of music through creative listening. \$3.95 **247**

THE NEW HIGH FIDELITY HANDBOOK

By GREENE and RADCLIFFE. A complete, practical guide for the purchase, assembly, installation, maintenance, and enjoyment of high-fidelity music systems. Includes the latest information on equipment. 250 illustrations, diagrams, and plans. \$4.95 **251**

"... Messrs. Greene and Radcliffe, two gentlemen whose knowledge of hi-fi is only slightly less than awesome. ... Read [this book] through, and you will arise full of knowledge." — Deems Taylor

High Fidelity Record Annuals

1955 ANNUAL — edited by Roland Gelatt
\$4.95 **201**

1956 ANNUAL — edited by Roland Gelatt
\$4.50 **237**

RECORDS IN REVIEW — 1957 — edited by Joan Griffiths
\$4.95 **257**

Each of these books, the only ones of their kind, contains reviews of classical and semiclassical music, and the spoken word, that appeared in HIGH FIDELITY Magazine for the twelve months — July through June inclusive — preceding their date of publication. The reviews cover the merits of the performance, the quality of the recording, and make comparative evaluations with releases of previous years. They are written by some of this country's most distinguished critics.

*A quick and easy way to find
the reference you want — exactly
when you want it —*

HIGH FIDELITY:

A Bibliography of Sound Reproduction

Compiled by K. J. Spencer Foreword by G. A. Briggs

This new book, imported in a limited quantity from England and available in this country only through the publishers of HIGH FIDELITY Magazine, is a volume whose value to everyone seriously interested in high fidelity need not be outlined.

It contains approximately 2,600 entries that represent the whole field of published information and research on high quality sound reproduction, from the subject's very early days up to and including June 1957. The whole literature on sound reproduction, which happens to be mainly English and American, is here cited — with the result that a specialized work of reference is now available for all who wish to be able to consult, quickly and easily, what has been published on every aspect of the subject from Definitions to Maintenance. Supplements are expected to be published from time to time. \$6.00 **271**

Audiocraft's Annual

FM STATIONS UP-TO-DATE

Here, in convenient booklet form, is a complete geographical listing of FM stations in the United States and Canada, accurate to January 2, 1958. The list was compiled directly from FCC records, and originally appeared in AUDIOCRAFT Magazine.

Only a limited number of copies of *FM Stations Up-to-Date* are available, so, to be sure of getting one, place your order soon. The price is only 50¢. **270**

Book Department
AUDIOCRAFT Magazine
Great Barrington, Mass.

I enclose \$..... for which please send me, postpaid, the books indicated by circled numbers below. (No C. O. D.'s or charge orders, please.) Foreign orders sent at buyer's risk. Add 55¢ per book for postage on foreign orders except Canadian.

Binder 1 (holds 14 issues)	223	\$3.50	201	251
Binder 2 (holds 12 issues)	245	\$3.00	232	254
Unmarked binders	265	\$2.75 ea.	232	255
NAME			233	257
ADDRESS			237	265
			239	270
			245	271
			247	

WHY DOES THE FISHER

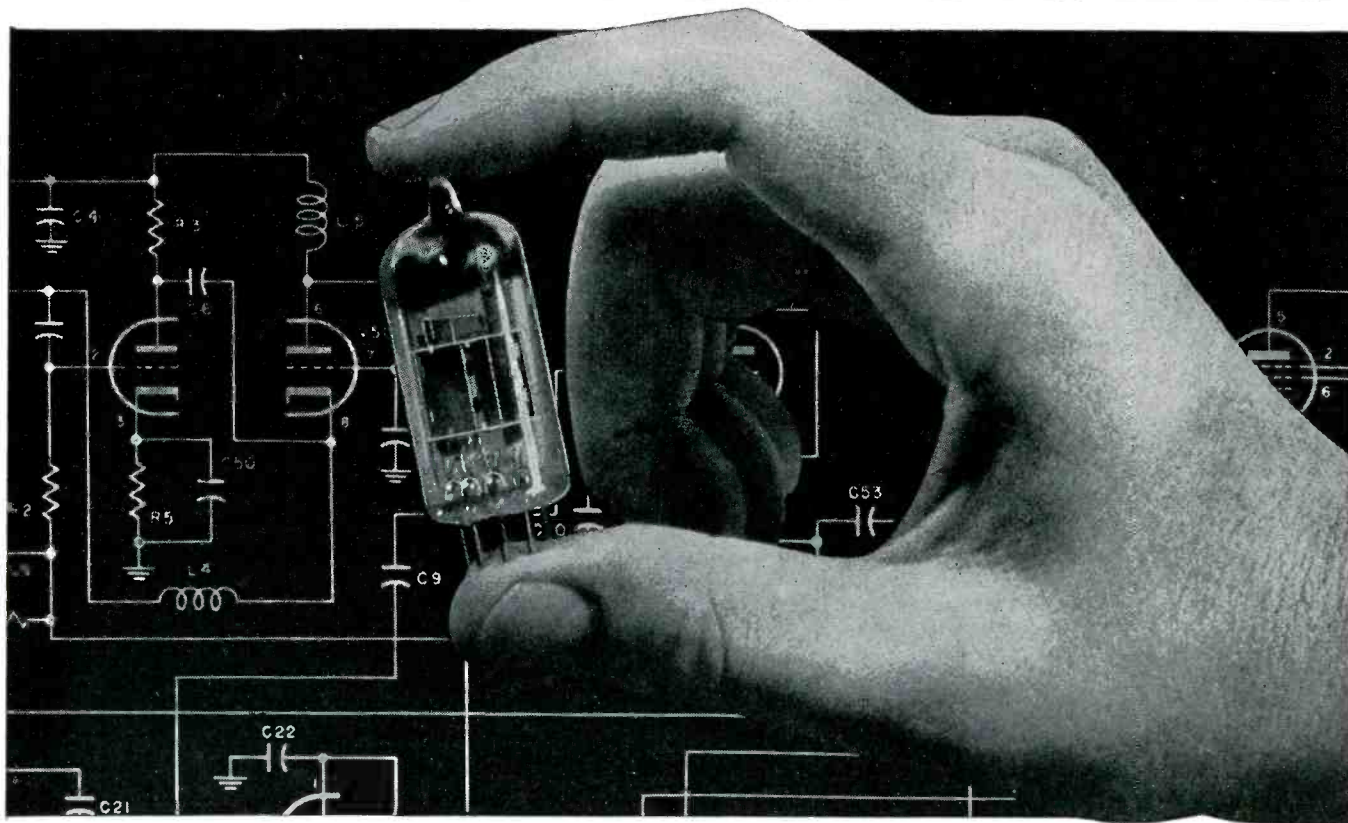

USE A GOLD CASCODE?

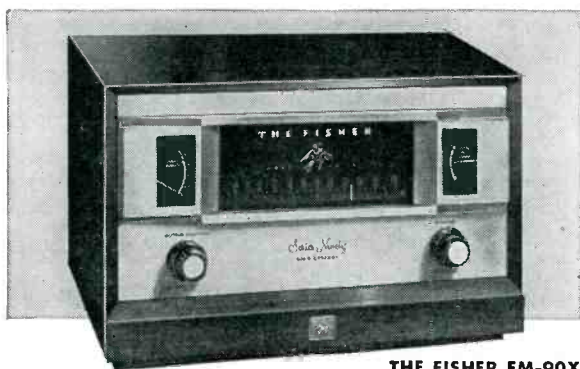

THE FISHER FM-90X

Everybody Knows...

that only Gold Cascode RF amplification brings FM sensitivity to the theoretical limit, allowing reception at tremendous distances.

Only FISHER has it!

Everybody Knows...

that Zero-Time-Constant, Dual-Dynamic Limiters operate instantaneously, eliminating any possibility of impulse and random noise.

Only FISHER has it!

Everybody Knows...

that four IF Amplifier stages are necessary for maximum bandwidth coupled with maximum selectivity, plus a vast increase in gain.

Only FISHER has it!

Everybody Knows...

that two tuning meters permit micro-accurate tuning plus orientation of the antenna for highest possible signal strength.

Only FISHER has it!

Everybody Knows... that only a GOLD CASCODE FM tuner CAN be *the* best! And the world's *only* FM tuners using the costly GOLD CASCODE are those made by FISHER. No amount of wild claims by envious competitors can change that simple fact! The costly GOLD CASCODE achieves the *highest possible gain with the lowest possible noise*, accounting for its amazing sensitivity. Its inherent gain is *twice* that of the RF tubes used in other FM tuners. On this type of tube, with its gold-plated grid—and **ONLY** this type of tube—is it possible to have the *microscopically small gap* between grid and cathode necessary to achieve absolute-maximum sensitivity.

You can *spend* more, but you cannot *buy* a finer instrument than a FISHER GOLD CASCODE tuner. The superior claims made for FISHER tuners are based on actual production units *exactly like the one you can buy*, not on a hand-tailored 'laboratory-pet' sample. Listed at the left are *other* important features, found **ONLY** in THE FISHER. If you have any doubt about the superiority of FISHER tuners, ask your dealer to permit a home trial, under identical conditions, alongside *any other make of tuner, regardless of price*. **YOU** be the judge!

WRITE TODAY FOR COMPLETE SPECIFICATIONS

FISHER RADIO CORPORATION
21-31 44th Drive • Long Island City 1, N. Y.

audiocraft

Roy F. Allison
Editor
Eleanore B. Wright
Assistant to the Editor
Philip C. Geraci
Associate Editor
Weldon Bedell
Art Assistant
R. D. Darrell
Joel Ehrlich
J. Gordon Holt
Joseph Marshall
Contributing Editors

Charles Fowler
Publisher
Warren B. Syer
Associate Publisher
Claire Eddings
Advertising Sales Manager
Andrew J. Csida
Marketing and
Merchandising Manager
Lee Zhitto
Western Manager



THE MAGAZINE FOR THE HI-FI HOBBYIST

AUGUST 1958

Volume 3 Number 8

	Book Reviews	4	<i>Richard D. Keller</i>
The Grounded Ear	<i>What's new in sound reproduction</i>	6	<i>Joseph Marshall</i>
	Audionews	12	
Electronic Firsts	<i>Origins of the transistor</i>	13	<i>Monroe Upton</i>
	Readers' Forum	14	
	Editorial	15	<i>Expanding the market for kits</i>
Stereo Cartridge Roundup	<i>Facts and photos on all stereo cartridges announced to date</i>	16	<i>Joel Ehrlich</i>
The Grommes LJ-6K Control Amplifier	<i>An AUDIOCRAFT kit report</i>	20	
How to Put Up an FM Antenna	<i>An AUDIOCRAFT photo how-to-do-it feature</i>	22	
Audiolab Test Reports	<i>This month: Marantz power amplifier; Gray AM-3 preamp-control unit; Scott 330-C FM-AM tuner</i>	26	<i>Hirsch-Houck Laboratories</i>
Transistors in Audio Circuits	<i>Part XI: Distortion in transistors</i>	30	<i>Paul Penfield, Jr.</i>
Using Test Instruments	<i>The Signal Generator, Part III</i>	32	<i>Joseph Marshall</i>
Puzzlements	<i>An explanation of stereo-disc techniques</i>	34	<i>Norman H. Crowhurst</i>
Tape News and Views	<i>Biasing tape for minimum distortion</i>	36	<i>J. Gordon Holt</i>
Sound-Fanciers' Guide	<i>Reviews of exceptional tape and disc records</i>	38	<i>R. D. Darrell</i>
	Audio Aids	40	<i>Short cuts for the experimenter</i>
	Traders' Marketplace	44	
	Professional Directory	46	
	Advertising Index	48	

ADVERTISING

Main Office — Claire Eddings, The Publishing House, Great Barrington, Mass. Telephone: Great Barrington 1300.

New York — 1564 Broadway, New York 36. Telephone: Plaza 7-2800.

Chicago — John R. Rutherford & Associates, Inc., 230 East Ohio St., Chicago 11, Ill. Telephone: Whitehall 4-6715.

Los Angeles — 1520 North Gower, Hollywood 28. Telephone: Hollywood 9-6239.

Audiocraft Magazine is published monthly by Audiocom, Inc., in Great Barrington, Mass. Telephone: Great Barrington 1300. Editorial, publication, and circulation offices at: The Publishing House, Great Barrington, Mass. Subscriptions: \$4.00 per year in the United States and Canada. Single copies: 35 cents each. Editorial contributions will be welcomed by the editor. Payment for articles accepted will be arranged prior to publication. Unsolicited manuscripts should be accompanied by return postage. Entered as second-class matter October 1, 1955, at the post office, Great Barrington, Mass., under the act of March 3, 1879. Additional entry at the post office, Pittsfield, Mass. Printed in the U. S. A. by the Ben Franklin Press, Pittsfield, Mass. Copyright 1958 by Audiocom, Inc. The cover design and contents of Audiocraft Magazine are fully protected by copyrights and must not be reproduced in any manner.



Robert Bell, assembly foreman at AR

FACTORY INSPECTION for AR SPEAKERS

A stethoscope is used in the production testing of every Acoustic Research speaker system, to detect possible air leaks in the cabinet. The speaker is driven by a twenty-cycle signal, and if there are any leaks a characteristic rushing sound can be picked up at the trouble spot.

This test procedure is necessary because the sealed-in air of an acoustic suspension enclosure is a basic working element of the speaker system. In conventional speakers the cone works against the springy stiffness of its mechanical suspensions; in AR speakers this stiffness is missing, and the cone works instead against the springiness of the enclosed air-cushion. Like the new air-suspension cars, the speaker literally rides on air.

The patented AR system requires a small cabinet, so that the enclosed air will be springy enough. And since the air-cushion does not bind or reach its elastic limit as do mechanical springs, the AR-1 has created new industry standards in the low-distortion reproduction of music. The "bookshelf" size of AR enclosures is associated with an absolute advance rather than a compromise in speaker bass performance.

AR speakers have been adopted as reference standards, as test instruments for acoustical laboratories, and as monitors in recording and broadcast studios. Their most important application, however, has been in the natural reproduction of music for the home.

The AR-1 and AR-2, two-way speaker systems complete with enclosures, are \$185 and \$96 respectively in either mahogany or birch. Walnut or cherry is slightly higher and unfinished fir is slightly lower in price.

Literature is available on request.

ACOUSTIC RESEARCH, INC.
24 Thorndike St., Cambridge 41, Mass.



by RICHARD D. KELLER

book reviews

Vacuum-Tube Rectifiers

Alexander Schure; pub. by John F. Rider Publisher, Inc., New York; 70 pages; \$1.50, paper-bound.

As a new addition to the Electronic Technology Series published by Rider, this booklet lives up to the fine reputation established by the series over the past few years.

As do the others, the book presents in a well-illustrated format the basic and essential ideas necessary to the understanding of the subject. Rectifiers and power-supply circuits are often taken for granted by many of us, since they are necessary in just about all electronic equipment. Their design can contribute much to the proper performance of such equipment, or conversely, can deteriorate performance substantially if not given due consideration.

There is a minimum of mathematical treatment, but the analyses are sufficiently extensive to permit the interested technician, practicing engineer, or advanced student to arrive at a full comprehension of the important aspects of such theory. Rectifier and power-supply filter-design data and charts are up-to-date and particularly well presented to be of maximum use to the student and engineer.

International Electronic Tube Handbook

Pub. by De Muiderkring, Bussum, Netherlands; 336 pages; paper-bound.

American tube-handbook publishers would do well to sit up and take notice of this excellent new handbook. It contains innovations and ideas which should quickly establish it as a standard the world over.

First, as the name implies, modern tubes from all nations are included. Second, the tubes are listed numerically within their own separate categories—diodes, triodes, tetrodes, and pentodes, output tubes, mixers, combination-type tubes, thyratrons, crystal diodes and transistors, and cathode ray tubes—and the pages containing the various categories are color end-coded (orange for diodes, green for triodes, etc.) for quick, easy reference.

But now comes the best part. Instead of giving long detailed technical ex-

planations of each tube, this book gives a clear, concise diagram of each tube in a typical circuit showing typical operating parameters, voltages, and currents—truly international in interpretation and application. Not only that, but each tube is presented with its own base diagram and ratings so that no time-consuming and error-producing references to other pages or "similar tube types" are necessary. For those desiring to operate the tubes under other than the "most typical operating conditions," the usual tabulation charts for RC-coupled amplifiers are given at the end of each category, along with cross references of similar tube types differing only in filament voltage and current or type of base.

What little written material is necessary is presented in nine languages, and very little is necessary because of the book's unique graphical and numerical presentation. As to completeness, the semiconductor listings are quite limited, but the tube categories appear to be right up-to-the-minute. With the increasing use of outstanding foreign-made tubes in American high-fidelity equipment, a book such as this, which gives those tubes their proper place alongside American tubes, is especially valuable today.

Electronic Hobbyists' Handbook

Rufus P. Turner; pub. by Gernsback Library, Inc., New York 11, N.Y.; 160 pages; \$2.50, paper-bound.

Here is another in the series of interesting books by this author for home experimenters. It is a collection of simple but practical circuits ranging from small general-purpose amplifiers to one-tube stroboscopes and electronic metronomes.

The opening chapters contain basic safety rules, shop-practice hints, and suggestions for the beginner. The rest of the book is subdivided into sections on amplifiers, oscillators, power supplies, communication equipment, control devices, photoelectric devices, and miscellaneous circuits such as Geiger counters, metal locators, field-strength meters, and the like.

The circuits are generally of the simpler and more basic types, and full parts-manufacturers data and circuit descriptions are given.

**STEREO
STEREO
AND
MONAURAL**

the
experts
say...
in HI-FI
the best buys are

EICO®

World-famous
EICO advantages
guarantee your complete satisfaction:

- Advanced engineering • Finest quality components
- "Beginner-Tested," easy step-by-step instructions
- LIFETIME service & calibration guarantee
- IN STOCK — Compare, then take home any EICO equipment—right "off the shelf"—from 1900 neighborhood EICO dealers. No mail delays, no high penalty freight costs.



Stereo Preamplifier HF85



FM Tuner HFT90



Stereo
Amplifier-Preamp
HF81



Bookshelf
Speaker System
HFS1



Monaural Integrated Amplifiers:
50, 30, 20, and 12-Watt
(use 2 for Stereo)



Speaker System HFS2
36" H x 15 1/4" W x 11 1/2" D

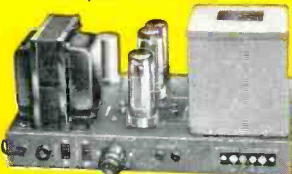

Monaural Preamplifiers:
HF65, HF61
(stack 2 for Stereo)



Monaural Power Amplifiers:
60, 50, 35, 30, 22 and 14-Watt
(use 2 for Stereo)



Over 1 MILLION EICO instruments in use throughout the world.

STEREOPHONIC EQUIPMENT

HF85: Stereo Dual Preamplifier selects, preamplifies & controls any stereo source — tape, discs, broadcasts. Distortion borders on unmeasurable. Self-powered. Works with any 2 high-quality power amplifiers such as EICO HF14, HF22, HF30, HF35, HF50, HF60. Available shortly.

HF81: Stereo Dual Amplifier-Preamplifier selects, amplifies & controls any stereo source — tape, discs, broadcasts — & feeds it thru self-contained dual 14W amplifiers to a pair of speakers. Monophonically: 28 watts for your speakers; complete stereo preamp. Ganged level controls, separate focus (balance) control, independent full-range bass & treble controls for each channel. Identical Williamson-type, push-pull EL84 power amplifiers, excellent output transformers. "Low silhouette" construction. Kit \$69.95. Wired \$109.95, incl. cover.

MONAURAL PREAMPLIFIERS (stack 2 for Stereo)
HF65: superb new design. Inputs for tape head, microphone, mag-phono cartridge & hi-level sources. IM distortion 0.04% @ 2V out. Attractive "low silhouette" design. HF65A Kit \$29.95, Wired \$44.95. HF65 (with power supply) Kit \$33.95, Wired \$49.95.

HF61: "Rivals the most expensive preamps" — Marshall, AUDIOCRAFT. HF61A Kit \$24.95, Wired \$37.95, HF61 (with power supply) Kit \$29.95, Wired \$44.95.

MONAURAL POWER AMPLIFIERS (use 2 for STEREO)

HF60: 60-Watt Ultra Linear Power Amplifier with Acro TO-330 Output Transformer; wide band-width, virtually absolute stability & flawless transient response. "One of the best-performing amplifiers extant; an excellent buy." AUDIOCRAFT Kit Report. Kit \$72.95. Wired \$99.95. Matching Cover E-2 \$4.50.

HF50: 50-Watt Ultra Linear Power Amplifier with extremely high quality Chicago Standard Output Transformer. Identical in every other respect to HF60, same specifications at 50 watts. Kit \$57.95. Wired \$87.95. Matching Cover E-2 \$4.50.

HF35: 35-Watt Ultra-Linear Power Amplifier version of the HF60 above. Kit \$47.95. Wired \$72.95.

HF30: 30-Watt Power Amplifier employs 4-EL84 high power sensitivity output tubes in push-pull parallel, Williamson circuit, 20 db feedback, & high stability margin. 2-EZ81 full-wave rectifiers for highly reliable power supply. Unmatched value in medium-power amplifiers. Kit \$39.95. Wired \$62.95. Matching Cover E-3 \$3.95.

HF22: 22-Watt Power Amplifier version of the HF60 above. Kit \$38.95. Wired \$61.95.

HF14: 14-Watt Power Amplifier of the HF81 above. Kit \$23.50. Wired \$41.50.

MONAURAL INTEGRATED AMPLIFIERS (use 2 for STEREO)

HF52: 50-Watt Integrated Amplifier with complete "front end" facilities & Chicago Standard Output Transformer. Ultra-Linear power amplifier essentially identical to HF50. "Excellent value" — Hirsch-Houck Labs. Kit \$69.95. Wired \$109.95. Matching Cover E-1 \$4.50.

HF32: 30-Watt Integrated Amplifier combines excellent HF30 power amplifier above with versatile preamplifier featuring tape head & microphone inputs, scratch & rumble filters, all amplifier facilities. Kit \$57.95. Wired \$89.95. Both include cover.

HF20: 20-Watt Integrated Amplifier complete with finest preamp-control facilities, excellent output transformer that handles 34W peak power, plus a full Ultra-Linear Williamson power amplifier circuit. "Well-engineered" — Stocklin, RADIO TV NEWS. Kit \$49.95. Wired \$79.95. Matching Cover E-1 \$4.50.

HF12: 12-Watt Integrated Amplifier provides complete "front end" facilities & excellent performance for any medium-power application. "Packs a wallop" — POPULAR ELECTRONICS. Kit \$34.95. Wired \$57.95.

SPEAKER SYSTEMS (use 2 for STEREO)

HFS2: Natural bass 30-200 cps via slot-loaded 12-ft. split conical bass horn. Middles & lower highs: front radiation from 8 1/2" edge-damped cone. Distortionless spike-shaped super-tweeter radiates omni-directionally. Flat 45-20,000 cps, useful 30-40,000 cps. 16 ohms. HWD 36", 15 1/4", 11 1/2". "Remarkable realism; eminently musical; unusual suitability for stereo." — Holt. HIGH FIDELITY. Completely factory-built: Walnut or Mahogany. \$139.95; Blonde, \$144.95.

HFS1: Bookshelf Speaker System, complete with factory-built cabinet. Jensen 8" woofer, matching Jensen compression-driver exponential horn tweeter. Smooth clean bass; crisp extended highs. 70-12,000 cps range. Capacity 25 w. 8 ohms. HWD: 11" x 23" x 9". Wiring time 15 min. Price \$39.95.

FM TUNER

HFT90: surpasses wired tuners up to 3X its cost. Pre-wired, pre-aligned, temperature-compensated "front end" — drift-free. Precision "eye-tronic" tuning. Sensitivity, 1.5 uv for 20 db quieting — 6X that of other kit tuners. Response 20-20,000 cps ±1 db. K-follower & multiplex outputs. "Drift absolutely absent; audio quality excellent; novel tuning quite effective." — ELECTRONICS ILLUSTRATED. Kit \$39.95*. Wired \$65.95*. Cover \$3.95. *LESS COVER, F. E. T. INCL.

EICO, 33-00 Northern Blvd., L. I. C. 1, N. Y. AC-8

SHOW ME HOW TO SAVE 50% on 60 models of top-quality equipment as checked below. Hi-Fi

Test Instruments Ham Gear.

Send FREE literature & name of neighborhood EICO dealer.

NAME.....

ADDRESS.....

CITY..... STATE.....

Copyright 1958 by Electronic Instr. Co., Inc. 33-00 N. Blvd., L. I. C. 1, N. Y.

Add 5% in the West.

The Grounded Ear

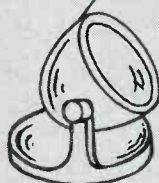

by Joseph Marshall

**What's new
in sound
reproduction?**

Driftless Tuners?

It must be admitted that few critical users have been completely happy with the stability of even the best FM tuners. AFC has its disadvantages, especially for long-range reception, because it tends to pull the tuner to a strong station next to a desired weak one. Wide-band detector circuits minimize distortion caused by drifting, but the oscillator must still be stabilized to keep the signal within the IF pass band. The claims of EICO that its new HFT-90 FM tuner has a maximum drift of 20 Kc, and that its stability is so good that AFC can be dispensed with are, therefore, of more than passing interest not only to users of hi-fi equipment but also to designers. I have been using one of these tuners for the past five months and I can report that its performance has overcome my very considerable initial skepticism.

I have not tried to measure the exact drift, but EICO's claim appears to be well founded. In fact, this is one of the most stable of all the score or more tuners I have used. With my specimen a local station in tune when the tuner is turned off will be in tune when the tuner is turned on several days later. Even the weakest stations, tuned in after

Fig. 1. Unique front end of Eico tuner.

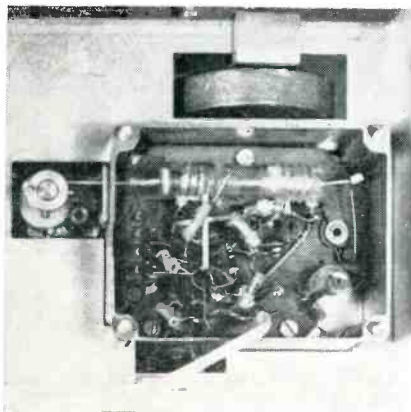

a minute or two of warm-up, will remain in tune thereafter indefinitely.

The secret of this achievement lies largely in the very unusual RF or "front-end" design. This section is shown in Fig. 1. The RF amplifier stage, converter, and first IF transformer are entirely contained in a small cast-aluminum-alloy case mounted in a hole in the chassis. The RF stage uses half of an ECC85 as a grounded-grid plate-tuned amplifier. The other half of the tube is the converter, but I am frank to admit I do not know how it works. The front end is permeability-tuned, and the oscillator tank has temperature-compensated capacitors. But I suspect this is only in part responsible for the stability.

Practical stability is also aided by the wide bandwidth of the IF amplifier—260 Kc at 6 db down. A drift of 20 Kc will still keep the station on the top of the IF curve. The ratio detector, which has a peak separation of 600 Kc and is linear for 200 Kc on each side of center, also helps. The wide bandwidth of the IF and detector also results in low distortion.

My specimen was factory-assembled* and could be expected to perform better in terms of sensitivity than one assembled from a kit unless the latter were carefully aligned with instruments. But the critical front end is completely pre-assembled and my experience in stability should be duplicated in a home-made kit. All in all, the HFT-90 represents a very fine value, whether in kit or wired form.

RCA Long-Playing Tape System

Right in the middle of all the hullabaloo about stereo discs RCA demonstrated a new long-playing stereo-tape system. This system puts *two* sets of stereo tracks on a quarter inch tape, to double the amount of program material on a given length of tape. Furthermore, the tape

*An HFT-90 will be the subject of an extensive AUDIOCRAFT kit report in the September issue.—ED.

is played back at $3\frac{3}{4}$ ips and this would once more double the playing time. In sum, the combination would provide four times the program material available on present stereo tapes. The tapes will be sold in cartridges (Fig. 2).

I won't argue on the good or bad points of the magazine-loaded tape. The idea of quadrupling the amount of music one can get on a stereo tape is certainly excellent, however, and obviously applicable to the normally spooled tape.

I did not hear the demonstration itself, but I have heard that the quality was not impressive. This no doubt was the result of using equipment not fully developed, or of mass-production standards. Nonetheless, there *are* tape recorders which can deliver as good, or better, quality at $3\frac{3}{4}$ ips as most recorders now deliver at $7\frac{1}{2}$ (see below). And I am sure that the possibilities of improving



Fig. 2. Model of RCA tape cartridge.

response at this speed are not exhausted. Therefore, I think this is an idea well worth looking into, for it promises to produce stereo tapes which could give stereo discs a run for the money.

Tandberg Tape Recorder

One tape recorder whose performance at $3\frac{3}{4}$ ips is highly acceptable (and correspondingly good at $7\frac{1}{2}$ and $1\frac{7}{8}$.) is the very compact Tandberg three-speed recorder. The curves in Fig. 3 tell the story, although not as strikingly as the sound of the unit itself. The final curve is the playback response to an NARTB test tape.

These are curves which would do

Continued on page 44

You've
been
asking for

HEATHKIT



stereo sound equipment . . . and here it is!

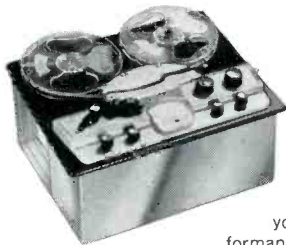

stereo tape deck kit

HEATHKIT
MODEL TR-1D **\$143⁹⁵**

Enjoy the wonder of Stereophonic sound in your own home! Precision engineered for fine performance, this tape deck provides monaural-record/playback and stereo playback. Tape mechanism is supplied complete. You build only the preamplifier. Features include two printed circuit boards—low noise EF-86 tubes in input stages—mic and hi-level inputs—push-pull bias-erase oscillator for lowest noise level—two cathode follower outputs, one for each stereo channel—output switch for instantaneous monitoring from tape while recording. VU meter and pause control for editing. Tape speeds $3\frac{3}{4}$ and $7\frac{1}{2}$ IPS. Frequency response ± 2 db 40-12,000 CPS at $7\frac{1}{2}$ IPS. Wow and flutter less than .3%. Signal-to-noise 55 db at less than 1% total harmonic distortion. NARTB playback equalization. Make your own high quality recordings for many pleasant listening hours.

stereo equipment cabinet kit

CENTER SECTION MODEL SE-1 **\$149⁹⁵**
SPEAKER WING MODEL SC-1L or R **\$39⁹⁵ ea.**

Beautifully designed, this stereo equipment cabinet has ample room provided for an AM-FM tuner—tape deck—preamplifier—amplifiers—record changer—record storage and speakers. Constructed of $\frac{3}{4}$ " solid-core Philippine mahogany or select birch plywood, beautifully grained. Top has shaped edge and sliding top panel. Sliding doors for front access. Mounting panels are supplied cut to fit Heathkit units with extra blank panels for mounting your own equipment. Easy-to-assemble, all parts are precut and predrilled. Includes all hardware, glue, legs, etc. and detailed instruction manual. Speaker wings and center unit can be purchased separately if desired. Overall dimensions with wings 82" W. x 37" H. x 20" D. Send for free details.



DELUXE AM-FM TUNER KIT

HEATHKIT
MODEL PT-1 **\$89⁹⁵**

Here is a deluxe combination AM-FM tuner with all the advanced design features required by the critical listener. Ideal for stereo applications since AM and FM circuits are separate and individually tuned. The 16-tube tuner uses three circuit boards for easy assembly. Prewired and prealigned FM front end. AFC with on/off switch—flywheel tuning and tuning meter.



STEREO PRE- AMPLIFIER KIT

HEATHKIT
MODEL SP-2 **\$56⁹⁵**

This unique two-channel control center provides all controls necessary in stereo applications. Building block design lets you buy basic single channel now and add second snap-in channel later for stereo without rewiring. 12 inputs each with level control—NARTB tape equalization—6 dual concentric controls including loudness controls—built-in power supply.



55 WATT HI-FI AMPLIFIER KIT

HEATHKIT
MODEL W-7M **\$54⁹⁵**

First time ever offered—a 55-watt basic hi-fi amplifier for \$51 per watt. Features EL-34 push-pull output tubes. Frequency response 20 CPS to 20 KC with less than 2% harmonic distortion at full output throughout this range. Input level control and "on-off" switch provided on front panel. Unity or maximum damping factors for all 4, 8 or 16 ohm speakers.



12 WATT HI-FI AMPLIFIER KIT

HEATHKIT
MODEL UA-1 **\$21⁹⁵**

Ideal for stereo applications, this 12-watt power package represents an outstanding dollar value. Uses 6BQ5/EL84 push-pull output tubes. Less than 2% total harmonic distortion throughout the entire audio range (20 to 20,000 CPS) at full 12-watt output. Designed for use with preamplifier models WA-P2 or SP-1. Taps for 4, 8 and 16 ohm speakers.

For complete information on above kits—Send for FREE FLYER.

HEATH COMPANY • a subsidiary of  **Daystrom, Inc.** • Benton Harbor 18, Mich.

easy-to-build

high quality

HEATHKITS®

Look . . . how simply you can assemble your very own high fidelity system! Fun-filled hours of shared pleasure, and an everlasting sense of personal accomplishment are just a few of the rewards. Heathkits cost you only HALF as much as ordinary equipment and the quality is unexcelled. Let us show you how easy it really is! . . .



✓ Install a .001 µfd disc condenser from socket B7 (NS) to ground lug B11 (NS). Cut the leads so that they are just long enough to reach and dress the condenser close to chassis, over the wires already present.

Ⓛ Connect a 470 KΩ resistor (yellow-violet-yellow) from socket B7 (S) (2) to B8 (NS). Mount as close to the socket as possible.

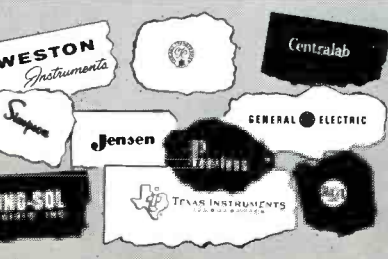
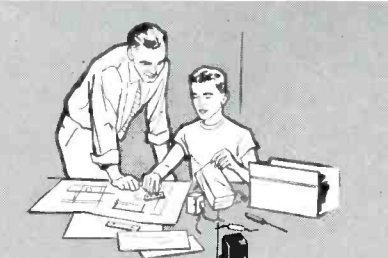
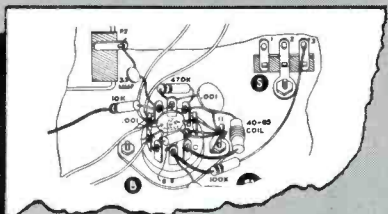

Step-by-Step Assembly Instructions . . .

Read the step . . . perform the operation . . . and check it off—it's just that simple! These plainly-worded, easy-to-follow steps cover every assembly operation.

Easy-to-follow Pictorial Diagrams . . .

Detailed pictorial diagrams in your Heathkit construction manual show where each and every wire and part is to be placed.

Learn-by-doing Experience For All Ages . . .

Kit construction is not only fun—but it is educational too! You learn about radio, electronic parts and circuits as you build your own equipment.

Top Quality Name-Brand Components Used in All Kits . . .

Electronic components used in Heathkits come from well-known manufacturers with established reputations. Your assurance of long life and trouble-free service.



HEATHKIT

bookshelf 12-watt amplifier kit

NEW

MODEL EA-2

\$27⁹⁵

There are many reasons why this attractive amplifier is a tremendous dollar value. You get many extras not expected at this price level. Rich, full range, high fidelity sound reproduction with low distortion and noise . . . plus "modern" styling, making it suitable for use in the open, on a bookcase, or end table. Look at the features offered by the model EA-2: full range frequency response (20—20,000 CPS ± 1 db) with less than 1% distortion over this range at full 12 watt output—its own built-in preamplifier with provision for three separate inputs, mag phono, crystal phono, and tuner—RIAA equalization—separate bass and treble tone controls—special hum control—and it's easy-to-build. Complete instructions and pictorial diagrams show where every part goes. Cabinet shell has smooth leather texture in black with inlaid gold design. Front panel features brushed gold trim and buff knobs with gold inserts. For a real sound thrill the EA-2 will more than meet your expectations. Shpg. Wt. 15 lbs.

TIME PAYMENTS AVAILABLE ON ALL HEATHKITS WRITE FOR FULL DETAILS



chairside enclosure kit

NEW

This beautiful equipment enclosure will make your hi-fi system as attractive as any factory-built professionally-finished unit. Smartly designed for maximum flexibility and compactness consistent with attractive appearance, this enclosure is intended to house the AM and FM tuners (BC-1A and FM-3A) and the WA-P2 preamplifier, along with the majority of record changers, which will fit in the space provided. Adequate space is also provided for any of the Heathkit amplifiers designed to operate with the WA-P2. During construction the tilt-out shelf and lift-top lid can be installed on either right or left side as desired. Cabinet is constructed of sturdy, veneer-surfaced furniture-grade plywood $\frac{1}{2}$ " and $\frac{3}{4}$ " thick. All parts are pre-cut and pre-drilled for easy assembly. Contemporary available in birch or mahogany, traditional in mahogany only. Beautiful hardware supplied to match each style. Dimensions are 18" W x 24" H x 35 $\frac{1}{2}$ " D. Shpg. Wt. 46 lbs.



CE-1C Mahogany
CE-1CB Birch

CONTEMPORARY



CE-1T Mahogany

TRADITIONAL

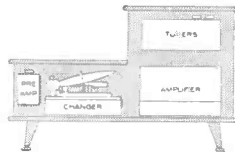

Be sure to specify model you prefer

\$43⁹⁵ each



HEATHKIT

high fidelity FM tuner kit

For noise and static free sound reception, this FM tuner is your least expensive source of high fidelity material. Efficient circuit design features stabilized oscillator circuit to eliminate drift after warm-up and broadband IF circuits assure full fidelity with high sensitivity. All tunable components are prealigned so it is ready for operation as soon as construction is completed. The edge-illuminated slide rule dial is clearly numbered for easy tuning. Covers complete FM band from 88 to 108 mc. Shpg. Wt. 8 lbs.

MODEL FM-3A \$25.95 (with cabinet)



HEATHKIT

broadband AM tuner kit

This tuner differs from an ordinary AM radio in that it has been designed especially for high fidelity. A special detector is incorporated and the IF circuits are "broadbanded" for low signal distortion. Sensitivity and selectivity are excellent and quiet performance is assured by a high signal-to-noise ratio. All tunable components are prealigned before shipment. Incorporates automatic volume control, two outputs, and two antenna inputs. An edge-lighted glass slide rule dial allows easy tuning. Your "best buy" in an AM tuner. Shpg. Wt. 9 lbs.

MODEL BC-1A \$25.95 (with cabinet)



HEATHKIT

master control preamplifier kit

Designed as the "master control" for use with any of the Heathkit Williamson-type amplifiers, the WA-P2 provides the necessary compensation, tone, and volume controls to properly amplify and condition a signal before sending it to the amplifier. Extended frequency response of $\pm 1\frac{1}{2}$ db from 15 to 35,000 CPS will do full justice to the finest program material. Features equalization for LP, RIAA, AES, and early 78 records. Five switch-selected inputs with separate level controls. Separate bass and treble controls, and volume control on front panel. Very attractively styled, and an exceptional dollar value. Shpg. Wt. 7 lbs.

MODEL WA-P2 \$19.75 (with cabinet)

pioneer in
"do-it-yourself"
electronics



a subsidiary of Daystrom, Inc.

HEATH COMPANY • BENTON HARBOR 18, MICHIGAN



HEATHKIT 25-WATT

MODEL W-5M
\$59⁷⁵

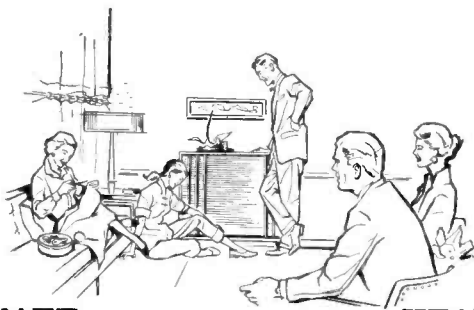

HEATHKIT 70-WATT

MODEL W-6M
\$109⁹⁵

high fidelity amplifier kits

To provide you with an amplifier of top-flight performance, yet at the lowest possible cost, Heath has combined the latest design techniques with the highest quality materials to bring you the W-5M. As a critical listener you will thrill to the near-distortionless reproduction from one of the most outstanding high fidelity amplifiers available today. The high peak-power handling capabilities of the W-5M guarantee you faithful reproduction with any high fidelity system. The W-5M is a must if you desire quality plus economy! Note: Heathkit WA-P2 preamplifier recommended. Shpg. Wt. 31 lbs.

For an amplifier of increased power to keep pace with the growing capacities of your high fidelity system, Heath provides you with the Heathkit W-6M. Recognizing that as loud speaker systems improve and versatility in recordings approach a dynamic range close to the concert hall itself, Heath brings to you an amplifier capable of supplying plenty of reserve power without distortion. If you are looking for a high powered amplifier of outstanding quality, yet at a price well within your reach, the W-6M is for you! Note: Heathkit model WA-P2 preamplifier recommended. Shpg. Wt. 52 lbs.

HEATHKIT DUAL-CHASSIS

MODEL W3-AM

\$49⁷⁵

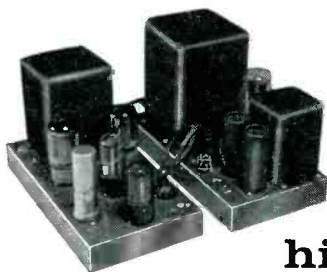

HEATHKIT SINGLE-CHASSIS

MODEL W4-AM

\$39⁷⁵

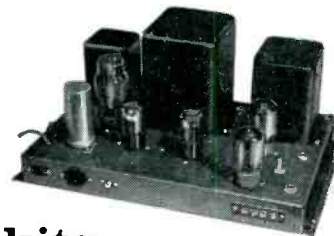

high fidelity amplifier kits

One of the greatest developments in modern hi-fi reproduction was the advent of the Williamson amplifier circuit. Now Heath offers you a 20-watt amplifier incorporating all of the advantages of Williamson circuit simplicity with a quality of performance considered by many to surpass the original Williamson. Affording you flexibility in custom installations, the W3-AM power supply and amplifier stages are on separate chassis allowing them to be mounted side by side or one above the other as you desire. Here is a low cost amplifier of ideal versatility. Shpg. Wt. 29 lbs.

In his search for the "perfect" amplifier, Williamson brought to the world a now-famous circuit which, after eight years, still accounts for by far the largest percentage of power amplifiers in use today. Heath brings to you in the W4-AM a 20-watt amplifier incorporating all the improvements resulting from this unequalled background. Thousands of satisfied users of the Heathkit Williamson-type amplifiers are amazed by its outstanding performance. For many pleasure-filled hours of listening enjoyment this Heathkit is hard to beat. Shpg. Wt. 28 lbs.

HEATHKIT

high fidelity amplifier kit

MODEL A-9C **\$35⁵⁰**



For maximum performance and versatility at the lowest possible cost the Heathkit model A-9C 20-watt audio amplifier offers you a tremendous hi-fi value. Whether for your home installation or public address requirements this power-packed kit answers every need and contains many features unusual in instruments of this price range. The preamplifier, main amplifier and power supply are all on one chassis providing a very compact and economical package. A very inexpensive way to start you on the road to true hi-fi enjoyment. Shpg. Wt. 23 lbs.

HEATHKIT

electronic crossover kit

MODEL XO-1 **\$18⁹⁵**

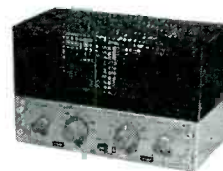

One of the most exciting improvements you can make in your hi-fi system is the addition of this Heathkit Crossover model XO-1. This unique kit separates high and low frequencies and feeds them through two amplifiers into separate speakers. Because of its location ahead of the main amplifiers, IM distortion and matching problems are virtually eliminated. Crossover frequencies for each channel are 100, 200, 400, 700, 1200, 2000 and 3500 CPS. Amazing versatility at a moderate cost. Note: Not for use with Heathkit Legato Speaker System. Shpg. Wt. 6 lbs.

NEW LOW PRICE!



HEATHKIT

"LEGATO"

high fidelity speaker system kit

Wrap yourself in a blanket of high fidelity music in its true form. Thrill to sparkling treble tones, rich, resonant bass chords or the spine-tingling clash of percussion instruments in this masterpiece of sound reproduction. In the creation of the Legato no stone has been left unturned to bring you near-perfection in performance and sheer beauty of style. The secret of the Legato's phenomenal success is its unique balance of sound. The careful phasing of high and low frequency drivers takes you on a melodic toboggan ride from the heights of 20,000 CPS into the low 20's without the slightest bump or fade along the way. The elegant simplicity of style will complement your furnishings in any part of the home. No electronic know-how, no woodworking experience required for construction. Just follow clearly illustrated step-by-step instructions. We are proud to present the Legato—we know you will be proud to own it! Shpg. Wt. 195 lbs.

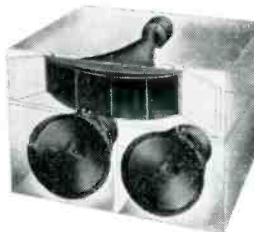
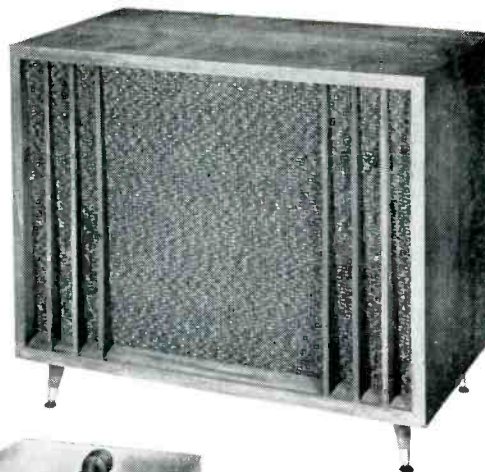

MODEL HH-1-C
(imported white birch)
MODEL HH-1-CM
(African mahogany)
\$299⁹⁵ each



**HEATHKIT
BASIC RANGE**

high fidelity speaker system kits

MODEL **\$39⁹⁵**
SS-2

A truly outstanding performer for its size, the Heathkit model SS-2 provides you with an excellent basic high fidelity speaker system. The use of an 8" mid-range woofer and a high frequency speaker with flared horn enclosed in an especially designed cabinet allows you to enjoy a quality instrument at a very low cost. Can be used with the Heathkit "range extending" (SS-1B) speaker system. Easily assembled cabinet is made of veneer-surfaced furniture-grade 1/2" plywood. Impedance 16 ohms. Shpg. Wt. 25 lbs.

**HEATHKIT
RANGE EXTENDING**

Designed to supply very high and very low frequencies to fill out the response of the basic (SS-1) speaker, this speaker system extends the range of your listening pleasure to practically the entire range of the audio scale. Giving the appearance of a single piece of furniture the two speakers together provide a superbly integrated four speaker system. Impedance 16 ohms. Shpg. Wt. 80 lbs.

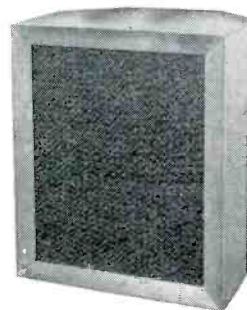

MODEL **\$99⁹⁵**
SS-1B

Free Catalog!

Don't deprive yourself of the thrill of high fidelity or the pleasure of building your own equipment any longer. Our free catalog lists our entire line of kits with complete schematics and specifications. Send for it today!



HEATH

COMPANY • BENTON HARBOR 18, MICHIGAN

*pioneer in
"do-it-yourself"
electronics*

HE a subsidiary of Daystrom, Inc.

- Please send the Free HEATHKIT catalog.
- Enclosed is 25c for the New HI-FI book.

name _____
address _____
city & state _____

ALSO SEND THE FOLLOWING KITS:

QUANTITY	ITEM	MODEL NO.	PRICE

Enclosed find \$..... Please enclose postage for parcel post—express orders are shipped delivery charges collect. All prices F.O.B. Benton Harbor, Mich. NOTE: Prices subject to change without notice.



Audionews

ELECTRO-VOICE STEREO

E-V's *Stereon* loudspeaker system is designed to solve the problem of those who want to convert to stereo but have a minimum of space. It is a very small, highly efficient system which reproduces only the frequencies above 300 cps. A control filter, *Model XX3*, feeds each



Stereon is smaller unit shown at left.

channel to the proper speaker system, but feeds frequencies below 300 cps from both channels to the larger full-range system.

CONDENSER MICROPHONE

Durant Sound Equipment Company is now importing the *Teladi K 125* condenser microphone from Germany. The variable output ranges from -40 to -95 db, and there is enough gain so that the mike may be plugged into an ordinary phono input. The output impedance is either 200 ohms balanced or 10,000 ohms unbalanced. Nondirectional and cardioid patterns are switch controlled. Claimed frequency response is 30 cps to 18 Kc; harmonic distortion at 1,000 μ bar is said to be less than

Has nondirectional or cardioid pattern.



1%; and IM is stated as not measurable. Size of the mike is 15½ by 1½ in., and its weight is 10.4 oz. Retail price: \$225.

SWITCHCRAFT PHONO JACK AND CATALOGUE

Switchcraft is marketing a new phono jack, *No. 3501-FP*, which requires only a single hole for mounting. No rivets or screws are needed; it has a bushing with ¼-32 threads which is conveniently assembled through panels up to ⅛ in. thick by tightening a hex lock nut. Over-all length of the jack is ¾ in., and it may be mounted in centers which are multiples of ½ in. Insulating washers are available separately.

A new catalogue, *S-58*, contains illustrations, prices, schematics, and dimensional drawings of hundreds of electronic components. Free.

FAIRCHILD STEREO PAMPHLET

Stereo! . . . the Easy Way is a fourteen-page pamphlet describing stereo in general and current stereo developments in particular. The last four pages are given over to descriptions of Fairchild equipment suitable for stereo hi-fi systems.

NORELCO PICKUP CARTRIDGE

North American Philips Company, Inc., has announced the *Norelco Magneto-Dynamic* phono cartridge. According to the manufacturer, it is the first cartridge to employ a magnet of nonmetallic ferrite material.

The *Magneto-Dynamic* cartridge has a stationary coil in which a voltage is induced by rotation of a ferrite magnet coupled to the stylus assembly. This is said to provide for a highly compliant system with low moving mass, high output, and good linearity. Specified compliance is better than 5; dynamic mass, 2.8 milligrams; output, 35 mv at 10 cm/sec; tracking force, 5 grams; and response, 10 to 20,000 cps \pm 2 db. The price is \$29.00 with diamond stylus.

GE STEREO CARTRIDGE AND ARM

GE has announced two versions of its new magnetic variable-reluctance stereo cartridge. The *Golden Classic Model GC-7* has a 0.7-mil diamond stylus and will sell for about \$24; The *Stereo Classic Model CL-7* is the same cartridge with a 0.7-mil synthetic sapphire and will sell for about \$17. Both versions are said to have a frequency response of 20 to 17,000 cps, high omnidirec-

tional compliance, and effective channel separation. A mu-metal shield protects against hum.

The *Stereo Classic Model TM-2G* tone arm is designed to accommodate the GE stereo cartridge and the VR-11 monophonic cartridge. It has a two-step adjustment for precise setting of tracking force, and is statically balanced so that lateral equilibrium is maintained even if the turntable is not perfectly level. Other features include lightweight aluminum construction, microball bearings, and a terminal board with four stereo-cartridge lead terminals and a ground terminal. Maximum tracking error is said to be 2°. Price is about \$30.

H-K STEREO AMPLIFIER

Harman-Kardon has announced production of its first stereo amplifier, the *Model A-224 Trio*. Each channel provides 12 watts of power (24 watts on peaks), and stereo-preamp facilities are

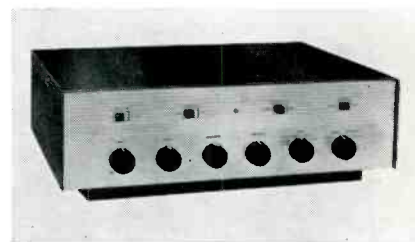

Stereo amplifier has 12 w per channel.

included. Controls include ganged TREBLE and BASS controls, BALANCE, MODE, SPEAKER selector, RUMBLE, CONTOUR, and a tape output. Price of the Trio is \$99.95.

ERASE HEAD

Michigan Magnetronics has announced a new low-power erase head, *Type S*, which is especially suited for use with transistor circuitry. With 0.5 va input, 55 db erasure is said to be obtained. The physical structure is extremely thin and designed to permit ganging for two-track and four-track erasure. Alignment of ganged units is achieved with a ball and ball-seat arrangement. Complete specifications in any desired configuration are available from the manufacturer.

For more information about any of the products mentioned in Audionews, we suggest that you make use of the Product Information Cards bound in at the back of the magazine. Simply fill out the card, giving the name of the product in which you're interested, the manufacturer's name, and the page reference. Be sure to put down your name and address too. Send the cards to us and we'll send them along to the manufacturers. Make use of this special service; save postage and the trouble of making individual inquiries to a number of different addresses.

The only stereo arm:

the
new
ESL
GYRO BALANCE



► From the laboratories which achieved the world-famed ESL C-60 Series cartridge and the triumphant new ESL GYRO/JEWEL stereo cartridge comes the first and only arm designed for all stereophonic and monophonic pickups.

► The striking new shape of the GYRO/BALANCE arm results from its unique rotationally balanced design. Turntable leveling is unnecessary; the GYRO/BALANCE arm plays records at any angle up to 90 degrees!

► Stereo discs may be easily ruined by vertical stylus forces which are satisfactory for standard records. With a high quality cartridge, such as the ESL GYRO/JEWEL, the GYRO/BALANCE arm will track properly at two grams.

► No other make of arm uses ball bearings throughout for all vertical and horizontal motions. This assures smoother operation, increased record life, and longer, trouble-free arm performance. Only \$34.95, complete with shell; write for details.

PS: Magnificent for standard records, too!



For Listening At Its Best
Electro-Sonic
Laboratories, Inc.

Dept. C • 35-54 36th St., Long Island City 6, N.Y.

Electronic Firsts

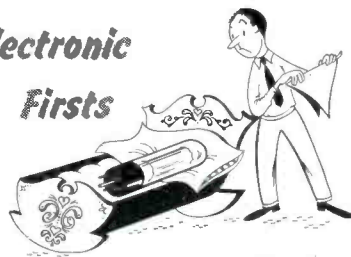

Author of
"Electronics for Everyone"
by MONROE UPTON

WILLIAM SHOCKLEY, solid-state physicist, and one of the three men responsible for the original *transistor*, has predicted that within five to ten years it will make vacuum tubes as obsolete as milking stools. Who would have thought a decade ago that the tube that evolved from Dr. Lee de Forest's little audion of 1908 would soon have a deadly rival? And to add insult to injury, the device now threatening the tube with extinction is a *crystal*, from the same family as the chunk of cat-whiskered galena the tube was believed to have safely buried 30 years before.

The transistor began with a simple idea. In the tube, a current flow is controlled directly by means of a voltage on a grid of wires through which the electron stream from cathode to plate must pass. Shockley asked himself why it wouldn't be possible to control a movement of the relatively few "free" electrons inside a semiconductor, such as the germanium crystal, by means of an electric field that would be applied to the crystal from the outside.

Control proved possible, though results were erratic, until J. Bardeen and W. H. Brattain placed a pair of tiny wires in contact with a sliver of germanium. With the application of two low voltages, the flow of electrons in one of the fine points controlled the flow in the other to such a degree that amplification occurred. The original *point-contact* transistor made its first public appearance in June, 1948.

Wobbly on its pins, it would amplify, but with very little gain; it oscillated, but at very low frequencies; and power output was extremely low. In fact, it proved a better noisemaker than anything else. However, its pygmy proportions and meager power requirements, compared with the tube, promised enormous potential advantages. Three years later the *junction* transistor, conceived by Shockley and built by Morgan Sparks, worked very well. In today's hi-fi gear, a greatly improved junction transistor is fast forcing tubes out of the preamplifier. And with new techniques, supplied by chemists, metallurgists, and others, both Shockley's originally conceived *field-effect* transistor and the point-contact transistor have proved practical, although they play minor roles along with several new variants.



build what it takes
to get the best

high fidelity

SOUND REPRODUCTION

IT TAKES THE FINEST OF COMPONENTS
— PRECISION JBL SIGNATURE LOUD SPEAKER UNITS —



THE D130
EXTENDED
RANGE SPEAKER

THE 175DLH
HIGH FREQUENCY
ASSEMBLY

OR THE 075
HIGH FREQUENCY
UNIT

— to get the best in high fidelity sound. And to get all of the rich, crisp, accurate, deep down bass generated by your D130, you must mount it in a carefully constructed, engineered acoustical enclosure. One of the most popular enclosures ever made, because of its compact dimensions and smooth, clean response, is the JBL Harkness Model C40—a back-loaded folded horn. Sound below 150 cps is radiated from the back of your D130 through the horn. Above 150 cps the speaker acts as a direct radiator. The six foot long, exponentially-flared horn path is ingeniously folded within sleek, low enclosure measuring only 38" wide. The horn is completely contained within the enclosure and is independent of room walls.

BUILD YOUR
C40 FROM
PRODUCTION
PRINTS

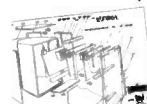

Prove your woodworking skill and get the greatest thrill high fidelity can give you. Here is a project that will make use of your finest craftsmanship for the enjoyment of yourself and your family—a project you can show off to others with pride. Detailed production prints, complete with a list of parts, and step-by-step instructions have now been released by the factory. The set is yours for only three dollars.

USE THIS FORM TO ORDER YOUR PLANS

JAMES B. LANSING SOUND, INC.
3249 Casitas Ave., Los Angeles 39, Calif.

Gentlemen: Enclosed find \$3.00 for one set of Model C40 Production Prints. Please print clearly or type your name and complete address:

Name _____

Address _____

Now! Convert to stereo for only \$26⁵⁰ plus amplifier!

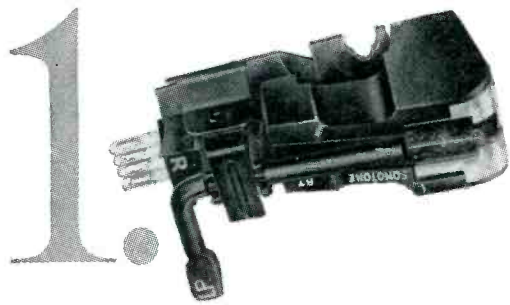

SPECIFICATIONS

Response Smooth from 20 to 12,000 cycles, gradual roll-off beyond
 Output Voltage 0.3 volt
 Compliance 2.0×10^6 cm/dyne
 Recommended Load ... 1-5 megohms
 Tracking Pressure ... 5-7 grams
 Cartridge Weight ... 7.5 grams
 Channel Isolation ... 20 decibels
 Stylus Dual jewel tips, 0.7-mil microgroove and 3-mil 78 rpm.
 Mounting Dimensions: Standard $\frac{7}{16}$ to $\frac{1}{2}$ inch centers

Start with Sonotone 8T ceramic cartridge to \$14⁵⁰ play both stereo and regular discs, costs only

- Plays all 4 speeds—does *not* obsolete your present equipment!
- Has Sonotone's unique, built-in vertical rumble suppressor so vital to stereo use! Doesn't need pre-amp!
- Famous Sonotone quality with top specifications!



2.

Add a Sonotone WR-8 speaker—experts' choice for stereo, \$12⁰⁰ costs only

- Brilliant reproduction of full fidelity spectrum from 55 to 15,000 cycles!
- Perfect for second stereo speaker... gives amazing stereophonic fidelity!

SPECIFICATIONS

Frequency Range 55 to 15,000 cycles
 Resonant Frequency 65 cycles
 Power Input 8 watts
 Impedance 8 ohms
 Flux Density 12,000 gauss
 Voice Coil Diameter... 1-inch

New 8-inch speaker.

3.

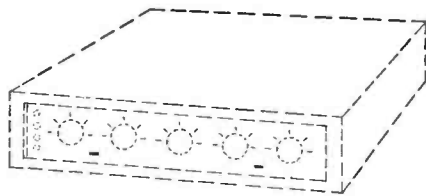

Choose the amplifier best for your set-up. You save on it, too, as Sonotone cartridge needs no extra rumble suppressor, no pre-amp!

Sonotone

Electronic Applications Division, Dept. CZ-88

ELMSFORD, NEW YORK

CORP.



Gentlemen:

As a result of an excellent hi-fi tip appearing in "Readers' Forum," April AUDIOCRAFT, I have been conducting my own experiments with No. 1 and No. 2 wash tubs. My technique, however, is to record in a conventional manner, using the wash tubs on playback only. I simply keep a few tubs handy and slip an appropriate one over my head when I am in the mood for that crazy tinny sound with my hi fi, which isn't always/often. The result is the same as when tubs are used as microphone technique during recording except my way is more flexible, like tone controls, in that you don't have to have it that way on days you can't stand it.

Christy Brown, Jr.
Mount Dora, Fla.

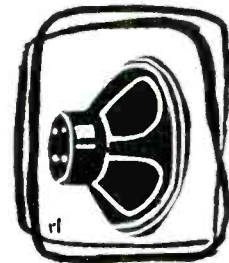

Gentlemen:

I wish to commend you and your staff on the type and quality of the material in your magazine, AUDIOCRAFT, in general, and on the nature of the "Audio-lab Test Reports" specifically.

Michael J. Townsend
Pasadena, Calif.

Gentlemen:

I have just finished reading your April and May issues, and I must say the effect of them on me has been overwhelming! It was only recently that I even became aware of the existence of AUDIOCRAFT, and what caused me to subscribe was your announcement of the forthcoming Hirsch-Houck Lab reports. Well, these reports are superb, and not only that, the rest of the magazine is too! "Audio Aids" and "Puzzlements" both are most helpful; Joseph Marshall's comments on the KT88 were very informative, as were his reviews and comments on ducted-port bass-reflex enclosures. As long as he, Norman Crowhurst, and Messrs. Hirsch and Houck continue to

write for you, I shall consider AUDIO-CRAFT the best aid an audiophile can have, and without question the most informative and valuable magazine in the field.

John L. Grauer
Great Neck, N.Y.

Gentlemen:

I read with much delight that AUDIO-CRAFT plans to test equipment. This is a great step forward in bringing the status of the magazine to a "best buy."

Willard Baptiste
Long Island City, N.Y.

Gentlemen:

Three rousing cheers for the "Audiolab Test Reports," the first and only unbiased reports in any mag since the good old days of the Audio League!

Fred H. Schellmat
Detroit, Mich.

Gentlemen:

In reference to your editorial, "Tape Should Be Compatible Too," on page 15 of your June 1958 issue, I should like to make a few remarks. When I first heard of four tracks for stereo I thought this was an excellent idea, little dreaming tracks 1 and 3 would be used for the two channels rather than tracks 1 and 2. Given a four-track stereo tape using tracks 1 and 2, my present machine (a "nonstereo" Ampex) should integrate the two tracks nicely, and I could play the tape as an ordinary monaural recording. Should I decide to buy a stereo machine later I could use tapes I'd been buying all along. But with tracks 1 and 3 being used I shall decide *now* against stereo! Therefore I was pleased to see your statement, that the RCA system is needlessly incompatible, and I hope you make a loud enough noise for the consumer so that we *do* get a four-track system using as pairs tracks 1 and 2 and then 3 and 4. This I could use on my machine — I can't play the present stereo tapes.

When I bought the Ampex I never expected to use the $3\frac{3}{4}$ speed; however, I've since found that in many cases I can't tell the difference and, thus, I now use the $3\frac{3}{4}$ speed much of the time. Let's have the four tracks; maybe even the slow ($3\frac{3}{4}$) speed; but not tracks 1 and 3 as pairs. I trust that your editorial will help give the industry a big push in this direction.

Robert W. Donselman
San Diego, Calif.

The advantage of using tracks 1 and 3, and 2 and 4, is that new machines could play existing two-channel stereo tapes — provided track and gap widths are standardized. Mr. Donselman's letter does, however, reinforce our argument that the change is ill-timed and will meet substantial buyer resistance. — Ed.

Getting New Customers for Kits

AT 732 BROADWAY, New York City, there is a new enterprise known as the Audio Workshop. It differs from the usual hi-fi equipment sales outlet because its owners, Elliott Gordon and David Muirhead, had an Idea. This idea (like most really good ones) is so simple and obvious that it prompts a reaction of, "Now, why didn't I think of that?"

What Gordon and Muirhead have done can be adopted very easily by other dealers. They have set aside space in the Audio Workshop for do-it-yourself kit builders, and have built in this area a long workbench with multiple AC outlets and a flexible lamp at each position. Soldering irons and other tools necessary for kit construction are supplied by the Workshop. There are also complete test and trouble shooting facilities if they should be required, and a supervisor is

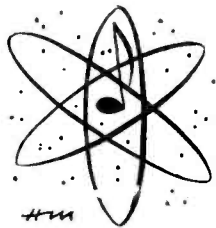

available for soldering lessons, diagram interpretation, and question answering. The charge for all this is only \$1 per hour.

Despite the recognized advantages of hi-fi kit building — money savings, the personal satisfaction of creative accomplishment, and familiarity with equipment that can be gained in no other way — it certainly is true that a great many potential kit customers hesitate to buy because they are completely unacquainted with soldering techniques and electrical parts, and lack confidence in their ability to put kits together correctly from written directions alone. With personal instructions and help readily available, these objections are removed.

Even after paying the moderate fee for use of these facilities, builders will be well ahead of the game so far as actual costs are concerned. The Audio Workshop plan is an inexpensive and convenient one from the novice audiophile's point of view, and practically guarantees satisfaction. For dealers it means an increased market: not only more kit sales, but more preassembled-component sales

too, for an amplifier or preamp is useless without a turntable, arm, cartridge, and speaker system. We congratulate the Audio Workshop, and hope that this innovation in kit merchandising will become commonplace around the country.

AUDIO SHOW season is approaching fast. Many of our readers are show buffs from 'way back, of course, and can be counted on to attend every show within weekend-driving distance. Others have never been to a real audio extravaganza, and that's a pity; it is a unique experience, one that no audiocrafter or prospective solder-sniffer should forego longer than necessary. Following is a list (arranged chronologically) of all the shows on which we have information at the present time.

Albany, New York, September 5-7,
DeWitt Clinton Hotel.
Syracuse, New York, September 19-21,
Onandaga Hotel.
Rochester, New York, September 26-28,
Sheraton Hotel.
New York City, September 30-October 4,
New York Trade Show Building.
Portland, Oregon, October 3-5,
Multnomah Hotel.
St. Louis, Missouri, October 3-5,
Hotel Statler.
Cincinnati, Ohio, October 10-12,
Sheraton-Gibson Hotel.
Philadelphia, Pennsylvania, October 10-12,
Benjamin Franklin Hotel.
Detroit, Michigan, October 17-19,
Hotel Statler.
Milwaukee, Wisconsin, October 23-26,
Wisconsin Hotel.
Boston, Massachusetts, October —,
Hotel Touraine.
Omaha, Nebraska, November 7-9,
Paxton Hotel.
Seattle, Washington, November 21-23,
New Washington Hotel.
Minneapolis, Minnesota, January 9-11,
Dyckman Hotel.
Indianapolis, Indiana, January 30, 31,
February 1, Antlers Hotel.
Denver, Colorado, March 6-8,
Cosmopolitan Hotel.
Baltimore, Maryland, March 20-22,
Lord Baltimore Hotel.
Pittsburgh, Pennsylvania, April 3-5,
Penn-Sheraton Hotel.
Buffalo, New York, April 10-12,
Statler Hotel.
Houston, Texas, June —,
Shamrock Hilton Hotel.

An audiocraft first

STEREO

*Response to the new stereo discs will be determined
them. Here's a complete list of all*

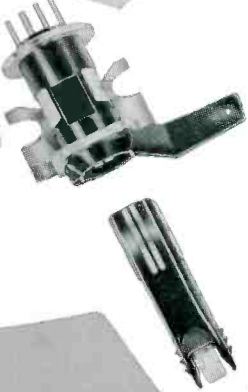

ASTATIC Model 13-TB
Designed for record
changers. Four-contact
unit, with replaceable
styli and elements.
\$20.50.

**MIRATWIN
STEREOTWIN (XP)**
Stereo version of
Miratwin cartridge.
Can be used in rec-
ord changers, but
performs best on
tone arms. Replace-
able styli.

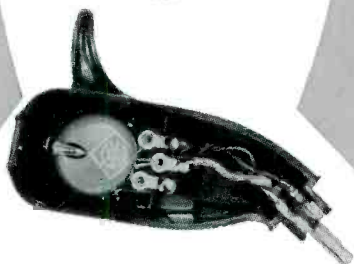

COLUMBIA SC-1
Dual-ceramic car-
tridge with mov-
ing lever. Single
diamond only, to
play all speeds.

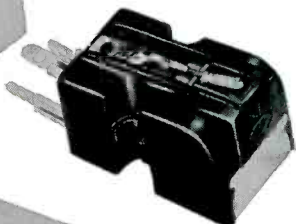

NEARLY EVERY major manufacturer of pickup car-
tridges has released a stereo model, and very few
record manufacturers have not yet released some stereo discs.
Presented here are most of the currently available stereo
cartridges, their prices, and some facets of their design. The
text discusses some of the more interesting features of
these designs. Before getting to this, however, let us see
what has happened lately to stereo records.

In March, Columbia Records announced a new com-
patible-type stereo record. This was cut with a V/L cutter
by the sum-and-difference technique described in the April
issue of this magazine, and featured reduced vertical modu-
lation of the groove. It was accomplished by subjecting the
vertical (difference) information to severe compression.
This compression was dynamic in nature, being greater for
high-level than for low-level recorded signals. By thus
limiting the amount of signal recorded vertically, almost
any cartridge, no matter how little vertical compliance it
had, could track the record with little resultant distortion.
But in the opinions of many auditors this process did harm
the stereo effect quite a bit; as a result, the system was
rejected by the RIAA.

The RIAA has now officially adopted the Westrex 45/45
system as the standard stereo recording process. This can
be cut in the 45/45 manner (as suggested by Westrex),
the V/L sum-and-difference manner (as recommended by
many recording companies), or by the M/S system (as
recommended by Neumann). In each instance, the re-
sultant recording can be played back with a 45/45 car-
tridge. Records cut by these various methods are almost
identical, although the proponents of each system claim
advantages for theirs that no other has. With the exception
of M/S, the recordings are made in the usual manner and
in all cases the same lathes can be used. The M/S system
described in the February issue of this magazine is a
radical departure from the usual stereo recording process
and will be used by some firms with certain mike tech-
niques.

Components Corporation has decided to forge ahead with
their MSD system of stereo recording, even though the
RIAA has rejected it. A number of releases are planned
and a decoder will be marketed in the near future at about
\$49 with all connectors. The records and the decoder will

CARTRIDGE ROUNDUP

to a large degree by the cartridges used for playing cartridges announced to date.

be sold through audio dealers. A special introductory offer is planned with the decoder and a sampling of records made available at a combination price.

On the other hand, the impetus of the Westrex type 45/45 system is being reinforced by other stereo cutting units. The Neumann cutter is now in full production and has been supplied to several recording companies. Newest of the cutters is the Fairchild, announced in early May.

Even with some differences of opinion on specific methods of recording the original tapes and some further dissent on the best way to cut the discs, it is clear that 45/45 playback is going to be standard. With low-priced cartridges on the market and the almost daily announcements of stereo phonographs by package-set manufacturers, we can now plan revisions of our sound systems with complete assurance.

Stereo discs have one important disadvantage in comparison with conventional records. The fact that there is vertical modulation in the groove of a stereo record means that the playback cartridge must be sensitive to vertical motion. Since vertical to lateral vibration (rumble) in a record changer may exist in a ratio of 3:1, there can be as much as 2.12 times as much rumble with a stereo record as a conventional record, both played on the same machine, each with its own cartridge. Thus, many people getting their stereo cartridges are going to find themselves with rumble troubles they never had before. For this reason the selection of a turntable is an important one. In fact, many people now contend that last year's models of record changers can no longer be considered for high-fidelity systems.

The major part of the market uses record changers. Since there will continue to be phonographs, some solution must be found to this rumble problem. A number of firms making cartridges for the mass market have developed answers to this. Since low frequencies have large wave lengths, signals below 200 cps are essentially in-phase signals at the microphones. And because in-phase components on stereo discs are lateral, a filter can be used to eliminate all playback signals below 200 cps in the vertical plane. This is a legitimate answer, although it does reduce some of the stereo effect and does lead to crosstalk at these low frequencies. Electro-Voice has installed a low-pass filter in their cartridges to stop low frequencies, primarily in the

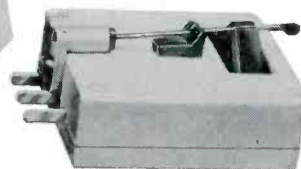

DUOTONE ACOS HI-G

Crystal cartridge for record changers. Replaceable styli. High output. \$31.25.



ESL

Moving-coil cartridge, with low moving mass and high compliance. Not for record changers. \$80.00.

ELECTRO-VOICE 66

Power-Point stereo cartridge. Replaceable styli and elements. For record changers. Several models, from \$5.95 through \$19.50.



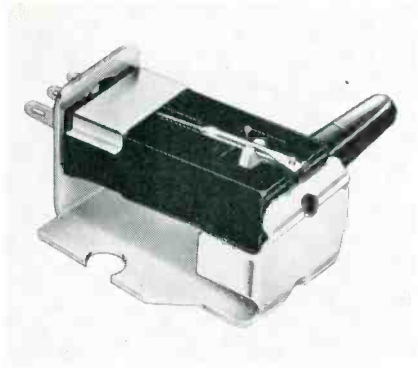

Electro-Voice 21-D. First mass-produced stereo cartridge. Ceramic element, for changers or tone arms. User price: \$19.50.

vertical plane, but a certain amount of all lows seem to be eliminated. Sonotone, on the other hand, has installed a spring between the cartridge and the arm which resonates at 200 cps. Vertical

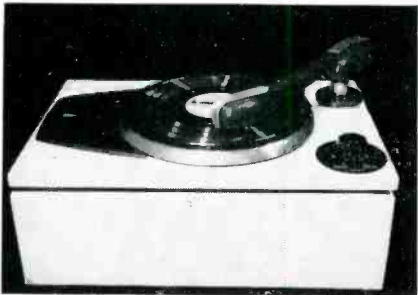

Fairchild 630. First stereo cartridge released, it is not intended for use by consumers. With tone arm: \$250.00.

motion of the record below 200 cps is absorbed by this spring, preventing the stylus from stressing the ceramic element. While there is no appreciable effect on the lateral motion of the stylus, the crosstalk of the two channels does skyrocket at these frequencies. Ultrapurist thoughts aside, these two ideas do make stereo discs a practical reality for the mass market. They are significant steps forward and illustrate good clean thinking. Unfortunately, the ideas are not practical for the audio perfectionist; and many people who bought what they thought were good record changers are going to find themselves in the market for a new one or a good transcription turntable. Many others who bought

Neumann cutter. Three versions of this cutter all will yield 45/45 results. A fine unit, it will see increasing usage.

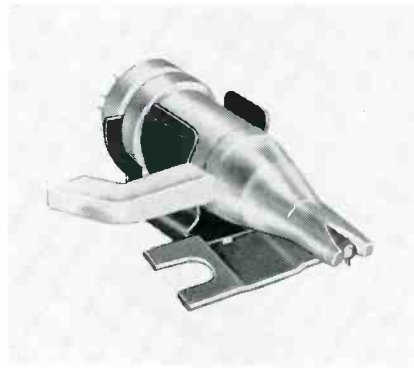
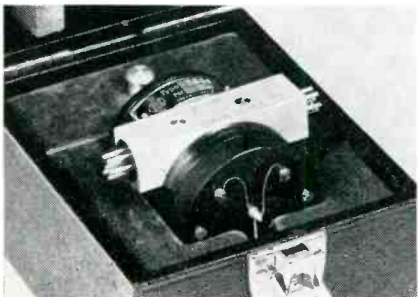

Erie Resistor Stereo. Single-element ceramic cartridge. Entire cartridge is replaced when worn. Priced at \$29.95.

turntables, but compromised too much on price, are going to find themselves in the same spot.

Since so many of the stereo cartridges are now available, we are able to get a good idea of the requirements of the tone arm. The cartridges have three or four contacts, so it is clear that the tone arm must either be modified or a new one purchased. The latter is advisable if not always necessary, for no matter what claims are made, a stereo cartridge is not likely to be as good at monophonic

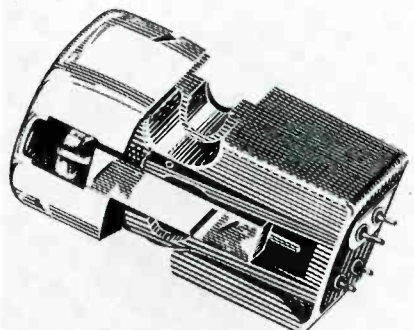

General Electric GC-7. Stereo version of variable-reluctance unit. With replaceable styli, for all uses. \$23.95.

record reproduction as a conventional monophonic cartridge. If you're very much interested in the best quality, then, save your old cartridge and arm to play your old records.

The new tone arm must have low moving mass in the vertical plane and

Pickering Stanton 45/45. Stereo version of Fluxvalve, this unit has replaceable styli, flat response. Priced at \$65.00.

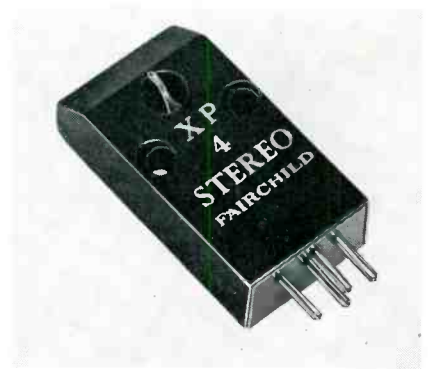
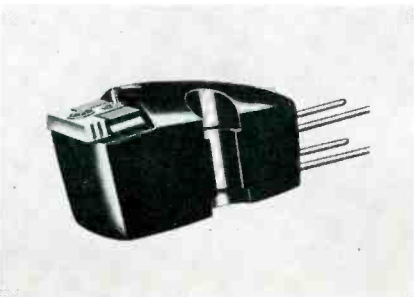

Fairchild XP-4. First magnetic cartridge on consumer market. Moving-coil design, intended for tone-arm use only. \$75.00.

must be capable of good vertical tracking. It must be able to work at low stylus pressures. The stylus must remain *absolutely* vertical to the record surface at all times. Many of the finer tone arms now in use cannot be used for stereo because of the no-tilt requirement.

Many stereo cartridges have only three output terminals while others have four. There are reasons for this, and it is best that they be gone into now. The cartridge having only three terminals has a common ground lead. Thus, the two amplifier circuits are tied together *at the cartridge*. Since the two preamplifiers will either be on the same chassis or will have some ground lead common to them, there will be two (or more) ground leads between the two circuits.

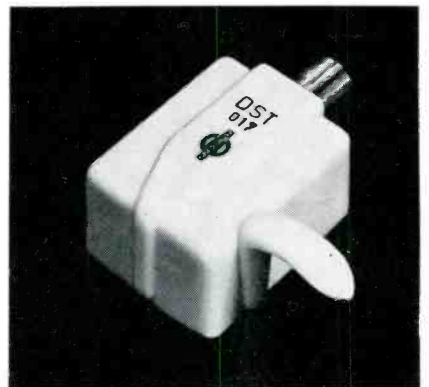

Neumann D.S.T. Top European cartridge, it fits its own special arm or modified ESL arm. Professional unit; \$350.00.

Shure Stereo Dynetic M3D. Of moving-magnet design like monophonic Dynetics. Performs best in tone arms. \$45.00.



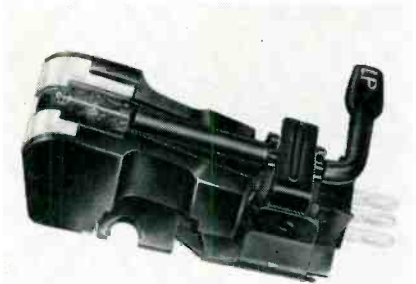

Sonotone 8T. Stereo ceramic cartridge, designed for changers. High- and low-output types, with simple stylus change.

With low-signal, high-gain circuits the resulting ground loop may produce audible hum. For this reason, there are many cartridges having separate ground leads from each element. On the other hand, there is a good excuse for the three-terminal types. Many of the record changers and tone arms on the market have an extra terminal running between the head and the rest of the arm. For these, it is only necessary to wire the third terminal, connect it to the contact on the cartridge, and you have stereo.

It appears that several manufacturers are making serious plays to the audiophile market for the first time with stereo cartridges. Webster-Electric is said to be working on a magnetic stereo cartridge in addition to the ceramic model, and while it was not ready in time to be shown in this roundup, it does appear to be another contender for honors in the audio market. Astatic is promising a professional type cartridge shortly, though they do not note whether it is to be magnetic or ceramic. It will be a stereo cartridge of design different from the 13-TB shown here. Electro-Voice notes that the 21-D is intended for audiophile use while the 66 and the 61 are mass-market units. The Ronette Binofluid is said to be an amazing cartridge, fully up to the quality levels that have made the name famous. It is a bit larger than most of the other stereo cartridges on the market, but it does sound quite good.

Other new cartridges to be announced shortly include Rek-O-Kut's first venture Webster-Electric SC1-D. An early ceramic cartridge, this unit is for changers. Light weight. Price: \$24.50.

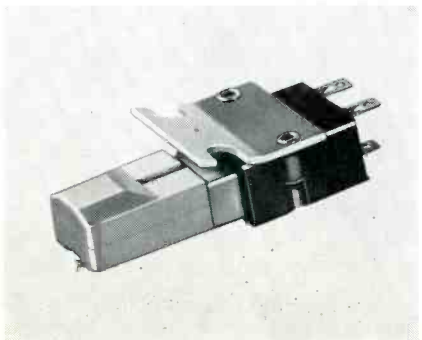

into the field. This new cartridge will be a stereo magnetic of some sort, but exact details are not yet available. Grado's stereo cartridge will, of course, be of moving-coil design. Still another suspected of having a stereo cartridge is Jensen Industries, the well known replacement stylus makers. Jensen has recently started making its own replacement ceramic-element type cartridge

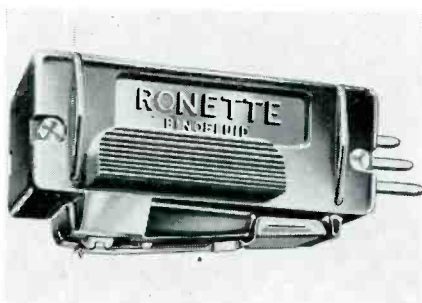

Ronette BF-40 Binofluid. One of the few crystal cartridges available, it is for changer or tone-arm use. Price: \$31.00.

(similar to Astatic's Soundflo and Electro-Voice's Power Point), for monophonic use.

It seems that ceramic cartridges survived the change to stereo better than the magnetic cartridges did; there generally is less retrogression in compliance, mass, and frequency response in all those seen so far than in magnetics thus far announced. In fact, many seem to be comparable to the magnetics in specifications. Some of the designs are most ingenious and all deserve a loud cheer of congratulations. The fixed RIAA equalization of the ceramic cartridges makes real sense now that there is no longer any need for variable equalizers. All stereo records are cut according to RIAA standards.

For example, Erie Resistor's first entry into the cartridge field was a stereo ce-

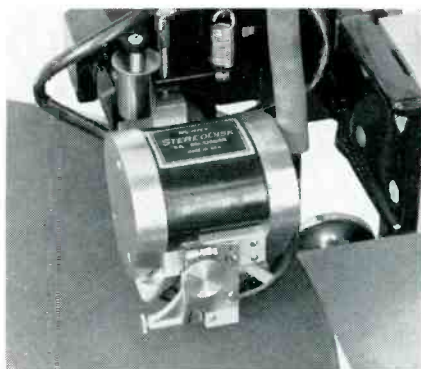

Westrex cutter. The original 45/45 cutter, this model is currently in use by most companies making stereo records.

ramic cartridge. This is the only single element stereo cartridge now on the market. One element produces both stereo channels. Both Sonotone and Ronette cartridges have symmetrical stylus-to-element configurations that have been

widely complimented. The CBS-Hytron cartridge has a novel "vane" coupling that is different from any other cartridge-coupling design ever used.

Possibly one of the simplest conversions of a conventional cartridge to stereo was that of the Weathers. The Weathers is an FM capacitance-operated cartridge. It has an oscillator modulated by a capacitor consisting of two plates; one is the stylus and the other, a fixed plate on the side of the cartridge. By moving the original fixed plate 45° and adding another oscillator and fixed plate 90° from that, the Weathers became a



Weathers. Ceramic (shown above) and FM models available. Choice of ceramic diamond (\$17.50) or sapphire (\$9.75).

Westrex 10-A. This is the first stereo reproducer as conceived by Westrex. A precision unit, it is priced at \$300.00.

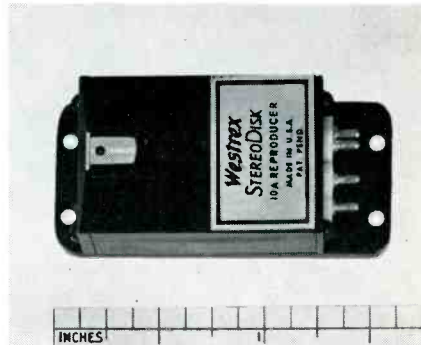

stereo cartridge. Weathers has also marketed a stereo ceramic.

A number of new stereo record changers and tone arms have been announced, all of which are important signs of the acceptance of stereo by component manufacturers. GE has released a new tone arm; Miracord, a new stereo changer/turntable; and Collaro, a changer modified for stereo. British Industries has announced that all Garrard changers will now be equipped for stereo. Pickering has an interesting new turntable. In addition, at the recent Chicago Parts Show, almost every manufacturer of loudspeakers demonstrated new stereo speaker systems.



LJ-6K

Control Amplifier

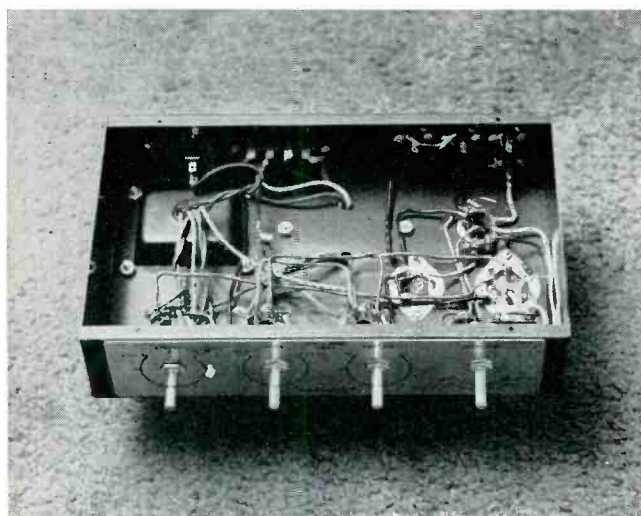

Figs. 1 and 2. Here is the Grommes LJ-6K control amplifier at an early stage of construction. Filament and power-supply wiring has been completed; sockets and controls are installed.



GROMMES Little Jewel amplifiers have been firmly established in the affections of thousands of users for a good many years. Designed without frills or fancy extras of any kind, these amplifiers do a workmanlike, reliable job of giving more listening pleasure per dollar invested than possibly any other item of high-fidelity equipment. Although the basic design has changed very little, there have been minor modifications—particularly in controls and input circuits—through the years. The latest model (LJ-6) costs \$39.50 ready to play; as a kit (Model LJ-6K), the price is \$24.95. A metal cage cover is available at \$4.75; without the cover, the kit appears as shown in Figs. 1, 2, 3, and 4.

Rated power output of the LJ-6K is 10 watts at middle frequencies, with 15 watts peak power. There are two high-level inputs (marked AUX-TAPE and RADIO) and a phono input channel with two alternative input circuits (one for a conventional magnetic pickup, the other for a ceramic or other constant amplitude pickup). The selector switch has three positions of phono equalization (FLAT, RIAA, and OLD LP) which are effective on either phono input. A treble control supplies variable high-frequency cut only, and is combined with the AC on-off switch. The bass control (which furnishes variable boost only) is designed to interact with the volume control in such a way that the amount of boost available at any given bass-control setting is dependent on the volume-control position; thus, it acts much like a variable loudness-compensation control. At volume-control settings beyond 6 (approximately 1:00 o'clock position), very little bass boost can be obtained. This is a clever and entirely sensible feature that minimizes the danger of overloading the amplifier, which has limited low-frequency power output.

The LJ-6 circuit (Fig. 5) is simple and conservative. One 12AX7 is used as a phono preamplifier with feedback equalization. The selector switch couples the preamplifier's output, or one of the high-level inputs, to the volume control, which has the bass tone-control circuit connected to a tap on it. From the volume control the signal goes to a paraphase-circuit inverter, using another 12AX7. This drives a pair of 6V6GT output tubes in standard beam-power connection with cathode bias. The treble tone control is a simple variable RC lossy circuit connected at the



How to put up an FM antenna

Radio reception for high-quality FM music for some time now an intrinsic part of the audiophile's listening schedule, may balloon in popularity as stereo broadcasting, particularly multiple FM stereo, becomes more prevalent. In some localities, close to large metropolitan centers with powerful transmitters, FM reception is a simple task, often demanding little more than a simple hank of wire draped behind any convenient piece of furniture. But as the distance from the transmitter increases, the signal reaching the input terminals of the FM receiver becomes more and more dependent upon special antennas designed to trap the elusive signal. Tiptop reception, especially in regions which lie beyond the 75-mile radius of the normal FM service area, demands an antenna which is highly directional — usually a Yagi — with greatest sensitivity at 98 Mc, the center of the FM band. Since this type of antenna discriminates against signals arriving a few degrees off axis, a rotator is essential to pinpoint reception. Antenna selection resolved, however, how to put the darn thing on the roof often is a more perplexing question. To settle installation queries once and for all, we present, on the next three pages, an ALDORCRAFT photo-how-to-do-it on antenna mounting, featuring a Taco FM Yagi and a Vee-D-X rotator in a guy-wire installation. Left unanswered is the problem of snaking the lead-in into the house. This you must resolve yourself depending upon your own requirements. A number of insulated lead-in tubes are commercially available. Or, you can follow the time-honored (but not necessarily recommended) alternative of poking the wires through existing cracks and crannies in walls, under doors or windows, or what-have-you. But that's your problem. How to mount the thing on the roof is ours. Read on.

*A sensitive antenna, properly installed, will do wonders
for FM reception. Here's a photo guide to installation.*

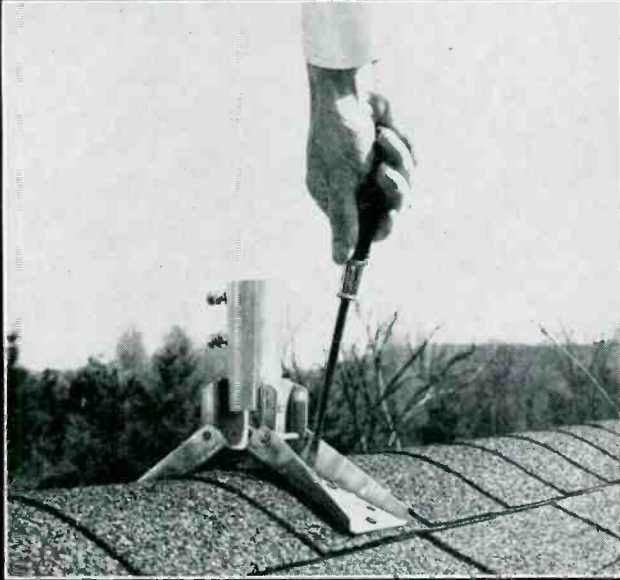

1 The base is adjustable, will accommodate any slope of roof. It is firmly attached with screws through tiles.



2 Rotator is bolted to one piece of mast, and guy wires, cut to proper length, fastened to rotator lugs.

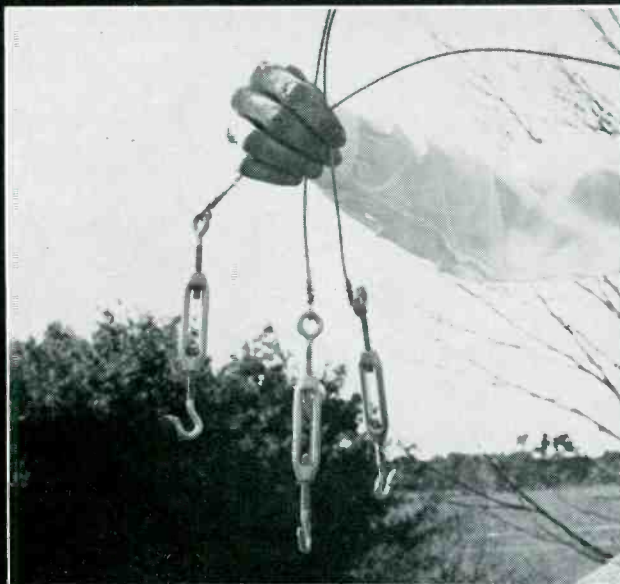

3 Turnbuckles in each guy wire permit wires to be tightened to insure rigid three-point mount for mast.

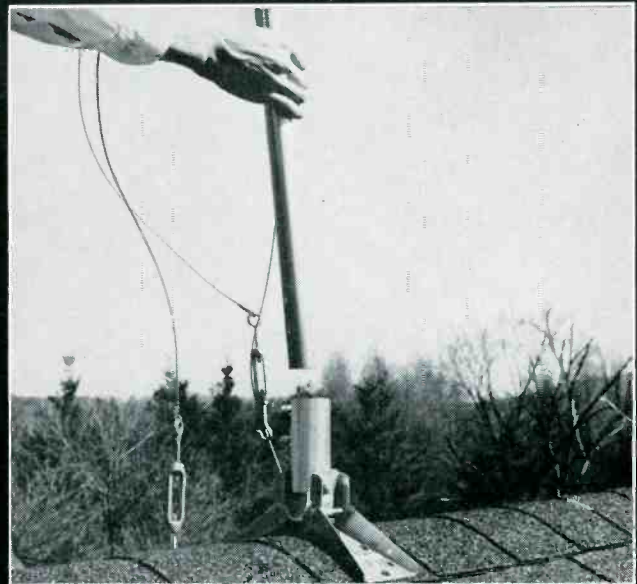

4 The piece of mast with rotator attached is lowered into position in base which now is secured to roof.

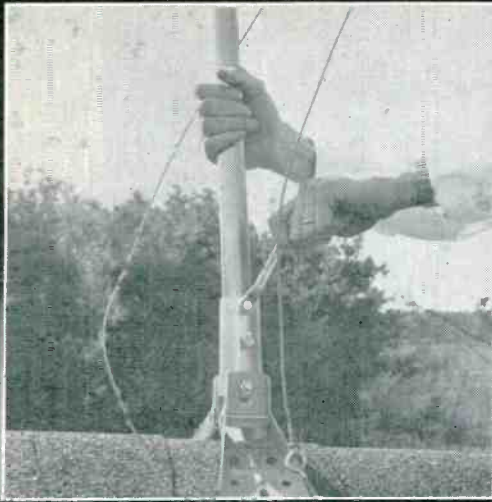

5 Mast is held as vertical as possible, and bolts in base assembly firmly tightened.

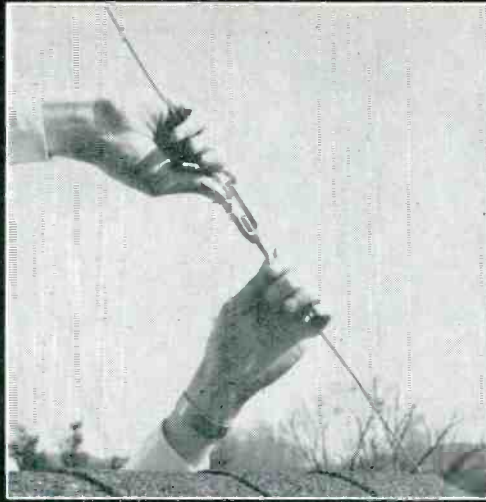

6 Turnbuckles are adjusted until mast is rigid and vertically positioned.



7 Over-all view of rotator and base. Guy-wire mount is most rigid of all.

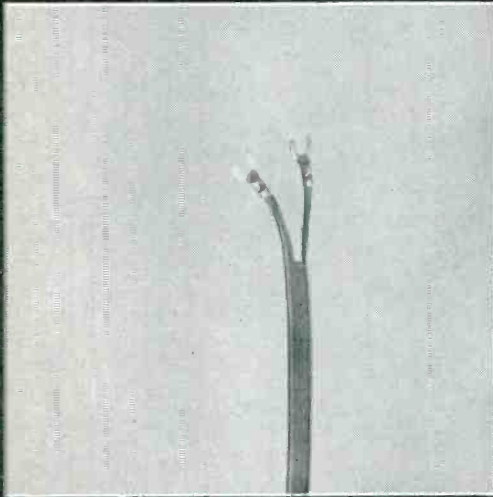

11 The ends of the twin lead are soldered to lugs to guarantee proper contact.

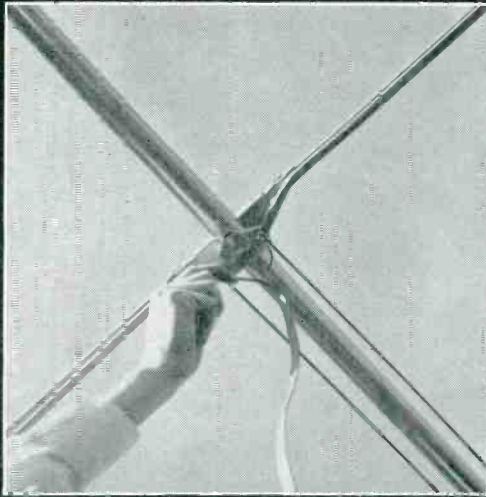

12 Antenna wing bolts secure twin-lead lugs and also hold one dipole in place.

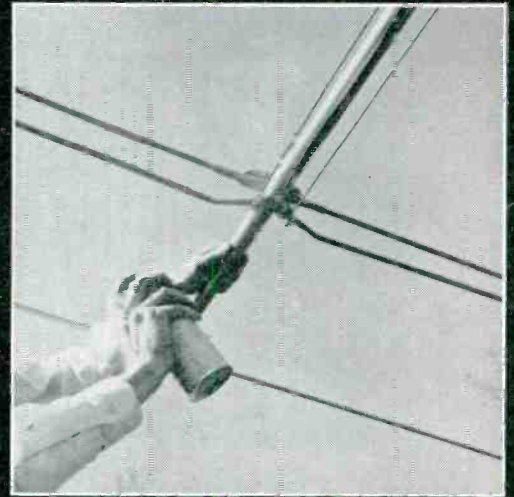

13 Twin-lead connection is coated with plastic spray to prevent corrosion.

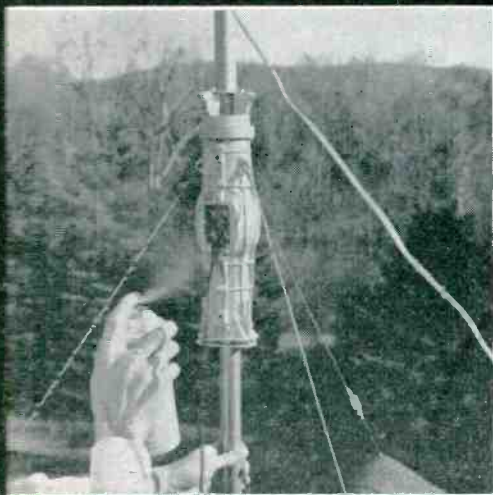

17 Wires carrying power to rotator are installed and coated with plastic spray.

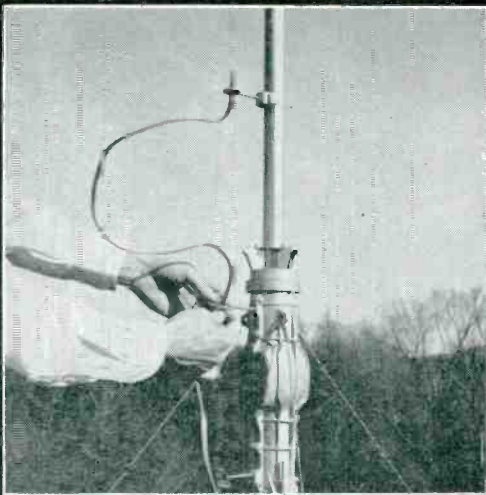

18 Twin lead is looped to permit antenna rotation and passed through standoff.



19 Twin-lead and rotator wires should be in standoffs at least 6 inches apart.

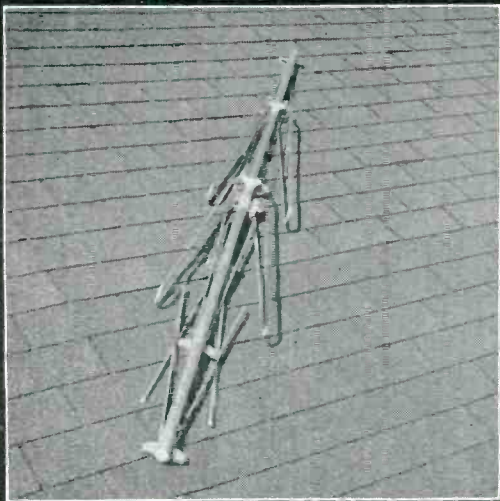

8 When it is received, antenna is in collapsed position as shown here.

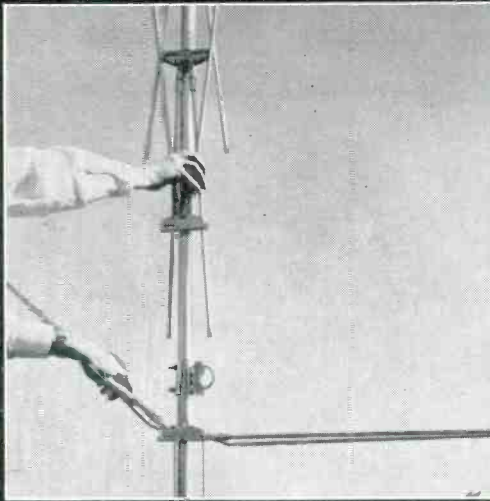

9 Antenna elements swing out from center mast, snap into place easily.

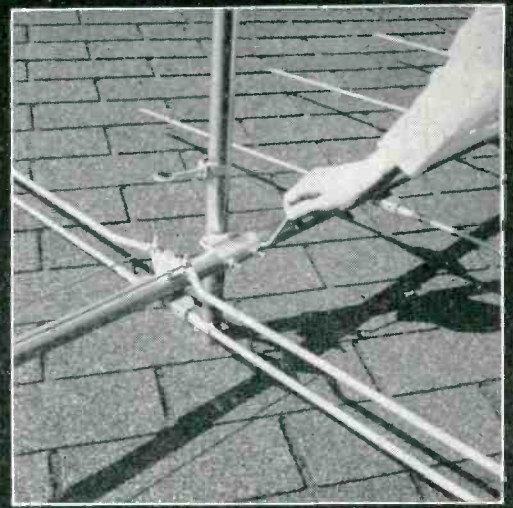

10 Upper mast is placed through U bolt on antenna, and bolts tightened.

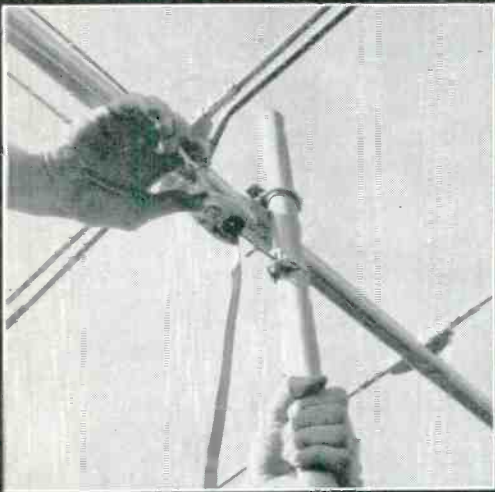

14 Twin lead is placed through mast stand-off; locked in position with pliers.

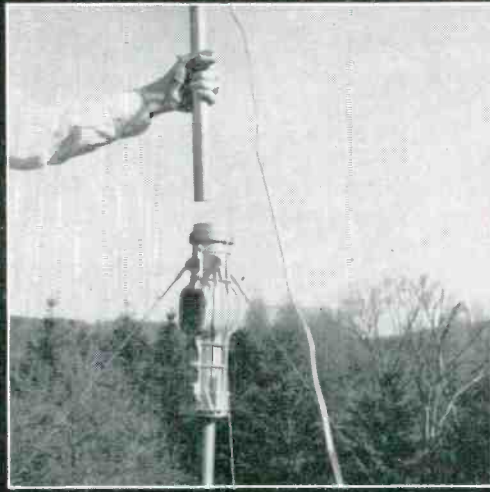

15 Mast and antenna fit into well in top of rotator; must be firmly seated.

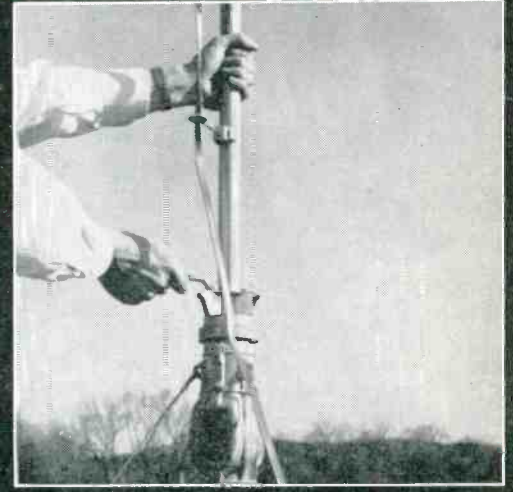

16 Bolts securing mast to top of rotator are tightened equally around mast.

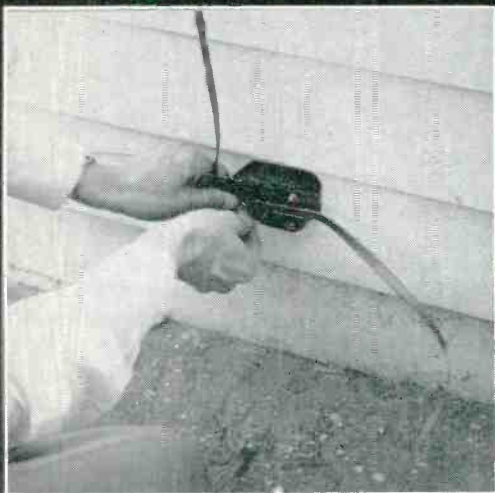

20 Twin lead is connected to lightning arrester at any convenient location.

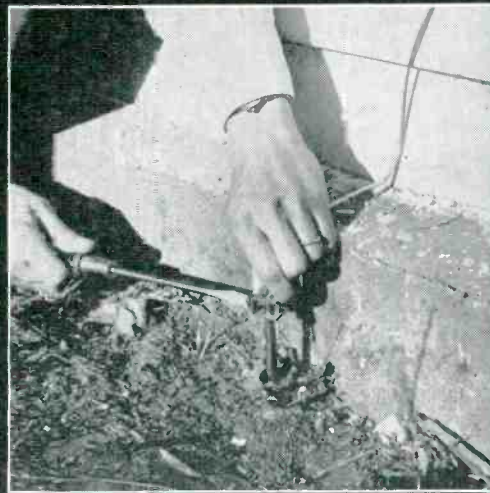

21 Ground lead from lightning arrester is anchored to five-foot ground rod.



22 Rotator wires are attached to control box and antenna is ready to operate.

AUDIOLAB

Test Reports

*An objective analysis
of high-fidelity components*

AUDIOLAB TEST REPORT POLICY

These reports are prepared by an organization whose staff was responsible for the original Audio League Reports, and which has no connection directly or indirectly with any manufacturer or publisher in the high-fidelity field. The reports are published exactly as they are received from Hirsch-Houck Laboratories. Neither we nor manufacturers of the equipment tested are permitted to delete information from or add to the reports, to amend them in any way, or to withhold them from publication; manufacturers may add a short comment at the end of a report, however, if they wish to do so.

GRAY AM-3 PREAMPLIFIER

The Gray AM-3 preamplifier is a compact, flexible control unit at a very moderate price. It is designed to be powered from its associated Gray 50-watt power amplifier, but by rewiring the accessory socket of a Heathkit or Dynakit amplifier, it can be used with them equally well. When a suitable power amplifier is not available to power the AM-3, a separate power supply is available for \$12.95.

The AM-3 has two magnetic-phono inputs, a crystal-phono input (which has a small series capacitor to convert the amplitude-responding crystal to a velocity response), plus high-level inputs for radio, TV, and tape. Each high-level input has its own level control, and the phono preamplifier section has a level control. One of the magnetic-phono inputs has a switch-operated rumble filter, effective below 50 cps.

The phono preamplifier stage uses feedback around two triode stages for equalization. Separate controls are used for low- and high-frequency equalization, providing a choice of 300-cps, 400-cps (AES), or 500-cps (RIAA) low-frequency-turnover frequencies, as well as high-frequency response down 8 db, 14 db (RIAA), 16 db, or 20 db at 10 Kc. In addition, a flat high-gain response is available for microphones.

The AM-3 has a built-in DC heater supply which converts 6.3 v AC from the power source to DC for the heaters of the two low-level stages. Power requirements are 275 to 400 v at 8 ma, and 6.3 v AC at 1.2 amps.

The high-level inputs and the output of the preamplifier are fed through the

selector switch to a stage of gain and a cathode follower which drives the tone controls and provides a low-impedance output independent of tone and volume controls for driving a tape recorder. Following the tone controls is another gain

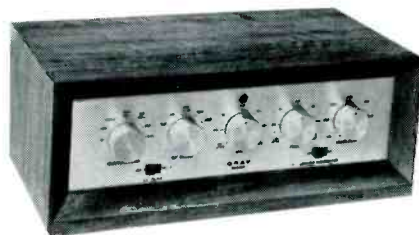

Gray AM-3 preamplifier.

stage, a compensated volume control, and a cathode-follower output stage. With this circuitry the high-frequency response on both main and tape outputs is virtually independent of cable capacitance.

The loudness compensation is always effective, but a two-position slide switch provides two degrees of compensation. The instructions accompanying the AM-

3 indicate the correct level settings for best use of the loudness compensation.

Test Results

The unit tested was operated from its companion Gray P-3 power supply.

The gain was unusually high on all inputs. Only 51 mv was needed on the high-level inputs, or 1.8 mv on the phono inputs to develop 1 v output. The hum level was quite low on high-level inputs, but not particularly low on PHONO in spite of the DC heater system. Under normal listening conditions it is not audible, however. Crosstalk was negligible.

The distortion at the tape output was very low up to outputs of several volts. Apparently a measurable amount of distortion was introduced in the tone-control stage and output cathode follower, but the over-all IM distortion remained about 0.5% up to 1 v output. This is well below the distortion of most power amplifiers when they are driven by a 1-volt signal. When the volume-control level was reduced by 20 db, overloading of the early stages caused severe distortion when the output exceeded a few tenths of a volt. This points up the vital importance of reducing the input signal with the appropriate level control so that the —8-db volume-control setting produces full room volume. This point is covered in the instructions for PHONO inputs, but we feel that more emphasis should have been placed on setting up the other input levels to prevent distortion.

The loudness compensation with the switch set to MIN is very gentle on the lows, but produces the full amount of

Hum and Noise		
Ref. level: 0 db = 1 v		
Input	TV, Tape, Radio	Mag 1, Mag 2
Sensitivity	.051 v	.0018 v
Hum and Noise		
Max. Gain		
Open	-70 db	-46 db
Min. Gain	-95 db	-95 db
Max. Gain		
Input shorted	-73 db	-42 db, -49 db
Standard		
Gain Setting	-60 db	-50 db
Crosstalk (radio, aux)	-60 db	below noise level

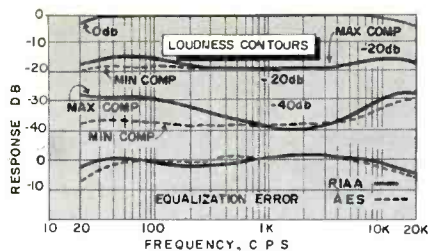

Loudness contours and phono errors.

treble compensation as the volume-control setting is reduced. Selecting the MAX position of the loudness compensator does not affect the highs, but puts in a moderate amount of bass boost. We found it pleasing in its action, and the high-frequency boost in the MIN position did not cause any adverse effects.

Phono equalization for the RIAA characteristic is very precise, with only a slight droop above 10 Kc to prevent it from being near-perfect. The AES low-frequency boost is a bit shy of what it should be, but we do not see much of a problem here due to the almost universal use of the RIAA curve.

The tone controls of the AM-3 are of the feedback type, which vary the frequency of boost or cut rather than the slope of the characteristic. We consider this to be a very desirable type of control, since it allows effective compensation of the frequency extremes where it is usually needed without undue influence on the middles. The tone-control

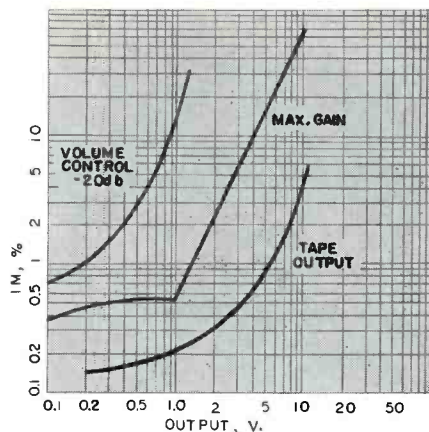

AM-3 intermodulation-distortion curves.

knobs are calibrated (with reasonable accuracy) in terms of the frequency at which a 3-db boost or cut is produced. We found the tone-control action of the AM-3 to be exceptionally pleasing.

Summary

From the standpoints of appearance, listening quality, and ease of operation, the Gray AM-3 preamplifier rates very highly. Its attractively low price of \$89.50 makes it an even greater value.

The only place where our measurements did not agree closely with Gray's specifications was in the hum level on PHONO. One would expect the hum level to be lower than we found it to be, considering that the power supply was

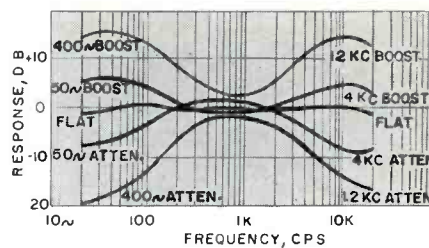

Bass and treble tone-control action.

separate and that DC heaters were used on early stages. Even so, it was not particularly audible in listening tests.

Since the loudness control of the AM-3 is located just before the last stage, it is especially important to follow the manufacturer's instructions for setting up input levels. If this is not done correctly, it is possible to get severe distortion, even at low loudness-control settings. The instructions are specific, but we do not feel that sufficient emphasis has been put on them, in view of the careless attitude which many people have toward reading installation instructions.

Manufacturer's Comment: We feel that the above test report is very well done and provides a thorough analysis of our product. The emphasis placed upon carefully following the instructions relative to level preset controls is important, both to insure distortion-free operation, as well as to provide proper loudness-control action.

The signal-to-noise ratio measured in the phono channel under standard conditions (i.e., 10 mv, 1 v output, RIAA curve, all tone controls flat) is considerably poorer than that normally obtained in our production-acceptance tests. A minimum of 65 db is acceptable, and 70 db is the average value as indicated in our specifications.

Your AUDIOLAB TEST REPORTS on high-fidelity components

H. H. SCOTT 330-C FM-AM TUNER

The H. H. Scott 330-C is an FM-AM tuner with completely separate tuner sections. Only the tuning meter and power supply are shared. This feature makes it a very desirable choice for those persons who live in an area served by stereo broadcasts over the AM and FM channels of the same station.

The FM tuner portion of the 330-C employs the wide-band limiter and detector circuitry which has characterized H. H. Scott tuners since their appearance several years ago. The use of limiters and a detector whose bandwidth is many times that of the IF amplifier (the detector of the 330-C is said to have a 2-Mc bandwidth) results in a good capture ratio. That is, if two stations are on the same frequency, only the stronger one will be heard, even if it is only slightly stronger than the other station. The capture effect is inherent in FM reception, but is greatly enhanced by the use of wide-band circuitry.

A second, and for most users a more important consideration is the ease of tuning which this type of receiver offers. Unlike conventional FM receivers, which have "three-point tuning" unless AFC is

used, the 330-C tunes in a station in only one spot. Tuning is quite non-critical, and clean, distortion-free reception results whenever the receiver is tuned for a maximum meter reading. AFC is not used, nor is it needed, either as a tuning aid or as a drift compensation.

The 330-C employs a cascode RF stage, two IF stages, a limiter, and an unbalanced ratio detector. The ratio detector is not widely used in high-quality receivers, but after our experience with the Scott tuners we can't see why not.

The AM tuner section of the 330-C is in many ways the most remarkable part of it. With one or two exceptions, every AM tuner we have encountered as part of an FM-AM combination has been so inferior in distortion, frequency

response, background noise, and other shortcomings that we could not justify its use in a high-fidelity system. The 330-C is a happy and outstanding exception to this rule. Its AM circuitry is not elaborate; it consists of an RF stage, converter, one IF stage, and a diode detector. However, the IF transformers are designed so that three degrees of selectivity are available, designated "wide range," "normal," and "distant." In the latter two positions the upper audio frequencies are reduced to the point where the result is typical "AM sound," though cleaner than we are accustomed to hearing. In the wide-range position, the frequency range closely approximates that obtained in FM reception. The detector is designed for low distortion, and the net result is a quality of sound which generally cannot be distinguished from FM. We made frequent A-B comparisons between the AM and FM outlets of the same station, and unless a live broadcast or an unusually wide-range recording was being transmitted, it was impossible to hear any difference between AM and FM.

Separate output jacks and level controls are provided for the AM and FM tuners, for stereo reception. A common

Scott 330-C tuner.



output jack is also provided, at which appears the output of the selected tuner only. Two output levels are included, for main and tape-recorder outputs, as well as an FM multiplex jack ahead of the de-emphasis circuit.

The sensitivity of the AM tuner appeared to be very adequate for the metropolitan area where we are located. We did not make any quantitative measurements on the AM tuner, but would judge that with a good antenna it should be adequately sensitive for most areas served by AM.

Test Results

The 330-C is rated at 2 μv for 20 db of quieting. Our tests indicate a slightly higher sensitivity, 1.7 μv being required to produce a 20 db signal-to-noise ratio referred to a 30%-modulated FM signal. Limiting was complete at about 20 μv , and the excellent automatic-gain-control (AGC) action kept the audio output level constant as the signal strength was increased above that level.

Equally important is the IF bandwidth, which is adequate to accommodate a fully modulated FM signal (75 Kc deviation) at 3.5 μv . This level also corresponds to 30 db of quieting. We have coined the term "effective sensitivity" to describe the lowest signal for which a 75-Kc deviation may be handled without appreciable distortion, and for which a signal-to-noise ratio of at least 30 db is obtained. For the 330-C, the effective sensitivity is 3.5 μv . This represents excellent performance. At higher signal levels, such as will generally be encountered, the 330-C will handle deviations of over 200 Kc without wave-form clipping.

The frequency response of the 330-C FM tuner is within ± 2 db from 25 to 20,000 cps, and falls off below 25 cps. Presumably this is a characteristic of its audio section. The high-frequency response is not affected by any reasonable capacity-loading output.

We measured intermodulation distortion by modulating our FM signal generator (a Boonton 202B) with the output of our IM analyzer, and connecting the receiver output to the analyzer input. The levels of the 60- and 5,000-cps tones were adjusted so that a 4:1 ratio was obtained in the de-emphasized tuner output. Distortion was measured as a function of deviation, using the sine-wave deviation equivalent to the peak deviation of the two tones. This is analogous to the procedure used in making IM tests on amplifiers. The tuner was tuned for minimum distortion at 75 Kc deviation and the tuning was not disturbed thereafter.

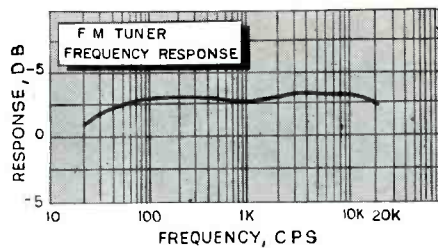

330-C over-all frequency response.

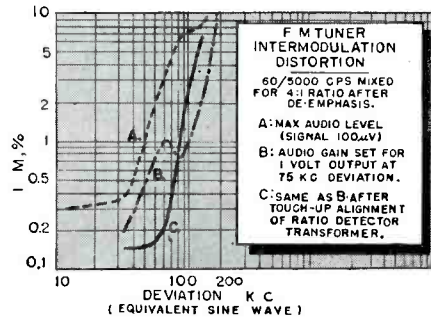

Intermodulation distortion.

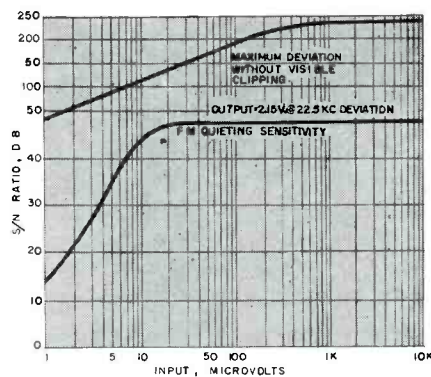

Quietening and deviation characteristics.

The curve marked A was taken with the level control of the 330-C set at maximum. The distortion becomes appreciable at deviations of the order of 30% to 40%. When the level control was reduced to a setting which gave 1 v output at 75 Kc deviation, the result was curve B. Apparently the audio section of the tuner distorts somewhat when the level control is advanced too far. The instruction booklet does not warn the user against setting the level too high, although the high output of the tuner (over 2 v at 22.5 Kc deviation) makes it likely that the control would be kept turned down. It is important that this be done at the tuner, however, rather than at the preamplifier.

Even curve B shows an IM level of 1% in the 70- to 80-Kc deviation region. This is low enough for any installation, since other parts of the system will generally have at least as much distortion at this peak output. We were curious to see if it could be further reduced, so we aligned the ratio-detector transformer for minimum IM distortion

at 75 Kc deviation and replotted the curve, shown as C. Although the distortion at maximum deviation and beyond was as great as or greater than before alignment, it fell off rapidly and was truly negligible at levels corresponding to average program level.

Unfortunately, we found that the tuning for this minimum distortion was so critical that it could not be done reliably with the tuning meter. Under practical conditions, the distortion was intermediate between curves B and C.

We could not make any drift measurements, but did ascertain that there is essentially no drift from a cold start. As soon as the tubes warmed up, a station was tuned in and the meter reading remained unchanged from that time until we closed down some hours later. Line-voltage changes likewise had no effect on tuning.

The AM rejection was approximately 27 db, and the capture ratio was 6.5 db. These are good but not exceptional figures. The capture ratio was somewhat better than we have measured on conventional tuners.

Filter-capacitor operating voltage was 87% of rated voltage; line leakage was 1.45 ma.

Summary

The H. H. Scott 330-C is a very high-quality FM tuner, combined with an AM tuner which is easily the best we have heard. From a practical standpoint, the FM section features completely drift-free, noncritical tuning, very high sensitivity, and low distortion. For the listener who must have AM, the 330-C offers quality virtually undistinguishable from FM except for the somewhat higher background hiss. The combination of separately tuned AM and FM sections makes it practical to get high-fidelity stereo reception from those stations using the FM-AM system of transmission.

The price is high (\$225), but we don't know of any less expensive way to get this particular combination of features with this caliber of performance.

Manufacturer's Comment: We are very pleased that the conclusions of the Audiolab test report are so close to our own ideas. In the 330-C we have tried to build an FM-AM and stereo tuner in which there need be no sacrifice in quality on AM. When good AM reception is available there is no reason why it cannot give practically the same quality of reproduction as FM.

Some of the measurements differ slightly from ours, but we feel that these differences may be attributed to a large extent to the measuring equipment used. For instance, our laboratory tests show about 40 db AM rejection and a capture ratio approaching 3 db on the FM section of the tuner. In years past, our engineers have designed many signal generators, and we appreciate that no single signal generator on the market is suitable for making all measurements with absolute accuracy. In particular, the distortion inherent in even the best signal generators may be many times that in a good tuner.

In any case, these discrepancies are minor from any practical operating standpoint.

Your AUDIOLAB TEST REPORTS on high-fidelity components

MARANTZ 40-WATT AMPLIFIER

At its price of \$198.00, the Marantz 40-watt power amplifier is probably the most expensive unit of its rating on the market. Marantz justifies this price on the grounds of unexcelled performance and the use of the highest quality of components and construction.

The construction of the Marantz amplifier can be appreciated even by persons not familiar with electronic equipment. It is constructed in a volume 15 in. wide by 9½ in. deep by 6½ in. high, and weighs 47 lbs. Because of its compact form and smooth sides, we can testify that it feels even heavier than that. All connections for inputs and outputs are available at the front of the unit, yet are covered by an easily removed cover and are invisible when finally installed. Wires leading in and out of the amplifier pass underneath it and also cannot be seen when the cover is in place.

With the cover removed, one of the most obvious features of this amplifier is its built-in metering system. A meter and switch are provided, with facilities for setting the operating bias of the output tubes, plus their DC balance and AC (driving signal) balance. In this way the user can always be sure of having his amplifier in proper operating condition without recourse to test instruments and without any special technical training.

A pair of 6CA7 output tubes are used, with a toggle switch to enable selection of Ultra-Linear or triode operation. In the latter condition, the maximum output is 20 w. This is recommended for use with delicate speaker systems which might be damaged by the output of a 40-watt amplifier.

A damping factor of 20 (fixed) or variable damping factors from 0.5 to 5 are provided, on the 4-, 8-, and 16-ohm outputs. There are three inputs, two high-gain and one low-gain, for use with preamplifiers having a high output. The latter input requires 2 v for full output; the former requires 0.7 v. One of the high-gain inputs and the preamplifier input have the response rolled off below 20 cps to eliminate low-frequency transients from the speaker system.

The power supply of the Marantz amplifier is unusual, since it uses an oil-

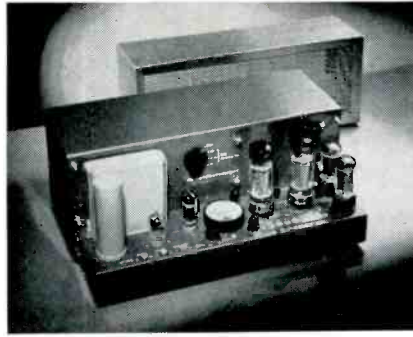

Marantz 40 watter.

filled input-filter capacitor instead of the usual electrolytic. This is one of the components of a power amplifier that is most likely to require replacement with time (next to tubes), and the oil-filled unit, though expensive, should last indefinitely. Even the electrolytic capacitor which follows it is of a special long-life type. The rectifiers are a pair of 6AU4 slow-heating tubes.

Test Results

We soon discovered that a true measurement of the distortion and flatness of re-

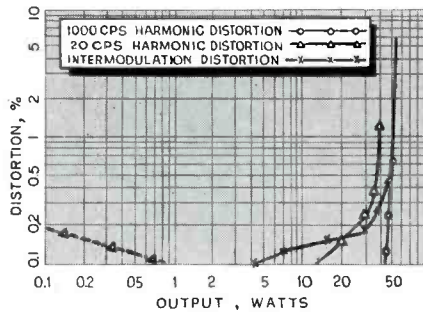

IM and harmonic distortion.

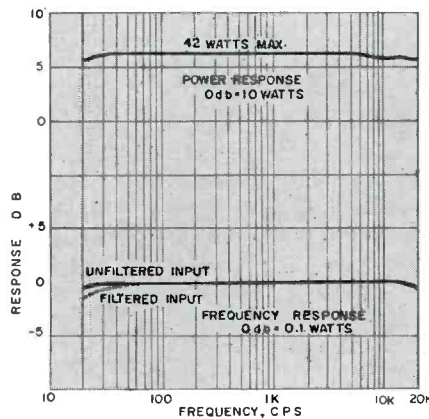

Power and frequency response.

1-Kc overload, 50 watts.

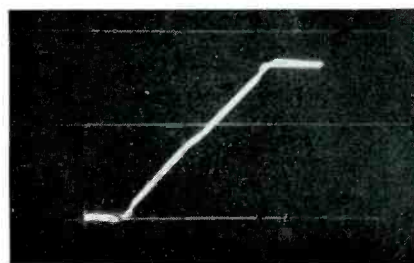

sponse of the Marantz 40-watt amplifier would require test equipment of a more advanced type than ours, and indeed of a higher caliber than most laboratory-type equipment. If any amplifier could be said to be "distortionless," this would be the one. As the curves show, the 1,000-cps distortion is well below 0.1% up to 40 w, and rises sharply as the power reaches 45 to 50 w. This applies when the line voltage is 117 v or greater. A slightly low line voltage may cause the clipping level to occur at 40 w, as will happen with any amplifier. Unlike any other amplifier we know of, the 20-cps harmonic distortion is just as low as the 1,000-cps distortion up to 15 w, and is only 0.22% at 30 w.

The triode connection, interestingly enough, resulted in distortion readings of less than .05% below 15 w, which is slightly below the residual distortion of our test equipment. Probably the amplifier's distortion was canceling some of our instrument's internal distortion. The IM-distortion curve also breaks sharply at 40 w, and reaches 2% at 50 w. At all listening levels it (like the other distortions) is well below 0.1%.

The power-response curve shows an output of 42 w at the clipping point between 50 and 5,000 cps, dropping at 20 and 20,000 cps to about 38 w. The frequency response is down only 0.2 db at the frequency extremes, which could well be a measurement error. Since the power-response curve is taken with visual observation of the output wave form as the criterion for distortion, it is somewhat less exact than the distortion measurements taken with instruments. This accounts for the slight discrepancy between the maximum-power-output indications in the two tests.

The hum level is far better than the rated 90 db below 40 w. We measured from 90 to 97 db below 10 w under various conditions of shorted and unshorted inputs, which corresponds to 96 to 103 db below 40 w. Needless to say, there can be absolutely no audible hum from this amplifier with the most efficient speaker system.

The damping-factor range was measured as 0.34 to 16. The variable-damping circuit had no effect whatever on gain, frequency response, or distortion.

The stability of this amplifier is apparently absolute (a much misused term these days). The 10-Kc square-wave pic-

Continued on page 41

10-Kc square waves.

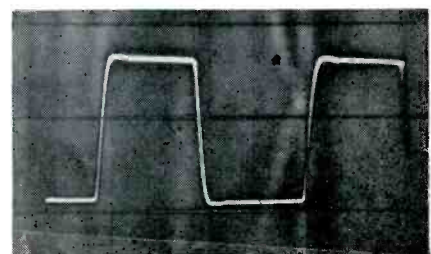

60-cps square waves.

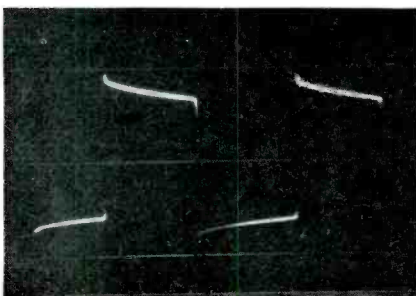

TRANSISTORS

by PAUL PENFIELD, Jr.

in audio circuits

PART XI: Transistor Distortion

THIS DISCUSSION of distortion follows the article on power transistor stages because power stages exhibit the most distortion. Lower-level stage distortion, although less serious, arises from the same causes and is reduced in the same way.

Distortion is *any* undesired change in the signal. The general facts about distortion and the classification of various types of distortion are the same as for vacuum-tube circuits; with transistors, however, different types may be more important.

What are the main types of distortion? Nonlinear distortion changes the shape of the signal; frequency-response distortion is the result of some frequencies being amplified more than others; overload-recovery distortion is caused by a finite time required to recover from overloads; phase distortion is a change in phase of some of the constituents of the signal. Finally, we must include as distortion any additions to the signal, such as noise or hum.

If the output of an amplifier is not directly proportional to the input, we have a nonlinear-transfer characteristic. If the input signal is a sine wave, this nonlinearity will add harmonic distortion to the output signal—the output

Fig. 1. Nonlinear input characteristic.

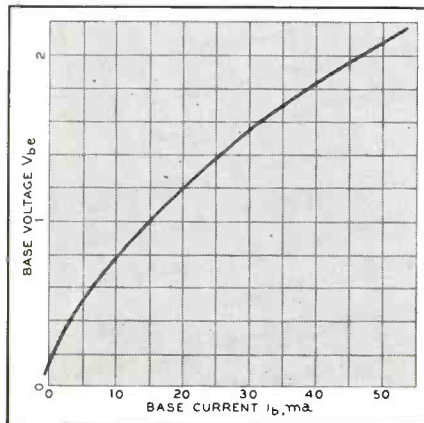

will not be quite a sine wave, but will be different in shape. If sine waves of two different frequencies are fed in, not only will both be deformed, but other frequencies will also be present in the output. This is known as intermodulation distortion. Both types of distortion have the same physical cause, but in practice intermodulation distortion,

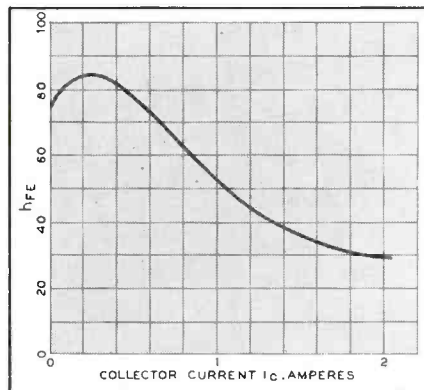

Fig. 2. Gain drop due to overloading.

which is thought to be more easily heard, is usually the one measured. But both are basically nonlinear distortion, and are eliminated only by getting rid of nonlinearities.

Frequency distortion is caused by different amplifier gains at different frequencies, and in general is ultimately traceable to reactances in the amplifier circuit. Specifying the frequency response of an amplifier is one way to indicate how severe frequency distortion is. It can be quite severe with power transistors.

Phase distortion is produced, basically, by the same things that cause frequency distortion. The human ear is reputedly unable to detect phase distortion. Phase distortion is important, however, because of its effect on any feedback that may be used. The same techniques are used to minimize frequency distortion and phase distortion.

Transient distortion has a separate

name only because it corresponds to a fuzziness on transient sounds which is easily noticed by the ear. It is really nothing more than the action of frequency (and phase) distortion on transients, possibly with a little overload-recovery distortion.

Overload-recovery distortion is caused by the fact that the amplifier may take some time to recover from being overloaded momentarily. There are many possible reasons for this, but the most common is the charging of a coupling or bypass capacitor when the transistor or vacuum tube is driven into a nonlinear region. It may be so driven either by too large a signal, or by a large signal produced by phase distortion acting on a fast transient. This type of distortion is not too well understood, especially with transistors.

Extraneous signals added to the sound, such as hum or noise, must (strictly speaking) be considered as distortion also. Noise in transistor circuits has been covered before in this series. Transistor circuits are "hum-free" (a claim often made) only if a battery power supply is used, and if they are well shielded against stray hum pickup. A transistor amplifier will, of course, pass along any hum present at its input, so in practical cases hum is nearly as much of a problem as with well-designed vacuum-tube circuits. Nothing more need be said here

Fig. 3. Combined form of Figs. 1 and 2.

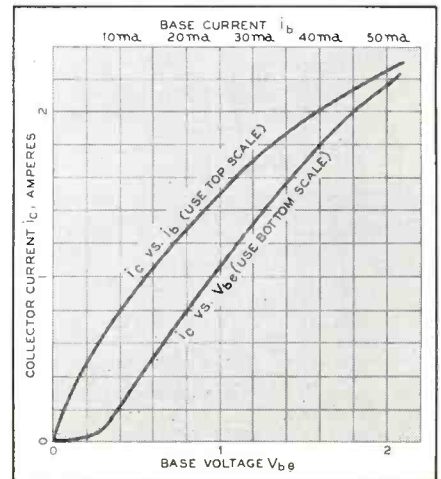

about hum and noise as forms of distortion.

Other specialized forms of distortion are recognized in audio work, but those listed above are the main ones.

Nonlinear Distortion

In a Class-A amplifier there are two main causes of nonlinear distortion: a nonlinear input characteristic, and a current gain that isn't constant. The distortion of a grounded-emitter stage is the worst of the three configurations, so let's examine such a case.

Fig. 1 shows the first of these nonlinearities. The soft curving at higher currents and the sharp curving near the origin are both important. This curve and Figs. 2 and 3 were taken from Part IX of this series [March 1958, p. 27].

Fig. 2 shows the second nonlinearity. The quantity plotted against the collector current i_c is the common-emitter gain, β . Notice that at higher currents the gain drops off, meaning a soft overloading type of distortion.

The same information is in slightly more usable form in Fig. 3. Here the collector current (on short-circuit output) is plotted as a function of both base current and base-to-emitter voltage.

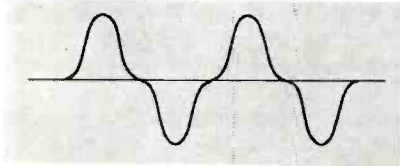

Fig. 4. Effect of crossover distortion.

Notice that the bottom curve, that of output current versus input voltage, is fairly linear over a wide range of output current. The reason for this is that the two nonlinearities of Figs. 1 and 2 tend to cancel over this range. Thus, for lowest distortion, Class-A stages should be run in such a way that the input voltage, not the input current, is the variable of interest. This can be done by making the output impedance of the previous stage small compared to the input impedance of the stage being considered — by incorporating a step-down transformer between the stages, for example, or by using a common-collector driver.

The desire for low distortion may be in conflict with a desire for high power gain, or good bias stability, and usually the final design will have to be a matter of compromise.

A push-pull Class-A circuit will provide even further cancellation of this distortion, even if the two transistors are not ideally matched.

In the analysis above we have assumed that we will stay within the so-called "linear" region of operation: away from saturation, cutoff, high-voltage breakdown, and severe alpha-crowding [see Part III of this series, December, 1956].

The severe distortion when the transistor hits saturation or cutoff is similar to the clipping obtained from overdriving a vacuum-tube amplifier.

In a Class-B amplifier we are confronted with all these troubles plus one more — that of providing a smooth transition from one-half of the cycle to the other half (that is, crossing over from one transistor to the other).

This crossover will be smooth if the input current is the variable of interest; in other words, if the driver stage appears as a high impedance. This is clear



Fig. 5. Unmatched transistor distortion.

from Fig. 3, which shows the input-current curve (on top) going straight toward the origin. Unfortunately, this is exactly the wrong condition from the standpoint of distortion within the linear region, for which we would like the driver stage to appear as a low impedance. The result is that if the driver looks like a high impedance, there is quite a bit of "soft" distortion which increases in severity as the signal gets larger. On the other hand, if the driver looks like a low impedance, there is extremely severe crossover distortion arising from the rather sharp kink in the bottom curve, Fig. 3. This crossover distortion chops the middle out of the signal, leaving only the top and the bottom. What it does to a sine wave is shown in Fig. 4. One particularly bad feature about it is that, unlike distortion from overloading or gradual bending of the transfer curves, crossover distortion becomes worse (on a percentage basis)

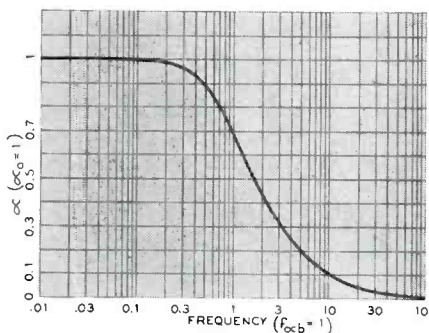

Fig. 6. Variation of α with frequency.

for smaller signals, and is quite unbearable to listen to.

A compromise between high and low output impedance for the driver stage will yield an over-all distortion somewhat better than either extreme case discussed above. But the real solution is to bias the transistors slightly away from cutoff, and drive the transistors from a low-impedance source. The bias should be large enough that there is very little crossover distortion left, yet small

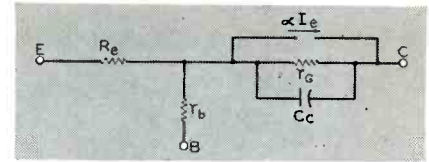

Fig. 7. High-frequency, common-base equivalent circuit with r -parameters.

enough so that not too much standby power is used in the biasing.

There is another potential source of distortion in Class-B stages. Theoretically, if both transistors were identical electrically, there would be no second-harmonic distortion, no fourth-harmonic, etc.; all even-order harmonics would be missing. Such a result is often achieved with vacuum-tube circuits, but unfortunately it is very difficult to match transistors exactly, so this "advantage" of push-pull transistor circuits is more theoretical than practical. In fact, the second-order distortion can be quite severe using unmatched transistors. For example, only a 10% mismatch in gain between the two stages would mean about 4% second-harmonic distortion, which is quite audible. This trouble is even worse in complementary circuits, for it is even harder to match $n-p-n$ and $p-n-p$

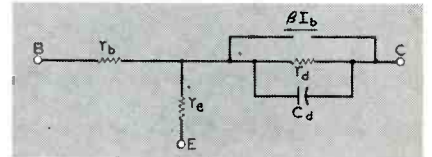

Fig. 8. High-frequency, common-emitter equivalent circuit using r -parameters.

transistors than it is to match two of the same type. A severe case of distortion from unmatched transistors is shown in Fig. 5. The second harmonic amounts to some 15% in this case.

Frequency Distortion

There are two physical mechanisms in a transistor which contribute to frequency distortion, or lack of extended frequency response. The low-frequency response of a transistor amplifier is limited only by the size of coupling capacitors and transformers used in the circuit, and not at all by the transistor. A transistor does limit the high-frequency response, however.

The first physical mechanism is the "transit time" for the current carriers (holes or electrons) to travel from the emitter to the collector, across the base. It turns out that the easiest way to ac-

Continued on page 44

Fig. 9. High-frequency, common-base equivalent circuit with b -parameters.

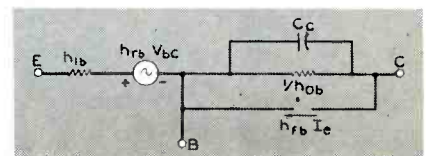

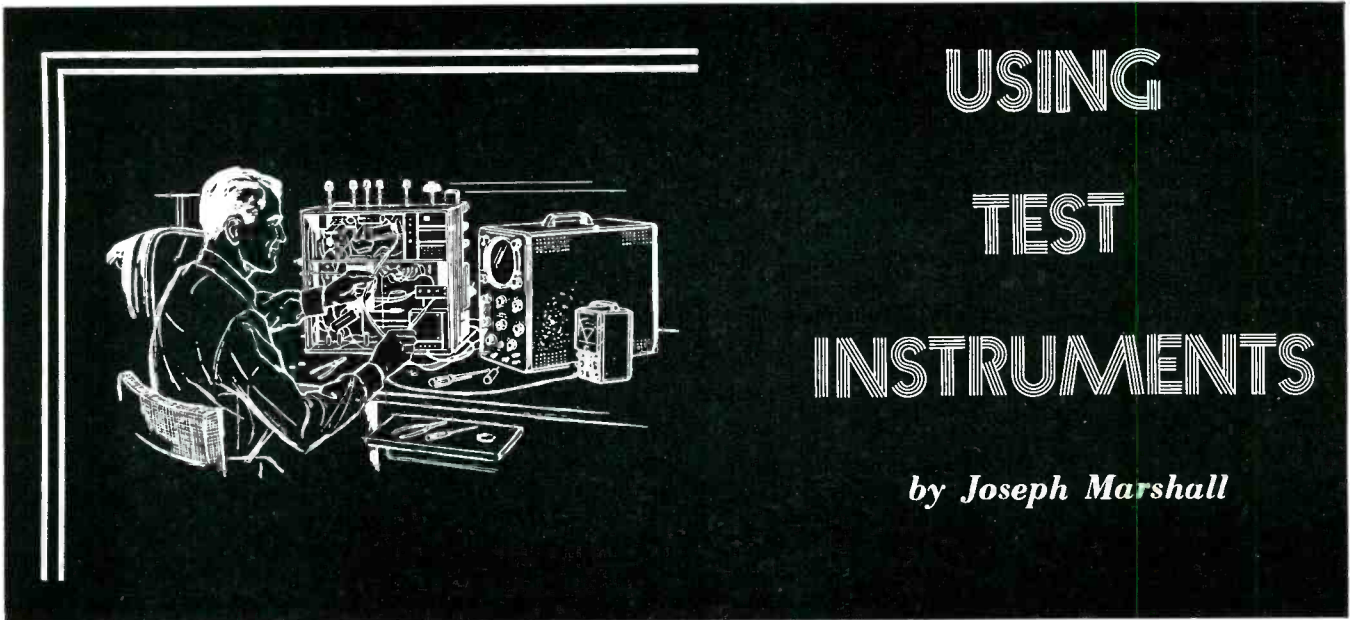

USING TEST INSTRUMENTS

by Joseph Marshall

Signal Generators, Part III

IT IS important to know how accurate and stable is the signal generator you depend on. Fortunately, it is quite easy to verify this and to make adjustments in calibration when necessary. This is most easily accomplished on the second or third band of the signal generator, the one that produces signals in the broadcast band from 550 to 1,600 Kc. Broadcast stations are required to maintain a very high order of frequency accuracy and stability, on the order of a few parts per million. It follows that they provide highly accurate and convenient standards for checking and calibrating signal generators.

To check accuracy and stability, first tune in a nearby radio station of known frequency on a radio or AM tuner. Turn on the signal generator (with audio modulation inoperative) and place it in close proximity to the radio or tuner, at first without a direct connection to the

radio or tuner. Tune the generator in the vicinity of the dial marking that indicates the frequency of the radio station.

As the frequency of the generator approaches that of the radio station you will hear a high-pitched squeal. If the squeal is very low in volume, make a direct connection from signal generator to radio or tuner and, if necessary, increase generator output. Tune the generator very carefully and slowly. The closer the generator approaches the frequency of the radio station, the lower the pitch of the squeal or "beat note." As it approaches identity, the beat note will go into the bass range, and when the generator is tuned exactly to the radio station frequency there will be no beat note at all. This is the "zero-beat" point.

It is not easy to adjust a generator to zero beat for it may take an excruciatingly small movement of the knob. Be

sure you have zero beat and have not passed beyond it on the other side to a frequency 10 Kc or more higher or lower. This is quite easy to verify, because when you have zero beat, turning the generator dial *either* way will result in a return of the beat note and the note will rise in pitch as you continue to turn the knob. But if you have passed zero beat and gone 10 Kc or more beyond, the beat note will return only when you turn the knob in one direction and will become *lower* in frequency as you continue to turn the knob; there will be no beat note at all when you turn the knob the other way.

An audio or AC VTVM, connected at the output of the tuner or radio, can serve as an excellent indicator for zero beat. The meter will begin giving a reading as soon as the beat note is audible or is produced. The meter will remain fairly steady as one approaches zero beat. When the beat note gets below 50 cps the needle probably will vibrate, and, when it gets below 10 cps, it will begin to swing slowly, standing

Setup for calibrating RF signal generators. If generator output is too weak, wire may be connected to tuner antenna terminals.

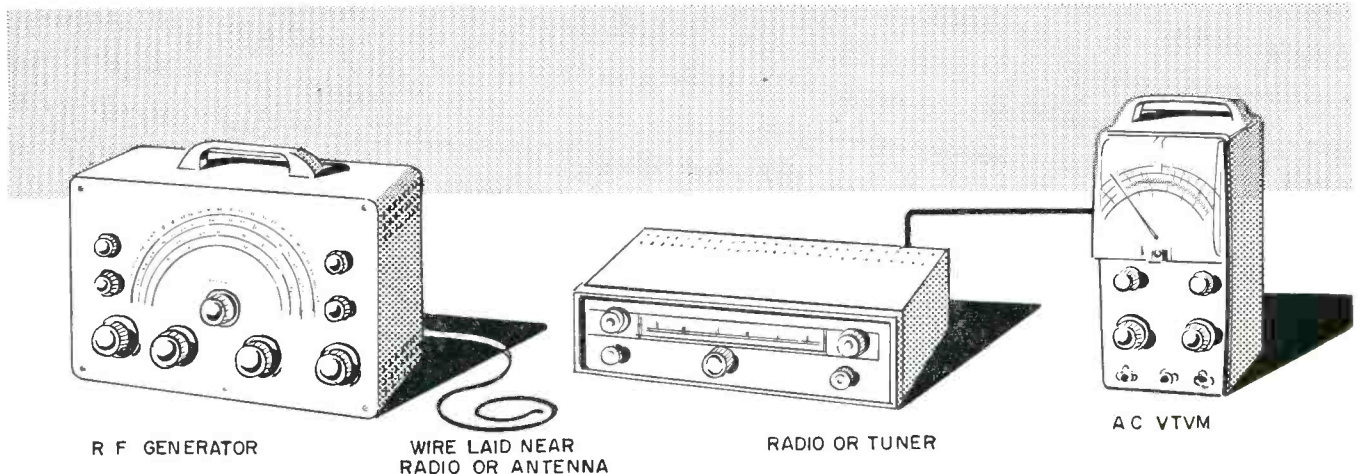

steadily once more at zero voltage when you reach exact zero beat.

Once zero beat or something close to it is achieved, you can check the reading on the generator dial against the known frequency of the radio station. If the reading departs more than a few kilocycles from the station frequency, the generator can be recalibrated as recommended in the instruction booklet. In any event, the error can be determined. The process can be repeated several times to verify how accurately the generator can be reset. If there is no appreciable play in the dial mechanism it should be possible to keep the error down to 1% or so.

Stability can be checked by leaving the generator tuned to the zero-beat point for an hour or so. As the generator drifts, the beat note will once more become audible and rise in pitch as the drift continues. The amount of drift can be checked by comparing the audible beat note with the note of a musical instrument such as a piano. An audio generator can also be used as a reference standard.

Having checked drift at the end of the first half hour, retune the generator to



Knight-Kit RF Signal Generator.

zero beat again and check the drift for another half hour. There may be a fairly considerable drift at first, but in the second half hour the drift should not exceed 1,000 cps or so. If the drift is greater than this it will be more difficult to obtain sharp alignment of a tuner or receiver. This can be compensated for by doing the alignment more rapidly.

The percentage of drift of a generator ought ideally to remain pretty constant throughout its range; but this will not always be true. Therefore, it is wise to check the drift at the several points of maximum importance. For hi-fi use the drift and calibration ought to be checked also in the region of 10.7 Mc. This can be done as easily provided a short-wave receiver is available. The Bureau of Standards operates frequency-standard stations (WWV and WWVH) which transmit at 2.5, 5, 10, 15, and 20 Mc. Not all of these will be heard in any given location, but the 10-Mc frequency is receivable in most parts of the country

most of the time. If a short-wave receiver is available, it can be tuned to this station and the signal generator then tuned to zero beat with it, as described above. It is altogether likely that the generator will drift until the beat note passes beyond 10 Kc and becomes inaudible. In that case the amount of drift can be estimated by retuning the generator to zero beat and noting the difference in the two readings of the generator dial. An error in accuracy or a drift of as much as 100 Kc is not too serious.

Incidentally, it is possible when making the above checks to tune the generator not to the frequency of the radio station but to that of the local oscillator in the radio or tuner. This is not likely on the broadcast band but may be rather easy on the short-wave bands. The simplest way to check this is simply to turn the dial of the radio one way or the other just a very slight amount. If the pitch of the beat note changes, the generator is tuned to the frequency of the local oscillator rather than the radio station; if there is no change in pitch, the generator is tuned to the radio-station frequency.

Obviously this method of zero beating can be used both to calibrate the signal generator and a receiver or tuner. The circuitry of signal generators provides for calibration adjustment at a single point in each band. It is assumed that if this is done the dial calibrations will be within 1% or 2% throughout that band. Still, it is always best to calibrate the generator at the frequencies which will be most used; for hi-fi applications these are 455 Kc, 600 Kc, 1,400 Kc, and 10.7 Mc. The last three points can be checked against radio stations at or near these frequencies—broadcast stations at or near 600 and 1,400 Kc; and WWV at 10 Mc. For 455 Kc it will be necessary to use harmonics, and this will require more care. The second harmonic of 455 Kc is 910 Kc; if you have a radio station on that frequency, the problem is solved. Tune in the 910-Kc station and then tune the signal generator near the 455-Kc point until again you obtain zero beat. Check the dial reading, and, if it is more than 1 or 2 Kc off 455 Kc, recalibrate for an exact reading.

If you do not have a radio station on the 910-Kc frequency, look for stations at 900, 920, 1,360, 1,370 Kc; having found one, tune the generator around the 455-Kc dial marking until you obtain zero beat. The first subharmonic of 900 Kc is 450 Kc; of 920, 460. In the case of 1,360 Kc, the generator would be tuned to 453.33 Kc, and the third harmonic would be beating with the radio station. The third harmonic of 456.67 Kc will zero-beat with a radio station at 1,370 Kc. If the generator is accurately calibrated anywhere between 440 and 470 Kc it will be accurate enough at 455.

So simple it's like magic...

Grommes Little Genie

HI-FI KITS

LAYER-BUILT • COLOR-GUIDE

Before you build another kit see this new method of Kit Assembly. Each kit is complete with all parts and the new exclusive "Little Genie" Instruction Book.

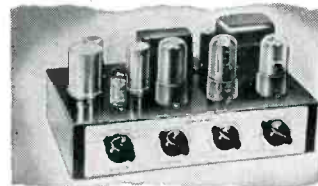

NEW LJ-6K \$24⁹⁵

LJ-6K 10 Watt Amplifier (Little Jewel). Highest value in the low priced field, with built-in pre-amplifier and record compensator on phono channel. Freq. Response: ± 1 DB 20 to 20,000 CPS at 1 watt. Distortion: 2% harmonic or less at 10 watts. In Charcoal and Brass. Shpg. Wt. 10 lbs. Complete Kit and instructions.....Net 24.95

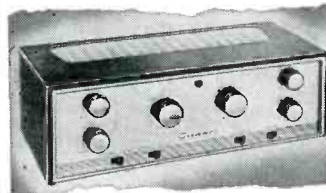

NEW 207A-K \$44⁵⁰

207A-K Hi-Fi Preamp. The ideal control unit with self-power feature for use with any basic amplifier. True flexibility with 10 separate controls. Feedback throughout for low distortion and wide frequency response. In charcoal gray and brass. Shpg. Wt. 10 lbs. Complete Kit and instructions.....Net 44.50

250A-K 60 Watt Basic Hi-Fi Amplifier. For use with a preamplifier (such as 207A-K). New advanced circuitry for true high fidelity with exceptional reserve power. Shpg. Wt. 40 lbs. Complete Kit and instructions Net 79.50

20PG8-K 20 Watt Hi-Fi Amplifier featuring greater flexibility of controls and new advanced circuitry. Feedback throughout, 10 controls and 6 inputs including tape. Wt. 21 lbs. Complete Kit and Instructions Net 59.50

Prices slightly higher West of the Rockies

See your Hi-Fi Dealer or write . . .

Grommes—A Division of Precision Electronics, Inc.
Dept. A-8 9101 King. Ave., Franklin Park, Illinois

Send details on all Hi-Fi Kits.
 Send complete details on Kit.

Name.....
Address.....
City.....Zone.....State.....

Stereo discs can be made by a variety of methods. How do they work?

by NORMAN H. CROWHURST

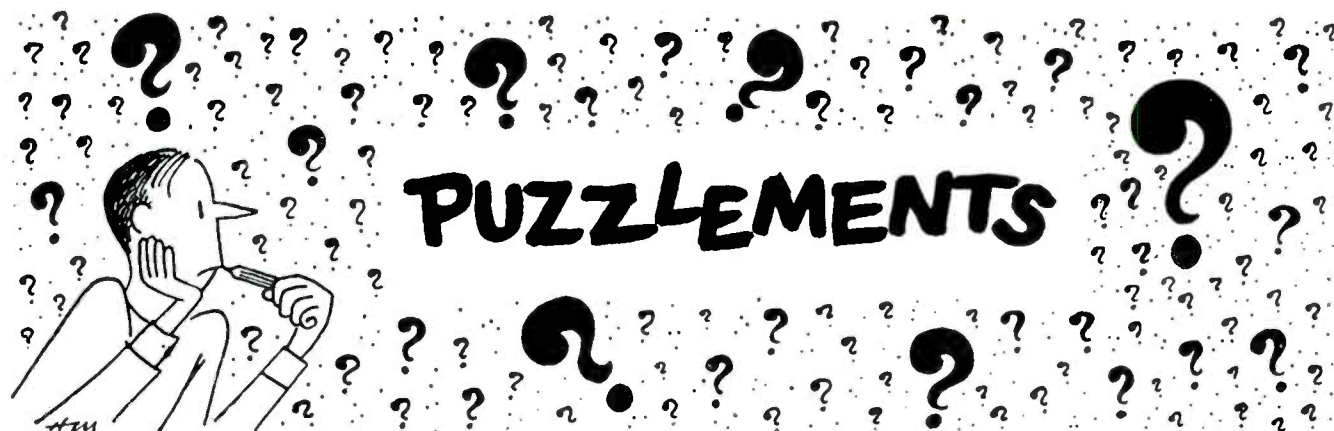

WHO would have thought that stereo on disc could get so complicated? At one time (not so long ago, either) most people in the business said it couldn't be done; now we have several contenders saying they've done it successfully, and most, if not all of them, claiming "compatibility."

The first effort—Cook's binaural—was not exactly practical for the mass market. The enthusiast would take the pains to get both styli in corresponding grooves, but the average disc user would never tolerate such a fiddly thing. A practical stereo disc had to be single-groove. And I think most people are by now aware that all new systems so far proposed use a single stylus in that groove, although it has puzzled some how this can be done. But articles all over the place have explained this, so we will take that as read.

What gets confusing is how there can possibly be so many ways of putting two channels in one groove with one cutter, to be played back with one stylus. In particular, people who bolt at any math higher than elementary algebra have been scared by mention of matrices in the circuitry for combining the channels into the groove. We have had mixing, coding, multiplexing, and now—matrixing. How are all these things related?

It all starts with the practical realization that the program contents of a pair of stereo channels are basically very similar. From this springs the possibility of simplifying the extremely rigorous problem of getting two separate channels of program into one groove (and also getting them out again) without undue distortion.

I believe it would be quite erroneous to start off, "first this was done, then that," because the initial concepts date from years ago. Recent developments have made their realization possible, and

many groups have been working independently along similar but different avenues; hence the confusion. So the order I adopt here to explain these relationships does not imply sequence of development. I have used it to make explanation easier.

First, we were presented with the simple possibility of recording both channels by means of cutter and stylus movements mutually at right angles: either one vertical and one lateral (the

formation—mixing, coding, matrixing or unmatrixing, whatever you want to call it (but we'll come back to that)—produces the correct output in left and right channels.

Examination of this arrangement, or its counterpart as a method of cutting 45/45's, reveals the interesting fact that an equal audio drive in each channel, in phase, produces pure lateral movement, while the same equal drive, out of phase, produces pure vertical movement. The interesting part arises from the fact that both original channels are *nearly* the same. But it is the *difference* between them that makes it stereo.

Consequently the lateral component in a 45/45, isolated from the vertical, is a mixture of both channels corresponding to a single-channel (monophonic) recording of the same program. All the "body" of the sound is in this lateral component.

Similarly the vertical component, isolated from the lateral, is a sort of difference mixture from both channels that gives it the stereo properties. There is a vertical component only when the channels are different. This means there will be very little "body" in this component, although occasionally its amplitude may peak up to the same excursion as the lateral component normally does. Most of the time the vertical component will be much smaller than the lateral.

If the vertical component never exceeded its average value, without those occasional peaks, we would have a much easier compatibility problem. But the occasional excursions make it difficult. An occasional vertical peak like this will make many monophonic pickups start to "toboggan" along the groove. This is the reason for all the hesitation in putting out stereo discs. Also it is why we have several possible alternative solutions.

Jerry Minter's multiplex system avoids



Sugden and London systems), or each at 45° so that the angle between them is 90° (the Westrex system). Without taking into account questions of compatibility or distortion, both these methods are equally valid, and one can be regarded as the same as the other rotated through an angle of 45°.

But there is another way of converting one into the other. Suppose a vertical-lateral pickup is used to play a 45/45 record; a fairly simple electrical trans-

Next month Mr. Crowhurst will discuss the differences between several types of amplifier output circuits.

the vertical problem by not using any vertical modulation at all. He uses this same sum-and-difference mixing, accomplished electrically, to separate the "body" from the "stereo." This double mixing is what CBS has called matrixing; and really, it is a better word. Each of the resultant channels is a mix: the "body" channel is a summation mix, and the "stereo" channel is a differential mix. It is important to the end result that these mixes be kept complementary.

By this I mean that the sum and difference each must have an equal part of both left and right channels. Otherwise, the final restoration is impossible. That is why the term matrixing began to be used. Matrixing consists of two mixes in a special relationship, one with the other.

In the Minter multiplex system, the "body" or sum combination is recorded laterally directly as it is, frequency for frequency, just as it is on a monophonic disc. The audible output of a monophonic pickup used to play this record will be much like that from a standard record. The "stereo" or difference combination is used to frequency modulate a 25-Kc carrier, with a peak fluctuation between 20 Kc and 30 Kc, and this too is cut laterally in the same groove.

That is what is meant by multiplexing: shifting the whole program spectrum of one channel to a different frequency range. Putting the "stereo" component on the multiplexed channel makes the system compatible, because the other channel ("body") carries normal single-channel program. On stereo playback the original channels are recovered by first demodulating the 25-Kc FM carrier and then recombining, or unmatrixing, to get left and right channels again.

Since the sum channel carries the "body" and the difference channel is responsible for the stereo effects, some change can be made by altering the proportions before recombining. If there is zero output from the difference channel, the "body" gets fed to both left and right channels unchanged. It is like two loudspeakers on single-channel program material. Full "stereo" combined with the "body" in the unmatrixing arrangement will give the original left and right exactly. But between these extremes, the difference between the two channels will be of the right kind but less than true stereo. Of course it is also possible to use a greater proportion of stereo component and get more than "true stereo"! At least, it may be a heightened illusion.

This is one advantage of the system to experimenters such as AUDIOCRAFT readers: you can adapt the stereo effect to suit your listening room or the program material, or both. I understand that Mr. Minter plans to release the necessary FM demodulator circuit and

also a catalogue of program material for this purpose.

The new CBS "compatible stereo" records, announced this spring and then withdrawn, also took advantage of matrixing techniques, but did so to produce a record similar to the 45/45. It differs in having the vertical, or "stereo" component, altered to remove the occasional high-amplitude peaks. Of course these cannot just be clipped off, because that would introduce distortion. The exact circuit they used is being kept under wraps.

This makes the record compatible by avoiding the toboggan effect. But it also, in the demonstrations heard so far, does detract somewhat from the stereo impression, and also seems to make a little distortion seem audible from the speaker that is momentarily off when the sound is supposed to issue all from the other. What is significant is that there must be an almost endless way in which this "stereo" component can be altered. So if CBS has not yet found the optimum method, maybe someone else will.

These methods do not exhaust the possibilities of utilizing the vertical com-

ponent for providing "stereo" control. Another uses what really is a code. That is why, although the word "code" has been applied to the recombining arrangement, it is not a good term for it. In real coded stereo, the main channel (in the case of a disc system, this would be the lateral channel) would contain the only audio. The code channel (which could be the vertical on a disc) would contain subaudio (or supersonic) control frequencies in some code, the purpose of which is to "direct" the instantaneous distribution of the audio between channels.

This is the basis of the Perspecta system used for movies, but to date it has not been applied to home stereo. It is not mentioned here in the hope that it will appear, but to show why the term "coding" is inappropriate for the double-mixing arrangement that has now been called matrixing. A code is something separate from the audio; it is used to control it.

I think that has about put the spotlight on all the contenders in the field and — I hope — clarified the differences between the fancy words used.





What is 'optimum' bias?

THERE ARE TIMES when I wish some respected potentate of the high-fidelity industry would hold up his hand to the world and say, "Stop! Let us have no more progress until we have better defined what we are talking about now." Ambiguity and redundancy may be tools of the trade for diplomats and soap salesmen, but they don't help the high-fidelity field one little bit. Take output impedance, for instance. High impedance is only high with respect to low impedance, and if it is not *that* much higher than low impedance, it may be referred to as medium impedance. Low impedance may refer to a low-impedance output that must be matched to a low-impedance input, or it may mean a low-impedance output that must feed a high-impedance input.

An amplifier may have an output impedance that is nominally 16 ohms but is actually 0.5 ohms. Both are low impedances, but one and not the other should be matched to the speaker. And how can you actually match the speaker when its impedance corresponds to its rated value only at one or two specific frequencies?

In our own sphere of interest, look at bias. This term was originally used in the electronics field to refer to a fixed DC voltage applied to the grid of an amplifying tube to keep it operating within its minimum-distortion range of plate current. Magnetic recording has absconded with the term and applied it to the AC current fed to the recording head in a tape recorder, to keep the tape within its minimum-distortion range of magnetic flux. There's some justification

for using the same word, particularly when it is correctly qualified as "recording bias," but it might have been less complicated all around had we called it "english," or "carrier," or "ultrasonic superimposition," or something.

Optimum bias may mean that value of recording bias which gives the lowest distortion, or it may mean a bias current which gives better high-frequency response at the expense of slightly increased distortion. The latter is often referred to as *peak bias*, because it is that

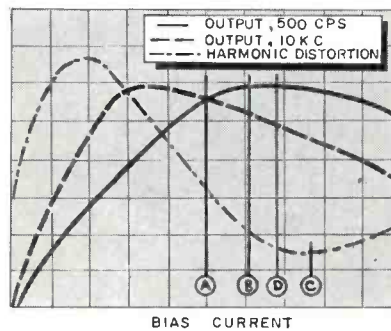

Fig. 1. Distortion and output versus bias current. See text for explanation.

bias current which elicits maximum output from the tape at middle and low frequencies. This is ambiguous, too, because for one thing, peak bias is a narrow range of bias currents rather than just one value of current, and for another, the actual bias current needed to peak the output will vary to some extent depending upon what frequency is being recorded.

Then there are expressions such as "biasing to 1 db beyond peak," and "biasing to -1 db beyond peak"; both

mean precisely the same thing. Related to this is another ambiguity concerning biasing, and this one has no mathematical correlation to anything at all, because it involves the case of a VU meter which is reading decibels, but isn't reading the *right* decibels.

The audio field as a whole is, semantically speaking, a lost cause. But perhaps we can deal a low blow to some of the ambiguities in tape recording—at least with regard to biasing—by defining some of the specialized terms involved.

The recording bias is an ultrasonic tone which, when fed to the recording head along with the audio signal, increases the output and reduces the distortion and noise from the tape recording. The degree to which the bias accomplishes its purpose depends upon the amount of bias that is passed through the recording head and the purity of its wave form.

Fig. 1 shows the effect of bias current on distortion, and on output from the tape at 500 and 10,000 cps.* It can be seen that output at 500 cps rises as bias is increased, until it reaches a maximum point (indicated by vertical line B). This is the peak output point, and the bias current that produces this maximum output is called peak bias. As bias is increased further, the tape's output at 500 cps begins to diminish; biasing within this range is known as biasing beyond peak. The amount of overbiasing is specified as the number of decibels by which the output has been reduced below peak level.

Thus, a recorder's service manual might specify biasing to peak the output, or it might specify a higher bias—for instance, biasing to -1 db. Remember,

*These curves, and all subsequent discussion of them, are related to a tape speed of 7½ ips.

this does *not* mean decreasing the level of the bias current itself by 1 db; it means *increasing* the bias until the output from the tape has been reduced by 1 db. All of which brings us to the problem with the VU meter that I mentioned earlier.

Many a recorder that is equipped with a VU meter has some provision for switching it to read bias current, as a spot check on this important adjustment. When the bias is optimized initially, a calibrating control in the recorder is used to set the meter to read zero VU when metering the correct bias current. Should the bias drift from its original value, switching the VU meter to BIAS will show the discrepancy. The bias control may then be adjusted to return the meter to zero. This is an excellent idea, but as a result of the arrangement, zero level on the meter is the crucial reading when metering bias *as well as* when metering record or playback levels. Consequently, the user who has been advised to bias his recorder to 1 db beyond peak may, without thinking, switch the meter to read bias current and then simply adjust the bias control until the meter moves to a +1 or -1 db indication (depending upon how he interprets the directive). This is, indeed, increasing (or decreasing) *bias* by 1 db, but it's the wrong db. The thing that should change by 1 db is the output from the tape, not the bias current itself. Changing bias current by 1 db will not give the desired bias setting, and will more than likely play havoc with the recorder's performance.

As we can see from Fig. 1, the bias current that produces minimum distortion from the tape is quite a bit higher than that which maximizes the tape's output at 500 cps. Thus, point C would be the proper bias setting for minimum distortion.

On the other hand, output at 10,000 cps reaches its peak at a very low bias setting, and is falling off quite rapidly by the time the bias current is approaching the 500-cps peak point. Biasing to point A in Fig. 1 might give the best compromise between middle-range output and high-frequency response, but distortion would be severe. Biasing to point C, the minimum-distortion point, would degrade high-frequency response too much for equalization to cope with; the necessary treble boost would either overload the tape, or would increase hiss to an annoying level. Obviously, no single bias setting is going to meet all the requirements, and we must find the "optimum bias" setting.

The best compromise bias current will generally fall somewhere between the 500-cps peak point (point B) in the drawing and the point of minimum distortion (point C). The upper limit here, which is set by permissible treble loss, usually turns out to be that overbias

Continued on page 46

Some facts on the measure of the

JansZen* loudspeaker

One very important measure of a loudspeaker's capability as a true high fidelity component lies in its ability to reproduce music with the same emphasis at all volume levels. As the volume control is turned from maximum to minimum, each instrument of an orchestra should remain in the same perspective . . . the effect being of walking farther and farther away from a live orchestra as it is playing.

When a response curve is taken on a JansZen speaker from the lowest listening level up to a full 50 watts of power, the resultant curves are absolutely identical.

This is a true measure of smooth response, which in turn is a measure of the similarity between what goes into a recording microphone compared with what comes out of your speaker at home. Hence, it is a measure of whether a high fidelity speaker is in fact what it is supposed to be.

A response curve is taken on every JansZen speaker before it leaves the factory. Only in that way can it be assured that each speaker is right. Only in that way can it be assured that all speakers are exactly the same. That's why most knowledgeable listeners consider JansZen as The Speaker.

*DESIGNED BY ARTHUR A. JANSZEN

Write for literature and the name of your nearest dealer

Product of **NESHAMINY ELECTRONIC CORP.**, Neshaminy, Pa.

Export Division: 25 Warren Street, N.Y.C. 7, Cable Simontrice, N.Y.

DYNAKIT

AMPLIFIER KITS

A great amplifier circuit of superb listening quality in money-saving kit form!



Available from leading Hi-Fi dealers everywhere. Descriptive brochure available on request.

NEW!! DYNAKIT STEREO CONTROL KIT

ADDS COMPLETE STEREO CONTROL FUNCTIONS TO TWO PREAMPLIFIERS For Only **\$12.95**
DATA SHEET AVAILABLE ON REQUEST

MARK III 60 watts 79⁹⁵* net

The new Mark III includes all the sensational attributes of the popular Mark II plus these outstanding deluxe features

- ★ 60 watts at less than 1% distortion. Instantaneous peak power of 140 watts. IM less than .05 at average listening levels.
- ★ Choke filtering and low noise circuitry reduce hum and noise to 96 db below 60 watts.
- ★ New rugged KT-88 tubes and other heavy duty parts used conservatively.

MARK II 50 watts 69⁷⁵* net

The Mark II is the best buy in high power high fidelity kits

- ★ Ease of assembly due to uniquely simple circuitry and printed circuit construction with factory-mounted parts.
- ★ Highest stability using patented stabilizing networks with minimum number of phase shifting stages. Suitable for all loudspeaker systems including electrostatic.
- ★ Dyna Biaset (patent pending) for simplified adjustment and complete freedom from effects of unbalanced components. No balancing adjustments required to meet published specifications.
- ★ Dynaco Super-Fidelity output transformer with patented para-coupled windings. This is the finest available transformer of its type for the most critical audio uses.

*Slightly higher in West

DYNACO INC. 617 N. 41st St., Phila. 4, Pa. 25 Warren St., New York 7, N. Y.

Sound-Fanciers' Guide

by R. D. Darrell

HOWEVER tantalizing the inevitable pipeline-filling delay between floods of stereo-disc and stereo-pickup-cartridge announcements and the emergence of more than a trickle of the actual products themselves, I welcome the further breathing space it gives me to continue the project, "Midsummer Housecleaning," begun, but by no means completed, last month. For my space ran out before I could get around to two special categories of conventional LP's and stereo tapes which are not only highly pertinent to this column's preoccupation with unusual sonic qualities, but present musical problems for which no recording technologies of any kind can provide satisfactory solutions.

Pseudo Exoticism

As an avid connoisseur of odd sounds, and especially those rich in percussive transients and piquantly novel tonal colorings, I am of course delighted with many recording companies' discovery that high fidelity, with or without stereo enhancements, is the ideal medium for primitive, non-Western, or otherwise exotic musical repertoires. Yet as something of a purist where folk and ethnic materials are involved, it is much too often that only my ears are titillated, while my mind is affronted by the insensitivity and tastelessness of "tourist-trade" arrangers whose popularized translations of foreign idioms are seldom free from the suave accents of Hollywood and Madison Avenue.

Now, I have never—to my regret—visited Hawaii, for example, and I know very little about authentic Hawaiian music, except that it must be a fascinating mixture of various oceanic traditions, now blended with European and American influences. So I welcomed the opportunity to be transported via LP to Henry J. Kaiser's aluminum-domed auditorium in Honolulu to hear the "exotic sounds of Arthur Lyman" and his versatile sidemen (*Taboo*, HiFi Record R 806), in which genuine surf roars and bird cries have been ingeniously dubbed. But while I find lively audiophile interest in the beautifully clean recording of vibes, xylophone, drums, and so on (marred only by an inexplicably over-



heavy piano in some selections), and in the transparently open acoustics of the auditorium itself, and while I have no doubt that some at least of the native tunes employed here are genuine enough, I never can escape the feeling that I've dropped in on a local-color show, designed to impress self-consciously *lei*-draped tourists, and given by extremely sophisticated musicians far more at home with a broadcast or film-studio microphone than with volcanic-island beaches and jungles. In short, *Taboo* is musically phony dressed-up pops stuff; it is a lot of fun if you don't take it seriously, but essentially no more Hawaiian than a glossy colored postcard of a Waikiki beach scene dominated by vacationing Californians.

More Jungles (from Jet Planes)

There are many even more commercialized exploitations of exotic materials, some of which are even uninteresting aurally, such as the Percy Faith Orchestra's *Viva* (Columbia stereo tape GCB-15) and *Enrique Torres Sings Exotic*

Love Music from Peru (Protonic, via Recotape, RS 102 S), since even stereo cannot compensate for the stridencies and apparent overloading of the former's quasi-Latin-American performances and the latter's too closely miked, *molto-vibrato* crooning. But, happily, there are also others in which the arrangements are less obviously sophisticated and the sonic qualities both striking and more cleanly and brilliantly recorded: *The Soul of Haiti: Songs of Magic, Love, and Voodoo Ritual*, by Jean Vincent with Alberto Socarrás's Orchestra (Vanguard VRS 9015), with many dubbed-in "natural" sound effects, but best for its emotional *Magné ta royo* and nostalgic *Marrassa é lou*; *Moondongo* by Subri Moulin's Equatorial Rhythm Group (Manhattan stereotape MRC 105) and *Duelin' Demon Drums* by Richard Campbell and Harry H. Coon (Concertapes Stereo 512), both of which have some pretty silly jungle chanting, yelping, and sound effects, but are redeemed by the vivacity of their virtuoso percussion playing—lighter and more varied in the former, and more energetic and impressive (especially for cross-channel antiphonics) in the latter.

The problem is much simpler, of course, when no pretence is made to any ethnological significance and more or less straight pops materials are frankly treated in novelty styles of various kinds, as they are in the following: Les Baxter's *Ports of Pleasure* (Capitol stereo tape ZC 20, or LP T 868), in which the exoticism is candidly of the film-cartoon or travelogue variety, the playing alternately languishing and bustling, but the sound itself always glittering; Ferrante and Teicher's latest *Soundblast* (Westminster Sonotape SWB 7065, or LP 6041), where four Latin-American tunes are used merely as pegs on which to hang a new display of characteristic prepared-piano and multidubbed sonic tricks; and *The End on Bongos* (HiFiTape R 804, also available in an LP version), in which Jack Burger and his small orchestra, co-starring Colette's flute and Schmidt's marimba with the leader's drums, bring considerable imagination and grace to their "jungly" saucing of vivacious dance materials.

And perhaps in an allied group, since they are frankly pops, if not at all "jungly," are two exuberant stereo tapings of now scarcely exotic native transplantings of European country dances: S. Tereo's *Inside Polka* (Stereotape ST 12) and Harry Zimmerman's *Mr. Z Polkas* (Hi-FiTape R 605). The former program is very dry, crisp, and zestfully sizzling; the latter, while also very dry and crisp, is played with rowdier sauerkraut-band touches, particularly those of Larry Breen's lumbering tuba.

The Realler McCoy's

Less familiar to many listeners and hence more foreign in flavor (although actually they have absorbed American elements) are the traditional dances essential to the festivities following Jewish and Armenian weddings. *Freilach in Hi-Fi*, by Murray Lehrer's Ensemble (Period stereotape PST 5), is a typically strenuous program of ear- and toe-tickling combinations of old-country and New York East-Side-Theater materials, very drily recorded, but performed with immense gusto; *Armenian Wedding*, by Mike Sarkissian's Café Bagdad Ensemble (Audio Fidelity AFLP 1865), features more oriental-sounding solo and choral vocals with a wide variety of curiously wheezing and jangling instruments (unfortunately unidentified in the liner notes). Here the recording is more brilliant, but there is no less indefatigable gusto, and while the American influences probably would be obvious enough to a native Armenian, they are scarcely likely to be recognized by most Yankee listeners.

The Montilla Company already has made so many *zarzuelas* and *jotas* (which themselves blend *flamenco* wildness with politer European salon and theater tunefulness) familiar to American listeners via LP that two of its first stereo-tape releases no longer can strike an entirely fresh note. Yet stereo itself effectively enhances the high-spirited performances of the Madrid Chamber Orchestra under Estela in medleys from Chucua's *Aqua, Azucarillos y Aguardiente* and Chapi's *La Revoltoso* (FMT 1000) and *Jotas, Vol. 2* (FMT 1003), although the latter in particular suffers from overenthusiasm, overintensity, and the regrettable inability of the various composers represented to refrain from stretching their jaunty basic ideas to exhausting lengths.

After hearing many previous records of Spanish dancing, singing, and guitar-playing *La Zambra*, by Reyes, Alvarado, and Sirvent (Audio Fidelity AFLP 1848), seems more authentic than novel, for all its blithe vivacity and glittering recording. I enjoyed much more the refreshing informality of the same record company's *¡Juerga Flamenca!* (AFLP 1852) by a larger ensemble of the same kind, but done as a sort of candid-mike documentary with background chatter,

strumming, and tapping tuning-up, in between the formal selections—which themselves also seem to be much more improvisatory and infectiously light-hearted than most I have heard previously. Certainly they sound as if they were intended as much for the performers' own relish as for that of a nonparticipating concert audience.

Amateurism: Nondescript and Incomparable

There is a little of the same quality in Lori Holland's straightforwardly sung *Scottish Folksongs for Women* (Folkways FG 3517), which includes some fine unfamiliar (notably *The Trees All Iviéd*) as well as often-heard ballads, but Miss Holland's guitar accompaniments seem incongruous and her oddly interesting voice lacks the genuine Highlands burr. Andrew Rowan Summers' American and British folksong program (Folkways FA 2348), however, makes the fatal mistake of introducing sentimental and dramatic expression which has no legitimate interpretative place here. And since Mr. Summers commands



few if any vocal attractions, the only sonic interest I found was in his tinkling mountain-dulcimer accompaniments.

The one program which is outstanding on all counts—unspoiled authenticity, genuinely natural fervor, and faultless recording (for all that it must have been made under "field" conditions)—is the *Mexican Panorama: 200 Years of Folk Songs* (Vanguard VRS 9014), by various soloists and ensembles. This is a companion release to the *¡Mexico, Alta Fidelidad!* (VRS 9009) I praised in the December 1957 SFG, but is more fascinating as well as more varied, even to the point of including some composed songs, which are, however, done in styles quite in keeping with the anonymous and communal materials—the best of which (like the village-church choir's *Alabanza a la Virgen* and the Clemente Sisters' naïve *Dalia Chinita*) are extraordinary documents indeed. And even the most instrumentally minded sound fancier will find much that is aurally intriguing in the primitively squeaky fiddling and more skillful

guitarring, much of it on the highly distinctive little *guitarra de golpe*.

"Un-American?"

When we turn to another, yet not unrelated, category of nationalistic serious or art music, and that of our own native composers in particular, the danger of falsified arrangements is seldom a significant factor. But now the problem of making such works genuinely meaningful is complicated by the comparative lack of those which possess more than merely historical or representative interest—which, old or new, unmistakably reveal the quintessence of the American spirit. These qualities are what I miss most in two otherwise admirable LP documentations: Howard Hanson's resurrections of a Sinfonia in G by the eighteenth-century Moravian-colony composer, Johann Friedrich Peter, and the Second Cello Concerto by Victor Herbert (Mercury MG 50163); and Marjorie Mitchell's recording debut in two major and three minor works by Edward MacDowell (Vanguard VRS 1011).

I enjoyed most old Peter's courtly but high-spirited string quintet, here played with fine sonority by the full string choirs of the Eastman-Rochester Symphony, but the fact that it was actually composed in Pennsylvania is sheer accident; it sounds far more typical of Boccherini or Abel, or even Haydn when he was depending more on his craftsmanship than on original imagination. Herbert's vehicle for his own instrumental virtuosity has even less personality, both in the derivatively romantic music itself and George Miquelle's overly slick performance of the solo part. MacDowell's once-famous Second Piano Concerto and Fourth ("Keltic") Piano Sonata, which many years ago I credited with true greatness and power, now sound merely grandiloquent—obviously rehashings of styles created and best exploited by Grieg and Tchaikovsky. Miss Mitchell's performances are overly cautious and mannered for such even pseudo-heroic stuff; she seems much more at home in three of the schoolgirlish *Woodland Sketches*. The recording itself, however, is excellent, if perhaps not so sumptuous as that of the Hanson disc, and perhaps many listeners will find the music less pretentious and dated than I do.

I can skip cursorily over a batch of recent contemporary-music releases which seem to me even less endowed with any marked character or appeal: Hanson's own emotional *Song of Democracy* (with chorus) and *Elegy*, with his pupil's, Richard Lane's, *Four Songs* with Patricia Berlin on Mercury MG 50150, notable only for the wide dynamic range of its recording; Berlinski's *Symphonic Visions*, Gershevski's *Saugatuck Suite*, and Ballou's *Prelude and Allegro*, con-

Continued on page 47

AUDIOLAB REPORTS

Continued from page 29

ture shows no trace of ringing or oscillation under any conditions of capacitive loading. The amplifier overloads cleanly without collapse of the output wave form or other side effects. With a 3- μ fd capacitive load, the 10-Kc output is 32 w. This is an exceptionally high percentage of the normal output into a resistive load.

There is little point in describing the listening characteristics of the Marantz amplifier. It has none, as one would expect from a virtually distortionless device.

Lest we seem to be praising this equipment excessively (an easy thing to do), we did succeed in finding one minor criticism. The fuse holder is located behind the output tubes, in such a position that it cannot be reached with the tubes in place without burning one's hand. Since a fuse blowing out would probably occur when the amplifier is hot, a waiting period would be in order before replacing it, unless asbestos gloves are on hand. The bias and balancing adjustments are also rather close to the output tubes, as we found to our discomfort on several occasions.

The Marantz amplifier has no gain control, which might be considered a disadvantage in some circumstances. However, having two input sensitivities helps to overcome this objection.

Summary

The Marantz 40-watt power amplifier comes the closest to meeting the requirements of an ideal amplifier of any we have seen. In it, all extraneous material such as distortion and hum have been reduced literally to the vanishing point. Its design suggests that a long life can be expected from tubes and other components, and the built-in metering makes it possible to maintain its original performance with the passage of time. The only price the consumer pays for this is money, since there has apparently been no compromise with quality in its design.

Manufacturer's Comment: We take some pride in the fact that every Marantz amplifier receives 100% inspection and testing before it is released in order to assure our customers that our specifications are adhered to. We have retested this amplifier, Serial No. 2-4728, using our lab standards and confirmed that it measures well within specifications of power and distortion at all stated frequencies.

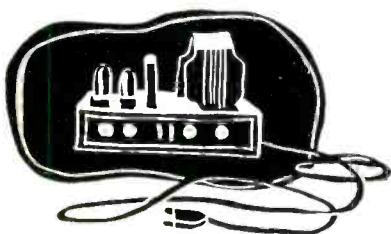

When Converting Your Phono to Stereo...Use

The ERIE AUDIO-AMPLIFIER KIT featuring "PAC" and an ERIE Printed Wiring Board

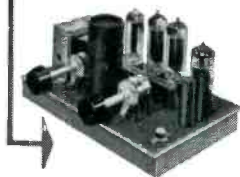
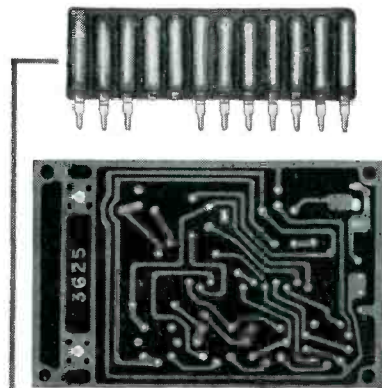

**MODEL
PAC-AMP-1**

See and hear it at
your local distributor
or *Write* for
nearest source.

With these Plug-in Components:

- ERIE "PAC" (Pre-Assembled Components)
- ERIE PRINTED BOARD
- OUTPUT TRANSFORMER
- FILTER CAPACITOR
- VOLUME CONTROL and SWITCH
- TUBE SOCKETS
- CAPACITORS
- TONE CONTROL
- TUBES

SPECIFICATIONS FOR ERIE STANDARD AUDIO-AMPLIFIER

- Frequency Response: 30 cycles to 12,000 cycles ± 0 , -3.5 db.
- Sensitivity: 0.56 volt RMS (input at 1 KC) for 2 watt output.
- Power Output: 2 watts • Input Impedance: 2 megohms.
- Output Impedance: 4 ohms • AC Power Consumption: 17 watts.
- Overall Dimensions: 6 $\frac{1}{8}$ " L x 4 $\frac{1}{16}$ " W x 3 $\frac{7}{8}$ " H • Shipping Weight: 2 lbs.



the most nearly perfect reproduction of bass



AUDIOLAB CUSTOM 16

low frequency loudspeaker

with DYNAMIC BRAKING

Response to 20 cycles; high compliance with 18 cycle cone resonance; special stabilizing domes prevent non-linear cone breakup; cast aluminum frame; plastic foam suspension; 2.5 pound magnet; functions in any enclosure regardless of size or design.

Proper reproduction of complex musical waveforms demands a speaker with minimum transient distortion. Dynamic braking, a specially engineered sensing coil added to the normal voice coil, insures transient distortion so slight in the Custom 16 that cone overshoot and oscillation cannot even be seen on an oscilloscope. Nearly perfect transient response means the finest sound available in any woofer today. Its appearance promises quality, its musical sound IS quality. See and hear the Custom 16 at your hi-fi dealer today, or write for further information.

AUDIOSPEAKER LABORATORIES P. O. Box 1082 Pomona, California

Plant address: 1114 E. Emporia St., Ontario, California

GROMMES KIT REPORT

Continued from page 21

wires, and other components used in the Little Jewel amplifier. While checking the parts list, however, I found that a few substitutions had been made. Although the resistors and capacitors were supplied on cards and identified as R-1, R-2, etc., I decided that it would be wise to check them against the parts list to make sure that I had received all the right values. A couple of substitutions had been made in the capacitors, but I found that they were minor and would not affect the performance of the amplifier. I also found that two ECC83 tubes had been sent in place of the two 12-AX7's that were listed on the parts list. But on the 11th page of the instructions there is a note to the effect that the ECC83 tubes can be used as a substitute for the 12AX7 without affecting the circuit in any way.

Instructions always emphasize the importance of reading and understanding thoroughly all directions before attempting the construction of any kit. I'd like to second this advice. When I first looked at the four pictorial diagrams

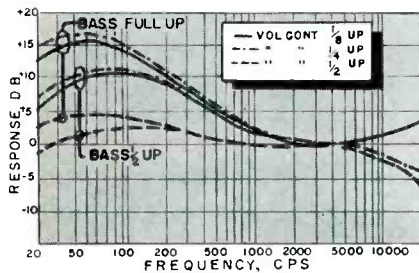

Fig. 6. Bass/volume-control response.

supplied I was sure that I would have no trouble, but as I started actual construction I felt the need to study the diagrams more thoroughly.

That part of the assembly shown in Figure 1 of the directions presented no difficulties. I found, however, that it was necessary to trim some of the leads about 1/2 in. in the second step of the wiring in order to make the angles of the leads correspond to those shown in the diagram. Possibly it would have been all right to use the leads as they were supplied, but because this was my first amplifier I wanted to be extra careful. After studying an actual photograph that was included with the directions, I decided that the wisest thing to do was to cut off the ends of the leads where needed.

Work on the next group of wiring directions was a bit more confusing. None of the wiring done in the first group is shown in the second, and I found myself glancing back and forth between the two in order to be sure that I was supposed to attach a second wire to a particular lug. Figs. 1 and 2 show how the amplifier looked at this point.

Anyone who has done much kit as-

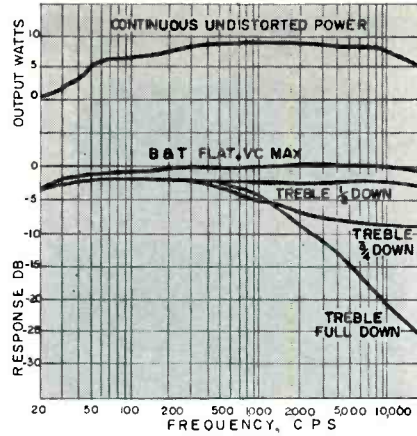

Fig. 7. Power response; treble control.

sembly would not have experienced the confusion I felt in wondering how much of a tail should be left on the ends of the resistors and capacitors. I decided finally that I would not cut off any ends until the resistor or capacitor was actually ready to be soldered in place.

When I came to the final group of wiring directions I was beginning to wonder whether or not there would be room for all the remaining parts. By carefully following the diagram I found that I was able to put all the resistors and capacitors in their proper places without having them conflict with those already there.

A final check of the diagram against the actual unit showed that there were several connections that were not soldered and that the diagrams did not indicate that they should be soldered. I was sure that a solid connection was needed at these points and, therefore, I applied solder in each place. The completely wired amplifier is shown in Figs. 3 and 4.

I was not certain of the reasons for doing many of the things indicated in the directions, but you can imagine my pleasure when the tubes were inserted, the line cord plugged in, the switch turned on, and each and every tube began to glow. With a little assistance the record changer on my radio-phonograph was adapted to make use of the amplifier. What a thrill when I heard the first

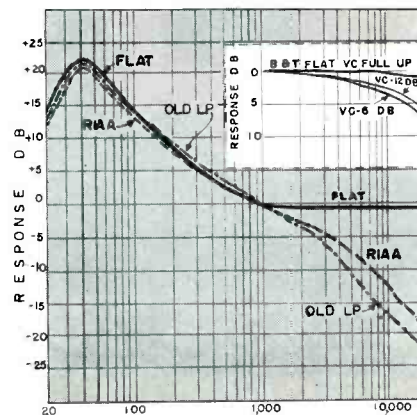

Fig. 8. Phono-channel equalization.

record played with the amplifier that I had actually built with my own hands!

Test Results

Our builder's exercise of caution and attention to detail was rewarded well, for the LJ-6K was in perfect operating condition when she returned it for testing. Results of our tests are shown here.

Fig. 6 represents the action of the bass boost control as interrelated with the volume control. Solid lines are response curves obtained with the volume control turned 1/8 up from its minimum position; the lower solid line, with a maximum of nearly 11 db boost at about 80 cps, is for the bass control turned halfway up; and the upper solid line, with a maximum of 16 db boost at about 45 cps, is for the bass control fully up. Dot-dash and dash lines are for similar bass-control settings at 1/4 and 1/2 rotation of the volume control, respectively. It can be seen that turning down the volume control increases bass boost for any given setting of the bass control. At volume-control positions beyond about 2/3 of the way up from minimum, it is impossible to obtain any significant bass

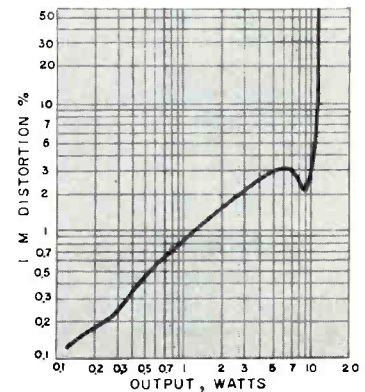

Fig. 9. Intermodulation distortion.

boost no matter how the bass control is adjusted. In addition to reducing the possibility of overloading the amplifier, this action provides for a flexible sort of automatic loudness compensation without the expense and complexity of an extra loudness control. The bass control does not furnish bass cut, however.

The lower part of Fig. 7 shows the action of the treble control, which accomplishes only treble reduction, not boost. Note that the amplifier's frequency response is flat within ± 1 db from 30 to 20,000 cps when the tone controls are set to the indicated flat positions and the volume control is at maximum. The treble-control curves have a pronounced tendency to level off at upper frequencies, which provides more of a balance adjustment than a continuous rolloff.

Maximum continuous undistorted power at various frequencies (as measured by eye on an oscilloscope) is plotted in the upper part of Fig. 7. The curve falls off rapidly below 50 cps; it

could hardly be expected to do otherwise in an amplifier of this price.

Equalization curves for the phono pre-amplifier appear in Fig. 8. Below 1,000 cps all three curves are much alike, and only moderately accurate; note, however, that well over 20 db boost is provided at 40 cps. Above 1,000 cps both the RIAA and Flat curves are just about perfectly accurate, and the Old LP curve is off only 1½ db at 10 Kc.

Also in Fig. 8 is shown the effect of volume-control setting on high frequency response. As usual, the response suffers most when the setting is for 6 db attenuation at middle frequencies; then it is down (relative to 1 Kc) 3.2 db at 10 Kc, and 7.4 db at 20 Kc. At most settings this effect is barely audible, and can be minimized by keeping the control at or below the 12:00 o'clock position, or near maximum setting.

Intermodulation distortion vs. power output of the LJ-6K is plotted in Fig. 9. IM is very low at low operating levels, not reaching the 1% mark until more than a watt. It climbs in almost linear fashion up to 3% at 6 w, decreases to 2.2% at 9 w, and doesn't reach 3% again except at powers above 10 w. Test frequencies were 60 and 7,000 cps mixed in the standard 4:1 ratio. If a higher bass frequency had been chosen, the IM figures would have been substantially lower up to the break point. This points up to the standard weakness of very low-priced amplifiers: the output transformer, which limits the low-frequency power-handling ability.

The LJ-6K is *not*, however, weak in another area in which low-priced amplifiers often suffer, and which may be more important to listening quality: stability. Its low-frequency stability is excellent, and at high frequencies it is very good also. It refused to oscillate or even peak badly with any value of capacitance across a resistive load.

We measured the amplifier's sensitivity at 1 Kc as the input required to produce clipping of the output wave form. On the phono input, this was 4.4 mv; on high-level inputs, 0.74 v. Noise was 35.5 db below maximum output on the RIAA position of the selector switch, and better than 80 db down in the RADIO and TAPE-AUX positions. The noise and hum level was affected quite substantially, incidentally, by the orientation of the line plug in the wall socket. We found that the noise, on a practical listening basis, was insignificant with any but very low-level pickup cartridges.

The sound was very listenable, even with speaker systems of fairly low efficiency, if sound levels were kept reasonably moderate. Within its limitations the LJ-6K is a good, dependable amplifier, with flexibility unique (so far as we know) at its price. No one need hesitate to use it as the basis for a modest hi-fi system.

POWERING 4 OUT OF 5

of the world's
greatest hi-fi
amplifiers

the
Amperex®
6CA7/EL34

HIGH-POWER
OUTPUT PENTODE



No other comparable tube combines to the same degree the 6CA7's exceptional linearity, high power dissipation and low drive-voltage requirements. It is a true pentode design, with a separate suppressor grid that controls the space charge, resulting in greater linearity on reactive speaker loads than is possible with competitive beam-power tetrodes. A single pair of 6CA7's in push-pull has been successfully used in power amplifiers delivering up to 100 watts undistorted output.

Ask your Amperex distributor about Amperex voltage amplifiers, rectifier and output tubes for hi-fi circuits



Amperex
ELECTRONIC CORP.
230 Duffy Avenue
Hicksville, L. I., N. Y.

HI-FI ACCESSORIES

MULTIPLE REMOTE SPEAKER SWITCH

Constant impedance switching device. Simplifies installation of one to six speakers in Hi-Fi or PA system. 42 combinations of operation.

For use with any size speaker and any speaker impedance. Gold embossed plate. MS-6. Complete with simple wiring instructions.

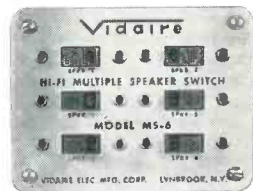

\$2.64
net

HI-FI CROSSOVER NETWORK

High pass filter network permits range of amplifier to be extended by addition of high frequency speaker. Prevents low frequencies from reaching the high frequency speaker, thereby eliminating the major source of distortion in a two speaker system. Universal can be used with 8 ohm or 16 ohm speaker systems. Facilitates the addition of a high frequency speaker. Model CN-5.



\$5.37
net

ORDER FROM YOUR DISTRIBUTOR

Vidaire

ELECTRONICS MANUFACTURING CORP.
BALDWIN • NEW YORK

NOW...enjoy your HI-FI OUTDOORS

PATIO, GARDEN, TERRACE, PORCH

with the new WT-6

ATLAS HI-FI COAX-PROJECTOR

all-weather construction... install it, forget it!...
or take it with you wherever you listen.

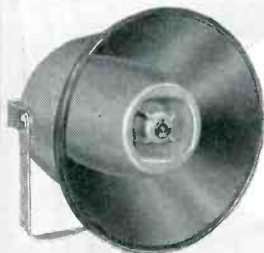

True HIGH FIDELITY TWO-WAY system—not just a "compromise" of two horns coupled to a single diaphragm. The WT-6 comprises a weather-proof cone type driver (with 6-inch throat) coupled to its individual woofer horn; a separate pressure-type driver loaded to its separate tweeter horn. The built-in crossover electronic filter supplements the electro-mechanical frequency-limiting characteristics of the 2 individual reproducers—providing for smooth frequency division as each speaker functions within its engineered range of frequencies.

All-weather... high efficiency... compact... for all indoor and outdoor uses... universally adjustable "U"-type rugged steel mounting... finished in high temperature baked modern beige enamel.

POWER RATING 15 watts continuous
FREQ. RESP. 140-15,000 cps
IMPEDANCE 8 ohms. DISPERSION 120°
DIMENSIONS bell opening 15", overall depth 12"

See the WT-6 at your local distributor. Send for catalog AC-8

ATLAS SOUND CORP.
1449 39th St., Brooklyn 18, N. Y.



TRADERS' MARKETPLACE

Here's the place to buy, swap, or sell audio equipment. Rates are only 20¢ a word (excluding name and address) and your advertisement will reach 20,000 to 35,000 readers. Remittance must accompany copy and insertion instructions.

HI-FI HAVEN, New Jersey's newest and finest sound center. Write for information on unique mail order plan that offers professional advice and low prices. 28 Easton Ave., New Brunswick, N.J.

WANTED: UTC LS-40 Transformer reasonable. Frank S. Levy, 2728 Haverford Place, Charlotte 9, N.C.

LOWEST QUOTES ON HI-FI components, tape recorders, tapes. Write to Dept. A, Professional Hi-Fi, Box 62, Canal St. Station, New York 13, N.Y.

HEAVY 18 cu. ft. infinite baffle enclosure. Reasonable. W. C. Hooks, 406 E. Hammond, Durham, N.C.

TAPE RECORDERS, hi-fi components, tapes. Unusual values. Free catalog. Dressner, 69-02D 174 St., Flushing 65, N.Y.

FISHER 80C Blonde Cabinet \$65.00. Scott 265A \$100.00. Both used less than 30 hours. Stored original boxes. Fisher 90X used. Excellent condition \$125.00. Art Taylor, 31843 Tennessee St., Yucaipa, Calif.

AMPEX 402C half track console. Like new as used in home only. \$500.00. E. J. Henning, M.D., 500 E. 11th Street, Tracy, Calif.

TAPE RECORDERS: hi-fi components, tapes at wholesale prices! Free catalogue Carston, 215-V, E. 88 St., N.Y.C. 28.

GROUNDING EAR

Continued from page 4

credit to some more expensive and bulky machines at twice the operating speed. Distortion at 400 cps at zero VU in my specimen was less than the specified 4% (actually, it was 2%). Wow, flutter, and noise were also up to professional standards. The tape transport was positive in operation and almost impossible to foul up. Strictly as a tape recorder, it is a fine bargain; it would be suitable (and is used) even for hi-fi broadcasting and recording. Not the least remarkable feature is the 2-inch mike which is included in the purchase price and which has a beautiful response all the way out to 13 Kc.

But the stereo version at \$369 is an especially good buy, because it will not only serve as well as any I have tried as the tape source for stereo, but, with the addition only of loudspeakers, can provide excellent stereo sound. Tandberg has built in two notably fine single-ended power amplifiers using EL84's, which deliver 3 w each with less than 1% distortion. There is a pair of excellent compact Tandberg speakers available for \$100 for the pair. I used a pair of AR-2's and found that despite their relative inefficiency, the combination delivered all the stereo sound we could use in our 13- by 20-foot apartment living room. The recorder has a bass-boost switch which provides good loudness compensation at low levels.

The outfit can also be fed into one or a pair of hi-fi amplifiers or control units. These outputs are taken right off the output transformers. I had some doubts about the wisdom of this arrangement before I tried it, but in plain fact the 1

volt needed to drive almost any hi-fi system is delivered at least as well as it would be by a cathode follower, with very low distortion and nearly perfect flatness between 30 and 20,000 cps. Further, the low output impedance of 4 ohms practically eliminates the possibility of hum pickup in the cables and permits the use of very long unshielded cables.

I used the Tandberg with a wide assortment of amplifiers and control units and found it altogether successful with all combinations.

It occurs to me that one of these provides a most convenient means of adding

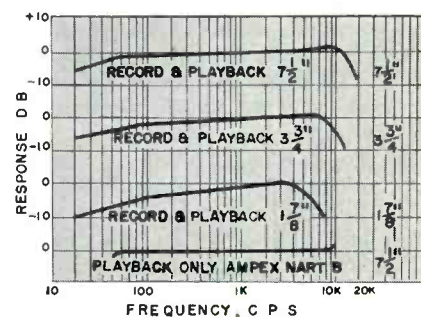

Fig. 3. Single-channel response of Tandberg recorder at three speeds.

tape stereo to a present single-channel system. One channel could be fed into the monophonic system, the other directly into a loudspeaker. Later a standard amplifier-control unit could be added.

Reports I have had from users and from servicemen indicate that the Tandberg is quite trouble-free and easy to service. I am not at all surprised, now that I have used one myself, that a number of FM stations use the Tandberg as the source for their tape stereo programs. In performance it rates with professional units.

TRANSISTORS

Continued from page 31

count for this effect is to modify the equivalent circuit of the transistor by letting the current gain α be dependent on the frequency, dropping off in the way indicated by Fig. 6. The frequency at which it is down to 0.7 of its low-frequency value α_0 is called the *alpha-cutoff frequency* f_{α} , a number which may get as low as 100 Kc in power transistors.

The second physical mechanism is a capacitance associated with the collector junction: the *collector capacitance*. This can be put directly in the usual equivalent circuits as a capacitor.

Small-signal behavior of the transistor for frequencies up to the alpha-cutoff frequency is represented approximately by the equivalent circuit in Fig. 7, which is an extension of the normal low-fre-

quency equivalent circuit given in Part V of this series [April, 1957]. Note that the current gain α is now a function of frequency of the form shown in Fig. 6. Actually, α should have an associated phase shift, but for most audio purposes this can be neglected in using Fig. 7.

Other common equivalent circuits also can be extended to higher frequencies. The most important is the common-emitter *r*-parameter equivalent circuit, which turns out to be Fig. 8, at least approximately. Remember that in getting from Fig. 7 to Fig. 8 in the low-frequency case we had the relations

$$r_d = r_c (1 - \alpha_0) \quad \dots (1)$$

and

$$\beta_0 = \frac{\alpha_0}{1 - \alpha_0} \quad \dots (2)$$

In the high-frequency case we have the additional relation

$$C_d = C_c (\beta_0 + 1) \quad \dots (3)$$

where β_0 is β at low frequencies. In addition, it turns out that β must be con-

LOOKING FOR VALUE?

...in high fidelity



LOOK FOR University

UNIVERSITY LOUDSPEAKERS, INC., WHITE PLAINS, N.Y.

sidered frequency dependent, and in fact can be approximated by the same sort of curve as α (Fig. 6), except that the curve dips down at a lower frequency. The frequency at which the value of β is down to 0.7 of its low-frequency value β_0 is called the *beta-cutoff frequency*, $f_{\alpha e}$, the subscript *e* referring to "common-emitter." This frequency is many times smaller than $f_{\alpha b}$; in fact,

$$f_{\alpha e} = \frac{f_{\alpha b}}{(\beta_0 + 1)} \quad \dots (4)$$

The *b*-parameter equivalent circuits also can be extended to higher frequencies. Common-base and common-emitter equivalent circuits are each modified in the manner shown in Fig. 9, which is the common-base high-frequency equivalent circuit. These modifications are made on the assumption that the current generator is frequency-dependent, and involve the addition of a capacitor in the output circuit. For the common-base circuit, the capacitor to be added is equal to C_c , and the frequency dependence of h_{fb} is identical to that of α .

The common-emitter *b*-parameter equivalent circuit looks just the same as that in Fig. 9, but with the corresponding common-emitter *b*-parameters used instead, and with the value of the capacitor C_d instead of C_c . In addition, h_{fe} must be considered as frequency-dependent in the same way that β is.

Both grounded-base equivalent circuits are valid almost up to the alpha-cutoff frequency $f_{\alpha b}$, while the grounded-emitter equivalent circuits are valid only up to about the beta-cutoff frequency $f_{\alpha e}$.

It is possible to use these equivalent circuits to derive formulas for single-stage gain, input impedance, etc., for high frequencies, but they are not as useful for audio design as are the corresponding low-frequency formulas. The essential information on frequency response can be presented more simply. What is of interest is really the frequency at which the amplifier gain deviates from its low-frequency value.

To be specific, assume that we have a common-emitter stage terminated by a load resistor of value R_L . The frequency at which the stage gain is down to 0.7 of its low-frequency gain (or 3 db) is approximately the lower of these two frequencies:

$$f_{\alpha e} \text{ or } \frac{1}{2\pi C_d R} \quad \dots (5)$$

where

$$R = \frac{r_a R_L}{r_a + R_L} \quad \dots (6)$$

is the equivalent parallel resistance of r_a and R_L .

$$\text{If } f_{\alpha e} \text{ is higher than } \frac{1}{2\pi C_d r_a}$$

then you can improve the frequency response by loading down the output—that is, by lowering R_L . This technique will not raise the frequency response above $f_{\alpha e}$.

For a common-base stage, the same sort of analysis holds. The frequency response does not extend much beyond the lower of these two frequencies:

$$f_{\alpha b} \text{ or } \frac{1}{2\pi C_e R'} \quad \dots (7)$$

where

$$R' = \frac{r_c R_L}{r_c + R_L} \quad \dots (8)$$

is the parallel combination of r_c and R_L . Note that the common-base configuration will give (under proper conditions) frequency response up to $f_{\alpha b}$, whereas the common-emitter stage, with higher gain, is useful only up to about $f_{\alpha e}$.

The equivalent circuits and other analysis for high frequencies given here are only approximate, and do not hold for frequencies higher than the alpha or beta-cutoff frequency. However, since we cannot get a flat frequency response much above these frequencies anyway, there seems to be no point in extending this analysis to higher frequencies, at least for audio purposes.

Normally in low-power transistors the frequency response can be improved by loading down the output. Beta-cutoff frequencies might lie anywhere from 10 Kc to 1 Mc.

In power transistors, however, the beta-cutoff frequency is even lower, and the capacitance C_d higher. The frequency response of power transistors is usually quite bad from a high-fidelity standpoint.

Conclusions

The main types of distortion are nonlinear distortion, comprising both harmonic and intermodulation; and frequency distortion. Nonlinear distortion is caused mainly by variations in current gain and input resistance. Frequency distortion, on the other hand, is caused primarily by the collector capacitance and the slow rate of travel of carriers through the base. The procedures for eliminating each kind of distortion may or may not conflict with the procedures for getting highest gain, best bias stability, and least power drain. The final design of a transistor stage should take all these things into account and should be the "best" compromise to fit each given instance.



ready for STEREOPHONIC records GLASER-STEERS GS-77

With the availability of stereophonic records, the requirements for turntable and record changer quality become more critical than ever before. Yesterday's 'bests' may no longer be good enough. All previously acceptable units must now be re-examined in the light of the new quality demands imposed by stereo.

That the Glaser-Steers GS-77 should be ideally suited for stereo is no mystery. It is simply the result of strict adherence to rigid precision standards, and permitting no compromise in quality. This is evident in every feature of the GS-77.

The Tone Arm, by reason of optimum mass distribution and free pivot suspensions, exhibits no resonance in the audible spectrum. And tracking error is virtually eliminated. In addition, the arm counterbalance is so designed that the stylus pressure between the first and tenth record in a stack does not vary beyond 0.9 gram. These characteristics virtually eliminate vertical rumble (to which stereo is sensitive).

Turntable Pause is an ingenious GS-77 innovation designed for added record protection. During the record-change cycle, the GS-77 turntable comes to a complete halt, and doesn't resume motion until the stylus has come to rest in the lead-groove of the next record. This completely eliminates the grinding action which takes place where records are dropped onto a moving turntable or disc—more important than ever because of the delicate grooves of stereo records.

The GS-77 is the perfect record changer for stereo as it is for conventional monaural high fidelity. Only \$59.50 less cartridge & base.

GLASER-STEERS CORP.
20 Main Street, Belleville 9, N. J.

Please send me complete information on the GS-77.

NAME _____

ADDRESS _____

CITY _____ ZONE _____ STATE _____





who said all brands
of recording tape
are alike?



obviously someone
who has not
tried

irish
BRAND
ferro-sheen



Available wherever quality tape is sold.

TAPE NEWS

Continued from page 37

value which drops the 500-cps output to 1/2 or 1 db below its peak. This might be point D in Fig. 1. Whether the bias is peaked or is set slightly above peak depends on which the user values more: maximum high-frequency response or minimum distortion. On the other hand, whether or not he has any choice in the matter at all depends upon how comprehensive are his recorder's adjustment and alignment facilities. If the recorder is rigged up with a bias control and variable equalizers for record and playback, he can set the machine up any way he pleases, and can, if he feels so inclined, thoroughly mess up its performance, too.

We'll get into specifics next month. For the present, my suggestion is that if you aren't sure of what you're doing, and don't have access to a service manual for your recorder, don't pick at it. It might not be perfectly adjusted, but on the other hand it might be made worse by blind fiddling.

Four-Channel Stereo

I have tried to keep out of the current hassle over RCA's revolutionary four-channel stereo-tape system, but I feel obliged finally to climb off the fence and loose some well-aimed shots at a creeping menace that's been lurking in the background for some time.

I have always felt, and still feel, that tape is potentially a better medium for home music reproduction than discs. Potentially, though, is not necessarily actually, and while tapes *can* be better than discs, the vast majority of commercially produced music tapes are sonically quite inferior to the discs released by the same manufacturers and carrying the same program material. There are some exceptions, of course, but in general the statement is true. Since the discs were made from the same original tapes, we can only assume that the duplicating process is the weak point in commercial tape production, but whatever the cause, most tapes are going to have to improve considerably before they provide any competition for discs. And the new four-channel stereo tape system does *not* appear to be the way of doing this.

At the present state of the art, 3 3/4 ips (which is the speed of the new four-track tapes) is still considered the "speech speed," and is not generally deemed satisfactory for high-quality music reproduction. The choice is going to be between restricted high-frequency range and excessive high-frequency distortion or excessive hiss. Either "solution" is a poor one.

The Editorial in the June issue of *Audiocraft* covered most of the pros and cons of this new tape system—its ability to cut the cost of recorded tapes

PROFESSIONAL DIRECTORY



ENJOY PLEASANT SURPRISES?

write us your hi-fi needs now, you'll be glad you did. Ask too, for our unusual free audio catalog.

KEY ELECTRONICS CO.
120 Liberty St.
N.Y. 6, N.Y.
EVergreen 4-6071

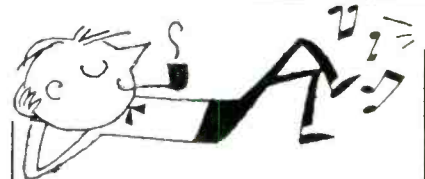

TAPE RECORDERS
EXCEPTIONAL VALUES
HI-FI COMPONENTS
NATIONAL BRANDS
WRITE FOR FREE CATALOGUE
CARSTON 215 VV E. 88 ST.
NEW YORK 28, N.Y.

World Renowned **HARTLEY** Speakers
Now Available to DEALERS, SERVICE-MEN, CUSTOM-INSTALLERS
Lowest Franchise Requirements in the Hi-Fi Industry
WRITE - WIRE - PHONE
HARTLEY PRODUCTS CO.
521 East 162nd Street, New York 51, N. Y.
LUdlow 5-4239

"BUCK STRETCHER" HI-FI VALUES!



Expand the buying power of your Hi-Fi dollar at Sun Radio on new and fully guaranteed name brand Hi-Fi components!

Send for our special price quotations and our Hi-Fi package specials!
Dept. X8
SUN Radio & Electronics Co., Inc.
650 6th Ave., New York 11, N.Y.
Phone: ORegon 5-8600

to a level comparable to discs, its convenience, and its incompatibility. It is my feeling, however, that tapes can never be as easy or as convenient to use as discs (until such time when all music comes to us at the push of a button), and that the future of tapes rests in their ability to sonically outperform discs. I believe that the more we compromise with tape quality, the less chance it has of competing with discs for the approval of the consumer. I do not think it is necessary that tapes be priced competitively with discs; if they are better than discs they can be sold at higher prices. If they are no better, then I don't think any competitive-pricing scheme will sell them.

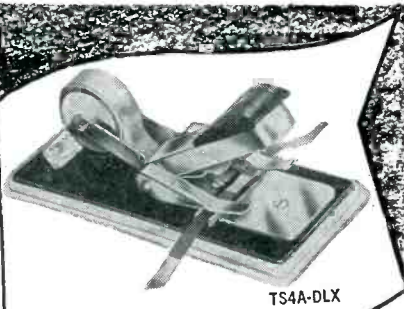

TS4A-DLX

GIBSON GIRL® ... TAPE SPLICERS

Six Models from 1.75 to 55.00

• ROBINS GIBSON GIRL tape splicers assure you of PROFESSIONAL SPLICES IN SECONDS! They are the accepted standard of the professional and industrial users of recording tape because of their ease and reliability of operation and high standards of workmanship. The only splicers which cut and trim the splicing tape and tape edges with an indented trim cut, making THE SPLICE WITH THE GIBSON GIRL SHAPE.

AT DEALERS EVERYWHERE
Write for FREE Catalog of ROBINS' Phono and Tape Accessories!

ROBINS
INDUSTRIES CORP.
FLUSHING 54 · NEW YORK

SOUND FANCIER

Continued from page 39

ducted by Korn and Adler, on Composers' Recordings CRI 115; Fischer's *Hungarian Set*, Nagel's Trumpet Concerto, Chou Wen-Chung's *Landscapes*, and Lessard's Concerto for Woodwinds and String Quartet, conducted by Thor Johnson, on CRI 122; and Ashalomov's *Taking of T'ung Kuan* and Cazden's *Catskills Ballads*, conducted by Buketoff, on CRI 117. However, this last disc is redeemed by the inclusion of Riegger's *Dance Rhythms*, *Romanze*, and *Music for Orchestra*, conducted by Antonini, in which a real and vivid personality shows clearly through even his earlier and less characteristic essays.

Among the Composers' Recordings representations of works in more modern and individual idioms, my attention was better held by Finney's vibrant Sixth String Quartet and Weiss's extremely difficult but oddly gripping Clarinet Trio (CRI 116). And I was delighted to hear again — on CRI 120 — Stokowski's propulsive performance of Goeb's vital and piquant Third Symphony (originally issued on RCA Victor LM 1727), although the present coupling of Weber's *Symphony on Poems of William Blake* (ex LM 1785) still baffles me for all its unmistakable mastery of the twelve-tone technique and its magisterial singing of the baritone solos by Warren Galjour. The first 1958 release (LOU 58-1) in the Louisville Orchestra's subscription series of commissioned works also is of more than routine interest, although for me, less in its episodic if lively Ballet in E by Haieff than in its curious, at times somewhat Orffian, *Symboli Chrestiani* by Nabokov, which is notable both for its robust baritone solos by William Pickett and the composer's lyrically expressive evocation of Early-Christian hymn idioms and Near-Eastern percussive piquancies.

Homespun Yankee Masters

Yet none of these men speak with as distinctively American accents or have as much to say that is worth saying, and as dramatically exciting to hear, as two of their older colleagues, Charles Ives (1874-1954) and George Whitefield

Chadwick (1854-1931). This is a strange coupling, I realize, since Ives generally is considered an eccentric revolutionary and Chadwick, an archconservative, if not an Old Fogy. But you can learn better by listening for yourself to the former's *Three Places in New England* and Third Symphony, and to the latter's *Symphonic Sketches*, as superbly performed by the Eastman-Rochester Symphony under Howard Hanson on a Mercury LP and stereo tape, MG 50149 and MDS 5-24, respectively.

Ives' *Three Places in New England* is perhaps properly considered somewhat eccentric in that it is indeed primitivistic in its impressionistic tone painting, and it certainly is revolutionary enough in its darkening harmonic clashes between two village bands in the second scene "Putnam's Camp." But his Third Symphony is scarcely revolutionary at all (hymn-tune melodic materials have been used by many composers before and since), while it certainly is wondrously taut, intricate, and eloquent music-making — a work which to my mind comes off far more successfully than most of Ives' major compositions, and is an incomparable example of native imagination.

Chadwick's actual idioms are more orthodox, of course, but in these sketches — especially in the heartbreakingly lovely *Noël* and the quite unprofessionally rowdy *Vagrom Ballad* — he transcends entirely his time and schooling. I wrote earlier (May 1957 SFG review of the original LP release of the *Symphonic Sketches* on MG 50104) of my own personal indebtedness to Chadwick; it is enough to say now that the stereo taping reveals still new beauties, depths, and impacts in Hanson's truly magnificent performance. I hope that the Ives Symphony, too, will soon appear in stereo, for, as the Chadwick tape clearly proves, the enormous dynamic range and kaleidoscopic coloring of these Rochester recordings can only be approximated in the single-channel medium, impressive as they do indeed sound in their LP versions. The insatiable sound fancier always demands more — and here, if he has a home stereo system fully adequate to its tremendous task, present-day technology and American musical genius give him that "more" in electrifying superabundance.

COMING NEXT MONTH

- Are Stereo Discs Compatible? by Joel Ehrlich
Results of practical compatibility tests
- Build a Printed-Circuit Oscillator by Thomas Jaski
How to make an etched-circuit board for use
in a wide-range audio oscillator
- The EICO HFT-90 An AUDIOCRAFT kit report
Construction tips on the latest EICO FM tuner
- Audiolab Test Reports Hirsch-Houck Laboratories
Marantz Audio Console; PERI-50 power amplifier

High priced speaker
a must?



Made in England

Not with the new



Coaxial 700 Series Mark III

Here is a speaker that brings you the luxury listening that is higher fidelity; yet its price is unbelievably lower than you would expect for such excellent performance. The new R & A speaker incorporates superb design details and is precision engineered to deliver a rare purity of sound — an experience that invites you to close your eyes and listen, and wonder how such a quality speaker can be offered at so low a price. (We won't tell you how little . . . you must hear the speaker first!)

8", 10" and 12" Models — all with Alcomax III Aniso-tropic Magnet systems of 12,000 Gauss Flux Densities. Buy it . . . try it . . . we back claims with a money back guarantee. At all hi-fi dealers.

ERCON CORPORATION
(Electronic Div.)

16 West 46 St., Dept. 75, New York 36, N. Y.
In Canada: Aural Electric Co. Ltd.
44 Danforth Road, Toronto 13

for everything in hi-fi
GET THE MONEY-SAVING 1958
ALLIED CATALOG

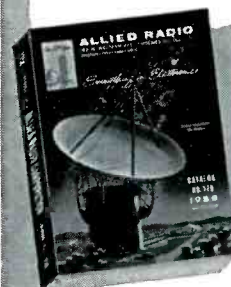

featuring the
world's largest
stocks of systems
& components

free!
SEND FOR IT

Here's your complete money-saving guide to Hi-Fi. Own a fine custom quality Hi-Fi music system at no more than the cost of an ordinary phonograph. See dozens of ALLIED-Recommended complete Hi-Fi systems, plus the world's largest selection of components (amplifiers, tuners, changers, speakers, enclosures and accessories). Want to build-your-own?—see our exclusive Hi-Fi KNIGHT-KITS. For everything in Hi-Fi—for everything in Electronics, get the FREE 1958 ALLIED Catalog.

ALLIED RADIO AMERICA'S
HI-FI CENTER

ALLIED RADIO CORP. Dept. 89-H8
100 N. Western Ave., Chicago 80, Ill.

Send FREE 1958 ALLIED Catalog

Name _____

Address _____

City _____ Zone _____ State _____

New! Years Ahead!



Use it as a Binaural-Stereophonic FM-AM tuner
Use it as a Dual-Monaural FM-AM tuner
Use it as a straight Monaural FM or AM tuner



KT-500 IN KIT FORM
74.50
ONLY 7.45 DOWN
7.00 MONTHLY

LAFAYETTE STEREO TUNER KIT

THE MOST FLEXIBLE TUNER EVER DESIGNED

- Multiflex Output for New Stereo FM
- 11 Tubes (including 4 dual-purpose) + Tuning Eye + Selenium rectifier Provide 17 Tube Performance
- 10KC Whistle Filter • Pre-aligned IF's
- Tuned Cascade FM • 12 Tuned Circuits
- Dual Cathode Follower Output
- Separately Tuned FM and AM Sections
- Armstrong Circuit with FM/AFC and AFC Defeat
- Dual Double-Tuned Transformer Coupled Limiters.

More than a year of research, planning and engineering went into the making of the Lafayette Stereo Tuner. Its unique flexibility permits the reception of binaural broadcasting (simultaneous transmission on both FM and AM), the independent operation of both the FM and AM sections at the same time, and the ordinary reception of either FM or AM. The AM and FM sections are separately tuned, each with a separate 3-gang tuning condenser, separate flywheel tuning and separate volume control for proper balancing when used for binaural programs. Simplified accurate knife-edge tuning is provided by magic eye which operates independently on FM and AM. Automatic frequency control "locks in" FM signal permanently. Aside from its unique flexibility, this is, above all else, a quality high-fidelity tuner incorporating features found exclusively in the highest priced tuners.

FM specifications include grounded-grid triode low noise front end with triode mixer, double-tuned dual limiters with Foster-Seeley discriminator, less than 1% harmonic distortion, frequency response 20-20,000 cps \pm 1/2 db, full 200 kc bandwidth and sensitivity of 2 microvolts for 30 db quieting with full limiting at one microvolt. AM specifications include 3 stages of AVC, 10 kc whistle filter, built-in ferrite loop antenna, less than 1% harmonic distortion, sensitivity of 5 microvolts, 8 kc bandwidth and frequency response 20-5000 cps \pm 3 db.

The 5 controls of the KT-500 are FM Volume, AM Volume, FM Tuning, AM Tuning and 5-position Function Selector Switch. Tastefully styled with gold-brass escutcheon having dark maroon background plus matching maroon knobs with gold inserts. The Lafayette Stereo Tuner was designed with the builder in mind. Two separate printed circuit boards make construction and wiring simple, even for such a complex unit. Complete kit includes all parts and metal cover, a step-by-step instruction manual, schematic and pictorial diagrams. Size is 13 3/4" W x 10 3/4" D x 4 1/2" H. Shpg. wt., 18 lbs.

KT-500 Net **74.50**
LT-50 Same as above, completely factory wired and tested. Net **124.50**

NEW! LAFAYETTE STEREO/MONAUROAL BASIC POWER AMPLIFIER KIT



LT-99
47.50
ONLY 4.75 DOWN -
5.00 MONTHLY

- 36-WATT STEREO AMPLIFIER - 18-WATTS EACH CHANNEL
- FOR OPTIONAL USE AS 36-WATT MONAUROAL AMPLIFIER
- EMPLOYS 4 NEW PREMIUM-TYPE 7189 OUTPUT TUBES
- 2 PRINTED CIRCUIT BOARDS FOR NEAT, SIMPLIFIED WIRING
- RESPONSE BETTER THAN 35-30,000 CPS \pm 1/2 DB AT 18 WATTS
- LESS THAN 1% HARMONIC OR INTERMODULATION DISTORTION

A superbly-performing basic stereo amplifier, in easy-to-build kit form to save you lots of money and let you get into stereo now at minimum expense! Dual inputs are provided, each with individual volume control, and the unit may be used with a stereo preamplifier, for 2-18 watt stereo channels or, at the flick of a switch, as a fine 36-watt monaural amplifier — or, if desired, it may be used as 2 separate monaural 18-watt amplifiers! **CONTROLS** include 2 input volume controls, channel Reverse switch (A-B-B-A), Monaural-Stereo switch, **DUAL OUTPUT IMPEDANCES** are: 4, 8, 16 and 32 ohms (permitting parallel (monaural) operation of 2 speaker systems of up to 16 ohms. **INPUT SENSITIVITY** is 0.45 volts per channel for full output. **TUBES** are 2-6AN8, 4-7189; GZ-34 rectifier. **SIZE** 9-3/16" d (10-9/16" with controls) x 5 1/4" h x 13 1/4" w. Supplied complete with perforated metal cage, all necessary parts and detailed instructions. Shpg. wt., 22 lbs.

KT-310 Stereo Power Amplifier Kit Net **47.50**

LAFAYETTE MASTER AUDIO CONTROL CENTER with BINAURAL CHANNEL AND DUAL VOLUME CONTROL.

- Self-Powered • DC On All Filaments • 24 Positions of Equalization
- Tape Head Input, High Impedance
- Dual Cathode Follower Output Stages

This is not only the finest hi-fi preamp characterized by unmatched features, but it has been functionally designed to keep pace with the conversion of your present hi-fi system to binaural (Stereophonic) sound. Incorporates an extra channel and dual volume control for binaural reproduction. Features include DC on all tube filaments, negative feedback in every stage, dual cathode follower output stages and latest printed circuit construction. Less than 0.09% IM distortion and less than 0.07 harmonic distortion at 1V. Hum and noise level better than 80 db below 3V. Uniformly flat frequency response over entire audible spectrum. 7 inputs for every type of phono, tuner or tape. Tasteful styling, brilliantly executed. Size 12 3/4 x 9 1/8 x 3 3/4". Shpg. wt., 10 1/2 lbs.

KT-300—Lafayette Master Audio Control Kit Complete with cage and detailed assembly instructions. Net **39.50**

LT-30—Same as above completely wired and tested with cage and instruction manual. Net **59.50**

DELUXE 70 WATT BASIC AMPLIFIER

- Conservatively Rated At 70 Watts • Inverse Feedback
- Variable Damping • Metered Balance And Bias Adjust Controls
- Available In Kit and Wired Form

Here's ultra-stability in a 70 watt basic power amplifier employing highest quality components conservatively rated to insure performance and long life. Features matched pair KT 88's and wide range linear Chicago output transformer, variable damping control, meter for bias and balance and gold finish chassis. Frequency response 10-100,000 cps \pm 1 db. Hum and noise 90 db below full output. IM distortion less than 1 1/2% at 70 watts, less than 0.3% below 30 watts. Harmonic distortion less than 2% at 70 watts from 20 to 20,000 cps \pm 1 db. Output impedance 4, 8 and 16 ohms. Handsome decorative cage perforated for proper ventilation. Size 14 1/2 x 10 x 7 3/4" including cage and knobs. Shpg. wt., 40 lbs.

KT-400—Lafayette 70 watt Deluxe Basic Amplifier Kit complete with cage and detailed assembly instructions. Net **69.50**

EA-70—Same as above completely wired and tested with cage and instruction manual. Net **94.50**

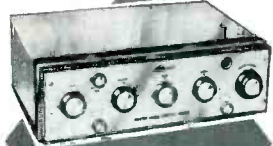

KT-300
39.50
IN KIT FORM

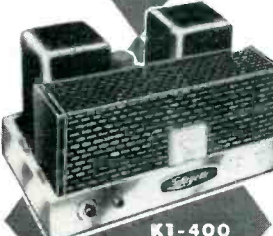

KT-400
69.50
IN KIT FORM

ONLY 6.95 DOWN -
7.00 MONTHLY

ADVERTISING INDEX

Key No.	Advertiser	Page
1	Acoustic Research, Inc.	4
2	Allied Radio Corp.	47
3	Amperex Electronic Corp.	43
4	Atlas Sound Corp.	43
5	Audio Fidelity Records	Back Cover
6	Audiophile's Bookshelf	I
7	Audiospeaker Laboratories	41
8	Carston Studios	46
9	Collaro	Inside Front Cover
10	Dynaco Inc.	37
11	EICO	5
12	Electro-Sonic Laboratories	13
13	Electro-Voice, Inc.	Inside Front Cover, Inside Back Cover
14	Ercona Corp.	47
15	Erie Resistor Corp.	41
16	Fisher Radio Corp.	2
17	Glaser-Steers Corp.	45
18	Grommes	33
19	Hartley Products Co.	46
20	Heath Co.	7-11
21	JansZen	37
22	Key Electronics Co.	46
23	Lafayette Radio	48
24	Lansing, James B., Sound, Inc.	13
21	Neshaminy Electric Co.	37
25	ORRadio Industries, Inc.	46
18	Precision Electronics, Inc.	33
	Professional Directory	46
14	R & A speaker	47
26	Robins Industries Corp.	46
9	Rockbar Corp.	Inside Front Cover
27	Sonotone Corp.	14
28	Sun Radio and Electronics	46
	Traders' Marketplace	44
29	University Loudspeakers, Inc.	44
30	Vidaire Electronic Mfg. Corp.	43

Lafayette Radio

165-08 LIBERTY AVE.
JAMAICA 33, N. Y.
PLEASE INCLUDE POSTAGE WITH ORDER

DEPT AC-H

Information service for **audiocraft** *readers*



We've made it easier than ever for you to secure prompt additional information about products advertised or mentioned editorially in this issue.

HERE'S ALL YOU DO:

1. Tear out one of the two lower cards along its perforated edges.
2. Fill in your name and address in the space provided at the top of the card. Please type, or print in ink, if at all possible.
3. To get additional information about products advertised in this issue, look up the advertiser's name in the index on the page facing this one. In the column at the left will be found the advertiser's current key number. Simply circle this number in the central section of your card. Do this for each advertiser in whose products you are interested.
4. If you want more information about products described in our Audionews department, or mentioned in other editoria sections, print the product names and the numbers of the pages on which they appear in the spaces provided in the lower section of the card.
5. Drop the card in the nearest mail box. We'll do the rest.

Note that two cards are supplied. You can keep one as a spare, for possible later use, or let a friend use the extra card.

Use this service—everything, even the postage, is free. A special service to Audiocraft readers.

THESE CARDS
FOR THIS ISSUE ONLY

Use this service



BUSINESS REPLY CARD

FIRST CLASS PERMIT NO. 62, SEC. 34.9, P. L. & R., GREAT BARRINGTON, MASS.

audiocraft

POST OFFICE BOX 600
GREAT BARRINGTON, MASS.

N 8-8



**AUDIOCRAFT
READERS'
SERVICE**

● PLEASE TYPE OR PRINT ●

NAME
STREET & NO.
CITY ZONE STATE

ADVERTISED PRODUCTS	1	2	3	4	5	6	7	8	9	10	11	12	13	14	15
(See Key Nos. in index on page at left)	16	17	18	19	20	21	22	23	24	25	26	27	28	29	30
	31	32	33	34	35	36	37	38	39	40	41	42	43	44	45
	46	47	48	49	50	51	52	53	54	55	56	57	58	59	60

PRODUCTS MENTIONED EDITORIALY (Including AUDIONEWS)	PRODUCT	PAGE
	PRODUCT	PAGE
	PRODUCT	PAGE
	PRODUCT	PAGE
	PRODUCT	PAGE

**AUDIOCRAFT
READERS'
SERVICE**

● PLEASE TYPE OR PRINT ●

NAME
STREET & NO.
CITY ZONE STATE

ADVERTISED PRODUCTS	1	2	3	4	5	6	7	8	9	10	11	12	13	14	15
(See Key Nos. in index on page at left)	16	17	18	19	20	21	22	23	24	25	26	27	28	29	30
	31	32	33	34	35	36	37	38	39	40	41	42	43	44	45
	46	47	48	49	50	51	52	53	54	55	56	57	58	59	60

PRODUCTS MENTIONED EDITORIALY (Including AUDIONEWS)	PRODUCT	PAGE
	PRODUCT	PAGE
	PRODUCT	PAGE
	PRODUCT	PAGE
	PRODUCT	PAGE

Subscription

SERVICE PAGE

Because we have so many requests for subscription information, we have decided to publish the full subscription story — all in one place — the result being this page. We hope you'll use it.

audiocraft

Great Barrington, Mass.

Please enter my subscription, starting with the next issue, at the **SPECIAL RATE of 3 years for only \$9.00.**

FOREIGN POSTAGE: \$1.00 per year outside the U. S. A., its possessions, and Canada.

- | | |
|---|---|
| <input type="checkbox"/> My remittance is enclosed. | <input type="checkbox"/> I prefer two years for \$7.00. |
| <input type="checkbox"/> Please send me your bill. | <input type="checkbox"/> I prefer one year for \$4.00. |

N 8-8

NAME _____

ADDRESS _____

CITY _____ ZONE _____ STATE _____

- | | |
|--|--|
| <input type="checkbox"/> Gift subscriptions attached. | <input type="checkbox"/> Send me the following back issues:
1 2 3 6 7 8 9 10 11 12 13 14 15 16 17 18
19 20 22 23 24 25 26 27 28 29 30
@ 35¢ each. Payment enclosed. |
| <input type="checkbox"/> Group subscriptions attached. | |



BUSINESS REPLY CARD
FIRST CLASS PERMIT NO. 2, COPAKE FALLS, N.Y.

audiocraft

POST OFFICE BOX 50
COPAKE FALLS, N.Y.

N 8-8



BUSINESS REPLY CARD
FIRST CLASS PERMIT NO. 2, COPAKE FALLS, N.Y.

audiocraft

POST OFFICE BOX 50
COPAKE FALLS, N.Y.

N 8-8

REGULAR SUBSCRIPTION RATES

Three years — Nine Dollars. *Save \$3.60 over the single copy cost.*
Two years — Seven Dollars.
One year — Four Dollars.
(Add \$1.00 per year for postage on all subscriptions sent to addresses outside of the United States, its possessions, and Canada.)

BARGAIN GROUP SUBSCRIPTION RATES

(One-Year Subscriptions Only)
Here's a real saving! Just get together a group of subscriptions and submit them all at one time.
First Subscription — \$4.00.
Each additional subscription — \$3.00.
Send the list to our Circulation Department (and mark it **SPECIAL GROUP SUBSCRIPTION RATE**) with a check or money order in the appropriate amount.

GIFT SUBSCRIPTIONS

You will find that a subscription to AUDIOCRAFT makes the perfect gift for any occasion. If you submit more than one subscription (at the same time), the special group rates shown above will apply. We will acknowledge your gift, to the person receiving it, with a special gift announcement card signed with your name, if you request us to do so.

BACK COPIES

Following back copies available at 35¢ each.

	No. 1 Nov. 1955	No. 2 Dec. 1955	
No. 1956	No. 1957	No. 1958	
3 Jan.	15 Jan.	27 Jan.	
6 Apr.	16 Feb.	28 Feb.	
7 May	17 Mar.	29 Mar.	
8 June	18 Apr.	30 Apr.	
9 July	19 May		
10 Aug.	20 June		
11 Sept.	22 Aug.		
12 Oct.	23 Sept.		
13 Nov.	24 Oct.		
14 Dec.	25 Nov.		
	26 Dec.		

Please circle number on card at upper left and enclose your remittance. Sorry we cannot bill for single copies.

STANFORD'S

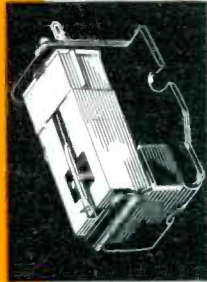

stereo's standard!

Model 505 Stereo Control with dual-channel magnetic adapter

Price \$11.50 Net
Model 504 single magnetic Adapter only

Price \$3.60 Net
Model 21D Stereo Cartridge with Diamond Stylus

Price \$19.50 Net
Model 21S Stereo Cartridge with Sapphire Stylus

Price \$9.90 Net
Model 26DST Stereo Turnover to 78 Monaural, Diamond and Sapphire

Price \$22.50 Net
Model 26ST Stereo Turnover to 78 Monaural, Two Sapphires

Price \$12.90 Net

Good stereo depends on these vital features: Range Response: 20-16,000 cps \pm 2½ db to RIAA; Distortion: Less than 2%; Channel Isolation: 20 db; Vertical Rumble Rejection: 15 db with 5 meg input; Elements: dual ceramic, (lead-zirconium titanate); Weight: 21D 2.4 grams, 26DST 2.6 grams; Tracking Force: 6 grams; Stylus: 21D—standard .7 mil diamond; 26DST—standard .7 mil diamond—standard 3 mil sapphire; Vertical Compliance: 2 x 10⁻⁵ cm/dyne; Lateral Compliance: 2 x 10⁻⁶ cm/dyne; Output: 5 Volt RMS from Westrex standard RIAA Test Record; Capacity: 500 mmfd per element for stereo; 1000 mmfd paralleled for monaural; Mounting: EIA (RETMA) standard ¼" and 7/16" centers; Recommended Amplifier Input Impedance: 5 megohms or higher.

the Electro-Voice totally compatible stereo cartridge

Thousands being installed as original equipment attest to industry acceptance; thousands in use prove its unquestioned superiority for monaural as well as stereo. The E-V Stereo Cartridge uses a .7 mil replaceable stylus and dual high fidelity ceramic elements so essential to the exacting demands of stereo reproduction. Pickup from stray magnetic fields is non-existent, hum and rumble are far below the level of even the most expensive magnetic cartridges, and PZT ceramic elements deliver a precise RIAA curve. The E-V Stereo Cartridges exclusive Rumble Suppressor (pat. pend.) virtually eliminates vertical turntable rumble without degrading full frequency response range of the cartridge... allows you to use it with any turntable or record changer. Totally Compatible... for stereo, it's superb; for monaural... it's superior to even your present cartridge.

THE FIRST STEP TO STEREO. Many fine monaural cartridges are too "stiff" to play stereo records without seriously damaging them; therefore, if you replace your present cartridge with the new E-V Compatible Stereo Cartridge, you may continue playing your present library of LP's plus all the new stereo records monaurally.

THE SECOND STEP TO STEREO. Connect the E-V Stereo Cartridge leads to the 505 Stereo Control Center (net \$11.50). You can then select from "monaural," "stereo," or "channel reverse" for easy balancing. The 505 also converts your magnetic input to high impedance ceramic input, if required. Run one lead to your present high fidelity system, run the second channel lead to a second amplifier (and speaker). NOTE: The E-V Stereo Cartridge is corrected for RIAA curve, doesn't need the equalization of a second preamplifier.

If you do not plan to purchase a second amplifier and speaker now, you can still get stereo by running the second channel lead through the 505 to your radio or TV set phono input. You can improve your system later by simply adding a second amplifier and speaker. Stereo records are available now. Why wait? Enjoy the vivid reality of stereophonic sound today. Whether you're purchasing your first system or converting now, use the Electro-Voice Compatible Stereo Cartridge. See your high fidelity dealer, or write Electro-Voice for free booklet on choosing stereo equipment, and a special Stereo Demonstration Record (\$1.50 prepaid).



Electro-Voice®
ELECTRO-VOICE, INC.
BUCHANAN, MICHIGAN

FOREMOST IN ELECTRO-ACOUSTICS—High Fidelity Loudspeakers and Enclosures for STEREO, Phono-Cartridges, Microphones and Public Address Speakers, Marine Instruments, EVI Professional Electronic Instruments and Military Materials.



ADD-ON STEREO—THE UNIQUE ELECTRO-VOICE CONCEPT THAT ELIMINATES THE NEED FOR A SECOND FULL-RANGE SPEAKER.



AFSD 1833



AFSD 1851



AFSD 1830



AFSD 1877



AFSD 1848



AFSD 1849



AFSD 1857

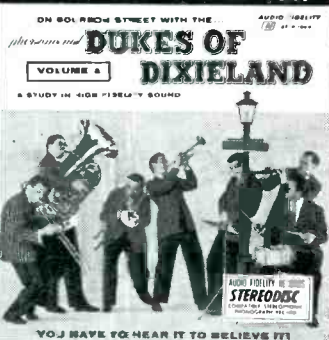

AFSD 1860



AFSD 1835



AFSD 1844



AFSD 1843



AFSD 1825

FIRST
IN QUALITY
FIRST
IN SOUND
FIRST
IN STEREO
AUDIO FIDELITY®
STEREODISC

The record used by an entire industry in developing the stereo cartridge.

\$6.95 each STEREO DISC

Sealed in heavy Polyethylene bag Complete with technical data and information.

Write for FREE Catalog **AUDIO FIDELITY, INC.**

770 Eleventh Avenue, New York 19, N. Y.

*Reg. App. for