

# Exciting New Releases!

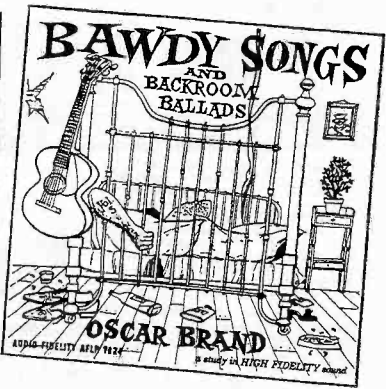


## AUDIO FIDELITY RECORDS

1. The phenomenal **DUKES OF DIXIELAND Vol. 2** — Spontaneity Supreme! The Dukes, and the Duchess, go all out on My Blue Heaven, Mama Don' Low, Sheik of Araby, etc. You have to hear it to believe it! AFLP 1840
2. **ROME WITH LOVE** — Come wander down picturesque streets, past little shops and elegant palaces . . . accompanied by the music of Rome, played by Jo Basile and his accordion. AFLP 1822
3. **TORERO! La Fiesta Brava! Vol. 3**—Another completely new album of Bullfight music played by the Banda Taurina. Luxuriously packaged, complete with 50-pg. illustrated book El Toreo, in English. AFLP 1818
4. **FIESTA EN ESPAÑA** — Flamenco—exciting, hand-clapping, heel-tapping music full of fire, color, passion and desire . . . danced and sung by authentic Flamenquistas. AFLP 1819
5. **HONKY TONK PIANO** — The roaring 20's in Hi-Fi! It's Eddie "Pianola" Barnes at the old upright playing favorites like: Hindustan, My Sister Kate, Little Nelly Kelly, etc. AFLP 1827
6. **RENDEZVOUS A PARIS (Accordion de Paris, Vol. 2)** — A dimly lit bistro . . . a long, soft sigh — and the singing accordion of Jo Basile create the mysterious enchantment for a Rendezvous in Paris. AFLP 1821
7. **LEON BERRY at the GIANT WURLITZER PIPE ORGAN** — A Strauss Waltz . . . a "Pop" tune . . . a Dixieland favorite. An exciting new excursion into the world of Theatre Organ Music. AFLP 1828
8. **CHA CHA CHA** — Pedro Garcia and his Del Prado Orchestra and the bubbling, infectious beat of romantic Latin rhythms. Complete with illustrated dance instructions. AFLP 1810
9. **PLAZA DE TOROS! La Fiesta Brava! Vol. 2** — Another afternoon at the Bullfights with the Banda Taurina. Luxuriously packaged with portfolio of full-color reproductions of Bullfight paintings, ready for framing, by renowned artists. AFLP 1817
10. **BAWDY SONGS and BACKROOM BALLADS Vol. 3** — Gather 'round you lovers of lusty lore . . . Oscar Brand has done it again! A complete new album of spicy musical folklore. AFLP 1824

each 12-in. LP  
\$5.95

WRITE FOR  
FREE CATALOG



NATIONALLY DISTRIBUTED BY  
**DAUNTLESS INTERNATIONAL** 750 TENTH AVENUE • NEW YORK 19, N. Y.

only **LAFAYETTE** can do it!  
**OUR DIRECT IMPORTATIONS**

**YOU SAVE IMPORTERS PROFIT!**

**SAVE 33 1/3-50%**



**LAFAYETTE MATCHED HIGH FIDELITY PHONO SYSTEM**

**NOTHING FINER AT THIS PRICE!**

Reg. Value  
~~158.55~~  
**SALE!**  
**119.50**

NEVER—in the annals of HIGH-FIDELITY has a phono system of this quality—at this price—been offered. A Lafayette "best buy" system designed around the new Lafayette LA-59 amplifier. The performance of this Phono system surpasses the most critical requirements of music lovers. Twenty-four combinations of tone compensation to match varying recording characteristics. This system includes the famous Garrard RC-121 "Renown" 3 speed automatic and manual record changer, LAFAYETTE LA-59 18 watt amplifier with features found only in the most expensive amplifiers, G.E. triple-play—turnover cartridges with genuine G.E. DIAMOND SAPPHIRE STYLI, AND LAFAYETTE SK-58 12" coaxial HI-FI speaker. All units are supplied with plugs, jacks and prepared color-coded interconnecting cables for quick easy installation. For 110-125 volt, 60 cycle AC. Shpg. wt. 50 lbs

HF-154—Complete Phono System.....Net 119.50

**PROFESSIONAL TRANSCRIPTION TURNTABLE AND VISCOUS-DAMPED TONE ARM**  
 THE FINEST TRANSCRIPTION TURNTABLE AND TONE ARM FOR THE PROFESSIONAL USER AND THE AUDIOPHILE



**PK-100A TRANSCRIPTION TURNTABLE**

New 3-speed instrument with built-in stroboscope and viewer for exact speed determination, and magnetic brake for instantaneous speed variation. Precision engineered to meet professional standards for wow, rumble and flutter content. Heavy 12" cast aluminum rim-driven turntable. Variable speed control permits adjustment of each speed within  $\pm 7\%$  using efficient frictionless magnetic brake. Heavy-duty constant speed 4-pole induction motor freely suspended and isolated by shock-mountings to eliminate vibration transference. R-C filter network suppresses "pop" in speaker. Truly a delight for the connoisseur. Size: 13 1/2" x 14" and requires 2 3/4" clearance above and 3 3/4" below motorboard. For 110-130V and 60/50 cycle AC. Power consumption 12 watts. Handsome hammertone gray finish. Shpg. wt., 20 lbs.

PK-100-A .....Net 49.50

**PK-90 VISCOUS-DAMPED TONE ARM**

This transcription arm assures dependable and stable operation, utilizing the "floating action" principle of "viscous-damping." The arm is supported at a single point by a pivot and jewel bearing having negligible friction. Damping is accomplished by a silicone fluid occupying the gap between a ball and socket. This damping control permits high compliance and negligible tracking error, and prevents damage to either record or stylus should the tone arm be accidentally dropped. Low frequency resonance, skidding and groove-jumping are likewise minimized. The tone arm accepts all records up to 16" and accommodates virtually all hi-fi cartridges by means of precisely engineered adapters which simplify installation and provide proper stylus pressure. This tone arm is a quality companion to the PK-100 with matching finish. Shpg. wt., 2 1/2 lbs.

PK-90 .....Net 15.95



**HIGH FREQUENCY TWEETER WITH ACOUSTIC LENS**  
 DIRECT IMPORTATION MAKES THIS PRICE POSSIBLE!

- FREQUENCY RESPONSE FROM 2000 CPS TO BEYOND AUDIBILITY
- LOUVERED ACOUSTIC LENS FOR UNIFORM SOUND DISPERSION
- HANDLES 25 WATTS OF POWER
- PRICED EXCEPTIONALLY LOW

**14.95**

New high frequency tweeter featuring a louvered acoustic lens for uniform sound dispersion and capable of handling up to 25 watts of distortion-free power. The directional tendency of high frequency notes is overcome by the natural wide dispersion angle of the short horn and the acoustic lens which disperses and radiates the high notes smoothly throughout the entire listening area. The lens is detachable for panel mounting, with a separate base for the tweeter furnished for external mounting where desired. Aluminum voice coil has 16 ohms impedance. Size: 4 3/4" long x 3" diameter, lens extends 2 1/2". Requires a crossover network, preferably one with a level control, such as the LN-2. With full instructions. Shpg. wt., 5 lbs.

HW-7 .....Net 14.95



**CROSSOVER NETWORK** • CAPACITIVE-INDUCTIVE NETWORK WITH CROSSOVER AT 2000 CPS • BUILT-IN LEVEL BRILLIANCE CONTROL

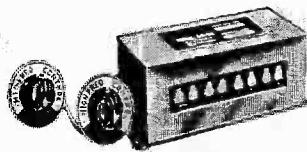
The frequencies above 2000 cycles are channeled to the high frequency tweeter by means of the high-Q inductance and capacitance comprising this efficient crossover network. The highs and lows are brought into acoustic balance by means of a continuously variable level-brilliance control. Control has a 2 1/2 ft. long cable for remote mounting. Network matches 8-16 ohm speakers with insertion loss reduced to a minimum. Enclosed in metal case 6" L x 2 5/8" H x 2 5/8" D. With full instructions. Shpg. wt., 5 lbs.

**8.75**

LN-2 .....Net 8.75

**3 WAY CROSSOVER NETWORK**

Carefully designed and engineered to Lafayette's own specifications. Insertion loss is well below the acceptable minimum. Crossover is at 350 and 5000 cycles. Permits full enjoyment of any 3 way system. Properly balances woofer-mid range speaker and tweeter inputs. Complete with 2 continuously variable "presence" and "brilliance" controls for tonal adjustment and full instructions. 8" L x 3 3/4" H x 2 3/4" W. Shpg. wt., 7 lbs.



LN-3 .....Net 14.95

**METAL-CASED CONE TYPE HI-FI TWEETER**  
 FREQUENCY RESPONSE 2000-16,000 CPS  
 HANDLES 20 WATTS OF POWER

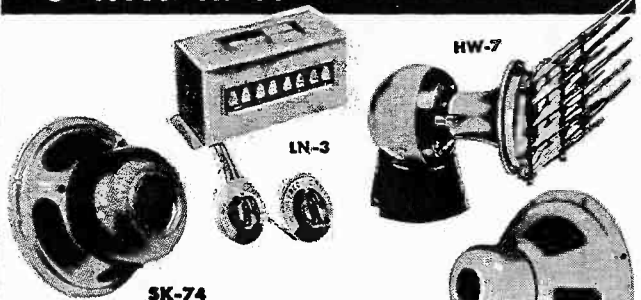
Highest quality cone type high frequency tweeter having a range from 2000 to 16,000 cycles. Especially efficient at higher end of audio spectrum where other cone type tweeters tend to lose clarity and volume. Entirely closed in a metal case with a base so that it can stand by itself or be mounted on a flat surface with mounting bracket supplied. Rated to handle 20 watts of power. A crossover network is required; the Lafayette LN-2 is ideal. Voice coil impedance 8-16 ohms. Size: 3 1/8" x 2 1/8" x 3" Diam. Shpg. wt., 3 lbs.



HK-3 .....Net 5.95

**5.95 Net**

**3 WAY HI-FI SPEAKER SYSTEM**



**55.50**

- 15" Woofer with 31.5 oz Magnet
- 8" Mid-range speaker
- Acoustical Lens Tweeter
- 3-Way Crossover Network

A complete 3-way system capable of performance heretofore found only in systems at many times this price. The components were specially selected by Lafayette sound engineers to offer the maximum in audio fidelity at the lowest price possible. Includes continuously variable presence and brilliance controls. Offers superb reproduction across the entire audio spectrum. Shpg. wt., 25 lbs.

SY93 .....Net 55.50

**LAFAYETTE RADIO**

DEPT. AC-D

JAMAICA 33, N. Y. 165-08 Liberty Ave. Write for FREE Bargain Packed Catalog!

100 SIXTH AVE., NEW YORK, N. Y.  
 BOSTON, MASS., 110 Federal St.  
 PLAINFIELD, N. J., 139 West 2nd St.  
 NEWARK, N. J., 24 Central Ave.  
 BRONX, N. Y., 542 E. Fordham Rd.

# audiocraft



Charles Fowler  
Publisher  
Roy F. Allison  
Editor  
Frank R. Wright  
Managing Editor  
Eleanore B. Wright  
Editorial Assistant  
Roy Lindstrom  
Art Director  
Eleanor Gilchrist  
Art Assistant  
Frances A. Newbury  
Manager, Book Division  
R. D. Darrell  
J. Gordon Holt  
Joseph Marshall  
Contributing Editors  
Claire Eddings  
Advertising Sales Manager  
Warren B. Syer  
Business Manager  
Arthur J. Griffin  
Circulation Manager

THE HOW-TO-DO-IT MAGAZINE OF HOME SOUND REPRODUCTION

APRIL 1957  
Volume 2 Number 4

<b>The Grounded Ear</b> <i>What's new in sound reproduction</i>	<b>4</b>	<i>Joseph Marshall</i>
<b>Audionews</b>	<b>6</b>	
<b>Tips for the Woodcrafter</b> <i>This issue: How to make your own workbench</i>	<b>8</b>	<i>George Bowe</i>
<b>Tape News and Views</b> <i>This issue: Microphone technique IV</i>	<b>10</b>	<i>J. Gordon Holt</i>
<b>Book Reviews</b>	<b>12</b>	<i>Richard D. Keller</i>
<b>Editorial</b>	<b>17</b>	
<b>Readers' Forum</b>	<b>17</b>	
<b>Stephens K-21 Enclosure Kit</b> <i>An AUDIOCRAFT kit report</i>	<b>18</b>	
<b>Optimize Your Amplifier for \$1</b> <i>Get the best you can from your present transformer</i>	<b>21</b>	<i>Norman H. Crowhurst</i>
<b>New Record-Pressing Process</b> <i>How the Microfusion system works</i>	<b>24</b>	
<b>Time-Constant Nomograph</b> <i>Convert RC time constants directly to cutoff frequencies</i>	<b>25</b>	<i>J. Gordon Holt</i>
<b>Transistors in Audio Circuits</b> <i>Part Va: Parameters; equivalent circuits</i>	<b>26</b>	<i>Paul Penfield, Jr.</i>
<b>Home-Built High-Frequency Horn</b> <i>How to make your own straight horn</i>	<b>28</b>	<i>Charles F. Baldwin</i>
<b>Audio Aids</b>	<b>30</b>	
<b>Basic Electronics</b> <i>Chapter XVb: Parallel resonance</i>	<b>32</b>	<i>Roy F. Allison</i>
<b>A Tape Monitor Switch</b> <i>Monitor from tape while you record</i>	<b>34</b>	<i>John J. Stern, M.D.</i>
<b>Sound-Fanciers' Guide</b> <i>Reviews of exceptional disc and tape records</i>	<b>35</b>	<i>R. D. Darrell</i>
<b>Advertising Index</b>	<b>48</b>	

## ADVERTISING

**Main Office** — Claire Eddings, The Publishing House, Great Barrington, Mass. Telephone: Great Barrington 1300.  
**New York** — Frederick H. Wallin, 280 Madison Ave., New York, N.Y. Telephone: Murray Hill 3-4449, 3-4450.  
**Chicago** — John R. Rutherford & Associates, Inc., 230 East Ohio St., Chicago, Ill. Telephone: Whitehall 4-6715.  
**Los Angeles** — Brand & Brand, Inc., 6314 San Vicente Blvd., Los Angeles, Calif. Telephone: Webster 8-3971.

Audiocraft Magazine is published monthly by Audiocom, Inc., in Great Barrington, Mass. Telephone: Great Barrington 1300. Editorial, publication, and circulation offices at: The Publishing House, Great Barrington, Mass. Subscriptions: \$4.00 per year in the United States and Canada. Single copies: 35 cents each. Editorial contributions will be welcomed by the editor. Payment for articles accepted will be arranged prior to publication. Unsolicited manuscripts should be accompanied by return postage. Entered as second-class matter October 1, 1955, at the post office, Great Barrington, Mass., under the act of March 3, 1879. Additional entry at the post office, Pittsfield, Mass. Printed in the U. S. A. by the Ben Franklin Press, Pittsfield, Mass. Copyright 1957 by Audiocom, Inc. The cover design and contents of Audiocraft Magazine are fully protected by copyrights and must not be reproduced in any manner.

# The Grounded Ear



by Joseph Marshall

## EICO Preamplifier Circuit

Even inexpensive high-fidelity amplifiers today have insignificant distortion at normal operating levels; the largest part of the residual distortion is now usually traceable to preceding units—including the preamplifier-control unit. Further, most good amplifiers have extremely wide band widths, far below and far above the audio range. A flat response at normal levels from 10 to 100,000 cps is not at all unusual. It is debatable whether or not such a response in the subsonic and ultrasonic regions has any value except to permit a stable feedback loop; but assuming, as some experts

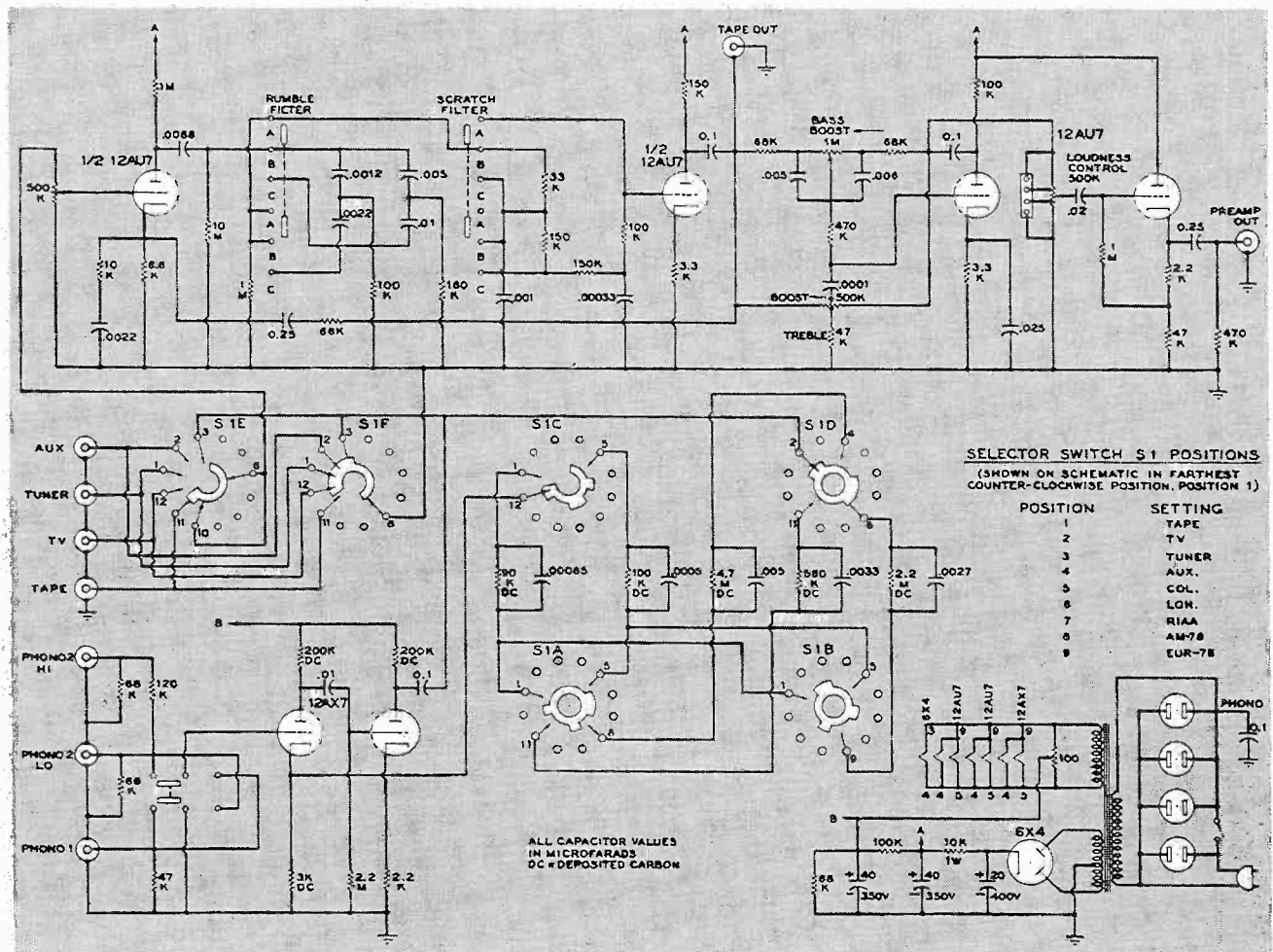
insist, that it does influence audible quality, it is hard to see how this value can be realized if the preamplifier-control unit has a much narrower band width.

The best tool for reducing distortion and expanding band width is negative feedback. A control unit provides several deliberate means for distorting the frequency response (for equalization, loudness control, and perhaps rumble and scratch filters). But a feedback loop around any frequency-discriminating network tends to force flatness of response and therefore to defeat the effect of the frequency control. This has made it difficult to employ feed-

back loops for minimizing control-unit distortion or expanding band width. There is no neater engineering feat than a preamp-control unit that does manage the job. The EICO HF-61 preamplifier, available both in kit and wired form, is a noteworthy example of how it can be done. The schematic diagram is shown in Fig. 1.

EICO's specifications state the response at an output of 3 volts (more than enough to drive any modern amplifier to full output) of 0.3 db from 12 to 50,000 cps and within 1 db from 8 to 100,000 cps. The IM distortion is claimed to be less than 0.2% at an output of 1/2 volt, and 1% at an output

Fig. 1. Circuit of the EICO HF-61 self-powered preamp-control-unit kit. Two switched magnetic phono inputs are supplied.



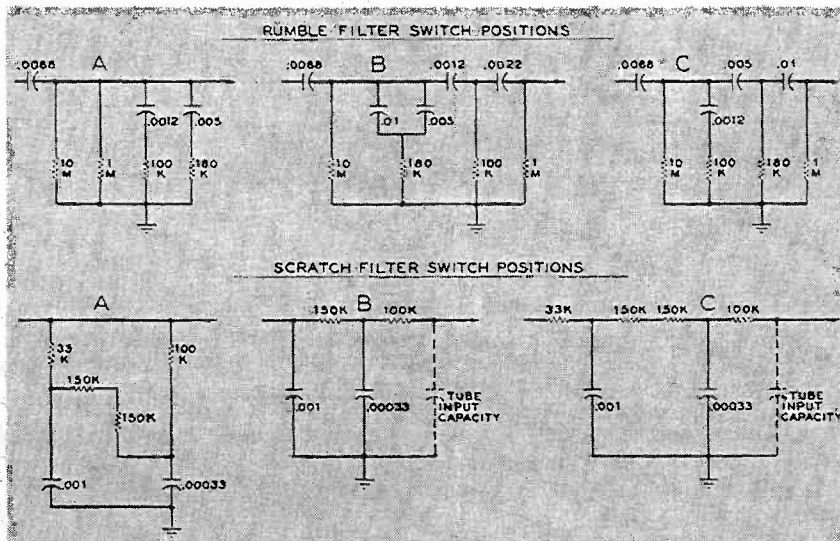


Fig. 2. The filter circuits redrawn. Feedback alters normal cutoff frequencies.

of 5 volts. Harmonic distortion is stated to be under 1% throughout the entire audible range. These specs compare quite favorably with those of typical power amplifiers, and indicate that the use of the preamp with such amplifiers

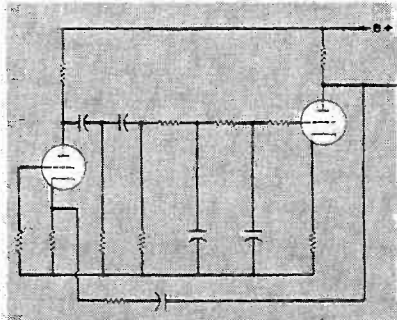


Fig. 3. Simplified version of filters.

would result in little or no deterioration of over-all quality.

The most interesting point, of course, is that these results (as well as some control features found only in the most expensive preamps) are achieved by relatively simple means.

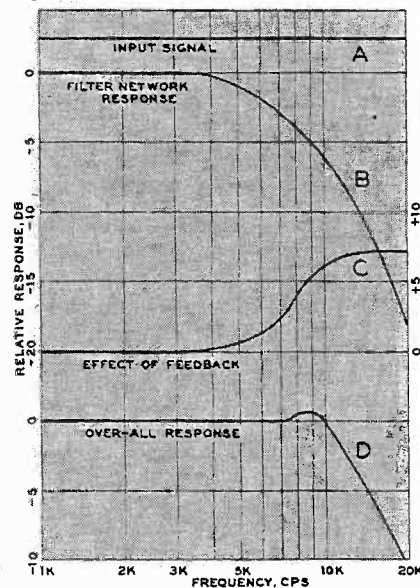
Every stage of the EICO preamp is affected by a feedback loop. There are four loops in all, counting the current feedback of the cathode-follower output stage. The first loop is around the dual-triode phono preamp; it provides equalization for phono-recording curves. The third loop is associated with the Baxendall-type tone-control stage. More unusual, however, is the second loop which goes around both sections of a 12AU7. This dual-triode provides the gain to lift an input signal high enough in level to drive the power amplifier. But it includes also a rumble filter and a high-frequency rolloff filter, each with a choice of two turnover points and an "off" position. Fig. 2 shows these filter circuits in each of their three switch positions.

In Fig. 3 is drawn a simplified representation of this section. The first stage is followed by a cascaded high-pass filter, and then by a cascaded low-pass filter which feeds the second stage. Each filter provides a 12-db-per-octave cutoff slope. A feedback loop is connected from the output of the second stage to the cathode of the first stage. With both filter networks out of the circuit, the feedback loop reduces distortion and increases band width. One would think that, with the filters in, the loop would tend to wash out the equalization and thereby reduce the filtering action. In fact, the loop greatly improves the filtering function.

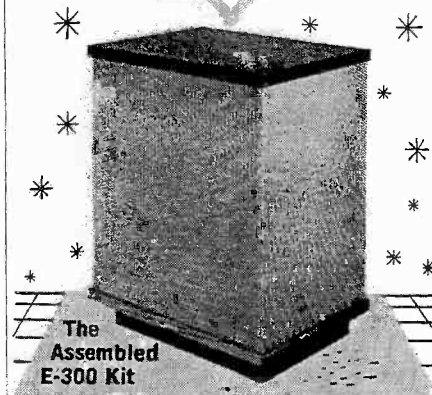
The behavior of this circuit is usually explained in complicated formulas, but it is easily understood in terms of the curves in Fig. 4. Curve A represents the flat input signal. Curve B is the

Continued on page 45

Fig. 4. How feedback sharpens cutoff.



Build with the Best —  
Build with  
**BOZAK**  
Quality  
Loudspeakers  
for  
Sustained Satisfaction



B-209  
Mid-Range Speaker

B-207A Two-Way  
Speaker System



N-10102  
Crossover Network

From the most modest to the largest, all Bozak Speaker Systems are formed from the same Bass, Mid-Range and Treble Speakers. All are unrivalled for realism and listening ease.

For instance: A Bozak B-207A two-way Speaker System and an E-300 Enclosure Kit\* assemble easily into a "Little Giant" that shames many a larger system. Now or later, add a Bozak B-209 Mid-Range and an N-10102 Crossover Network. You can use these same speakers for systematic growth into a Bozak B-305 or B-310.

Whether you assemble it yourself or buy it ready-made, each Bozak Speaker System, in its class, offers

*The Very Best in Sound*

\* — E-300 Kit \$42.50; slightly higher in the Deep South and Far West  
Export: Electronics Manufacturers' Export Co.,  
Hicksville, N.Y.

The R. T. **BOZAK** Sales Co.

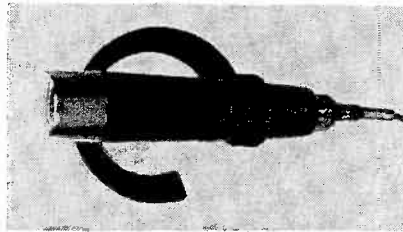
Box 966 • Darien • Connecticut



# Audioneers

## NEW INTERSEARCH ITEMS

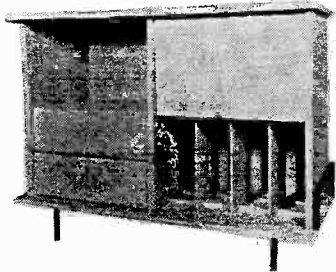
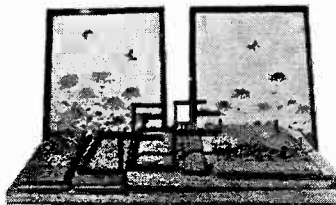
The I/S Sony Model 10, a dynamic microphone, is reported to be capable of smooth frequency response from 50 to 12,000 cps. Impedance of the micro-



*High-impedance hi-fi microphone.*

phone is 10,000 ohms; output level is -62 db (open circuit) at 1,000 cps.

The product is made in Japan by Tokyo Tsushin Kogyo, producers of Sony condenser microphones, Sony Stereocord stereophonic tapes, and the Sony electrostatic pickup. The I/S Sony Model 10 microphone is available



*Prefinished equipment cabinet kit has hand-painted silk sliding door panels.*

through U.S. high-fidelity dealers at \$17.95.

The I/S Model T-1 equipment cabinet is also made in Japan and sold through audio dealers in the United States. The cabinets are prefinished and are sold knocked down. Parts are specially designed and grooved for easy assembly with a screw driver. The sliding door panels are covered with hand-painted silk, and are available in a variety of designs and colors. The legs are fabricated of wrought iron bars. The unit includes a turntable or changer base, and an accessory drawer. Dimensions are 44 in. by 34 in. by 20 in.

The I/S Model T-1 cabinet was designed for Intersearch by Andrew Thul.

## TRANSISTORIZED TAPE RECORDER

The Radio Corporation of America announced recently the commercial availability of a tape recorder incorporating transistors, printed circuitry, and electrodynamic operation.

The SRT-2 magnetic tape recorder is said to cover the audible range from 30 to 15,000 cps. It utilizes all types of standard magnetic tapes in 5- and 7-inch reels, and it can be installed in either vertical or horizontal position. The SRT-2 is a dual speed unit, operating at speeds of 7½ and 3¾ ips, and features a fast forward and rewind speed of 1,200 ft. of tape in 45 seconds. The unit also features a VU-meter recording-level indicator, a device to minimize accidental erasures, an automatic tape lift during fast winding, and a monitor jack for plug-in earphones.

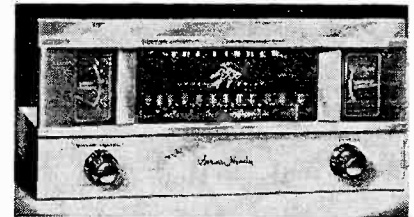
The RCA SRT-2 recorder-reproducer chassis measures 10½ in. high, 19 in. wide, and 8½ in. deep. Weight of the unit is 35 pounds. Price is \$495.

## FISHER FM TUNER

Fisher Radio Corporation has started shipments on its latest FM tuner, the Model FM-90. The FM-90 uses a wide-band detector. Fisher Dynamic Limiters are said to reject completely noise and interference caused by automobile or oil-burner ignition systems and household appliances.

It is reported that the FM-90 offers virtually automatic operation. Once the variable AFC and Interchannel Muting Controls have been adjusted, a slight touch of the station selector locks into each station in turn as the pointer travels across the dial. There are two

meters to aid in tuning; one indicates signal strength and the other shows center of channel. The FM-90 is priced at



*Latest Fisher FM tuner, model FM-90.*

\$149.50, and a mahogany or blond cabinet is available for an additional \$17.95. Prices are slightly higher in the far West.

## NO-SPILL TAPE REEL

The Irish No-Spill Reel, introduced by ORRadio Industries, Inc., utilizes two notches on opposite edges of the reel. By slipping a rubber band over the notches, the tape can be held securely in place. An additional feature of the



*Irish tape now comes on No-Spill Reel.*

new reel is 28 sq. in. of indexing space on the four large flange areas, two on each side of the reel.

All Irish Brand tape on 7-inch reels is now being delivered on the No-Spill Reel at no extra cost.

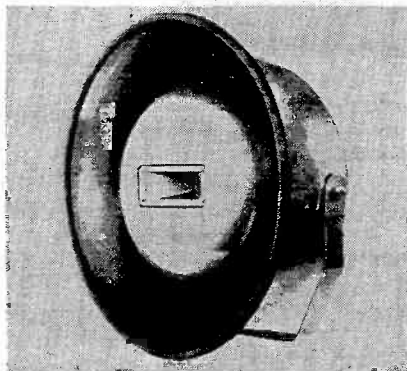
## TWO-WAY WEATHERPROOF SYSTEM

A high-fidelity projector for indoor and outdoor use under all weather conditions has been introduced by the Jensen Manufacturing Company as one of the components in its Professional Series line of loudspeakers.

The HF-100, as the system is called, is designed for use where weatherproof features or unitary form must be combined with high-fidelity performance of music and realistic reproduction of

voice. The unit is a two-way divided system, coaxially arranged to provide the best performance in compact form.

An 8-inch loudspeaker reproduces the frequency range below 2,000 cps. A bridging-type electrical network, along with the electromechanical properties of the speaker units, provides frequency



*New Jensen weatherproof coaxial unit.*

division. All frequencies above 2,000 cps are reproduced by a horn-loaded compression driver h-f unit opening to the front of the projector.

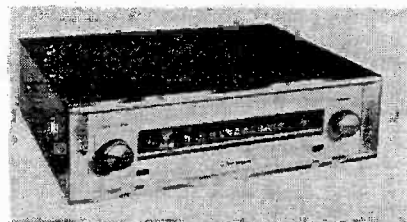
The h-f horn has a 90° fold placing the driver unit at the top of the assembly, thus providing self-draining. It is virtually impossible, according to the manufacturer, for rain, sleet, or snow to reach the driver unit. The l-f unit is moisture proofed; corrosion- and weather-resisting finishes and materials are used throughout. Glass-fiber reinforced plastic inner section and spun-aluminum outer horn also provide mechanical protection.

Further information about the Jensen HF-100 projector will be furnished on request.

### SHERWOOD LINE

Two new units, an FM tuner and a 20-watt amplifier-preamp, have been introduced by Sherwood Electronic Laboratories, Inc.

The FM tuner, the *Model S-3000*, is said to have a sensitivity of 0.95  $\mu\text{v}$  for 20 db quieting. Other features of the



*Sherwood's high-performance FM tuner.*

tuner are a "Feather-Ray" tuning eye for sharp tuning, and a local-distance switch to suppress cross modulation. The S-3000 also has delayed AGC which is reported to reduce intermodulation distortion to below 1½% at 100% modulation. Price of the unit is \$99.50.

The amplifier, *Model S-1000 II*, is a

20-watt Williamson-type unit with a frequency response said to be  $\pm 1/2$  db from 20 to 20,000 cps at 20 watts. Features include six inputs (two with preamp) selectable from the front panel, presence-rise control, tape-head equalization, microphone equalization, feedback tone controls, scratch and rumble filters, and a tape-monitor switch. Intermodulation distortion is said to be 1% at 20 watts. All unused inputs are shorted to prevent crosstalk.

Price of the S-1000 II amplifier-preamp is \$99.50.

Complete data on both the S-3000 tuner and the S-1000 II amplifier-preamp are available upon request.

### NEW E-V SPEAKER CATALOGUE

Electro-Voice, Inc., Buchanan, Michigan, has added Catalogue 118, *How To Choose High-Fidelity Speakers and Components*, to its list of available literature on hi-fi equipment. The new catalogue contains detailed information on building-block kits used to improve an existing hi-fi speaker system. The 118 supplements Catalogue 117, *Guide to High-Fidelity Loudspeaker Systems*. The two catalogues form a complete guide to the selection of speaker systems.

E-V stresses the latest in hi-fi equipment, the building-block kit. If you choose to expand your present system, several choices of kits plus wiring diagrams are presented. A chart shows the proper crossover network to use with your speaker components.

Catalogue Guides 117-118 are available upon request for 25¢ to cover postage and handling.

### PANEL-METER BULLETIN

A new six-page panel-meter bulletin 2057 has been released by the Simpson Electric Company of Chicago.

The new bulletin contains descriptions and specifications, along with latest prices of over 800 models of meters. Meter styles and various types of meter movements are illustrated with photographs, and dimensional drawings are

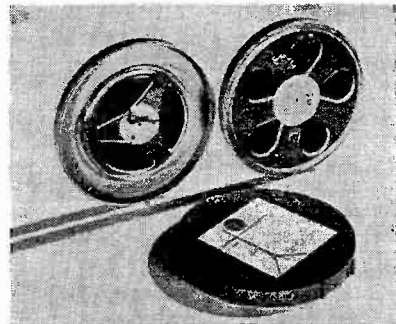
*For more information about any of the products mentioned in Audio-news, we suggest that you make use of the Product Information Cards bound in at the back of the magazine. Simply fill out the card, giving the name of the product in which you're interested, the manufacturer's name, and the page reference. Be sure to put down your name and address too. Send the cards to us and we'll send them along to the manufacturers. Use this service; save postage and the trouble of making individual inquiries to a number of different addresses.*

given for meter mounting. Many typical Simpson meter scales are reproduced in actual size.

This bulletin is available free on request.

### TAPE CONTAINER

A new product of Concertapes, Inc., is the *Stor-A-Tape* container for storing or shipping recorded tape. The Stor-A-Tape is made of high-impact plastic. Its round design matches the tape reel, and a center pin suspends the tape reel inside the container. The Stor-A-Tape accom-



*Stor-A-Tape plastic tape container.*

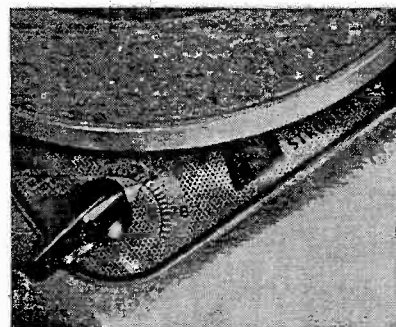
modates all sizes of reel, up to and including 7-inch.

Important for safe storage of tape is the fact that Stor-A-Tape keeps dust out and humidity in. Special labels for storage and shipping are provided with the container.

### STROBESELECTOR

The Califone Corporation has announced the introduction of the *Strobe-selector* variable speed control on many of its 1957 phonographs and sound systems.

The Strobe-selector consists of a full-vision control and a stroboscope window which is illuminated when the phonograph power is on. An arrow indicates the desired speed on a graduated scale which has the standard 16⅓, 33⅓, 45, and 78 rpm printed on it. The Strobe-



*Califone variable-speed strobe device.*

selector shows the stroboscope lines for each of the four speeds plainly marked. When the lines appear motionless, the exact speed is achieved.

Complete details and catalogues of Califone phonographs will be furnished on request.

# TIPS FOR THE WOODCRAFTER

by George Bowe

"I WANT to make myself a home workshop — where do I begin?"

I had gone to the doctor's for an annual checkup, but the stethoscope and sphygmomanometer soon took a back seat for the woodworking vise and lumber-storage rack. It was the doctor who asked the question, and I trust he learned more about a workshop than I did about the state of my health. The truth of the matter is that, once he got me started, he couldn't shut me up.

I think that each man has his own idea of what his workshop should be, and that should be the deciding factor in its creation. The "perfect" workshop is perfect only as it suits the individual who must use it. How big it should be and what it should contain are dictated by the materials to be handled and the work to be done. In the initial planning it is important, too, to allow for expansion of facilities as one's experi-

ence and talents develop. For the person beginning a workshop, here's a rule of thumb that I've found to work pretty well: whatever space is needed to start, allow equally as much for future expansion.

Now, to requote the doctor: "Where do I begin?" The location of the workshop is the initial question and the answer lies in the facilities of the home: basement, attic, garage, extra room, or even a building separated from the house (my own workshop is in a barn). Each location can present a problem — dampness, heat, cold, transmission of noise, lack of light — but these are things that can be overcome with modern methods and materials.

Once the location is decided, sketch a plan of the area on paper, indicating existing doors, windows, electrical outlets, light fixtures, etc. Draw the plan to scale; one-half inch to a foot works

well on standard 8-by-11 bond paper. Decide where the workbench will fit best from the standpoint of natural light and artificial light, and indicate it on the plan. Plot the position of any other existing equipment such as power tools. Plan the location of shelves and storage racks and cabinets against the walls. Allow room in the center of the area so that you'll be able to work on all sides of a project elevated on planks supported by sawhorses. Incidentally, a matching pair of sawhorses is one of the greatest assets of any home workshop. Several boards stretched between the two provide a portable workbench wherever needed, an extra dining table for the house, or an outdoor picnic table for the summer. A few lengths of two-by-four and some sawhorse clamps from your neighborhood hardware store will make your sawhorses a reality.

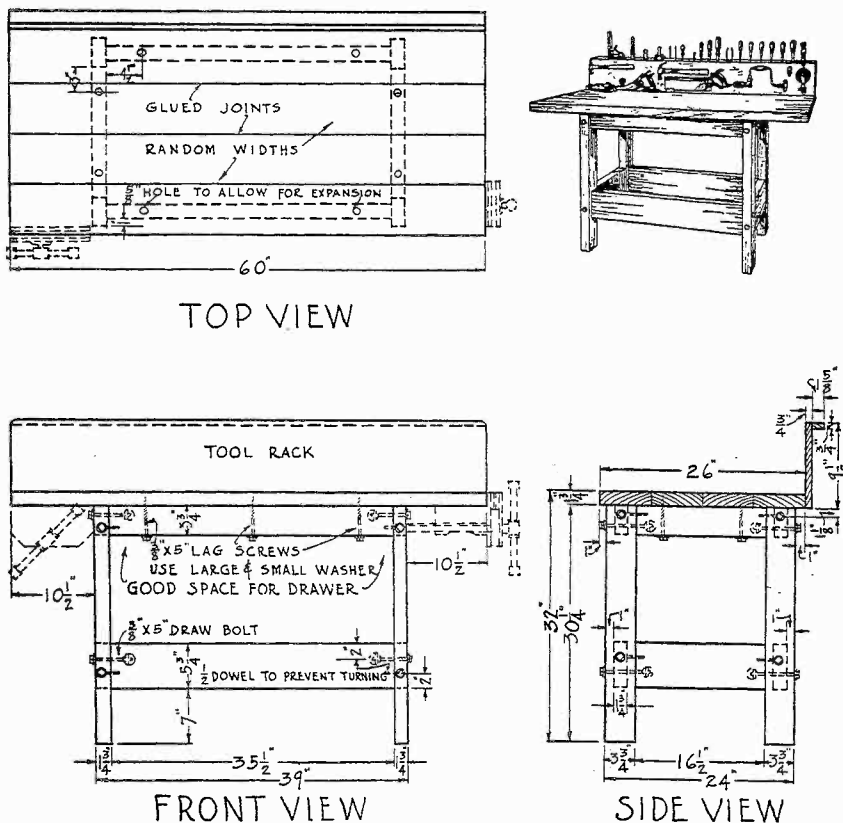
## The Workbench

The heart of a workshop is the workbench (Fig. 1), and many different types of workbenches can be made without a great deal of expense. Rigid construction is of prime importance, as is a hard working surface. The frame (Fig. 2) can be made of fir, pine, or spruce with a top of maple, birch, or other hardwood. An effective alternative top can be made from a sheet of plyscord  $\frac{3}{8}$  in. thick covered with  $\frac{1}{4}$  in. of tempered hardboard. Tempered hardboard will last indefinitely and can be replaced readily if necessary. Nothing smaller than two-by-fours should be used for the legs. Over-all height of the bench should be from 30 to 36 in., depending on the individual who is going to use it; for the average person an over-all height of 32 in. is satisfactory. Nails should never be used in the construction of a workbench — only screws and bolts.

Steel bench legs are available for mounting your own workbench top and shelf. Holes are provided for attaching to top, shelf, or rails. This type of leg will withstand tremendous weight, will always remain rigid, and can be bolted to the floor.

A workbench is not complete without a woodworking vise (Fig. 3). Buy a good one, for it must withstand constant usage. Place it at the left end of the bench to facilitate sawing through stock.

Fig. 1. Plans for a workbench you can make yourself. Tool rack may be omitted.



Courtesy Stanley Tools, division of The Stanley Works



A utility bench vise for handling metals can be mounted at the opposite end of the bench.

Plans for many workbenches provide for a tool rack fastened to the back edge. Unless the bench is especially rigid, the tools will rattle and occasionally shake loose during certain operations. If possible, a tool rack mounted independently will serve to better advantage. Modern peg board, with a variety of holding devices, provides a solid and neat support for all types of tools (Fig. 4). Its flexibility permits changing the arrangement at any time.

Courtesy Stanley Tools, division of The Stanley Works

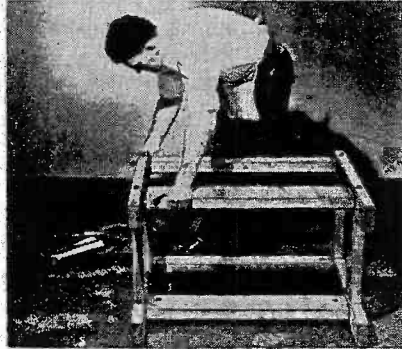


Fig. 2. Frame for workbench in Fig. 1.

Storage cabinets, also, can be bought or built to hold the tools. A good tool arrangement presents a neat appearance and, at the same time, protects the tools. Whatever system of storage is used, the tools should be accessible to the bench or machine where they are to be used. The saving of time and temper is an important factor in workshop operation. As mentioned earlier in regard to shop area, after providing for your present tools, allow as much space again for tools you will be adding in the future.

### Storage of Small Parts

Anyone who has had the experience of looking for bolts, screws, nails, washers, or any other small items will appreciate the convenience of having small parts readily accessible. Among many methods of storage, I have found a set of shallow drawers most convenient when provided with dividers of  $\frac{1}{8}$ -inch plywood arranged as a honeycomb. Small drawers with identifying tabs on the front can also be used.

Convenience is also provided by the "Ferris wheel", which is made by nailing the metal tops of glass jars to the edge of a wooden disc of suitable diameter. Put two nails through the jar tops when you fasten them and they won't turn with the jar. Fill the glass jars with small parts and screw them into the tops. Pivot the disc vertically on a loose-fitting wood screw. Several of these Ferris wheels can be mounted in a workshop, taking up little space and

*Continued on page 40*



ON ONE COMPACT CHASSIS! FISHER FM-AM TUNER, AUDIO CONTROL AND 30-WATT AMPLIFIER!

**New!**

EVERYTHING YOU NEED!  
ON ONE SUPERB CHASSIS!

# THE FISHER "500"

**T**HOUSANDS have asked us for it—and here it is! An extreme-sensitivity FM-AM tuner, a powerful 30-watt amplifier, and a Master Audio Control—all built on one compact chassis. Simply add a record changer and loudspeaker to the FISHER "500" and, as easily as that, you have a complete high fidelity system. Its quality—in the finest FISHER tradition. Its appearance—the timeless beauty of classic simplicity. Here is the most economical form in which you can own FISHER equipment.

Chassis Only, **\$249.50**

Mahogany or Blonde Cabinet, **\$19.95**

### Outstanding Features of THE FISHER "500"

- Extreme sensitivity on FM and AM. Meter for micro-accurate tuning. ■ Full wide-band FM detector for maximum capture ratio. ■ Powerful, 30-watt amplifier; handles 60-watt peaks. ■ Uniform response, 16 to 32,000 cycles. ■ 4 inputs, including separate tape playback preamp-equalizer. ■ 4, 8 and 16-ohm outputs match all existing speakers. ■ Recorder output ahead of volume and tone controls. ■ 7 Controls, including 9-position Channel Selector (AM, FM, AES, RIAA, LP, NAB, TAPE, AUX 1 and AUX 2), Loudness Contour (4-position), Volume, Bass, Treble, AC-Power, Station Selector. ■ Beautiful, die-cast, brushed brass escutcheon and control panel. ■ Pin-point, channel indicator lights. ■ Smooth, flywheel tuning. ■ Largest, easy-to-read, slide-rule dial, with logging scale. ■ High efficiency FM and AM antennas supplied. ■ 14 tubes plus 2 matched germanium diodes. ■ size: 13 7/16" w. x 12 3/4" d. (excluding knobs) x 6 1/4" high.

WRITE TODAY FOR COMPLETE SPECIFICATIONS

**FISHER RADIO CORP., 21-31 44th DRIVE • L. I. CITY • N. Y.**

# T A P E

# N E W S & V I E W S

by J. Gordon Holt

## Microphone Technique IV

The art of using microphones is something that, like riding a bicycle or cooking sukiyaki, can be learned from books and improved with practice. But one thing that remains a problem for even the most advanced recordist is room acoustics. Mike technique can control acoustic properties to some extent, and can modify them to a somewhat lesser extent, but it can't really change them. Nothing short of a full-scale acoustic treatment of an auditorium can make bad acoustics good.

This is one reason, perhaps, why speech recording is so appealing to the recordist who reacts with greater than normal frustration to an impossible acoustical environment; in a good speech recording, ambient acoustic coloration should be absent. True, there are some cases (to be examined later) in which special dramatic effects require reverberation, but in general a speech recording is intended to convey the illusion of someone speaking. Such an illusion is best served if the reproduced voice seems to be in the same room as the listeners. The logical place for said speaker, then, is (no pun intended, really) in the speaker cabinet—not ten feet behind the loudspeaker, or on the other side of a hole in the wall.

This may at first seem to be splitting hairs, but in truth there is a definite distinction to be drawn between the speaker in the room and the speaker in another room. The distinction is one of intent and appropriateness, and it is perhaps best shown by an example. Consider for a moment someone reciting the *Rubaiyat of Omar Khayyam*. Should the voice seem to be right in the room with us, or should it seem to be in another room? It depends. If we are trying to convey the idea that our Persian orator is addressing us from the Caliph's chamber, or from within the marble walls of a palace, then we don't want to hear his voice as though he were standing on the parlor rug, midway between the TV set and the Thermopane picture window. He should seem to be in another room behind the loudspeaker cabinet, which means that he should be miked from a distance of several feet. The distant miking will add reverberation to the

sound, and if we can make the recording in a room whose acoustics sound like those of a Caliph's chamber (soft, fairly subdued echo) or a palace throne room (hollow, rather harsh, and rolling echo), we will add to the voice the sonic flavor needed to complete the illusion of realism.

However, let's say that we don't wish to produce the effect of someone speaking the *Rubaiyat* in a certain place, but only to record a recitation of it for appreciation on its own merits. The voice will then be only a medium for expression, and the *act* of speaking will lose its significance. The voice should be heard as though it were right in the listening room, emanating directly from the loudspeaker cabinet, and it should have no flavor of "the other room". This means it will have to be very closely miked, so the echo in the recording studio will be completely overridden by the voice. By the same token, the acoustics can be ignored. It doesn't mat-

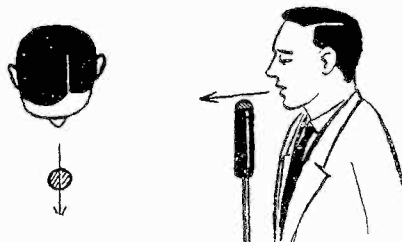


Fig. 1. Using mike properly for speech.

ter if the echo is hard, soft, dead, or live—it won't be audible to the listener. Ergo, it ceases to be an annoyance to the recordist.

This background-suppression effect of ultraclose microphoning is the sole reason that radio and TV sportscasters always seem to be trying to swallow their microphones. By getting as close as possible, they can make themselves heard above the din of 20,000 hysterical ball fans or a football cheering section with megaphones, brass band, and two Napoleonic cannons firing smoke bombs. There are several good reasons, though, why the sportscaster technique is not deemed advisable for home recording. To begin with, it is hard on the microphone, and is likely to ruin anything as fragile as a ribbon mike. Second, it is unnecessary; the home recordist does not have to fight against the high

background-noise levels of a sporting event. And finally, it doesn't give the best results.

A voice can be reproduced well with a narrower frequency response than is necessary for music reproduction, but the ultimate in realism is obtained only when the same high standards are applied to both. A microphone that reproduces music well will reproduce speech very well, but close placement of a quality microphone engenders a few of its own unique problems, all of which can be overcome. Unless some precautions are taken, a close-miked speech taping is likely to exhibit accentuated sibilants, blasting (from the shock waves of explosive consonants like "p" and "b"), and sometimes accentuated bass.

So we must perforce resort to trickery. First, let's see what constitutes close miking for speech. This is, as usual, related to the microphone's pickup pattern, and while an omnidirectional mike will give a close-to sound at distances from 3 in. to 1 ft., a unidirectional mike will seem to be the same distance away when used at from 1 to 3 ft. Blast effects are troublesome only at distances of less than a foot, so a unidirectional mike will solve this problem without further ado. Yet it may still produce overly sibilant sound.

Most microphones exhibit maximum high-frequency response to those sounds arriving perpendicular to their diaphragms and begin to lose highs as soon as the mike is turned to one side. We can reduce sibilance by directing the microphone slightly to one side or the other of the speaker's face.

Sibilance and blasting can be simultaneously minimized by speaking *across* the face of the mike, as shown in Fig. 1, rather than straight into it, but this should be necessary only with omnidirectional or bidirectional mikes (which might be used at distances of less than a foot). Bass accentuation at close quarters is not a characteristic of pressure-sensitive microphones, but it can be quite severe with velocity types. Some velocity mikes have a voice-music switch that enables bass to be reduced, while a few others come with felt baffle strips that can be installed inside the case for the same purpose. If neither is provided, then turning the mike to one

side will help matters appreciably (as would feeding it through a control unit set for bass cut, or using it at distances of over a foot).

Before we get specific, let's generalize for a moment on the subject of speech mike technique. While these suggestions pertain mainly to close miking, some are equally applicable to any situation in which a voice is being picked up, closely miked or otherwise.

First, don't touch the microphone. While it is not unusual to see nightclub singers and news commentators clutching the microphone like a favored dance partner, this sort of familiarity causes mysterious background noises that will be puzzling if not downright annoying to listeners who can't figure out what they are.

Second, learn to vary your mike position when you vary the volume of your voice. If you feel an emphatic shout coming on, back away from the mike or (if it is dead at the sides) lean to one side of it. Conversely, when whispering, get as close to the mike as is possible without incurring blasting. A softly whispered voice, recorded about 3 in. from the mike, can sound hair-raising. (This is getting into the realm of "special effects".)

Third, if you use a script, don't fidget with the corners of the sheets while talking. Hold them in one hand or let them lie in front of you with their bottom edges hanging over the edge of the desk. This way the top sheet may be lifted out of the way without scraping across the one underneath.

Fourth, never, under any circumstances, sneeze into a microphone. This will almost certainly damage a ribbon microphone, and may even magnetize the record head on the recorder. Address coughs, sneezes, and such incidental sounds to the space behind you or under the desk.

Fifth, if you're ad-libbing, it's better to punctuate the recording with dead spaces than to fill these with "ers" and "ahs".

So much for the voice in the living-room corner. The voice in the other room, or any combination of voices that are supposed to be somewhere in particular rather than right in front of you, come under the broad category of dramatic effects, with acoustics.

Echo is important in dramatic productions because of the more distant mike technique that is required, and because echo must be audible to give the effect of the "other room" where the action takes place. Dramatic shows, plays, and so on are, more often than not, set in somebody's living room; it just happens that the acoustics of an average room will be fine for recording. It should be reiterated, though, that the recording should not be made in the

*Continued on page 47*




THE "Californian" SPEAKER ENCLOSURES  
NOW IN KITS

The best engineered speaker cabinet we've ever built. Combines the new Jensen Bass Ultraflex\* principle for improved tone plus long wearing St. Regis Panelite top for lasting beauty.

Jensen's new Ultraflex principle provides the newest assistance for low notes giving unbelievable richness of tone without booming and without damping the highs. Space for tweeter, if desired.

The wood appearance of the St. Regis Panelite top has the grain and color sealed in. It resists scratches, scuffing, cigarette burns, fruit acids, alcohol.

The "Californian" enclosures are available two ways—as regular factory built cabinets, or in easy-to-assemble pre-finished kits. Top and bottom of kits are all finished—no painting, varnishing, sanding or covering required.

AVAILABLE TWO WAYS	FACTORY BUILT	PRE-FINISHED KITS	 <b>Argos</b> PRODUCTS COMPANY 310 MAIN STREET • GENOA, ILLINOIS <i>Craftsmanship in Cabinets</i>
The Californian... 24x29x15 inches deep For 12" or 15" speaker AUDIOPHILE NET	DSE-1 \$52.50	DSE-1K \$37.50	
The Californian Jr.... 19½x23½x13½ in. deep For 8" or 12" speaker AUDIOPHILE NET	DSE-2 \$42.00	DSE-2K \$30.00	
Blonde or Mahogany Finish, same price *TM of and Lic. by Jensen Mfg. Co.			

Ask your Parts Distributor or write Dept. A for FREE Catalog

by RICHARD D. KELLER

# book reviews



## Transistor Techniques

Pub. by Gernsback Library, Inc., New York; 96 pages; price \$1.50; paper bound.

This is a collection of material which originally appeared in *Radio-Electronics* magazine. It is evidently intended to give the home experimenter a "feeling" for the use of junction transistors.

The first half of the book is concerned with transistor techniques. Various simple methods are described for testing and measuring parameters such as Beta (the important current-amplifying parameter) and  $I_{c0}$  (the detrimental leakage, or back-current, value). A discussion on determining unmarked transistor types, the protection of units in experimental circuits, the stabilization of circuits, and brief introductions to tetrodes and power transistors are included.

The second half of the book deals with applications, with four chapters covering oscillators, multivibrators, DC transformers, an auto-light control (for automatically turning on headlights when darkness approaches, *not* for automatic dimming at night), and a portable geiger counter using three transistors, a Geiger-Muller tube, a diode, and several flashlight batteries. There are no audio applications or circuits as such.

In summary, this book may be of some use to experimenters, particularly those interested in simple circuits apart from audio.

## High Fidelity: The Why and How For Amateurs

G. A. Briggs; pub. by Wharfedale Wireless Works, Ltd., Bradford, England; 188 pages; \$2.95.

As its title implies, this is a nontechnical book intended for amateurs. However, it will probably repeat the success of the author's other publications, *Loudspeakers* and *Sound Reproduction*, because of its touches of warm and ingratiating humor and the enjoyable manner in which technical information is presented throughout.

The chapters on amplifiers, records and recording, and stylus wear should be of special interest to engineers too, for they are well illustrated with oscillograms of amplifier and speaker response under varying conditions, and photomicrographs of record grooves in various states and conditions of wear.

There are interesting accounts of the several concert-hall demonstrations given by the author at Carnegie Hall, the Royal Festival Hall, and at other halls in both the United States and England. Hints and tips for such demonstrations are included, along with recommendations for suitable records and listings of power levels necessary to re-create live performances when making such A-B tests. (Why high powers for the home?, he asks. 10 watts in a home matches the sound intensity of the loudest tug-boat or organ sounds which were played at the huge Royal Festival Hall in London. An interesting contention.)

As a final word, in comparing some of the prices mentioned, it would help to know that the pound (£) is now worth \$2.80, the shilling (s) is 14¢ and the penny (d) is 1¢. This book is well worth its price.

## Hi Fi From Microphone to Ear

G. Slot; pub. by Philips Technical Library, Eindhoven, Holland; 180 pages; price \$2.75; paper bound.

It is always interesting to see what nations across the seas are doing in fields in which we are interested. This book shows the trends and the thinking on high fidelity going on in one of Europe's largest electronic concerns, the Philips Company of Holland. Although written expressly for the nontechnical reader, this tightly packed work contains a great deal of technical information.

Detailed accounts are given of record making, phonograph pickups, tracking, tracing distortions, turntable rumble, changer mechanisms, amplifier designs using Philips tubes (EL 81, etc.), loudspeakers and enclosures, tape recorders, and microphone arrangement; complete

explanations of a large number of Philips components such as record changers, crystal pickups, amplifiers, loudspeakers, and so forth, are included.

This book may be ordered from the Philips Technical Library, Eindhoven, Holland, postage free, if it is not available locally.

## Easy Ways to Expert Woodworking

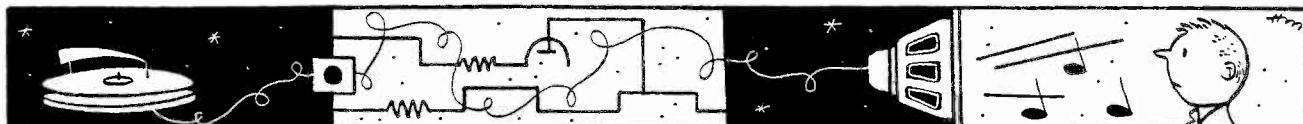
Robert Scharff; pub. by McGraw-Hill Book Co., Inc., New York; 186 pages; price \$3.95.

Most audiophiles have discovered that sound reproduction requires not only a fine amplifier, pickup, and loudspeaker, but also proper baffling for the loudspeaker. Moreover, since the lady of the house may object to having exposed amplifiers and wires in her well-ordered living room, a proper enclosure for equipment may be required. With strained budgets and an acquired familiarity with soldering irons and schematic diagrams, many hobbyists have also developed talents with saws, screws, and stains. Here is a well-illustrated book written by an expert to help do that part of the job right.

The greater part of the book tells "how to do it" with the rather ingenious AMF DeWalt radial-arm power-saw equipment. This machine simulates all the motions of the human arm in that it can swing to any angle, and allows the cutting tool to swivel in any direction, vertical or horizontal, working from the top of the material for safety and accuracy. Fully illustrated explanations for using the shaping, jointing, sanding, grinding, buffing, polishing, and drilling attachments are also given.

In addition to the information on power equipment, excellent chapters on shop safety, wood buying, woodworking and fastening techniques, and wood finishing are included.

Anybody who plans to do all his own cabinetry work will find this a very helpful book, even if he does not own the specific power equipment described.



"We're building a  
**HEATHKIT<sup>®</sup>**...

BECAUSE IT'S SUCH GREAT FUN... AND BECAUSE WE GET SO MUCH MORE FOR OUR MONEY!"

Every day more and more people (just like you) are finding out why it's smart to "do-it-yourself" and save by building HEATHKIT high fidelity components. These people have discovered that they get high-quality electronic equipment at approximately one-half the usual cost by dealing directly with the manufacturer, and by doing their own assembly work. It's real fun—and it's real easy too! You don't need a fancy work shop, special tools or special knowledge to put a Heathkit together. You just assemble the individual parts according to complete step-by-step instructions and large picture-diagrams. Anyone can do it!

**Heathkit Model SS-1 Speaker System Kit**

This high fidelity speaker system is designed to operate by itself, or with the range extending unit listed below. It covers the frequency range of 50 to 12,000 CPS within  $\pm 5$  db. Two high-quality Jensen speakers are employed. Impedance is 16 ohms, and power rating is 25 watts. Can be built in just one evening. **\$39<sup>95</sup>**  
Shpg. Wt. 30 lbs.

**Heathkit Model SS-1B Speaker System Kit**

This high fidelity speaker system kit extends the range of the model SS-1 described above. It employs a 15" woofer and a super-tweeter to provide additional bass and treble response. Combined frequency response of both speaker systems is  $\pm 5$  db from 35 to 16,000 CPS. Impedance is 16 ohms, and power is 35 watts. Attractive styling matches SS-1. Shpg. Wt. **\$99<sup>95</sup>**  
80 lbs.

**HEATHKIT**

**"LEGATO" SPEAKER SYSTEM KIT**

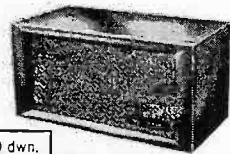
Months of painstaking engineering by Heath and Altec-Lansing engineers has culminated in the design of the Legato, featuring "CP" (critical phasing) and "LB" (level balance). The result is a *new kind* of high fidelity sound, to satisfy even the most critical audio requirements. Two high-quality 15" theater-type speakers and a high-frequency driver with sectoral horn combine to cover 25 to 20,000 cycles without peaks or valleys. "CP" and "LB" assure you of the smooth, flat audio response so essential to faithful reproduction. Choice of two beautiful cabinet styles below.

**"Legato" Traditional Model HH-1-T**

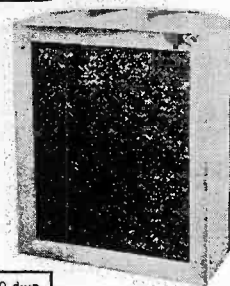
Styled in classic lines to blend with period furniture of all types. Doors attractively paneled. African mahogany for dark finishes unless you specify imported white birch for light finishes. Shpg. Wt. 246 lbs. **\$345<sup>00</sup>**

**"Legato" Contemporary Model HH-1-C**

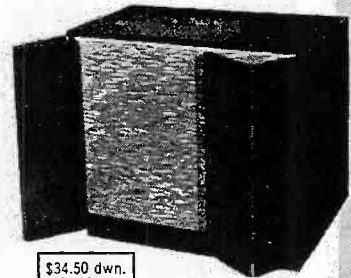
This fine cabinet features straightforward design to blend with your modern furnishings. Slim, tapered struts run vertically across the grille cloth to produce a strikingly attractive shadowline. Wood parts are precut and predrilled for simple assembly. Supplied in African mahogany for dark finishes unless you specify imported white birch for light finishes. Shpg. Wt. **\$325<sup>00</sup>**  
231 lbs.



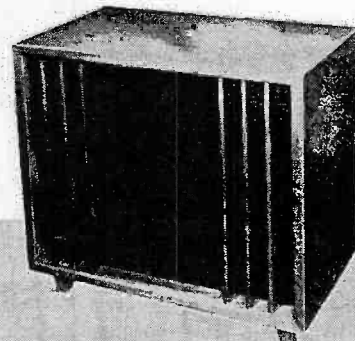
\$4.00 dwn.  
\$3.36 mo.



\$10.00 dwn.  
\$8.40 mo.



\$34.50 dwn.  
\$28.98 mo.



\$32.50 dwn.  
\$27.30 mo.



**HEATH COMPANY**

A Subsidiary of Daystrom, Inc.

BENTON HARBOR 18, MICHIGAN

# Make yours a **HEATHKIT**<sup>®</sup>

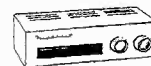
**It's Easy (and fun) to Plan Your Own Hi-Fi Installation  
By Choosing the Heathkit Components  
That Best Suit Your Particular Needs.**

As the world's largest manufacturer of electronic equipment in kit form, Heath Company can provide you with a maximum variety of units from which to choose. You can select just the amplifier you need from five different models, ranging in power from 7 watts to 25 watts, some with preamplifiers, and some requiring a separate preamplifier. You can pick your speaker system from four outstanding high fidelity units ranging in price from only \$39.95 to \$345.00. You can even select a fine Heathkit FM or AM Tuner! Should there be a question in your mind about the requirements of an audio system, or about planning your particular hi-fi installation, don't hesitate to contact us. We will be pleased to assist you.



### MATCHING CABINETS . . .

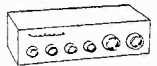
The Heath AM Tuner, FM Tuner and Preamplifier are housed in matching satin-gold finished cabinets to blend with any room decorating scheme. Can be stacked one over the other to create a central control unit for the complete high fidelity system.



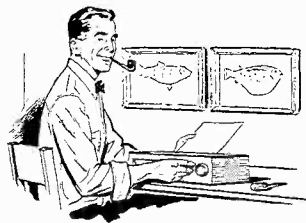
MODEL FM-3A



MODEL BC-1



MODEL WA-P2



### PRE-ALIGNED TUNERS . . .

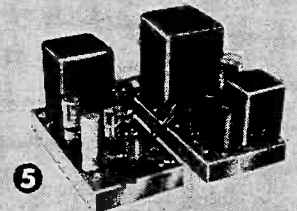
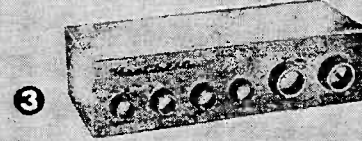
A unique feature of the Heathkit AM and FM Tuners is the fact that both units are pre-aligned. A signal generator is not necessary! IF and ratio transformers are pretuned at the factory, and some front-end components are preassembled and pretuned. Another "extra" to assure you of easy kit assembly.



## HEATH COMPANY

A Subsidiary of Daystrom, Inc.  
BENTON HARBOR 18, MICHIGAN

**EASY TIME PAYMENTS . . .** We invite you to take advantage of the Heath Time Payment Plan on any order amounting to \$90.00 or more. Just 10% down and the balance in twelve monthly payments. WRITE FOR COMPLETE DETAILS.



# HIGH FIDELITY SYSTEM

**1 HEATHKIT HIGH FIDELITY FM TUNER KIT** Features AGC and stabilized, temperature-compensated oscillator. Sensitivity is 10 microvolts for 20 db of quieting. Modern circuit covers standard FM band from 88 to 108 mc. Employs ratio detector for efficient hi-fi performance. Power supply is built in. Illuminated slide rule dial for easy tuning. Housed in compact satin-gold enamel cabinet. Features prealigned transformers and front end tuning unit. Shpg. Wt. 7 lbs.

MODEL FM-3A Incl. Excise Tax (with cab.)

**\$25.95**

\$2.60 dwn., \$2.18 mo.

**2 HEATHKIT BROADBAND AM TUNER KIT** This fine AM Tuner was designed especially for use in high fidelity applications, and features broad bandwidth, high sensitivity and good selectivity. Employs special detector circuit using crystal diodes for minimum signal distortion, even at high levels. Covers 550 to 1600 kc. RF and IF coils are prealigned. Power supply is built in. Housed in attractive satin-gold enamel cabinet. Shpg. Wt. 8 lbs.

MODEL BC-1 Incl. Excise Tax (with cab.)

**\$25.95**

\$2.60 dwn., \$2.18 mo.

**3 HEATHKIT HIGH FIDELITY PREAMPLIFIER KIT** This pre-amplifier meets or exceeds specifications for even the most rigorous high fidelity applications. It provides a total of 5 inputs, each with individual level controls. Hum and noise are extremely low, with special balance control for absolute minimum hum level. Tone controls provide 18 db boost and 12 db cut at 50 cps, and 15 db boost and 20 db cut at 15,000 cps. Four-position turn-over and four-position rolloff controls for "LP", "RIAA", "AES", and "early-78" equalization. Derives power from main amplifier, requiring only 6.3 VAC at 1A and 300 VDC at 10MA. Beautiful satin-gold enamel finish. Shpg. Wt. 7 lbs.

MODEL WA-P2 (with cab.)

**\$19.75**

\$1.98 dwn., \$1.66 mo.

**4 HEATHKIT ADVANCED-DESIGN HI-FI AMPLIFIER KIT** This fine 25-watt high fidelity amplifier employs KT66 output tubes by Genalex and a Peerless output transformer for top performance. Frequency response  $\pm 1$  db from 5 to 160,000 cps at 1 watt. Harmonic distortion less than 1% at 25 watts, an IM distortion less than 1% at 20 watts. Hum and noise are 99 db below 25 watts. Output impedance is 4, 8 or 16 ohms. Extremely stable circuit with "extra" features.

MODEL W-5: Consists of W-5M plus WA-P2 Preamplifier

MODEL W-5M  
**\$59.75** \$5.98 dwn.  
\$5.02 mo.

Shpg. Wt. 38 lbs. \$79.50 \$7.95 dwn.  
Express only \$6.68 mo.

Shpg. Wt. 31 lbs.  
Express only

**5 HEATHKIT DUAL-CHASSIS HI-FI AMPLIFIER KIT** This 20-watt Williamson-type amplifier employs the famous Acrosound model TO-300 output transformer, and uses 5881 tubes. Frequency response is  $\pm 1$  db from 6 cps to 150 kc at 1 watt. Harmonic distortion less than 1% at 21 watts, and IM distortion less than 1.3% at 20 watts. Output impedance is 4, 8 or 16 ohms. Hum and noise are 88 db below 20 watts.

MODEL W-3: Consists of W-3M plus WA-P2 Preamplifier

MODEL W-3M  
**\$49.75** \$4.98 dwn.  
\$4.18 mo.

Shpg. Wt. 37 lbs. \$69.50 \$6.95 dwn.  
Express only \$5.84 mo.

Shpg. Wt. 29 lbs.  
Express only

**6 HEATHKIT SINGLE-CHASSIS HI-FI AMPLIFIER KIT** This 20-watt Williamson-type amplifier combines high performance with economy. Employs Chicago-Standard output transformer and 5881 tubes. Frequency response  $\pm 1$  db from 10 cps to 100 kc at 1 watt. Harmonic distortion less than 1.5% and IM distortion less than 2.7% at full output. Output 4, 8 or 16 ohms. Hum and noise—95 db below 20 watts.

MODEL W-4A: Consists of W-4AM plus WA-P2 Preamplifier

MODEL W-4AM  
**\$39.75** \$3.98 dwn.  
\$3.34 mo.

Shpg. Wt. 35 lbs. \$59.50 \$5.95 dwn.  
Express only \$5.00 mo.

Shpg. Wt. 28 lbs.  
Express only

**7 HEATHKIT 20-WATT HIGH FIDELITY AMPLIFIER KIT** Features full 20 watt output using push-pull 6L6 tubes. Built-in preamplifier provides four separate inputs. Separate bass and treble controls. Output transformer tapped at 4, 8, 16 and 500 ohms. Designed for home use, but also fine for public address work. Response is  $\pm 1$  db from 20 to 20,000 cps. Harmonic distortion less than 1% at 3 db below rated output. Shpg. Wt. 23 lbs.

MODEL A-9B

**\$35.50** \$3.55 dwn., \$2.98 mo.

**8 HEATHKIT ELECTRONIC CROSS-OVER KIT** This device separates high and low frequencies electronically, so they may be fed through two separate amplifiers driving separate speakers. Eliminates the need for conventional cross-over. Selectable cross-over frequencies are 100, 200, 400, 700, 1200, 2000 and 3500 cps. Separate level controls for high and low frequency channels. Attenuation 12 db per octave. Shpg. Wt. 6 lbs.

MODEL XO-1

**\$18.95** \$1.90 dwn., \$1.59 mo.

**9 HEATHKIT 7-WATT ECONOMY AMPLIFIER KIT** Qualifies for high fidelity even though more limited in power than other Heathkit models. Frequency response is  $\pm 1\frac{1}{2}$  db from 20 to 20,000 cps. Push-pull output and separate bass and treble tone controls. Good high fidelity at minimum cost. Uses special tapped-screen output transformer.

MODEL A-7E: Same as A-7D except one more tube added for extra preamplification. Two inputs, RIAA compensation and extra gain.

MODEL A-7D

**\$17.95** \$1.80 dwn., \$1.51 mo.

Shpg. Wt. 10 lbs. \$19.95 \$2.00 dwn.  
Incl. Excise Tax \$1.68 mo.

Incl. Excise Tax  
Shpg. Wt. 10 lbs.

## HOW TO ORDER

Just identify kit by model number and send order to address below. Write for further details if you wish to budget your purchase on the HEATH TIME PAYMENT PLAN.

## HEATH COMPANY

A Subsidiary of Daystrom, Inc.

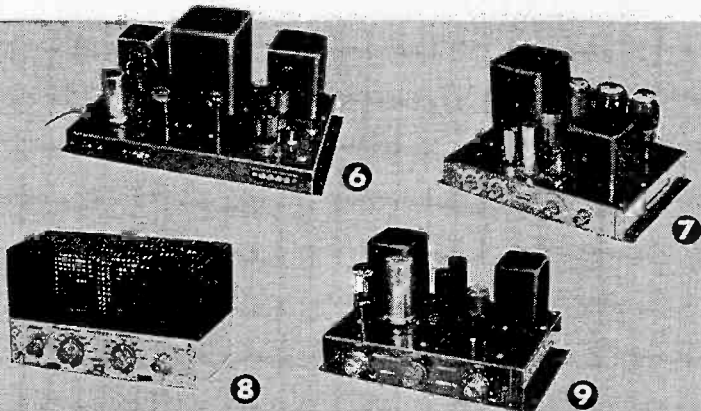
BENTON HARBOR 18, MICHIGAN

Please send Free HEATHKIT catalog.

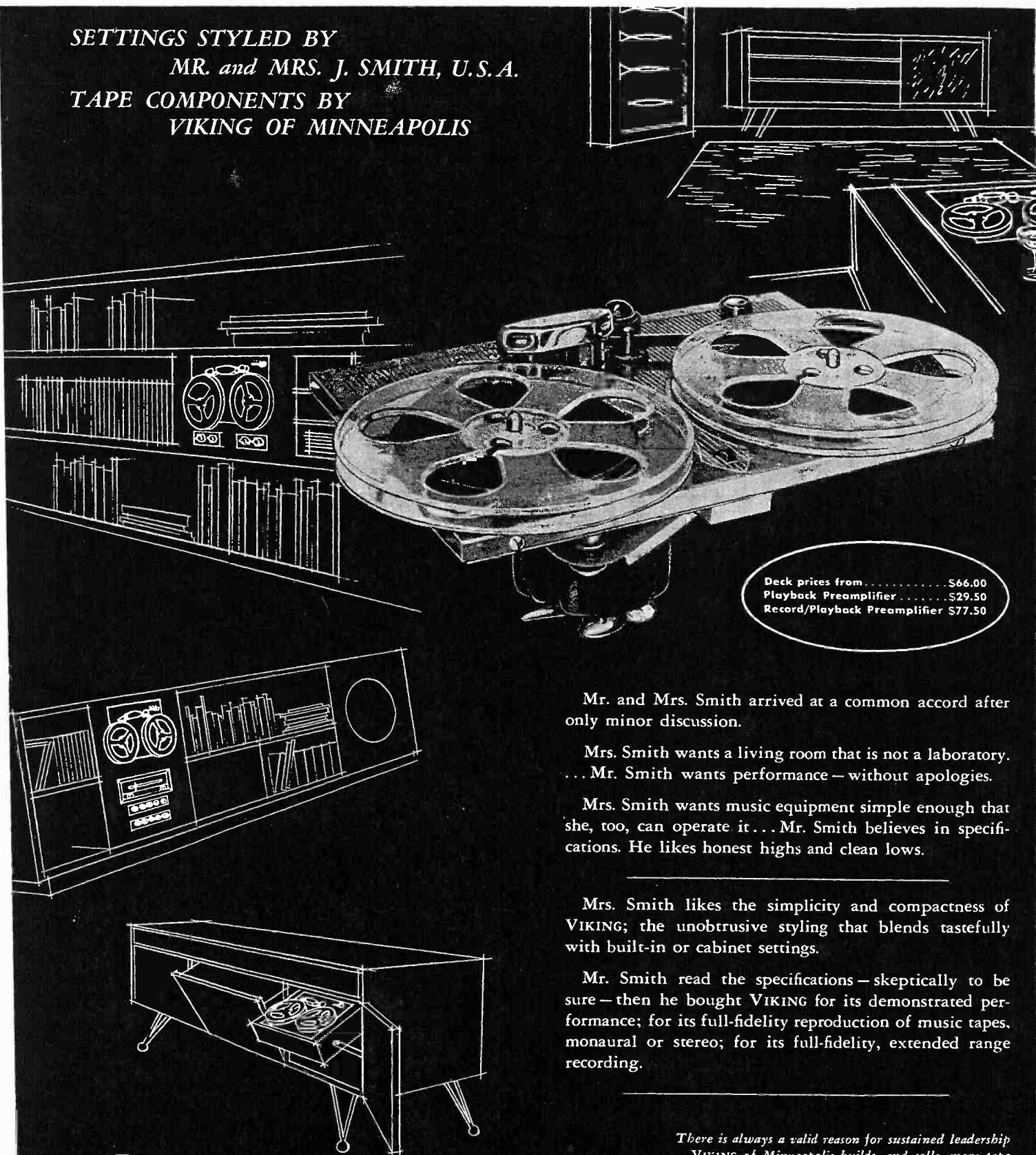
Name \_\_\_\_\_

Address \_\_\_\_\_

City & Zone \_\_\_\_\_ State \_\_\_\_\_



SETTINGS STYLED BY  
 MR. and MRS. J. SMITH, U.S.A.  
 TAPE COMPONENTS BY  
 VIKING OF MINNEAPOLIS



Deck prices from . . . . . \$66.00  
 Playback Preamplifier . . . . . \$29.50  
 Record/Playback Preamplifier \$77.50

Mr. and Mrs. Smith arrived at a common accord after only minor discussion.

Mrs. Smith wants a living room that is not a laboratory. . . Mr. Smith wants performance — without apologies.

Mrs. Smith wants music equipment simple enough that she, too, can operate it . . Mr. Smith believes in specifications. He likes honest highs and clean lows.

Mrs. Smith likes the simplicity and compactness of VIKING; the unobtrusive styling that blends tastefully with built-in or cabinet settings.

Mr. Smith read the specifications — skeptically to be sure — then he bought VIKING for its demonstrated performance; for its full-fidelity reproduction of music tapes, monaural or stereo; for its full-fidelity, extended range recording.

*There is always a valid reason for sustained leadership . . . VIKING of Minneapolis builds, and sells, more tape system components (decks and preamplifiers) than any other manufacturer of high fidelity equipment.*



**VIKING OF MINNEAPOLIS**  
 9600 Aldrich Avenue South, Minneapolis 20, Minnesota  
 EXPORT DIVISION: 23 Warren Street, New York City 7, New York  
 Cable: SIMONTRICE, NEW YORK (All Codes)





# EDITORIAL

Gentlemen:

I thought the November issue was, on the whole, pretty good, but I wonder about the Geraci article ["Rebuild Your Recorder"]. It seems to me he would have done better to tell how to rework a Brush of the 1946-or-so era.

I have changed the amplifier on mine, but will have to use a bulk-erase or a magnet preceding the erase head to get the tape clean. I did see an article somewhere telling how to change the plate-circuit load of one of the 6SN7's to an 80-mh choke plus a variable 10-K pot for 1.8-ma erase current, but what is the exact value?

There are other circuits using one 6V6 instead, so can someone do a follow-up on that? And what Dynamu heads are used for the Brush?

Albert R. Jourdan, Jr.  
Meriden, Conn.

*Reader opinions about an article on conversion or modernization of the old Brush recorder will be welcome. We'll run such an article, of course, if there is sufficient interest among our readers to warrant it.—ED.*

Gentlemen:

In the October 1956 issue of AUDIO-CRAFT, on page 48, reference was made to the Goodmans Acoustic Resistance Units in the following words:

"The gadget is a grille which fits over the reflex vent, and is designed to provide just the right amount of viscous damping for most reflex enclosures."

This is misleading, insofar as the ARU is designed for speakers of certain characteristics and cabinets of specified volumes. As a matter of fact, a Goodmans "Friction Loaded" cabinet is considerably smaller than a properly designed reflex enclosure for the same speaker. Readers interested in the engineering analysis of this design may wish to consult *Baffles Unbaffled*, by E. J. Jordan, a pamphlet available on request to Rockbar Corporation, 650 Halstead Ave., Mamaroneck, N. Y.

George L. Augspurger  
Los Angeles, Calif.

Gentlemen:

Ever since fine high-fidelity equipment has been on the market there has been universal complaint about a part, almost always incorporated, which is not of the standard normally expected. We

*Continued on page 47*

SOME years ago, when we had decided to stick with the Berkshires through snow, sleet, and the current spring mud, we put a down payment on one of the quite large, very old houses that grace this area in abundance. Even more remarkable than the cool green of summer or the splendor of fall, we have since discovered, are the bills for fuel oil and repairs that go with living in such a house. Still, we have never regretted our choice—except when listening to the living-room speaker system.

Visit any old house in this vicinity, and you'll discover that it contains a lot of rooms, most of them virtually square. Our living room was even more than virtually square; it was *perfectly* square, 15½ ft. along each wall. As luck would have it, the ceiling height was precisely 7¾ ft. The room had the worst possible dimensions for sound reproduction, in the ratio of 1:2:2. Our main speaker system is in itself what we consider to be among the finest we've heard for home use, but it produced tubby, violently resonant bass no matter where it was put in that room. For any serious listening it was necessary to use our combination test and work room, which has more favorable dimensions. An embarrassing situation for the editor of a magazine concerned with high fidelity, you will agree.

Fortunately, this true confession has a happy ending. We have just completed removal of a partition wall between our old living room and an adjacent room. The dimensions of that room were 12 by 17 ft., with the long wall along the removed partition; the ceiling was slightly lower also. Now we have a single large room that is roughly 16 by 28 ft., with a ceiling that varies in height. The improvement in sound is so astonishing that it is difficult to believe the same speaker system produces it. The bass range has been extended, to be sure. More important, it is now smooth and well defined, even though

the room dimensions are still not ideal. Listening in the new room is now thoroughly enjoyable; in the old room it was barely tolerable.

The point of all this is that we want to emphasize, by relating a striking experience of our own, the importance of *your* listening room on what *you* listen to. If your speaker sounds overly shrill, or if it is echoey and lacking in middle-range or high-frequency definition, don't overlook the possibility that the room may be at fault. Heavy carpeting, acoustic treatment of the ceiling, or drapes along one wall may cure the trouble.

If the room is responsible for low-frequency troubles, on the other hand, a cure may involve more drastic measures. Before doing anything else, try moving the speaker around in the room, even if it is a corner speaker. We know of one man who uses his corner horn along one wall and about 4 ft. from the corner, simply because it sounds best there in his large (but square) living room.

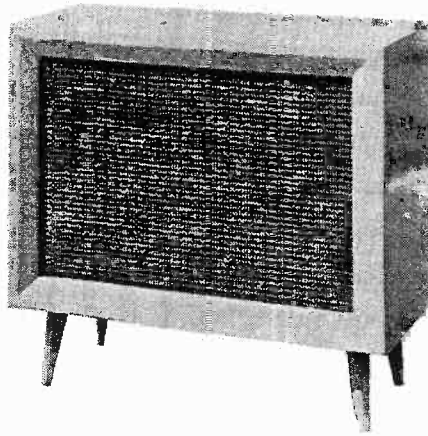
The ideal listening room has dimensions in the ratios 1:1.26:1.6, or multiples of these ratios. Major room resonances will be evenly distributed in a room of such dimensions, giving the minimum amount of peakiness. Sometimes it is feasible to build cabinets on a wall to reduce one room dimension slightly, bringing it closer to the ideal. A large hole in an offending wall, for a wide archway to the adjoining room, can decrease the amplitude of one resonant mode. Very large and very heavy drapes hung 1 to 2 ft. away from a wall may accomplish the same thing.

As a final resort, you may be able to remove completely a wall between two rooms. Before you attempt this, though, consider carefully whether or not the new dimensions will be better than the old; make certain that you aren't removing a bearing wall; get all furniture out of both rooms, and hang old blankets or drapes over the doorways to stop plaster dust from getting into other parts of the house; and finally, if you're doing the job yourself, be prepared for the worst mess you ever got into. We did, but it was worth it. Our new room looks better too.

For more information on room acoustics in general, we recommend Chapter 3 of *High Fidelity: A Practical Guide*, by Charles Fowler (McGraw-Hill, New York; \$4.95). The book is available, incidentally, through AUDIOCRAFT's book department; see page 37.—R.A.

## ERRATUM

In "Basic Electronics", Chapter XIV, February 1957 issue, page 33, column 1, six lines below caption for Fig. 4, the quotient of 104/1,300 is given as .80 a. Between page proof and printed form the two numerals in this figure were somehow interchanged; the correct value, of course, is .08 a.



# Stephens K-21 Enclosure Kit

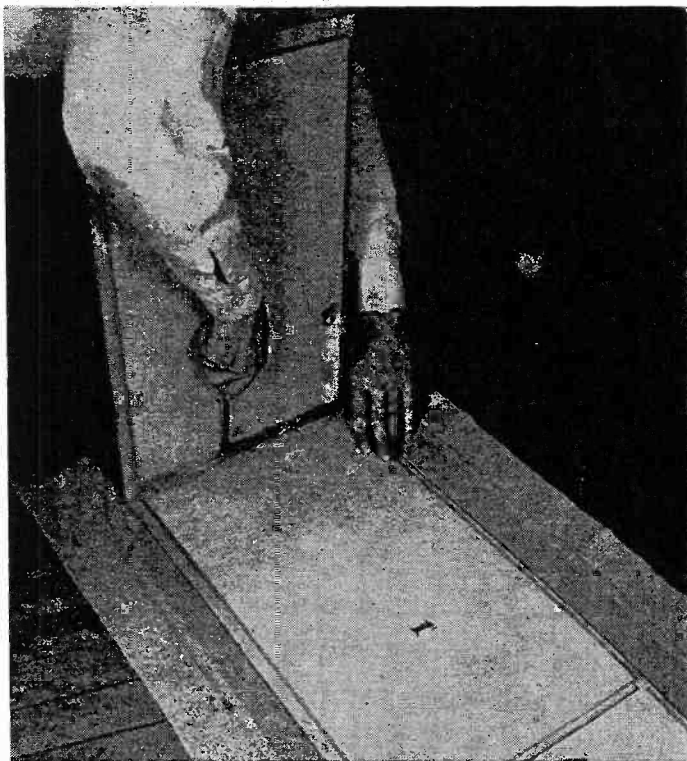
*An AUDIOCRAFT kit report*

**T**HERE are six Stephens Tru-Sonic loudspeaker enclosure models you can buy with or without accompanying speakers; other models are sold only with their speaker complements. Of these six, three are available in kit form also. They are the Coronado (K-20), the Coronet (K-21), and the Columbian

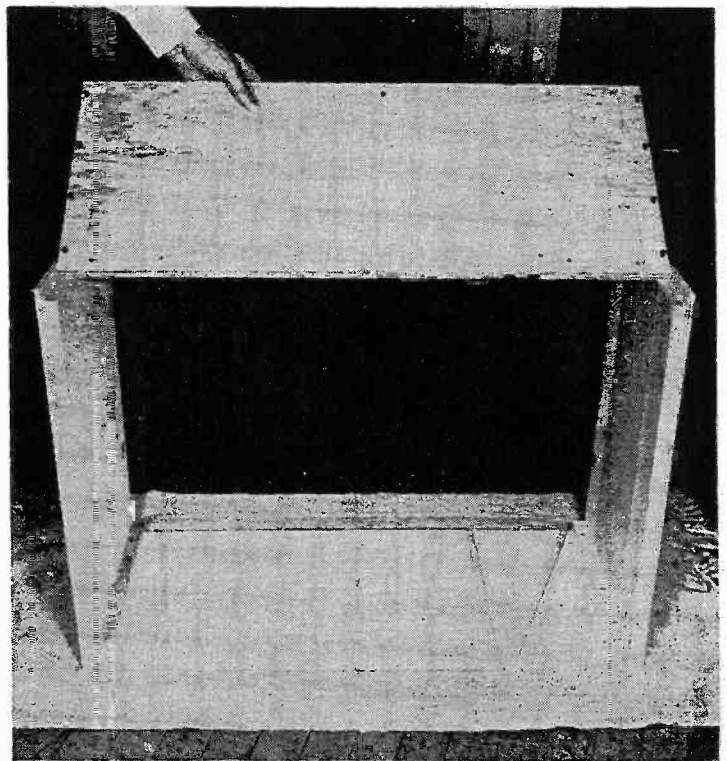
(K-22). For this report we obtained a K-21 Coronet kit. Ready-made, the Coronet costs \$85.50 in blond, walnut, or mahogany finish. The kit version is priced at \$55.00. Building it yourself, then, saves you \$30.50. Similar savings can be made on the other enclosure kits.

The K-21 is of contemporary design

and of medium size: 29½ in. wide by 21 in. high by 14 in. deep. It will take any 12-inch woofer or coaxial speaker, and has a cutout on the speaker mounting board for a high-frequency speaker or horn. This cutout is about 5 by 7 in. Stephens speaker systems recommended for use in the Coronet

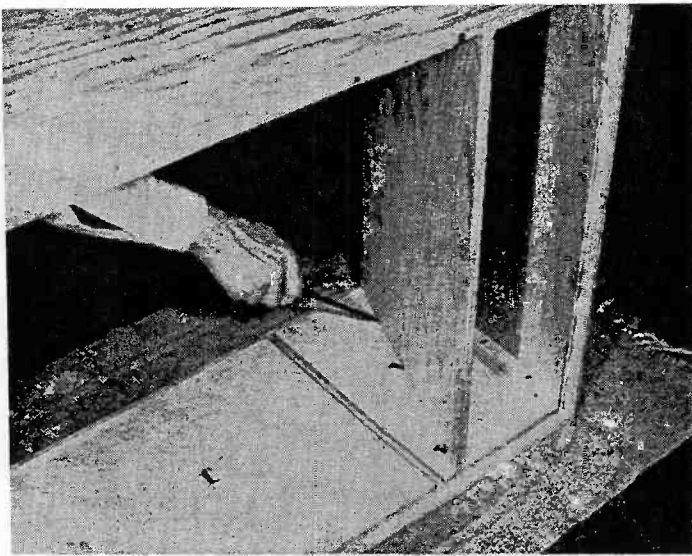


*Fig. 1. Tighten these screws only until side panels are square with top. Check with a framing square if you have one.*

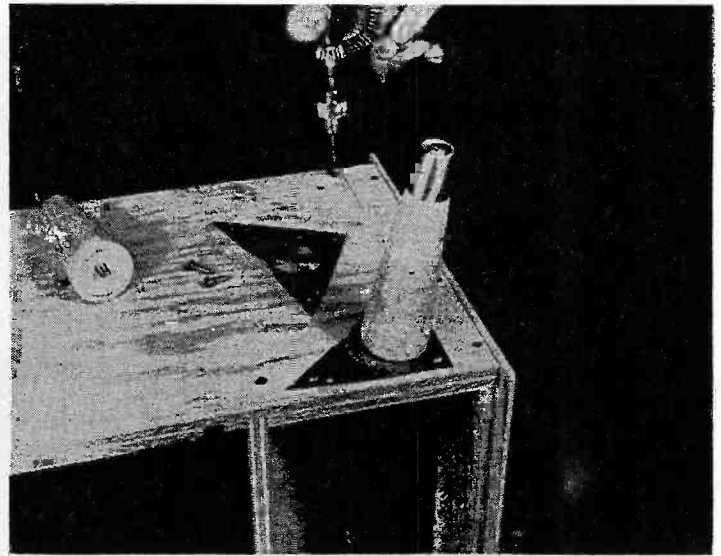


*Fig. 2. Bottom panel fits into rabbets. Note that this enclosure is assembled upside down; rug avoids gouges on top.*

All Photos by Warren Syer



*Fig. 3. Slanted baffle is held with 3 screws at each end. Those at bottom go through bottom panel up into the piece.*



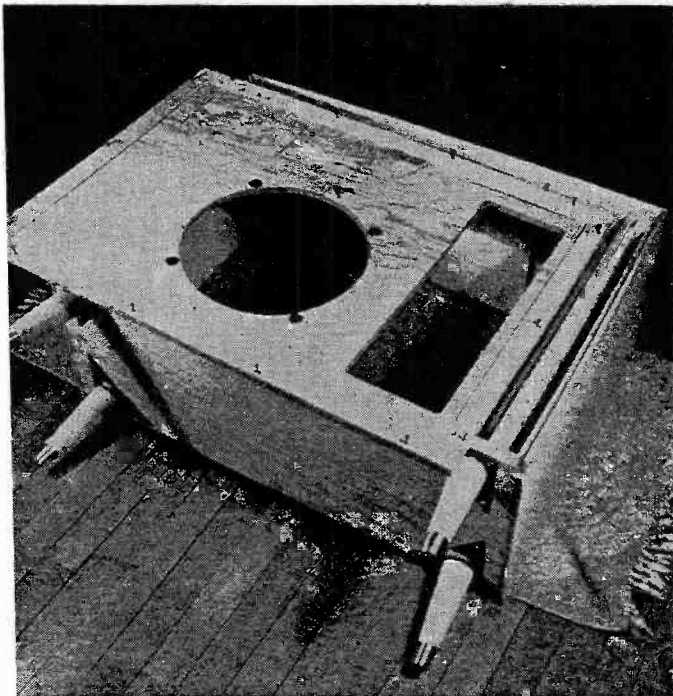
*Fig. 4. The leg brackets require sturdy screws, which will be a lot easier to drive if you drill small pilot holes.*

are the 122AX, the 112FR, or the Companion Two-Way system (120LX woofer, 214 super tweeter, and 5000X crossover network). A box matching the tweeter cutout is supplied for a separate tweeter; there is also a cover plate for the cutout when a coaxial or wide-range speaker is used alone. The enclosure is based on the bass-reflex principle, with a short horn on the reflex vent that provides improved damping and slightly increased efficiency.

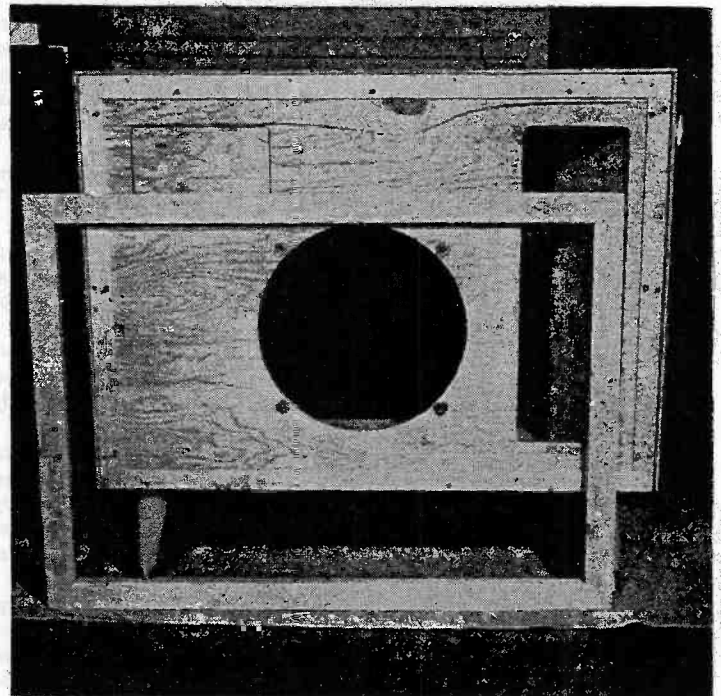
All panels are cut to size and stamped with identifying marks. Glue cleats are installed on the panels at the factory,

and screw holes are drilled in them and countersunk. No work with a saw is necessary. Top and side panels are of  $\frac{3}{4}$ -inch sanded birch plywood; the legs and one-piece trim frame are of solid hardwood. Other panels are  $\frac{1}{2}$ -inch,  $\frac{5}{8}$ -inch, or  $\frac{3}{4}$ -inch plywood as required. Glue, screws, grille cloth, tacks, acoustical lining, and complete step-by-step assembly instructions are supplied with the kit. Even T nuts and speaker mounting bolts, and the speaker-lead terminal board, are furnished! This is one of the most complete enclosure kits we know of.

We enjoyed building the K-21, and did not hurry the job. As with any kit we work on, we put it together first without glue, to make sure that everything would fit (it did) and that we understood the instructions (we did). Our pictures were taken during this trial assembly; note that the baffle horn areas were not yet painted black, the acoustic lining was not installed, and the grille cloth was not attached, so that the main construction details would be shown as clearly as possible. Preliminary assembly might be dispensed with if you're in a great hurry—but we don't recommend



*Fig. 5. Speaker panel nestles in side- and top-panel rabbets. In a permanent assembly, grille cloth is added first.*



*Fig. 6. Trim molding frame, after being finished separately, is held by screws into back driven through speaker panel.*

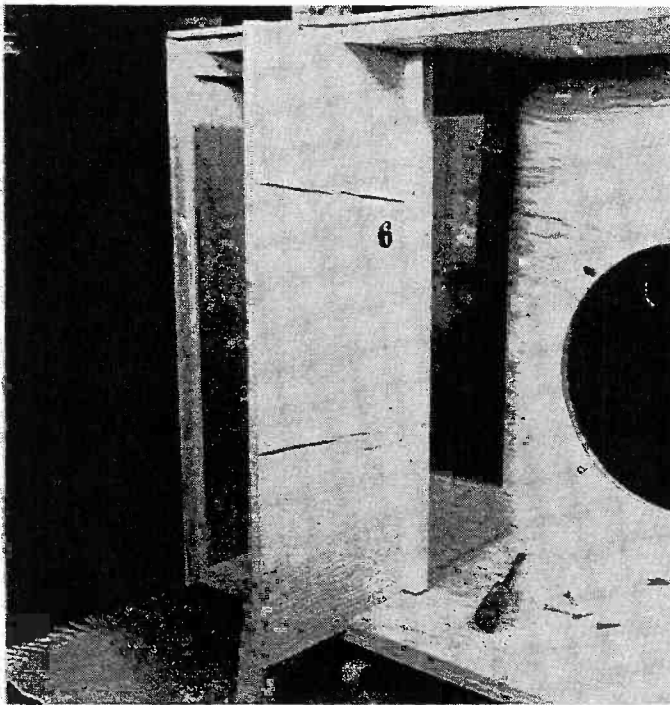


Fig. 7. After trim frame is installed, this "shelf" slides into dados. Glue should not be used to secure the shelf.

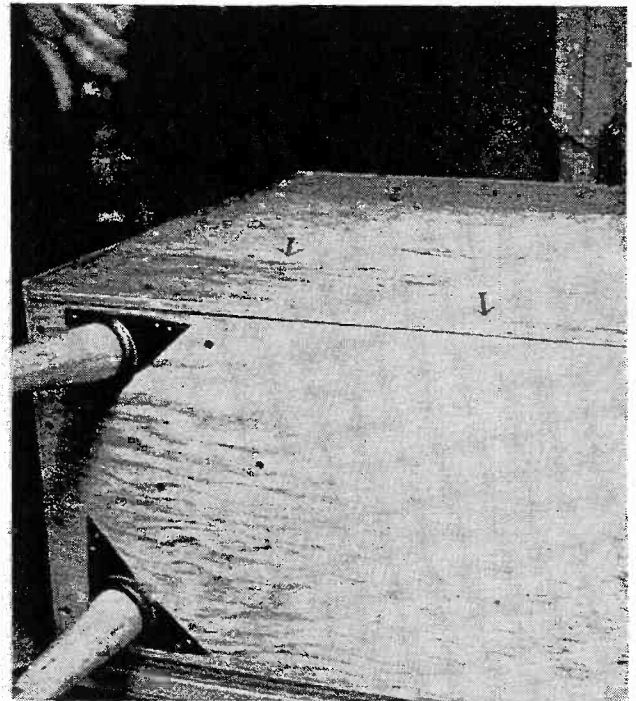


Fig. 8. Kimsul and speakers would go in at this point in final assembly. Note screw holes in back panel for piece 5.

it. It took us only an extra hour and a half, and we learned a few things that were helpful when we finally broke out the glue bottle and went to work in earnest. These are noted in the following section.

### Construction Notes

Slot-head wood screws are furnished for all the assembly work, on the theory that no special tools should be required for kit assembly, and every home has a screw driver for standard screws. These are fine in most places, but are very difficult to use in steps 2 and 3 (attach-

ing the side panels to the top panel), because it is impossible to get an ordinary screw driver perfectly aligned with the screws. Result: stripped heads. Cure: get eight 1¼-6 or 1¼-8 phillips-head wood screws, and a suitable phillips screw driver, if you don't have one, from the hardware store; use them in steps 2 and 3. To assure a tight fit of the rabbet joints, start the screws with their tops leaning back toward the side panels. After the threads have caught in the top panel, gradually force them into vertical positions as you drive them.

When installing the bottom panel, don't turn the screws in too hard; you're going into the side-panel end grain. Tighten them just enough to get a good squeeze fit. When the glue has set, the screws serve no useful purpose anyway—they simply replace clamps during the setting period.

It is important for piece 5, the slant partition, to be precisely flush with the back edge of the bottom panel and the back edge of the top-panel rabbet. Let the front edge go where it will. Conversely the front edge of the shelf (piece 6) should be precisely flush with the front edge of the bottom panel and the front edge of the top-panel rabbet, so that it will make a tight seal with the speaker mounting panel. You'll find holes in the bottom panel for screws to be driven up into both pieces 5 and 6, instead of holes in the pieces for screws into the bottom panel, as shown in the illustrations.

Be sure to insert the tweeter-hole cover plate from the inside of the speaker mounting board (step 7) so that you'll be able to get it out later

if you should want to. Also, when installing the speaker bolt T nuts, put the bolts through the holes, thread the T nuts on them, and then hammer the nuts into place. That will assure good alignment of the holes and nuts. Obviously, the T nuts must be installed before the grille cloth is attached to the board.

In step 9, piece 5 has a cleat on its front edge that is apparently intended to be screwed to the speaker mounting panel. When installing the panel, therefore, put glue on the front edge of this cleat and drive screws through it into the panel, from the inside. It will help to stiffen the speaker mounting board, which is all to the good.

There isn't much use in putting the shelf, piece 6, in place before finishing the enclosure, because you'll only have to remove it when the time comes to

*Continued on page 44*

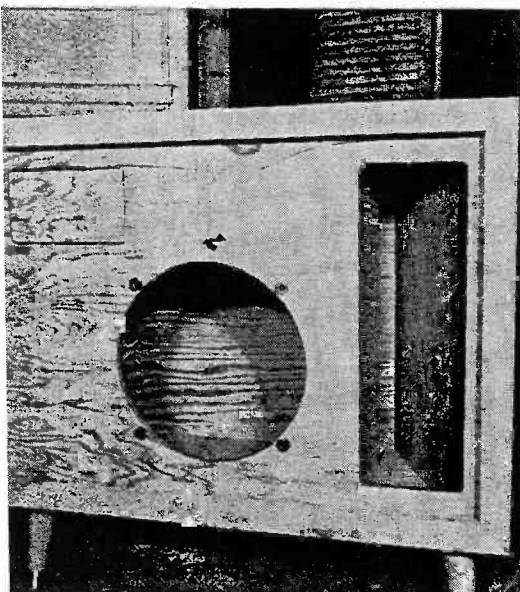


Fig. 9. Construction view of enclosure at end of trial assembly. Tweeter hole cover plate, upper left, is in place.

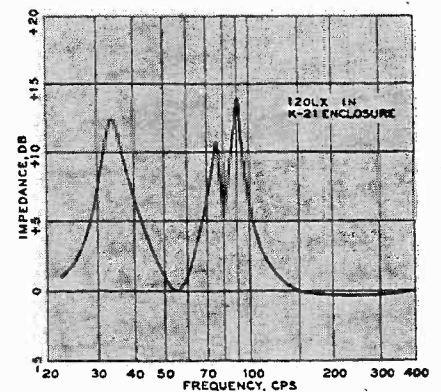


Fig. 10. Low-frequency impedance of the system, measured as voltage across the woofer fed by constant-current source.

# OPTIMIZE your amplifier for

# \$1<sup>00</sup>

IT is possible to improve almost any feedback amplifier without buying a new output transformer for it.

Such improvements can be effected a little more easily if you have the use of an audio oscillator and an oscilloscope. It is quite possible, however, to achieve practically the same results without an oscillator, while an oscilloscope can usually be borrowed, for a little while at least.

## Outside the Range

Before we start in to work, let's consider briefly what we will try to do. Experiments resulting in this article confirmed a suspicion I have long held (in company with several other engineers): that amplifiers misbehave under practical operating conditions in ways not shown by the technical specifications. In this article we shall tackle two of these ways, which seem to account for quite a large proportion of the defects observed in many amplifiers.

The first concerns transient performance at the high-frequency end. Many amplifier specifications show or state square-wave response to fairly high frequencies. This should prove a safeguard against transient misbehavior at this end of the response band, except for one thing: the specified performance is taken either into a resistance load or, if reactance is included at all, into a combined resistance and capacitance. But an electromagnetic-loudspeaker voice coil does not look like a capacitance; at the high-frequency end it is definitely inductive, as shown in Fig. 1.

This being the case, the response to square waves specified under test conditions is no indication of how the amplifier will behave when feeding a loud-

speaker. That is one reason why some amplifiers do not sound as good at the high-frequency end as their specifications would imply.

The other defect is one that seems to have been given even less consideration: the response of the amplifier at sub-audio frequencies. Many modern feedback amplifiers have a peak in the feedback loop response around 2 cps, although this may not show up as a peak in the over-all amplifier response. How does this cause trouble if it does not produce a resultant over-all peak?

Program material often has an asymmetrical wave form, as when a trumpet is played or a string bass plucked. These asymmetrical wave forms are equivalent to a temporary short-duration DC pulse applied along with the AC component to the amplifier. In normal amplification, each AC coupling, consisting of a resistance with a coupling capacitor, will readjust itself for this DC component according to the time constant of the circuit, and no distortion will occur. But this sort of DC pulse, when applied to a feedback amplifier in which the loop gain rises toward the extreme low-frequency end, may set up an oscillatory condition inside the amplifier. Such a very low-frequency oscillation (only one or two per second) may take several seconds to die away.

The oscillation itself, of course, is inaudible. Usually it does not move the loudspeaker diaphragm appreciably, because of the loss in the output transformer at this frequency. At some stages in the amplifier, however, this frequency appears at considerable amplitude, sufficient to cause modulation or distortion of the program material by this frequency. It is a form of IM dis-

ortion of considerably greater amplitude than that normally measured by standard methods.

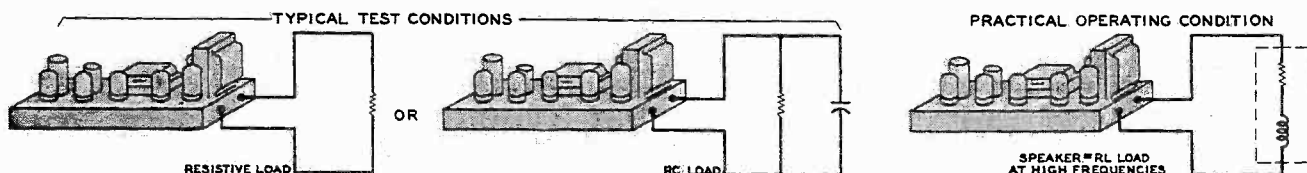
## Feedback Technique

The first defect occurs because the method of achieving high-frequency response is not strictly according to best feedback principles. In the literature a great deal of stress has been put on extending the high-frequency response to some figure well above the top limit of the audio spectrum. This necessitates a very wide-band amplifier and, in an endeavor to achieve this, the designer has adopted some measures which might better have been left out.

This we see on the schematic of the average amplifier in the form of one or more phase-shift compensating capacitors of small value, connected at various points in the amplifier. The over-all result of these phase-shift capacitors is to produce a satisfactory frequency response and square-wave response *when the amplifier is resistance loaded*. At the same time, their presence tends to aggravate the defects that occur when the amplifier is inductively loaded, as is normally the case using the voice coil of a loudspeaker.

A particularly poor, but quite common, practice is the one of putting a phase-correction capacitor across the feedback resistor itself, as shown in Fig. 2. With this capacitor connected, the amplifier has a flat response, as measured from input to output, between the limits of the frequency band established. Because the frequency response measured at the output of the amplifier is flat, the phase-shifting capacitor across the feedback resistor must produce a rising characteristic at 6 db per

Fig. 1. Why test specifications may not accurately reflect listening quality.



octave on the feedback voltage applied to the cathode of the first stage.

Notice that this is fundamental, because of the flat response over-all; if there were *not* a rising characteristic on the feedback voltage at this point, then the response would have to roll off at the output.

Of course, at some frequency, determined by other parameters in the forward-gain part of the amplifier circuit, this rising response turns into a

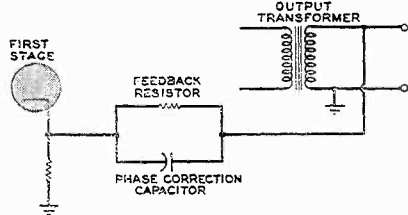


Fig. 2. A particularly common position for a phase-correction shunt capacitor.

falling one, so that the loop-gain characteristic looks something like Fig. 3.

Now we can see why use of a phase-shift capacitor in this position is a particularly bad thing: the exact point of the turnover, in the loop-gain characteristic, is determined by all the parameters in the amplifier, including the kind of load impedance connected to the output. The mere fact that the amplifier is measured under resistance-load conditions, but works into a highly inductive load (the voice coil of a loudspeaker), means that the response must be quite different with each.

So the first step in amplifier modification is to remove the phase-shift capacitors, particularly the one across the feedback resistor if one is used at that point. Then the method of making the adjustment will depend on whether an audio oscillator is available or not. For these tests connect a resistance load across the output, of a value to match the speaker to which it is connected.

Sometimes, removal of the phase-shift capacitors will produce instability in the amplifier, as shown by high-frequency

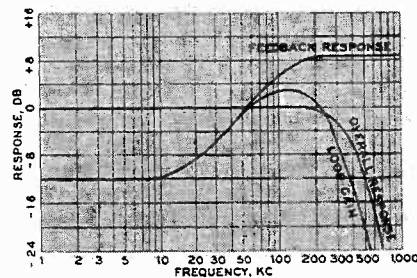


Fig. 3. Response associated with the circuit of Fig. 2. High end only shown.

oscillation on the oscilloscope screen. In this case the feedback resistor should be increased in value until the oscillation disappears. In most instances, however, removal of these capacitors does

not result in oscillation, but merely decreases the margin of stability.

### The High End — Method 1

If you have an audio oscillator with a range that extends beyond the top end of the audio spectrum, up to 200 Kc or 1 Mc, then sweep through this range of frequencies, using the oscilloscope connected as shown in Fig. 4. With most oscilloscopes it is advisable to connect the inputs directly to the CRT plates by means of the terminals usually found at the back. If the amplifier has a gain control, turn this all the way up.

At middle frequencies the trace on the screen should be a straight slanting line. Adjust the values of resistance on the input circuit until this line slants at an angle close to 45°. Now sweep the frequency on up until the line opens out into an ellipse. You will probably find that, as it turns into an ellipse, it also stretches vertically, as shown in Fig. 5A, and that the maximum height of the ellipse occurs when its position is vertical. As it flops over into the opposite direction, with further phase shift, the ellipse dies down

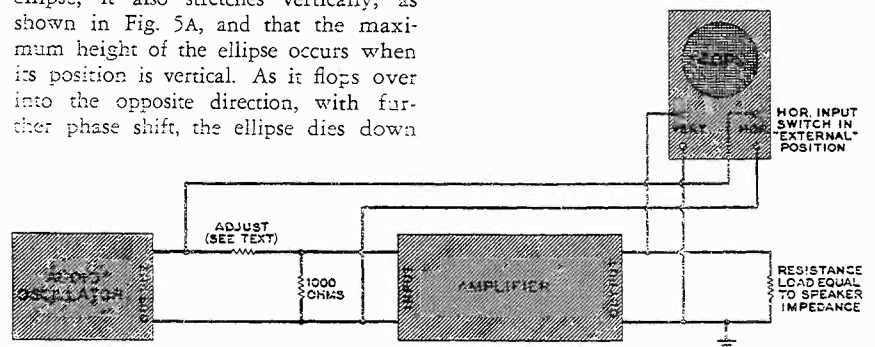


Fig. 4. Method of connecting test equipment for making adjustments by method 1.

in height. This elongation of the ellipse indicates the peaking region.

Now try the effect of various small shunt capacitors (starting from, say, .0001  $\mu$ fd and trying larger ones as necessary) across different points in the amplifier circuit. The best place to connect this capacitor is from the plate of the first stage to ground, as a rule, but you will find that one point in the circuit proves to be more beneficial than others in reducing the height of the ellipse as it passes through the vertical position.

Having found the position in the circuit most effective in reducing the peak, go on increasing the value of the capacitor connected in this position until the ellipse is broader than it is high under all conditions. The desired sequence of patterns at different frequencies is drawn in Fig. 5B. The value that does this is the correct value of capacitor to connect at this point. You may find that as much as .002 to .005  $\mu$ fd, from plate to ground of the first stage, is necessary to produce this condition.

Now you can check back and find the frequency response of the amplifier with this arrangement. You will probably find that it is as much as 1 db down at 20 Kc, or perhaps even a little lower.

### The Low End

Now to tackle the low-frequency end. Here, if you have an oscillator whose frequency range extends downward to about 1 cps, a similar method can be employed. But most oscillators do not go below 20 cps, so a different method must be used for checking performance at the low end. The following method can also be applied at the high end, if you do not happen to have an oscillator that extends to 200 Kc or 1 Mc. If the oscillator you use covers only the range from 20 cps to 20 Kc it will not help in making the adjustments, only in checking the over-all response after you have made a satisfactory alteration to the circuit.

This other method of making adjustments depends on the fundamental relationship between a) the amount of feedback necessary to cause peaking to

begin at either end of the response, and b) that necessary to make the unit go into oscillation at the same point. The relationship is listed for different numbers of "stages" in the table below. It is listed in db as well as in numerical ratio, to assist in calculating the values of resistance to be used for checking purposes.

Table of Gain Margins

Effective number of stages contributing to rolloff	Required margin	
	db	ratio
3	18.0	8.0
4	14.5	5.3
5	13.0	4.5

Take, for example, the amplifier circuit in Fig. 6. This is one I actually worked on. It has three "stages" contributing to low-frequency rolloff: 1) the coupling capacitor between the first plate and the second grid; 2) the push-pull coupling capacitors between the drive stage and the output; and 3) the primary inductance of the output transformer. Note that the coupling between the second stage and the phase splitter does not count in the low-frequency rolloff, because it is direct-coupled.

Therefore, the figures for three stages

must be used for the low-frequency end. The peaking-to-oscillation gain margin for a three-stage amplifier is 18 db, which means that the feedback resistor should be able to be reduced from its normal value by a ratio of 8:1 before

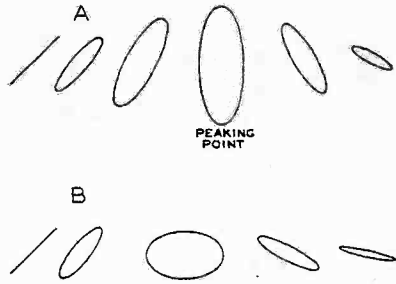


Fig. 5A. Sequence of traces on oscilloscope screen, showing peaking occurring approximately at 90° phase-shift frequency (the usual place). Fig. 5B. Traces at successfully higher frequencies, showing patterns obtained when values have been adjusted to eliminate peaking.

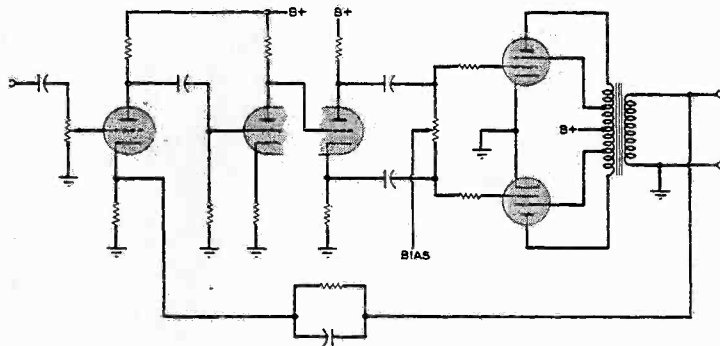


Fig. 6. Amplifier circuit discussed in the text, before any changes were made.

the amplifier begins to oscillate. If the feedback resistor used is 39 K, which is a typical value, then the amplifier should remain stable at the low-frequency end if this value is reduced to 1/8 of 39 K, or 5 K (5 K is not a preferred value, so 4.7 K or 5.6 K could be used as a substitute here, being near enough for practical purposes). Test-equipment connections are the same as shown in Fig. 4, except that no input signal is used to the amplifier. The oscilloscope sweep switch is turned to INTERNAL.

Making this change may cause the amplifier to oscillate at a high frequency, as will be seen on the scope. If this occurs, then put a larger capacitor (say .01  $\mu\text{fd}$ ) temporarily across the first-stage plate to ground to prevent this instability, so that the low-frequency condition can be observed separately. If the amplifier is unstable in the region of 1 or 2 cps, the trace will be observed to go up and down gently on the screen — unless the oscillation is severe, in which case it will vibrate up and down violently.

If it does the latter, try an intermediate value of resistor, one that pro-

duces a gentle up-and-down oscillation.

The best coupling capacitor to try changing is the one between the first-stage plate and the second grid. First, try using a somewhat smaller value. This will make the oscillation either more or less violent. If it makes the oscillation more violent, a larger capacitor is necessary. In this case continue to increase the capacitor value until stability is achieved with the 4.7- or 5.6-K resistor in place. Then you can solder the capacitor in firmly as a coupling capacitor and return the feedback resistor to its original value of 39 K, at the same time removing the temporary capacitor which may have been used to stabilize the high end.

### Transient Blocking

If you have already taken care of the high end by method 1, the amplifier should now be considerably improved in performance. There is just one thing

to guard against if a much larger capacitor is used in this first-stage coupling network: that is the possibility of blocking when an overload signal comes through the amplifier. This will not happen in normal program material, but could be caused, for example, by a slight crack in a record, the pop from which would produce an overload and temporarily block the amplifier, killing the signal for a moment or so.

This may be caused by a positive-going excursion of high amplitude at the second grid, which draws grid current and charges the coupling capacitor negatively. If the capacitor is very large, it can take sufficient time to discharge

that some of the program can be lost. A safeguard against this occurrence is to put a resistor of about 100 K in series with the grid, as shown in Fig. 7. Use of this resistor will also permit a different method of taking care of the high-frequency response.

Instead of using, say, .0025  $\mu\text{fd}$  from plate to ground, a much smaller capacitor can be used from grid to ground, following the 100-K resistor — possibly about .0005  $\mu\text{fd}$ . This new value would have to be verified, either by method 1 described above, using the oscillator and oscilloscope, or by the method of attending to the high-frequency response now to be described.

### The High End — Method 2

To check the high-frequency response without an oscillator, we again count the number of effective stages. This means the number of points at which stray capacitance is likely to cause sufficient effect to produce a high-frequency rolloff.

The first bit of stray capacitance of this nature is that from the plate of the first stage and the grid of the second stage to ground; the second, from the plate of the second stage and the grid of the phase splitter to ground; the third, from the output grids to ground; the fourth, primary capacitance in the plate circuit of the output stage; and a possible fifth, leakage inductance in the output transformer.

This amplifier (Fig. 6) may have as many as five effective stages for high-frequency-stability consideration. Turning back to our table, it is seen that the margin required is 13 db, or a ratio of 4.5:1. Assuming still the 39-K feedback resistor as the correct value, the amplifier should remain stable if this resistor is reduced by the ratio 4.5:1 — about 8.7 K. (The nearest practical value to this would be 8.2 K or 9.1 K, whichever happened to be available.)

Accordingly, in the absence of an oscillator with a range to 200 Kc or 1 Mc, change the feedback resistor by the appropriate ratio and then try shunt capacitance, in this case from the second-stage grid to ground, until it just stops the oscillation. At that point there

*Continued on page 46*

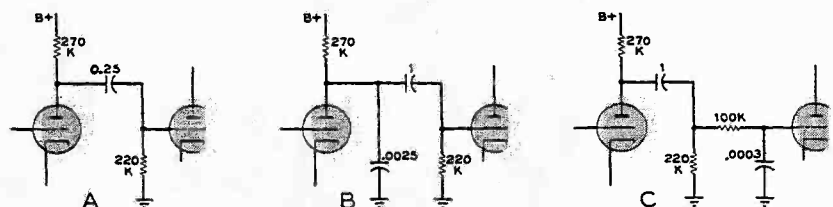


Fig. 7. Sequence of changes made to the first-stage coupling network in the circuit of Fig. 6. A: original values. B: values after original phase-shift capacitor had been removed, and adjustments made for optimal low- and high-frequency response. C: further revision made to take care of blocking, with rolloff capacitor transferred.



Fig. 1. To begin Microfusion process of making a record, lightweight book die is placed in simple jig and opened up.

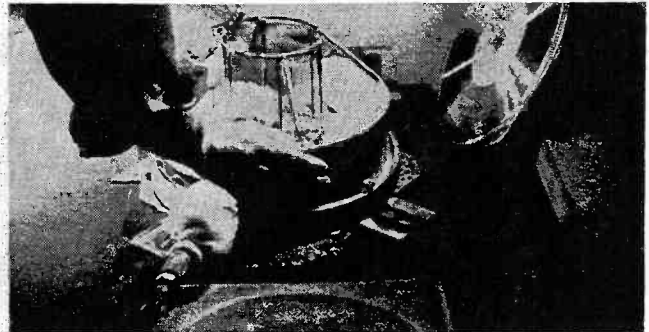


Fig. 2. Vinyl powder dispenser has perforated bottom. Compressed air vibrator shakes out the powder in an even layer.

## New Record-Pressing Process



Fig. 3. Powder depth is fixed by simple adjustment on dispenser. Labels fit on center pin under and over powder layer.

THE Microfusion process for making disc records is out of the development stage, and is now a commercial reality. Production equipment for the new record-pressing process was demonstrated recently at the offices of Cook Laboratories, Inc., in Stamford, Connecticut. It will be sold by Microfusion, Inc., a firm incorporated in Puerto Rico by Emory Cook, Lawrence Scully (of Scully cutting-lathe fame), and John O'Sullivan (Papermate pens).

With the new system, records are made directly from vinyl resin powder rather than solid plastic biscuits. All its advantages stem from that simple difference. To begin with, the raw material is less costly because the solid-biscuit forming operation is bypassed. In the conventional record-pressing system, these biscuits are preheated and then put in a large press under very high pressure, with steam as the heating

*Continued on page 43*



Fig. 4. Die is closed, then put in the press, and undergoes automatically controlled rapid heat and pressure cycle.



Fig. 5. After a fast cooling operation record is removed by its edges, given a visual inspection. Rejects are rare.

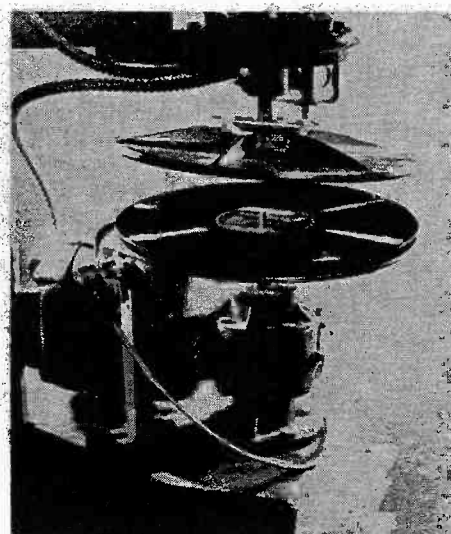


Fig. 6. This cutter trims edge evenly. There is no waste, since trimmings and rejects can be reprocessed to a powder.



IT is often convenient, when making calculations for equalizer-network values, amplifying-stage rolloff frequencies, etc., to use time-constant figures rather than cycles per second. A time constant for an RC network is defined as the product of the resistance (in ohms) times the capacitance (in

by J. Gordon Holt

# Time-Constant Nomograph

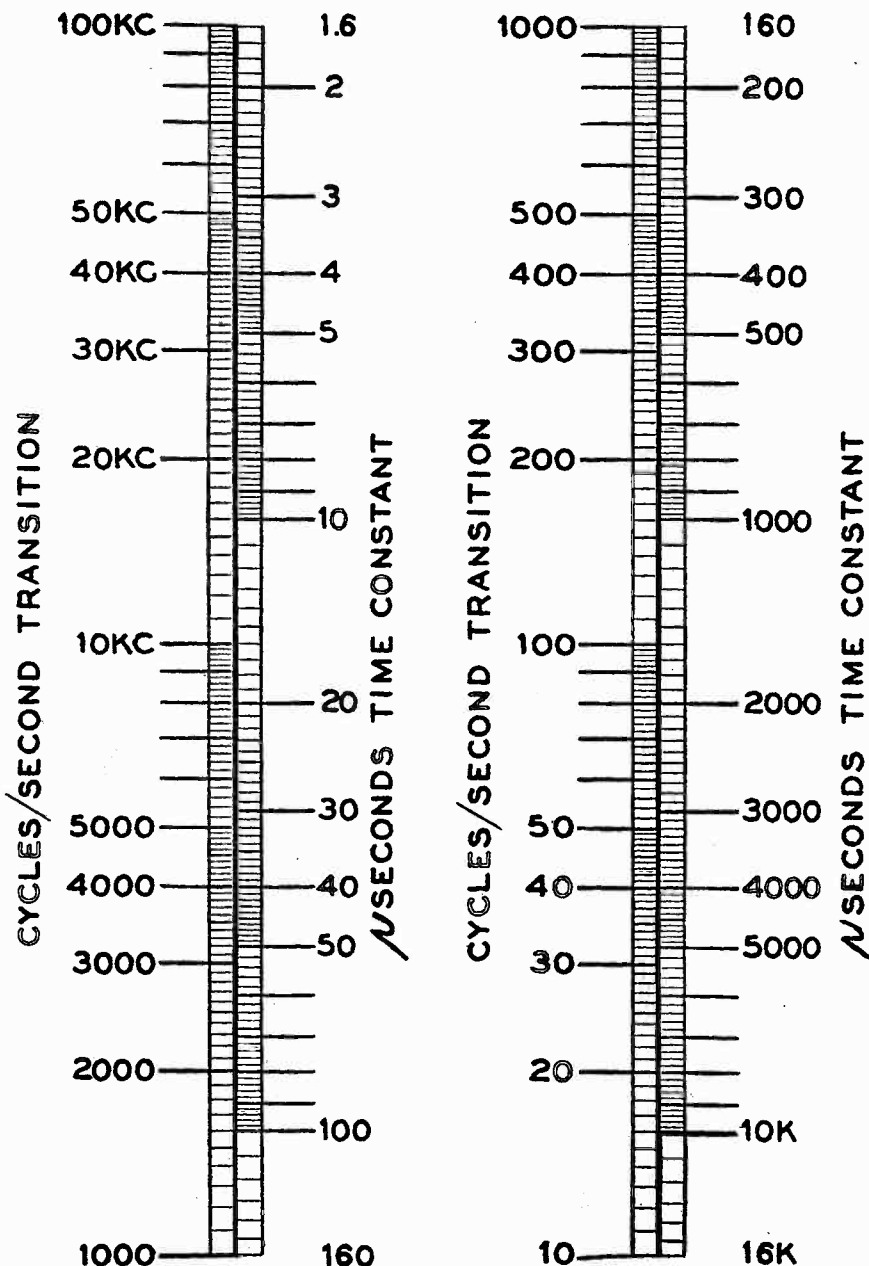
farads). The resultant figure in seconds is the time it takes for the capacitor to charge to 63.2% of a DC source voltage, when the resistor and capacitor are put in series across the source. Therefore, the time constant is intimately related to the frequency response of the network.

The frequency at which signal boost or attenuation becomes effective in such a network is commonly understood to be that at which the boost or attenuation reaches 3 db; normally, this is the frequency for which the resistance equals the capacitive reactance in magnitude. It is known as the transition frequency or *turnover frequency*. It is inversely proportional to the product of R and C, and, accordingly, inversely proportional to the network's time constant.

For simplified calculations, it is often sufficient to know only that frequency at which 3 db attenuation or boost occurs. Phono-equalization curves, for example, may be specified simply as a microsecond value for the 3 db transition frequencies. The scales on this page show direct conversions between microsecond time-constant values (resistance in ohms times capacitance in microfarads) and the corresponding cycles-per-second transition frequency.

A bass-boost network might be described as having a 318- $\mu$ sec time constant. Reading directly from the scales, we find this to be equivalent to a 500-cps turnover frequency. An interstage coupling network of .01  $\mu$ fd and 100 K total resistance would have a time constant of 1,000  $\mu$ sec, and—according to the chart—would roll off response below 160 cps.

To facilitate easy determination of attenuation at any specified frequency, the scales here are reproduced so that one octave equals one inch. Once the transition point has been located on the scales, a ruler may be used to find the number of octaves (inches) between that point and the second specified frequency. The *approximate* attenuation in decibels may then be readily calculated from the attenuation rate of the network.



# TRANSISTORS *in Audio Circuits*

by PAUL PENFIELD, JR.

*Va: Parameters; Equivalent Circuits*

IN part 4 of this series we were concerned with biasing transistors for operation as amplifiers. Because of the complicated nature of the transistor volt-ampere curves, it was necessary to use graphical methods to analyze and build circuits.

Once the transistor is biased properly, we can worry about the small AC signals that are really our main interest—the

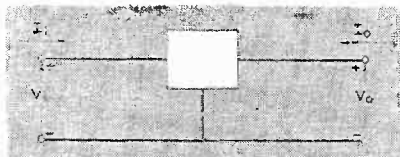


Fig. 1. Transistor as a 3-terminal box.

audio frequencies. Fortunately, the AC analysis is simple enough that it can be carried out on an approximate mathematical basis; no unwieldy, tiresome, graphical constructions are necessary. This month we will derive a simple equivalent circuit that can be substituted for the transistor as far as small signals are concerned.

Essentially, what we must do is approximate the *actual* transistor characteristic curves by a set of curves which can be expressed mathematically in very simple form. Then the problems reduce to simple algebra, which is both faster and easier than working graphically from a set of curves.

This approximate set of curves represents the transistor with reasonable accuracy *only in a certain region*. Thus, when working with the scheme to be outlined, you will get wrong and meaningless answers if you extend them beyond their applicable region. It is important to keep this in mind.

## Limitations

We wish to represent the transistor, in the linear region, by an equivalent circuit. The one we will derive is a *linear, low-frequency, small-signal, incremental equivalent circuit*. With this

we will be able to work with the audio frequencies of interest quite easily.

The circuit will be *linear* because, to simplify the math, we choose to ignore distortion-causing nonlinearities in the transistor curves.

It will be valid at *low frequencies* only because, for simplicity, we will not take account of the factors within the transistor which reduce the performance at high frequencies. Special high-frequency equivalent circuits are available for above the audio range.

The circuit holds only for *small signals*: that is, the audio frequencies of interest must not be too large. It will be clear later just how small they must be.

The circuit is *incremental* because we consider the transistor already biased in the linear region of operation. The audio frequencies of interest then are merely small excursions or *increments* from the DC quiescent values. The equivalent circuit we're after only accounts for the increments.

The circuit is *equivalent* because when substituted for the transistor under consideration, it yields equivalent results, provided the approximations outlined above are valid.

Our linear, low-frequency, small-signal, incremental equivalent circuit, then, is an approximation to the already biased transistor, used to allow a simple mathematical solution rather than a long, tedious graphical one. We substitute an easily handled mathematical approximation for the actual transistor curves. The sum and substance of the often misunderstood equivalent circuit is just that.

## Small-Signal Parameters

Up to this point we've been talking about "the" equivalent circuit. Actually, for each quiescent point, there are several different equivalent circuits, of several different types. We'll only bother with the most important ones.

In finding valid equivalent circuits, we decide to look at the transistor as a circuit element. What does the transistor represent to the rest of the circuit? Merely the voltages and currents that are associated with each of the three electrodes. To the rest of the circuit, the physics of transistor action is unimportant; what are important are the voltages and currents at the transistor terminals. We'll adopt the same attitude in deriving the equivalent circuit.

Let the transistor be represented for the moment by a little box with three leads, as in Fig. 1. Since we don't care what is inside, but only about the terminal voltages and currents, we won't confuse the picture by putting in the transistor symbol.

Which terminal is which in Fig. 1? We need not know this until later. But one is common to both the input and the output circuit, another is the input terminal, and the last one the output terminal. If the emitter were the common terminal, then the stage would be in the common-emitter, or grounded-

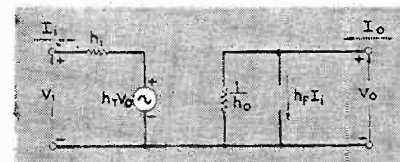


Fig. 2. Circuit for equations 1 and 2.

emitter, configuration. Similarly, the grounded-base transistor has the base lead common to the input and the output, the emitter at the input, and the collector at the output. And finally, the grounded-collector circuit has a common collector, a base input, and the emitter in the output circuit.

Consider the box in Fig. 1 as the transistor *already biased*. This means that the voltages and currents in Fig. 1 are automatically incremental values—not the absolute values. Thus our equiv-

alent circuit will be an incremental circuit.

The current and voltage directions shown in Fig. 1 are arbitrary, and may not coincide with the actual current directions or voltage polarities. For example, if in our work we discover that  $I_i$ , as shown, is negative, then we know that in fact the current is headed in the opposite direction.

Now we will assume that the relationships between the four variables ( $I_i$ ,  $I_o$ ,  $V_i$ , and  $V_o$ ) are linear ones—that is, each is equal to the sum of a constant times each of the other variables. This is equivalent to requiring that the curve families be merely straight lines, equally spaced. We ignore the curvings of the graph families, distortion, noise, etc.

It should be obvious that, once we choose to ignore distortion and noise, the resulting equivalent circuit cannot possibly give us any information about

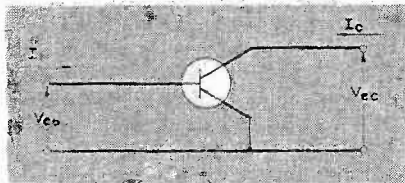


Fig. 3. Grounded-emitter case of Fig. 1.

them. These quantities have been "approximated away". This is one of the major limitations of the linear equivalent circuit.

At this point we're almost done. We only have to write the equations relating the four variables  $V_i$ ,  $V_o$ ,  $I_i$ , and  $I_o$ . We know from experience that we can specify two of them at will, and then the other two are automatically determined by the transistor. Let us say that we somehow set the incremental output voltages  $V_o$  and the input current  $I_i$  to some values, and want to express  $V_i$  and  $I_o$  as functions of them. Then our linear approximation says that

$$V_i = b_i I_i + b_v V_o \quad \dots (1)$$

$$I_o = b_f I_i + b_o V_o \quad \dots (2)$$

where the four constants, the so-called "h-parameters"  $b_i$ ,  $b_r$ ,  $b_f$ , and  $b_o$ , must be determined by testing the transistor.\* That is, once we decide on the form of the relationship (i.e., linear), and decide which variables are independent ( $I_i$  and  $V_o$ ) and which dependent ( $I_o$  and  $V_i$ ), we can take an actual transistor, bias it at the desired point, and then measure results to obtain numbers for the four parameters.

The  $b$  quantities are "operationally defined"; it is clear from the formulas how to measure them. For example, to

\*This terminology has recently been standardized by the Institute of Radio Engineers. These four quantities were formerly known as  $h_{11}$ ,  $h_{12}$ ,  $h_{21}$ , and  $h_{22}$ , respectively. The new subscripts stand for "input", "reverse", "forward", and "output".

determine  $b_f$ , we can set the output voltage equal to zero (just the AC part of it), perhaps by means of a large capacitor, and then vary the input current  $I_i$ , perhaps with a low-frequency sine wave. Then we simply measure the resulting sine wave at the output,  $I_o$ . The ratio  $I_o/I_i$  then gives  $b_f$ , as seen by Eqn. (2). The details of setting up a circuit to measure these quantities need not concern us here, but we should remember that they can be measured without too much difficulty.

We decided for no apparent reason to express the incremental variables  $V_i$  and  $I_o$  in terms of the other two. What if we had picked the two voltages to be functions of the two currents?

Again, a set of linear equations would have resulted:

$$V_i = r_i I_i + r_o I_o \quad \dots (3)$$

$$V_o = r_f I_i + r_e I_o \quad \dots (4)$$

There are four other sets of parameters produced by picking different sets of independent and dependent variables. The only reason one of these six representations is preferred is a practical one—for present-day transistors, it is easiest to measure the quantities in the first set, the  $b$ -parameters. For that reason, the other parameter sets at present are mainly of academic interest. We'll follow through on the  $b$  set only.

### Equivalent Circuits

Going back to Eqns. (1) and (2), we have a relatively simple mathematical representation of a transistor, in a small region surrounding its bias point.

Another way of working with these two equations is drawing an electrical circuit that satisfies them. If we can find such a circuit, then the circuit or the equations can equally well describe the transistor. This circuit will then be an "equivalent circuit", equivalent to the biased transistor. Furthermore, it will be linear, because its equations are linear; it will be incremental because its voltages and currents are assumed to be incremental; it will hold for small signals; and it is low-frequency, because the test to find the parameters was

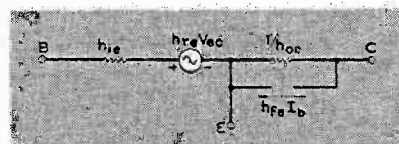


Fig. 4. A grounded-emitter equivalent circuit with two fictitious generators.

carried out with audio-range frequencies. Thus, it is the circuit we've been looking for.

Fig. 2 is such a circuit. It is clear from looking at it that Eqns. (1) and (2) are satisfied. The arrow on the right at one point, marked  $b_f I_i$ , is a fictitious current generator. By this we mean the current through that part of the cir-

cuit is constrained to be exactly the value marked, regardless of what voltage may be across it. It is just the opposite from a fictitious voltage generator (such as the one marked  $b_r V_o$  in Fig. 2), which automatically fixes the voltage regardless of the current through it.

Equivalent circuits can also be derived from the other parameter sets, such as

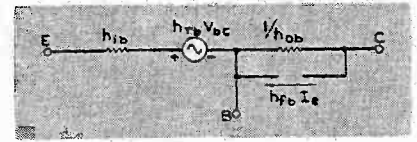


Fig. 5. Common-base equivalent circuit.

Eqns. (3) and (4). These are seldom used, however, and won't be given here.

So far we haven't bothered to consider which terminal of our "black box", Fig. 1, is which. The preceding analysis held for all three possible cases: grounded-emitter, grounded-base, and grounded-collector. The grounded-emitter case is by far the most important of the three, although the less-used grounded-base case was analyzed first and is still considered by many to be more "fundamental". In part 3 of this series, the grounded-emitter graphs were the only ones covered, indicating the importance of this configuration.

If the common element is the emitter, transistor action occurs when the base is used as the input, and the collector as the output. Then our vague black box becomes the transistor circuit in Fig. 3 (neglecting the bias network for the moment); the four variables  $I_i$ ,  $V_i$ ,  $I_o$ , and  $V_o$  become  $I_b$ ,  $V_{be}$ ,  $I_c$ , and  $V_{ce}$ , respectively. For the grounded-emitter case,  $b$ -parameters are given an additional subscript "e". Thus,

$$V_{be} = b_{ie} I_b + b_{re} V_{ce} \quad \dots (5)$$

$$I_c = b_{fe} I_b + b_{oe} V_{ce} \quad \dots (6)$$

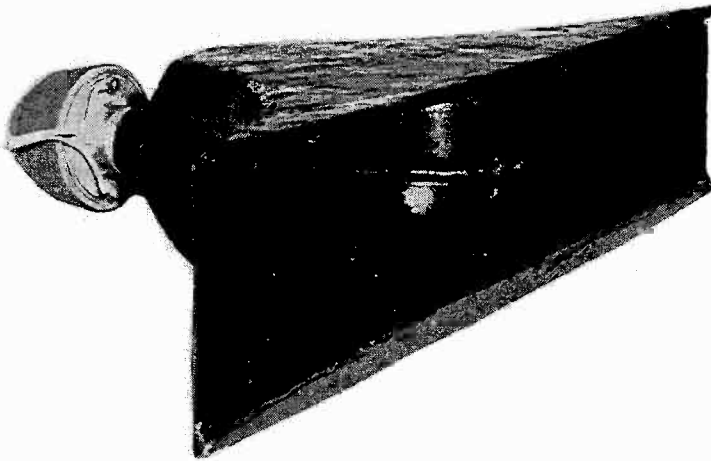
are the equations which describe this operation. These relationships are also described by the equivalent circuit of Fig. 4. This circuit represents, for small signals of audio frequency, the actual biased transistor.

Often transistors are described by giving the four numbers (the  $b$ -parameters) on the manufacturer's specification sheet. Some manufacturers, however, describe the transistor by means of the grounded-base  $b$ -parameters. In general, the transistor can be equally well specified by either, in the sense that if one set is given, the other set can be derived. The formulas are not very complicated, and will be given in the second part of this article. To simplify these transformations, it was assumed that  $(1 + h_{re}) \gg (b_{ie} b_{oe} - b_{fe} b_{rb})$  which for modern transistors is quite all right. To find the  $b_o$  set when the  $b_b$  set is given, and vice versa, use the appropriate parts of the chart.

Continued on page 42

# Home-Built HIGH-FREQUENCY Horn

by CHARLES F. BALDWIN



A RECENT modification in my speaker system required a high-frequency exponential horn with characteristics not available from commercially produced units. I needed a 350-cps horn for a 500-cps crossover, with a 7/8-inch-diameter throat and a suitable coupling which would accept a University T-30 compression driver. The horn had to be about 20 3/4 in. wide at the mouth. After a long period of consideration, it became evident that the only hope of attaining these desired qualities rested in some rusty algebra and geometry, and a pair of tin snips.

Rather than delve too deeply into the complexities of the calculations, only a brief description of the equations and the terms will be discussed. The two principal factors that must be considered in horn design are the rate of flare ( $X_a$ ) and the area of the mouth (large end) of the horn.

The expansion formula for an exponential horn is

$$S = S_0 e^{mx}$$

where  $S$  is the horn cross-sectional area at distance  $x$  from the small end, or throat;  $S_0$  is the horn cross-sectional area at the throat;  $e$  is the natural, or Napierian, base of logarithms, a quantity equal approximately to 2.7183; and  $m$  is the flare constant. This flare constant,  $m$ , obviously determines how fast the horn expands, and this in turn de-

termines the low-frequency cutoff of the horn. A horn that expands quickly will not handle frequencies as low as one which expands slowly.

If the areas in the formula above are in square feet, and the distance  $x$  is in feet; and further, if the speed of sound in air is taken as 1,100 ft. per sec., then the  $m$  required for a given cutoff frequency  $f_c$  is  $m = f_c/87.3$ . The flare rate,  $X_a$ , is the distance along the horn axis in which the cross-sectional area doubles, Fig. 1, and it is related to the flare constant  $m$  in the following manner:  $X_a = 0.6931/m$ . Combining the two latter formulas,

$$X_a = \frac{0.6931}{f_c/87.3}, \text{ or } X_a = \frac{61.1}{f_c}$$

where  $X_a$  is in feet and  $f_c$  is in cps. Thus, for a bass horn whose cross-sectional area doubled every two feet of length, the theoretical cutoff frequency would be about 30 cps. For a high-frequency horn with  $f_c$  of 500 cps,  $X_a = 61.1/500 = 0.122$  ft., or 1.47 in.; the cross-sectional area should double at length intervals of not less than 1.47 in.

The second limitation on horn performance is the mouth area. It has been found that the mouth diameter of a circular cross-section horn must be equal to at least 1/2 the wave length of the lowest frequency to be reproduced, for

good performance down to that frequency. With a 300-cps cutoff frequency, for example, 1/2 of the maximum wave length would be 14.7 in. This would require a circular mouth area of 169 sq. in. Fortunately, the mouth need not be circular in shape provided its area is maintained.

Table 1 provides the information necessary to design high-frequency exponential horns of types most frequently used. It is recommended that the cutoff frequency be at least 150 cps below the operating crossover frequency,  $f_c$ . At lower cutoff frequencies this gives a safety margin somewhat greater than is normally used, but at lower frequencies an adequate safety margin is more important.

Construction of such a horn is not too difficult. Careful planning and layout will facilitate assembly and prevent many irksome errors and delays. Tem-

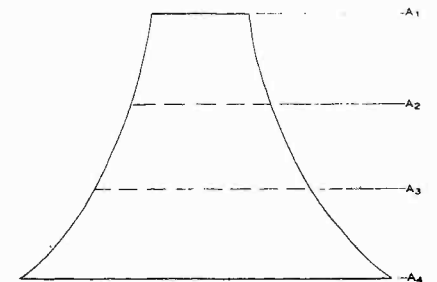


Fig. 1. In an exponentially expanding horn, cross-sectional area doubles at equal length intervals:  $A_2 = 2A_1$ ,  $A_3 = 2A_2$ ,  $A_4 = 2A_3$ , etc. Distance interval between doubled areas is rate of flare, which is related to cutoff frequency.

plates of paper and wood will provide an immeasurable service in forming and fitting the horn sections.

Galvanized iron was used for my own horn, but any 16- or 20-gauge sheet metal which solders easily will satisfy the requirements.

The procedure I followed was to cut the four panels as accurately as possible and fasten them to the wooden templates with nails. Even though the nail holes were later filled with solder, it is observed, in retrospect, that C clamps

Table 1

$f_r$	$\lambda$	$\frac{1}{2}\lambda$	Mouth Area	$X_d$	$f_o$
250 cps	52.8 in.	17.6 in.	243 sq. in.	2.93 in.	400 cps
300	44.0	14.7	169	2.44	450
350	37.7	12.6	125	2.09	500
400	33.0	11.0	95	1.83	550
450	29.4	9.8	75	1.63	600
500	26.4	8.8	61	1.47	650
550	24.0	8.0	50	1.33	700
600	22.0	7.3	42	1.22	750
650	20.3	6.8	36	1.13	800
700	18.7	6.3	31	1.05	850
750	17.6	5.9	27	.98	900
800	16.5	5.5	24	.92	950
850	15.5	5.2	21	.86	1,000

would have accomplished the same results in a neater manner. The four sections, after being carefully fitted, were connected with a generous application of solder to assure a strong, airtight bond. For the sake of appearance, solder

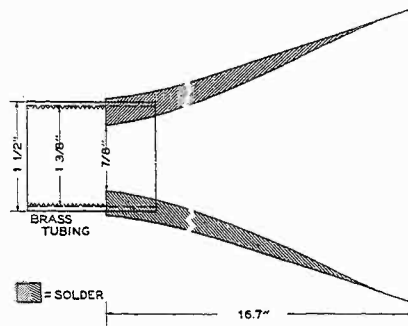


Fig. 2. Throat and coupler construction. was used to build up the 90° inner angles into smooth rounded seams. The throat and a satisfactory connector for the driver unit will be responsible for most of your construction

problems. The throat of my horn, Fig. 2, was enlarged to 1½ in. from the 7/8-inch diameter opening required by design specifications for driver loading. A short section of brass tubing (1⅜ in. inside diameter) was inserted into the enlarged throat and soldered into place. The inside of the tube had been covered with approximately 1/8 in. of solder, and tapped to accept the 1⅜ × 32 threads on the driver unit. The throat end of the tube was built up to 7/8 in. diameter with solder. Smoothing out the solder throat and driver connection was done with a low-heat iron. This part of the assembly is quite critical, and great care should be taken to assure an airtight driver connection. I used a rubber gasket between the driver and the throat.

A gradual slope of solder from the throat to the horn itself will provide the smooth transition from circular to rectangular and from 7/8 to 1½ in. Since the driver unit is rather heavy (the T-30 weighs about 11 lbs.), it is recommended that the connector be rein-

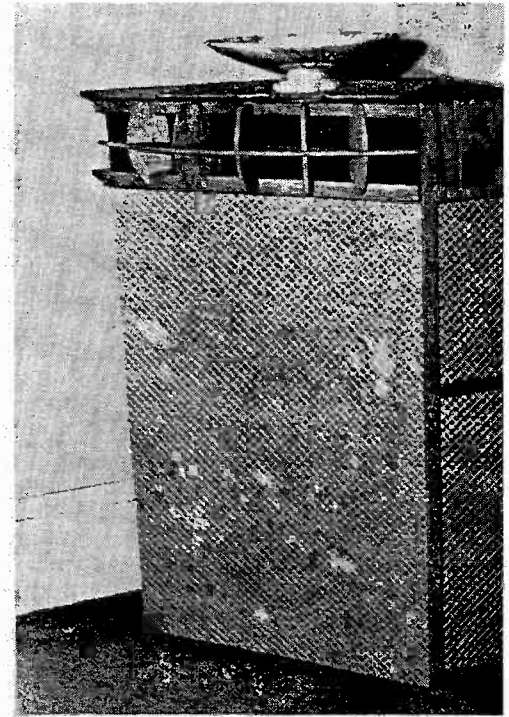


Fig. 4. Wood grille conceals the horn.

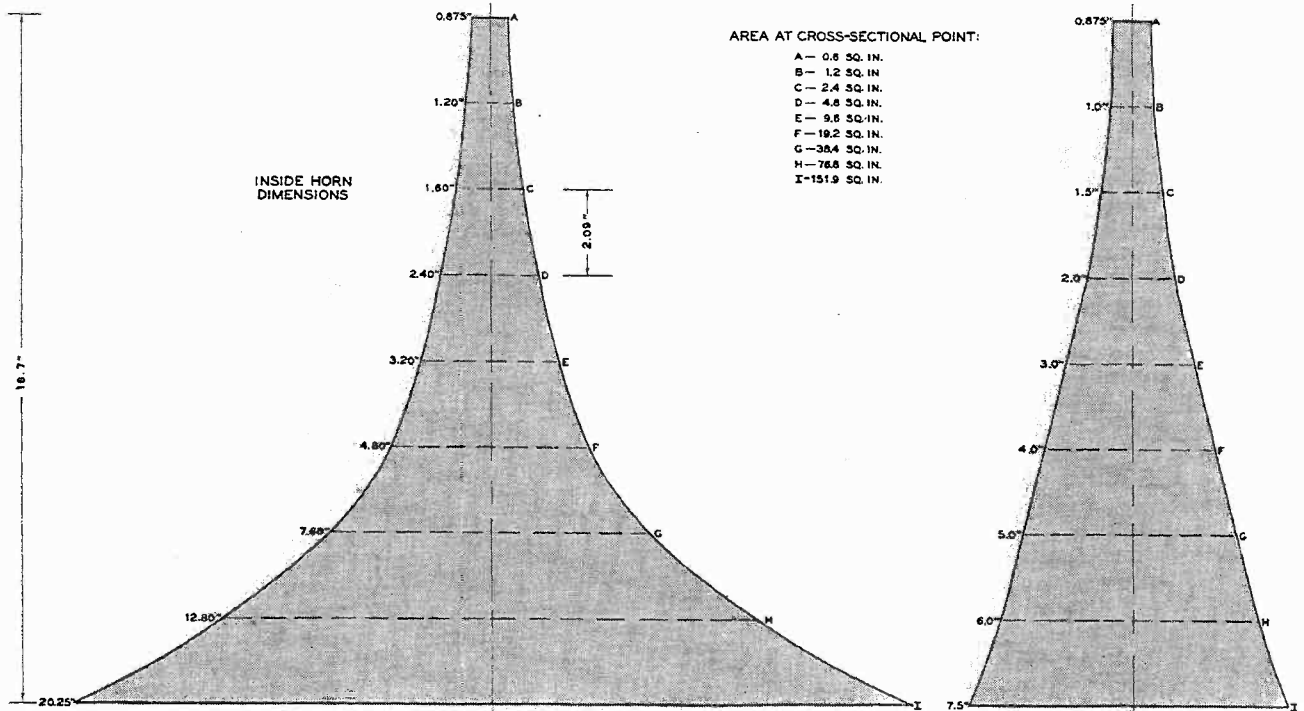
forced by a generous application of solder to the tube exterior.

The final touch is deresonating the horn. I encased the horn exterior in plaster of Paris, but again, in retrospect, tar, pitch, or roof coating would be easier to apply, neater in its application and result, and every bit as effective.

Fig. 3 is a diagram of my 350-cps horn. Although no tests have been con-

Continued on page 41

Fig. 3. How the author arranged vertical and horizontal expansion of his 350-cps horn, for 500-cps crossover.





### Turntable Dust Cover

The main purpose of the plastic covers which are sold for phono player units is to prevent dust from settling onto the turntable while the player is not in use, and from being subsequently transferred to the reverse side of the next record placed on the turntable.

A much less expensive form of dust cover which effectively serves the same purpose can be made by cutting a 12½-inch-diameter disc from a sheet of heavy plastic (such as that used for the outer cover on Westminster *Westlab* discs), and then cutting a small hole in the center of this to fit over the turntable spindle. One side of this protective cover can then be marked "up" with a grease pencil, so that the clean side is always placed downward when the cover is replaced on the turntable.

J. Gordon Holt  
Great Barrington, Mass.

### Uses for Aluminum Foil

Sometimes the audio experimenter has to resort to temporary or makeshift devices when his parts stock is running low. One versatile material to keep on hand for such occasions is aluminum foil—the kind that comes in rolls and is available at the grocery store.

Generally speaking, aluminum foil can be used for most applications where electrostatic shielding is called for. Here are three uses I have discovered.

1) In the absence of tube shields, the foil can be wrapped around a tube, and a piece of wire soldered to it and circuit ground. Leave a large opening at the top for ventilation.

2) The foil can be cut into a strip from ⅛ to ¼ in. wide. This strip is spiraled around a piece of insulated wire to produce a shielded cable. The capacitance of such a cable is rather high, but in low-impedance circuits it works well. It can also be used satisfactorily in high-impedance circuits if the length is kept to a minimum. The cable can be dressed up and insulated by slipping a piece of spaghetti tubing over it.

3) Aluminum foil can be used to cover a sturdy cardboard box, giving a chassis that's both easy to work with and

very inexpensive. It is particularly handy for experimental circuits which are to be torn down later.

Standard sheet-metal thicknesses of aluminum cannot be soldered by ordinary methods; however, aluminum foil can be tinned with rosin-core solder and a good hot iron. Don't expect the joints to look pretty, but they're quite durable. Just solder as rapidly as possible so as not to melt the foil.

Norman V. Becker  
Hollywood, Calif.

### Stylus Overhang

Not having the facilities nor material described in Dr. Seagrave's article in the January issue, I resorted to the following expedient.

Using a ⅜-inch-thick piece of Masonite 2 in. square, I punched a mark in the approximate center. Setting my

dividers accurately to the amount of overhang desired for my particular arm, I scribed a short arc, using the punch mark as the pivot point. The hole for the turntable pin was then drilled accurately through the punch mark. The Masonite template was then placed over the turntable pin and the stylus adjusted to come tangent to the scribed arc.

The slight vertical error caused by the difference between the height of the ⅜-inch Masonite and a phonograph record can easily be corrected if it is considered excessive.

A. J. Neil  
Farmingdale, N. Y.

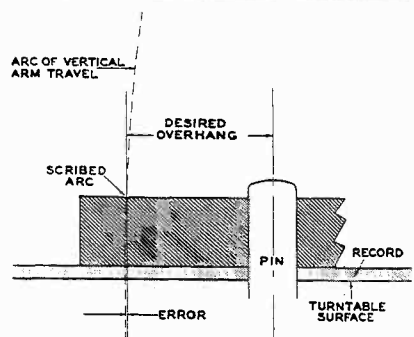
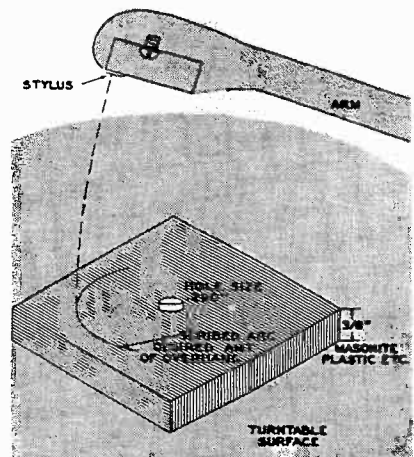
### Impedance Mismatch and Distortion

Distortion in the higher frequencies, to which the human ear seems particularly sensitive, sounds harsh and raspy and can be most irritating. The cause of such distortion can be very difficult to find. I was pleased in one case to find the distortion in an unexpected place and to be able to cure it easily and completely.

In a table-model television receiver I have, the raspiness could be subdued only by turning the tone control to its bass position, but that meant a sacrifice of range and was no solution. My first suspicion was that the speaker's voice coil was rubbing, but substituting other speakers, large and small, did not help. Replacing the power-output tube did not have any effect either.

Some time later I found a cure accidentally when I added a second speaker to improve bass reproduction. When the second speaker was connected in parallel with the small one in the set, the distortion vanished. I assume, therefore, that the distortion was caused by an impedance mismatch.

This idea found support when I bought a circuit diagram for the set. The schematic reveals that the same chassis is used for three receivers of varying price. Cabinets range from my table model up to console size. My set uses one speaker, the small console uses two in parallel, and the large console uses three. I would guess that the engineers who designed this set compromised on



How to obtain correct stylus overhang distance with an insignificant error.

an impedance figure for two speakers, failing to consider possible consequences of loading the output transformers differently in the other models. It is probably wiser to buy the table model, as I did, and add one large speaker in an adequate cabinet, than to have the much-ballyhooed large console with its three medium-size speakers and restricted baffle area.

Harry L. Wynn  
Derry, Pa.

### Eliminating Acoustic Feedback

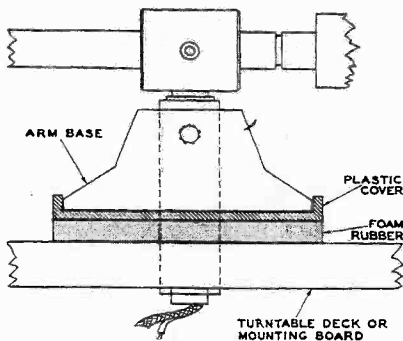
The familiar remedy for low-frequency acoustic feedback is the use of acoustic isolating material around the turntable mounting board to isolate it from the loudspeaker system. This remedy eliminates only the feedback occurring at medium volume levels. Feedback can be eliminated completely at all volume levels by isolating the pickup arm from the mounting board, in addition to isolating the mounting board itself.

If the following steps are followed carefully, no difficulty should be experienced with tracking error.

1) With the arm mounted, outline its base on the mounting board. Then remove the arm.

2) Obtain a flexible plastic cover (such as those used as covers of small plastic cheese containers) that will fit snugly under the base of the arm. Cut a hole in the cover so that wires from the arm can pass through.

3) Glue the cover to a piece of foam rubber  $\frac{1}{4}$  in. thick. ("Elmer's Glue



Acoustic cushion for pickup arm base.

All" should be used because it will stick well to the plastic.)

4) Trim the foam rubber to the same size as the plastic cover. Don't forget to extend the hole you made in the plastic cover through the foam rubber.

5) Glue the foam-rubber side of the assembly to the mounting board within the arm-base outline drawn in step 1.

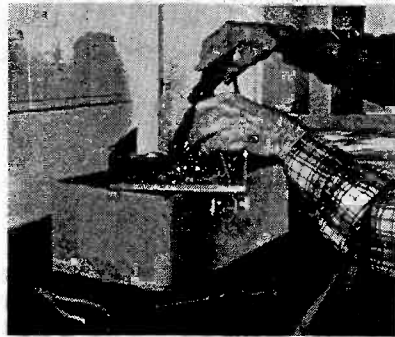
6) Snap the arm into the plastic cover.

I found that this remedy not only eliminated acoustic feedback, but it also reduced the audibility of turntable rumble.

A. Michael Noll  
Newark, N. J.

### Construction Support

An ordinary cardboard box makes a convenient stand for supporting a radio or amplifier chassis upside down while



Cardboard box makes a chassis support.

working on it. Pick a size that will fit between the components on the top, so that the chassis rests on the edges of the box. The carton in which kits arrive is often just the right size.

L. E. Johnston  
Madison, Wis.

### Refrigerator Enclosure

Don't dispose of that old refrigerator that has been standing idle in your basement or garage. Because of its heavy, rigid construction and internal volume (6 to 14 cu. ft.), it can serve as a bass-reflex or infinite-baffle loudspeaker enclosure. While specific details for converting the "cooler" into a speaker enclosure will vary with the individual refrigerator, the general procedure is as follows:

1) Remove the door and all interior parts such as shelves, trays, drawers, and so forth. Plug all screw holes left after the interior parts have been removed.

2) Fasten wooden cleats to the top, bottom, and sides. The loudspeaker baffle board will be attached to these cleats later.

3) Fix the necessary padding to the interior surfaces of the refrigerator.

4) Cut the baffle board (with a port of the proper size if for bass reflex, or without a port if for infinite baffle), mount the speaker or speakers, and screw the baffle board to the cleats.

5) Attach a grille cloth to a decorative wooden frame which, in turn, is attached to the front of the enclosure. Some ingenuity will be required here. The frame can be painted to match the exterior of the refrigerator.

When the last step is completed, you

#### AUDIO AIDS WANTED

That's right—we'll pay \$5.00 or more for any short cut, suggestion, or new idea that may make life easier for other AUDIOCRAFT readers, and which gets published in our Audio Aids department. Entries should be at least 75 words in length, and addressed to Audio Aids editor. No limit on the number of entries.

will have an acoustically excellent enclosure built with a minimum of expense. It can be used where furniture appearance is not a primary consideration.

Bernard J. Finnegan  
Los Angeles, Calif.

### Bulk Tape Eraser

The item by Lionel C. Holm in the November issue on constructing a bulk tape eraser was very interesting, especially since we had just finished making a similar one. The following experience may be of interest to others making it.

We used a rather small transformer, the only one available here. Rather than using the primary, we wound a coil of #30 SWG wire to fill the space. It amounted to 3,200 turns. The outer arms of the core were bolted together.

When we tried it out, it didn't have a strong enough field to erase one track completely. There was always a little sound left and, with metal reels, the arms of the reel interfered with the field. We decided to try to resonate the coil with capacitors in series with it. As we could not find any formula for determining the inductance of a choke with such a large air gap, it was decided to experiment. We added capacitances of 2  $\mu$ fd, one at a time, and tested the result. The capacitors were oil filled, 700-v DC. The field increased markedly after each addition until, at 8  $\mu$ fd, the coil started to shake the table. With this capacitance it does a remarkable job, erasing both tracks at once.

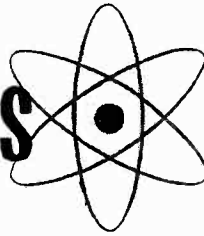
It is difficult to move a steel reel over it because of the intense attraction, so we are now making a spindle on which to turn the reels. A piece of  $\frac{1}{8}$ -inch Bakelite is screwed to tapped holes in the outer arms of the transformer core with flat-head brass machine screws. The spindle is placed in the Bakelite in such a manner that the outer portion of the tape reel passes across one gap and the inner portion across the other. After the reel has been slowly rotated about  $1\frac{1}{2}$  times, the spindle is removed and the reel is slid off the Bakelite slowly. A plastic or wooden box can be made to enclose the transformer and capacitors. An ON-OFF switch can be attached to the side of the box.

As the heat generated using capacitors is considerably greater than without them, it is advisable to use the spindle so the reel can be rotated more easily, taking less time. Two or three seconds is enough for one reel.

One word of caution: the capacitors are left with a very nasty charge and they should either be discharged after use or bridged with a high-resistance bleeder.

Gordon W. Richmond, M.D.  
Masjid-i-Sulaiman, South Iran

# BASIC ELECTRONICS



by Roy F. Allison

## XVb: Parallel Resonance

**D**URING the first part of this chapter, parallel LC networks were discussed for the ideal case; that is, resistance was assumed to be absent. In this analysis the resonant frequency was found to be that at which the two reactances are exactly equal in magnitude, the same as for the series-resonance case. At that frequency the two branch currents are equal in value and opposite in phase. No current flows in the external circuit at resonance and, accordingly, the impedance of the combination is infinitely high.

It was stated also that resistance is always present to some degree in such a circuit, even if it consists only of the DC resistance of the coil winding. Resistance slightly changes the phase of the current through one or both branches, so that the currents do not cancel at the same frequency as before. Therefore, the added resistance shifts the resonant frequency slightly. In the illustration given (Fig. 4, reproduced here), each reactance was 100 ohms at the resonant frequency, and the resistance was 10 ohms. This shifted the resonant frequency about 0.5%.

If the resistance had been larger, it obviously would have shifted the phase of the inductive-branch current further

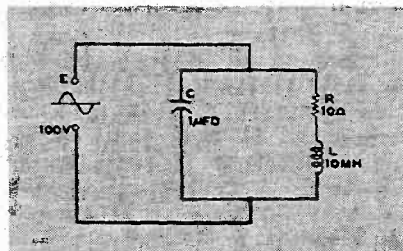


Fig. 4. Practical LC circuit has  $R$  in  $L$  branch, representing choke resistance.

away from  $-90^\circ$ , and so would have caused a greater change in the resonant frequency. If it had been smaller, on the other hand, it would have caused less current phase shift, and would have produced a smaller change in the resonant frequency. This leads us to recall that useful ratio  $Q$ , defined in a previous chapter as the ratio of inductive reactance to series resistance:  $Q = X_L/R$ , or  $2\pi fL/R$ .

The  $Q$  of the circuit shown in Fig. 4 is, at resonance,  $100/10$ , or 10. If  $R$  is reduced to 5 ohms,  $Q$  increases to  $100/5$ , or 20; if  $R$  is increased to 40 ohms,  $Q$  decreases to  $100/40$ , or 2.5.  $Q$  at resonance is a usefully simple way to specify how nearly an LC circuit approaches the ideal resistance-free case, and with what margin of error we may

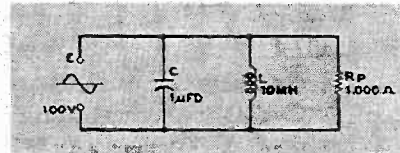


Fig. 5. Parallel  $R$  of value  $X_L$  times  $Q$  is equivalent to series  $R$  of  $X_L/Q$ .

apply the simpler ideal-case formulas. For example, we know from Fig. 4 that with a  $Q$  of 10,

$$f_o = \frac{1}{2\pi\sqrt{LC}}$$

will give us the parallel resonant frequency with an error of about 0.5%. If this is close enough (and it usually is), then this simple formula may be used when the  $Q$  at resonance is 10 or greater. Often the error will be small enough for practical cases with  $Q$ 's as low as 4 or 5. It should be mentioned that, since  $X_C \doteq X_L$  at resonance,  $Q$  is also very nearly equal to  $X_C/R$  at resonance.

As the resistance in either branch decreases in value—in other words, as  $Q$  increases—the phase of the current in that branch at resonance becomes closer to  $90^\circ$  from the applied voltage, and more nearly in opposition to the current in the other branch. Current through the source, therefore, becomes less and less, and the circulating current increases toward its maximum value. The minimum value of external current (when  $R$  is zero) is, of course, zero; the maximum value of circulating current is  $E/X_L$  or  $E/X_C$ . These values were determined previously for the ideal case, in which  $R=0$ . It is intuitively apparent that the external current at resonance is directly related to  $Q$ : the greater the value of  $Q$ , the smaller the source current. And, because the impedance is equal to the source voltage divided by the source current, the maxi-

imum impedance at resonance is also directly related to  $Q$ : the greater the value of  $Q$ , the greater is the maximum impedance. By simple algebra it is found that within a small margin of error,  $Z$  and  $I_s$  at resonance are

$$Z = QX_L \text{ or } QX_C$$

$$I_s = \frac{E}{QX_L} = \frac{I_L}{Q}, \text{ or}$$

$$I_s = \frac{EX_C}{Q} = \frac{I_C}{Q}$$

Thus, at resonance, the parallel impedance is the reactance of either branch multiplied by the value of  $Q$ . The external, or source, current is the circulating current (found by dividing the source voltage by the reactance in either branch) divided by the value of  $Q$ . For the circuit in Fig. 4,  $Z$  at resonance is  $10 \times 100$ , or 1,000 ohms;  $I_s$  is  $1/10$ , or 0.1 a. If  $R$  were decreased to 1 ohm,

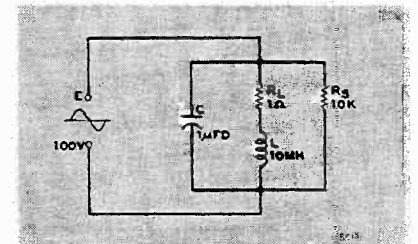


Fig. 6. Transformation example circuit.

$Q$  would become 100. Then  $Z$  at resonance would be  $100 \times 100$ , or 10,000 ohms;  $I_s$  would be  $1/100$ , or .01 a.

It is easily seen that the circuit in Fig. 4 has characteristics strikingly similar to those of the circuit in Fig. 5; in fact, the two are very nearly equivalent in their effects. If  $R_p$  were not present in Fig. 5, it would be the same ideal circuit as would be obtained by omitting  $R$  from Fig. 4. At resonance the impedance would be infinitely high and the source current would be zero. By paralleling  $R_p$  with the resonant circuit, Fig. 5, we have reduced the maximum impedance to 1,000 ohms and increased the minimum source current to 0.1 a, just as adding the series resistance did in Fig. 4.

In order to make the circuits correspond, we note that in each case  $Z$  at resonance must be equal to  $QX_L$ . For



Fig. 5,  $R_p = Z$  at resonance; accordingly,  $R_p$  must equal  $QX_L$  or, what is the same thing,

$$R_p = \frac{X_L^2}{R} = \frac{X_C^2}{R}$$

Then it follows that  $Q$ , in terms of the circuit components in Fig. 5, is equal to  $R_p/X_C$  or  $R_p/X_L$ . A resistance in parallel with the choke in an LC circuit, and of  $Q$  times its reactance at resonance, has the same effect as a resistance in series with the choke and of  $1/Q$  times its reactance at resonance.

This is a convenient relationship because it often helps to simplify calculations. In Fig. 6, for example, is shown an LC circuit with both series and parallel resistance; values for  $L$ ,  $C$ , and  $E$  are the same as those in Figs. 4 and 5, because we have already computed the reactances at resonance (100 ohms) and the resonant frequency (1,592 cps).  $R_L$  is the series winding resistance, and

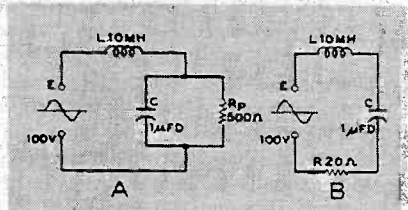


Fig. 7. Equivalent series LC circuits.

$R_s$  is the shunt resistance in the circuit. What is  $Q$ , and what is the total impedance at resonance? We can begin by transforming  $R_L$  into an equivalent resistance,  $R_p$ , in parallel with  $R_s$ :  $R_p = X_L^2/R_L = (100)^2/1 = 10,000$  ohms. This, in parallel with  $R_s$  (also 10,000 ohms), gives an equivalent shunt resistance of 5,000 ohms, which is the impedance at resonance.  $Q = R/X_L = 5,000/100 = 50$ .

In the same way, a shunt resistance across an element of a series LC circuit can be transformed into an equivalent series resistance. The ratio of  $X_L$  or  $X_C$  at resonance to  $R_p$ , in Fig. 7A, is  $100/500$ , or 1 to 5. Therefore it may be replaced for purposes of calculation with an equivalent series resistance,  $R$ , whose value is  $1/5$  the magnitude of  $X_L$  or  $X_C$ :  $100/5$ , or 20 ohms. The new circuit (Fig. 7B) is obviously less confusing than the original; it is now a simple LCR circuit that can be solved almost by inspection. If there had been another series resistance in the circuit, it and the equivalent resistance would have been added to obtain the total effective series resistance, and the total would have been used in calculations. In Fig. 7B,  $Q = X_L/R = 100/20 = 5$ . Impedance at resonance is  $R$ , 20 ohms. Source current at resonance is  $E/R = 100/20 = 5$  a. Voltage across each reactance is  $E_L = IX_L = 5 \times 100 = 500$  v; it is also  $EQ$ ,  $100 \times 5 = 500$  v.

We have seen that there is a marked rise in current at frequencies near reso-

nance in a series LC circuit, and a similar rise in impedance near resonance in a parallel LC circuit. The amplitude of the rise in both cases is proportional to  $Q$ ; the higher the values of  $Q$ , the greater

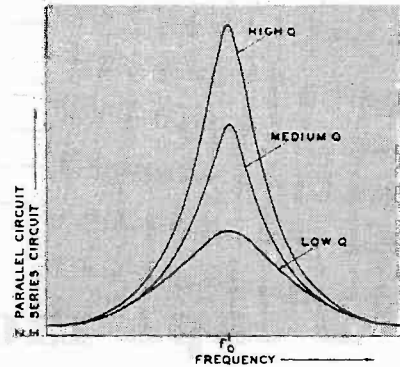


Fig. 8. How  $Q$  affects resonance peak.

is the maximum value of  $I$  or  $Z$ , as the case may be, and the more sharply the rise occurs. Fig. 8 demonstrates this clearly. It demonstrates also that near  $f_0$ , the circuit resistance has a major effect because it determines  $Q$ . At frequencies far from  $f_0$ , however, the curves in Fig. 8 are very close, indicating that  $Q$  has little effect on  $Z$  and  $I$  at those frequencies. It follows that  $R$  can be neglected in calculations for LC circuits far off resonance, particularly if  $Q$  at resonance is 5 or more.

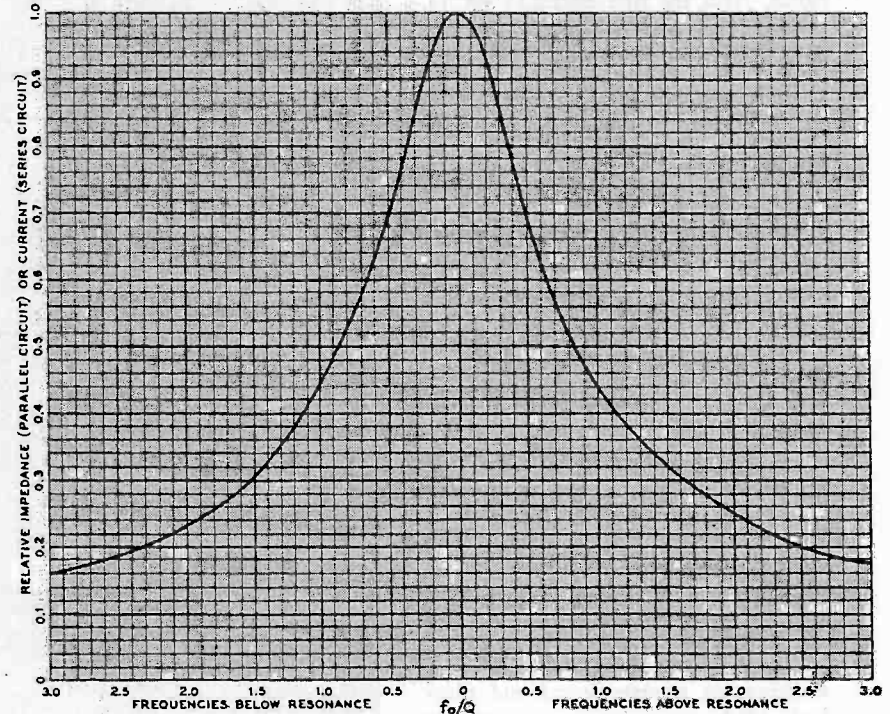
Since  $Q$  determines the sharpness of the resonant peak, it has a direct bearing on the frequency range over which the peak is uniformly effective; that is, the *band width* of resonance. Band width is usually considered to be that range of frequencies situated between

the points on either side of resonance at which the response is decreased by 3 db, and these points are those at which the current or impedance is reduced to 0.707 times the maximum value. If  $f_0$  is the resonant frequency, then the band width in cps is  $f_0/Q$ . Assuming a parallel resonant frequency of 1,000 cps and a  $Q$  of 20, the band width would be  $1,000/20$ , or 50 cps. The impedance at 975 cps and 1,025 cps (25 cps each side of the resonant frequency) would be only 0.707 times the resonant impedance. If  $Q$  were increased, the resonant impedance would be proportionately higher, but the band width would be proportionately smaller. With a given tuned circuit, obviously, the product of band width and  $Q$  is constant; if one increases, the other must decrease.

This leads to the concept of a universal resonance curve. It can be shown mathematically that the shape of any LC resonance curve is basically similar to any other, if the scales are adjusted so that their maximum and minimum points correspond. Such a curve is given in Fig. 9. The vertical scale is graduated in units up to 100, indicating the per cent of maximum resonant impedance (for parallel LC circuits) or per cent of maximum resonant current (for series LC circuits). The horizontal scale is centered around resonant frequency  $f_0$  and is graduated to the right and left in units of  $f_0/Q$ . For a frequency  $2f_0/Q$  cps higher than  $f_0$ , for example, the current in a series LC circuit is about  $1/4$  of the resonant current. The curve shown is precise for a  $Q$  of 25, but

Continued on page 43

Fig. 9. A universal resonance curve; see text for information on how to use it.



Courtesy Terman, F. E., *Electronic and Radio Engineering*, 4th Ed.

by JOHN J. STERN, M.D.

# a tape monitor switch

SOME of the newer preamplifier-control circuits are now arranged so that the owner of a three-head tape machine can use his hi-fi system for monitoring what actually goes on the tape while recording. This is usually accomplished with a separate TAPE MONITOR switch, which does two things: 1) opens the normal straight-through signal path in the control unit directly after the tape-output jack; and 2) transfers the tape-input jack from its normal connection point, preceding the selector switch, to the point at which the circuit was opened. Then the control unit is effectively separated into two sections, with the tape recorder in series between them. The first section, including the preamp-equalizer and input-selector switch, feeds the tape machine's record amplifier and record head; the second section receives the signal from the tape-playback head and its amplifier. In the

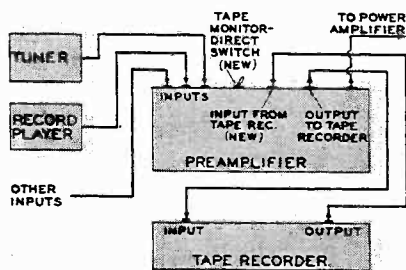


Fig. 1. With connections as shown, the tape monitor switch provides simultaneous playback for three-head recorder.

normal position of this switch, of course, you hear the same signal that is being fed to the recorder, as in conventional systems.

To anyone having a recorder with a combined record-playback head, such a switch is useless, since the monitor signal coming from his recorder is taken from its input circuit anyway. But if your machine has separate record and playback heads, you'll find a tape-monitor switch convenient and useful. Here's

how to add one to your preamplifier-control unit.

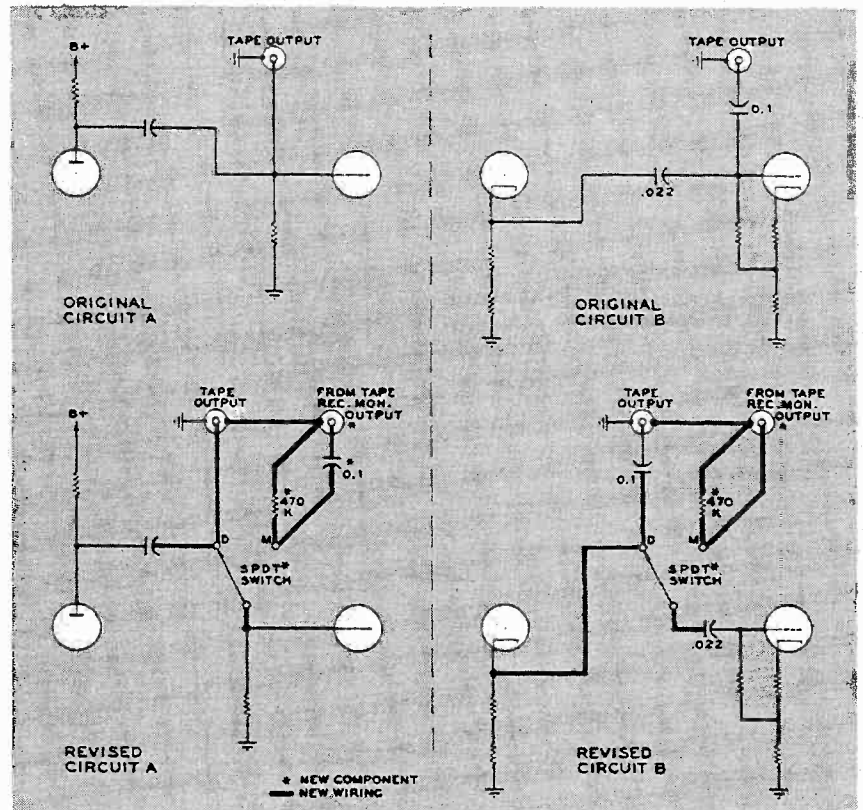
Fig. 1 shows a block diagram of the new setup. Input circuits are left as they were, except that the lead from the tape recorder is removed from the tape-input jack. Holes for a new tape-input jack are drilled in the back panel close to the tape-output jack, or at any convenient place nearest that part of the circuit to be altered. If the old tape-input jack happens to be close enough, it can be used after disconnecting it from the selector switch. The new tape-monitor switch can be a single-pole

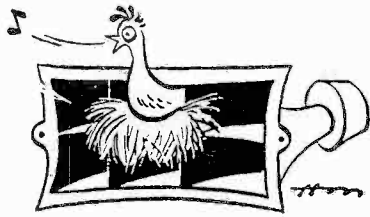
double-throw toggle, slide, or wafer switch, depending on space limitations and what you may have in the parts box. It should ideally be located on the back panel next to the tape input and output jacks; if you put it on the front panel, you'd be wise to use shielded cables and a double-pole double-throw switch, to avoid the possibility of hum pickup.

There are two general types of tape-output circuits in wide use, as Fig. 2 shows. In the first, circuit A, connection is made from a grid at DC ground

*Continued on page 39*

Fig. 2. Tape-output circuits in most units are one of the two originals shown.





# Sound-Fanciers' Guide

by R. D. DARRELL

## Are You Suffering from "Listener Hysterisis"?

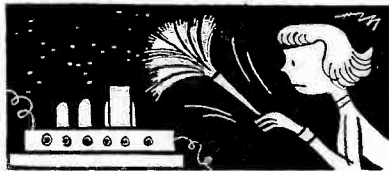
Inevitably, in a "Time of Troubles" and a world no less fascinated than tormented by its own neuroses and obsessions, the singular phenomenon (or disease?) of *audiophilia* has come to the delighted attention of our contemporary equivalents of ancient witch doctors. At a recent meeting of the American Psychiatric Association (as reported by *Time*), Dr. Henry Angus Bowes lectured to a rapt audience (which undoubtedly included many other self-confessed hi-fi fans besides himself) on the syndrome of this strange mania — distinguished by its victims' "... tendency to become pre-occupied with, and dependent upon, bizarre recorded sounds ... combined with the urgency of the need and the final insufficiency of all attempts to satisfy it. . . The sound is turned up and up until it reaches the physical level of pain. . . One addict told me he would not be satisfied until he could hear the drop of saliva from the French horns. . ."

Well, overlooking the learned doctor's naïve confusion of raised loudness levels with the means of achieving them (i.e., turning a volume control clockwise, not up), and disregarding the fact that for any acute ears distortion normally becomes intolerable long before the home loudness level reaches that of physical pain, it must be admitted that he has something there. But I wish he had found a better name than "audiophilia", which I'm sure Dr. Bowes would be quick to concede is a susceptibility not always accompanied by abnormal behavior. My own diagnostic term for the more advanced stages of the mania which grips some (but certainly not all) audiophiles is "listener hysterisis" — one perhaps legitimately torn from its usual motor usage in that its dictionary definition is "the lagging of magnetic effects behind their causes" (which surely has psychological as well as technical applications), while the word itself unmistakably suggests the quasi-hysterical intensity of emotional disturbance that attends audiophilia in its more virulent forms.

A family journal is hardly the place to examine Dr. Bowes's Freudian attempts

to find sexual connotations in listener hysterisis, yet it may well be that some more innocent hereditary or early childhood environmental influences are operative in the development of many hi-fi fans' eccentricities. Without descending to the jokester's level of suggesting that some sound fanatics must have been dropped as babies on their heads or excitedly shocked by the shriek of a steam whistle, it certainly is conceivable that some early traumatic experience may often have had decisive consequences.

At any rate, I've considered this notion as a possible explanation of my own seemingly inexhaustible, if not obsessive, interest in odd sounds in general, and those of musical instruments in particular. Perhaps it stemmed from infancy; my father was a semipro trombone and double-bass player! But I'm sure it was well established before I ever wrestled clumsily myself with the piano, clarinet, bassoon, bass harmonica (of all things!), and the intricacies of orchestration and score reading. Even today it is as much in the delighted pursuit of a hobby as in the line of



professional duty that I tackle the jobs of reviewing offbeat instrumental LP's and soak myself in the organological literature as a preliminary to preparing annotations for some such recording projects.

Fortunately, the sonic study of both novel and familiar tone qualities need not involve any of the excesses of listener hysterisis. To some extent it directly enhances our general musical knowledge; in many instances it provides materials exceptionally well-suited to testing and demonstrating home sound systems; but best of all it sharpens and sensitizes our aural sensibilities for more acute and accurate tonal discriminations. Even where the materials themselves exhibit no extraordinary frequency or dynamic characteristics, a close familiarity with their distinctive timbres, and the subtlety

with which these can be controlled for expressive purposes, enables us not only to evaluate the authenticity with which they are recorded and reproduced, but also the artistry with which they are scored by composers and manipulated by performers.

## Primitive and Exotic Instruments

The weakness of most music-lovers' approach to instrumental studies is that normally they encounter a relatively few, almost exclusively modern "art"-music types, and that even these are most often heard in blended combinations and in musical contexts which — quite naturally — distract attention from the individual roles of specific sound qualities in the over-all drama in which they participate. How little even an experienced listener really knows about less familiar sound makers is demonstrated by the arresting novelty of most of those featured in *Man's Early Musical Instruments* (Folkways P 525, two 12-in.), a long sequence of excerpts from the richly diversified Folkways series of ethnic recordings, illustrating over sixty various primitive and exotic (to our ears) instrumental types. They have been edited by the supreme living authority in this field, Dr. Curt Sachs, who has also prepared the concise yet informative 11-page illustrated booklet of annotations. No listener-reader can fail to profit immensely by these vivid displays and lucid explanations, not only of the basic species (*membranophones*, *idiophones*, *aerophones*, and *chordophones*, in scientific terminology), but also of the playing and construction details which determine the subspecies and individual forms.

I relish especially perhaps the piquancies of the tuned sticks, pounding bamboos, slit drums, hollow-log drums, drum chimes, Japanese bell, Jew's harp, Australian wooden trumpets, Kurdish double clarinet, Irish bagpipes, Malayan nose flute, African musical bow, Philippine tubular zither and diminutive guitar, Watusi bowl zither, Japanese *samisen*, Pakistani *sarinda*, Ethiopian spike fiddle, and — among the "orchestral combinations" — the Siamese *gamelan*, and Spanish *cobla*. But everything

here is rich grist for every sound-fancier's mill. My only complaints are that the field recordings naturally vary considerably in quality, most of the illustrations are all too short, and in many cases they include other instruments and/or voices. However, this last feature is actually an advantage from another point of view, in that it is likely to serve as an inducement to investigate the complete pieces and albums from which these samples are drawn—a repertory which too many collectors may have assumed is of exclusive interest to folklore specialists.

Two of the examples here, for instance, made me regret having passed over the *Classical Music of India* (Folkways P 422), from which they are taken, and in which they and other Indian instruments and styles are analyzed in detail. Luckily, however, a somewhat similar album was on hand, patiently awaiting the attention I have denied it for far too long. That is the *Music of India* (Angel 35283) which created something of a sensation when it first appeared nearly two years ago. If you missed it, or felt as I did that it wasn't likely to be your dish, profit by my belated discovery! You can never imagine the full potentialities of plucked-string tones (with transients and micro-tones galore) until you have heard Ali Akbar Khan's virtuoso *sarod* playing. The ostinato eerie drone of the accompanying *tamboura* is interesting too, as is Chatur Lal's *tabla* (paired drums) playing which enters after the improvised *sarod* solos begin to work up in excitement after their meditative beginning. The only catch is that, long before the end, one is sure to forget all about the instruments themselves as one is completely caught up in the infectious, rhapsodic musical frenzy—which is, however, free from any hint of hysteria.

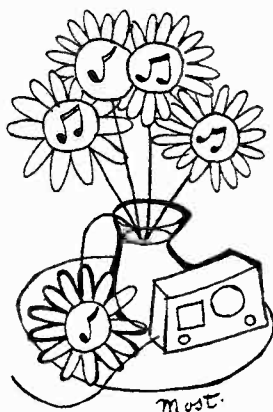
Another ethnic series, that of Emory Cook's Road Recordings, presents equally curious if less versatile instruments: tuned bamboo tubes in *Bamboo Tambou* (RR 5017); Moslem *ghangs* (cymbals), *tassas* and a *dhole* (drums) in *East Indian Drums* (RR 5018). But here the spirited, hypnotically monotonous chanting in the former, and the implacable, rhythmically not unusually complex pounding in the latter are very wearing, except perhaps for a folklore specialist—or one of Dr. Bowe's patients in *extremis*! Yet these discs might well suggest to the good doctor that the virus of acute audiomania has existed since time immemorial in the ritual manifestations of music, and often may have been an efficacious counter-irritant to the fears and neuroses which beset primitive man no less than his descendents. Certainly the obsession of hi-fi fanatics with overwhelming dynamic impact is exactly comparable with the Trinidad Moslems' insistence on ultrapowerful

drum thumping; whether it can have the same therapeutic value, of course, remains to be demonstrated!

### In and Out of the Spotlight

Except for a couple of prehistoric prototypes like the elephant horn and *zanza*, the stars of two recent releases in the Vox Spotlight series belong to Western art-music traditions—both of the past and the present. These are grouped as "Brasses" (DL 300) and "Keyboards" (DL 362, two 12-in.): ranging in the former album from the ancient *buysine* or heralding trumpet, cornett or *Zinke*, serpent, and various "natural" horns to the trumpets (in various keys), trombones, French horn, cornet, bugle, and tubas of present orchestral and band use; and in the latter, from spinets, clavichords, and harpsichords (to say nothing of a keyboard monochord, *glaschord*, and stringed, *not* street-organ, hurdy-gurdy), to old and new pianos and organs, celesta, and accordion.

Both practically and ethically, I'm disqualified from impartially reviewing these sets; not out of modesty as the



author of the elaborate 18-page and 26-page accompanying booklets (for, frankly, I'm quite proud of them!), but because I have been so deeply involved in the whole Spotlight project that I'm incapable of an objective appraisal of its over-all qualities, let alone those of my own texts. I shouldn't be entirely disqualified, however, from making the necessary warning to potential listeners that these (like the Folkways *History* above) are definitely *not* records one can hear all the way through for sheer enjoyment, and that, unless you are particularly interested in instruments themselves, you'll find these sequences of isolated passages, unaccompanied pieces, and oftentimes exceedingly strange tonal qualities or subtle distinctions confusing if not boring. But if you are fascinated by such things as sonic differentiations between a spinet and two-manual harpsichord, natural and valved horn, a baritone and a euphonium, etc., then you'll surely sympathize with my present inability to express my personal feelings

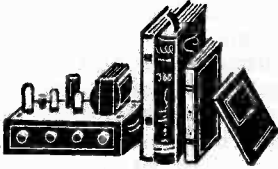
about them. And, individual enthusiasms and involvements aside, it bears noting that such sharply focused sonic illustrations have special characteristics which legitimately can be considered either disadvantageous or advantageous from different listening points of view. In the former aspect, the instruments sound unnatural in that they are heard unsupported, quite closely, and under circumstances in which *what* they play is largely subordinated to *how* they sound. (This inevitably includes some incidental mechanism or breathing noises that even the players themselves never notice ordinarily. However, they'll disappoint Dr. Bowe's addict-patient in that, as far as I can hear, any drops of saliva from the French horn remain inaudible!) In the latter aspect, these same characteristics lend themselves better to analytical-study purposes than normal, more distant, and more musically meaningful performance reproductions.

No sonic analysis can ever be a substitute for musical enjoyment; such laboratory study, however absorbing in its own right, is aesthetically justified only when it is used as a preparatory tool to enrich one's understanding of the creative exploitation of tonal vehicles and media. Fortunately, the two approaches sometimes can be combined—bridging the examination of isolated instrumental factors and the comprehension of large, multivoiced symphony orchestras—in listening to small ensembles made up exclusively or predominantly of a single instrumental family. Thus, after hearing some of the "spotlighted" brasses above, one well may be better prepared to relish their ingenious manipulation by some of the same Bostonian virtuosi, led by Roger Voisin, in *The Modern Age of Brass* (Unicorn 1031). The music here is not as immediately appealing as that in the earlier *Golden Age of Brass*; or perhaps I might more fairly say that for me the Hindemith and Sanders pieces seem utilitarian only, although the Berezowski suite has considerable comic vivacity, and Dahl's work boasts tremendous power and sonority for all its harshness. But the recording, in which Peter Bartók makes the most of the superb MIT Kresge Auditorium acoustics, matches the magnificence of the performances themselves.

And for those susceptible, as I am, to perhaps the noblest brass voice, I can also highly recommend the *Trombone* LP (Audio Fidelity AFLP 1811) in which Davis Shuman and the angular instrument of his own refinements are starred in the Tibor Serly Concerto and Miniature Suite with chamber orchestra. The latter is a jaunty workout on some charming Transylvanian folk tunes; the former rises at its best to impressively declamatory eloquence; and the little encore pieces on the second side include

*Continued on page 38*

Save yourself time and trouble  
by ordering your books directly from us.  
Just fill in the coupon below.



# audiophile's bookshelf

## HIGH FIDELITY RECORD ANNUAL: 1956

Edited by **ROLAND GELATT**. The second volume in the planned series of *High Fidelity Record Annuals*. Included in this new collection are reviews of classical and semiclassical music and the spoken word which appeared in *HIGH FIDELITY Magazine* from July 1955 through June 1956. Comparisons with recordings of previous years emphasized. A performer index is included. \$4.50 **237**

## MAINTAINING HI-FI EQUIPMENT

By **JOSEPH MARSHALL**. A much needed book on the specialized approach necessary to service high-fidelity equipment. The author discusses not only electronic faults, but the mechanical and acoustical defects which cause a hi-fi system to function less than perfectly. Hard cover, \$5.00 **232** Soft cover, \$2.90 **233**

## HIGH FIDELITY CIRCUIT DESIGN

By **CROWHURST & COOPER**. Two of England's top high-fidelity writers give complete information on high-quality audio circuit design procedures. The authors discuss circuit components, derive design formulas, describe testing methods and test equipment, and give examples of "how to" design data for the improvement of existing audio systems. Numerous diagrams and charts. \$5.95 **218**

## AMPLIFIERS

By **NORMAN H. CROWHURST**. Will help solve the problems that often arise when equipment has been built, but won't work. The "Trouble Tracing Guide" gives a table of symptoms, possible causes, and references to chapters which offer aid. \$1.00 **213**

## THE QUEST FOR QUALITY

By **NORMAN H. CROWHURST**. Discusses the basic requirements for fidelity and various methods of achieving it. Shows how to design equalizers, how to build circuits for expanding dynamic range, how to check equipment. Also takes up various kinds of stereophony, and the arrangement of a listening room for the greatest pleasure. \$1.50 **217**

## THE STORY OF JAZZ

By **MARSHALL W. STEARNS**

Executive Director of the Institute of Jazz Studies in New York

"Mr. Stearns has written one of the great books on jazz. The cultural-musical antecedents of this contemporary musical growth have been treated in a few thoughtful articles but never before in any detail, between book covers. Add to this the author's incisive analysis of the "swing" era, his lucid exposition of bop and cool jazz and his appraisal of Midwest jazz (Moten, Kirk, Basie, etc.), along with his intimate knowledge of periods and styles, and you have a book of immense interest. . . . There is a comprehensive bibliography by Robert George Reisner and an impressive folio of photographs."—Charles Edward Smith in *THE NEW YORK TIMES BOOK REVIEW*. \$5.75. **228**

## HIGH FIDELITY A Practical Guide

By **CHARLES FOWLER**, Publisher of *Audiocraft Magazine*

Whether your budget is small or large, whether you are a beginner or a devotee from way back, this complete and definitive guide can help you get the most enjoyment out of your high-fidelity system.

Here is the practical, expert advice needed by everyone who has, or expects to have, a high-fidelity system. Starting with an introduction to sound, the author then describes the various links in the hi-fi chain, explaining their features and specifications so as to provide the most helpful criteria for evaluating, and for selecting and matching components. \$4.95 **234**

## TAPE RECORDERS AND TAPE RECORDING

By **HAROLD D. WEILER**. This book, by the author of the best-selling *High Fidelity Simplified*, supplies the amateur and semi-professional tape recordist with sound, practical, and factual information about all aspects of tape recording—microphones and their placement for both indoor and outdoor recording, room acoustics, sound effects, recording from discs and off-the-air, maintenance, etc. All the vital principles necessary for the realization of optimum results with tape recorders. Paper, \$2.95 **225** Cloth, \$3.95 **243**

## THE FORMS OF MUSIC

By **SIR DONALD FRANCIS TOVEY**. Written by one of the most literate and profound of modern interpreters of music—its theory and history, these essays are all drawn from those articles on music which Tovey prepared for the *Encyclopaedia Britannica*. There are in all twenty-eight articles on different kinds and elements of music—aria, chamber music, concerto, harmony, mass, melody, opera, programme music, sonata, symphony, and others. Paper, \$1.35 **239**

Book Department  
AUDIOCRAFT Magazine  
Great Barrington, Mass.

I enclose \$..... for which please send me, postpaid, the books indicated by the circled numbers below. (No C.O.D.'s or charge orders, please.) Foreign orders sent at buyer's risk. Add 55¢ per book for postage on all foreign orders except Canadian.

Binders for AUDIOCRAFT: Vol. I (holds 14 issues) — \$3.50 **223**  
Vol. II (holds 12 issues) — \$3.00 **245**

	<b>213</b>	<b>232</b>
	<b>217</b>	<b>233</b>
NAME .....	<b>218</b>	<b>234</b>
	<b>223</b>	<b>237</b>
ADDRESS .....	<b>225</b>	<b>239</b>
	<b>228</b>	<b>243</b>
		<b>245</b>

**the specs prove it... in HI-FI**  
**BEST BUYS are** **TEICO**



**NEW! HF20** **20-WATT Ultra-Linear AMPLIFIER**  
**KIT \$49<sup>95</sup>**  
**WIRED \$79<sup>95</sup>**  
**COMPLETE with**  
**Preamplifier, Equalizer & Control Section**

Highest quality Williamson-type complete-facility amplifier that sets a new standard of performance at the price, kit or wired. **Rated Power Output:** 20 w (34 w peak). **1M Distortion:** 1.3%. **Max Harmonic Distortion:** below 1%, 20-20,000 cps, within 1 db of 20 w. **Power Resp (20 w):** ±0.5 db 20-20,000 cps; ±1.5 db 10-40,000 cps. **Freq Resp (½ w):** ±0.5 db 13-35,000 cps; ±1.5 db 7-50,000 cps. 5 feedback equalizations. Low-distortion feedback tone controls. 4 hi-level & 2 lo-level inputs. Conservatively rated, fully potted output transformer; grain-oriented steel, interleaved windings. 8½" x 15" x 10". 24 lbs. Matching Cover E-1. \$4.50



**NEW! 60-WATT Ultra-Linear POWER AMPLIFIER**  
**KIT \$72<sup>95</sup>**  
**WIRED \$99<sup>95</sup>**  
**with ACRO T0-330 Output XFMR**

Superlative performance through world's finest components & circuitry — at incredibly low price. EF86 volt ampl direct-coupled to 6SN7GTB K-coupled phase inverter driving two U/L-connected p-p EL34 output tubes. GZ34 extra-rugged rectifier. **Rated output:** 60 w. (130 w pk). **1M Distortion:** less than 1% at 60 w; 0.5% at 50 w. **Harmonic Distortion:** less than 0.5% from 20-20,000 cps within 1 db of rated power. **Sine Freq. Resp:** at 1 w: ±0.5 db 5-100,000 cps; ±0.1 db 15-35,000 cps at any level from 1 mw to rated power. **Square Wave Resp:** excellent 20-25,000 cps; 3 usec rise-time; **Sens:** 0.55 v for 60 w. **Inverse Feedback:** 21 db. **Damping Factor:** 17. **Input level control.** Both bias & DC-bal adj. 7" x 14" x 8". 25 lbs. Matching Cover E-2. \$4.50



**NEW! HF61 PREAMPLIFIER**  
**KIT \$24.95**  
**WIRED \$37.95**  
**with Power Supply: KIT \$29.95 WIRED \$44.95**

Does not add distortion or detract from wide-band or transient response of finest power amplifiers at any control settings. High-quality feedback circuitry throughout & most complete control & switching facilities. Feedback scratch & rumble filters, equalizations, tone controls. Centralab Senior "Compentrol" loudness control, concentric level control. 4 hi-level, 2 lo-level switched inputs. **Extremely flat wideband freq resp:** ±1 db 8-100,000 cps; ±0.3 db 12-50,000 cps. **Extremely sensitive.** Negligible hum, noise, harmonic or 1M distortion. 4-7/8" x 12-5/16" x 4-7/8". 8 lbs.

**COMPLETE with FACTORY-BUILT Cabinet**

**NEW!**

**2-WAY SPEAKER SYSTEM HFS1**

Jensen heavy-duty 8" woofer (6.8 oz. magnet) & matching Jensen compression-driver exponential horn tweeter with level control. Smooth clean bass & crisp, extended natural highs. **Factory-built** tuned bass reflex imported white birch hardwood cabinet (not a kit). Neutral acoustical grille cloth framed by smooth-sanded solid birch molding. **Freq Resp — woofer:** ±4 db max. variation 80-2000 cps; **tweeter:** ±2 db max. variation 2000-10,000 cps; **overall response:** ±6 db 70-12,000 cps. **Power-handling capacity:** 25 w. **Bookshelf size:** 23" x 11" x 9". 19 lbs. **Wiring Time** 15 min.

See these "BEST BUYS" IN STOCK at your distributor. Write for FREE Catalog AC-4

**TEICO** Brooklyn 11, N. Y. Prices 5% higher on West Coast.

**SOUND FANCIER**

*Continued from page 36*

some imaginative, novel, and effective transcriptions. I first made Shuman's (aural) acquaintance in his Circle LP of Rimsky's Concerto some years ago, and this is an even more brilliantly recorded display of his prowess. Best of all, it presents even more diversified explorations of the trombone's wide range and surprisingly versatile technique, including some of the finest examples of muted tone colorings I have ever heard anywhere.

**Reinforced-Concrete Music**

If the hi-fi fan's sense of "insufficiency of all attempts to satisfy" his aural needs seems anything new to the psychiatrists, they are surely lacking in historical perspective on musicians' and listeners' ageless search for fresh timbre sensations, either as derived from extensions of the ranges, agility, and color spectra of existing instruments, or from the invention of entirely new tone producers. The records already discussed this month are rich in typical examples of the former practice; another, far stranger one, the *Panorama of Musique Concrète* (London, Ducretet-Thomson, DTL 93090) is the most arresting contemporary illustration to date of the latter.

By the time this appears in print, the hullabaloo over this extraordinary disc may have quieted down or begun to bore you to death, but if you haven't yet heard it for yourself, and especially if you have interpreted the publicity to imply that this is something altogether too *outré* for normal listening tastes, I beg you to reconsider. At the very least, this LP has historic significance as a documentary of composers' achievements in making montages of natural (i.e., concrete) sounds for expressive purposes, and in exploiting present-day technical resources (earlier, "locked"-groove discs; today, tape editing, pitch changing, and superimposed or multidubbed recording) to produce tones the like of which was never known, and scarcely imaginable, hitherto.

Luening's and Ussachevsky's *Tape Recorder Music* (reviewed here Nov. 1956) was an interesting but overtentative step in this direction; the present *Panorama*, featuring the works of Schaefer, Henry, and Arthuys, is a far more ambitious and — at its best — successful one. The earlier pretape pieces here may depend too much on stuck-in-the-groove effects, some of the later ones on paroxysmal gasping utterances, and too many of them betray a lack of conviction

and direction by the abruptness with which they end — as if the composers realized they hadn't got anywhere, and weren't going to, and so just had to stop someplace. But even here, to say nothing of the better designed and integrated works, the varieties of total qualities have stimulated every commentator to a frantic search for adequate descriptive terms. After noting John Conly's apt *bubbulation*, I don't dare enter that competition, but I should make the pertinent point that no verbalizations, however ingenious, can more than faintly suggest some of the weirdest sounds here — in itself, clear proofs that these experiments have resulted in truly revolutionary sonic discoveries.

Moreover, and far more significant than even the valuable expansion of the tonal vocabulary itself, this novel medium has given birth to an authentic musical-dramatic masterpiece. Pierre Henry's *Veil of Orpheus* probably demands visual experience of the staged action for its full impact, yet in an aural encounter alone it reveals itself unmistakably as an incomparable evocation of ancient terrors and magic and catharsis. You may not "like" it — indeed, it's likely to scare you out of a year's growth — but for all its nightmarish qualities (or perhaps because of them) you'll be irresistibly and unforgettably shaken.

**A Spirit of Health**

"Angels and ministers of grace defend us!" we well may beg with Shakespeare. But if the *Veil of Orpheus* might serve as the aural embodiment of "a goblin damned . . . making the night hideous", music on records can bring us "airs from heaven" as well as "blasts from hell". And right here I'll part even jesting company with Dr. Bowes in assuming that audiophilia is primarily a quirk or neurosis of "compulsive" personalities. It may also be a craving for music which is at once food for the soul and an invigorating replenishment of depleted vital energies.

Listen, as I have been listening to — and exulting in — the sheer healthfulness of a double and triple concerto by Bach, and various concertos and sinfonias by Vivaldi, as played by the Solisti di Zagreb (Vanguard-Bach Guild BG 562 and 560). No matter on what level you begin to hear these wondrously skilled and zestful young musicians, whether for the meaningful music itself, the restrained eloquence of the interpretations, or the vibrant yet transparent recording of a small group of instruments, before long the various level demarcations will



be erased and you'll experience as an integrated totality, or *Gestalt*, all aspects of these masterpieces simultaneously — and as richly and intensively as the stretching power of your own sensibilities permits.

Baroque composers never have been adequately credited with a mastery of instrumentation, probably because primarily they preserved and contrasted clearly differentiated timbres in their intricately woven textures, rather than blending and massing them like the later romanticists. But in the works above, and again, perhaps even more exhilaratingly, in Handel's *Water Music*, the listener who loves to approach music first of all through its distinctive instrumental voices finds the readiest and most enticing paths to still more substantial rewards. The finest complete *Water Music* disc recording is of course Lehmann's (on Archive 3010 specifically, which is several orders of magnitude superior to the less satisfactorily processed Decca DL 9594 version). After that, what more can you ask for? Well, that, like still "higher" fidelity, is what you never can know until you hear something still better. In this case, it's the Concert Hall stereo tape (CHT/BN 14) of Carl Bamberger's performance, which not merely has the slight advantages of a better balanced ensemble (with fewer strings so that the winds regain their old Handelian equality), but the irresistible and indescribable ones of an out-of-doors spaciousness and airborne buoyancy which are stereo sound's finest contributions to the revelation of new dimensions of aural experience.

It may be psychiatrically true that we are "compulsively" magnetized by such attractions. But in my own mind, it's an act of free choice, and I can't imagine one more rewarding — not in achieving peace of mind, perhaps, but something far better: a sense of mental and spiritual uplift. We can't all be Bachs or Handels, but we can meet them, in the nonhysterical domains of high-fidelity sound reproduction, as the good companions and "ministers of grace" whose supreme gift is that of galvanizing us to transcend our everyday world and selves.

## TAPE MONITOR

*Continued from page 34*

potential, so that no series capacitor is used to the jack. In this case the interstage coupling capacitor is removed from the following grid terminal and its free end connected to one side terminal of the switch. The lead to the tape-output jack is also removed from the grid terminal and connected to the same side of the switch. The center terminal of the switch is then connected

to the grid terminal. From the ground lug of the tape-input jack, new or old, a wire is soldered to the ground lug of the tape-output jack. A 470-K resistor is connected from this ground lug to the remaining switch terminal, and a 0.1- $\mu$ fd 600-volt capacitor is connected from the same switch terminal to the center lug of the tape-input jack. If shielded cables are employed, the braids should be connected to the ground bus in the vicinity, and should not be permitted to touch the chassis.

In some preamp circuits the tape-output connection is made from a grid that is not at DC ground potential, as in circuit B, and a series capacitor is used to the tape-output jack. Such a circuit should be revised as shown. The interstage coupling capacitor should be disconnected from the preceding stage drive point and the free end connected to the center switch terminal. A wire is then run from the point at which the coupling capacitor was disconnected to one side terminal of the monitor switch. The capacitor going to the tape-output jack is disconnected from the grid, and this free capacitor lead is connected to the same side switch terminal. The two jack ground lugs are wired together, and a 470-K resistor is connected from the tape-input-jack ground lug to the remaining switch terminal. Finally, a wire is connected from the same switch terminal to the tape-input-jack center lug. Capacitor values shown in Fig. 2B are those for the Heathkit WA-P2 preamp-control unit, on which I installed tape monitoring facilities for my recorder.

It is evident that, with these alterations, any signal coming from the recorder — even in the nonrecording playback mode — cannot be affected by pre-



amp controls that precede the tape-output takeoff point. Ideally, then, all controls except the selector and equalization switches should follow. In the MONITOR position of the switch you can hear only what comes from the recorder or from whatever source is plugged into the tape-input jack. You can, for example, tape-record a borrowed disc record while listening to a radio or TV program you don't want to miss, by plugging the tuner into the tape-input jack. In the DIRECT position of the switch your preamp will operate as it used to, except that the TAPE position on your selector switch is vacant.



## Why Buy?

*Twice the RUMBLE*  
*Twice the FLUTTER*  
*Twice the WOW for*  
*Twice the PRICE*

**When you can have**

*Half the RUMBLE*  
*Half the FLUTTER*  
*Half the WOW for*

# HALF THE PRICE

For exceptional performance, choose either of these professional quality Component turntables:

The Duo-speed . . . a two-speed, belt-driven turntable . . . \$49.50  
The Professional Junior . . . a single speed, belt-driven turntable . . . \$39.50

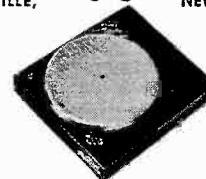
For full details and name of dealer write:

## COMPONENTS

CORPORATION  
Department D2

DENVILLE,

NEW JERSEY



# AR-1

PRESS COMMENT

## "Atlantic

"The AR-1W woofer gives the cleanest bass response I ever have heard."

**AUDIO** (Edward Tarnall Canby)

"...the highs impressed me immediately as very lovely, smooth, unprepossessing, musical (for music) and unusually natural. No super-hi-fi screech and scratch... As to the lows... I was no end impressed, from the first time I ran my finger over a pickup stylus and got that hearty, wall-shaking thump that betokens real bottom bass to the time when I had played records and tapes on the speaker for some months on end."

## The Audio League Report\*

"Speaker systems that will develop much less than 30% distortion at 30 cycles are few and far between. Our standard reference speaker system,† the best we've ever seen, has about 5% distortion at 30 cycles."

\*Vol. 1 No. 9, Oct., '55. Authorized quotation #30. For the complete technical and subjective report on the AR-1 consult Vol. 1 No. 11, The Audio League Report, Pleasantville, N. Y.

†The AR-1W

## The Saturday Review (R. S. Lanier)

"... goes down into the low, low bass with exemplary smoothness and low distortion. It is startling to hear the fundamentals of low organ notes come out, pure and undefiled, from a box that is two feet long and about a foot high."

## High Fidelity (Roy Allison)

"...a woofer that works exceptionally well because of its small size, not in spite of it... I have heard clean extended bass like this only from enclosures that were at least six or seven times its size."

## THE NATION (B. H. Haggin)

"... achieves the seemingly impossible; a real and clearly defined bass in a cabinet only 14 by 11 3/8 by 25 inches in size."

## audiocraft

"The reproduced sound\* so perfectly duplicated that of the organ that no one could be sure which was playing."

\*At a demonstration of live vs. recorded pipe organ, in which the reproducing system included four AR-1's.

**ACOUSTIC RESEARCH, INC.**  
24 Thorndike St., Cambridge 41, Mass.

Courtesy Stanley Tools, division of The Stanley Works

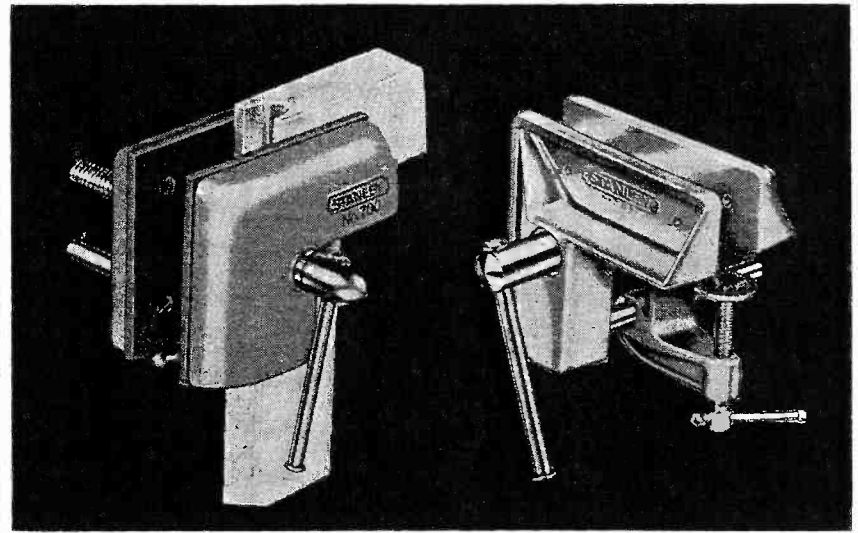


Fig. 3. Two types of woodworking vise. The one at right clamps on end of bench.

## WOODCRAFTER

Continued from page 9

providing ideal storing places for small parts, since the contents are both visible and easily accessible. By mounting the jar lids on the surface of a horizontally pivoted wooden disc, instead of the edge, it becomes a Lazy Susan and serves the same purpose (Fig. 5). Individual jar tops can be mounted under shelves or overhead on the joists in a workshop to provide the same convenience.

Household baking tins are serviceable bins for open storage of many items. Bread pans hold many of the larger items while muffin tins have separate bins for tinier parts. However, I wouldn't suggest raiding the kitchen for tins—it will be a happier household if you buy your own!

## Storage of Lumber

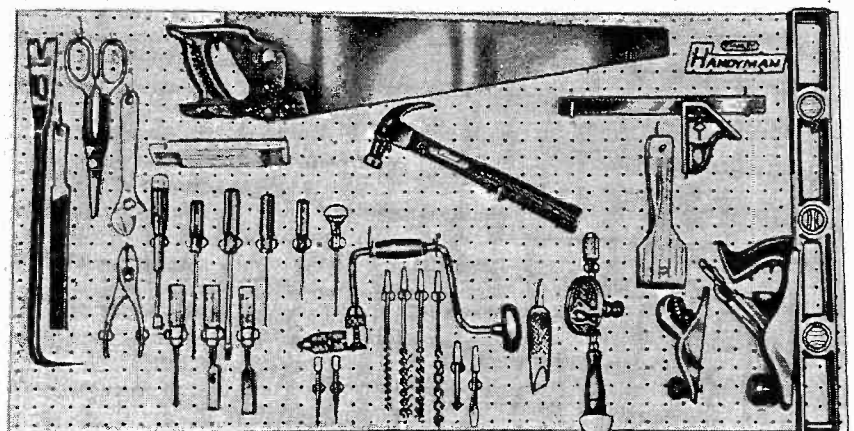
Proper storage of lumber in the workshop is important to prevent warping and to allow needed ventilation. It should be stacked above the floor and supported at all points to prevent per-

manent sagging. You will avoid one of the causes of warping if you do not stand lumber on end. Frequently, the bottom shelf or rails of a workbench can be utilized to hold lengths of wood. A simple rack constructed of 2-by-3-inch lumber can be suspended from the overhead floor joists in a basement workshop, providing a good view of the stock on hand and allowing easy removal of the pieces selected (Fig. 6). Actually it consists of a series of simply constructed ladders fastened to every other joist and arranged in line so that the rungs become shelves to support the lumber. Cross supports of one-by-four give the rack rigidity. Where no joists are available overhead, this type of rack can stand on the floor.

## Storage of Finishing Materials

The quality of any finish you apply to a project depends to no small degree upon the condition of the finishing materials. Dust and dirt have an adverse effect on paints, varnishes, stains, waxes, and brushes. These items should be kept enclosed and yet where they can be seen for ready selection. Second-

Fig. 4. Peg board with removable wire hooks makes a good inexpensive tool rack.



Courtesy Stanley Tools, division of The Stanley Works



hand bookcases with glass doors are ideal for this purpose. It should also be remembered that the containers of finishing materials should be kept tightly closed. By the way, never use a hammer to close a paint can; place the can on the floor and, with the ball of your foot, apply your weight to the lid.

Storing sandpaper can be a problem since it has a tendency to curl up unless you have something to keep it flat. A discarded 78-rpm record album makes an excellent file with compartments for various grades of paper. Or, if you can spare a wire record rack, you'll find it serves nicely as a holder for sheets of sandpaper.

### Wiring in the Shop

Unless specifically planned at the time of construction, the area housing the home workshop will need additional wiring for satisfactory operation. If it is in a basement, there are usually two or three outlets for lighting purposes only. However, an excellent arrangement for a typical workshop can be installed easily by a licensed electrician. It is a wiring plan that consists of two branch circuits, each independent of the other. One line is reserved for lighting the shop only; the other provides outlets for operation of power tools. Thus, the lighting system is not affected if a machine is overloaded and a fuse blows. There is always light to make repairs and adjustments, and there is never an annoying dimming of lights when equipment is turned on.

These two circuits should be rated as 15-ampere lines. Because only one motor is used at a time, the total load

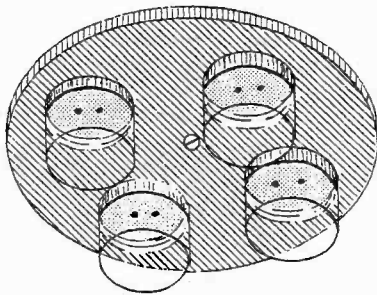


Fig. 5. Small hardware storage device.

on the power line will be no greater than the rated amperage shown on the motor.

Good lighting pays dividends in better, safer, and easier operation. Make certain the workbench, the power tools, and the finishing area are well lighted. Fluorescent lighting is topnotch illumination for the workshop.

### Sound Deadening

A workshop often is a noisy place. Transmission of much of the noise can be reduced by various materials and devices. Installation of acoustical ceiling

tile or panels of insulating board will help, and mounting power-tool stands on special rubber feet will reduce noise and vibration. If the machine must be moved about, special rubber casters with a locking mechanism can be attached to the stand's legs. When the machine is in use, it is safeguarded against rolling.

Even motor noise can be minimized by mounting the motors on fiber insulation washers or other similar material.

Remember, your workshop can be your castle or your doghouse, depending upon such little things as tracking sawdust into the house on your shoes or

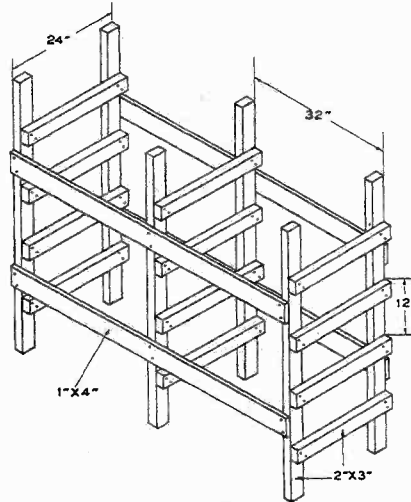


Fig. 6. Rack for lumber is easy to make.

in the cuffs of your trousers, along with wood chips, metal scraps and sundry other unwanted items. Moral: *Don't* let sawdust or chips accumulate on the workshop floor—they're fire hazards, too! *Do* place a doormat near the exit of your workshop to clean the bottoms of your shoes. *Do* try wearing trousers without cuffs while working in the shop and you won't be guilty of littering the living-room rug.

### HOME-BUILT HORN

*Continued from page 29*

ducted to determine the actual angles of high-frequency distribution, listening tests are reassuring and I am quite satisfied with the horn's performance.

In use, the horn is mounted above a Rebel III enclosure. As a means of beautifying the large, gaping mouth of the horn, I built a twelve-cell wood grille to fit over the horn mouth. A grille substantially adds to the sightliness of the horn, and has no detectable effect on its sound quality. The finished unit is shown in Fig. 4.



# AR-2

The AR-1 acoustic suspension\* speaker system is now widely recognized as reproducing the cleanest, most extended, and most uniform bass at the present state of the art. It is employed as a reference testing standard, as a broadcast and recording studio monitor, as an acoustical laboratory test instrument, and in thousands of music lovers' homes.

The AR-2, our second model, is a two-way speaker system (10 in. acoustic suspension woofer and newly developed tweeter assembly), in a cabinet slightly smaller than that of the AR-1—13½"x24"x11¾". It is suitable for use with any high quality amplifier which supplies 10 or more clean watts over the entire audio range.

# AR-2

The price of the AR-2 in hardwood veneer is \$96.00, compared to the AR-1's \$185.00. Nevertheless we invite you to judge it directly, at your sound dealer's, against conventional bass-reflex or horn systems. The design sacrifices in the AR-2, comparatively small, have mainly to do with giving up some of the AR-1's performance in the nether low-frequency regions, performance which is most costly to come by. The AR-2 can radiate a clean, relatively full signal at 30 cycles.

The AR-2 speaker was designed as the standard for medium-cost high fidelity systems. Our tests have shown it to be so far ahead of its price class that we think it will come to be regarded as such a standard within its first year.

# AR-2

Literature, including complete performance specifications, available on request from:

**ACOUSTIC RESEARCH, INC.**  
24 Thorndike St., Cambridge 41, Mass.

\* Pat. pending and copr., Acoustic Research, Inc.

# AUDIOCRAFT Sound Sales Directory

Following is a list of dealers who state that they carry the products specified.

KEY TO PRODUCTS HANDLED	
1	Audio system components
2	Speakers and enclosures
3	Records and record accessories
4	Tape recorders
5	Pre-recorded tape
6	Radio hardware
7	Tools, wood
8	Audio parts
9	Microphones
10	Books
11	Test equipment

*A series of items numbered consecutively is identified by a hyphen between the first and last numbers. Thus, 1-6 indicates 1 through 6; 8-11 indicates 8, 9, 10, and 11.*

**CALIFORNIA**  
*Hollywood*  
Hollywood Electronics  
7460 Melrose Ave.  
Webster 3-8208 1, 2, 4, 5

*Los Angeles*  
Beverly Hi-Fi  
468 S. Robertson Blvd.  
CRestview 4-8045 1, 2, 4, 5, 9

**CONNECTICUT**  
*Hartford*  
Belmont Record Shop  
163 Washington St.  
CHapel 9-0414 1-5, 8-10

*West Hartford*  
Audio Workshop, Inc.  
1 South Main St.  
Adams 3-5041 1-5, 9, 10

**DELAWARE**  
*Newark*  
Delaware Music House  
20 Academy St.  
Endicott 8-3258 1-5, 8, 9

**ILLINOIS**  
*Chicago*  
Allied Radio Corp.  
100 N. Western Ave.  
HAYmarket 1-6800 1-11  
Evergreen Allied High Fidelity, Inc.  
2025 W. 95th St.  
BEverly 8-1067 1-11

Voice and Vision, Inc.  
921 N. Rush St. 1-11

**Evanston**  
Allied High Fidelity Stores, Inc.  
602 Davis St.  
DAvis 8-8822 1-11

**Oak Park**  
West Suburban Allied High Fidelity, Inc.  
7055 W. North Ave.  
ESTebrook 9-4281 1-11

**LOUISIANA**  
*New Orleans*  
The Music Shop, Inc.  
4215 South Claiborne Ave.  
TW. 1-5871 1-5

**MASSACHUSETTS**  
*Boston*  
The Listening Post, Inc.  
161 Newbury St.  
COpley 7-7530 1, 2, 4, 8-10

**MISSOURI**  
*St. Louis*  
The High Fidelity Showroom  
6383 Clayton Rd.  
Parkview 1-6500 1-5, 9

**NEW JERSEY**  
*New Brunswick*  
Hi Fi Haven  
28 Easton Ave.  
CHarter 9-5130 1-5, 9

**NEW YORK**  
*Albany*  
Audio-Video Corporation  
324 Central Ave.  
3-1167 1-5, 8-10

*Buffalo*  
Frontier Electronics, Inc.  
1507 Main St.  
GA. 5727 1-5, 8-10

*New York City*  
Arrow Audio Center  
65 Cortlandt St.  
Digby 9-4730 1, 2, 4-6, 8-11

**PENNSYLVANIA**  
*Philadelphia*  
Danby Radio Corp.  
19 South 21st St.  
Rittenhouse 6-5686 1-5, 8-10

Ten Cate Associates  
6128 Morton St.  
Germantown 8-8500 1-5, 8-10

**WASHINGTON**  
*Seattle*  
High Fidelity Headquarters  
603 Broadway North  
CApitol 2266 1-4, 8, 10

**WEST VIRGINIA**  
*Charleston*  
Electronic Specialty Co.  
Virginia Street W., At Park Avenue  
3-5656 1-11

**CANADA**  
*Montreal*  
Payette Radio Limited  
730 St. James West  
UNiversity 6-6681 1-11

## TRANSISTORS

Continued from page 27

The equivalent circuit for the grounded-base *b* set, which is useful in analyzing grounded-base circuits, is shown together with the equations in Fig. 5.

For the seldom-used grounded-collector amplifier, an analysis in terms of the equivalent circuit of Fig. 6 is useful.

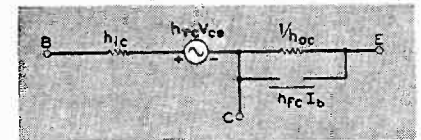


Fig. 6. Equivalent circuit for the rare case of a common-collector connection.

The  $b_c$  parameters are given in terms of the other two sets in Table I, also.

Each of the equivalent circuits so far has used two resistors and two generators. The circuit of Fig. 7 is often used to represent the grounded-base transistor, and can be shown to be adequate and exactly equivalent to the other grounded-base set, provided the new parameters  $r_e$ ,  $r_b$ ,  $r_c$ , and  $\alpha$  are related to the  $b_b$  parameters by the following formulas:

$$r_b = \frac{b_{rb}}{b_{ob}} \dots (7)$$

$$r_e = b_{ib} - \frac{b_{rb}}{b_{ob}}(1 + b_{fb}) \dots (8)$$

$$r_c = \frac{1}{b_{ob}} \dots (9)$$

$$\alpha = -b_{fb} \dots (10)$$

Fig. 7 appeals to people because it associates with each lead an appropriately labeled resistor, and has only one fictitious generator. Many transistor manufacturers describe their products in terms of these parameters. The circuit is easier to use than the  $b$ -parameter

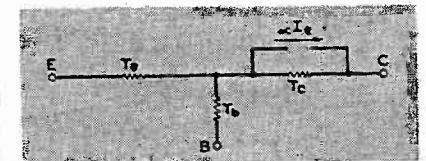


Fig. 7. Common-base *r*-parameter setup.

circuit in many cases, although the values of  $r_b$ ,  $r_e$ ,  $r_c$ , and  $\alpha$  cannot be measured directly. In practice they are computed from measured values of the  $b_e$  or  $b_b$  set.

If Fig. 7 is useful for grounded-base circuits, perhaps we should look for a similar circuit for the grounded-emitter configuration. Fig. 8 does the trick, provided that

$$r_a = r_e(1 - \alpha) \dots (11)$$

$$\beta = \frac{\alpha}{1 - \alpha} \dots (12)$$

We've gone rather fast describing

these equivalent circuits. First, we got the grounded-emitter  $h$ -parameter set:  $h_{ie}$ ,  $h_{re}$ ,  $h_{fe}$ , and  $h_{oe}$ . Then we mentioned the grounded-base set:  $h_{ib}$ ,  $h_{rb}$ ,  $h_{fb}$ , and  $h_{ob}$ . The existence of the grounded-collector set was mentioned. Then, the grounded-base  $r$  set was shown, and it was stated that if the  $r$ -parameters were

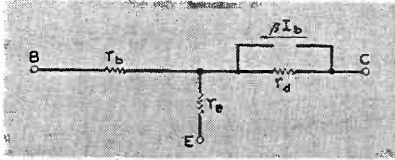


Fig. 8. Grounded-emitter  $r$  parameters. computed according to the formulas given, then the equivalent circuit shown would describe the behavior of the transistor accurately. Finally, the grounded-emitter  $r$  set was shown. This last equivalent circuit (Fig. 8) is very widely used in practice.

## BASIC ELECTRONICS

*Continued from page 33*

curves for other values of  $Q$  are identical within an insignificant margin of error. For frequencies further away from resonance than  $3f_0/Q$ , which is the limit of the chart in either direction, the circuit resistance (and  $Q$ ) may be disregarded, and calculations made simply on the basis of the  $L$  and  $C$  values.

## RECORD PRESSING

*Continued from page 24*

medium. The biscuit melts and flows into the grooves of the record mold assemblies, which must be bulky and rigid to withstand the pressure. Then cold water is introduced for cooling the molds. These presses cost a great deal of money; it takes a long time to set up the stampers for any given record; and the stampers wear quickly—usually, not more than 1,000 records can be made from each set. Because of the great dependency on plastic flow to fill the grooves, plasticizers and other adulterants must be added to the vinyl resin during the biscuit-making process. These additives deteriorate the finished record; moreover, the reject rate is still high.

Very much lower pressure is needed in the Microfusion process. The press is smaller and far less expensive. The magnesium dies are light (a "book" containing molds for both sides of a 12-inch LP weighs about 5 lbs.) and, therefore, are easily handled and filed. They are good for at least 20,000 pressings with no quality deterioration. Since the powder is distributed uniformly over the face of the mold, the need for free plastic flow is greatly reduced, so that vinyl of greater purity can be used and the reject rate is virtually

*Continued on next page*

For the Audio Perfectionist

## DYNAKIT MARK II



An amplifier kit which provides the finest sound at low cost. The listening quality of the Dynakit is unequalled by any amplifier, regardless of price; and this kit can be readily assembled in about three hours.

The Dynakit uses a new bug-free circuit, designed by David Hafner. Complete reproducibility of operating characteristics is guaranteed by the use of a factory-wired printed circuit board. The Dynakit comes complete with all components including the super-fidelity Dynaco A-430 transformer.

### Specifications:

**Power Output:** 50 watts continuous rating, 100 watts peak. **Distortion:** under 1% at 50 watts, less than 1% harmonic distortion at any frequency 20 cps to 20 kc within 1 db of max. **Response:** Plus or minus .5 db 6 cps to 60 kc. Plus or minus .1 db 20 cps to 20 kc. **Square Wave Response:** Essentially undistorted 20 cps to 20 kc. **Sensitivity:** .5 volts in for 50 watts out. **Damping Factor:** 15. **Output Impedances:** 8 and 16 ohms. Tubes: 6CA7/EL-34 (2) (6550's can also be used) 6AN8, 5U4GB. Size: 9" x 9" 6 3/4" high.

**69.75**  
net

## Dynaco Output Transformers



Featuring para-coupled windings, a new design principle (patents pending). These transformers use advanced pulse techniques to insure superior square wave performance and undistorted reproduction of transients. Dynaco transformers handle full rated power over the entire audio spectrum from 20 cps to 20 kc, without sharp rise in distortion at the ends of the band which characterizes most transformers. Conservatively rated and guaranteed to handle double nominal power from 30 cps to 15 kc without loss of performance capabilities.

### Specifications:

**Response:** Plus or minus 1 db 6 cps to 60 kc. **Power Curve:** Within 1 db 20 cps to 20 kc. **Square Wave Response:** No ringing or distortion from 20 cps to 20 kc. **Permissible Feedback:** 30 db.

### MODELS

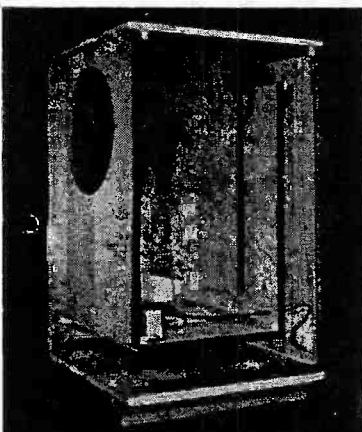
A-410	10 watts 6V6, EL-84	14.95
A-420	25 watts KT-66, 5881, EL-34	19.95
A-430	50 watts 6550, EL-34 (6CA7)	29.95
A-440	100 watts 6550	39.95
A-450	100 watts PP par, 6550, EL-34	39.95

(All with tapped primaries except A-440 which has tertiary for screen or cathode feedback)

Additional data on Dynakit and Dynaco components available on request including circuit data for modernization of Williamson-type amplifiers to 50 watts of output and other applications of Dynaco transformers.

**DYNA COMPANY**

Dept. AC, 5142 Master St., Phila.



### Inside Acousti-Magic DIMENSIONS

Highboy 38 1/2" H x 23 3/4" W x 22" D  
Lowboy 26 1/2" H x 35 3/4" W x 22" D  
Shipping Wt. 100 lbs

### GUARANTEE—

Acousti-Magic must give complete satisfaction sound and sight or return it for a full refund.

For Complete Details write for our free Brochure.

**ACOUSTICAL DEVELOPMENT CORP.**  
DEPT. A-1, 577 NEWBRIDGE AVE.  
EAST MEADOW, L. I., N. Y.

## Acousti-Magic

## New STANDARDS of EXCELLENCE in KIT CABINETY

### ACOUSTI-MAGIC FEATURES

- SUPERIOR PERFORMANCE in direct comparison
- VERSATILITY expansion to multiple speaker system
- FINE FURNITURE no end grain or joints visible
- EASE OF ASSEMBLY cleverest new idea in kit cabinetry
- CONVERTI-BASE high and low boy in one unit
- 3/4" CONSTRUCTION THROUGHOUT solid, stiff and sturdy
- NO RISK HOME TRIAL unconditionally guaranteed

Choice of Mahogany, Oak, Walnut or Fir

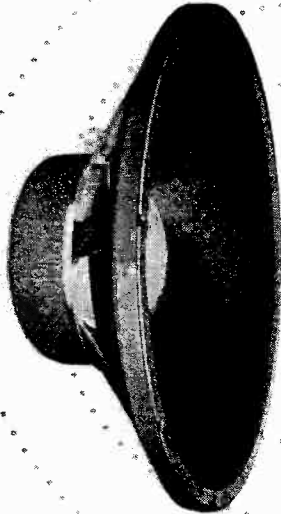
From \$54.75 to \$79.50

Kit includes grille cloth, frame and internal damping material. Specify speaker and size when ordering.

All prices F.O.B. East Meadow, N. Y.

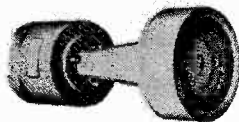


**JBL signature**



## great speakers...

All that it takes to make a speaker great — excellent basic design, precision-made parts, painstaking craftsmanship, meticulous assembly — goes into JBL Signature Loudspeakers. The JBL Signature Model D130 is the only fifteen-inch extended range speaker made with a four-inch voice coil of edge-wound aluminum ribbon. It has a rigid cast frame, silvery dural dome, highly refined magnetic circuit. The D130 is distinguished by its clean, smooth coverage of the complete audio spectrum... crisp, clean bass; smooth, extended highs. It is the most efficient speaker made anywhere.



**PRECISION  
HIGH FREQUENCY  
UNITS**

The greatest single improvement you can make in your high fidelity system is to add a JBL Signature High Frequency Unit. The popular 175DLH is made with all of the precision necessary to retain the subtleties which are the essence of high frequency reproduction. In addition it has an acoustical lens — an exclusive JBL Signature feature — which disperses sound over a 90° solid angle with equal intensity regardless of frequency.

## RECORD PRESSING

*Continued from preceding page*

negligible. The process is inherently faster than the conventional one. Very short runs are feasible, because the setup time for a new record involves only the time necessary to pull a new book out of the file. Finished record quality is better, particularly in regard to surface noise.

With all these advantages, and a few others we don't have room to describe, the Microfusion process appears well adapted to operation on a large or small scale. The large concerns, having substantial investments in existing equipment and in personnel to operate it, certainly won't replace it overnight. But small record companies which now use the custom-pressing facilities of the giants will be able to afford their own presses. Furthermore, and perhaps most important, short runs will now be potentially profitable, and we may expect a considerable expansion in the number of offbeat music and sound records that were formerly unprofitable because of limited demand.

## STEPHENS K62I

*Continued from page 20*

install the trim frame (piece 6 blocks access to one of the frame screw holes). When installing the frame, incidentally, it's a good idea to use flat washers with the screws, because the screw holes are rather large for the heads. A supply of flat washers is included in the hardware assortment.

## AUDIOCRAFT Test Results

Although it is strictly true that the K-21 will work with any 12-inch woofer, wide-range speaker, or coaxial speaker, we found that it worked *best* with Stephens speakers and those having similar free-air cone resonance frequencies. This is undoubtedly because the vent is tuned to match such speakers. Fig. 10 shows the impedance curve, at bass frequencies, of a Stephens 120LX speaker in the K-21. The curve is much like that of a conventional bass-reflex system accurately tuned, with two impedance peaks of about equal amplitude centered around the free-air resonance frequency. With this system, however, the upper impedance peak is split into two closely spaced ones, possibly because of the unorthodox vent loading.

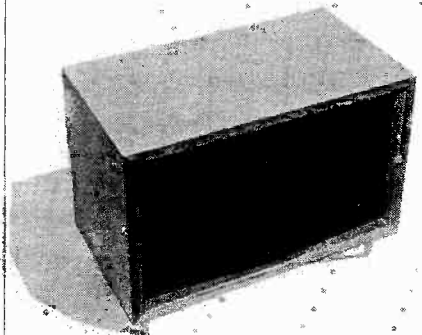
According to our measurements, bass response held up well down to about 34 cps before doubling began, with the enclosure situated in a corner; there was a gradual rise in efficiency up to about 80 cps. Along a wall, of course, bass became less prominent. We preferred the balance obtained when the K-21 was used along the wall, as it was meant



If you are to hear fundamental bass tones, your speaker must be properly enclosed. JBL Signature Enclosures are engineered to make full use of the great sound potential in Signature Speakers. They are handsome to look at, wonderful to listen to. A wide range of types — bass reflex and folded horns — and sizes is available. All are superbly engineered, superbly designed, superbly built. Panels of specially selected plywood are precision cut. Joints are lock-mitred and wood-welded. An unusually wide choice of fine, hand-rubbed finishes is offered. It is even possible to order an enclosure from the factory to exactly match a sample supplied by you. If you want to build your own, you can get detailed blueprints of most Signature Enclosures from your audio dealer or the manufacturer.

## superb enclosures

Below is shown the new JBL Signature "Harkness," a back-loaded folded-horn in lowboy console styling. Although its proportions are such that it will be welcome in any living room, the Harkness encloses an ingeniously folded six foot horn path for smooth, crisp, deep-down bass.



**THERE IS A JBL  
SIGNATURE SPEAKER  
SYSTEM FOR  
EVERYONE... ONE IS  
JUST RIGHT FOR YOU.**

*Write for free catalog and technical bulletins and the name of the authorized JBL Signature Dealer in your community.*



means

**JAMES B. LANSING SOUND, INC**  
2439 Fletcher Drive, Los Angeles 39, Calif.

to be, and a slight amount of electrical bass boost added. In our opinion, the sound benefited throughout the bass and middle range when we added a sturdy diagonal stiffening brace on the inside of the back panel. This involves little effort; and perfectionists will find it time well spent that is used in stiffening the panels of any enclosure.

The cabinet finishes beautifully, with little effort. Its finished appearance is graceful enough to go well in any surrounding. We believe it to be a good buy for anyone to whom sound and sightliness are of equal importance.

## GROUNDING EAR

*Continued from page 5*

natural response of the high-frequency rolloff filter network. You will note that the curve assumes a 12-db-per-octave slope eventually, but not until more than one octave above the point where response begins rolling off. If a 12-db-per-octave rolloff slope were desired above 10 Kc, it would be necessary to tolerate significant losses above 5 Kc. Now, suppose we put a feedback loop around the entire network. The flat portion of the filtering curve will be reduced in level; but the reduction will be much less in the portion where response slopes, because less voltage is fed back at these frequencies. The feedback loop therefore produces an effective gain for the frequencies along the slope—up to the point at which the feedback voltage becomes insignificant. We can represent this by the curve C. The over-all curve is represented in D, which is a distinct improvement over A; now we have a curve which is flat to 10 Kc and then immediately starts a 12-db-per-octave slope. The result is a much more satisfactory rolloff filter, one which attenuates the undesired frequencies but leaves unaffected the desired frequencies. Precisely the same effect occurs with the rumble filter at the bass end.

In the actual circuit, the constants of the two filters are changed to provide a choice of turnover points at 50 and 100 cps at the bass end, and 5,000 and



10,000 cps at the treble end; a third position removes the filters from the circuit to provide a flat response.

With this and other features, the HF-61's performance rivals that of the most expensive preamps. There are inputs for several types of phono cartridges; five phono-equalization curves; a tape output which follows the filters but precedes the tone-control stages; inputs for tape recorder, tuner, TV, and

*Continued on next page*

# COMING to your city HIGH FIDELITY MUSIC SHOWS

*See and hear the latest in HIGH FIDELITY from leading high fidelity manufacturers . . .*

Don't miss these public showings of Hi-Fi Equipment . . . from the most economical units for the budget-minded to spectacular home music theatres . . . compare and enjoy them all. Components and complete systems will be displayed.

## THREE DAYS OF CONTINUOUS DEMONSTRATIONS 1 P.M. to 10 P.M.

Philadelphia	April 5, 6, 7	Benjamin Franklin Hotel
Buffalo	April 12, 13, 14	Statler Hotel
Cincinnati	September 20, 21, 22	Sheraton-Gibson Hotel
Miami	October 18, 19, 20	McAllister Hotel
St. Louis	November 22, 23, 24	Statler Hotel

**Rigo Enterprises, Inc.** 500 North Dearborn Street, Chicago 10, Illinois

## GRAY 50 watt Power Amplifier . . with power to spare!

One of the very few High Fidelity Amplifiers that meets its advertised claims without straining. This amplifier can handle all unusual load and power problems including electrostatic and low efficiency speaker systems without diminution of quality. This results in "Concert Hall Presence", the unusual effect of "Being There" experienced by owners of Gray High Fidelity equipment.

Can be used with any make or model of pre-amplifier • Switched and unswitched power receptacles for auxiliary equipment • Pre-amplifier power supply with remote "On-Off" switch circuit • Input level control • Bias control of output tubes • Line fuse • Highly stable rectifier circuit

At all Gray Dealers or write direct for technical literature.



### SPECIFICATIONS:

**POWER OUTPUT**—50 watts continuous, 100 watts peak.  
**DISTORTION**—I. M. distortion less than 1% at full 50 watts. (Average .5 of 1%)  
**FREQUENCY RESPONSE**—Plus or minus .5 db from 6 to 60,000 cycles.  
**POWER RESPONSE**—20 to 20,000 cycles within 1 db at 50 watts without exceeding 1% harmonic distortion, even at 20 cycles.

**GRAY** RESEARCH and Development Co., Inc.  
MANCHESTER, CONNECTICUT  
Subsidiary of the Gray Manufacturing Company



Export Division: Rocke International Corp., 13 E. 40th Street, New York 16, N.Y.—Cables: ARLAB

the ultimate goal  
of the  
critical listener

**★ marantz**

*Audio Console*  
preamplifier, complete \$168\*

*Power Amplifier*  
\$198\*

\*slightly higher  
west of  
the Mississippi

write for literature

**marantz company**  
44-15 Vernon Blvd., Long Island City 1, N. Y.

for everything in **hi-fi**  
GET THE MONEY-SAVING 1957  
**ALLIED CATALOG**

**featuring the  
world's largest  
stocks of systems  
& components**

**free!**  
SEND FOR IT

Here's your complete money-saving guide to Hi-Fi. Shows you how to select a custom Hi-Fi music system for your home at no more than the cost of an ordinary phonograph. Tells you what to look for and how to save money. Offers the world's largest selection of complete Hi-Fi systems as well as individual amplifiers, tuners, changers, speakers, enclosures and accessories. Want to build-your-own?—see the famous Hi-Fi KNIGHT-KITS. For everything in Hi-Fi—for everything in Electronics, get the FREE 1957 ALLIED Catalog.

**ALLIED RADIO** AMERICA'S  
HI-FI CENTER

**ALLIED RADIO CORP. Dept. MM-47**  
100 N. Western Ave., Chicago 80, Ill.

Send FREE 1957 ALLIED Catalog

Name \_\_\_\_\_  
Address \_\_\_\_\_  
City \_\_\_\_\_ Zone \_\_\_\_\_ State \_\_\_\_\_

## GROUNDING EAR

*Continued from preceding page*

an auxiliary; AC sockets for four other pieces of equipment; the Compentrol type of loudness control with a separate level control; the excellent tone-control action of the Baxendall circuit; a hum adjustment; and low-impedance main output.

All in all, here is an example of a high level of engineering skill, which has managed to achieve fine performance with simple means and low cost.

## OPTIMIZE FOR \$1

*Continued from page 23*

will be a considerable peak at some high frequency, but the amplifier will not be oscillating, as observed on the oscilloscope screen. Then, when the feedback resistor is put back to its original value, the amplifier will have its correct peak-free rolloff characteristic.

## Gains and Losses

This is quite a simple and effective procedure. Why is it not employed by manufacturers in producing or designing amplifiers? Principally because it results in rolloffs at both ends of the range that do not look too good in a specification. You will probably find, after giving it this treatment, that your amplifier has a loss in response of a little more than 1 db in the region of 20 cps, and also at 20 Kc. But if you will make a listening comparison, you will find that the amplifier sounds considerably cleaner on several kinds of program material as a result of these changes.

Assuming that you were successful in borrowing an oscilloscope (and did not have to buy one) to make these checks, all that the changes have cost you is a few cents for various resistors and capacitors for making the tests, some of which you will have permanently soldered into the amplifier.

It will be obvious that specific values cannot be given here. I could state the values that were used in the amplifiers on which these tests were made, but they would not be the same for other amplifier designs.

## Conclusions

Do not get the impression from this article, however, that these simple changes will do as much for an amplifier as the more elaborate changes recommended in other articles. Changing the output tubes, output circuit, and



using a better transformer, will enable you to get more power and also, using the kind of technique described above, to get a wider frequency response between the rolloff points.

If you have a rather poor transformer you may find that the response may be down as much as 3 db at 50 cps and 10 Kc, which would not be considered by some to be a very high-fidelity amplifier. The point to remember is that adjustment in this manner will give performance of as high a fidelity as this particular amplifier, or rather the output transformer in it, is capable of.

It is evident from this discussion that it isn't difficult to adjust an amplifier to see just how good it can be made with its existing output transformer. We may find the improvement is not as much as we would like; perhaps we feel that we need a bigger power margin to handle crescendos, or that the frequency response should be a little wider, to go out nearer to the extreme limits of the audio spectrum. In either case, the only thing to do is get that more expensive transformer. In many instances, however, it will be found that the lower-cost unit we already have will give quite pleasing results with just these simple modifications.

## PROFESSIONAL DIRECTORY

### Artisan Build-It-Yourself

#### ELECTRONIC ORGANS

Send \$1.00 for "Organ Builders Manual!"

#### ELECTRONIC ORGAN ARTS

4878 Eagle Rock Blvd.  
Los Angeles 41, Calif.

### GIBSON GIRL TAPE SPLICERS

**splices in a wink!**  
NO SCISSORS!  
NO RAZOR BLADES!  
Diamond cut tape ends  
and trim splice edges

**At Your Dealers**

**ROBINS INDUSTRIES CORP.** Bayside 61, N. Y.

### AUTOMATIC CHANGER NEEDLE BRUSH

**KLeeNeeDLE**

KLeeNeeDLE automatically keeps record changer needles clean. It is designed to remove the familiar "dust-blob" from under the needle point. At Your Dealer

**ROBINS INDUSTRIES CORP.** Bayside 61, N. Y.

**AUD-O-FILE**  
An entirely new method for filing fine records.

NO INDEXES!  
NO JACKETS!  
NO SLEEVES!  
NO ALBUMS!

**ROBINS INDUSTRIES CORP.**  
Bayside 61, N. Y.

## READERS' FORUM

*Continued from page 17*

are sure that everyone by now will have guessed that this is that old bugaboo, the phono plug, commonly known as the "RCA type". Everyone knows how poorly constructed this plug is, how hard to work with, and how shoddy generally.

It is gratifying that one firm, Ampex, has started to use a new plug in lieu of the RCA-type misfit. In the new Ampex Model 601 portable recorder a "Switchcraft" plug and mating receptacle are used. These are easy to work with, substantial, and the plug has a decent gripping surface and is capable of being plugged and unplugged many times without falling apart.

Here at High Fidelity House, we look forward to the day other manufacturers will use plugs of this caliber in place of that old "thorn in the side". Congratulations to Ampex for being the first to our knowledge.

Arthur Cunliffe  
High Fidelity House  
Baltimore, Md.

## TAPE NEWS

*Continued from page 11*

same room as that wherein it will be heard, because this will cause doubling

## LEGS!

- Legs screw in and out in a jiffy.
- Rigid support with heavy gauge bracket
- Recessed solid brass tip
- Genuine hardwood
- Gracefully tapered, sanded ready for finish

## SET of 4...

with 4 adjustable brackets for straight or flare style and all hardware.

Sizes	
3½" - 4.00	16" - 5.75
6" - 4.25	18" - 6.50
9" - 4.75	22" - 7.25
12" - 5.25	28" - 8.25

Satisfaction Guaranteed

Some uses:

Chests — bookcases — TV and Hi Fi consoles — all tables, — chairs, etc.

Send check or Money Order, Postage Paid — U.S.A.

(Sorry no C.O.D.)

## CUSTOMLINE CABINET CO.

Dept. AC4  
Box #267

East Orange, New Jersey



of every standing wave in the place and will really garble things.

A bidirectional microphone is usually best for dramatic shows. Its live front and back pickup areas allow plenty of room for the actors, and its dead sides can be used for off-stage effects without obliging the actor in question actually to walk off stage. The actors group themselves around the mike at an average distance of 3 ft., within the live pickup areas (Fig. 2). If some actors

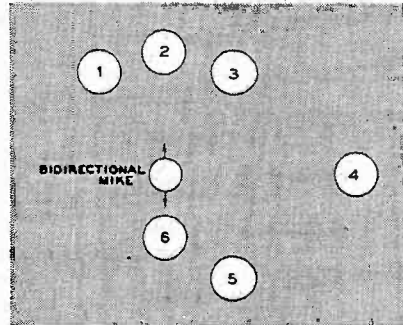


Fig. 2. Talk-miking a group; see text.

have voices weaker than others, they can be placed closer to the mike.

The microphone should be set at about eye level, so that the actors can hold their scripts in front of them without obscuring their view of the mike (or its coverage of them). They address themselves directly to it at all times except when the dialogue or directions indicate otherwise. Such indications might be a shouted call to another party (at which time the actor should turn his back on the microphone or step part way into the microphone's dead area), or an intimate whispered conversation (when the actors involved should get close to the microphone).

If sound effects are required, these may be fed into the live rear of the microphone or, better still, delivered to a second mike via an input mixer. As for the effects themselves, these deserve attention on their own, so I'm not going to take the space to do it right at this time. Meanwhile, anyone with an uncontrollable intellectual curiosity about sound effects might delve into that chap-

*Continued on next page*

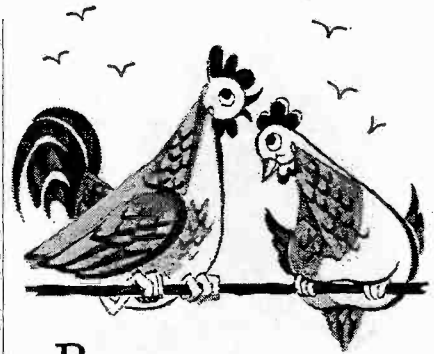
## TRADERS' MARKETPLACE

Here's the place to buy, swap, or sell audio equipment. Rates are only 20¢ a word (excluding name and address) and your advertisement will reach 20,000 to 35,000 readers. Remittance must accompany copy and insertion instructions.

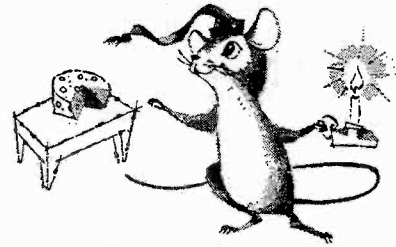
\$200 MONTHLY POSSIBLE, sewing babywear! No house selling. Send stamped, addressed envelope. Babygay, Warsaw 105, Indiana.

TAPE RECORDERS, tape, Unusual values. Free catalog. Dressner, 69-02D, 174 St., Flushing 65, N. Y.

LEARN WHILE ASLEEP with your recorder. Amazing book gives full instructions. \$2.00. Guaranteed. Research Association, P. O. Box 610-AC, Omaha, Nebr.

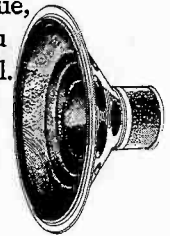


Birds of a feather  
flock together,  
And so will pigs  
and swine;



Rats and mice  
will have their choice,  
And so will I  
have mine.

My choice is Norelco,  
Speakers, of course,  
The reason I'm honored  
to tell;  
Few other speakers are  
quite as true,  
Or will please you  
half as well.



Norelco \*F.P.S. Speakers are available in 5", 8" or 12" sizes in standard impedances. Priced from \$6.75 to \$59.98. Blueprints are available for the do-it-yourself enclosure builder. Norelco Enclosures are available in three sizes, priced from \$33.75 to \$119.95.

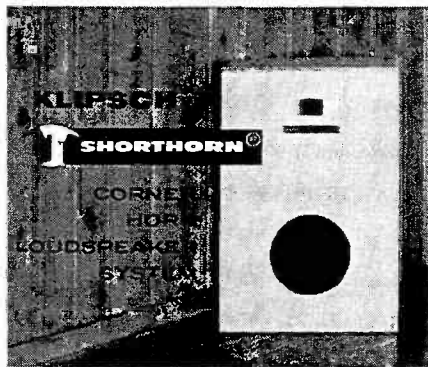
ADD TO ... and improve any sound system with Norelco®

\*FULL RESPONSE SPEAKERS

Write today to Dept. M4 for brochures and prices of these unique speakers.



NORTH AMERICAN PHILIPS CO., INC.  
100 E. 42nd St., New York 17, N.Y.



**CABINET STYLES  
UTILITY STYLES  
(ILLUSTRATED)  
ASSEMBLY KITS**



DESIGNED AND MANUFACTURED by PAUL W. KLIPSCH, originator of the KLIPSCHORN\* speaker system, the SHORTHORN\* is second only to the KLIPSCHORN\* system in performance. Using coordinated acoustic elements, including filters, it offers exceptionally smooth response, free from distortion. Back loading horn extends bass range without resonance.

Available in handsomely finished enclosures, in stripped down utility styles (as illustrated) or separate components for assembly.

\*REGISTERED TRADEMARKS

**KLIPSCH**  
AND ASSOCIATES  
HOPE, ARKANSAS

**Now! New RCA Victor  
superstrength, extra-long  
play Hi-Fi "Mylar"\* tape!**



Plays 50% longer! Not 1200 feet, but 1800 feet on a 7" reel! Extra-thin—superstrong! Costs \$7.50 per 7-inch reel. Also available: new RCA Victor acetate tape with full frequency performance—at a special low price! And RCA Victor acetate tape with full High Fidelity response. The same tape used for professional recordings—\$3.50 for 7-inch reel.

\*"Mylar" is a registered Dupont trademark for its polyester film. Nationally advertised list prices shown, subject to change.

**RCA VICTOR**  
RADIO CORPORATION OF AMERICA  
CAMDEN 8, NEW JERSEY

**TAPE NEWS**

*Continued from preceding page*

ter of Audio Devices' book, *How to Make Good Tape Recordings*.

That about covers the basic rules for speech recording. Further experimentation and the needs of the moment will undoubtedly suggest many variations to the recordist. Speech-recording technique has, as a matter of fact, a number of things in common with a type of recording that a number of readers have inquired about: small-group jazz combos.

This is one type of musical material that thrives on close microphoning, and the requirements for its realistic reproduction are much the same as those of the dramatic production. If a special recording session is planned, the musicians can be grouped around a bidirectional microphone in much the same manner as the actors in a play, slightly varying their distances where necessary to correct for imbalance. When recording musical groups, however, dead areas of the mike should not be used for correcting imbalances, because high frequencies may be lost through the mike's selective directivity. The dead areas should, rather, be used for taming highs in overbright instruments, simultaneously moving those instruments closer to maintain correct balance.

It is much more often the case that a jazz-band recording will take place in its natural habitat—usually a long, narrow, walk-down night spot. This of course complicates matters, because the acoustics are often very poor, the audience is (if enthusiastic about the music) extremely noisy, and there are always at least a few individuals present who show their enjoyment by stamping heartily on the floor in time to the music. These clamorous thuds then travel up the mike stand, shake it rhythmically, and add overload booming noises to the recording.

The best kind of microphone to use for live-performance jazz recording is a unidirectional cardioid type. A handy accessory for it is a shock mount like the one made by Electro-Voice (and designated the 345). Better still, if circumstances and the management will permit it, the mike should be suspended from a rope strung across the room, for ultimate suppression of floor-borne interference. All the characteristics of a cardioid microphone are good for this kind of recording. Its lack of rear pickup minimizes audience noises and the bad acoustics, and its concentrated front pickup gives the very close and high-powered sound that jazz enthusiasts like, while at the same time enabling the mike to be far enough away to include all the instruments in its field of maximum sensitivity.

**Put your tapes to work**



with **Microfusion** \*  
yes, records can now be made from your own tapes

- in small quantities
- in large volume
- at a fraction of what records ordinarily cost

with top professional quality—  
a complete service from tape

**FULL INFORMATION--  
SAMPLE PRESSING**

use the coupon below . . .

**Electronic Press corp.**  
351 Courtland Avenue, Glenbrook, Connecticut

Please send full information on custom pressing by microfusion\*.

I enclose 25c for sample pressing.

Name \_\_\_\_\_

Address \_\_\_\_\_

City \_\_\_\_\_ State \_\_\_\_\_

\*TM of Cook Laboratories, Inc.

**ADVERTISING INDEX**

Key No.	Advertiser	Page
1	Acoustical Development Corp.	43
2	Acoustic Research, Inc.	40-41
3	Allied Radio Corp.	46
4	Argos Products Co.	11
5	Audio Fidelity Records	1
6	Audiophile's Bookshelf	37
7	Bozak, R. T., Sales Co.	5
8	Components Corp.	39
9	Conrac, Inc.	Inside Front Cover
10	Cook Laboratories	48
11	Customline Cabinet Co.	47
5	Dauntless International	1
12	Dyna Co.	43
13	EICO	38
14	Electronic Organ Arts	46
10	Electronic Press Corp.	48
9	Fleetwood	Inside Front Cover
16	Gray Research & Development Co.	45
17	Heath Co.	13-15
18	Klipsch & Associates	48
19	Lafayette Radio	2
20	Lansing, James B., Sound, Inc.	44
21	Marantz Co.	46
22	North American Philips Co.	47
23	Professional Directory	46
24	RCA Victor	48, Inside Back Cover
25	Rigo Enterprises, Inc.	45
26	Robins Industries Corp.	46
27	Sound Sales Directory	42
28	Stephens Tru-Sonic	Back Cover
29	Traders' Marketplace	47
30	Viking of Minneapolis	16