

audiocraft

SEPTEMBER 1956

THE HOW-TO-DO-IT MAGAZINE OF HOME SOUND REPRODUCTION

35 CENTS

204

THIS MONTH

For the first time:
how to evaluate true
sound quality by ear.

Soldering materials
that are available,
and how to use them.

Quality of discs vs.
recorded tapes dupli-
cated at high speed.

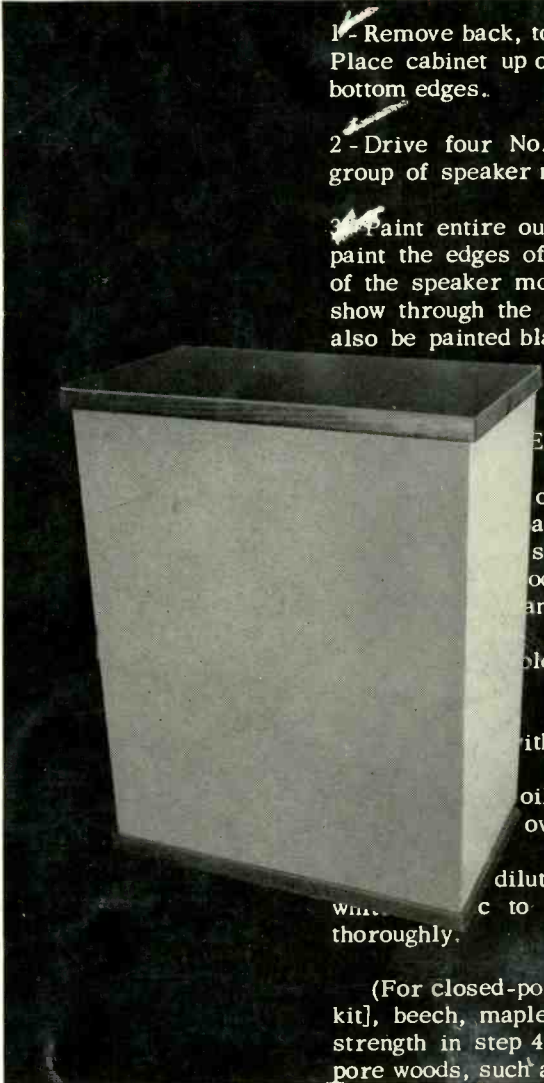

1 - Remove back, top assembly, and bottom assembly. Place cabinet up on wood blocks for easier access to bottom edges.

2 - Drive four No. 8-32 fin-shank screws into each group of speaker mounting holes in front panel.

3 - Paint entire outside cabinet surface black. Also paint the edges of the speaker cutouts and the heads of the speaker mounting screws so that they will show through the grille cloth. The back panel also be painted black at this time although this is not necessary.

EXPOSED WOOD SURFACES

On all of the exposed wood surfaces, the wood panels should only be attempted if the wood is screwed from the cabinet. All good finishes are possible, a true finish can be obtained by following these steps: 1. Fill holes with wood filler, colored to match the wood. 2. Sand with No. 0000 sandpaper, then dust off. 3. Wipe with oil stain, wipe thoroughly as directed, and let dry over night. 4. Apply a diluted shellac wash coat, mixed one part shellac to two parts alcohol. Allow to dry thoroughly.

(For closed-pore woods, such as birch [supplied in kit], beech, maple, cherry, or pine, use shellac wash coat in step 4 and omit steps 5 and 6. For open-pore woods, such as oak, mahogany, walnut, or k

THE SHERWOOD FORESTER KIT

This issue contains a comprehensive report on the Forester speaker system kit, which costs only \$129 complete. Helpful hints on construction are given, together with test results and performance data.



"My interest is music—and I'm sensitive to distorted or uneven notes. I compared the sound, and then decided that the Garrard RC 121 gave better performance. The music comes over clean and clear...without wows, flutter, or rumble."

"We live on a budget

—and want the best our money can buy. The RC 121 Garrard gives us the 'tops' in record changers at a price we can afford. It comes pre-wired, so easy to install that I did it myself."



"Radio service men have been waiting for the new Garrard RC 121. It's the first Garrard changer that fits into any cabinet. It will play for years, keep my customers satisfied. And parts are always available."

"I'm an engineer, and I can understand why the Garrard is called the world's finest record changer. It has heavy-duty steel construction, adjustable levers, a lot of quality playing features, and it is put together carefully."



"My friends at school all like the Garrard RC 121. When I'm alone and just listening, I play records one at a time, by hand. For dancing or background music while I'm studying, the changing and mixing features of the RC 121 are perfect."

"I'm an old hand at high fidelity. Being critical about sound, I like to experiment. I find that the new RC 121 won't hum with the most sensitive pickup, has the easiest adjustments for stylus pressure on any changer, and tracks without resonance or distortion."



There's something exciting for everyone

in this entirely new

GARRARD

World's Finest Record Changer

These features make the GARRARD RC 121 "Renown" your best buy in record changers ... at \$42⁵⁰



HEAVY STEEL PRECISION TURN-TABLE: A full inch high. Eliminates magnetic hum by strengthening motor shielding. Fly-wheel action. Silent, free-wheeling, ball-bearing turntable mount.

GENUINE RUBBER TRACTION MAT: Exclusive raised tread—adapts itself to contours of your records; protects grooves.



TRUE-TURRET DRIVE: Eliminates vibration, plays records at perfect, constant speed. Single turret, direct operation without belts.

EXCLUSIVE SENSI-MATIC TRIP: Sure operation even with tone arm set at lowest tracking pressures. Quiet, safe, gentle to records.

4-POLE SHADED "INDUCTION SURGE" MOTOR: Constant in speed, with minimum vibration. Smoothest, quietest, most powerful type. No hum, even with sensitive pickups. Self-aligning Oilite bearings. Exclusive dynamically-balanced rotor.

FULL MANUAL POSITION: Fingertip control adds to your automatic changer the advantages of a manual record player. Professional-type finger lift.

STEEL MONO-BUILT UNIT PLATE: Years of trouble-free service. Exclusive SNAP MOUNT springs mount changer instantly; can be levelled from top!

EASIEST STYLUS PRESSURE ADJUSTMENT ON ANY CHANGER: Protects delicate record grooves! Stylus Pressure set with easily-accessible knob on tone arm.

Exclusive! TRUE-TANGENT TONE ARM OF ALUMINUM: Plays better by eliminating resonance, providing greater rigidity, low mass, and lightness.

INTERCHANGEABLE PLUG-IN HEADS: Accommodate your choice of pickups. Fit all cartridges—crystal, ceramic, or magnetic; turnover, twist or plug-in types.

READY FOR PLUG IN! 6-ft. U-I approved electric cord and pickup cable, standard jack. No soldering, tools required.

SIMPLI-MIX OPERATION: You load records of any standard diameters in size order on fixed spindle. Automatic spindle for 45 rpm records optional.



The Garrard RC 121 "Renown" is everyone's quality record changer... engineered to bring you unmatched craftsmanship and features in a compact, economical unit. Whether you are assembling your first high fidelity system or rebuilding an old set, this fine Garrard changer meets every requirement. See it, test it — and you'll agree.

Now there's a GARRARD for every high fidelity system. Write for B.I.C. Plan Book.



301 Turntable \$89.00
 RC 98 Super Changer \$67.50
 RC 88 Deluxe Changer \$54.50
 RC 121 Mixer Changer \$42.50
 Model T Manual Player \$32.50

GARRARD—A quality endorsed product of the B.I.C. group.

BRITISH INDUSTRIES CORP., Dept. GM-96
 Port Washington, N. Y.
 Please send B.I.C. High Fidelity Plan Book.
 Name..... Address..... City..... State..... Zone.....

UNUSUAL RECORDINGS

for the Discriminating **Hi-Fi** Record Collector

AUDIO FIDELITY RECORDS presents *Studies in HIGH FIDELITY sound*

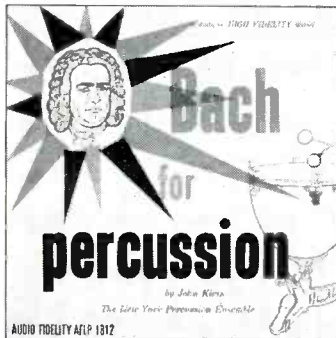

NEW !!! on AUDIO FIDELITY RECORDS for the FIRST TIME !!!
BACH TRANSCRIBED FOR PERCUSSION

The most exciting, original and powerful percussion work yet.

- Toccata and Fugue in D Minor
- "Great" Fugue in G Minor
- Toccata in F Major
- Fugue in C Major

AUDIO FIDELITY AFLP 1812
12" \$5.95

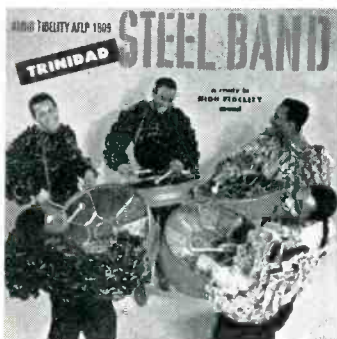

TRINIDAD STEEL BAND

The exciting, throbby rhythms of the Steel Band, trademark of the West Indies, in a modern high fidelity tropical treatment. Oil Drums in Hi-Fi, a 20th Century phenomenon.

AUDIO FIDELITY AFLP 1809
12" \$5.95

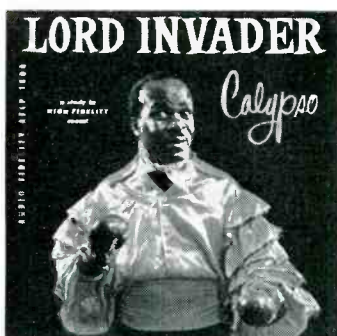

LORD INVADER: CALYPSO

The "Rum and Coca Cola" man from Trinidad in a recording of new calypso songs. Trinidad's foremost calypso artist singing his latest and his greatest songs.

AUDIO FIDELITY AFLP 1808
12" \$5.95

STUNNING NEW RELEASES with that well known AUDIO FIDELITY Sound!

- STRINGS OF PEARL, Harp and Rhythm AFLP 1805 12-in. \$5.95
- CHA CHA CHA, Pedro Garcia Orch. AFLP 1810 12-in. 5.95
- TROMBONE, Concerto with Orch.-Serly AFLP 1811 12-in. 5.95
- BACH FOR PERCUSSION, N. Y. Percussion Ens. AFLP 1812 12-in. 5.95
- CHA CHA CHA, Salamanca Orch. AFLP 1813 12-in. 5.95
- PATACHOU, with Jo Basile & Orch. AFLP 1814 12-in. 5.95
- ACCORDION DE PARIS, Vol. 1, Jo Basile & Orch. AFLP 1815 12-in. 5.95
- FIESTA EN MEXICO, Mariachis AFLP 1816 12-in. 5.95
- PLAZA DE TOROS, Vol. 2, Banda Taurina AFLP 1817 12-in. 5.95
- TORERO, Vol. 3, Banda Taurina AFLP 1818 12-in. 5.95
- FIESTA EN ESPANA, Flamenco Guitar AFLP 1819 12-in. 5.95
- GRAYVILLE SINGS, Music of Advent & Christmas AFLP 1820 12-in. 5.95
- ACCORDIONISTE DE FRANCE, Vol. 2, Jo Basile & Orch. AFLP 1821 12-in. 5.95
- ROME . . . WITH LOVE! I, Italian Accordion AFLP 1822 12-in. 5.95
- THE DUKES OF DIXIELAND:
YOU HAVE TO HEAR IT TO BELIEVE IT! AFLP 1823 12-in. 5.95
- BAWDY SONGS & BACKROOM BALLADS, Vol. 3. AFLP 1824 12-in. 5.95
- BAWDY SONGS & BACKROOM BALLADS, Vol. 1. AFLP 1906 now 12-in. 5.95

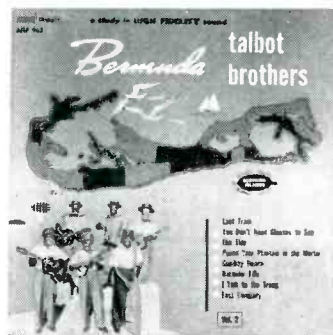

THE TALBOT BROTHERS of BERMUDA

The greatest tourist attraction that ever happened to any island, bar none. Calypso rhythms and pop favorites in an idyllic tropical setting.

Vol. 2—AUDIO FIDELITY AFLP 903
10-in. \$4.00
VOL. 3—AUDIO FIDELITY AFLP 1807
12-in. \$5.95

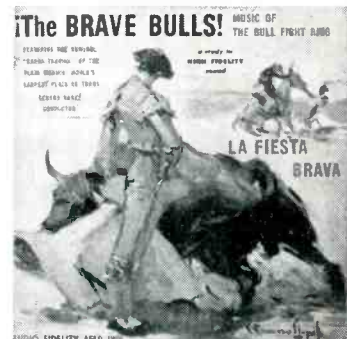

THE BRAVE BULLS!—La Fiesta Brava

Music of the Bullfight Ring
Featuring the "Banda Taurina" of the Plaza Mexico world's largest bullfight arena. A Hi-Fi presentation of an afternoon at the bullfights. Complete with book of 24 full color Bullfight Poster Reproductions. "brilliant engineering"

— HIGH FIDELITY MAGAZINE
AUDIO FIDELITY AFLP 1801
12-in. \$5.95

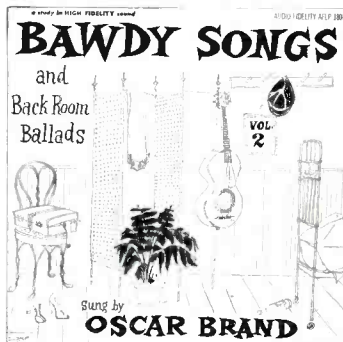

BAWDY SONGS and BACKROOM BALLADS

Oscar Brand, noted balladeer sings Folk-Americana often heard but never recorded. Rollicking songs for people with lusty appetites and strong musical tastes.

Vol. 1.—AUDIO FIDELITY AFLP 1906
12-in. \$5.95
Vol. 2—AUDIO FIDELITY AFLP 1806
12-in. \$5.95
Vol. 3—AUDIO FIDELITY AFLP 1824
12-in. \$5.95

other studies in HIGH FIDELITY sound on AUDIO FIDELITY

- MERRY GO ROUND MUSIC AFLP 901 10-in. \$4.00
- DRUMS OF THE CARIBBEAN AFLP 902 10-in. 4.00
- CIRCUS CALLOPE MUSIC AFLP 904 10-in. 4.00
- MERENGUES AFLP 905 10-in. 4.00
- MARIMBA MAMBO Y CHA CHA CHA AFLP 1802 12-in. 5.95
- KATHERINE DUNHAM, DRUMS OF CUBA-HAITI-BRAZIL AFLP 1803 12-in. 5.95

These records are available at your favorite Audio or Record Shop

WRITE FOR FREE CATALOGS

Nationally distributed by
DAUNTLESS INTERNATIONAL

750 TENTH AVE.
NEW YORK 19, N. Y.

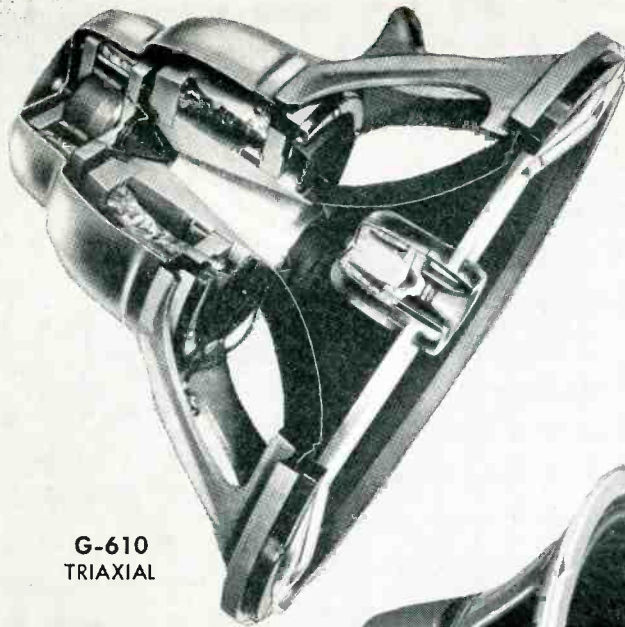

G-610
TRIAXIAL

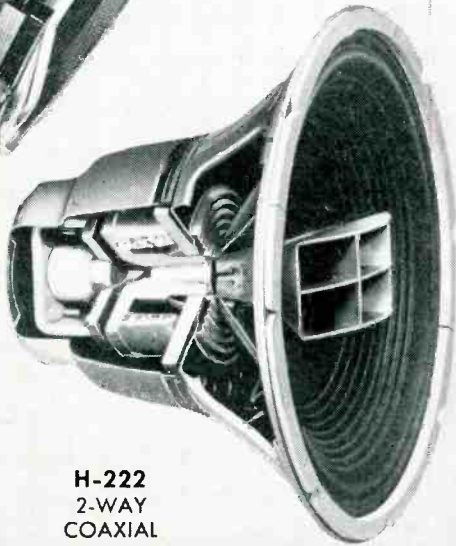
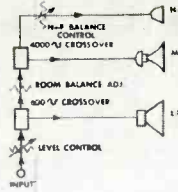

H-222
2-WAY
COAXIAL

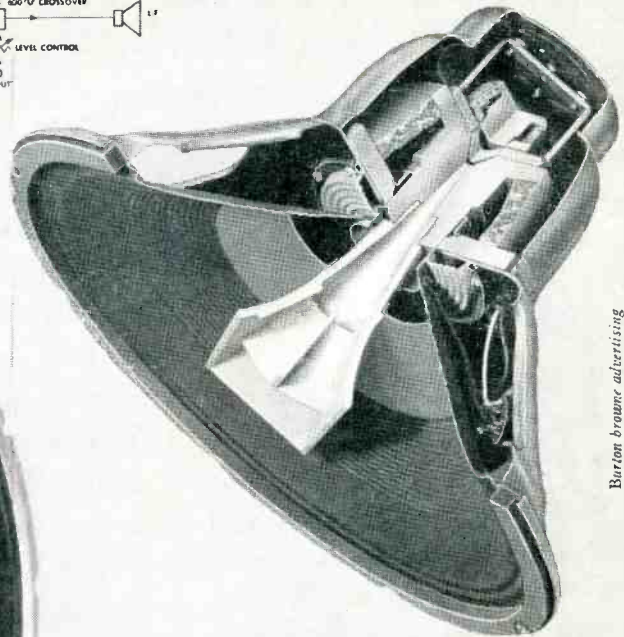
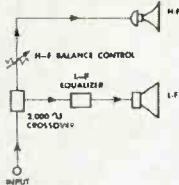

H-530
2-WAY
COAXIAL

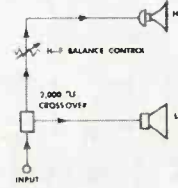

CUTAWAY VIEWS

Barton Branner Advertising

PRECISION ELECTROACOUSTICS for FINEST HI-FI LISTENING

There are many ways of designing an electro-dynamic loudspeaker system to "cover" a wide frequency range. There are only a few ways to accomplish this smoothly, cleanly, and with full coverage of the listening space . . . all of which attributes are of extreme importance when the finest listening is the objective.

Shown in cutaway views above are three classic examples of the precision electroacoustic systems used by Jensen in fine unitary high fidelity speaker systems. Direct radiator elements are confined to the low channel only. There are no freely vibrating uncontrolled appendages to give beamed peaks in the highs. High frequency channels employ scientifically flared Hypex* horn loaded compression driver units giving smooth wide-angle response. In the H-222‡ 12" and H-530 15" two-way coaxials, the h-f horn,

begins in an accurately tapered passage through the "woofer" pole piece, joining the final horn section which nests within the cone. In the TRIAXIAL* G-610 3-way the mid-channel final horn section is formed by the curvilinear cone of the "woofer," giving a large mouth with an extremely low first crossover at 600 cycles; the top channel from 4000 cycles to beyond audibility is handled by a horn loaded compression driver supertweeter. Precise control of all moving systems is insured by precision dimensioned components and correct loading. All channels have completely independent electrical systems and balance controls provide listening adjustment to your taste.

If you're looking for a listening thrill, we invite you to audition these fine speakers at your dealers.

G-610 \$252.75; H-530 \$129.50; H-222 \$58.50

*Hypex and TRIAXIAL are registered trademarks of Jensen Manufacturing Company.
‡The same construction is used in H-520 15" coaxial.

Jensen

MANUFACTURING COMPANY

6601 S. Laramie, Chicago 38, Illinois • Division of The Muter Co. • In Canada, Copper Wire Products, Ltd., Licensee

September 1956

Volume I Number II

audiocraft

THE HOW-TO-DO-IT MAGAZINE OF HOME SOUND REPRODUCTION

Authors new in this issue, in order as they appear at the right:

Herbert Drapkin is the ideal author for an article on soldering. Now chief engineer for the Anchor Metal Company, a leading manufacturer of soldering products, Mr. Drapkin has worked in the metal-joining field for 25 years. He has been responsible for the development of new forms of solder for automatic and semi-automatic production lines, his latest achievement being a 99.999% pure microscopic solder. He wrote this article because of a conviction that, while solder is used widely, it isn't often used well. A perfectionist of any sort is welcome in these pages.

D. L. Devendorf is an aeronautical communications specialist for the CAA, operating the airway radio range station, ground-to-air radio, and teletype equipment at the Lansing, Michigan, airport communications station. He has had a ham license since 1931; his station is W8EGI. After spending years trying to strain WQXR through noise and interference at night, he says that it didn't take much to sound real hi when LP records hit the market. A succession of home-built amplifiers and sound equipment followed, culminating in the circuit described in this issue.

CHARLES FOWLER, *Publisher*

ROY F. ALLISON, *Editor*

FRANK R. WRIGHT, *Managing Editor*

ELEANORE B. WRIGHT,
Editorial Assistant

ROY LINDSTROM, *Art Director*

ELEANOR GILCHRIST, *Art Assistant*

FRANCES A. NEWBURY, *Manager,
Book Division*

Contributing Editors

R. D. DARRELL

J. GORDON HOLT

JOSEPH MARSHALL

WARREN B. SYER, *Business Manager*

ARTHUR J. GRIFFIN, *Circulation
Manager*

Advertising

Main Office — Claire Eddings, The Publishing House, Great Barrington, Mass. Telephone: Great Barrington 1300.

Chicago — John R. Rutherford & Associates, Inc., 230 East Ohio St. Telephone: Whitehall 4-6715.

Los Angeles — Brand & Brand, Inc., 6314 San Vicente Blvd. Telephone: Webster 8-3971.

The Grounded Ear, by Joseph Marshall	4
<i>What's new and significant in sound reproduction.</i>	
Audionews	6
Tips for the Woodcrafter, by George Bowe	10
<i>This issue: The drill press.</i>	
Sound Servicing, by Irving M. Fried	12
<i>This issue: Speaker systems, Part 4.</i>	
Tape News and Views, by J. Gordon Holt	14
<i>This issue: Recorded tape vs. disc quality.</i>	
Readers' Forum	17
Editorial	17
The Sherwood Forester	18
<i>An AUDIOCRAFT kit report.</i>	
The Soldering Story, by Herbert Drapkin	21
<i>Materials and techniques for successful soldering.</i>	
Loudspeakers and Enclosures, by George L. Augspurger	22
<i>Part 2: Electrical relationships; the infinite baffle.</i>	
W-3 to Dyna II, by D. L. Devendorf	25
<i>Another way to convert the Heath W-3 Williamson.</i>	
Listening for Quality, by Joseph Marshall	26
<i>Part 1: Introduction; bass performance.</i>	
Designing Your Own Amplifier, by Norman H. Crowhurst	28
<i>Part IVb: Push-pull power stages.</i>	
Audio Aids	30
Sound-Fanciers' Guide, by R. D. Darrell	31
<i>Reviews of exceptional disc and tape records.</i>	
Sound Sales Directory	44
Symbols and Abbreviations	46
Traders' Marketplace	48
Advertising Index	48

Audiocraft Magazine is published monthly by Audiocom, Inc., at Great Barrington, Mass. Telephone: Great Barrington 1300. Editorial, publication, and circulation offices at: The Publishing House, Great Barrington, Mass. Subscriptions: \$4.00 per year in the United States and Canada. Single copies: 35 cents each. Editorial contributions will be welcomed by the editor. Payment for articles accepted will be arranged prior to publication. Unsolicited manuscripts should be accompanied by return postage. Entered as second-class matter October 1, 1955, at the post office, Great Barrington, Mass., under the act of March 3, 1879. Additional entry at the post office, Pittsfield, Mass. Printed in the U. S. A. by the Ben Franklin Press, Pittsfield, Mass. Copyright 1956 by Audiocom, Inc. The cover design and contents of Audiocraft Magazine are fully protected by copyrights and must not be reproduced in any manner.

The Grounded Ear

by Joseph Marshall

Marantz Amplifier

In one of the very first of these columns I expressed admiration for the Mullard circuit. This consists basically of a high-gain triode that is direct-coupled to a cathode-coupled or long-tailed-pair inverter, which drives the output tubes. At that time the only American amplifier on the market employing the circuit was the Ampex 620, using 6V6's. This past month I have been trying a new commercial amplifier, the Marantz, which uses the circuit with high powered 6CA7's (EL34's) to deliver an output of about 40 watts. It is a superlative amplifier, especially notable for fine sound in both extreme bass and treble regions. This is the result of high stability at both ends, which follows from reduction of the number of phase-shift networks within the feedback loop. Its performance is in the same class as that of the Dynakit amplifier, reviewed in this magazine recently.

I mentioned in my first comments on the Mullard circuit that one disadvantage is the difficulty of obtaining high output from the inverter-driver. Marantz engineers have solved this problem, apparently; partly by using the

EL34's, whose drive requirements are lower than those of KT66's and similar tubes, and partly by careful circuit design. Especially notable is the fact that a means is provided for balancing the inverter-driver. This is achieved by a potentiometer in the plate circuit which can be adjusted to obtain exact balance. There is then more complete cancellation of distortion, so the inverter can be driven harder. In addition to this, which is labeled a "dynamic balancing control", there is another control for balancing the output stage. To insure that correct balance is obtained and maintained and to make adjustments of balance so simple that even the layman owner can make them periodically, the Marantz incorporates a meter to indicate correct balance as well as correct bias adjustment. These means of balancing contribute a great deal to the fine performance of the amplifier.

The Marantz has several other features very much worth comment (and imitation). For one thing, the feedback network is arranged to give the same feedback stability regardless of the impedance of the speaker. There are separate stabilizing networks for the three taps; each network is compensated

to provide about the same feedback stability. This is by no means true of amplifiers using a single feedback network; in such cases, feedback stability is optimal only for one load condition.

Feedback is increased at ultrasonic frequencies by a separate loop from the 16-ohm output tap, through a 510- μmfd capacitor, to a higher tap on the input tube cathode. This forms, in effect, an inner loop which rolls off loop gain at these frequencies and gives an improvement in stability rather like that obtained in the Dynakit through feedback from one screen. The Marantz also employs variable damping and, again, provides the same damping factor for any speaker load by a separate current feedback circuit for each load tap. Incidentally, this is a smooth and very stable damping control.

Another circuit innovation is the switch-selected choice of pentode or triode operation. The maximum output power is halved in the triode position. Marantz suggests triode operation to protect speakers with low power-handling ability against possible damage through overloading. That is just about the only real use for it. Perhaps my ears are not as golden as I thought they

Complete schematic diagram of the new Marantz power amplifier. Switch selects 20-watt triode or 40-watt tapped-screen output.

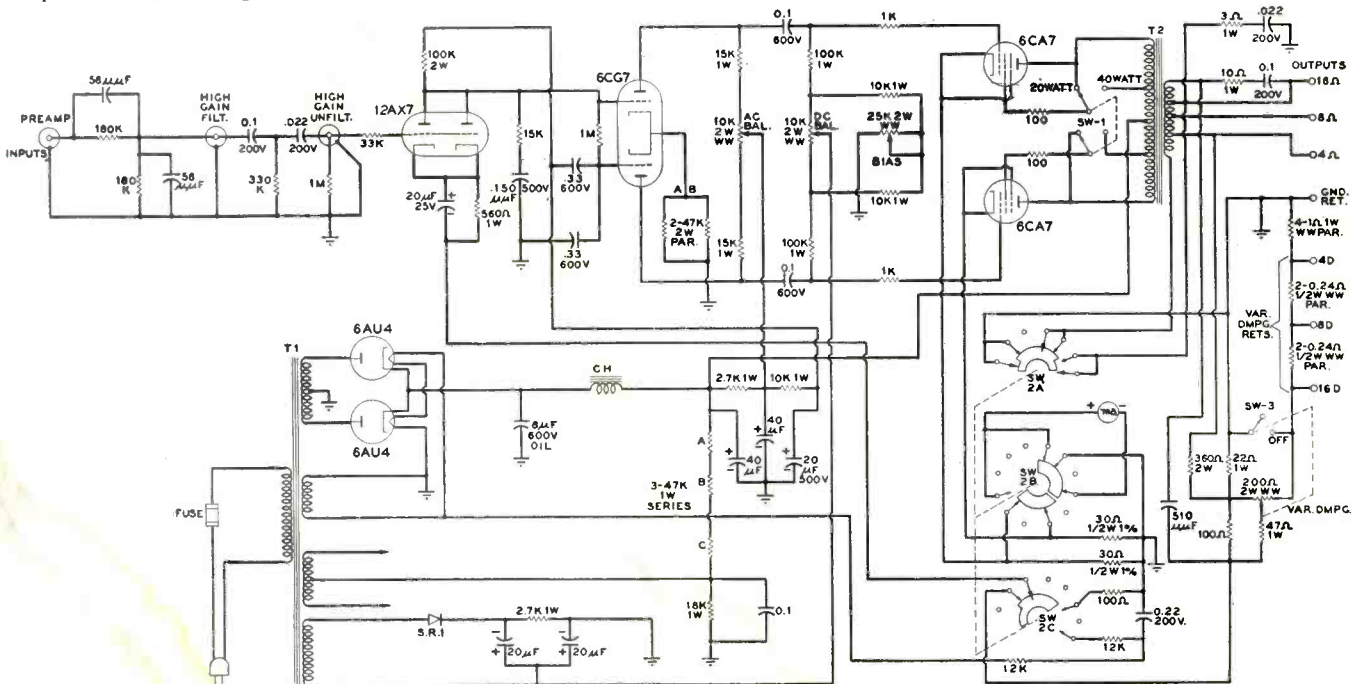

were, but I could not discern any really significant difference in sound between triode and pentode operation—except for the greater maximum output with the pentode connection. Possibly this is only an affirmation of the fine characteristics of EL34's as pentodes with slight ultra-linear type screen feedback; in any case, those who still insist that triode output tubes are superior to pentodes will not find that the Marantz provides any supporting evidence.

Another new design feature is an option of three input circuits. The first is for high-output preamps likely to overload a normal amplifier input. This goes through the entire network preceding the input tube in the diagram. The first section of the network is simply a frequency-compensated attenuator. The second section is a high-pass filter with a 12-db-per-octave slope below 20 cps. Its purpose is to filter out low-frequency transients which might overload the amplifier.

The second input circuit does not go through the attenuator but is affected by the high-pass filter. The final input circuit bypasses both attenuator and filter, and has a response to considerably below 10 cps for systems in which very low-frequency transients are not likely to be troublesome. Incidentally, the high-pass filter is not necessary to protect the stability of the amplifier itself; a very large low-frequency transient can overload the amplifier, but it will not produce instability. Most, possibly all, Williamson-type amplifiers would profit from the addition of a similar high-pass filter input.

Only the word "superb" can describe the workmanship and the quality of electrical components. The input filter capacitor of the high-voltage power supply is an oil-filled paper type, not electrolytic; electrolytic capacitors in other parts of the circuit are about the best obtainable. Other components are of similar quality. The layout is such as to minimize overheating of critical components, yet it furnishes excellent accessibility for servicing and adjustment. All this, of course, is costly, and the Marantz has to be priced in the top bracket. Even those who cannot afford the price, however, might borrow some of the excellent design features to incorporate in their present commercial or home-built amplifiers.

New Screen-Feedback Idea

Mention of the Dynakit reminds me that Dave Hafler, in a recent letter, reported obtaining even finer performance with EL34 tubes by using an output transformer with an independent 10% feedback winding, closely coupled to the two primaries. This transformer was originally designed with the idea of using partial cathode loading of the

Continued on page 42

Save Money BUILD YOUR OWN Hi-Fi

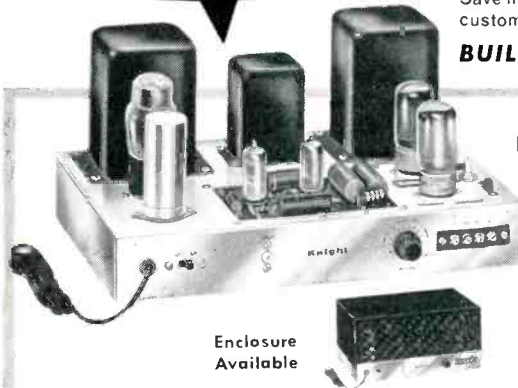

Enclosure Available

get custom quality at low cost in ALLIED'S own HIGH FIDELITY

knight-kits

KNIGHT-KITS give you the last word in Hi-Fi design, performance and value...and they're easy to build from crystal-clear manuals featuring "Step-and-Chek" assembly. Save money—get true Hi-Fi quality with these custom-designed KNIGHT-KITS.

BUILD THE BEST...AND SAVE!

knight-kit LINEAR DELUXE

25-WATT BASIC HI-FI AMPLIFIER KIT

Model S-755 **\$44.50**

Williamson-type Circuit
Printed Circuit Board
Chrome Plated Chassis

Designed to satisfy the most critical listener. Intended for use with tuners incorporating built-in preamp or with separate preamp. Uses latest Williamson-type circuit. Has potted, matched transformers. Output: Maximum, 45 watts; undistorted, 25 watts. Frequency response: ± 0.5 db, 10 to 120,000 cps, measured at 20 watts. Harmonic distortion is only 0.15% right up to 30 watts. Intermodulation is only 0.27% at 17 watts and only .5% at 20 watts, using 60 cps and 7 kc, 1:4 ratio. Hum level is 85 db below rated output. Output impedance, 4, 8, 16 ohms. Uses two 12AU7's, two 5881's, and a 5V4G. Printed circuit is utilized in voltage amplifier and phase inverter stages. Has output tube balancing control, variable damping control, and on-off switch. Handsome chrome-plated chassis, 14" x 9" x 2". Overall height, 7". Complete with all parts, tubes and construction manual. Shpg. wt., 27 lbs.

Model S-755. Basic 25-watt Hi-Fi Linear-Deluxe Amplifier Kit. Net **\$44.50**
S-759. Metal enclosure for above amplifier. Black finish. Shpg. wt., 3 1/2 lbs. Net **\$4.25**



Chrome Chassis

Enclosure Available

knight-kit 10-WATT HI-FI AMPLIFIER KIT

Model S-753 Famous for wide response and smooth reproduction at low cost. Only 0.5 volt drives amplifier to full output. Response: ± 1 db, 30-20,000 cps at 10 watts. Harmonic distortion less than 0.5% at 10 watts. Intermodulation is less than 1.5% at full output. Controls: On-off volume, bass, treble. Input for crystal phono or tuner. Chrome-plated chassis is punched to take preamp kit (see below) for magnetic cartridges. Matches 8 ohm speakers. Shpg. wt., 14 lbs. Complete; ready to build.

Model S-753. Amplifier Kit. Net **\$23.50**
Model S-235. Preamp Kit for above. Net **\$3.10**
S-757. Enclosure for above. Net **\$3.95**

ALL PRICES NET F.O.B. CHICAGO



Enclosure Available

Chrome Chassis

knight-kit 20-WATT HI-FI AMPLIFIER KIT

Model S-750 True Hi-Fi for less! Response, ± 1 db, 20 to 20,000 cps at 20 watts. Distortion, 1% at 20 watts. Hum and noise level: Tuner input, 90 db below 20 watts; magnetic phono, 72 db below 20 watts. Sensitivity: Tuner input, 0.6 volt for 20 watts output; magnetic phono, .007 volts, 4 inputs: Magnetic phono, microphone, crystal phono or recorder, and tuner. Controls: Bass, Treble, Volume Selector with compensation positions for 78 and LP records. Handsome chrome-plated chassis. Shpg. wt., 23 lbs. Complete; ready to build.

Model S-750. 20-Watt Kit. Net **\$35.75**
S-752. Chrome control panel. Net **\$1.40**
S-758. Enclosure for above. Net **\$4.15**

ORDER FROM

ALLIED RADIO

America's Hi-Fi Center

ALLIED RADIO CORP., Dept. 089-J-5
100 N. Western Ave., Chicago 80, Ill.

Ship the following: _____ \$ _____ enclosed

Send me your FREE 1957 ALLIED 356-Page Catalog

Name _____

Address _____

City _____ Zone _____ State _____



FREE

ALLIED'S
1957
CATALOG

Send for this 356-page value-packed catalog covering everything in Electronics. Complete sections featuring world's largest selection of Hi-Fi components and music systems, many more famous KNIGHT-KITS, recorders, P.A. systems, Amateur gear, parts, tubes, tools and books. Send for your FREE copy today.





Audionews

HEATHKIT RANGE-EXTENDING SPEAKER SYSTEM

This Range-Extending Speaker System, Model SS-1B, has been designed especially to form a complete 4-way speaker system when used in conjunction with the Heathkit Model SS-1. Employing

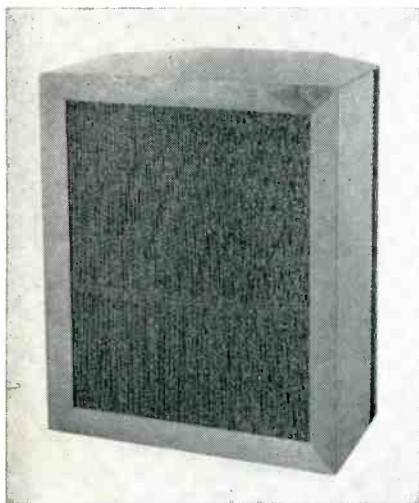

Second unit of Heath 4-way kit speaker.

a super tweeter and a 15-inch woofer, it functions between 35 and 600 cps, and between 4,000 and 16,000 cps. Combined frequency response of the two units is said to be ± 5 db from 35 to 16,000 cps.

The Model SS-1B is styled to match the Model SS-1. Exposed cabinet panels are furniture-grade plywood suitable for light or dark finish.

All parts are pre-cut and ready for assembly. The speakers are ready for installation, and a crossover circuit with balance control is included.

STEEL SLIDE FOR RECORD CHANGERS

A new sliding device for record changers and tape recorders, manufactured by Single-unit drawer slide for changers.



Steel Slides, Inc., features extra-long extension, quick release, positive-lock stop. The steel slide is supplied with neoprene mountings for cushioning the transmission of vibration and shock. These cushion-mounted guides also help to maintain a level position of the phono drawer for its full length of travel.

Installation is simple as only one sliding device is required for each instrument, thus eliminating careful alignment and reducing installation costs.

CARRYING CASE FOR TAPE DECK

A new carrying case accommodating the Brenell Hi-Fi tape deck and PRO-2 preamplifier complete with mounting hardware is now supplied by Fenton Company through their accredited jobber channels.

The tan, leatherette-covered, modernistically styled, lightweight case has white-plastic perforated grilles on the front and back. The front is slanted



Case makes Brenell recorders portable.

to about 80°, permitting use of the Brenell/PRO-2 combination either horizontally or 80° vertically, as shown in the illustration. The 80° tilt makes tape loading a "drop-in" operation.

FOR MORE INFORMATION

For more information about any of the products mentioned in Audionews, we suggest that you make use of the Product Information Cards bound in at the back of the magazine. Simply fill out the card, giving the name of the product in which you're interested, the manufacturer's name, and the page reference. Be sure to put down your name and address too. Send the cards to us and we'll send them along to the manufacturers. Use this service; save postage and the trouble of making individual inquiries to a number of different addresses.

WALSCO SCREW DRIVER

A new precision screw driver, introduced by Walsco Electronics Corporation, holds extremely small screws securely while starting or removing. The new Walsco screw driver is said to hold screws as small as Nos. 1 to 4 used



Driver holds tiny screws while starting.

in transistor radios and similar instruments. Available in both 4- and 7-inch lengths, the screw-holding screw driver has a shank $\frac{1}{8}$ in. in diameter, and is made of durable material.

The 4-inch screw driver (Catalogue No. 2568) is sold at a user's net of \$1.98; the 7-inch model (Catalogue No. 2569) is sold at a user's net of \$2.24.

B&O SPECIAL MAGNETIC CARTRIDGE

Fenton Company has recently introduced a new single-play B&O A+ Special Anti-Static Magnetic Cartridge for broadcast and professional use. This cartridge is available only with a single stylus and is designed to fit all professional arms with $\frac{1}{2}$ -inch, center-spaced mounting holes or stand-offs. In order that the B&O may be used with high-level magnetic input professional amplifiers as well as with amplifiers having only low-level

The B&O Special cartridge.



magnetic input, it is made in two series:

B&O 350 A+ Special with 350-ohm DC resistance having 30 mv output at 4.4 cm/sec (black body and red lettering).

B&O 72 A+ Special with 73-ohm impedance having 15 mv output at 4.4 cm/sec (black body and gold lettering).

The B&O Special has the same 8-pole construction as the standard series.

The new B&O Special has been accepted by Gray Research & Development Company for use in the new Audoramic Sound System.

Audiophile net price on the Fen-Tone B&O Special is, with single diamond stylus, \$24.20; with single sapphire stylus, \$11.60.

FISHER MASTER CONTROL AMPLIFIER

Fisher Radio Corporation has announced the addition of a Master Control Amplifier to its line of high-fidelity components. The Model CA-40 provides, on one compact chassis, a preamplifier



New unit has a response indicator dial.

with controls and a 25-watt amplifier. The amplifier is said to have less than 1% distortion at full output.

The Model CA-40 features six inputs; six equalization facilities for records and direct tape-head playback; "ToneScope" to provide a graphic indication of tone-control settings; a four-position loudness contour control; and rumble and noise filters to suppress turntable rumble, FM hiss, or extreme record scratch.

The frequency response of the Master Control Amplifier is said to be constant within 0.5 db from 10 to 90,000 cps, with hum and noise reported to be 90 db below full output. Bass and treble controls provide 15 db boost or cut. The Model CA-40 has 4-, 8-, and 16-ohm speaker outputs, plus a cathode follower output for a tape recorder.

All low-level stages utilize DC filament voltages; and shielded, shock-mounted construction is used throughout the unit to eliminate microphonism.

The Model CA-40, complete with cabinet, is priced at \$139.50 (slightly higher in the West).

NEW KIT FOR TV CABINET

A cabinet kit to house their Fleetwood line of custom TV receivers has just been announced by Conrac, Inc. The individual parts of the kit are con-

structed of sturdy 3/4-inch plywood and are preglued by the manufacturer. Exposed wood surfaces of the unit are



Kit cabinet for Fleetwood TV chassis.

presanded and ready for finishing by the user. A screw driver is the only tool needed to assemble the cabinet; assembly time, according to the manufacturer, is 20 minutes.

Dimensions of the cabinet, without legs, for a TV chassis with a 27-inch picture tube are 36 1/4 in. wide by 23 5/8 in. high by 24 1/2 in. deep. Tapered round wooden legs with metal bases bring the total height of the cabinet to 36 in.

Further information about the Fleetwood cabinet kit will be furnished on request.

RCA BIAxIAL SPEAKER

Development of a new biaxial high-fidelity speaker, the RCA-501S1, combining a 12-inch low-frequency woofer, a specially designed 3-inch high-frequency tweeter, and a crossover network, was announced recently by the RCA Tube Division.

The speaker is said to be capable of handling 12 watts continuously and is claimed to give substantially uniform response over the range of frequencies from 40 to 18,000 cps.

The unit has an 8-ohm aluminum voice coil and features a 1 1/2-oz. Alnico V magnet. The tweeter is mounted off-axis to permit smooth acoustical crossover.

The speaker, which carries a nationally advertised retail price of \$55.95, is sold complete with polarized plug-in leads and terminal boards.

ACOUSTICAL RESISTANCE UNIT

The Goodmans ARU (Acoustical Resistance Unit) which, it is claimed, produces better loudspeaker performance than a bass-reflex cabinet in an enclosure of only 2/3 its volume, was recently announced by Rockbar, Inc., U.S. distributor of Goodmans loudspeakers.

Designed to be used in lieu of the conventional bass-reflex port, the ARU is mounted in an aperture in the wall of the speaker enclosure. The ARU is a rectangular unit, about 2 in. deep, consisting of a specially designed wire grid,

partially coated with flock, suspended in a wooden frame. The flock is said to act as a friction-loading device inhibiting the movement of air in the enclosure and making it possible to maintain air loading of the loudspeaker cone down to zero frequency. Harmonic and intermodulation distortion due to excessive cone displacement at low frequencies is thereby reduced, and the speaker response is extended down to one octave below the fundamental resonance of the loudspeaker with virtually no resonant peaks above that frequency, according to the manufacturer.

Unlike a bass-reflex enclosure, an enclosure using the ARU, it is claimed, delivers a smooth response if its volume lies within 10% of the specified volume. Because of this wide latitude many problems usually associated with the construction of speaker enclosures no longer apply, and the hi-fi enthusiast may design and build an enclosure to fit his particular needs without having to worry about critical adjustments. All the usual precautions (heavy construction; tight, glued joints; interior lined with sound-absorbent material) necessary to the construction of a good enclosure must, of course, be observed.

The ARU is available in four different sizes for varying speaker characteristics: the Model 172 ARU for most 12-inch loudspeakers and the Goodmans Axiom 22 Mk. II, Axiom 150 Mk. II, Axiom 60, or Audiom 70 speakers (speaker-enclosure volume, 7,800 cu. in.; ARU aperture size, 10 1/2 in. by 10 in.); Model



Goodmans acoustical resistance insert.

480 ARU for four Goodmans Axiom 80 speakers (speaker-enclosure volume, 11,700 cu. in.; ARU aperture size, 17 1/2 in. by 13 1/2 in.); Model 280 ARU for two Goodmans Axiom 80 speakers (speaker-enclosure volume, 8,300 cu. in.; ARU aperture size 14 1/2 in. by 10 in.); and the Model 180 ARU for one Goodmans Axiom 80 speaker (speaker-enclosure volume, 5,900 cu. in.; ARU aperture size, 12 in. by 7 in.).

Tentative prices for the ARU are: Model 172 ARU, \$12.00; Model 480 ARU, \$17.50; Model 280 ARU, \$14.50; and Model 180 ARU, \$11.75.

A series of enclosures and enclosure kits especially designed for the ARU is now being planned.

Fine High-Fidelity is for you too . . .



You *can* enjoy savings *without* sacrificing quality—if you “build-it-yourself” and eliminate labor charges; and if you buy direct from the manufacturer and eliminate extra profit.

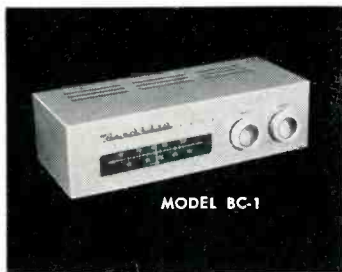

MODEL BC-1

Here's what you get:

High-fidelity amplifiers, tuners, and speakers that you *assemble yourself*, from the step-by-step instructions furnished. You get, top-quality parts at lower cost through Heath mass purchasing power. You get the equivalent of systems costing approximately twice the Heathkit price.

MATCHING CABINETS

The Heathkit AM tuner, FM tuner, and preamplifier kits may be stacked one on the other to form a compact “master control” for your hi-fi system.

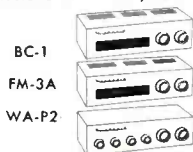

BC-1
FM-3A
WA-P2



MODEL WA-P2



MODEL W-5M

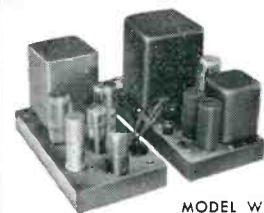

MODEL W-3M



MODEL FM-3A

HERE'S WHY A Heathkit[®] IS FUN TO BUILD:

Instructions are *complete*, and our amazing step-by-step method, tied-in with large pictorial illustrations, guide the beginner through each stage of assembly. If you can follow directions you can succeed, and can build high-fidelity equipment you will be proud to show off to your family and friends.



Here's the proof:

Thousands of Heathkits have been built at home by people just like yourself, and you should treat yourself to this same experience by dealing with the world's largest manufacturer of top-quality electronic kits for home and industry.

Heathkit Model FM-3A High Fidelity FM Tuner Kit

Features A.G.C., and stabilized, temperature-compensated oscillator. Ten uv sensitivity for 20 DB of quieting. Covers standard FM band from 88 to 108 mc. Ratio detector for efficient hi-fi performance. Power supply built in. Illuminated slide rule dial. Pre-aligned coils and front end tuning unit.

\$26⁹⁵*

(With Cabinet)
Shpg. Wt. 7 Lbs.

Heathkit Model BC-1 Broadband AM Tuner Kit

Special AM tuner circuit features broad band width, high sensitivity and good selectivity. Employs special detector for minimum signal distortion. Covers 550 to 1600 kc. RF and IF coils pre-aligned. Power supply is built in.

\$26⁹⁵*

(With Cabinet)
Shpg. Wt. 8 Lbs.

Heathkit Model WA-P2 High Fidelity Preamplifier Kit

Provides 5 inputs, each with individual level controls. Tone controls provide 18 DB boost and 12 DB cut at 50 CPS and 15 DB boost and 20 DB cut at 15,000 CPS. Features four-position turnover and roll-off controls. Derives operating power from the main amplifier, requiring only 6.3 VAC at 1 a. and 300 VDC at 10 ma.

\$21⁷⁵*

(With Cabinet)
Shpg. Wt. 7 Lbs.

Heathkit Model W-5M Advanced-Design High Fidelity Amplifier Kit

This 25-watt unit is our finest high-fidelity amplifier. Employs KT-66 output tubes and a Peerless output transformer. Frequency response \pm 1 DB from 5 to 160,000 CPS at one watt. Harmonic distortion less than 1% at 25 watts, and IM distortion less than 1% at 20 watts. Hum and noise are 99 DB below 25 watts. Output impedance is 4, 8 or 16 ohms. Must be heard to be fully appreciated.

\$59⁷⁵

Shpg. Wt. 31 Lbs.
Express Only

MODEL W-5: Consists of Model W-5M above plus Model WA-P2 preamplifier. Shpg. Wt. 38 Lbs. Express only **\$81.50***

Heathkit Model W-3M Dual-Chassis High Fidelity Amplifier Kit

This 20-watt Williamson Type amplifier employs the famous Acrosound Model TO-300 "ultra linear" output transformer and uses 5881 output tubes. Two-chassis construction provides additional flexibility in mounting. Frequency response is \pm 1 DB from 6 CPS to 150 kc at 1 watt. Harmonic distortion only 1% at 21 watts, and IM distortion only 1.3% at 20 watts. Output impedance is 4, 8 or 16 ohms. Hum and noise are 88 DB below 20 watts.

\$49⁷⁵

Shpg. Wt. 29 Lbs.
Express only

MODEL W-3: Consists of Model W-3M above plus Model WA-P2 preamplifier. Shpg. Wt. 37 Lbs. Express only **\$71.50***

HEATHKIT SPEAKER SYSTEM KITS

These speaker systems are a very vocal demonstration of what can be done with high-quality speakers in enclosures that are designed especially to receive them. Notice, too, that these two enclosures are designed to work together, as your high-fidelity system expands.

Heathkit Model SS-1 High Fidelity Speaker System Kit

Employing two Jensen speakers, the Model SS-1 covers 50 to 12,000 CPS within \pm 5 DB. It can fulfill your present needs, and still provide for future expansion through use of the SS-1B. Cross-over frequency is 1600 CPS and the system is rated at 25 watts. Impedance is 16 ohms. Cabinet is a ducted-port bass-reflex type, and is most attractively styled. Kit includes all components, pre-cut and pre-drilled, for assembly.



\$39⁹⁵

Shpg. Wt. 30 Lbs.

Heathkit Model SS-1B Range Extending Speaker System Kit

This range extending unit uses a 15" woofer and a super-tweeter to cover 35 to 600 CPS and 4000 to 16,000 CPS. Used with the Model SS-1, it completes the audio spectrum for combined coverage of 35 to 16,000 CPS within \pm 5 DB. Made of top-quality furniture-grade plywood. All parts are pre-cut and pre-drilled, ready for assembly and the finish of your choice. Components for cross-over circuit included with kit. Power rating is 35 watts, impedance is 16 ohms.

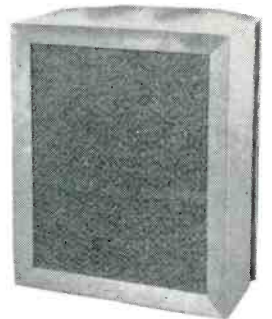

\$99⁹⁵

Shpg. Wt. 80 Lbs.

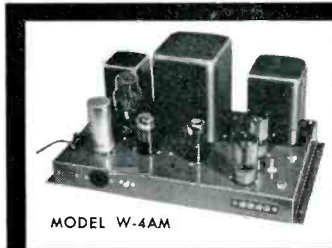

MODEL W-4AM

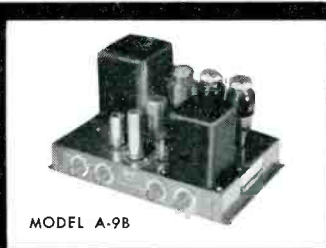

MODEL A-9B



MODEL A-7D



MODEL XO-1

Heathkit Model W-4AM Single-Chassis High Fidelity Amplifier Kit

The 20-watt Model W-4AM Williamson type amplifier combines high performance with economy. Employs special-design output transformer by Chicago Standard, and 5881 output tubes. Frequency response is \pm 1 DB from 10 CPS to 100 kc at 1 watt. Harmonic distortion only 1.5%, and IM distortion only 2.7% at this same level. Output impedance 4, 8 or 16 ohms. Hum and noise 95 DB below 20 watts.

\$39⁷⁵

Shpg. Wt. 28 Lbs.

MODEL W-4A: Consists of Model W-4AM above plus Model WA-P2 preamplifier. Shpg. Wt. 35 Lbs. Express only **\$61.50***

Heathkit Model A-9B 20-Watt High Fidelity Amplifier Kit

Features full 20 watt output using push-pull 6L6 tubes. Built-in pre-amplifier provides four separate inputs. Separate bass and treble tone controls provided, and output transformer is tapped at 4, 8, 16 and 500 ohms. Designed for home use, but also fine for public address work. Response is \pm 1 DB from 20 to 20,000 CPS. Harmonic distortion less than 1% at 3 DB below rated output.

\$35⁵⁰

Shpg. Wt. 23 Lbs.

Heathkit Model A-7D 7-Watt High Fidelity Amplifier Kit

Qualifies for high-fidelity even though more limited in power than other Heathkit models. Frequency response is \pm 1 1/2 DB from 20 to 20,000 CPS. Push-pull output, and separate bass and treble tone controls.

\$18⁶⁵*

Shpg. Wt. 10 Lbs.

MODEL A-7E: Same, except that a 12SL7 permits preamplification, two inputs, RIAA compensation, and extra gain. **\$20.35*** Shpg. Wt. 10 Lbs.

Heathkit Model XO-1 Electronic Cross-Over Kit

Separates high and low frequencies electronically, so they may be fed to separate amplifiers and separate speakers. Selectable cross-over frequencies are 100, 200, 400, 700, 1200, 2000, and 35,000 CPS. Separate level control for high and low frequency channels. Minimizes inter-modulation distortion. Attenuation is 12 DB per octave. Handles unlimited power.

\$18⁹⁵

Shpg. Wt. 6 Lbs.

*Price includes 10% Fed. Excise tax where applicable.

HOW TO ORDER:

It's simple—just identify the kit you desire by its model number and send your order to the address listed below. Or, if you would rather budget your purchase, send for details of the HEATH TIME-PAYMENT PLAN!

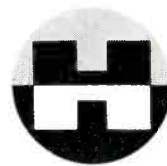

HEATH COMPANY

A Subsidiary of Daystrom, Inc.

BENTON HARBOR 18, MICHIGAN



HEATH COMPANY A Subsidiary of Daystrom, Inc.
BENTON HARBOR 18, MICHIGAN
Please send Free HEATHKIT catalog.

Name _____
Address _____
City & Zone _____ State _____

TIPS FOR THE WOODCRAFTER

by George Bowe

Basic Power Tools, Part IV

PORTABLE electric drills are rapidly becoming as common in the American household as egg beaters. Once the home craftsman discovers the variety of uses for the electric drill, it becomes an indispensable part of his workshop. With it he drills, sands, grinds, polishes, and even saws; it's a tough, dependable tool and a certain amount of precision work can be done with it. When the craftsman thinks of adding to his power equipment, he might well be inspired by his granddaddy—the drill press (Fig. 1).

The drill press once was used only for drilling holes in metals. Today, however, woodcutting utilizes this precision machine for a variety of important jobs—boring, mortising, tenoning, routing, joining, shaping, planing, dovetailing, sanding, grinding, and polishing. Even when the machine is resting overnight

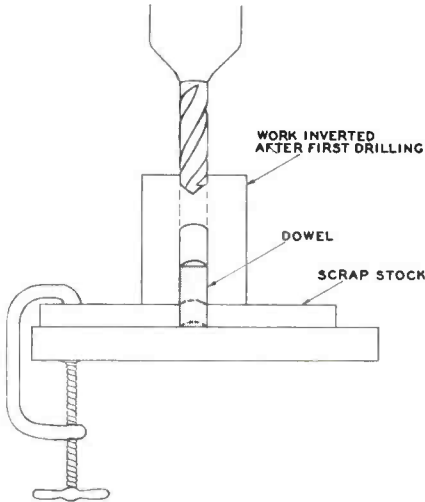

Fig. 2. Deep-hole boring with a dowel.

it can serve to apply pressure to some glue jobs.

Although the drill press is available in either floor or bench models, or as part of a multi-purpose tool, the basic components of all types are essentially the same. The base is usually made of heavy cast iron. The column, made of polished steel, screws into the base and supports the rest of the mechanism. The table clamps to the column at any point to fit the work. The head encompasses all the operating mechanisms. The spindle is the revolving shaft which is driven by a pulley at the top; the bottom end is equipped to hold the drills and other accessories. Spindles to hold various cutters are interchangeable, but for most work a spindle equipped with a Jacobs chuck is satisfactory.

Testing Alignment of the Table

The precision of the drill press depends to no small extent upon correct align-

Fig. 1. Two types of drill press: a Shopsmith, at left, and an Atlas, at right. Part names are identified; refer also to text.

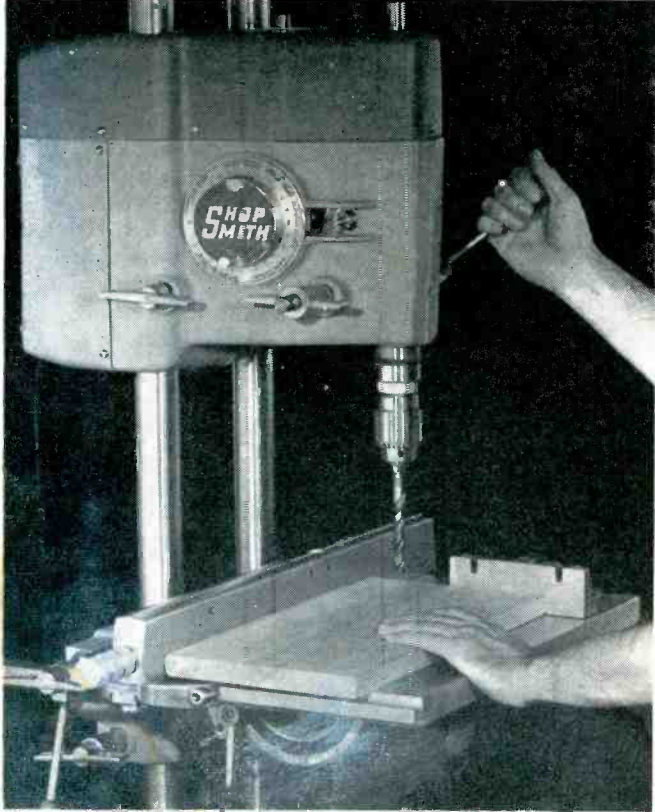

COURTESY MAGNA ENGINEERING CORP.

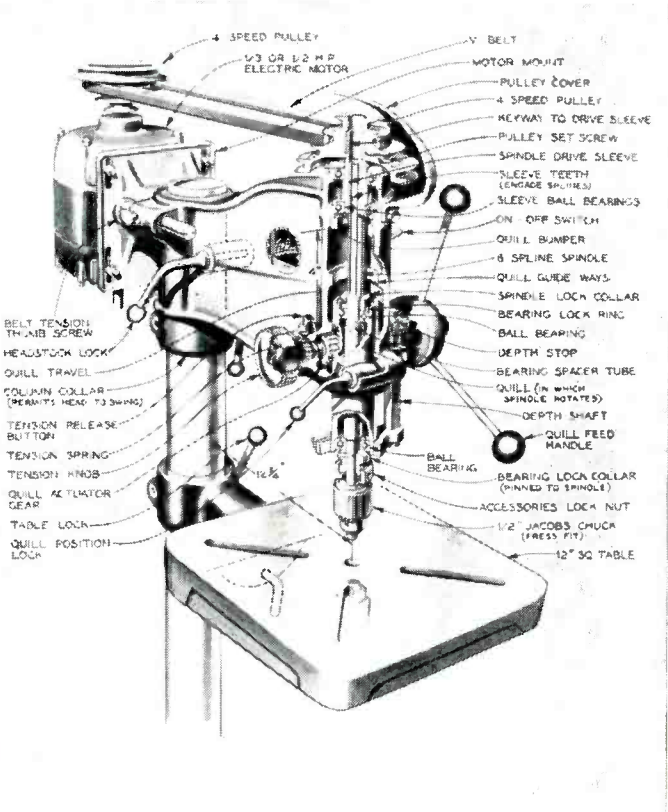

COURTESY ATLAS PRESS CO.

ment of the table with respect to the spindle. A simple method of testing alignment requires only a short length of wire about $\frac{1}{8}$ in. in diameter. Bend the wire in the middle to an angle of about 30° and insert one end into the chuck so that the other end is barely touching the table. Slowly turn the spindle of the drill press by hand and the end of the wire will describe a circle. If the table is accurately aligned, the end of the wire should touch the table with the same degree of pressure throughout the entire sweep of the circle. If the table is not level, the wire will bend as it reaches the high point; the table should be adjusted until this condition is corrected.

The choice of cutting tool to use is dictated by the job to be done, and the selection runs the gamut from drills to expansion bits and from plug cutters

COURTESY ATLAS PRESS CO.

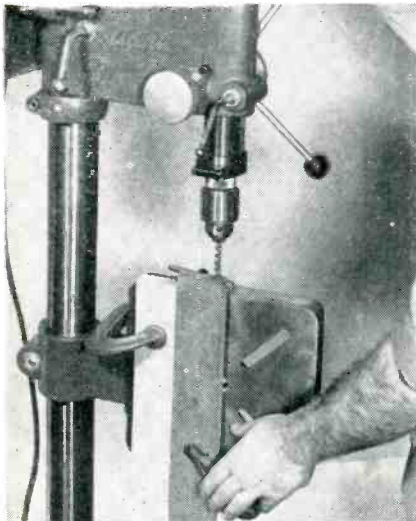

Fig. 3. Deep-hole boring with a fence.

to dovetail cutters. For drilling wood the spur type bit is preferred for two reasons: a smoother cut is provided by the spurs, and the point keeps the bit accurately centered.

With the table leveled and the proper cutting tool selected let's proceed with the basic steps necessary for drilling.

1) Install the bit or drill in the chuck and tighten with the key. Remove the key immediately to eliminate danger of injury when the motor is started. Use only a drill or bit with a round shank; never attempt to drill with a tapered or square-shank drill or bit.

2) Raise or lower the table by loosening the clamp that holds it tight to the column. The clearance hole in the table should always be directly under the chuck.

3) Be sure the drill press is set for the proper speed. The cone pulleys in the head provide a choice of speeds. As a general rule always maintain a slow speed for large drills and bits,

Continued on page 40

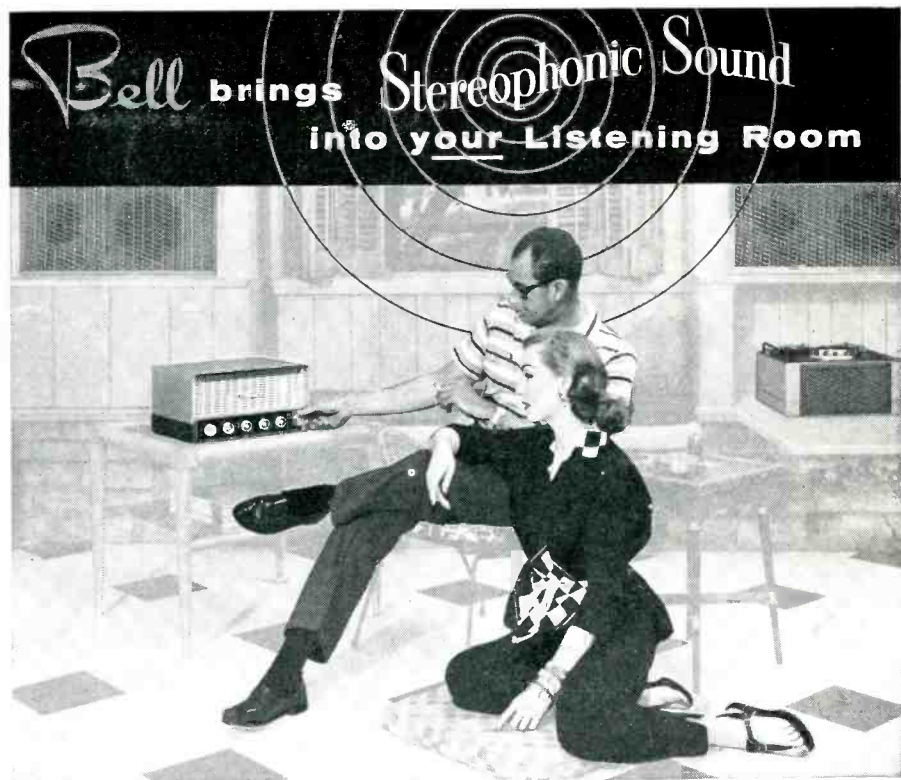

Yours to **COMMAND . . .**
New, incredibly realistic PERFORMANCE
 exclusive with the
BELL 3 DTG 2-Channel Amplifier

ONLY BELL BRINGS THIS ULTIMATE IN REALISM . . .

Stereophonic Sound . . . with its brilliant presence and glorious depth . . . into your home, your listening room, with a single, compact High Fidelity Amplifier which brings forth magnificent sound at the simplest flick-of-your-finger.

USE ANY 2-CHANNEL (STEREO) PROGRAM SOURCE . . .

Tape, (from deck or recorder, with or without pre-amplification), disc, or broadcast. The 3-DTG amplifies through two separate High Fidelity channels, each of which drives a separate speaker system. Speaker systems and pickups need not be matched, since Bell's *exclusive* Single-Knob Control allows simultaneous control of both channels for perfect electronic and acoustical balance.

BEST FOR MONAURAL, TOO!

When you feed conventional program material into this Bell Amplifier—with a simple flick of the Function Switch—the resulting reproduction through two channels and two speakers increases the feeling of realistic performance beyond that of any single channel (conventional) amplifier's ability.

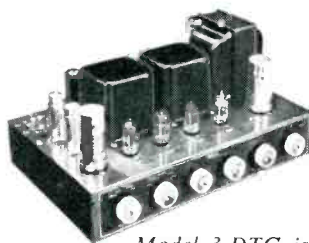

HEAR THIS FASCINATING BELL AMPLIFIER! YOUR NEAREST HI-FI DEALER HAS ONE SET UP NOW. IT OPENS A WHOLE NEW DIMENSION IN HIGH FIDELITY LISTENING PLEASURE. DON'T MISS A DEMONSTRATION.*

Model 3-DTG is available as Model 3-DT, without cover.

BELL SOUND SYSTEMS, Inc.
A SUBSIDIARY OF THOMPSON PRODUCTS, INC.

557 MARION ROAD COLUMBUS 7, OHIO

*Write us . . . we'll send you illustrated literature and the name of your nearest Bell Hi-Fidelity dealer.



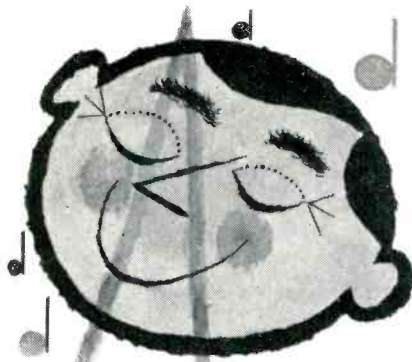

how "fi" is your hi-fi?

ENJOY ALL THAT HIGH-FIDELITY CAN GIVE YOU— WITH CENTRALAB COMPENTROL®



You bought your hi-fi to enjoy concert-hall realism. Are you actually getting it? You are for sure, if you use a Centralab Compentrol.

When an ordinary volume control is turned down, it not only lowers the sound—but cuts down both the high and low frequencies, leaving only the uninteresting middle range.

That's when you need a special control that bolsters frequencies otherwise lost.

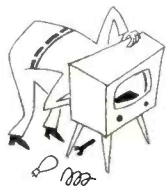

THAT'S WHERE COMPENTROL COMES IN with do-it-yourself fun!

Compentrol is a COMPensated conTROL that provides tonal balance of the lows and highs — and does it automatically at any volume level. You hear the pleasing full range of the orchestral score.

It's easy to replace an ordinary volume control with Centralab Compentrol — in amplifiers, pre-amplifiers, radios, TV, tuners, tape recorders, and record players.

Buy a Compentrol from your Centralab distributor today.

Remember, only Centralab makes Compentrol

6 models from \$2.50 suggested net price



Send for Compentrol Booklet. Write Centralab, Dept. 0281, Milwaukee 1, Wis.

Centralab



SOUND SERVICING

by Irving M. Fried



Loudspeakers, Part 4

After you have cleaned up your bass reproducer, smoothed out your middle-frequency and treble units, and gone through phasing and repositioning the drivers in relation to each other, you are finally ready for some actual speaker testing. Everyone is interested in just how well his equipment will reproduce the full range of audio frequencies. But hardly anyone is quite sure how to go about testing a loudspeaker.

Since most people seem to be more curious about frequency response than anything else, I will try to discuss home testing methods — those which do not require anechoic chambers, special equalized microphones, and all the paraphernalia of the speaker laboratory.

Many try to use frequency-response records for frequency testing. This is a poor method, for you may be testing something beyond the speaker; and it is not very scientific or informative to include more than one unknown in a test. For instance, with a frequency-response record you may be testing a) the range and smoothness of the particular record you are using, b) translation loss, c) pickup response, d) tone-arm resonance, e) tracking error, f) pre-amplifier equalization error, g) amount of acoustic feedback, or h) the speaker.

It is strongly recommended, therefore, for purposes of speaker testing, that you avoid conventional frequency-response records. If you want to make frequency measurements, use an audio oscillator. And, before you use that as a standard, connect a sensitive VTVM across it, at the output voltage you will be using to drive your amplifier, and make sure the oscillator is reasonably flat within the frequency range you will be working. You are probably safe in assuming that the harmonic distortion of the oscillator will be only a few per cent at any frequency, well below the harmonic distortion of your speaker.

Then, you can proceed with your frequency runs, estimating the flatness of the signal with your ears. The following points must be taken into consideration (these are some of the reasons that there are so many conflicting tales on speakers):

1) *Varying ear sensitivity.* To be more accurate, make the runs at high level, uniformly across the band. Of course, the middle frequencies (between 2 and 3 Kc) may screech badly, partly because the ear is most sensitive in this region.

2) *Room position.* You will undoubtedly note remarkable changes in sound level, particularly at low frequencies, as you walk around the room. This is caused by room reflections and phase interferences, the phenomenon of standing waves, and directionality at high frequencies. For instance, if you can't hear anything at 60 cps, walk around the room to be sure you weren't standing in a null. On the other hand, if you think your bass response is superb, move your head a foot or so — it may not be so good, after all. This is such a problem that only a curve averaged from several different and random room positions has any validity at all.

3) *Frequency doubling.* Most people, unfortunately, hear a noise when 30 cps goes into the speaker, and assume that 30 cps is coming out. With most speakers, however, chances are that 60 or 90 cps is coming out. If you aren't sure, set up a mike and oscilloscope, study the wave form, and compare it to that of the upper frequencies. Or, if you want only to listen, remember that fundamental tones are much duller and more solid (though less impressive sounding) than harmonics. For more information on this subject see page 27 of this issue.

The comments above apply to frequency runs for the sake of pure frequency response. There are many authorities who say that these are meaningless. Everyone agrees, though, that oscillator runs at high levels are helpful in spotting immediately frequencies at which wooden panels take off, where speaker cones buzz, where tweeters spit or break up, and other distortions occur. Once you hear these unnatural effects, you can take steps to eliminate them.

Another method of looking for defects in your speaker is this: shock-excite the complete system and listen for obvious hangovers. A good method is to brush the stylus of your cartridge with the volume advanced. Listen for a characteristic swish, then silence. If your woofer is still undamped, or your cabinet still rattling, you will hear a thuddy sound, or a woody sound; if your tweeter is still fairly peaky, you will hear a rasp rather than a swish. This is a method of pulse-testing.

You may prefer to experiment with white noise testing, which can be fascinating. The Cook White Noise record is useful in switching "white" (wide-band) noise against "gray" noise (which has a definite upper frequency limit)

—permitting you to compare the differences in sound and evaluate the upper frequency limit of your system, insofar as response to musical transients is concerned. Full directions accompany each record.

Even easier to use is the original white-noise idea; using a signal which has random noise at all frequencies, and seeing how your speaker reacts. The best way to get a test signal is to tune a sensitive FM tuner between stations, turning up the volume so that you get plenty of noise. The practiced ear can tell a good response characteristic immediately from a poor one, picking out bad crossovers, resonant bass effects, peaky tweeters, holes in response, and so on. Here is a simplified idea of what you should listen for:

1) *In the bass*—absence of thudding, boom, or wooden sounds, or of ponderousness. Instead, the bass should be smooth and clean, with no obvious hangover effects.

2) *In the treble*—a smooth, sweet sound, that seems to have no definite pitch (any trace of pitch in treble or



bass indicates a sharp peak.) A smooth tweeter will seem not to be as loud as a peaky one. If the sound is grating, hard, or otherwise unpleasant, the tweeter is not smooth.

3) *Over-all*—smooth continuity, with no abrupt changes of volume, pitch, or coloration; waterfall sound.

Once you have finished as many of the above tests as you like, you can go ahead to the final test: the listening test. Many people ask me what I think to be the single most important attribute of a good speaker, the thing I look for in a new design. It isn't bass response, or treble response, or presence, or any of the positive characteristics. It is a sort of negative thing—the ability to listen to the speaker for long periods of time without "listening fatigue". Experience has taught me that "deep-throated" (resonant) and "brilliant" (screechy) speakers generally produce listening fatigue, though they tend to be most impressive at first.

I should say that, if your speaker doesn't sound like a bellows or a megaphone or a fire siren, but can be listened to for long hours without producing an impulse to turn it off, it has passed the final and most important test you can give it.

AUDIO AIDS

We'll pay \$5.00 or more for usable Audio Aids. See page 30 for details.

NOW FOR BOTH 12" AND 8" SPEAKERS

The NEW *Tiny Mite*
Model TM-812

A TINY GEM WITH MIGHTY PERFORMANCE
AT AN UNBELIEVABLY LOW PRICE

It is hard to describe "sound." The picture above gives a pretty good idea of what a TINY-MITE looks like, but what it sounds like . . . that's not so easy.

If we used words like "beautiful," "sonorous," "rich-bodied," you'd conjure up some sort of mental auditory response. But at best it wouldn't be accurate. You have to actually listen with your own ears to know what "sound" really sounds like. You'd have to look twice to believe that the magnificent sound produced by the TINY-MITE was emanating from an enclosure only 21" h. x 15½" w. x 12" d.

It's no trick to achieve good results with a large enclosure, but realizing the great need for limited space enclosures, we set ourselves the goal of producing the finest small enclosure possible. . . . *This is it!*

JUST LOOK AT THESE FEATURES:

1. The *only* cornerless-corner enclosure for both 12" and 8" extended range speakers, employing highly efficient University horn-loaded phase-inversion principle.
2. Versatile design permits use in room and ceiling corners or along flat wall. All exteriors, including the back, are beautifully finished, permitting unlimited decorating possibilities.
3. Construction equals the finest cabinetry. Full ¾" wood used throughout, thoroughly braced.

4. Supplied with mounting board cut out for 12" speaker; adapter for 8" speaker with ample space for tweeter opening is available.

5. No more struggling to install speakers. Baffle board is easily removed at front of cabinet.

The TINY-MITE makes any speaker sound its best. Matching the superb quality of the TINY-MITE, University offers the largest selection of 8" and 12" 2- and 3-way Diffaxials . . . to meet any budget requirement. Visit your favorite Hi-Fi center and listen for yourself.

Mahogany . . . \$39.75
Blond 42.25
Unfinished . . 34.00

UNIVERSITY LOUDSPEAKERS, Inc., 80 South Kensico Ave., White Plains, N.Y.

LISTEN

University sounds better



T A P E

N E W S & V I E W S

by

J. Gordon Holt

News From the War Front

Tape and disc adherents have often assumed the existence of a struggle for supremacy between these recording media. The facts that discs are processed by recording companies from tape masters, and tape dubbings are used by many home recordists for preservation of their discs, would hardly indicate any serious competition in the recording field, but we still hear some talk about an inevitable struggle to the death which will begin as soon as commercial recorded tapes begin to approach discs in the price department.

Briefly, let's look at the advantages we may expect to obtain from recorded tape. First, and most obvious, is noise. A commercial recorded tape is as free of clicks, pops, and tearing sounds as the newest quietest record, and can be expected to stay that way under most conditions of use. One condition that may modify this flat statement is the use of a tape-playback unit having some obscure type of defect that sends an electrical pulse through the record, playback, or erase head each time the recorder is started or stopped. This will leave a click on the tape, and the accumulation of a few of these on a tape can make it about as noisy as an average disc.

Second, tapes are permanent so far as wear *in use* is concerned. There is no audible deterioration in quality over thousands of plays; no increase in surface noise, no increase in distortion, and negligible loss of high-frequency response. There are modifying conditions here, too. A partially magnetized record or playback head will permanently raise the hiss level of a recorded tape, and will gradually erase the highs from the tape.

Third, a recorded tape does not depend upon the quality of a phono cartridge for the cleanness of its sound. A poor tape-playback head may restrict high-frequency response, but it won't produce blasting on loudly recorded passages, and it won't chew up the surface of a tape, rendering it unplayable later on a better-quality head. A tape played 500 times on a poor playback head will be as good as new when the time comes to replace the playback equipment with a more ambitious model. On the other hand 10 plays

with a heavy, low-compliance pickup can render a disc totally unfit for use with the light, wide-range cartridge that may later replace the old one.

Fourth, tape is the simplest and easiest way (at the present time) to reproduce stereophonic recordings. Emory Cook's disc-record stereo system, which has been around a few years, involves two bands on each record side which must be played simultaneously and in synchronism. Even though the Cook dual playback arm is an ingenious device, it still requires precise adjustment and careful operation to make it work.

After doing some stereo tape listening recently with a pair of top-quality amplifiers and speaker systems, I am convinced that stereo is worth the cost

can continue to undersell recorded tapes for quite some time to come; and, when stereo discs are compared with stereo tapes, the cost difference is likely to be a definite factor.

Fifth, the dynamic range of tape recordings can be greater than that of the average disc—provided that the tapes are played on machines with very low playback preamplifier noise.

All of which leads up to the main point: tapes are more costly to duplicate than are discs, and *they may or may not be as good*. As heretical as that may sound, it is not an unconsidered statement. I have been busy comparing commercial recorded tapes with discs, and I must say that in many cases I prefer the discs.

R. D. Darrell's tape review column in *HIGH FIDELITY* Magazine devoted some space a while ago to speculations about the apparent loss of "steep wavefronts" in many commercial recorded tapes, and it is the same loss that has bothered me when listening to tapes. In direct comparison with LP discs of the same recording, some tapes are less crisp and lacking in definition.

A well cut and carefully processed disc, in new condition, played on a super-quality pickup, properly equalized down to around 30 cps, is often indistinguishable from the best recorded tape of the same music. But there are just as many shadings in recorded tape sound as there are in disc sound. This is understandable, perhaps, but I fail to see why *some* recorded tapes are muffled and subtly veiled when compared with disc versions of the same thing. Phonotapes—Sonore's *Spotlight on Percussion*, to take one example, is a beautifully clean tape and very well miked for the intent of the recording (miking is fairly close, to preserve the original characteristic sounds of the instruments being demonstrated). But on comparing it with Vox's disc of the same thing, the tape is markedly less effective. Without a standard of comparison the tape would probably be adjudged a masterpiece of realistic close-to recording, but, when put beside the disc, the velvet curtain becomes evident. I found myself listening to and enjoying the disc more than the tape. The difference is, admittedly, very subtle, and I may be overlooking the possibility that something was done



of the additional playback channel. Whether it is worth what is currently being asked for the tapes is another matter, but the sensation that it creates is undeniably thrilling. The release of new stereo recorded tapes is certainly not an overwhelming flood at present; they are still coming in tantalizingly small dribblets and at staggering prices, although many of them are really good. Conversion to stereo, though, means adding not only a second amplifier and speaker system, both of which should be as good as the existing monaural system components, but for most of us it also means buying a stereo-tape playback unit or, if we're driven by illusions of grandeur, a complete stereo recorder.

On the other hand, we have been hearing portentous rumors from across the Atlantic, where our British friends at Decca report some success with a system for recording two stereo channels in a single disc record groove. This system may or may not turn out to be as satisfactory as stereo tape, but the fact remains that discs are much less expensive to duplicate than tapes. They

between the master tape and the disc, but there was an audible difference.

I noticed, though, that this illusion of the missing transients was *not* just a matter of a scattered few tapes. It seems to run by label. For instance, Phonotapes, early Livingstons, and Berkshires seem to have it fairly consistently. RCA Victors and the newer Livingston releases are considerably better in this respect, while Sonotapes are remarkably lacking in this "rounded-off" sound.

As I said, I have no definite idea why this should be so, but I suspect that it might have something to do with the speed at which the tapes are duplicated. Some companies duplicate at 60 ips, others at 30, and a few reportedly run their dupes off at twice normal speed: 15 ips. Others may go even higher than 60 ips, but I doubt it. There are several facts to support this theory concerning the effect of duplicating speed, and they could all explain why the subjective loss of crispness seems to run by brand of recorded tape.

To begin with, most recorded-tape manufacturers use the same duplicating machines. Yet, differences in sound are evident between the products of these companies.

Again, these differences in crispness are so consistent by tape brand that we can largely rule out the possibility of mediocre master tapes. Masters will vary rather widely, but it isn't likely that one manufacturer would buy all the mediocre masters available and pass the good ones on to his competitors. Besides, if the master tapes were poor, the discs processed from them would presumably be equally poor.

Finally, unsubstantiated reports from informers who hide in desk drawers have supported this theory consistently; the better recorded tapes allegedly are duplicated at 15 or 30 ips.

Going a little further out on a limb, I will offer one possible contributing cause for this effect. The reason a normal tape recorder's ultrasonic bias is set at such a high frequency (usually between 50,000 and 100,000 cps) is to reduce the possibility of high-frequency signal harmonics (that are introduced by the recorder's amplifier stages) from creating audible beat notes with the bias wave form. It is generally accepted in tape recording that, if the bias frequency is at least 5 times the highest signal frequency, there will be no audible interaction. Some insist that the ratio should be even higher.

At normal operating speeds, the usual safety margin will hold true, but at high duplicating speeds the original frequencies on the master are increased by a multiple of two, four, or eight, so the bias frequency should be raised correspondingly when duplicating. A 15,000-cps tone on a $7\frac{1}{2}$ -ips master that is

Continued on page 42

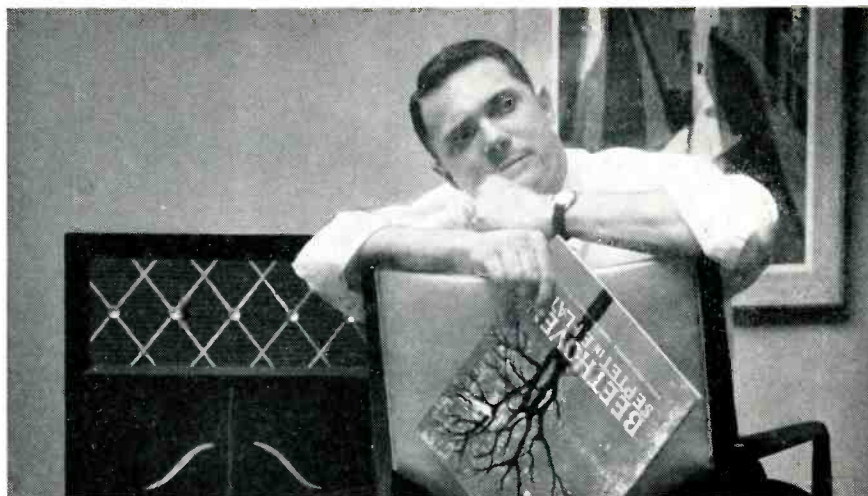

Only planned high fidelity can give you true high fidelity!

Putting together a hi-fi system for your home *can be simple*—and it probably will cost a lot less than you think! Here at MusiCraft we offer the kind of information and guidance that will help you get started right and avoid mistakes.

As you may know, possible combinations of components are practically

limitless. We're happy to help you choose what will best suit your home and your budget. You can start small and add as you wish.

Stop in at MusiCraft soon or write us for further information. Let us help you plan the *kind* of high fidelity system that will give you *true* high fidelity.

Send your name and address if you would like to be on our mailing list for our announcements. Would you like a free copy of "Understanding High Fidelity"?



If you want to "build-it-yourself" and save—MusiCraft has a complete line of component parts in stock. The step-by-step directions are easy to follow—and you can feel free to call on us for any technical assistance you may need.

MusiCraft

43 East Oak Street • Chicago 11, Illinois • DElaware 7-4150

Lowest Prices • Largest Component Selections • Complete Custom Installation Service

Save yourself time and trouble
by ordering your books directly from us.
Just fill in the coupon below.



audiophile's bookshelf

Now available in this country **AUDIO HANDBOOKS** By Norman H. Crowhurst

- | | | | | | |
|-----|-------------------|--|-------------------------------------|--|-----|
| 213 | AMPLIFIERS | Will help solve the problems that often arise when equipment has been built, but won't work. The "Trouble Tracing Guide" gives a table of symptoms, possible causes, and references to appropriate chapters which offer aid in spotting the trouble. 38 diagrams. Index. \$1.00 | THE USE OF A.F. TRANSFORMERS | Shows in clear detail how circuit values affect a.f. transformer performance. With the aid of a detachable special ruler, the charts included make it effortless to find a circuit suitable for any a.f. transformer. 44 diagrams. Index. \$1.00 | 215 |
| 214 | FEEDBACK | Explains clearly what feedback can do, where and how to use it, and what its limitations are. The theory of closed loops is presented in easy-to-understand mathematics; design charts use a simplified approach; and the numerous examples illustrate practical applications to circuits. 40 diagrams. Index. \$1.00 | THE QUEST FOR QUALITY | Discusses the basic requirements for fidelity and the various methods of achieving it. Shows how to design equalizers, how to build circuits for expanding dynamic range, how to check equipment. Also takes up various kinds of stereophony, and the arrangement of a listening room for the greatest pleasure. Diagrams and half tones. Index. \$1.50 | 217 |

Each of these handbooks is concise in treatment, clearly written, and without involved mathematics. They are imported from England.

224 **RECORD RATINGS** *The Music Library Association's Index of Record Reviews*
Compiled by Kurtz Myers, Chief, Music and Drama Department, Detroit Public Library
Edited by Richard S. Hill, Head, Reference Section, Music Division, Library of Congress

This new book is, without question, an essential reference for the serious buyer of records. Unique both in content and organization, it indexes practically all serious music ever recorded on LPs, listing the date and issue of the most important American and European periodicals in which reviews appeared. Symbols indicate what the reviewer thought of that particular release—i.e. excellent, adequate, or inadequate. The prospective buyer is thus provided with the considered opinion of *several* critics and thereby given a nearer approximation to objective judgment. Full bibliographical information is given for each record (manufacturer, serial and opus numbers, thematic catalogue listings) and a list of performers follows. The *Index of Performers* provides a complete key to musicians, conductors, artists, and orchestras. **RECORD RATINGS** is the most complete and informative discography available. 440 pages. **\$5.95**

- | | | | | | |
|-----|--|--|-------------------------------|---|-----|
| 225 | TAPE RECORDERS AND TAPE RECORDING | By <i>Harold D. Weiler</i> . Written by the author of the best-selling <i>High Fidelity Simplified</i> this recently-published book supplies the amateur and semiprofessional tape recordist with sound, practical, and factual information about all aspects of tape recording—microphones and their placement for both indoor and outdoor recording, room acoustics, sound effects, recording from disks and off-the-air, maintenance, etc. Provides all the vital principles necessary for the realization of optimum results with tape recorders. Paper-back edition, \$2.95 Cloth-bound edition, \$3.95 | TRANSISTORS HANDBOOK | By <i>William D. Bevit</i> . The author (Transistor Applications Engineer at CBS-Hytron) here presents for practical use the latest information about transistor circuits and their applications. Diagrams of tested circuits, with typical values of the circuit elements are included where possible. Subject and author indexes. Appendix. \$9.00 | 226 |
| | | | BINDERS FOR AUDIOCRAFT | Now available—attractive, protective blue leatherette binders which will hold 14 issues of AUDIOCRAFT . \$3.50 each. | 223 |

Book Department
AUDIOCRAFT Magazine
Great Barrington, Mass.

I enclose \$..... for which please send me, postpaid, the books indicated by the circled numbers. (No C.O.D.'s or charge orders, please.) Foreign orders sent at buyer's risk. Add 55¢ for postage on foreign orders.

Name.....

Street.....

City..... State.....

213	224	225
214	217	226
215	223	



EDITORIAL

Gentlemen:

I have very much enjoyed and profited from Mr. Crowhurst's articles on "Designing Your Own Amplifier". In these articles some statements are made for which no proof is given. To give proof would probably clutter the articles too much, and I am not being critical about them but wish to ask for information.

Would you be good enough to give me references in books or published articles as to where I might find justification or mathematical analysis of the following statements:

1) Distortion and production of a second harmonic from the graphs of plate current-plate voltage curves in triodes; "The ratio of peak-to-peak amplitude of second harmonic to the peak-to-peak amplitude of the fundamental is $\frac{2}{195.85}$, or 1.8% (p. 21, March issue)."

2) The low- and high-frequency roll-off curves (Figs. 5 and 6, p. 22, March issue).

3) Analysis of pentode curves for distortion.

4) Power output in amplifier (April issue) is calculated with division by 8,000, while it seems to me (probably wrong) that the division should be by 4,000.

5) Distortion from curves for pentode (Fig. 10, p. 41, April issue).

Any information you can give me on these statements would be greatly appreciated.

R. Jos. Stephenson
Wooster, Ohio

1) This I have illustrated in the accompanying sketch. AOB represents the spacing along the load line, and a

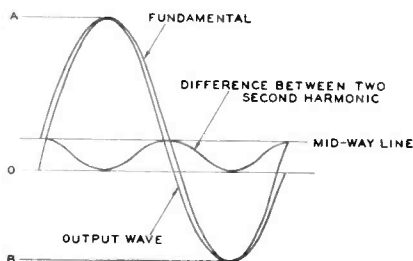

developed output wave is shown; the midway line (between A and B) is also shown, and it will be seen that AB is the peak-to-peak amplitude of fundamental, while the space between O and the midway point is the peak-to-peak amplitude of second harmonic. I think this, in conjunction with the text of

Continued on page 47

DURING the week of June 18 through 23, the Massachusetts Institute of Technology and Harvard University were hosts to the Second International Congress on Acoustics, held in conjunction with the 51st meeting of the Acoustical Society of America. Some 280 technical papers were given and symposia held at sessions throughout the week; occasionally, as many as six sessions were in progress simultaneously. Subject matter ranged from bioacoustics and psycho-physiological acoustics, through speech analysis and synthesis, noise control and measurements, and auditorium acoustics, to sound absorption and propagation, musical acoustics, and transducers. Authors and panel members included the best-known workers in sound from the USA, Eng-



land, the USSR, Belgium, the Netherlands, Germany, Japan, France, Canada, Sweden, Denmark, Italy, Argentina, Hungary, and India.

These papers, then, can fairly be said to describe the most advanced work being done by the finest brains on acoustics in the world. They will be published as a book by the American Institute of Physics, 57 East 55th Street, New York 22, N. Y. The price is \$5.00. We recommend it heartily to all who are interested in keeping abreast of the latest developments in audio.

THE subject of conventions brings to mind audio shows, of which there will be quite a few in the next several months. Three are currently being planned by the Institute of High Fidelity Manufacturers: the New York High Fidelity Show, September 26 through 30, at the New York Trade Show Building, 36th Street and Eighth Avenue; the Los Angeles High Fidelity Show, February 6 through 9; and the San Francisco High Fidelity Show, February 15 through 18. The Audio Engineering Society will hold its annual convention in conjunction with the New York Show.

Before the IHFM became active, several major audio shows (trademarked "Audio Fairs") were sponsored by an incorporated firm set up for that purpose. The management of this firm has informed us that this year its Audio Fair in New York will be held in conjunction with the Disc Jockey Salute to the Recording Industry, on its Diamond Jubilee. Dates are September 7 through 14 at the New York Colosseum.

September 26 through 30 are the dates also for the 1956 Electronic Jubilee, to be held at the Mechanics Building in Boston. At the Palmer House, Chicago, the International Sight and Sound Exposition will take place November 2 through 5. And finally, the London Audio Fair will be at the Waldorf Hotel, Aldwych, London, April 12 through 15.

These are shows about which we have definite information. There will be many others less well publicized, and several one-evening lecture-demonstrations, in large and small cities throughout the country. On October 9, for instance, New Englanders will have an opportunity to hear the Hartford Symphony Orchestra compared in live and recorded versions at Bushnell Memorial Auditorium, Hartford, Connecticut. Paul Klipsch will be the commentator. We urge readers to be on the lookout for local hi-fi promotional affairs, to make it a point to attend them, and to bring friends—even if you plan to see one of the major shows too. As pointed out by Joseph Marshall in his August "Grounded Ear" column, high fidelity needs promotion not in the great metropolitan areas, but in the hundreds of smaller and medium-sized cities and towns such as Hartford. You can help accomplish this task by seeing to it that local demonstrations and shows are well attended.

EFFECTIVE with the September issue, subscription prices to **Audiocraft** will be raised to \$4.00 for one year, \$7.00 for two years, and \$9.00 for three years. All present subscribers will have received by now a card containing this notification, and an invitation to renew or extend present subscriptions at the old rates (\$3.50, \$6.50, and \$9.00). We cannot accept subscriptions at the old rates received after September 30, so be certain to return your card—or to enter your new subscription—well before that date.—R.A.

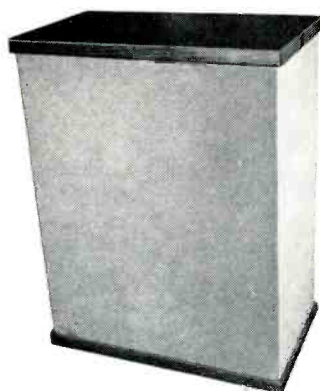

PHOTOS BY SYER

The Sherwood Forester

An AUDIOCRAFT kit report.

ANOTHER of the loudspeaker enclosures currently available in money-saving kit form is the Forester, manufactured by Sherwood Electronic Laboratories. A three-way system, the Forester uses specially designed 12-, 8-, and 5-inch cone speakers in a 5½-foot curled-horn cabinet. As a factory-finished unit its price runs from \$189.00 to \$289.00, depending on style and finish; considerable savings can be realized by purchasing the system in kit form. The cabinet itself is available in either of two kits: as Model SFP it comes completely assembled of ¾-inch unfinished plywood; as Model SFK the pre-cut ¾-inch plywood pieces come unassembled. No grille cloth is furnished with either kit. There are two

Speaker holes are cut by manufacturer.

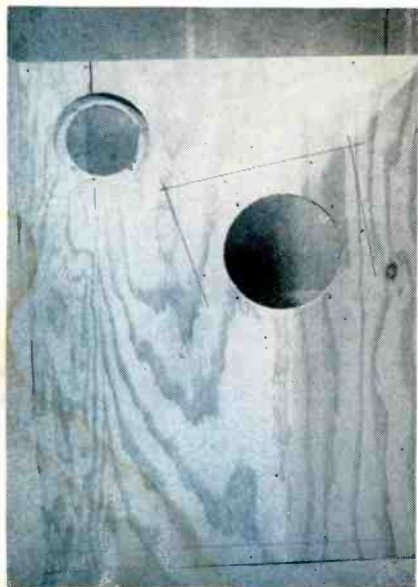

choices of speaker kits for use with the Forester cabinet. Model SF1 consists of a 12-inch woofer with a 1-pound magnet for coverage of the 30-to-300-cps frequency range, an 8-inch middle-range speaker with a 14.6-oz. magnet for frequencies from 300 to 5,000 cps, a 5-inch tweeter with a 2.15-oz. magnet for the range from 5,000 to 18,000 cps, and a 12-db-per-octave crossover network crossing over at 300 and 5,000 cps. The Model SF2 speaker kit includes the same middle-range speaker, tweeter, and crossover network as the SF1, but it does not include the woofer. We built the SFK/SF1 combination which retails for \$129.00.

Cabinet Assembly

Before attempting to begin assembling the kit, be sure that you have on hand the necessary minimum of tools and materials. The kit contains all the requisite wooden cabinet parts, and screws and nails for putting them together. But glue is not furnished, nor is the calking compound you'll need later to make sure that all the joints of the cabinet are tightly sealed. Although instructions call for nailing and gluing most of the cabinet's joints, you may decide that, while you're about it, you might just as well do a really good job and screw and glue all joints. In such case, be sure you have a generous supply of flat-headed wood screws. In building our kit, we used 2-inch and 1½-inch number 8 screws for everything except fastening down the top of the cabinet; for that purpose we used screws 1 in. long.

If you decide to use nail and glue construction for your enclosure, you will

need at least the following tools to work with: hammer, coping saw, medium-sized regular and medium-sized Phillips-head screw drivers, a nail set, a rasp or some coarse sandpaper, and a pair of pliers or a small adjustable wrench. If you think that screw and glue construction is worth the extra effort, you'll need, in addition to these tools, an electric or hand drill with bits of the proper size for the diameter of the screws you are going to use, and a countersink.

The pre-cut wooden parts for the Forester cabinet are packed in a flat carton, together with the necessary hardware and the instruction booklet. The first task is to unpack the parts and identify them with the labeled drawings in the instruction manual. The pictures of the

Woofer and squawker cavity assembly.



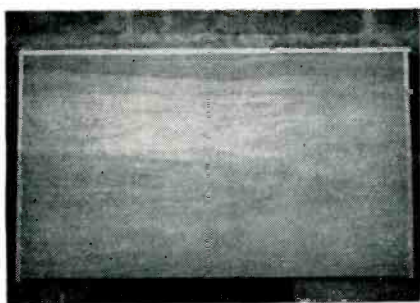

Top panel with molding strips mounted.

various sections are identified by letter in the instructions, and it is wise to write these letters on the wooden pieces before starting to assemble them. Doing this will speed the work later on by making the parts readily identifiable, as well as by familiarizing you with their general appearance.

With our Forester kit came a mimeographed page of corrections to the parts layout appearing on pages 4 and 5 of the instruction booklet. It is quite possible that these corrections will have been incorporated in later kits, but, in the event that you get a kit with the corrections still in mimeographed form, be sure to check the dimensions of the wooden pieces in question before you start work. We found that the only changes it was necessary for us to make were to cut down slightly the molding strips used for trim around the top and bottom of the cabinet and to change the angle of the bevel on one of the pieces of the cavity assembly. Since these changes were very small, we simply noted them in the instructions and left them to be done when we came to them in the process of assembly.

The instructions supplied with the kit are clearly written and, if they are followed carefully, construction should proceed smoothly and quickly. Because we were looking for trouble spots, and also because it was necessary to photograph progressive stages in the construction, we first assembled the cabinet with just the minimum of screws necessary to hold it together. The time consumed by this test assembly is slight, and it provides complete assurance that everything goes together all right. If you're using nail and glue construction, of course, the trial assembly won't be possible; but if you've decided on screw and glue construction we recommend that you put the cabinet together first without the glue. It takes about an hour and a half of extra time, but it's time well spent.

Once all the wooden cabinet pieces are counted and labeled, the actual construction can get under way. The front and sides of the enclosure are put together first, making certain that the edges of the pieces are lined up correctly. The pieces of wood used for the front and sides of the enclosure are

comparatively large and heavy. The job of putting them together will be simplified if you can get a second person to hold them in place for you while you're driving the first nails or drilling the pilot holes for the screws. Help isn't essential, just convenient.

After the sides and front of the cabinet have been put together, the cavity is assembled. It was panel C of the cavity, the panel on which the woofer is later mounted, that needed a change made in the angle of bevel along one of its edges. Because the change was very slight, only a few degrees, we first fitted the piece in place and estimated just how much wood would have to be taken off. Then we got to work with a rasp. Checking the angle after every few strokes with the rasp, a snug fit was achieved with piece D, the piece adjacent to C along its beveled edge.

When the cavity is assembled, take the four number 10-24 carriage bolts supplied with the kit and insert them in the holes around the woofer opening in panel C. Then put the nuts on them. If you're assembling the kit permanently, this is the time to put the padding in the middle-range speaker's enclosure. Padding is supplied with the kit, and it should be cut according to instructions and stapled to the walls of the squawker cavity. If you're making a trial assembly, don't bother putting on the padding until the final time around.

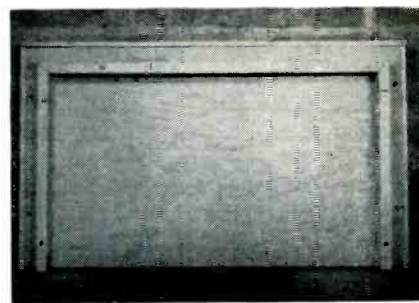

Footing strips mounted on bottom panel.

The next step is to fasten the cavity assembly to the inside of the front of the cabinet. This is a ticklish operation at best, because the cavity must be lined up correctly with the bottom of the right side of the cabinet and with the opening in the front panel for the middle-range speaker. Lines are drawn on the inside of the front panel (panel B) to assist in this operation. Since screws or nails to hold the cavity assembly in place are driven through from the outside of the front panel, the easiest way to proceed at this point is to place the cavity assembly on blocks, with the side of the cavity that is to face against the inside of the front of the cabinet, up. Then lower the cabinet shell over the cavity assembly, making sure that the back edges of the sides of the cabinet do not rest on the blocks supporting the cavity assembly. Maneuver the cabinet shell so that the cavity assembly

Back panel covers all except lower left corner, forming horn mouth for bass unit.

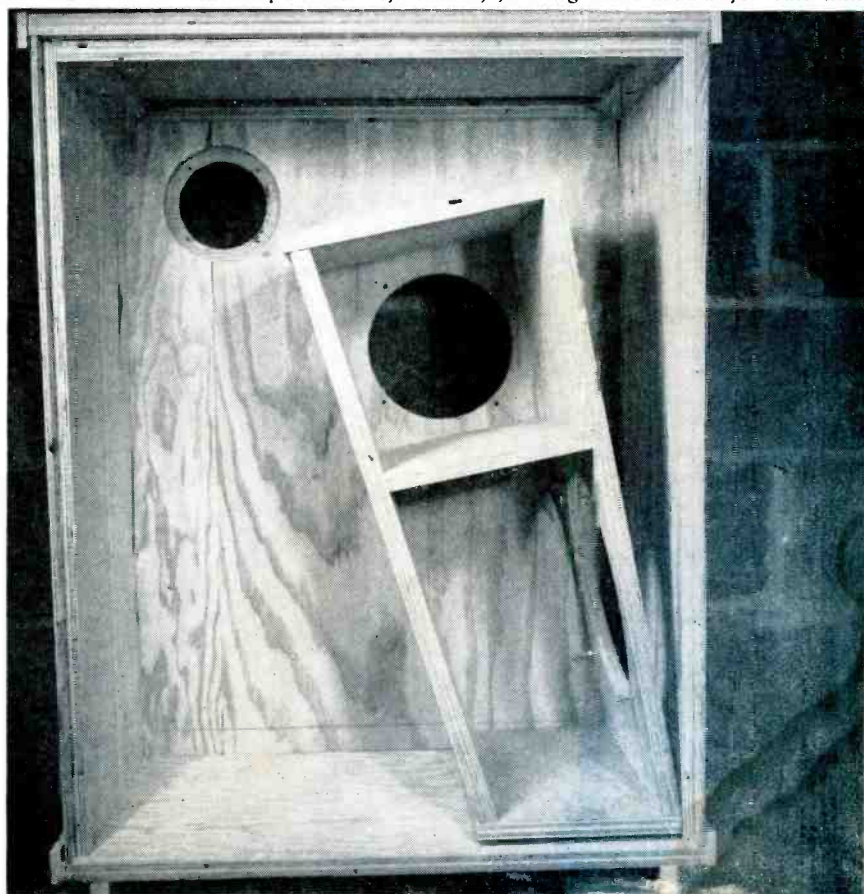

is correctly positioned. Be sure that the lower edge of the cavity, where panels C and D are joined, forms a snug fit against the lower edge of the right-hand side of the cabinet. We recommend strongly that this assembly operation be tried once before the joints are finally glued together. Make certain that all the joints are snug, and figure out how you're going to fasten the top of the cabinet in place. This



Front panel comes with lines scribed for screws or nails to hold cavity assembly.

latter question may be quite a puzzler later on if you have glued and nailed the cavity in place; unless, of course, you're willing to drive screws down through the top of the enclosure.

Assembly of the top and bottom of the enclosure is quite simple. Footing strips are fastened in place on the bottom of the bottom board. If you follow exactly the measurements for placement of these strips there should be no difficulty in fitting them together evenly in the front. Prudence dictates, however, that you just place them in position first, to make sure that they come out even. The side footing strips are mounted first, with the front footing strip being fitted between them.

Next, the top panel, the one with the attractive hardwood veneer, is fitted with its molding strips. Be sure to choose the best molding strips for the top, and save the poorest for the bottom board. The molding strips supplied with our kit were cut too long; the proper dimensions were given in the corrections to the instructions. However, the strips were left long until after they were glued and nailed in place; they were then trimmed with a coping saw and sanded off to form a square joint.

After the top and bottom boards have been put together, braces are placed around the top inside edge of the cabinet. Cleats M, N, O, and P are used for this purpose. First, cleat M is fastened flush with the top edge of the left-hand side of the cabinet. Here again it is wise to make haste slowly; we suggest that you do not nail and glue

cleat M in position right away. Fasten it in position with two screws, one through the front panel into the cleat lengthwise, and one through the side panel into the rear side of the cleat. The instructions then call for cleat N to be mounted against the inside top edge of the cabinet front. We found it was better to mount cleat O along the top of the other side of the cabinet, and then fit cleat N between them. Cleat N, in our kit, was too long by about $\frac{1}{8}$ in. One end was sanded with coarse sandpaper until the cleat was slightly less than $\frac{1}{16}$ in. too long. The cleat was then forced into position, making a very snug fit. Doing this naturally forced apart the sides of the cabinet somewhat, but cleat P, inserted across the top of the cabinet at the rear, pulled the sides back into position when it was screwed in place. It should be noted that this expedient would not have been possible with nailed construction; if the cleats were to have been nailed in place, it would have been necessary to trim cleat N to exact size.

With the braces in position around the top, the cabinet is turned upside down and the bottom is temporarily fitted in place. This part of the assembly *must* be done with screws, as the bottom is not being attached permanently at this time. With the bottom fastened on, the cabinet is again turned over and the top fitted in place. Guide holes must be drilled through the cleats for the screws which will hold the top of the cabinet in place. If you have fastened the cavity assembly permanently in position inside the cabinet, you're going to have some trouble spacing these screws evenly because of the inaccessibility of some positions under the top board. It's easier to remove the cavity assembly entirely and put on the top unimpeded. Remember that the top is only being fitted in place temporarily, but get everything laid out so that, when the time comes to fasten it on permanently, the work can be done as a matter of course.

Final Assembly

If you have put the enclosure together on a trial basis, you can now proceed with the permanent assembly of the unit. Remove the top and bottom boards, and disassemble the cavity assembly and the cabinet shell. Starting again from the beginning, put the front and sides of the cabinet together. Use a generous amount of good wood glue, so that some glue is squeezed from the joint as the screws are tightened. Be generous with the screws too; the more rigid the construction, the better. The cavity assembly should be fitted together in the same manner. Be sure to put the padding on the inner surfaces of the middle-range speaker now. Before mounting the cavity assembly against

the front of the cabinet, take a look and see if you think you can mount the middle-range speaker and the woofer without too much trouble after the cavity assembly is in place. We thought we couldn't so we mounted them before the cavity was fastened to the front panel. When putting the woofer in position, be careful not to tear the cone on the mounting bolts that were inserted around the woofer cutout earlier. With the woofer mounted in the cavity assembly and the middle-range speaker in position on the front of the cabinet, the cavity assembly can be fastened permanently in place. Follow the same procedure used before, placing the cavity assembly on blocks and lowering the cabinet shell into position over it. Extra care must be taken this time, however, so that no damage is done to the speakers. When the cavity assembly has been mounted, put the mounting bolts for the tweeter in the holes for them around the tweeter cutout. If you're not absolutely certain that all joints in the construction are air-tight, calk them now. Total construction time thus far should be about five hours, including an hour and a half for the trial assembly.

Finishing the Enclosure

If you are planning to finish the Forester enclosure as suggested in the kit's instructions, the front and sides of the cabinet will be covered by grille cloth. Paint the front and sides of the cabinet with flat black paint, making sure to paint carefully around the edges of the speaker cutouts so that no light will be reflected from behind the cloth. If you have mounted the middle-range speaker,



Everything is in place except back panel.

take extra care when painting around the speaker cutout so that no paint gets on the cone.

Since no grille cloth comes with the kit, choice of a fabric is up to you. Whatever material is used, the weave of the fabric should line up with the corners of the cabinet. If you use cloth of a solid color, as we did, you may find

Continued on page 34

The Soldering Story

by HERBERT DRAPKIN

WHEN soldering high-fidelity components it is important to use the right joining materials, tools, and techniques. Many modern components — particularly those used in miniaturized equipment — can be destroyed or damaged by heat that is too intense or applied too long. Solder, when splattered or used too liberally, can cause trouble by forming hard-to-find short circuits. A bad solder joint can ruin the performance of a potentially excellent amplifier. For these reasons it is wise for the hi-fi hobbyist to become proficient in the operation of soldering.

Types of Solder

Soft solders used in electronic joining differ from hard solders in that they have melting points lower than 800° Fahrenheit. Soft-solder alloys consist mainly of tin and lead combined in varying proportions; those containing between 40% and 50% tin have ideal spreading and joining qualities. Naturally, a higher tin content means somewhat higher cost, but a 1-pound spool of solder lasts such a long time that it is actually cheaper to buy the best grade.

Good solder flows easily when heated, and less of it is required for strong joints that will not separate. Inferior formulations (possessing substantially more lead than tin) will spatter on contact with the soldering iron, so that you must apply more solder without any guarantee of tight connections.

Because they have low strength compared with the metals to be joined, soft solders are used primarily for parts that will not be subjected to mechanical strain. Solder comes in many different forms (bars, wire, rings, pellets, micro-forms, to name a few), but the most commonly used for home electronic work are flux-cored wire and solid wire. In the former, a rosin flux is injected into the core of the wire when it is manufactured. This makes possible simultaneous fluxing and soldering, since the flux is applied exactly where it is needed.

When you buy this type of solder it is wise to insist on a reputable make, since cheaper grades have a tendency to

develop "dry" flux pockets — sections in the core that do not contain any flux.

Solid wire solder contains no flux, so a separate fluxing agent is required.

Wire-type solders are obtainable in various diameters to permit selection of a proper thickness for joining small or large parts. One diameter alone will not fully meet all your requirements, so two sizes are suggested: $\frac{1}{16}$ -inch for fast soldering not requiring extensive coverage (fine-gauge solder wire melts instantly on contact with the heated iron tip); and $\frac{3}{32}$ -inch for larger deposits and for tinning a section.

Recently, a new type of liquid solder-paste has been introduced. Called Redi-Mix, it combines both flux and solder in a liquefied suspension agent and is packaged in a polyethylene squeeze

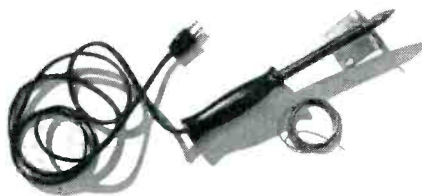

bottle. It is recommended for non-electronic joining of such items as shields and housings. For electronic joining, where a non-conductive flux is necessary, it is available in cans and has a rosin-flux base.

Flux

The purposes of a flux are to "clean" the metal surfaces chemically by removing the oxides (film coating), to reduce additional oxidation of the metal during heating, and to reduce the surface tension of the melted solder alloy as it is being applied. To work best, flux should melt and clean at a temperature below that of the solder. Flux is a chemical composition dissolved in a special solvent. At the proper temperature the solvent evaporates, and the flux melts and spreads to accomplish the cleansing action. At too low a soldering temperature the flux will not melt, and is therefore limited in its effectiveness. Flux is manufactured in liquid, paste, and pow-

der forms; for most home applications the liquid is best.

In joining electrical and electronic parts two types of fluxes are used: standard rosin and activated rosin. Both are non-corrosive and non-conductive, but the latter is more powerful, and is used mainly in industrial applications for which speed of soldering is essential.

Under no circumstances use an acid-type flux or acid-core solder, since either will inevitably cause corrosion and result in leakage of current. If you have done some solder repair work recently and your equipment is not functioning properly, check the flux and solder you used. The trouble may be traceable to an acid flux.

When rosin flux is used the residues remaining after soldering are chemically inactive and need not be wiped off. Acid-flux residues must always be washed off with water or a detergent.

Soldering Irons

The soldering iron should provide enough heat on the tip to bring it and the base metals to the solder's melting temperature, and must also be capable of maintaining that heat during the soldering operation. There is a wide variety of irons available, but the important considerations are heating capacity, length and type of tip, and the shape of iron you want.

In conventional soldering irons heat is supplied by means of a mica-covered element located inside the barrel a short distance from the tip. Heat is conveyed to the tip by conduction. Many of the newer soldering "guns" utilize step-down transformers with shorted-turn secondaries. Heating capacity depends primarily on wattage, which may be from 25 to over 600 watts. Tip shapes include the pyramid, chisel, pencil, and offset. Iron shapes include straight handle and barrel, pistol grip (constant temperature), pistol grip (trigger-actuated), and the pencil.

It would be difficult to prescribe one particular type of iron since the one you buy will depend upon your style prefer-

(Continued on page 39)

by George L. Augspurger

and

LOUDSPEAKERS ENCLOSURES

II. Electrical Relationships; the Infinite Baffle.

Impedance

It is not uncommon for buyers of hi-fi equipment, and even salesmen (who ought to know better), to become completely unnerved at the prospect of connecting a 16-ohm speaker to an 8-ohm amplifier tap. "Impedance mismatch," they mutter, and wonder if perhaps they hadn't better hide before the crime has been committed. At the last moment, the salesman drags out a new amplifier which combines positive, negative, and sidewise feedback that is supposed to compensate automatically for varying speaker impedance. Everybody is happy that the problem has been solved without mismatch. The customer twiddles the "Impeda-Matic" knob and listens to the speaker "compensate".

Speaker impedance is, however, far less critical and far more complicated than most people realize. The power from an audio amplifier is used in at least four ways in the speaker system:

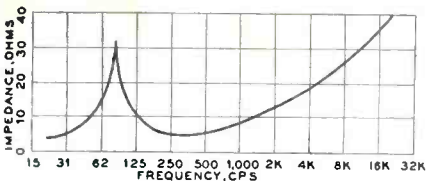

Fig. 1. How speaker impedance varies.

some is wasted as heat by the resistance of the voice coil wire; a lot is required to overcome the inertia of the cone and voice coil; at low frequencies, force is needed to overcome the stiffness of the cone suspension; and a small fraction of the electrical power fed to a speaker (about 4%) is used to generate sound waves.

Because all these things take place more or less simultaneously, the electrical impedance that an amplifier "sees" is extremely complex. Fig. 1 is an impedance curve of a typical cone loud-

speaker mounted on a small flat baffle. This speaker is rated at 8 ohms. Problem: find the 8 ohms.

Notice that at cone resonance, 70 cps, the speaker is a load of at least 30 ohms. At 300 cps its impedance is 6 ohms, and above 500 cps the curve starts going up and up until, at 20 Kc, the line is off the graph. The peak at 70 cps is there because at resonance the cone is swinging wildly back and forth without much outside help needed to keep it going. Just as in an electric motor, this movement generates an opposing voltage which has the effect of raising the load impedance and reducing the power drain. The steady rise above 500 cps is caused by voice-coil inductance, and has nothing to do with movement of the cone.

This curve is common to all dynamic speakers. The only differences will be the frequencies at which the effects occur, and the amount which the impedance varies. In table-model TV or radio speakers the bass resonance occurs at about 200 cps, and the impedance may vary from 3 ohms at 500 cps to 50 ohms at 15,000 cps. A carefully engineered quality speaker will have a much lower-frequency bass resonance, perhaps 40 cps, and much less variation in impedance.

Such a curve is easy to run on your own speaker if you have a good AC voltmeter and a source of variable audio frequencies, such as an audio oscillator. Connect a 10-watt resistor of about 50 ohms in series with your speaker, as shown in Fig. 2. First, run through the band of frequencies you intend to check with the meter connected directly across the amplifier output. If your amplifier has a damping factor control, it should be set at its highest value, but *not* into the negative or minus region. If the voltmeter reading changes very much while various frequencies are being am-

plified, either the amplifier is not flat or the meter is not accurate at all frequencies.

Assuming that things are fairly constant within the range from 40 to 10,000 cps, connect the meter across the series resistor and run through the band

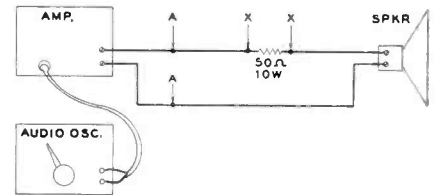

Fig. 2. A setup for impedance checking.

again. Dips in voltage correspond to peaks in impedance, and the two are inversely proportional. If you *do* have a damping control, an entertaining evening can be spent observing the fascinating things that happen to your meter readings as the control setting is changed. Of course, you won't get more than a general idea of your speaker's characteristics unless you have uniform voltage at the amplifier output and a meter which is accurate over a wide frequency range. But simply watching that needle swing back and forth has a sobering influence on most devotees of perfect matching.

Still another factor must be considered. Such curves as the one we have examined tend to give the impression that speaker load is a sort of variable resistance which rises and falls at different frequencies. We forget that impedance includes reactive as well as resistive components. Fig. 3, taken from Langford-Smith's *Radiotron Designer's Handbook*, shows the reactive component of an ordinary speaker impedance curve. Note that just below cone resonance the speaker behaves as an inductor, and just above resonance

it suddenly becomes a capacitor. While this curve isn't of much use to anyone but an engineer, it does help point up the complexity of the whole subject. Such a curve also gives a hint as to why variable damping controls may give all sorts of unexpected surprises.

We should keep in mind two main points from this examination of speaker impedance characteristics:

1) Impedance variations from cone motion are generally evident only below

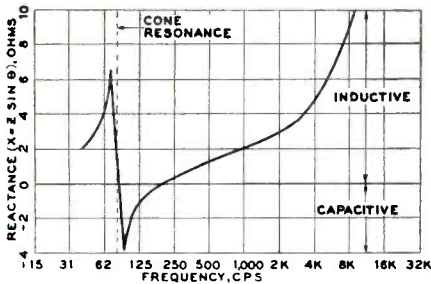

Fig. 3. Reactive impedance component.

500 cps. Above this frequency, the inductance of the voice coil is responsible for a steady rise in impedance.

2) Below 500 cps, speaker impedance is directly related to the movement of the cone. For a given input voltage, the more the cone swings back and forth, the higher the impedance. The impedance peak at bass resonance is due to the wide cone excursions at this frequency.

These points naturally apply only to single speakers. The situation is confusing enough without getting involved with what happens when crossover networks are introduced. However, a carefully designed two- or three-way speaker system may exhibit more linear impedance characteristics than a single cone unit.

Damping

Damping is a term used to cover many different effects, so let's take them up in order.

Mechanical damping—Any resonant system which oscillates a long time after initial excitation is said to be lightly damped. A tuning fork and a pendulum are good examples. Once started, they will continue to oscillate. But if the tuning fork is packed in sponge rubber, it won't ring at all because it is now highly damped. The suspension system on a loudspeaker cone similarly contributes to the damping of the system at bass resonance. When not connected to an amplifier, a speaker with poor mechanical damping will go "boinnng" if the cone is tapped, while a highly-damped unit will issue only a dull thud. Some sort of mechanical damping is desirable at the natural bass resonance to get away from the one-note boom effect of a lightly damped speaker.

Magnetic damping—This is tied up with electrical damping. If the voice

coil leads are shorted together, any movement of the speaker cone will generate a voltage which opposes the movement. The higher the flux density in the gap, the more effective will be this damping. This is one reason why a speaker with a heavy magnet may have better transient response than one with a smaller magnet.

Electrical damping—Although the output of an amplifier may be rated at 8 ohms, meaning that its ratio of power to distortion is best when loaded by this impedance, its effective resistance across the voice coil is generally much lower. The lower it is, the more nearly it approaches the shorted voice-coil condition which permits maximum magnetic damping. If the amplifier output impedance is one ohm across the 8-ohm tap, the damping factor is 8. Any tendency of the speaker to wander about on its own is then restricted by magnetic damping. Furthermore, with a damping factor of 8 or higher, the impedance variations of the speaker will not noticeably affect the output voltage.

Some designers feel that a constant voltage output is not a good idea. They point out that if the speaker's impedance rises from 8 ohms to 20 ohms at resonance, it is only getting 40% as much power as it would at 8 ohms. Such engineers provide current feedback in their amplifiers to raise the output impedance, so that the output volt-

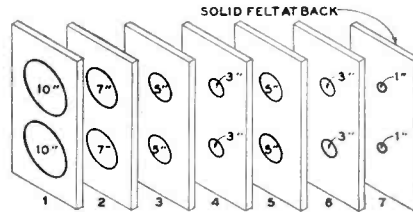

Fig. 4. Felt layers in Hartley Baffle.

age does vary with the load impedance. Power taken by the speaker then remains fairly constant. The only flaw in this reasoning is that at the bass resonance, the point at which a speaker's impedance is highest, the efficiency is also highest. That is, a speaker normally requires less power for a given output at its bass resonance than at any other frequency below 1,000 cps. By forcing the normal amount of power into the speaker at this already-accentuated note, we run the risk of getting an earth-shaking jukebox boom. In complicated acoustically tuned speaker enclosures, for which the impedance curve bears no direct relationship to sound output, the effects of current feedback may be completely unrelated to reproduction fidelity.

Another school insists that, since a speaker takes less power at resonance, the thing to do is damp out resonance by automatically lowering the amplifier output voltage at resonant peaks. This

involves positive current feedback and a damping control for adjustment into the negative impedance region. Unfortunately, once we have compensated in this direction, the bass response is practically lost altogether in most speakers. Needless to say, proponents of both types of variable damping have all sorts of graphs and measurements to prove that their amplifiers deliver higher fidelity than a live orchestra.

Acoustic damping—If a speaker cone is put to work moving air, it will be damped in the process of generating sound waves. In certain types of enclosures the impedance may actually drop at the fundamental cone resonance. This is because the cone has been tricked into stirring up more air at that frequency, and since it meets more acoustic resistance, the amplitude of cone movement is restricted, and the impedance is accordingly lowered. This sort of acoustic damping is desirable because it achieves the properties of damped bass resonance and more efficient acoustic output at the same time.

The Infinite Baffle

So far, we have been talking about speakers as if they were disembodied mechanisms which had interesting engineering features and peculiar impedance characteristics; we have barely mentioned various types of enclosures. The way a speaker is mounted may completely change its acoustic output and impedance curve. The speaker and its enclosure are actually two parts of a single mechanism we have come to think of as a *speaker system*.

In referring to the idealized speaker in our first article, we noted that the classic concept involves a rigid piston moving in a wall of infinite dimensions. The purpose of the wall was to prevent the sound from the front of the piston from getting mixed up with that coming

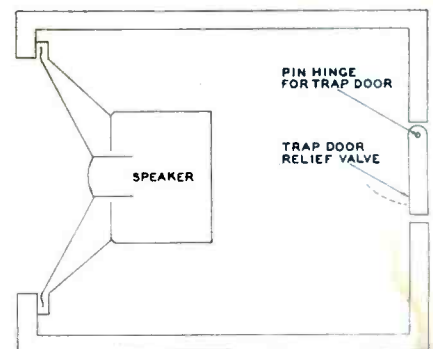

Fig. 5. The Bradford Perfect Baffle.

from the rear, and thereby cancelling out the lower frequencies. Such a wall is the pure form of an infinite baffle and is the most predictable type of speaker mounting. A real wall of finite dimensions works almost as well, and this type

of baffling arrangement is quite popular among audiophiles.

Altec Lansing has recommended for years that its larger speakers be mounted in closet doors. The back of the speaker is then essentially isolated from the front, so that no undesirable acoustic interference can take place. In such a system, the bass resonance of the speaker compensates for the normal droop in bass response resulting from the limited size of the cone. A normal closet is larger than necessary for a satisfactory infinite baffle; a completely closed box can be used provided it isn't

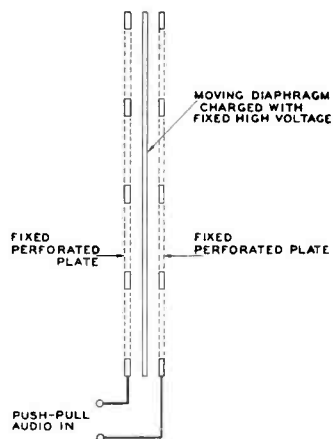

Fig. 6. Push-pull electrostatic speaker.

too small. The Bozak Company uses this type of baffle for its products exclusively. Box-type baffles have several interesting properties seldom advertised, and these are here explained by R. T. Bozak:

"An infinite baffle is the fundamentally perfect baffle. The function of the baffle is, as its name implies, a separation of the air in front from that in back of a loudspeaker. This separation can be accomplished either by an infinite plane or wall (the theoretical infinite baffle) or a completely enclosed box, commonly referred to as the infinite baffle.

"The infinite baffle, because it is passive, affords the broadest frequency response with the lowest distortion and the best transient response. Since this is totally contrary to the experience or statements of some others in this field, further qualifications are in order. As stated above, the infinite baffle is passive. So, when used with a poor bass driver, you get the unvarnished truth about the driver . . . all its distortions come through. The same poor bass driver, when used with a resonant type of enclosure (bass reflex and the like) may show less distortion because the enclosure is excited to speak in its own characteristic manner. Its output masks or overrides that of the driver, resulting in less apparent driver distortion. Similarly, if an infinite baffle is not rigid, and the driver does not have adequate linear displacement or travel, the bass

range will be poor as compared to some resonant types of enclosure.

"Since the baffle must contain air pressure, it must be rigid. If it is not rigid, the walls will flex and cancellation will take place. The ideal infinite baffle is made of masonry which is, more frequently than not, impractical. Rigid wood construction can be entirely adequate. A box constructed of double-thick $\frac{3}{4}$ -inch plywood on all sides, glued and screwed and rigidly braced, may well equal the masonry construction. Note that the walls must be *rigid*; sand-filled walls may be dead, but not necessarily rigid. The interior of the baffle must be heavily damped with sound-absorbing material to preclude the development of standing waves as well as to kill all cavity resonance.

"Since there is air behind the diaphragm, the air volume determines the frequency at which response begins to roll off. The driver must have not only high compliance and low resonance frequency, but also adequate linear displacement characteristics. When these conditions are met, the cubical volume is not critical. Specifically, a 5-cubic-foot enclosure will increase the resonance frequency of a good driver by about 5 cps. A speaker with a free-air resonance of 40 cps will have a 45-cps resonance in the enclosure. This is not a severe rise.

"Response below the resonant point will roll off at a rate of 12 db per octave if the cabinet is perfectly rigid. Because below resonance the driver is a constant-amplitude device, its generating power falls off at the rate of 6 db per octave and the increasing wave length of the sound is responsible for another 6 db per octave. If the rolloff rate is faster, the walls are pulsing and causing cancellation between internal and external pressures.

"The infinite baffle still remains the ideal for the home music system. While it imposes some stringent requirements, it is utterly simple to build, extremely flexible as to shape, and above all, offers the best frequency range, the lowest distortion, and the greatest undistorted power output per cubic foot of space occupied."

An interesting variation of the box-type baffle is the recent Acoustic Suspension system designed by Edgar M. Villchur. By using a speaker with a very low resonance, and then mounting it in a small box, Mr. Villchur came up with a system whose bass resonance was controlled by the enclosed air rather than the mechanical suspension of the speaker cone. The speaker used is carefully designed to allow wide cone excursions while maintaining a constant magnetic field for the voice coil. Air compression is more linear than most mechanical arrangements, and together with long-throw voice coil design, keeps

the distortion very low at bass frequencies.

Both the Villchur system and Bozak speakers show a marked impedance rise at the resonance frequency of the speaker system. This is understandable because any type of infinite baffle depends on somehow increasing the amplitude of the cone movement to make up for the inevitable loss of efficiency at low frequencies. Bozak depends on the cone suspension to set the resonance point; the Villchur enclosure peaks the resonance frequency of the system with the stiffness of the enclosed air. But neither design depends on acoustic resonances or auxiliary ports or ducts. Both use sound-absorbing material on the interior walls of the enclosure to prevent standing waves or column resonances from influencing the speaker.

Such acoustic material takes up space in the box, but it doesn't subtract from the total volume as far as the speaker is concerned. As a matter of fact, acoustic lining can effectively increase the size of an enclosure up to 40%. It is used most effectively in H. A. Hartley's Baffle, an infinite baffle that isn't enclosed at all! A Baffle designed for two Hartley speakers is only 30 by 18 by 16 in., gives the back-wave suppression associated with an infinite baffle, and yet has no acoustic stiffness due to enclosed air. The energy of the back wave is dissipated in a multiple-stage acoustic filter. Fig. 4 is a sketch of the seven layers of thick felt hung inside the Baffle. These felt layers absorb even low frequencies without adding acoustic springiness to the system.

Heavy felt has almost no elastic properties—if it is deformed, it simply hangs in the new position until something comes along to shove it back again. A low-frequency pulse travelling

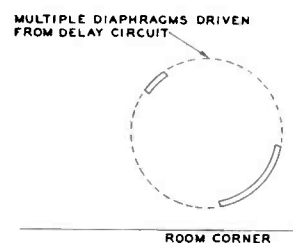

Fig. 7. Corner full-range electrostatic.

from the rear of one of the speakers in the Baffle tries to move the felt screens aside in its progress from front to back. Each time it goes through a layer of felt, part of its energy is used up in heat; by the time it gets to the end of the labyrinth, it is so exhausted that there isn't much left to interfere with the sound waves coming from the front of the speaker. The holes cut in the felt are computed to get the maximum possible absorption from each layer.

Hartley claims the Baffle is completely

Continued on page 35

W-3 to Dyna II

by D. L. DEVENDORF

THIS article is in the nature of an apology to David Hafler. After taking exception to his "Modernizing Your Williamson Amplifier"¹ in a letter to AUDIOCRAFT, I discovered that the output transformer I had so stoutly determined to keep in service in my W-3 Heathkit had gone bad. It may have been accidentally overloaded during some experiments; it certainly wasn't helped by an over-zealous application of Irving Fried's bass-stability test² during which an output tube arced and went short.

¹Hafler, David, AUDIOCRAFT, Jan. 1956, page 16.
²Fried, Irving M., "Sound Servicing" AUDIOCRAFT, Feb. 1956, page 10.

Then Hafler's 6AN8 Dynaco driver circuit was published³, and struck me at once as the answer to amplifier instability and driver troubles. It was thereupon decided to rebuild to this circuit as well as to replace the output transformer, doing away with the 6SN7's and, along with them, a large handful of parts. In fairness to Hafler it was further decided to give his new Dynaco A-430 transformer a try. Subsequent correspondence with Mr. Hafler made it plain that a modification of his Dyna II circuit would be just the thing for the relatively small W-3 chassis. Fig. 1

³"The Dynakit Mark II Amplifier", AUDIOCRAFT, April 1956, page 19.

shows the main amplifier and power-supply chassis as they appeared after modification; the revised schematic diagram is given in Fig. 2.

The 6AN8 driver tube was mounted in the former 6SN7 input socket hole, using an Amphenol S-78-A9P 9-pin socket, which is of the same diameter as the octal it replaces. I left the phase-splitter 6SN7 socket in place unused, except as tie points for the heater wiring. The preamp power outlet socket was left intact with the switch wires to the preamp remaining on pins 6 and 7, but with pins 5 and 8 now blank (pin 4 carries the B+ to my Heath WA-P2 preamplifier).

The W-3 power-supply chassis now contains the bias supply diagrammed on page 16 of AUDIOCRAFT for January 1956. To avoid crowding the amplifier chassis, the 10-K bias potentiometer was mounted in the power-supply chassis together with the selenium rectifiers and voltage divider. One of the unused jacks on the amplifier chassis was mounted in the former cathode-balancing pot hole, to be used as a tie point for the bias line (can as a test jack to check bias voltage). The other jack was left in position with its insulating washers, to serve as a tie point for the loose 8-ohm output wire. You can plug your scope in here to show visitors how music *looks* while it's playing through the speaker.

A Littelfuse 372001 extractor-post fuse holder was mounted in the remaining jack hole, connected in series with the B+ line to the output transformer centertap. A ¼-amp 8AG instrument fuse therein will blow instantly to protect the output tubes or transformer if the bias should fail; 36¢ for fuse and holder is cheap insurance for \$36 worth of tubes and transformer.

The Dynakit Mark II diagram shows only the 47-K 6AN8 cathodyne output resistors and the 100-K 6CA7 series bias resistors as matched pairs. For good measure the 0.25-μfd coupling capacitors and the 1-K grid stopper

Continued on page 36

Fig. 1. Except for power supply, this W-3 Williamson has been completely revamped.

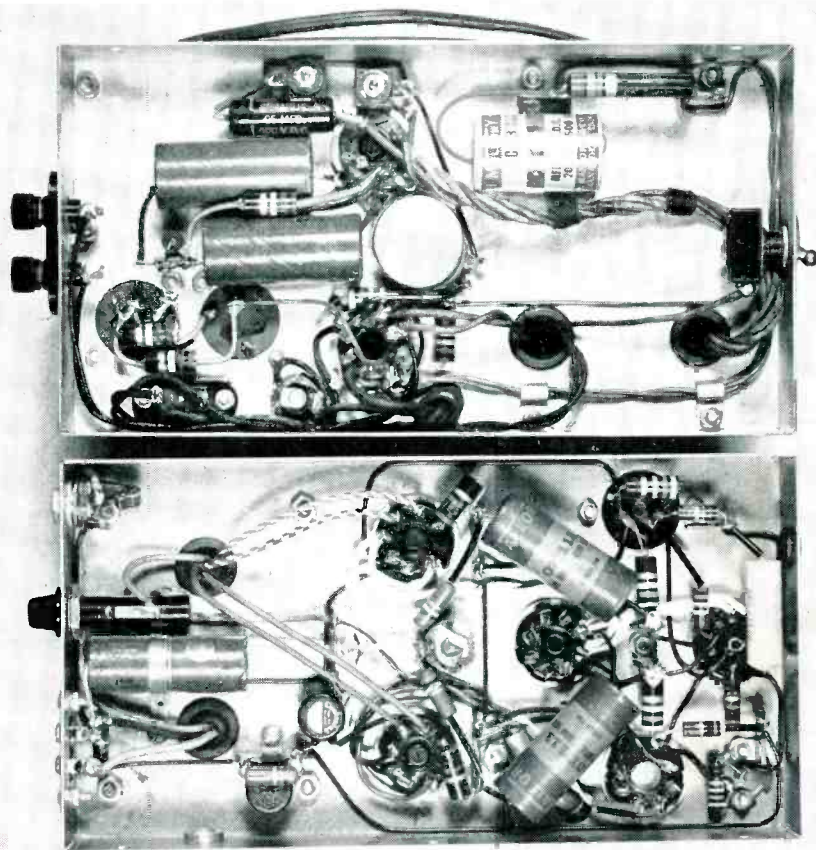

LISTENING FOR QUALITY

by JOSEPH MARSHALL

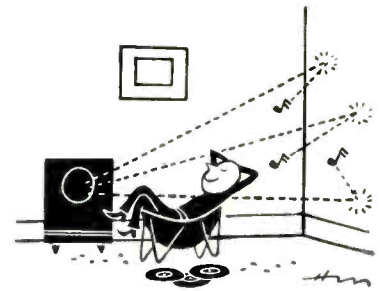

Introduction

The proof of the pudding is in the eating, and of high fidelity in the listening. The purpose of a high-fidelity system is to produce the most satisfying sound to the listener, not good curves on graph paper nor nice traces on oscilloscopes. It is quite true that instruments provide accurate measurement of certain characteristics, and are not subject to the influence of personal taste or prejudice. It is also true that measurements correspond in many ways to audible qualities, and that systems which meet certain standards will provide satisfactory audible results to most normal ears. On the other hand, some of the most important qualities—definition, for example—are either difficult or impossible to measure with instruments. Furthermore, like the musical instruments they reproduce, practical high-fidelity systems inevitably possess a distinctive character which colors the sound. This character may please some individuals more than others and may make one system more suitable for a given application than another, although electrical specifications may appear to be identical by measurement.

Engineers have a tendency to underestimate the importance of listening tests and judgments. But as long as reproducing systems continue to color or modify (or give the user an opportunity to color or modify) the material they deal with, our ears, rather than meters or scopes, must continue to be the final arbiters of high-fidelity performance and quality—precisely as the performance of a racing car when driven, rather than its performance on a dynamometer, will continue to be the criterion of racing-car quality; or as the taste of a sauce, rather than a chemical analysis of its constituents, will continue to be the measure of its quality. Yet, despite the importance of judgments by listening, there is no aspect of high fidelity about which there is a more abysmal ignorance. Everybody listens, everybody demonstrates, but few have any clear idea of what they are demonstrating or of what they are or are not hearing.

It is my purpose in this series to

present some guidance in the art of testing by listening. Listening is a highly personal experience, and it is no more possible to give detailed rules for listening than for living or loving. It helps, of course, if one has a good ear to begin with, and even more if the ear has had some training in acuity through experience in music. The total acuteness of any sense is only partly physiological. The senses merely act in perception; it requires recognition, analysis, interpretation, and judgment to turn perception into *apperception*. Many a man with inferior senses (physiologically) has made them extraordinarily sharp by training and experience. Golden ears are not always given at birth; more frequently they are the product of experience and training. One must know what to listen for, to recognize what was there originally and what has

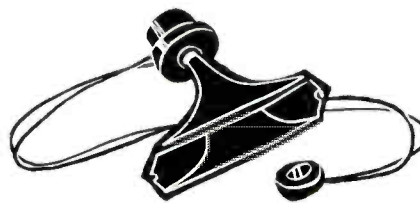

been added, taken away, or changed, in order to judge quality. As in most arts, there are few hard and fast rules in high fidelity, but many ideals; the problem is so complicated that yes-or-no answers are seldom possible. Ideals are never met; they are only approximated. Judgment is, therefore, always relative.

In the following discussion on judging high-fidelity sound by listening, I will concentrate on establishing criteria of good quality, rather than pointing out bad quality. Once the listener knows what is good, he will find it very simple to decide whether any particular sound meets the standards or departs from them.

Frequency Response

No ear can match a signal generator and a suitable meter as a measure of the frequency response of the electrical elements of a hi-fi system. But when it comes to loudspeakers and the over-all

response of a system in a given room, the most expensive measuring instruments in the world seldom do as good a job as a knowing ear. The unknowing and untrained ear, though, is capable of quite ridiculous judgments.

For example, many jukeboxes may seem to the casual ear to have a bigger bass and a wider response at the bass end than a really fine high-fidelity system, although the response may cut off at 75 cps, while that of the fine system may extend to 30 cps. Many poor systems seem to have more treble response and a wider band width because distortion raises the proportion of high-frequency components in the over-all sound. Actually, in judging frequency response by listening, the quality of the sound one hears is far more important and significant than the quantity.

All distortion adds something to the original sound; that is true equally of harmonic, intermodulation, and transient distortion. A loudspeaker which generates a lot of distortion, especially at low frequencies, will produce harmonics by doubling and tripling. It may also produce subharmonics; it can produce an apparent multiplication of low frequencies through intermodulation and hangover; and finally, it may generate low frequencies at the resonant points of the speaker and enclosure. A speaker that generates a lot of distortion will produce more total audible bass than a perfect speaker system. To make matters worse, bass distortion is not as unpleasant to most ears as treble distortion; in fact, to the uncritical ear, it may sound very good indeed.

At the other end, a combination of harmonic and intermodulation distortion may increase the total sound level above 5,000 cps by 25%, and above 10,000 cps by many times that. The highest audible tone on a record may be 10,000 cps, but a distorting system may extend the sound content to 20,000 cps by producing harmonics or intermodulation products, thus extending the apparent bandwidth of the system by an octave or more. Similarly, the tendency of some speakers to produce subharmonics may appear to extend the bandwidth on the bass end by an octave or more. Even

though the jukebox may have a fundamental response which actually slopes at both frequency extremes, the addition of distortion products may bring up the output so that the system seems flat to either the ear or a meter.

Indeed, this gives us a very useful criterion of high-fidelity quality. All other things being equal—that is, assuming the same or better frequency response, the same input source, and the same adjustment of over-all tonal balance with tone controls—the wider and flatter the bandwidth, the lower the distortion, and the less the resonant effects of the system, the smaller will be the proportion of both highs and lows in the over-all sound. This is true because the system which adds no distortion will have a smaller total of sound at the two extremes.

Power Levels

Furthermore, our ears and minds have been conditioned by circumstance and habit to expect more bass and treble in reproduced sound than actually exists "live". One of the jokes in the musical instrument business concerns the purchaser of a fine bass viol who returned it with the complaint that it was not as loud as the double basses heard through jukeboxes. Now, the double bass can be pretty overwhelming by itself in a small room, but it is by no means capable of the loudness most of us would expect. The total *peak* acoustic power of the double bass, when heard at a distance of only 3 ft., is about 150 mw. This compares with 275 mw for a bass sax or piano, 200 mw for a tuba, 300 mw for a trumpet, and about 50 mw for most of the woodwinds and triangle. The peak power of a 15-piece orchestra is around 9 watts; that of a 75-piece orchestra, 65 watts. In other words, the bass viol is only some 5 db (or two audible steps) louder than a clarinet, and is actually softer than a trumpet, piano, tuba, or bass sax. A single double bass in a 15-piece Dixieland band will be 30 db under the over-all sound—scarcely audible at all. Anyone who listens to live jazz bands of as few as five or six men is familiar with the way the double bass seems to disappear as soon as the whole band starts playing. Yet most of us are disappointed if the double bass on our hi-fi system doesn't rise above everything else, and rattle a few loose windows besides. Catering to this attitude, recording and broadcast engineers manage to accentuate the double bass by various tricks of microphone placement and gain riding. Even so, expecting a double bass (especially a single one) to rattle the windows, particularly at normal living room volume, is clearly calling upon it to act very unnaturally indeed.

The pedal tones of the organ, on the other hand, are quite formidable and

we have every right to expect them to vibrate the floors and walls. Unfortunately, they are so powerful and occur so much of the time (30 to 40%) that it is difficult to record them in their full natural intensity, even with modern variable-pitch techniques. This is also true of drums and cymbals. A 36-inch bass drum at a distance of 3 ft. produces a peak power of 24 watts and that, you may be sure, is more than enough to rattle windows and loose floors. A snare drum will deliver 12 watts, and a cymbal, 9.5 watts. Such bursts of sound are so steep and their amplitudes in relation to the average level so high that it is almost impossible to put them in a record groove (especially a micro-groove). Reproducing them calls for such reserves of power, so superb a transient response, and such complete freedom from instability and hangover, that few systems can reproduce them fully when they are well recorded.

The amplitudes quoted here are those which exist at full volume in a studio or auditorium at a distance of 3 ft. High-fidelity listening levels in the home will be at 20, 30, or 40 db lower. Even after compensating with loudness controls to produce a response flat to the



ear, the amplitude will be very much lower than exists in the studio or auditorium, and there is all the less reason to expect the double bass or tuba to rattle the windows. On the other hand, because of recording difficulties the organ pedal and drums are somewhat lower in amplitude to begin with; and, unless they are boosted out of balance, they too cannot be expected to do much house-shaking at home listening levels. It takes power to vibrate a structure as heavy as a home. With a really efficient speaker system, 20 electrical watts can begin to do it. Even this is amazing, for 20 electrical watts is approximately 1/37th horsepower, an amount of power which you can easily develop yourself and yet, if you've ever tried to vibrate the house by your own energy, you will have found that it is by no means easy.

Because in radio and TV listening we have been deprived of treble response, we tend, when converted to high fidelity, to expect also a much exaggerated treble. The fact is that there is only one instru-

ment in the orchestra capable of producing any respectable sound amplitude at frequencies above 5,000 cps: the cymbal. Its peak output, when struck violently, can be as high as 9.5 watts; a lot of this falls in the range above 8,000 cps. But the peak output of a triangle is only 50 mw and, in any moderately loud passage of an orchestra, it is almost completely lost. Here again, recording and radio engineers, catering to an artificial taste, tend to exaggerate the very high frequencies to produce hi-fi effects.

Clearly, then, the mere volume of bass and treble can be very deluding, whether it is measured with the ear or a sound-level meter, and it is obvious that attaining legitimate judgment takes care and skill.

Bass Response

Judgments of bass response are especially prone to error because of prejudice or ignorance. Besides the unrealistic tastes developed by radio and jukebox conditioning, there is a psychological factor which has to be taken into account: the ear has the strange property of imagining it hears a fundamental when it hears only the harmonics. It is this that accounts for the seemingly fine bass of small table-model radios whose speakers and enclosures could not possibly radiate any appreciable amount of sound below 100 cps. Indeed, speakers for small radios are often deliberately designed to produce high amounts of harmonic distortion—that is, to generate harmonics of the energizing signal—or to peak in the region of the second harmonic of the double-bass bottom octave. Enhancement of harmonics by these means gives the illusion that the full tone, including the fundamental, is heard. Very few of even the finest speaker systems will reproduce the bottom octave of the organ pedal from 16 to 32 cps. The organ pedal is usually accentuated by speaker distortion in the form of doubling or tripling; hence, the ear has an impression that it hears the entire tone.

Take a sine-wave audio generator or test record and sweep the bass spectrum from 100 cps downward. You will be delighted to hear that, although your speaker may be supposed to cut off below 50 cps, it continues to produce a bass with inputs far below 50 cps. If you listen very carefully as you tune the generator downward, you will note that at a certain point the tone, instead of growing deeper, either rises in pitch or remains at about the same relative pitch. At this point the response to the fundamental becomes very low or nil. What you hear from that point downward are the second and other harmonics. Unless you listen carefully, you are likely to be deluded into believ-

Continued on page 43

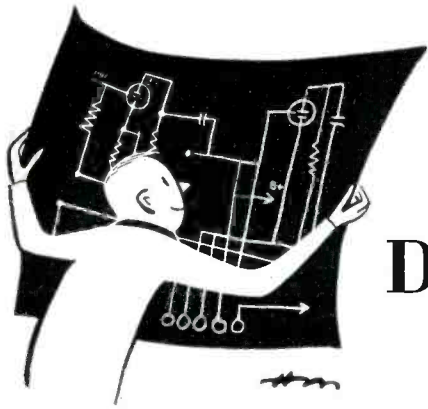

Designing Your Own Amplifier

by Norman H. Crowhurst

Part IVb: Push-Pull Power Stages

Plate-to-Plate Load

The rated value of plate-to-plate load impedance is based on the method usually adopted for transformer design. This may be clarified by considering a true Class-A stage in which both tubes are operating all the time. Such a bias condition is illustrated in Fig. 4, for the same 45 tube. Here, for convenience, we have used 60 volts bias, which gives a quiescent current of a little over 25 ma per tube, and the curves for grid voltage of 0, -30,

-60, -90, and -120 are drawn in, with composites for each of these combinations. This is to avoid making the picture too confusing.

On the individual curves are drawn two straight lines, each representing a load resistance of 5,750 ohms for each tube separately. Then, on the composite curves (which are drawn straight), is plotted a composite load line representing a plate-to-plate value of 6,800 ohms, from which the dotted curves are drawn using the original individual curves to represent the load line applied

to each tube by this composite load. This is the practical working load for each tube.

The important thing to realize is that the load lines drawn, both in Fig. 2 and Fig. 4, for composite conditions are referred to current in one half of the output transformer primary winding. When the current in each half is equal, the two balance out and produce a resultant magnetization in the transformer of zero, referred to one half of the primary winding. When, say, there is 30 ma in one half of the winding, and 5 ma in the other half of the winding, this is equivalent to having 25 ma in the first half of the winding and zero in the second. Similarly the voltages measured at the plate, and charted on the graphs, are those referred to one half of the winding, as far as the load is concerned. When the plate voltage in one tube has dropped to 200, and in the other has risen to 350, there is a change of 75 volts on each half of the winding.

The load lines as drawn, then, represent the working impedance as measured across one half of the transformer primary winding.

Now, the actual load is connected on the secondary of the transformer. Suppose for example that the transformer is a 40-to-1 step-down—that means 20 to 1 from each half of the primary—and that the secondary is loaded with a 2-ohm resistor. The impedance ratio from one half of the winding to the secondary is 20^2 , or 400 to 1, so the impedance presented to one half of the primary, by the secondary load, will be 400×2 or 800 ohms. To refer the secondary load to the whole winding, it will be multiplied by an impedance

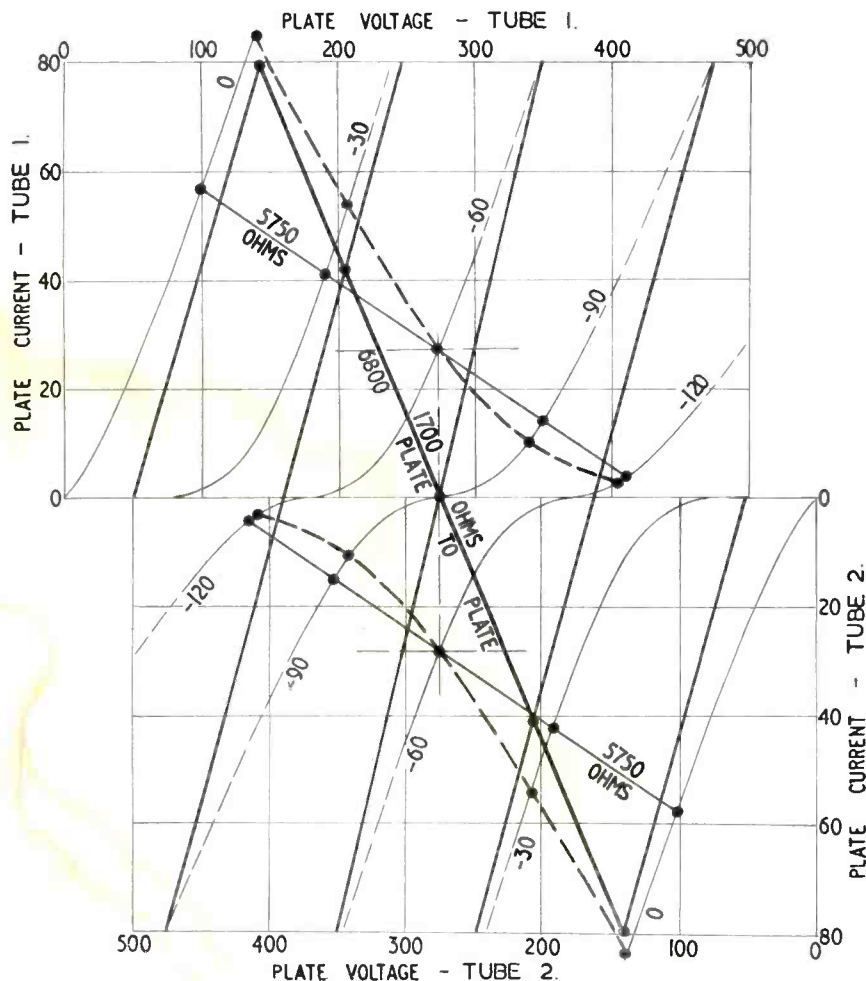

Fig. 4. Another set of composites drawn from the same originals as Fig. 2, using the same plate voltage but a different bias (-60 volts) for Class-A operation. This illustrates how a lower effective load can be used with a push-pull arrangement than for single-ended tubes.

ratio of 40^2 , or 1,600 to 1, and will appear as 3,200 ohms. The figure quoted as plate-to-plate load would be 3,200 ohms, but the load for each tube

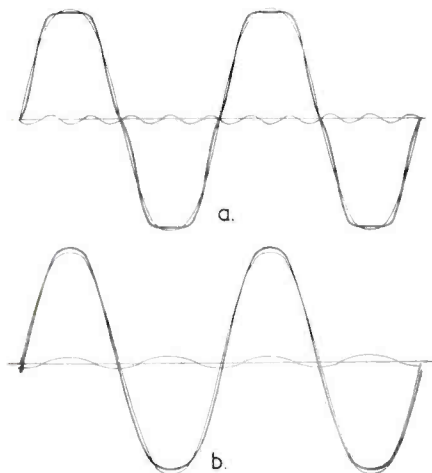

Fig. 6. To illustrate how pentode distortion is more serious than its specification figures suggest, at a is shown the effect of 5% fifth harmonic on a wave form; from this it will be realized that the load line of Fig. 5 will give less than 5% distortion, although it looks bad. At b, for comparison, is shown the effect of 5% second harmonic. In each case, the thin lines represent the component frequencies, fundamental and harmonic, while the heavy line is the composite distorted wave form.

would be equivalent to 800 ohms. This is the load represented by the dashed lines in Fig. 2.

Looking at Fig. 4 now, we see that the 5,750-ohm load lines are at a much shallower slope than the composite load line. Because of the push-pull operation it is possible to use a considerably lower effective loading per tube than the 5,750 ohms used for only one tube, so the over-all plate-to-plate load is made 6,800 ohms, which is much less than twice 5,750 ohms. When drawn against the composite load line, the load for each tube will only be $\frac{1}{4}$ of 6,800 ohms, or 1,700 ohms.

All this may seem a little confusing at first, but the important point to realize is that the practical circuit makes the two loads appear to be in series, because the windings of the transformer which combine the output are in series; but the magnetizing effect in the transformer is differential, so one subtracts the smaller current from the larger.

This means that the current change represented on the curves is double that

Fig. 5. Two sets of curves for the 5881 tube, with 400 volts on plates and screens, put together for composite characteristics. This method of operation can be used to work the tubes harder without exceeding their ratings. However, pentodes and tetrodes operated this way are still much more critical of loading than are triode-type tubes.

occurring in each half-winding and the voltage difference on the curves is that occurring across one half of the winding (either half). Hence, the effective impedance considered on the composite load line is $\frac{1}{4}$ of the apparent impedance from plate-to-plate.

Operating Class

We have used the expressions Class A and Class AB. The method of operation represented in Fig. 4 is called Class A, because both tubes are contributing towards the amplification throughout the entire cycle, even at full amplitude. This is shown by the complete excursion of the individual curved load lines contributing to the composite load line.

In the combination shown in Fig. 2 the individual load lines only operate from -110 volts bias to zero, while the grid excursion goes on down to the full -140 volts. During part of a cycle at full output, each tube is biased beyond cutoff. This method of operation is called Class AB.

Class B, from which the idea of AB is derived, is a method of operation in which both tubes are biased almost to cutoff with no signal applied. When any appreciable signal comes along, each

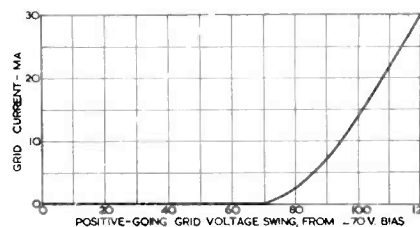
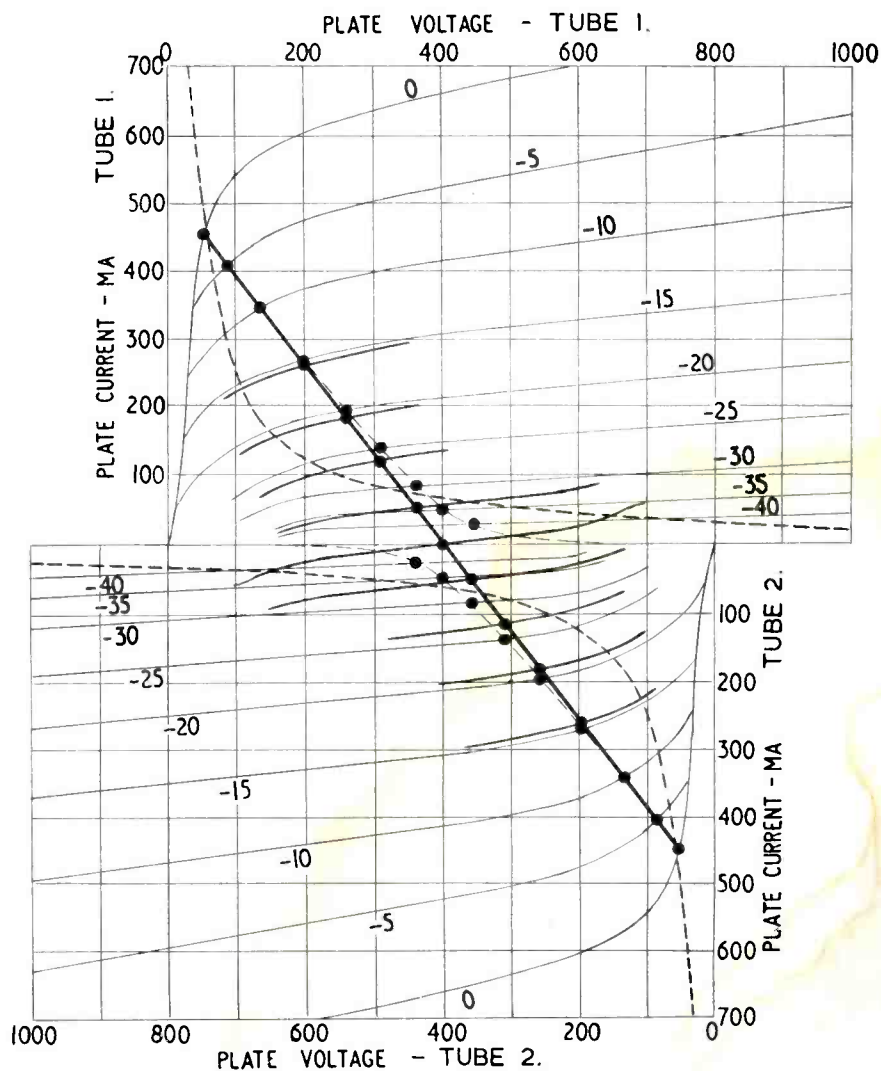

Fig. 7. The grid-current curve of an output tube. Bias is -70 volts, and the positive swing is 120 volts from this. tube amplifies precisely half of the wave form, while the other tube amplifies the other half.

The kind represented at Fig. 2 is called Class AB because, for small signals up to approximately $\frac{1}{4}$ full output (that is, a grid swing of about 35 volts out of the 70 available before we run into the positive grid region), the amplification is Class A because both tubes are contributing to the output all of the time. When the input swings up to full amplitude, each tube is only operative for part of the time — although it is rather more than half in each case. For small signals the tubes act in Class A, but for larger ones, they tend to turn into a Class-B arrange-

Continued on page 37





Crystal Reception for AM

There may be some readers assembling hi-fi installations for whom prices of good equipment are a delaying factor. They begin, therefore, by acquiring a good speaker, power amplifier, and pre-amplifier, intending to use their old AM receiver for AM broadcast reception.

Such radios may have poor detection and poor-quality audio output. In this case a crystal receiver will provide fine reception, subject to such limitations as broadcast quality and the frequency range of the station being received, and a 10-Kc whistle that can be filtered out (along with a slice of the musical spectrum).

One way of improvising a crystal receiver is to get an old radio of 1925-30 vintage and connect the crystal detector across the secondary of the tuner as shown in the diagram. If a choice is

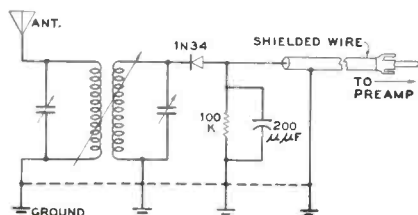

Conversion of old receiver for hi-fi AM.

possible, such a receiver will be better if both primary and secondary coils are tuned with a capacitor section each, as selectivity is very important. It will be still better if the tuner is also a vario-coupler. Either the tuner or the whole radio should be shielded to prevent pick-up of unwanted signals by the coils. I use a Northern Electric (Western Electric) Peanut superhet having ganged primary and secondary tuning capacitors and a vario-coupler. The whole receiver is housed in a shielded box. All tubes are removed.

A 75- to 125-foot antenna will be needed to raise signals above background clicks and static. There should be little or no fading on strong signals. Don't forget a lightning arrester.

It may be surprising to know that stations 200 or 300 miles away will be received at times. Such reception is possible because of the sensitivity of

modern crystals and the fact that a pre-amplifier and power amplifier can amplify a signal of 10 mv sufficiently to operate a loudspeaker.

L. E. Ashton
Montreal, Que.

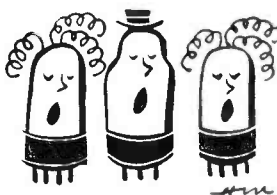

Speaker Connections

Even if you don't have as frequent occasion to move your amplifier or speakers as I do, you have probably been as impatient with the output screw terminal strip on your amplifier—an item which has comparable merit with the RCA phono jack, and is universally used for the same reason: it's cheap.

Of course, you may plan to replace the strip entirely, in which case there are lots of suitable connectors. Whatever you do, *don't* use AC line connectors or someone may "help" you and plug either your speaker or transformer into the power line! Here are some less radical suggestions:

- 1) Use spade-end solder or crimp lugs on the wires to the speaker.
- 2) Use some form of binding screw or nut in place of the simple screw supplied. Most strips have 6-32 threads; a few have 8-32.

My own solution is to use 6-32 knurled-head machine screws, as shown in the picture. These don't seem to be available from radio supply houses, but they should be carried by the larger hardware stores.

You can make your own using the

8-32 knurled nuts from an old battery. At the left in the picture is one counter-sunk for a 6-32 flat-head screw and soldered. It is desirable to use internal-toothed lock washers with either of the above solutions, so that finger-tight connections won't come loose accidentally. A washer of some sort is essential with the commercial screws, as they are not threaded all the way to the head.

If you have 8-32 holes, or wish to drill and tap to that size, you can use the battery nuts on an 8-32 stud formed by passing a screw (with lock washer) out from the inside. If there is room for them, you might also use the larger bakelite knobs from some old B batteries.

Any of the larger binding posts made by Superior, EBY, or ICA can also be used if there is room. Most are 8-32 or 10-32 except the EBY Type 30, shown in the center of the picture, which is 6-32. The binding posts used in Heathkits (one is shown at the right in the picture) have 6-32 studs; they

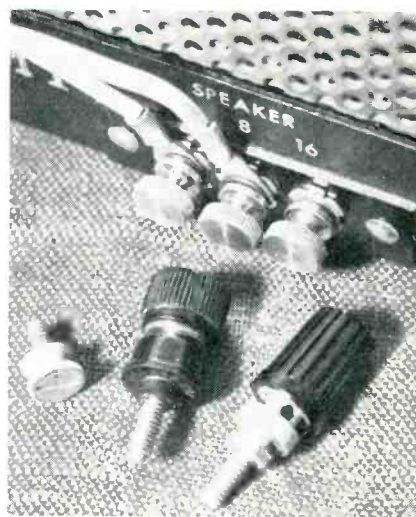

Easier-to-use speaker outlet terminals.

are available from the Heath Company at \$4 for 20. They have the additional merits that connections to the terminals for measurements *with speaker load* are neat and convenient, and that lugs on the speaker line can be eliminated in favor of twisted-and-tinned ends passed through the holes in the posts.

Dr. John D. Seagrave
Los Alamos, N. Mex.

AUDIO AIDS WANTED

That's right—we'll pay \$5.00 or more for any short cut, suggestion, or new idea that may make life easier for other AUDIOCRAFT readers, and which gets published in our Audio Aids department. Entries should be at least 75 words in length, and addressed to Audio Aids editor. No limit on the number of entries.

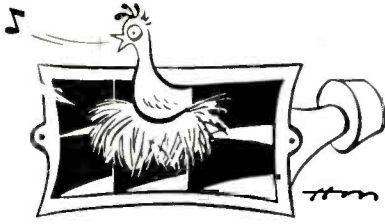

Sound-Fanciers' Guide

by R. D. DARRELL

DESPITE the stress on "sound" in the title of this column and in most of its usual contents, I'd like to devote some space to a special category of recordings in which sound, as such, is almost wholly inconsequential or incidental. These discs and tapes are intended to be played, like any others; but often they don't need to be (indeed are better not) listened to—at least for any kind of aural enjoyment. Yet indirectly they can contribute significantly to the improved reproduction of listening-type sound by your home music system, and to your own better understanding of both sonic and system characteristics.

These are, of course, the true *test* records—distinguished from the check, demonstration, and display works with which this column is primarily concerned. Their program materials are not music or sound effects, but various kinds of audio "signals": sine waves (pure tones), square waves, frequency sweeps, combined frequencies for intermodulation-distortion testing, and so on. Their main uses are to measure systems' or components' frequency ranges, transient response, and distortion; but many of them include special materials for testing such characteristics as drive-mechanism speeds, wow, and rumble; pickup tracking or tape head alignment; overload levels; and resonances in both components and rooms. Properly utilized, and with the results intelligently (and skeptically) interpreted, they can be invaluable tools for any *serious* audiophile.

I stress the adjective "serious", for there is little if any value in playing such records merely casually. Most of them (there are a few special exceptions) are virtually useless unless employed in conjunction with measuring or visual-display equipment: a vacuum-tube voltmeter and oscilloscope, specifically. Merely playing them through your entire system and evaluating the sounded results by ear may be amusing, or interesting (or aurally intolerable!), but it seldom proves a thing—except perhaps the deficiencies of your own ears and your room's acoustics.

If you are seriously interested in using them properly, I earnestly advise your studying carefully not only the detailed

instructions that accompany individual test records, but also as many as possible of the published materials describing them, the testing procedures involved, and the special precautions that must be observed in evaluating the results obtained. Since most audio books and general test articles mention these records only in passing, if at all, and since the more detailed reviews and discussions are widely scattered, I attach a brief bibliography of the most helpful references, at least insofar as I have been able to trace and judge them.

Test-Disc Repertory

Unlike almost every other category of recordings, this one never has been large and even today grows very slowly. Here, we can conveniently skip all except a couple of the 78-rpm examples, and also several 33 $\frac{1}{3}$'s issued before the LP era. Most of them probably are no longer available anyway; for that matter, I can't be too sure of all those I shall include in the following hasty survey. Generally, when they are accessible, it



is only through the larger audio dealers or on special order.

Most important of the earlier releases is Clarkstan 102M, which contains a fast-swept (20 sweeps per second) frequency spectrum, 70 cps to 10 Kc, old NAB characteristic on one side, no pre-emphasis on the other (according to the catalogue; my old copy is single-side only). This is usable only in conjunction with an oscilloscope. While I have been told by experts that it is not quite as good as the 78-rpm 5-to-10-Kc sweep disc (Clarkstan 1000D) I, like many others, have found it immensely valuable for quick over-all frequency-response checks and for those of room acoustics.

Although issued around 1949, it still remains the only record I know of its particular kind and convenience. (See esp. Ref. 6; also Ref. 8a.)

Some other early releases can be dismissed with briefer mention, since they have been either superseded by later discs of the same general kind or retain interest only for professional specialists: Clarkstan 101 and 2001s/2002s, IM-distortion test materials, and spot frequencies (50 cps to 10 Kc), respectively; see Refs 6, 8a, and 10; Columbia XERD 281 ("gliding-tone", 50 cps to 10 Kc), RD 130A and RD 103 (spot frequencies, 30 cps to 10 Kc.) Even two later releases have never found wide circulation outside the engineering staffs of their particular manufacturers: London LL 738 (spot frequencies, 40 cps to 15 Kc; see Ref. 11) and RCA Victor 12-5-49 (spot frequencies, 50 cps to 10 Kc), although the former is useful for checking equalization according to the FFRR LP characteristics in use before the adoption of the RIAA curve, and the latter is recorded according to the "New Orthophonic" characteristics, which of course are the same as those now best known as RIAA.

Still others, which in my opinion don't warrant any special attention here, are: an Audio-Video single-faced acetate disc issued in 1952, with unmodulated microgrooves for checking stylus wear; the Audax *Stylus Test Disc* of 1953, with unmodulated and eccentric microgrooves for checking stylus wear, wow, and tracking (see Ref. 3a); and a set of six Walsco *Standard Test Records*, Nos. 720-1, 725-8, issued probably well before 1950, with which I am totally unfamiliar, but presume to be 78's rather than LP's (see Ref. 8a). But I should make a special note of a quite recent *Quiet Please* rumble test record (with unmodulated grooves) announced by the Components Corporation of Den-ville, New Jersey, and produced by that company's new Hydrofeed recording process.

Dubbings Workhorses; Cook Masterpieces

Prominent among the most widely circulated and useful test discs are two issued by the Dubbings Company in 1953 (see Refs. 1, 3a, 5a, 7, 8a, and

11). Dubbings D 101, *The Measure of Your Phonograph's Equalization*, includes four bands, two on each side, of identical spot-frequency runs in 13 steps from 30 cps to 12 Kc, individually recorded according to the old AES, old NARTB, Columbia LP, and RCA New Orthophonic (=RIAA) characteristics. Dubbings D 100, *The Measure of Your Phonograph's Performance*, which contains the same material on each side*, is perhaps less directly useful for checking equalization, for its similar frequency run is recorded with no pre-emphasis (constant velocity above 500 cps). But while this very feature is handy for some purposes, many varied uses can be made of the other bands on this extremely versatile disc: an unmodulated band for checking turntable rumble; another of 3-Kc tone for checking wow and flutter; and five bands of 400-cps tone at different intensity levels (0, +3, +6, +9, and +12 db) for checking pickup tracking and amplifier overloading.

(It also might be noted that the Dubbings Company put out, at the same time, a D 500 inexpensive "Test Level Indicator" using neon bulbs—a poor man's substitute for a VTVM, but naturally quite inadequate for any kind of precision measurements. See Refs. noted above, but especially 3a and 7.)

But perhaps the best known and most widely used (and certainly the most imaginatively designed) of all test discs are those issued by Emory Cook. His first, the Series 10, in the copy I have (78 rpm, but playable with either a 1- or 3-mil stylus) contains 23 spot frequencies, from 36 cps to 20 Kc, with old Columbia LP characteristics; an IM test band of 7 Kc and 100 cps combined frequencies, no pre-emphasis; and a slow sweep from 35 cps to 1 Kc, with 350-cps crossover, for checking arm resonances and pickup tracking. But I understand that a later version, Series 10A, contains the same material at 33 $\frac{1}{3}$ rpm and with—I think—old Columbia LP characteristics for the frequency runs. (See Refs. 2, 8a, 8b, 11, and 12.) [After writing the foregoing, I was delighted to receive a review copy of the current version, Series 10 LP, which is not only 33 $\frac{1}{3}$ rpm on both sides, but is pressed by the ever-so-quiet-surfaces Microfusion process. In addition to the materials enumerated above, it also contains an additional band, near the label of Side A, of 1-10-1 Kc spot frequencies, for comparing inner-groove response with those of the same frequencies recorded near the outer edge.]

*This feature, the duplication of identical material on both disc sides, is more of an advantage than a disadvantage. To be sure, fewer different types of test material can be supplied, but when the grooves on one side have lost some of their highs through wear or accident, entirely fresh grooves are still available on the other.

Emory's test masterpieces, however, are the Series 20 *Thermal (White) Noise* and the Series 50 *N-A Beam* discs. Both are unique in that the test results can be readily evaluated by ear alone. The former (78 rpm, for 1- or 3-mil stylus use) offers switched contrasts between wide-range 20-cps-to-20-Kc "white" noise, and restricted-range "gray" noise (high cutoffs at 12, 9, and 7 Kc; low cutoffs at 150 and 80 cps); also contrasts between 40 and 10 cps cutoffs; and several sets of steady frequencies and restricted-range sweeps—all on a constant-velocity basis. The beauty of the switching contrasts is that, if no difference is discernible between the full-range white noise and any given restricted-range gray noise, obviously your system isn't putting out (or your ears can't hear!) anything above the top, or bottom, limits of the restricted range. The thermal-noise material of course

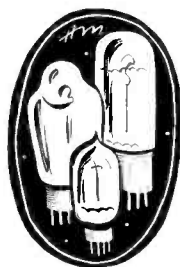

provides an admirable test for cleanness of transient response as well. (See esp. Ref. 4a; also 5a, 8a, and 8b.)

The N-A Beam disc is even more ingenious, if perhaps more dangerous to rely on carelessly, for it contains, on one side, two LP bands and one 78-rpm band of combined frequencies, 1 Kc apart (CCIF method), sweeping from 20 to 4 Kc and from 19 to 3 Kc, for IM-distortion checking. But in this case no IM analyzing equipment is needed; the signals are devised and coded so that one hears a dot-dash *A* if the total IM distortion in reproduction is 2% or less—a dash-dot *N* if it is over 2%. (See esp. Ref. 2 and 4b; also 1, 3b, 5b, 8a, 8b, and 11.) Side 2 of this disc can be skipped, however, by most audiophiles, for it is useful only for so-called "binaural" phono-equipment testing (as in Cook's Series 20 *Binaural Test* record of a ticking clock).

Bartok-Folkways; Hancock-Elektra

Around 1954 Folkways issued its FPX 100 (see Ref. 2), Peter Bartok's *Complete Test of an Audio System*, one of the most interesting—and controversial—releases in this category and one which I'm afraid is still too little known and appreciated. According to the album cover and Bartok's admirable booklet (effectively illustrated with pertinent scope patterns), side 1 of this 12-inch

disc is 78 rpm (for either 1- or 3-mil stylus) and side 2 LP, but my copy of the current version is 33 $\frac{1}{3}$ rpm on both sides. It includes a great many spot-frequency runs, from as low as 15.6 cps to as high as 22.5 Kc; 2 bands of square waves and 2 for checking IM distortion; and a fascinating comparison of the standard 440-cps A with those of 435 and 444 cps. Most of these are recorded with 500-cps turnover and no high-frequency pre-emphasis, but for more controversial features there are more spot frequencies with Bartok's own favorite characteristic (630-cps turnover with pre-emphasis starting at 1,600 cps), and a bit of music (*Bulgarian Dance* from *Mikrokosmos*, arr. Serly, from BR 303) done first with no pre-emphasis, then with RIAA characteristics, and finally with Bartok's own. Here, at least, it does "prove" the superiority of the last—but it still seems an instance of special pleading that hardly belongs here, interesting as it is.

In any case, to digress for a moment, young Bartok doesn't really need to argue. It's useless, for one thing, since the RIAA curve is now solidly established as *the* standard; for another, Peter's own recordings speak more eloquently than he can for his engineering mastery. Listen, for example, if you haven't already, to the truly magnificent recording of his father's choral-and-orchestral *Cantata Profana* (BR 312) and early opera, *Bluebeard's Castle* (BR 310-1).

The latest test disc to appear is the hot-off-the-griddle Elektra *Playback System Calibration Record* (EKL 35, 10-in.), engineered and annotated by David Hancock. The material on each side is the same: framed between the usual 1-Kc level settings, there are three bands of continuous, slow, frequency sweeps (gliding tone), from 20 Kc to 18.75 cps, with pauses—or, rather, "holds"—at 15 different specified steps for identification purposes, all recorded without pre-emphasis above a 500-cps turnover point, and pressed on unusually stiff material to avoid the effect of plastic resonances. I have just heard it once and have had no chance to make real use of it yet, but it certainly seems to be uniquely valuable, perhaps especially for loudspeaker and room-acoustics checking.

Combined Tests and Demonstrations

In addition to the foregoing exclusively test discs, there are a number of others which combine one or several bands of test signals (usually just a spot-frequency run) with more or less appropriate demonstration excerpts from the issuing company's musical repertory. Three of these are so well known by now that I need only mention them in

passing: Urania 7084, with 6 spot frequencies, 30 cps to 10 Kc (see Ref. 11); Vox UHF 1, with an uncommonly fast run of 10 spot frequencies, 20 cps to 15 Kc; and Westminster DRB, with 12 spot frequencies, 40 cps to 15 Kc (see Ref. 11). I can't comment objectively on the leaflet for the Vox disc, since I wrote it (discussing mainly the delights and dangers of hi-fi demonstrations), but Westminster's DRB leaflet has been generally, and perhaps not unfairly, criticized for its scantiness of content—at least in comparison with the very high level of technical excellence of the musical samples.

Last fall, however, Westminster more than made up for this with the truly sumptuous treatment of its already celebrated TRC release, for this not only is encased in a handsome album, but is accompanied by an exceptionally attractively-printed and illustrated (and informative) 22-page booklet, by HIGH FIDELITY's John M. Conly—perhaps the very best of its kind I've ever come across! The strictly test section includes a 440-cps A; 19 spot frequencies, from 15 Kc to 30 cps; a slow sweep covering the same spectrum; and a band of 1-Kc tone at 0, -10, -20, -30, and -40 db levels—all done to RIAA characteristics, and serving as one of the most generally convenient and versatile short test recordings available.

But the prime attraction to most less professionally interested audiophiles is of course the batch of some 17 excerpts from current Westminster releases, many of them from the Laboratory series. As usual in such samplers, the selections are too short for musical satisfaction (except as appetizers for the complete works), but here each illustrates, as described in the notes, one or more particular technical features. I might question mildly the complete suitability of one or two for their specified purposes, and even the naturalness of sound in a couple of others; but for the most part these demonstrate magnificently the top-most peaks of recording techniques attainable today—and the best of them surely cannot be heard by any dedicated hi-fi fan without a supreme thrill of dramatic delight.

Coming Next Month

Now, I see that even so hurried a survey of just the test and combined test-and-sampler discs leaves me no space for any other types of recordings this month if I try to include test and sampler tapes. So, reluctantly postponing the latter for my next column, I'll pause here only for a preliminary tip-off to stereo listeners that they shouldn't wait for my forthcoming more detailed reviews to get—or at least hear—the first two stereo samplers that have come my way;

the Stereotape (Audio Arts) ST 1, and Concertapes 501, *Sound in the Round*, Vol. 1.

Theater Organ Addenda

Alas, my aural ordeals with Mighty Wurlitzers weren't finished with last month's reports: some of the oddest sounding and most famous (or notorious?) examples came along later to contribute further to the exacerbation—yet horrid fascination—of my ears and to a more-than-usual Tintinnabulation of the Decibels in my living room. Anyway, I now can triumphantly assert that I've heard, and lived through *Glockenspiels*, *Traps*, and *Plenty of Pipes*, Vol. 1; *Beast in the Basement*; and *Fabulous Eddie Osborn* (Replica 501, 509, and 511 respectively; also available on Replica tapes, T 501, T 509, and T 511).

Leon Berry is the artist in the first two, belaboring the Chicago Hub Rink organ and a converted Wurlitzer in his own cellar (the "beast" is a behemoth or mastodon indeed!). Both exhibit some of the roughest and harshest tone qualities I've ever heard, as well as a kind of elephantine interpretative approach, and a general air of innocently unashamed vulgarity. But the recording, just to cope with all this—and a fantastic assortment of non-pipe sounds of pseudo percussion, etc.—is certainly out of this world. Nail down anything loose in your living room before play-



ing: I doubt whether I've ever heard discs which set up more potent resonances!

Eddie Osborn, on another Mighty Wurlitzer, location unspecified, depends somewhat less on traps (although the klaxon blast with which he begins will send you rushing to the door to receive unexpected guests), but again there is plenty of woofy pedal . . . wheezy, rough, and rasping tone qualities . . . and lush *vox humana* throbbing "expressiveness". And again it's a miracle how—not to say why—all this was ever captured in recording.

And just to show that tapes can do some of the same, there are two new 5-inch reels of *More George Wright*, on the Chicago Paradise Theater Wurlitzer, and *George Wright's Showtime*, on the San Francisco Fox Theater Wurlitzer (HiFiTapes R 707 and R 708; also available in both LP and stereo tape versions, which I haven't heard). As in R 702, reviewed here last month, Wright depends far less on assorted sound effects (a notable exception is

the larger-than-life, resounding bird-call embellishment of his own *Sanctuary* in R 707), and plays with greater verve, as well as more impassioned, schmaltzy sentimentality, than most of his ilk.

All of this might be generically labelled, by my lights, *Music to Wallow In*, but even I can't deny that those who like that sort of thing will like these a lot.

Percussion Addendum

What a relief it is to get back to genuine, rather than largely synthetic, percussion sound! And the only catch for me in the latest and probably the finest to date of all-percussion recordings, Saul Goodman's *Bell, Drum, and Cymbal* (Angel 35269), is no fault of its own. It's just that it covers so much of the same ground as the Vox Phonotapes-Sonore *Spotlight on Percussion* (reviewed in this column in July), that it seems to make a somewhat anticlimactic effect.

Otherwise, prejudiced as I may be about the earlier work, I have little but the highest praise for Goodman's superlatively assured playing . . . for the effortless, low-level, and always crystalline recording in Angel's best tradition . . . and for the ingenious choice of some of the musical materials. I can't say that I liked as well what seemed to me rather more talk than necessary (but that was true of the Vox set too, and here at least the talk and music levels are better balanced) . . . nor the shifting of narrators between the admirably easy-going, professionally skillful Leonard Sterling and the more amateurish-sounding (away from his instruments!) Goodman himself . . . and of the two long multi-dub pieces on Side 2, the variations on *My Country 'Tis of Thee*, for 7 instruments, struck me as rather artificially contrived (musically, that is; not in the performance), while the *Danse Macabre* in a 14-instrument percussion transcription seemed curiously undramatic. Yet soundwise, this disc is a hi-fi dream throughout, and the sound system which is able to do full justice to its immaculately clean transients and ringing sonorities can never be considered to have justified its existence until it is given the opportunity to demonstrate in actuality both its own powers and those of this virtuoso recording.

Current and Choice

Finally, for now, a quick run-through of some of the "Listening I've Liked" recently, but for which I haven't left myself space to discuss in more detail. I'll come back to many if not all of these later; meanwhile, perhaps even this cursory listing may provide some timely and decidedly worthwhile tips on

what to hear and buy for yourself.

For Music, Performance, and Recording: Busoni's opera *Arlecchino* (RCA Victor LM 1944); Novaes playing the Schumann *Kinderszenen* and Beethoven *Moonlight Sonata* (Phonotapes-Sonore PM 110 and PM 121; also Vox PL 8540 and PL 8530); Rodzinski's *Strauss Waltzes* (Sonotape SW 1016; also Westminster W-LAB 7026); and the Roger Wagner Chorale's *Gregorian Chants* (Omegatape 8003).

Ditto, plus the Finest Stereo-Sound Enhancements: Reiner's *Bartok Concerto for Orchestra* and Mozart *Jupiter Symphony* (RCA Victor ECS 9 and DCS 10); the Stagliano-Zimmler *Mozart Horn Concertos* (Boston 7-3 BN and 7-5 BN, via Livingston—the stereo version of the same recorded performances reviewed in this column in July from the LP, Boston 401); and Montoux's *Debussy Nocturnes* (RCA Victor CCS 12).

For Genuinely "Big-Sound" Recordings: Van Remoortel's *Grieg program* (VOX PL 9840); the Istomin-Ormandy *Rachmaninoff Second Piano Concerto* (Columbia ML 5103); Boult's *Suppe Overtures* (Westminster W-LAB 7033); and the Deutschmeister Band's *Marches of Many Nations* (Westminster W-LAB 7037).

For Diverting Lighter Fare: The Orquesta Chiapas' *Marimba Mambo y Cha-Cha-Cha* (Audio Fidelity AFLP 1802); Anton Karas' *Mister Zither* (Omegatape 2001); Stan Seltzer's *Stereo Steinway* (Stereotape ST 4a); and Paul Barbarin's *New Orleans Jazz* (Atlantic stereo tape, via Livingston, 7-8 BN).

For Authentic Exoticism: Choco and Chimi's *Drums of the Caribbean* and the Banda Taurina's *The Brave Bulls* (Audio Fidelity AFLP 902 and AFLP 1801). And *For Revelatory Musicological Exploration:* Dr. Fritz A. Kuttner's *Theory of Greek Classical Music* (Murgia Theory Series A-1).

REFERENCES

Note: The following list also may serve as a fairly complete *Test Disc Bibliography* (not otherwise available, as far as I know), except that it does not include references to articles on optical and other methods of calibrating test records, and also omits merely passing mentions of test discs in book chapters and articles primarily concerned with audio-test procedures, equalization-circuit design, etc. A similar *Test Tape Bibliography* is in preparation. Meanwhile, I shall greatly appreciate having my attention called to any significant entries I may have overlooked in compiling the present list.

1. Allison, Roy F. "Sound, Test, and Show-Off Records." *Building Your Record Library*, ed. Roy H.

Hoopes, Jr. New York: McGraw-Hill, 1956. (Originally printed in *HIGH FIDELITY*, v. 5, Oct. 1955.)

2. "Test Records." *Audio League Report*, (Mar. - Apr. 1955).
- 3a. Canby, Edward Tatnall. "Gadget Collection" (in *Audio Etc.* series). *Audio Engineering*, (Dec. 1953).
- 3b. Canby, Edward Tatnall. "Cook 'N-A' Beam Test Record" (in same series). *Audio*, XXXVIII (Mar. 1954).
- 4a. Cook, Emory. "White Noise-Testing Methods." *Audio Engineering*, XXXIV (Mar. 1950).
- 4b. Cook, Emory. "Significance of Intermodulation of High Frequencies in Audio Equipment." *Journal of the AES*, II (Jan. 1954).
- 5a. Darrell, R. D. "Testing and Tasting." *Saturday Review*, XXXVI (25 Apr. 1953).
- 5b. Darrell, R. D. "Checks and Double-Checks." *Saturday Review*, XXXVI (28 Nov. 1953).
6. Johnson, Wayne R. "Analyzing Sweep Frequency Transcriptions." *Audio Engineering*, XXXI (Oct. 1947).



7. Konins, Julius A. "Checking Your Audio System." *Radio and Television News*, LI (May 1954).
- 8a. Marshall, Joseph. "Test Records" (in Chap. 2). *Maintaining Hi-Fi Equipment*. Gernsback Audio Library, 1956.
- 8b. Marshall, Joseph. "Servicing High-Fidelity Equipment." *Radio Electronics* (May 1954).
9. McProud, C. G. "Test Record List." *Audio Engineering*, XXXIII (Sept. 1949). (With additional lists, Nov. 1949 and May 1950.)
10. Read, Oliver. "Audio Measurements." *The Recording and Reproduction of Sound*. 2nd revised ed., Howard A. Sams & Co., 1952.
11. Varkonyi, George F. "Modern High Fidelity Test Records." *American Record Guide* (Feb. 1954).
12. Villchur, Edgar M. "Testing and Measurement." *Audio*, XXXVIII (Apr. 1954).
13. Wood, L. A., and Moyer, R. C. "Proper Care of Test Records." *IRE-PGA Transactions* (Jul. 1952).

FORESTER

Continued from page 20

it advantageous to run a thread of contrasting color vertically along the weave of the material at each end. This thread can then be lined up with the rear edges of the sides of the enclosure as the grille cloth is tacked on. Measurements for the grille cloth, according to the instruction manual, are 33 in. by 48 in. The latter dimension is not correct. The cabinet, from the back of one side around the front to the back of the other side, measures 53½ in. A piece of material 33 in. wide and 58 in. long should be adequate for the job. Before attempting to put on the grille cloth, make sure you have enough staples or upholsterer's tacks; they aren't supplied with the kit. Directions for putting the grille cloth around the cabinet are given in the instruction booklet. Here again, while one person alone can do the job, it will be easier if a second person is around to give a little assistance, particularly during the initial stages of operation. There is one point not mentioned in the instructions which might be helpful in doing a neat job of putting on the fabric. If the cloth has a selvage along one edge, use this edge along the top of the cabinet. Fasten the material so that the edge of the selvage is even with the top edge of the cabinet and no trimming will be necessary. Tacking through the selvage will allow the material to be pulled tighter than would otherwise be possible without danger of tearing. It also helps in aligning the material on the cabinet. The material along the bottom of the cabinet will have to be trimmed after it is tacked securely in place.

The top and bottom of the Forester constitute the only exposed wood surfaces of the enclosure. Suggestions for finishing them are given in the instructions.* The chances are that, if you do a painstaking job of finishing the top and bottom of the cabinet, it will take you considerably longer than it did to do all the construction work. This is not to say that the finishing operation is overly tedious, but a lot of time is spent waiting for the finish material to dry so that it is possible to rub it down and go on to the next step. The easy way out, of course, is to paint the top and bottom of the cabinet; but if the top board supplied with your kit has such a beautifully grained veneer as ours had, you'll want to do everything possible to show it off to good advantage.

When the top and bottom of the cabinet have been completely finished,

*For more suggestions on finishing wood surfaces, see "Tips for the Woodcrafter", on page 8 of the May 1956 issue of *AUDIOCRAFT*.

they can be mounted. The cabinet, with the grille cloth on, is turned upside down, and the bottom is put on first. Use screws. When the bottom is secure, turn the enclosure over and fasten the top on. This too should be done with screws. If you have already tried the top on the enclosure and made holes for the screws, as we suggested, you should have very little trouble here. Because of cramped quarters around the cavity assembly, a very short screw driver will be most convenient for tightening the screws to hold the top in place. The joints where the top and bottom boards meet the front and sides of the cabinet should be calked after everything has been screwed in position.

All that remains to be done now is to install the loudspeakers and crossover network and wire them. If you've followed our suggestions, the woofer and middle-range speaker are already installed and it is only necessary now to mount the tweeter. A brilliance control for the tweeter is furnished, and this is mounted on the right-hand wall of the cabinet so that its frame is 1 in. from the rear edge and $12\frac{1}{2}$ in. from the bottom. The crossover network is screwed to the floor of the enclosure with its terminal strip facing the rear. The network is mounted so that its back is 2 in. from the rear edge of the enclosure's floor and its side is 3 in. from the enclosure's right-hand wall. Wire is furnished with the kit for connecting the tweeter with the brilliance control and the brilliance control with the crossover network, and for hooking up the woofer and middle-range speaker. Use wire with black insulation for the common lead, and colored wire for the other connections. The terminals of the loudspeakers are color coded; one terminal of each speaker is marked with red. Black-insulated wire should be used on these terminals, and all should be connected to the ground connection on the crossover network. If the speakers are connected this way, they will be properly phased. The other speaker terminals should be hooked up to the appropriate terminals on the crossover network, using differently colored wire for each speaker for easy identification. The wires should be soldered to the speaker terminals.

After the speaker connections have all been made, the back panel of the cabinet can be screwed in place and the unit is ready for testing. Connect the 16-ohm output and ground terminals of your power amplifier to the AMPLIFIER INPUT terminals on the terminal board of the crossover network.

The Forester kit, in our opinion, can be made into a mighty nice looking enclosure. And it sounds as good as it looks.

AUDIOCRAFT Test Results

Specifications given by the manufacturer are as follow:

Impedance—16 ohms.

Power rating—20 watts continuous program material.

Response—48 to 13,000 cps, ± 5 db.

Distortion—less than 0.6% IM at 10 watts (measured with any frequency from 55 to 500 cps mixed 4:1 with any frequency from 2 to 20 Kc).

The major design consideration for the Forester was obviously utmost cleanliness of response: superior transient performance combined with very low distortion. This was done by using three separate drivers which are isolated both mechanically and electrically, and by horn-loading the woofer over its entire operating range. The bass driver is enclosed within a sealed cavity, as in Klipsch-type horns, and the bass horn is driven by the front of the woofer; the horn path is curled around the cavity assembly and exhausts through the back of the enclosure.

A separate sealed cavity above the woofer chamber is furnished for the middle-range direct-radiator speaker.



The tweeter is sealed at the rear also. Pressure within the enclosure from any of the drivers, then, cannot affect any other driver. Electrical isolation is accomplished by a three-way 12-db-per-octave crossover network operating at 300 and 5,000 cps.

The enclosure is uncommonly rigid, being made of $\frac{3}{4}$ -inch plywood throughout, and is not large, so that panel resonances are negligible. The tweeter is of small size and shallow construction, which gives excellent distribution of high frequencies. All the drivers are made to Sherwood specifications. The result, in the Forester, is sound that is beautifully clean and exceptionally easy to listen to, at a price that is modest indeed. Because the bass crossover is so low, there is little of the disturbing difference in bass and middle-range tonality often heard in fully horn-loaded systems. There is a tweeter level control furnished that

permits tailoring the high-frequency intensity to the listening room.

The Forester's range doesn't extend so low nor so high as that of some very expensive speaker systems: it cuts off at around 40 cps and 13 or 14 Kc. Bass response is better in a corner, but it can be used along a wall if it is placed 4 to 6 in. from the wall. Within its range, however, it is a better reproducer than the majority of systems costing far more. In our opinion, it is a great deal more satisfactory (if unusual) to sacrifice a slight bit of range in a budget-priced speaker system than cleanliness of response.

LOUDSPEAKERS

Continued from page 24

non-resonant and it is easy to see why this must be so. It is difficult to imagine a few layers of felt having much influence on the longer wave lengths, but frequency-response curves indicate that this design acts as an infinite wall down to about 75 cps, where its effectiveness begins to decrease. Since all other designs depend on a peaked response of some kind to help out below 100 cps, the good bass response of the Hartley system to 50 cps or so is quite amazing.

Another enclosure even smaller than the Baffle which makes similar claims of non-resonant properties is the Bradford Perfect Baffle. So far as I know, no analysis of the Bradford baffle has appeared in print, and no data on speakers mounted in this unit have been published. A cross section of this enclosure is shown in Fig. 5. The little swinging trap door in the back is only about 8 sq. in. in area, and there are no other gimmicks at all. Such Bradford baffles as I have examined did not even have sound absorbing material on the interior.

The theory of the gadget seems to be that the trap door, "operating in perfect unison with the speaker", will relieve the changes in air pressure behind the cone without generating any out-of-phase noises at the rear of the cabinet. Granted that some energy may be used in overcoming the stiffness of the hinge, there seems to be no reason for assuming that waves coming through the valve are going to be much different than they would be if the valve weren't there. At high frequencies, to be sure, the mass of the swinging door is sufficient to keep it from moving at all, and the box behaves as if it were solid.

At one particular frequency the Bradford baffle will behave like a bass-reflex enclosure, with the trap door and speaker moving in opposite directions. The explanation of this belongs under a discussion of vented enclosures, but Mr. Bradford can't be counting on such phase reversal anyway since he states

Continued on next page

LOUDSPEAKERS

Continued from preceding page

that his box is completely non-resonant with any speaker. It may be that there is impartial information available on the Bradford baffle which I don't know about. On the basis of what I have seen and heard, I can only pass along the personal opinion that the Perfect Baffle, while not perfectly baffling, is very confusing indeed.

Note that in all the variations of the infinite baffle described, the designers face the double problem of preventing cancellation from opposite sides of the diaphragm and compensating for inefficient coupling at low frequencies because of the limited size of the vibrating piston. One idea which presents itself is to use a really big piston—on the order of 25 sq. ft. or so. If you could get such a device in operation you wouldn't need a baffle at all since, at normal distances from the sound source, you would not be in an area where low-frequency cancellation could take place. One way of simulating such a large piston is the use of great numbers of standard cone speakers all operating in unison. John Goodell has used multiple speakers with great success in electronic organ installations. A bank of 100 or more 12-inch speakers produces an awesome 30-cps growl.

An alternative is to control somehow a single diaphragm having a large cross-sectional area. The new wide-range electrostatic speakers, which are peeping over the horizon, use this second approach. A diagram of a simple electrostatic speaker is given in Fig. 6. As the voltage on the two grids is varied in opposite directions, the diaphragm will be repelled by one and attracted to the other. Since the force on the diaphragm is applied simultaneously at all points on its surface, there is no theoretical reason why the thing can't be made as big as a whole wall. The close spacing necessary between the grids and the diaphragm limits the distance the vibrating element can move, but if the diaphragm is big enough it won't have to move very far to generate a satisfactory amount of acoustic power.

Manufacturing difficulties limit the size of most commercially available electrostatic speakers, and their range is therefore restricted to the higher frequencies. Experimentation with big units is going on, however, and full-range electrostatic speakers may be available commercially within the next two or three years. Acoustical Manufacturing Company, in England, has tentative plans for a commercial model at the end of this year.

Norman Crowhurst told me of another experimental English full-range electrostatic model which is built in the shape of a cylinder and set in a

corner of the listening room. A top view is shown in Fig. 7. The space between the multiple diaphragms of the speaker and the room corner forms a natural horn. Moreover, the long thin vibrating elements are driven by a delay network so that each tone is in phase with the sound waves as they pass by. Sound originates in the rear of the unit, toward the corner, and as it moves out into the room, it is successively amplified by the multiple electrostatic diaphragms.

W-3 TO DYNA II

Continued from page 25

resistors were also matched, although it probably wasn't necessary. Incidentally all resistors used were rated at 1 or 2 watts, chiefly because they are more stable than the little 1/2-watt jobs—especially after having been soldered with a gun as hot as mine, which doesn't just melt solder; it practically vaporizes the stuff.

The old power cable seemed rather small in view of the increased heater drain of the 6CA7 tubes. Accordingly, Belden 8448 cable, with two No. 18 conductors for the heaters, was substituted and kept short (2 ft.).

All components of the bias supply were installed on the power-supply chassis, with the exception of the 100-

μfd bias-filter capacitor. The two 1/2-inch 20-ma selenium rectifiers were mounted on bolts holding the 5V4 socket and the filter choke. The bias pot was put in a 3/8-inch hole drilled in the center of the chassis. In this particular case it was found necessary to use a 15-K resistor from pot to ground, to bring -35 volts within the adjustment range of the pot, instead of 47 K.

While I had the drill out, a dual Eby binding-post assembly was installed at one end of the power-supply chassis for an external pilot-light connection to the 6.3-volt heater wiring. A single-pole single-throw toggle switch was mounted at the other end to permit grounding the heater winding center tap should the amplifier ever be used with a preamplifier in which the heater circuit isn't grounded or with a unit having its own heater supply.

The 6.8-K decoupling resistor and 20-μfd 500-volt capacitor, shown under the power transformer, had previously been installed there and were left intact. Since this took the spare power cable wire, the unused AC line wire to pin 8 was removed and the cable wire from pin 8 became the bias line. While the power supply was dismembered, 220-K equalizing resistors were installed across each series filter capacitor.

One great advantage of the Dyna

Fig. 2. Complete schematic diagram of W-3 amplifier converted to Dyna circuit.

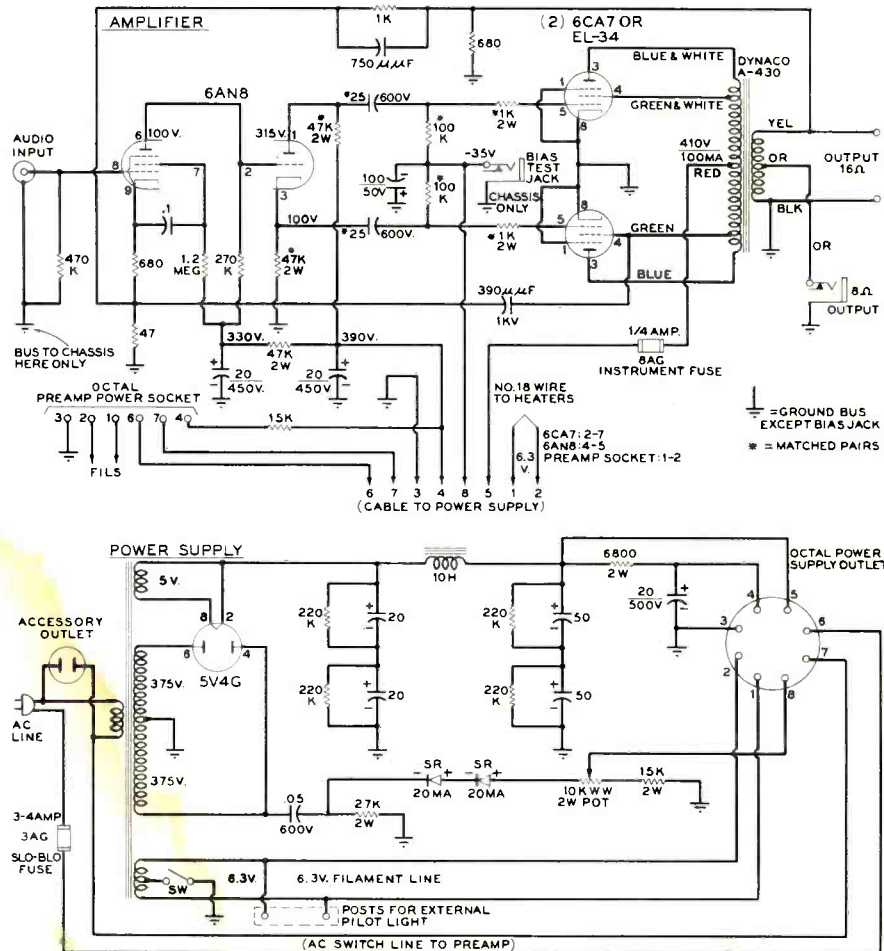

circuit here: in the small amplifier chassis there are no big heat-producing resistors; the 6CA7 cathodes are grounded, and very little heat is produced by the 6AN8 resistors. Previously, the 47-K phase-splitter resistors turned very dark, their once-equal values drifted apart, and the wax practically boiled out of the coupling capacitors. This is no longer the case.

At this writing the Amperex 6CA7 or Mullard EL-34 tubes must be ordered by mail here, but the color-TV 6AN8 is in stock at local distributors . . . and what a voltage output this little tube has! If you've been testing around miniature tubes, watch out for your VTVM on this one. It's almost unbelievable that so much could come from so small a bottle.

On test, the rebuilt amplifier turned out to be rock-stable at all frequencies and absolutely quiet when connected to a speaker. Results given for the Mark II Dynakit⁴ apply equally here, with the exception of power output which is somewhat lower with the W-3 power supply. Idle values were 410 volts and 110 ma to the output stage, with the bias set at -35 volts; even so, maximum output at 1 Kc was 27 watts across a 16-ohm load before any signs of clipping were noticed on the scope. The completed amplifier's operation exceeded expectations. It is used with a Heath WA-P2 preamp, a Garrard RC-90 changer and Pickering D-140S cartridge, an AM-FM tuner of dubious ancestry, and 40 ft. of twin lead to an Electro-Voice Aristocrat II speaker system.

Clarity is one criterion of musical reproduction, and that this amplifier has, very noticeably. Of course, it isn't necessary to run the gain wide-open for clear reproduction (I certainly don't drive my 200-hp car that way!), but it is nice to know it's there for peaks as required. So I take back what I said previously about the baronial hall—in my little living room this Dyna circuit sounds good. Very good.

⁴"The Dynakit Mark II Amplifier" AUDIO-CRAFT, April 1956, page 21.

AMPLIFIER DESIGN

Continued from page 29

ment. This is why the method of working is designated Class AB.

A further class distinction is that between operation with and without positive grid swings. A small subscript 1 after the letter designating the class indicates that the grid is never driven positive with respect to the cathode; a subscript 2 indicates that it is driven positive, and accordingly that power drive is required in the grid circuit.

Thus the operation in Fig. 2, with a 3,200-ohm plate-to-plate load, gives 5.5 watts maximum output in Class AB₁ and 18 watts in Class AB₂.

Pentodes in Push-Pull

How about working pentodes in push-pull? These can provide an even more efficient output stage, although the distortion situation is not so good, and

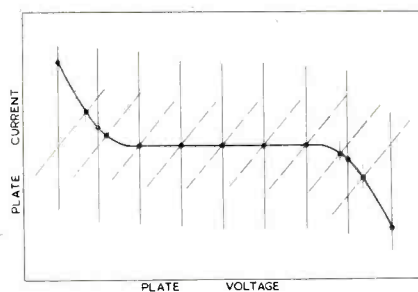

Fig. 8. Applying the form of load line produced by push-pull grids, with the characteristics of Fig. 7, to idealized tube characteristics. The parallel vertical lines, representing a theoretical tube with zero AC resistance, would be ideal. The parallel dotted lines show how the presence of AC resistance, represented by the slope, causes distortion where grid current occurs; along the straight central section, the spacing is the same, but closing up occurs at ends.

the operating conditions are more critical than with triodes. However, with modern feedback amplifiers it is possible, for specification purposes at least, to achieve a very good output.

Fig. 5 shows two sets of 5881 characteristics placed back to back for producing composite load lines. Here the operation is Class AB once again, so that toward each end of the load line one tube only is conducting. In the region near zero plate current on each, the resultant plate current is contributed partly by each tube, and so a difference value is taken to produce composite load lines.

These characteristics illustrate how it is possible to increase the output rating of pentode tubes (or beam

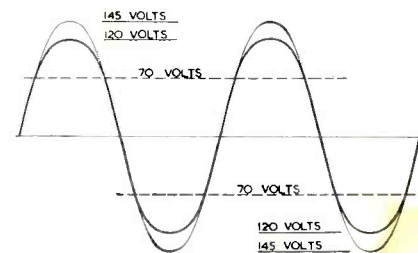

Fig. 9. The form of distortion that will occur by using 1:1 coupling from a push-pull 6SN7 to get the drive discussed as necessary for type 45 tubes.

tetrodes) by this method of operation. The heavy dashed lines represent the maximum rated plate dissipation of 25 watts. The fine dashed curves represent the load presented to each tube, while the solid load line is the composite value. The bias is -35 volts, and 400 volts are applied to both plates and screens. This gives 50 ma for each tube at the

quiescent point. The composite load line is for an impedance of 800 ohms; by the relationship already discussed, this represents a plate-to-plate working impedance of 3,200 ohms.

About 70 watts output can be obtained from these two tubes rated at 25 watts plate dissipation, with distortion a little less than 5%. This is possible because the individual load lines go through points representing about 50 watts dissipation at about -15 volts on the grid, but dissipation during the whole negative-going excursion from the -35-volt bias point is far below 25 watts. The average over a complete cycle of applied signal is within 25 watts.

From the high-quality point of view, however, this output rating should be examined more closely. At a first glance, the composite curves would suggest that the distortion must be considerably more than 5%, because the spacing between consecutive curves along the composite load line deviates quite markedly; but notice how the deviation occurs. Closing up occurs both at the extremities, between the zero and -5-volt curves, and also between the composite curve for -35 volts on each grid and the curves representing -30 volts on one and -40 volts on the other. The extent of closing is almost equal in all three regions. This signifies that there will be a flattening of the tops of the wave form, and also a kinking near the zero line, as shown in Fig. 6.

This is equivalent to almost pure fifth-harmonic distortion. Now, 5% fifth harmonic will produce a deviation from a true sine wave that is about as noticeable as 10% third or 20% second harmonic. This is because the deviation from the true wave form is that much more rapid. Second-harmonic distortion causes 1 area of closing up and 1 area of widening out per cycle. Third harmonic causes 2 areas of closing up and 2 areas of widening out in every cycle. Fifth harmonic causes 4 areas of closing up and 4 areas of widening out in every cycle. The amplitude of any harmonic is measured in terms of the variation from the mean value of true sine-wave fundamental.

If the variation has to take place four times a cycle instead of only once, then it will need to be only a quarter as great to produce as noticeable an effect both on listening, in audible harmonic distortion, and on the visual presentation of the wave on a scope. A similar principle holds true with regard to the corresponding IM distortion, but the figures will be modified to some extent by the relative audibility of the respective tones. At low frequencies, the harmonics and higher-frequency components are much more audible than the fundamental, and so the magni-

Continued on next page

AMPLIFIER DESIGN

Continued from preceding page

fication will be even greater; while at high frequencies, the reduction in oral sensitivity to the higher harmonics will tend to offset the otherwise increased noticeability.

As regards intermodulation distortion, the values measured will be dependent upon the deviation from normal, and so should be proportional to the percentage harmonic reading, regardless of the order of the harmonic. In practice, however, the audibility of the intermodulation goes up in proportion to the order of curvature producing it.

The net result of this general principle is that, although pentodes appear to give harmonic distortion values competitive with triodes, and very much more output, the figures given are somewhat deceptive because the order of harmonics produced by them is much higher than that from triodes.

There is another factor which push-pull operation has not removed from the pentode tube: notice how little the load line of Fig. 5 would have to rotate or tilt about its central point for much more distortion to become evident. Rotated in a clockwise direction, representing an impedance lower than the optimum value, the spacing between the zero and -5 -volt curves would open out, representing the introduction of a larger proportion of third harmonic than the original value of fifth. Going in the opposite direction, the spacing between the zero and -5 -volt grid characteristic closes up with a similar rapid increase in both third and fifth.

This low value of distortion has been obtained by what is in effect a *critical adjustment of load value*. Not only this, but the load line used represents a pure resistance. Because the characteristic curves which it intersects are all very definitely curved, any opening out into an ellipse, due to reactances being present, will also introduce distortion quite rapidly. This is a good reason why a great many high-fidelity enthusiasts still prefer to use triodes, although they do not give such large power outputs as pentodes for the same plate dissipation rating.

Of course, pentodes connected as triodes behave exactly the same as triodes and can be considered in the same group.

Power Drive Stages

We have mentioned the use of power drive—that is, providing current for driving the output-tube grids positive with respect to their cathodes, so we shall have to consider how we can get this drive effectively without distortion.

Consider first the kind of load that the output-stage grids will provide for

the preceding stage. Assume, for example, that we are using 70 volts negative bias. Then, for the first positive 70 volts of a signal swing there will be practically no load on the previous stage; the impedance looking into the grid will be very nearly that of the grid resistor. Then, as the grid starts to go positive with respect to the cathode, it will start to conduct.

The curvature of the conduction characteristic when it runs positive will be somewhat like that of a diode: this is not exactly a straight line, but a curve of about $1\frac{1}{2}$ power law. The current in the drive circuit will be as shown in Fig. 7. The current will naturally be in the same direction as the voltage, and on the opposite swing the current will be negative from the point of view of the first circuit, although of course it will be positive grid current in its own circuit.

Thus, the current loading on the preceding stage occurs only at the tips of the drive-signal wave form. It is rather like trying to place a heavy article on a top shelf that you can only reach by tiptoe. The article is fairly easy to lift until you get it to head height; then it becomes harder. When you get on

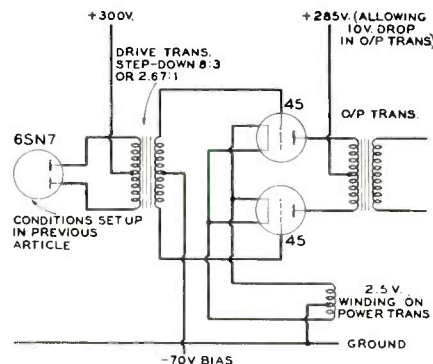

Fig. 10. Using a step-down transformer of ratio 8:3 or 2.67:1, the distortion which is so prominent in Fig. 9 can be reduced to less than 1.5%. See text.

tiptoe, it requires all your effort to lift the last little distance. If someone gives you a push at the critical moment, you simply won't make it! In providing power for a grid drive, the highest current drain occurs at the very extreme tip of the voltage swing.

If we apply the composite load line representing the grid-current load to some theoretical tube characteristics, as in Fig. 8, we can see that the ideal tube characteristics will be vertical straight lines, representing zero AC resistance. It is immediately evident that triode tubes present the best initial possibility of approaching this.

A useful drive tube is the 6SN7 that was discussed under Phase Inverters. Using the 8-volt grid bias operating condition with transformer coupling, a single tube would give a swing of 340 volts peak to peak. If two such

tubes were operated in push-pull, there would be an available peak-to-peak voltage of 680 on the primary. The AC resistance of each tube at zero grid voltage is about 6.5 K.

Suppose the peak drive voltage we require is 120 volts on each grid, and that the peak grid current is 30 ma. When 30 ma is drawn from a source with an AC resistance of 6,500 ohms, a voltage drop of about 20 volts is obtained. If the drive circuit gave 120 volts open circuit, the drive would be reduced to 100 volts because of grid current. We should have to provide an input swing that would give about 145 volts without grid current, which would be loaded down to the 120 volts we require.

The wave form will be as shown in Fig. 9. Without bothering to calculate how much distortion this represents, it can be seen to be quite large. Remember, though, that this stage has available a peak-to-peak swing of 680 volts (that's not allowing for grid-current loading), whereas we require only 240 volts (120 for each grid of the output stage).

Let's assume that we will throw away about 40 volts of available swing because of the loading of the extreme tips, and to allow a safety margin. We need to use a step-down transformer that will change the 640 volts we have to the 240 we require. This is a step-down ratio of 8 to 3, or $2\frac{2}{3}$ to 1. The loading effect of the grid current will then be reduced from 30 ma to $\frac{3}{8} \times 30$, or 11.25 ma. This current in the AC resistance of 6,500 ohms represents just under 7.5 volts drop in the available swing per tube of 344 volts. That drop will be stepped down on the secondary side by a ratio of 8 to 3, so as to be less than 3 volts in the 120 volts grid swing required. An open-circuit swing of 123 volts will be ample to give a loaded swing of 120; an obvious improvement over the 1 to 1 coupling ratio. Distortion will be less than 1.5%. The complete circuit is shown in Fig. 10.

In this article we have not considered questions such as frequency response or the stability of the amplifier, and other things that we shall have to account for in practice. What we set out to do was to get a picture of what push-pull amplification can do. Before we can really design a complete, up-to-date, push-pull output amplifier, we need to go over some other details connected in one way or another with the use of feedback, so the next article will deal with feedback in amplifier design. This will provide the basis for completing a whole amplifier, using the procedures already discussed.

Next in this series: Design of Feedback Amplifiers.

SOLDERING

Continued from page 21

ence and the amount you want to spend (models range from one dollar up). If we were to be pinned down, however, we'd recommend two soldering irons for electronic work: a lightweight electric type with 60- to 100-watt capacity for almost all your soldering; and a pencil-type with 25-watt capacity for those hard-to-reach spots in closely confined areas. The iron should be convenient and non-tiring to handle over long periods.

Work Preparation

If there is any secret to successful soldering, it lies in the cleanness of the metals to be joined. The surfaces of metals become oxidized when exposed to the air for any length of time, and strong soldered joints are possible only when these surface oxides are removed. Flux is of course important, but mechanical cleaning is necessary to remove dirt and grime. Unless the base metal is thoroughly clean, the solder will be unable to perform its function—to alloy with the metal by penetrating the pores and thus fuse the two parts with a permanent, trouble-free bond.

Wire connections: Cut back the insulation of wire leads at least $\frac{3}{4}$ in. to permit twisting the wires together, and also to keep the heat of the soldering iron from injuring the insulation material. Scrape the wires with a knife to clean the bare metal. Follow the same procedure when joining pigtail leads of condensers, resistors, and other components to each other and to other parts.

Solid metal: Electronic chassis bases are constructed usually of steel or aluminum. The steel is either cadmium or zinc plated to provide a protective coating against rust. Both types of plating are readily solderable, but cadmium's soldering characteristics are superior to those of zinc. Ordinarily, a hotter iron will be needed on cadmium. If you have trouble when soldering cadmium, rub down a small section of the plating with steel wool or fine sandpaper (00 grade).

On aluminum chassis bases, ordinary fluxes and tin-lead solders are unsuitable, which you may have discovered for yourself if you've tried to attach any metal or make a ground connection to this type of base. Aluminum joining requires a special aluminum solder and a flux capable of removing the tough, highly resistant oxide surface film.

Tinning the Iron

The copper tip of a soldering iron must be properly prepared in order to transfer iron heat to the metal quickly. This means putting a thin alloy coating of solder on the tip to facilitate joining.

The process is called *tinning* and involves five steps:

a) Heat the iron until it is dark red, then file the copper faces clean of scale and pits until the metal shines brightly. File in one direction, preferably away from you.

b) Coat the tip with rosin liquid flux by brushing a small amount on each copper face.

c) After the flux bubbles, rub wire solder against the faces until they are completely coated.

d) Shake off the excess solder, or wipe it from the tip with a rag.

e) After you have been soldering, the copper faces may become tarnished and

filled with dross. Remove these impurities, reflux the faces, and tin them again.

Soldering Procedure

Good soldering requires clean metal surfaces, suitable flux, sufficient heat, and solder with a high pure-tin content. Soldering is simplified if you use a rosin-core solder, since the flux will automatically ensure cleansing action prior to deposition of solder. But keep a bottle of liquid rosin flux handy for tinning the iron tip, and for soldering sizable metal areas.

The bulk of electronic soldering consists of attaching wires to wires, to tube

Continued on next page



add the dimension
of realism
to your
listening
pleasure

pre-recorded

BINAURAL stereophonic TAPES

by *Concert Hall Society*

Long a recognized leader in high fidelity recordings, Concert Hall Society has expanded its facilities to include production of binaural stereophonic pre-recorded tapes. Concert Hall is taking this step to help meet the demand for truly high fidelity tapes. An ambitious program of outstanding items has been planned; two notable "firsts" have already been chalked up—



LA BOHEME—Puccini
Complete on two 7" reels (3600 ft.)

SYMPHONY #9—Beethoven
Complete on two 7" reels (3000 ft.)

All Concert Hall Society Tapes are 7" reels, 7½ ips, available for either stacked or staggered heads. Positive color identification is provided by the color of the reel material—*clear plastic for stacked, yellow plastic for staggered*. And please note these extras:

- All CHS Tapes bring you complete works
- All CHS Tapes come with full program notes
- All CHS Tapes are splice free
- All CHS Tapes are packed in attractive boxes
- All CHS Tapes are of highest fidelity

The listing at right is only the beginning! Many exciting items are in the works—so watch for our announcements of new tapes to be released on a regularly scheduled basis.

Concert Hall Binaural Stereophonic Tapes are available now at record dealers and hi-fi audio centers, or write us for complete catalog and name of nearest dealer.



CONCERT HALL SOCIETY
BINAURAL
(STEREOPHONIC) TAPES

45 Columbus Avenue • New York 23, N.Y.

THE FIREBIRD (Stravinsky)
Netherlands Philharmonic,
Walter Goehr. CHT/BN-1 (1200')
\$11.95

EL AMOR BRUJO (de Falla)
Netherlands Philharmonic, Walter
Goehr, Annie Delorie, *contralto*.
CHT/BN-2 (1200') \$11.95

PICTURES AT AN EXHIBITION
(Mussorgsky-Ravel) Netherlands
Philharmonic, Walter Goehr.
CHT/BN-3 (1200') \$11.95

SYMPHONY #101 IN D MAJOR—
"CLOCK" (Haydn) *Orchestre*
Pacheloup de Paris, Louis Martin.
CHT/BN-4 (1200') \$11.95

SYMPHONY #9 IN D MINOR—
"CHORALE" (Beethoven)
Netherlands Philharmonic Chorus
& Orch., Walter Goehr, *Soloists*.
CHT/BN-5-2 (3000') \$23.90

PIANO CONCERTO #2 IN A
MAJOR (Liszt) *Philippe Entremont*,
Radio Zurich Orchestra, Walter
Goehr. CHT/BN-6 (1200') \$11.95

RHAPSODY IN BLUE (Gershwin),
BOLERO (Ravel) *Philippe*
Entremont, Concert Hall
Symphony Orchestra, Walter
Goehr. CHT/BN-7 (1200') \$11.95

LA BOHEME (Puccini) Netherlands
Philharmonic Chorus & Orch.,
Carl Bamberger, *Soloists*.
CHT/BN-9-2 (3600') \$23.90

THE MOLDAU (Smetana),
POLOVIZIAN DANCES FROM
"PRINCE IGOR" (Borodin) *Utrecht*
Symphony Orch., Paul Hupperts.
CHT/BN-10 (1200') \$11.95

LES PRELUDES (Liszt) *Utrecht*
Symphony Orch., Paul Hupperts;
ROMAN CARNIVAL (Berlioz)
Netherlands Philharmonic Orch.,
Walter Goehr. CHT/BN-11 (1200')
\$11.95

DEATH AND TRANSFIGURATION
(R. Strauss) *Utrecht Symphony*
Orchestra, Ignace Neumark.
CHT/BN-12 (1200') \$11.95

DOWN THE MIDDLE with Jimmie
McPartland & Orch.—J. & Marian
McPartland, Stegmeyer,
Dickenson, Freeman, Morello,
Hinton. CHJT/BN-13 (1200') \$11.95

SOLDERING

Continued from preceding page

sockets, and to lugs, terminals, and components. In every case twist leads firmly; if lugs have small holes supplied for connecting purposes, push the wire through the hole and coil it around the lug. You can remove the plastic covering on hook-up wire by touching the hot iron to it.

Apply the tinned and heated iron to the parts and hold the wire solder on the other side of the metal until the solder melts and flows freely. At this point, the flux will have melted and boiled off. Do not drip molten solder onto the joint; it is important to get the base metal hot enough to melt the solder. If minute individual globules of solder remain, the part was insufficiently heated and must be resoldered.

Some components, such as precision resistors, germanium diodes, and transistors, are easily damaged by excessive heat. When soldering a pigtail lead on one of these, grasp the lead with a pair of pliers midway between the soldering point and the component body. This will conduct heat away from the pigtail before it reaches the body.

Remove the soldering iron from the joint as soon as the solder melts. Capillary action will cause it to flow into the crevices between the two metal parts being joined. Parts should not be touched until the molten solder has had a chance to cool and harden properly.

Use just enough solder to join the parts. Excess amounts are unnecessary and wasteful, and can result in one section being heavily built up with material while another is weakened by lack of solder.

Soldering is by no means difficult. With the right materials, some practice, and a little patience, you can obtain sound, permanent solder joints.

WOODCRAFTER

Continued from page 11

and a higher speed for small ones. For example, bits up to $\frac{1}{2}$ in. in size should be operated at a speed between 2,000 and 3,000 rpm; bits from $\frac{1}{2}$ in. to 1 in., between 1,000 and 2,000 rpm; and any bit above 1 in., between 300 and 500 rpm. When using the drill press for a shaper operation, a speed of 4,000 to 5,000 rpm is required.

4) If the hole to be drilled in wood is small, the hands can be used to hold the work in place. For other operations always clamp the work securely, especially when working with metals. This will produce a precision cut by eliminating any movement of the work, and will avoid the possibility of serious injury which can occur when the drill

grabs an unclamped piece and spins the work dangerously. It's a good policy to center punch the mark where the hole is to be drilled to provide a pilot for the drill or bit.

5) If the hole is to be drilled completely through the stock, keep a piece of scrap between the work and the table. This back-up board prevents splintering around the underside of the hole as the drill cuts through the stock, and protects the table from damage if it is not accurately centered. If the stock is of hardwood, or the hole to be drilled is deep, raise the bit once or twice during the drilling to remove chips that might get wedged in the spur of the bit.

How to Bore Deep Holes

The spindles of most drill presses have a maximum stroke of about 4 in. For holes deeper than that, but not more than 8 in. deep, there are two methods that can be used. In one (Fig. 2), a

COURTESY ATLAS PRESS CO.

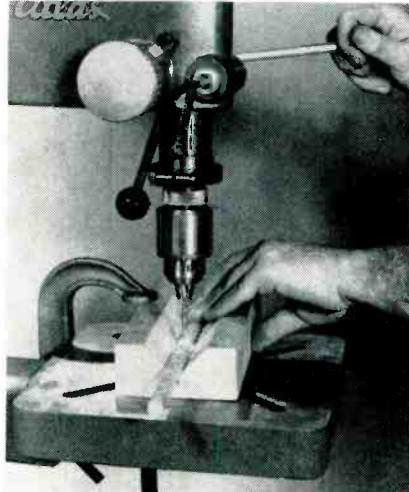

Fig. 4. Using V-block to drill a dowel.

piece of scrap stock is clamped to the table of the drill press. The regular work is placed in position on top of the scrap and one end of the desired hole is drilled halfway through. The work is then removed and the table of the drill press is raised to permit boring a shallow hole of the same diameter in the scrap stock. After lowering the table again, a short length of dowel of the same diameter as the holes is inserted in the hole in the scrap stock and the work is seated over the dowel pin. This positions the work accurately for drilling from the other end. Drilled from the other end, the second hole will meet the first in the center of the work.

A second method for drilling holes between 4 in. and 8 in. deep requires turning the table until it is parallel to the column (Fig. 3). The work is clamped to the table in alignment with the bit using a guide block or temporary

fence also clamped to the table. Drilled from one end halfway through, the work is reversed and drilled from the other end. The guide block or fence will as-

COURTESY ATLAS PRESS CO.

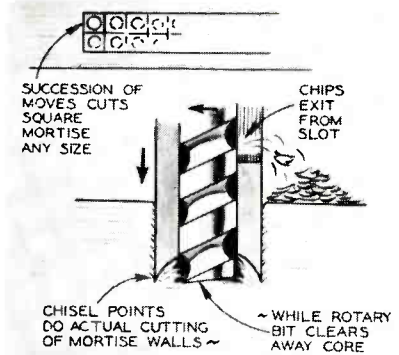

Fig. 5. How mortising accessory works.

sure perfect repositioning of the work so that the boring will meet in the center.

How to Bore Holes in Round Stock

Boring stock of cylindrical shape requires a wedge type of support to prevent the work from rolling; a homemade V-block (Fig. 4) will serve the purpose. Be certain to align the V directly under the center of the bit. When drilling edges of circular stock, such as a disc, turn the table to its vertical position as suggested for drilling deep holes. Clamp a V-block to the table, again centering it exactly beneath the point of the bit. Especially with round stock, remember to use a center punch to start the hole.

Frequently in cabinet work pegged joints are used for strength and decorative effect. The drill press is the perfect tool for this type of joint since it bores the holes and even makes the dowel pegs. The latter operation is accomplished with a plug cutter which is actually a drill with a hollow core. The dowel must be cut so that its length

Fig. 7A. Shaper cutter on a drill press.

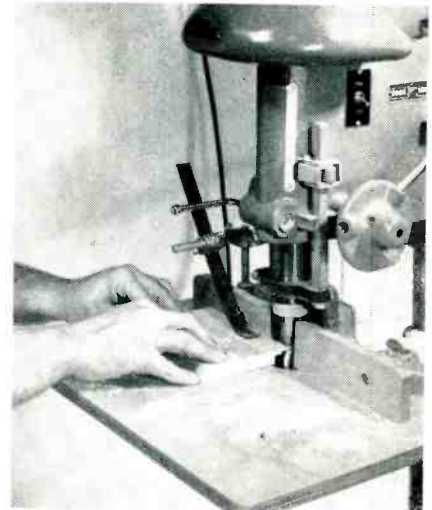

COURTESY ATLAS PRESS CO.

is parallel to the grain of the wood. A spindle speed of about 1,200 rpm is maintained when cutting dowel. Here again, a scrap block clamped to the table beneath the work will prevent the cutter from striking the table.

How to Make a Mortise

The ability of a drill press to bore square holes is not only one of its most unique claims to fame but also is a great labor saver when a mortise is to be cut. When making a mortise by hand a drill is needed to remove the waste material in the center of the mortise,

COURTESY ATLAS PRESS CO.

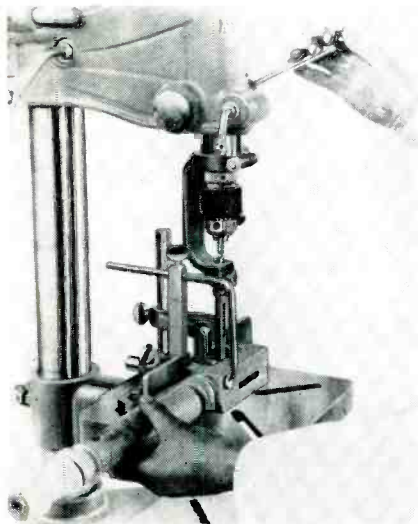
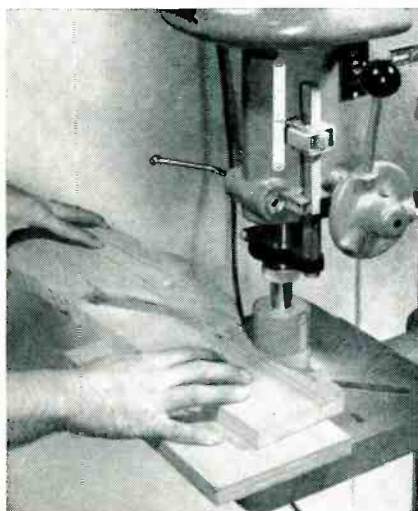

Fig. 6. Using the mortising attachment.

a chisel to cut the side squarely, and a mallet to apply pressure to the chisel. With a mortising chisel and bit (Fig. 5) these three operations are performed simultaneously by the drill press. The cutting bit is housed inside the hollow chisel, with the tip of the bit extending 1/16 in. into the open. As pressure is applied, the bit bores out the stock and the chisel cuts the sides of the hole square and straight. In addition to the bit and chisel, a special mortising at-

Fig. 7B. The sanding drum in operation.



COURTESY ATLAS PRESS CO.

tachment (Fig. 6) is available which consists of a clamp to hold the work in position, a fence for aligning the work, and a mortising chisel holder which attaches to the quill (the steel sleeve supporting the spindle). Mortising chisels and bits are made in the following sizes: 1/4 in., 3/8 in., 1/2 in., 5/8 in., 3/4 in., and 1 in. For most cabinet work the 1/4 in. size suffices.

Here is the routine to follow when installing and using a mortising attachment:

- 1) Remove the chuck and feed-stop bracket from the quill.
- 2) Replace the feed-stop bracket with the mortising chisel socket and clamp it in place.
- 3) Replace the drill chuck.
- 4) Fasten the fence to the table and adjust at the proper location where the mortise is to be made in the stock.
- 5) Install the desired size of mortising chisel bit. Make certain that the bit extends 1/16 in. beyond the chisel to lighten the cutting load on the chisel. Tighten the set screws of the chuck.
- 6) Adjust the drill speed to about 1,500 rpm.
- 7) Lay out the position of the mortise on all pieces.
- 8) Adjust the depth of cut.
- 9) Place the stock against the fence and set the hold-down so that it securely positions the stock against table.
- 10) Start at the right end of the mortise and proceed with the cutting, moving the work sidewise by hand slightly less than the width of the cut each time. The chisel movement is operated by the hand lever. Apply only enough pressure to let the chisel and bit do the job. Do not use excessive force.

So many are the tasks which the drill press can perform, it would consume many more pages to tell the complete story. A number of accessories (Fig. 7) are available to convert the machine to

Continued on next page

Fig. 7C. The dovetail cutter attachment.

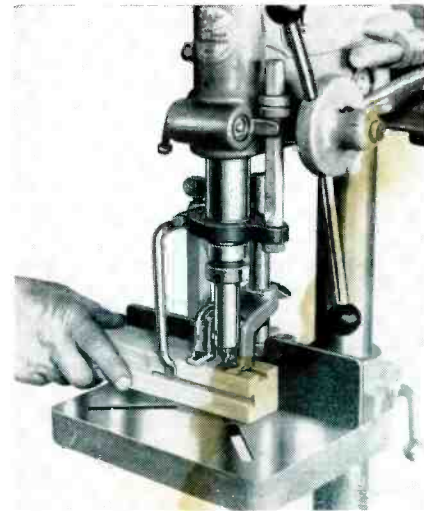

COURTESY ATLAS PRESS CO.



build your own FORESTER 3-way Low Distortion SPEAKER SYSTEM

for as little as \$129.00

... with 1M distortion below that of systems costing more than \$350.00. Intermodulation distortion or "blurring" of the most-listened-to middle and high frequencies is prevented by complete electrical and acoustical isolation of each speaker. This results in less than 0.5% 1M distortion to provide exceptionally clean middle tones and clear highs with no harshness.

The Forester system contains 3 low distortion speakers. (A) a 12" woofer, 30-300 cps, with a 1 lb. magnet; (B) an 8" mid-range unit, 300-5000 cps. with a 14.6 oz. magnet and (C) a 5" tweeter, 5000-18,000 cps with a 2.15 oz. magnet and lightweight, spiderless cone.

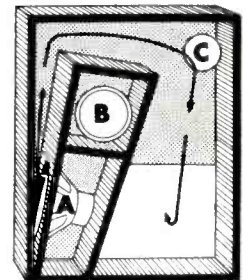

Front View

These three speakers are controlled by a 6-element, 300:5000 cps, 12 db/octave crossover network. The entire cabinet measures 32" high, 25" wide, 14 1/2" deep.

COMPLETE SYSTEMS

SF1	Spkrs., network, cabinet drawings...	\$ 79.50
SF1/SFK	Spkrs., network, cabinet kit.....	\$129.00
SF1/SFP	Spkrs., network and assembled 3/4" unfinished plywood cabinet.....	\$154.00
SF1C	Spkrs., network, in finished bleached mahogany cabinet (illustrated)....	\$189.00

MODERNIZATION SYSTEMS

For use with your present 12" speaker, instead of the Sherwood Woofer.

SF2	Same as SF1, less 12" woofer.....	\$ 49.50
SF2/SFK	Same as SF1/SFK, less 12" woofer...	\$ 99.00
SF2/SFP	Same as SF1/SFP, less 12" woofer...	\$124.00

CROSSOVER NETWORKS (16 ohms)

For your own speaker system.

SFX35	300/5000 cps, 12 db/octave.....	\$ 19.50
SX2	200 cps, 12 db/octave.....	\$ 26.00
SX55	500/5000 cps, 12 db/octave.....	\$ 18.50
SX6	600 cps, 12 db/octave.....	\$ 16.90
SX8	800 cps, 12 db/octave.....	\$ 15.50
SX36	3500 cps, 12 db/octave.....	\$ 6.50

See the Forester Speaker System at your hi-fi dealer or write for free descriptive catalog. Construction manual also available at 50¢.

Other Sherwood products include: Low Distortion Amplifiers from \$99.50 and FM-AM Tuners from \$139.50

Sherwood
ELECTRONIC LABORATORIES, INC.

Dept. 9C • 2802 W. Cullom Ave.
Chicago 18, Illinois

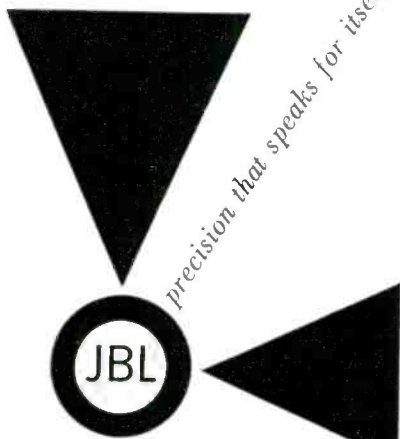

signature speakers

precision loudspeakers

and enclosures

for the world's

finest sound systems

"JBL" means James B. Lansing Sound, Inc.

the ultimate goal
of the
critical listener

marantz

Audio Console
preamplifier, complete \$168*

Power Amplifier
\$198*

*slightly higher
west of
the Mississippi

write for literature

marantz company

44-15 Vernon Blvd., Long Island City 1, N. Y.

WOODCRAFTER

Continued from preceding page

its other uses—cutters for shaping, sanding drums and rotary sander, dovetail cutter, routers, a planing attachment, etc. When you set up a drill press in your workshop, the scope of your operation is limited only by the variety of accessories you acquire. Rules for safe operation of the drill press are much the same as the safety rules for other power tools, but the following precautions should be emphasized:

- 1) Keep cutting tools sharp.
- 2) Make sure the stock is properly clamped whenever necessary.
- 3) Always remove the key immediately after installing a bit or drill in the chuck.
- 4) Keep your fingers away from revolving tools.
- 5) Do not attempt to remove chips with your fingers.
- 6) Do not wear loose clothing or jewelry while operating the machine.

GROUNDING EAR

Continued from page 5

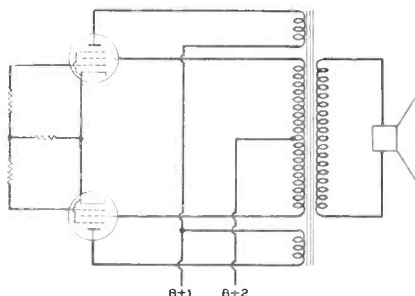

Fig. 2. Screen tertiary winding circuit.

output tubes, as in the Acoustical Quad circuit. Mr. Hafler says that using this winding to provide feedback to the screens of the EL34's results in a considerable improvement over that with a tapped primary. The result is a circuit on the order of Fig. 2. He did not specify the optimum screen and plate voltages, but clearly the independent winding permits their individual adjustment. Presumably, there is one relationship which will provide the most linear operation, and others for the highest output, sensitivity, and the most desirable compromise of all three. The transformers are presently available in the Dyna line. I might point out to experimenters who would like to try this circuit that there are a lot of old transformers lying around which have 10% tertiary windings; anybody who has one or can pick one up for a little odd change might find it instructive to do a little experimenting, not only with EL-34's, but with older tubes including the 6V6's and 6L6's. Hafler says the design of the tertiary winding for op-

imum results is rather critical, but I suspect this is an approach which is well worth looking into even without specially designed transformers. I would be interested in receiving reports on any such experiments.

TAPE NEWS

Continued from page 15

being duplicated at 60 ips will appear as 120,000 cps; it and its harmonics are dangerously close to the 400,000-cps bias that is used on modern duplicating machines. The signal's harmonics on the master would create significant distortion at lower frequencies because of the addition of intermodulation products to the signal.

It is not difficult to imagine what this might do to a complex pattern of musical overtones. The initial effect would be much like serious harmonic distortion in the program, but in playback the loss of highs above about 3,000 cycles that always takes place in the playback head would attenuate the extreme upper harmonics that were produced; instead of being hard, brittle, and ill-defined, the signal would simply be ill-defined.

The obvious way to minimize this beat-frequency generation is to limit duplicating speed or increase the bias



MELLOTONE
HI-FI SARAN
GRILLE FABRICS

... announces this special
"FREE" SAMPLE OFFER!

● Write for MELLOTONE sample advising color requirements.

● When you receive your free sample, take it to your local dealer to buy yardage needed, and see his complete line.

Remember, MELLOTONE FABRICS are HI-FI FABRICS for all color tones.

Offer limited, write today!



WENDELL PLASTIC
FABRICS CORP.
17 West 17th St., New York 11, Dept. G

frequency drastically. In commercial duplicators the 400-Kc bias frequency is not, according to the rule-of-thumb, high enough to permit duplication of 7½-ips masters at 60 ips. Until it can be raised even further, we shall have to continue to expect some deterioration in program quality from rapidly duplicated tapes.

LISTENING

Continued from page 27

ing that you hear both the fundamental and the harmonics.

If you are using a sine-wave generator reasonably free of distortion, the real criterion of quality is this: the less you hear below the cutoff point, the better the system from the point of view of distortion. A good audio generator has practically no harmonics. Therefore, if the amplifiers and speakers were equally free of distortion, you would hear no sound at all below the cutoff point. Most speakers to some extent and poor ones to a marked extent, however, are guilty of frequency doubling at very low frequencies. What you hear below speaker cutoff is the distortion of the speakers. While it may seem that you're getting something for nothing, this can be too much of a good thing; for when generated distortion is added to the signal which already possesses harmonics, the general faithfulness will obviously deteriorate.

It is much more difficult to avoid being fooled with music than with a sine-wave generator. Music has plenty of natural harmonics, so even a loud-speaker entirely free of distortion will pass on the harmonics to the ear, which will then blithely imagine that it is also hearing the fundamental.

There is still another complication. It is very difficult to achieve a genuine response below 50 cps with loudspeakers even if size is no object. Therefore, the response is often extended downward by utilizing the resonances of the speaker and the enclosure, or of both. This makes a musical instrument of the speaker system. When its resonances are excited it will produce a tone whose fundamental is determined by the resonances of the speaker system, rather than by the resonance of the exciting musical instrument. To make matters worse, a resonant system can be excited by a very wide range of exciting frequencies. Thus, an enclosure system resonant at 70 cps may sound when excited by a 40-cps drum, a 100-cps double-bass note, or even a 200-cps snare-drum note, just as the drum will produce its natural fundamental whether it is struck by a stick, stone, bone, or even a ripe tomato. The resulting tone reflects the character of both the exciting instrument and the system resonance. A large part of the fundamental

component will be that of the resonant enclosure, but the dominant harmonics will be those of the musical instrument. Since it is the harmonics and their relationship which produces the characteristic tone of a musical instrument, the mere substitution or reinforcement of the fundamental supplied by the enclosure for that of the instrument will not be too obvious and the over-all sound may have considerable resemblance to the live instrument itself. But the difference is great enough that if a comparison with the original is possible, the illusion is shown up as a rather wry delusion.

Even the most unskilled ear will have no trouble recognizing these effects and noting the difference when a comparison with the sound of the instrument is possible. Such comparisons are usually impossible, and other means must be used to recognize the effects and make the distinctions. Of course, the person who hears a great deal of music and is familiar with its sound is less likely to be fooled; there is no finer exercise of one's listening faculties than frequent attendance at live concerts and performances. Fortunately, however, there are some criteria which, with care, enable



us to recognize the effects and to judge real bass quality, even in the absence of such experience.

There is no difficulty whatever in recognizing the extremely rare systems which have genuine response to 20 cps or lower. They have an immediate authority which speaks for itself and requires no interpretation. Unfortunately, the ads for speaker systems notwithstanding, you are quite likely to spend a lifetime without ever hearing one—even at audio shows or in theaters. If you know of the existence of such a system, it is worth going many miles to hear it, simply to establish a point of reference for your own judgment.

It is obvious that a system which really reproduces the fundamental will have a lower tone than one which reproduces only the harmonics. If it is also free of distortion, the bass tone will be much duller because the proportion of fundamental to harmonics will be higher. A bass drum produces a great many harmonics, and will make a loud noise through almost any system, even one which cuts off the fundamental and the first harmonic (as in most table radios). On a really fine system the drum sound will be much more like

Continued on page 45

Fen-tone HI-FI IMPORTS

The FIRST really
**STATIC-FREE, DUST-FREE,
NOISE-FREE CARTRIDGE**

NOW AVAILABLE IN
TWO SERIES:

1.

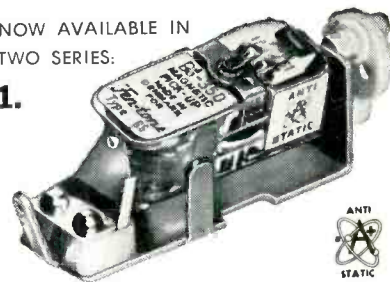

Fen-tone 8 POLE A+ STANDARD

Professional 8 pole magnetic cartridges reversible and single play cartridges for all modern plug-in shell record players and changers; and

2.

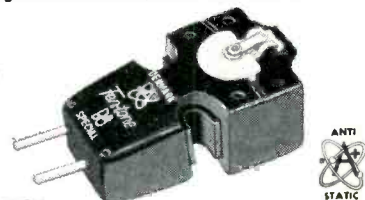

Fen-tone 8 POLE A+ SPECIAL

Professional 8-pole magnetic cartridges Single play only for all professional transcription arms.

Standard and Special series available in two impedances: 350 ohms & 72 ohms to suit high-level (350 ohms = 30mV) or medium level (72 ohms = 10-15mV) magnetic phono inputs.

Leading audio critics comment:

MONITOR — RADIO-ELECTRONICS: "An extremely fine value. . . . Remarkably good on old 78 rpm shellac records . . . with a unique and exclusive feature—a strip of radioactive foil built into the cartridge to neutralize static charge on records."

J. B. BENTON HARBOR, MICH.: "They are absolutely magnificent. I will recommend it to everyone I know as being THE CARTRIDGE!"

ONE DEMONSTRATION WILL CONVINC
YOU TOO!

Audiophile Net Prices:

	Standard	Special
Single (LP or ST) Sapphire	\$ 9.30	\$11.60
Single (LP or ST) Diamond	\$21.30	\$24.20
RS Dual Sapphire	\$ 9.78	None
RG LP Diamond/ST. Sapphire	\$21.78	None



FREE! 1956 *Fen-tone* Catalog. The above are only samples of the many terrific values in the new 1956 Fen-Tone Hi-Fi catalog including mikes, tape decks, cartridges, record changers, silent listening devices, etc.

FENTON COMPANY
15 Moore Street, New York 4, N. Y.

Sold through better
Audio Distributors.
See yours today!

West of Rockies,
prices slightly higher.



AUDIOCRAFT Sound Sales Directory

Following is a list of dealers who state that they carry the products specified.

KEY TO PRODUCTS HANDLED

- 1 Audio system components
- 2 Speakers and enclosures
- 3 Records and record accessories
- 4 Tape recorders
- 5 Pre-recorded tape
- 6 Radio hardware
- 7 Tools, wood
- 8 Audio parts
- 9 Microphones
- 10 Books
- 11 Test equipment

A series of items numbered consecutively is identified by a hyphen between the first and last numbers. Thus, 1-6 indicates 1 through 6; 8-11 indicates 8, 9, 10, and 11.

CALIFORNIA

Beverly Hills

Minthorne Music of Beverly Hills
230 N. Beverly Dr.
BR. 2-7676; CR. 6-4793 1-5, 9

Culver City

Bar-Shel's Hi-Fi Supply
5512 S. Sepulveda Blvd.
EX. 8-6747 1, 2, 4-6, 8-11

Hollywood

Holly Wood Electronics
7460 Melrose Ave.
Webster 3-8208 1, 2, 4, 5

Los Angeles

Crenshaw Hi-Fi Center
107 Santa Barbara Plaza
Axminster 3-8201 1-5, 9

Menlo Park

Science in Sound
777 Santa Cruz Ave.
DA. 2-1611 1-11

Santa Barbara

Pacific Audio Supply
2919 De La Vina St.
Woodland 5-6422 1-5, 9

CONNECTICUT

West Hartford

Audio Workshop, Inc.
1 South Main St.
Adams 3-5041 1-5, 9, 10

DELAWARE

Newark

Delaware Music House
20 Academy St.
Endicott 8-3258 1-5, 8, 9

FLORIDA

Miami

High Fidelity Assoc.
3888 Biscayne Blvd.
82-8401 1-5, 8-10

GEORGIA

Atlanta

Baker Fidelity Corp.
1140 Peachtree St., N. E.
TRinity 5-2156 1-6, 8, 9
High Fidelity Sight & Sound Sys.
606 Peachtree St., N. E.
Vernon 6534 1-10

ILLINOIS

Champaign

The New Sound
35 E. Springfield Ave.
6-9119 1-5, 8-11

Chicago

Allied Radio Corp.
100 N. Western Ave.
HAYmarket 1-6809 1-11

ILLINOIS — Chicago (continued)

Evergreen Allied High Fidelity, Inc.
2025 W. 95th St.
Beverly 8-1067 1-11
Musicraft
48 East Oak St. 1-11
Voice and Vision, Inc.
Rush and Walton Place
Whitehall 3-1166 1-6, 8-10

Evanston

Allied High Fidelity Stores, Inc.
602 Davis St.
DAvis 8-8822 1-11

Oak Park

West Suburban Allied High Fidelity, Inc.
7055 W. North Ave.
ESTebrook 9-4281 1-11

LOUISIANA

New Orleans

The Music Shop, Inc.
4215 South Claiborne Ave.
TW. 1-5871 1-5

MASSACHUSETTS

Boston

The Listening Post, Inc.
161 Newbury St.
COpley 7-7530 1, 2, 4, 5, 8-10

MICHIGAN

Detroit

Hi-Fi Studios
8300 Fenkell
Diamond 1-0894 1-6, 8-10

MISSISSIPPI

Pass Christian

The Music Box
121 Davis Ave.
185 or 301W 1-5, 8, 9

MISSOURI

Kansas City

David Beatty Hi Fi Sound & TV
1616 West 43rd (Westport Rd.)
Jefferson 1-3110 1-10

St. Louis

The High Fidelity Showroom
6383 Clayton Rd.
Parkview 1-6500 1-5, 9

NEW YORK

Albany

Hi-Fidelity Center, Inc.
324 Central Ave.
3-1167 1-5, 8-10

Amsterdam

Adirondack Radio Supply
185-191 West Main St.
VI. 2-8350 1, 2, 4, 8

Buffalo

Frontier Electronics, Inc.
1507 Main St.
GA. 5727 1-5, 8-10

New York City

Arrow Audio Center
65 Cortlandt St.
DIgby 9-4730 1, 2, 4-6, 8-11
Grand Central Radio, Inc.
124 East 44th St. at Lexington Ave.
MUrray Hill 2-3869-70 1-6, 8-11

Yonkers

Westlab Electronics, Inc.
2475 Central Ave.
SP. 9-6400 1-6, 8-10

OHIO

Dayton

Custom Electronics, Inc.
1000 S. Main St.
AD. 3158 1-11

PENNSYLVANIA

Allentown

Baker Communications
9 South 12th St.
Hemloch 3-3326 1-11

Bethlehem

Audio Laboratories, Inc.
808 Mohican St.
UNiversity 7-3909 1-5, 9

Philadelphia

Almo Radio Co.
509 Arch St.
WAlnut 2-5153 1-4, 6-11

Danby Radio Corp.
19 South 21st St.
Rittenhouse 6-5686 1-5, 8-10

Radio Electric Ser. Co. of Pa., Inc.
7th & Arch Sts.
LO. 3-5840 1-11

Ten Cate Associates
6128 Morton St.
Germantown 8-5448 1-5, 8-10

SOUTH CAROLINA

Columbia

Hi-Fi Sound & Records Co.
621-23 Harden St.
6-3538 1-6, 8-10

TENNESSEE

Kingsport

Radio Electric Supply Co.
245 East Market St.
CI. 5-1471; 5-2651 1, 2, 4, 6, 8-11

TEXAS

San Antonio

Bill Case — Records & Sound
4206 Broadway
TAYlor 2-1341 1-5, 8-11

VERMONT

Rutland

Fleetwood Sound Studio
285 S. Main St. (Rt. 7)
Prospect 3-2312 1-5, 8, 9

VIRGINIA

Arlington

Audio Services
3131 N. 10th St.
JACKson 7-2552 1, 2, 4, 5, 8, 9

WASHINGTON

Seattle

High Fidelity Headquarters
603 Broadway North
CApitol 2266 1-4, 8, 10

WEST VIRGINIA

Huntington

Singer Electronics
1555 Third Ave.
3-7439 1-5, 8-9

WISCONSIN

Milwaukee

The Hi-Fi Center, Inc.
4236 W. Capitol Drive
Uptown 1-2113 1-5, 9, 10

CANADA

Montreal

Payette Radio Limited
730 St. James West
UNiversity 6-6681 1-11

Toronto

Electro-Voice Sound Systems
141 Dundas St., W.
EM. 8-7750-8301-8302 1-11

LISTENING

Continued from page 43

that produced when a rug is beaten — there will be a deep, dull, tight quality to it. The sound will produce a very noticeable sensation of compression over the entire body, not just in the ears.

With a well-reproduced bass viol you have not only the same lower, duller tone, but you have a more vibrant one. It is best described in an expression used by a friend: "More like you could count the cycles per second." All the bass viols, the tuba, the bass sax, and contrabassoon will growl more. Beware of a mellow bass. None of the bass instruments is mellow in its low register. They all have a certain roughness which can be as ominous as the growl of a very large dog.

The ideal system should be perfectly nonresonant; always merely a reproducer, never a generator. These qualities are evidenced in several ways at the bass end. A peaked system will produce a louder sound in some narrow-band frequencies and will, therefore, favor certain types of drums or other bass instruments. A resonant system will tend to have a "one-note" deep bass which remains stationary and of constant pitch. Good recordings of bass marimbas are especially revealing of resonance. Because they are poorly damped, the fundamental tones of the marimba tend to fade into each other. On a poor system the result is a strange, vague, stationary booming overlaid by the melody which is communicated principally by the harmonics. On a fine system you will hear not only the fundamental tones, but also the way they slide into each other, producing vibratos and beat notes as they decay. Resonant enclosures will betray a favoring of one narrow band of tones, a tendency to surround each tone with a ghost or a shadow. If resonance is really bad, the instrument will sound like two instruments — a one- or two-note bass marimba and a full-scale baritone or tenor marimba playing the melody.

Tympani or kettle drums are more heavily damped, higher in pitch, and do not provide quite so good a basis for judgment. In many test records they are cleverly played in their high register so they will sound good on almost any system. The best tympani to listen to are those in such music as the *William Tell* overture, Beethoven's *Sixth*, Holst's *The Planets*, and Mussorgsky's *Pictures at an Exhibition*. Here they are played in their lowest and more awesome register to imitate thunder, gunfire, etc. They should not sound like an imitation of thunder produced by waving a piece of sheet metal, but like the thunder itself. Any tendency to favor one of a pair or trio of tympani, or one note over an-

other, may indicate a peak in response; any difficulty in distinguishing the differences in tone indicates very bad resonance.

There aren't many records which offer a clear test of double-bass response. The double basses in orchestras usually play in unison, which has the effect of blending them into a louder but smoother and rather indefinite sound. Moreover, they are usually noodling in the background behind the melody. Sibelius' *Second Symphony*, however, has some fine scoring for the double basses, and a really good recording of it can give a spectacular bass sound and a severe test of system response. Saint-Saëns' *Carnival of the Animals*, in the movement called "Elephants", is written for a solo double bass; a good recording of it is also a fine test of bass quality. Again, listen for the growl, the plainly defined melody, and the roughness indicative of the presence of a genuine fundamental and the absence of any confusing system resonances.

If you play or listen to a concert grand piano, you are no doubt aware that its lowest octave is fully as awesome as bass from the organ or anything else. You will especially have noted the variety of beat notes formed when this lowest octave is hit hard. There are a few modern recordings which do the piano bass real justice and deliver the full piano sound, beat notes and all.

So in a fine system, nonresonant and flat, the bass will be duller, more vibrant and rougher, have more growl, will move up and down the scale and, in general, will be more awe-inspiring. But there is more to good bass quality than this. If the system is free of resonance, has no tendency to become a generator, and is free of hangover, the definition of the bass will be excellent. Hangover, which is an echolike effect, is particularly likely to limit bass definition. But assuming good definition, the various bass instruments, as well as their individual tones, will stand out more clearly and distinctly; the differences in the tonal qualities of the various bass instruments will be clearly evident. It will be possible to distinguish between a double-bass choir and an organ pedal, between the bass viol and a piano or harp, whether they play together or in counterpoint. Unfortunately, only a few recordings possess good enough inherent bass definition to offer a conclusive test of this. Good bass definition is possibly the most difficult quality of all to achieve, especially when there are several transducers in the chain.

Very few hi-fi systems, even those employing horns of large size, possess much fundamental response below 40 cps. And there is little music in the octave below 40 cps. Some organs go

Continued on page 47

Completely New! DYNAKIT MARK II



An amplifier kit which provides the finest sound at low cost. The listening quality of the Dynakit is unequalled by any amplifier, regardless of price; and this kit can be readily assembled in about three hours.

The Dynakit uses a new bug-free circuit, designed by David Hafler. Complete reproducibility of operating characteristics is guaranteed by the use of a factory-wired printed circuit board. The Dynakit comes complete with all components including the super-fidelity Dynaco A-430 transformer.

Specifications:

Power Output: 50 watts continuous rating, 100 watts peak. Distortion: under 1% at 50 watts, less than 1% harmonic distortion at any frequency 20 cps to 20 kc within 1 db of maximum. Response: Plus or minus .5 db 6 cps to 60 kc. Plus or minus .1 db 20 cps to 20 kc. Square Wave Response: Essentially undistorted 20 cps to 20 kc. Sensitivity: 5 volts in for 50 watts out. Damping Factor: 15. Output Impedances: 8 and 16 ohms. Tubes: 6CA7/EL-34 (2) (655J's C.U. as an be - sed) 6AN8, 5U4G3. Size: 9" x 9" 6 3/4" high.

69.75
net

Dynaco Output Transformers



Featuring para-coupled windings, a new design principle (patents pending). These transformers use advanced pulse techniques to insure superior square wave performance and undistorted reproduction of transients. Dynaco transformers handle full rated power over the entire audio spectrum from 20 cps to 20 kc, without sharp rise in distortion at the ends of the band which characterizes most transformers. Conservatively rated and guaranteed to handle double nominal power from 30 cps to 15 kc without loss of performance capabilities.

Specifications:

Response: Plus or minus 1 db 6 cps to 60 kc. Power Curve: Within 1 db 20 cps to 20 kc. Square Wave Response: No ringing or distortion from 20 cps to 20 kc. Permissible Feedback: 30 db.

MODELS

A-410	10 watts	34	14.95
A-420	25 watts	KT-66, 5881, EL-34	19.95
A-430	50 watts	6550, EL-34 (6CA7)	29.95
A-440	100 watts	6550	39.95
A-450	100 watts	PP par, 6550, EL-34	39.95

(all with tapped primaries except A-440 which has tertiary for screen or cathode feedback)

Additional data on Dynakit and Dynaco components available on request including circuit data for modernization Williamson-type amplifiers to 50 watts of output and other applications f Dynaco transformers.

DYNA COMPANY

Dept. AC, 5142 Master St., Phila.

Now! New RCA Victor acetate tape with full High Fidelity response!



Now you can get the full High Fidelity response you hear on professional recordings at no extra cost! Costs only \$3.50 per 7-inch reel. Also available: new RCA Victor acetate tape with full frequency performance — at a special introductory low price! For extra-long performance: new RCA Victor superstrength, extra-long play "Mylar"™ tape. Superstrong, plays 50% longer — costs \$7.50 per 7-inch reel.

*"Mylar" is a registered Dupont trademark for its polyester film. Nationally advertised list prices shown, subject to change.

RCA VICTOR
RADIO CORPORATION OF AMERICA
CAMDEN 8, NEW JERSEY

High Fidelity Magic... from **EICO**

KIT \$49.95
Factory Wired \$79.95

NEW! 20-WATT HIGH FIDELITY AMPLIFIER #HF20

Due to its Ultra-Linear output stage with its conservatively-rated Ultra-Linear output transformer, the #20 features negligible distortion & increased power-handling capacity at both extremes of the audio spectrum. Costliest, complete equalization facilities—plus low-distortion, wide-range tone controls & Centralab Compentrol loudness control—create a preamplifier and control section unsurpassed even in units ticketed at much higher prices.

- Power Response (20W): ± 0.5 db 20-20,000 cps; ± 1.5 db 10-40,000 cps.
- Frequency Response (¼W): ± 0.5 db 13-35,000 cps; ± 1.5 db 7-50,000 cps.
- Rated Power Output: 20 w (34 w peak).
- IM Distortion: (60 cps; 6 kc/4:1) at rated power: 1.3%.
- Mid-Band Harmonic Distortion at rated power: 0.3%.
- Maximum Harmonic Distortion (between 20 & 20,000 cps at 1 db under rated power): approx 1%.
- Speaker Connection Taps: 4, 8 & 16 ohms.
- High quality preamp-equalizer & control section plus complete 20-watt Ultra-Linear Williamson-type power amplifier. Output transformer in compound-filled seamless steel case.

See and HEAR it at your neighborhood distributor. Write for FREE Catalog A-9
EICO 84 Withers St., Brooklyn 11, N. Y.
Prices 5% higher on West coast © 56

Abbreviations

Following is a list of terms commonly used in this magazine, and their abbreviations. The list is arranged in alphabetical order.

alternating current	AC
ampere, amperes	amp, amps
amplitude modulation	AM
audio frequency	AF
automatic frequency control	AFC
automatic gain control	AGC
automatic volume control	AVC
capacitance	C
cathode ray tube	CRT
characteristic impedance	Z ₀
current	I
cycles per second	cps
decibel	db
decibels referred to 1 milliwatt	dbm
decibels referred to 1 volt	dbv
decibels referred to 1 watt	dbw
direct current	DC
foot, feet	ft.
frequency	f
frequency modulation	FM
henry	h
high frequency	HF
impedance	Z
inch, inches	in.
inches per second	ips
inductance	L
inductance-capacitance	LC
intermediate frequency	IF
intermodulation	IM
kilocycles (thousands of cycles) per second	Kc
kilohms (thousands of ohms)	K
kilovolts (thousands of volts)	KV
kilowatts (thousands of watts)	KW
low frequency	LF
medium frequency	MF
megacycles (millions of cycles) per second	Mc
megohms (millions of ohms)	MΩ
microampere (millionth of an ampere)	μa
microfarad (millionth of a farad)	μfd
microhenry (millionth of a henry)	μh
micromicrofarad	μμfd
microvolt (millionth of a volt)	μv
microwatt (millionth of a watt)	μw
milliampere (thousandth of an ampere)	ma
millihenry (thousandth of a henry)	mh
millivolt (thousandth of a volt)	mv
milliwatt (thousandth of a watt)	mw
ohm	Ω
permanent magnet potentiometer	PM
potentiometer	pot
radio frequency	RF
resistance	R
resistance-capacitance	RC
resistance-inductance	RL
revolutions per minute	rpm
root-mean-square; effective value	RMS
synchronous, synchronizing	sync
television	TV
ultra high frequency (radio)	UHF

PROFESSIONAL DIRECTORY

SEND NO MONEY
Write for free sample **FREE** free samples

2 PLASTIC RECORD COVERS

Keep your valuable records free from dust, scratches, finger marks, spilled liquids, etc.
Made of Polyethylene Plastic.

- ★ Ends scratch
- ★ Resists water, oil, etc.
- ★ Seals out dust
- ★ No more fingermarks
- ★ Tear Resistant
- ★ Protects against heat

Dealer Inquiries Invited
BRADLEY MFG. INC.
11 W. Magnolia Blvd. Burbank, Calif.

FM/Q antenna systems

High gain broadband FM Antennae for max. tuner sensitivity to 72 or 300 ohm inputs. Provides optimum signal level for best recording of high fidelity broadcasts.

APPARATUS DEVELOPMENT CO.
FM/Q Dept. Wethersfield 9, Conn.

GIBSON GIRL TAPE SPLICERS

splices in a wink!
NO SCISSORS!
NO RAZOR BLADES!
Diagonal cuts tape ends and trims splice edges.
At Your Dealers

ROBINS INDUSTRIES CORP. Bayside 61, N. Y.

AUTOMATIC CHANGER NEEDLE BRUSH

KLeeNeeDLE

KLeeNeeDLE automatically keeps record changer needles clean. It is designed to remove the familiar "dust-blob" from under the needle point. At Your Dealer

ROBINS INDUSTRIES CORP. Bayside 61, N. Y.

ATOMIC JEWEL RADIOACTIVE STATIC ELIMINATOR

- Reduces Record Wear
- Reduces Needle Wear
- Improves Fidelity

At Your Dealer
ROBINS INDUSTRIES CORP. Bayside 61, N. Y.

vacuum-tube voltmeter (multipurpose)	VTVM
vacuum-tube voltmeter for AC measurements only	AC VTVM
variable reluctance	VR
very high frequency (radio) volt.	VHF
volt	v
volt-ampere	va
voltage, or potential difference	E
volts, center-tapped	vct
watt	w

AUDIO AIDS
We'll pay \$5.00 or more for usable Audio Aids. See page 30 for details.

LISTENING

Continued from page 45

down to 16 cps and the lowest notes on grand pianos fall just below 30 cps. The double bass stays above 40 cps and so do most drums, though very large bass drums occasionally are resonant below 40 cps. This point, therefore, offers a good cut-off point for compromise systems. Speaker systems capable of covering that final octave below 40 cps well and with good definition cost a lot of money, but a response to about 40 cps can be obtained quite reasonably. On the surface it might seem that such a compromise would not produce a very great loss, but the fact is that the difference can be very marked indeed. Although there is little music in that final octave, good music possesses many sounds in that region. There are beat notes, reverberations, and many noises incidental to producing music on various instruments. These sounds are not necessary to appreciate the music, but they are very helpful in producing realism and the illusion of presence.

As for music, records containing musical material below 40 cps are very scarce. Some recent organ records have managed to capture even 16-cps pedal tones with excellent fidelity. It is not easy, however, to determine whether one is hearing the fundamental or the harmonic of 16- or 32-cps organ tones. The lowest tones of the organ are not so much heard as felt. If this is to be approximated in the home, it is necessary to have a speaker system capable of reproducing the fundamental, and also to play the records at a level high enough to develop the power to vibrate the environment. Still, a sensible vibration of the floor is pretty good evidence that the fundamental is being reproduced, and the absence of such vibration is equally good evidence that however loud the reproduction, it is largely harmonic.

READERS' FORUM

Continued from page 17

the article, will explain the figures you question.

2) These curves are based on the formula $db \text{ loss} = 10 \log_{10} (1+x^2)$, where x is the frequency normalized to the point where reactance is equal to resistance. The only place I know of where this is treated more fully is in an article I wrote in *Electronic Engineering*, November 1951. Other publications have given the curves, but they do not usually give a basis. Similar data (the mathematics) are given in my article "A New Approach to Negative Feedback Design" in *Audio Engineering*, May 1953.

3) In a later article in this series.

I will be going into more detail about the distortion produced by tubes in different operating conditions, including triode, pentode, ultra-linear, and some of the more "fancy" circuits. I think you will find this adequate when it appears.

4) This might need more explaining: the 8,000 figure has no connection with the load value; the peak watts will be given by multiplying half the peak-to-



peak volts by half the peak-to-peak amps; the maximum watts (average over a cycle) will then be half the peak watts. The maximum watts will therefore be given by dividing the peak-to-peak volts, multiplied by the peak-to-peak amps, by 8. As the plate current variations are given in milliamps, the product of peak-

to-peak volts and peak-to-peak milliamps is divided by 8,000 to get maximum watts (average over a cycle). Dividing by the figure you suggest (4,000) would give the peak watts, attained only for an instant at the very top of each wave.

5) I do not quite see what you want here, so I will go over it a little and hope I cover your difficulty. The curves shown are not theoretical, but representative of pentode characteristics in general. For one particular load value, the closing-up effect toward both ends will be symmetrical, represented approximately by the middle line of Fig. 10 on page 43 of the March issue. Movement of the load line, either by changing load value, which will rock it about the center point, or by changing supply voltage or bias, will cause the non-linearity to be asymmetrical as at the upper and lower lines of Fig. 10 in the March issue. The plot in Fig. 10 on page 41 of the April issue represents the resultant distortion as the load line is tilted about its center point. Too low a value will cause the closing up at the bottom end to be greater than at the top end. Too high a value will cause greater closing up at the top end, by the knee. Movement either way introduces second-harmonic distortion, which is practically absent at the one

Continued on next page

COLBERT LABORATORY, INC.

NEW YORK HIGH FIDELITY SHOW

September 26-30 . . . Room 505

subject:

A Significant Departure in the Direction of Highest Fidelity

featuring:

The COLBERT ELECTRONIC 3-CHANNEL FREQUENCY DIVIDER

specification summary:

- Complete Range Controls for three frequency bands
- Eliminates impedance mismatching
- Complete electronic compensation for unequal speaker efficiencies
- Affords optimum damping of individual loudspeakers
- Provision for use on two or three-way loudspeaker systems
- Includes Williamson-type amplifier for use on middle or high range
- For use with regular or electrostatic loudspeakers, or combinations
- Three-channel operation results in lowest over-all distortion

MODEL 3-CFD \$15450

Decorator style case in blonde or mahogany formica finish... \$15
Slightly higher in west and deep south

For full specifications see your dealer or write to Dept. AC96

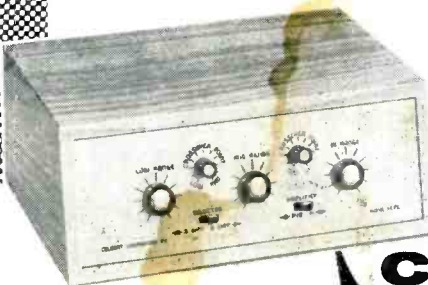

colbert

LABORATORY, INC.

159-19 Hillside Avenue • Jamaica 32, New York

Audio Exchange

is privileged to be the first to introduce the new

COLBERT ELECTRONIC FREQUENCY DIVIDER MODEL 3-CFD

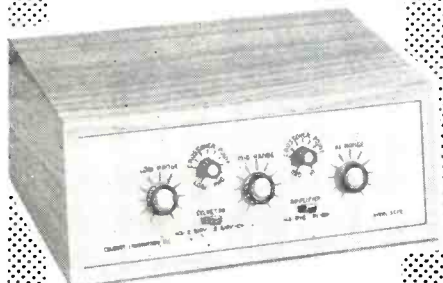

colbert

LABORATORY, INC

- Complete Range Controls for three frequency bands
- Eliminates impedance mismatching
- Complete electronic compensation for unequal speaker efficiencies
- Affords optimum damping of individual loudspeakers
- Provision for use on two or three-way loudspeaker systems
- Includes Williamson-type amplifier for use on middle or high range
- For use with regular or electrostatic loudspeakers, or combinations
- Three-channel operation results in lowest over-all distortion

MODEL 3-CFD \$154.50

Decorator style case in blonde or mahogany formica finish... \$15

Slightly higher in west and deep south

Write Dept. AC96 for trading information and catalog

audio exchange

THE TRADING ORGANIZATION OF THE HI-FI FIELD

159-19 Hillside Ave. | 367 Mamaroneck Ave.
Jamaica 32, N. Y. | White Plains, N. Y.
AXtel 7-7577 | White Plains 8-3380
near subway | next to Pix theatre

METER PARKING



AT BOTH STORES

audio exchange exchanges audio

READERS' FORUM

Continued from preceding page

critical value. The curves in Fig. 10 of the April issue represent the variation of second harmonic, which passes through a null and increases with both higher or lower loads; the variation of third, which increases with higher load value; and the combined distortion, obtained by taking the root-mean-square of the two components. Curves like this are usually taken under a condition of constant-drive voltage (AC) on the grid. The curves do not show the variation in power output with change of load, which is another thing.

I hope the above answers your questions satisfactorily. I am glad you appreciate the difficulty in formulating this kind of presentation. Most readers (we think — this is what we want to know) prefer to have a maximum of useful data, and do not want to bother with proofs.

Norman H. Crowhurst



TRADERS' MARKETPLACE

Here's the place to buy, swap, or sell audio equipment. Rates are only 20¢ a word (including address) and your advertisement will reach 20,000 to 35,000 readers. Remittance must accompany copy and insertion instructions.

PRE-RECORDED TAPES, Low price recording tape accessories, catalog. Efsco Sales, 270-5 Concorrd Avenue West Hempstead, N. Y.

WANT A VERY LOW RESONANCE SPEAKER? Ask your dealer to demonstrate the Racon floating cone, foam suspension. Or write for literature and prices to Racon Electric Co., 1261 Broadway, New York 1, N. Y.

PROFESSIONAL RECORDING SERVICE: Tapes made copied, masters cut, processed, pressings made — short runs our specialty — all AMPEX 300's, Telefunken and Altec, HYDROFEED Lathes, monofusion presses. Components Corporation, 106 Main St., Denville, N. J. Phone: Rockaway 9-0290.

TRADE high fidelity speakers, changers, output transformers etc., for 35mm photo equipment. Box CE, The Publishing House, Gt. Barrington, Mass.

ADVERTISING INDEX

Allied Radio Corp	5
Apparatus Development Corp.	46
Audio Exchange	48
Audiophile's Bookshelf	16
Bell Sound Systems, Inc.	11
Bradley Mfg.	46
British Industries Corp.	
Inside Front Cover	
Centralab	12
Colbert Associates	47
Concert Hall Society	39
Dauntless International	1
Dyna Co.	45
Eico	46
Electro-Voice, Inc.	Back Cover
Fenton Co.	43
Heath Co.	8-9
Jensen Mfg. Co.	2
Lansing, James B., Sound, Inc.	42
Marantz Co.	42
Music Box	Inside Back Cover
Musicraft	15
Professional Directory	46
RCA Victor	46
Robins Industries Corp.	46
Sherwood Electronic Laboratories, Inc.	41
Sound Sales Directory	44
Traders' Marketplace	48
University Loudspeakers, Inc.	13
Wendell Plastic Fabrics Corp.	42

A SPECIAL SERVICE FOR AUDIOCRAFT READERS

To secure prompt information about products advertised in this issue, just fill in the coupons at the right and drop in your nearest mail box.

PLEASE BE SURE TO:

1. Send *complete* postcard even if all four coupons are not used.
2. Fill out each coupon *completely* and clearly.

The coupons are cut apart mechanically and forwarded to the advertisers you list. Your name and full address must appear on each coupon or the advertiser will not know to whom to send information.

Please use ink or typewriter if at all possible.

USE THIS SERVICE — EVERYTHING, EVEN THE POSTAGE, IS FREE. A SPECIAL SERVICE TO AUDIOCRAFT READERS.

FOR ADVERTISEMENTS
IN THIS ISSUE ONLY

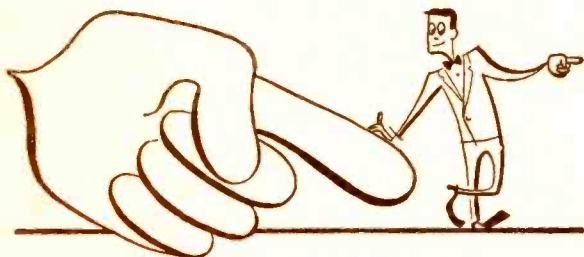

USE THIS
SERVICE



BUSINESS REPLY CARD

FIRST CLASS PERMIT NO. 62, SEC. 34.9, P. L. & R., GREAT BARRINGTON, MASS.

audiocraft

POST OFFICE BOX 600

GREAT BARRINGTON, MASS.

PLEASE SEND INFORMATION ABOUT:

Product

Advertiser Page.....

TO:

J AUDIOCRAFT

PLEASE SEND INFORMATION ABOUT:

Product

Advertiser Page.....

TO:

J AUDIOCRAFT

PLEASE SEND INFORMATION ABOUT:

Product

Advertiser Page.....

TO:

J AUDIOCRAFT

PLEASE SEND INFORMATION ABOUT:

Product

Advertiser Page.....

TO:

J AUDIOCRAFT

PLEASE SEND INFORMATION ABOUT:

Product

Advertiser Page.....

TO:

J AUDIOCRAFT

PLEASE SEND INFORMATION ABOUT:

Product

Advertiser Page.....

TO:

J AUDIOCRAFT

PLEASE SEND INFORMATION ABOUT:

Product

Advertiser Page.....

TO:

J AUDIOCRAFT

PLEASE SEND INFORMATION ABOUT:

Product

Advertiser Page.....

TO:

J AUDIOCRAFT



SUBSCRIPTION SERVICE PAGE

audiocraft

Great Barrington, Mass.

Please enter my subscription, starting with the next issue, at the **SPECIAL RATE of 3 years for only \$9.00.**

FOREIGN POSTAGE: \$1.00 per year outside the U. S. A., its possessions, and Canada.

- My remittance is enclosed.
- I prefer two years for \$7.00.
- Please send me your bill.
- I prefer one year for \$4.00.

9-6

NAME _____

ADDRESS _____

CITY _____ ZONE _____ STATE _____

- Group subscriptions attached.
- Send me the following back issues:
1 3 6 8
payment for which is enclosed.
- Gift subscriptions attached.

On this page you will find complete subscription information about **AUDIOCRAFT**. The full subscription story is here—in one place—for your convenience.

REGULAR SUBSCRIPTION RATES

Three years—Nine Dollars. *Save \$3.60 over the single copy cost.*
Two years—Seven Dollars.
One year—Four Dollars.
(Add \$1.00 per year for postage on all subscriptions sent to addresses outside of the United States, its possessions, and Canada.)

BARGAIN GROUP SUBSCRIPTION RATES

(One-Year Subscriptions Only)

Here's a real saving! Just get together a group of subscriptions and submit them all at one time.
First Subscription—\$4.00.
Each additional subscription—\$3.00.
Send the list to our Circulation Department (and mark it **SPECIAL GROUP SUBSCRIPTION RATE**) with a check or money order in the appropriate amount.

GIFT SUBSCRIPTIONS

You will find that a subscription to **AUDIOCRAFT** makes the perfect gift for any occasion. If you submit more than one subscription (at the same time), the special group rates shown above will apply. We will acknowledge your gift, to the person receiving it, with a special gift announcement card signed with your name, if you request us to do so.

BACK COPIES

At present we have on hand a supply of the November 1955 (No. 1), January (No. 3), April (No. 6), and June (No. 8) 1956 issues of **AUDIOCRAFT**. Copies are available at 35¢ each. To order yours, use the card at upper left, checking the appropriate box at the bottom of the card and circling the number of the issue or issues you want. Please be sure to enclose payment with your order as we cannot bill for single copies.

IMPORTANT

We cannot be responsible for currency sent through the mail. When remitting, please be sure to send only check or money order.

Postage
Will be Paid
by
Addressee

No Postage
Stamp Necessary
if Mailed in the
United States

BUSINESS REPLY CARD

FIRST CLASS PERMIT NO. 62, SEC. 34.9, P. L. & R., GREAT BARRINGTON, MASS.

audiocraft

POST OFFICE BOX 600

GREAT BARRINGTON, MASS.



9-6

Postage
Will be Paid
by
Addressee

No Postage
Stamp Necessary
if Mailed in the
United States

BUSINESS REPLY CARD

FIRST CLASS PERMIT NO. 62, SEC. 34.9, P. L. & R., GREAT BARRINGTON, MASS.

audiocraft

POST OFFICE BOX 600

GREAT BARRINGTON, MASS.



More and more discriminating people are discovering this

COMPLETE RECORD MAIL ORDER SERVICE

Quick, intelligent service. We can supply you
with anything currently available on disc.

Complete catalog of the famous WESTMINSTER W-LAB SERIES. SINGLE	12 inch records	\$ 7.50
Westminster Test record TRC . . . Check and Double Check.	12 inch	\$10.00
Victor LM 1802. "An Adventure in High Fidelity"	12 inch	\$ 4.98
Victor LM 1922. The Sounds and Music of the RCA Electronic Synthesizer.	12 inch	\$ 3.98
Capitol SAL 9020. A Study in High Fidelity.	12 inch	\$ 6.95
Capitol SAL 9027. Further Studies in High Fidelity.	12 inch	\$ 6.95
Vox DL 130. This is High Fidelity.	12 inch	\$ 6.95
Vox DL 180. Spotlight on Percussion.	12 inch	\$ 6.95
Full line of Cook Laboratories remarkable records, including Voices of the sea . . . Earthquake . . . Steel band . . . Mariachi.		
	10 inch	\$ 3.98
Audio Fidelity AFLP 1081. The Brave Bulls. Music of the bullfight ring	12 inch	\$ 4.98
AFLP 1803. Drum Rhythms of Cuba, Haiti and Brazil.	12 inch	\$ 5.95
AFLP 901. Merry-go-round music.	12 inch	\$ 5.95
AFLP 902. Drums of the Caribbean.	10 inch	\$ 4.00
AFLP 904. Circus and Calliope Music.	10 inch	\$ 4.00
AFLP 906. Bawdy Songs and Backroom Ballads.	10 inch	\$ 4.00
Superb realisation of the full sound of the cathedral organ of Grace Cathedral, San Francisco, played by Richard Purvis. Hi-Fi Records R 703 and R 704.	two 12 inch	\$ 4.95 ea.
The sound of the mighty Wurlitzer organ, played by George Wright, realistically captured on Hi-Fi Records R 701, R 702	two 12 inch	\$ 4.95 ea.
Richard Dyer-Bennet 1. At last, a brand new high fidelity recording by this famous folk singer, of English and American folk songs. A true presentation of his superb artistry.	12 inch	\$ 4.95
Sounds of nature . . . Birdsongs . . . Frogs etc. on Ficker and Cornell University Records. Ficker 12 inch \$7.95 Cornell 12 inch \$7.75	10 inch	\$ 5.00
THE SPOKEN WORD. Caedmon's unique catalog of plays, poetry, prose, stories . . . High fidelity recordings of great literature by Poe, Whitman, Chaucer, Faulkner, Millay, Dylan Thomas, O'Casey, Tennessee Williams, Ogden Nash, Colette Macleish, Auden, Sitwell. Some read by the authors, others by famous actors.	All 12 inch	\$ 5.95
McIntosh MM 105. Breaking the Sound Barrier.	12 inch	\$ 4.98
Music Minus One. Fine recordings of great chamber music, with missing instrumental parts, permitting you to play your own instrument with the recorded ensemble. Wonderful for the amateur and professional chamber music player. Catalog on request. All 12 inch LP records, complete with score.		

- ★ Every order over \$6.00 is mailed POSTAGE FREE anywhere in the U. S. A. On orders of less than \$6.00, please add 40¢ to cover mailing charges.
- ★ Our service is fast, prompt and courteous. All records are sold at the manufacturer's suggested list price only.
- ★ THE MUSIC BOX is devoted to mail orders exclusively. The general public does not have any access to our stock, which is handled only by two people.
- ★ When ordering, simply list the records needed, plus your check or money order to cover their cost. To avoid delay, list substitutions, since we will never make substitutions without your written permission. Sorry . . . no C.O.D.'s.

The Music Box

BOX 637, GREAT BARRINGTON, MASS.

our next step to

Perfection

IN HIGH FIDELITY



CIRCLOTRON AMPLIFIERS

and MUSIC CONTROL CENTERS

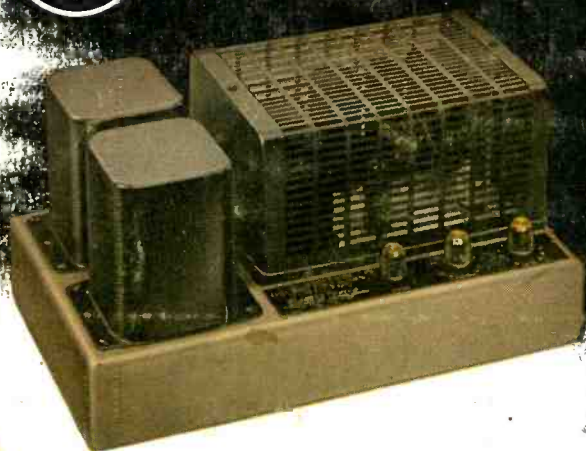

Model A20CL Music Control Center and 20-watt Power Amplifier. Features unique, exclusive "Presence" control. Response 20-20,000 cps. ± 1.0 db at rated 20 watts, 40 watts peak. Controls include Playing Selector, Loudness, Bass, Treble, Volume and Power, Phono-Selector. Power Amplifier utilizes Circlotron Circuit and Variable Damping Control. Low-boy style. **Net, \$124.50**

Model A15CL Music Control Center and 15-watt Power Amplifier. Similar to Model A20CL above except Power Output 15 watts rated, 30 watts peak. Controls include Power, Bass, Treble, Volume, Playing Selector and Phono-Selector. **Net, \$99.50**

Model PC1 Music Control Center. Serves as control for line amplifiers. Has self-contained, shielded, low-noise power supply. Features exclusive E-V "Presence" control. Other controls include Playing Selector, Loudness, Bass, Treble, Volume, Power and Phono-Selector. **Net, \$99.50**

Model PC2 Music Control Center. Serves as control for line amplifiers. Controls include Playing Selector, Bass, Treble, Phono-Selector, Volume and Power. Self-contained, shielded, low-noise power supply. **Net, \$67.00**

Model A15 Circlotron Amplifier. Power output: 15 watts rated, 30 watts on peak. Response: $\pm .5$ db 20-50,000 cps. **Net, \$69.50**

Model A20 Circlotron Amplifier. Power Output: 20 watts rated, 40 watts on peak. Response: $\pm .5$ db 20-60,000 cps. **Net, \$85.00**

Model A30 Circlotron Amplifier. Power Output: 30 watts rated, 60 watts on peak. Response: $\pm .5$ db 20-75,000 cps. **Net, \$108.00**

Model A50 Circlotron Amplifier. Power Output: 50 watts rated, 100 watts on peak. Response: $\pm .5$ db 20-75,000 cps. **Net, \$169.00**

Model A100 Circlotron Amplifier. Power Output: 100 watts rated, 200 watts on peak. Response: $\pm .5$ db 20-50,000 cps. **Net, \$261.00**

Prices slightly higher west of the Rockies.

Featuring the new, vital PRESENCE CONTROL

With the thrilling new PRESENCE CONTROL, you take the leader's baton and conduct the orchestra to suit your own listening pleasure in the ELECTRO-VOICE MUSIC CONTROL CENTER. Balances vocals to orchestra and room acoustics for true high fidelity. Just like the network and recording studios, the PRESENCE CONTROL gives mid-range program equalization never before available in home systems. Low-boy styling is skillfully blended with mocha, satin brown, and brushed brass trim for a beautiful appearance that matches blonde or mahogany cabinets.

With ELECTRO-VOICE CIRCLOTRON AMPLIFIERS, you come closer than ever to perfection in high-fidelity reproduction. The famous Circlotron Circuit provides unity coupling between output tubes; eliminates switching transients and removes DC from output transformer. The exclusive Variable Damping Control greatly reduces loudspeaker low-frequency distortion and voice-coil override. Permits matching amplifier, speaker and enclosure to room...for the closest approach to reality of reproduction.

See your E-V High Fidelity Distributor or write for Bulletin 222-B69

Electro-Voice[®]

Producers of famous E-V High-Fidelity Speaker Enclosures and Systems

ELECTRO-VOICE, INC. • BUCHANAN, MICHIGAN

Export: 13 East 40th St., New York 16, U. S. A.

Cables: ARLAB