

Audio®

THE FUTURE
OF THE LP

AUGUST 1989 • US \$2.75 • UK £2.00 • CAN \$2.95

NAD 7400 RECEIVER

SIGNAL-PULLING
POWERHOUSE

CABLES
BETWEEN AMP
AND SPEAKER



TESTED
LEVINSON No. 26
PREAMP
A TRUE REFERENCE

SONY SDP-777
SOUND PROCESSOR
FULL OF FEATURES



*Classic Beauty
in Sight and Sound*



Dedication to research . . . discovery . . . invention . . .
bring even further improvements in sound.

The new TSW-A series . . .

A product line that embodies the very latest in
design and engineering technology.

From the company that has always stood for
natural, clear, and detailed listening.



T I M E L E S S I N N O V A T I O N

Enter No. 1 on Reader Service Card

Special CD
Changer Offer
Save \$50 or Receive
a Free 6-Disc Magazine.
See your Pioneer Dealer for Details.



Quality Time. Your moments together are too precious to waste. That's why Pioneer created the PD-M700 6-disc CD player. Now you can enjoy up to six hours of digital music without interruption, at the touch of a single button.

Pioneer invented the 6-disc CD magazine system. This innovative format offers you multiple programming options, cataloging capability and is designed to work in both Pioneer home and car multi-CD players. Simply put, no other CD format offers you so many features and is so easy to use.

Pioneer offers a complete line of 6-disc CD players, all with Non-Repeating Random Play. Now you can spend less time changing your music and more time enjoying it.

 **PIONEER**

We Bring The Revolution Home.™

©1988 Pioneer Electronics (USA) Inc., Long Beach, CA. For more information call 1 800-421-1434.

Enter No. 22 on Reader Service Card



NAD Receiver, page 62

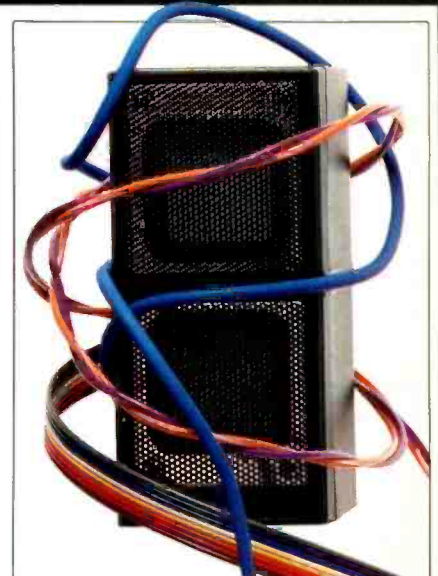

Cables/Amps and Speakers, page 46

FEATURES

CABLES AND THE AMP/SPEAKER INTERFACE	R. A. Greiner	46
WHITHER THE STEREO LP?	John Eargle	54
NIGHTS THE STARS CAME OUT	Donald Spoto	60

EQUIPMENT PROFILES

NAD 7400 RECEIVER	Leonard Feldman	62
SONY SDP-777ES DIGITAL SURROUND PROCESSOR	Howard A. Roberson	80
SUMO ATHENA PREAMP	Bascom H. King	94
AURICLE: MARK LEVINSON NO. 26 DUAL MONAURAL PREAMP	Anthony H. Cordesman	106

MUSIC REVIEWS

ROCK/POP RECORDINGS	112
CLASSICAL RECORDINGS	115
JAZZ & BLUES	118

DEPARTMENTS

AUDIOCLINIC	Joseph Giovanelli	4
TAPE GUIDE	Herman Burstein	8
THE BOOKSHELF		14
SIGNALS & NOISE		22
AUDIO ETC	Edward Tatnall Canby	26
BEHIND THE SCENES	Bert Whyte	34
DEPT. OF AMPLIFICATION	Willis Connor	38
SPECTRUM	Ivan Berger	40
ROADSIGNS	Ivan Berger	42

The Cover Equipment: NAD 7400 receiver.
 The Cover Photographer: David Hamsley.
 Table Design: Pascal Mourque, SEE, New York, N.Y.

Audio Publishing, Editorial, and Advertising Offices,
 1515 Broadway, New York, N.Y. 10036.

Subscription inquiries, (800) 274-8808;
 in Canada or other foreign countries, (303) 447-9330.



Stereo LPs, page 54



American Musicals, page 60

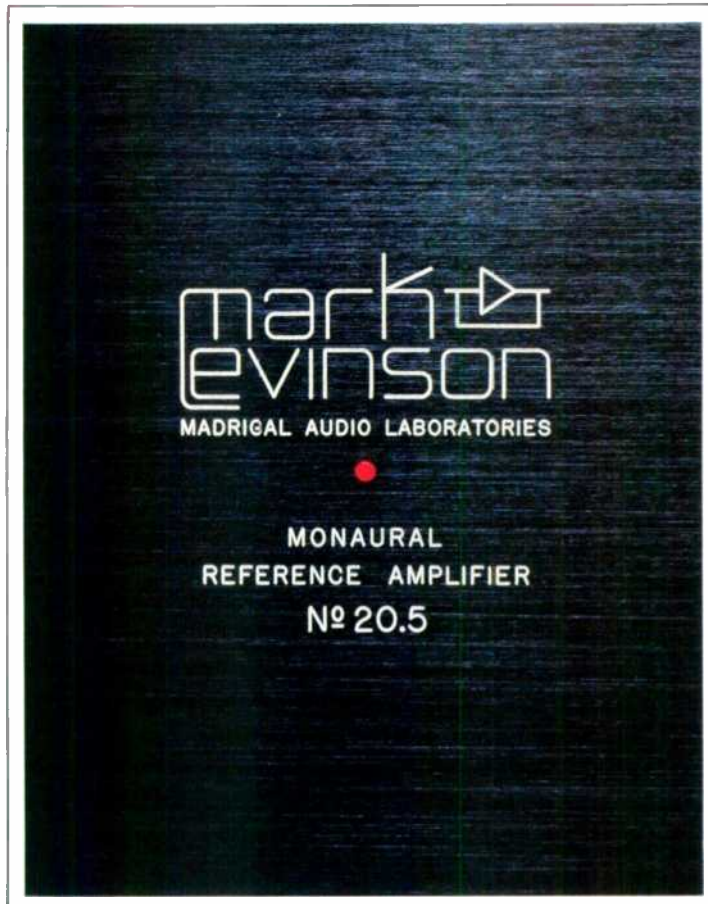

ENGRAVING — January 1989

In the three years since the introduction of the Mark Levinson No. 20 Monaural Reference Amplifier, advances in circuit topologies and components available to the Madrigal design staff have made it possible to produce a new reference. The No. 20.5 Monaural Reference Amplifier is an ultimate statement of our craft and a benchmark for future designs.



It enables you to achieve emotionally complete musical reproduction in your home. Owners of the No. 20 may incorporate these advancements through an exchange of modules. Mark Levinson products are handcrafted in limited quantities to ensure their high standards. Visit your Mark Levinson dealer to hear how good music can sound in your home.

Surge Protection and R.f. Filtering

Q. A friend of mine and I were discussing surge protectors for use with my stereo system. He suggested that I buy a surge protector that does not include r.f. protection. From what I can see, the better devices do include r.f. protection. Why wouldn't I want to filter my system against stray radio frequencies? I note with interest that my security alarm company is opposed to the use of r.f. protection. What is going on?—Michael Coverman, Austin, Tex.

A. Most of the time, I agree that it is good to eliminate stray radio frequencies from your power supplies. They can ultimately find their way into the audio portions of your equipment, where they may be rectified and amplified. However, some devices which are supposed to filter r.f. from the input of your equipment don't do a good job; they are nothing more than r.f. line-bypass capacitors. Good filters must also contain series inductors.

As for your security alarm company not liking r.f. filters, this is understandable. Many alarm systems operate by sending their signals on the power lines because this is a very convenient way to pass information among the various sensors and receivers in their systems. If filters are in the way, the alarm will never sense the signals it is designed to "hear."

Preamplifiers with Different Features

Q. I plan to replace my integrated amplifier with a separate preamp and power amp. What I want to know is, how can two preamplifiers vary so widely in terms of what I thought were basic features? Examples are the Bryston 12B and the Carver 4000t. The Bryston offers just a volume control. The Carver offers treble and bass controls, along with Sonic Hologram circuitry. My less than great integrated unit has tone controls, so how can the Bryston get away without them and still be considered a good preamp?—Tim Swarek, Ont., Canada

A. Some equipment manufacturers believe that tone controls and other additions alter the sound in undesired ways. They feel that phase problems in tone controls affect clarity. Hence, they don't build such controls into their equipment. I have received letters from

readers who don't even use a preamp, preferring to connect their CD player directly to the inputs of their power amp. Other equipment makers offer tone controls and similar features because they believe that flexibility is important and that these added circuits don't distort the sound in any significant way. The use of tone controls or other processing circuits, therefore, does not serve as criteria to help determine the quality of a given unit.

Amplifiers by the Pound

Q. I have noticed that most power amplifiers in the price class of my equipment are large—at least 7 inches high—and weigh about 75 pounds. My new power amp measures 17 1/8 inches wide and 3 1/4 inches high, and weighs only 25 pounds! Can a power amplifier as small as mine provide the same performance as the "heavyweights" in this same price and power class? What about durability? Will it sound as good?

I drive this amp with a receiver, via its "Preamp Out" terminals. The sound is good, but I wonder if I can obtain better sound with a different preamp and tuner.—John De Rosa, Mattapan, Mass.

A. I see no reason why a power amplifier weighing only 25 pounds can't sound as good as a much heavier unit—if it is designed correctly. I own a "little fellow" that weighs less than 10 pounds. It produces 50 watts per channel and employs a switching-type power supply. It has run well for the few years I have owned it; it measures well and sounds fine, and I have had no problems with component failure. These days, it is possible to design a very light power supply. One way is to replace the bulky and heavy power transformer with a toroidal transformer. Thus, I have to believe that you will not have problems caused by owning a sophisticated piece of equipment.

I really can't say whether a new pre-amplifier/tuner will sound better than your present equipment. Much depends on how well your present equipment performs and on your tastes. **A**

If you have a problem or question about audio, write to Mr. Joseph Giovanelli at AUDIO Magazine, 1515 Broadway, New York, N.Y. 10036. All letters are answered. Please enclose a stamped, self-addressed envelope.

Technical Editor: Ivan Berger
 Managing Editor: Kay Blumenthal
 Associate Managing Editor: Tony Scherman
 Copy Chief: Marita Begley
 Associate Art Director: Linda Zerella
 Assistant Editor: Karen Clark
 Editorial Assistant: Michael Bieber

Associate Editors:

Edward Tatnall Canby, Bert Whyte, B. V. Pisha

Senior Editors:

Leonard Feldman, Howard A. Roberson

Senior Editor/Music Features: Ted Fox

Editor-At-Large: David Lander

Contributing Editors/Artist:

Michael Aldred, Susan Borey, Herman Burstein, David L. Clark, Anthony H. Cordesman, Ted Costa, John Diliberto, Frank Driggs, John M. Eargle, Joseph Giovanelli, Bascom H. King, Hector G. La Torre, Edward M. Long, Frank Lovece, Jon W. Poses, Jon R. Sank, Donald Spoto, Michael Tearson, Jon & Sally Tiven, Paulette Weiss, Michael Wright

Business Services Director: Greg Roperi

Circulation Director: Leon Rosenfield

Production Director: Patti Burns

Production Manager: Nancy Potts

Research Director: Neil Karlin

Special Projects Coordinator: Phyllis K. Brady

Ad Coordinator: Sylvia Correa

Sales Secretary: Liz Dedivanovic

V.P./Publisher: Stephen Goldberg

ADVERTISING

Associate Publisher: Stephen W. Wilthoft
 (212) 719-6335

Account Managers: R. Scott Constantine
 (212) 719-6346
 Barry Singer
 (212) 719-6291
 Carol A. Berman
 (212) 719-6338

Western Manager: Bob Meth

Regional Manager: Paula Borgida Mayeri
 (213) 739-5130

Automotive Manager: James Main
 (313) 643-8800

DCI EXECUTIVE STAFF

President and CEO: Peter G. Diamandis
 Executive V.P.: Robert F. Spilane
 Sr. V.P., Finance, and CFO: Arthur Sukel
 Sr. V.P., Mfg. & Distribution: Murray M. Romer
 Sr. V.P., Operations: Robert J. Granata
 V.P., Controller: David Pecker
 V.P., General Counsel: Catherine Flickinger

AUDIO, August 1989, Volume 73, Number 8
AUDIO (ISSN 0004-752X, Dewey Decimal Number 621.381 or 778.5) is published monthly by DCI, a wholly owned subsidiary of Hachette Publications, Inc., at 1515 Broadway, New York, N.Y. 10036. Printed in U.S.A. at Dyersburg, Tenn. Distributed by Warner Publisher Services Inc. Second class postage paid at New York, N.Y. 10001 and additional mailing offices. Subscriptions in the U.S.: \$21.94 for one year, \$39.94 for two years, \$53.94 for three years; other countries, add \$6.00 per year. **AUDIO** is a registered trademark of DCI. ©1989, Diamandis Communications Inc. All rights reserved. **Editorial contributions** should include return postage. Submissions will be handled with reasonable care, but the Editor assumes no responsibility for safety or return of manuscripts, photographs, or artwork. The Publisher, in his sole discretion, reserves the right to reject any ad copy he deems inappropriate. **Subscription Service:** Forms 3579 and all subscription correspondence must be addressed to **AUDIO**, P.O. Box 52548, Boulder, Colo. 80321-2548. Please allow at least eight weeks for the change of address to become effective. Include both your old and your new address and enclose, if possible, an address label from a recent issue. If you have a subscription problem, please write to the above address or call (800) 274-8808; in Canada or other foreign countries, (303) 447-9330.

Until now, separates this good had to be inconvenient.

Since time immemorial, dedicated audio buffs have been forced to choose between all-out performance or all-out convenience.

Such a decision is no longer necessary.

Introducing seriously sophisticated separates that not only offer performance designed to bring tears to your eyes, but also uncompromising remote control capabilities, as well.

The heart of this remarkable new stack is the CX-1000U digital preamp.

You'll find audio and video switching with 10 audio and 4 video inputs. 5 audio and 2 video record outputs.

Even optical and coax digital audio inputs and outputs.

And Yamaha's Hi-Bit, 8 times oversampling digital filter moves unwanted digital noise so inaudibly far above your music, it can't possibly interfere.

While our Hi-Bit twin D/A converters ensure even the lowest level signals are reproduced with excellent linearity.

Anchoring the power portion of the trio is the new MX-1000U power amp.

Featuring specs nothing short of sensational, with a rather awesome 260 watts RMS per channel. (Both channels driven into 8 ohms, 20-20,000 Hz at no more than 0.003% THD.)

And dynamic power capable of delivering a phenomenal 1000 watts per channel into 1 ohm.

All made possible by Yamaha's exclusive Hyperbolic Conversion Amplification (HCA) circuitry that eliminates crossover and switching distortion and provides extremely high



Quite possibly the most potent remote to ever grace your coffee table.

dynamic power to drive the greatest possible range of speakers.

And as a versatile complement to the CX and MX-1000U, we proudly introduce our new TX-1000U tuner.

You'll find a 6-way multi-status memory to lock in 6 different parameters to give you optimum reception.

Plus 24 station presets. Even programmable station call letters. And more.

Drop by your Yamaha dealer for a demonstration today.

The experience may be a bit unnerving at first.

All that uncompromised power and performance. *Plus* the convenience of a full-function remote control.

But we have a feeling you'll get used to it.

YAMAHA®



Public phone. Private moment. Lee jeans.



Easy Rider™

Azimuth by Ear

Q. Is adjusting azimuth by ear a good practice? I set the azimuth screw on my Onkyo deck to be a bit more compatible with my Aiwa deck. Since I adjusted the azimuth, the sound is better. Perhaps the ear triumphs over instruments.—G. H. Sauter, Jr., San Jose, Cal.

A. Azimuth adjustment by ear is acceptable, particularly if the signal has substantial treble content. Turning up the treble using a tone or equalizer control can be helpful in this respect.

Is your Onkyo a three-head deck? If it is, when you adjusted the azimuth of the play head, did you also adjust it for the record head so that both have the same azimuth alignment? Doing so will prevent treble loss when recording and playing back on this machine. If the record head is not truly separate but is mounted in the same casing as the playback head, such further azimuth adjustment would not be necessary with your deck.

Why the "Cellophane"?

Q. What is the purpose of the cellophane strip before the actual beginning of a cassette tape?—Richard Harding, Peabody, Mass.

A. Any deviation in roundness of the hub of the tape reel will adversely affect sound reproduction. This deviation has its greatest relative effect at the beginning and end of the tape—namely, where the tape is attached to the hub. The leader—or "cellophane," as you call it—provides something of a "cushion" against this deviation; it also gives a visual indication of where you can begin recording. In some decks, the clear leader actuates an automatic stop and/or reverse mechanism.

Equalization for Types II and IV

Q. If you're using a high-quality cassette deck to record CDs on Type II or IV tape, would there be any advantage to recording and playing with 120- μ S, instead of 70- μ S, equalization? When I use 70 μ S with these tape types, the sound is duller.—Thomas L. Savio, Bloomington, Minn.

A. The 120- μ S equalization setting is sometimes used with Type II tape, but not with Type IV, in order to achieve greater headroom. In other words, it can provide more protection against

tape overload at high frequencies, with consequent distortion and treble loss. This equalization uses less bass boost in playback than does 70- μ S EQ; a response characteristic that slopes downward from low to high frequencies may also be viewed as treble drop. Therefore, we may say that 120- μ S equalization yields less treble drop in playback. Correspondingly, it requires less treble boost in recording to maintain flat response. The smaller treble boost in recording with 120- μ S equalization reduces the risk of tape overload. However, 120- μ S equalization, compared with 70- μ S EQ, results in about a 4.5-dB loss in S/N ratio in the upper frequencies. This is because the smaller treble drop of 120- μ S equalization in playback reduces noise. With decks such as yours, which provide very good S/N ratios, the loss in S/N tends to be inconsequential and possibly inaudible if you play music at reasonable levels.

Theoretically, unless you record at excessively high levels, your recordings should not sound duller with 70- μ S equalization than with 120- μ S, assuming Type II tape is used. Type IV tape provides substantially more headroom than Types I and II, so there is no apparent incentive to employ 120- μ S equalization with Type IV.

Problems of High-Speed Dubbing

Q. All other things being equal, why is a tape copy made in real time (1:1) better than a copy made, say, at a speed of 32:1?—Charles Warwick, Anaheim, Cal.

A. The frequencies seen by the recording electronics and heads of the duplicator are multiples of the original frequencies. For example, if the duplicating ratio is 32:1, a 15-kHz signal becomes 480 kHz. It is more difficult for the electronics—and especially the record head—to handle a 480-kHz signal than a 15-kHz signal. The problem is exacerbated for the bias frequency. Assuming that a 100-kHz bias signal is satisfactory at the real-time speed of 1 $\frac{1}{2}$ ips, at a duplicating speed of 60 ips (32:1), the required bias is 3,200 kHz (32 MHz), which is not the most manageable frequency in the world for the electronics and the record head to handle. The coil of the head presents a series inductance and a parallel ca-

pacitance, which, respectively, tend to restrict the flow of bias current through the head and to short-circuit this current. There also tend to be physical problems in handling the very thin cassette tape at speeds such as 60 ips.

HX Pro Retrofit

Q. I have read a lot about HX Pro and would like to add this feature to my cassette, 8-track, and open-reel decks. How is it available—as an outboard device, or as a unit that can be wired in internally?—Tom Harrelson, Columbus, Ohio

A. To my knowledge, there is no in-board or outboard device for adding HX Pro to a tape deck's recording circuitry. Doing so would be quite difficult, since HX Pro must sense the amount of high-frequency content in an audio signal and then adjust the bias current from the deck's oscillator accordingly. The bias would have to be decreased when the high-frequency content goes up, and vice versa. The reason is that the high frequencies themselves act as bias for lower frequencies, and the objective of HX Pro is to keep total bias, from the high frequencies and oscillator, constant.

Cassette Tape Life

Q. Under normal conditions of operation and storage, how long does it take for a prerecorded or home-recorded cassette to show marked deterioration in sound?—Frank Muñoz, Carteret, N.J.

A. Information from a leading manufacturer of high-quality cassettes leads me to expect that such a cassette should operate satisfactorily for at least 500 passes through a deck of good quality under normal conditions—including those of temperature and humidity. That number could be appreciably higher, depending on the deck used. For example, in a deck where the pressure pad is lifted away from the tape or where other measures are taken to ensure firm but smooth tape passage over the heads, tape life may be extended. A

If you have a problem or question on tape recording, write to Mr. Herman Burstein at AUDIO, 1515 Broadway, New York, N.Y. 10036. All letters are answered. Please enclose a stamped, self-addressed envelope.

SURGEON GENERAL'S WARNING: Smoking Causes Lung Cancer, Heart Disease, Emphysema, And May Complicate Pregnancy.

17 mg. 'tar', 1.2 mg. nicotine av. per cigarette by FTC method.

© 1989 R. J. REYNOLDS TOBACCO CO.



SALEEM

the refreshest

Make room for...



McIntosh[®]

To maintain and advance its worldwide leadership in innovations and technology is the ongoing challenge for McIntosh engineering. The McIntosh C35 SYSTEM CONTROL CENTER responds to that challenge. Among the innovative improvements in the C35 are:

The challenge for remote control. The C35 provides complete remote control from the main area and two remote areas. In addition it can interface with the McIntosh Remote Control System for independent control in 5 additional areas!

The Challenge to design a preamplifier that would equal the CD in performance. The C35 has normal unbalanced outputs and balanced outputs to prevent deterioration of the excellent signal to noise ratio and low distortion which provide full CD dynamics.

The challenge for more inputs. The C35 has nine inputs.

Handcrafted with pride in the United States

McIntosh

C35 SYSTEM CONTROL CENTER

56

SENSOR % VOLUME

EQUALIZER FREQUENCY



PANLOC

QUALITY

The challenge to maintain the McIntosh reputation for versatility with distortion free performance. The C35 has a motor driven, precision volume control with channel to channel accuracy with 1dB. Its position is indicated by LEDs as a percentage of rotation; a continuously variable loudness control accurately modeled after the family of "equal loudness" curves developed by Drs. Fletcher and Munson; five separate tone shaping controls which provide musically based spectra adjustments, a legion of input, output and interconnects, and more - more - more.



The photograph of the McIntosh C35 SYSTEM CONTROL CENTER is 92% life size...

CAN YOU MAKE ROOM FOR McINTOSH QUALITY?

For information on McIntosh products, please send your name, address and phone number to:

McIntosh Laboratory Inc.
Department 118A
PO Box 96 East Side Station
Binghamton, NY 13904-0096

by dedicated, highly trained craftspeople.

Make room for...



McIntosh[®]

PERI

The challenge in power amplifiers is to be able to deliver extraordinary performance with exceptional power capabilities that can satisfy the demands of uneven speaker loads. Poor speaker designs have input impedance curves that dip to 1 or 2 ohms at various frequencies causing great current demands from the amplifier. The MC 7200 can deliver more than 50 amps of peak output current practically distortion free (0.0005 THD). The 50 ampere gold plated output terminals assure that the full current availability is delivered to the loudspeaker cables. You can connect loudspeaker cables in excess of 1/4" diameter directly, without special lugs or pins that can cause power losses.

The challenge satisfied - in the MC 7200 - extraordinary performance with exceptional power capabilities.

Handcrafted with pride in the United States by ded

McIntosh
200

GUARD

RIGHT

STEREO POWER AMPLIFIER

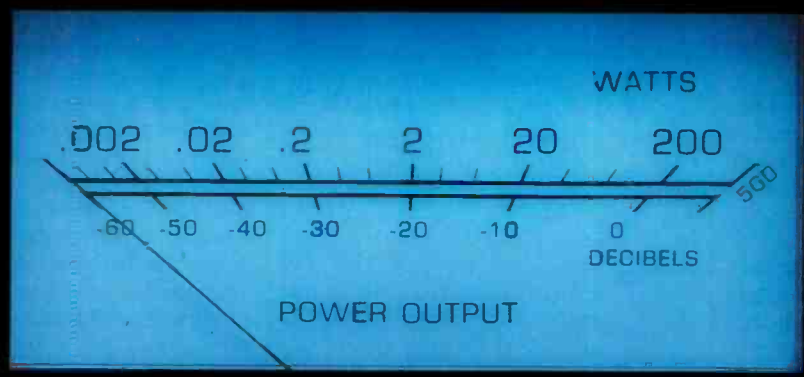

POWER

RIGHT/MONO GAIN

PANLOC

PERFORMANCE

The photograph of the McIntosh MC 7200 POWER AMPLIFIER is 92% life size...

CAN YOU MAKE ROOM FOR McINTOSH PERFORMANCE?

For information on McIntosh products, please send your name, address and phone number to:

McIntosh Laboratory Inc. PO Box 96 East Side Station
Department 889A Binghamton, NY 13904-0096

...ated, highly trained craftspeople.



Enter No. 17 on Reader Service Card

POLARITY IN ABSOLUTE TERMS

The Wood Effect, by R. C. Johnsen. Modern Audio Association, 100 pp., softbound, \$7.95. (Available from The Modern Audio Association, 23 Stillings St., Boston, Mass. 02210.)

The main theme of this book deals with absolute polarity, a very important aspect of sound reproduction which has been much neglected. Because most natural sounds are nonsymmetrical, there is a correct, "true to nature," absolute acoustical polarity of sound. Natural "live" sound is always heard with the correct acoustical polarity, but when it is picked up by a microphone, amplified, and reproduced by a loudspeaker, it can be reversed. This can be demonstrated with a single-channel system by merely connecting the loudspeaker leads one way or the other; a stereo system would require that both speakers have their leads reversed. Because there has never been an official standard to control this aspect of sound reproduction, it is easy to see how this reversal of acoustical polarity is completely random. Although the author of this book is mainly concerned about the fact that every electrical recording ever made is either one polarity or the other, the same problem is present in every sound system, even those used for concert sound.

Chapter 1 begins with a brief history of the recording industry, a long quote from an R.I.A.A. brochure, and a shorter quote from the book *From Tin Foil to Stereo*, by Read and Welch. It shows the many influences which have driven the recording industry. Near the end, Johnsen states his major premise, "Only one concept must be grasped: Electricity can reverse its phase, while music cannot." The problem with this statement, from my viewpoint, is that the author uses the word "phase" instead of "polarity" to describe what can happen to the electrical signal. He does this elsewhere in the book also, which can tend to confuse the very issue that he is trying to clarify. The problem is one of terminology, not of substance. Years ago, during a discussion of this problem, someone asked, "How can we get people to pay attention to absolute phase?" A friend of mine, Ron Wickersham, replied, "When we stop calling it absolute phase and start calling it absolute po-

larity." When I saw the quizzical look on the face of the man who had asked the question, I said, "Phase is frequency dependent; polarity is not." Polarity is a universal concept—something is either plus or minus, positive or negative, up or down, black or white. There

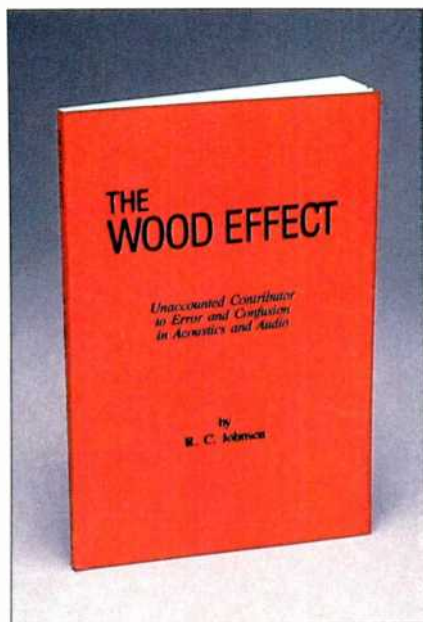

is no in-between or gray area. Phase can be anything from zero to 360° at a given frequency. (*Editor's Note: Or even more if the delay is more than a wavelength; again the difference between a repetitive sinewave and music.—E.P.*)

In Chapter 2, the author lists 10 effects which can be heard when a recording is auditioned with the correct absolute polarity. He also cites two different reviews of the same record, which contain statements about the quality of the sound. Johnsen traced the two reviewers' comments to the different absolute polarities of the records: "'Muffled' was the word both reviewers instinctively and revealingly applied to their reversed-phase conditions." Johnsen also makes the case for correct absolute polarity by comparing photographic negatives and positives: "Negatives are hard to evaluate visually, although all information is present."

Chapter 3 consists of excerpts from a large number of journals and magazines which discuss the merit of the concept of maintaining the absolute polarity of the signal; the term absolute

phase, however, is used interchangeably here. The title of the book is explained by the description of an experiment conducted by Charles Wood in 1957. Wood used a sinusoidal signal which was clipped on one side only, making it nonsymmetrical. He noticed that the timbre changed when the headphone leads were reversed. This finding led to further investigation by the respected researchers James Craig and Lloyd Jeffress, which appeared in the November 1962 issue of *The Journal of the Acoustical Society of America*. The trail of comments in print about the audibility of absolute polarity is followed by Johnsen all the way to 1984.

The next three chapters are very short. The lack of a standard for absolute polarity in professional recording equipment is discussed in the four pages of Chapter 4. Chapter 5 is basically an attack on the Audio Engineering Society for not setting appropriate standards for absolute polarity. Chapter 6 presents the author's own experiences in tracking down examples of polarity confusion on various recordings, as well as some anecdotal evidence for the importance of listening to music with the correct polarity. Information about the differences between the way AM and FM radio broadcasters handle the polarity problem sheds light on why correct polarity is easy to hear on AM and almost impossible to discern on FM.

Chapter 7 begins with revelations about the effects of polarity reversal on radio and TV broadcasts, concert sound reinforcement, and even the sale of equipment. The next 13 pages provide an interesting investigation of recordings—from 78s, through LPs, to CDs—with comments about the sound from various published sources. A section is devoted to the audibility of the effects upon music reproduction of the polarity of the a.c. power line, with comments by a number of writers. Johnsen includes a story in which he spent three hours with the late Richard Heyser, discussing whether there could be a preferred a.c. power-plug polarity that would make an audible improvement in the sound. It appears that Richard Heyser didn't think so, but the passage might leave the reader with the idea that Heyser wasn't aware

of the audible effects of absolute polarity on the perceived sound. I can attest to the fact that he was very aware of the importance of maintaining absolute polarity—at least as far back as 1979, when we were both at an A.E.S. meeting. When I got up to speak, I said that I thought the absolute polarity of the system was reversed and saw Heyser nod in agreement. I then spoke into the microphone while someone reversed the leads to the loudspeaker system and, sure enough, the reaction of the audience showed me that Heyser and I had been correct; the polarity had been reversed. (Editor's Note: I can attest to the fact that Heyser was aware of absolute polarity and its importance in recording and in testing speaker systems for this magazine. Indeed, the seminal 1967 JAES paper on time-delay spectrometry makes the distinction between polarity and phase plainly.—E.P.)

Although I agree with the major premise of this book—that absolute polarity is extremely important—I must say that pages 67 to 74 are full of erroneous and misleading information about loudspeakers. Unfortunately, it is a case of trying to explain, in technical terms, why some loudspeakers behave the way they do, without having the expertise required to do so. Since the author is not a loudspeaker system designer and quotes the writings of others who are not designers either, perhaps this is excusable. Most speaker designers also have difficulty with such concepts as minimum phase, linear phase, phase delay, phase deviation, phase alignment, group delay, etc. Indeed, the design of a coherent loudspeaker is not a trivial task—even for those who are aware of what they are doing.

The last two chapters are an odd mixture and, therefore, difficult to describe. There is an interesting list of recordings, each marked with the author's own polarity convention, which is relative to the first record for which he determined the correct polarity. It would have been better if he had determined the absolute polarity of his own system before he began marking his collection. As it is, his "normal" and "reverse" designations might be reversed! Oh well, at least they are con-

sistent, which is more than the whole audio industry can say for itself. The Epilogue contains additional press comment on the importance of absolute polarity, while the Appendix consists of tape-recorded comments about absolute polarity, from exhibitors at the 1987 summer C.E.S.

The tone of Johnsen's book is rather quixotic, and I don't think the author will mind my saying so. Rather, I suspect he will take this as the compliment it is meant to be. This is a potentially controversial book, and it is quite clear the author intends it to be so. I found it fun to read. *Edward M. Long*

CASSETTES/STEREO RECEIVERS/TAPE DECKS/EQUALIZERS/ACCESSORIES/TELEVISION COMPACT DISC PLAYER/TELEPHONE S/ELECTRON

J&R MUSIC WORLD

SAVE 60%



Tandberg TPR-3080A
Audiophile Programmable Receiver
•State-of-the-art in audiophile performance from Tandberg •80 watts per channel RMS •Zero negative feedback design •16 FM presets •Black finish

Sale Price **\$999** Retail \$2500 (TAN 3080A)

Dual CS-5000/X3-MC
Turntable with Ortolan Cartridge
•Quartz locked belt drive •Floating subchassis •High performance dynamic balance tonearm •Ortolan X3-MC high output moving coil cartridge

Sale Price **\$449⁹⁵** Retail \$650 (DUA CS5000/X3MC)

SAVE 50%



SAE T-102
Computer Direct Line Digital Tuner
•Quartz reference tuning for precise station selection •8 AM & 8 FM presets •Manual & auto search tuning •Signal strength, stereo, & frequency display •19-inch rack mount!

Sale Price **\$174⁹⁵** Retail \$349 (SAE T102)

SAVE 50%



Tandberg TCP-3015A
Audiophile Compact Disc Player
•Features 16 bit four times oversampling •Zero negative feedback •No capacitors between D/A converters •Headphone output with volume control

Sale Price **\$999** Retail \$1995 (TAN 3015A)

SAVE 50%



SAE A-202
High Resolution Power Amplifier
•100 watts RMS per channel •Complementary amplifier design delivers greater stereo imaging and reduced phase shift •LED power output display •Black finish

Sale Price **\$249⁹⁵** Retail \$500 (SAE A202)

Ohm F-II
Loudspeakers
•A world renowned speaker is updated •Now using the Coherent Line Source driver for realistic 3-dimensional imaging •Handles 300 watts •8 ohm impedance

Sale Price **\$899⁹⁵** Retail \$2500/PPR (OHM FII)

Audio Specials

Tandberg 3018A Preamplifier
•Zero negative feedback, discrete design
Orig. Mfg. \$2500... Save 60% **\$999⁹⁵**

Tandberg 3016A Power Amplifier
•220-watts/channel
•Zero negative feedback
Orig. Mfg. \$4000... Save 50% **\$1999⁹⁵**

Tandberg 3031A Digital FM tuner
•16 presets
Orig. Mfg. \$1200... Save 50% **\$599⁹⁵**

Tandberg 3038A Preamplifier
•Zero negative feedback
Orig. Mfg. \$1350... Save 63% **\$499⁹⁵**

Tandberg 3036A Power Amplifier
•100-watts/channel, high-current
Orig. Mfg. \$1350... Save 55% **\$599⁹⁵**

Tandberg 3008A Preamplifier
•Servo controlled volume
Orig. Mfg. \$1200.00... Save 58% **\$499⁹⁵**

SAE A-502 Power Amplifier
•200-watts/channel, 19" rack mountable
Orig. Mfg. \$800... Save 50% **\$399⁹⁵**

SAE P-102 Preamplifier
•Direct-line, 19" rack mountable
Orig. Mfg. \$650... Save 44% **\$249⁹⁵**

Audio Specials

SAE T-101 Tuner
•Computerized direct-line, 19" rack mountable
Orig. Mfg. \$650... Save 61% **\$249⁹⁵**

SAE C-102 Cassette Deck
•With Dolby B/C, 19" rack mountable
Orig. Mfg. \$500... Save 50% **\$249⁹⁵**

SAE D-102 CD Player
•4X oversampling, 19" rack mountable
Orig. Mfg. \$600... Save 50% **\$299⁹⁵**

Shure V15-VMRLE Limited Edition
•Hand-picked cartridge, includes stylus gauge **\$189⁹⁵**

Audioquest "CD Feet"
•Sorbathane feet for CD players **\$34⁹⁵**

Audioquest "CD 30"
•CD rings with locator **\$24⁹⁵**

Audioquest "Pria Lift"
•Lifts tonearm at end of record **\$34⁹⁵**

ADC SS-525X
•12-band graphic equalizer, real time analyzer **\$349⁹⁵**

Audio Specials

Terk 8500
•Electronic FM Antenna **\$29⁹⁵**

Terk 9500 FM Antenna
•Deluxe, with 24db's of gain **\$39⁹⁵**

Teac X-200ORB
•Reel-to-Reel recorder, 3-motors, 6-heads **\$1199⁹⁵**

Shure V15-VMR
•Great tracking cartridge **\$129⁹⁵**

Beyerdynamic DT-990
•Top Rated Dynamic Headphones **\$189⁹⁵**

Ortolan 540
•Top-of-the-Line Moving Magnet Cartridge **\$199⁹⁵**

Toshiba DX-900 Hi-Fi VCR
•4-head with PCM recording **\$669⁹⁵**

Technics SL-P999 CD Player
•20-bit, 8X oversampling **\$429⁹⁵**

Celestion DL4-II
•2-Way Bookshelf Speakers, Walnut or Black Finish . Pair **\$275**

Camber 3.5 Audiophile Speakers
•Mirror imaged 2-way speakers, Heavy H-braced cabinet . Pair **\$499⁹⁵**

Panasonic PV-4860 Hi-Fi VCR
•4-video heads, MTS stereo, 44-function remote **\$449⁹⁵**

ORDER TOLL FREE **1-800-221-8180**

Outside U.S.A. 1-716-417-3737 BY FAX: 1-716-497-1791

Mail Order Hours: Monday to Friday 9 AM to 6 PM, Saturday 9 AM to 4 PM, Sunday 10 AM to 4 PM

Phone 3 (toll-free) required Call Toll-Free 1-800-221-8180 in New York 716-417-3737

TO ORDER BY MAIL:

SEND MONEY ORDER, CREDITED OR CASHIER'S CHECK, MASTERCARD AND VISA, AMERICAN EXPRESS OR DISCOVER CARD (Please include reference No., expiration date and signature.) TO ALL OTHERS: \$3.00 PER ORDER. \$5.00 PER ORDER. \$10.00 PER ORDER. \$15.00 PER ORDER. \$20.00 PER ORDER. \$25.00 PER ORDER. \$30.00 PER ORDER. \$35.00 PER ORDER. \$40.00 PER ORDER. \$45.00 PER ORDER. \$50.00 PER ORDER. \$55.00 PER ORDER. \$60.00 PER ORDER. \$65.00 PER ORDER. \$70.00 PER ORDER. \$75.00 PER ORDER. \$80.00 PER ORDER. \$85.00 PER ORDER. \$90.00 PER ORDER. \$95.00 PER ORDER. \$100.00 PER ORDER. \$105.00 PER ORDER. \$110.00 PER ORDER. \$115.00 PER ORDER. \$120.00 PER ORDER. \$125.00 PER ORDER. \$130.00 PER ORDER. \$135.00 PER ORDER. \$140.00 PER ORDER. \$145.00 PER ORDER. \$150.00 PER ORDER. \$155.00 PER ORDER. \$160.00 PER ORDER. \$165.00 PER ORDER. \$170.00 PER ORDER. \$175.00 PER ORDER. \$180.00 PER ORDER. \$185.00 PER ORDER. \$190.00 PER ORDER. \$195.00 PER ORDER. \$200.00 PER ORDER. \$205.00 PER ORDER. \$210.00 PER ORDER. \$215.00 PER ORDER. \$220.00 PER ORDER. \$225.00 PER ORDER. \$230.00 PER ORDER. \$235.00 PER ORDER. \$240.00 PER ORDER. \$245.00 PER ORDER. \$250.00 PER ORDER. \$255.00 PER ORDER. \$260.00 PER ORDER. \$265.00 PER ORDER. \$270.00 PER ORDER. \$275.00 PER ORDER. \$280.00 PER ORDER. \$285.00 PER ORDER. \$290.00 PER ORDER. \$295.00 PER ORDER. \$300.00 PER ORDER. \$305.00 PER ORDER. \$310.00 PER ORDER. \$315.00 PER ORDER. \$320.00 PER ORDER. \$325.00 PER ORDER. \$330.00 PER ORDER. \$335.00 PER ORDER. \$340.00 PER ORDER. \$345.00 PER ORDER. \$350.00 PER ORDER. \$355.00 PER ORDER. \$360.00 PER ORDER. \$365.00 PER ORDER. \$370.00 PER ORDER. \$375.00 PER ORDER. \$380.00 PER ORDER. \$385.00 PER ORDER. \$390.00 PER ORDER. \$395.00 PER ORDER. \$400.00 PER ORDER. \$405.00 PER ORDER. \$410.00 PER ORDER. \$415.00 PER ORDER. \$420.00 PER ORDER. \$425.00 PER ORDER. \$430.00 PER ORDER. \$435.00 PER ORDER. \$440.00 PER ORDER. \$445.00 PER ORDER. \$450.00 PER ORDER. \$455.00 PER ORDER. \$460.00 PER ORDER. \$465.00 PER ORDER. \$470.00 PER ORDER. \$475.00 PER ORDER. \$480.00 PER ORDER. \$485.00 PER ORDER. \$490.00 PER ORDER. \$495.00 PER ORDER. \$500.00 PER ORDER. \$505.00 PER ORDER. \$510.00 PER ORDER. \$515.00 PER ORDER. \$520.00 PER ORDER. \$525.00 PER ORDER. \$530.00 PER ORDER. \$535.00 PER ORDER. \$540.00 PER ORDER. \$545.00 PER ORDER. \$550.00 PER ORDER. \$555.00 PER ORDER. \$560.00 PER ORDER. \$565.00 PER ORDER. \$570.00 PER ORDER. \$575.00 PER ORDER. \$580.00 PER ORDER. \$585.00 PER ORDER. \$590.00 PER ORDER. \$595.00 PER ORDER. \$600.00 PER ORDER. \$605.00 PER ORDER. \$610.00 PER ORDER. \$615.00 PER ORDER. \$620.00 PER ORDER. \$625.00 PER ORDER. \$630.00 PER ORDER. \$635.00 PER ORDER. \$640.00 PER ORDER. \$645.00 PER ORDER. \$650.00 PER ORDER. \$655.00 PER ORDER. \$660.00 PER ORDER. \$665.00 PER ORDER. \$670.00 PER ORDER. \$675.00 PER ORDER. \$680.00 PER ORDER. \$685.00 PER ORDER. \$690.00 PER ORDER. \$695.00 PER ORDER. \$700.00 PER ORDER. \$705.00 PER ORDER. \$710.00 PER ORDER. \$715.00 PER ORDER. \$720.00 PER ORDER. \$725.00 PER ORDER. \$730.00 PER ORDER. \$735.00 PER ORDER. \$740.00 PER ORDER. \$745.00 PER ORDER. \$750.00 PER ORDER. \$755.00 PER ORDER. \$760.00 PER ORDER. \$765.00 PER ORDER. \$770.00 PER ORDER. \$775.00 PER ORDER. \$780.00 PER ORDER. \$785.00 PER ORDER. \$790.00 PER ORDER. \$795.00 PER ORDER. \$800.00 PER ORDER. \$805.00 PER ORDER. \$810.00 PER ORDER. \$815.00 PER ORDER. \$820.00 PER ORDER. \$825.00 PER ORDER. \$830.00 PER ORDER. \$835.00 PER ORDER. \$840.00 PER ORDER. \$845.00 PER ORDER. \$850.00 PER ORDER. \$855.00 PER ORDER. \$860.00 PER ORDER. \$865.00 PER ORDER. \$870.00 PER ORDER. \$875.00 PER ORDER. \$880.00 PER ORDER. \$885.00 PER ORDER. \$890.00 PER ORDER. \$895.00 PER ORDER. \$900.00 PER ORDER. \$905.00 PER ORDER. \$910.00 PER ORDER. \$915.00 PER ORDER. \$920.00 PER ORDER. \$925.00 PER ORDER. \$930.00 PER ORDER. \$935.00 PER ORDER. \$940.00 PER ORDER. \$945.00 PER ORDER. \$950.00 PER ORDER. \$955.00 PER ORDER. \$960.00 PER ORDER. \$965.00 PER ORDER. \$970.00 PER ORDER. \$975.00 PER ORDER. \$980.00 PER ORDER. \$985.00 PER ORDER. \$990.00 PER ORDER. \$995.00 PER ORDER. \$1000.00 PER ORDER.

J&R Music World, Dept. AMO389, 59-50 Queens Midtown Expressway, Maspeth, Queens, NY 11378

Loudspeaker and Headphone Handbook, with 14 sections written by various authors, brings the advantages of each writer's expertise.

Loudspeaker and Headphone Handbook, edited by John Borwick. Butterworth & Co., 573 pp., hardbound, \$97.50.

The years 1987 and 1988 have seen the publication of some very important books on sound. In 1987, there was a new edition of *Sound System Engineering* by Don and Carolyn Davis, then the *Handbook for Sound Engineers* edited by Glen Ballou, which is subtitled "The New Audio Cyclopaedia." Then in 1988 came the *Audio Engineering Handbook* edited by K. Blair Benson, and now we have the *Loudspeaker and Headphone Handbook* edited by John Borwick. Although the book reviewed here was published in England and most of the contributors are English, there are also contributors from Austria, Canada, and the U.S. The book is divided into 14 chapters and includes an Index. As the reviewer's favorite cliché says, "It is profusely illustrated," with many charts, graphs, tables, and schematics. Because each chapter covers a rather broad topic, there is bound to be some overlap, but I consider this an advantage. For example, when I looked in the Index for "Positioning of loudspeaker," I found four different pages listed. These pages are in Chapters 3, 7, 10, and 11, which were written by four different authors. (Each author touches upon different aspects of the positioning of a loudspeaker.) Another advantage of having different authors cover the 14 different sections of the book is that each is able to concentrate on a subject and present it in great detail. Every chapter includes references; Chapters 4 through 9 also include a bibliography.

Chapter 1, written by R. D. Ford of the University of Salford, England, is titled "Principles of Sound Radiation." Ford begins with a brief explanation of such topics as sound waves, loudness and hearing, sound pressure, and decibels. The following sections—on sound radiation from a simple source and the relationship of sound intensity and power—are explained with mathematical equations. Radiation from a flat, rigid, circular piston in an infinite baffle is covered graphically and mathematically. Radiation from a rectangular source is similarly treated, and then

the author covers the acoustic impedance of an enclosure. A section on the radiation from multiple drivers has graphic examples as well as the appropriate mathematical formulas. The section on horns left me wishing that more information had been included. Formulas are given only for the exponential horn, although a graph of the acoustical resistance and reactance versus frequency for parabolic, conical, exponential, and hyperbolic shapes are shown. The author argues in favor of the exponential flare as be-

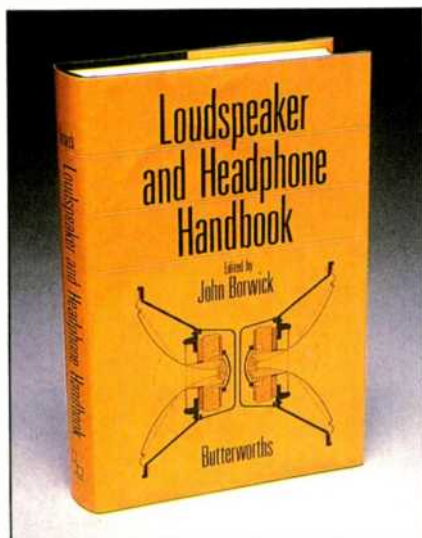

ing probably the best compromise as well as easy to analyze mathematically. He also includes a brief but effective discussion of constant-directivity horns, but there is only one reference cited. Since constant-directivity horns have become so popular, more references on the subject would have greatly enhanced this section. The last section presents electrical circuit analogs of a loudspeaker driver.

I consider Chapter 2, written by the legendary Stanley Kelly, worth the price of the book all by itself. It covers transducer drive mechanisms and their effects in tremendous detail, and includes information not found in other books. It begins with an historical treatment of the subject and includes such original designs as the Western Electric WE555W horn driver and the legendary Ionophone, complete with construction details and even the schematic for the Ionophone high-frequency oscillator and power supply. The

next section has a chart and diagram which show the relationship between electrical, mechanical, and acoustical terms and their schematic representations, followed by an explanation of the Helmholtz resonator, which is the basis of all bass-reflex or ported enclosures. The next two sections cover direct-radiator diaphragms and motors in great detail, showing the effects of various design parameters on performance. Horn drivers are well covered in the next section, while the last section contains excellent information about ribbon speakers. This is not unusual because the author is the world's foremost expert on this type of design. The ribbon driver—which has become popular in the last few years, especially in audiophile systems—is not even included in most other books.

The next chapter, by designer and consultant Peter Baxandall, is a must for anyone interested in electrostatic loudspeaker design. Electrostatic drive theory is covered in extreme detail, with appropriate schematic representations, graphic relationships, and mathematical formulas. Radiation characteristics are also extensively covered. Practical designs are examined next, with the Quad Mark I and ESL 63 used as examples. Baxandall acknowledges the assistance of Peter Walker, the designer of these two legendary ESLs, so the information can be considered not only reliable but very practical as well. In fact, the practical considerations are covered so thoroughly that I am left with admiration for anyone who has produced a successful ESL system.

Multiple loudspeaker system design is covered in Chapter 4 by Laurie Fincham of KEF Electronics. The first section considers the design of multiple-driver systems from a theoretical viewpoint and deals mainly with the target-function approach, which requires that driver and filter characteristics be considered together to arrive at a desired acoustical-output filter shape. Both amplitude and phase characteristics of filter functions are considered. The main crossover types used as examples are the Butterworth, Linkwitz-Riley, and time-delay derived. These are described in terms of their transfer functions, and they are used again later, in the section on practical design procedures. This section would have

The International Preview Society

3 COMPACT DISCS, RECORDS OR CASSETTES \$1

plus shipping
and handling with
Club membership

for just

With No Obligation To Buy Anything...Ever!

Perlman: French Violin Showpieces Carmen Fantasy, more. DG DIGITAL 115457

Ashkenazy: Rachmaninoff, Piano Concerto No. 3 Concertgebouw Orch./Hallink. London DIGITAL 125157

The Academy—By Request Bach, others. Marriner cond. Angel DIGITAL 154094

Heifetz: The Decca Masters, Vol. 1 Clair de lune, more. MCA 100604

Tchaikovsky, Symphony No. 4 Chicago Symphony/Solti. London DIGITAL 125038

Andrés Segovia Plays Bach Chaconne, more. MCA 163600

Mozart, Eine kleine Nachtmusik; Pachelbel, Canon; more Marriner cond. Philips DIGITAL 115530

Beethoven, Symphony No. 6 ("Pastorale"); 2 Overtures Academy of Ancient Music/Hogwood. L'Oiseau-Lyre DIGITAL 125397

Liszt/Tronque J. R. Baker, synthesizer. Newport Classic DIGITAL 134622 *

André Previn: Gershwin, Rhapsody in Blue; Concerto; An American in Paris Philips DIGITAL 115437

Mozart, Piano Concertos Nos. 20 & 21 Malcolm Bilson, fortepiano. English Baroque Solists/Gardiner Archiv DIGITAL 125208

Beethoven, Symphony No. 9 (Choral) London Classical Players/Norrington. Angel DIGITAL 100467

Pavarotti At Carnegie Hall Schubert, Verdi, others. London DIGITAL 115311

Barry Douglas: Brahms, Piano Concerto No. 1 London Symphony Orch. RCA DIGITAL 100732

Hoist, The Planets Montreal Sym./Dutoit. London DIGITAL 115448

On The Boardwalk Paragon Ragtime Orch. Newport Classic DIGITAL 124699 *

Adams, The Chairman Dances; more San Francisco Sym./deWaart. Nonesuch DIGITAL 100491

Handel, Water Music English Concert/Pinnock. Archiv 115306

Mussorgsky, Pictures At An Exhibition; more Montreal Sym./Dutoit. London DIGITAL 125314

Perlman: Brahms, Violin Sonatas Ashkenazy, piano. Angel 233760

Kiri te Kanawa Sings Gershwin Somebody Loves Me, I Got Rhythm, more. Angel DIGITAL 170258

Vivaldi, The Four Seasons English Concert/Pinnock. Archiv 115356

Canadian Brass: More Greatest Hits Golliwog's Cakewalk, more. RCA DIGITAL 164348

Krystian Zimerman Plays Chopin 4 Ballades, Barcarolle, Fantasie. DG DIGITAL 115332

Kronos Quartet: Winter Was Hard Barber Adagio, more. Nonesuch 100675

Horowitz in Moscow Scarlatti, Mozart, others. DG DIGITAL 125264

Ute Lemper Sings Kurt Weill Mack The Knife, Speak Low, more. London DIGITAL 115163 *

Ravel, Boléro; La Valse; more Montreal Symphony/Dutoit. London DIGITAL 115199

Simon Rattle: The Jazz Album Rhapsody In Blue, more. London Sinfonietta. Angel DIGITAL 172226

Rossini, Overtures. Orpheus Chamber Orch. DG DIGITAL 115527

Digital Juke Box John Williams & The Boston Pops. More, more. Philips DIGITAL 125059

Heifetz: Tchaikovsky & Mendelssohn, Violin Concertos RCA 104833

James Galway's Greatest Hits Memory, more. RCA 173233



This remarkable \$1 offer is being made to introduce you to an outstanding classical music membership—with never any obligation to buy.

You'll find hundreds of outstanding albums in each issue of the Society's magazine, which will be sent to you approximately every 3 weeks. That gives you 19 convenient, shop-at-home opportunities a year. But there is no obligation to accept any offering at any time.

You choose only the music you want!

If you'd like to accept the Main Selection, you need not do a thing. It will be sent automatically. If you'd prefer an alternate selection or none at all, just mail back the Notification Card by the specified date. You'll always have at least 10 days to decide. But if you don't, you may return your Main Selection at our expense for full credit. You may cancel your membership whenever you wish, simply by writing to us. Or, remain a member and take advantage of future money-saving bargains.

Substantial savings with our bonus plan.

For every regular purchase you do make, you'll receive bonus certificates good for discounts up to 50% off. (Shipping/handling added to each shipment.)

3 Compact discs or records or cassettes for just \$1!

Begin your membership now by choosing any 3 albums shown here for just \$1 plus shipping and handling. Send no money now. We want you to judge for yourself before you decide to buy. If not delighted, return your 3 albums at the end of 10 days without obligation.

SAVE UP TO

50%

INSTANT HALF-PRICE BONUS PLAN

Unlike other clubs, you'll receive bonus certificates for each album you order, right with your very first full-price purchase. Use them to get additional albums at up to half off!

The International Preview Society

P.O. Box 91406 • Indianapolis, IN 46291

YES! Please accept my membership in The International Preview Society and send me, for 10 days' FREE examination, the 3 albums I have indicated below, under the terms of this offer. I may return them after 10 days and owe nothing, or keep them and pay only \$1 (shipping and handling added to each shipment). I understand that I'm not obligated to buy anything...ever!

Please send all selections on Compact Disc Cassette Record *

Write Selection Numbers Here:

--	--	--

Selections marked with () are not available on LP record.

Mr. Mrs. Miss
 First Name Initial Last Name (PLEASE PRINT)

Address _____ Apt. _____

City _____ State _____ Zip _____

Telephone (_____) _____
 Area Code

NOTE: Members who select compact discs will be serviced by the Compact Disc Club. Full membership details will follow with the same 10-day, no-obligation, no-minimum purchase privilege.

Limited to new members; continental U.S.A. only. Current CD Club members not eligible for this offer. One membership per family. We reserve the right to request additional information or reject any application. Local taxes, if any, will be added.

YHP EL BF PEL PJ

IPS/6550 E 30th St./Indianapolis, IN 46219

IPS \$29

Editor John Borwick can be justly proud of the great job he's done. This book should remain a valuable asset for years to come.

been more useful if it had shown the method to be used to generate actual parts' values for crossovers. It does give a schematic representation, used to model a speaker driver, which should be used as a load for the crossover, rather than a simple resistive dummy load, as shown in other books on crossover design. The author cautions that in order to obtain the desired acoustical target function for a driver/crossover combination, the crossover network must also provide for driver-response equalization.

Chapter 5, written by the famous equipment reviewer and designer Martin Colloms, covers from a number of angles the amplifier/loudspeaker interface and its effects upon performance. Included are typical dynamic and electrostatic speakers with data on impedance and phase versus frequency. Zobel compensation for the rise in dynamic-driver impedance is demonstrated. The graph of impedance versus frequency is shown for a commercial loudspeaker system, which also uses conjugate impedance compensation. The crossover schematic, complete with parts' values for this system, makes clear how complicated such compensation can be. Colloms also presents a case for using the amplifier output resistance, rather than the damping factor, as a criterion. He also shows that, from a loudspeaker designer's or user's standpoint, it would make more sense to rate amplifiers on a system of available level in dB than power in watts. He then covers active loudspeakers—that is, those with built-in amplifiers. Next, he describes motion feedback and digital loudspeaker concepts. The last section is devoted to cables, fuses, protection devices, and connectors. The fact that the resistance of cable used to connect the loudspeaker to the amplifier can effect the amplitude-versus-frequency response is shown graphically.

Chapter 6, "Loudspeaker Enclosures" by Desmond Thackeray of the University of Surrey, is rather brief and very general. Certain aspects of closed-box and vented enclosures are covered, but readers seeking a guide for designing enclosures will have to look elsewhere. Formulas for the exponential and the hyperbolic exponential, however, are included.

Chapter 7, "The Room Environment" by Glyn Adams of the University of Sydney, has an excellent discussion of standing waves, room modes, and reverberation. The section on speaker placement shows the interaction with room boundaries, the effect of room modes, and even includes a discussion of stereo imaging. The discussion of measuring room acoustics is rather basic and shows only reverberation and third-octave techniques, although the use of time-delay spectrometry, developed by Richard Heyser, is mentioned. A few pages are devoted to listening room design, including the use of sound-absorber panels. The last section touches briefly upon the use of equalization.

Chapter 8, "Sound Reinforcement and Public Address" by Peter Mapp, begins by making a distinction between sound reinforcement and public address, with distributed and central loudspeaker systems covered. A section on auditorium systems is followed by a discussion of the Haas effect, as well as the findings of Wallach and others regarding the precedence effect. Mapp also covers response shaping, speech intelligibility, and climatic effects. Sound masking systems, reverberation systems, electronic architecture, and cinema systems are all dealt with in a clear fashion.

Chapter 9, "Loudspeakers for Studio Monitors and Musical Instruments," was written by Mark Gander of JBL. He begins by laying out a number of performance requirements for studio monitors. A section is devoted to "significant monitor designs" and includes this reviewer's contribution to the genre, the UREI 813 Time Align monitor, as well as monitors by JBL, B & W, and Tannoy. An excellent section follows and is devoted to the construction of high-powered, musical-instrument loudspeaker drivers. Many details are made clear by diagrams and photographs. The chapter ends with a discussion of speaker enclosures that includes photos and drawings.

Chapter 10, "Loudspeaker Measurements," was written by the book's editor, John Borwick. He first lays out the important parameters which should be measured and then mentions the published standards. Borwick then discusses the measurement environment

(i.e., free-field, diffuse-field, etc.) before covering other test conditions which should be taken into account. Various test methods are then discussed, including: Continuous sine wave, using either small, discrete steps or slow sweep; time-delay spectrometry; gated tone burst; impulse, and random noise. Various speaker parameter measurements are covered, including directional response, sensitivity, efficiency, impedance, and large-signal distortion.

Chapter 11, "Subjective Evaluation," covers its topic in great detail. It was written by Floyd Toole, who has become an acknowledged expert in this area. Toole discusses various aspects, including the room, program material, selection of listeners, procedures, and rating schemes.

Chapter 12, "Headphones" by C. A. Poldy of AKG Acoustics, is a small book in itself. Since in-depth information on headphones is so difficult to find, this chapter alone is extremely valuable. Just about every aspect of 'phones is covered in detail, including the different types of transducer elements, the effects of ear cushions, and sound insulation. The hearing mechanism and the many aspects of out-of-head localization are discussed, including left-right, front-back, cone of confusion, elevation effect, and more. The problems of defining a standard for headphone measurement are made very clear, as are the problems of testing headphones, covered at the end of this chapter and followed by a section containing 178 references! Phase effects, binaural recording and reproduction, artificial heads, compatibility with loudspeaker listening, and blending circuits are also well covered.

Chapters 13 and 14, "International Standards" and "Terminology," both by J. M. Woodgate, discuss the various measurement standards published by the I.E.C. and by various countries and give definitions for the terms used in this book.

To conclude, I must say that editor John Borwick has done an excellent job and can be justly proud. This book should remain a valuable asset for years to come. I recommend it to anyone interested in speakers, especially those who want to know more about headphones.

Edward M. Long

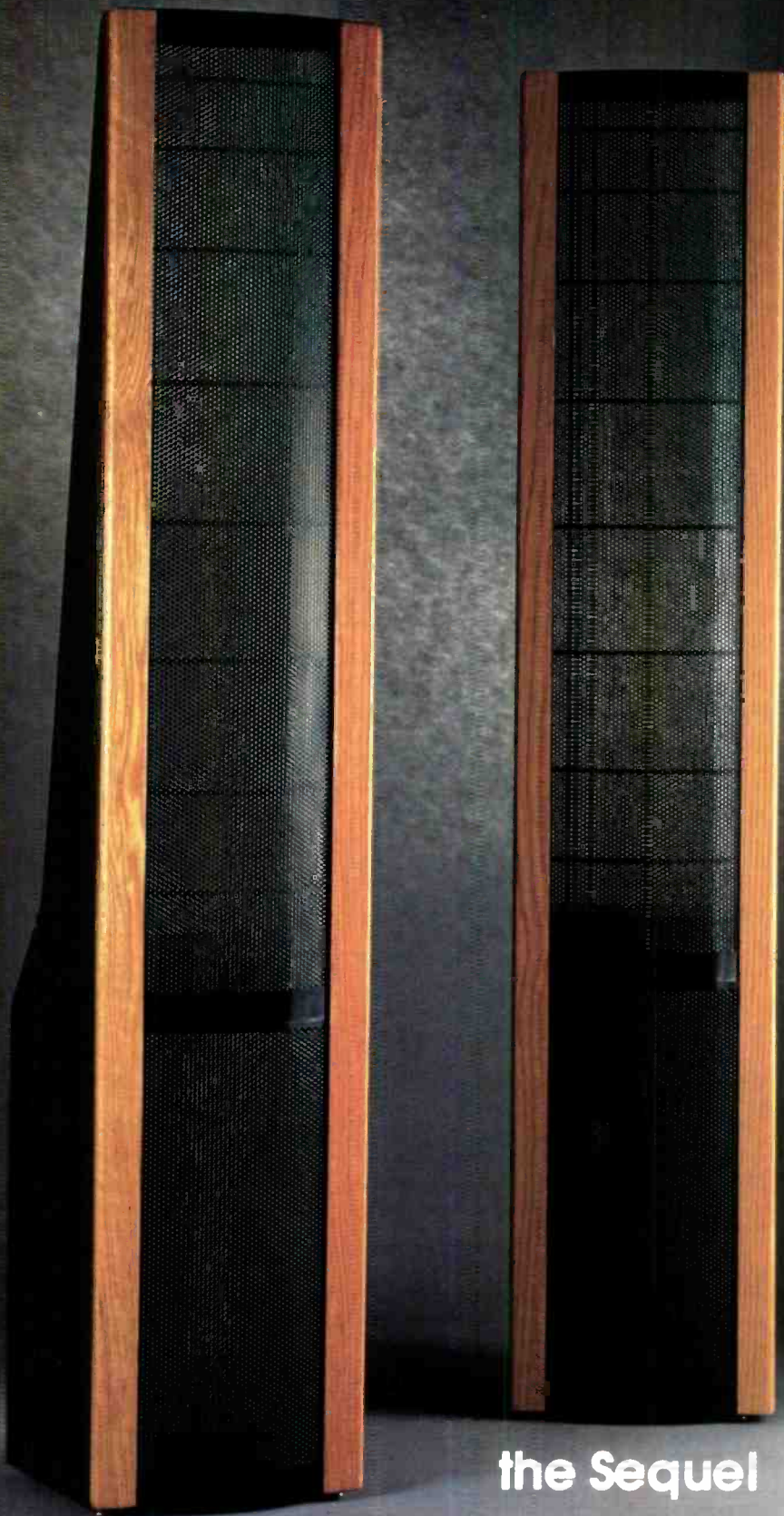

the Sequel

MARTIN-LOGAN, LTD.
The electrostatic loudspeaker technology co.

p.o. box 741
2001 delaware
lawrence, kansas 66044
1-913-749-0133
telex 262817 mlesl

“Because I wanted to have the world’s finest amplifier and the world’s greatest transfer function, I built the astonishing Silver Seven.”

The Silver Seven, finest power amplifier in the world. \$8,750 each. Two required for stereo. Tube counters note: The 15th KT88, 6550A is a voltage regulator.

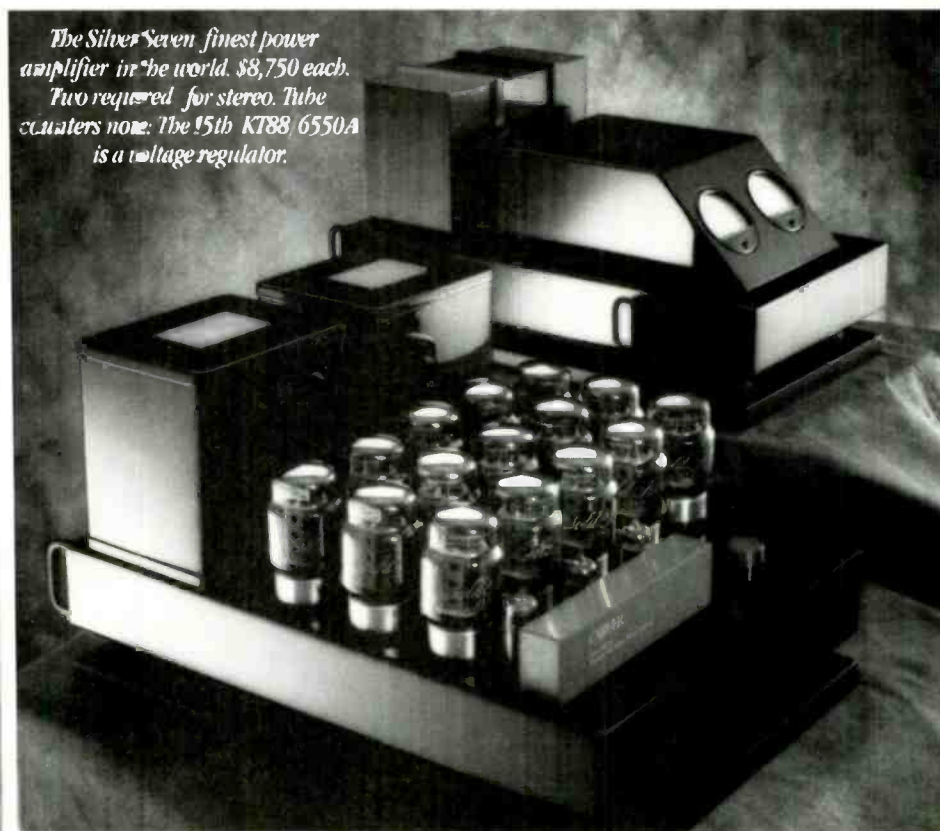

Before you meet the new M-4.0i, Bob Carver wants you to meet its inspiration, the money-is-no-object Silver Seven.



Bob Carver

“One of my important design precepts is that power amplifiers should be easily affordable but last year, when I began designing a powerful new amplifier, I temporarily set aside that precept of affordability. The result is the Carver Silver Seven Mono Power Amplifier.”

Destined to redefine ultra-high-end values forever, the Silver Seven is truly a “money-is-no-object” design. In fact, just a single pair of its fourteen KT88, 6550A Beam Power output tubes cost more than some budget amplifiers.

The Silver Seven employs classic, fully balanced circuit topology and the finest components in existence.

A-450 Ultra Linear output transformers with oxygen-free primary leads and pure silver secondaries.

- *Wonder Cap capacitors throughout.*
- *Interconnects are Van den Hul Silver.*
- *Internal wiring is pure silver.*
- *Wonder Solder throughout.*
- *Gold input connectors and high current gold output connectors.*

The Silver Seven’s polished granite anti-vibration base floats on four Simm’s vibration dampers. The separate power supply’s power transformer end-bells are machined from a solid block of high-density aluminum.

Capable of an astonishing 390 joules energy storage, the Silver Seven delivers *a conservatively rated 375 watts into 8 ohms from 20Hz to 20kHz with no more than 0.5% distortion.* On the 1-ohm tap, peak current is in excess of 35 amps!

Sonically, a pair (for stereo) of the flawless Silver Sevens almost defies description.

Powerful

Distributed in Canada by: *evolution technology*

“Because I wanted to share its magnificent sound with you we built the new Carver M-4.0t.”

The M-4.0t, identical transfer function and 375 watts rms, ch. at 8 ohms 20-20kHz with no more than 0.5% thd. Total maximum output current is 60 amperes.

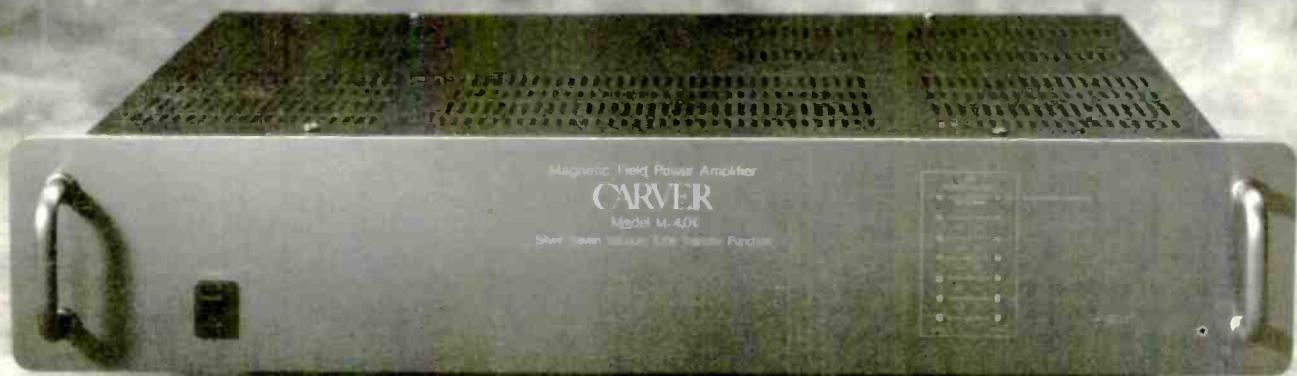

Superlatives are insufficient.

What does this have to do with the new M-4.0t?

Everything. Because the M-4.0t precisely duplicates the transfer function of the Silver Seven.

Ever wondered why two amplifiers of identical wattage can sound different? Or why two designs with different output ratings can sound much the same? In many cases, it's because each power amplifier exhibits a unique relationship between its input and output signals. Like human fingerprints, this *transfer function* is subtly distinct, defining much of the sonic character of the design. Bob has not only perfected the art of measuring an amplifier's transfer function, but is able to duplicate it in a completely dissimilar amplifier design! That's how he invested his solid state M-1.0t with the

transfer function of a set of \$5000 esoteric tube amps several years ago.

This time he's gone one better. Or two.

He's used this powerful scientific method to duplicate the transfer function of the Silver Seven in the new M-4.0t (now you know what the "t" signifies). Mind you, we are not saying the M-4.0t is *identical* to a pair of Silver Sevens. An M-4.0t weighs 23 pounds versus the Silver Seven at 300 pounds a pair. The Silver Seven stores 390 joules of energy while the M-4.0t stores none. As a Magnetic Field Power Amplifier the M-4.0t instantly draws the power it needs directly from the AC line.

Though in choosing the M-4.0t you may miss the warm glow of the Silver Seven's silver tipped vacuum tubes reflecting in polished black lacquer, be assured both amplifiers are the most musical, effortless, and open sounding you have

ever heard. Bass is full and tight, midrange is detailed, treble is pure and transparent.

Each can float a full symphony orchestra across the hemisphere of your living room with striking realism.

Bob Carver developed this incredible design for one reason: to bring you the best the world has to offer and the best amplifier value ever, and he has succeeded handsomely.

Listen to the new, incredibly affordable M-4.0t at your nearest Carver dealer. Or write us for more information. We'll even send you data on the Silver Seven. After all, if you ever want to move up from the M-4.0t, there's only one possible alternative.

CARVER

FM in China

Dear Editor:

I really enjoyed Robert Angus' wonderful article, "Audio in China: Hi-Fi Takes a Great Leap Forward" (April). Some of the changes he describes are surprising, even to me, a graduate student who left China only about four years ago.

However, Angus mentions more than once that FM stereo does not exist in China. This is not true. Years before I came to the U.S., there were FM stations in the capital cities of most provinces, operating a few hours each day. When I visited my parents in the summer of 1987, I even heard FM broadcasts in some less important cities and more than one in Shanghai.

I agree with Angus that LPs and turntables may gain popularity in the near future. The main obstacle now is the price. Imported LPs, mostly from Deutsche Grammophon and similar labels, cost 40 to 50 yuan each. That is about one-third of a month's income for most people. However, I did see a domestically made LP selling for 15 yuan, though this is still relatively high.

If the labels exporting to China, or prospective exporters, can arrange to sell for about half the current price, I am sure there will be a much higher demand. This is still plausible since the large sales volume will compensate for the price drop—at least I believe so. I hope this opinion is of interest to some recording or equipment companies.

Mingchang Jiang
Waltham, Mass.

Author's Reply: Whenever a writer travels to a country as different as China, there is a temptation to think that eight days make one an expert, and to assume that what one sees is somehow frozen in time. In China, I found no equipment which contained an FM band. When I asked why, I was told that there was no need for it, except for export. Before I wrote the piece, I checked the *World Radio TV Handbook*; it lists AM and short-wave frequencies for China but no frequencies for FM. I have subsequently been informed by the Chinese Embassy in Washington, D.C. that there are FM broadcasts in Beijing and other major cities. I apologize for inadvertently overstating the case.—Robert Angus

M & K Is Très Okay

Dear Editor:

Seven years ago, I purchased a pair of SV-200 tower speakers from Miller & Kreisel. I like to hear and *feel* my music. In my enthusiasm, I finally managed to open a midrange voice-coil. (In other words, I accidentally blew the midrange.) I phoned M & K and spoke to a very pleasant, helpful technician. He explained that my particular midrange was no longer available but said he would be happy to update both speakers with M & K's new midrange. He also assured me that my SV-200s would sound the same as when they were new.

My speakers were returned to me with new midranges, a new tweeter, new dust caps on the subwoofers, spotless cabinets—even new M & K emblems on the grilles! The speakers had their original great sound, and I was charged only a small amount for the one midrange I fried.

I thought other *Audio* readers should be aware of the outstanding service and superior product from M & K.

Timothy Stinson
Ventura, Cal.

Audio FYI

Dear Editor:

Surely Edward Tatnall Canby's trials and tribulations converting that mystery tape given to him by his local historical society could have been alleviated if he had consulted a hi-fi expert ("Audio ETC," June). Did you run this column just to see if we were listening?

I have never read an article with so much emphasis on what the writer didn't do, know, or have. He sounded like he was consulting *The Audio Farmers' Almanac*. The Connecticut area has many audio professionals whom Canby could have asked to ponder this obviously major dilemma. I qualify and volunteer.

First, identify the format. Get some notch filters/equalizers and compressors, and maybe even get a de-esser for a kick. When bouncing to tape for editing, some noise reduction might be fun. A combination of equalization (voice is easy to isolate) and compression/limiting will make the words clear and the levels even. De-essing isn't usually needed because equalization, for this application, has a lower "point"

than where sibilant sounds usually "live." Editing will make for more coherent listening. If you must use tape (yech!), noise reduction helps; my preference would be Dolby SR. I would also transfer the old tapes to DAT, then compress, equalize, and edit/sequence while going to another DAT. This gives you a nondegradable master for cassette duplication.

If all of this sounds like overkill, that's because it's "like" professional.

Tom Christopher
New York, N.Y.

Electro Ecstatic

Dear Editor:

Having been impressed, but not convinced, by what I've read and heard about electrostatic loudspeakers over the years, I was compelled to purchase an abused and orphaned set of Acoustat Three ESLs at a price I could justify for an experiment. When I got them home, I disassembled, inspected, cleaned, and reassembled the speakers before testing them. Under test, I saw some problems with the left panels, but the problems weren't pronounced so I let them go for a while. I literally spent months experimenting with room placement. I think it was six months before I arrived at that "magic" location. Suddenly, there was no doubt I would be keeping these speakers for a long time.

Over the course of another six months, the love affair blossomed, but at last I felt I could part with the speakers for a while. I had already been in touch with Acoustat, who *knew* that the speakers had been physically and electrically abused and that I was not the original owner. Nonetheless, they seemed eager to address the problems I had discovered.

I shipped the panels to the company for their inspection, sending all six panels on their recommendation. In the meantime, I had arranged for a carpenter friend to build new frames while I went through the transformers. It was a busy time, but on the few occasions I listened to music, my Acoustats were sorely missed.

After four weeks, Jonathan Hart of Acoustat contacted me. He said the testing was over, and they didn't feel *any* of the panels were performing to spec so they had decided to replace

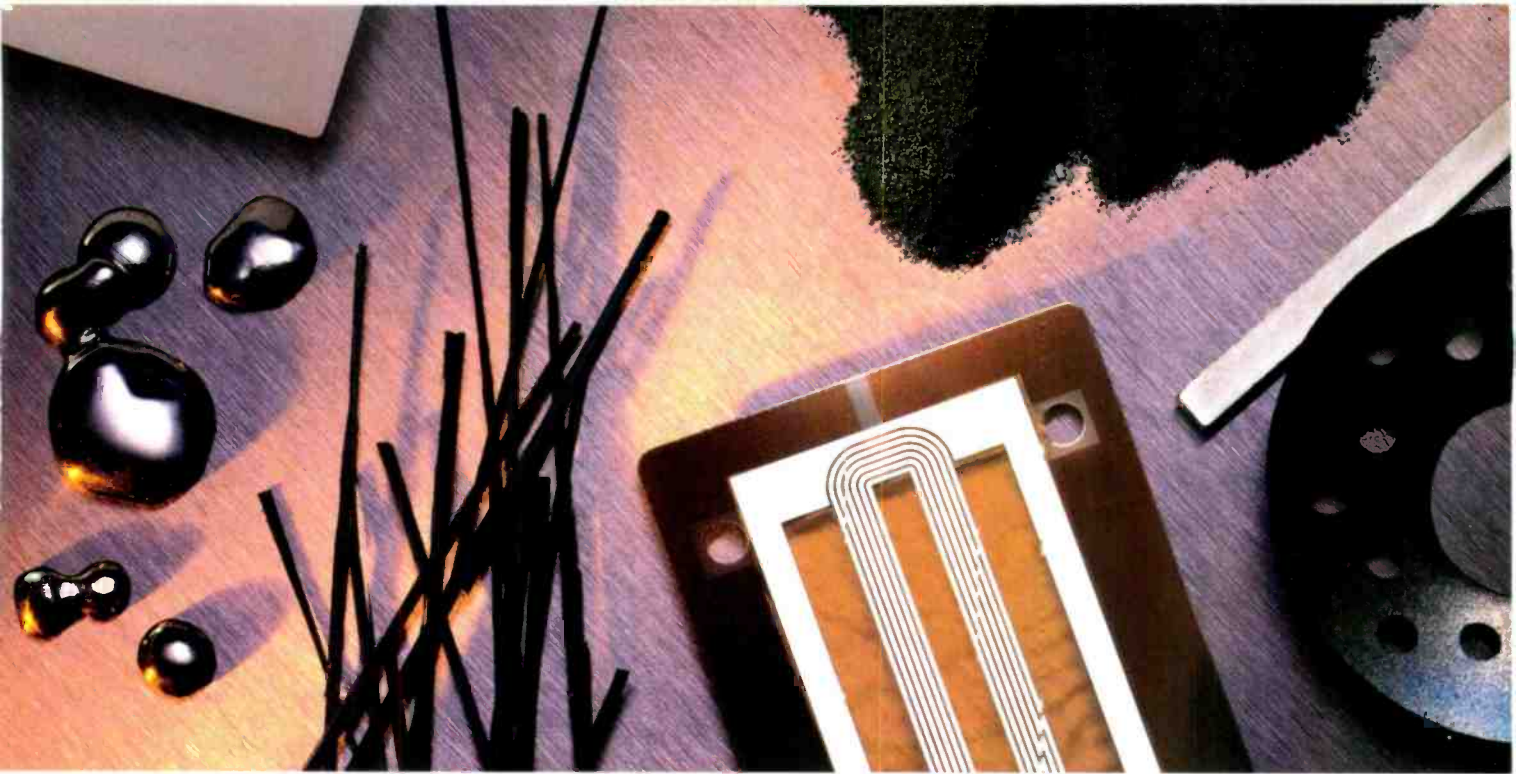

An earful of new technology.

Looking at them, you'd never suspect that carbon graphite, kapton and polypropylene are all that musical.

But in the hands of our engineers, these disparate materials are transformed into the most positive proof that the State of the Art in loudspeakers has dramatically advanced.

Introducing the new RS Series by Infinity.

These six speakers embody everything we know about the physics of transforming exotic plastics and rare-earth metals into music.

Their technology is without peer. Their drivers are unlike any you've seen or

heard before. Even their cabinet profiles were shaped by our understanding of the behavior of soundwaves.

And yet, the RS Series wasn't created for the money-is-no-object audiophile.

Its price range of only \$85 to \$530 per speaker

puts the RS Series well within the reach of most people who simply love listening to music.

Come hear these phenomenal new speakers now at your nearest Infinity dealer. And be prepared for an earful like you've never heard before.



 **Infinity**

We get you back to what it's all about. Music.



LISTEN UP A BLUE STREAK

Use AudioQuest Blue speaker cable — it will make you think you are hearing your favorite music for the first time.

AudioQuest Blue uses surface-only conductors. This technology was previously available in only our most expensive cables. A surface-only conductor has a single layer spiral of strands around a non-conductive core. Every strand is always on the surface and every strand has the same electrical values. Skin-effect induced distortion is eliminated, current does not cross between strands and magnetic interaction is greatly reduced.

The result is a cable that sounds much more dynamic, dimensional and focused than the competition's. The mid-

range and highs are sweeter, more extended and less "confused" sounding, while the

bass is tighter and better defined.

So, replace your current cables with AudioQuest cables and rediscover your entire music collection. Call today for the AudioQuest dealer near you.

audioquest[™]

Tel: 714/498-2770 Fax: 498-5112
P.O. Box 3060
San Clemente, CA 92672 USA

Given the stratospheric volume levels at rock concerts, I'm surprised bands don't sell earplugs that sport their logos.

them all. A couple weeks later, I received six beautiful new panels. My carpenter friend had done his homework, and the panels fit perfectly in their new solid-oak frames. I hooked up the transformers and sat back with some new music I had been saving for this moment. The magic was back, with even greater authority, and the visual impact was the icing on the cake.

I wish to stress that Acoustat charged absolutely nothing for their efforts and even returned the new panels to me with the shipping prepaid! I have had good experiences with a number of manufacturers, but I have never experienced this type of service and dedication before. Acoustat and the few other companies who offer such extraordinary service should be recognized for their commitment to music reproduction and to their customers.

Jerald R. Cook
Colorado Springs, Colo.

Turn It Down

Dear Editor:

As a follow-up to R. H. Coddington's letter on volume levels at rock concerts ("Signals & Noise," March), let me add the following measured average values: Van Halen, 117 dB from row 30, indoors; Beach Boys, 105 dB from row 20, outdoors; Iron Maiden, 122 dB from row 40, indoors; Motorhead, about 130 dB (they overloaded the meter!). Needless to say, I wear earplugs at these events. I agree that new P.A. technology has gone much more toward increasing volume than bettering sound quality—even, sadly, with jazz artists like Miles Davis (107 dB), who sounds worse because of this. I'm just surprised bands don't merchandise earplugs with their logos silk-screened on the sides.

Ralph Haddock
Aurora, Ill.

It's Only Rock 'n' Roll . . . But I Don't Like It

Dear Editor:

I wish Gordon Pyzik had not used the word "music" when writing ("Signals & Noise," March) about how rock and pop music sounds on speakers reviewed in *Audio*. He should have just said rock and pop, and let it go at that.

The stuff Pyzik is referring to is composed by "composers" who don't

know a diminished seventh from an empty fifth. It is played mainly by guitarists who have learned three chords and one rhythm. When they want to change the sound, they have to hire another guitarist.

The vocalists of these groups scream lyrics that don't rhyme and seldom have any redeeming social value. Plus, they scream at the top of their lungs, in spite of the fact that they are going to be amplified to jackhammer levels before they reach the audience's eardrums. There is some poetic justice in the fact that the ability to hear high-fidelity sounds is soon greatly impaired in players and audience both.

Using the kind of speakers that are usually reviewed in *Audio* to play rock "noise" to a hearing-impaired audience is certainly a waste of money. Adequate speakers can be found at any flea market for a price that will remove some of the sting from the cost of replacing overdriven cones.

John B. Ona
San Diego, Cal.

Another Fine Fix

Dear Editor:

I would like to acknowledge the excellent service I received from Jung-Childress Audio & Electronics. Recently, I purchased a Pooge-4+ modification kit for my Magnavox CDB-560 CD player. I had a problem while installing the kit, and Walt Jung was extremely helpful in resolving it—even though the problem was caused by *my* error during part of the installation. (Jung-Childress will also install this kit for a nominal charge.)

Once my CD player was working properly, the transformation of the sound from the stock player to the modified one was remarkable. My "new" machine is dramatically superior to the stock player in all areas of performance. In comparative listening, it now outperforms friends' units that are much more expensive.

It is a pleasure to relate a positive experience about an audio company which has such concern for its products and customers. For anyone who is interested, the address of Jung-Childress Audio & Electronics is P.O. Box 36141, Towson, Md. 21286.

Barry Kohan
Woodland Hills, Cal.

IF YOU COULD ONLY HEAR THIS AD



Through Our New Electronics

Counterpoint's "New Generation" tube circuitry uses solid-state devices in a support role. Our SA-3000 pre-amplifier gives maximum performance: tube musicality plus solid-state reliability. Team it up with our SA-20 power amp — a tube/solid-state powerhouse that provides 220 watts per channel. Then experience the closest re-creation of a live musical event; the three-dimensional depth of a holographic soundstage, see-through clarity, dynamics, and musical truth.



SA-3000 PreAmplifier

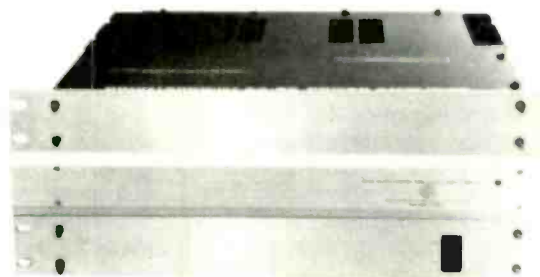

Counterpoint SA-20 Power Amp



COUNTERPOINT

The New Generation of Tube Electronics

2610 Commerce Drive, Vista, CA 92083 • Call 800-266-9090

Enter No. 10 on Reader Service Card

FILE QUIRKS



Illustration: Yvonne Buchanan

Lately, I've been cleaning house and throwing out, not wishing quite yet to join the Collier brothers. About time, after more than 42 years with this magazine! What an accumulation of *stuff*—that's the safest word for it. For all these years, I have kept this *stuff* safe and dry in my dwelling places, and now, you might say, I am awash in it. Old audio equipment, yes. But much more prominently, yard after yard of solidly stacked *paper*, valiantly filed and filed and *filed* in case of future need. What need? That's always the question, and the answers keep changing.

I ran out of big metal file cases on roller bearings years ago and turned desperately to old cardboard cartons. Now they are everywhere—corners, desk, table tops—and not only do they bulge, but they burst, the files spewing out. It's terrible. I *am* a Collier brother. Or will be soon. The inflow continues.

Throw it all out quick? Ah, the easy solution, the sort that unmakes history in every age. Junk? Who ever knows? if you have a conscience, you do not throw out quick. So with a conscience, and interest, too, I am a squirrel. I keep. On a chance.

It's like those lottery tickets with the odds printed right on them. One

chance in 40 million? Go for it! I just cannot miss the chance of *some* value in all that stuff—or throw out the enormous effort it symbolizes, over the years, without even a look-see. Yes, 99% is indeed and indisputably left-over junk. Reams of invoices, memo sheets, bills of lading (1959), tattered instructions for nonexistent equipment, routine business notes in standard format, plugs galore: "*Dear Sir or Madam, I am about to introduce you to the greatest hi-fi sound you will ever experience, brand new for 1961. . . .*" A bloated mass of triviality, long departed, and long may it rest in oblivion!

Yet in the middle of all this is the other stuff, extremely well dispersed and easy to miss. The older world of audio itself, alive and strong. It's bad enough to junk all the labor I did in answering 1,000 letters, along with my slaving and highly intelligent sec'y, who typed, filed, typed, filed, year after year so neatly, until she went on to better things. Beyond our efforts, there are those other souls who return to life—if I pause a moment in sorting—almost stifled among the invoices. Every so often, one of them suddenly *communicates* out of the past—or so does a colorful leaflet—to persuade, to inform, to offer useful thoughts, ideas,

and explanations, or just to kibitz. This is our world in the very shaping, moment by moment, back then. How can I junk it? I mean, sight unseen.

If I do not cope with this philosophical problem, a large dump truck will eventually do the job for me.

Only last year, screwing up my courage, I made a start. I opened up a lowly "Small Business" file, company by company, and pulled the dusty folders out one at a time, just to see what I could do. Mostly a batch of silly or routine products, the predecessors of the routine products of today. So the work went fast. In a long evening, I got through about 2 feet of files and saved only about 2 inches. But there were items to give me brief pause, even here. Sprightly letters from the founders, the chief engineers, the sales reps. I rescued a little bit of each of them, and it felt good! Only 24 yards of file to go. The junk slid neatly into the compactor chute of my New York City apartment building.

In my Connecticut home, things are not so simple. The cardboard boxes were, for a time, a brilliant idea—economical, space-saving, efficient. But cardboard is not for the ages, even my age. Now the spewing is relentless. If I lift a box, the bottom falls out or the sides collapse. On the floor, I stumble on one and out pour 1,000 pages, jumbled. Ants get into the cardboard tunnels; spiders weave sticky webs. Buy expensive metal cases for *this* stuff? Not before reducing the sheer mass, thank you. And by a lot.

I am no file man. My mind is much too inventive, my memory too short. I can think of a dozen heads under which every item could go—then I forget which heading I chose. To file is to lose. Thus, any recent stuff that seems important is left out, where it remains visible (until buried by more "visible" material).

The persistence of time annoys me. I have folders marked "Current Letters" to keep myself up-to-date. Another file follows and another "Current." Straight in front of me, as I write, I see a folder (in a new cardboard box) marked "AUDIO Letters—Lately." How "lately," I will not tell you. Behind it is another that just says, "AUDIO." Then there is "Recent AUDIO Correspondence." Should I go on from that to "More Recent"?

“Line protection - you can pay a little for it now, or you can pay a lot for it later.”

—Ken Pohlman, *AUDIO*,
November 1987.

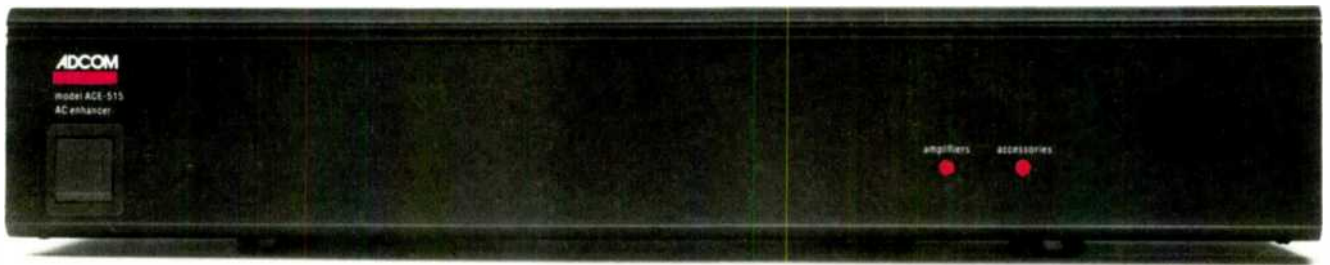

Regardless of how sophisticated your stereo and video system is, it may never achieve its full potential if plugged directly into an AC outlet. Raw and unprocessed AC power can severely diminish the clarity of audio signals and reduce the resolution of your video picture. Harmful high-voltage spikes and surges can also damage your valuable equipment.

The ADCOM ACE-515 AC Enhancer significantly improves the performance capabilities of your system by filtering and processing raw AC power, unveiling a pure, noise-free power source. And, it protects your components from harmful line voltage disturbances.

Listen To The Critics

“Electronic equipment (especially digital audio gear) is vulnerable to both annoying and catastrophic power-line problems. Your stereo gear should have line spike and surge protection, with hash filters thrown in too.”

—Ken Pohlman, *AUDIO*, November 1987.

“. . .the effective suppression of AC ‘RF hash’ by the ACE-515 improved clarity and lowered noise in all three CD players. . . .the significant improvements in instrumental and vocal harmonic retrieval and hall ambience are superb. . . . it simply appears to allow musical information to be passed through to the listener with less veil and electronic ‘haze.’ ”

—Lewis Lipnick, *Stereophile*, Vol. 11 No. 4, April 1988.

Recommended accessory in *Stereophile*, Vol. 12 No. 4, April 1989.

For a modest investment, the ADCOM ACE-515 enhances both audio and video clarity while protecting your equipment. Once again, ADCOM lives up to its reputation of offering superior performance at a reasonable cost. For complete technical data, please visit your Adcom dealer. You’ll discover the ACE-515 is more than an accessory.

It’s a necessity.

ADCOM[®]
details you can hear

the *Soundcraftsmen* STORY



SECTION OF PRODUCTION AREA IN MAIN PLANT



One hundred percent quality control is seen on EVERY unit manufactured. EVERY completed unit is electronically tested for specification accuracy and then EVERY unit is connected to a high fidelity system and listened to—just like you would at home. If your unit meets or exceeds the critical standards set forth on these tests, it is then packaged for shipment.

INDIVIDUAL CERTIFICATE OF PERFORMANCE WITH EVERY AMPLIFIER



Soundcraftsmen celebrates its 20th year of manufacturing audio components for the discriminating audiophile.

Soundcraftsmen engineers are highly respected in audio design circles as being very forward thinking, yet practical, when engineering new products, by using proven design principles from the past with tomorrow's technology.



From the finest equalizers, the most accurate analyzers, to the unique preamps, to the revolutionary Class H and Power MOSFET amplifiers, you cannot purchase finer audio components.

The next few pages will answer many of your questions. If you have more, our customer service department will be pleased to assist you by telephone or letter. We invite your questions and appreciate your interest.



Soundcraftsmen NEW -17" separate components are guaranteed to improve and enhance any fine audio system's performance . . .



...If you want to upgrade your present system, whether stereo receiver, audio/video receiver or separate components, a high powered amplifier will give you the most dramatic improvement. MOSFET amplifiers ...205 w/p/c at 8 ohms, 300 w/p/c at 4 ohms. Audio magazine Test Report by Len Feldman says, "You can spend five times as much as what this amp costs, but you won't get a better, more reliable, or more musical unit." Circle Reader number for complete review.



Our "Control-series" preamplifiers are a virtual patch-bay of features, plus Digital C-MOS switching for the quietest, lowest noise and distortion sound reproduction you can buy. Auto-Bridge circuitry triples system power...Direct mode bypasses tone controls and signal processing section. Audio magazine Test Report says, "...superb engineering and dedication to user convenience and product flexibility." Circle Reader number for complete review.



DIGITAL QUARTZ PLL AM/FM
Stereo Tuner... 16 Memory station presets... AM Broad band improves frequency response of AM broadcasts... Super sensitive and quiet tuner pulls in even the most difficult stations... "Auto Mute" for inter-station noise-free tuning.



Exclusive **DIFFERENTIAL COMPANDER** circuit means this is the only Disc player that allows cassette dubbing without overload, and allows listening to CD's on a background music system without losing the low-level passages.

The World's Finest Stereo Components
Are Still...**MADE IN U.S.A. !**

Soundcraftsmen

FREE!

\$19.95 SYSTEM EVALUATION KIT includes 1-12" LP Frequency Spectrum Analysis test record 2-sets of Computone Charts, 1-Connector Cable for comparison test, 1-instruction folder. WRITE TO US FOR FAST ACTION, OR CIRCLE READER CARD, and we'll send you FREE SPECIAL OFFER DETAILS, and 16-page COLOR BROCHURE.



Audio

**BOUND VOLUMES
BACK ISSUES
BINDERS/SLIPCASES**



BOUND VOLUMES Great Reading, Great Price!

A ready reference for audiophiles! A full year of AUDIO is carefully hard-bound for easy reference. Complete volumes for the years 1979 through 1984 are available. Only \$24.95 including shipping and handling.

TO ORDER:

Indicate year(s) requested and send check or money order, NO CREDIT CARDS, to: AUDIO Magazine, 1515 Broadway, New York, NY 10036, Attn: Bound Volume Dept. Allow 4 weeks for delivery.

BACK ISSUES

Single-copy back issues of AUDIO from 1983 through current issue are available. (Note: April, August, and October 1983 are unavailable.) \$5.00 per issue postpaid.



BINDERS/SLIPCASES



Maintain your AUDIO collection in these top-quality binders or slipcases. Binders, \$9.00 each; 3/\$26.00; 6/\$50.00. Slipcases, \$7.65 each; 3/\$22.00; 6/\$40.00. Include \$2.50 per order for postage and handling.

TO ORDER: Indicate issue/binder/slipcase. Include proper amount for postage and handling. Please add your applicable sales tax. Allow 6-8 weeks for delivery. Make check/money orders payable to: Audio Magazine, P.O. Box 765, Holmes, PA 19043. DIRECT TOLL-FREE ORDER NUMBER: 1-800-345-8112. Use your Visa, Mastercard or American Express card. \$10.00 MINIMUM CREDIT CARD ORDER.

I am no filing man. My mind is too inventive, my memory short. I concoct dozens of title ideas for each file, then forget which I chose.

To be sure, I've made one improvement of great psychological significance: Instead of recycling the paperwork, I recycle the folders. When I run out of them, I just *have* to get to work on another cardboard box—to retrieve its folder content. This adds urgency to my task, something I deeply require.

I am assisted in the accumulation of ever more *stuff* by those who, obligingly and innocently, copy off and send to me all sorts of paperwork of *real* audio importance, industriously complete, at length, and in bulk. No complaints! Very helpful and interesting. A fine example, a couple of years back, was a whole fat set of proprietary newsletters, around 1935, from that pioneer hi-fi maker E. H. Scott not (H. H.). In those distant years, older readers will remember, Scott built an astonishing "radio phonograph," with specs that stand up remarkably to this day. Quantities of big tubes, for versatility and to build up power, AM radio with variable bandwidth so you might choose wide-range hi-fi or long-distance precision reception. No FM; it wasn't around. Neither were solid state, integration, or digital. I was sent four or five of these well-written newsletters—publicity, but on a reasonably high level. I was so intrigued by their voice from the hi-fi past (using the term high fidelity even then) that I sent them on to Technical Editor Ivan Berger. Dutifully, he copied them and sent them back, and I filed them away—all 2 inches or so. Only I forget just where I filed them.

Two readers sent me off-copies of the original print face on an LP made by Virgil Fox playing the famed Wanamaker organ in Philadelphia. The LP, I knew, was way back, and I remembered having played it; now it had been refashioned, with some debatable tonal adjustments, on CD. My copy was not to be found (no doubt on "permanent loan"), and on it was the proper information I would have liked to have around. Thanks, then, to readers Robert Baker of Humboldt, Iowa and Lewis Millett of Kensington, Md.

Another major category of old files is not companies but *subjects* of some special continuing interest. Wow, are these revealing! It's always my habit to collect anything and everything I see that relates to such a category, especially if I may one day be writing about

it. This includes not only company handouts but all sorts of ads, newspaper articles, pictures—anything even marginally apropos. Bulk! But I can use it. Thus, the other day, I hauled out an old "Binaural" file, about 3 inches thick and dating mostly from my first years of interest in that subject in the 1950s. True binaural—that is, recording and playback of two-channel material for 'phones, each channel going exclusively to one ear.

As to binaural recording, after 35 years I do not perceive any significant breakthrough, in spite of dummy heads, mini-mikes, JVC, Sennheiser, Bob Carver, and John Sunier. Plenty of highly technical and expensive research and large doses of wishful thinking, I say. (At last, you hear it out *in front!*) My 1952 binaural sounds much the same as the very latest. But on the playback scene, there was a huge and paradoxical breakthrough—the tiny Sony Walkman, with its miniature 'phones, and all the millions of its successors.

The paradox is, very simply, that the sounds we listen to on those fabulous players are almost never binaural in the mike pickup. Instead, they are stereo—two channels designed for two loudspeaker systems. Yes, we *hear* them in binaural, each ear with its own channel. But we love the altered stereo sound! So why bother with special binaural recordings?

Anyhow, in my voluminous "Binaural" file is an astonishing collection of forgotten audio, if you can call it that—notably, the addition of the first soundtracks to 8-mm home movies. To my surprise, this was, for a time, a very big thing, a real craze. Everybody was in on it, with competing products and all the normal hype: "Now you can Thrill to the sound of your Child's Immortal Words." Fantastic—such enthusiasm!

Just think, *four whole minutes* per expensive roll of 8-mm film, a fancy new camera with turret lenses (no zoom), an elaborate projector, and a mono soundtrack, probably not very good. *That* didn't stop anyone. This was the sensation of the early '50s and on, as my file easily proves. The LP was only four years old; magnetic recording, at least in public, was brand new. The pictures weren't even Super-8, just the old 8-mm film on small reels,

● BRYSTON'S INTERNATIONAL ACCLAIM

Bryston for over a quarter century has dedicated itself to the recreation of the musical performance. Here is what a few of our critics have to say about Bryston products:

"The way in which orchestral peaks were handled indicated that the Bryston .5B/2B combination's control over dynamics and attack was very impressive indeed."

Paul Miller
The New Hi-Fi Sound, Britain



Bryston 12B preamplifier

"Overall tonal balance of the system was beyond reproach, and I was particularly pleased with the clean, smooth reproduction of high frequencies using the Bryston .5B preamplifier."

Leonard Feldman
Audio Magazine, U.S.A.

"I would say that the LP playback qualities of the 12B with either moving coil or moving magnet cartridges are state of the art. I have not heard better from other more expensive amplifiers."

Andrew Marshall
Audio Ideas Guide, Canada

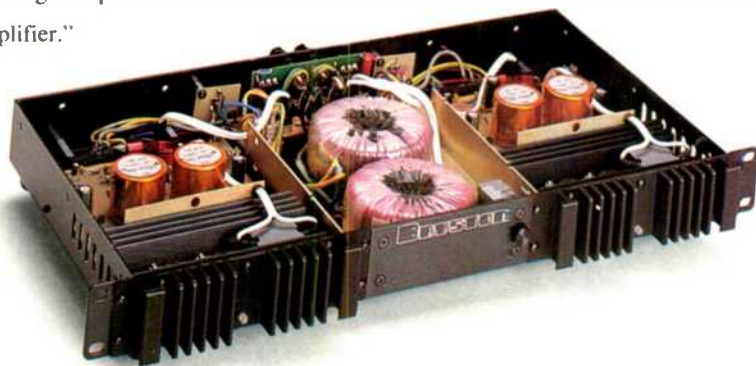

Bryston 2BLP power amplifier

"Simply put the Bryston 2B is a giant killer, one of the finest amplifiers on the market."

Gerard Rejskind
Hi-Fi Sound, Canada

"The recreation of ambiance is superbly spacious and gives an impression of pushing back the walls of the listening room. Symphonies and large orchestras are reproduced with extreme realism thanks to the wide stereophonic effect."

Revue De Son
France



57 Westmore Dr., Rexdale, Ontario, Canada M9V 3Y6 Telephone: (416) 746-1800 Telex: 06-989548 Fax: (416) 746-0308
Brystonvermont, RFD#4 Berlin, Montpelier, Vermont 05602 Telephone: (802) 223-6159

Enter No. 7 on Reader Service Card

As to binaural recording, after 35 years I see no significant breakthrough, just expensive research and much wishful thinking.

not cartridge, recorded on 16 mm twice through like today's audio cassettes. The film was then split to 8 mm in the processing, the two halves joined sequentially.

All the big names were in on it. "Now hear what your home movies have been missing," says Fairchild. "Only

Fairchild takes pictures that talk." That is a revealing bit. Most of the 8-mm sound was audio applied afterwards, not simultaneous with the original filming. Added commentary, musical backgrounds, very much as we know this kind of thing today. But not really a home-movie talkie.

The double talk on this basis was clever enough. "How would you like a good sound recorder that also shows movies?" asks Kodak. "Just take your pictures and send them to us for the Kodak Sonotrack coating. Project with the new Kodak Sound 8 projector, and into the little microphone speak your comments." Whimsical but a wee bit evasive, I'd say. You did not take sound pictures with Kodak. You did with Fairchild.

Also Eumig. "Sick of Silents?" asks Eumig. "Are you a disillusioned home movie producer? Does your audience doze quietly through your greatest epic?" If so, you are supposed to wake them up with the new Eumig Model C5, the camera that takes pictures you hear as well as see. This one, you discover, uses a separate, synchronized tape recorder, the Model T5. And, of course, you had to have a sound/picture projector to match, plus an amp, a speaker, and a screen.

Another flyer plugs the Elite "Talkie" projector and a film-stripping service somewhat like Kodak's. And many more of the same. Such an effort and expense to produce sound from those four-minute rolls of film! A comparison with today's camcorder is inevitable. What immortal sounds do we record with our camcorders? Mostly, we ignore audio. Hour after hour.

The strangest device I found in this old file was a home system, 6 pounds and portable, that applied a liquid magnetic "paint" stripe to your 8-mm films, right in the living room. Dried in a minute, ready for recording and erasing. The Argus Syntronic 8-mm Soundstriper. Just pop the film into the Penn Cinesone Sound Outfit, a fancy projector with amp and speaker, and you had sound movies for \$99.50. (Read, \$900 today.)

All this, for me, had binaural potential—if only there were two stripes and two channels. It was possible because there was the Movie Sound Eight Projector of 1952, as noted in a mag called *Audio Engineering*. It provided two separate channels of audio playback from 8-mm film. *Binaural!* That's what I thought. New worlds to conquer, right and left? They are still unconquered.

You want me to throw *this* file out? Not on your life. Or mine. 

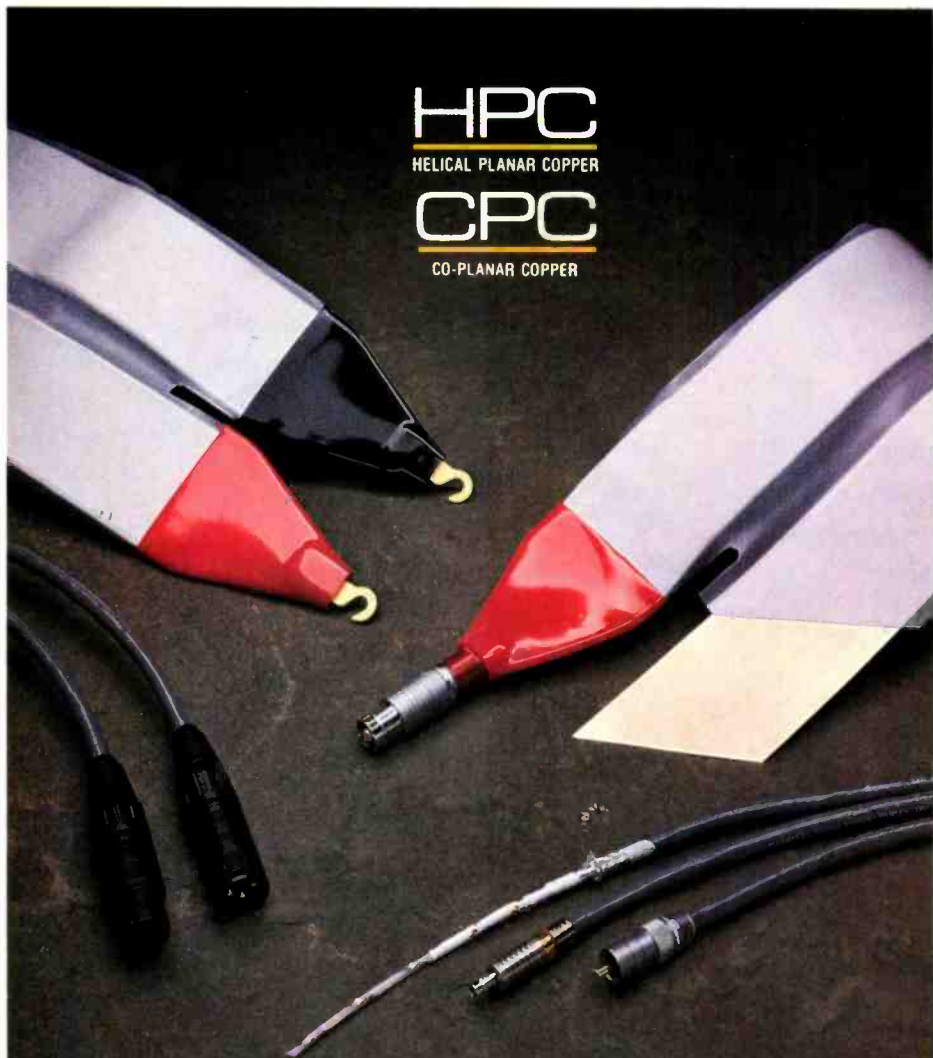

Over two years ago the staff at Madrigal Audio Laboratories began accumulating convincing evidence that solid conductors of rectangular cross-section would do a better job of carrying musical signals. Years of listening and engineering tests making use of ribbons of specially processed, high-purity copper with teflon insulation and the highest quality terminations, have resulted in the new Madrigal HPC and CPC cables.

Visit your Madrigal dealer and hear what these original designs can do to improve your music system.

HPC and CPC cables are designed by, and manufactured exclusively for Madrigal Audio Laboratories, P.O. Box 781, Middletown, CT 06457 ITT TLX 4942158

At nearly \$50,000 and 428 lbs.,
our Multitrack Recorder
would definitely be impressive
in your living room.



The Studer A827 24-track Studio Recorder with Autolocator and Audio Remote Control.

See page 36
for the Revox dealer nearest you.

BERT WHYTE

WHAT PRICE GLORY?

The year was 1943. I was in the army, attached to the 114th General Hospital in Fort Bragg, N.C. I was on night duty in the clinical lab, a lonely vigil, listening to a table-model radio. Tube, of course, with the sound emanating from a 5-inch speaker which might have cost 50¢. I was very frustrated, because all I could seem to tune in was the incessant twang and melancholic ballads of country music—not too surprising, considering my location. Country music, I freely admit, is not my cup of tea. I nudged the tuning control a little and was stunned to hear the distinctive, instantly recognizable high-register bassoon passage that opens Stravinsky's "Rite of Spring."

The radio had a frequency response of perhaps 200 Hz to 2 kHz, liberal quantities of distortion, and a dynamic compass of no more than 10 dB. Yet here was Stravinsky's gigantic orchestral canvas, evoking the primitive rituals of pagan Russia, reproduced through this absurd little radio. I reveled in every glorious moment.

More respite from country music could be found in the USO club, where a monster "Queen Anne" mahogany radio console sat. It had a 12-inch public-address speaker in its open-back cabinet, along with a puny little 5-watt amp tucked in a corner. A Webster-Chicago 78-rpm record player was included. Thanks to the generosity of RCA Victor and Columbia, a library of unwieldy, fragile, 78-rpm albums of classical music was available. We whiled away many an hour as the record player ground through such standards as the Beethoven Fifth, the Schubert "Unfinished," and the Franck D Minor, by the likes of Stokowski and Monteux.

Today's cheapest rack system is sonically far superior to that ancient radio, but at the time it was a godsend. Remember: In those days high-fidelity sound was still a distant dream. If one was familiar with classical music, the only reference was the concert hall. Needless to say, the old 78s we played in that USO club were a cruel caricature of the real thing. However, as always, the music survived the technology of the day. The structure could still be discerned, the melodies sweet on the ear, the beauty and spiritual exalta-



tion of the music endured in spite of its electromechanical maltreatment. . . .

The foregoing was prompted by a letter from a reader upset by several columns I had written on very sophisticated and expensive high-end audio components. "No one needs this highfalutin', chromium-plated, overpriced equipment in order to enjoy music," he wrote, and then went on to describe the decidedly low-fi audio components he has used for 20 years. He ended: "People who really love classical music can enjoy it on a cheap radio."

Of course, he is entitled to his opinion. I did not answer his letter, but perhaps if he reads this column, he will understand my views.

I can feel genuinely sorry for this fellow, and others like him, whose economic circumstances limit their choice of audio components. God knows I can empathize with this man, for I've always had a champagne palate and a beer pocketbook! But I'm forced to take issue with his berating of those who aspire to the better things in life.

We have an audio component industry offering an incredible diversity of devices whose common function is the reproduction of recorded music in all its formats. This equipment covers a price range from unbelievably cheap

to astronomically expensive. Overall, audio equipment is one of the few remaining bargains in modern life: Even very modest component systems offer reliability and sonic performance as good as, or better than, far more expensive systems of a decade ago. The very rich, it is well known, are among the poorest sales prospects for audio systems—mid-fi, high end, or otherwise. Far more meaningful a question to put to a prospective audio buyer than "How much money do you have?" is "To what degree are you committed to, and involved with, music?"

By no means are a system's price, or the size of one's wallet, the only criteria determining which components one chooses to buy. What about decor, space, and other environmental factors? Since audiophiles are mostly men, do the women in their lives resent audio's intrusive size and volume?

The average audiophile owns from \$5,000 to \$7,000 worth of components. For this kind of money, one can assemble a sound system that will reproduce music with quite remarkable fidelity. Audiophiles soon learn that improving system performance is an endless, frustrating, and expensive undertaking. In his heart, every true-blue audiophile secretly aspires to an ultimate

Illustration: Bob Scott

But so would our B100 Series.
And save you about \$47,000.



Much of the music you listen to is recorded on Studer studio equipment—like our multitrack master recorder on the previous page.

The Studer name is well-known, even revered, among many recording artists and record producers. Our professional studio equipment—multitrack recorders, mixing consoles, CD players, cassette decks—is found in the best studios and major broadcast facilities around the world. Why? Because the Studer name means superior quality, great sound and high technology.

The microprocessor technology, the intelligence behind our Studer equipment, is the *same* microprocessor technology that makes the B126 CD Player, B150 Integrated Amp and B160 FM Tuner so sophisticated, so logical and friendly to use. And, so utterly unlike conventional high fidelity components.

You may not need 24 tracks in your living room. But if you're serious about a world class home audio system built to professional studio standards—for *less than \$3,300**—then you need to take a serious look at the Revox B100 Series.

STUDER REVOX

Bringing professional components to home audio.

*Contact your select Revox Dealer for exact pricing.

Studer Revox America, Inc. • 1425 Elm Hill Pike • Nashville, TN 37210 • (615)254-5651

See page 36
for the Revox dealer nearest you.

REVOX SELECT DEALER DIRECTORY

SEE AND HEAR THE INCOMPARABLE 100/200S
SERIES AT THE FOLLOWING SELECT DEALERS

CALIFORNIA

Beverly Stereo, Los Angeles (213) 651-3523
Harmony Audio Video, San Francisco (415) 661-2525
Paris Audio, Los Angeles (213) 820-2578
Woodland Hills (818) 704-7677

CONNECTICUT

Audiocom, Old Greenwich (203) 637-3621

FLORIDA

Audio 2000, Hollywood (305) 962-5300
Boss Audio & Video,
Altamonte Springs (305) 332-9043
Dalton Audio, Clearwater (813) 447-0987
Sound Components, Coral Gables (305) 284-9360
Sound Performance, Coral Gables (305) 446-8055
Sound Plus Wood, Boca Raton (407) 391-1843

GEORGIA

Stereo Shop, Smyrna (404) 438-2423

HAWAII

20/20 Audio Video, Honolulu (808) 523-2020

ILLINOIS

Audio Consultants, Evanston (312) 864-9565,
Hinsdale (312) 789-1990,
Libertyville (312) 362-5594
Audio Enterprises, Chicago (312) 527-2252,
Chicago Heights (312) 754-6056
Belmont Camera and Electronics,
Chicago (312) 975-0280
Paul Heath Audio, Chicago (312) 549-8100
Victor's Stereo, Chicago (312) 787-0750

KANSAS

Kief's Records and Stereo, Lawrence (913) 842-1811

MASSACHUSETTS

Audio Studio Stereo, Brookline (617) 227-0111
Music Box, Wellesley (617) 235-5100
Natural Sound, Framingham (617) 879-3556

MICHIGAN

Hi Fi Buys, Ann Arbor (313) 769-4700
East Lansing (517) 337-1767
Lansing (517) 321-2373
Midland (517) 839-0972

NEW JERSEY

Sight and Sound, Morristown (201) 267-6700

NEW YORK

Gala Sound, Rochester (716) 248-8430
Innovative Audio, Brooklyn (718) 596-0888
Rosner Custom Sound,
Long Island City (718) 726-5600
Sound by Singer, New York (212) 683-0925
Thalia HiFi, New York (212) 371-2111

NORTH CAROLINA

Dacia Audio Video, Hickory (704) 324-5054
Stereo Showcase, Charlotte (704) 334-0744

PENNSYLVANIA

Audio Insight, Wexford (412) 935-8663
Canlen Audio, Bethlehem (215) 866-0728
David Mann Audio, Philadelphia (215) 922-3007
Stereo Outlet, Washington (412) 225-1292

TENNESSEE

Tenzel Audio, Nashville (615) 297-7400

TEXAS

La Frontera, Brownsville (512) 544-2554

UTAH

Audition Music, Salt Lake City (801) 467-5918

WISCONSIN

Salon One, Wisconsin Rapids (715) 421-5910
Specialized Sound, Madison (608) 271-7744

Studer Revox America, Inc.
1425 Elm Hill Pike
Nashville, TN 37210
(615) 254-5651

God knows I can empathize
with those whose means
limit their audio buying.
I've always had champagne
tastes and a beer budget!

audio system, cost no object. (The trouble is, there are some widely divergent opinions on just which components would grace this dream system.) One assumes that many of these music-loving folks read *Audio*.

These people, then, along with engineers and other professionals in the audio field, are my audience, and I must present my columns and record reviews to please most of the people, most of the time. (Or at least stimulate them to vent their spleen through the mails.) After all these years, I can tell you that *Audio* readers have very strong opinions. Naturally, I like the letters that tell me what a great guy I am and what wonderful stuff I write! I can honestly say that what criticism I get is usually constructive, but I do get some doozies from people who abrogate the laws of physics or believe they've reinvented the wheel.

I get a lot of interesting mail, for instance, about my CD reviews. Of course, many other publications carry CD reviews, and many readers compare reviews of a particular CD. For the most part, the letters I receive on CD reviews are concerned with the technical aspects of the recording. The common denominator in most of the letters is, "I don't hear what you are describing in your review of CD such and such, and neither does the reviewer in Magazine X." Quite often, the writer goes on to describe his audio system, and this usually furnishes a clue as to what he is hearing. (Of course, there is no way of knowing what audio equipment the reviewer in Magazine X is using.) With their ultra-wide dynamic range and ability to reproduce the lowest bass fundamentals, some CDs have, for example, organ-pedal notes in the range from 16 to 32 Hz, sometimes at whopping volume levels. The majority (yes, I said majority) of loudspeakers on the market cannot reproduce those frequencies, no matter what inflated claims have been made by advertising copywriters. If a party who writes me indicates he has speaker X, which I know falls off rather rapidly below 50 Hz, I gently inform him of this; for the most part, this is accepted with good grace. On the other side of the coin are those who not only resent what I have told them but actually suggest that I should use a more "aver-



age" system rather than my own state-of-the-art components.

This attitude reminds me of the old days, when we had Hi-Fi Fairs. I always made a point of using the very best source material in demonstrating audio components. Most of the time, I was able to use 15-ips Dolby A master tapes or first-generation copies of them. Some people accused me of having an unfair advantage. "Well," they would exclaim in high dudgeon, "anything would sound good with those tapes." When I pointed out that my tapes' wide dynamic and frequency range would severely stress most equipment, they were marginally placated. The real enthusiasts would have sold their grandmothers for a copy!

Of course, using a sound system that has subterranean bass response can be problematic, too. For example, most of the monitor speakers used in studios and on-location recordings do not have really extended bass response. As a consequence, the recording engineers don't hear many low-frequency sounds, such as hall rumble, mechanical noises, etc., which are faithfully reproduced on my system. There are also such problems as the more acrobatic conductors, like Bernstein and Solti, who stomp their feet on the podium for emphasis.

Using a less revealing component system that glosses over defects carries the penalty of submerging important musical detail. I am not willing to review CDs on equipment that cannot do full justice to the power and grandeur of the music. Yes, I can appreciate great music on a table-model radio—but the devoted music lover/audiophile wants the best! 

All this jazz

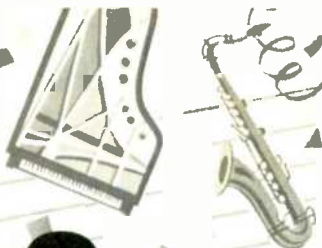

ANY 8 CD's FOR ONLY 1¢

Plus shipping and handling, with membership

POPULAR HITS

- Richard Marx—Repeat Offender (EMI)** 380915
- Beaches—Original Soundtrack (Atlantic)** 379669
- Gipsy Kings (Elektra/Musician)** 377812
- Debbie Gibson—Electric Youth (Atlantic)** 377275
- Roy Orbison—Mystery Girl (Virgin)** 377101
- Journey's Greatest Hits (Columbia)** 375279
- Traveling Wilburys Vol. 1 (Wilbury)** 375089
- Barbra Streisand—Till I Loved You (Columbia)** 374884
- Anita Baker—Giving You The Best That I Got (Elektra)** 374058
- U2—Rattle And Hum (Island)** 374017
- Enya (Atlantic)** 373712
- Tracy Chapman (Elektra)** 369892
- Steve Winwood—Roll With It (Virgin)** 371211

- Jimmy McGriff—Blues To The Bones (Milestone)** 380931
- Harry Connick, Jr.—20 (Columbia)** 379818
- Michel Camilo (Portrait)** 379107
- Dave Grusin Collection (GRP)** 378398
- Gerald Albright—Bermuda Nights (Atlantic)** 377903
- Tom Scott—Flashpoint (GRP)** 377044
- Vangelis—Direct (Arista)** 376756
- Lee Ritenour—Festival (GRP)** 376301
- Fattburger—Living In Paradise (Intima)** 376277
- Al Jarreau—Heart's Horizon (Reprise)** 376186
- Michael Brecker—Don't Try This At Home (MCA/Impulse)** 374769
- Jack DeJohnette's Special Edition (MCA/Impulse)** 374751
- Blues For Coltrane—Various Artists (MCA/Impulse)** 374744
- Diane Schuur—Talkin' Bout You (GRP)** 374298
- Stanley Jordan—Flying Home (EMI)** 373860
- Bird—Original Soundtrack (Columbia)** 373332
- Dianne Reeves (Blue Note)** 372953
- Bob James—Ivory Coast (Warner Bros)** 372789
- Najee—Day By Day (EMI)** 371856
- Branford Marsalis—Random Abstract (Columbia)** 371849
- Stanley Clarke—If This Bass Could Only Talk (Portrait)** 371823
- Kenny G—Silhouette (Arista)** 371559
- Grover Washington, Jr.—Then and Now (Columbia)** 371476
- Weather Report—Heavy Weather (Columbia)** 273557

- Spyro Gyra—Rites of Summer (MCA)** 370767
- Chick Corea—Eye Of The Beholder (GRP)** 370718
- David Sanborn—Close Up (Warner Bros)** 370304
- Wynton Marsalis Quartet—Live At Blues Alley (Columbia)** 370080-390088
- George Howard—Reflections (MCA)** 369314
- Bobby McFerrin—Simple Pleasures (EMI)** 369306
- Basia—Time And Tide (Epic)** 368043
- GRP Super Liv In Concert—Various Artists (GRP)** 367979-397976
- Oscar Peterson—The Trio (Pablo)** 367268
- Kirk Whalum—And You Know That! (Columbia)** 367037
- Bill Watrous—Reflections (Soundwings)** 366971
- George Benson—Bad Benson (CBS Assoc.)** 365114
- Mitt Jackson—Sunflower (CBS Assoc.)** 365031
- Jim Hall—Concierto (CBS Assoc.)** 365015
- Claude Bolling, Piano—Bolling Plays Ellington, Vol. 1 (CBS)** 364331
- Lee Ritenour—Portrait (GRP)** 363994
- The Manhattan Transfer—Brasil (Atlantic)** 363648
- Crusaders—The Vocal Album (MCA)** 362897
- The Best Of The Manhattan Transfer (Atlantic)** 312009

- Ahmad Jamal—Crystal (Atlantic Jazz)** 362251
- Duke Ellington Orch.—Digital Duke (GRP)** 357350
- Jean Luc Ponty—The Gift Of Time (Columbia)** 361485
- Pat Metheny Group—Still Life (Talking) (Geffen)** 359018

- Sarah Vaughan—Brazilian Romance (CBS)** 359695
- Glenn Miller Orchestra—In The Digital Mood (GRP)** 347492
- Herbie Hancock—Future Shock (Columbia)** 321331
- Diane Schuur And Count Basie Orch. (GRP)** 361048

- Round Midnight—Original Sound Track (Columbia)** 349613
- Spyro Gyra—Stories Without Words (MCA)** 360016
- George Benson/Earl Klugh—Collaboration (Warner Bros.)** 356501

LEGENDARY JAZZ PERFORMANCES

- The Gil Evans Orchestra—Out Of The Cool (MCA/Impulse)** 370072
- Various Artists—The Impulse! Collection Volume 1 (MCA/Impulse)** 369561
- Art Blakey Quartet—Jazz Messengers (MCA/Impulse)** 374975
- Oliver Nelson—Blues And The Abstract Truth (MCA/Impulse)** 374934
- Quincy Jones—The Quintessence (MCA/Impulse)** 374918

- John Coltrane—Giant Steps (Atlantic)** 371591
- Woody Herman—The Thundering Herds (Col Jazz Masterpieces)** 368993
- The Be-Bop Era—Various Artists (Col Jazz Masterpieces)** 368969
- The Lyrical Stan Getz (Col Jazz Master)** 368951
- The Best Of Chess Jazz—Various Artists (Chess)** 363937



Miles Davis—Sketches Of Spain (Col Jazz Masterpieces) 353037

Louis Armstrong and His All-Stars—Satch Plays Fats (Col Jazz Master) 353169

Duke Ellington Orch. & Count Basie Orch.—First Time The Count Meets The Duke (Col Jazz Master) 353078

The Dave Brubeck Quartet—Time Out (Col Jazz Master) 353060

Atlantic Jazz Bebop—Various Artists (Atlantic) 352112

Benny Goodman—Benny Goodman Sextet (Col Jazz Master) 347930



Charlie Parker—Bird / The Savory Recordings (Master Takes) (Savoy Jazz) 373340-393348

- Charlie Christian—The Genius Of The Electric Guitar (Col Jazz Masterpieces)** 362707
- The 1950's—The Singer—Various Artists (Col Jazz Master)** 357731
- The Thelonious Monk Quartet—Monk's Dream (Col Jazz Master)** 357723
- Billie Holiday—From The Omg Decca Masters (MCA)** 354985
- Charles Mingus—Mingus Ah Um (Col Jazz Master)** 354795

© 1989 CBS Records Inc.

From Charlie Parker to Chick Corea—and all the jazz in between—now all available on CD! As your introduction to the CBS Compact Disc Club, you can choose any 8 CDs listed in this ad for 1¢. Fill in and mail the application—we'll send you CDs and bill you for 1¢ plus shipping and handling. You simply agree to buy 6 more CDs (at regular Club prices) in the next three years—and you may cancel membership anytime after doing so.

How the Club works: About every four weeks (13 times a year) you'll receive the Club's music magazine, which describes the Selection of the Month... plus new hits and old favorites from every field of music. In addition, up to six times a year, you may receive offers of Special Selections, usually at a discount off regular Club prices, for a total of up to 19 buying opportunities.

You will always have at least 10 days in which to make your decision. If you ever receive any Selection without having 10 days to decide, you may return it at our expense.

The CDs you order during your membership will be billed at regular Club prices, which currently are \$12.98 to \$15.98—plus shipping and handling. (Multiple-unit sets may be somewhat higher.) After completing your enrollment agreement you may cancel membership at any time; if you decide to continue as a member, you'll be eligible for our money-saving bonus plan. It lets you buy one CD at half price for each CD you buy at regular Club prices.

10-Day Free Trial: We'll send details of the Club's operation with your introductory shipment. If you are not satisfied for any reason whatsoever, just return everything within 10 days and you will have no further obligation. So why not choose 8 CDs for 1¢ right now?

ADVANCE BONUS OFFER: As a special offer to new members, take one additional Compact Disc right now and pay only \$6.95. It's a chance to get a ninth selection at a super low price!

If you wish to receive the Selection of the Month, you need do nothing—it will be shipped automatically. If you prefer an alternate selection, or none at all, fill in the response card always provided and mail it by the date specified.

Selections with two numbers contain 2 CDs and count as 2—so write in both numbers

CBS COMPACT DISC CLUB: Terre Haute, IN 47811

CBS COMPACT DISC CLUB, 1400 N. Fruitridge 105/F89

P.O. Box 1129, Terre Haute, Indiana 47811-1129

Please accept my membership application under the terms outlined in this advertisement. Send me the 8 Compact Discs listed here and bill me 1¢ plus shipping and handling for all eight. I agree to buy six more selections at regular Club prices in the coming three years—and may cancel my membership at any time after doing so.

SEND ME THESE 8 CD'S FOR 1¢		

My main musical interest is (check one): Jazz Soft Rock Classical
 Dave Brubeck, John Coltrane, Debbie Gibson, Vladimir Horowitz, Kenny G, Al Jarreau, Fleetwood Mac, Luciano Pavarotti

Mr _____
 Mrs _____
 Miss _____
 Print First Name Initial Last Name

Address _____ Apt _____
 City _____

State _____ Zip _____

Do you have a VCR? (04) Yes No
 Do you have a credit card? (03) Yes No 386/F6 387/F7

ADVANCE BONUS OFFER: Also send me one more CD right now at the super low price of just \$6.95, which will be billed to me

We reserve the right to reject any application or cancel any membership. These offers not available in APO/FPO, Alaska, Hawaii, Puerto Rico. Write for details of alternative offer. Canadian residents serviced from Toronto. Applicable sales tax added to all orders. *Classical members serviced by the CBS Classical Club.

WILLIS CONNOR

ENGINEERING REPORT

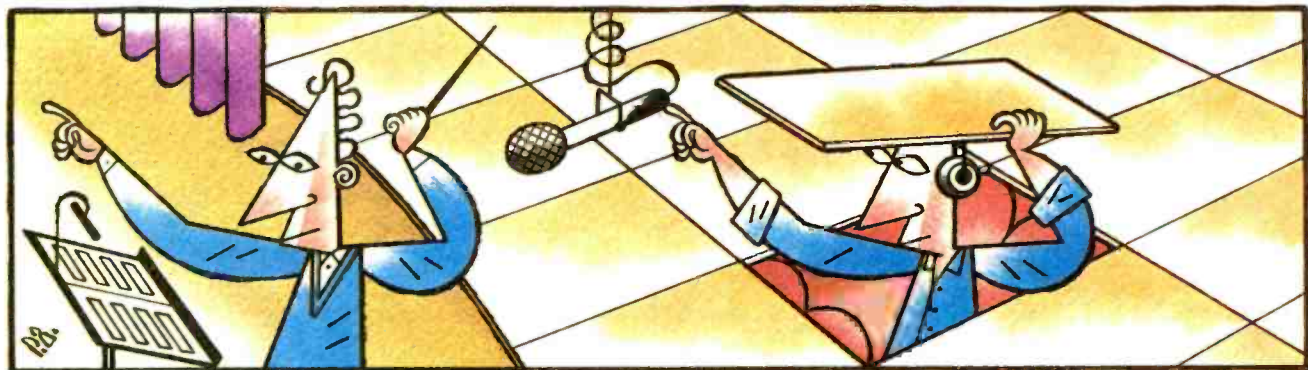

Illustration: Philip Anderson

In his column on "sound labels" past and present ("Behind the Scenes," April), Bert Whyte recalled RCA's Chicago Symphony/Fritz Reiner recordings in the 1950s and 1960s. I was the second engineer on all these recordings, and I have a few insights that might prove of interest.

Let me first explain what my duties were. The equipment would be sent in from either Boston or New York—most of the time in the middle of the night, just preceding the day of the recording. Dick Bayne, our maintenance engineer, and I would arrive at Orchestra Hall at about 4:00 a.m. and set up. Dick would line up the tape machines and equipment; I would be responsible for the mike setup, which was always the same (Lou Layton and Al Pulley determined the original mike setup). The New York crew usually arrived at about 8:45 for the 9:00 a.m. session, put on their white gloves, and we were ready to roll. Once in a while, Jack Pfeiffer or Dick Mohr would ask me to raise a mike a quarter inch or so. I would run the tape machines during the recordings.

Bert Whyte spoke of the rich patroness who donated the money for the 1965 restoration of Orchestra Hall. If I'd had her money and was paying what she did for her seats, I, too, would have been glad to donate \$3 million for the rehabilitation of the hall. It was the greatest hall in the world for the recording of classical music, but, granted, it had its faults. Those in the hall's first five rows not only broke their necks looking up if they wanted to see the orchestra, but heard very little of the concert. Orchestra Hall had more than its share of "dead spots"; as good as it was for recording, it was just as bad for the audience.

When it was announced that the hall was going to be renovated, RCA engineering sent out the head of their acoustic labs to make measurements. His name escapes me, but I remember that he originally came from Arlington Heights and had gone to the schools my kids were attending. I went with him to assist. If memory serves me, Mr. Whyte is right in his comments on the hall's new measurements. After the restoration, the two of us went back to the hall to see how it had changed. We just couldn't believe our findings. Of course, we knew it was the end of Orchestra Hall's recording days.

About this time, RCA was having trouble with Arthur Fiedler and gave thought to making the Chicago Symphony its pops orchestra. A Saturday night pops concert was arranged, with Morton Gould conducting. If it was successful, Gould was going to be appointed "pops conductor." During the morning rehearsal, I recorded with a mono 350, as allowed by the union. Gould came off the stage with tears in his eyes. He knew that his career with the Chicago Symphony was over before it had started. We went back to our studios to give a listen. We were the two saddest people alive.

However, RCA had one last session after the restoration. Before the session, they tried laying 4 x 8-foot sheets of quarter-inch plywood over all the seats and along the walls to liven up the hall. It didn't work. That's when we went over to the Masonic Temple. It, too, was very dead until Roger Antinson, who replaced me as second man, came up with the idea of placing the mike up in the dome and feeding the output back as echo. This made it suitable for recording. It is my understanding that EMI booked the Masonic

three times, and their efforts were cancelled because of the poor sound they were getting. It was then that a musician in the orchestra told them about RCA using the mike in the dome.

I spent some 30 years working for Columbia and RCA. I was the first engineer outside of New York hired by Columbia when it was bought by CBS. Bill Savory broke me into recording in 1938. I was with Columbia a year before I was called into the army. When I returned, the LP was just coming into being, and Peter Goldmark came out to Chicago to teach me LP mastering. About the same time, a fellow by the name of George McProud came through Chicago to tell us about a new magazine he was starting, *Audio Engineering*. McProud asked me to write about mastering. A few years later, I was fired from Columbia on the pretext that they were going to get out of the record business before TV put them out. Many years later, Al Pulley told me it was a setup to get me over to RCA, so I could teach them something about LP mastering. It was something they'd cooked up over a monthly luncheon.

In April 1972, we were given notice that our studios would be closed in two weeks. A vice president from New York came out to Chicago and tried to talk me into staying with RCA. But I decided against it. My last date was with The Supremes.

I stayed on alone to close the studios. During those last months at RCA, I was so busy working around the clock doing overdubs that I had my 14-year-old twins come down to the studios and run the Ampex blockbuster 16-track. I showed them how to "punch in and out" while I took a nap. I walked out on my birthday, August 18, 1972. The party was over. A

THE SHOCKING TRUTH!

Speakers are *the most important part* of your stereo system. It is the speaker that turns amplifier signal into sound and so ultimately determines what you hear. If your speakers do not perform well, your stereo system will simply not sound like music.

The search for musically satisfying speakers, however, can lead to some very expensive products. And if you have already bought those high priced speakers, then you better not listen to Paradigms. But if you haven't better not miss them. Why? Because from the time they were first introduced, Paradigm's sheer musical ability utterly amazed listeners.... but what caused even more amazement was the *unprecedented low price*.

The shocking truth is, you no longer have to amass a small fortune to buy speakers that will satisfy your love of music. Simply visit your authorized Paradigm dealer.... *and listen*.

The critics agree:

"... natural, open and clear... excellent depth... lots of hall sound... big, expansive soundstage... well defined... a *REFE* achievement for any loudspeaker, but when price is taken into account the Paradigm's performance must be considered as nothing short of remarkable."

- *Sound & Vision Magazine*

"... we can't think of another speaker at or below this price that manages to match the Paradigm's overall sense of balance and competence... exceptional value."

- *Hi Fi Heretic Magazine*

Sound & Vision



CRITIC'S CHOICE AWARD

Paradigm®

music... above all.

In the U.S.: AudioStream, MPC Box 2410, Niagara Falls, New York 14302
In Canada: Paradigm Electronics Inc., 457 Fenmar Drive, Weston, Ontario M9L 2R6

Enter No. 4 on Reader Service Card

HARMONIC CONTORTIONS

**Running on Overdrive**

Try as we may to avoid harmonic distortion in home playback equipment, it's an integral part of much modern pop music. Musicians of the '60s responded creatively to the overload characteristics of tube instrument amps by using the extra harmonics as a form of tonal enrichment—not just as a sign that the musicians were playing loud

enough to bother our parents. The accepted wisdom in the rock world is that "typical amps sound best when they're run full out," according to Harry Kolbe of Harry Kolbe Soundsmith, an equipment manufacturer and modifier in New York. As a result, rock amplifier settings "are sheer Spinal Tap, with everything cranked full. This gives you a rich harmonic overload and 'sustain'—a harmonic composite, the amp singing over time, sounding like a saxophone or violin instead of a plucked string.

"The whole idea is to overdrive the amp as much as possible, from the input to the output stage. This, of course, generates a lot of harmonics, which are hopefully musically related. And that gives you the great big, fat, rock 'n' roll sound."

Overdriving only works because tube amps overload gracefully, gradually becoming more distorted as their level is increased, giving the musician a wide range of distortion levels to play with. The power versus distortion curves of modern transistor amps have sharper knees—a quicker transition from clean to clipping.

Full-tilt funk, however, is only available at full-tilt levels, through overloaded amps and their associated (usually built-in) speakers. There are times when musicians need line-level signals, though. Instrument amps usually aren't loud enough to

reach large audiences, so the musicians must play through big power amps and multiple speakers. Overdriven instrument amps are also way too loud for comfortable recording in a studio, and recordings made by miking the instrument speakers rarely sound as clear as those made by direct feeds into the recording console.

The solution, in both cases, is to run a tube amp, full blast, into a dummy load that absorbs most of its power and then tap off a line-level signal to the house sound system or studio console. Until a year or two ago, resistive dummy loads were used, but these didn't yield the same sound from the amp as speaker loads do. Since then, more complex loads have appeared, such as Kolbe Soundsmith's Silent Speaker and others from Rocktron, Groove Tube, and one or two German companies.

Coils and capacitors bridged across such dummy loads' resistances simulate the induction, energy storage, and sometimes even the bandpass-filtering effects of yesteryear's rock speakers. The Silent Speaker, for example, "was patterned after a '412' Marshall cabinet," says Kolbe. "That's four 12-inch Celestion speakers together, probably the most-used cabinet in rock 'n' roll today. If you were to run an impedance curve on it, it would probably be within 10% of the Marshall's."

Illustrations Valerie Pizzo

Diverse Reflections

Diversity reception, a system which compares the signals from two spaced antennas and accepts the better of the two, has been around since it was invented in 1927 at RCA. Long in use for short-wave reception, it surfaced briefly in hi-fi about 20 years ago, in one H. H. Scott tuner, and has been recently revived for car stereo. (We tested diversity-equipped Blaupunkt and Clarion head units in our May 1988 issue; Sony, last I heard, makes a diversity-tuned TV set for car use.)

I'd been hoping it would resurface in home tuners or receivers. Sure enough, both Onkyo's T-9090II (reviewed in July 1988) and Akai's AT-93 (December 1988) have dual

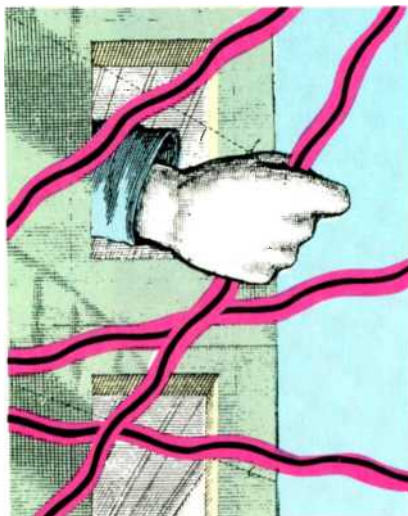

antenna inputs and automatic antenna selection. Unfortunately, that's not enough diversity to suit my needs. I'm an apartment dweller, forced to use indoor antennas in a high-multipath environment. When I move around my living room, the signal pattern changes, and any antenna orientation which brings good results when I stand in one spot works poorly when I shift to another. To handle this problem, a diversity system needs to monitor its antennas' signals constantly, selecting and reselecting from moment to moment. The Akai and Onkyo tuners both lock in their antenna choices when the station's first tuned in. That's fine for outdoor antennas or for antenna and cable, but not for indoor-antenna use.

High Definition® has never been more down to earth.

Every audiophile, every music lover wants to hear through the veil of his or her audio system, straight to the music.

The new SP14 and popular SP9 hybrid preamplifiers put that dream within everyone's reach, bringing together superlative sonics and affordability. But without sacrificing Audio Research's legendary quality of design, construction and service.

For sonics and control features nearly equal to the state of the art, choose the SP14—the preamplifier that will take you as far as your system is ever likely to go. It will bring the best out of new components, for years to come.

And while more modest in features and performance, the SP9 has been delighting thousands of cost-conscious

audiophiles and music lovers the world over for two years. It's a proven performer.

Both preamplifiers reflect the 20-year Audio Research tradition of distinguished engineering. Ultra-critical parts selection and unstinting handcrafted manufacture assure honest musical satisfaction today, and reliable performance for years to come. Like every Audio Research product, the SP14 and SP9 represent not just a purchase, but an investment.

Audition either model soon at your authorized Audio Research dealer.



audio research®
HIGH DEFINITION®

6801 Shingle Creek Parkway / Minneapolis, Minnesota 55430 / Phone: 612-566-7570 FAX: 612-566-3402

Enter No. 3 on Reader Service Card

IVAN BERGER

INFO ON THE AIR



Radio News

I travel enough between New York and Hartford to know which stations will give me jazz, classical music, sports, and so on. If I venture to the Finger Lakes or Philadelphia, it takes a bit of dial-twisting (repeated every 60 miles or so) to bring in the programs I want. Were I to drive from Florence to Frankfurt, you'd expect the problem to be even worse—especially as I speak little German and virtually no Italian.

In fact, I'd have an easier time finding what I wanted on that route than I do stateside, thanks to a new FM service called Radio Data System (RDS), which transmits digital data on a 57-kHz subcarrier. There are already RDS-affiliated stations in Germany, Italy, England, and 10 other countries, and the European Broadcasting Union has made RDS a Standard.

Stations can broadcast several kinds of program information via RDS, including station call letters or name (i.e., "R. LONDON" for Radio London), network (the "BBC R3," say, for the Radio 3 network), and program format (jazz, talk, etc.).

In countries where a program can be heard throughout a national network at one time (as was formerly the case here), the radio can automatically find and tune to the strongest signal from that network, then switch to other network stations as distance fades the original one out. (The service includes alternative-frequency codes, listing frequencies carrying the network.) When network programs are undesired or unavailable, you can punch in a program format; the radio will find any nearby stations broadcasting it. Time and date can be displayed, with automatic correction for local time zones.

The system can be used for automated traffic reports, with network stations signalling RDS-equipped radios to shift to local stations' reports when they occur. If desired, the radio can monitor for traffic reports even while a tape or CD plays (a feature introduced years back in Blaupunkt's ARI system) and can suspend play when reports become available.

In the near future, RDS codes could indicate mono or stereo, matrix quadraphony, compression, or other transmission systems, telling the radio to switch to the desired reception mode. A music/speech code might readjust the radio's volume when switching from one to the other, with relative levels preselected by the user. Radios could be preprogrammed to switch on automatically when a desired program aired. Up to 64 characters of text could display titles of programs and musical selections, phone-in numbers (there had better be a memory to freeze and hold phone numbers until you can call), or even ads. Paging systems might be tied in, with receivers programmed to display information in their owners' native languages—maybe even to speak it aloud, with a voice-synthesizer chip.

The first RDS receivers, sold in Britain, were made for Volvo; others have appeared or been promised from Blaupunkt, Clarion, Digatec (Magnat), Ford, Mitsubishi, Philips, Pioneer, and Sony. Most of the interest has been from car radio companies, but Revox has announced plans to offer RDS boards for its Model B260 tuner. The BBC is trying to drum up interest in a portable RDS radio, possibly in a version which could insert RDS codes into the BBC's short-wave World Service—RDS is also adaptable to AM.

Sterling Idea

How can you prevent car stereo theft? Austin Rover's idea is to divide the stereo system into separate modules, tucked away throughout a car's interior. Digging the modules out would probably take so long no thief would attempt it, unless he could steal the whole car and take it someplace where he could work on it undisturbed.

He'd have trouble doing even that. The stereo system, introduced at a crime-prevention congress in the United Kingdom, is part of a Security Concepts adaptation of the Rover 800, which is known here as the Sterling. Thanks to a number of special lock systems and construction techniques, it took five minutes for a team of police officers to break into the car—and even then, they couldn't get the doors open. The shrieking alarm probably didn't help any.

Even if a thief did manage to steal a Sterling and get its stereo modules out, they'd be of little use to him. They have tamper-resistant labels, and they probably wouldn't fit any other car.



The Lap of Luxury

By the fall of '89, you'll be able to get a car with a factory-installed Nakamichi sound system, but it will probably cost you about \$35,000. The car will be the new Lexus LS 400, a V8-powered luxury car made and sold by a new division of Toyota. The standard system on the car, and on the V6-powered ES 250 (which will sell for about \$10,000 less) will be made by Pioneer. Both sound systems will include FM/AM/cassette head units and will offer CD players as an option. The head units will also adjust the power antenna's height to precisely match the frequency of whatever station is tuned in.

Illustrations: David Goldin



STREETWIRES®—THE ONLY CHOICE
WHEN PERFORMANCE MATTERS

Whether you are building a car audio system for competition or just want to get the most out of the system in your everyday car, StreetWires® is a must. Only StreetWires® gives you the performance, fit and finish you need for a competition quality installation. Only StreetWires® has the unique advantage of in house product research, innovative design and engineering. And only StreetWires® guarantees superior material selection, 100% quality control and "state of the art" manufacturing. StreetWires® is more than just wires. StreetWires® provides you with all the innovative accessories you need to create a system that will interface better, perform better, look better, and last longer. That's why virtually all competition show cars and car audio manufacturers use StreetWires® in their demonstration vehicles. They know StreetWires® are the best money can buy. Visit your local StreetWires® dealer and make the "StreetWires® Connection"... and let your system be the best it can be!

Distributed in Canada by:
LINGAR MARKETING CORP.
2197 Dunwin Drive
Mississauga, Ont. L5L 1X2

STREETWIRES®
by **ESOTERIC AUDIO USA**

RR3 Box 262, Winder, Georgia 30680. Dealer Inquiries Invited.

Enter No. 11 on Reader Service Card



RISING ABOVE THE CD JUNGLE

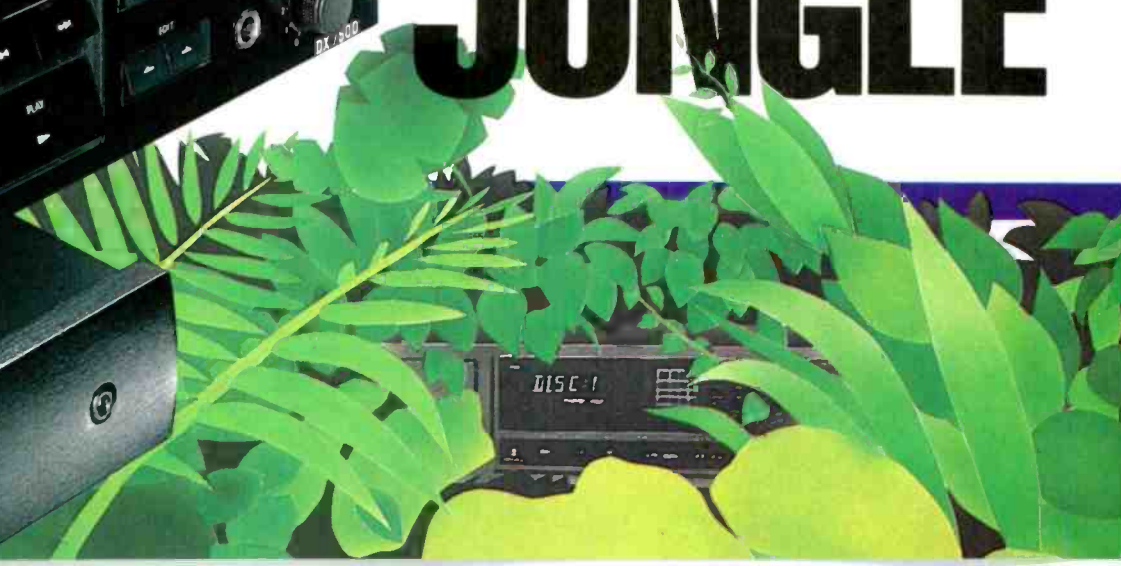
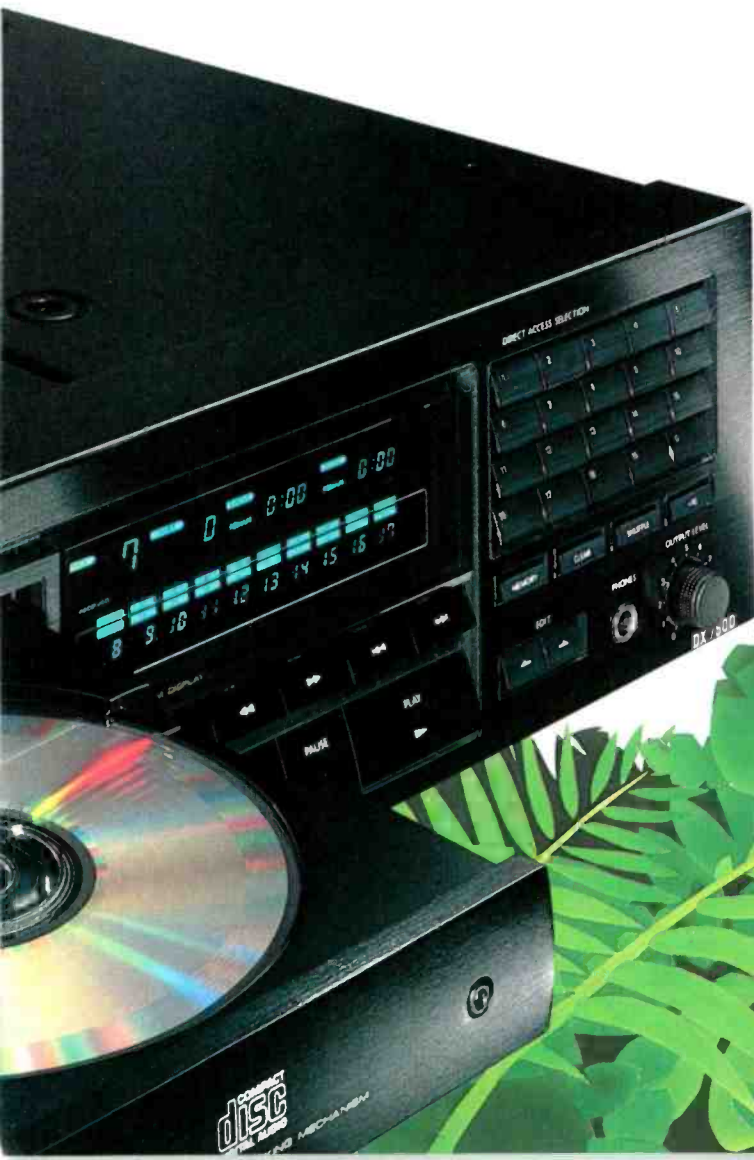

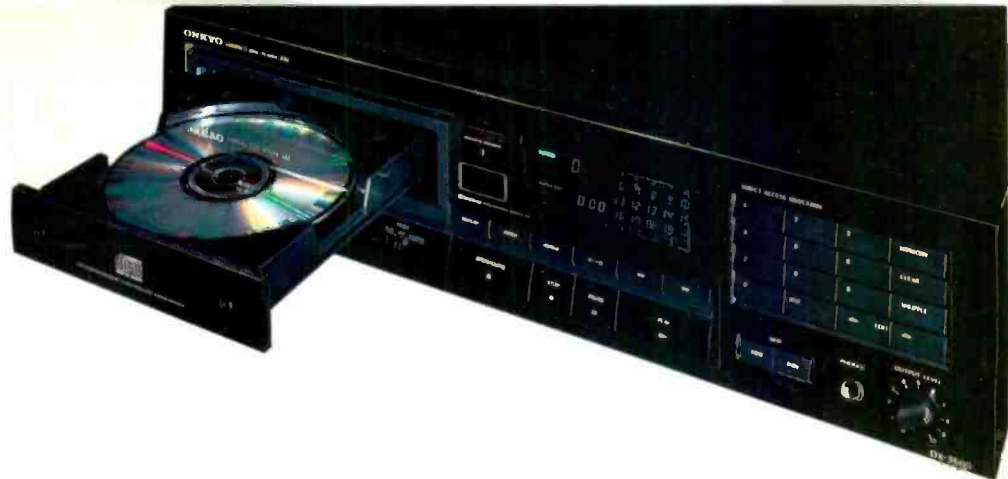

For most people, buying a CD player is a lot like taking a short stroll along the Amazon. And forgetting your map. Sooner or later, you're going to get lost. That's because the "jungle of misinformation" about CD players makes it difficult to know what's really important. And what isn't.

Take a quick look at some of the claims—digital bit structures (what are they, anyway?) ranging from 1 to 45. Oversampling rates from 2x to (quick, who's got the latest?) 16x. All this for the sake of a numbers race. And not necessarily for the sake of the music.

Well, Onkyo offers you a real way through this undergrowth.

Of course, we have an impressive variety of both single- and multiple-disc players. With extraordinary levels of technology in even our most affordable models.

For example, we individually calibrate the critical Digital-to-Analog Converters in our DX-1700 and DX-2700 players to fine-tune their linearity and minimize distortions peculiar to the digital process.



Most of our models also benefit from Opto-Coupling, an Onkyo-developed technology that transmits data optically rather than through conventional wiring for more accurate CD sound.

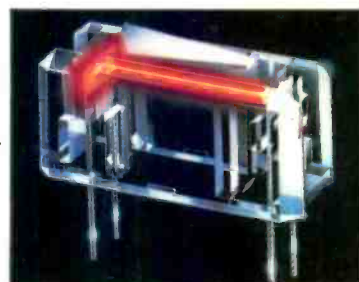

But for Onkyo, outstanding products are just the beginning. We'll make your journey through the CD jungle even easier with two indispensable guides.

The first is an in-depth explanation of digital bit structures and how they affect musical performance. The second is a down-to-earth journey through all the claims you're likely to run into, as well as the hard facts you'll need to master the CD jungle. And they're available at your Onkyo dealer now.

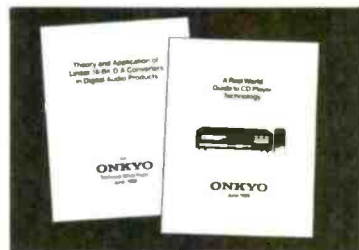

Onkyo. We'll give you more than just superb CD players. We'll also give you the knowledge you need. Because it is a jungle out there. And only the fittest survive.

ONKYO

200 Williams Drive, Ramsey, N.J. 07446 201-825-7950

For your nearest dealer, call 1-800-553-4355 and enter code 41244 when asked.



Cables and the Amp

R. A. GREINER

This article is adapted from a paper which I wrote and presented to the Audio Engineering Society 10 years ago, and which was later published in the Journal of the Audio Engineering Society (Vol. 28, No. 5, May 1980). My original paper discussed the issue of cables used for connecting power amplifiers to loudspeakers. In the intervening years, an entire industry for the manufacture of special cables has grown up around this issue. I have therefore added comments to expand the notions presented in the original paper and to bring it more up to date. The paper has also been edited slightly to make it clearer to persons not entirely familiar with some of the electrical engineering terms used. The substance of the paper, however, is based on electromagnetic theory, and no amount of advertising in the past 10 years has changed that base.

Loudspeakers seem to be connected to power amplifiers with greatly varying degrees of care. The professional generally selects wiring of appropriate size and type for the given application, while many others are quite casual about such matters. Recently, however, considerable attention has been drawn to the issue of loudspeaker cables by the appearance of numerous "special" cables with properties that allegedly improve the quality of the sound delivered by the loudspeaker. While most of these claims are no more than pure fantasy, there is just enough edge of truth showing to make a hard look at loudspeaker cables seem appropriate.

In this article, loudspeaker cables are investigated to determine whether or not their transmission-line behavior is significant for audio frequencies. Conclusions are reached regarding the validity of lumped equivalent representations of short transmission lines. Certain critical frequencies are calculated and measured to estimate the effect that the cable will have on the amplifier and the loudspeaker load. The problems caused by the resistance of the crossover, level pads, and any fuses in the circuit are considered briefly.

R. A. Greiner is Professor of Electrical and Computer Engineering at the University of Wisconsin, Madison. He teaches and does research in electroacoustics, acoustic measurements, applications of digital signal processing, audio system design, and noise control. He holds over a dozen patents in electronic instrumentation and audio systems and was elected a Fellow of the Audio Engineering Society in 1984.

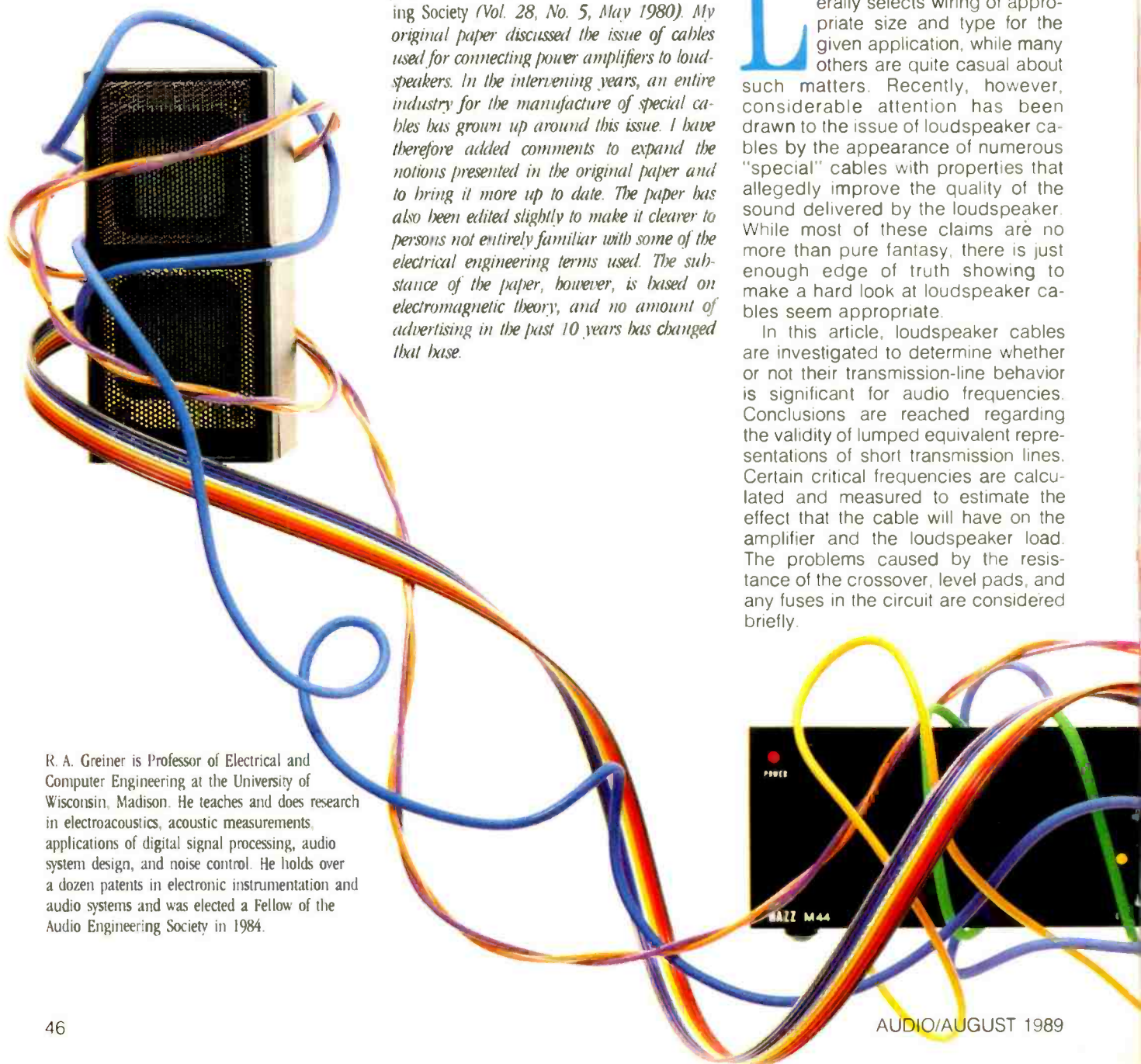

/Speaker Interface

Cable Parameters

The parameters which describe the cable electrically are series resistance, series inductance, shunt conductance, and shunt capacitance. These parameters can be determined by direct measurement and/or by calculation from elementary formulas. They depend entirely on the geometry of the cable and the nature of the conductors and the insulation used. The approximate values for a variety of cables made of copper wire and rubber or plastic insulation are summarized in Table I.

Conductors of copper, silver, or similar high-conductivity materials—regardless of the method of drawing the wire—behave similarly. The electrical properties of cables are not significantly affected, at audio frequencies, by the type of insulation used. The mechanical properties of the cable, however, may be more desirable with use of certain insulators and construction techniques.

Note that the larger the physical size of the wire, the smaller its gauge number, and that each change of three wire-gauge sizes doubles or halves the wire's cross-sectional area. The nature of the insulation, and whether or not the wire is "tinned," have little effect on the electrical parameters of the cable at audio frequencies.

The accompanying Tables, based on my 1979 investigations, cover both "normal" and selected "special" cables. Three of the normal cables are typical two-wire pairs, such as standard zip cord with rubber insulation. Of these, the No. 12 zip cord is a European extension cable made by Lucas; its wires are more widely spaced than those of U.S. extension cords, giving it a slightly higher inductance. Two of the other normal cables are standard twisted-pair types in a vinyl jacket, normally used by professionals; these are available from Alpha, Belden, Consolidated, and other manufacturers. The RG-9 is a standard coaxial cable made, in this instance, by Belden.

Of the three types of special cables included, one is a large-gauge coaxial of dual-cylindrical construction by Mogami. Another is a braided cable by Cobra. The third is a plastic-jacketed pair of "welding size" conductors—real welding cables, I believe—from Fulton.

Present-day cables that deviate from the techniques used to construct cables in 1979 usually use fine strands of wire which are gathered or braided in a variety of complex geometries. Some of these techniques increase and some decrease the series inductance of the cable slightly. Both techniques, increasing and decreasing induc-

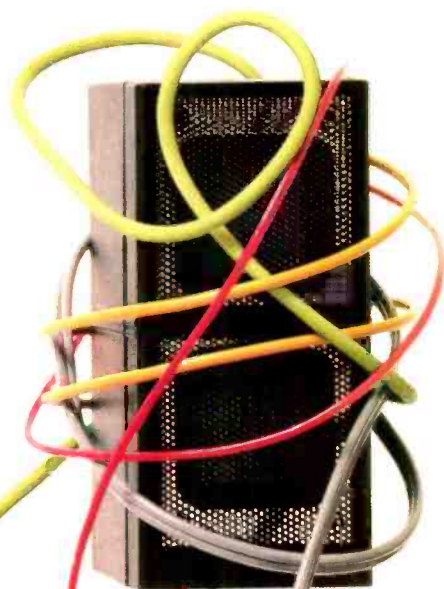

Photograph: James Nazz

tance, are claimed to improve the electrical properties of the cables. In the following discussion, it should be apparent that neither of these techniques makes much difference at audio frequencies.

A review of Table I is interesting since it shows that something quite drastic has to be done to the geometry of the cable before its inductance or capacitance per unit length changes very much. The normal cables, even including the welding-cable pair, have values of inductance and capacitance within a factor of about 2. The resistance of the thicker wires, of course, goes down greatly. Skin-depth phenomena have only a slight effect on copper wires at audio frequencies. The skin depth for copper at 20 kHz is about 0.5 mm. Thus, wires larger than No. 14 gauge will have a resistance, at 20 kHz, slightly higher than the d.c. value. The ratio of the 20 kHz to d.c. resistance is given in Table I.

The wire listed as No. 12 zip cord is a high-quality extension-cord style of construction with slightly greater than normal spacing. Thus, it has a slightly higher series inductance compared to domestic zip cord. This cable and the welding type fall just slightly outside the range of values for normal wires (one above and one below).

The issue of Litz-type wire construction, using a multitude of tiny strands, could be discussed at length, but at this point, let it be said that the topic is largely irrelevant at audio frequencies. There simply is no significance to "skin effect" at audio frequencies, and wires which purport to fix this effect usually do not do so in any case.

Spacing the wire pair more closely has the advantage of reducing the series inductance. Unfortunately, this tactic also increases the shunt capacitance substantially. Various braided cables seem to attain a reduction of three or four times in the series inductance, but show a rise of 10 to 20 times in the capacitance. Whether the advantages of this type of construction outweigh the disadvantages will be considered later. Some users have suggested spacing wires farther apart to give less "interaction" between the wires. However, it is well known that the inductance of a cable rises as the wires are spaced farther apart. This effect is shown in Table II. Spaced wires not only interact more with each other but also show crosstalk with oth-

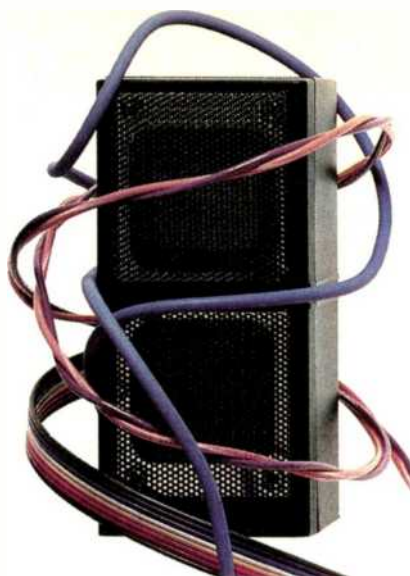

SOME OF THE SPECIAL cable designs increase inductance while others decrease it. Either way, enhanced performance is the claimed result of such a change.



er nearby pairs. Spacing the wires offers no advantages whatever and several serious disadvantages. This configuration should never be used and will not be considered further here.

Some regular coaxial cables have attractive values of inductance and capacitance. However, only a few of the larger sizes have large enough conductors to make them useful for loudspeaker connections. Standard RG-9 has been included in Table I. One sample of a special coaxial cable consisting of two concentric cylinders of stranded wire has been included as well. This coaxial cable is of No. 12 gauge and is specifically designed for low-impedance transmission-line purposes.

Cables as Transmission Lines

When considering cables as transmission lines, thoughts come to mind of characteristic impedance, termination, matching, reflections, and frequency dispersion. All of these are valid concepts, but they are not usually considered for very short transmission lines. And indeed, any reasonable-

length loudspeaker cable is a very short line. The wavelength of a 20-kHz signal is about 10 miles (16 km). Thus, a 10-meter cable is 1/1,500 of a wavelength. Any fluctuations in the signal caused by reflections at the ends of this cable will take place at a frequency of 30 MHz. Or, to look at it another way, 1,500 iterations toward the final voltage distribution in the cable will take place every cycle at 20 kHz. One must conclude that there are absolutely no audio frequency effects related to these reflections for cables of any reasonable length.

It is fortunate that reflections in loudspeaker cables are irrelevant, since they are never matched at either the amplifier or the loudspeaker ends. In practice, both the source and the load are quite complex and frequency dependent. Nevertheless, it is interesting to take a look at the characteristic impedance of a typical loudspeaker cable, which is also quite complex.

The characteristic impedance of a transmission line is given by:

$$Z_0 = \left(\frac{R + j\omega L}{G + j\omega C} \right)^{1/2}$$

where R is the line resistance per unit length, L is the series inductance per unit length, C is the shunt capacitance per unit length, and G is the shunt conductance per unit length. Of the two constants, j is the square root of -1 and ω is equal to two times the frequency.

For all practical loudspeaker cables, G equals 0. Thus, for high frequencies, where $\omega L \gg R$, we have:

$$Z_{OH} = \left(\frac{L}{C} \right)^{1/2}$$

This is an impedance called the characteristic impedance. It is given for selected cables in Table I. For low frequencies, where $\omega L \ll R$, we have:

$$Z_{OL} = \left(\frac{R}{j\omega C} \right)^{1/2}$$

This expression is the correct one for frequencies which fall below a value f_m , which can be defined as R divided by $2\pi L$, and which is typically somewhere in the middle to upper audio band. For the physically smaller normal cables, f_m is about 13 kHz; it is about 520 Hz for physically larger welding cable, 40

kHz for braided cable, 30 kHz for cylindrical coaxial cable, and about 26 kHz for regular coaxial cable.

For frequencies well above f_m , the cable behaves more ideally in the sense that there is no frequency dispersion in the line, and the impedance has reached a limiting value that is resistive. At lower frequencies, the impedance is complex, and the line contributes some frequency dispersion to the signal. When there is dispersion in the line, the high frequencies arrive at the end of the line ahead of the low frequencies. This happens because the line's series inductive reactance is too small compared to its resistance. The principles of transmission-line theory require that for purely distortionless transmission:

$$\frac{R}{L} = \frac{G}{C}$$

Since G equals 0 for typical audio cables, it is impossible to make the line perfect. However, R should be made small and C should be made small as well. When this has been done to the greatest extent possible, then L should be made larger. The telephone company does just this by inserting loading coils in long lines to reduce dispersion distortion.

It would appear that reducing series inductance, as some special cables do, does not make much sense from a transmission-line viewpoint. When cables are considered as lumped element circuits, however, there are some good reasons to decrease all of the elements as much as possible; this will be discussed below. First, it is interesting to calculate the dispersion for some typical loudspeaker cables. Since all loudspeaker cables show some amount of loss and some dispersion, a vital question to be answered is: How much?

To determine the difference in the arrival times of the high frequencies compared to the low frequencies, we need to find the group velocity of the transmitted signal. This is given by:

$$V_p = \frac{2\pi f}{\beta}$$

where

$$\beta = \left(\frac{1}{2}\right)^{1/2} \left[(ZY)^{1/2} + BX - GB \right]^{1/2}$$

Table I—Typical loudspeaker cable parameters. The ratio in the fifth column is impedance divided by d.c. resistance.

Cable Type	Inductance, $\mu\text{H}/\text{m}$	Capacitance, pF/m	Resistance, Ohms/m	$\frac{R_{a.c.}}{R_{d.c.}}$	Z_{OH} , Ohms
No. 18 zip cord	0.52	58	0.042	1.05	95
No. 16 zip cord	0.60	51	0.026	1.15	108
No. 14 speaker cable	0.43	57	0.016	1.3	87
No. 12 speaker cable	0.39	76	0.01	1.5	72
No. 12 zip cord	0.62	49	0.01	1.5	112
Welding cable	0.32	88	0.001	4.0	60
Braided cable	0.10	1,630	0.026	1.0	8
Coaxial dual cylindrical	0.052	580	0.01	1.0	9
Coaxial RG-9	0.075	30	0.013	1.0	50

Table II—Parameters of spaced wires for No.12 gauge wire.

Wire Spacing, mm	Inductance, $\mu\text{H}/\text{m}$	Capacitance, pF/m
0.4	0.39	76
1.0	0.86	34
2.0	1.27	24
4.0	1.67	17
8.0	2.07	14
16.0	2.48	12
3.5 m	50.00	1

Table III—Dispersion characteristics of selected loudspeaker cables, in order of dispersion, showing propagation velocity at two frequencies and the delay difference between them.

Cable Type	V_p (100 Hz), m/S	V_p (10 kHz), m/S	Delay Difference, S/m
No. 12 wires (4-cm spacing)	8.15×10^7	1.87×10^8	0.69×10^{-8}
Coaxial RG-9	5.67×10^7	4.76×10^8	1.55×10^{-8}
No. 12 zip cord	4.92×10^7	2.57×10^8	1.64×10^{-8}
No. 12 speaker cable	4.03×10^7	1.78×10^8	1.92×10^{-8}
No. 18 zip cord	2.28×10^7	1.59×10^8	3.76×10^{-8}
Coaxial dual cylindrical	1.45×10^7	1.24×10^8	6.09×10^{-8}
Braided cable	5.45×10^6	4.84×10^7	16.30×10^{-8}

and

$$Z = R + j\omega L$$

$$Y = G + j\omega C$$

$$B = \omega C$$

$$X = \omega L$$

For G equals 0,

$$\beta = \left(\frac{1}{2}\right)^{1/2} \left\{ \omega C \left[(R^2 + \omega^2 L^2)^{1/2} + \omega L \right] \right\}^{1/2}$$

Dispersion characteristics for selected cables are shown in Table III for frequencies of 100 Hz and 10 kHz. From the Table, it is apparent that for a 10-meter cable, the delay differences are only a fraction of a microsecond—except for the braided construction, which is a little worse. In any case, the delay time, or frequency dispersion, is certainly not a problem for loudspeaker cables of any reasonable length.

Before going on to the lumped parameter treatment of short lines, we should make one additional general observation about transmission lines. A line will look much like a shunt capacitance when it is loaded with an impedance much higher than its characteristic impedance, and it will look like a series inductance when loaded by an impedance much lower than its characteristic impedance. Almost all loudspeaker cables are loaded according to the latter criterion. In general, playing numbers games with the high-frequency value of characteristic impedance for short cables at audio frequencies is largely useless.

Cables as Lumped Lines

It should be clear that treating loudspeaker cables as transmission lines, while interesting, is not of much direct

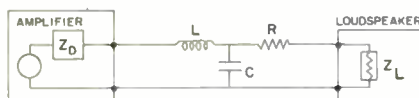
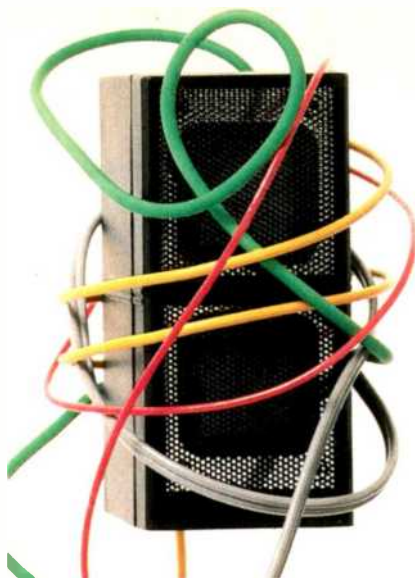

Fig. 1—Amplifier/cable/loudspeaker circuit using lumped circuit elements to represent the properties of the cable. Typical R , L , and C values for cables 10 meters long are given in Table IV.



WITH THE MAJORITY OF cables, 100-Hz and 10-kHz signals do not actually arrive at the same time. However, their arrival times are only fractions of a microsecond apart.



design value. The loads are complex, the lines very short, and the frequencies too low to allow easy, ideal treatment. Exact treatment is more complex than is warranted. In this section, loudspeaker cables will be treated as wire pairs that can be represented as lumped element equivalent circuits. This method will give reasonable design guidance and intuitively sensible results. A satisfactory equivalent circuit for an amplifier/cable/loudspeaker circuit is shown in Fig. 1. In order to have convenient numbers to use for examples, the values for typical cables 10 meters in length are given in Table IV. Applications using shorter or longer cables can be scaled up or down from these examples.

There are at least two major interactions to consider in the system shown in Fig. 1. One is the interaction of the amplifier with the total load, including the cable; the other is the interaction of the loudspeaker with the amplifier, including the cable. Since the system is so tightly coupled, some consideration to the nature of Z_0 and Z_L must be given. While it is not possible to con-

sider all possible cases, certain more common ones will be discussed. First consider the amplifier end of the high-fidelity system.

An ideal amplifier would be a voltage source with a Z_0 of zero. In fact, many high-quality amplifiers come very close to this ideal. At low and middle frequencies, the output resistance of an amplifier will typically be less than 0.05 ohm, with a rise to 0.2 ohm at the very highest frequencies. The output will usually be slightly inductive. Often a series inductance of 2 μH will be used to isolate the amplifier feedback loop from capacitive loads. This inductance is 0.25 ohm reactive at 20 kHz. A good amplifier should be stable for any load, including capacitive loads.

Since even the worst of the cables is only 0.2 μF for 10 meters, such a cable should not cause a good amplifier to become unstable or to ring. It would take 35 μF to resonate 2 μH at 20 kHz. Thus, amplifier/cable interaction problems in the audio band are not likely. However, it is known that some amplifiers will not tolerate even slightly capacitive loads. This is an amplifier design problem, not a cable problem, and should be dealt with at that level. It is easy to test amplifiers for load sensitivity problems, and those amps that are not satisfactory should be eliminated. We will assume that the amplifier/cable interface question is settled by using a "good" amplifier. The problem of fuse-protecting the output circuit is not trivial and will be discussed later.

With a good amplifier in place, the remaining electrical problems are related to how the loudspeaker loads the cable and interacts with it. It is possible to simplify the equivalent circuit a bit with the assumption that the amplifier can, at the very least, drive the cable capacitance. An appropriate circuit is shown in Fig. 2. While the values of the series resistance and induc-



Fig. 2—Simplified circuit for a "good" amplifier driving a cable and loudspeaker load. Critical frequencies for this circuit are summarized in Table V.

tance for the cable are easily measured, well known, and well behaved, such is not true of the load. The simplest equivalent circuit for a loudspeaker will be a series resistor/inductor combination. But real loudspeakers consist of crossover networks with inductors, capacitors, resistors, transformers, and voice-coils, all in some complex combination. Fortunately, it is not necessary to consider all possible combinations but only some limiting, worst cases. At low frequencies, most loudspeakers become mainly resistive, and some have a rather low value of resistance. Often the lowest value is below the rated impedance. Let us assume that this value never gets lower than one-half the rated impedance. If the loudspeaker becomes inductive at higher frequencies, as most cone-type drivers do, there should be no problems worse than the low-frequency problems. It is possible, however, with capacitive tweeters, ribbons, or some more unusual tweeters to have low-impedance effects in the loudspeaker at the high frequencies. It will therefore be wise to investigate resistive, capacitive, and inductive loads at about one-half the rated impedance at the high-frequency end of the spectrum as well. The low-frequency end of the spectrum will be taken as 20 Hz and the high-frequency end as 20 kHz.

Using the simplified equivalent circuit of Fig. 2, several frequencies of interest have been calculated. The first is the upper corner frequency for a load that is low and resistive at very high frequencies. While this is not a likely load, it is a worst possible case. It is the case for which the cable series inductance causes a roll-off of the high frequencies. For any realistic load, with some inductance, the cable inductance will be entirely swamped out by the load, of course. A second is the frequency at which the cable inductance and a highly capacitive load will resonate. The capacitive load is chosen as 4 μ F, which would correspond to a 2-ohm impedance at 20 kHz. While such a load is quite unreasonable, it represents a possible worst case. The frequencies given in Table V thus represent the lowest possible values for about the worst possible loading one could consider driving. All of the frequencies are well above the audio spectrum. However, they are not so high that if the cable lengths were doubled, they would be of no interest at all.

Table IV—Lumped element values for 10-meter lengths of cable.

Cable Type	Inductance, μ H	Capacitance, pF	D.C. Resistance, Ohms	Impedance (20 kHz), Ohms
No. 18 zip cord	5.2	580	0.42	0.44
No. 16 zip cord	6.0	510	0.26	0.30
No. 14 speaker cable	4.3	570	0.16	0.21
No. 12 speaker cable	3.9	760	0.10	0.15
No. 12 zip cord	6.2	490	0.10	0.15
Welding cable	3.2	880	0.01	0.04
Braided cable	1.0	16,300	0.26	0.26
Coaxial dual cylindrical	0.5	580	0.10	0.10
Coaxial RG-9	0.75	300	0.13	0.13

Table V—Frequency limitations for 10-meter lengths of cable with various loads.

Cable Type	Upper Corner Frequency, kHz		Resonant Frequency, kHz, for 4- μ F Load	Measured Phase Angle at 20 kHz, for 4-Ohm Load
	2-Ohm Load	4-Ohm Load		
No. 18 zip cord	75	136	35	3°
No. 16 zip cord	61	114	32	2°
No. 14 speaker cable	82	156	38	2°
No. 12 speaker cable	88	169	40	1.5°
No. 12 zip cord	55	106	32	4°
Welding cable	100	200	44	1.5°
Braided cable	360	680	80	1°
Coaxial dual cylindrical	670	1,300	112	
Coaxial RG-9	450	880	92	

Table VI—Worst-case distortion for power bursts just short of those necessary to burn out the fuse at any frequency.

Load	5 Amperes	3 Amperes	2 Amperes
8 Ohms	0.5%	1.0%	2.0%
4 Ohms	1.0%	2.0%	4.0%

It appears that, as common sense would tell us, one should not try to drive a loudspeaker of very low impedance at great distances, or that one should use higher impedance loudspeakers if long cables are necessary. With most normal listening room situations, the cables will be short enough so that no audio frequency problems arise from the loudspeaker cables. It is interesting to note that changing to larger wire has little effect on the high-frequency resonance or fall-off frequencies. Those frequencies are controlled by the series inductance. Thus, there is some rationale for using cables that have low series inductance. Standard coaxial construction of the cable seems to give all of the advantages of low series inductance without the serious disadvantages of high shunt capacitance.

Since most loudspeakers have their lowest impedance at low frequencies, there are some advantages in using physically larger wire, with its lower series resistance. One advantage is reducing losses of power in the connecting wire; another is preserving the high damping factor of the power amplifier. It seems unlikely that for runs of under 30 meters and with normal loudspeakers, there is any reason to use wire larger than No. 12 gauge for even the highest fidelity applications.

A large number of cables with resistive, capacitive, and real loudspeaker loads were measured using sensitive, broad-band, difference amplifier techniques. Resistive loads were more difficult to drive than typical loudspeakers. Capacitive loads were slightly more difficult still. Electrical problems of *any kind* (that is, phase shift, attenuation, dispersion, etc.) with 10-meter cables driving normal loudspeakers were just barely measurable using these refined measurement techniques. *Absolutely no audible problems could be heard.* The best solution to cable problems by far is to move the amplifier to the loudspeaker, thus making the cable very short.

Loudspeaker Considerations

When discussing wires used to connect amplifiers to loudspeakers, it would be wise to consider the residual effect of the wiring within the loudspeaker itself. At low frequencies, the worst offender is the series resistance of the low-pass crossover filter—in addition to the voice-coil resistance, of

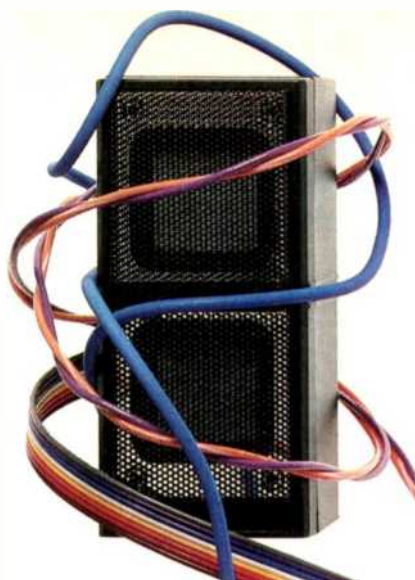

IF YOU DETERMINE the absolute worst-case frequency limits for a 10-meter-long run of cable, the effects will occur at frequencies well above audibility.



course. After all, 20 meters of No. 18 wire in an inductor introduces just as much resistance as 10 meters of No. 18 connecting cable from the amp to the speaker and back again. With essentially all loudspeakers that have internal crossovers and/or level-control pads, the internal resistance and inductance totally swamp out any possible small effects due to the connecting cable. These internal resistances of the crossovers and pads in a typical loudspeaker generally obviate the usefulness of the high damping factor of a typical amplifier. The only way to get the amplifier signal directly to the voice-coil is to use crossovers ahead of the amplifiers and multiple amplifiers. In very high-quality systems, elimination of the internal passive crossovers is a step that might be taken to obtain improvement of the sound.

Therefore, very good advice for improving a system and essentially eliminating cable concerns is to place the amplifiers at the loudspeaker and eliminate the crossovers by multi-amplifying the system with electronic crossovers. The problem of getting the low-

level signal to the amplifier from the source is relatively simple, since the impedance levels are relatively high and excellent coaxial cables have been available for many decades. This tactic also moves the power-level signals, hum, heat, and the like away from the signal sources and preamplifiers. Many of these practices are normal, good engineering methods and are commonly found in professional audio systems.

Fusing the Output Circuit

All of the above problems have been concerned with linear circuit elements. Ideally, the fuses used in the output circuit would be linear resistors as well. However, since they have to get hot, and melt, to burn out, they are actually nonlinear elements in the output circuit. If fuses are to be useful, they must blow out when the system is used at some specified power level over the maximum desired. Typically, a fuse will increase in resistance to about three or four times its cold value just short of burnout. At 60% of full load, it will increase to about twice its cold value. A typical fuse blow-out cycle is shown in Fig. 3; the resistance change per cycle is clearly evident. The calculations and measurements of this section show some possible problems with distortion caused by these changes in the fuse during normal program reproduction.

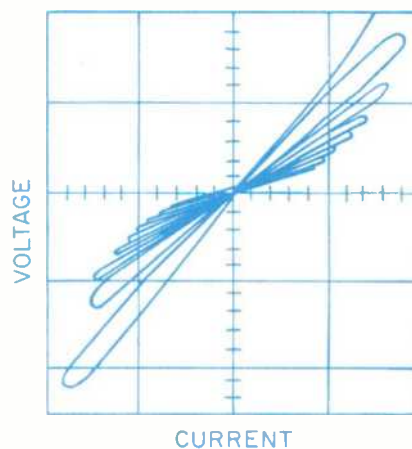

Fig. 3—Fuse-burnout cycle for a 20-Hz signal large enough to cause burnout in about 0.8 S. In this reproduction of an oscilloscope trace, the substantial change in the slope of the voltage-current curve indicates a large resistance change as the fuse element heats up.

Using the simple circuit of Fig. 4, it can be shown that for a typical, regular-speed fuse of the tubular type, the distortion produced could reach the values in Table VI. These figures represent intermodulation distortion for any frequency when the output circuit is pulsed with power bursts just short of fuse burnout. Typical measured modulation of a high-frequency signal when pulsed with tone bursts that are set at 60% of burnout are shown in Fig. 5. This Figure shows the oscilloscope trace of a 5-kHz signal modulated by 20-Hz tone bursts. The tone bursts have been filtered out to show only the 5-kHz modulated signal. The heating and cooling cycle of the fuse is clearly visible. The time constants of typical fuses are such that this heat and, consequently, resistance cycling can take place for normal musical beats at low frequencies. To minimize interaction of this type across the frequency spectrum, it would seem wise to provide separate fuses for each frequency range of a multi-way system. Fast-blow fuses are worse than regular fuses since they change temperature 10 times more quickly. There is no solution to this problem except overfusing or not using fuses at all, unless the



Fig. 4—Circuit for the series fuse often used for speaker protection. Possible worst-case distortion figures for this circuit are given in Table VI.

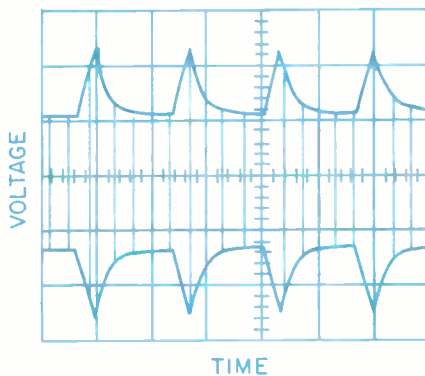
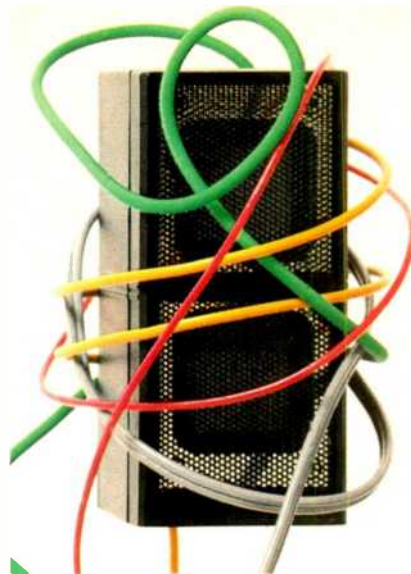

Fig. 5—Cycling of fuse resistance with a 5-kHz signal and a 20-Hz tone burst. In this reproduction of an oscilloscope trace, the burst is on for eight cycles and off for 32 cycles, at 60% of the amplitude that would cause burnout.



BY FAR THE BEST WAY to remedy cable problems is simply to move your amplifier closer to the loudspeakers, thus making the connecting cable as short as possible.



fuses are included within the feedback loop. This can be done, of course, by putting the fuses in the power-supply bus or even within the normal feedback loop.

Conclusion

It has been shown that loudspeaker cables need not be treated as transmission lines. It has also been shown that, in fact, transmission-line theory can give misleading results for very short lines, and that short lines should be treated as lumped lines. On the other hand, with poor choice of load and with longer cables, there may be some defects in phase or frequency response or some resonances introduced in the extreme upper audio frequency range.

It is clear that normal cables are suitable, and essentially perfect, compared to other defects in the transmission system—not the least of which is the loudspeaker crossover network and level-pad arrangement.

The use of special cables, including normal coaxial cable, is not warranted except in a few extraordinary applica-

tions. And in those particular applications short runs of cable would be a better solution.

Retrospect, 1989

There has been a great deal of interest in cables and interconnects in the years since this article was originally published. In fact, a whole industry has appeared. A number of new cable designs have appeared which have slightly different characteristics from the "standard" cables. Interestingly, these designs have gone in both directions at once, in that some increase inductance and some decrease it, some increase capacitance and some decrease it, some lower the impedance and some increase it, some reduce the time dispersion and some increase it, and so forth.

I have seen no scientific or statistically significant studies which show that all of the different designs have any significant or audible effect whatever on the transmission of audio frequencies in these cables. This is not to say, however, that there are not some common and sensible precautions which should be taken when wiring a system. I would recommend the following for consideration:

Choose a cable that has reasonably low resistance—say, less than 5% of the lowest resistance of the loudspeaker at any frequency. Choose a twisted pair to reduce or eliminate any possible crosstalk between wire pairs or from parallel power cords. Make connections on each end with proper spade lugs or screw terminals which can be firmly tightened. Additionally, it is a good idea with any cable—be it for loudspeakers or other interconnections—to look for a mechanically sound connector. Too many connectors are mechanically unreliable, with possibly one of the worst being the common RCA phono connector used on consumer equipment. Professional equipment uses XLR or BNC connectors, for good reason. Gold-plating is quite common today and certainly does no harm.

Recognize that while the sonic effects of cables have not been scientifically verified, it does no harm to use good-quality, more or less normal, cables. These are commonly available at modest cost, and their application gives psychological, and perhaps psychoacoustical, satisfaction, which is of some value.

Whither the Stereo LP?

JOHN EARGLE



From its introduction in 1957 until 1983, the vinyl LP was the major medium for stereo sound in the home. It was in 1983 that the Philips cassette eclipsed the LP in unit sales.

You may recall that the cassette was introduced around 1966, and at that time was of little more than dictating-machine quality. Through a series of developments in tape technology, electronics design, and noise reduction, the cassette emerged as a remarkable medium. During the 1970s, it effectively knocked open-reel tape out of the consumer marketplace.

As a home recording medium, the cassette eventually reached quality

levels high enough to satisfy even fussy users. And as a carrier of recorded program material, it survived the rigors of high-speed duplication. In time, the base of cassette players in the home, and especially in the automobile, increased to the point where tape decks rivalled turntables, and the cassette became the dominant medium for recorded music. The important thing to note is that it took some 17 years for this to happen.

The CD was introduced in 1982, and its phenomenal growth is something we have all witnessed in recent years. In 1982, no one could have foreseen that it would eclipse the LP in dollar

sales in 1987 and overtake it in unit sales in 1988. The CD has accomplished in five years what it took 17 years for the cassette to do.

The big question is this: Is the LP truly doomed? Or are we looking at a realignment of marketplace tastes and priorities, in which the LP will settle into a new but lower volume plateau? There are many commercial factors to be considered here, and I will try to sort them out.

First, we must realize that the record industry thrives as much on new technology as it does on new artists and new music. The record industry reached a peak in 1978, and the slump



that followed was devastating. The last five years have seen new growth in the industry, and it has been largely fueled by enthusiasm for the CD. Last year, in fact, was the banner year in the history of the record business.

CD mania has carried through into consumer electronics and record retailing as well, the high prices of discs notwithstanding. In an effort to make room for new CD releases, many large retail chains have cut back on LP bin space, and many record companies have adopted a CD-only policy for classical releases. Record retailers want to maximize the yield of every square foot of store space, and record

manufacturers are always looking for ways to delete slow-moving product and reduce their catalog size.

A related factor, at least in the United States, is the tooling down of LP manufacturing. In the last two decades, RCA and Capitol/EMI have between them closed six LP pressing plants, leaving the business largely to CBS, WEA (Warner/Elektra/Atlantic), and a group of relatively small, independent pressing houses. Ultimately, it may be the independents who keep the LP art going.

It would appear that economic factors are hastening the demise of the LP when, in fact, there may be a market

ILLUSTRATION: JOSÉ ORTEGA



A ANALOG TAPE RECORDING
NEED NOT SUFFER FROM
COMPARISON WITH ANY DIGITAL
RECORDING SYSTEM BASED UPON
TODAY'S RECORDING STANDARDS.

ation players and well-recorded program material.) In time, many of the LP's proponents may adopt the CD, but for the present, they are deeply committed to the older medium.

What, then, are the characteristics of the LP which make it such a favorite? And how good can the LP really be? In order to answer these questions, let's take a short look at the history of the medium.

Alan Blumlein cut the first 45/45 stereo disc in 1931, but it couldn't be played at that time. Many in the industry felt it would never be practical, and it was more or less hidden in EMI's archives for many years.

It wasn't until 1947 that the mono LP became a reality, and with it came a new approach to phonograph cartridge engineering. This sparked a re-examination of stereo disc problems, and by the mid-1950s, stereo had become a fact in the laboratory. By 1957, there was product on the market. It didn't always sound good, though, and there remained much work to be done. One by one, the significant problems were solved.

In the early 1960s, the discrepancy between vertical cutting and playback angles was identified and the adjustment made. About that same time, the problems of tracing distortion were addressed by "predistorting" the groove electronically. Later, this technique was abandoned in favor of elliptical playback stylus design, which further alleviated high-frequency loss at inner grooves. All along, there were improvements in vinyl formulations for pressing, resulting in lower noise. The American industry, however, was never able to maintain the generally high levels in pressing quality routinely met by Japanese, German, and Dutch manufacturers.

By the late 1960s, direct-to-disc recording had established new limits for the stereo LP by circumventing the tape recorder altogether and simplifying the overall recording chain. Then came the golden era of \$18 LPs. Throughout the 1970s, many small, audiophile-oriented companies regularly turned out superior disc product, with most of the pressing done in Japan. Denon and JVC releases were imported from Japan, and domestic labels such as Telarc and Delos were putting out superior product, via Soundstream digital sources, long before the majors realized that a market for a "super record" existed. Mobile Fidelity took the

which is not quite ready to die. Given a stronger dollar, there would be plenty of high-quality imported LP product to fill some of this need. Many American record manufacturers, however, feel that between cassettes and CDs, they are pretty well covering the important retail bases.

If there is to be an ongoing market for the LP, it will be that which is fueled

largely by high-end audiophile tastes. To many, this must seem paradoxical in an age of rapidly improving digital technology, but it is the case nonetheless. A trip through any high-end hi-fi show will reveal a large number of expensive turntable/cartridge combinations, most reproducing superb sound. (The same, I might add, holds for CD demonstrations which use later gener-

Fig. 1—Signal space available for standard analog recording on 15-ips tape, with and without Dolby SR. The top solid curve shows the normal limits in analog tape systems due to equalization requirements at low frequencies and the risk of tape saturation at high frequencies. Dolby SR effectively compensates for these problems, creating overall flat power-bandwidth capability at full signal level. Upper frequency boundaries, with or without SR, are not absolute limits. Low-level noise readings were made in third-octave bands; thus, the data indicates the effective dynamic range of the system.

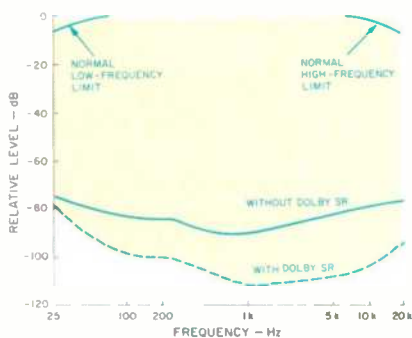
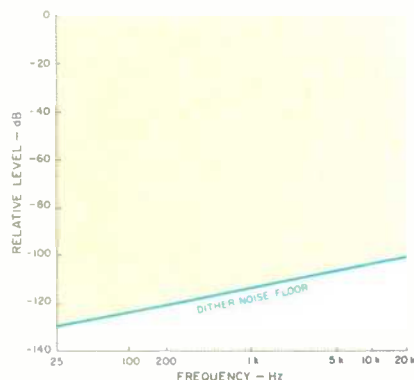

Fig. 2—Signal space for a 16-bit digital system operating with a 44.1-kHz sampling rate. Once converted to the digital domain, these characteristics can be carried through to the end product—in this case, the CD itself. A dithered noise floor has been added to the digital input signal to linearize the system's low-level performance. Low-level noise readings were made in third-octave bands.



Dolby Spectral Recording



boldest stand of all in leasing master tapes from the majors, transferring them to disc at half speed with loving care, and making much better product than the larger record companies knew was possible.

But back at the studio and the laboratory, there were still many nonlinearities in the overall disc transfer process remaining to be solved. Some of these could be dealt with and compensated for by creative "adjustment" of transfer processes and even of studio techniques themselves. (See my discussion of this in "Do CDs Sound Different?" in the November 1987 issue.)

Digital recorders had come into the studio during the mid-1970s. While solving the knotty problems of alignment and response stability, these machines did not provide the natural cushion at high recording levels which the analog machines did. It was at this point that many audiophiles developed their first doubts about digital recording technology in general.

When the earliest CDs hit the market, these doubts were reinforced. Many of the new discs did sound strident. It has only been in recent years that the problems with digital have been solved, again through adjustments in recording philosophy as well as improvements in recording and playback processes.

How good can the stereo LP be, given today's state of the art? It can be a superlative medium. An all-analog recording chain of the highest quality would certainly begin in the studio with Dolby Spectral Recording and analog tape running at 15 ips. Dolby SR is that company's latest generation in complementary pre- and post-processing for noise and distortion reduction at the initial recording stage, and its overall dynamic range capability is shown in Fig. 1. It effectively adds about 25 dB of dynamic range to the normal performance of a tape recording channel. (The zero reference level in Fig. 1 is established as the normal maximum operating level the engineer wishes to reach. Normally, with current tape formulations, this is set at around 200 nWb/m. Any modulation over this reference level will fall into the analog cushion range. It is best to avoid this, but there would be no catastrophe if occasional forays into this area were unavoidable.)

Figure 2 shows the signal space of a 16-bit digital system operating at a sampling frequency of 44.1 kHz. The

Most readers of *Audio* probably have some familiarity with the basics of noise reduction, if for no other reason than that they have had these functions on their cassette machines for years. The heart of most noise-reduction systems is signal compression during recording and complementary signal expansion during playback. Complementary equalization is also an important part of the noise-reduction process, as is the selection of proper attack- and release-time characteristics for the various gain manipulations.

Dolby Laboratories introduced its A-type noise-reduction system for professional use in the late 1960s, with the consumer B- and C-type systems following later. Nothing is free, and the price paid for the dynamic range extension of the earlier noise-reduction systems was occasional audibility of the compression/expansion actions when those actions were "unmasked" by the specific nature of the input signal. Dolby Laboratories analyzed the audibility problems of the earlier systems and, in 1986, introduced yet another generation, called Spectral Recording, which embodies many of the advantages of the earlier A-type system plus the sliding-band techniques introduced in the B- and C-type systems.

The action of Dolby SR is basically to analyze the spectral composition of the input signal on a continuous basis and to define a protective dynamic "gain envelope" for the signal, such that no part of it will drop below the audible noise threshold of the recording medium. On playback, the inverse action is carried out, and the original signal dynamics are restored. The overall improvement in dynamic range over the non-Dolby SR recording channel is about 24 dB, from 2 to 8 kHz.

At the lowest recording levels, the SR system is in its full boost mode in recording and full attenuation mode in playback. What this means is that the inherent tape noise floor of the recorder is lowered by as much as 25 dB in the range where the ear is most sensitive to noise. The long solid curve in Fig. 1 shows the normal limit for tape without Dolby SR, while the

dashed curve shows the effect of Dolby SR. The spectral characteristics have been plotted based on third-octave noise measurements and, thus, are some 14 to 15 dB lower than wideband noise measurements. To the extent that we can hear pure tones in the midband which are some 12 to 15 dB below a wideband noise level, the total spread between upper and lower bounds in Fig. 1 gives an accurate indication of the subjective dynamic range capability of the recording system. The gradually fading boundaries indicate that the limits are not firmly fixed and that recorded modulation may exceed them slightly.

In Fig. 1, spectral data on the analog recording system is from Camras [1, page 351], modified by recent tape improvements which I have described [3, page 305]. The Dolby SR data is from Dolby [2].

As with all Dolby NR systems, a full-level signal goes through the system almost unimpeded, with little action by the signal-analysis and gain-change circuitry. It is only when the signal drops to lower levels that the circuit complexities come into play.

With good analog tape recording channels already pushing a dynamic range of 68 to 70 dB, the additional 25 dB afforded by Dolby SR gets it into the range of 90 to 95 dB, which is comparable to digital recorders. Some engineers say it is even better.

Is there a price for all this improvement? Not as far as I can tell. I auditioned a pair of Dolby SR retrofit cards with my Dolby A units, and I could not make the action audible—no matter how hard I tried. J.E.

References

1. Camras, M., *Magnetic Recording Handbook*, Van Nostrand Reinhold, New York, 1988.
2. Dolby, R., "The Spectral Recording Process," *Journal of the Audio Engineering Society*, Vol. 35, No. 3, March 1987.
3. Eargle, J., *Handbook of Recording Engineering*, Van Nostrand Reinhold, New York, 1986.
4. Pisha, B. V. and G. Alexandrovich, "Direct Metal Mastering—A New Art in LP Records," *Audio*, April 1987.



WILL THE IMPROVEMENTS
IN ANALOG RECORDING
TECHNIQUES, SUCH AS DOLBY SR
AND DMM, GIVE THE LP A NEEDED
REPRIEVE? I SUSPECT THEY WILL.

upper boundary is firmly established, due to the hard clipping of the system once full modulation is reached. Also, the upper frequency limit of the system is firmly established at 20 kHz, due to the filter demands of anti-aliasing.

A comparison of Figs. 1 and 2 shows that, at some higher frequencies, the signal space of the Dolby SR-equipped tape recorder actually ex-

ceeds that of the digital system. Furthermore, the upper frequency limit of the Dolby SR analog system is not limited to 20 kHz. Actually, Dolby SR could be used with 30-ips tape recorders, with overall system response well beyond 20 kHz.

Analog tape recording, then, given the dynamic code/decode action of Dolby SR, is effectively a match for

current digital standards and does not take a back seat at all in any listening comparisons. However, subsequent analog transfers will show some degree of degradation, while subsequent transfers of digital recordings can be virtual clones of the original.

Moving on to the stereo LP itself, the quality improvements inherent in Direct Metal Mastering are substantial. One of the best papers covering DMM was published in *Audio* (April 1987). In that article, authors B. V. Pisha and George Alexandrovich covered the technology in detail. Figures 3 and 4 represent measurements presented in this article and data regarding the performance of disc systems at high frequencies. Note that DMM provides a lower noise floor for the system as well as extended high-frequency response.

DMM accomplishes these improvements through use of a precision cutting tool which has no burnishing facets, cutting directly into a copper surface instead of the conventional lacquer-coated disc. Lacquer is a complex organic mixture and introduces its own distortion and noise into the cutting process. By comparison, the copper is dimensionally stable and produces a more accurate signal, virtually free of bothersome groove echo. Further, the number of replicated generations between the master and the finished product can be reduced, with consequent improvement in noise.

While the superb low-noise characteristics of Dolby SR are not carried through into the finished disc product, the resulting noise floor is quite acceptably low. Partisans of extended frequency response will be quick to point out that the response of the finished discs, at outer and middle diameters, can easily exceed 20 kHz.

Time will tell if the improvements in analog processes, both tape and disc, will be able to forestall the demise of the LP and give it a reprieve. I suspect they will. Like so many other fans of the CD, I have a vast collection of LPs going back to the beginning of that art. Many items in my collection will never see the light of day on CD, so I do a good bit of listening to both formats. I am comfortable with both mediums. However, given the choice of buying Sheffield's Moscow Sessions on CD (made from digital masters) or LP (made from analog masters), I opted for the CDs. But I might, at least some of the time, be fooled in a blind A/B comparison!

Fig. 3—Signal space for DMM and standard stereo LPs. The upper limit shown is determined by a maximum recorded stylus velocity of 10 cm/S, as modified by RIAA pre-emphasis. Low-level noise readings were made in third-octave bands. (After Pisha and Alexandrovich.)

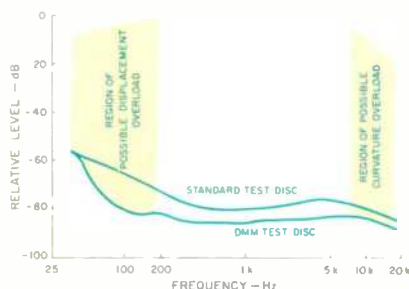
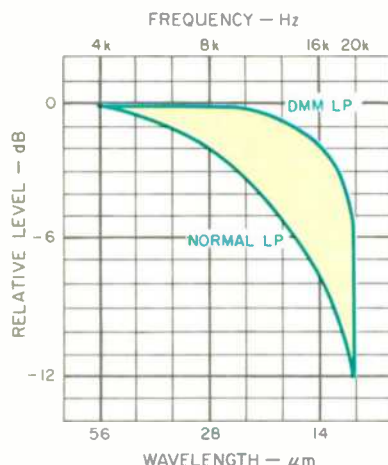

Fig. 4—Reduction in high-frequency losses at moderate playback levels when DMM is used. The losses are minimized due to the absence of burnishing facets on the DMM cutting stylus. Curves shown are from playback of actual pressings. (From Pisha and Alexandrovich.)



MAGNEPLANAR[®]

LOUDSPEAKERS



Elegance of appearance has finally been combined with highly refined ribbon and planar-magnetic driver technologies. Serious music lovers must audition Magneplanars to fully appreciate how an enclosureless design can bring home the beauty and dynamics of live music. From \$495 pair.

 **MAGNEPAN**

1645 Ninth Street, White Bear Lake, MN 55110

Enter No. 16 on Reader Service Card

NIGHTS THE STARS CAME OUT

The best and brightest sing 65 years
of Broadway show-stoppers.

What makes the American musical theater such a unique contribution to world culture?" asks historian Dwight Blocker Bowers at the beginning of his scholarly, engaging, and informative book accompanying *American Musical Theater: Shows, Songs, and Stars* (RD-036/A4-20483). This extraordinary boxed set—available as six LPs or four cassettes or CDs—answers the question.

As performing arts historian at the Smithsonian's National Museum of American History, Bowers supervised the selection, presentation, and annotation of 81 recordings. These works cover the astonishing range of native American talent in the musical theater over seven decades, from Eugene Cowles' charmingly naive singing of Victor Herbert and Harry B. Smith's "Gypsy Love Song" from *The Fortune Teller* (recorded in 1906) to

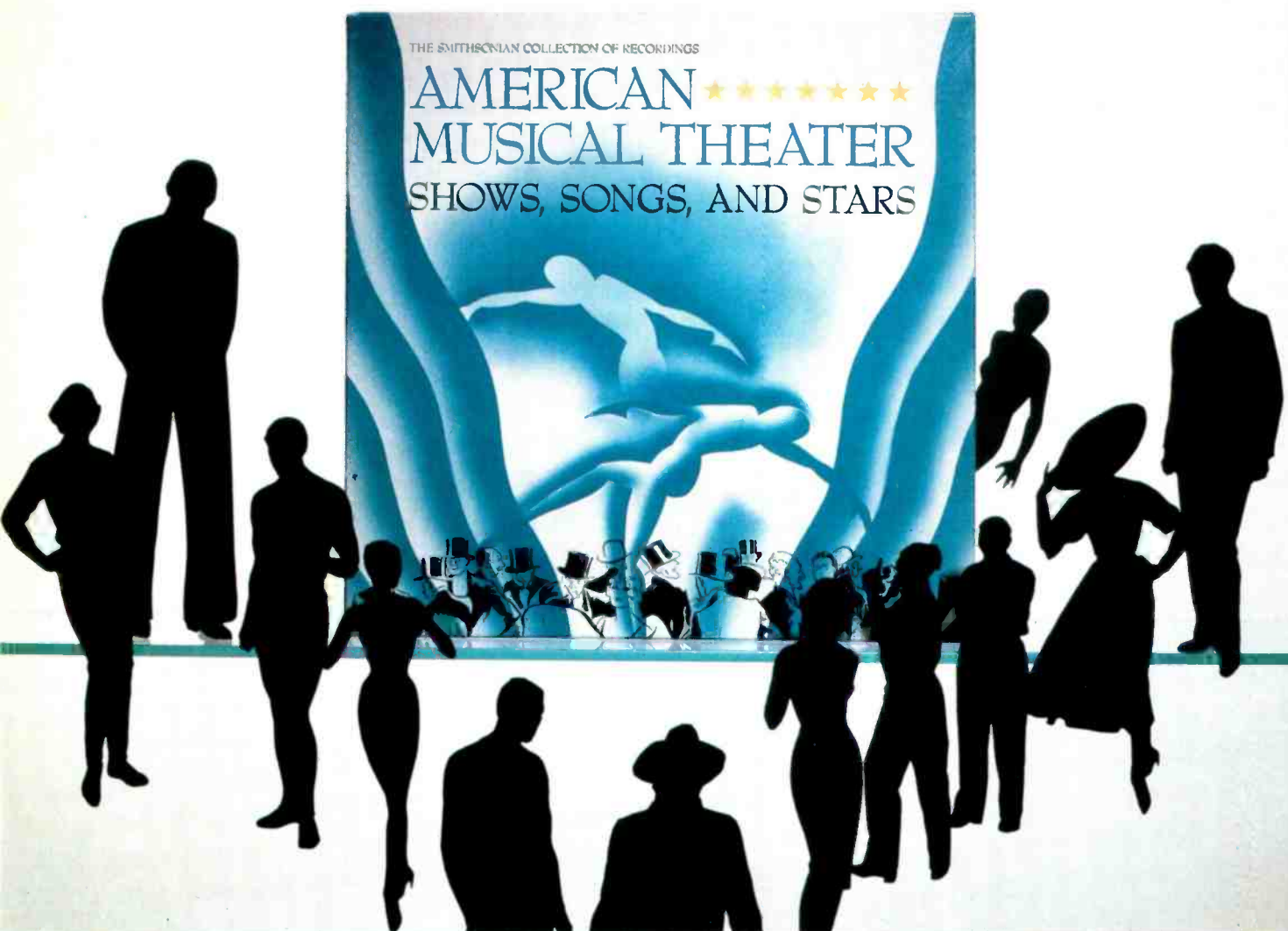

the unselfconscious valor of Zero Mostel and Maria Karnilova in "Sunrise, Sunset" from Jerry Bock and Sheldon Harnick's *Fiddler on the Roof* (1964). There have been dozens of audio anthologies in recent years, yet this one from the Smithsonian Collection of Recordings, produced in association with CBS Special Products, may be the definitive one.

With the 132-page handbook and recordings, you have virtually a home course in American musical theater. The book contains a very carefully researched history of each representative selection and the work from which it has been excerpted, a generous sampling of period photographs, and a distillate of musical commentary that is refreshingly devoid of arid academicism.

Here, for example, is Lillian Russell's recording of "Come Down, Ma Evenin' Star" from something called *Twirly-Whirly*. Composer John Stromberg, the notes tell us, died tragically just before the show premiered in 1902, and the song became Russell's signature piece. Her limpid, controlled emotionalism helps us understand why Russell was a legend in the theater. We can never again think of her as simply Diamond Jim Brady's sidekick.

There is no stereotyping in this collection, no bowing to just what you'd expect. As sung by George M. Cohan in 1911, "Life's a Funny Proposition, After All" from *Little Johnny Jones* demonstrates that Cohan was not simply a rambunctious fireball of energy. He speaks the lyrics of his own bittersweet song, a reflection on romantic ambiguities worthy of Cole Porter or Stephen Sondheim. Again, the selection gently contradicts our presumptions about the artist's achievements.

Porter and Sondheim are here, of course—the former's "Night and Day" from *Gay Divorcee* sung with Fred Astaire's crystalline simplicity in 1932, and "I Get a Kick Out of You" crooned by Ethel Merman with her wondrous vocal irony in 1934, after her triumph in *Anything Goes*. Sondheim's contribution is his deftly and swiftly composed last-minute addition, "Comedy Tonight," for Zero Mostel and company in *A Funny Thing Happened on the Way to the Forum* (1962). Because this collection spans 1898 to 1964, the later Sondheim is omitted.

With almost seven dozen major moments in musical history, a reviewer can only take you at a gallop around the rich buffet and hope that you will be intrigued enough to ring your local music shop and insist they order this historic anthology for you. At any rate,

here is a sampling, in no special rank, of what the collection includes:

- Noble Sissle's wry, beguiling "Baltimore Buzz" from Eubie Blake and Sissle's *Shuffle Along* (1921).
- The limpid, melodic sentiment of "Till the Clouds Roll By" from Jerome Kern and P. G. Wodehouse's *Oh, Boy!* (1917), disarmingly affecting as sung by Anna Wheaton and James Harrod.
- Eddie Cantor, giving a calmly risqué turn to "Makin' Whoopee" from *Whoopee* (1928); Cantor sings it with the final "g" on the title's gerund.
- "He Had Refinement" (my favorite among the lesser known tunes of this collection) from *A Tree Grows in Brooklyn*; this piece reveals forever not only the eloquence of Arthur Schwartz and Dorothy Fields' comic symbiosis but also the full range of the great and gifted Shirley Booth, one of the few American artists whose voice and intonation brilliantly combined humor and pathos.
- "Try to Remember" from Tom Jones and Harvey Schmidt's still-running *The Fantasticks* (1960), with Jerry Orbach in fine vocal form and avoiding any hint of the maudlin.
- Rosalind Russell and Edie Adams, lamenting their decision to leave "Ohio" for the *Wonderful Town* of New York created by Leonard Bernstein, Betty Comden, and Adolph Green in 1953.
- The shimmering brilliance of the great Barbara Cook in "Glitter and Be Gay" from Bernstein's *Candide* (the 1956 original and much the superior version, I think).

Of course, there are also selections from *South Pacific*, *The King and I*, *The Music Man*, *West Side Story*, *My Fair Lady*, *Oklahoma!*, *Carousel*, *Guys and Dolls*, and . . . well, it's enough to make you think there was talent and artistry *before* humans crept around dressed like cats and Broadway stages depended on crashing chandeliers to entice audiences. Anywhere you listen in this Smithsonian/CBS Special Products set, you risk being afflicted with severe nostalgia. **A**

American Musical Theater: Shows, Songs, and Stars is available as a complete set of LPs, cassettes, or CDs for \$59.95 (postpaid) to the general public or \$54.95 (postpaid) to Smithsonian Associate Members from: American Musical Theater, Smithsonian Collection of Recordings, P.O. Box 23345, Washington, D.C. 20026; (800)678-2677.

Photograph: David Hamsley

DONALD SPOTO

1

NAD 7400 RECEIVER

Manufacturer's Specifications

FM Tuner Section

Usable Sensitivity: Mono, 10.3 dBf.

50-dB Quieting Sensitivity: Mono, 13 dBf; stereo, 35 dBf (25 dBf with NR on).

S/N: Mono, 80 dB; stereo, 75 dB at 65 dBf.

THD: Mono, 0.08% at 1 kHz, 0.2% at 100 Hz and 6 kHz; stereo, 0.08% at 1 kHz, 0.3% at 100 Hz and 6 kHz.

Frequency Response: 30 Hz to 15 kHz, ± 0.5 dB.

Capture Ratio: 1.5 dB.

Alternate-Channel Selectivity:

Wide, 75 dB; narrow, 80 dB.

Adjacent-Channel Selectivity:

Wide, 7 dB; narrow, 20 dB.

AM Rejection: 65 dB.

Image Rejection: Greater than 90 dB.

I.f. Rejection: Greater than 100 dB.

SCA Rejection: 70 dB.

Subcarrier Suppression: 60 dB.

Separation: 50 dB at 1 kHz, 40 dB from 30 Hz to 10 kHz.

AM Tuner Section

Usable Sensitivity: 300 μ V/m.

Selectivity: 35 dB.

Image Rejection: 50 dB.

I.f. Rejection: 50 dB.

S/N: 45 dB.

THD: 0.5%.

Amplifier Section

Power Output: 100 watts per channel, 8-ohm loads, 20 Hz to 20 kHz; bridged mode, 300 watts, 8 ohms, 20 Hz to 20 kHz.

THD: 0.03%.

Clipping Power: 130 watts per channel, 8 ohms.

IHF Dynamic Headroom: +5.7 dB.

Slew Factor: Greater than 50.

Slew Rate: Greater than 30 V/ μ S.

SMPTE IM: 0.03%.

CCIF IM: 0.03%.

Input Sensitivity: MM phono, 0.28 mV; MC phono, 0.02 mV; high level, 15 mV.

Phono Overload at 1 kHz: MM, 180 mV; MC, 13 mV.

S/N: MM and MC, 76 dB; high level, 96 dB.

Frequency Response: Phono, RIAA, ± 0.5 dB; high level, 20 Hz to 20 kHz, ± 0.3 dB.

Tone-Control Range: Bass, ± 10 dB at 50, 120, or 250 Hz; treble, ± 10 dB at 3, 6, or 12 kHz.

Bass EQ Action: +3 dB at 60 Hz, +6 dB at 36 Hz.

Infrasonic Filter: -3 dB at 12 Hz, 12 dB per octave.

Audio Muting: -20 dB.

General Specifications

Power Requirements: 110, 120, 220, or 240 V a.c., 50/60 Hz; 390 VA.

Dimensions: 17 $\frac{1}{8}$ in. W x 4 $\frac{3}{4}$ in. H x 15 $\frac{1}{4}$ in. D (43.5 cm x 12.1 cm x 40.1 cm).

Weight: 26 lbs. (11.8 kg).

Price: \$999.

Company Address: 575 University Ave., Norwood, Mass. 02062.

For literature, circle No. 90

It is always a pleasure to come across an audio component where the manufacturer takes the trouble to tell us exactly how the product measures up, using approved standards of measurement. It's an even greater pleasure to encounter a product which meets or exceeds virtually all of those published specifications. The powerful NAD 7400 receiver is just such a product. If you've glanced at NAD's published specs, above, you may feel that my calling this receiver "powerful" may be a bit of an overstatement. Believe me, it is not, for although the continuous power rating is 100 watts per channel, the "power envelope" circuitry, for which NAD is noted, can deliver short-term power peaks of 300 to 500 watts per channel, depending upon your speaker's impedance. It is also possible to operate this receiver in the bridged or mono mode, for a continuous power output of about 300 watts into an 8-ohm load. I doubt very much if most users of this product would want to do that, however, for it would be necessary to add a second amplifier of the same power-handling capability to drive the right-channel speaker. Seems to me most people opt for a receiver in order to minimize the number of components needed in the





system. Still, I guess it does no harm—and doesn't add much to the cost—to include this extra feature.

NAD has always had the knack of providing all the useful features most people want in an audio component, without going overboard on needless frills. Instead of those seldom-used features that some manufacturers insist upon giving us, NAD concentrates on providing a product in which performance levels are well balanced. In the Model 7400, we have superb FM tuner performance coupled with high-level and phono preamp audio stages that deliver excellent sound reproduction.

The FM tuner section's 75-ohm coaxial antenna input is directly connected to the first stage of r.f. amplification, avoiding the use of—and the losses generated by—a 300-to-75-ohm balun transformer. The input circuit employs a dual-gate MOS-FET. A buffer stage precedes the i.f. circuitry, and a balanced quadrature detector is used for demodulation of the composite audio signal. That signal is then phase-compensated to make sure that the phase-locked-loop, multiplex-decoder circuit maintains high levels of stereo separation. There's a carefully designed "narrow" i.f.

mode which increases adjacent-channel rejection to 20 dB—although I actually measured 21.5 dB!

NAD seems to have a habit of calling certain features by names which are not used by anyone else. For example, the partial FM-stereo blend circuit, useful when stereo signals are weak and noisy, is dubbed "FM NR" by NAD. By whatever name it's called, this circuit's net effect is to reduce noise at the expense of stereo separation. NAD makes sure the trade-off is worthwhile, however, by carefully controlling the amount of blend. The 7400 offers two "banks" of seven presets, and you can program any combination of AM and FM station frequencies into the resulting 14 memory preset locations. Though tuning is digital, as is the frequency display, the tuning knob offers the intuitive feel of an analog system, providing a sense of extreme accuracy and eliminating those manual up and down tuning buttons or rocker switches which are often awkward to use and yet are found on so many of today's tuners and receivers. With the NAD 7400 you can give the knob a quick spin to scan rapidly across the FM or AM band or turn the knob slowly for fine tuning.

NAD's "power envelope" amp circuitry provides extra power for several hundred mS—not just the 20 mS of dynamic headroom tests.

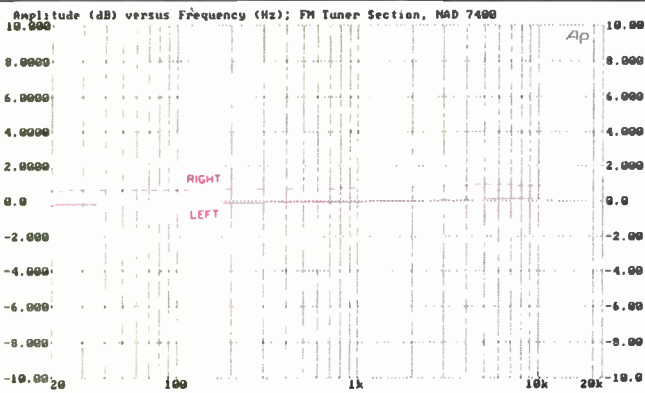

Fig. 1—Frequency response, FM tuner section.

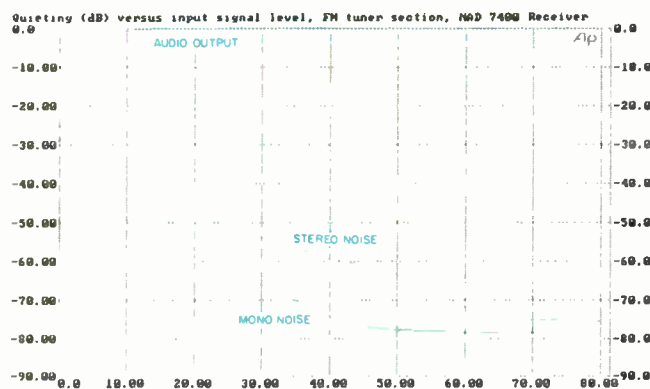

Fig. 2—FM quieting characteristics.

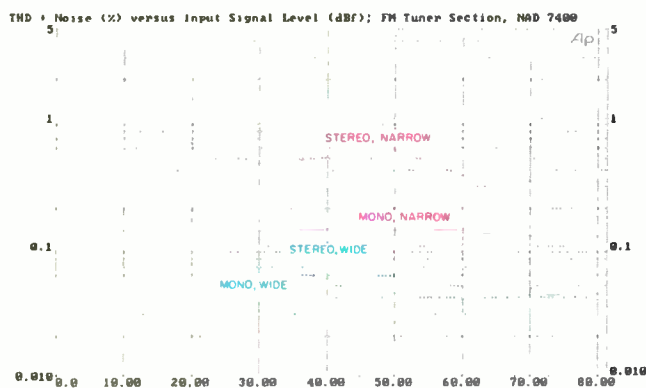

Fig. 3—THD + N vs. r.f. signal level for mono and stereo, in wide and narrow i.f. modes.

I have discussed NAD's "power envelope" circuitry in previous test reports of their receivers, but a quick review might be useful to those not familiar with this circuit. Essentially, two supply voltages are available for the amplifier's output stages. At moderate signal levels, the normal (lower) voltage supply provides all current. When the audio signal level rises above the rated power level, a controller turns on a "gate" transistor, so maximum current can flow from the alternate (higher) voltage supply. While the IHF Standard for dynamic headroom calls for measuring the ability of an amp to deliver levels in excess of its rated power for 20 mS, the NAD "power envelope" circuit provides this extra power for several hundred milliseconds. Of course, if constant, high power-output currents are called for—as, for example, during my bench tests—a second controller gradually shuts off the flow from the high-voltage supply to prevent overheating and possible damage to the amplifier. The Model 7400, according to NAD, can supply peak output current of up to 40 amperes.

The volume control of the 7400 is part of a feedback loop which varies preamplifier gain. As a result, when volume is turned down from maximum, residual circuit noise is also reduced proportionately. When the volume up and down buttons on the supplied remote control are used, a miniature motor inside the receiver actually turns the volume control, avoiding the noise and distortion which sometimes occur with all-electronic level control circuits.

With three distinct crossover frequencies for both the bass and treble controls, the tone-control flexibility of this receiver approaches that of a parametric equalizer. Rather than provide a loudness control, NAD chose to incorporate a "Bass EQ" circuit. Instead of a loudness circuit's volume-dependent boost of the low and upper bass, NAD's circuit simply boosts the lowest bass frequencies by a fixed amount. At the same time, a sharp infrasonic filter is switched in, to avoid boosting or amplifying signals below the audible range. The 7400 has input/output circuits for two tape decks and allows dubbing in either direction. In short, this receiver offers most of the essential conveniences found in separate power amplifiers, preamplifiers, and tuners—all on a single, well-designed chassis.

Control Layout

The power switch and a stereo 'phones jack are at the extreme left of the matte-black front panel. Speaker selector pushbuttons "A" and "B" and the "Bass EQ" button are to the right of the 'phones jack. Further to the right are the bass and treble controls, a pair of three-position lever switches that select bass or treble turnover frequencies, a pushbutton that bypasses the tone controls altogether, and a "Copy" lever switch with positions for copying from tape 2 to tape 1, and vice versa. Next are the two tape-monitor selector buttons; the "Phono," "Video," and "CD" input selectors; a button marked "Low Level," usually called muting, which reduces volume by about 20 dB; a rotary balance control, and a rotary volume control. All the button switches are of the push-on/push-off type and are surmounted by indicator lights so you can tell which are activated. Along the upper half of the front panel are seven numbered buttons for the preset radio station frequencies, as well as a

True Story

KLIPSCH® speakers weren't the first I owned. Fact is, I had another 'highly touted' brand and thought they were wonderful. Those speakers were almost new when a friend came to live with me for a few days between apartments.

He'd put all his furniture in storage, but he brought his KLIPSCH FORTÉs® with him and hooked 'em up next to my speakers. I was ready for the duel and confident my speakers would win.

On the very first CD, the FORTÉs made it clear that I'd been missing a lot in my music. They delivered so much more detail and articulation. So much more dynamic range. The sound was alive. There was no contest.

As soon as my friend moved on, I sold my speakers and bought a new pair of FORTÉs. I was pleasantly surprised at the price. I could have bought them to begin with and saved some money.

I think the FORTÉs are just great. No component in my system, not even my CD player, ever made such a vivid difference. Music never sounded so good to me.

For your nearest KLIPSCH dealer, look in the Yellow Pages or call toll free, 1-800-223-3527.

 **klipsch**®
A LEGEND IN SOUND™

P.O. BOX 688 • HOPE, ARKANSAS USA 71801

Enter No. 15 on Reader Service Card

The FM frequency response was considerably better than claimed, deviating by no more than 0.15 dB across its bandwidth.

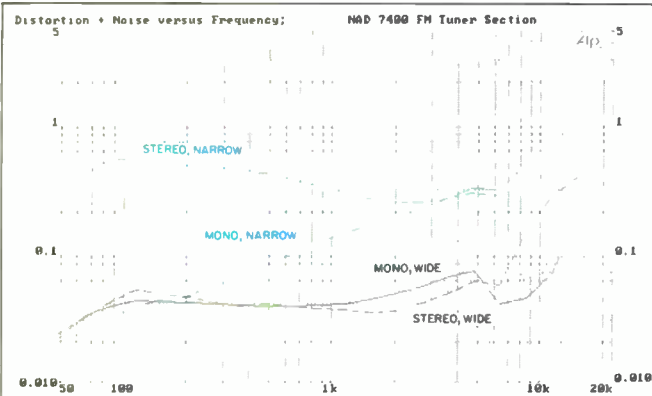

Fig. 4—THD + N vs. frequency.

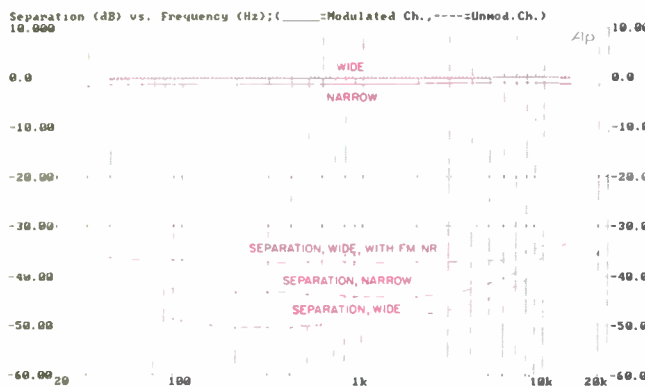

Fig. 5—Frequency response (solid curves) and separation in both wide and narrow i.f. modes, and with "FM NR" in wide mode.

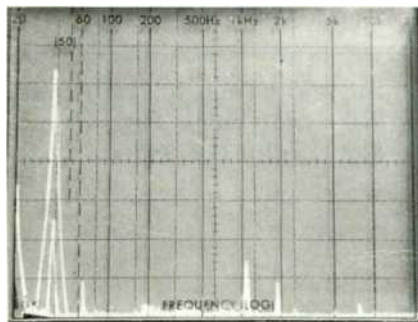

Fig. 6—Separation and crosstalk components for a 5-kHz modulating signal.

"Bank" button which selects between two banks of presets and an "Enter" button used for memorizing the frequencies selected. Pushbuttons for "Mono," "AM," and "FM" come next, and near them are the buttons for selecting the narrow i.f. mode and "FM NR." Pressing this last button reduces weak-signal FM stereo noise by moderately "blending" left- and right-channel signals. The digital frequency display, in addition to showing the tuned-to frequency, also has five LEDs below the numerals that show relative signal strength and a single LED that illuminates when center tuning has been achieved. Above the display are three more LEDs; these light in the presence of an FM stereo signal, when the "Soft Clipping" switch on the rear panel has been activated, or when protection circuitry has been triggered.

A pivotable AM loopstick is on the rear panel, adjacent to the 75-ohm F-type FM antenna connector and the spring-loaded terminals used for hooking up an external AM antenna. Further to the right are two pairs of color-coded speaker-cable binding posts and two convenience a.c. outlets, one switched and one unswitched. Under the speaker terminals are slide switches for optimizing the speaker impedance match, for mono bridging, and for activating the infrasonic filter, plus a "Soft Clipping" switch for altering the way in which clipping occurs when amplifier overload is reached. The "Impedance" and "Bridging" switches are normally locked in their preferred positions by means of small plastic strips which must be unscrewed in order to alter those switch settings. "Preamp Out" and "Main Amp In" jacks are centered beneath the two sets of speaker terminals. At the lower left, beneath the loopstick and the other antenna terminals, are the various phono and high-level inputs, a switch that selects MM or MC cartridge preamplification, and a ground terminal.

Tuner Measurements

Figure 1 shows the frequency response of the FM tuner section, measured across the speaker loads, with tone controls bypassed. Response was considerably better than claimed, never deviating by more than 0.15 dB. The right-channel response has been deliberately offset for clarity. Actual channel balance was virtually perfect at the volume setting used in this test.

Figure 2 shows how noise decreased with increasing signal strength for mono and stereo FM signals. At 65 dBf, S/N measured 78 dB in mono and 73 dB in stereo—just 2 dB short of the claimed 80 and 75 dB, but still excellent results for any tuner section. In mono, 50-dB quieting required only 14 dBf of signal input. This level is also the point at which stereo threshold occurs; to reach 50 dB of quieting in stereo, a signal level of only 23 dBf was needed. This result is all the more impressive since the "FM NR" circuit was not used when obtaining this measurement. There was an improvement of about 2 dB in S/N when I switched to the narrow i.f. mode. However, since the shape of the quieting curves—and of the audio output, represented by the top curve in Fig. 2—remained essentially the same, I did not plot a second graph for this operating condition.

In measuring THD, on the other hand, choosing the narrow i.f. setting made a substantial difference compared with operation in the normal (wide) i.f. mode, so THD + N versus

Music made Beautiful



Sonance makes music more beautiful with "Architectural Audio." Custom in-wall stereo speakers and controls that blend unobtrusively into your home's most discriminating decor.

All Sonance speakers and controls can be painted or cloth covered to aesthetically match any room's delicate design. Precision flush mounting insures excellent high fidelity response and consistent decorative perfection.

To experience "Architectural Audio" we invite you to call your local Custom Audio/Video Specialist.



32992 CALLE PERFECTO, SAN JUAN CAPISTRANO
CALIFORNIA 92675 (714) 661-7558
Outside CA (800) 582-7777 FAX (714) 240-4995

SONY WOULD ASK YOU TO SPEND \$ BLOW EVERYTHING

While the best things in life may be free, the best in car stereo is anything but. So cost containment had to take a back seat when Sony set out to outperform every car CD changer available today. Presenting the CDX-A2001 DiscJockey® car CD changer. It recreates music so real, so all-encompassing, it drives even the most exotic cars to a higher level of performance.

The 2001 owes its existence to the world's foremost experts in digital audio—the Sony engineers who introduced the first car CD changer and invented the



Compact Disc format itself. To create the 2001, they drew upon a host of Sony digital refinements unlike anything

previously found in a car CD changer.

For starters, Sony engineers developed an 8x oversampling digital filter with 45-bit processing that reveals music's subtle overtones with superlative accuracy. It also includes a proprietary noise shaping circuit that reproduces bass fundamentals with a strength and clarity that leave typical



LDN'T DARE O MUCH IF IT DIDN'T ING ELSE AWAY.

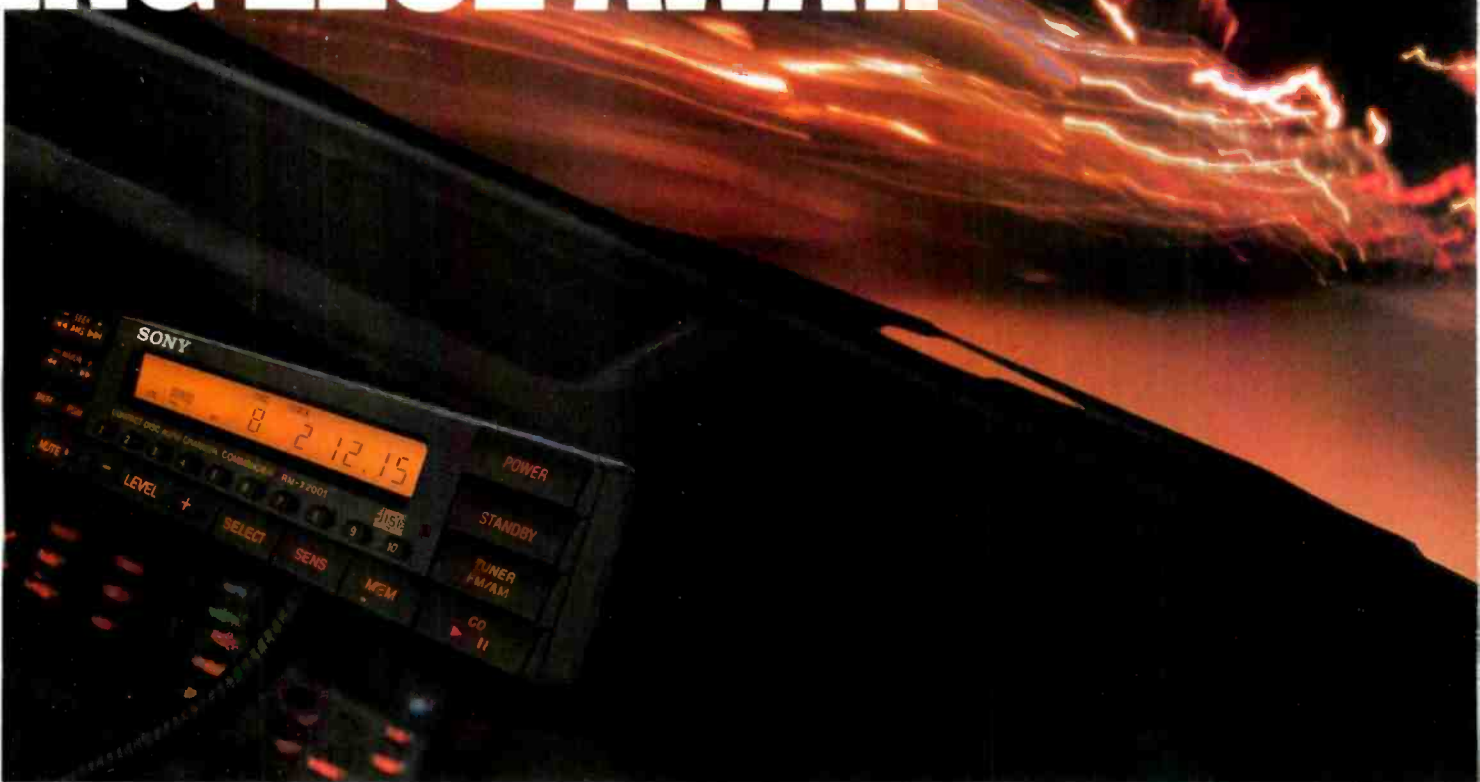

car CD players far behind. And while all other car CD players have one or perhaps two digital-to-analog converters, the Sony 2001 uses four to extract greater musical detail from every compact disc.

So from the grandeur of a full orchestra to the nuances of a solo guitar, the 2001 will accelerate

the beating of your heart.

To take advantage of this incredible digital performance, Sony designed the RM-X2001 Remote Commander® unit. Its logic-controlled attenuator banishes the distortion of conventional volume controls. The preamplifier section also employs a

switching power supply and copper-capped resistors—provisions that would be at home on sophisticated high-end home components.

In fact, the 2001's advanced technology inspires so much confidence, we back it with an unprecedented three year limited parts and labor warranty. (Please see your authorized Sony

Autosound dealer for details.)

So audition the CDX-A2001 system for yourself and experience the one car CD changer with everything. Except competition.

SONY
THE LEADER IN DIGITAL AUDIO™



Phono-input response did not deviate from the RIAA curve by more than 0.13 dB. You can't ask for equalization more accurate than that.

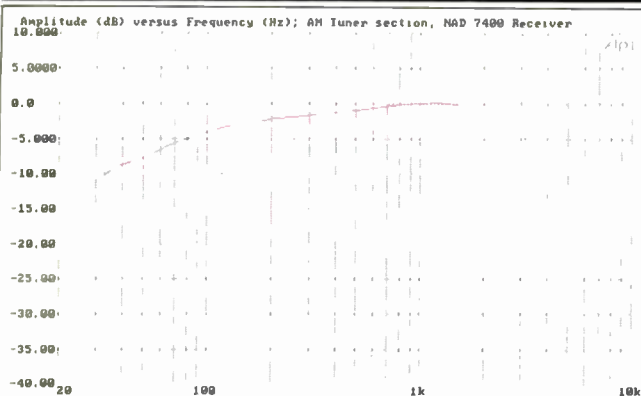

Fig. 7—AM frequency response.

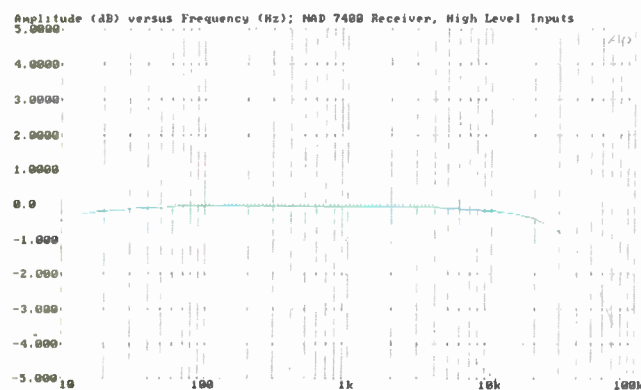

Fig. 8—Frequency response, preamp and amp sections, via high-level inputs.

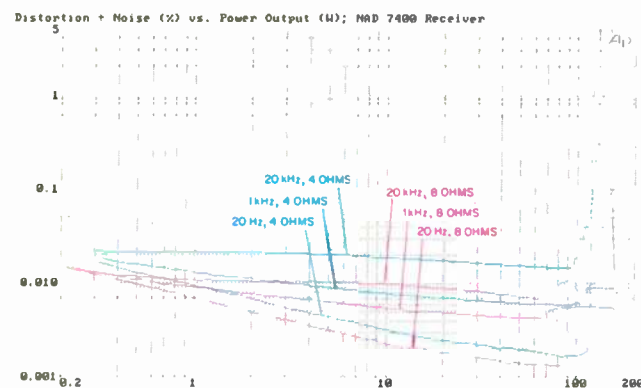

Fig. 9—THD + N vs. power output for 8- and 4-ohm loads.

signal level for 1-kHz signals modulated 100% was plotted for both modes (Fig. 3). Usable sensitivity for mono—the point at which THD + N rises to 3%—measured exactly 10 dBf in the wide i.f. mode and about 12 dBf in the narrow. At the strong-signal reference level of 65 dBf, THD + N in the wide i.f. mode decreased to 0.045% for mono and an even lower 0.04% for stereo. The effect of narrowing the i.f. bandwidth is clearly evident; THD + N rose to 0.13% for mono and 0.32% for stereo. While these figures are significantly higher than those obtained in the wide i.f. mode, they are nevertheless quite low, considering the benefits obtained when this mode is needed for rejecting adjacent-channel interference.

Figure 4 shows THD + N versus frequency for strong (65-dBf) signals in both the wide and narrow i.f. modes. Here, THD + N in the wide mode hovered around the 0.04% mark at 1 kHz for both mono and stereo. At 100 Hz, it measured 0.04% in mono and 0.046% in stereo; at 6 kHz, the wide-mode results were 0.045% in mono and just a bit below 0.06% in stereo. When the narrow i.f. reception mode was used, THD + N in mono remained low, reading only 0.033% at 100 Hz, and increasing to about 0.13% at 1 kHz and just over 0.3% at 6 kHz. Stereo THD + N in the narrow mode measured 0.5% at 100 Hz, 0.3% at 1 kHz, and just under 0.3% at 6 kHz. The minor differences between the readings at 1 kHz and 65 dBf, in Figs. 3 and 4, are possibly caused by very slight detuning of either the generator or the tuner between readings. When THD levels are this low, it is extremely difficult to take two successive plots and obtain absolutely identical results. The important conclusions that can be drawn, however, are that this tuner section provides remarkably low distortion plus noise when operated in the wide i.f. mode and offers tolerably low THD levels even when it becomes necessary to employ the narrow i.f. mode.

In Fig. 5, I plotted FM stereo separation for three conditions. The bottom dashed curve represents the best separation, using the wide i.f. setting and no blend—or, as NAD calls it, "FM NR." Under these conditions, separation came close to 50 dB at 1 kHz. Even more remarkably, it measured about 37.5 dB at 10 kHz and 48.5 dB at 100 Hz. Next, I repeated the test, this time using the narrow setting. Separation remained high—about 42.5 dB at 1 kHz, 41 dB at 100 Hz, and 34.5 dB at 10 kHz. Finally, I returned to the wide i.f. mode but turned on the "FM NR" circuit. Unlike with other blending arrangements, which usually degrade separation levels down to 10, 15, or at best 20 dB, I still obtained about 37 dB of separation at 1 kHz, 36.5 dB at 100 Hz, and 33 dB at 10 kHz with this circuit activated.

Figure 6 is a spectrum analysis, from 0 to 50 kHz, showing a 5-kHz output on the left channel (the tall spike near the left end of the sweep) as well as crosstalk products and noise appearing at the output of the unmodulated channel. A small amount of second-harmonic distortion also can be seen (the first major peak to the right of the main peak), but the only other significant crosstalk products evident are small sideband components near the 38-kHz subcarrier frequency—well outside the audio range.

The NAD 7400's SCA rejection was an excellent 72 dB. Alternate-channel rejection in the narrow i.f. mode measured 85 dB, while in the wide mode it was still a relatively

ZAPCHORD

From **MIT**

The Fruit Doesn't Fall Far From The Tree

After nearly a decade of groundbreaking research and development, Music Interface Technologies now has neutral, noise-free audio cable that is easy for the picking.

Within reach of any audio budget, MIT's new ZAPchord Speaker Cable and Interconnect "ZAP" the noise and leave the music with special "ZAPline" networks and patented terminal or techniques. Because ZAPchord cables remove the noise, audio components sound more powerful, dynamic, defined, and detailed than ever before.

Unlock the vibrancy of the music on your favorite records, tapes, and CDs with ZAPchord from Music Interface Technologies.

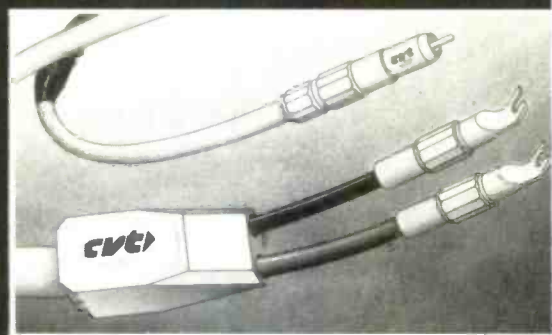

Constant Velocity Transmission™ Series • Selected from the top of the tree, CVT™ is MIT's "cost-no-object" and newest technology. The CVT Connector™ in every cable is calibrated to eliminate delay distortion and phase noise.

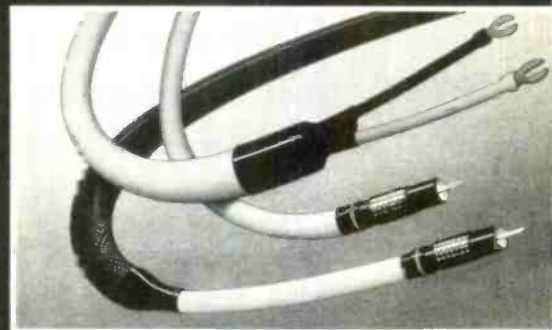

MIT and Shotgun Series • Plucked from the upper branches, these established MIT cable products are the audio industry's standard for neutrality, clarity and precise focus because of their minimal delay distortion and phase noise.

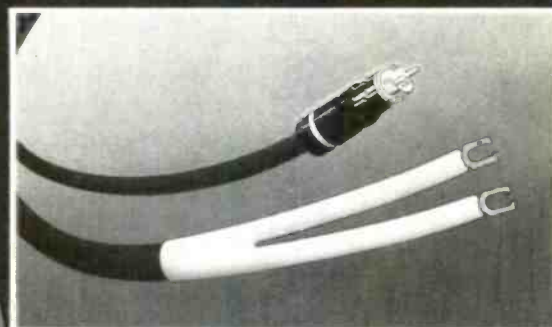

PC Squared • Ripe and ready to improve your system. MIT's new mid-priced line uses UNIFIELD™ and VARI-LAY™ construction, our patented computer modeled techniques that insure tonal neutrality and phase correctness.



HOME AUDITION PLAN
Visit Your Authorized MIT Dealer

Music Interface Technologies **MIT**

Distributed by Transparent Audio Marketing - Rt 202, Box 117 - Hollis, ME 04042 - (207) 929-4553
Enter No. 21 on Reader Service Card

Expensive Car Stereo.

Introducing the Canton Mainframe system, the most extraordinary amplifier in auto-sound history.

The Mainframe System. With a Mainframe Base Unit and plug-in Module Amplifiers anyone can configure a sophisticated, actively-driven autosound system. Easily, quickly. Mainframe's unique modularity allows for limitless future expansion possibilities, with a minimum of installation fuss and muss.

Emitter-Follower Circuit Design. This design—common to home power amps—allows minimal negative feedback, a high level of thermal stability and superior musicality.

Fast, Accurate Thermal Tracking. Each Module Amp cools down as soon as the music does. An important plus in cramped, hot car trunks.



Triple Fuse Protection.

The Mainframe guards your autosound system with fuses at the battery, at each amp input and electronically within each amp.

Active Electronic Crossovers.

Mainframe Module Amps contain no passive circuitry to rob amplifier power.

Balanced Transformerless Output Topology.

This provides high immunity to electrical vehicle noise, both on ground and on battery.

Multiple Crossover Modes.

With each Module Amp choose the crossover characteristic you need for that channel—midrange, woofer, sub-woofer, full-range, tweeter, mid + high, mid/high or center channel (S 30 only).

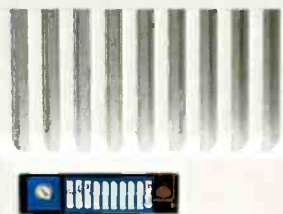

M 50 Monophonic and S 30 Stereo Power Amplifiers.

The plug-in M 50 and S 30 Module Power Amps are exceptionally compact. Thanks to advanced SMD technology, they're packed with variable active electronic crossovers, fully regulated power supplies and an audiophile sound quality that belies their diminutive size.



Two Base Unit Sizes, Unlimited Configurations.

The MF 3 accommodates three Module Amps, the MF 5 five Module Amps. Multiple Base Units can be daisy-chained to accommodate any number of actively-driven speakers. Bi- or tri-amplify. An unlimited variety of configurations is possible.

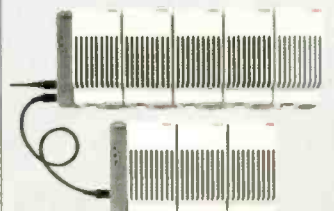

Exceptional Auto Sound.

Sophisticated Electronic Monitoring Circuits. Each Module Amp monitors its operating temperature and current consumption, and intervenes to prevent anomalous conditions.

Ultra-Secure Speaker Connections. PL 2 plug-in speaker connectors eliminate any chance of intermittent amp/speaker connections.

Ten Mounting Points on Base Units. With this feature you have the option of extra flexibility in installation placement.

True Plug-In Modularity. Module Amps snap firmly into place, but are easily removed when you need to make changes. The only tool required is your hand.

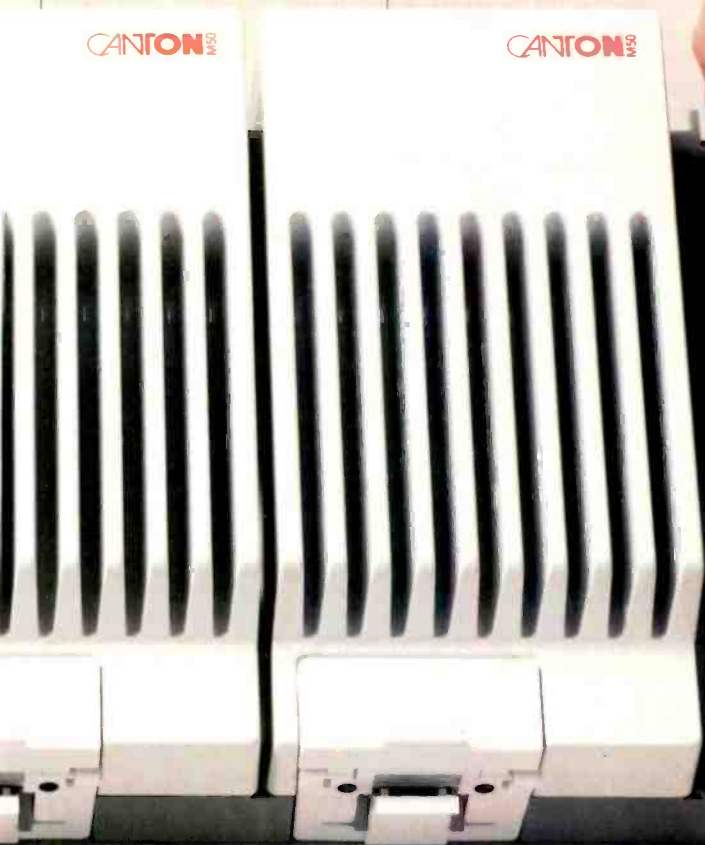

Mainframe Cable Posts and Ties. For the neatest speaker cable layout possible.

Adjustable Amp Level Controls. Achieve precise dynamic command of each driver, for perfect level balancing.



Classic Canton Fit and Finish. The Mainframe System features award-winning good looks and construction quality built to withstand years of rugged use.

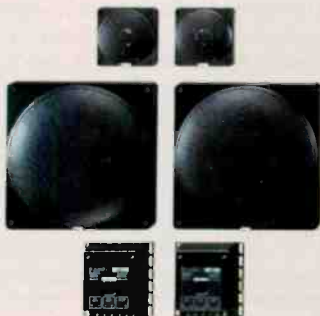

Simplified Installation. The sophisticated straightforwardness of the Mainframe System makes complex installations easy.

The Canton Mainframe System is built to the same exacting standards of performance, manufacture and appearance as our critically acclaimed home and automotive loudspeakers.

Canton Automotive Speaker Systems are available in a variety of preconfigured sets to match any budget, and as individual drivers for unique custom applications.

Compatibility with All Future Canton Modules.

You'll be assured of perfect fit and function, whether it's the M 50 or the new S 30 Stereo Module Amp.

To audition the Canton Mainframe System and Automotive Speakers, visit your nearest Canton dealer today.

Canton North America, Inc.
915 Washington Avenue South
Minneapolis, Minnesota 55415-1245

Telephone 612/333-1150

CANTON

See our dealer list on page 136

Enter No. 9 on Reader Service Card

Noise was incredibly low:
 Better than -94 dB for the
 high-level inputs, down
 90.4 dB for MM phono, and
 at least -76 dB for MC!

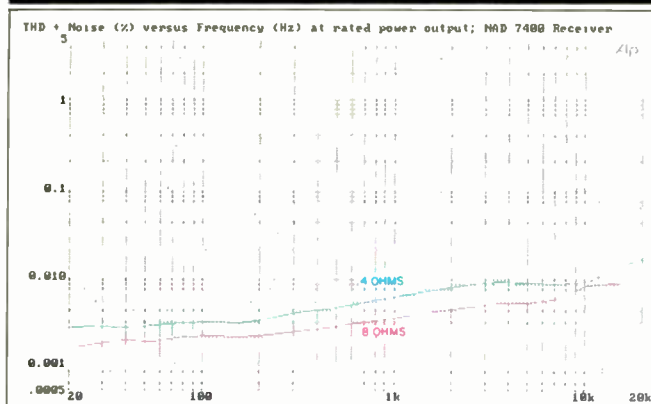

Fig. 10—THD + N vs. frequency at rated output (100 watts per channel) into 8 ohms and at 100 watts per channel into 4 ohms; see text.

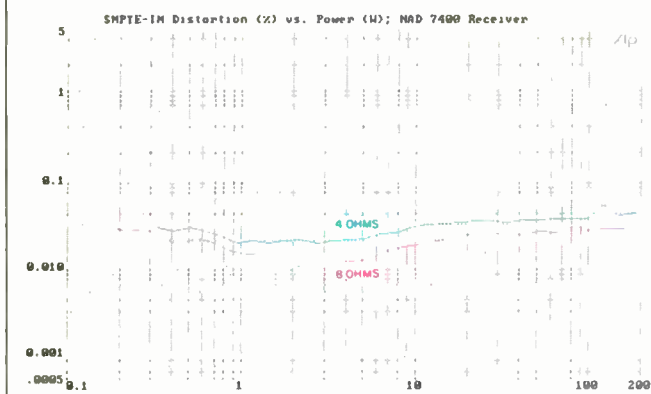

Fig. 11—SMPTE-IM distortion vs. power output.

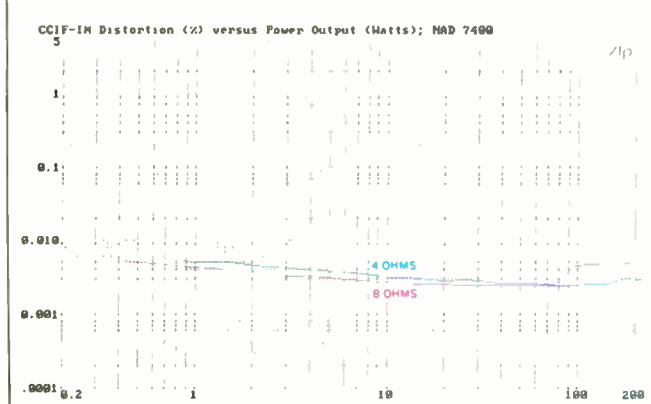

Fig. 12—CCIF-IM (twin-tone) distortion vs. power output.

high 75 dB. Image rejection and i.f. rejection both measured in excess of 100 dB; capture ratio measured 1.4 dB at 45 dBf, and AM rejection was 65 dB, exactly as specified.

In their descriptive brochure, NAD maintains that the AM section has "unusually wide audio bandwidth . . . that is in striking contrast to the muffled AM reception that many tuners provide." Well, I suspect that judgment is relative, because my sample, at least, didn't do all that well in the audio bandwidth department, as shown by Fig. 7. Response was down 6 dB at 65 Hz and 3.5 kHz. Some of the other claims made for this AM circuit did seem justified, however. The AM tuner section appeared less susceptible to noise than most, and did have lower THD—about 0.45% for a 400-Hz signal, 30% modulated, at an r.f. level of 50 mV.

Amplifier Measurements

Frequency response of the preamp/amp section is shown in Fig. 8. Here, I configured my Audio Precision System One test gear to sweep from 10 Hz to 100 kHz. Response was off by about -0.25 dB at 20 kHz and about -0.15 dB at 20 Hz. The -3 dB point occurred at a frequency of 68 kHz.

The curves in Fig. 9 represent plots of THD versus power output, using 8- and 4-ohm loads for 20 Hz, 1 kHz, and 20 kHz. With 8-ohm loads, the rated THD of 0.03% at 20 Hz was reached for a power output level just short of the 100 watts per channel rating, but the amplifier easily delivered far more than 100 watts per channel of power at 1 and 20 kHz. In fact, at 1 kHz, clipping did not begin until the power level reached 160 watts per channel! While no official continuous power rating is provided by NAD for operation with 4-ohm loads, it is obvious from these curves that, at 1 kHz, power output was around 150 watts per channel before significant levels of THD were reached. And with 4-ohm loads, the 20-Hz signal produced a power level of around 120 watts per channel. It was the 20-kHz test signal that proved to be the limiting factor in trying to establish a continuous power rating for 4-ohm operation. At this frequency, the amplifier began to show increased distortion for levels not much above 100 watts per channel.

Accordingly, when I plotted THD + N versus frequency for *rated* output (Fig. 10), I regulated the input signal so that a constant 100 watts per channel was maintained for both 8- and 4-ohm loads. Figure 11 shows how SMPTE-IM distortion varied with increasing equivalent power output levels. At 100 watts per channel, SMPTE IM measured only 0.026% and 0.037% for 8- and 4-ohm loads, respectively. Since NAD is one of the few companies to quote IHF-IM distortion—also referred to as CCIF IM—I measured this type of distortion as well (Fig. 12). I plotted CCIF IM, using twin tones of 19 and 20 kHz, against power output levels. For 8-ohm loads, CCIF IM was a very low 0.0045% at rated output, while for 4-ohm loads, at 100 watts per channel, CCIF IM was even a bit lower, reading 0.0025%. Dynamic headroom, measured in accordance with the IHF Amplifier Standard, was just short of 5 dB. In power terms, this means that for at least 20 mS, this amp can deliver more than 300 watts per channel into 8-ohm loads, if called upon to do so.

High-level input sensitivity, referred to 1 watt output, was 16 mV. The A-weighted S/N ratio for the high-level inputs, referred to 0.5-V input with the volume control adjusted to

Hear The Glow...!



Omar Hakim
"Rhythm Deep"

ERIC MARIENTHAL
"Round Trip"

EDDIE DANIELS
"Blackwood"

NEW YORK VOICES

Diane Schuur
"Collection"

THE RIPPINGTONS
"Tourist In Paradise"

...Brilliant new recordings
that ignite the imagination and
excite the senses... Hear it on...
GRP...The Digital Master Company...

THE
DIGITAL MASTER
COMPANY



On GRP
Compact Discs,
HQ Cassettes
and Records.

©1989 GRP Records

Enter No. 12 on Reader Service Card

The NAD 7400 makes it very easy to relate directly to the music, with smooth controls and no audible hum or noise.

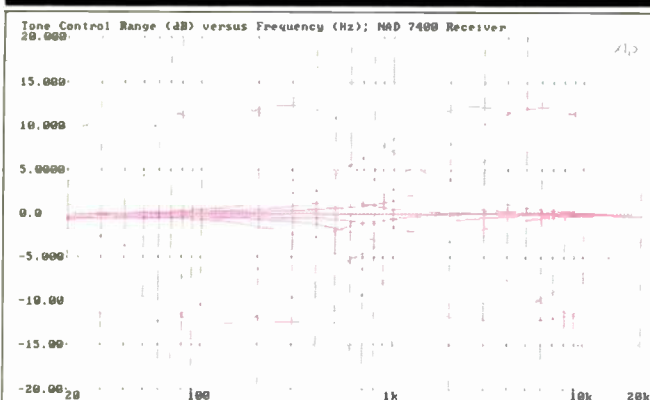

Fig. 13—Bass and treble control range. Note the effects of switching turnover frequencies.

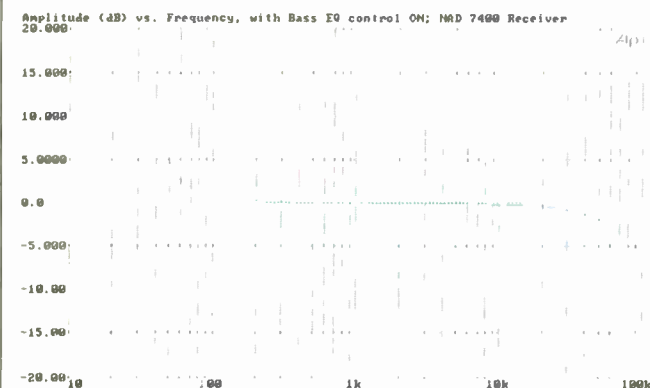

Fig. 14—Amplifier response, with measurement extended from 10 Hz to 100 kHz and "Bass EQ" on. Note

the steep roll-off at 20 Hz, caused by the infrasonic filter incorporated in the "Bass EQ" circuit.

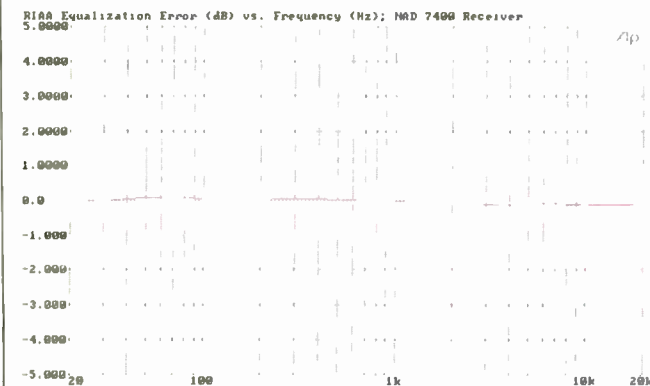

Fig. 15—Deviation from RIAA equalization.

produce 1 watt output into 8-ohm loads, measured an incredibly high 94.6 dB for the left channel and 94.2 dB for the right. I suspect that NAD's method of including the volume control in a feedback loop paid off in terms of S/N.

Next, I measured the maximum boost and cut characteristics of the tone controls. As mentioned earlier, both the bass and treble control can be adjusted for one of three turnover frequencies. As a result, the flexibility of these tone controls approaches that of a parametric equalizer. It took 12 successive response sweeps to plot the curves shown in Fig. 13. Center frequencies, at which maximum boost or cut occurs, came quite close to the nominal values listed by NAD (50, 120, or 250 Hz for the bass control and 3, 6, or 12 kHz for the treble). The response of the amplifier when the "Bass EQ" switch was pressed is plotted in Fig. 14. Maximum boost occurred at around 35 Hz and amounted to about +6 dB, but response rolled off rapidly below that frequency because of the action of the infrasonic filter incorporated in this bass-enhancement circuit.

I turned to the phono circuits next and was pleased to see that deviation from perfect RIAA playback equalization, over the range from 20 Hz to 20 kHz, never exceeded 0.13 dB. You can hardly ask for a more accurate equalization circuit than that. Moving-magnet input sensitivity for 1 watt output was 0.27 mV, while the MC input required only 33 μ V for the same output level. Phono overload via the MM inputs measured 200 mV for a 1-kHz signal, while the MC inputs were able to handle signal levels up to 21 mV at that same test frequency.

Perhaps the most remarkable aspect of the NAD 7400's phono section was its S/N ratio. NAD quotes a figure of 76 dB, referred to 5 mV input, with the volume control adjusted so that 1 watt is developed across the speaker loads. However, they qualify this specification by saying it is that good with a cartridge connected. In fact, what little noise and/or hum occurs under these conditions actually comes from the cartridge and its cables. The IHF Standard calls for the inputs to be shorted for a true measurement of preamp S/N. Under those conditions, I measured the highest S/N I have ever encountered for any phono preamp—whether a separate component or part of an integrated amp or receiver. This remarkable preamp circuit, measured with shorting plugs connected to the MM phono inputs, yielded an S/N ratio of 90.4 dB for either channel! If you are going to play records through this receiver, I would strongly suggest that you choose a cartridge that's sufficiently well shielded to take advantage of this incredible S/N ratio. Even the MC inputs yielded a much better S/N ratio than most other MC preamps I have measured. Referred to 0.5 mV input, with the volume control again set for 1 watt output, the S/N ratio was 77.8 dB for the left channel and 76.0 dB for the right.

Use and Listening Tests

The most impressive thing about this receiver is its ability to handle the dynamic peaks that occur so often in CD and DAT recordings. I recently had the good fortune of being able to record a live performance of a local professional chamber music group, and several of the selections on the program that evening included piano trios and quartets. You don't realize how dynamic the piano can be until you are

THE NEXT PLATEAU



Kinergetics KCD-40

You Can Hear The Beauty Of The Music Free From Hysteresis Distortion.

In *all* audio equipment, each transistor, wire and connector adds its own minute bit of distortion. The sum total of this is *hysteresis distortion*. It dulls the clarity and obscures the realism of the music.



Only Kinergetics' patented hysteresis canceling circuitry gives you the true quality of the music free from this distortion. We have invented a creative merger of art and technology in music reproduction.



***Our reputation is built on our obsession—
to reproduce music with perfect realism.***

© Kinergetics Research 1989

Our reputation...

"Kinergetics' KCD-20... "the first CD player to crack the Class I Sound barrier"

J. Peter Montcrieff

"International Audio Review", Hotline #43-45

CES Winter '87

"Their KCD-20A puts other CD players in the shade musically... it is a clear first-choice recommendation among CD players."

Neil Levenson

"Fanfare", Vol.10, No.4

CES — Summer '87

"Pure musicality is the only way I can adequately describe what I heard: no sensation of electronics or speakers, with believable sound staging and tonal accuracy... I think it would be safe to say that this represented the most 'music for dollar' at the show."

Lewis Lipnick

"Stereophile" Vol.10, No.5 Aug. 1987

CES — Winter '88

"The Death of Mid-Fi: The Big Chill in Vegas"

Michael Fremer

"The Absolute Sound" Vol.13, Issue 52, page 250

CES — Summer '88

We weren't there.

CES — Winter '89

"...I am pleased to note that the sound in the Kinergetics room was stunningly true to the sound of the original Steinway. Nice one, Ken and Tony!"

John Atkinson

"Stereophile" Vol.12, No.3, Mar. 1989

Kinergetics Research — "constantly reaching for the final plateau — perfection."

KCD-20 Compact Disc Player • KCD-40 Compact Disc Player • KBA-75 Class A Power Amplifier • KBA-202 Mono Power Amplifier • KBT-1 FM Tuner • KPC-1 Passive Control Center • BSC Compusound Systems: SW-200 Sub-Woofer Amplifier • SW-100 Sub-Woofer • SW-100.5 Sub-Woofer • Music Mate Speaker/Sub-Woofer Stands

 **KINERGETICS
RESEARCH**

6029 Reseda Boulevard • Tarzana, California 91356 • Phone (818) 345-5339 • Fax (818) 609-8576

A receiver like this could convert even confirmed fans of audio separates to the ranks of all-in-one receiver enthusiasts.

called upon to record its sound without any compression, as was the case at this concert. Even driving my low-efficiency KEF 105.2 reference speakers, the NAD 7400 had no trouble delivering clean peaks on even the most dynamic and percussive moments of the DAT recording—at levels I judged to be the same as those I heard during the performance, while seated only a few feet from the piano.

I also played a few of my newest CDs through the high-level inputs of this receiver. Among them were two recent Telarc releases. One featured music of Gabrieli, performed by the Empire Brass and augmented by additional trumpets, horns, trombones, and tubas (CD-80204). What a glorious sound that combination produced, and how totally clean the sound was, as reproduced by this sterling combination of components! The second new disc, which did equally well when played through the NAD 7400, was the Brahms Piano Concerto No. 2 (CD-80197). The piano soloist was Horacio Gutierrez, with André Previn conducting the Royal Philharmonic Orchestra.

Listening to this kind of music, you tend to forget there is all that electronic equipment between you and the music, and the NAD 7400 makes it particularly easy to do so. Its controls work smoothly. There are no clicks or pops when switching from one program source to another. There is no audible background hum or noise, even when pushing the amp section to its limits of power.

Of course, I must not forget to comment favorably about the FM section, the operating parameters of which are set so perfectly that, even when receiving relatively weak signals, I was still able to enjoy good stereo imaging with the "FM NR" circuit activated. Every once in a while, I become worried about the calibration of my FM generator because so few tuners and receivers are able to meet their usable sensitivity figures these days. However, the FM tuner in this NAD receiver not only met but actually exceeded its sensitivity rating. This means that at 10 dBf, an input voltage of only 0.87 mV across a 75-ohm impedance was all that was needed to reach the 3% THD + N level that defines usable sensitivity. I can't remember the last time I came across a tuner—let alone the tuner section of a receiver—which was that sensitive. It goes without saying that I was able to log as many stations (57, to be exact) as I have ever been able to receive in my location, using my rotatable outdoor antenna. Furthermore, at least a half-dozen of these were only 200 kHz away from their neighbors and yet, with the aid of my directional antenna and the NAD 7400's narrow i.f. setting, I was able to listen to them. A receiver such as this, if auditioned by dyed-in-the-wool adherents to the separate components approach, may actually convert a few to the all-in-one school. NAD has always offered components that deliver a lot of value for their price. The NAD 7400 continues this worthwhile tradition.

Leonard Feldman

The Record Player

FROM WELL TEMPERED LABS

Brilliantly Simple. Modestly Priced.

Manufactured & Distributed by Transparent Audio Marketing
Rt. 202, Box 117, Hollis, ME 04042 (207) 929-4553

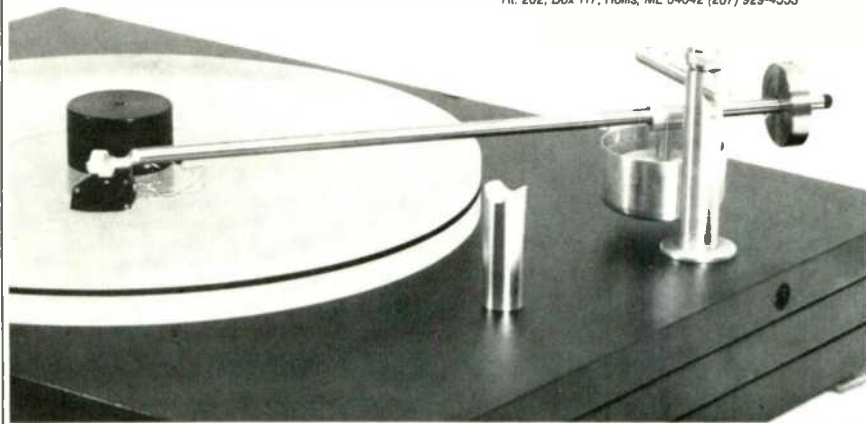

Enter No. 29 on Reader Service Card

**Be as selective in
where you buy
as you are in
what you buy.**

We know they're hard to resist. Guaranteed lowest prices in the universe. Every day's a sale day. Big, bigger, biggest.

But, buying a serious audio or video component isn't the same as buying a dishwasher or microwave. And that's why AUDIO recommends you visit an independent A V specialty retailer when shopping for equipment.

A V product is the heart of his business, not a "profitable or trendy" sideline. That means the independent dealer will always be more concerned in helping you select the proper equipment than he will be in helping himself to a commission.

So, be as selective in where you buy as you are in what you buy. Support your independent specialty dealer.

Audio

The Equipment Authority



The Definition of Excellence. In Sight and Sound.

Introducing Proton's new big screen 31" monitor/receiver with Aphex Aural Exciter.®

Proton has always set the industry standard for breathtaking video performance. And our big new 31" picture follows in that tradition. But this time, the picture isn't all we've expanded.

By incorporating the Aphex Aural Exciter circuitry, we've achieved a new level of audio clarity and transparency. So harmonics are restored, highs more natural, and vocals more vivid. And, at the touch of a button, our Expander provides vastly superior stereo imaging.

With our SD-1000 Enhanced Surround Decoder, your enjoyment will be even greater. This Aphex innovation starts where Dolby® leaves off, creating an expanded listening area that wraps you in pure listening pleasure.



Unmatched by many professional systems, the Dolby compatible SD-1000 offers dynamic surround sound from any stereo source.

We took the industry's best and brightest picture. And added the most advanced sound. Proton. The new definition of excellence.

For a free brochure and the Proton retailer nearest you, call (800) 772-0172. In California, (800) 428-1006. Or write to 5630 Cerritos Ave., Cypress, CA 90630.

PROTON[®]
CLEARLY THE BEST

2

SONY SDP-777ES DIGITAL SURROUND PROCESSOR

Manufacturer's Specifications

Sampling Frequency: 48 kHz.

Code Format: 16 bits linear.

Delay Time: 0.1 to 80 mS in 0.1-mS steps, independently adjustable for left and right channels.

Harmonic Distortion: 0.008% at 1 kHz.

Dynamic Range: 90 dB, A-weighted.

Frequency Response: Digital section, 5 Hz to 20 kHz. Analog section, center, 110 Hz to 100 kHz; sub-walker, 12 dB per octave below 110 Hz.

Power Requirements: 120 V a.c., 60 Hz.

Power Consumption: 30 watts.

Dimensions: 18½ in. W x 3¾ in. H x 13¾ in. D (47 cm x 8.6 cm x 34.5 cm).

Weight: 13.4 lbs. (6.1 kg).

Price: \$850.

Company Address: Sony Dr., Park Ridge, N.J. 07656

For literature, circle No. 91



The SDP-777ES, the surround processor in Sony's premium ES series, features Dolby Pro-Logic, the movie-theater version of Dolby Surround. Pro-Logic, as compared to regular Dolby Surround, has superior steering and localization when decoding Dolby Stereo movies. All of the processor's six channels are available for this mode. The outputs are for two front (main) speakers, two rear/surround speakers, a subwoofer, and a center speaker. The center-channel output ensures optimum dialog centering. If the system does not include a center speaker, a "Phantom" mode can be selected to feed centered information equally to the two main speakers.

The front/main (stereo) and rear/surround speakers would normally be used with any of the other three surround modes: "Matrix," "Hall," and "Simulated." The subwoofer output can also be used in all modes, but the center output is operational only with Dolby Pro-Logic.

"Hall" surround re-creates the sound of a concert hall by reproducing the direct sound from the front and the reverberative sound from the back. Acoustics appropriate to the program source can be created by adjusting the delay time of the reverberative sound. A low-pass filter can also be set in this mode, at any frequency from 1 to 16 kHz as well as flat (out of circuit); its factory-set default is 7 kHz. The "Matrix" surround circuits, according to Sony's brochure, create "a hard-driving sound that causes everything around you to vibrate." This surround mode can make the listener feel that he is at the center of the stage; Sony recommends it for rock music. "Simulated" surround mode gives a stereo effect to monaural sources by re-creating sound reflected from various directions.

The digital-delay times can be adjusted in 0.1-mS steps from 10.0 to 30.0 mS for Dolby Pro-Logic and from 0.1 to 80.0 mS for the other three modes. These are wider ranges than many other units offer, and their precision is much greater than most. The ability to adjust left and right delays individually is a good feature, and few units have it. When the surround speakers are not the same distance from the listening area, the delays can be set so that the two sound-waves arrive at the same time.

The polarity of a channel can be inverted with a push of a button. With some source material, you can thus get a more expansive sound field.



The SDP-777ES offers two other operating modes, presence delay and stereo reverberation, in addition to the main surround modes discussed above. The presence-delay circuit is designed to expand the apparent music source. In this mode, the surround speakers are placed outside of the main speakers and pointed at the wall behind them. The stereo reverberator circuit, according to the manual, "re-creates sound like that of a live house which is full of the reverberative sound."

The front panel has close to a full complement of switches and controls, including "Master Volume," providing much more operating convenience than many units do. A front-panel display gives the status of the various modes. Usually, it shows the mode and delay times; if a level is changed, the display shows level status while you're making the change. The six-channel "Master Volume" control can also be operated with the remote control.

The remote has many other functions, including input selection, surround mode, and adjustment of delays and levels. This flexibility enables you to make instant comparisons among modes from the listening position, which is important, in my view. The SDP-777ES has input selection for one audio and four video sources. Pin-jack connections for video dubbing are included, as well as two sets of connections for S-video in and out.

Control Layout

The power switch for the SDP-777ES is at the upper left of the front panel. Below the switch and to the right are the surround-mode selector buttons: From left to right, "Off," "Matrix," "Hall," "Simulated," and Dolby Surround for Dolby Pro-Logic ("Dolby" is indicated with the standard double-D symbol). Above the mode selector buttons are "Time Memo-



Being able to adjust delay times separately for right and left channels is good. Few other units offer this useful feature.

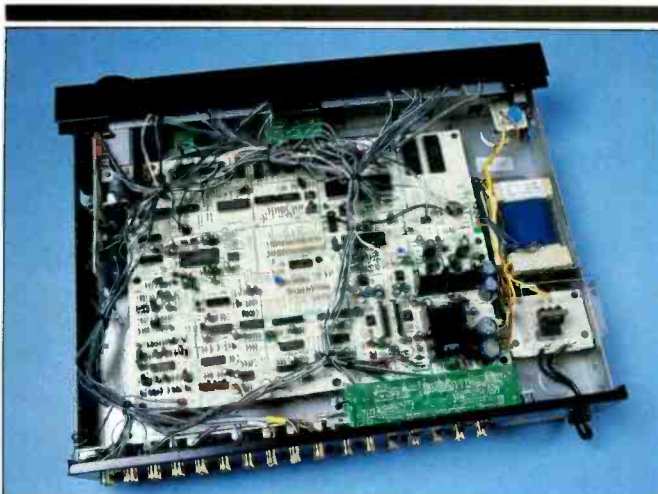

ry" ("Set," "1," "2," and "3") and then "Delay Time" (with separate increase and decrease buttons for left and right). Up to three sets of left and right delay times can be stored for each surround mode. When "Set" is pushed, "Memory" appears in the display panel, and about 4 S remain in which to select the memory storage position. Left and right delays are easily adjusted, independently and to any desired value from 0.1 to 80.0 mS for "Matrix," "Hall," and "Simulated," and from 10.0 to 30.0 mS for Dolby Pro-Logic. A single, short push of a delay-time button will cause a 0.1-mS change. Holding in the button obtains continuous stepping, with a speed-up after about 2 S. All of the switches described give good tactile and audible cues when actuated. The mode switches also cause relay actuations which are quite audible.

Above the memory and delay-time switches is the display panel. The word "Digital," permanently screened at the upper left, notes the delay type; below it is the receptor for the remote control. The display usually shows the left and right delay times in bright, bluish-white numerals with "msec" after each number. To the left of these numerals is a small orange number corresponding to the delay-time memory in use. No number appears when delay is in its default mode or is being changed. "Memory" appears above this number when time delay is being set in memory. "Over," which is above "Memory," will turn on if the input level is too high in Dolby Surround. Selecting a surround mode turns on the appropriate indicator at the top of the display: From left to right, "Off," "Matrix," "Hall," "Simulated," and the Dolby double-D symbol. Simultaneously pushing "Set" and "Hall" turns on presence delay, indicated *only* by the delay times being shown. Pushing "Set" and "Simulated" at the same time turns on the stereo reverberator circuit, indicated by "Sdp Pro." Other information appearing in the display will be discussed when the action that produces it is covered.

To the right of the display, along the top, are the electrically interlocked input-selector switches. "Video 1" is first on the left, followed by "Video 2," "Video 3," "Video 4," and "Audio." The video buttons have full-width, red LED status indicators along their tops; the audio button has a green LED. "Audio" can be selected in conjunction with any video input, but a second push on that video button, or a change

in the video selection, will turn the "Audio" function off. This is actually very logical, because the audio may come from a simulcast or other non-video route.

Below "Video 1" is the "Input Level" pot, with "Min" and "Max" labels at its left and right extremes of rotation. The bar knob makes turning very easy, and the narrow face of the bar has an index groove. The "Input Balance" pot, to the right, has the same type of knob, a soft center detent, and "L" and "R" at its limits of rotation. Next is the "Center Mode" pushbutton for "On," "Phantom," and off; red LEDs indicate when either "On" or "Phantom" is selected. Starting from off, pushing the switch gets "Phantom," then "On," and then off again. This switch operates only in Dolby Surround mode. "Phantom" feeds movie dialog or other centered sounds to both left and right speakers for a phantom center. "On" is used when a center speaker is part of the system. When the switch is off, Dolby Surround can be used for music without causing unwanted centering effects.

In Dolby Surround, pushing "Test Tone," which is next on the right, initiates a shaped pink-noise signal. The signal automatically cycles from left front, to center, to right front, to the surround speakers, and then around again. If the system has no center speaker, the tone switches back and forth between the front and surround speakers. Pushing the button again turns the tone off. The bar-type knob just to the right, "Surround Level," matches the knobs on the "Input Level" and "Input Balance" pots. However, turning it reveals that it is a spring-loaded rotary switch. When this knob is turned to the left ("−") or right ("+"), the display shows the surround level. During adjustment, the display shows a small orange "S" in its lower left corner and bluish-white numbers indicating left- and right-channel attenuation. Attenuation can be set anywhere from 0 to −79 dB in 1-dB steps, and then finally muted (shown as "−∞ dB"). The attenuation starts increasing or decreasing less than 1 S after you turn the knob. With the knob held, attenuation changes continuously, at a rate of about 8 dB per S. The "Master Volume" control, with its very large knob and helpful red LED index line, is the last control on the right. The panel labels are all quite easy to see, although in dim light, the white ones are easier to see than the gold.



The front panel carries a fairly full complement of controls and switches for operating convenience that other units lack.

The remote control is fairly large and might be difficult for some to operate with one hand. A small red LED near the emitting end goes on whenever a button is pushed. The front-panel receptor does not flash in response, but the effect of any transmitted instruction is easy to see or hear. The top row of five buttons duplicates the input selector switches: "Video 1," "Video 2," "Video 3," "Video 4," and "Audio." The next row has the "Surround Mode" choices: "Off," "Matrix," "Hall," "Simulated," and Dolby Surround. The following row is for "Time Memory," with "Set," "1," "2," and "3" duplicating the front-panel choices.

The two rows of buttons just below control "Delay Time" ("L," "R," and "L&R") and "Hall LPF"; the upper row of buttons here increases the setting, and the lower row decreases it. Notice the helpful addition of "L&R" buttons on the remote. If the right and left delay times are different, the "L&R" change is the same, in mS, for both. It is *not* possible to change left and right simultaneously on the front panel by holding in both the left and right buttons—nothing changes if that is done. A push of either "Hall LPF" button in "Hall" mode changes the display to a small orange "L" and two bluish-white displays of the cutoff frequency. This can be set in 1-kHz steps from 1.0 to 16.0 kHz and out (or flat).

Below the remote's "Hall LPF" buttons is the "Center Mode" button. The next two rows control "Surround Level" and "Center Level." Once again, the upper row increases the setting, and the lower row decreases it. "Surround Level" has separate "L," "R," and "L&R" buttons. This arrangement is just as helpful to have on the remote as it is for the "Delay Time" controls. It can be very useful in some systems because it facilitates balancing the sound level when the two surround speakers are different distances from the listening position. The "L&R" button steps attenuation equally for the two channels—even if they have different values to begin with.

The remote's last two rows control polarity inversion, low bass, master volume, and the test-signal generator. "Bass Level" and "Master Vol" have stacked "+" and "-" buttons. The "Inv" buttons ("L" and "R") operate in all modes and can be used for a possible expansion of the sound field. The "Inv" indicators on the front-panel display are immediately above the delay-time numbers. The "Bass Level" buttons affect the main channels, in Dolby Pro-Logic mode, when the "Center Mode" is set to "On" or "Phantom." The level can be changed about ± 10 dB in 1-dB steps, indicated in the display by an orange "b" and by the amount of boost or cut. The remote's "Master Vol" buttons for increasing and decreasing level are angled, which makes it easy to rock back and forth between them. The attenuation in dB is not displayed, but the front-panel control's red index shows clearly what the setting is.

At the left of the rear panel are 10 gold-plated jack pairs for audio signals. The first three pairs are stereo inputs for "Audio," "Video 4," and "Video 3." Next are the stereo input/output connections for "Video 2" and "Video 1," followed by the "Line Out" stereo pairs ("Front" and "Rear") and the monophonic "Center" and "Subwoofer" jacks. The "Video 2" and "Video 1" input/output jacks can be used for regular tape recorders if they are not needed for video units. Further to the right are the video jacks. Again, "Video 4" and "Video



3" are for input only, while "Video 2" and "Video 1" have inputs and outputs. The latter two video circuits, and the adjacent "Monitor" output, have both pin and S-video jacks.

I removed the wood side pieces and the metal top and side cover to get a look at the processor's internal construction. The unit had been operating for several hours, and I made my standard temperature checks. Putting my fingers directly on the laminations of the transformer, which is mounted on the left side rail, showed me that the transformer was hot, although not excessively so. I did not spot any fuses, but I did notice an r.f.-suppression filter on the incoming a.c. power lead, which is a good feature. The great majority of the circuitry is on one high-quality p.c. board which covers most of the chassis area. The parts' quality is high, and each part is identified by number. Sections of the board are labelled by function.

Smaller boards, positioned around the main one, hold the circuitry for the front panel, input/output interfaces and connections, and the master volume control. The boards are interconnected by multi-conductor cables and plugs.

The soldering is excellent, and very little flux was left around any of the hand-soldered points. The main board is supported by side and center rails, running from front to back, which rest on a bottom-chassis stiffener. This is better board support than is found in most units. The side rails of the main chassis add still more overall rigidity, and the resistance to twisting and bending is certainly among the best I have seen. Replacing the cover and side pieces increased the overall ruggedness.

Measurements

Let me first point out that all measurements were made after the listening and viewing.

Figure 1 shows the main-channel frequency responses in Dolby Surround mode, with a mono input, for two "Center Mode" settings. The flatter response, obtained with the "Phantom" setting, is actually +2.2 dB at 20 Hz and -1.5 dB at 20 kHz. With "Center Mode" set to "On," response is almost 3 dB down by 100 Hz. It falls off steadily with increasing frequency—as it should with the center speaker handling the in-phase information. In other surround modes,

The RTA Series



RTA 11t

"They provide smooth, fast and incredibly well detailed sound."

“Polk’s RTA Tower Loudspeakers Combine Legendary Polk Performance with Contemporary Style.”

Big speaker performance with an efficient use of space.

RTA 11t — \$449.95 ea.

The RTA 11t is the finest conventional (non-SDA) speaker that Polk Audio manufactures. Its extremely high power handling (250 watts) and high efficiency (90dB) provide remarkable dynamic range from both large and small amplifiers. The RTA 11t utilizes the same technologically advanced fluid-coupled subwoofer design found in Polk’s flagship model. Dual 8” sub-bass radiators are coupled to two 6½” mid/bass drivers, resulting in a fast, powerful, deep, and ultra-accurate bass response, without the boomy, undetailed sound of large woofer systems.

RTA 8t — \$289.95 ea.

In a slightly smaller package, the RTA 8t offers the same driver complement as the larger, more expensive RTA 11t, and thus shares its benefits of superior imaging, musicality, and detail.

Both Polk RTA series loudspeakers achieve the extremely rare combination of good looks and state-of-the-art performance. The tall, elegantly slender, and deep “tower” design cabinets allow for substantial internal volume for high efficiency and powerful bass, while requiring less than one square foot of floor space. The small baffle surface area around each driver minimizes diffraction (sonic reflections), thereby insuring outstanding imaging and low coloration.

Positioning the 1” silver-coil dome tweeter between the two 6½” trillaminate polymer bass/midrange drivers achieves what is called “coincident radiation.” This means that both the mid- and high-frequencies appear to radiate from the same place on the baffle resulting in perfect blending at the critical crossover point. (See illustration, below).

Polk RTA speakers have an uncanny ability to perfectly reproduce the human voice, pianos, guitars, and every other instrument whose faithful reproduction demands superlative midrange and high-frequency performance. Bass and percussion instruments are accurately reproduced with full visceral power and realism, without the heaviness, boominess, or lack of detail that plague lesser designs.

The discriminating listener who seeks state-of-the-art performance and design will find the quintessential combination of both in Polk’s RTA series loudspeakers.

THE PRINCIPLES OF COINCIDENT RADIATION

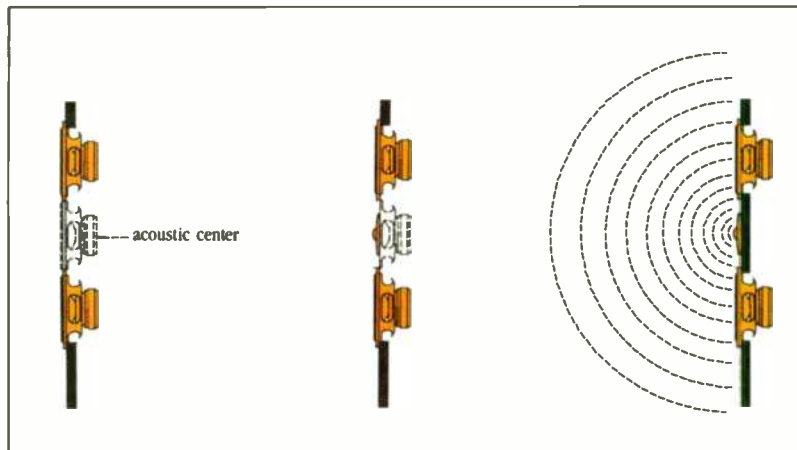

The perceived source of sound of two identical drivers is centered in the area between them.

The benefit of coincident waveform propagation resulting in precise imaging, uniform vertical dispersion and startling midrange accuracy.

In the Polk RTA loudspeaker, the tweeter is positioned at the acoustic center of the drivers.

polk audio
The Speaker Specialists



Polk Audio's RTA 8t and RTA 11t High Performance Tower Speakers

Where to buy Polk Speakers? For your nearest dealer, see page 110.

Enter No. 23 on Reader Service Card

An intelligent interlock between the "Video" and "Audio" source selectors takes simulcasting and overdubbing into account.

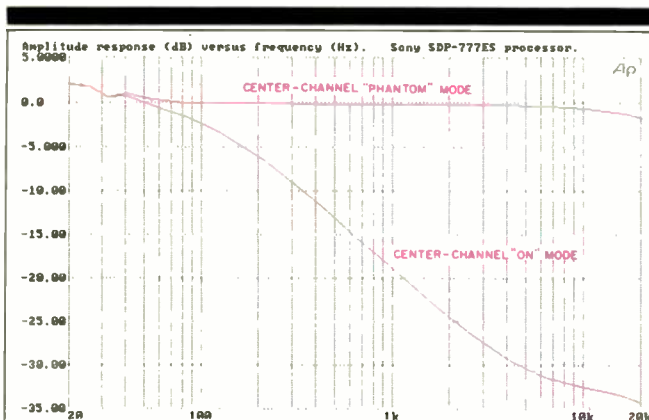

Fig. 1—Frequency response of main channels to mono inputs, for two settings of "Center Mode." The frequency slope with "Center Mode On" is complementary to the center-channel response seen in Fig. 2; see text.

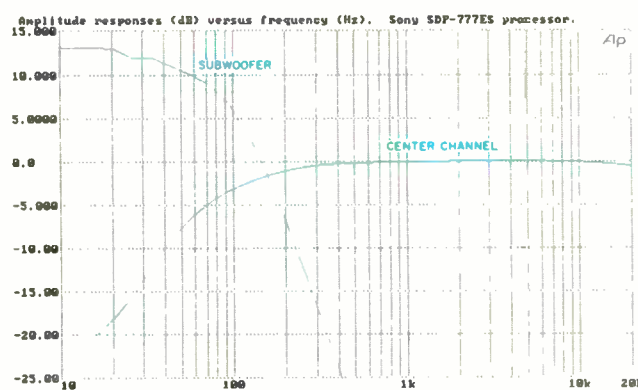

Fig. 2—Frequency response of center and subwoofer outputs to swept test signals.

responses were down 0.02 dB at 20 Hz and 0.03 dB at 20 kHz. The -3 dB points were at 1.5 Hz and 198 kHz.

Figure 2 shows the subwoofer and center-channel responses with the center level at maximum. There is no subwoofer level control, and its output at 20 Hz is about 13 dB higher than the center-channel maximum. The subwoofer roll-off above 100 Hz is at 18 dB per octave. If the subwoofer level were reduced to make its 60-Hz level match the center-channel level at 1 kHz, the two responses would cross at 100 Hz, close to 3 dB down. The center-channel

response was at -18.5 and -0.8 dB at 20 Hz and 20 kHz, respectively. Notice how this response is complementary to the main-channel response (Fig. 1) when the center channel is on. Figure 3 shows the response of the surround channels in Dolby Pro-Logic mode. The response was 7.1 dB down at 20 Hz and 2.8 dB down at 7.0 kHz, showing agreement with Dolby Surround standards. The crosstalk in the surround channels in Dolby Surround mode (Fig. 4) was measured with the balance pot centered and my test signals fed to left and right inputs.

The S/N ratio, relative to 1 V, was 115.8 dBA for the main channels in all modes except Dolby Surround, which had a ratio of 89.9 dBA. The ratios for the surround channels varied with mode but were about 80 dBA for "Matrix," "Hall," and "Simulated," and from 88 to 92 dBA for Dolby Surround, depending on the center-speaker mode. These figures would be 10 dBA higher with the rated maximum output level of 3 V as the reference.

Figure 5 shows THD + N across the band for the main channels at 1 V input and output. The rise in distortion at the highest frequencies is limited to just about 0.005% at 20 kHz. With the input-level control at maximum, the input sensitivity was 117 mV for maximum acceptable input level in Dolby Surround, with "Over" just on. Clipping appeared at 6.5 dB above "Over" turn-on, a much better margin than some units have. The "Over" indicator turned on with a single-cycle, 5-kHz tone burst whose level was 1 dB above the indicator turn-on point—the fastest response I've seen to date. The input pot had no effect on the level in other modes. Depending on the mode selected, input levels of 2.2 to 2.9 V were needed for clipping to show in the surround outputs, and levels up to 6 V did not cause clipping in the main channels.

Figure 6 shows the surround-channel output in "Hall" mode with 30-mS delay (bottom trace) for an 8-mS, 5-kHz tone-burst input (top trace). The surround output shows two bursts, one synchronized with that in the main output, followed by a delayed, lower level replica. Although referred to as "reverberative," the delayed signal is basically a simple echo without decay. I tried the stereo reverberator by pushing "Set" and "Simulated." Reverberation-like energy did appear after the test tone burst, although it seemed to be low in level. However, I had heard this mode in the earlier listening tests, and it sounded quite good. (More on this later.)

The output's polarity was the same as the input's in all channels. The main-channel level change from input to output, with the volume control at maximum, was -0.9 dB for all modes except Dolby Surround, which had a change of -0.2 dB. Input impedance was 24 kilohms. Output impedance was close to 1 kilohm on all channels.

The two sections of the input-level pot tracked within 1 dB of each other, from wide open down to -45 dB. The master volume control's sections tracked within 1 dB over a 50-dB range. The surround channel levels tracked very accurately and made precise 1-dB steps from 0 down to -79 dB. The Dolby Surround input-balance control had a range of ± 35 dB. Exact balance with a 1-kHz mono input, indicated by a null in the surround outputs, was achieved with the control at the 12 o'clock center detent. The 10 steps of "Bass Level

The components, soldering, and p.c. boards are of high quality, and the main board's support is better than on most units.

+ " gave a maximum boost of 9.0 dB at 35 Hz. The 10 steps of "Bass Level—" caused a total cut of 6.5 dB. The maximum cut is not close to the expected 10 dB, but I don't see the discrepancy as particularly important.

The delay adjustment range was from 10.0 to 30.0 mS in Dolby Surround and from 0.1 to 80.0 mS in the other modes. All delay settings were accurate to well within 0.1 mS. Relative to 1 V, the 48-kHz residual from the digital sampling in the outputs was down more than 87 dB in the main and surround outputs.

The test signal was shaped pink noise, rolled off above and below 800 Hz; the signal's -3 dB points were at 300 Hz and 2 kHz.

The remote control was reliable out to at least 25 feet, as long as the beam was no more than $\pm 20^\circ$ off the axis of either the processor or the remote. At normal viewing and listening distances, the remote could be positioned up to $\pm 45^\circ$ off axis when aimed at the processor, and it could be pointed at least $\pm 45^\circ$ away from the unit when located on the processor's axis.

Use and Listening Tests

The reference processor was the Yamaha DSP-1 used with the DSR-100 PRO Dolby Pro-Logic decoder. The decoder was added recently, to get better steering with movies that have Dolby Surround encoding. A Yamaha AVC-50 amplifier was used for switching the various input sources: A Yamaha TX-900U AM/FM tuner, a Magnavox 1041 CD player, a Sanyo VCR-7200 Beta VCR, an Akai VS-555U VHS VCR, and a Yamaha LV-X1 videodisc player. For power amplification, I used the second section of the AVC-50 for the main stereo channels, a JBL/UREI 6210 for the center channel, and a Yamaha M-35 for the surround channels. The speakers were two JBL 4301s (main stereo), a JBL 4408 (center), a self-powered Triad Design HSW-300 (sub-woofer), and two Dynaco A-25s (surround). A Yamaha MX-35 amp was used to drive speakers that were substituted during the presence delay tests. The Akai VS-555U VCR was used as the stereo-TV decoder. I connected a two-channel oscilloscope across the left and right inputs and operated it in X/Y mode to show the existence or lack of stereo and surround information. Figure 7 demonstrates how the display is used to detect the absolute and relative polarity of the left and right input signals.

The trilingual (English, Dutch, and French) owner's manual contains an impressive 30 pages in each language. It has a good table of contents, which some large manuals sorely lack. The overview of the surround modes is rather brief, however, and hoped-for details do not appear later. The illustrations and instructions on speaker location are good, and six pages on system connections provide desirable detail. The 10 pages on system setup, balancing, and operation offer a very good combination of illustrations and text. Many of the pages have additional comments at the bottom, beneath a separating line. I compliment Sony on the quality of the comments but wish important ones had not been separated from the main text. Input/output tables are helpful inclusions, particularly for dubbing.

In general, the front-panel display was easy to read from my listening/viewing position. I couldn't make out the little

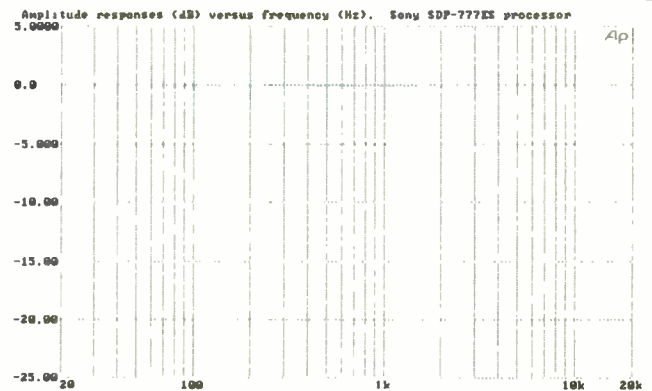

Fig. 3—Response of surround channel to left and right swept-frequency inputs of opposite polarities, in Dolby Pro-Logic mode. The high-frequency roll-off is deliberate and is called for by Dolby Surround standards.

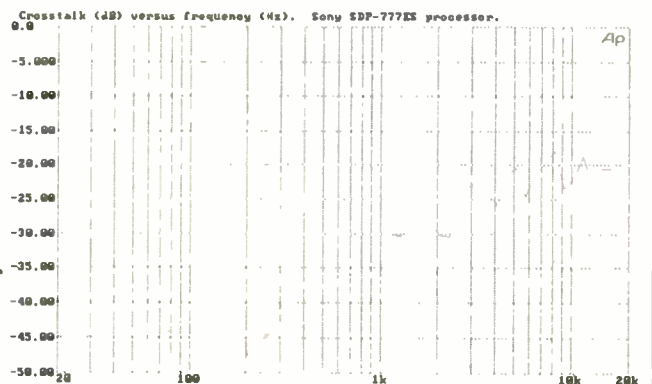

Fig. 4—Crosstalk in surround channels with left and right inputs of same polarity.

orange letters or the program names very well, but I knew what function I had selected and could tell the name from its position in the display. With the processor in Dolby Surround mode and using a mono source, I set the input balance for minimum output from the surround speakers. With Shure's special test videocassette, left/right separation was very good, and there was little crosstalk in surround. The SDP-777ES, however, was not quite as good as the reference system in this respect. I used "Test Tone" to trim levels among all the speakers and reduced main-channel levels to

The S/N ratio for the main channels was 115.8 dBA in all modes except Dolby Surround. Surround channels measured 80 to 92 dBA.

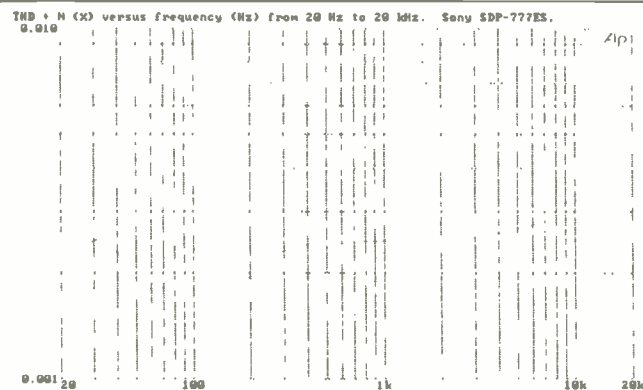

Fig. 5—THD + N vs. frequency for main channel, at 1 V in and out. Note the expanded distortion scale.

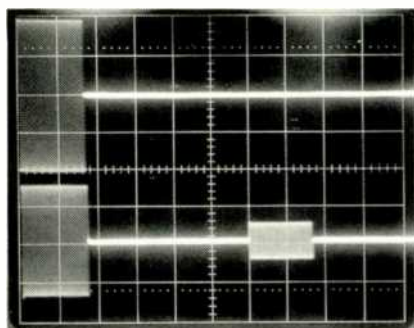

Fig. 6—Surround-channel output in "Hall" mode and set for 30-mS delay (bottom trace), for 8-mS input burst of 5-kHz tone (top trace). Note the delayed, lower level repeat burst in the surround output. (Horizontal scale: 5 mS/div.)

get a wider relative adjustment range for the surround channels. In the process of running these checks, I realized that the SDP-777ES has no specific muting function. It was easy to switch to an unused input, but I still missed the mute.

After some preliminary listening and switching among the available modes, I changed some of the preset delay times to suit my particular room and my preference for a greater sense of space and liveness. The three preset delays in the "Hall" and "Simulated" modes were increased by 5 mS apiece. Dolby surround settings were unchanged, and for the "Matrix" mode I increased the delay in preset memory 2

from 0.1 to 5 mS. Occasionally during listening, I made other temporary delay changes as well. I kept left and right delays the same in all cases, as the listener/speaker distances are the same for left and right surround in my evaluation system. I did not feel a need to adjust "Bass Level" of the main speakers, so I did not use this function. I concluded that I liked "Hall" mode better after I set the low-pass filter 1 kHz higher, to 8 kHz. I tried the stereo reverberator circuit along with the regular surround modes. Because the presence delay mode required a change in loudspeaker position, I didn't try it until after all my other listening.

The CBS program, *Hard Time on Planet Earth*, had limited surround and effects; Dolby Surround with "Center Mode On" was best. The following program, *Jake and the Fatman*, had much more stereo and surround with music and effects. I put a slight presence boost in the center channel for better voice quality. A repeat of HBO's May 1988 *Atlantic Records 40th Anniversary Show* featured many artists, including Foreigner, Phil Collins, Genesis, and Roberta Flack. I brought the center channel up and the surround channels down to get the needed vocal presence. Dolby Surround was definitely best overall. "Hall" mode was next best, but the vocals were too difused for my taste.

Around the World in 80 Days, with Pierce Brosnan, was on NBC after I had finished my intended evaluation. I'm glad I decided to check this made-for-TV movie anyway, because it showed what television can accomplish. Dialog was not panned to match the scene, but very few regular movies have dialog panning. There was good surround of music and effects, and panning was used with sounds of trains and carriages, tracking them into and out of shots. The videocassette version of *My Fair Lady*, the 1964 movie starring Rex Harrison and Audrey Hepburn, surprised me with its regular panning of dialog to match the scene. Sometimes the voices seemed almost too far left or right, but I won't fault Dolby Surround for that. Voices from the back of the scenes had the added depth (room sound) called for. Unfortunately, this happens rarely in movies made recently.

Moonwalker, on Showtime, with Michael Jackson and Joe Pesci, had Dolby Stereo encoding. The music and effects in surround were very good, and Dolby Surround was preferred most of the time. Some portions of a concert scene, however, were better in "Matrix," with 30-mS delay. *Biloxi Blues*, with Matthew Broderick and Christopher Walken, was also on Showtime. This movie had little stereo or surround information, but the various modes helped make it more realistic. Dolby Surround with "Center Mode On" was best; "Hall" and "Simulated" were fairly good. The videocassette *E.T.*, from MCA Home Video, demonstrated effective use of music and effects in surround sound. Low-level music and effects were very well done to establish moods, heighten tension, etc. Switching Dolby Surround off caused an immediate, obvious loss. The flying bicycle scene had very good integration of picture, dialog, music, and effects. I thought the final chase was just great.

Sheena, with Tanya Roberts, was on HBO, and I overcame my resistance to watching it when I found it was Dolby Stereo encoded. Some of the surround effects were quite good in Dolby Surround, but the script and the acting did



New

Monster Cable®

The Next Generation

1989 Celebrating 10 years of Monster Cable leadership in providing the highest performance cables for the audiophile.

Beginning a second decade of exciting new product innovations in audio cable technology for today's new music and new music systems.

ANNOUNCING: New Monster Cable® With Our Latest Technological Advancements:

A new performance standard with dynamic range, impact, clarity and frequency response that maximizes the reproduction of today's best recordings.

- 2 Separate conductor networks for accurately balanced sound of highs and mid-low frequencies.
- Specially wound Amplitude Balanced™, multiple gauged wire networks for greater sonic accuracy.
- New flat profile with ultra flexible folding capability allows the cable to lie flat or neatly tack around walls and corners.
- Bi-wire/bi-amp ready for a higher performance connection with the latest generation speakers.

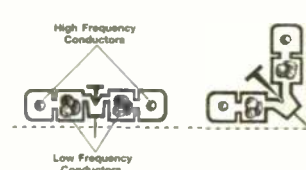

New Monster Cable with flat or 90° profile.

Monster's Newest Product Innovations:



New Turbine Design™ RCA Connectors
Greater contact area and contact pressure for improved sound.



OmniFlex™ Connectors
(Pictured with Angled Gold Pins™)
Bends in any direction for easy installation.



Bass Control Conductors™
Special center conductor that increases bass response and dynamic range in the Powerline® and M Series cables.

Ask about Monster's Trade-Up program available at participating Monster Cable dealers.

Monster Cable® Products, Inc.
101 Townsend Street
San Francisco, CA 94107

Tel: 415 777-1355
Fax: 415 896-1745

MONSTER CABLE®
Technology for Music.

The Sony had enough flexibility to give me reasonable settings for all the varied program material I used with it.

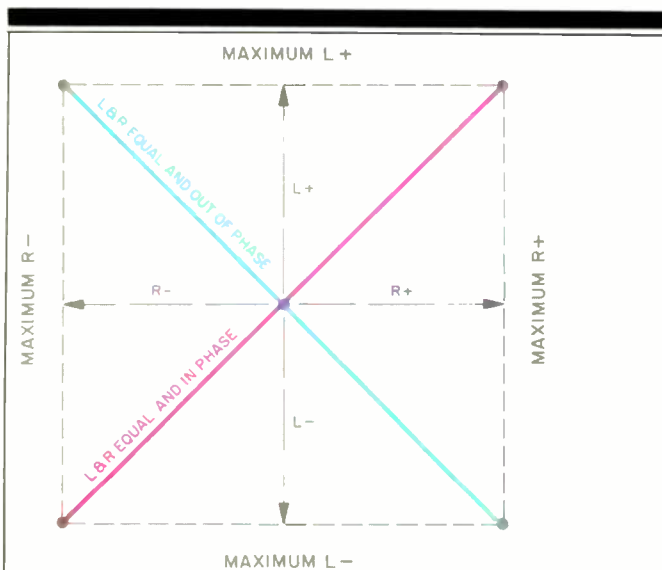

Fig. 7—Vector indications of X/Y oscilloscope displays. Left-channel signal amplitudes are indicated by trace height, right-channel amplitudes by trace width. Equal, same-polarity (“in-phase”) signals from each channel, representing monophonic information, create a trace from lower left to upper right; opposite-polarity (“out-of-phase”) signals, representing stereo difference information, create trace from upper left to lower right.

not improve—no matter what button I pushed. *Planes, Trains and Automobiles*, with Steve Martin and John Candy, was watched in the videodisc version. Dolby Surround was needed for good dialog centering and presence. I preferred a fairly high surround level for music, crowd and traffic noises, and effects, but other viewers found my level setting distracting. The *Gremlins* videodisc, from Warner Home Video, delivered high-quality sound and was at its best, overall, with Dolby Surround. There was very good use of music and other effects to support scenes, building suspense in a number of cases. The Pioneer *Duran Duran* videodisc had substantially no stereo or surround information on it. Dolby Pro-Logic could not extract much from it, and “Simulated” was actually best, which is not surprising, considering the monaural character of the source.

The first Compact Disc I used was Mozart’s *Eine Kleine Nachtmusik*, with Charles Mackerras and the Prague Chamber Orchestra (Telarc CD-80108). It sounded best in “Hall” with 30-mS delay. I tried inverting a channel, but I didn’t consider the resulting change an improvement. The stereo reverberator gave perhaps too much of an effect, but the results were quite good. For Mozart’s *Symphony No. 40*, with Eugen Jochum and the Bamberg Symphony Orchestra (Orfeo C-045901), I had the same first choice (“Hall”), also liked the stereo reverberator, but didn’t like “Inv.” I did find, however, that “Matrix” with 30-mS delay sounded good after

polarity inversion. “Hall” with 40-mS delay was the best overall setting for Tchaikovsky’s *Nutcracker Suite*, with Neville Marriner and the Academy of St. Martin (Philips 411471-2-PH). Polarity “Inv” was perhaps better for some pieces, but the stereo reverberator had an undesirable liveness. When in “Hall” mode, switching the surround circuits off caused an obvious and undesirable collapse of the sound field to normal stereo.

Elgar’s *Overtures*, with Alexander Gibson and the Scottish National Orchestra (Chandos CHAN-8309), seemed best to me in “Hall” with delay at 40 to 50 mS. Polarity “Inv” was just acceptable, in my view, but “Matrix” with 30-mS delay was fairly good. I could neither get the greater sound spread I wanted, nor could I control some of the good things I heard with the stereo reverberator. The Sousa music on *Peaches and Cream*, with Erich Kunzel and the Cincinnati Pops (MMG MCD-10005), was quite a good match to “Hall” with the delay increased to 50 mS and the filter cutoff lowered to 6 kHz. “Matrix” with delay of 30 to 40 mS was quite good for marches but not for other things. Polarity “Inv” was not good with either of these modes. The stereo reverberator was quite good for most of the tracks on this CD.

I tried Victoria’s *Requiem Mass*, with The Tallis Scholars (Gimell CDGIM-012), using “Hall” and 50-mS delay, but the sound was better after a reduction to 30 mS. “Matrix” with 40-mS delay was fairly good, but voices became too pointed. Polarity “Inv” was not good with either mode, but the stereo reverberator was a possible choice. The Charpentier *Motets* CD, with the Concerto Vocale (Harmonia Mundi HMC-901149), sounded best with “Hall,” 40-mS delay, and a low surround level. I couldn’t get the sonic illusion of the room I wanted, and the stereo reverberator had too much of an effect. The Swingle Singers’ *Anyone for Mozart, Bach, Handel, Vivaldi?* was good with “Hall,” a high surround level, and a short delay of 20 mS. Longer delays were good at times but only with lower surround levels. The stereo reverberator was a good choice, particularly for some tracks. I wondered what sort of illusion I would get for an opera and tried Puccini’s *La Bohème*, with Moffo, Tucker, Leinsdorf, and the Rome Opera House Orchestra and Chorus (RCA 3969-2-RG). The opera was quite good in “Matrix” and “Hall,” although the presence that “Matrix” added to the voices was not successful at all times. Dolby Surround centered the voices too much, and “Simulated” was less effective overall than “Hall” or “Matrix.” The stereo reverberator added too much liveness for this music.

The Brahms Trio in B from *The Piano Trios*, performed by the Beaux Arts Trio (Philips 416838-2-PH2), was fairly good in “Hall” with 40-mS delay and the surround level set at -6 dB. Occasionally, however, the piano’s sonic placement seemed to slip sideways a bit. “Matrix” provided more stable localization but was less satisfactory in other ways. Polarity “Inv” was not acceptable, but the stereo reverberator was quite good in this case, including a steady piano image. For the Brahms Concerto No. 2 for Piano and Orchestra, with Ashkenazy, Haitink, and the Vienna Philharmonic (London 410199-2-LH), “Hall” with 40-mS delay and -9 dB surround level was my choice. The stereo reverberator was a good mode for the orchestral sound but not for the piano. I preferred just about the same combination for

If getting everything you've ever dreamed about in a receiver has been just, well, a dream, this message could prove to be most valuable.

Because the RV-1340R Audio Video Remote Receiver is the finest Sherwood has ever built. With tighter engineering tolerances and more high performance features than any other component in its price range.

Behind its double-thick brushed aluminum front-end are two discrete amplifiers and Dolby® surround sound circuitry. One amp sends 100 watts per channel to the front speakers. While the second delivers a full 20 watts per channel to the rear. So you can turn on your Sherwood and turn your living room into a home theater experience.

The unit is designed with MOS-FET components and fully complementary circuitry. Plus video dubbing with adjustable video enhancement. And with Sherwood's DIGI-LINK unified wireless remote, you'll put an entire Sherwood system at your command.

To put the RV-1340R to the test, visit your Sherwood dealer for a thorough demonstration. And discover a receiver you can look up to that's within your reach.



MOST VALUABLE RECEIVER.



 **Sherwood®**
LIVE PERFORMANCE SOUND™

13845 ARTESIA BLVD. CERRITOS, CA 90701 • IN CANADA: NORESKO CANADA INC., TORONTO, ONTARIO © 1989 INTEL CORPORATION.
Dolby is a trademark of Dolby Laboratories Licensing Corporation.

Enter No. 26 on Reader Service Card

At its relatively moderate price, complete with Dolby Pro-Logic, the SDP-777ES is well worth comparing to more expensive models.

Michael Murray's *Bach: The Organs at First Congregational Church, Los Angeles* (Telarc CD-80088). I liked a higher surround level (-5 dB), though, and the stereo reverberator was basically good for this organ CD.

"Matrix" seemed best to me for *Brothers in Arms*, the Dire Straits album (Warner Bros. 25264-2). I set the delay anywhere from 0.1 to 30 mS, reacting to the particular track. The surround level was reduced (-10 dB) to help emphasize the vocals. Dolby Surround with "Center Mode On" was very good on some tracks for bringing vocals out of the total sound. The stereo reverberator failed because it was lacking in vocal presence. Patti LaBelle, on *I'm in Love Again* (Philadelphia International ZK-38539), did not fare well with Dolby Surround until I switched "Center Mode" to its "Phantom" setting, to make the voice sound less brittle by spreading it. The stereo reverberator feature was also good, making the voice less brittle than the "Matrix" mode did.

Sony also suggests a presence delay mode, obtained by positioning the surround speakers outboard of the main speakers and pointed at the wall behind them. Since my surround speakers are hard to move, I substituted others. The effect of all this was generally pleasant for many of the CDs, but I did not think the sonic results were superior to those from the other music surround modes. With the changed speaker positions, the four regular modes would be greatly compromised and, in my view, basically lost

without compensating advantages. The positioning of dialog and localization in the surround field for television and movies were very nearly the same for the SDP-777ES and the reference Yamaha DSP-1 and DSR-100 PRO. The Sony unit provided very satisfying reproduction of music—far superior to regular stereo. It was not possible, however, to manipulate the processing to create definite room illusions, as is possible with the reference DSP-1.

The Sony SDP-777ES processor has low noise and distortion and very good frequency response. This unit's Dolby Pro-Logic surround mode is certainly one of its best features, particularly for those who want good sound from Dolby Stereo movies. The range of delays is good for all modes, and the precision of the settings is better than would ever be needed. Control of levels is quite complete, especially with the remote control. Many users will benefit from being able to set different levels, and delays, for the two surround speakers. The easily read front-panel display and the flexible input/output connections and switching add to the value of the Sony processor. The music surround modes are not a match for those of the reference processor, but their superiority over regular stereo is very obvious. The relatively moderate price of the Sony SDP-777ES, considering the inclusion of Dolby Pro-Logic, makes this unit worthy of comparison to other processors at noticeably higher prices.

Howard A. Roberson

RICHARD C. HEYSER SCHOLARSHIP LOAN FUND

The purpose is to assist needful graduate students to pursue advanced studies in the field of acoustical engineering or audio related subjects.

Contributions may be sent to:

Richard C. Heyser Scholarship Loan Fund
c/o Audio Engineering Society
60 East 42nd Street
New York, NY 10165-0075 USA

*Tax deductible status pending final approval by IRS.
Until it is obtained, please make checks payable to:
The Audio Engineering Society. Note on your check this is for:*

THE RICHARD C. HEYSER
SCHOLARSHIP LOAN FUND

ORIGINAL MASTER RECORDINGS™

UNEARTH THE TREASURES OF GOLD WITH THE LIMITED EDITION COLLECTOR'S SERIES. The most advanced compact disc in the music industry today! The 24K Gold **ULTRADISC™** is a dramatic breakthrough in the consumer music market. Capable of generating music far above current audio standards, it is setting new highs in listening pleasure. **Current releases on ULTRADISC™:** Moody Blues, Steely Dan, The Police, Pink Floyd & more. **Upcoming on ULTRADISC™** Jethro Tull, Bryan Adams, Elton John & more.

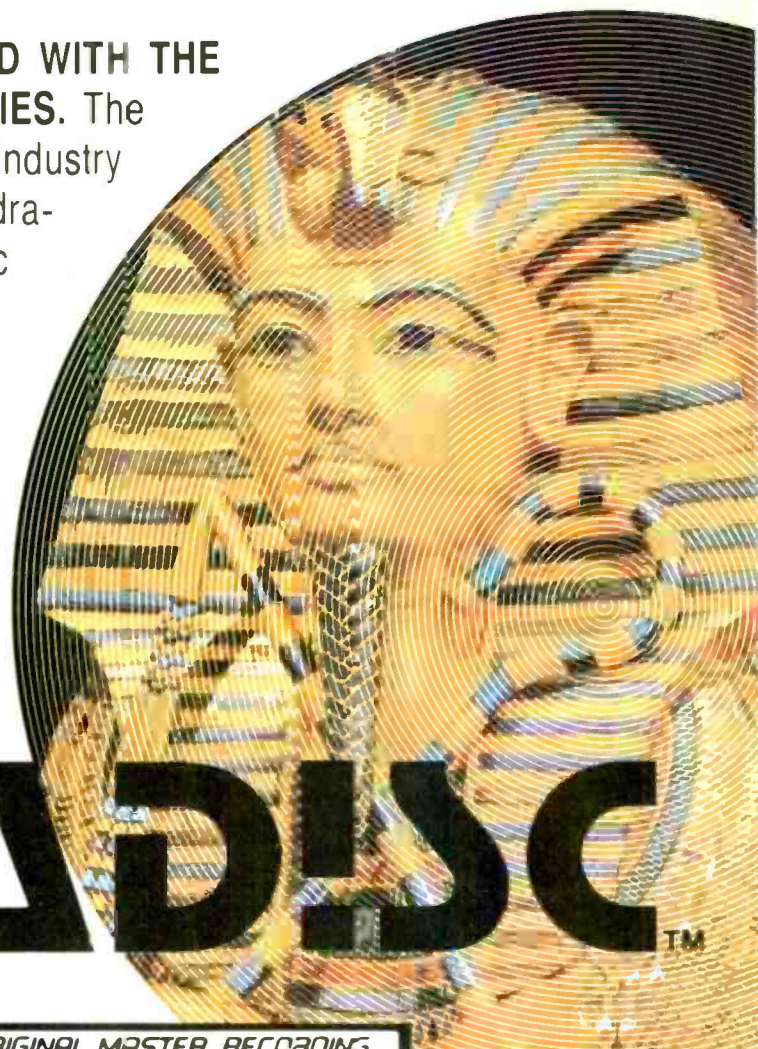

ULTRADISC™

ORIGINAL MASTER RECORDING.



ORIGINAL MASTER RECORDING.



ORIGINAL MASTER RECORDING.



ORIGINAL MASTER RECORDING.



For a complete free Original Master Recordings catalog, call toll free: 800-423-5759, or write: Mobile Fidelity Sound Lab, 1260 Holm Road, Petaluma, CA 94952.

Enter No. 18 on Reader Service Card

3

SUMO ATHENA PREAMP

Manufacturer's Specifications

Frequency Response: 20 Hz to 20 kHz, ± 0.1 dB; 1.5 Hz to 500 kHz, ± 1.5 dB.

RIAA Equalization Accuracy: ± 0.25 dB, 20 Hz to 20 kHz.

THD and IM Distortion: Less than 0.01% below 18 V output.

S/N: MM phono, 85 dBA; MC phono, 80 dBA; high level, 100 dB; all re: 3 V out.

Input Sensitivity: MM phono, 2.3 mV; MC phono, 115 μ V; high level, 315 mV.

Input Overload at 1 kHz: MM phono, 165 mV; MC phono, 8 mV; high level, infinite.

Dimensions: 19 in. W \times 1 $\frac{1}{4}$ in. H \times 8 $\frac{3}{4}$ in. D (48.3 cm \times 4.4 cm \times 22 cm).

Price: \$729.

Company Address: 21300 Superior St., Chatsworth, Cal. 91311.
For literature, circle No. 92



The Athena is a new preamp from Sumo that replaces their older Electra unit. Unlike the Electra, the Athena does not use IC operational amplifiers; it has more than 100 discrete transistors in its circuitry. Although the Athena's uncluttered front panel does not have tone controls, it does have ample facilities, including a switchable MC stage, separate switches for tape recording and input selection, and plenty of high-level and tape recorder inputs.

Front-panel controls, from left to right, are a pushbutton power switch; a rotary tape record selector; a rotary input selector; concentric, rotary volume and balance controls, and pushbutton switches for mono/stereo, for the low-cut filter, and to bypass the output line amplifier. On the rear panel are a two-wire power cord, gold-plated input and output signal jacks, and a chassis grounding post.

The construction of this preamp is relatively simple and straightforward, utilizing a single piece of sheet steel that is bent up to form the bottom, sides, and rear panel. An extruded piece of aluminum, backed with a piece of sheet steel, forms the front panel and, via a short lip along the bottom of the extrusion, is attached to the chassis bottom piece. The piece of sheet metal backing the front panel has rear-facing tabs, about an inch long, on each end; the rear panel has similar forward-facing tabs. Two Pem nuts are arranged vertically on each of these four tabs. A top cover with sides fits over this assembly. A pair of rack handles is bolted onto the front subpanel tabs. A pair of short machine screws bolts through the top cover sides into the rear tabs. It all fits together nicely, but the metal seems a bit thin.

Circuit Description

Figure 1 is a block diagram of the Athena's signal flow. This preamp uses the increasingly popular scheme of separate selector switches, one for record out and the other for listening. Two additional switch poles per channel on the tape record selector switch are wired into the output of the tape output buffer circuit, to prevent output-to-input feedback in connected tape recorders or other signal processing devices. This works by grounding the feed to tape out of the selected tape input. This really necessary completeness of design is something that I don't believe I've seen in other units that use the dual-selector scheme.

The low-cut filter has a slight flaw regarding its effectiveness in the tape-out path. If phono is selected for recording but not for listening, and the low-cut filter is engaged, the cutoff frequency of the filter becomes much lower than when phono is selected for listening. This is because the resistances of the volume and balance controls aren't loading the low-cut filter's series capacitor. However, when phono is selected as the listening source, the cutoff frequency is as intended, for use in reducing acoustic feedback and/or woofer excursion due to warped records when listening through the preamp's line output section.

Bypass switches are becoming increasingly popular on preamps, with two kinds in use today. One type bypasses the mode and balance controls when engaged. The other type, used by Sumo in the Athena, bypasses the preamp's line output amplifier, for greater signal purity. There are three considerations regarding whether one can get away with not using a line output amplifier: Adequate gain, high-

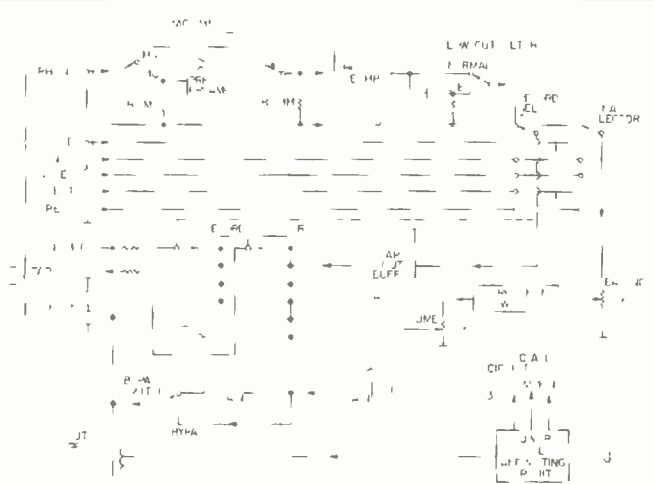

Fig. 1—Block diagram (one channel shown).

frequency roll-off due to cable capacitance in the preamp-to-amp connecting cable or in the input circuitry of some power amps, and overall sound-quality improvement possibilities without a line amplifier in the signal path.

About gain: Most signal sources, even many phono preamp outputs, have enough output level to drive the majority of power amplifiers and speakers to a reasonable level. Whether or not the volume attainable in a system without the extra gain of a preamp line amp is satisfactory depends on your definition of reasonable volume, the phono cartridge output, the phono preamp gain, the sensitivity of the speakers used, and the gain or sensitivity of the power amplifier. A relatively easy way to find out if enough volume would be attainable in your system without a preamp line stage is to select the weakest signal source (usually, but not necessarily, phono), turn off the system power amplifier, and then plug the amp input leads into the preamp's tape outputs rather than its main outputs, where they had been. Next, turn the power amp back on and listen to the selected source. If the volume is loud enough, or perhaps more than loud enough, you could use a preamp with an output amplifier bypass mode or make an external volume control in a box chassis and interpose it between tape out and power amp input. I have been using an external volume control this way for some 25 years with my sound systems.

High-frequency roll-off: A variable, first-order (6-dB/octave) low-pass filter is formed by the shunt cable capacitance and the resistance looking back into the wiper of the volume control. The highest resistance, and consequent lowest cutoff frequency, is with the control set about 6 dB down from full volume, where it will surely be when the Athena is in bypass mode. A popular resistance value for volume controls, and the value I usually use, is 50 kilohms. The worst-case impedance looking back into the wiper is about one-fourth of the pot's resistance, or 12.5 kilohms. A check of some 1-meter interconnects that I happen to have on hand yielded total capacitances of about 160 to 360 pF, which would cause response to be 3 dB down at 79 and 35

Sumo's attention to detail is shown by extra switch contacts that prevent any accidental feedback from output to input.

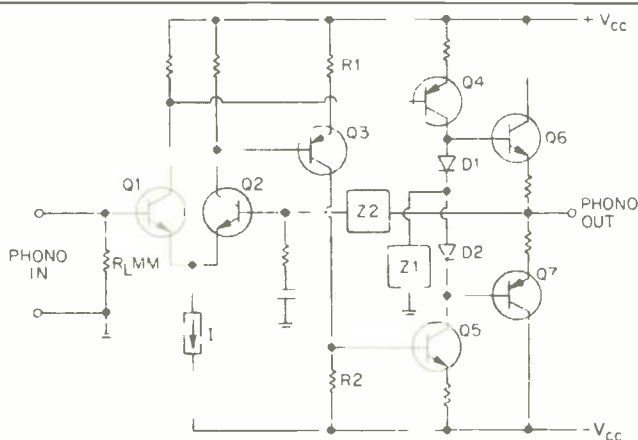

Fig. 2—Simplified schematic of circuit used for phono-preamp and $\times 10$ line-output sections.

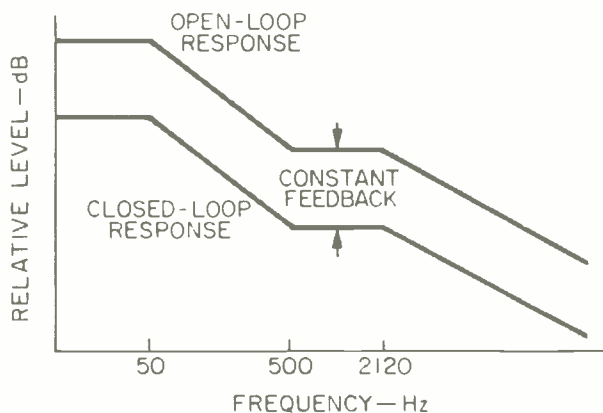

Fig. 3—In the phono equalization section, a loading network (Z1, in Fig. 2) shapes the circuit's open-loop gain to follow the RIAA curve, and negative feedback is constant over the audio range and beyond.

kHz, respectively. Some people could hear such filters if inserted into an otherwise wider bandwidth system, but the improvement in sound quality without a line stage could be worth it. If one needs longer cable runs to the power amplifier, then the worst-case high-frequency cutoff point moves down. A 10-kilohm volume control raises the high-frequency cutoff by a factor of five. However, 10 kilohms is generally too low a load impedance for most tube sources to drive happily. Often, some compromise is needed to resolve these conflicting requirements.

Sound quality: This is the main reason for being nuts like this. The above considerations aside, the bottom line for me is that I prefer the sound that I get using my present, 50-kilohm switched attenuators over any preamp line stage (and its internal switches, wiring, and balance and volume controls) that I've heard so far.

In the case of the Athena, a unity-gain buffer circuit is in the signal path between the volume control wiper and the $\times 10$ line-out amplifier circuit. The bypass mode selects the output of the unity-gain buffer instead of the output of the $\times 10$ amplifier. This use of the unity-gain buffer keeps the high-frequency response wide even when the interconnect cables cause capacitive loading, but it does so at the price of inserting an extra active circuit in the signal path. Further, in normal mode, there are two output amplifiers in series rather than the one that would be present if the unity-gain buffer amp weren't used.

Another little subtlety in the signal path warrants comment. When a preamp has a mono/stereo switch, usual practice is to have a resistor in series in each channel such that, when the mono mode is engaged, the channels are tied together at these resistors' output ends. This ensures that the source will not be excessively loaded with out-of-phase signal currents from the opposite channels. In the Athena, the series resistors are only switched in for the mono mode. In stereo, no series resistors are in the signal paths, thus enhancing high-frequency response. When the Athena's mono mode is engaged, a level drop of 3 dB occurs in each channel, presumably to make the acoustic mono sum come out at the same level as the stereo signals.

The actual circuits used for the various blocks are of three basic types: Simple circuit with voltage gain (used in the MC pre-preamp), complicated circuit with gain (phono and $\times 10$ line amp), and unity-gain voltage follower (tape-out and unity-gain line-amp buffers).

Starting with the MC pre-preamp, we have a circuit topology consisting of a cascade of common-emitter, common-emitter, and common-collector (emitter-follower) stages. The first stage is made up of two paralleled NPN transistors in a common case; its emitter-to-ground resistance is a fairly low 22 ohms for low equivalent input noise. The second stage is a PNP transistor with a fairly large, bypassed emitter resistance along with a much lower value of unbypassed resistance. The input of this second stage is direct-coupled from the output of the first stage. The collector output of the second stage is direct-coupled to an NPN transistor functioning as an emitter follower. Overall negative feedback is applied from the last-stage emitter (which is the circuit output) to the first-stage emitter, for a resistor-determined circuit gain of $22 \times$. The main power supply of ± 35 V is divided down, capacitor-bypassed to about ± 5 V, and applied to the moving-coil circuit through emitter-follower pass transistors. Signal input and output are capacitor-coupled in this circuit.

This leads us to the complicated circuit with gain used in the phono preamp and $\times 10$ line amp; a greatly simplified schematic of this topology is shown in Fig. 2. The basic principle seen here is the use of a noncomplementary differential amplifier in which both output phases are used to create a complementary output signal. (This topology has

Eugene Hummelmyer has the MTX advantage.

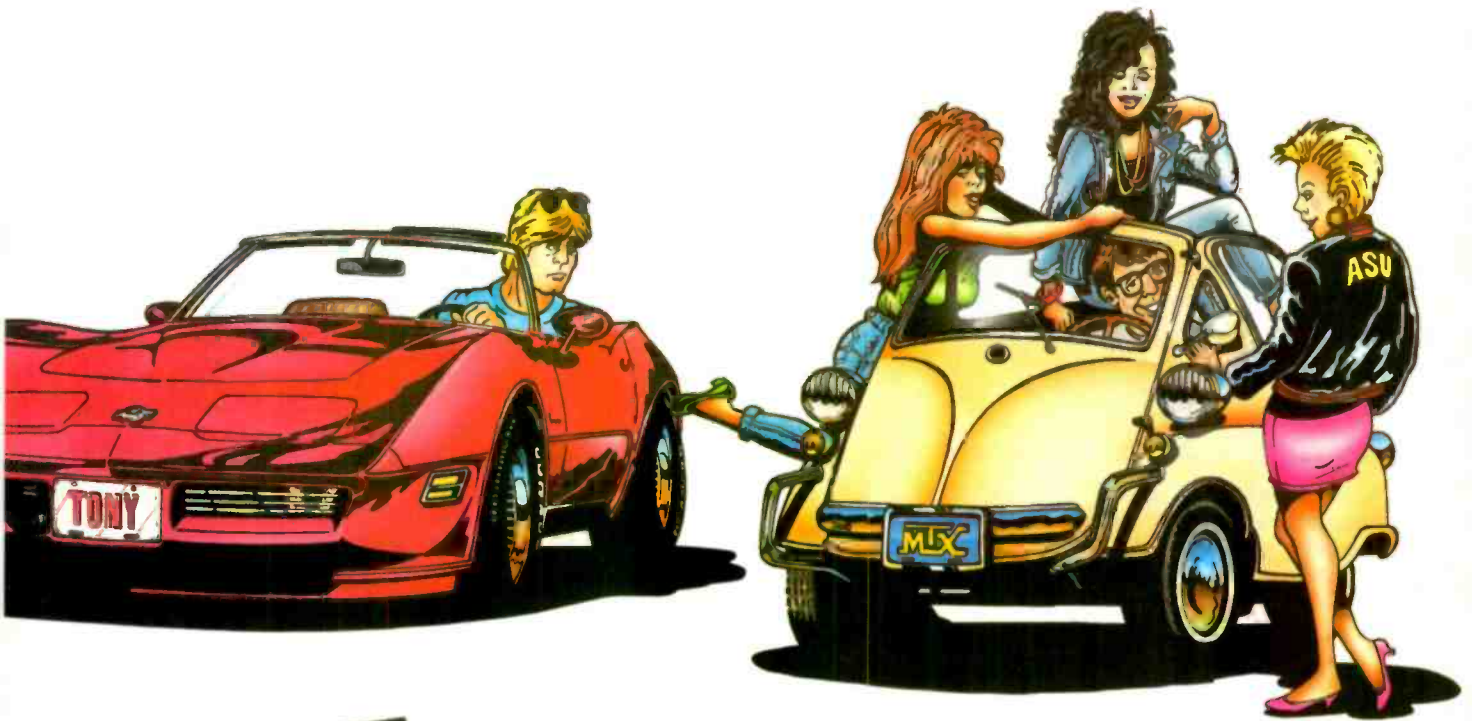

Things used to be pretty dull for Eugene. That is, until he visited his local MTX dealer. An hour later, Eugene roared away with MTX Thunder in his car. Serious speakers designed for serious sound-pressure-levels. Concussive bass. Crystal clear highs. Clean mid-ranges. And the very best warranty in the auto sound business. Well, it's "Gene" now and things are different. You might say his social life has more "life" now. Sorry Tony. All's fair in Rock and Roll.



MTX[®]

ROAD THUNDER • TERMINATOR • BLUE THUNDER • RFL • LOUDSPEAKERS AND COMPONENTS
MITEK • One Mitek Plaza • Winslow, IL 61089 • (815) 367-3000

Enter No. 20 on Reader Service Card

The line-output amplifier stage can be bypassed for increased signal purity when signal levels and amp sensitivities allow.

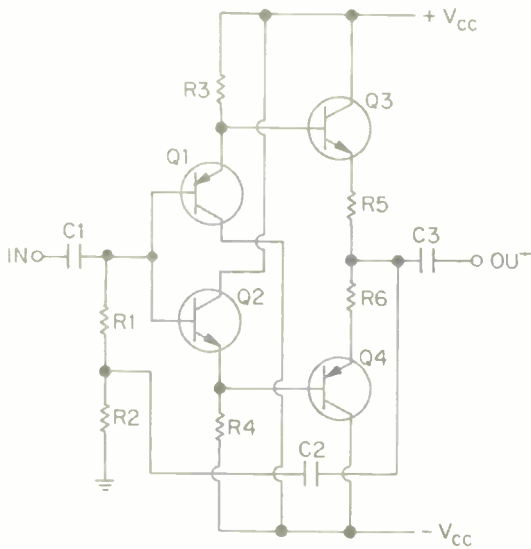

Fig. 4—Simplified schematic of the voltage-follower circuit used for the tape-output and unity-gain line-output buffers.

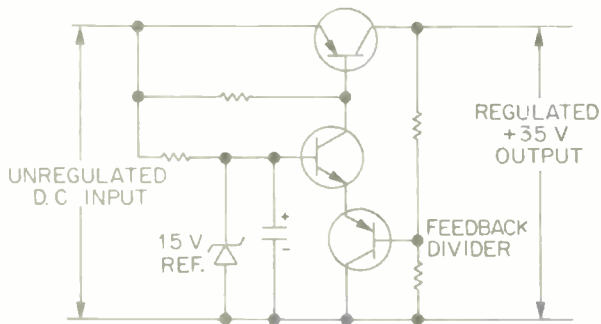

Fig. 5—Power-supply regulator circuit; see text.

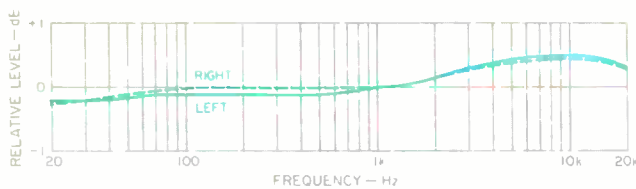

Fig. 6—RIAA equalization error, MM mode. Error in MC mode was essentially the same.

been used in power amplifiers before. I first saw it in the Marantz 510, and I believe I have seen it used recently in some high-quality car amplifiers.) Here, Q1 and Q2 function as the input differential amplifier. The collector of Q1 drives the base of Q4, whose collector output has the correct polarity to drive the emitter-follower output stage so that negative feedback can be returned to the base of Q2. The collector of Q2 is out of phase with the signal at Q1's collector. By applying the signal from Q2 to the base of Q3, a phase-inverted and level-shifted signal appears at the base of Q5, which is in phase with the signal at Q4's base. The two phases from the output of the differential input amp are thus added to form the composite signal appearing at the collectors of Q4 and Q5. The phase inversion in Q3 occurs because the signal across R1 is very close in amplitude to the signal at the base of Q3 due to "emitter following." Since R1 is equal to R2, whatever is developed across R1 is transferred, in opposite polarity, to R2 because the current in R2 is the same as in R1, except for a small amount of base current. D1 and D2 are biasing diodes for the output transistors Q6 and Q7. As mentioned, Fig. 2 is a conceptually accurate but simplified schematic of the phono circuit. The actual circuit has eight transistors in its input differential-amp circuit, uses two transistors plus a diode-connected transistor for Q3, and uses cascaded emitter-follower pairs for Q4 through Q7, making a total of 19 transistors used in one channel of the phono preamp.

In the use of this circuit as a phono equalizer, Sumo has used an interesting (though not original) idea of having the network Z1 load the collectors of Q4 and Q5 such that the open-loop gain of the circuit follows the RIAA characteristic. Then, with overall feedback applied through Z2 (which is a series impedance network for producing the RIAA curve), the amount of negative feedback is constant over the audio range and beyond. (See Fig. 3.)

Next, we look at the voltage-follower circuit used as a tape-out buffer. (Refer to Fig. 4.) This is essentially a complementary, cascaded emitter follower. The bases of Q1 and Q2 are tied together and are driven through the input coupling capacitor. The emitters of Q1 and Q2 will be up and down about 0.6 V, which is just what is required to bias Q3 and Q4 into conduction. The values of resistors R3 through R6 are selected so as to allow the desired idling current in Q3 and Q4. This topology, including Q1 and Q2, permits biasing Q3 and Q4 without a resistor/diode network, which would lower input impedance. Capacitor C2, from the circuit's output to the midpoint of R1 and R2, bootstraps R1 to a higher effective value than its actual resistance. For instance, if the overall gain of the circuit were to be 0.9, R1 would appear 10 times higher or, to be more precise, the circuit input impedance would be 10 times the value of R1 in parallel with the reflected impedance at the bases of Q1 and Q2.

The voltage follower used in the unity-gain output amp is like the circuit of Fig. 4 except that R3 and R4 are replaced by current sources. In addition, the supply voltage to this circuit is reduced to about ± 20 V by placing 15-V zener diodes in series with the supply feed lines.

In the $\times 10$ output amplifier, the circuit is exactly like the phono preamp except that the network Z2 is set for a flat,



fundamentally extraordinary.

Acclaimed by the leading high end publication, the Precision Monitor 10 has built an enviable reputation for its honesty, clarity and extraordinary orchestral fundamentals.

There's an entire family of Precision loudspeakers that embodies these same qualities. Designed by noted engineer Keith Johnson with the express purpose of bringing the high end experience to a greater number of enthusiasts.

Audition Precision speakers, the affordable reference systems, today. For the name of your nearest Precision dealer, call 1-800-553-4355, and enter code 41228 when asked.

Precision
Acoustic Laboratories

Suite B 200 Williams Drive Ramsey NJ 07446
Enter No. 24 on Reader Service Card

Even with unrealistically high input levels, output in bypass mode was clean and unclipped.

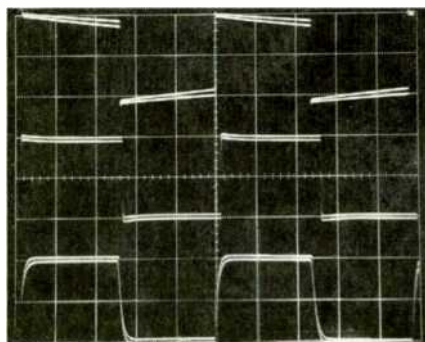

Fig. 7—Square-wave response through the MM phono input, at 40 Hz (top), 1 kHz (center), and 10 kHz (bottom). The lower amplitude trace of each pair is with IHF

loading, the other trace with instrument loading. (Scales: Vertical, 1 V/div.; horizontal, 5 mS/div. for 40-Hz signals, 200 μ S/div. for 1 kHz, and 20 μ S/div. for 10 kHz.)

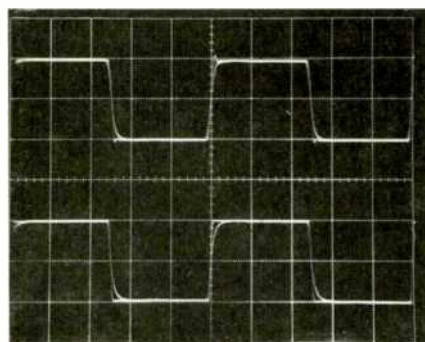

Fig. 8—Response to 200-kHz square waves via high-level inputs, for normal mode (top) and bypass mode (bottom). Waveforms for both IHF

and instrument loading are superimposed. (Scales: Vertical, 5 V/div. in normal mode, 0.5 V/div. in bypass mode; horizontal, 1 μ S/div.)

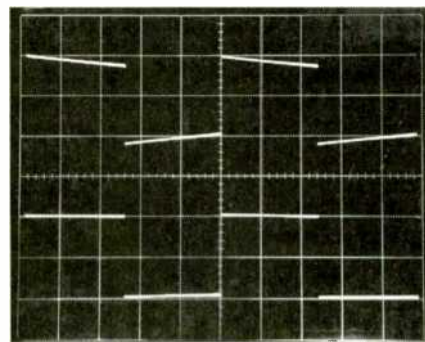

Fig. 9—Same as Fig. 8 but for 20-Hz square waves. (Horizontal scale: 10 mS/div.)

wideband gain of 20 dB. Network Z1 consists of a resistor and a series RC network in parallel to limit open-loop gain and roll it off above about 130 kHz.

The power supply in the Sumo Athena produces regulated ± 35 V for all circuit blocks. With the exception of the MC circuits, each circuit block is decoupled by a 10-ohm series resistor and a 0.1- μ F capacitor to local ground for the positive and negative rails. The moving-coil circuits have their own local positive and negative regulators.

A toroidal power transformer feeds a full-wave bridge rectifier composed of individual diodes, which in turn feeds a capacitor input filter with 2,000 μ F each for the positive and negative unregulated voltages.

The regulator circuitry (Fig. 5) is unusual in a number of interesting respects. First, the series pass devices are connected in a common-emitter mode rather than the more usual common-collector (emitter-follower) configuration. Second, the error amplifier, which in simpler regulator circuits has a zener diode in its emitter circuit as the regulator reference voltage, is configured like a differential amplifier but with opposite-sex devices rather than the usual, same-sex configuration. A slow turn-on of the power supply is achieved by an RC network, buffered by an emitter follower, across the reference zener diodes. One disadvantage of the error-amplifier circuit used here is that the base-to-emitter voltage change with temperature is not reduced by regulator feedback; in fact, the regulator output voltage would drift some four to five times as far, in millivolts, as either error-amp transistor. This is probably not a problem in this preamp, though, as the internal temperature is rather high and reasonably constant.

Lastly, another circuit controls the output muting relay which, upon turn-on, delays the unshorting of the outputs by 10 to 15 S and, when the unit is turned off, shorts the outputs immediately.

Phew! What a circuit! Definitely not of the "simpler is better" school of design.

Measurements

Circuit gains and IHF sensitivities were measured first, and results appear in Table I. Phono and output amplifier noises are enumerated in Table II for various bandwidths and source impedances. Noise in MM mode was satisfactorily low, and MC noise was among the lowest I have measured in a preamp for quite a while. IHF signal-to-noise ratios for all inputs are shown in Table III.

RIAA equalization error for MM mode, as measured at tape out, is shown in Fig. 6. Since the MC pre-preamplifier circuit's response was flat, the equalization error in MC mode looked essentially like Fig. 6. A 'scope photo of various square waves through the MM phono circuit is shown in Fig. 7. Each trace is for instrument and IHF loading, with the lower amplitude waveform being for IHF loading.

MM phono THD + N at 15 V rms output, as measured at the tape output, was about 0.02% from 1 to 20 kHz, increasing to about 0.05% at 200 Hz, 0.1% at 50 Hz, and 0.2% at 20 Hz for the left channel. The right channel stayed at about 0.02% down to 50 Hz and rose to 0.03% at 20 Hz. At a more moderate and realistic level of 5 V rms, THD + N was less than 0.01% from 20 Hz to 20 kHz for both channels. Left-

"They Were Designed To Play Music And Make It Sound Like Music..."

This They Do Very Well, In A Most Unobtrusive Way, At A Bargain Price... It's Hard To Imagine Going Wrong With Ensemble!"

Julian Hirsch
Stereo Review, Sept. '88

Cambridge SoundWorks has created Ensemble™ a speaker system that can provide the sound once reserved for the best speakers under laboratory conditions. It virtually disappears in your room. And because we market it directly, Ensemble costs hundreds less than it would in stores.



Henry Kloss, creator of the dominant speaker models of the '50s (Acoustic Research), '60s (KLH), and '70s (Advent), brings you Ensemble, a genuinely new kind of speaker system for the '90s, available only factory direct from Cambridge SoundWorks.

The best sound comes in four small packages.

Ensemble consists of four speaker units. Two compact low-frequency speakers reproduce the deep bass, while two small satellite units reproduce the rest of the music, making it possible to reproduce just the right amount of energy in each part of the musical range without turning your listening room into a stereo showroom.

Your listening room works with Ensemble, not against it.

No matter how well a speaker performs, at home the listening room takes over. If you put a conventional speaker where the room can help the low bass, it may hinder the upper ranges, or vice-versa.

What Henry Kloss tells his friends

Every time I came out with a new speaker at AR, KLH, or Advent, my friends would ask me, "Henry, is it worth the extra money for me to trade up?" And every time I would answer, "No, what you've already got is still good enough."

But today, with the introduction of Ensemble, I tell them, "Perhaps now is the time to give your old speakers to the children."

Ensemble is a Trademark of Cambridge SoundWorks, Inc.

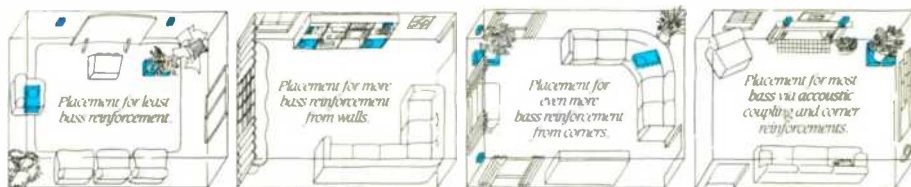

You can put Ensemble's low-frequency units exactly where they should go for superb bass. You can't do this with conventional speakers because you have to be concerned about the upper frequencies coming from the same enclosures as the low ones.

Ensemble, on the other hand, *takes advantage* of your room's acoustics. The ear can't tell where bass comes from, which is why Ensemble's bass units can be tucked out of the way—on the floor, atop bookshelves, or under furniture. The satellites can be hung directly on the wall, or placed on windowsills or shelves. No bulky speakers dominate your living space, yet Ensemble reproduces the deep bass that *no* mini speakers can.

Not all the differences are as obvious as our two subwoofers.

Unlike seemingly similar three-piece systems, Ensemble uses premium quality components for maximum power handling, individual crossovers that allow several wiring options and cabinets



Unlike seemingly similar satellite systems which use a single large subwoofer, Ensemble uses two separate, compact bass units. They fit more gracefully into your living environment, and help minimize the effects of the listening room's standing waves.

ruggedly constructed for proper acoustical performance. We even gold-plate all connectors to prevent corrosion. An even bigger difference is how we sell it...

Thousands agree: the best showroom is your living room.

We make it possible to audition Ensemble the *right* way—in your own home. In fact, Ensemble is sold *only* by Cambridge SoundWorks directly from the factory. Listen for hours without a salesman hovering nearby. If after 30 days you're not happy, return Ensemble for a full refund.

At only \$499*—complete with all hardware and 100' of speaker cable—Ensemble is *the* value on today's speaker market.

Call 1-800-AKA-HIFI!
(1-800-252-4434)

Our toll-free number will connect you to a Cambridge SoundWorks audio expert. He or she will answer all your questions, take your order and arrange surface shipment via UPS. Your Cambridge SoundWorks audio expert will continue as your personal contact with us. We think you'll like this new way of doing business.

*In Canada, call 1-800-525-4434. Audio experts are on duty Mon.-Sat., 9AM-10PM, Sun., 9AM-6PM Eastern Time. Fax #: 617-332-9229.

CAMBRIDGE SOUNDWORKS

Suite 104AUG, 154 California St., Newton, MA 02458

- Send more information and test reports.
- Send Ensemble risk-free for 30 days, for \$499*.
- Send an Ensemble Gift Certificate for \$499*.

I'm paying by Check MC Visa AmEx

Acct. Number _____ Exp. _____

Signature _____

Name _____

Address _____

City _____ State _____ Zip _____

Phone (Area Code) _____ Number _____

FOR IMMEDIATE SERVICE: 1-800-AKA-HIFI

We ship worldwide, including APO & FPO.

MA residents add 5% sales tax.

*Plus freight (\$7-\$25). Delivery time usually 2-7 days.

Rise- and fall-times were 100 and 200 nS in normal mode, and 60 and 100 nS in bypass mode. These circuits are fast!

Table I—Gain and IHF sensitivity for IHF load, normal mode. In bypass mode, sensitivity for main outputs will be 10 times less, and input levels will be 10 times more for reference output of 0.5 V. Gain figures for instrument load or loads more than 100 kilohms are 0.1 dB greater for main outputs and 1.0 dB greater for tape outputs.

	Gain, dB		IHF Sensitivity	
	LEFT	RIGHT	LEFT	RIGHT
MC to Main Out	87.6	87.5	20.8 μ V	21.0 μ V
MM to Main Out	61.1	61.1	445 μ V	440 μ V
MC to Tape Out	66.6	66.5	235 μ V	237 μ V
MM to Tape Out	40.0	40.1	5.0 mV	4.95 mV
AUX to Main Out	19.7	19.7	52 mV	52 mV
AUX to Tape Out	-1.2	-1.2	575 mV	575 mV

Table IIA—Phono-section noise, referred to input. With zero-ohm input impedance, noise measured in wideband mode was basically subsonic, decreasing as frequency increased (a $\frac{1}{f}$ characteristic).

Bandwidth	Source Impedance, Ohms	Referred Input Noise	
		LEFT	RIGHT
MM MODE			
Wideband	0	1.1 μ V	0.6 μ V
20 Hz to 20 kHz	0	0.75 μ V	0.55 μ V
400 Hz to 20 kHz	0	0.28 μ V	0.275 μ V
A-Weighted	0	0.29 μ V	0.29 μ V
Wideband	IHF MM	1.2 μ V	1.0 μ V
20 Hz to 20 kHz	IHF MM	1.1 μ V	0.95 μ V
400 Hz to 20 kHz	IHF MM	0.7 μ V	0.69 μ V
A-Weighted	IHF MM	0.7 μ V	0.65 μ V
MC MODE			
Wideband	0	100 nV	200 nV
20 Hz to 20 kHz	0	95 nV	130 nV
400 Hz to 20 kHz	0	46 nV	55 nV
A-Weighted	0	48 nV	60 nV
Wideband	100	170 nV	200 nV
20 Hz to 20 kHz	100	130 nV	150 nV
400 Hz to 20 kHz	100	64 nV	68 nV
A-Weighted	100	67 nV	72 nV

Table IIB—Line-amp section noise, referred to input, with $\times 10$ (normal) gain setting and 1-kilohm input termination, for fully clockwise volume-control settings and worst-case settings (usually about 6 dB below full clockwise).

Bandwidth	Referred Input Noise, μ V			
	Clockwise		Worst-Case	
	LEFT	RIGHT	LEFT	RIGHT
Wideband	4.0	4.4	15.5	20.0
20 Hz to 20 kHz	2.0	2.0	6.3	5.1
400 Hz to 20 kHz	1.5	1.5	5.3	4.8
A-Weighted	1.4	1.45	5.1	4.7

channel MM phono overload versus frequency, for instrument and IHF loading, is shown in Table IV; the right channel was very similar in behavior. Moving-coil input voltages for phono output overload are roughly 20 times lower than shown in the Table. It is very unlikely that any moving-magnet cartridge out there is going to overload the Athena's phono circuitry. However, if a high-output moving-coil pickup with nominal output of 1 to 2 mV is fed through the MC pre-preamp, there could be trouble if the peak levels on the record reach 14 dB above the nominal 3.54-cm/s output. I would recommend that such pickups be used in the moving-magnet mode.

Phono crosstalk versus frequency was found to be greater than 80 dB up to about 500 Hz, decreasing to about 66 dB at 3 kHz and to about 50 dB at 20 kHz. These results were about the same in both directions (R to L and L to R) and for source impedances up to 1 kilohm. With the IHF MM simulated source, the figures were only about 3 dB worse in the region of 10 kHz, which is outstanding. Crosstalk in MC mode was about the same as for MM. All crosstalk for the phono circuitry was in phase.

In assessing the performance of the line-amp section, one of the first things I checked was input overload levels for the high-level inputs with the volume wide open and in the bypass mode. For a signal input of 3 V rms, which was clipping the $\times 10$ amp, the output of the unity-gain amp (which is the preamp output in this mode) was still clean, with no distortion artifacts caused by clipping in the following circuit. These are unlikely conditions of use. If the source delivered more than 2 V rms, the volume control would probably not be turned up most of the way. Exceptions would be to make up for an excessively low speaker sensitivity or for a power amp with unusually low gain or with its input level control turned down too far.

In the normal output amp mode, using the $\times 10$ amp, the Athena could put out 20 V rms into an IHF load with less than 0.01% THD + N from 20 Hz to 20 kHz. Impressive! Further, with a 600-ohm load, THD + N was less than 0.01% from 20 Hz to 20 kHz at 13 V rms output for the right channel and 11.5 V for the left.

The detented volume control used in the Athena was checked for tracking error and step consistency for each of its 30 positions. Channel-to-channel tracking was within 0.7 dB down to -50 dB and within 1.6 dB to -70 dB. The steps are finer (less than 1 dB) near full clockwise and get larger as the control is turned down. There were a few glitches in the control's attenuation curve. Attenuation per step decreased from 3.9 dB at the 20th position from full clockwise to 1.7 dB at the 21st. Also, the rate of attenuation dropped from 5.3 dB at the 25th position to 2.2 dB at the 26th. The audible consequence of this would simply be a different volume increment through these positions compared to the neighboring positions.

Output amplifier bandwidth and speed were next looked at. With volume fully clockwise and normal mode engaged (i.e., using the $\times 10$ amp), rise- and fall-times were 100 nS with instrument load (90 kilohms in parallel with 200 pF) and 200 nS with the IHF load (10 kilohms in parallel with 1,000 pF) at an output level of 10 V peak to peak. Switching into bypass mode gave rise- and fall-times of 60 and 100 nS,



—Leonard Feather, Celebrated Jazz Critic for the L.A. Times, Washington Post News Service and Author of many books including "The Jazz Years—Earwitness to an Era."

"BBE made my audio system sound better than I ever dreamed possible!"

"Listening to music has been my vocation and avocation for a lifetime. I've spent countless hours sitting in front of bandstands while some of the world's greatest musicians mesmerized me with their artistry.

"Listening to recorded music, of course, falls short of the delights of listening to a live performance. I was therefore skeptical when told that BBE could make a dramatic improvement to virtually all audio systems and I had to hear for myself.

"I was amazed at how much better the BBE 1002 made my music system sound! There was a presence, a *being there* sense of excitement. The rich textures of the instrumental sounds, the subtle nuances and details in the music come through with clarity and authenticity.

"BBE is clearly one of the most important advances in the electronic reproduction of music to come along in my lifetime. Bravo, BBE! Encore!"

The Great Professional Music Magazines Love BBE

"The difference in processed audio and non-processed audio is like the difference between high-fidelity speakers with and without pillows placed in front of them."

—Radio World

"There was no doubt the BBE processor added more spatial quality, more transients and more clean highs. This is the first black box that actually helped make my music sound the way that I *knew* it should. The effect is shattering!" —*Music Technology*

BBE Really Fits In

Measuring 16½" x 9" x 1¾", BBE fits perfectly into your audio rack. Then just plug it into your wall socket and standard tape loop.

Full Money-Back Guarantee

If you're not completely satisfied with the BBE 1002, return it within 30 days. We'll refund your money. No questions asked.

Full Warranty

All BBE products are backed by a full year's warranty on all parts and labor—and by our reputation for innovation and leadership in the audio and electronics industries.

Easy to Order

It's as easy as one, two, or three.

1. Call us. Toll free. 1-800-233-8346. In California, 1-800-558-3963.
2. Or, complete and send us the coupon at right.
3. Or, if you're in New York or New Jersey, pick up your BBE 1002 in any **MACY's** audio department.

BBETM Sound Inc.

5500 Bolsa Ave., Suite 245, Huntington Beach, CA 92649, (714) 897-6766. (800) 233-8346. In California, (800) 558-3963. In Canada, contact Daymen Audio, 3241 Kennedy Road, #22, Scarborough, Ontario M1V2J9 or call (416) 298-9644. BBE is a trademark of BBE Sound, Inc.

Send me _____ BBE 1002 unit(s) at \$189 each. (U.S. currency only. California residents add applicable tax. Price includes UPS ground shipping charges. For UPS overnight shipping, add \$18. For UPS 2nd day shipping, add \$8.50. Canadian residents: please write or call for additional information.)

Enclosed is a check for \$ _____
Or please charge to my:
 Visa MasterCard
 American Express

Card #

Exp. Date

Signature

Name (print)

Address

City/State/Zip

Area Code/Phone No. (To facilitate shipping)

5500 Bolsa Ave., Suite 245, Huntington Beach, CA 92649, (714) 897-6766. (800) 233-8346. In California, (800) 558-3963.

A-8

Considering this preamp's price, the Athena provides good performance and value for the money.

Table III—Signal-to-noise ratio.

Input and Gain Mode	Source Impedance, Ohms	IHF S/N, -dB	
		LEFT	RIGHT
MM to Main Out, × 10 Gain	IHF MM	76.8	77.2
MC to Main Out, × 10 Gain	100	77.0	76.5
AUX Input, × 10 Gain	1k	86.5	86.5
AUX Input, × 1 Gain	1k	109.0	109.0

Table IV—Moving-magnet phono overload vs. frequency, left channel.

Frequency, Hz	IHF Load		Instrument Load	
	Input, mV	Output, V	Input, mV	Output, V
20	13.0	18.0	13.0	19.8
50	26.8	18.0	26.8	19.8
100	41.0	18.0	41.0	19.8
300	94.0	18.0	94.0	19.8
700	150.0	18.0	150.0	19.8
1k	172.0	18.0	172.0	19.8
3k	290.0	18.0	290.0	19.8
5k	445.0	18.5	445.0	20.5
7k	615.0	19.0	615.0	21.0
10k	870.0	19.0	870.0	21.0
15k	1240.0	18.5	1240.0	20.5
20k	1600.0	18.3	1600.0	20.2

respectively, for instrument and IHF loads. These circuits are fast! Turning the volume control down about 6 dB slows things down to about 0.5 μ S with either load. Worst-case speed degradation was with the balance control partially off to one side: rise- and fall-times lengthened to about 1 μ S, still equivalent to a bandwidth of about 350 kHz. Scope photos of square waves through the line output amplifiers are shown in Figs. 8 and 9. Figure 8 is for 200-kHz square waves, with the volume control set fully clockwise. Shown in the top trace is the output of the × 10 amp at 10 V peak to peak. The faster rise- and fall-times on the traces are for the instrument load. On the bottom trace, the bypass mode is engaged. Output is 1 V peak to peak. Figure 9 is for 20-Hz square waves. In the top trace, the output is shown for the × 10 amp; the bottom trace is for the output of the unity-gain amp. Note the greater low-frequency tilt in the × 10 amp. In both of these traces, instrument and IHF loadings are shown, although it's hard to see any difference.

Crosstalk of the line section was measured with volume full up, balance at center, × 10 mode used, and a 1-kilohm resistor terminating the input of the undriven channel. Crosstalk between channels was greater than 80 dB up to about 1 kHz, decreasing to about 62 dB at 10 kHz and 57 dB at 20 kHz. With the balance control set to attenuate the undriven channel by 2 or 3 dB, the crosstalk increased some 10 dB at 10 kHz. The results were symmetrical in both directions, and crosstalk was in phase.

Line-section IHF sensitivities, gains, IHF signal-to-noise ratios, and noise referred to input for various conditions appear in Tables I, II, and III.

I noticed with the cover off and the unit fully warmed up that the output devices in some of the circuit blocks, notably the phono preamp, were running a bit too hot, in my opinion, and should have some heat-sink radiators attached.

Use and Listening Tests

Equipment used to evaluate the Sumo Athena included an Oracle turntable fitted with a Well Tempered Arm and a Koetsu Black Goldline cartridge, a California Audio Labs Tempest CD player, a Nakamichi 250 cassette deck, Cook-King reference and Motif MC8 preamps, and Classic Audio CA260 and Motif MS100 power amplifiers driving Siefert Research Magnum III speakers.

When listening to CDs, tuner, and tapes through high-level inputs, I preferred the sound with the Athena's bypass mode engaged. By contrast, the normal mode wasn't quite as open and was a bit less defined—but I'm talking about fairly subtle differences here. When comparing the sound of the line section (which in any preamp includes not only the sound of the output amplifier circuitry per se but also the sound of the internal wiring, switches, and level controls) to a passive switched set of attenuators that I frequently use, I felt the Athena sounded noticeably more electronic, less open, and with less feeling of the instruments actually being in the room.

When playing records, I used the MM mode for the majority of my listening. I found overall reproduction to be pretty good, with reasonable openness and detail although with a sense of being a bit dry and spatially flat. Signal-to-noise ratio was okay for me in this mode, although, with the arm off the record, I could hear hiss from the speakers at playing level when I got closer to the speakers and listened for noise. Most of my listening was with the Classic Audio CA260 tube power amp. The overall sound was a little forward and aggressive but not edgy or irritating. When I used the Motif MS100, the sound was more laid back and smoother. I didn't have a chance to pair the Athena with a Sumo Polaris power amp, which is an obvious combination, but my sonic memory of the Polaris' sound leads me to believe that the combination would be sort of mid-way between.

The question of which might sound better—MM phono with × 10 output amp (needed to get enough playing gain) or MC phono with unity-gain output amp mode—was answered in favor of the former, with MC loading of 100 ohms as installed at the factory. When I attempted to unload the MC input with a higher load, like 47 kilohms, I got excessive woofer-cone excursion in the range from 1 to 10 Hz and not-so-good sound. I tried to simulate this condition in the lab, and indeed the Athena acted as though some high-frequency oscillation was occurring (presumably in the MC preamp) when the MC load resistance was 47 kilohms. The subsonic frequency response looked okay, i.e., not peaked like I got in the listening setup. When the 100-ohm loading resistors were reinstalled, the unit acted normally. This phenomenon may be a peculiarity of my sample.

I did listen quite a bit to the Athena and got good musical satisfaction from it. When one considers its price, it gives good performance and value for the money.

Bascom H. King

Threshold Salutes its...

#1 NYC Dealer Stereo Exchange THE MEGA-STORE



FET 10 Preamp



SA 1

THRESHOLD...the legend continues...

the FET 10 Preamp ("Class B"-Stereophile recommended component list) and the new SA 1 optically biased power amp...in a class by themselves. *

We also carry Forte Components...

lower priced audiophile electronics designed Nelson Pass, of Threshold fame.

\$1,600-\$14,000

*Stereophile Vol. 12 No. 4, April 1989

STEREO EXCHANGE

Authorized Dealerships:

Apogee, Arcam, Ariston, ASC Tube Traps, Audioquest, Boston Acoustics, B&K (#1 N.Y.C. Dealer), B&W, California Audio Labs, Cambridge (#1 E. Coast Dealer), Carver, Celestion SL, Chicago Stands, Classe, conrad-johnson, Convergent Audio Technology, Counterpoint (#1 U.S. Dealer), CWD, Duntech, Eminent Technology, Grado, Infinity, Janis, Kimber Kable, Klyne, Luxman, Magnum Dynalab (#1 E. Coast Dealer), Mod Squad (#1 E. Coast Dealer), MIT, NAD, Nitty-Gritty, Precise, ProAc, PS Audio, Rogers, Sony ES, Sonographe, Spica (#1 E. Coast Dealer), Stax, Straightwire, Sumiko, Sumo, Target, Threshold—Forte (#1 N.Y.C. Dealer), Tice (#1 U.S. Dealer), Van Den Hul (#1 U.S. Dealer), VPI (#1 U.S. Dealer), Velodyne (#1 N.Y.C. Dealer), Versa Dynamics (#1 N.Y.C. Dealer), Vendetta, VTL (#1 E. Coast Dealer), Wadia, Well Tempered (#1 E. Coast Dealer), etc

New Location: 627 Broadway, The NoHo Building, NYC 10012

Also: 687-A Broadway, New York, NY 10012

212 505•1111 800 833•0071 outside NYC *most major credit cards*

MARK LEVINSON NO. 26 DUAL MONAURAL PREAMP

Company Address: c/o Madrigal Audio Laboratories, P.O. Box 781, Middletown, Conn. 06457.
For literature, circle No. 93

Let me begin by confessing a few secrets about my reviews for *Audio*. I don't review for a living, I do it for fun. As a result, I try to pick for review the kind of equipment that helps me find out how good high-end gear can sound. I could claim that I do this unselfishly and out of a noble desire to inform my fellow man. The fact is, I do it for my own pleasure. I review equipment simply to find out how close audio reproduction can come to live music, and to determine what would belong in an ideal reference system—if I could only afford it.

I have enjoyed every step in this search, but it is rare for any single piece of high-end equipment to stand out from the others, unless it performs a new function or introduces a new technology. Most high-end audio equipment has gotten so good that it is rare to find a piece of gear that is so much better than its competition that it is really exciting. This is particularly true of electronics such as preamplifiers and amplifiers. Almost all such high-end components are now at least very good, and many perform superbly in systems which are well set up.

With that said, let me go on to say that the Mark Levinson No. 26 dual monaural preamp still stands out from its competitors. I cannot promise that this is the world's best preamplifier. I'm still waiting to hear many contenders, and, given the rapid change in high-end electronics, it is impossible to predict how long any model can remain at the top. Still, I can say that the No. 26 is clearly the best preamplifier that I have ever listened to.



In fact, this Mark Levinson preamp has redefined my understanding of the state of the art in terms of both recording and home playback, and it has done so in a wide range of high-end systems and with a wide range of recorded music. It is simultaneously the most transparent and revealing preamp I have heard and the most musically convincing—at least in its ability to re-create how music sounds at the distances from which it is actually recorded. A few competing preamplifiers may produce more of a concert hall sound, but only at the price of changing the recording's original sonic perspective and some degree of euphonic coloration.

Before I heap too much praise on the No. 26's sound, I should tell you a little about its features, technology, and specifications.

To begin with, this preamp is available in a mix of configurations. You can choose a unit with a phono board for either moving-coil input (58- or 64-dB gain) or moving-magnet/moving-coil input (38- or 44-dB gain) plus a power supply; this combination will cost you about \$4,995. For about \$4,750, you can choose a unit without a phono board but with a balanced-line input and a power supply. You can keep the balanced-line input, add a No. 25 external phono preamp, and use one power supply for both the

Photograph: David Hamsley

PARTICIPATING LOCATIONS

ARIZONA
HI FI SALES, MESA

ARKANSAS
AUDIO WORLD, LITTLE ROCK NO LITTLE ROCK
CALIFORNIA
BOOTS CAMERA, FRESNO— CREATIVE STEREO, SANTA BARBARA, SANTA MARIA, THOUSAND OAKS, VENTURA—
DAVID RUTLEGE AUDIO, PALM SPRINGS **DB AUDIO**, BERKELEY—**DOW STEREO, EL CAJON, ESCONDIDO**, CHULA VISTA, VISTA, SAN DIEGO—**EBER ELECTRONICS**, MENLO PARK, SAN FRANCISCO **EUREKA AUDIO**, EUREKA **THE GOLDEN EAR, CHICO**—**MARCONI RADIO**, GLENDALE—**PARIS AUDIO, WEST LOS ANGELES**, WOODLAND HILLS—**ROGERSOUND LABS, CANOGA PARK**, EL TORO, PASADENA, SANTA MONICA, TORRANCE, WESTMINSTER, VAN NUYS, SHERMAN OAKS **CAMERA & STEREO, SHERMAN OAKS**—**SOUND GOODS, CAMPBELL**, MOUNTAIN VIEW **TURNTABLES UNLIMITED**, SACRAMENTO—**WATER STREET STEREO, SANTA CRUZ**—**WILSHIRE TV, LOS ANGELES**

COLORADO
LISTEN UP, BOULDER, DENVER **SOUND SHOP, COLORADO SPRINGS**

CONNECTICUT
AUDIO ETC., NEW HAVEN

DELAWARE
HI FI HOUSE OF DELAWARE, WILMINGTON

FLORIDA
THE CONSUMER CENTER, TAMPA—**ELECTRONIC CREATIONS, ATLANTON SPRINGS**—**HOYT HI FI, JACKSONVILLE**—**SALON OF MUSIC, WEST PALM BEACH**—**SOUND ADVICE, ATLANTON SPRINGS**, BOCA RATON, CLEARWATER, CORAL GABLES, FT LAUDERDALE, HIALEAH, HOLLYWOOD, MIAMI, NO MIAMI BEACH, ORLANDO, SARASOTA, ST PETERSBURG, SUNRISE, TAMPA, WEST PALM BEACH—**TVC, TEQUESTA**
TV & MUSIC CENTER, ST PETERSBURG

GEORGIA
AUDIO WAREHOUSE, SAVANNAH—**HI FI BUYS, ATHENS**, ATLANTA, DULUTH, KENNESAW, MORROW, NORCROSS, RIVERDALE, TUCKER

ILLINOIS
GOOD VIBES, CHAMPAIGN—**MILLS RECORDING, CHICAGO**—**STEREO SYSTEMS, AURORA, JOLIET**, NAPERVILLE—**UNITED AUDIO CENTERS, AURORA**, CHICAGO, DEERFIELD, NILES, SCHAMBERG, WERNON HILLS

INDIANA
GOOD VIBES, LAFAYETTE—**HJS SOUND, NEW HAVEN**

KANSAS
RED BARON, WICHITA

LOUISIANA
ALTERMAN AUDIO, METAIRIE—**NEW ORLEANS**

MAINE
NEW ENGLAND MUSIC, SCARBOROUGH

MARYLAND
AUDIO BUYS, GAITHERSBURG—**THE GRAMOPHONE LTD.**, ELLICOTT CITY, LUTHERVILLE

MASSACHUSETTS
MUSIC BOX, WELLESLEY—**Q AUDIO, CAMBRIDGE** **SOUND & MUSIC, NORTHAMPTON**

MICHIGAN
AUDIOVISION, WEST BLOOMFIELD—**POINTE ELECTRONICS, GROSSE POINTE WOODS**—**THE STEREO SHOPPE, ANN ARBOR, EAST LANSING, LANSING**—**SAGINAW TRAVELER, TRAVELER CITY**

MINNESOTA
AUDIO KING, BROOKLYN CENTER—**BURNSVILLE**—**EDINA**, MANKATO, MINNEAPOLIS, MINNETONKA, ROCHESTER, ROSEVILLE, ST CLOUD, ST PAUL

MISSISSIPPI
McLELLAND TV, HATTISBURG

MISSOURI
SOUND ENTERPRISES, KANSAS CITY—**STEREO ONE, CAPE GIRARDEAU**

NEBRASKA
STEREO WEST, LINCOLN—**OMAHA**

NEW JERSEY
HARVEY ELECTRONICS, PARAMUS—**MONMOUTH STEREO**, SHREWSBURY—**RECORD SHOP, CHERRY HILL**—**ROUTE ELECTRONICS, PARAMUS, TOTOWA**

NEW MEXICO
HUDSON'S AUDIO CENTER, ALBUQUERQUE

NEW YORK
GRAND CENTRAL RADIO, MANHATTAN—**HARVEY ELECTRONICS, MANHATTAN**—**WHITE PLAINS**—**LISTENING ROOM, SCARSDALE**—**LYRIC HI FI, MANHATTAN**—**WHITE PLAINS**—**RABSONS AUDIO/VIDEO, MANHATTAN**—**GARDEN CITY**—**SQUARE DEAL, PATCHOGUE**—**STEREO CHAMBER, ORCHARD PARK**—**THE NEW STEREO EXCHANGE, MANHATTAN**

NORTH CAROLINA
AUDIO BUYS, RALEIGH—**SOUNDHAUS, DURHAM**

OHIO
ALAMO ELECTRONICS, CINCINNATI—**B&B, EUCLID**, MIDDLEBURG HEIGHTS—**GOLDEN GRAMOPHONE, AKRON**—**JAMIESON'S, TOLEDO**—**STEREO LAB, CINCINNATI**—**COLUMBUS**

OREGON
BRADFORD'S HIGH FIDELITY, EUGENE—**FRED'S SOUND OF MUSIC, GRESHAM**, PORTLAND

PENNSYLVANIA
AUDIO INSIGHT, WEXFORD—**STEREO BARN, EPHRAATA**, LANCASTER

RHODE ISLAND
STEREO DISCOUNT CENTER, PROVIDENCE

SOUTH CAROLINA
READ BROTHERS, CHARLESTON—**STEREO VIDEO, GREENVILLE**

SOUTH DAKOTA
AUDIO KING, SIOUX FALLS

TENNESSEE
HI FI BUYS, MURFREESBORO—**NASHVILLE**

TEXAS
BJORN'S AUDIO/VIDEO, SAN ANTONIO—**DIGITAL CENTER, DALLAS**—**GROOVE AUDIO VIDEO, HOUSTON**—**HAROLD'S ELECTRONICS, MIDLAND**—**ODESSA**—**METEX INTERNATIONAL, LAREDO**—**McALLEN**—**OMNI SOUND, DALLAS**—**SOUTHWEST RECORD & TAPE, HOUSTON**—**STEREO VIDEO CENTER, TYLER**

UTAH
STANDARD AUDIO, SALT LAKE CITY

VIRGINIA
AUDIO ART, RICHMOND—**AUDIO BUYS, BAILEYS CROSSROADS, MANASSAS**—**THE AUDIO CENTER, ROANOKE**—**DIGITAL SOUND, VIRGINIA BEACH**

WASHINGTON
ADVANCED AUDIO, TACOMA—**DEFINITIVE AUDIO, SEATTLE**—**HUPPINS HI FI, SPOKANE**—**MAGNOLIA HI FI & VIDEO, BELLEVUE**—**LYNWOOD**—**SEATTLE**—**TACOMA**

WISCONSIN
HI FI HEAVEN, GREEN BAY—**SOUND STAGE, MILWAUKEE**

Announcing!

TECHNOLOGY #5 UPDATE #5

ANYTHING NEW IN CD? YOU BET THERE IS!

Audio Magazine and Sony Combine to Reveal
the Latest CD Research and Development

There are significant new CD player technologies that make
CD performance better than ever.

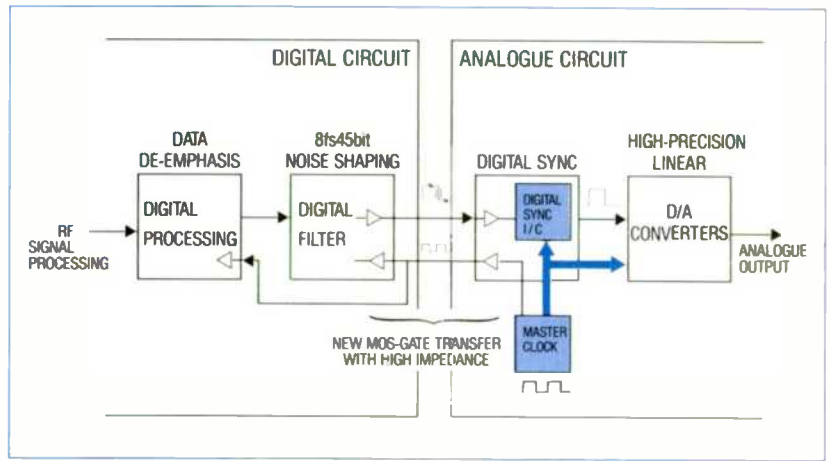

Block Diagram of Digital Sync System

Right now, new Audio Information Magazine (AIM) displays describing these developments are at select audio specialty dealers (see list on left). Free literature explaining these developments, including an explanation of the diagram (above), is yours for the asking.

It all adds up to what you should know
before you invest in your next player.

You owe it to yourself to see this joint effort of
Audio Magazine and Sony ES.

UPDATE: CD TECHNOLOGY

- ▶ Getting *all* the music from your CDs with new Noise-Shaping circuitry
- ▶ Eliminating digital jitter with new ICs
- ▶ How advanced control circuits track those hard-to-read discs

FREE!

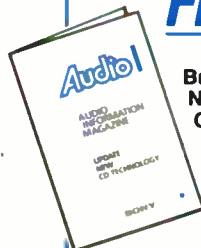

Brochure on
New
CD Technology
is yours free!

Audio

ES SONY
THE LEADER IN DIGITAL AUDIO

©1989 Sony Corporation of America
Sony and The Leader in Digital Audio are trademarks of Sony

High-end amps and preamps are now so good that it's rare to find one which stands out excitingly. But the No. 26 preamp does.

main and phono preamps; this will cost about \$6,350. You can buy separate power supplies for the main and phono preamps; if you also buy the balanced-line input card, you'll pay about \$6,575.

If this sounds a bit complex, let me hasten to say that I found the "stripped

down" No. 26 with a moving-coil phono board and a single power supply to offer a reference-quality package with all the features I really need but a minimum of extra boxes and interconnects. I have to admit, however, that the balanced-line input can make an audible improvement with those few CD play-



Natural ingredients. The components of a great audio product are like the ingredients of a great recipe. With the help of skilled hands they can become a work of art. Your nearest Accuphase dealer invites you to a feast for your ears.

DP-80L CD Transport
DC-81L Discrete 20-Bit Digital Processor

Accuphase

Exclusive U.S. Distributor **MADRIGAL AUDIO LABORATORIES**
P.O. Box 781, Middletown, CT 06457 ITT TLX 4942158



ers and tape decks that have balanced outputs. Further, a separate power supply for the phono unit does slightly improve the dynamics and S/N ratio with a moving-coil cartridge. You will have to make your selection based on your own needs.

In any case, the main preamp unit is nicely styled in black and muted silver, and has a distinctive enough sculptured front panel to rise above the standard black box, providing the kind of "feel" that its high price tag deserves. The front-panel features are particularly well chosen. The "Input Selector" has settings for "CD," "Tuner," "AUX 1," "Phono/AUX 2," "Tape 1," and "Tape 2." There are enough tape-switching features to allow you to easily use both analog and R-DAT recorders, plus recording switches for "Defeat," "Input," and "Monitor" and for selection between monitoring "Tape 1" and "Tape 2." That's an almost ideal set of switches for A/B reviewing as well. There is an absolute-phase (polarity) switch, a stereo/mono switch, a Penny and Giles "Output Level" pot (custom-made, according to Madrigal, to track within 0.5 dB and to be good for at least 1 million rotations), and two switchable balance controls.

The interior features are equally impressive. For the moving-coil buff, there is an excellent set of phono loading options. The input switch uses high-quality relays in the signal path to preserve signal purity, and the circuit is designed so that only two switching contacts exist between the source input and the line output. Special attention is given to thermal compensation and stability. This preamp takes only about an hour to warm up, and its sound character does not change with time; drawing relatively little power, it can be left on permanently to further improve the consistency of its sound character.

Line-stage gain can be varied for each channel, which lets you set the output level for ideal compatibility with a given amp. There is no risk of having

"The sound of silence" is what really describes the No. 26 preamp. This unit is almost totally neutral.

so much gain that your volume control has to stay at six o'clock or of losing apparent musical energy because the preamp does not drive the amplifier at the proper level. This feature can be of great benefit in a reference-quality preamp because many preamplifiers do not mate ideally with the gain of other manufacturers' amps. Further, the No. 26's output impedance is only 40 ohms, ensuring minimum line noise and preamp-to-amp interaction.

Self-shorting Camac input jacks are used to avoid circuit bangs and cable problems. Camac jacks are also used for the unbalanced outputs, and XLR jacks for balanced-line connections. The XLR jacks are fed by circuitry designed to maximize common-mode rejection. I must say that I have never been able to detect any real reason for using Camac jacks instead of high-quality RCA connectors, but this seems to be a Mark Levinson "thing," and Camac jacks do help ensure that interconnects stay firmly in place. The problem is that the use of Camac jacks also forces the use of specially terminated interconnects, and these are anything but cheap.

Unlike many other high-end preamplifiers, the No. 26 is light and comparatively small. This may sound like a minor virtue, but if you really use the inputs and features of the preamp, it is very important indeed. Further, the power supply is small enough to leave some room in your cabinet or shelves and can be kept a good distance away from other signal sources and electronics.

I have rarely seen a unit which had as many technical specifications as the No. 26. Yet all the specifications have something in common: The figures are outstanding. Every distortion spec listed—all 23 of them!—is less than 0.006%, and the overload and clipping specifications should satisfy any audiophile. The S/N ratios and crosstalk specs are all excellent, and the RIAA accuracy is said to be ± 0.3 dB. As for the circuit details, without reproducing the manufacturer's brochure in depth, there are several points of interest. The Mark Levinson No. 26 uses the same flat-ribbon conductors of silver-plated, high-purity, OFC copper used in Madrigal HPC interconnect cable. The circuit board is designed to

place components in what the manufacturer feels are the best locations rather than in neat rows.

Like virtually all modern high-end preamps, this unit operates in the pure Class-A mode and has carefully chosen capacitors and resistors. Unlike some recent high-end preamps, how-

ever, the No. 26 places more emphasis on the power supply than on circuit features such as direct coupling (eliminating all capacitors from the signal path) or on trying to eliminate all feedback. Two toroidal transformers with Faraday shielding provide a separate power source for each of the two chan-

THE TEN BEST BUYS IN AUDIO:

reprinted from *HIFI Heretic*, Number Ten

A listing of audio components that offer both musical sound and excellent value.

B&K ST-140 Power Amplifier: \$498



In a field littered with supposed giant-killers (i.e., the field of "inexpensive" basic amps with perfectionist aspirations), this solid-state amp is the true standout. The ST-140's sound is musical and well-controlled, with good detail and a degree of smoothness that has prompted many to describe the amp as being "tube-like". Good build quality, too — and we've never heard of

anyone having reliability problems with this one. Sure, more money, spent wisely, *can* buy more pitch certainty, stronger bass, an "airer" top end, a little less artificial texture, etc. But then, more money can (and very often does) buy a lot of crap, too — and crap that blows up, to boot. (Exploding crap — now *there's* a lovely image.) For \$500, the B&K ST-140 seems almost unbeatable.

The other nine:

Rega RB300 Tonearm: \$300
 Arcam Alpha Plus Integrated Amplifier: \$300
 Sony Walkman Pro Portable Cassette Recorder: \$400
 Spica TC-50 Loudspeaker: \$550
 Thiel SC1.2 Loudspeaker: \$1090
 Audible Illusions Modulus 2 Stereo Preamplifier: \$850
 ProAc Studio 1 Loudspeaker: \$1150
 Linn Sondek LP12 Turntable: \$1165
 Superphon Revelation II/DM 220 Preamplifier & Power Amplifier: \$699/\$899

Features:

- Class A pre-driver circuitry driving class AB Mosfet output stage.
- Toroidal transformers for highly efficient power supply operation.
- Differential input stage with an active current source load, assuring DC stability and extremely wide band width linearity.
- 5-45 K Hz Frequency Response
- 95 dB Signal to Noise Ratio, A Weighted
- 105 Power Rating (1K Hz at less than .09THD, 8 ohms)
- 14 Amperage (peak to peak)
- 14 dB Dynamic Headroom



B&K COMPONENTS, LTD.

1971 Abbott Road
 Lackawanna, N. Y. 14218
 FAX: (716) 822-8306
 NY: (716) 822-8488
1-800-543-5252

A slight thinning of the lower midrange and a shift in the soundstage were the worst effects I found; even this was reaching for flaws.

nels. The PLS-226 contains three power supplies: One for each channel and a third to feed the relay-control circuit. Spikes, r.f., and surges are eliminated at the a.c. inputs. Four Class-A regulators are inside the preamp chassis—one for each side of each rail. The goal: to have all this so-

phistication: Eliminate any trace of noise in the circuitry.

Having made my obligatory bows toward features, technology, and specifications, let me return to the sound—or lack of it. One of the most striking things about the No. 26 is its combination of transparency and silence. No

unit I have ever reviewed delivered the lack of perceptible noise with low-output moving-coil cartridges that this preamp achieves. Nor have I ever auditioned a preamp that provided so much musically natural information in low, medium, and loud passages and that was so totally silent and coloration-free in its high-level line stages.

In fact, it is the sound of silence that really describes this preamp. The No. 26 is almost totally neutral when inserted into the signal path. No preamp I have yet heard has been equally neutral—particularly one whose signal path goes through so many gain and control features. No preamp I have heard has provided similar gain in the phono or high-level stages without adding coloration. No preamp I know of provides so much detail and so natural a set of musical dynamics, delivers so much information in the upper octaves, and stays as musically sweet and natural. No preamp I have yet heard has provided as much detail in the bass, as neutral and musical a midrange, and so much information at the frequency extremes.

As nearly as I can determine, the No. 26 introduces less audible change in the sound than many straight-wire bypasses using relatively high-quality interconnects. In fact, this preamp was more neutral in its high-level stages than a very good passive preamplifier.

This makes it difficult to talk about the character of the bass, midrange, or treble or to describe the impact on depth, imaging, or the soundstage. There are slight effects. Nothing inserted into a signal path is ever truly neutral, but the worst effect I found was a very slight thinning of the lower midrange and a slight shift in the soundstage which widened it at the expense of depth. Even then, I felt I was reaching to find flaws. These problems could just as easily have resulted from the fact that nothing is neutral.

All in all, after three months of extensive listening, the only warning I can give you about the No. 26 is that it can become awfully addictive. It has been a real pleasure to review. This preamp is one of those products that brings the excitement back to critical listening. It belongs on the short list for selecting the finest of reference systems.

Anthony H. Cordesman

Where to buy Polk Speakers

AUTHORIZED HOME DEALERS

CANADA Cal. Evlaur on Technology, Toronto for nearest dealer 1-416-847-8888
AK Anchorage: Magnum Electronics • Fairbanks: Ken's

AL Birmingham: Audition • Dothan: International Audio • Huntsville: Sound D's Distributors • Mobile: Hi-Fi Zone • Montgomery: The Record Shop • Tuscaloosa: ncaid Stereo & TV
AR Fayetteville/Ft. Smith: Stereo One • Little Rock: Leisure Electronics • Searcy: Solmart
AZ Flagstaff: Sound Pro • Phoenix: Mesa: Hi-Fi Sales • Tucson: Audio Emporium • Yuma: Ware House Stereo

CA Bakersfield: Casa Moore • Campbell: Sound Goods • Canoga Park: Shelley's • Carpinteria: Creal ve Stereo • Chico: Sounds By Dave • Corona Del Mar: Pacific Coast Audio Video • Davis: World Electron cs • Eureka: Eureka Audio Video • Lancaster: California Soundworks • Longbeach: Audio Concepts • Mountain View: Sound Goods • Napa: Futur sion • Orange: Absolute Audio • Penningrove: California Stereo • Redondo: Systems Design • Riverside: Speakercraft • Sacramento: Good Guys • San Diego: Sound Company • San Francisco & Suburbs: Good Guys Stereo Store • San Gabriel: Audio Concepts • San Jose: Good Guys • San Luis Obispo: Audio Ecstasy • Santa Barbara: Creal ve Stereo • Santa Cruz: Sound Wave • Santa Maria: Creative Stereo • Santa Monica: Shelley's Stereo • Sherman Oaks: Syn-Ters Design • Stockton: Gussins • Thousand Oaks: Creal ve Stereo • Ukiah: Music Hut • Upland: Audio Haven • Ventura: Creative Stereo • Victorville: Incredibly Sounds • Westminster: J'oelect Stereo

CO Boulder: Soundtrac • Colorado Springs: Sunshine Audio • Denver & Suburbs: Soundtrac • Grand Junction: Sound Company • Minturn: Custom Audio Video • Pueblo: Sunshine Audio
CT Avon: Hi-Fi Stereo House • Danbury: Carlson's • Fairfield: Auto & Stereo • Hartford: Carlson's • Hartford: Al Franchino • New Haven: Audio Ent. • Newington: Hi-Fi Stereo House • New London: Robert's • Norwalk: Audiotronics • Waterbury: Zinn Music

DE Wilmington: Bryn Mawr Stereo
FL Daytona Beach: Stereotypes • Ft. Myers: Sterer Garage • Ft. Lauderdale: Sound Beach • Ft. Pierce: Sound Shack • Ft. Walton Beach: Audio International • Gainesville: Electronics World • Jacksonville: Audio Tech • Key West: Audio International • Lakeland: Sound Factory • Merritt Island: Southern Audio • Miami: Electronic • Eau de ment Co. • Sound Advice • Naples: Sterer Garage • Panama City: Walford Sound • Pensacola: Flier H • Ft. Sunrise: Sound Advice • St. Petersburg: Cooper for Stereo • Sound Advice • Tallahassee: Sterer Stereo • Tampa: Sound Advice • W. Palm Beach: Electronic Connection • Sound Advice • GA Athens: Hi-Fi Buys • Atlanta & Suburbs: Hi-Fi Buys • Augusta: Stereo City • Brunswick: G&H Stereo • Columbus • Merit TV Macon: Georgia Music • Savannah: Audio Warehouse • Valdosta: Stereo Connection

HI Honolulu: Honolulu Audio Video
IA Davenport: Griggs Music • Des Moines: Audio Labs • Dodge City: Sound World • Dubuque: Reners Iowa City: Haweye Audio • Mason City: Sound World • Sioux City: Audio Visions • Waterloo: Team
ID Boise: Stereo Shoppe • Moscow: Stereo Shoppe • Sandpoint: Electracraft • Twin Falls: Audio Warehouse

IL Alton: Reliable Stereo • Aurora: Stereo Systems • Carbondale: Southern Stereo • Champaign: Good Guys • Chicago & Suburbs: United Audio • Decatur: Team Electronics • DeKalb: Audio Plus • Highland Park: Chlumba • Joliet: Stereo Systems • Kankakee: Barret's Entertainment • Lansing: Audio Clinic • Naperville: Stereo Systems • Normal: Sundown Div. • Peoria: Team Electronics • Rockford: Columbia • Springfield: Sundown One • Spring Valley: Audio Labs • Waukegan: Alan
IN Bloomington: Campus Audio • Bluffton: Eley • Ft. App. • Evansville: Riverside • Ft. Wayne: W.L. Stereo • Indianapolis: Oval on Lafayette:

Good Vibes • Marion: Classic Stereo • Michigan City: Audio Connection • Muncie: Classic Stereo • South Bend: Classic Stereo • Terre Haute: Stereo Crafters
KS Junction City: Audio Junction • Kansas City: Brands Mart • Overland Park: Audio Electronics • Brands Mart • Wichita: Audio Visions • Topeka: Neilson
KY Bowling Green: Audio Center • Lexington: Ovalton Audio • Louisville: Audio Video Buy, Design • Owensboro, Paducah: Risley's • Pikeville: Mayo Inc
LA Lafayette: Sound Electronics • Metairie & New Orleans: Alterman Audio • Opelousas: Sound Electronics

MA Boston: Waltham Camera & Stereo • Fitchburg: Fitchburg Music • N. Dartmouth: Sound II • Pittsfield: H B S Stereo • Worcester: O Cons ME Bangor: Sound Source • Camden: Harbor Audio • Portland: New England Music
MD Baltimore: Soundscape • College Park: Spaceways • Gaithersburg: Audio Buys
MI Ann Arbor: Absolute Sound • Hi-Fi Buys • Birmingham: Almas Hi-Fi • Dearborn: Almas Hi-Fi • Farmington Hills: Almas Hi-Fi • Flint: Stereo Center • Grand Rapids: Classic Stereo • Kalamazoo: Classic Stereo • Lansing Midland: Hi-Fi Stereo • Petoskey: Kurtz Music • Royal Oak: Absolute Sound • Court St. Listening Room • Traverse City: Kurtz Music

MI Duluth: Mel's TV & Audio • Mankato: Audio King • Minneapolis & Suburbs: Audio King • Rochester: Audio King • St. Paul: Audio King
MO Cape Girardeau: Stereo One • Columbia: Johnston Audio • Rolla: End of the Rainbow • St. Louis: Sound Central
MS Hattisburg: McLellan TV • Jackson: Hooper's • Pascagoula: Empress

MT Billings • V. deo Sat & Sound Bozeman: Thrifty Ear • Great Falls: Rocky Mountain Hi-Fi • Kalispell: Audio Visions • Missoula: Aspen Sound
NC Boone: Holtons • Chapel Hill: Stereo Sound • Charlotte: Audio Video Systems • Conover • Tri City • Greensboro: Stereo Sound • Hendersonville: Pro Sound • Kinston: Stereo Concepts • Moorehead City: Anderson Audio • New Bern: Anderson Audio • Raleigh: Audio Buys Stereo Sound • Rocky Mount: Microwave Audio • Wilmington: Atlantic Audio • Wilson: Modern Stereo • Winston-Salem: Stereo Sound
ND Bismarck: Pacific Sound • Fargo: Today Electronics

NE Kearney: Midwest Audio • Lincoln: Stereo West • Omaha: Stereo West • York: Midwest Audio
NH Concord: Audio of New England • Laconia: Lakeside Stereo • North Hampton: The New Audio • North Star • Salem: Cumpo's

NJ East Brunswick: Atlantic Stereo • Maple Shade: Bryn Mawr Stereo • Montclair: Perdue Radio • Paramus: Haney Electronics • Raritan: AC Audio • Ridgewood: Soundings Board • Shrewsbury: Monmouth Stereo • Toms River: Rams Camera • Wall Twp.: Monmouth Stereo • West Caldwell: Perdue Radio
NM Alamogordo: D&K Electronics • Albuquerque: West Coast Sound • Carlsbad: Beason's • Clovis: Towne Crier • Santa Fe: West Coast Sound
NV Las Vegas: Upper Ear • South Shore Lake Tahoe: Audio Video Den

NY Albany: Clark Music • Batavia: Unicorn Audio • Buffalo: Speaker Shop • Corning: Chemung • Elmira: Chemung • Fredonia: Studio One • Glens Falls: Audio Genesis • Goshen: Longplayers Stereo • Ithaca: Chemung Sound Image • Jamestown: Studio One • Manhasset: Audio Breakthroughs • Massena: Hi-Fi Shop • Newburgh: Audio Expressions • New Hartford: Adirondack Music • New

York City: Audio Breakthroughs • Electronic Workshop • Harvey Electronics • Rochester: JB Sound • Scarsdale: Listening Room • Syracuse: Clark Music • Westfield: Hart Electronics • White Plains: Harvey Electronics • Woodbury: Audio Breakthroughs
OH Akron: Audio Craft • Canton: Beiden Audio • Cleveland & Suburbs: Audio Craft • Cincinnati: Stereo Lab • Columbus: Stereo Lab • Dayton: Stereo Showcase • Findlay: Audio Craft • Lima: Classic Stereo • Toledo: Audio Craft
OK Lawton: Hi-Fi Shop • Oklahoma City: Audio Dimensions • Shawnee: Rare Sounds • Stillwater: Carlunes • Tulsa: Audio Advice
OR Beaverton: Stereo Superstores • Eugene: University Hi-Fi • Grants Pass: Shekells • Medford: Shekells • Portland: Stereo Superstores
PA Allentown: Bryn Mawr Stereo • Blakely: Hart Electronics • Bryn Mawr: Bryn Mawr Stereo • Camp Hill: Bryn Mawr Stereo • Chambersburg: Sunrise Electronics • Erie: Studio One • Harrisburg: Bryn Mawr Stereo • Johnstown: Gary's Entertainment • Kingston: Hart Electronics • Lancaster: G n T Stereo • Longhorne: Bryn Mawr • Montgomeryville: Bryn Mawr Stereo • Natrona Heights: Stereo Land • Philadelphia & Suburbs: Bryn Mawr Stereo • Pittsburgh: Audio Junction • Quakertown: Bryn Mawr Stereo • Reading: G n T Stereo • Sellers Grove: Stereo Shoppe • State College: Paul & Tony's Stereo • Stroudsburg: Mam SA Audio Video • Westford: Audio Insight • Williamsport: Robert M. Sides
PUERTO RICO Rio Piedras: Precision Audio
RI N. Providence: Eastern Audio
SC Anderson: Music Machine • Charleston: Audio Warehouse • Columbia: Music Machine • Greenville: Mitchell's Music • Myrtle Beach: Greenwood: Stereo Shop • Spartanburg: Stereo Shop

SD Aberdeen: Engel Music • Rapid City: Team Electronics • Sioux Falls: Audio King
TN Chattanooga: R&R TV • Cookeville: Lindsey Ward • Jackson: New Wave Electronics • Kingsport: Audition • Knoxville: Lindsey Ward • McMinnville: Lindsey Ward • Memphis: New Wave Electronics • Nashville: Hi-Fi Buys
TX Amarillo: Sound Systems Ltd. • Arlington: Sound Idea • Austin: Marcum Electronics • College Station: Audio Video • Corpus Christi: Tape Town • Dallas: Hilcrest Hi-Fidelity • El Paso: Soundwaves • Ft. Worth: Sound Idea • Houston: Sheffield Audio • Hurst: Sound Idea • Laredo: Miles Interna tional • Longview: Audio Techniques • Lubbock: Electronics Supercenter • San Antonio: Bill Case Sound • San Marcos: Discovery Audio Video
VA Alexandria: World of Stereo • Temple: Audio Tech • Texarkana: Sound Town • Waco: Audio Tech
UT Logan: Stokes Brothers • Ogden: Stokes Brothers • Salt Lake City: Broadway Music • St. George: Boulevard Home Furnishings
VA Bristol: Audition • Charlottesville: Holdrens Sound Machine • Falls Church: Manasco: Audio Buys • Richmond: Gary's Stereo • Roanoke: Holdrens • Virginia Beach: Digital Sound
VT Brattleboro: Scientific Stereo • Essex Junction: Cealve Sound • Rutland: Mountain Music • WA Bellingham: QC Stereo • Cheney: Music & Electronics • Oak Harbor: QC Stereo • Spokane: Electracraft (Hals)
WI Appleton: Sound World • Eau Claire: EME Audio Systems • Green Bay: Sound World • La-crosse: Sound World • Madison: Happy Med um • Marinette: Sound Seller • Milwaukee: Audio Emporium • Wausau: Sound World
WV Barboursville: Beckley • Charleston: P Paper • Clarksburg: Audio Visual Concepts • Huntington: PreP per • Piedmont: Sound Gallery • Wheeling: Stereo Lab
WY Cheyenne: Electric cs • Union Fed • Gillette/Sheridan: Star Video Distrib.



WDS

"A CUT ABOVE THE REST"

WISCONSIN DISCOUNT STEREO EST. 1954
2417 W. Badger Road
Madison, WI 53713
1-608-271-6889
SOME ITEMS CLOSEOUTS

DISC PLAYERS



10 DISC STACKER ... \$379
32 Track Programming
SPECIAL PURCHASE
SAE D102 ... \$289
SPECIAL PURCHASE
JVC XLM300 ... CALL
6 Disc Stackler

JVC XLM701 ... CALL
6+1 Slacker—SPECIAL
TEAC PD500M ... \$219
6 Disc Stackler

TEAC AD5 ... \$355
Combinatonal CD/Cassette

PIONEER CLD1070 ... CALL
Combi-Player-NEW

TEAC PD700 ... \$269
6-Disc, X, Dual D/A

JVC XLZ411 ... CALL
Top Rated—SPECIAL

JVC XLZ611 ... CALL
SPECIAL PURCHASE

VHS



JVC HRD520 ... CALL
Dual Screen Programming
with Instant TV Monitor
VHS MTS HIFI ... \$349
On Screen Programming
4-HEAD VHS MTS HIFI \$389
SPECIAL PURCHASE

HITACHI VT2600 ... CALL
Digital 4-Head MTS HIFI

JVC HRD750 ... CALL
4-Head MTS HIFI

SONY SLV70 ... CALL
4-Head MTS HIFI

PANASONIC VCR's ... CALL
New Models

GE 4-HEAD MTS HIFI ... \$389
SPECIAL PURCHASE

TOSHIBA M9485 ... CALL
4-Head MTS HIFI

RCA VCR's ... CALL
Brand New Models

CD PORTABLES



SONY CFD64 ... \$189
Slim Line, AMS

JVC PCV2 ... CALL
Hyper-Bass Driver

SHARP OTC025 ... CALL
AMPS, Cue/Review

JVC PCV300 ... CALL
BEST Portable Made

SONY D444 ... \$219
5-Band EQ, AMS on CD

CAR STEREO



CLARION 5630CD ... CALL
Car CD Player—SPECIAL

SHERWOOD XR1604 ... \$229
High Power, Dolby BC

CLARION 9730RT ... \$199
Dolby High Power DIN

ALPHASONIC PMA2075 ... CALL
75 W/Ch AMP

CLARION 8302RT ... \$149
Digital, Auto Reverse

CAR STEREO



CLARION 9770RT ... \$229
Dolby, High Power DIN

SHERWOOD CRD210 ... \$149
Dolby B/C, CD Input

CLARION 8671RT ... \$189
Removable DIN Chassis

SHERWOOD CRD350 ... \$179
High Power DIN

PYLE KP6940 ... CALL
We Carry Wide Ass't. of Pyle

AUDIO ACCESSORIES



ORTOFON X3MC ... CALL
Phono Cartridge

MAXELL T120HGX \$4.39 ea.
VHS TAPE

SONY ES90 ... \$3.49 ea.
Metal Audio Tape

MEMOREX CP8 ... \$69
Programmable Remote

SHURE V15 ... \$69
Phono Cartridges

SIGNAL PROCESSORS



ATUS AM500E ... \$189
Professional DJ Mixer

AUDIOSOURCE SS-TWO \$199
Remote Dolby Surround

ADC SS525X ... \$339
Computerized 12 Band EQ

TEAC EQ20BL ... \$99
10-Band EQ with Spectrum

AUDIOSOURCE EQ8II ... \$97
10 Band EQ with LED's

MISCELLANEOUS



DUAL CS5000 ... CALL
Walnut Base Turntable

SONY WMAF604 ... \$124
Super Walkman—Loaded

UNIDEN TALKER ... CALL
Radar Detector—SPECIAL

SAE T102 ... \$189
Digital TUNER

COBRA CP485 ... CALL
Cordless Intenna Phone

WDS Rated #1 for SERVICE and PRICE Guaranteed Low Price 10-Day Return

* We get the BEST volume discounts
* LOW OVERHEAD—To sell at best discounts
* We shop the competition to ensure the best price

Most Major Brands

* THIS IS ONLY A PARTIAL LISTING
* IF YOU DON'T SEE IT LISTED—CALL!

1-800-356-9514

IF YOU FIND A BETTER PRICE — CALL US



* 30-DAY GUARANTEED NO LEMON
* EVERY PRODUCT BRAND NEW—FULL WARRANTY

* Returns accepted within 10 days (must be called in for prior authorization). Products must be in original condition. Returns subject to restocking fee. Shipping and handling not refundable.

Buyer Protection Plan—FREE

PHONE HOURS
M-F 8 a.m. - 8 p.m.
SAT 8 a.m. - 5:30 p.m.
SUN 11 a.m. - 5 p.m.
Central Time Zone

CALL US TOLL FREE
* For expert recommendations
* For product information
* TO ORDER PRODUCT

CAMCORDER



JVC GR577 ... CALL
Super VHS, 8-Head, 8X
SPECIAL PURCHASE
HITACHI VM5200 ... CALL
Audio Monitor, 8X Zoom

RCA CC310 ... CALL
Audio Monitor, 8X Zoom

RCA CC175 ... CALL
Super VHS—SPECIAL!

JVC GRA30 ... CALL
Flying Erase Heads, 6X

SONY CAMCORDER ... CALL
We carry full line

SHARP VLL80UA ... CALL
SPECIAL PURCHASE

PANASONIC CAMCORDER ... CALL
CALL—SPECIAL PRICES

JVC GFS550 ... CALL
Super-VHS—SPECIAL

JVC GR5707 ... CALL
Brand New—SPECIAL

CASSETTE DECKS



SAE C102 ... \$289
SPECIAL PURCHASE
2 Motor, Dolby B/C
JVC TDW777 ... CALL
Auto-Reverse Dubbing

TEAC W670 ... \$259
3-Head, Dolby B/C/HX PRO

TEAC W660 ... \$297
Auto Reverse Dubbing

JVC TDV711 ... CALL
3-Head SPECIAL PURCHASE

TEAC R616X ... \$297
Auto Reverse RECI/PLAY

TEAC V285CHX ... \$97
Dolby B/C/HX PRO

TEAC W355 ... \$109
High Speed Dubbing

TEAC X2000 ... CALL
10" Reel-to-Reel SPECIAL

JVC TDV621 ... CALL
3-Head, Dolby B/C/HX PRO

SPEAKER/HEADPHONES



SONY MDR1F5K ... CALL
Wireless Headphones

KOSS JCK200S ... \$99
Wireless Headphones

SONY MDRV6 ... \$67
Professional Headphones

BOSE AM5 ... CALL
Subwoofer System

RECOTON WIRELESS 100's \$189
Wireless Add-On Speakers

HOME OFFICE



PANASONIC KXW1500 ... \$519
Word Processor with Accu-Spell

SHARP UX50 ... \$588
FAX Machine

SHARP Z70 ... \$759
Personal Copy Machine

PANASONIC KSR340 ... \$197
Typewriter

SMITH CORONA PWP3 ... \$369
Word Processor

CIRCLING BACK



Will the Circle Be Unbroken, Vol. Two: The Nitty Gritty Dirt Band
Universal UNLD-12500, CD; DDD;
 72:29

Sound: A Performance: A—

If the first *Will the Circle Be Unbroken* was a landmark achievement that did a whole lot to send country music back to the basics, its sequel, 17 years later, is more a report on the progress of the next generation. A lot of noise was made when the Nitty Gritties recorded the first *Circle* album. They were essentially a folk-rock band, but their project exploded the boundaries of this genre and erased any preconceptions about long-haired rocksters mixing with Nashville's best. To say the least, it worked brilliantly.

On that first *Circle* release, the Nitty Gritties played with the likes of Doc Watson, Mother Maybelle Carter, Merle Travis, Roy Acuff, and Jimmy Martin, and the band featured Pete "Oswald" Kirby, Vassar Clements, and Roy "Junior" Huskey on dobro, fiddle, and upright bass. This second *Circle* album, however, spotlights a whole new generation of singers as well as some of the surviving pioneers. This time, the band consists of Jerry Douglas, Mark O'Connor, and Roy Huskey, Jr. (Junior's son) in the featured player spots, and these guys play their hearts out.

Though some traditional country songs are here, most of the 20 selections represent the newer generation of country music. There are a lot of absolutely wonderful performances: Johnny Cash leading off with "Life's Railway to

Heaven," John Prine with his "Grandpa Was a Carpenter," Levon Helm of The Band singing "When I Get My Rewards," Jimmy Martin returning to serve up a sizzling "Sitting on Top of the World," the John Hiatt/Rosanne Cash duet on John's "One Step over the Line," Byrds alumni Roger McGuinn and Chris Hillman reunited to rerecord Dylan's "You Ain't Going Nowhere," which they first recorded on the seminal *Sweetheart of the Rodeo* (truly the first *Circle* album's predecessor), and Bruce Hornsby redoing his hit song "The Valley Road" as a fast bluegrass number in a version that forces reassessment of Hornsby's songs through the lens of country tradition. As with the first *Circle*, the album closes with a celebratory, "everybody join in" version of the title song and a final guitar solo spot by Randy Scruggs, who acted as project producer this time. Ironically, while the first *Circle*—which featured virtually all traditional or classic country songs—closed with the Joni Mitchell song "Both Sides Now," this new *Circle*, a far more contemporary album, closes with the traditional hymn "Amazing Grace."

Technically, this album is a superb achievement. The acoustic instruments and voices, elements that benefit the most from quality digital recording, sound warm and right there in the room.

The CD version makes excellent use of the medium's index capability. With a push of your remote's rarely used index button, you can cue past the

studio patter to the start of the song proper. Since the patter is often informative and always entertaining and enlightening, you may not want to, but it is nice to see the technology used to afford that flexibility.

There is one noticeable drawback to the CD, and that is the packaging. Though all the liner notes, credits, and photos in the two-LP boxed set are included with the CD, the 24-page insert and the photos—particularly the cover shots—are reduced so drastically that you can't even see them with a magnifying glass. Do check out the LP to appreciate the front-cover photos of hands on instruments and the back-cover shots of the participants. Yes, you do give up something to get that state-of-the-art sound.

Michael Tearson

Delicate Sound of Thunder: Pink Floyd

Columbia C2K 44484, two CDs; DDD;
 49:03 and 55:15.

Sound: B Performance: B

When it comes to live recordings, it's no surprise that the CD format brings to listeners the best of both worlds: The perfected science of faithful reproduction gets frosted with one of the sweetest of human emotions—appreciation. Whether they're inspiring the band to outdo studio efforts or reinforcing the pulse by clapping along (usually reproduced out of sync by a drawback of the laws of acoustics), a good audience on record can enhance a mediocre performance or gild a sterling one.

Since *Delicate Sound of Thunder* is of the latter variety, it should be added only that Pink Floyd has taken pains to keep the audience as part of the entire experience rather than mix them in and out as filler between songs. Throughout much of this two-disc recording of 1988's Momentary Lapse of Reason tour, the enthusiastic crowd's presence sounds like sea waves breaking behind the band.

The 28-page booklet that comes with the set does little more than document the tour's ambitious, if ostentatious, laser light show without offering much information about when, where, and how the music was recorded. It does tell us that the discs were produced by David Gilmour, who has managed to mix the vocals in what seems like a three-dimensional space: At times, they seem to come from back in a low corner; at another point, they soar right over your head.

Gilmour's increasingly accomplished and majestic guitar work carries the 11-member band, which is composed of a core group of Gilmour, keyboardist Richard Wright, and drummer Nick Mason. This core is fleshed

out with a bassist, percussionist, saxophonist, three female backup singers, an additional keyboard player, and a supplemental guitarist. Whenever Gilmour plays, he instantly fills up the sound picture, whether with power chords, piercing single-note leads, or a barrage of effects that sound like a gigantic industrial machine turned predator.

Although disc one is consistently satisfying and features some of Pink Floyd's choicest lesser known material, its energy level cannot match that of its mate. From the jangle of alarm clocks that mark the beginning of "Time," to the sparkling-bright acoustic-guitar duet that creates the framework for "Wish You Were Here," to the ever balletic and serene "Us & Them" (whose echoing verse ends float around the soundscape in separate directions like huge soap bubbles), to a souped-up "Money" and a funky "Another Brick in the Wall" (complete with kiddie chorus), disc two runs like a "Best of Pink Floyd" that is buoyed even higher by the crowd's enthusiastic response.

Susan Borey



Lucinda Williams

folks will go to in order to get out of a bad affair; the forlorn heartbreak of "Abandoned," and the drive-all-night desperation of "I Just Wanted to See You so Bad."

Clearly, a whole lot of love's labors went into making the album sound as fine as it does on its minuscule \$10,000 recording budget. Lucinda fronts a small band that is tight and sure, with co-producer Gurf Morlix on all sorts of guitars, Dr. John Ciambotti on bass, and Don Lindley on drums, all supporting Lucinda's voice and acoustic guitar. Embellishments of keyboards, harmonica, fiddle, washboard, and accordion add character to a bright-sounding album, with just enough oomph to move things along briskly.

Michael Tearson

Lucinda Williams

Rough Trade US-47CD, CD; ADD. 39:16. (Available from Rough Trade, 611 Broadway, Room 311, New York, N.Y. 10012.)

Sound: B Performance: A-

I first heard *Lucinda Williams* at the end of a long day of wading through the new release pile that had left me cranky and irritable. But from the first notes of the opener, "I Just Wanted to See You so Bad," Lucinda won me over with a confidence and energy that oozes from these tracks.

Lucinda is a Louisiana and Texas girl, and she wears it proudly with her accent and the stories she tells in her music. She is a terrific songwriter with an excellent sense of how to use detail to expose a character and get a story told succinctly. There's the Beaumont, Texas waitress Sylvia, who saves her money, quits waiting tables, and moves to a secretary's job in the big city—just to get to the nightlife—in "The Night's too Long." Check out the cold dish of revenge served up in the wildly funny "Changed the Locks," a song that explores the lengths some

Guitar Speak: Various Artists

I.R.S. IRS-42240, LP; IRSD-42240, CD. AAD; 48:50.

Sound: A-/B+ Performance: A

A gaggle of guitarists kick out the jams on the latest I.R.S. instrumental in the NoSpeak series. *Guitar Speak* features hot axe work by some of the more talented guitar heroes of the last two decades: Alvin Lee (Ten Years After), Randy California (Spirit), Phil Manzanera (Roxy Music), Rick Derringer (The McCoys), Pete Haycock (Climax Blues Band), Steve Hunter (Alice Cooper), Hank Marvin (The Shadows), Leslie West (Mountain), Ronnie Montrose (Montrose), Steve Howe (Yes and Asia), Robby Krieger (The Doors), and Eric Johnson. Several of these artists



Pink Floyd



Like another great Charles (Dickens, that is), Ray has leapt to a new level of mastery in middle age.

are working on solo albums for the series, but the songs here are unique to this anthology.

Very strong on melodic content (as opposed to blues-based scalar riffing), this music lies somewhere between progressive rock and jazz fusion, with a decidedly biting rock edge to it. Every performer cuts loose on blistering raves; most haven't sounded this good in years. Each track gives a good taste of the guitarist's individual style, yet the composition is similar enough to make the project hang together as an organic whole. Production values are first-rate, with both LP and CD sounding clean and spacious despite considerable multi-tracking.

Guitar Speak doesn't really introduce anything that hasn't been done before, but it does give some very fine players a forum and a focus. This, in turn, has the effect of almost creating a new genre. If you like instrumental music that doesn't pull its punches, check this out. *Michael Wright*

Just Between Us: Ray Charles
Columbia FC-40703, LP.

Sound: A Performance: A

Charles Dickens was already established as a first-rate author when he reached a new level of mastery in his fiction; his work abruptly took on a new character. It almost instantly proceeded from a higher level of control—and for all its new strengths and depths, it seemed to be created effortlessly, a semblance Dickens bitterly refuted.

Does it come easily for Ray Charles? *Just Between Us* is the work of another

master at the top of his form, spinning off perfect song after perfect song with the same kind of power and apparent grace. Charles has produced, engineered, and mixed the album, which, with its amazing cleanness and clarity (the ever-present hi-hat sounds like it's being played in your living room, not on your turntable) sounds more like a CD than an LP.

The album opens with "Nothing Like a Hundred Miles," a James Taylor tune Charles pushes from the limited potential of folk rock into a solid blues number that ought to find its way onto a film soundtrack. His laid-back vocal, flowing on top of a bare-bones arrangement, is set off against a scorching, sinuous guitar line delivered by B. B. King. Other guest artists include Lou Rawls, Milt Jackson, and Gladys Knight, who makes an appearance on a ballad that turns her and Charles loose for the recriminating duet, "I Wish I'd Never Loved You at All."

Charles moves through many shades of blues and soul on the 10 songs found here, but he draws from an even wider range of styles. ZZ Top comes to mind (no kidding) with the rock edge of "Too Hard to Love You," and snazzy horn arrangements and lush production values evoke the big band era throughout the second side. "Let's Call the Whole Thing Off," co-produced and arranged by Quincy Jones, is a bouncy and whimsical romp that is matched in tone by "Save the Bones for Henry Jones," which closes the album on an upbeat note.

The only disappointments that come with *Just Between Us* are that none of

the fine musicians who back Charles are credited and that there's less than 37 minutes of music. *Susan Borey*

Like a Prayer: Madonna
Sire Warner Bros. 25844-2, CD; 51:16.

Sound: A— Performance: B+

As much fun as Madonna-bashing has been, *Like a Prayer* is not an occasion for another round. Much to my surprise, I found myself captivated by the maturity of the work and the depth and substance of a lot of the songwriting on Madonna's new album.

High points abound. The title track is an ambiguous paean of faith in either an absent lover, or religion, or both. "Love Song," the collaboration with Prince, is a lover's plea for clearer communication. It is set to a slow, slinky, seductive beat with spare, sassy, spacey production to tweak the ear. "Dear Jessie" uses psychedelic strings à la "She's Leaving Home" to present a plea not to run through childhood too quickly. This one acts as the light counter to the darker "Dear Father" which follows. Here, Madonna uses her lower register in a song to a father who made childhood difficult—to say the least. "Spanish Eyes," another slow one, relates a *West Side Story* kind of tale. You can't hide very easily on the slow ones, and Madonna's singing here shows just how good a vocalist she has become.

On the downside are the sincere but sappy "Express Yourself" and a rather awkward song about her breakup with Sean Penn, "Till Death Do Us Part." There's also the pointless, pretentious, and ultra-arty finale, "Act of Contrition," which would have been better served by being left off the album.

Madonna co-wrote and co-produced everything on *Like a Prayer*. Clearly, she knows what she wants, and she gets it. She has crafted an album with excellent sound and a nice diversity of arrangements.

Madonna is no flighty puff of pop pap. In retrospect, maybe she never was. Maybe she used her "boy toy" and "material girl" masks to belie a canny pop savvy. This may sound like a backhanded compliment, and maybe, in part, it is. But it is meant far more as a show of grudging respect for work well done. *Michael Tearson*

SCARLATTI FEVER

Scarlatti Sonatas. Colin Tilney, harpsichord.
Dorian DOR-90103, CD; DDD; 70:17.

An unusual, almost unsettling recording, this one, for all who may have fallen for the magic of even a few of these lively, high-style little 18th-century "sonatas," most of them no more than a couple of minutes long. I was somewhat repelled at the start of the CD—I, who discovered the harpsichord for myself long before WWII, with the 78-rpm recordings of the great Wanda Landowska playing Scarlatti. A virtue of the CD is that it gives you time to acclimate yourself and your ears. After more than an hour and 10 minutes, I was enthusiastic.

Landowska's Scarlatti was the essence of drama, played on a large and not very suitable French harpsichord with two keyboards and an anachronistic 16-foot bass. I loved it. Colin Tilney, almost a half-century later, is a contemporary performer and very much of our times. His fingers are rapid and his pace taut and intense, where Landowska gloried in a late, expansive Romanticism right out of the 19th century. Tilney's instrument, too, is much nearer the truth, so to speak—a restored 1730 Italian harpsichord of Scarlatti's own day, with a single keyboard and strung in brass, as it was originally. This produces a sharp and unavoidable metallic edge—at first, I thought it might be too-close microphoning—which may grate on our softened ears but was very likely the instrument's sound in 1730. And Scarlatti's sound, too. Moreover, the dramatics Landowska used in her registration—quick startling color changes, echo effects between two keyboards—are not Tilney's. How could they be? His instrument does not allow them. Nor, probably, did Scarlatti's.

And yet, there is all the drama you can imagine here. It is in the playing, by suggestion. Tricks! Sleight of hand. Mesmerism. What else is a fine keyboard performance?

The harpsichord has no facility for adjusting tone and volume via the fingers. The quill or plectrum snaps across the string and that's it. Nor is there any pedal, for a romantic blur. In a way it is a stark instrument, and so it was considered by the later pianists,



who quickly forgot its existence. But is any acoustic instrument more than this, without a performer who really can make it go?

As you listen to Tilney's 19 sonatas here, one after the other, you will hear what I mean. All is *suggested*, even the frequent echo effects. The instrument is limited, its brassy sound harsh, yet under these fingers, this mind, it speaks in a human way. It is nervous, or calm—full of variety that in physical fact isn't there.

My own thoughts go further. With Colin Tilney, here at such length, I think that at last Domenico Scarlatti sounds out as one of the great musical innovators. On a different scale, yes, but in a class with J. S. Bach and George Frideric Handel, his birth mates of 1685. And this simply because Tilney is able to produce warmth and passion on a music machine that is, by itself, rigid.

Edward Tatnall Canby

Stravinsky: Petrouchka, Scherzo Fantastique, Fireworks; Rimsky-Korsakov: Russian Easter Overture.

The Seattle Symphony Orchestra, Gerard Schwarz.

Delos D/CD-3054, CD.

Delos' latest recording with Gerard Schwarz and the Seattle Symphony Orchestra is both a musical and a sonic triumph. The coupling of Rimsky-Korsakov's "Russian Easter Overture" with Stravinsky's "Scherzo Fantastique," "Fireworks," and "Petrouchka" is inspired, inasmuch as Stravinsky must be considered Rimsky-Korsakov's most prized and famous pupil. No doubt the pupil owes a debt to his teacher, but both Rimsky-Korsakov and Stravinsky were masters of colorful orchestration.

Maestro Schwarz provides a brilliant performance of the "Russian Easter Overture," managing to give equal

Conductor Gerard Schwarz must be given much credit for the top-class playing which he elicits from the Seattle Symphony.



notably in the European East, where this sort of Western music is just making its first real impact. Now we hear Moscow sampling the great George—a good deal cooler, indeed, and perhaps not absolutely at home (to put it mildly, a trace cautious), and yet very warmly interested. I laughed right out at Ferde Grofé's famous up-sliding clarinet at the beginning of "Blue"; this Russky almost fudged it, but he got there okay. It's not all-out, full-blast, Broadway Gershwin, but the soul of the man shows, all right.

The "Rhapsody" is only one item in an unusual program. First, there's the "I Got Rhythm" variations, surprisingly seldom heard and a masterpiece of harmonic subtlety. And after "Blue," there is a group of piano solo works—same pianist but recorded earlier on in California. They blend effortlessly in recording and acoustics. The "Impromptu in Two Keys" (C and D flat) is a trifle which every jazz pianist should study, so effortlessly are the two keys juxtaposed. And a ragtime from 1917—Gershwin in his teens!—it, too, is a little masterpiece, perfectly styled. In contrast to these, there is an even earlier attempt at a classical string quartet, here set for orchestral strings. You'd never recognize the composer, but the music is faithfully of its classical day, 1916—mystical and high colored (of course!) and wholly professional.

To end, there is a brief and "unrehearsed" jam session on "Summertime," with a Russian hornist, the pianist, and an audio engineer trading riffs or shots or whatever. *What* audio engineer? Stan Ricker, on bass! Unless there are two Stans, this is one of the more esteemed pros in audio.

I should add that Mayorga matches well with the Moscow people. He is a proficient but rather cool pianist with a

weight to both the pagan Russian and liturgical elements in the score. In the "Scherzo Fantastique" and "Fireworks," Schwarz emphasizes their rhythmic aspects, and these are brisk, propulsive readings. In "Petrouchka," Schwarz wisely uses the original 1911 scoring and even retains the snaredrum "bridges" connecting various sections. Here again, Schwarz's approach is strongly balletic, and he accents the rhythmic thrust of the score with a bright, joyous, ebullient reading. Much credit must be given to this conductor for the top-class playing of the Seattle Symphony Orchestra.

In matters of sound, engineer John Eargle once again bolsters his reputation as one of today's most skilled practitioners of the art and science of recording classical music. Eargle has the acoustic measure of the Seattle Opera House, with just the right placement of the various orchestral choirs to provide superb balances, high definition, and a perspective which provides a spacious ambience while preserving orchestral presence. Eargle used the ORTF mike setup, with Sanken CU-41s and Neumann, Sennheiser, and Milab stereo pair "sweeteners." He also employed the Colossus digital recorder, and the resulting sound has awesomely wide dynamic range and tremen-

dous weight of brass and bass drum in the huge climaxes of "Russian Easter Overture" and "Fireworks."

If you have a really top-notch playback system, this CD will tax its limits while reminding you how good the digital medium can be. *Bert Whyte*

Rhapsody in Russia: A Gershwin Celebration. Moscow Philharmonic Orchestra, Dmitri Kitayenco; Lincoln Mayorga, piano.
Sheffield Lab CD-28, CD; AAD.

As any businessman ought to know by now, the arts lead the way. Trade comes next, politics last—if ever. Wendell Wilkie's "one world" of so many years ago still is far from achieved, but the arts are getting there at an astonishing rate.

Witness this sequel to Sheffield's recent series of Moscow recordings. It's a dilly, if an odd one. True to earlier colors (remember Direct to Disc?), Sheffield did this in the traditional "live" format, with a remarkably disciplined audience that does not intrude and a bit of skillfully managed clapping just to set the scene.

As the publicity puts it, many an American orchestra now plays Gershwin in a ho-hum fashion. Not so for Gershwin in the rest of the world, and

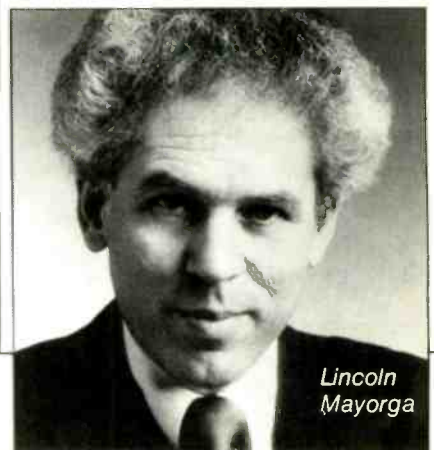

Lincoln Mayorga

Photograph: Jack Mitchell

The New York Vocal Arts Ensemble sings gently and quietly, as if they were performing in a Victorian living room!

redeeming sense of rhythm and a very good knowledge of what Gershwin is all about. *Edward Tatnall Canby*

Johann Strauss II: Waltzes for Singing. The New York Vocal Arts Ensemble, Raymond Beegle.
Arabesque Z6586, CD; 51:24.

Surprise, surprise. I almost put this aside—*singing* a Strauss waltz? What a nutty idea.

Well, no. Remember that before the phonograph put the music-loving audience into its present total passivity, there were indeed arrangements made of every sort imaginable, so people could do it like a kit—produce their own. Mostly, these were not put together by the original composers, but the flood could not be stopped—too much demand. So a popular waltz set for standard vocal quartet and piano (simplified) would be strictly expectable in the Strauss era. Full of authenticity.

There is even one waltz here, the familiar "Wine, Women, and Song," which has an entirely different introduction, not the orchestral one at all. It is perhaps by Strauss II himself.

What you hear in this recording is interesting. At the beginning, piano solo—not voices. Only after quite a stretch do the voices appear, and again not what you may expect—particularly out of New York, where professional singing tends toward the very loud and strident. (You hafta out-sing the police sirens every three minutes.) Instead, four voices here sing gently and quietly, as in a Victorian living room! Hard to believe. The easygoing tenor and light-toned soprano are the typical 19th-century leads, the contralto and bass mostly singing with them in dulcet thirds. All four singers can sing loud on occasion, and do. But the director keeps them down, keeps them sweet and expressive—definitely not opera house.

The arrangements are skillful—very few outright solos, except short range—and there's a lot of expert vocal harmonizing while the piano expresses itself.

Though the savvy director, Raymond Beegle, seems to be the pianist—it doesn't say so, but on the cover, his hand is on the keyboard!—I found the piano Strauss nice but a bit unimaginative,



not evoking the sound of the orchestra as well as it might. No great problem. *Edward Tatnall Canby*

David Borden: The Continuing Story of Counterpoint, Parts 9-12.

Cuneiform Rune 16, CD; DDD; 69:19. (Available from Cuneiform, P.O. Box 6517, Wheaton, Md. 20906.)

Sound: A— Performance: A

The Continuing Story of Counterpoint, Parts 9-12 is the first summation in the career of an overlooked composer. Within the minimalist ranks, David Borden's music has always stood alone with its logic of motion, elegance of line and form, and deft use of state-of-the-art technology.

Borden's been leaking out his *Counterpoint* series on record for seven years, with Parts 2-6 and 9 having been previously recorded. But this Compact Disc is the first of a three-volume set that offers new recordings of these works, updated technologically from the old Moog synthesizer versions which Borden began in 1976.

Borden writes a complex and hyperactive form of counterpoint, often through-composing each line as a separate entity yet interlocking them in synchronous orbits. He winds his pieces up like gyroscopes and sends them spinning full tilt right from the start. Part 9 is launched with colorful percussive synthesizer timbres that drive through relentless cycles while soprano Ellen Hargis curls through the layers.

Each *Counterpoint* employs thematic material used in Part 1, which makes the variety that Borden elicits all the more amazing. After the excited dazzle

of Part 9, Part 10 sounds stately and refined, its strings and basset horn lines rolling out in a ceremonial march. A shift into symmetrical bell patterns bouncing like cosmic Morse code reveals Ellen Hargis intoning the names of contrapuntal theorists like a Gregorian choirboy. Borden throws in one of his wild cards on this piece, as the third part is sent into a folk-dance rhythm setting for a tenor saxophone improvisation by Les Thimmig.

With all the digital technology and computers, Borden can elicit more colorful arrangements with a greater dynamic range, but the early works, with the antique electro-harpsichord twang of Moog's synthesizers, had their own charm. This sound returns a bit on Part 11, which is the most variegated of the *Counterpoint* series, as Borden sends in one theme after another. Yet, for the most part, his themes flow together like scenes viewed through the window of a fast-moving car.

The concluding Part 12 is a three-movement work, shifting from insistent marimba-like cycles to the heroic middle movement with urgent synthesizer cellos and a Moebius strip melody. Part 12 finally ends in an ethereal wash of patterns suspended in time.

Digitally recorded and using digital synthesizers, *The Continuing Story of Counterpoint* is a sharply detailed recording, balancing electronic and sampled sounds perfectly with the pure soprano of Hargis and Thimmig's array of horns.

When released in its entirety, this series may stand as the "Goldberg Variations" of minimalism, a canon of work that defines a style and an era.

John Diliberto

SHAW 'NUFF



ny Goodman's sextet, was an added feature to the big band. Goodman's groups, however, had considerably more rhythmic variety and emotional appeal, at least to this reviewer's ears, regardless of either leader's merits in terms of mastery of the clarinet.

I won't single out selections, other than those mentioned above, because as with all small groups, there was plenty of space for soloists. Featured here are Butterfield, who is adept with the plunger, and Eldridge, one of our national treasures. The two keyboard men are good; Marmarosa, in particular, is well worth hearing since he did so little recording.

Despite claims for the much-touted NoNoise system, there is considerable noise and crackle on "Gentle Grifter." In fact, the noise is even more noticeable than on the previous Bluebird re-issue, suggesting a damaged master.

This CD contains the full extent of Artie Shaw's small combo recordings from the 1940s and certainly ought to satisfy his many fans. *Frank Driggs*

Photograph: Frank Driggs Collection

Artie Shaw—The Complete Gramercy Five Sessions
RCA Bluebird 7637-2-RB, CD; ADD;
 47:28.

Sound: B+/B Performance: A-/B+

Artie Shaw always stood apart from the crowd, cerebral and nonconformist. His music could be counted on to be well thought out and often filled with innovative sounds and ideas. Most striking was the near-hypnotic effect he achieved in his first Gramercy Five recordings by using trumpet (Billy Butterfield), harpsichord (Johnny Guarneri), and clarinet (himself) driven by guitar, bass, and drums. Particularly effective are the two opening cuts, "Special Delivery Stomp" (really "Diga Diga Do" reworked) and "Summit Ridge Drive," named for the street in Beverly Hills where Shaw was then living with his new bride, silver-screen siren Lana Turner. These recordings achieve a propulsive swing aided by riffing at the end, but somehow, after hearing a few selections done by this group, no matter how well played, you have the urge to throw the harpsichord through the window, go back to piano, and alter the sound. The later (1945) edition—with Roy Eldridge on trumpet, gifted pianist Dodo Marmarosa, and

fine guitarist Barney Kessel—sounds much fresher and swings with a great deal more ease than the earlier sides.

One of the worst features of this particular Bluebird CD is the preponderance of bass, which on the early sides brings unwanted and unwarranted attention to Jud DeNaut, a good but unsensational player who does a solid, workmanlike job and, along with the leader, would most likely have preferred to be *felt* more than heard in these circumstances.

John P. Callanan's liner notes give a fine overview of Shaw's career and ambitions, but Callanan draws the long bow when he makes the assertion that guitarist Kessel's idol, Charlie Christian, would have had a difficult time matching Kessel's efforts on these recordings. Christian, who died in 1942 at the age of 25, would not have had difficulty matching or surpassing Kessel at that time, and I'm sure Kessel would agree. But no matter—Kessel's guitar work was fine then and has only gotten that much better over the years.

Aside from the overemphasis on bass, remember that these small-group recordings were performed in public, with one, two, or three numbers at a time sandwiched between stretches of big band fare. This unit, like Ben-

World Dance: Do'ah
Global Pacific/CBS ZK-40734, CD;
 ADD; 41:49.

In Do'ah's most recent release, *World Dance*, the group moves slightly toward a mainstream pop style—but without losing the folk elements and exotic instrumental sounds that have been an important part of their world music style. By adding MIDI synthesizers and Western jazz instruments to their palette of sounds, they are successfully appealing to a wider audience than before. At the same time, they are introducing new listeners to their distinctive style. Do'ah managed to make these changes without selling out. In fact, the inclusion of pop and jazz elements serves to make their music still more interesting.

In "Wayo" and "Night-Season," Do'ah uses elements of Brazilian jazz styles quite prominently. This gives them not only the exoticism of Brazilian music, but also the mainstream feeling that style carries. Charlie Jennison's skillful soprano sax solos, along with the wordless chorus sounds, contribute to the effect. But mixed in are all the other African, Middle Eastern, and Far Eastern sounds Do'ah loves to use.

The fusion of these diverse musical elements is by far the smoothest of all Do'ah's efforts to date.

The sound is clean and spacious, especially considering the album's origins as an analog multi-track tape. Many of the exotic instruments are quite weak alongside modern Western instruments, but the mix retains their unique and subtle qualities quite well. Do'ah used reverb with tasteful restraint but still managed to create contrasts of effects. For example, in the "One World Symphony," the first movement opens with a chorus bathed in reverb, while the plucked strings and the solo flute are fairly dry. As the piece progresses, Do'ah uses different ambient qualities to highlight the contrasting instrumental sounds in each section. The middle movement has a noticeably more spacious sound, which helps to convey its relaxed, peaceful mood quite effectively. The last movement has a rather dry sound that helps to clarify the intricate rhythmic accompaniments. In all, this is an imaginative and polished recording that should win many new admirers for Do'ah.

Steve Birchall

Julius Hemphill Big Band
Elektra/Musician 60831-2, CD; ADD;
60:39.

Sound: B+ Performance: B+

Julius Hemphill Big Band rolled out of the horizon like a trumpeting storm; it's one of the most exciting jazz recordings of the last year. Hemphill is a saxophonist best known as part of the World Saxophone Quartet. That group serves as a distant point of reference for the propulsive, big band arrangements which Hemphill has conjured. Working with a 16-piece ensemble, he dashes through a varied palette that can be tight and pointed, raucously joyous, or coolly elegant.

Since his first records, *Dogon A.D.* and *Coon Bidness* (Arista), were made in the early '70s, Hemphill has buried his roots in the blues, but he's always taken those roots and bent and twisted them into skyscraping harmonic architecture. He has a reputation as a free-music player, but freedom is knowing you can go home and that's where he goes on "Leora." The horns breathe gently back and forth while Hemphill's

alto saxophone spins and stretches the melody, swooping low, growling, fluttering, and screaming.

The band gets a heavy workout on "At Harmony." It screams out in overdrive and never lets up. The horns pump and thrust, sometimes in opposition, sometimes in unison, demarcating frantic solos from trombonist Frank Lacy, soprano Marty Ehrlich, and alto John Stubblefield. Hemphill's alto rips serrated grooves into the ferocious rhythms of drummer Ronnie Burrage and electric bassist Jerome Harris.

Hemphill shifts grooves at will on "C/Saw," starting out as a raunchy roadhouse blues before flying into a straight-ahead jazz vamp for his solo. Jack Wilkins runs some speedy guitar blues on this track, pumped up by the horns.

Hemphill has always been an exhilarating soloist, but this album highlights his compositions and arrangements more than any record since *Roi Boye and the Gotham Minstrels* (Sackville Records), an album for multiple pre-

corded and live saxophones. Whenever anyone does a big band record, Duke Ellington is immediately called upon as a point of reference, and that's certainly true here. Like Ellington, Hemphill's charts are full of translucent textures, earthy colors, and unusual contrasts (such as the flutes cascading against the muted horn section on "For Billie").

"Drunk on God" provides an out-of-balance center for the album, based on a poem written and recited by K. Curtis Lyle. Hemphill frames Lyle's declarative style with a variety of textures, from gut-bucket blues to rock riffs and free-bop-swing charts, that save what could've been a tedious rant. By the time Lyle starts chanting "Cosmic Country Boy," even he is immersed deep into the groove.

The acoustic balance of *Julius Hemphill Big Band* sounds like it was recorded live, which makes some of the ragged lines forgivable in the face of the exuberant performances.

John Diliberto



Julius Hemphill

Tony Williams' new LP, *Angel Street*, turns the music crisply and moves it forward with complete resolve.



**Angel Street: Tony Williams
Blue Note B11H-48494, LP.**

Sound: A - Performance: A -

A while ago, when I was talking with pianist James Williams, the integrity-filled and serious-minded former Jazz Messenger (1977 to '81), he lamented the state of his profession. Unlike days gone by, when ensemble personnel toured for long stints, James contends that the rigors of travel, the nature of the record industry and its financial structure, stress, etc. have made the ongoing jazz collective an all-but-extinct species today. Williams, who in any conversation emphasizes tradition, says unless musicians play together for substantial periods—years, he implied—jazz tends to stagnate. He claims longevity is a necessary ingredient for musical advancement.

Drummer Tony Williams' band (no relation to James) gives credence to James' theory. While its members, including Williams, have each participated in other simultaneous or overlapping projects and, indeed, led their own ensembles, this quintet, with rare exception, has undergone few personnel changes in the last three years. The result: Without question, this is one of the most solid working bands in the country.

Williams has come full circle since earning his teen-age degree with Miles Davis some 25 years ago and his subsequent, more commercial, fusion efforts with his Tony Williams Lifetime bands. Now in his early 40s, Williams works only acoustically, save an occasional adventure where he incorporates drum machines and computer programs into his music. He has also surrounded himself with one of the best rhythm sections around, pianist Mulgrew Miller and bassist Charnett Moffett. Miller entered the fast track some four years ago and has since become one of the most in-demand players. He has recorded with everyone from Frank Morgan to Bobby Hutcherson and entrenched himself, now with four albums to his credit, as a cornerstone for Orrin Keepnews' Landmark Records. Meanwhile, Charnett Moffett, son of Charles, is also getting around, having released *Net Man* on Blue Note in late '87. The quintet is rounded out by the well-schooled

reedman Bill Pierce, who handles tenor and soprano duties, and Wallace Roney on trumpet. Both, again, are Messenger alumni.

Tony Williams has learned well, drawing predominantly from the generation that preceded him. He absorbed the wisdom of Davis, John Coltrane, and the plethora of great hard boppers of the 1950s and 1960s who recorded for Blue Note—among them, naturally, Art Blakey.

As is the case with Williams' two previous recordings on the legendary label since its 1985 rebirth (*Foreign Intrigue* and *Civilization*), he delivers another gem here. *Angel Street* turns the music crisply, tosses it on its side gently but fervently, and, as James Williams suggests, moves it forward with complete resolve.

The title track epitomizes and typifies this band's conviction and commitment to quality. Stylistically, the composition (incidentally, Williams wrote all nine pieces on the album) contains all the tonal pizzazz and elegant phrasing of Benny Golson's 20-year-old classic, "Killer Joe." It's just that Williams & Co. leave no doubt you're listening to something that's a late-'80s piece. Same with "Only with You" and the set's energetic and raucous closer, "Obsession," where Pierce's best tenor work appears.

Williams proved himself as a writer with his already semi-classic "Sister Cheryl," where the head, hook, and keen sense of phrasing mesh an exquisite, almost uncanny sense of accessibility with challenge. Cuts such as "My Michele" and "Takin' My Time" (both on *Foreign Intrigue*) never grow tiresome and, at particular moments, enthrall. Williams now submits "Dreamland," a 10-minute, even-handed, straight-ahead voyage that, with each listening, tugs on you and says, "Check this out again; you missed

something." While "Dreamland" remains *Angel Street's* best selection, virtually the entire album tantalizes.

Jon W. Poses

**The New York Album: Lee Konitz
Quartet**

Soul Note 121-169-1, LP.

Sound: B Performance: A

There are many unsung heroes in jazz; Lee Konitz is one. An exquisite alto saxophonist who epitomizes consistency, Konitz evinces extraordinary sensibilities and commands powerful textural arrangement skills. His latest triumph, *The New York Album*, is a delicate yet forceful quartet exposition precisely executed with pianist Harold Danko, bassist Marc Johnson, and drummer Adam Nussbaum.

A Tristano disciple, Konitz perseveres, always working pensively, intellectually, and thoughtfully. From the outset, this horn man has defied categorization; he's travelled in and through the big band, be-bop, and "birth-of-the-cool" circles. So light and airy one moment—say on Danko's elaborate "Candlelight Shadows" and Kenny Wheeler's "Everybody's Song but My Own"—Konitz and his cohorts can also dig in big-time and caress Bird-like visions, such as on the classic "Limehouse Blues." Side two of *The New York Album* begins with Konitz's own angular entry, an all-too-brief composition which is an obvious tribute, "Monkian Round."

Throughout this voyage—and Konitz makes you feel as if you are at sea—the ensemble's attitude sails with combined gusto and complementary cooperation and interplay. Make no mistake, however: The saxophonist is the guiding light here, the compass and the ship's rudder; his solo opening on his "Dream Variation" remains the set's bow, the moment that, although it arrives near the album's end, inspires most. On this tune, Johnson enters slowly, becoming Konitz's second voice; they, in turn, are soon joined by Danko's spacious notes. Nussbaum is nowhere to be heard (this is a trio number), but you sense Konitz has him in the room listening, playing silently along. Besides, given a choice, where else would he want to be?

Jon W. Poses

SERIOUS AUDIOPHILES DESERVE SERIOUS SERVICE.

Acoustat • ARK • Audible Illusions • Audio Pro • Audioquest • Bedini • Beyer Dynamic • Blaupunkt • Bose • Celestion • Counterpoint • Crest • Dahlquist • dbx • DCM • Dual • Fosgate • Grado Signature • Haller • Harman Kardon • JBL • JSE • NEC • Niles Audio • Nitty Gritty • Olim Acoustics • Onkyo • Ortofon • Philips • Precise • Proton • PS Audio • Revox • SAE • Sonance • Sony • Sumiko • Stax • Straightwire • Superphon • Talisman • TDK • Teac • Thorens • Ungo Box • VPI • Wharfedale

Reference Audio Systems

Call Us . . . (213) 719-1500
18214 Dalton Ave., Dept. A6, Gardena, CA 90248

VALUEable

Products, Service and Consultation designed to give you the maximum performance for your dollar.

Adcom • B&W • Polk • NAD • Celestion • Carver
PS Audio • Kyocera • M&K • Denon • Tark
Proton • Pioneer Video • ADS • Tera
Canon Video • Stax • Magnum • Linn • Hafler
Ambria • Thorens • Mod Squad • Lexicon
Grado • Signet • Klipsch • Rotel • Nitty Gritty
Tara Labs • Livewire

Systems
Design
Group

(213) 370-8575
1310 Kingsdale Ave.
Redondo Beach, CA. 90278
Mon-Fri 11am-7pm
Sat 11am-6pm

Select Audio Design

"Only the finest in audio components"

Electronics: Accuphase ■ Conrad Johnson ■ Jeff Rowland ■ Motif ■ Muse ■ B and K ■ Marantz ■ Audio Dynamics ■ SAE ■ Dynalab

Speakers: Sound Lab ■ Nestorovic ■ JSE ■ Dahlquist ■ DBX ■ Snell ■ Synthesis ■ Rauna ■ JBL

Turntables: VPI ■ JA Michell ■ Systemdek

Accessories: Carnegie Two ■ Straightwire ■ Vanden Hull ■ Audioquest ■ SME

Your unique audio specialist located at:
2740 E. Oakland Park Blvd.

FT. LAUDERDALE, FLORIDA 33306

(305) 564-0772-0773

FAX: (305) 564-0774

SPEAKERS REBUILT

All makes, all models

Dealer for:

Carver

B&B Research

Rave

Audio Dynamics

Boston Acoustics

B.I.C.

K-Mod

Atlanta Sound Works

2901 Buford Hwy.

AT NORTH DRAUID HILLS RD.

404-325-1808

THE SPEAKER SPECIALIST!

Stop in our factory showroom
or call us at (312)-769-5640
for complete info on our full

line of high performance

SPEAKERS & KITS.

Authorized Dealer For:

Adcom*Arison*B&K*Counterpoint
DynaLab*Meitner*Musical Concepts
Paasound*Proton*PS Audio*VPI
VTL and more.

Car Audio:ADS*Boston Acoustics*Cooustic
Kerwood*Nakamichi*Soundstream

CHICAGO SPEAKERWORKS

5700 N Western Ave, Chgo IL, 60659

Audio Research	Infinity	Meitner
Oracle	Hafler	Vandersteen
KEF	Threshold	Rega Planar
Tandberg	Revox	Nitty Gritty
Snell	CWD	Sony ES
Nakamichi	MIT	Sme V
Denon	Koetsu	Velodyne
Carver	Monster Cable	Adcom
Rogers	Linn HiFi	Janis
NAD	Perreaux	
B&W		
Stax		

	401	
	Worcester	
	Road	
	Framingham	
	Massachusetts	
The	508	
ultimate	879	
audio	3556	
store.	01701	

Natural Sound.

Dealers . . . Just
as you're reading
this ad, so are
thousands of
buyers.

For complete
information on
placing your
ad, call
Carol Berman at
(212) 719-6338.

O'Coin's

SERVING CENTRAL NEW ENGLAND WITH
VALUED PRODUCTS FOR OVER 30 YEARS

AKG. APATURE. AUDIO CONTROL. AUDIO
DYNAMICS. AUDIOQUEST. BEYERDYNAMIC.
BOULDER. CARVER. DUAL. ESOTERIC. FORTE.
HAFLER. HARMAN KARDON. HK CITATION.
INTRACLEAN. KEF. LEVICON. MAXELL. MISSION.
NAD. NITTY GRITTY. ONKYO. ONKYO GRAND
INTEGRA. ORTOFON. PANAMAX. PARASOUND.
PARSEC. POLK AUDIO. REVOX. SONY VIDEO.
TDK. TECHNICS. TRIAD . . . AND MANY MORE
AT PRICES THAT SOUND RIGHT.

O'COIN'S

239 Mill Street Worcester, MA 01602

508-791-3411 x 315

M-F 10-9pm, Sat 9-6pm

DISCOVER, MASTERCARD, VISA . . .

FINANCING AVAILABLE

Aragon . . . Apogee . . . Audible Illusions
. . . Audioquest . . . Audio Research . . .
Bryston . . . Canon . . . Compact Discs
. . . Counterpoint . . . Creek . . . CWD . . .
Denon . . . Dynavector . . . Grado . . .
Lexicon . . . Livewire . . . Magneplaner
. . . Magnum Dynalab . . . Mariah . . .
Mark Levinson . . . Mission . . . NAD . . .
Nova . . . Pinnacle . . . Revolver . . . SME
. . . Sota . . . Sumiko . . . Sumo . . . Stax . . .
Symdex . . . Vandersteen . . . VPI . . . YAMO
And Much More!

Hi Fi Exchange

FORESIDE MALL • ROUTE ONE
FALMOUTH, ME 04105

(207) 781-2326

DEALER SHOWCASE

Savant Audio & Video

For The Novice & Connoisseur

Apogee • Arcici • Atma-sphere
AudioPrism • Audioquest • Basis
Benz • Cardas • Cello • Chesky
Chicago Speaker Stand • Classé
Clearaudio • Cogan Hall • Creek
Distech • Electron Kinetics
Eminent Technology • Garrott
Lantana • Last • Merrill • Mod Squad
Morch • Rega • Reference Recordings
Sequerra • Sheffield Lab • Souther
Superphon • Tara Labs • Tice Audio
Vendetta Research • VMPS • VPI
Wadia • Yankee & More

287 Clarksville Road
Princeton Jct., N.J. 08550
(609) 799-9664



ALPHA STEREO

Quality Components, Professional Installation & Service



NAD

"We are known for the
companies we keep"

Adcom, NAD, Rotel, Onkyo, Dual,
Mission, Celestion, Paradigm,
Soundstream, Boston Acoustics,
Cooustic, Monster Cable, Ortofon
Polk Audio, Alpine, AKG

Northern NY's oldest & most renowned dealer.
345 Cornelia St., Plattsburgh, NY 12901
518-561-2822

Monday-Friday 10am-8pm, Saturday 10am-6pm
Mastercard, Visa, Discover, Amex

Classic Values

Tubes

Conrad-Johnson VTL

Sources

California Audio Labs
Nakamichi Sota Sonographe
Theta Well-Tempered

Transducers

Magnepan Mirage Rogers
Sota Synthesis Stax Velodyne

Audio Den

2021 Smith Haven Plaza
Lake Grove, N.Y. 11755

(516) 360-1990

audio experts

Integrity and Service!

SPECIAL EVENT

Wednesday, August 16th 6-9pm

Come learn all about compact
disc technology as factory
personnel from Denon (the
inventors of digital recording)
introduce their latest generation
of cd players. Refreshments will
be served. Reservations imperative.
**Specializing in Custom Home
& Automotive Installations. We
are pleased to work with your
architect or designer.**

(914) 698-4444

875 Mamaroneck Ave., 
Mamaroneck, NY 10543

The Texas Specialists

AUDIO

- B&W • B&K • Sony ES • Luxman
- Carver • Allison • Sonance • Velodyne
- Lexicon • Canton • Ohm • Shure
- Sound Connections • Van den Hull • M&K
- Dual • Ortofon • Sennheiser • Niles Audio
- Proton • Bose • Sonrise/Xylophile • Target
- Monster Cable • Parasound • Ambria
- White Instruments • Terk

VIDEO

- Sony • Proton • JVC • Minolta • Panasonic
- Sonrise/Xylophile • Pioneer

AUDIO

groove

VIDEO

Financing Available
We Accept All Major Credit Cards

2624 Westheimer at Kirby
Houston, Texas 77098 713-523-2900

Vermont's
Audio Leader!

DUAL
ARISTON

A&R CAMBRIDGE
DENON • SUPERPHON • KLIPSCH
KEF • ADVENT • ADS • ROTEL
MARANTZ • REGA • AUDIOQUEST
B&K • AUDIO CONTROL • AKG
SENNHEISER • CREEK • GRADO
TARGET • AVIA • AUDIOLAB
ORTOFON • SPICA • KIMBER
PRO-AC • VPI • MAGNUM

"INTELLIGENT AUDIO AT
REASONABLE PRICES"

**city
stereo**

207 College St • Burlington, VT • 802-863-4372

**Be as selective
in where you
buy as you
are in what
you buy.**

We know they're hard to
resist. Guaranteed lowest
prices in the universe. Every
day's a sale day. Big, bigger,
biggest.

But, buying a serious audio
or video component isn't the
same as buying a
dishwasher or microwave.
And that's why AUDIO
recommends you visit an
independent A/V specialty
retailer when shopping for
equipment.

A/V product is the heart of
his business, not a
"profitable or trendy"
sideline. That means the
independent dealer will
always be more concerned in
helping you select the proper
equipment than he will be
helping himself to a
commission.

So, be as selective in
where you buy as you are in
what you buy. Support your
independent specialty dealer.

Audio

The Equipment Authority

CLASSIFIED ADVERTISING RATES

BUSINESS ADS—\$2.30 per word, 20 word/\$46 minimum charge per ad.

BOLD FACE ADS—\$2.75 per word, 20 word \$55 minimum charge per ad.

EXPAND AD—\$3.45 per word, 20 word \$69 minimum charge per ad.

EXPAND AD BOLD—\$3.90 per word, 20 word \$78 minimum charge per ad.

JUMBO TYPE—\$7.50 per word, 3 word/\$22.50 minimum charge PER LINE (2x larger than normal type and bold).

CENTERED or SPACED LINE—\$16.00 additional.

BOXED AD—\$15.00 additional for a one-point ruled box.

ALL LINE ADS—First line set in bold type at no extra charge. Additional bold words at \$2.75 extra per word.

CLASSIFIED LINE ADS ARE PAYABLE IN ADVANCE BY CHECK OR MONEY ORDER ONLY. (Sorry, we cannot accept credit cards or bill for line advertising.) **ALL LINE ORDERS** should be mailed to:

AUDIO MAGAZINE, P.O. Box 9125
Dept. 346-01, Stamford, CT 06925

ORDERS WILL NOT BE PROCESSED WITHOUT ACCOMPANYING CHECK OR MONEY ORDER FOR FULL AMOUNT.

CLOSING DATE—First of month two months preceding the cover date. If the first of the month falls on a weekend or holiday, the closing date is the last business day preceding the first. **ADS RECEIVED AFTER THE CLOSING DATE WILL BE HELD FOR THE NEXT ISSUE UNLESS OTHERWISE STATED.**

PREPAYMENT/FREQUENCY DISCOUNTS—3 times less 5%, 6 times less 10%, 12 times less 15%. These discounts apply to line ads only and all payments must be made in advance to qualify. Agency discounts do not apply to line advertising.

GENERAL INFORMATION—Ad copy must be typewritten or printed legibly. The publisher in his sole discretion reserves the right to reject any ad copy he deems inappropriate. **ALL ADVERTISERS MUST SUPPLY:** Complete name, Company name, Full street address (P.O. Box numbers are insufficient) and telephone number. Classified LINE ADS are not acknowledged and do not carry Reader Service Card Numbers. **FREQUENCY DISCOUNTS** not fulfilled will be short rated accordingly. Only those line advertisers who have prepaid for their entire contract time will be **RATE PROTECTED** for the duration of that contract, in the event of a rate increase.

CLASSIFIED DISPLAY RATES

1 col x 1 inch	\$344
1 col x 2 inches	\$543
1 col x 3 inches	\$777
2 cols. x 1 inch	\$618
2 cols. x 2 inches	\$1044

One column width is 2 1/8". Two columns wide is 4 1/4". For larger display ad rates and 6, 12, 18 and 24 times frequency rates call (212) 719-6338.

DISPLAY ADVERTISERS should make space reservation on or before the closing date. Ad material (film or velox) may follow by the tenth. **DISPLAY ADVERTISERS MUST SUPPLY COMPLETE FILM NEGATIVE READY FOR PRINTING OR VELOX. PRODUCTION CHARGES WILL BE ASSESSED ON ANY AD REQUIRING ADDITIONAL PREPARATION.**

ALL DISPLAY CORRESPONDENCE should be sent to: Carol A. Berman, AUDIO MAGAZINE, 1515 Broadway, New York, NY 10036

FOR ADDITIONAL INFORMATION: CLASSIFIED DISPLAY ADS: Carol A. Berman (212) 719-6338. **CLASSIFIED LINE ADS:** 800-445-6066.

CHADWICK MODIFICATIONS

Our speaker cables and interconnects bring the music back to you!

- Upgrades for Thorens turntables & Grado cartridges
- Corktone Platter Mat, F-1 Dustcover Weight and more
- Complete catalog \$3.00, refundable with purchase.

1925 Massachusetts Avenue, Cambridge, MA (617)354-8933

ANNOUNCEMENTS

AUDIO CLASSICS

Precision Stereo Components Bought-Sold-Traded-Repaired-Modified-Updated-Appraised. Offering an excellent and diversified collection of fine audio equipment.

AMPLIFIERS: Classic Audio CA260 \$1299; Conrad-Johnson Premier 1B (\$5950) \$3900, MV50 (\$1685) \$1000; Eagle 2 \$595; Haller XL280 Demo (\$675) \$575, XL600 Demo (\$1195) \$995; Krell KMA100 II (\$6000) \$3700, KSA100 II (\$3650) \$2700; McIntosh MC40 \$400, MC50 \$275, MC60 \$550, MC225 \$700, MC250 \$1000, MC2125 \$1000, MC2002 (\$1895) \$1600, MC2250 (\$2495) \$1700, MC2300 \$1700, MC2500 (\$3495) \$2200; Phase Linear 700 \$200-300; SAE A201 (\$650) \$300; Threshold S200 (\$1950) \$1200. **CARTRIDGES:** Cello Chorale (\$900) \$690, Grace, Grado, Ortofon, Pickering. **EQUALIZERS:** Audio Control Octave (\$179) \$149, Ten \$229, Ten Plus (\$329) \$295; Cello Palletto (\$12,864) \$7,500; McIntosh MQ101 \$99-175, MQ102 \$60, MQ104 (\$500) \$99-285, MQ107 (\$650) \$400; SAE E101 (\$650) \$300. **HEAD AMPS:** audio-research MCP33 (\$1395) \$700. **HEADPHONES:** AKG & Stax. **INTEGRATED AMPLIFIERS:** McIntosh MA230 \$399, MA5100 \$400, MA6100 \$500-600. **PREAMPLIFIERS:** Audio Research SP3A1 \$595; Cello Etude (\$1200) \$800; Conrad-Johnson PV1 \$375; Haller Iris Demo (\$800) \$679; Krell KRS1A (\$8200) \$5900; McIntosh C11 \$700, C20 \$600, C24 \$250, SAE P101 (\$650) \$300. **PROCESSORS:** Audio Control; Lexicon. **RECEIVERS:** McIntosh MAC1700 \$450, MAC4100 \$1100, MAC4200 (\$2890) \$2150, MAC4275 (\$1798) \$1200. **SPEAKERS:** Acoustat; Apogee Duetta Signatures (\$3735) \$2999; Dahlquist DQ10/DQ1W/DQMX1 \$800; JSE Infinite Slope Demos 6 (\$599) \$475, Demo 2 (\$2295) \$1865; McIntosh ML1C \$450-550, ML2C (\$1598) \$900, ML4C (\$2400) \$1100-1800, XL1 (\$525) \$375, XL1W (\$549) \$375, XL10 (\$858) \$400, XR5-19 \$900, XRT20 \$3200; Velodyne ULD 12" (\$1195) \$1095, ULD 15" (\$1795) \$1669, ULD 18" (\$2595) \$2395. **TAPE DECKS:** Kyocera New DB11 (\$750) \$545; Tandburg TCD330 \$300. **TEST EQUIPMENT:** Audio Control SA3050A 1/3 Octave Real Time Analyzer (\$965) \$877; McIntosh M13 \$500, Sound Technology 1000A \$1500, 1701A (\$3600) \$2600. **TONE-ARMS:** Alphason, Premier, SME. **TUBES:** Many major brands. **TUNERS:** Magnum Dynalab FT101 Demo (\$698) \$599, 205 Demo (\$229) \$199, FT101A Demo (\$1195) \$995, FT11 Demo (\$449) \$425; McIntosh MR55 \$100-350, MR65B \$200-500, MR66 \$350, MR73 \$450, MR75 (\$1349) \$900, MR80 (\$2495) \$1600; SAE T101 (\$650) \$300. **TUNER PREAMPS:** McIntosh MX110 \$350-500, MX113 \$600, MX117 \$1200. **TURNABLES:** Ariston; Audiomeca J1 (\$3200) \$1995; Dual: \$700; VPI. Audio Repairs-Updates-Modifications by Richard Modafferi and Cliff Ramsey. Over 55 years combined-experience. **AUDIO CLASSICS** invites you to visit our new retail location at the United States Post Office Building in Walton, NY. FREE Catalogue. Layaway Program. Major Credit Cards accepted. 8AM-5PM EST Mon.-Fri., P.O. Box 176 Walton, NY 13856.

607-865-7200

—Audio Advertiser for over a Decade—

High-end and hard-to-find audio components. New and used. Foreign and domestic. Low, low prices! **AUDIO AMERICA** (Virginia). Call 1-703-745-2223.

Gifted Listener Audio



Ariston • Audioquest • Celestion • ET • Euphonic Technology • Forte • Mirage • Nitty Gritty • Onkyo • Phantom Acoustics • Premier • Scorria • SOTA • Sumiko • SME • Taisman • Threshold • Koetsu • Dynavector • Livewire Books Recordings Accessories

586 Old Centreville Road
Centreville, Virginia 22020

703-818-8000

ANNOUNCEMENTS

AUDIO RESOURCE HAS MOVED to its new 4400 sq. ft. store at 3133 EDENBORN AVENUE, METAIRIE, LOUISIANA 70002. We now have five private listening rooms where you can audition one of the **LARGEST SELECTIONS** of **HIGH END AUDIO EQUIPMENT** in the country. **AUDIO RESOURCE** continues to offer precision-matched tubes, plus sales, service, and restoration of vintage components. Call or write for information on our products and services **AUDIO RESOURCE**, 3133 EDENBORN AVE. METAIRIE, LA 70002. (504) 885-6988.

HOUSTON TEXAS

AUDIOPHILES can now audition important components by Alchemist, Aural Symphonics, Celestion, Emergent Technology Speakers, Euphonic Technology, Forte, Kiseki, MIT, TARA Labs, Threshold, Vanden Hul, VMPS, Well Tempered Labs and more at **STEREOWORKS**. By appointment. (713) 497-1114.



DAT/DIGITAL Ready. Probably the most accurate speakers you will ever own for the price. Exquisite 3/4" cabinet work with oak veneer. Available unfinished, oiled, or black matte wood grain. Built with the finest speaker components from America, Denmark, and England. Samaritan Cobalt tweeter 1,500-20,000hz. 6 1/2" Rolled edge woofer 40-4,000hz. Gold plated binding posts. Transparent sparkling highs with thunderous bass. \$260.00 pr/Two Year Warranty. Hand Made In The USA By Fourth Generation Family. Personal/Cashiers Check Only.

TelePac Communications
310 North Lapeer Drive
Beverly Hills, California
90211-1638 [213] 271-4689
24 Hour Ordering Available

A JANIS BASS SYSTEM

IT'S THE CHOICE
WHEN ONLY THE BEST WILL DO

- Perfect coherence with all speakers
- Flat, calibrated low bass response
- No exaggerated, equalized bass response
- High speed transient response
- Up to four times more amplifier response
- Up to four times more speaker response

John Marovskis Audio Systems, Inc.
2889 Roebling Avenue
Bronx, New York 10461 (212) 892-7419

ANNOUNCEMENTS

BUYING OR SELLING USED EQUIPMENT? Our company will distribute your listing to interested buyers. Send name, address, phone, equipment description, price, \$5 per unit. For complete equipment list send \$5. RJM, Box 294, Mckean, PA 16426.

ANNOUNCEMENTS

INVESTORS WANTED: On Dec. 20, 1989, the most advanced and unique acoustic generating device will be available to the discriminating esoteric audiophile. This state of the art speaker shall be the best and like no other. Period. (Pat. Pend.) For more information on the concept of becoming associated with this speaker company; please send \$15.00 to: AWH, P.O. Box 591, Bellport, N.Y. 11713.

MOSCODES, FUTTERMANS, AUDIO RESEARCH SP3, 6 & 8'S MODIFIED & SERVICED BY GEORGE KAYE, Moscode Designer—Tremendous improvement. Protect your investment. SOUND SERVICES, 238 Liberty Avenue, New Rochelle, NY 10805. (914) 633-3039.

... **NONSPEAKER™**
RESOLUTE, MUSICAL & ULTIMATE. 619/480-4804.

FOR SALE

AAA—AUDIO ELITE IN WISCONSIN!!!
DENON, HAFLER, PS AUDIO, YAMAHA, B&K, JSE, NAKAMICHI, PROTON, CARVER, ONKYO, ADS, VPI, DCM, SPECTRUM, SONOGRAPH, AR, FRIED, NITTY GRITTY, SUMIKO, THORENS, KEF, ADCOM, SUPERPHON, SNELL, M&K, LUXMAN, SPICA and any others you desire. (414) 725-4431.

CALL US WE CARE!!!

AAA—LOW PRICES—HIGH END EQUIPMENT!!!
DENON, PS AUDIO, HAFLER, YAMAHA, B&K, CARVER, AR, NAKAMICHI, SUPERPHON, LUXMAN, THORENS, M&K, SNELL, SPECTRUM, INFINITY, ONKYO, PROTON, KEF, SONOGRAPH, FRIED, NITTY GRITTY, SUMIKO, SPICA and any others you desire. AUDIO ELITE, (414) 725-4431, Menasha, Wisconsin.

OUR PRICES CAN'T BE BEAT!!!

TIPS FOR MAIL ORDER PURCHASERS

It is impossible for us to verify all of the claims of advertisers, including product availability and existence of warranties. Therefore, the following information is provided for your protection.

1. Confirm price and merchandise information with the seller, including brand, model, color or finish, accessories and rebates included in the price.
2. Understand the seller's return and refund policy, including the allowable return period and who pays the postage for returned merchandise.
3. Understand the product's warranty. Is there a manufacturer's warranty, and if so, is it from a U.S. or foreign manufacturer? Does the seller itself offer a warranty? In either case, what is covered by warranty, how long is the warranty period, where will the product be serviced, what do you have to do, and will the product be repaired or replaced? You may want to receive a copy of the written warranty before placing your order.
4. Keep a copy of all transactions, including cancelled checks, receipts and correspondence. For phone orders, make a note of the order including merchandise ordered, price, order date, expected delivery date and salesperson's name.
5. If the merchandise is not shipped within the promised time or if no time was promised, 30 days of receipt of the order, you generally have the right to cancel the order and get a refund.
6. Merchandise substitution without your express prior consent is not allowed.
7. If you have a problem with your order or the merchandise, write a letter to the seller with all the pertinent information and keep a copy.
8. If you are unable to obtain satisfaction from the seller, contact the consumer protection agency in the seller's state or your local U.S. Postal Service.

Does your system sometimes sound different for no apparent reason?

The reason could be your power. A refrigerator or air conditioner, even in another part of the house, may cause voltage to vary whenever they kick on or off. Or you may be getting line noise—electrical interference that your preamplifier and amplifier amplify and send on to your speakers.

Solution? Tripplite LC-1800. It regulates voltage so it's constant—not too low, not too high. Full voltage—even in brownouts. LEDs show you what Tripplite is doing!

Tripplite's patented ISOBAR circuits provide three "banks" of isolation, two receptacles per bank. You can eliminate interference between critical components. It's like putting your CD player, preamp, and power amp all on separate lines. Sonic benefits may be subtle... but real.

Protection, too

And Tripplite prevents spikes and power from damaging your equipment. This protection is absolutely essential if you leave any of your gear on all of the time.

Take a Power Tripple—No Risk!

Try the Tripplite LC-1800 for 30 days. If not satisfied with the performance (and protection), return it for a full refund of your purchase price. Made In USA by Tripple Manufacturing Co., Est. 1922. Only \$299.00 plus \$9.95 shipping in the US. If you want a clean musical signal, start with clean, consistent power. Order now.



Charge It! Amex / Discover / MC / Visa

1-800-942-0220

audio
advisor, inc.

225 Oakes SW • Grand Rapids, MI 49503
616-451-3868 • FAX 616-451-0709

FOR SALE

AAA-CALL US LAST! LUXMAN, DENON, AR, YAMAHA, CARVER, BOSTON ACOUSTICS, ADCOM, PS AUDIO, HAFLE, ADS, B & K, ONKYO, KEF, PROTON, SNELL, DCM, NAKAMICHI, INFINITY, JSE, SPICA, SUPERPHON, M & K, BOSE SPECTRUM, VPI, SONOGRAPH, SUMIKO, THORENS. WHY CALL US LAST? 414-727-0071. WE HAVE THE LOWEST PRICES!!!

AAA-YAMAHA, DENON, CARVER, BOSTON ACOUSTICS, LUXMAN, AR, ADCOM, PS AUDIO, HAFLE, ADS, B & K, ONKYO, KEF, PROTON, SNELL, DCM, NAKAMICHI, INFINITY, JSE, SPICA, SUPERPHON, M & K, SPECTRUM, VPI, BOSE, SONOGRAPH, SUMIKO, FRIED, THORENS, PLUS A LARGE SELECTION OF OTHERS 414-727-0071.

AAAAH! FREE UPS SHIPPING B&K, PS Audio, Celestion, Superphon, Ariston, Ortolon, Onkyo, Classe, B&W. Expert consultation—ask for Audio Dept. THRESHOLD AUDIO, 605 Hebron, Newark-Heath, Ohio 43056, 614-522-4501.

ABARGAIN: TECHNICS STYLUS/GUAGE \$159.; 100CMK4 \$475.; STAX PRO/LAMBDA (#3) \$799.; PRO/LAMBDA (#1) \$499.; GRACE 747 \$169.; F9E (SUPER) \$160.; F93RUBY \$229.; DENON 103D, KOETSU, FR1MK3F \$235.; SGT. PEPPER/UHQ \$169.; ZEISS BINOCULARS. ALL UNUSED; (212) 966-1355 (Day); (201) 863-4278 (Eve.).

ABSOLUTE POLARITY/LEVEL/BALANCE infinite resolution remote controller for virtual direct-wire auditioning by the serious Audiophile. Change polarity instantly, select alternate inputs, make precision level/balance adjustments from your favorite listening position. The Thornton Controller Model 100. \$850 from TBG Productions, P.O. Box 34710, San Francisco, CA 94134. FAX (415) 468-5481. PHONE (415) 467-5697.

ADCOM and B&K MODIFICATIONS by MUSICAL CONCEPTS

Musical Concepts, enjoying our 10th successful year, brings unmatched expertise to Adcom and B&K. Our record is clear! When our products are reviewed, they're compared to the best (*The Absolute Sound*™ #55). Now owners of B&K and Adcom can enjoy the kind of sound that has made Musical Concepts a "runaway" success! Adcom modifications from \$195, B&K from \$219, options include special wire/connectors and dual-mono. Musical Concepts, One Patterson Plaza, St. Louis, MO. 63031, 314-831-1822. DEALER INQUIRIES INVITED.

A&E PHOTON 6000 MONO AMPS. 500W PER CHANNEL. FACTORY INSTALLED UPGRADES INCLUDE: CARDAS HEX WIRE THROUGHOUT, MAS POWER CORDS, SPECIAL TORRID TRANSFORMERS, 4 BINDING POSTS FOR BI-WIRING, ETC. \$6000 NEW + \$1200 FACTORY UPGRADES—ASKING \$3600 WITH FULL WARRANTY. SUITABLE TRADES CONSIDERED. RUTH INDUSTRIES (314) 569-0007, 567-6421.

AFFORDABLE HIGH-END AUDIO. ACOUSTIC ENERGY AE-1, AE-2, AE-4, ASC TUBE TRAPS, AUDIBLE ILLUSIONS (NEW S-120 POWER AMP), AUDIOQUEST-LIVEWIRE, TARA-LABS NEW TFA-RETURN, B&K-SONATA, CELESTION SL-SI BI-WIRE SERIES, CHICAGO STANDS, ENTEC-SUBWOOFERS, EPOS, GOLDAERO, KEF CUSTOM SERIES, KIMBER KABLE, LEXICON, MAGNUM DYNALAB NEW FT-101 ELITE, MISSION/CYRUS, MOD SQUAD, MERLIN LOUDSPEAKERS, NILES AUDIO, PHILIPS AUDIO/VIDEO, PSE, REGA/PLANAR, STAX, SONRISE CABINETS, SONUS FABER ELECTA, TARGET STANDS, TERA VIDEO, VELODYNE. CUSTOM INSTALLATION AVAILABLE. FOR FREE BROCHURE AND LITERATURE CALL: 301-890-3232. J S AUDIO ONE CHILDRESS COURT, BURTONSVILLE, MARYLAND 20866. AUDITION BY APPOINTMENT. MONDAY THRU FRIDAY 10AM TO 7PM. SATURDAY 11 TO 5, MC, VISA, AMEX.

A SOUND EXCHANGE

Utah's New and Used store. Easterners! Look for our new DELAWARE STORE opening this fall. We're cleaning house. Examples: Soundlab Dynastats \$1099, B&K 202+ \$499, Linn LP-12 Itok Arm \$1199, Carver M1.5t \$425. Call for Mailing List, Sound Exchange, 5130 South State Street, Murray, UT 84107. (801) 268-6066.

All the best.

Krell Audio Research B&W
ProAc Thiel Cello Koetsu
Meitner SOTA Versa/Dynamics
Well-Tempered Duntech Aragon
Linn Analogic Design Dahlquist

...and many more!

C&A AUDIO

193 Bellevue Ave. 20 Olcott Square
Upper Montclair, NJ Bernardville, NJ
201 744-0600 201 953-9777

FOR SALE

ATTENTION HAFLE, DYNA, MAGNAVOX OWNERS!

Audio by Van Alstine builds complete new higher performance circuits for you. Not "modifications," but original new engineering designs that eliminate transient distortion, have no on or off thumps, are durable and rugged, and sound closer to live than anything else at a rational price. Our complete do-it-yourself rebuild kits start at \$200, including all new PC cards. Complete wonderfully-musical factory wired amplifiers, preamplifiers, tuners, CD players, and a great \$99 phono cartridge. Write or call for our new illustrated catalog. Audio by Van Alstine, 2202 River Hills Drive, Burnsville, MN 55337. (612) 890-3517.

AS-ONE™ INTERCONNECT

SYMPHONIC CONDUCTOR™
SPEAKER CABLES

MISSING-LINK™
AUDIOPHILE A.C. POWER CABLE

DIFFERENTIAL BALANCED INTERCONNECT

Aural Symphonics

2016 Flintbury Court San Jose, California 95148 408-270-6033
FAX 408-270-6039
IN CANADA: INTERLINEAR 105 RIVIERA DR. UNIT #3,
MARKAM, ONTARIO L3R 5J7 416-479-1893

FOR SALE

AUDIOPHILES: NO RISK AUDITIONINGS! On-premises engineering, state of the-art audio: B&K, Audioquest, Counterpoint, Eminent Technology, JSE, Sosy ES, Kinergetics, Magnum Dynalab, & many more! We pay shipping. SOUND UNLIMITED, 169 Church St., Bristol, CT 06010. Est. 1959, (203) 584-0131.

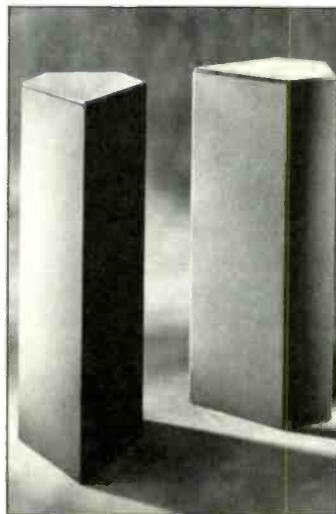

Soundwave Baffleless Speakers

(patent pending)

REFLECTION FREE SOUND

Soundwave loudspeakers have the open, seamless, and transparent sound of the best "panel" (electrostatic, ribbon, and planar) speakers, while offering the superior dynamic range and extended bass response of the best "dynamic" designs. And they offer a stereo image that is second to none.

A revolutionary design, achieved by the utilization of acoustic intensity mapping techniques, Soundwave loud-

speakers have a unique "baffleless" enclosure, special drive units, and a 180 degree radiation pattern. The result is sound so natural and three dimensional, you'll think there are live musicians performing in your listening room.

"Soundwave loudspeakers create a breathtaking stereo image, possess tremendous dynamic range, and are harmonically correct; they're the most musical speakers I've ever heard," says Dr. Christopher Rouse, world famous composer.

"From jazz through the classics, the response (of the Western New York Audio Society members) was always glowing praise!" —Tom Kasperzak.

For further information, write Soundwave Fidelity Corp.
3122 Monroe Avenue, Rochester, New York (716) 383-1650



Model 8-02/B



THE ACCURATE LOUDSPEAKER

Music is an expression of emotion, communicated between the composer and the listener. By allowing the true dynamics and clarity of the music to reach the listener, Nelson-Reed loudspeakers actually accent that communication which is music.

15810 Blossom Hill Rd., Los Gatos, CA 95032 408-356-3633

FOR SALE

AUDIO ARCHIVES IN SAN DIEGO. We have MERLIN SIGNATURE speakers (Cardas-wired), CARDAS cables, WINGATE Class-A amps, CONVERGENT tube preamp, SOUND ANCHOR equipment stands. (619) 455-6326.

AUDIO NEXUS = EXCELLENCE

Featuring legendary VANDERSTEEN loudspeakers & COUNTERPOINT tube electronics.

STEREO COMPONENTS THAT HONOR MUSIC

APOGEE • ARISTON • AUDIOQUEST • BEL • B&K • BRITISH FIDELITY • COUNTERPOINT • EMINENT TECHNOLOGY • FORTE • FRIED • JSE • KIMBER KABLE • KLYNE • MELOS • MERIDIAN • MIT • MONSTER CABLE • MUSICAL CONCEPTS • NITTY GRITTY • ORTOFON • PREMIER • PS AUDIO • PRECISE • ROTEL • ROWNLAND RESEARCH • SME • SONOGRAPHIE • SONY ES • SOTA • SPECTRUM • STAX • SYSTEMDEK • TALISMAN/ALCHEMIST • TUBE TRAPS • VAN DEN HUL • VANDERSTEEN • VENETTA • VTL • Summit, NJ. (201) 277-0333.

CALL US FOR QUALITY AUDIO AT THE LOWEST PRICES WITH FAST SERVICE, EVEN ON ESOTERIC ITEMS

SOUND ADVICE . . . without the price



(914) 666-0550

PO Box 673
Bedford Hills, New York 10507-0673

FOR SALE

ALABAMA—WEST GEORGIA: Quad, Spica, Meitner, Cal Audio, Well Tempered, VPI, Audioquest, MIT and more! ACCURATE AUDIO, 110 E. SAMFORD AVE., AUBURN, AL 36830. (205) 826-1960.

AUDIOPHILE PARTS

WonderCap, Rel-Cap, Solen, Wima, Aselco, Vishay, Holco, Resista, Cardas, VandenHul, MIT, TaraLabs, Teflon, WBT, MisticPost, Tiffany, Gold Aero (10% discount), Grado, Q.E.D., Target, etc. PreAmp (Daniel) and PowerAmp Kits Parts upgrade Kits. Call/Write/FAX for free catalogue. **SONIC FRONTIERS**, 181 Kenilworth Ave., Toronto, Ontario, Canada. Tel: (416) 691-7877, FAX (416) 338-2562.

BARCLAY CD PLAYERS

TARA LABS, DNM and MUSIC METRE—Custom Terminations. Audio Prism Antenna, Creek Electronics, Epos ES14, Musical Concepts, Revolver, **SUPERPHON**, VISA/MC, AUDIO EXCELLENCE, LIVERPOOL, NY. (315) 451-2707.

B&K MODIFICATIONS: IMPROVED DETAILING, INCREASED DEPTH OF soundstage & transparency, deeper & tighter bass. State-of-the-art!! We pay shipping. SOUND UNLIMITED, 169 Church St., Bristol, CT 06010. Est. 1959. (203) 584-0131.
MC/VISA/AMEXP ACCEPTED

BEST TRADES OFFERED. We buy sell, trade, consign most high-end products. Audio Doctor, 1518 W. Commercial, Buffalo, MO 65622. 417-345-7245. COD-VISA-MC. Newsletter.

CABLE TV CONVERTERS: ZENITH, JERROLD, TOCOM, SCIENTIFIC ATLANTA, HAMLIN, OAK, NEW: VIDEO TAPE DESCRAMBLER ONLY \$79.95. CALL NOW! VISA/MC-COD. 415-584-1627.

CABLE TV CONVERTERS. Jerrold, Oak, Scientific Atlanta, Zenith, and many others. "New" MTS Stereo Add on: Mute & Vol., 400 and 450 owners! Visa, Mastercard, American Express, **B & B Inc.**, 4030 Beau-D-Rue Drive, Eagan, MN 55122. (1-800-826-7623).

CALL 1-800-648-6637 FOR THE SWEETEST CD MODS that you can install yourself. We have the Crown S1 D/A converters, \$55. Premium Digital Filter chips, \$45. Call or write for info on these and many other CD player modifications. Solist Audio 348 Tuttle, S.A., TX 78209.

CALL TOLL FREE! 1-800-826-0520 FOR: ACOUSTAT, Apature, Audio Control, Nitly Gritty, M&K, Oracle, Proac, Proton, Stax, Thorens, Dahlquist, Hafler, Monster Cable, Belles, CWD, dbx, Fried, Harman Kardon, 3D, Onkyo, Grado, Audioquest, Celestion, DCM, Duntech, Niles, Clitaton, Kinergetics. Sound Seller, 1706 Main St., Marinette, WI 54143. (715) 735-9002.

CARVER, NAKAMICHI, BANG & OLUFSEN, A.D.S., CROWN, REVOX TANDBERG, HAFLER, ADCOM, MISION, N.A.D., HARMANKARDON, KYOCERA, YAMAHA, LUXMAN, DENON, KLIPSCH, B & W, KEF, D.C.M., E.V. J.B.L., INFINITY, D.B.X., AKG, AND OTHER QUALITY COMPONENTS. BEST PRICES—PROFESSIONAL CONSULTATION. OPEN 24 HOURS A DAY. ALL PRODUCTS COVERED BY MANUFACTURERS' U.S.A. WARRANTY. AMERISOUND SALES, INC., JACKSONVILLE, FLORIDA 32241. EAST: (904) 262-4000 WEST: (818) 243-1168.

CLASSIC AUDIO

CA260 DUAL MONO TUBE AMPLIFIER—10 DAY HOME AUDITION—MADE WITH REAL MCINTOSH TRANSFORMERS—SAVE!! FACTORY DIRECT—IN STOCK—CLASSIC AUDIO, LTD., 238 LIBERTY AVE., NEW ROCHELLE, NY 10805. (914) 633-3039.



THE SPEAKER SOURCE

At Lyric, you'll find more loudspeakers to choose from. And along with all the brands and models on display, more knowledge and experience. More service, too. Which explains why more people around the world make Lyric their source for quality audio components.

Come in and audition speakers from B&W, Boston Acoustics, Cabasse, Celestion, Duntech, Entec, Goldmund, Infinity (including IRS), JSE Infinite Slope, M&K, Magneplanar, Meridian, Mirage, PSB, Quad, Rogers, Sonance, Synthesis, Velodyne, Wilson Audio and others. All models are available for export.

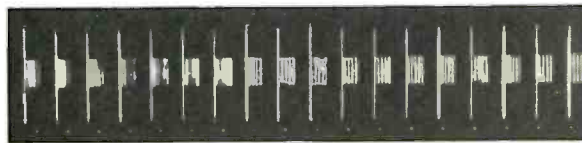

1221 Lexington Ave.
New York, NY 10028
212-439-1900

2005 Broadway
New York, NY 10023
212-769-4600

146 East Post Road
White Plains, NY 10601
914-949-7500

FOR SALE

CASH for USED AUDIO EQUIP. BUYING and SELLING by PHONE. CALL for HIGHEST QUOTE. (215) 886-1650. The Stereo Trading Outlet, 320 Old York Road, Jenkintown, PA 19046.

COMPACT DISC PLAYERS BY MUSICAL CONCEPTS

"EPOCH", with dual-mono outboard supply and sound rated "Best of Summer CES" by many! "ERA" replaces and improves CD-3/TPS (reviewed *The Absolute Sound* #52), separate analog supply, superb imaging, transparent! The "ENIGMA", so much for so little! Complete new "582" chassis, 1yr. warranty! "ENIGMA" \$595, "ERA" \$895, "EPOCH" \$1195. We'll modify 16-bit Philips/Magnavox!

ADCOM, B&K AND HAFLER MODIFICATIONS BY MUSICAL CONCEPTS

Inductorless, refined, transparent! Many former tube lovers are using our amplifiers? Halfer modifications from \$149, B&K from \$219 installed. Adcom (GFA-555, 545, 535) from \$195 installed. Options, include special wire/connectors, Dual-Mono.

NEW STANDARDS

TEFLON™ MC-2 preamplifier retrofits Halfer, B&K and Adcom preamps. Why is the MC-2T replacing \$5000 tube preamps? MC-2T is the ultimate price/performance standard!

SuperConnect III! You can't buy better! \$55/1M pair.

DEALER **MUSICAL CONCEPTS SEND INQUIRIES ONE PATTERSON PLAZA FOR INVITED ST. LOUIS, MO 63031 REVIEWS/ 314-831-1822 BROCHURE**

COPY CD TO DAT!! Direct digital recording rate converter to absolutely preserve the quality of the original CD digital signals recorded to your DAT, Box 908, New London, CT 06320.

Custom DAT Tapes. Three Centuries of French Organ Music & "Fenstermaker Plays Bach". Both from live concerts at Grace Cathedral, from digital masters. \$30.00 each. T-V Recording, Box 70021, Sunnyvale, CA 94086.

Demo clearance sale of new components. Power Amp Jeff Rowland Mod. 7 (Reg. \$4900) \$4000; Mod. 5 Stereo (Reg. \$5500) \$4500; Electrostatic SoundLab A1 (Reg. \$9395) \$7950; Power Amp. Motil MS 100 (Reg. \$3250) \$2700; Preamp Motil MC8 (Reg. \$2250) \$1800; Eminent Technology speakers (Reg. \$3250) \$2600; Call on prices on DBX, Dahlquist, JBL and Snell. (Florida) 1-305 566-9257.

DYNACO ST70 UPGRADES. Get High End Performance for \$450. ST70 kits assembled, repairs and more. DoReTech Audio Services, P.O. Box 6054, South Hackensack, NJ 07606-4354. (201) 233-2659.

EXCELLENT, AFFORDABLE EQUIPMENT BY: B&K, MFA, VPI, MIT, TARA, BERNING, KIMBER, FRIED, SPECTRUM, SYSTEM DEK, WELL TEMPERED, SUMIKO, ANALOGIC, MAGNAVOX, PARASOUND, DEMO SPECIALS, ALPINE AUDIO. (703) 628-3177.

FINAL CLEARANCE of new and demo equipment—Spica Angelus Walnut speakers (\$1195) 750, B&W CM2 speakers (\$1750) \$1295 Mission 763 speakers (\$600) \$375, Energy Reference Connoisseur speakers (\$1650) \$1095, Energy 22 Reference Oak Designer Speakers (\$1180) \$795, Energy 22 Pro Monitor speakers (\$820) \$550, John Bowers (B&W) Active 1 speakers (\$3394) \$995, Sansui DW11 double auto-reverse cassette (\$600) \$350, Kyocera R661 receiver (\$900) \$450, Kyocera DA510CXCD (\$700) \$350, Maplenoil Athena table w/autolite, (\$915) \$595. Call for other specials. The King's Stereo, 1275 Wabash, Springfield, IL 62704. (217) 787-5656.

GAS EQUIPMENT OWNERS: Since 1977 we have offered expert service on GAS equipment. From repairs to complete rebuilds with a one year guarantee. Our work compares with today's finest. We've kept the fire burning! Call or write: **GASWORKS** 5563 Kendall Street, Boise Idaho 83706. (208) 323-0861.

HAFLER, TEXAS BIGGEST DEALER, TOBY CORPORATION. Also ROTEL, TOBY HI-TECH HOME, CAR SPEAKERS, SATELLITE, SUBWOOFER SYSTEMS. (817) 732-6301. 2060 Montgomery; Fort Worth 76107.

HIGHER FIDELITY

800-438-6040

FOUR PRIVATE LISTENING ROOMS
1620 South Blvd, Charlotte, NC 28203
704-376-0350

Authorized Dealer for:

AKG • AMERICAN AUDIO • ARAGON • ARISTON
AUDIOPRISM • AUDIOQUEST • AUDIOSOURCE • BEYER
B&W • CAMBRIDGE • CELESTION • CHICAGO
COUNTERPOINT • CRAMOLIN • DAHLQUIST • GRADO
KOSS • MAGNUM DYNALAB • MAY AUDIO • MEITNER
MOD SQUAD • NILES • RATA • ROTEL • SENNHEISER
SHURE • SONRISE • SUMIKO • SUMO • SUMO ARIA
SYSTEMDEK • TERK • TWEED • VAN DEN HUL
VAMPIRE • VPI • WBT • ZETA AND MORE. ALL MAJOR
AUDIOPHILE RECORDINGS AND COMPACT DISCS. ASK
ABOUT OUR PROFESSIONAL AUDIO DIVISION.

DAT—We have legal DAT with full warranty.

FOR SALE

GENTLY USED CLASSICS ARC SP-11 MKII Black \$3199.00, INFINITY Gamma \$4499.00, CLASSE AUDIO DR-9 \$2499.00, CAL Tempest II \$2150.00, VPI HW-19 MKII, Black \$699.00, SOTA Sapphire \$599.00, SME IV \$699.00, THRESHOLD FET 10 Phono stage \$995.00, MEITNER MTR-101 \$1699.00, MEITNER STR-50 \$599.00, MEITNER PA-6 \$995.00, MELOS GK 1+1 \$519.00, VAN DEN HUL Silver, 1M \$699.00, LAZARUS H-1 \$799.00. Everything mint! Galen Carol Audio 512-494-3551.

HIGH-END, LOW PRICES. ADS • BANG & OLUFSEN • CARVER • DBX • DENON • H • K • NAKAMICHI AND MANY MORE! FULL MANUFACTURERS WARRANTY. TECH ELECTRONICS SYSTEMS. SINCE 1981. GAINESVILLE, FL (904) 730-3885.

DAT

Digital Audio Tape

We have digital audio home, portable and professional cassette recorders and tapes (blank & prerecorded) **IN STOCK NOW!**

We were the first U.S. company to import both CD and DAT into the U.S. We carry various DAT decks and offer the latest models as soon as they become available. We also carry DAT Rax 60, solid oak cassette holder.

**Audio Gallery
(213) 829-3429**

2716 Wilshire Blvd., Santa Monica, CA 90403

FORTE

The performance of "exotics" for the heart of your music system

Critical music listeners agree that Forté components furnish a level of performance comparable to state-of-the-art "exotics."

The Forté Model 2 pre-amplifier provides gain for either moving coil or moving magnet cartridges with a single ultra-low noise stage. "Straight-line" circuit design, class A operation throughout, the highest quality parts, and a separate power supply assure that the phase and amplitude characteristics of the source material are precisely maintained.

The Forté Model 1a pure class A or Model 3 high bias class AB power amplifiers can be used to bi-amp, bi-wire, or conventionally drive any high-accuracy loudspeaker—even those considered "difficult" as a load.

State-of-the-art musical accuracy coupled with the reliability of superior parts and construction make these Forté components worthy of consideration for any high performance music system.

For more information on these Forté products, write: Forté Audio, 12919 Earhart Avenue, Auburn, California 95603, or call 1 (800) 888 8055. Forté products are exclusively distributed by

INCORP

division of Threshold Corporation.



Model 3 amplifier
Model 1a amplifier
Model 2 preamplifier

SPEAKER WIRE • AUDIO INTERCONNECTS • SOUND CONNECTORS • TONEARM CABLES • SOLDER

...audible results with the finest in connecting components.

Vampire

201F flag hip dr. lutz. fla. 33439 (813) 948-2707

HUL MATCHED CRYSTAL CABLE • HEADSHELL LEADS • BINDING POSTS

FOR SALE

JAY'S AUDIO. NEW HAMPSHIRE'S AFFORDABLE AUDIO DEALER. AMPS, PREAMPS, SPEAKERS, TURNTABLES, CABLES AND CD PLAYERS. WILL BUY MINT USED HIGH-END EQUIPMENT. (603) 883-1982.

MAGNAVOX CD's: CDB480 \$135, CDB482, \$159, CDB486, CHANGER \$259, CDB473 \$199, CDB582, CDB586, CDB650—CALL TRADES WELCOME Mod Squad, Audioquest, Philips/MODS, Soundcraftsmen, Monster Cable, Heybrook, Apature. FREE CATALOG!! DIGITAL SOUND: (312) 674-8024.

MARTIN-LOGAN CLS, \$1500.00; Counterpoint SA-3000 preamp-new, sealed, retails for \$1895.00, sell for \$1325.00; Counterpoint SA-3.1 preamp, latest, \$675.00; Counterpoint SA-1000, \$525.00; Entec SW-1 subwfr., \$1100.00; Focus 7 spkrs w/stands retail for \$1200.00, sell for \$400.00; Symdex Sigma spkrs w/Omega sub-wfrs., \$2400.00 when new, sell for \$1000.00; Carver TX-11 tuner, \$200.00; Acoustat 2 + 2 spkrs w/Medallion, \$895.00; Enigma sub-wfr., like new \$795.00 SOTA pwr. line cond., \$100.00; Acoustat TNP preamp, \$100.00; ADC SS425X equalizer, \$100.00, Eminent Tech. #2 arm, \$450.00; Monster Alpha 2 cartridge, good cond., \$100.00; Monster Alpha 2 high output cart., gd cond. \$100.00; Magnum FT-101 tuner, \$250.00; Goldmund Studio Turntable, latest, like new, \$1800.00 (603) 888-6017.

MCINTOSH

Bought-Sold-Traded-Repaired. FREE Catalogue. See our ad at the beginning of the classifieds. **AUDIO CLASSICS**, POB 176MM, Walton, NY 13856 607-865-7200. 8AM-5PM EST Mon.-Fri.
—Audio Advertiser for over a Decade—

MCINTOSH. JBL (ALNICO), Krell, M. Levinson, and other high end audio components. Let us find your hard to get items. Call John Wolff, 313-229-5191 (24hrs. machine)

MIT cables, custom terminations, Camacs, XLR balanced, hi-flexibility tonearm sets. Shotgun CVT; MIT hookup for internal rewiring; Athena PolyPhasors; ATMA-SPHERE OTL amplifiers, CLEMENTS speakers, VENETTA RESEARCH, VAN DEN HUL GRASSHOPPER, ASC Tube Traps; Wonder Caps-solder-wire; Resistas; Edison Price, Odyssey, Tiffany connectors; Simply Physics Tone Cones & Iso-drive; many accessories-mod parts, \$1 catalog (\$3 overseas); Michael Percy, Box 526, Inverness, CA 94937; (415) 669-7181.

SPEAKERS DRIVERS IN CANADA

sean vifa morel scan-speak DYNAUDIO FOCAL

CROSSOVER, SPEAKER COMPONENTS
SOLENCROSSOVERS
 Custom Computer Design
 Passive Crossover for Professional, Hi-Fi and Car Hi-Fi Application.
 Power up to 1000 Watt.

SOLENDUCTORS
 Perfect Lay Hexagonal Winding Air Cored
 Values from .10 mH to 30 mH.
 Wire Sizes from #20 AWG to #10 AWG

CHATEAURoux CAPACITORS
 Metallized Polypropylene (Non-Polarized)
 Values from 1.0 mfd to 200 mfd.
 Voltage Rating: 250 VDC / 150 VAC

CROSSOVER, SPEAKER PARTS
 Mylar Capacitors, Power Resistors, Crossover Terminals, Nylon Ty-Wrap, Binding Post, Banana Plugs, Speaker Terminals, Grill Cloth, Plastic Grill Fast Snap, Neoprene Gasket, Misc. Parts.

COMPUTER AIDED DESIGN FOR ENCLOSURE AND CROSSOVER AVAILABLE TO CUSTOMER
 Product specifications and prices available upon request.

SOLENC INC.
 4470 Thibault Ave
 St. Hubert, Quebec
 J3Y 7T9 Canada
ORDERS: Tel.: (514) 656-2759

PLEASE, NO MAIL ORDER

NAD	CARVER	DENON	BANG & OLUFSEN
ADS	M&K	ENERGY	DBX SOUNDFIELD
CWD	GRADO	ELITE	AUDIO CONTROL
DCM	PULSAR	SIGNET	MONSTER CABLE
NEC	KOSS	TALISMAN	UNICO BOX
			AMBRA

Call for store hours
 (718) 961-9888
 115 W 40th St.
 NYC, NY 10018
 (betw B'way & 6th)

173 Broadway
 NYC, NY 10007
 (NW corner of
 B'way & Carlant)

184 10 Horace Harding Expwy.
 FreshMeadow, NY 11365 (Exit 251E)

FOR SALE

CARVER, NAKAMICHI, BANG & OLUFSEN, A.D.S., CROWN, REVOX TANDBERG, HAFNER, ADCOM, MISION, N.A.D., HARMAN/KARDON, KYOCERA, YAMAHA, LUXMAN, DENON, KLIPSCH, B & W, KEF, D.C.M., E-V, J.B.L., INFINITY, D.B.X., AKG, AND OTHER QUALITY COMPONENTS. BEST PRICES—PROFESSIONAL CONSULTATION. OPEN 24 HOURS A DAY. ALL PRODUCTS COVERED BY MANUFACTURERS' U.S.A. WARRANTY. AMERISOUND SALES, INC., JACKSONVILLE, FLORIDA 32241. EAST: (904) 262-4000 WEST: (818) 243-1168.

HYBRID III Driver Board updates Dynaco MKIII to latest audio standards. Precision parts factory assembled and tested. Includes unpopulated power supply board for extra storage. Sutherland Engineering, Box 1363, Lawrence, KS 66044. (913) 841-3355.

SOUND INVESTMENTS

If you own vibration sensitive equipment like CD players, turntables, VCR's or videodisc players you can greatly improve your systems sound quality with AQ's Sorbothane Big Feet and CD Feet. They are simply amazing in their ability to eliminate unwanted vibration.

"You can't buy more improvement for less!"

aq audioquest

P.O. Box 3060
 San Clemente, CA 92672 USA
 Tel: 714/498-2770
 Fax: 714/498-5112 Tlx: 205864

ATTENTION DENON CUSTOMERS

Not everyone offering Denon products for sale is an authorized Denon dealer. This has great significance to you as a potential Denon customer.

Denon America's warranty applies to the original purchase only. Denon products sold by non-authorized dealers are not covered under this or any other warranty.

Additionally, some of this equipment may have been designed for foreign markets and therefore will not meet Denon America's specifications.

So look for the Authorized Denon Dealer Sticker before you buy.

To find your nearest AUTHORIZED Denon Dealer call: 1-201-575-7810 (9:00am - 5:00pm EST)

FOR SALE

NOW FOR MAGNEPANS

Improve bass and imaging at minimum cost! Stop speakers from rocking on thick carpet. Our GROUNDING SPIKE firmly couples your speaker to the floor. Call/write for free information. SOUND FUNDAMENTALS, 24002 Swallowtail, Laguna Niguel, CA 92677. (714) 831-9721, 8-5PST.

NYC HI-FI AND MUSIC COLLECTIBLES FLEA MARKET: An Earful. September 10th, Sunday at downtown NYC Cafe Ham Heaven. Classic and collectible Hi-Fi, theater and studio sound equipment, radios, records, tapes and tubes galore. Exhibitor spaces \$30 & \$40. Buyers admission: \$4. An Audiomotivating event. Reserve now—call Larry (609) 426-9744, before 10PM, EST.

PAUL HEATH AUDIO

Audiophile Illusions, B&K, Classe Audio, Cardas Theta, Iverson Eagle 400, Gryphon, Dynalab, Epos, PS Audio, Philips Audio-video, Melos, MFA, MIT, Mod Squad, Merlin, TDL, Quicksilver, VPI, Well-tempered, 217 Alexander, Rochester, NY 14607. (716) 262-4310.

PS AUDIO — SUPERB!

Fast, **FREE** shipping! Knowledgeable, friendly service! Audire, Chesky, CWD, Fried, Grado, Kinergistics, Mirage, Monster Cable (M-series), Quad, SME, Sota, Spica, Stax, Straightwire, Thorens, more. **READ BROTHERS STEREO**, 593 King Street, Charleston, South Carolina 29403. (803) 723-7276.

REVOLUTIONARY 35MM 3-DIMENSIONAL CAMERA. Incredibly Beautiful Photographs. Easy To Operate. Brochure, Including Sample Photograph, **ONLY \$2.** **NEW AGE OPTICAL**, (714) 731-2129; 1088 Irvine Blvd., Suite. 371-20, Tustin, CA 92680.

SAN FRANCISCO AREA—IRRESISTIBLY priced audiophile components. Shipped/delivered. New/used. World's best CD Players/speakers/electronics/cables/turntables. 1548 Center Rd, Novato, CA 94947 (415) 898-1464.

60 YEARS IN BUSINESS...WE MUST BE DOING SOMETHING RIGHT! If it's a much-in-demand audiophile product, we're likely to have it for immediate shipment. Consult with one of our quiet experts or just order U.S.—warranted components directly. **VISA/MC**. Ask for Steve K. or Dan W. **SQUARE DEAL**, 456 Waverly Ave., Patchogue, N.Y. 11772. (516) 475-1857.

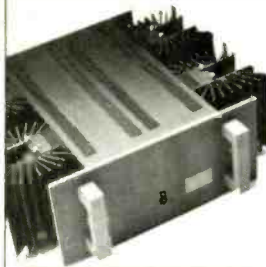

HI-FI HEAVEN

BRANDS AND MODELS ON DISPLAY

- KRELL "ALTAIR" POWER AMP
- DUNTECH SOVEREIGN II
- WADIA DIGITAL
- CAL TEMPEST II SPECIAL EDITION
- MGNSTER CABLE SIGMA SERIES
- MIRAGE M-1
- ONKYO TG-10 FM TUNER

1917 S. WEBSTER
GREEN BAY, WI 54301
(414) 437-8727

FOR SALE

SAVE 40% ON HIGH-END home speakers, subwoofers, amplifiers. FREE CATALOG! CATALOG, 3121 Sangamon Ave., Springfield, Il. 62702. (217) 529-8793.

Savings to 40%. Nobody beats our prices. Midfi to highend. Over 150 product lines. Free Shipping. Full US Warranty. **Quality Audio** 902-582-3990 7-10pm Eastern Time.

SELLING: MCINTOSH MCD7005, MC2500, XRT22 (OAK), MQ101.102, MC2205, C33, CONRAD JOHNSON PREMIERE 3.4.6, HV2, AUDIO RESEARCH SP111I, D1155II, M100, COUNTERPOINT SA12, SA20, MARK LEVINSON ML3, CLASSE AUDIO DR7, TURNTABLE, AR, ORACLE, LINN, SONY, SANSUI AV RECEIVER, PIONEER LD700, LD900, CLD1030, ALTEC WOOFERS & HORN, YAMAHA SUBWOOFER . . . **WANTED:** MCINTOSH, MARANTZ, LEVINSON, KRELL, ARC, TOP PRICE, MCINTOSH LOCATER 201/935-4026 (NJ).

VELADYNE ULD 18 \$1200, KEF 104-2 \$1000, KRELL KSA 100 MARK II \$2400, (312) 423-7680.



Shown: The Audio Control Phase Coupled Activator™

Excite. Fulfill. Reclaim.

The Phase Coupled Activator™ digitally reconstructs lost music.

Lurking beneath the surface of every record — and most CD's — are ultra-low fundamental notes that have been lost from the moment they left an instrument. Lost to microphones, recording processes and mastering. Even the best cartridge, biggest woofers or most advanced CD player can't bring them back. . . . The first bass-recovery device that we can unhesitatingly recommend to audiophiles."

— *High Fidelity*
Using patent pending intelligent circuits the Audio Control Phase Coupled Activator detects harmonic artifacts and digitally reconstructs the previously lost portion. Musically. Without introducing unrealistic by-products. "The Phase Coupled Activator added clarity and definition to the bass." — *Stereo Review*
"Compared to other bass enhancers, the Phase Coupled Activator reigns as state of the art." — *Chicago Tribune*

That's because it isn't really an "enhancer" at all; it's a *restorer*. Designed and built in America by a company with a 10-year reputation for quality and value. Packed with extras like a separate video circuit that works wonders on bass-shy rental tapes, cable and regular broadcasts. And a built-in 18dB/oct. programmable electronic crossover.

"My stereo now sounds (and feels) like I have always fantasized the 'ultimate sound' to be. Outstanding!" — *D.H., Torrance, CA*

Discover why initially skeptical reviewers and audiophiles are raving about the Phase Coupled Activator. Enjoy live performance bass. Visit your nearest Audio Control dealer or write us for more information.

AudioControl™

22313 70th Ave. W. Mountlake Terrace, WA 98043 (206) 775-8461

Stop.

Stop and consider the Allison difference. Roy Allison's unique room-matched design ensures that your loudspeakers sound as good—or better—at home as they do in the store. Unmatched quality control for top performance. Specifications are guaranteed by a full five-year warranty.

Look.

Look at the sculptured beauty of natural wood veneer cabinets, hand finished to look as great as they sound.

Listen.

Listen to the closest replica of the original music as is possible today.

Call us toll free at 1-800-225-4791 for the name of your nearest Allison dealer. (In Massachusetts call 508-788-1500.)

ALLISON™

A little bit different.

1590 Concord St., Framingham, MA 01701

HERE

... is where you will find knowledge, experience, honesty, value, and over fifty of the finest names in audio.

Krell, Apogee, SOTA, Quad, Counterpoint, VPI, Eminent Technology, Wilson Audio WATT, Meitner, California Audio Labs, Quicksilver — MORE!

We sell virtually all cable and accessory lines.

Call us for friendly advice and a free copy of our informative Newsletter.

Galen Carol Audio P.O. Box 17562 San Antonio, TX 78217 512-494-3551

AmEx VISA
MASTERCARD
10 AM - 7 PM DAILY

The
DA
Digital Audio Tape
STORE

2624 Wilshire Blvd. Santa Monica, CA 90403
(213) 828-6487 • FAX: (213) 470-6176

DIGITAL AUDIO TAPE RECORDERS
PROFESSIONAL
PORTABLE
HOME

ALL BRANDS IN STOCK NOW!!!
FULL WARRANTY • ENGLISH MANUALS
TRANSFORMERS, TAPES and
ACCESSORIES AVAILABLE

Shipping VIA UPS/FED-EX

WAVEGUIDE

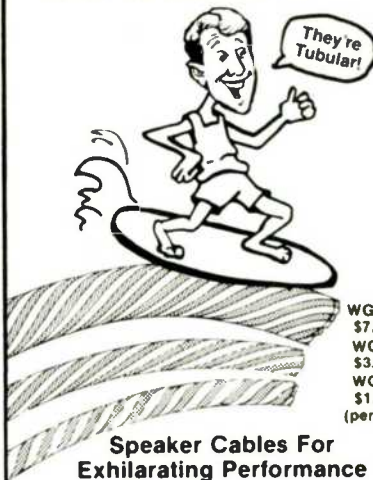

WG-16
\$7.00
WG-8
\$3.50
WG-4
\$1.75
(per ft.)

Speaker Cables For
Exhilarating Performance

STRAIGHT WIRE

1909 Harrison St. #208 / Hollywood, FL 33020
Telephone (305) 925-2470

FOR SALE

SUMO

AMPS • PREAMPS • TUNERS • SPEAKERS
MUSICALLY ACCURATE AND QUALITY CRAFTED AUDIO
COMPONENTS. DESIGNED AND BUILT IN THE U.S.A.
(214) 347-2191.

OPTIMA AUDIO

SOTA Panorama: Small is Beautiful

To neutralize the loudspeaker enclosure—so drivers move only with the music—that is the first task of the SOTA design team. Minimize colorations at the source and you neutralize all sorts of room gremlins.

That is what SOTA does best. We neutralize gremlins. Using mass, rigidity and all the energy controls for damping resonances that made us America's pre-eminent turntable maker, we propose to transform the small monitor just as SOTA turntables redefined the high end turntable world eight years ago. Our goals:

- Resolution and coherence second to none, especially in bass extension.
- Compatibility with the widest range of electronics and rooms.
- A gorgeous form equal to the gorgeous performance.

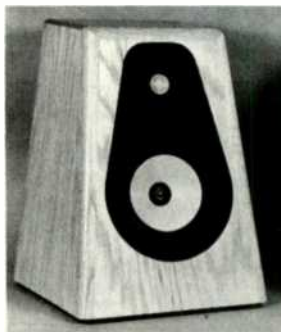

The result of our research: the optimum "truncated pyramid" shape; all curved corners to minimize refraction; and heavily-braced, laminated 1/4" thick walls. Plus, the latest kevlar drivers and ultimate crossover components. The classic two-way speaker may never be the same.

SOTA
industries
P.O. BOX 7075, Berkeley, CA 94707

FOR SALE

SONY TAPE DELIVERED: UX-PRO-90 268./100, METAL-ES-90 362./100, P6-90 248./40, L-500-PRO-X 235./40, T-120-PRO-X 287./40, Sennheiser, AKG, A-T, dbx, Uher, Loftech, Carpenter/GHP, P.O. Box 1321, Meadville, PA 16335-0821.

Sound Technology Test Equipment Bought-Sold-Traded. See our list at the beginning of the classifieds. AUDIO CLASSICS, POB 1765T, Walton, NY 13856 607-865-7200. 8AM-5PM EST Mon.-Fri.

—Audio Advertiser for over a Decade—

TRANSCENDENCE THREE—Finally musical reality!

Announcing the stunning original new hybrid Fet-Valve designs from Audio by Van Alstine. The Fet-Valve Amplifiers, the Fet-Valve Preamplifiers, and the Fet-Valve CD Players. A perfect combination of tubes for voltage gain and power fets for current gain, each used ideally! The result is musical reality—the closest approach to live music in your home short of bringing in the musicians. One listen and you will be satisfied with nothing less. Now ultimate musical enjoyment is much less expensive. Write or call for our illustrated catalog. Audio by Van Alstine, 2202 River Hills Drive, Burnsville, MN 55337. (612) 890-3517.

LOUDSPEAKERS

SpeakerBuilder

THE LOUDSPEAKER JOURNAL

The world's only magazine for people who love building all kinds of loudspeakers—from bookshelf kits to electrostatics to horns. A rich mix of how-to-do-it and theory. Only \$35 for 2 years (12 issues), 1 year for \$20 (6).

Box 494, Dept. A83, Peterborough, NH 03458 USA
(Outside USA add \$4/year postage. US \$ only.)

A&S SPEAKERS offers high-end speaker components, kits and systems in the Bay Area and mail order. We have all of the legends: Audax, Dynaudio, Scan-Speak, SEAS, Morel, Peerless, Focal, Eton, VMPS, others. Free literature. A&S Speakers, 3170 23rd Street, San Francisco, CA 94110. (415) 641-4573.

ANALOG READY? For \$3800 our Audio Mirrors achieve higher fidelity than ANY PAIR of speakers from ANYONE at ANY PRICE. GUARANTEED! Dipoles, Dipoles subs and 1000 watt Omnis also available. FREE information. Analog One, Box 7202, St. Paul, MN 55107-0202. (612) 222-2296

BEST SELECTION—50 HOME, SUBWOOFER, CAR & PRO SPEAKERKITS. JBL, B&W, AUDAX, MOREL, PEERLESS, SEAS, VIFA, 24DB ELECTRONIC CROSS-OVER. 40p CATALOG. \$2. GOLD SOUND, BOX 141A, ENGLEWOOD, CO 80151.

CARVER, NAKAMICHI, BANG & OLUFSEN, A.D.S., CROWN, REVOX, TANDBERG, HAFLER, ADCOM, MISSION, N.A.D., HARMAN/KARDON, KYOCERA, YAMAHA, LUXMAN, DENON, KLIPSCH, B & W, KEF, D.C.M., E-V, J.B.L., INFINITY, D.B.X., AKG. AND OTHER QUALITY COMPONENTS. BEST PRICES—PROFESSIONAL CONSULTATION. OPEN 24 HOURS A DAY. ALL PRODUCTS COVERED BY MANUFACTURERS' U.S.A. WARRANTY. AMERISOUND SALES, INC., JACKSONVILLE, FLORIDA 32241. EAST: (904) 262-4000. WEST: (818) 243-1168.

DYNAUDIO SPEAKER KITS

AUTHENTIC FIDELITY. We believe that superior sound quality sells itself. To that end, we extend to you, the Akustik experience. Advanced Akustik, 4555 Pershing, Suite 33-184, Stockton, CA 95207. (209) 477-5045.

FIND OUT WHY AUDIO CONCEPTS INC., sells more high-end speaker kits and parts than anyone in the country. Catalog Toll Free: 1(800) 346-9183. Allow 4-6 weeks for delivery. First class mailing send \$2 to Audio Concepts, Box 212, LaCrosse, WI 54601.

LOUDSPEAKER COMPONENTS-KITS. Dynaudio, Morel, Eclipse, Focal, Peerless, Eton, Vifa, more! Crossover parts—design books also. Catalog \$1. Meniscus, 3275W Gladiola, Wyoming, Michigan 49509. (616) 534-9121.

LOUDSPEAKERS

FRIED SPEAKERS & KITS

State-of-the-art! Amazing performance/price! **FREE** shipping. Knowledgeable, friendly service! Audire, Chesky, CWD, Grado, Monster, PS, Quad, Sota, Spica, Stax, Thorens, more. **READ BROTHERS STEREO**, 593 King Street, Charleston, South Carolina 29403. (803) 723-7276.

HIGHTECH Loudspeaker Manufacturer Home/Auto: Die Cast Drivers, Metal Dome Tweeters. Representatives Wanted. AudioLab, Box 18009, Seattle, WA 98118. 1(206) 323-4987, Fax 1-206-325-7601.

LEGACY-1 LOUDSPEAKERS BY REEL TO REAL DESIGNS: Probably the most accurate speaker system you'll ever own. Samarium Cobalt leaf tweeter hands off to a 30mm European dome. Vocals are recreated by the most remarkable cone driver anywhere. A multi-chambered, slot-loaded dual woofer configuration extends bass response to 16 Hz. Biampable through Tiffany gold binding posts and high definition cable. Elegant 43" tower design. Ten year warranty. \$1648 pr shipped prepaid. Ten day home trial. RTD. 2105 Claremont, Springfield, IL 62703. 1(800) 283-4644.

SOUND ANCHORS Specialty Audio Stands

SOUND ANCHORS stands come **PREFILLED** with special materials to dampen resonances and add mass. you don't have to fool with sand or shot. **SOUND ANCHORS** stands are engineered to interface with your specific components and speakers so they sound their best...period. Special stands are available for these speakers. **Vandersteen 2-C, B&W 801 Matrix, Spica TC-50, Sota Panorama** and now **Magnepan** models MG 2C/2.5 and MG 3A. For information and the name of your nearest dealer please call (407) 724-1237.

CD PLAYERS

ORGANIZE AND ALPHABETIZE YOUR CD SELECTIONS WITH THE NEW 26 CARD INDEX SYSTEM. SEND \$5.99 EACH SET PLUS \$2.00 SHIPPING TO: AARON DISTRIBUTION, 3262 SUPERIOR LANE, SUITE 101-A2, BOWIE, MARYLAND 20715.

audio-technica *Twek*

YOUR SEARCH IS OVER!

We specialize in hard to find phono cartridges and original replacement styli or lyli!

(800) 221-0906

CAL. TOLL-FREE FOR FREE PRICE QUOTES AND VISA/MC ORDERS N.Y. STATE (518) 599-1112

SEND SELF ADDRESSED STAMPED ENVELOPE FOR OUR FREE CATALOG.

LYLE CARTRIDGES
Dept. A, Box 158
Valley Stream, N.Y. 11582
Phones Open Mon-Sat 9 am-8 pm

ortofon SHURE STANTON

CD PLAYERS

COMPACT DISC PLAYERS

Knowledgeable, friendly service! Finest brands. **FREE** shipping. **READ BROTHERS STEREO**, 593 King Street, Charleston, South Carolina 29403. (803) 723-7276.

COMPACT DISCS—AT LOW WAREHOUSE PRICES. Now in our 5th year. CATALOG: Send \$2.00. Oz Warehouse, 1575P Hwy 29, Lawrenceville, GA 30244.

PHILIPS COMPACT DISC PLAYERS PHILIPS CD-960 & CD-880, REMARKABLY SMOOTH & DETAILED. EXCELLENT DYNAMICS. CD-680 EXCEPTIONAL VALUE UNDER \$300.00. FOR INFORMATION CALL (301) 890-3232. J.S. AUDIO, ONE CHILDRESS COURT, BURTONSVILLE, MD 20866. MONDAY THRU FRIDAY 10am. TO 7pm. SATURDAY 11-5 M/C VISA AMEX.

Your Records will sound better and last longer.

Audio Advisor's New "Record Doctor" vacuum cleans records... spotless! Only \$169.95

You don't have to spend \$300 or more to clean your records right—liquid application and vacuum suck-up. New "Record Doctor" exclusively from Audio Advisor cleans records right for only \$169.95.

Get serious

Serious audiophiles ALWAYS vacuum-clean their records—for less surface noise and fewer ticks and pops. Sound is clearer, cleaner... the music more natural. Your amplifier doesn't have to amplify noise!

Longer record life

Records LAST LONGER because your stylus no longer pushes particles of dust into soft vinyl grooves. You protect irreplaceable, priceless LPs for years to come. The "Record Doctor" pays for itself!

Sucks up debris

Record Doctor's powerful vacuum sucks up fluid, safely removing dirt, dust, grease and fingerprints. Debris is sucked up, NOT picked up from one part of the record and left on another.

"I can't believe how good my records sound. Record Doctor gets rid of the grunge that was getting between me and the music," says D.P.G., Brooklyn, NY.

"You are right. Record Doctor does the job just as well as an expensive machine," writes D.K. from LA. "And I'd rather rotate the records myself anyway!" (Expensive machines have an extra motor to rotate records. Rotate them yourself and save!)



The Record Doctor™

You get the complete package: vacuum machine, professional applicator brush, and cleaning fluid—all for only \$169.95 (220v version \$189.95) plus \$8.95 shipping & handling in US. Satisfaction guaranteed—no other machine near this price cleans records better.

Charge It! Amex / Discover / MC / Visa

1-800-669-4434

audio advisor, inc.

225 Oakes SW • Grand Rapids, MI 49503
616-451-3868 • FAX 616-451-0709

Now available from Madisound:
NEW AUDAX DW50A
Introductory Special: **\$25 per pair***



This is the next generation of tweeter following in the tradition of the Audax TW60a. With its low resonance and high efficiency, this is an ideal choice for a car two-way system.

*includes 2 each (tweeter, wedge, ring, and crossover).

- Direct Drive 19mm Dome Tweeter
- Voice Coil Diameter 14mm
- 4 Ω
- wedges
- 94 db sensitivity (1watt @ 1 meter)
- Resonant Frequency 2050 hz.
- Power handling 70 watts @ 5Khz
- 6 db crossover featuring Carli polyester capacitors
- Dimensions—6cm X 6cm

Frequency Response

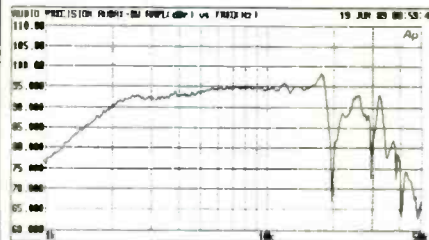

Ordering Information: All speaker orders will be shipped promptly, if possible by UPS. COD requires a 25% prepayment, and personal checks must clear before shipment. Adding 10% for shipping charges facilitates shipping procedure (Residents of Alaska, Canada and Hawaii, and those who require Blue Label air service, please add 25%). There is no fee for packaging or handling, and we will refund to the exact shipping charge. We accept Mastercharge or Visa on mail and phone orders.



MADISOUND SPEAKER COMPONENTS
8608 UNIVERSITY GREEN
BOX 4283
MADISON, WISCONSIN 53711
FAX: (608) 831-3771
VOICE: (608) 831-3433

ESOTERIC SOUND
Presents the

MUSIC

WITHOUT BOUNDARIES

Audition Models 3, 5 & 7
amplifiers and the
Coherence One preamp.



Model 5 Amplifier

High End Components For The Audio Perfectionist

ANALOG RESEARCH • APOGEE • BEDINI • COGAN-HALL
COUNTERPOINT • ESSENCE • HARTLEY • JANIS • KEF
LEXICON • MARANTZ 94 • PRECISE • PULSAR • ROTEL
JEFF ROWLAND • SHAHINIAN • WADIA • AND MORE

Esoteric
SOUND SYSTEMS LTD.
COVENTRY COMMONS Rte 347
STONY BROOK, N.Y. 11790
516/689-7444

ACTIVE ELECTRONIC CROSSOVERS

MODEL 120 CABINET & NEW 120-R
"RACK AND PANEL" DESIGNS

Made to order in Butterworth bi-amp,
tri-amp, or quad-amp configurations
with optional level controls, subsonic
filters, or summers. Filters, regulated
power supplies, equalizers, are also
available.

New catalog and price sheet. Free!

DeCoursey Eng. Lab.

11828 Jefferson Bl. Culver City, CA 90230
PHONE (213) 397-9668

W. New England's Best!

Acoustaf • Apogee • Aragon • Boston Acoustics • B&W • Cembaco • CWD • dbx •
Dual • Energy • Fried • Hagler • Infinity • JSE • JVC Video • Koetsu • Krell • Magnum
• Meitner • Meridian • Mi1 • Mod Squad • Monster • NAD • Onkyo • Ortolan • Rotel
• Shure • SME • Snel • Sony ES • SOTA • Stax • Sumiko • Velodyne • Well Tempered

Sound & Music

Sales & Service • 351 Pleasant St • Northampton MA 01060 • (413) 584-9547

RECORDS

OVER 15,000 TITLES! 1950's-1980's. All Categories. Al-
bums, Tapes, 45s, 78s, Posters, Books, Etc. \$2.00 catalog.
HOT PLATTERS, Box 2793-A, Los Angeles, CA 90078.

INTRODUCING THE SME MODEL 309



This exciting new addition to the SME range of tonearms exemplifies the
design philosophy of SME. While the influence of the classic Series V will
be clearly seen, the aim has been to meet the needs of a broader
market in which an interchangeable headshell is required.

We believe SME's designers can be justly proud of this new model which,
although not intended to challenge the Series IV or ultimate Series V,
offers a performance and manufacturing excellence otherwise without
equal.

For more information and the name of your
nearest dealer call us at 415/843-4500 or write
to P.O. Box 5046, Berkeley, CA 94705

sumiko

RECORDS

albumTRAK™

Provides the album enthusiast with the complete soft-
ware package to track group; title; label; style; substyle;
recording mode and date; purchase price, source and
date; and comments. Handles 1 billion albums-disk
space providing. Also tracks wanted albums. Runs on
any IBM PC compatible. Send check/money order for
\$39.99 to BLH Systems Group, 920 W. 4th Street,
Second Floor, Philadelphia, PA 19123. Or call (215)
829-9213.

RECORD COLLECTORS SUPPLIES. REPLACEMENT
JACKETS, INNER SLEEVES, 78 RPM SLEEVES, OPERA
BOXES, LASER DISK BOXES, ETC. FREE CATALOG.
CABCO PRODUCTS, BOX 8212, ROOM 662, COLUMBUS,
OHIO 43201.

COMPACT DISCS

DIRECT-TO-TAPE RECORDINGS-CD's and 70+ DAT
tapes plus other tape formats. Primarily classical/jazz. Send
75 cents (3 stamps), for CATALOG/NEWSLETTER to:
Direct-to-Tape Recording, 14-R Station Avenue, Haddon
Heights, NJ 08035.

FREE CD/RECORD OFFER! FREE CATALOG! World's
Best Brass Catalog (Fanfare). Outstanding Brass, Wood-
winds, Strings, Orchestra. CRYSTAL RECORDS, Sedro-
Wooley, WA 98284.

FREE JAZZ CATALOG: CD'S, LP'S, CASSETTES, VID-
EOS. SINCE 1975. WRITE TO DEPT. AU, DAYBREAK
EXPRESS RECORDS, P.O. BOX 150250, VAN BRUNT
STATION, BROOKLYN, NY 11215-0005.

NEW Compact Disc Index Organizers. Inexpensive 26
card set organizes and alphabetizes. Quantity discount.
Write: Aaron Distribution, 3262 Superior Lane, Suite 101-A1,
Bowie, Maryland 20715.

PRECISION SOUND YOUR NIMBUS CD CONNECTION (DEALERS ONLY)

Audio Equipment Dealers Can Now Offer Their Cus-
tomers The Highest Quality Classical Recordings
Available...Nimbus Compact Discs.

NIMBUS RECORDS

Call For a Free Nimbus CD Sampler, Catalog and
Order Information. (No Consumers Please!).

PRECISION SOUND

Toll Free 1-800-547-7715.

21601 66th Avenue, West, Suite 8, Mount Lake Ter-
race, WA 98043. FAX: (206) 774-4178.

Distributed by A&M Records in North America

WE'RE MUSIC TO YOUR EARS

- Free Catalog of CD's
- Same day shipping if you order
before 12:00n. EDT.
- *1⁰⁰ DISCOUNT per disc on orders
of 10 or more
- *2⁰⁰ for UPS Cont. U.S. shipments.

Call Toll Free to order:
1-800-333-4422

P.O. Box 616, Clifton Park, NY 12065
518-383-4855



SHURE • MONSTER CABLE • GRADO

We Are Proud To Offer
A LARGE SELECTION OF:
**NEEDLES
CARTRIDGES**

**TOLL FREE
(800) 342-9969**
*High Quality Turntables
& Accessories in Stock...*

M&Y CO.
7418 Beverly Blvd.
Los Angeles, CA 90036

Featuring

- ORTOFON
- SHURE
- GRADO
- DYNAVECTOR
- AUDIO TECHNICA
- PICKERING
- SIGNET
- NITTY GRITTY
- STANTON
- BEYERDYNAMIC
- AUDIOQUEST
- STAX
- CARNEQ JE ONE
- THORENS
- AR
- MICRO SEIKI
- AND MANY MORE

SHURE • MONSTER CABLE • GRADO

SHURE • MONSTER CABLE • GRADO

**THE FINEST IN HOME AUDIO,
CAR STEREO & VIDEO EQUIPMENT**

AUTHORIZED DEALER FOR

- ADS
- AKG
- ALTEC-LANSING
- AUDIO CONTROL
- AUDIO PRO
- AUDIO SOURCE
- B & W
- dbx
- DENON
- GJL
- FINITY (CAR)
- JVC
- KENWOOD
- KICKER
- NOLTA
- MISSION
- MONSTER CABLE
- ORION
- OLYMPUS
- POLK AUDIO (CAR)
- PROTON
- SAE
- SANSUI
- SIGNET
- SNOOPER
- SONANCE
- SOUND CRAFTSMEN
- TERK ANTENNAS
- VSE ALARMS
- CERWIN VEGA

Sound CITY
Meadow Shopping Center
Route 23 South
Kearlton, N.J. (201) **838-3444**

**SINGERS!
REMOVE VOCALS
FROM RECORDS AND CDs!**

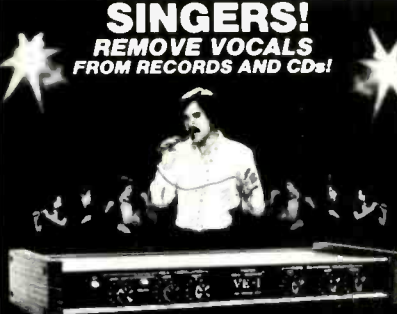

SING WITH THE WORLD'S BEST BANDS!
An Unlimited supply of Backgrounds from standard stereo records! Record with your voice or perform live with the backgrounds. Used in Professional Performance yet connects easily to a home component stereo. This unique product is manufactured and sold Exclusively by LT Sound - Not sold through dealers. Call or write for a Free Brochure and Demo Record.

**LT Sound, Dept. AU-3, 7980 LT Parkway
Lithonia, GA 30058 (404) 482-4724**
Manufactured and Sold Exclusively by LT Sound
24 HOUR PHONE DEMO LINE: (404) 482-2485

WANTED TO BUY

DONT CALL ME (first) ON MARANTZ McINTOSH, other tube components, vintage speaker systems (Patricians, Tannoy's, J.B.L. Paragon, Harlfield, etc.) esoteric High-end equipment, better prewar radios until you're called competition for best prices! (718) 377-7282 afternoons. *NO EXPORT*

IT'S WORTH IT CALLING ME! McIntosh, Marantz Tube components, Western Electric, Altec, JBL, Jensen, Tannoy Lan-Gevin Trusonic Raw speaker Tube etc., top cash, Henry Chang, 309 E. Garvey Ave., Monterey Park, CA 91754. (818) 571-6274 LAX.

McINTOSH, MARANTZ TUBE, McINTOSH S.S. equipment, Western Electric, Tubes, Speakers, etc. TOP CASH. Scott Dowling, 9908 Daines Drive, Temple City, CA 91780. (818) 286-9122, evenings/weekends.

TOP PAYING FOR MCINTOSH, MARANTZ TUBE AMP McIntosh Solid State, Western, JBL, Altec, Tannoy, EV, Jensen, Speakers & Horn, EMT Turntable, Ortofon, Arm. Temma—(516) 997-7633, (516) 496-2973.

WANTED: MARANTZ, McINTOSH, WESTERN, JBL, ALTEC OLD EQUIPMENT JOE (213) 320-7020 9am-5pm. TORRANCE, CA.

DAT

DAT RECORDERS: The Time is Now. Join the DAT Revolution. AudioLab, Box 18009, Seattle, WA 98118. 1-206-323-4987, Fax 1-206-325-7601.

DAT REPAIRS performed on all SONY, TECHNICS, JVC and AIWA models. **GUARANTEED WORK. FREE ESTIMATES.** FET Electronics, 17718 Vanowen Street, Reseda, CA 91335. (818) 345-8565.

INVENTIONS WANTED

A NEW IDEA? Call NATIONAL IDEA CENTER of Washington D.C. **FREE INFORMATION--1(800) 247-6600 EXT.155.** Come see THE INVENTION STORE!!

SERVICES

SPEAKER REPAIR. 4" to 18" speakers reconed. Orban Audio, 119 7th St., N.W., North Canton, OH 44720. (216) 497-9932. 6pm - 9pm EST.

DIMENSIONAL PURITY VANDERSTEEN AUDIO



Vandersteen Audio was founded in 1977 with the commitment to offer always the finest in music reproduction for the dollar. Toward this goal there will always be a high degree of pride, love, and personal satisfaction involved in each piece before it leaves our facilities. Your Vandersteen dealer shares in this commitment, and has been carefully selected for his ability to deal with the complex task of assembling a musically satisfying system. Although sometimes hard to find, he is well worth seeking out.

Write or call for a brochure and the name of your nearest dealer.

VANDERSTEEN AUDIO
116 WEST FOURTH STREET
HANFORD, CALIFORNIA 93230 USA
(209) 582-0324

MODEL 2C

The best place to be seen is where people are looking. And each month, both enthusiasts & dealers read **AUDIO's Classifieds** for information.

AUDIO's Classifieds
—where consumers shop and dealers buy.

Audio For complete information, call Carol Berman at (212) 719-6338.

SERVICES

AUDIO PULSE SERVICE. Factory trained technicians. We manufacturer and repair digital time-delay (ambience) systems. White Labs, 10528 Lower Azusa Rd., Suite 192A, El Monte, CA 91731. (818) 446-5346.

Audio Repairs and Restorations by Richard Modafferi, and Cliff Ramsey. Over 55 years combined-experience. See our ad at the beginning of the classifieds. **AUDIO CLASSICS**, POB 176AR, Walton, NY 13856. (607) 865-7200. 8AM-5PM EST Mon.-Fri.
-Audio Advertiser for over a Decade-

RETAIL MART

AUDIO BEST: LA, ORANGE, SAN BERNADINO, CALIFORNIA. HOT COMPONENTS: CELESTION SL-700, COUNTERPOINT SA3000, TARALAB, PS4.6 100C; MIT CVT; AUDIBLE ILLUSIONS AMPLIFIER; MODSQUAD PRISM CD; ACOUSTAT SPECTRA 22&23; SPICA ANGELA; WELL-TEMPERED; VELODYNE, MAGNUM; FOSGATE; ADCOM, B&K, SUPERPHON, MUSIC REFERENCE, PALANTIR, SPECTRUM, RAUNA, SOUNDLAB, VPI, MAPLENOLL, SYSTEMDEK, GRADO, ALPHASON, GARROTT, VDHUL, MONSTER, STRAIGHTWIRE, (714) 861-5413. APPOINTMENT.

WE HAVE THE FINEST SHOWROOM in our area with the best selection of audio/video components available. We represent Adcom, Infinity, Thorens, Dual, Jamo, Yamaha, Canton, Luxman, Klipsch, SONY ES, and more. **CONTINENTAL SOUND**, 98-77 Queens Blvd., Forest Hills, NY 11375. (718) 459-7507.

BUSINESS OPPORTUNITIES

LET THE GOVERNMENT FINANCE your new or existing small business. Grants/loans to \$500,000 yearly. Free recorded message: 707-448-0270 (KF1)

MISCELLANEOUS

TERMPAPER assistance. 15,278 papers available! 306-page catalog—rush \$2.00. Research, 11322 Idaho #206AD, Los Angeles 90025. TOLL FREE HOTLINE: (800) 351-0222 (California: (213) 477-8226).

DAT

WE OFFER DIGITAL AUDIO TAPE RECORDERS with one year warranties. **SONY, JVC, TECHNICS**, and more! Home, studio and portable. State of the art sound for \$995 & up! **NEW: DATRAX-60** attractive, solid oak, DAT storage unit. **AUDIO GALLERY**, 2716 Wilshire Blvd., Santa Monica, CA 90403. (213) 829-3429.

HELP WANTED

EASY WORK! EXCELLENT PAY! Assemble Products At Home. Call for Info. 504-641-8003 Ext. 5737.

CAR STEREO

"STEREO WORLD" is your discount mallorder source with super deals on your car stereo needs. Lines include: Kenwood, Technics, Panasonic, JVC, Sony, Pyle, Pioneer, Sherwood, Philips, Clarion, Blaupunkt, Aiwa, G&S Designs Amps. Uniden and many others. Please call or write for free catalog. Free UPS in 48 states. **10AM-6PM Mon-Fri.; Wednesday 11:30-7 PM. Visa/MC; COD extra.** "Celebrating our 3rd year." P.O. Box 596, Monroe, NY 10950 (914) 782-6004.

RATA Torlyte® Turntable Stands & CD Platforms from Britain

Torlyte Turntable Stand



Turntable Stands

Model A for Linn/Rega or B for SOTA. List \$350.00.	Now \$199.95.
Model D with special platform for SOTA. List \$650.00.	Now \$399.95.
SOTA "Sub Base" Platform only for SOTA. List \$300.00.	Now \$199.95.

Isolation Platforms CD Players, Amps, Preamps, etc.

CDT Platform, 11.6"x 13.6", for CD Players. List \$125.00.	Now \$79.95.
SMALL PL1 Platform, 13.6"x 16", for preamps, other electronics. List \$125.00.	Now \$79.95.
MEDIUM PL2 Platform, 14"x 17.8", for electronics. List \$140.00.	Now \$89.95.
LARGE PL3 Platform, 14.8"x 19.2", for large & heavy electronics. List \$140.00.	Now \$89.95.
TT-1 platform replacement for the Target TT-1 wall shelf. List \$140.00.	Now \$89.95.

Below Dealer Cost!

Turntables, CD players, preamps and power amps—tube gear especially—all sound clearer, cleaner, more **FOCUSED** with Torlyte isolation platforms. Light, rigid, honeycombed Torlyte stops vibrations from getting into the signal path and getting amplified! RATA double-shipped a big order to the importer. So we bought and YOU save.

Linn Mod Kit

Recommended by leading mags. Includes sub-base, subchassis, armband, hardware and set-up jig.
List \$600.00. Now \$399.95.

Any questions? Call 1-800-942-0220 to discuss. All products new in sealed boxes. All sales final at closeout price.
Shipping in US: Platforms \$4.95 ea, Stands/Mod Kit \$7.95.

Charge It! Amex / Discover / MC/ Visa

1-800-942-0220



225 Oakes SW • Grand Rapids, MI 49503
616-451-3868 • FAX 616-451-0709

Low-Price Accessories

Hard-to-find Audiophile LPs/CDs

Get 'em while they last!

Proprius: Cantate Domino (cd/tp) 17.95	
Jazz at Pawn Shop (cd) 16.95 (2 lps) 34.95	
Anthphone Blues Jazz (cd/tp) 17.95	
3-Blind-Mice Jazz CD #1 (cd) 17.95	
Mobile Fidelity Beatles LPs	
Sgt. Peppers, Please, Hard Day's Night, For Sale, Help, Yellow Sub, Let It Be (lps) 17.95	
Cheesy New Jazz CDs JD1 Johnny Frigo, JD2 Clark Terry, JD3 Phil Woods (cds) 14.98	
JD28 Caram, Rio Afret Dark (cd) 14.98	
JD29 Biontra, Nonstop to Brazil (cd) 14.98	
Lyrta LPs	Call
Reference Recordings CDs and LPs	
All Titles	(lp/cd) 15.99
Sheffield Labs: Kodo Drums (cd) 14.99	
Moscow Sessions Set (cd/tp) 39.95	
Wilson Audio Recordings	
All Titles	(lp/cd) 15.98

Everything for CD Players

AQ CD Isolation Feet (4) 19.95	
MonsterCable CD Sound Rings (12) 14.96 (25) 29.95 (50) 49.95	
Monster Footers: New! Small 29.95	
Reg (CD) 49.95 Large 99.95	
Interconnects for CD Players	Call
Magnavox CD Players	
CDB262 w/remote **149.95	
CDB582 w/remote **199.95	
CDB586 CD Changer **279.95	
CDV485 CD/video Player **659.95	

Powerstraps for Audio and Video

With fine filtering

TrippLite 1B-6, 6 outlets 89.95	
TrippLite 1B-8, 8 outlets 99.95	
Powerline regulators with filtering:	
LC-1200-220, for 220 volt, 4 outlets **249.95	
LC-1800, 6 outlets, for 120 volts **299.00	

Prices subject to change

Everything for Turntables

Alphason automatic tonearm raiser 29.95	
AR ES-1 armless turntable *419.95	
DB Cartridge Alignment Protractor 24.50	
Grado Cartridges: Grado ZTE+1 19.95	
Grado Signature 8M2, MC2, TLZ, XTZ	Call
Electronic stylus cleaner 19.95	
Record Doctor : vacuum-powered record cleaning machine **169.95	
LAST Record Products: #1 Cleaner 11.95	
#2 Preservative 14.95	
#4 Stylus Cleaner 7.95	
#5 Stylus Treatment 16.95	
Maadahlia: Sumiko HS-12 29.95	
Headshell wires: SME silver litz 22.95	
Record Brushes : AQ or Nitty Gritty 9.95	
Record Cleaning Machine Solutions :	
Nitty Gritty First (5oz) 14.95 (16oz) 24.95	
Turmat Fluid 16 oz 14.95	
Nitty Gritty Purifier 2 (16oz) 11.95 (1gal) **39.95	
Record Mats : AQ Sorbothane Mat 29.95	
SOTA Acrylic Mat 129.95	
Shure VNRS/MR Replacement Stylus 129.95	
SOTA Retlex: Record Clamp 14.95	
Stylus Gauge: Shure Gauge 14.95	
Sumiko: FB-1 MC Demagnetizer 149.95	
Sumiko Blue Point MC cartridge 99.95	
Tip Tools for turntables: C3 for AR 4.95	
For VPI, Sola, Oracle 8.95	
Lead Balloon Turntable Stand *249.95	
Turntable Wall Shelves	
Target TT-1 **109.95	
Target PS-1, for big tables **149.95	
VPI Record Cleaning machines Call	
VPI Suction tubes for 16.5 & 17 19.95	

Target Equip Racks from England

A1B Floor Stands for amps 75.00	
TT3 33" tall, 3 shelves 219.95	
PS3 Like TT3, for large gear 275.00	
TT5 33" tall, 5 shelves 275.00	
TTST 40" tall, 5 shelves 299.95	
Target heavy-duty speaker stands Call	

Cables and Cable Accessories

Interconnect Cables:

As One, Cardas, FMS, Distech, Livewire, MIT, Monster, VandenHul	Call
Custom length cables	Call
Distech Powerbridge Cables 8 ft 169.95	
Speaker Cables : Aural, Cardas, FMS, Livewire, Monster, Space & Time	Call
Banana Connectors : King Size (8ga) 9.95	
Monster X-terminators (pr) 24.95	
Tiffany RCA connectors	Call
Wonder Solder : (1.5oz) .999 (1 lb) 39.95	
WBT Silver Solder 250 mg roll 29.95	
Video Cables : Monster (1m) 19.95 (20') 49.95	
VandenHul video (1m) .24.95 (2m) 30.95	
Twinkl : Contact Conditioner 14.95	
Cramoline : Contact cleaner 15.95	

Specialty Speaker Stands

Chicago Hercules Stands : 12"-25" *149.95	
ARCII specialty stands : B&W 801M *399.95	
Quad 63 Stand *175.00 ESL stand *175.00	
Sound Anchors specialty stands for :	
VS IIC *219.95 Spica TC-50 *199.95	
B&W 801M *399.95 MGIII *299.95	

All kinds of other Accessories

ASC Tube Trap room dampers Call	
AQ Sorbothane Isolation Feet	
Large... (4) 34.95 Small (for CDs) (4) 19.95	
Audiophile Books : Good Sound, Dearborn 12.95	
The VTL Tube Book, D. Manley 12.95	
Beysrdynamic headphones Call	
dbx 200XG tape routing selector **99.95	
Sonex Acoustic Room Treatment	
Sonex Juniors: 2'x2'x2' sheets (4) 49.95	
Niles SPS-1 4-speaker selector 75.00	
Niles HDS-6 6-speaker selector 175.00	
Niles Audio/Video switching systems Call	
Terk FM-2000 antenna 19.95	
Terk "PI" FM antenna 79.95	
Vacuum Tubes : RAM Labs Premium Call	
VPI HW-5db, "Magic Brick" 39.95	

Shipping Charges
UPS, insured, 48 States
Accessories: One Item 3.95
Each Extra Item 1.25
*Turntables, Stands 12.95
**Electronics 8.95

UPS International Air to the Far East, Europe, New Zealand and Australia.
1-800-942-0220
Amex / Visa / Mastercard / Discover

audio advisor, inc.
225 Oakes SW • Grand Rapids, MI • 49503
FAX: 616-451-0709 Service: 616-451-3868

CANTON

Authorized Canton Dealers

AZ Phoenix: Audio Video Specialists, Bruce Wardin & Associates • Tempe: Precision Audio Specialists •
CA Corona del Mar: Pacific Coast Audio Video • Glendale: Crystal Sonics, Marconi Radio • La Crescenta: Chatham-Becker Corp. • Long Beach: Audio Concepts • Los Angeles: Henry Radio, Paris Audio, Audio Command Systems, Supervision, Robert's Home Audio & Video, Western & Olympic A/V Center • Mission Viejo: Video Laser • Newhall: Chatham-Becker Corp. • Oakland: Pro Audio Electronics • Palm Desert: Desert Stereo • San Francisco: Custom Car Alarms, Harmony A/V of Fillmore, House of Music, Peter's Auto Radio • San Gabriel: Audio Concepts • San Jose: Paradise Sound • San Leandro: Mad Audio Systems • San Mateo: Mateo High Fidelity • Santa Ana: Solid State TV-Audio • Santa Monica: R Squared Installers • South Lake Tahoe: Accurate TV • Torrance: Dimensions in Stereo • Woodland Hills: Paris Audio
CO Aspen: Aspen Audio • Boulder: Listen Up • Colorado Springs: Listen Up • Denver: Listen Up
CT Greenwich: F. Steyer Design • Hartford: The Stereo Shop • Old Greenwich: C.A.R.S.
DC Washington: Myer-Emco, Provideo, Inc.
DE Dover: Sound Studio • Newark: Sound Studio • Wilmington: Sound Studio
FL Boca Raton: Sound Plus Wood • Brandon: The Car Stereo Shoppe • Coral Gables: Sound Performance • Daytona Beach: Audio Video Analyst • Dunedin: All States Radio • Hollywood: Audio 2000 • Ft. Lauderdale: Sound Design & Engineering • Ft. Myers: Car Tunes • Jacksonville: Behrens Audio Lab, Cruising Tunes • Miami: Las Fabricas • Naples: Stereo Garage • New Port Richey: Stereo Specialties • Palm Harbor: Auto Audio • Tampa: Monte's Rolling Sound • Tequesta: TV/Audio Ctr • Winter Haven: Audio Equalizers
HI Honolulu: Custom Car Stereo, Hakko Camera & Electronics
IA Cedar Rapids: H-S Industries
IL Aurora: United Audio Centers • Chicago: United Audio Centers, Hi Fi Hutch • Northbrook: United Audio Centers • Naperville: Hi Fi Hutch • Niles: United Audio Centers • Northlake: Guy's Auto Sound • Schaumburg: Hi Fi Hutch, United Audio Centers • Vernon Hills: United Audio Centers • Villa Park: Hi Fi Hutch • Downer Grove: Safear Autosound Engineering • Wilmette: Village TV A/V
IN Carmel: Tom Doherty's Custom Audio • Ft. Wayne: Classic Stereo • Michigan City: Audio Connection
KS Overland Park: Brands Mart • Wichita: Custom Sound
MA Cambridge: Audio Video Environments, New England Audio/Media Systems • Medford: Boston Media Design
MI Mount Pleasant: Dr. Goodears Audio Palor
MD Gaithersburg: Myer-Emco, East Coast Auto Sound-Owings Mills: Lighting Experience • Rockville: Myer-Emco Provideo-Salisbury: Sound Studio
MN Brooklyn Center: Audio King • Burnsville: Audio King • Edina: Audio King • Mankato: Audio King • Minneapolis: Audio King, Audio Systems & Design, Audio Video Environments, Blumberg Communications • Minnetonka: Audio King • Rochester: Audio King • St. Cloud: Audio King • St. Paul: Audio King • St. Louis Park: Audio by Design
MO Kansas City: Brands Mart Midwest • St. Louis: T. Melodious
NC Charlotte: Stereo Showcase • Winston-Salem: Audio Video Concepts • Ed Kelly's, Inc.
NE Lincoln: Sound Environment • Omaha: Sound Environment
NJ Cliffside Park: Entertainment Environments • Deptford: Hi-Fi Connection • Livingston: Electromedia Design, Inc. • Marlton: Hi-Fi Connection • Millburn: Professional Audio Consultants • Northfield: Sound, Inc. • Ocean side: Ocean Cellular • Paramus: Stereo Video Warehouse • Springfield: Kartunes Mobile Electronics • Wayne: Studio Standards Inc. • West Caldwell: Comtal, Samm Sound • West Long Branch: Woodbridge Stereo Center • Woodbridge: Woodbridge Stereo Center
NV Las Vegas: Elite Systems
NY Brooklyn: Rabson's Stereo Warehouse • Coram: Sound Images • Garden City: Rabson's • Hauppauge: Audio Interiors • Huntington: AB Car Stereo, Total Media Systems • Manhasset: Autospec • New York: Cosmophonic Sound, Harmony House, Mobile Audio Specialists, Rabson's • Ocean side: Absolute Auto Sound, Sound Insights • Port Jefferson Stn: Designatron • Rego Park: Continental Sound • Rockville Centre: Audio Command Systems • Syosset: American Soundcraft • Southampton: Charos Custom Sound • Staten Island: Clone Audio • Valley Stream: Stereo Video Warehouse • West Nyack: Audio Video Systems, Inc. • White Plains: Audio Design Associates, Stereo Video Warehouse
OK Tulsa: Imperial Sound
OR Eugene: Bradford's High Fidelity
PA Ardmore: All That Jazz • Bethlehem: Carlen Audio • Ephrata: Stereo Barn • Lancaster: Stereo Barn • Philadelphia: David-Mann Ltd., Teppers Autosound
RI Middletown: Soundings
SD Sioux Falls: Audio King
TX Austin: Audio Dimensions • Houston: Groove Audio Video • Laredo: Jett Sales • San Antonio: Bjorn's Stereo Designs
VA Charlottesville: Preferred Sound • Falls Church: Myer-Emco • Fredericksburg: Contemporary Sounds • Roanoke: Custom Auto Sound • Virginia Beach: Videorama
WA Bellevue: Home Entertainment by Design
WI Milwaukee: Flanner & Halscoos • Mequon: Flanner & Halscoos
WV Princeton: The Sound Post

See our ad in this issue for more information
 Canton N. America (612) 333-1150



Your search for refinement will end here.

Brown Electronic Labs

2530 Berryessa Rd., Suite 126, San Jose, CA 95132

MAIL ORDER

ANALOG BREAKTHROUGH! Our ACOUSTICOVER turntable isolation system improves sound of all record players. Beautiful wood, glass, acrylic design. \$1.00 for photo. info. The WallWorks, RD #1, Box 503, Sanford Rds Road, Glen Falls, NY 12801. (518) 798-1844.

THE BEST RECORD RACK IN AMERICA. Stackable, portable, oak units hold LP's, CD's and tapes. Free Mailorder Brochure, (please mention Audio). Per Madsen Design: (415) 928-4509. P.O.Box 330101, San Francisco, CA 94133.

CARVER, NAKAMICHI, BANG & OLUFSEN, A.D.S., CROWN, REVOX, TANDBERG, HAFNER, ADCOM, MISSION, N.A.D., HARMAN/KARDON, KYOCERA, YAMAHA, LUXMAN, DENON, KLIPSCH, B & W, KEF, D.C.M., E.V. J.B.L., INFINITY, D.B.X., AKG, AND OTHER QUALITY COMPONENTS. BEST PRICES—PROFESSIONAL CONSULTATION. OPEN 24 HOURS A DAY. ALL PRODUCTS COVERED BY MANUFACTURERS' U.S.A. WARRANTY. AMERISOUND SALES, INC., JACKSONVILLE, FLORIDA 32241. EAST: (904) 262-4000, WEST: (818) 243-1168.

FREE MAILORDER CATALOG. MID, HIGH-END AUDIO. LOW, LOW WAREHOUSE PRICES. CALL (602) 829-6710 NOW! NO TAX OUTSIDE ARIZONA. AUDIO ADVANTAGE. SINCE 1981.

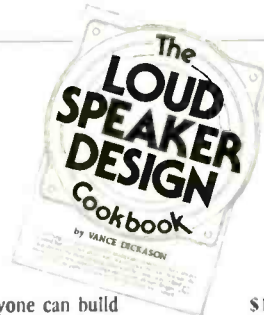

Now, anyone can build a superior loudspeaker from scratch. All the help you'll need.... handling

OLD COLONY SOUND

Box 243, Dept. LDA, Peterborough, NH 03458

NAME _____

STREET _____

CITY _____

ST _____

ZIP _____

CREDIT CARD TELEPHONE (MC/VISA): 603-924-6371 or 924-6526, (9-4 EST, M-F)

AD INDEX

Firm (Reader Service No.)Page

Accuphase	108
Acoustic Research (1)	Cover II
Adcom (2)	27
Audio Research (3)	41
AudioQuest	24
Audiostream (4)	39
B & K (5)	109
BBE Sound, Inc. (6)	103
Brystonvermont (7)	31
BMG	17
Cambridge Soundworks (8)	101
Canton (9)	72 & 73
Carver	20 & 21
Columbia House	37
Counterpoint (10)	25
Esoteric Audio (11)	43
GRP (12)	75
Infinity Systems Inc. (13)	23
J & R Music World (14)	15
Kinergetics Research	77
Klipsch (15)	65
Lee Jeans	6 & 7
Levinson	3, Cover IV
Madrigal	32
Magnepan (16)	59
Martin-Logan	19*
McIntosh (17)	10-13
Mobile Fidelity (18)	93
Monster Cable (19)	89
MTX (20)	97
Music Interface Technology (21)	71
Onkyo	44 & 45
Parliament	19*
Pioneer (22)	1
Polk (23)	84 & 85
Precise (24)	99
Proton (25)	79
Salem	9
Sherwood (26)	91
Sonance (27)	67
Sony	68 & 69
Soundcraftsmen (30)	28 & 29
Stereo Exchange (28)	105
Studer Revox	33, 35
U.S. Army	Cover III
Well Tempered Labs (29)	78
Wisconsin Discount Stereo	111
Yamaha	5

*Regional Ads

YOU GET A LOT MORE THAN MONEY FOR COLLEGE SERVING PART-TIME IN THE ARMY RESERVE.

Joining the Army Reserve is one of the smartest ways to help pay your way through college. In fact, you can earn over \$18,000 through the Montgomery GI Bill and your Reserve pay during a standard enlistment. And, if you have or obtain a federally insured student loan, you may qualify for a government program that will help repay up to \$20,000 of it for you.

But you get a lot more than just money in the Army Reserve. You get hands on training in one of over 250 skills... skills like modern health care techniques, engineering, foreign languages, criminology and many others.

You get the pride and confidence that come with

tackling a tough job and doing it well. And service with the Army Reserve can help you develop the maturity and self-discipline it takes to succeed in college and in life.

You also get the satisfaction of knowing you're helping to keep America strong.

Besides completing Basic and Advanced Individual Training, you'll usually serve just one weekend a month in a nearby Army Reserve unit, plus two weeks of Annual Training. Find out more. See your Army Reserve recruiter or call 1-800-USA-ARMY.

BE ALL YOU CAN BE®

ARMY RESERVE



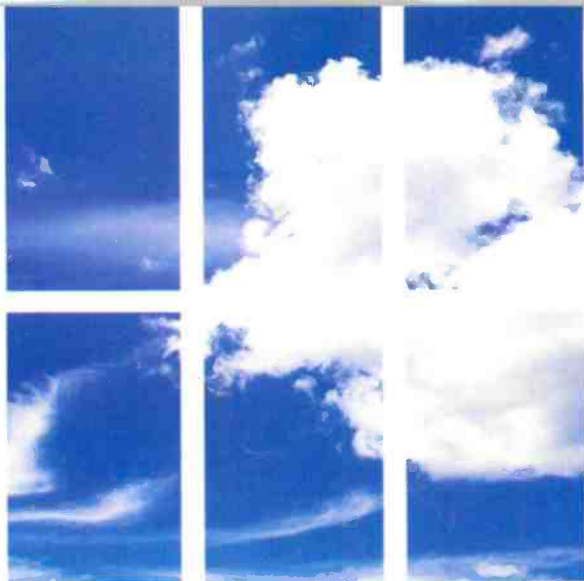

Nº 27

The music begins and a window opens. The boundaries of time and place fade as a unique musical experience is recreated in your home.

Our quest for this ideal has produced the new Mark Levinson No. 27 Dual Monaural Power Amplifier. We believe it is destined to bring more music lovers closer to their ideal than ever before.

To learn why, you are invited to share the experience at your nearest Mark Levinson dealer.

