

Audio

NOVEMBER 1983 • \$1.75 • Ⓢ G6J30

**SPECIAL ISSUE!!!
COMPUTERS IN AUDIO**

**COMPUTER AIDED
POWER CONVERSIONS,
FILTER DESIGNS,
TIME/ENERGY/
FREQUENCY
ANALYSIS**



TESTED

NEC CD-003 COMPACT DISC PLAYER
ARCORCE EQ-ONE
ARCORCE EQ-ONE
ARCORCE EQ-ONE
ARCORCE EQ-ONE

460350 MKW 67126099 14 6 SEP84
MR FRED B MAXWELL
16712 GOLDSBOROUGH
LAUREL MD 20707
11*5E



**INTRODUCING
DIGITAL-READY
COMPONENTS.**

**FROM THE PEOPLE
WHO BROUGHT
YOU THE
DIGITAL DISC,
DIGITAL PLAYER,
DIGITAL
PROCESSOR,
DIGITAL MIXER,
DIGITAL
REVERBERATOR,
DIGITAL RECORDER,
DIGITAL EDITOR,
DIGITAL
DISC MASTERING**

When the history of music is written, the chapter on digital will read like a list of accomplishments from just one company—Sony.

And now, to meet the stringent demands of their digital creations, Sony engineers have developed an entirely new line of high-fidelity components. The ES Series.

To handle the phenomenal dynamic range of the new CDP-701ES compact disc player and PCM-701ES digital audio processor, ES features what Stereo Review calls a "truly exceptional" integrated amp. One that offers "the highest dynamic headroom of any amplifier we have yet measured."

The patented Accurate Pistonic

Motion (APM) speaker design has been engineered to handle prodigious quantities of power without distortion. Even the tuner's Direct Comparator has been designed to complement the improved FM broadcast signals that result from digital source material.

Furthermore, because no innovation, no matter how remarkable, should force you to discard

your present music collection, ES also includes a LaserAmorphous™ 3-head cassette deck and linear tracking Biotracer turntable—worthy challengers to anything on the market today.

To find out the name of your nearest ES dealer, call Sony toll-free at 1-800-222-SONY.

SONY

THE LEADER IN DIGITAL AUDIO

© 1983 Sony Corp. of America. Sony and LaserAmorphous are trademarks of the Sony Corporation.



Enter No. 1 on Reader Service Card

Audio

NOVEMBER 1983

VOL. 67, NO. 11



See page 32.



See page 28.

FEATURES

COMPUTER-AIDED FILTER DESIGN	Richard Kaufman	28
COMPUTER-AIDED AUDIO CALCULATIONS	Leonard Feldman	32
TDS COMPUTING	Gerald R. Stanley	38
DIRECTORY OF BLANK TAPE		44
DIRECTORY OF NOISE-REDUCTION UNITS		46
DIRECTORY OF MANUFACTURERS		48

EQUIPMENT PROFILES

NEC CD-803E COMPACT DISC PLAYER	Leonard Feldman	50
LINN SONDEK LP12 TURNTABLE	Edward M. Long	56
AUDIOSOURCE EQ-ONE EQUALIZER and SPECTRUM ANALYZER	Howard A. Roberson	64
JVC R-X80 RECEIVER	Leonard Feldman	68
ESB 7/06 SPEAKER	Richard C. Heyser	72
JANDBERG TPT 3001A TUNER and TIA 3012 AMP	Leonard Feldman	80

MUSIC REVIEWS

COMPACT DISCS	Bert Whyte, John M. Eargle, C. Victor Campos	88
ROCK/POP RECORDINGS	Michael Tearson, Jon & Sally Tiven	96
AUDIOPHILE RECORDINGS		104

DEPARTMENTS

AUDIO ETC	Edward Tatnall Canby	8
BEHIND THE SCENES	Bert Whyte	14
TAPE GUIDE	Herman Burstein	21
AUDIOCLINIC	Joseph Giovanelli	24
CLASSIFIED ADVERTISING		111
ADVERTISING INDEX		128

The Cover Equipment: NEC CD-803E Compact Disc player.
The Cover Photographer: Robert Lewis



Audio Publishing, Editorial and Advertising Production Offices,
1515 Broadway, New York, N.Y. 10036.

Subscription Inquiries, (800) 525-9511; in Colorado (303) 447-9330.



See page 102.



See page 8.

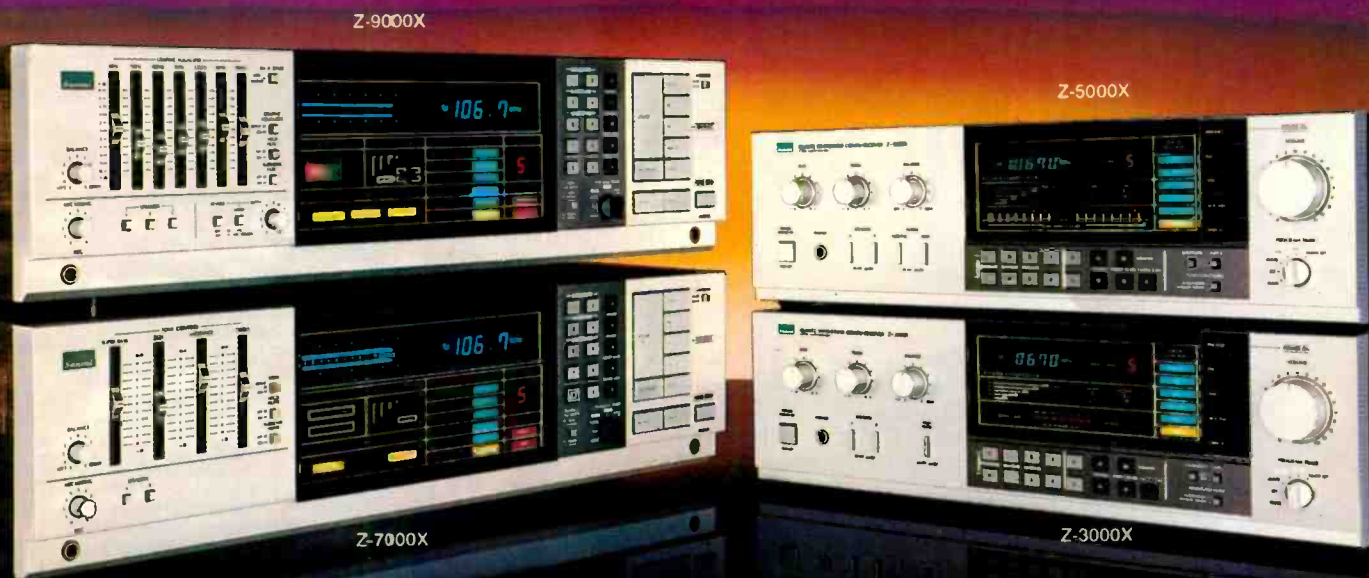

SANSUI DOESN'T CLAIM TO HAVE THE WORLD'S ONLY DISTORTION-FREE RECEIVER. NOW WE HAVE FOUR.

Unlike most high fidelity companies, Sansui doesn't reserve its most advanced technology exclusively for the top-of-the-line model.

That's why every model in our new "Z" Quartz Synthesizer Compu Receiver line (Z-9000X, Z-7000X, Z-5000X, Z-3000X) is distortion-free.

Sansui puts its best Super Feedforward

Some competitive receivers herald the fact that they eliminate audible distortion. But only Sansui, with its highly acclaimed and exclusive Super Feedforward DC power amplifier system, banishes every conceivable type of audible and inaudible distortion—THD, TIM, intermodulation, envelope, switching, crossover, etc. And this unique distortion-destroying circuitry is built into every new Sansui "Z" receiver.

The super intelligence of microprocessor control

Similarly, all models incorporate a high degree of automation, thanks to microprocessor

control. One-touch Simul Switching simultaneously turns on the power and one input—turntable, tape deck or AM, FM broadcast. The microprocessor also controls the Quartz-PLL digital synthesized tuning that presets 3 FM and 8 AM stations. The drift-free tuning, whether auto scan or manual, is so precise that in congested areas even the weakest station sounds as if it's just around the corner. There's also a programmable digital quartz timer/clock with three daily independent memory functions. You can awaken to FM: fall asleep to cassette music; and arrive home to hear your favorite record.

The top-of-the-line Z-9000X makes listening even more pleasurable with a 7-band graphic equalizer, a built-in reverb amp, preset volume control, plus preamps for MC and MM cartridges.

More music control across the board

Combine all this with power handling capability ranging from

130 to 55 watts, and you can appreciate why no other collection of receivers gives you so much control over your music.

Maybe you're wondering why Sansui doesn't give you less technology and fewer features, as others do. It's because we never compromise when it comes to music. And neither should you.

Watts per channel

Minimum RMS, 20-20KHz, both channels driven into 8 ohms, at rated Total Harmonic Distortion.

Z-9000X	130 w.	.005%
Z-7000X	100 w.	.005%
Z-5000X	70 w.	.007%
Z-3000X	55 w.	.008%

SANSUI ELECTRONICS CORPORATION
 yonkers, NJ 07071, Garden, CA 90248
 Sansui Electric Co., Ltd. Tokyo, Japan

Putting more pleasure in sound

DON'T MISS OUT!



On Sale November 15
at your local newsstand.

Audio

Eugene Pitts III
Editor

Art Director: Cathy Cacchione

Technical Editor: Ivan Berger
Managing Editor: Kay Blumenthal
Editorial Assistant: Andrea Lynne Hecker

Associate Editors:
Edward Tainall Canby, Bert Whyte
Senior Editors:
Leonard Feldman, Richard C. Heyser, B. V. Pisha,
Howard A. Roberson

Contributing Editors/Artists:
Herman Burstein,
Ted Costa, John Diliberto, John M. Eargle,
Joseph Giovannelli, Bascom H. King,
David Lander, Edward M. Long,
C. G. McProud, Jon Sank, Donald Spoto,
Michael Tearson, Jon & Sally Tiven,
Linda Zerella

General Manager: Mary Anne Holley
Production Manager: Elaine S. Geiger
Asst. to the Publisher: Susan L. Newkirk

Marlene Jensen
Publisher

ADVERTISING

Advertising Director: Roman Beyer
(212) 719-6335
Eastern Ad Manager: Stephen W. Witthoft
(212) 719-6337
Western Ad Manager: William J. Curtis
Account Manager: Steve Moser
(213) 487-5880
Classified Ad Manager: Laura J. LoVecchio
(212) 719-6338

OPERATIONS

V.P., Circulation: Robert F. Spillane
Circulation Director: Norma Darragh
Marketing Services Director: Perry Grayson
Production Director: Gerald Palacios

CBS CONSUMER PUBLISHING EXECUTIVE STAFF

President: Robert J. Krefling
Sr. V.P.: George H. Allen
V.P., Group Publisher: Peter G. Diamandis
V.P., Finance & Admin.: Robert J. Granata
V.P., Editorial: Harold Hayes
V.P., Group Publisher: Patrick M. Linskey
V.P., Group Publisher: Michael J. O'Neill
V.P., General Manager: Thomas M. Kenney

Thomas O. Ryder
V.P., Group Publisher

AUDIO (ISSN 0004-752X, Dewey Decimal Number 621.381 or 778.5) is published monthly, except semi-monthly in October, by CBS Publications, The Consumer Publishing Division of CBS Inc., at 1515 Broadway, New York, N.Y. 10036. Printed in U.S.A. at Nashville, Tenn. Second class postage paid at New York, N.Y. 10001 and additional mailing offices. Subscriptions in the U.S., \$15.94 for one year, \$27.94 for two years, \$37.94 for three years; other countries, add \$6.00 per year.

AUDIO is a registered trademark of CBS Inc. ©1983. CBS Publications, The Consumer Publishing Division of CBS Inc. All rights reserved.

Editorial contributions are welcomed but should be accompanied by return postage. Submissions will be handled with reasonable care, but the publisher assumes no responsibility for safety or return of manuscripts, photographs, or artwork. The Publisher, in her sole discretion, reserves the right to reject any ad copy she deems inappropriate.

AUDIO Publishing, Editorial and Advertising Production offices, 1515 Broadway, New York, N.Y. 10036. Subscription offices, P.O. Box 5318, 1255 Portland Place, Boulder, Colo. 80322. (800) 525-9511, (303) 447-9330 in Colorado. Postmaster: Send change of address to P.O. Box 5316, 1255 Portland Place, Boulder, Colo. 80322.

HARMAN KARDON INTRODUCES STATE-OF-THE-MIND TECHNOLOGY

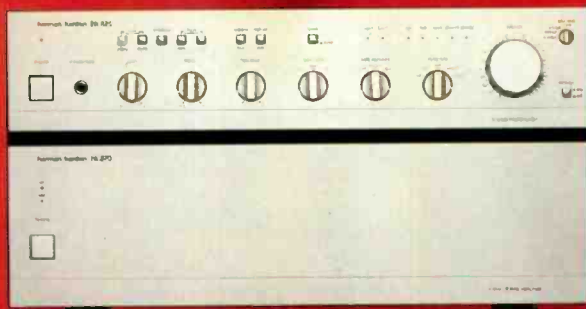

30 years ago Harman Kardon introduced the world's first high fidelity receiver. It was built on the philosophy that quality audio must evolve from creative, quality thinking.

Over the years, Harman Kardon continued to introduce original audio theories that were truly "state-of-the-mind", each proving so successful that they were immediately absorbed into the marketplace as "state-of-the-art".

For example, in 1958, Harman Kardon developed the first stereo receiver. A state-of-the-mind theory that instantaneously became state-of-the-art.

Harman Kardon, in 1976, saw the need for a noise reduction system for recording tape and became the first company to use Dolby¹ in a cassette deck.

Now, Harman Kardon's most important state-of-the-mind concept, High Current Capability, has turned state-of-the-art. A recently published paper² states that in order for an amplifier to properly drive loudspeakers it must have the High Current Capability to instantaneously generate as much as 6 times its rated power into a 1.33 Ohm load. Harman Kardon has consistently

used High Current Capability in our products and we are presently using it in all of our receivers and amplifiers.

The HK870 100 Watt³ power amplifier our newest product, carries this philosophy even further. The HK870 has an exceptional 60 Arms of High Instantaneous Current Capability and maintains a negative feedback level of only 12dB.

The HK870 is matched by the HK825 preamplifier. The HK825 offers dual RIAA equalization circuitry in the phono section, a discrete Moving Coil head amplifier and Ultra wide bandwidth of 0.1Hz to 180kHz delivering extremely pure, transparent sound.

So, while other manufacturers continue to pile on unnecessary features and performance reducing gimmicks, Harman Kardon continues to fine tune the basics and develop fundamentally advanced audio equipment.

1. Dolby is the registered trademark of Dolby Laboratories Inc.

2. "Input Current Requirements of High Quality Loudspeaker Systems", published and presented to the AES by Dr. Matti Otala. For a copy of this paper, write to Harman Kardon.

3. 100 Watts RMS per channel, into 8 Ohms, 20Hz-20kHz with less than .06% THD.

harman/kardon

Our state-of-the-mind is tomorrow's state-of-the-art.

From lasers that play digital records to computerized tape decks that make digital recordings, nobody delivers the startling realism of digital sound like Technics.

The challenge: to eliminate the audible differences between live music and its recorded counterpart.

The solution: Technics digital audio technology.

Technics digital technology is not a conventional (analog) process of music reproduction as in ordinary turntables and tape decks. Instead, music that is recorded in the digital process is electronically translated into a numerical (digital) code. So sound is not only immune to the scratching and physical damage that can affect conventional records and tapes. But also to distortion that can ruin music.

When you play back a digital disc or tape, the numerical code is translated back into music. And the sound is indistinguishable from the original.

With all of this digital technology Technics has emerged as the only manufacturer to bring you not one, but three digital components. For both tape and disc formats.

First there is the extraordinary Technics SL-P10 Compact Disc Player.

The SL-P10 uses a standard 4.7-inch grooveless, digitally encoded disc. This compact disc (CD) is not played in the conventional sense with a tracking stylus that can damage a record. Instead it is scanned by a computerized laser system. There is no wear on the disc, and the music is reproduced with a purity that could only be digital.

And the SL-P10 can be programmed to find a specific cut, play a series of cuts in any order or play a cut repeatedly.

Then there is the Technics SV-P100. The world's first compact, fully self-contained digital cassette recorder. It is a computerized marvel that uses ordinary video cassettes to record, store and play back the astonishing realism of digitally encoded music.

If you already have a video cassette recorder, the ingenious Technics SV-100 Digital Audio Processor connects to your VCR. This endows it with the same kind of computerized digital capability as our digital cassette recorder.

And whatever the future of audio holds, digital and beyond, Technics is committed to leading you to it.



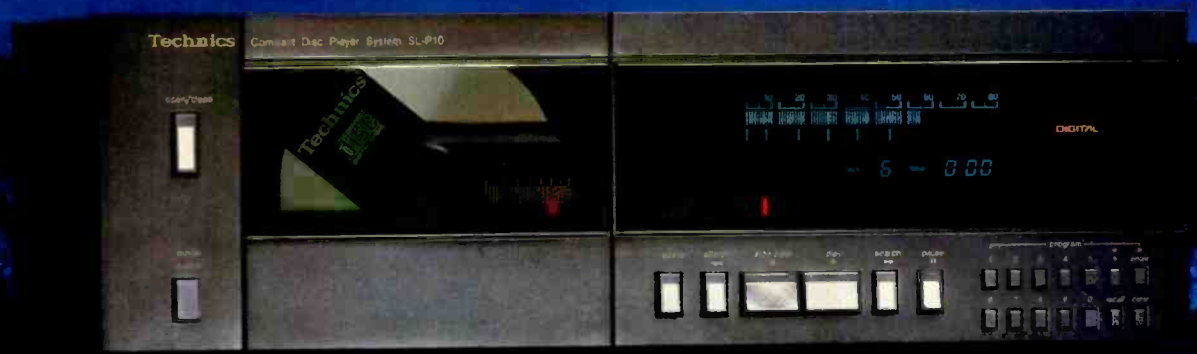

Technics
The science of sound

Enter No. 3 on Reader Service Card

EARS AND ERES

Illustration: Philip Anderson



As I listened to concert after concert in Silva Hall, the new electronically assisted large concert space in Eugene, Oregon (described last month), I developed a strong first-hand feeling as to what this remarkable new kind of sonic architecture can do for the listener in his seat and the live performance on a stage—in a sweeping variety of music, speech, opera, ballet, drama, lectures, pop shows and what have you. At a far remove, I'm already thinking, could not this approach also work in our own little concert halls, the better to fit our living rooms for recorded and broadcast music? Why not. Assisted Resonance, the other AR, has it well in hand, as a beginning.

The music of the 1983 Oregon Bach Festival was, of course, all classical. Even so, an astonishing variety of shapes and sizes of music were accommodated though the Festival audiences mostly took it all for granted. Just think: We heard in that space, full-size, everything from the monumental Bach B minor Mass to that feeble instrument, a solo harpsichord. And, along the way, there were violin and cello sonatas, trios, quartets with piano (Brahms), an evening of late-Baroque

concerti and another for small chamber groups (C. P. E. Bach). Also, there was a solo lied recital for soprano, very intimate in intent, and a series of Bach cantatas—with spoken comment—ranging from the smallest, a few faint solo instruments (gamba, recorder) and a tiny chorus, to Bach's biggest public music complete with a trio of trumpets.

In terms of sheer volume, then, both in the sound and the required space, this suggests roughly a 200:1 relationship, whether in decibels or cubic feet. The hall was stretched to its widest capacity even within the strict classical category. Unobtrusively, it was serving the functions of maybe a dozen separate and very different locales, ideally speaking, each suitable for a much narrower range of performance. As my Bach program book said, "From Symphony to Rock, from Broadway to Ballet, they're all at the Hult Center." True. Even as Bach unfolded in two weeks of glory, Harry Belafonte and troupe came through Eugene and occupied Silva Hall on a free evening.

The all-purpose hall isn't exactly new. Ever since the precedent-setting Jazz at Carnegie Hall series of a generation ago, we have been adapting

old halls, building new ones, to solve the all-in-one problem. The whole apparatus of mechanically shifting wall panels, screens, hanging clouds, unfolding drapes and more was developed in the attempt to make these halls sonically variable and good in the listening for many uses. Or we have simply ignored the problem and used the halls anyway. Long ago I heard a solo harpsichord recital in Carnegie, unassisted—Landowska in her last years of public performing. The place was packed, the audience sound-absorbing, and you could not hear a pin drop as the great little lady came on the stage. Alas, you could not hear the harpsichord either. I listened reverently to pages of silence, not even a cough. Only the loudest segments, all the strings coupled in high gear, came through as a faint shimmering. Great just to see such a famous artist in the flesh, and no regrets! But . . .

Now we can tactfully, expertly, enhance such instruments and others with close-up mikes and discreet amplification, scarcely noticeable to most listeners. This indeed is a subtle and still-developing art in itself. It is even used in Silva Hall, exactly as it is elsewhere.

But in Silva (and perhaps a scant dozen halls in the world) we are dealing with an utterly different concept. As I have said, this is not *sound* reinforcement but *hall* reinforcement. The electronic systems are a part of the hall itself in acoustic terms. Silva Hall is the first to be predesigned from the start for this dual acoustic structure, electronic and architectural elements permanently joined and working as one—with variability. The actual physical hall *cannot be used by itself* minus electronics, a bold innovation.

A sudden flash occurred to me the other day. Silva's unique look (as described last month) may not be entirely for technical reasons nor for architectural novelty. There's a better thought. We often find it anachronistically uncomfortable to listen to loud pop music in the traditionally austere spaces of, say, Carnegie Hall or the equally formal setting of many modern halls. Similarly, we are ill at ease hearing loud, non-sacred music in a church concert, though all of these contradictions are commonplace. Ears and eyes, our

POWER ON DEMAND



THE SOUNDCRAFTSMEN A2801 POWER MOSFET STEREO AMPLIFIER



Ordinary Recordings—even so-called “audiophile discs”—are often so limited in their dynamic range that even small, lightweight, low-powered amplifiers and receivers can reproduce their musical information without serious problems.

However, Digital, dbx and CX-encoded records have changed all that. Where 20 to 40 watts once was acceptable, not even double and triple that power is enough to reproduce these new recordings without severe “clipping” distortion!

Designed specifically for this new technology, the A2801 produces 140 watts per channel continuously with 8-ohm loads and 205 watts per channel continuously with 4-ohm loads and huge power reserves of more than 700 watts are always available to reproduce the tremendous Digital dynamic “peaks” with absolutely effortless clarity. More than enough for these new wide-range Program Sources.

Featuring the latest POWER MOSFET circuitry, the A2801 offers power, sonic purity and unmatched reliability at only \$549.00.



SOUNDCRAFTSMEN A2502

A deluxe, full-featured version of the A2801, the A2502 includes Calibrated 20-LED Power Meters, Full-Range Input Level Controls, and Switching for Two Separate Pairs of Loudspeakers in Any Combination. The A2502 Represents an Excellent Value at \$649.00.

CONVENTIONAL RECORD

Oscilloscope photo shows music playing at normal listening level. Only 1 watt of power is required for average level, but 16 watts are needed to produce “peaks.”

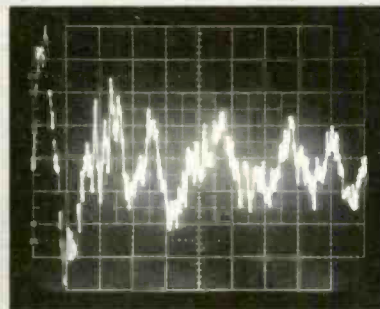
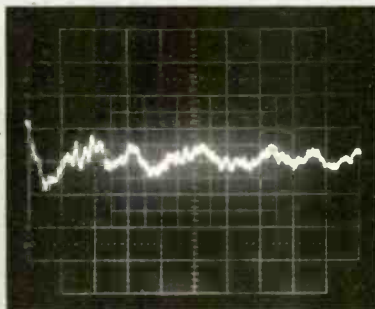

DIGITAL AUDIO DISC

Oscilloscope photo shows same music playing at same normal listening level. Again only 1 watt is required for average level, but 500 watts are needed to produce the... “digital/dynamic peaks” without distortion!

The World's Finest Stereo Components
Are Still...MADE IN U.S.A.!

Soundcraftsmen

FREE!

FREE! \$19.95 EQ EVALUATION KIT, including 12" LP Frequency Spectrum Analysis Test Record, 2 sets of Computone Charts, Connector Cable, complete instructions. JUST WRITE TO US OR CIRCLE Reader Service Card #30. We'll send Free Special Offer Details and 16-page full-line color brochure featuring "WHYS AND HOWS OF EQUALIZATION."

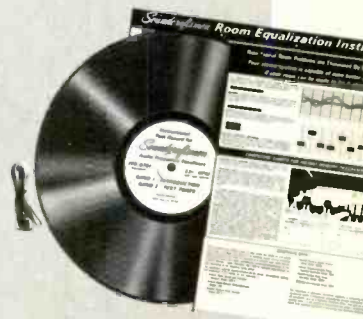

2200 So. Ritchey, Santa Ana, California 92705, U.S.A./Telephone (714) 556-6191/U.S. Telex/TWX 910 595 2524 • International Telex: 910 595 2524/Answer-back Code SNDCRFTSMN NA

Enter No. 30 on Reader Service Card

"...a receiver of exceptional quality."
—STEREO REVIEW

"...the finest 'receiver' we have ever tested."
—HIGH FIDELITY



Tandberg's remarkable TIA 3012 Integrated Amplifier and TPT 3011A Programmable Tuner are individually considered to be amongst the world's finest music reproduction equipment. Together, they have become a truly extraordinary stereo receiver.

Write or call for complete literature on all of Tandberg's exceptional products, as well as the name of your nearest authorized dealer.

TANDBERG
Labriola Court, Amosk, NY 10504
(914) 273-9150

Enter No. 4 on Reader Service Card

"You can change the effect, change the hall itself, with just a few computer keys. Devilishly ingenious! Also devilishly tricky."

sense of place (and suitability) are at odds, though we do go along. What we need for a multi-purpose listening place is *neutrality*. But how?

Silva—that extraordinary upside down basket-weave thing—is very positively neutral! There is nothing else like it. Who ever heard of listening inside a giant green fruit basket? It has its formal aspects but also much whimsy and informality—it's okay for anything. Was that the architects' idea? Anyhow, it works.

Last month, I briefly described one of the two interlocking electronic systems that power the Silva acoustics; AR, Assisted Resonance, with its 90 tuned microphones and 90 loudspeakers, all located on two high catwalks above the hall's floor. Each of these 90 sharply resonant channels, as they were called, cover a band only a few Hertz wide, not far from a pure tone. I should add that the 45 amp systems that link each mike and speaker combination, a pair of channels per amp, adjust the signals so that mike and speaker are exactly in phase, for a very smooth and sophisticated feedback loop, 90 separate loops, controlled with enormous finesse. This allows the ambient sound-slice in each narrow band to be selectively amplified and, more important, selectively adjusted for die-away time or reverb, frequency by frequency, via the controlled feedback. Thus, not only the overall reverb time is adjusted but the coloration too, dynamically changing with time! The reverb you hear in the hall depends on the *combined* sound of these dynamic feedback loops, and the original natural architectural reverb—you cannot tell them apart, they are one. But you can change the effect, change the hall itself, with no moving parts except a few computer keys and such. Devilishly ingenious!

Also devilishly tricky, if you know about feedback instability. Gremlins by the thousands, just waiting to produce howls, squeals, unimaginable chaos. How would you like to have that much near-instability in your public system? A horrid thought. Sanity is maintained in Silva, I gather, via the central computer that controls everything. Sometimes those little gadgets with the keys and the screens can be quite useful.

The second system in this array,

linked and cooperating, is entirely different in purpose and operation. It is known at the moment as ERES (terms for all this gear are still a bit unstable), signifying Electronic Reflected Energy System, basically a complex digital delay. We have similar, if rudimentary, systems in our various home-based synthetic reverb units, AR being the reverb control and ERES hall size or equivalent.

Up to a point AR and ERES share many qualities. Both work at surprisingly low levels, never above the live stage sound to the point of conscious awareness. In the hall, you simply do not hear either one. Both use smallish speakers and low power; in both, the speakers and microphones are entirely hidden and completely unidentifiable. After two weeks I still could not visually locate a single speaker out of the hundred plus in that hall, and no microphone other than the stage mikes.

The entire sound pickup of both AR and ERES is strictly at a distance, like ambient mikes; there is absolutely no differentiation between sources on the stage—even when that includes conventional sound reinforcement. The mikes are high above in both systems, and so are most of the speakers, on the happy principle that our vertical directionality is vague when we are not aware of the source location and cannot see it. It works—I never could pinpoint any trace of sound coming from above me, even though I stared at those catwalks where I *knew* some of the speakers lived.

You can appreciate the difference between AR and ERES by their radically different equipment. In contrast to AR's 90 mikes, ERES uses only one, normally hung at the top of the sound-transparent proscenium, 50 feet above the stage. (Other, similar locations serve varying needs.) The ERES speakers, used to define space, are strategically located in various parts of the hall, tied to various delays, creating calculated sound reflections that simulate solid architecture—instantly movable, of course. ERES in particular provides that mystical 20-mS delay for first reflections that has been found to provide presence, vibrancy, realism, as well as spaciousness in good halls, especially large ones. Hence those long, narrow rectangular shapes in the

AUDIOPHILE FILE™ XL-S

GREATER DYNAMIC RANGE

Maxell XL I-S and XL II-S are the ultimate ferric oxide cassette tapes. Precision engineered to bring you a significant improvement in dynamic range.

XL I-S provides exceptionally smooth linear performance characteristics with high resolution of sound and lower distortion.

While XL II-S has a greater saturation resistance in higher frequencies resulting in an excellent signal to noise ratio.

How did we achieve this?

IMPROVED EPITAXIAL PARTICLES.

Maxell engineers have managed to improve the Epitaxial magnetic particles used on both tapes.

By developing a crystallization process that produces a more compact, smoother cobalt ferrite layer on the gamma ferric oxide core, they've been able to pack the particles more densely and with greater uniformity on the tape surface.

This increases maximum output level and reduces AC bias noise which in turn expands the dynamic range.

IMPROVED EPITAXIAL PARTICLE CHARACTERISTICS:

MORE UNIFORM COBALT-FERRITE LAYER

SMOOTHER PARTICLE SURFACE

GAMMA-FERRIC OXIDE

470Å

COATING THICKNESS: 10-11A (1A = 1/10,000,000 mm)

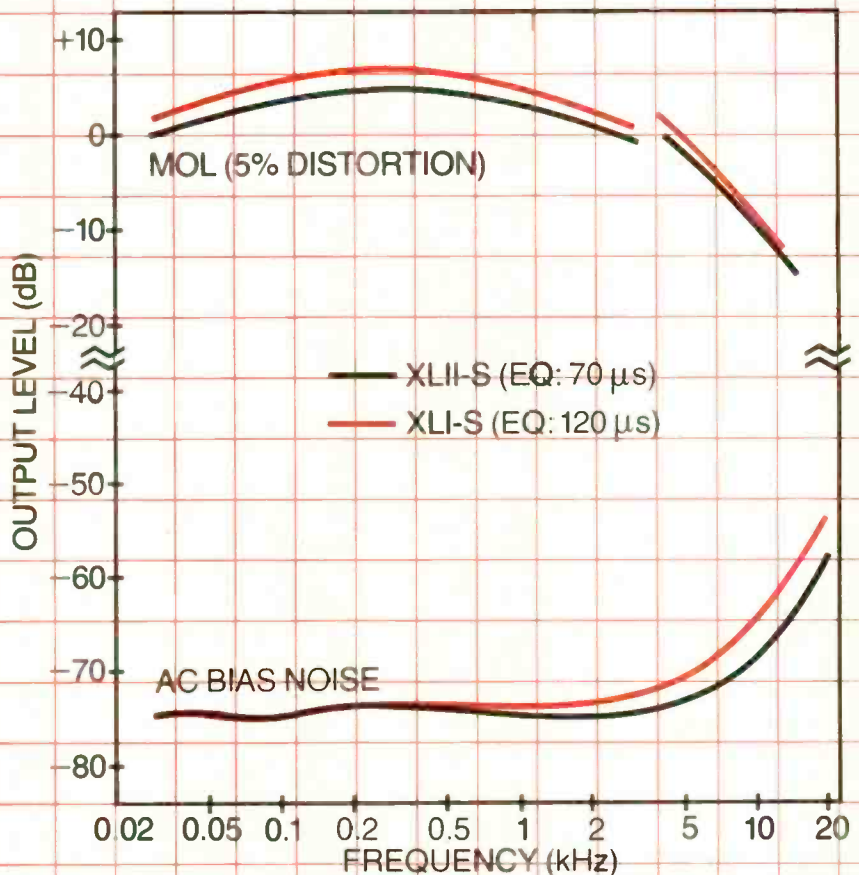

So you get a better signal to noise ratio, greater resolution of sound and higher output levels.

Of course, greater dynamic range isn't the only reason to buy Maxell high bias XL II-S or our normal bias equivalent XL I-S.

Both tapes have more precise tape travel and greatly reduced distortion levels.

You'll see both these improvements covered in detail in future Audiophile

Files. In the meantime, we suggest you listen to them.

For technical specification sheets on the XL-S series, write to:

Audiophile File, Maxell Corporation of America, 60 Oxford Drive, Moonachie, New Jersey 07074.



IT'S WORTH IT.

©1983 Maxell Corporation of America, 60 Oxford Drive, Moonachie, N.J. 07074

Enter No. 5 on Reader Service Card

DENON



DESIGN INTEGRITY Formerly, audiophiles seeking uncompromised sonic performance from separate components had to sacrifice either construction quality and flexibility or spend an inordinate amount of money.

Denon, through intelligent and efficient circuit design and newly developed manufacturing processes, now offers the PRA-1000 Pre-amplifier (Sug. Ret. \$495) and the POA-1500 Power Amplifier (Sug. Ret. \$695) with sound quality, control flexibility and craftsmanship formerly unavailable at anything less than three times the cost!

Denon America, Inc., 27 Law Drive, Fairfield, New Jersey 07006

Enter No. 6 on Reader Service Card

A better amp and pre-amp simply cannot be built.

- ASK any hi-fi reviewer.
- ASK any hi-fi salesman what he uses at home.
- ASK any FM broadcaster.
- ASK any designer of speakers which amp he uses to drive them.
- ASK any one who owns one.

A better amp and pre-amp simply cannot be built.
Or bought.



The new Holman stereo preamplifier two



Come up to apt

Apt Corporation, 148 Sidney St., Cambridge, MA 02139 Tel: 617 492-5145

Enter No. 7 on Reader Service Card

"ERES aims to bring that mystical, 20-mS delay of first reflection to all parts of the house, and further delay bass for a sense of warmth."

best of the old halls, where the close-in sides do this job, also such newer, scientifically designed halls as Boston's (the first, around 1900) and the recent reconstruction of Avery Fisher Hall in New York.

ERES is supposed to bring that 20-mS reflection to every part of Silva Hall. And in addition it further delays the lower bass (still unobservable as a separate echo), for a sense of warmth and amplex. This and much, much more. Sonic walls can be moved, even the ceiling (maybe), creating many sizes and shapes for differing purposes, both smaller and larger, if I am right, than Silva's actual dimensions.

Both systems, remember, were designed into the hall itself. Accordingly, for AR the architectural acoustics were intentionally deadened (in the basket-work)—AR brings them up again, variably. The very shape of the hall was designed for ERES. The space is daringly wide, the stage deep, the sides and top rounded, depending on ERES to compensate (variably!) for the severe penalties such a shape would otherwise involve—poorly defined, distant music, a lack of immediacy of presence, a generally blurred and ineffective ensemble of musical sound, as though the performers were somewhere else, not right down in front. In Silva, this is heightened by the muffled, dead acoustic of the hall minus AR.

The eyes, my experience tells me, are not at all confused by AR's variable reverb and coloration, which does not change during the music unless by emergency. ERES's variable shapings are potentially more of a problem, with eye-walls and ear-walls that do not coincide, but I was never really bothered by any falsity. After all, what we hear in such places is the entertainment on stage; that is quite conscious. All the rest is subliminal, if important, walls and all.

And then there's that third system, the regular or house system! It has power! It's plastered with JBL 15-inchers in the dozens, mids and tweets to match, a huge central cluster, front-fill, side-fill, monitor systems, and three operating boards. Wow—it's loud. But AR and ERES between them, so puny in volume, absolutely inaudible as separate sound sources, are what really matter in Silva Hall.

4

Sneak preview

The other day one of our engineers made an interesting observation.

He was trying to illustrate how much better the new ADS speakers sound.

"Think of the speaker as a camera lens," he said. "What we've done is improve resolution, extend depth of field, magnify detail, produce a finer image."

Not a bad analogy we thought, and asked him to go on.

"We've done it with a lot of new technology," he explained, "but precision is critical. Take voice coil gaps. Ours are no thicker than your business card. About twice as fine as the gaps in most drivers, which has a lot to do with improving efficiency and reducing high end distortion.

"We've improved power-handling in the high end, too, by using a new high-gravity cooling fluid made to our own specifications.

"We've developed a new Linear Drive, long-voice-coil woofer which really improves bass response. The cone is Stiffite, an expensive, low-mass material used only by ADS. The result is a woofer with very high force-to-mass ratio, which means it goes lower, is more accurate and has more dynamic range."

As you read this, new ADS speakers are on their way to an ADS dealer near you. For his name write us: Analog & Digital Systems, Inc. 221 Progress Way, Wilmington, MA 01887. Or call toll free: 800-824-7888 (in CA 800-852-7777) and ask for Operator 483.

They're truly magnificent speakers. Sneak your own preview soon.

ADS Audio apart.

The new L780 is one of seven new ADS speakers available in black or walnut finish. You'll recognize it by the new angled corner and distinctive deep-drawn metal grill.

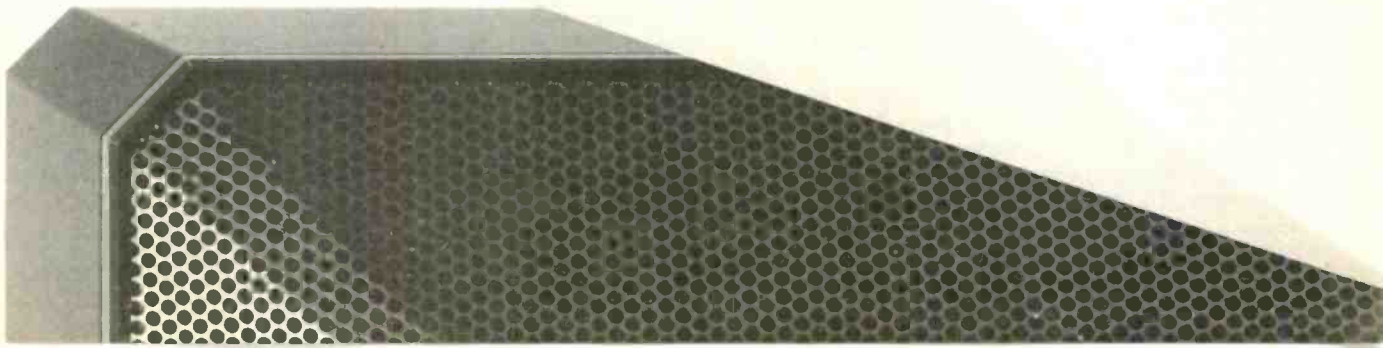

BERT WHYTE

OUT ON A LAMBDA



Stax Lambda Professional

Thirty-three years ago, I was a sales executive and music director of Magnecord, the Chicago-based company which, along with Ampex, pioneered the development and manufacture of professional magnetic tape recorders.

By 1950, the Magnecord PT-6, a 7½ or 15 ips, quarter-inch full-track recorder, was well-established as the workhorse of the broadcast industry. Needless to say, this was a monophonic machine, but the winds of change were already blowing even in those early days. We received a request from the U.S. Navy Special Devices Center in Sands Point, New York for a Magnecorder that could record two channels of data from underwater sonar experiments. Almost at the same time, there was a request from General Motors for a two-channel recorder for the study of interior noise in their cars.

There was no such thing as a stacked two-channel magnetic head in those days, so Magnecord took an expedient step. They used two half-track heads, with their magnetic gaps separated by 1¼ inches, thus achieving the necessary track isolation for the two independent recording channels.

Having made several of these two-channel Magnecorders with what

came to be known as staggered heads, we recalled the binaural hearing experiment with "Oscar, the dummy," a popular feature at the 1933 Chicago World's Fair. This showed how the time of arrival and intensity of sound give us our directional cues in the normal hearing process.

All this led to our first experiments in the binaural recording of music, using two microphones spaced 6 to 8 inches apart. We would record in this mode or with a baffle board between the microphones to simulate the human head's shadow.

Binaural recordings were played back via headphones. In those days, we didn't have the wide choice of high-quality headphones we have now. In fact, the best headphones we could come up with, made by a company called Permoflux, actually had been made for military pilots during World War II. They were heavy and clumsy, and still had those bright yellow chamomis ear pads. Wearing them, you felt like you were heading out on a bombing mission! As you can appreciate, frequency response wasn't the greatest, with response dropping like a stone at about 7 to 8 kHz. Nevertheless, the Permoflux phones served well to introduce many people to binaural

recording. Few ever forget the incredible thrill of listening to true binaurally recorded music for the first time.

I was soon very involved with making binaural recordings and would go anywhere and do almost anything to record binaural music. I recall bootlegging the U.S. Navy Band through a pair of mikes surreptitiously lowered from a crawl space above the ceiling of a high school auditorium in suburban Chicago! On another occasion, I recorded Woody Herman and his Thundering Herd at the Blue Note nightclub in Chicago. The day after the recording was St. Patrick's Day, and I invited Woody and 14 of his band members to a friend's house for dinner and to listen to what we had recorded. I cooked up a huge vat of corned beef and cabbage, and we had copious quantities of Guinness stout on hand. At Magnecord we had made up some multi-output jack boxes so that several sets of headphones could be used simultaneously. I had brought enough multi-jack boxes for 16 sets of phones, and after we were all well-fed with the corned beef and well-lubricated with the Guinness, we started our listening session. You can imagine what a sight this was—all of us sitting in a circle on the floor of the living room, each wearing the Permoflux headphones with the bright yellow ear pads, the tangle of connecting cords to the jack boxes, and the binaural Magnecorder in the center. Of course, there was no sound of music in the room, but everyone was swaying and gyrating, and shouting comments to each other about their performance the previous night. To a stranger walking into the room, it would have looked like some strange tribal ritual.

I still have those Woody Herman binaural tapes, as well as similar recordings I made in the Blue Note with Stan Kenton and Benny Goodman. After more than 30 years, without any special care in storage, the tapes are still in good condition, with only a slight amount of "cupping"—a longitudinal curvature—due to the gradual drying of the plasticizer in the tape.

Magnecord also produced a standard PT-6 BN binaural recorder, and many of my recordings were demonstrated at the Audio Fairs of that time. I received a request for, and supplied a

MAGNEPLANAR® SCREENS

Technology

Elegance

Value

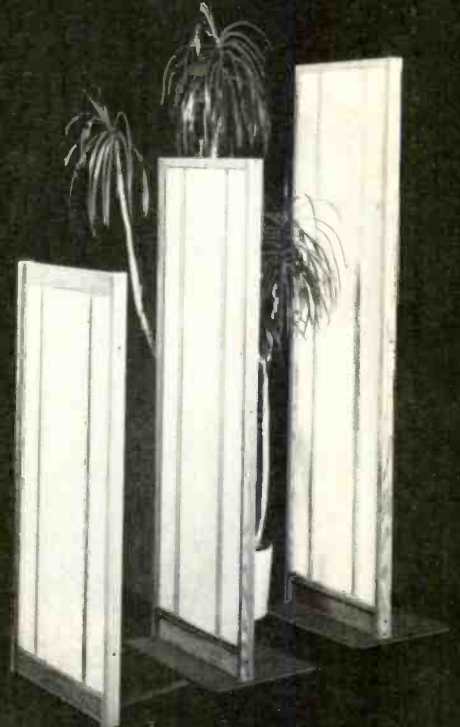

binaural Magne recorder to, one Edward Tatnall Canby of *Audio Engineering* magazine, who duly reported on his experiments with this recorder.

I soon moved on to stereo, and in 1951 made my first such recording with Leopold Stokowski, Monteverdi's Vesper Mass of 1610. I also had the pleasure of working with the late Bob Fine. He was making his superb monophonic Olympian Series recordings for Mercury with the Chicago, Detroit and Minneapolis Symphony Orchestras, while I was experimentally recording them in stereo.

All of the foregoing is a preface to the main thrust of this column—to wit, how far technology has advanced headphone design from those primitive Permoflux phones to the sophisticated, high-quality headphones of today. In this digital era, the headphone is finding an increasingly important role, and it is obvious that listening to music through headphones is a very widespread practice these days. I don't mean just the Walkman phenomenon, though that too seems to be spreading, but rather listening through good-quality headphones to a home stereo system. There are innumerable people living in apartments who simply cannot play their loudspeakers at high levels for fear of bringing down the wrath of neighbors. Others wish to retreat into private musical worlds and escape the nonstop TV of their kiddies.

It is also generally acknowledged that, despite the many very high-quality dynamic headphones on the market, electrostatic headphones offer the highest fidelity of reproduction.

One of the companies preeminent in electrostatic headphone design is Stax Kogyo of Japan. Their various models have generally found a good deal of favor among audiophiles, but one which is particularly well regarded is the Stax Lambda headphones—or "earspeakers" as Stax calls them.

The Stax Lambda's large, elliptical diaphragm entirely covers the ear. It is ultra-thin, only 2 microns thick, and is made of a high-polymer film. This almost massless diaphragm permits near-instantaneous acceleration, so transient response is lightning fast. The diaphragm is said to be essentially free of internal resonances, and thus tonal colorations are absent. Frequency re-

sponse is claimed to be a phenomenal 8 Hz to 35 kHz, and the maximum output is said to be 100 dB SPL!

I can testify that the dynamic range is extremely wide, and the sound quality is outstanding, utterly clean, transparent, and oh so effortlessly produced. These phones are tonally accurate to an incredible degree and can ruthlessly expose the shortcomings of any type of program material.

The SR Lambda earspeaker is optimally driven by the SRM-1/MK2 Class-A amplifier, which provides 210 volts in a direct-drive configuration, thus eliminating the need for coloration-producing coupling transformers. The SR Lambda earspeakers and the SRM-1/MK2 are a formidable combination and have enjoyed a reputation as the most critical monitoring system extant.

This is a view also held by none other than Daimler-Benz, the German manufacturer of the prestigious Mercedes automobiles. Now history repeats itself: Just as General Motors was studying car interior noises 33 years ago, Daimler-Benz is conducting similar research today. This time around, the research is an even more highly sophisticated effort. It appears that most car noise presently lies in a very low frequency range, and is produced at very high levels. The extended low-frequency response of the Stax Lambda earspeakers (8 Hz) was just what the Daimler-Benz engineers needed, but there was not sufficient output from the phones.

The car maker thus asked Stax to make a special Lambda earspeaker that would satisfy their requirements, and Stax responded with the Lambda Professional System. To produce low frequencies at higher output levels, the phones needed a larger spacing between the electrostatic elements and the electrodes on either side, to permit greater excursions of the element. The electrode gap was thus changed from the 0.3 mm of the standard Lambda to 0.5 mm on the new Lambda Professional. However, this wider spacing of the electrostatic element caused a weaker electrostatic field, necessitating a redesign of the direct-drive amplifier. Voltage was increased more than 2½ times—to 580 volts. The greater excursion of the diaphragm and the higher voltage drive enabled

- **LIFE-LIKE IMAGE**—Full height, width and depth of sound.
- **LOW COLORATIONS**—No box resonance to color sound.
- **UNIFORM DRIVE**—All parts of diaphragm driven; not just apex of cone.
- **LOW MASS**— .0005 inch thick diaphragm for clear, crisp sound.
- **RESISTIVE LOAD**—Ideal for amplifiers.
- **PHASE RESPONSE**— Tweeter, midrange/bass on same diaphragm.
- **ELEGANT SCREENS**—A beautiful alternative to boxes in the living room.

Prices starting at \$475.00 per pair

MAGNEPAN

1645 9th Street
White Bear Lake, MN 55110

"If a loudspeaker could sound as clean, detailed, transparent, open and distortionless as Stax Lambda earspeakers, we would be in hi-fi heaven!"

Daimler-Benz to get their desired high-output bass response.

Stax decided to make the Lambda Professional System available to audiophiles, pricing it at \$780. The lightweight units weigh only 325 grams and they are equipped with a connecting cord with a specially polarized plug.

The SRM-1/MK2 Professional Class-A direct-drive amplifier has a polarized receptacle for one pair of Lambda Professional earspeakers and another for a pair of the standard Lambdas. A volume/balance control is on the front panel of the amplifier, which measures 150 mm W x 87 mm H x 370 mm D.

Other side benefits resulted from the work on the Lambda Professional. The already very low distortion was reduced a further 10%, while maximum SPL increased 5 dB and sensitivity 2 dB.

I have been using a Lambda Professional System for some months now, and it is truly incredible, really quite extraordinary. If only a loudspeaker could sound as clean, detailed, transparent and open, and distortionless as these earspeakers, we would be in hi-fi heaven! If you want to find out how everything really sounds in your system up to the point of amplifier output, listen via the Lambda Professional System and all will be starkly revealed.

If you want the ultimate in sound quality, just hook up the output of a CD player to the input on the rear of the SRM-1/MK2 Professional amplifier, put on the Lambda Professional earspeakers, and play a well-recorded CD. The result can be magical—an incredibly detailed sound with absolute tonal purity, ultra-wide frequency response and dynamic range, and without a trace of noise! This Lambda Professional System is so exacting, so critical a monitor, that it is ideal for auditioning CDs. Believe me, if it sounds poor on the earspeakers, with even the slightest stridency on high strings, it will sound awful through your loudspeakers. It's a truly great sound—but there are several caveats. Just remember the Compact Discs (those that are not compressed) and the Lambda Professional System are capable of more than 90 dB dynamic range. One must be absolutely certain the volume control is turned way down before commencing to listen—each of us has only one pair of ears. It also must be noted that all of the music heard through headphones has been recorded for playback through loudspeakers. Thus, when listening through headphones, the effect can be quite pleasing and even spectacular, but in truth it is a distortion of perspective. What is needed is a return to true binaural recordings, ones made specially for headphone listening. It would not be that expensive to run a parallel digital recorder to accept binaural sounds, and there is a huge headphone market to justify the release of such recordings. Digital binaural! Wow!



The sound engineers at most of the world's great classical recording studios* have at least one thing in common.

*Decca, Deutsche Grammophon, CBS, Capitol, EMI, Polygram

They all choose B&W 801F loudspeakers to monitor the fidelity of their recordings.

You, too, can choose this same digital technology to monitor your recordings in your own home. B&W has just released the all new DM110 at only \$298.00 per pair and the DM220 at \$498.00 per pair.

These speakers are engineered for high acoustical output, high sensitivity (not less than 90db) and a linear and extended frequency response.

Complete your studio with a pair of B&W's.

B&W Digital
Analogs **the Best in the World**

Distributed in United States and Canada by
Anglo American Audio Co. Inc., Box 653, Buffalo, NY, 14240. (416) 438-1012
Member of Misobanke International Group

Buff Stuff from TDK.



You, the audiophile, are the toughest critic we know when it comes to sound performance. You're very selective in deciding the perfect equipment for your recording and listening needs.

And you're just as selective in choosing your recording tape. TDK knows that. So we developed a line of high performance audio cassettes that meet your critical requirements.

We call it the TDK Professional Reference Series.

You're probably using TDK SA-X high bias cassettes now because of their superior performance characteristics. In addition, TDK has developed normal bias AD-X which uses TDK's famous Avilyn particle formulation and delivers a wider dynamic range with far less distortion than ever before. Plus, TDK's unique metal bias MA-R cassette which features high-energy performance in a one-of-a-kind unibody

die-cast metal frame.

The TDK Professional Reference Series... it'll sound impressive to your ears. So share the pleasure with your friends; they'll appreciate it.

 **TDK**
THE MACHINE FOR YOUR MACHINE[®]



Walker Percy

PHOTO CREDITS: Kurt Vonnegut Jr. by Jill Kremenitz



Gore Vidal



Theodore H. White



William Styron



Kurt Vonnegut Jr.

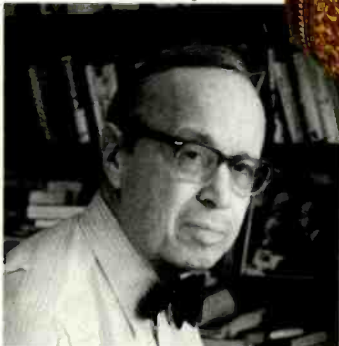

Arthur M. Schlesinger Jr.

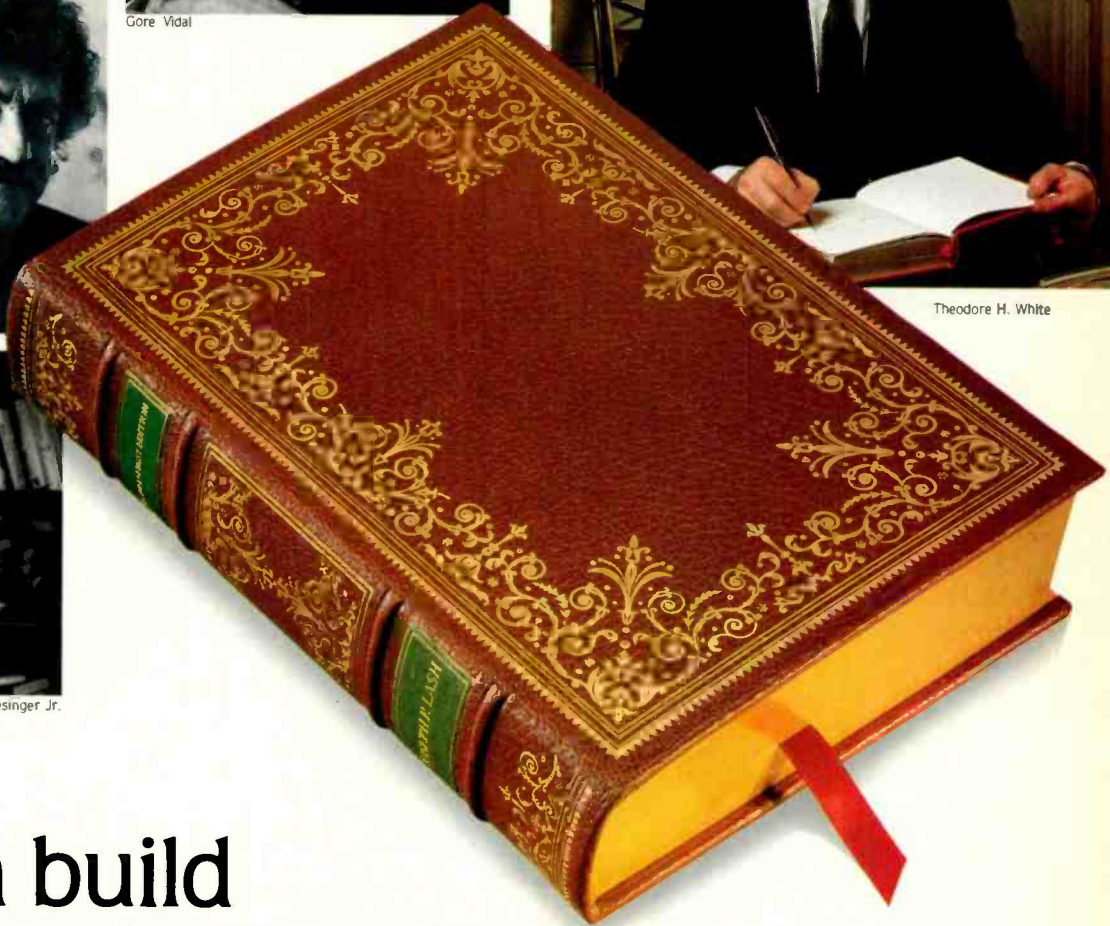

You can build a private library of author-signed First Editions.

Important new books by today's great writers, in First Editions that may well become tomorrow's collecting treasures.

- Published in limited edition, solely for members of The Signed First Edition Society.
- Membership rolls are now open for a limited time.

Special enrollment deadline:
December 31, 1983.

You are invited to begin building a private library unlike any that has existed before. A unique collection of leather-bound First Editions of today's major new books. Each book signed by its author. And each volume a limited First Edition that may well become a book collector's "find" of tomorrow.

By arrangement with America's leading publishing houses, each of these Signed First Editions will mark the very first publication of an outstanding new work. To document this fact for future gen-

erations, every volume will contain a statement of authenticity attesting to its First Edition status and certifying the author's signature.

Furthermore, these volumes will be privately printed, the spines richly embellished with 22 karat gold, and published solely for members of The Signed First Edition Society.

By enrolling now, you can build your own private library of these important volumes. And, for as long as you wish to continue in the Society, you will be among



© 1983 SFES

a select number of people to receive each new, author-signed First Edition, as it is published.

Major works by great authors

The Society has already arranged to obtain and review new manuscripts by such prominent authors as Kurt Vonnegut Jr. (Slaughterhouse Five and Breakfast of Champions), Allen Drury (Advise and Consent), John Hersey (The Wall and A Bell for Adano), William Styron (The Confessions of Nat Turner and Sophie's Choice), Wallace Stegner (The Spectator Bird), Leon Uris (Exodus, Armageddon, and Trinity).

Indeed, the authors to be published by the Society in the coming months have accounted for seven Pulitzers and five National Book Awards. There will be a harrowing mystery that delves into the nature of evil, by award-winning author Joyce Carol Oates. A biographical novel by Irving Stone. And eagerly awaited new books by such best-selling authors as Irwin Shaw, Theodore H. White, Walker Percy, Gore Vidal, Arthur Schlesinger Jr. and Robert Penn Warren.

The First Editions of all of these new books will be reserved exclusively for members of the Society.

The value of owning author-signed First Editions

Among knowledgeable book collectors, First Editions have traditionally been held in highest esteem. Especially prized are First Editions that have been signed by their authors. For then the book—like a signed work of art—serves as a direct link between the owner and the writer.

Accordingly, as each new book is prepared for publication, every aspect of the volume—from the marbled endleaves of the book to the unique design of its leather binding—will be carried out to reflect the spirit and intent of the work. And the author's hand-written signature in the book will be a final mark of approval.

In addition, each author will write a special foreword that will appear only in the Signed First Edition issued by the Society—adding to the importance of owning these superb volumes.

As a member, therefore, you will possess perhaps the most desirable books of all:

important new First Editions, bound in leather, and signed for you by the greatest authors of today. A private library to be treasured throughout a lifetime—and by generations to come.

Leather accented with 22kt gold

Every one of these Signed First Editions will be created to enhance the collector's library and the reader's enjoyment.

Each volume will be fully bound in carefully selected hand-cut leather, deeply stamped with an original cover design. The leather of the spine will be "hubbed" with raised horizontal ridges, and richly decorated in 22 karat gold. And throughout the collection, the books will vary in height, size, cover design, and in the color and grain of their leather bindings.

Leading artists and book illustrators will be commissioned to create original works of art exclusively for these volumes—they will never appear in any other editions.

Further, only quality bookpapers will be used—custom-milled to be free of the acids that cause ordinary papers to yellow. Pages will be thread-sewn into separate "signatures" and the edges gilded with a tarnish-free finish to seal the volume from dust and moisture. Finally, a ribbon page-marker will be bound into each book—an elegant touch and added convenience.

These will be volumes of such beauty and craftsmanship that their authors will be proud to sign them. And you will be equally proud to own them.

Long-term price guarantee— at no obligation

The total number of each new First Edition will be limited to just one volume per member. No additional copies will ever be made available.

By enrolling now, you will receive each new Signed First Edition—approximately one book each month—at the original issue price of just \$35. This price will be guaranteed to you for three full years. And you will have the right to cancel your membership at any time, simply by giving thirty days' written notice.

Limited opportunity to enroll

To enroll as a member of The Signed First Edition Society, simply complete and return the accompanying application by December 31, 1983.

Applications from prospective members will be accepted again in the future. However, those who enroll in The Signed First Edition Society later on will be able to acquire only those volumes offered during the period of their membership—at prices then prevailing.

To be sure of acceptance now, mail your application by the special membership deadline of December 31st. No payment is required now, but it is important to respond by that date.

THE FRANKLIN LIBRARY
A FRANKLIN MINT COMPANY



SPECIAL MEMBERSHIP APPLICATION

The Signed First Edition Society

Valid only if postmarked by
December 31, 1983.

The Franklin Library
Franklin Center, Pennsylvania 19091

Please enroll me as a Member of The Signed First Edition Society, and send me the First Editions to be published by the Society during the period of my three-year membership. Each volume will be fully bound in leather, the spine accented with 22 karat gold, and personally signed by the author. I understand there will be approximately 12 books published each year, and that I can cancel my membership at any time upon 30 days' written notice.

I need send no money now. I will be billed \$35.* for each leather-bound volume in advance of shipment. This price will be guaranteed to me as a Member for three full years.

*Plus my state sales tax and \$2.50 for shipping and handling.

Signature _____
ALL APPLICATIONS ARE SUBJECT TO ACCEPTANCE.

Mr. _____
Mrs. _____
Miss _____
PLEASE PRINT CLEARLY

Address _____

City _____

State, Zip _____

Limit: One Membership per person.

HEAR ALL OF THE MUSIC AND NONE OF THE TAPE...



SWITCH TO BASF CHROME AUDIO TAPE

THE WORLD'S QUIETEST TAPE

If you won't settle for anything less than pure music, accept nothing less than BASF Pure Chrome audio tape. Unlike ferric oxide tapes, BASF Pure Chrome is made of perfectly shaped chromium dioxide particles. And that exclusive Chrome formulation delivers the lowest background noise of any tape in the world, as well as outstanding sensitivity in the critical high frequency range. And this extraordinary tape is designed especially for the Type II Chrome Bias position. So make sure you're hearing all of the music and none of the tape. Make the switch today to the world's quietest tape. BASF Chrome.



TAPE GUIDE

HERMAN BURSTEIN

Info on Print-Through

Q. *Is it possible to get print-through on 1-mil and 1.5-mil tapes if they are played infrequently, say every six months or yearly? Does print-through occur on C-60 or C-90 cassette tapes?*—T. K. Duker, Columbus, Ga.

A. Yes, print-through is possible in all the cases you mention. The thinner the tape (e.g. 1-mil instead of 1.5-mil or C-90 instead of C-60), the more likely audible print-through is to occur. For example, print-through tends to be about 3 dB greater on 1-mil tape than on 1.5-mil.

Print-through tends to increase logarithmically with time. To illustrate, about as much print-through occurs during days 2 to 11 of storage as occurs during day 1, and about as much occurs again during days 12 to 111. The higher your recording level, the more likely that you will get audible print-through.

The tape oxide tends to transfer its signal primarily to the next layer above it. Thus, if you leave a tape in the played condition (tail out), print-through will tend to occur as a post-echo, which usually is less objectionable than pre-echo—which occurs when the tape is stored in the recorded condition (head out). If you leave the tape tail out and rewind just before playing, you may accomplish something like a 6 dB reduction in apparent print-through.

Multiple Signal Processors

Q. *Is it possible to connect two signal processors (such as a tape noise-reduction unit and an equalizer) to one set of tape jacks in an amplifier? If yes, please explain how.*—John Chan, Long Island City, N.Y.

A. Ordinarily one can connect more than one signal processor to an audio system. These devices usually contain tape-in and tape-out jacks to replace the ones they preempt in the amplifier or receiver. Thus, two or more signal processors can often be "daisy-chained" to each other. Another tactic is to introduce a signal processor, such as an equalizer, between the preamp and the power amp if these are separate units (or if the receiver or integrated amplifier separates its preamp and power amp sections, with output jacks for the former and input jacks for the latter).

I cannot give you specific details for doing the above, as it may vary according to what components are employed. Consult the hookup instructions of the signal processors, and if these aren't adequate, consult your audio dealer. Perhaps you should pick your dealer on the basis of his being able to provide proper help.

Riding Gain

Q. *Is it practical for an amateur home recordist to try to ride gain when making a tape from a disc?*—Philip Leak, Roseville, Cal.

A. Apparently, your intention is to vary the gain so as to maximize dynamic range, by reducing gain on low-level signals and increasing gain on high-level signals. I think that this tends to be impractical. First, you need a tape deck with excellent signal-to-noise ratio, probably at least 70 dB, in order to have a *substantial* margin over the dynamic range of a high-quality phono disc. Second, you must have the music well memorized, or be able to read a score before you, in order to successfully anticipate the passages that you wish to emphasize or de-emphasize. However, if you can meet both requirements, you may be able to achieve your objective.

Recording Levels

Q. *Should the recording level be higher when recording from tapes or when recording from discs?*—Philip Leak, Roseville, Cal.

A. Generally speaking, recording level should be about the same when recording from tuner, phono disc, or tape. All these sources generally suppress strong transients—which could saturate the tape. However, if you have a superior source with superior dynamic range, such as a state-of-the-art phono disc, it may be desirable to back down a few dB in recording level to allow for strong transients. This is all the more advisable when recording live material that has strong transients, such as guitar or piano. Obviously, judgment and experience must be

If you have a problem or question on tape recording, write to Mr. Herman Burstein at AUDIO, 1515 Broadway, New York, N.Y. 10036. All letters are answered. Please enclose a stamped, self-addressed envelope.

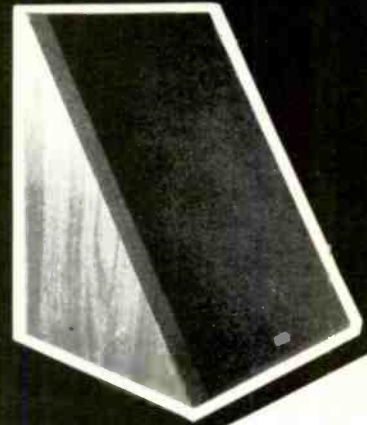

MUSIC:
"something
delightful
to hear"

Hardware freaks don't like
Spica loudspeakers because
they lack lights, bells, and
whistles. Snobs absolutely
hate them because they
don't cost enough. But there
is one group that positively
loves the Spica TC-50. Not
surprisingly, these are the
same people who love music.

GREENFIELD EQUIPMENT
ESOTERIC AUDIO SYSTEMS
River Forest, IL 60305 312/771-4660

spica
HIGH RESOLUTION LOUDSPEAKERS
2886-A TRADES WEST RD.
SAINT FE, NEW MEXICO
505-871-7728
TELEX 296480 SPICA UR

THE CENTER FOR THE PERFORMING ARTS

Nowadays, there's no place like home to enjoy the great performances of our time. Protect and display your valued audio, video and computer equipment with Custom Woodwork & Design.

Handcrafted in select oak or walnut hardwoods, CWD's modular furniture systems stand the test of time. And only CWD lets you add 'n stack matching units and accessories as your center expands!

Quality, versatility and value. Three good reasons why great Home Entertainment Centers begin with Custom Woodwork & Design. From \$235. (Manuf. sugg. retail) Call toll-free for the CWD dealer nearest you.

CWD

CUSTOM WOODWORK & DESIGN INC

TOLL-FREE: 1-800-323-2159
IN ILLINOIS: 312-563-1745



In Natural Oak, Dark Oak or Natural American Walnut

FREE

McIntosh STEREO CATALOG and FM DIRECTORY

Get all the newest and latest information on the new McIntosh stereo equipment in the McIntosh catalog. In addition you will receive an FM station directory that covers all of North America.

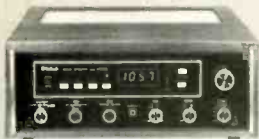

**SEND
TODAY!**

McIntosh Laboratory Inc. A
East Side Station P.O. Box 96
Binghamton, N.Y. 13904-0096

NAME _____
ADDRESS _____
CITY _____ STATE _____ ZIP _____

If you are in a hurry for your catalog please send the coupon to McIntosh. For non rush service send the Reader Service Card to the magazine.

brought to bear in setting recording level so as to maximize signal-to-noise ratio without incurring noticeable distortion. Fortunately, modern noise-reduction systems (such as dbx and Dolby C) can achieve noise reduction so great that one can afford to under-record a bit in order to avoid distortion yet maintain excellent S/N.

Dolby Noise Reduction

Q. Using Dolby C, how much noise reduction is there in a no-signal situation and in a 148-Hz signal situation? Also, is S/N (signal-to-noise ratio) always measured at 1,000 Hz?—Réal La Branche, Granby, Que., Canada

A. Inasmuch as Dolby C achieves about 18 to 20 dB of noise reduction (on a weighted basis), presumably this would be the amount of noise reduction in a no-signal situation. Such NR becomes effective around 150 Hz, so that the amount of noise reduction at 148 Hz would be roughly 3 dB.

Today, S/N is customarily measured on the basis of a 315-Hz signal recorded at a level that produces 3% harmonic distortion. Noise in the audio range is generally measured on a weighted basis, to reflect the ear's varying sensitivity to different frequencies; thus more weight is given to mid-range frequencies than to bass and treble ones.

Changing to a Different Tape

Q. I have recorded hundreds of tapes on my open-reel deck, using Scotch 150, now phased out. I am changing to Scotch 207 and believe that the bias and equalization of my deck will have to be adjusted for the new tape. If I do this, won't it unfavorably affect the playback of my earlier hundreds of recordings?—John Sabritt, Philadelphia, Pa.

A. No. To obtain optimum performance from the tape you now plan to use, your deck should be checked and adjusted as necessary for proper bias (at least), and desirably also for proper record equalization. The objectives should be wide, flat frequency response and suitably low distortion.

But this will not affect playback of previously recorded tapes. The adjustments outlined apply only to recording. Playback equalization does not change; bias plays no part in playback. A

REDEFINITION.

THE CARVER RECEIVER

Redefines your expectations of receiver performance with the power you need for Digital Audio Discs plus virtually noise-free stereo FM reception. A receiver with astonishing performance incorporating two highly significant technological breakthroughs: Bob Carver's Magnetic Field Power Amplifier and his Asymmetrical Charge Coupled FM Detector.

ESSENTIAL POWER: Your system needs an abundance of power to reproduce, without distortion, the dynamic range of music on Digital Audio Discs and fine analog recordings.

The Magnetic Field Amplifier in the CARVER Receiver gives you 130 watts per channel* of pure, clean power with superbly defined, high fidelity reproduction.

The Magnetic Field Amplifier produces large amounts of power (absolutely necessary for the accurate reproduction of music at realistic listening levels) without the need for heavy heat sinks, massive transformers, and enormous power capacitors required by conventional amplifier design.

Unlike conventional amplifiers which produce a constant, high voltage level at all times, irrespective of the demands of the ever-changing audio signal (Even when there is no audio signal in the circuit at all!), the Magnetic Field Amplifier's power supply is signal responsive. Highly efficient, it produces *exactly and only* the power needed to carry the signal with complete accuracy and fidelity.

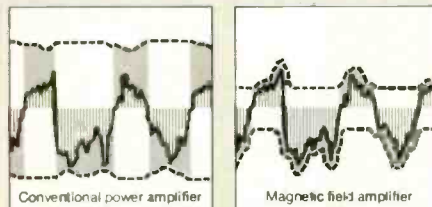

Solid line: audio output signal. Broken line: power supply voltage. Shaded area: wasted power. Vertical lines: power to speakers.

The 130 watts-per-channel* CARVER Receiver is about the same size and weight of conventional receivers having merely 30 watts per channel!

NOISE-FREE RECEPTION: The AM-FM CARVER Receiver gives you FM stereo performance unmatched by that of any other receiver.

As it is transmitted from the station, the stereo FM signal is extremely vulnerable to distortion, noise, hiss and multipath interference.

However, when you engage CARVER's Asymmetrical Charge Coupled FM Detector circuit, the stereo signal arrives at your ears virtually noise-free. You hear fully separated stereo with space, depth and ambience!

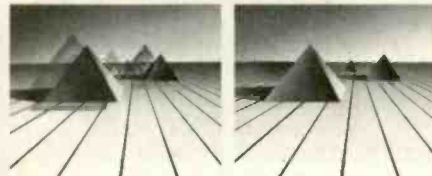

Reflected multi-path signals cause audible distortion.

Asymmetrical Charge Coupled FM Detector gives your ears a true sonic image.

The Asymmetrical Charge Coupled FM Detector was first introduced in CARVER's TX-11 Stereo Tuner, receiving unparalleled critical acclaim:

"A major advance... Its noise reduction for stereo reception ranged from appreciable to tremendous. It makes the majority of stereo signals sound virtually as quiet as mono signals, yet it does not dilute the stereo effect."

Julian D. Hirsch, STEREO REVIEW (December, 1982)

"Separation was still there; only the background noise had been diminished, and with it, much of the sibilance and hissy edginess so characteristic of multipath interference."

Leonard Feldman, AUDIO (December, 1982)

"What distinguishes the TX-11 is its ability to pull clean, noise-free sound out of weak or multipath ridden signals that would have you lunging for the mono switch on any other tuner we know of."

HIGH FIDELITY (January, 1983)

The CARVER Receiver has been designed for fidelity, accuracy and musicality. You will want to visit your CARVER dealer for a personal audition of this remarkable instrument.

*130 watts per channel RMS into 8 ohms, 20 Hz to 20 kHz with no more than 0.05% total harmonic distortion.



CARVER Powerful Musical Accurate

Carver Corporation P.O. Box 664, Woodinville, WA 98072

Distributed in Canada by Evolution Audio, Ltd.

Enter No. 14 on Reader Service Card

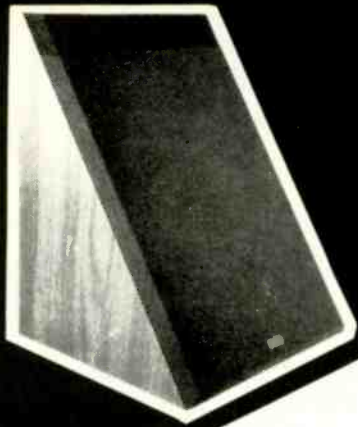

**FIDELITY:
"faithfulness
to the original"**
Let's face it. When it comes
to real fidelity, most speak-
ers suck out in frequency
or fall down on phase. So,
instead of hearing your fa-
vorite music, you end up
hearing the speakers. But
not at Spica! They've start-
ed the second revolution in
phase coherent dynamic
loudspeaker design. With
just one listen, the remark-
able TC-50 will spoil you
forever. Fidelity. Haven't
you waited long enough?

opus one
four hundred smithfield, pittsburgh, pennsylvania 15222
412-281-3569

spica
HIGH RESOLUTION LOUSPEAKERS
2806-A TRADES WEST RD.
SANTA FE, NEW MEXICO
305-871-7788
TELEX 293480 SPICA UR

AUDIOCLINIC

JOSEPH GIOVANELLI

Range Expanders and Noise Reduction

Q. Would a good dynamic range expander provide as much reduction in high-frequency annoyances as a good noise filter? Does a range expander reduce audible rumble?—Roger Ross, Peshastin, Wash.

A. A range expander is used for enhancing the dynamic range of suitable program sources. Because the device is single-ended (not involving the recording of the signal), it is really not designed to act as a noise reduction aid.

But, as you will see, it can do so under some circumstances.

If you use the range expander and keep your loudest listening to its present level, the soft passages will be heard at a lower volume. This will mean that, along with the reduction in loudness of the softer passages, the noise will be lowered proportionately.

The problem is that most listeners want their loud music even louder, and the softer passages to remain at their present volume levels. This will not result in audible reduction of noise, including rumble. For this purpose we can consider that the rumble is a part of overall noise.

Channel Separation

Q. What is channel separation? How is it measured? What factors tend to degrade it?—S. Untermyer, Lisle, Ill.

A. Let us assume that we are feeding a signal into only the left channel of a device. This signal will appear, of course, at the output corresponding to the left-channel input. Unfortunately, since nothing is perfect, some signal will also appear at the right-channel output. This *unwanted* signal is known as crosstalk. If the amount of signal appearing at the left-channel output is measured and compared to that measured at the right-channel output, we would obtain a ratio between these two signals, called separation, which we then express in dB.

We try for the greatest possible channel separation. Experts have made studies, however, which tend to support the idea that 12-dB channel separation is all that is really required in order to produce flawless stereo.

What tends to degrade separation? This depends on the nature of the de-

vice we are considering. In a power amplifier, common coupling in the power supply is the likely cause of lost channel separation. In tape recorders, channel separation is limited by the degree to which the heads have been shielded against inductive and/or capacitive pickup between channels. Phonograph systems are limited because of both the geometry and the elasticity of the grooves. Cartridges also degrade channel separation by the very nature of their mechanisms. Both channels share a common stylus, and when it vibrates, its motion is not absolutely accurate. This will result in the translation of some energy into the "wrong" channel.

Regulated Power Supplies

Q. What are the advantages and disadvantages of a regulated power supply?—B. A. Meichan, Toronto, Ont., Canada

A. In a power amplifier, the advantage of a regulated supply is that the power delivered to an external load by each channel will be constant, regardless of whether one or both channels are driven. The amplifier will not have a higher output for a single channel than for that same channel with the second one driven. This means a more linear output curve can be realized, thus lowering distortion.

The question in my mind is that, once this has been achieved, can the listener determine a difference between the regulated and the unregulated system? I do not have an answer.

A disadvantage of regulated power supplies is inefficiency. In order for the regulator to operate, it must be fed by a voltage which is considerably higher than the voltage actually required. The difference between the unregulated and the regulated voltages can be used to calculate the power losses in the system. The power transformer must also be somewhat huskier for a regulated system. "Switching" power supplies eliminate such power losses and thereby improve the efficiency of the regulated power supply. **A**

If you have a problem or question about audio, write to Mr. Joseph Giovanelli at AUDIO Magazine, 1515 Broadway, New York, N.Y. 10036. All letters are answered. Please enclose a stamped, self-addressed envelope.

**Our pride
can be your enjoy.**



BK COMPONENTS, LTD.
POWER AMPLIFIER ST-140

**Excellent music reproduction.
Designed for reliability.
Yet affordably priced.**



Series 140 Power Amplifier

Call us about it. Toll-free.

1-800-543-5252 /NY State: 1-800-235-5020

B & K Components, Ltd.

P.O. Box 331 Orchard Park, NY 14127
716-652-7667 Telex: 466482

Enter No. 16 on Reader Service Card

N a k a



SP-400 3-Way
Mobile Speaker System

PA-300 Mobile
Power Amplifier

TD-1200
Mobile Tuner
Cassette Deck

Win The Nakamichi Mobile Sound System—Gift Wrapped

Amazing but true! You can win the incredible Nakamichi Mobile Sound System gift wrapped in a 1983 BMW 318i! Just drop into your nearest Nakamichi Mobile Sound dealer and fill out an entry form. That's all there is to it! But bring your favorite cassettes along. This system will amaze you! It's unlike *any* other mobile-sound system ever created.

Only the TD-1200 Mobile Tuner/Cassette Deck has NAAC—the unique Nakamichi Auto Azimuth Correction system that automatically aligns the playback head in *each* direction to extract the last iota of per-

formance. Only the TD-1200 senses when the music has stopped and fast winds to the end of tape for quick reversal. Only the TD-1200 is powered by the unique Nakamichi SLT motor that virtually eliminates wow and flutter. And, the TD-1200 gives you a choice of EQ and Dolby* B or C noise reduction to accommodate the many tapes in your collection.

That's not all. Tone controls are specifically designed to compensate for *automobile* acoustics, and the TD-1200's 10-preset quartz-PLL synthesized FM/AM tuner has the pulling power, selectivity, and immunity to

multipath that you *need* on the road.

The PA-300 Mobile Power Amplifier is incredible—70 watts per channel continuous power, with a dynamic range of more than 115 dB and distortion under 0.003%! Matched with the Nakamichi SP-400 3-way Mobile Speaker System, the TD-1200 and PA-300 bring home music fidelity to the road!

The Nakamichi Mobile Sound System—it not only *rivals* the finest home equipment, it *outperforms* most of it!

 **Nakamichi**

Entry Forms Available At Your Nearest Authorized Nakamichi MSS Dealer



BMW 318i

Grand Prize

1983 BMW 318i with a complete Nakamichi Mobile Sound System—TD-1200 Tuner/Deck, PA-300 Power Amplifier, and SP-400 Loudspeaker System

First Prize
Nakamichi Mobile Sound System

12 Second Prizes
Nakamichi Windbreaker Jackets

Entry forms and complete contest rules are available from your local authorized Nakamichi Mobile Sound dealer. Open to all residents of the United States, except employees and their families of Nakamichi U.S.A. Corporation, C.B.S. Inc. and members of the judging organization. Void where prohibited by law.

*TM Dolby Laboratories Licensing Corporation

- Alabama**
AUDITION: Birmingham, Homewood
SOUND ADVICE: Mobile
SOUND DISTRIBUTORS: Huntsville
- Alaska**
SHIMEK'S: Anchorage
GREAT ALASKAN SOUND: Anchorage
- Arizona**
CLASSIC CAR SOUNDS: Tucson
JERRY'S AUDIO EXCHANGE: Phoenix
- Arkansas**
CUSTOM AUDIO: Little Rock, North Little Rock
- California**
ANDY'S AUTO RADIO: Sherman Oaks
AUDIO VISION: Santa Barbara
BEVERLY ELECTRONICS: Los Angeles
BEVERLY HILLS AUTO RADIO: Los Angeles
BURDICK'S: Santa Cruz
CENTURY STEREO: Hayward, San Jose
DEALER'S CAR STEREO: Los Altos
ELECTRONIC ENTERTAINMENT: Hawthorne
GARLAND AUDIO: San Jose
GENESIS AUDIO: El Toro
GLENDALE AUTO RADIO: Glendale
GROSS NATIONAL PRODUCTS: Pasadena
HAVENS AND HARDESTY AUDIO SYSTEMS: Huntington Beach
HERMARY'S: San Carlos
HONKER'S SOUND: Berkeley
HOUSE OF MUSIC: San Francisco
HOUSE OF NATURAL SOUND: Monterey Park
JONAS MILLER SOUND: Santa Monica
KAR TUNES: Seaside
KUSTOM HI FI: Burlingame
MARIN AUTO STEREO & ALARM: San Rafael
MESATRONICS: Costa Mesa
MOBILE ACOUSTICS CAR STEREO: Dublin, Fremont
MONTEREY STEREO: Monterey
NOR-CAL OFFSHORE, LTD.: Santa Clara
PAN AUTO SOUNDS: San Mateo
PARADYME CAR AUDIO: Davis
PETER'S AUTO RADIO: San Francisco
THE RADIOMAN: San Diego
REUS AUTOSOUND: Villa Park
SOUND COMPANY: San Diego
SOUND FACTOR: Encino, North Hollywood
SOUND ON WHEELS: Glendale
SOUND STATION: Northridge
SPEAKER WORKS: Orange
STEREO SHOWCASE: Sacramento, Vallejo
TOWN & COUNTRY: Mill Valley
TRANS-LEX TRAVELIN' MUSIC: Bakersfield
WALNUT CREEK AUTO RADIO: Walnut Creek
WESTERN AUDIO IMPORTS: Palo Alto
- Colorado**
AUDIO JUNCTION: Ft. Collins
AUDIOTRONIX: Grand Junction
LISTEN UP: Boulder, Denver, Evergreen
MOBILE ACOUSTICS: Aurora
SOUNDS GREAT: Colorado Springs
- Connecticut**
AUDIOCOM: Old Greenwich
AUDIOTRONICS: Fairfield, Norwalk
MOONROOFS: New Haven
SOUNDS INCREDIBLE: Brookfield
- Delaware**
SOUND STUDIO: Newark
- Florida**
AUTO AUDIO: Tallahassee
AUDIO GARAGE: Orlando, Winter Park
CAR SOUNDS: Miami
CARTRONICS OF AMERICA: Miami
HI FI ASSOCIATES: Fort Lauderdale, Miami
KUBAN'S: Brandenton, Sarasota
SENSUOUS SOUND: Tampa
SOUND PLUS WOOD: Boca Raton
SOUND SHACK: Fort Pierce, West Palm Beach
TECH ELECTRONICS: Gainesville
THE TRUCK STOP: Melbourne
WALDER ELECTRONIC DISTRIBUTORS: Jacksonville
- Georgia**
HI FI BUYS: Atlanta
HI FIDELITY SSS: N.E. Atlanta
SOUTHLAND SOUND: Savannah
STEREO DESIGNS: Atlanta
- Hawaii**
ISLAND SOUND: Honolulu

- Illinois**
APPLETREE STEREO: Champaign, Decatur, DeKalb, Normal, Peoria, Rockford
AUDIO CONSULTANTS: Evanston, Libertyville
AUDIO ENTERPRISES: Chicago Heights
COLUMBIA HI FI VIDEO: Buffalo Grove, Highland Park, Rockford
HI FI HUTCH: Villa Park
MUSIC IN MOTION: Glenview
NORTHWEST AUDIO VIDEO: Crystal Lake
STEREO DESIGNS: Riverdale
VICTOR'S STEREO: Chicago, Morton Grove
- Indiana**
AUDIOTREND: Evansville
HI FI BUYS: Greenwood, Indianapolis, Lafayette, Muncie, South Bend, Speedway
SOUND PRODUCTION: Carmel
- Iowa**
AUDIO EMPORIUM: Sioux City
AUDIO LABS: Des Moines
AUDIO ODYSSEY OF IOWA CITY: Iowa City
- Kansas**
CUSTOM SOUND: Wichita
RIVER CITY RADIO: Lawrence
- Kentucky**
HI FI BUYS: Louisville
- Louisiana**
ART COLLEY'S AUDIO SPECIALTIES: Baton Rouge
AUDIO FIDELITY: Shreveport
AUDIO SYSTEMS: Lafayette
STEREO VILLAGE: Metairie
- Maryland**
GRAMOPHONE: Lutherville
HUNT AUDIO & ASSOCIATES: Hagerstown
MYER EMCO: Rockville
- Massachusetts**
NATURAL SOUND: Framingham
RICH'S CAR TUNES: Watertown
SOUNDTRAK AUDIO: Brockton
TWEETER, ETC.: Boston, Burlington, Cambridge, Chestnut Hill, Danvers, Dedham
WALTHAM CAMERA & SOUND: Waltham
- Michigan**
ABSOLUTE SOUND: Ann Arbor, Royal Oak
ALMAS HI FI: Dearborn
BIRMINGHAM AUTOSOUND: Birmingham
HI FI BUYS: Grand Rapids, Kalamazoo
- Minnesota**
AUDIO KING: Minneapolis
- Mississippi**
AUTOMOTIVE AUDIO: Jackson
IDEAL ACOUSTICS: Starkville
SOUND ADVICE: Gulfport
- Missouri**
AUTO-EAR-OTIC: Saint Louis
BRAND'S MART: Kansas City
- Montana**
ROCKY MOUNTAIN HI FI: Great Falls
THIRSTY EAR: Bozeman
- Nebraska**
CUSTOM ELECTRONICS: Omaha
STEREO WEST: Omaha
- Nevada**
Q AUDIO: Reno
SOUND EMPORIUM: Las Vegas
- New Hampshire**
TWEETER, ETC.: Manchester, Nashua, Newington
- New Jersey**
AUDIO 22: North Plainfield
BRYN MAWR STEREO: Maple Shade
CONKLIN'S: Wycoff
HAL'S STEREO SOUND CENTER: Trenton
LEONARD RADIO: Paramus
SAMM SOUND: West Caldwell
SOUNDWAVES: Northfield, Tom Rivers
- New Mexico**
SOUND IDEAS: Albuquerque
- New York**
A B CAR STEREO: Huntington, Manhasset
AUDIO DEN: Lake Grove
AUDIO GENESIS: Glens Falls
AUTO SOUND SYSTEMS: Latham

- AUTOSOUND UNLIMITED:** White Plains
- CHAROS CUSTOM SOUND:** Southampton
- CLARK MUSIC CO.:** Albany, Syracuse
- 4-WHEEL SOUND:** Mount Kisco
- GORDON ELECTRONICS:** Schenectady, Syracuse, Vestal
- HI-WAY HI FI:** Ithaca
- MUSIC BOX:** New Windsor
- ROGERS STEREO:** Freeport
- SOUND ODYSSEY:** Wappinger Falls
- SQUARE DEAL RADIO & TV:** Patchogue
- ULTRA SMITH SYSTEMS:** New York
- North Carolina**
ATLANTIC AUDIO: Wilmington
DASHBOARD STEREO: Durham
HIGHWAY FIDELITY: Raleigh
SOUND SYSTEMS: Charlotte, Fayetteville, Greensboro
- North Dakota**
PACIFIC SOUND: Bismark
- Ohio**
AUDIO CRAFT: Cleveland, Fairlawn, Mayfield Heights, Westlake
CARLIN AUDIO: Dayton
MAH, INC.: Columbus
SOUNDWAVES: Dayton
- Oklahoma**
GRAMOPHONE: Norman
IMPERIAL SOUND: Tulsa
SOUND ROOM: Altus
- Oregon**
CHELSEA AUDIO: Beaverton, Portland
PENNINGTON'S AUDIO: Coos Bay
STEREO TO GO: Coos Bay
- Pennsylvania**
BRYN MAWR STEREO: Bryn Mawr, Frazer, Jenkintown, Quakertown
WES, INC.: State College
- Rhode Island**
TWEETER, ETC.: Providence
- Tennessee**
HI FI BUYS: Nashville, South Madison
HI FI HOUSE: Knoxville
MODERN MUSIC AUDIO: Memphis
NICHOLSON'S STEREO: Nashville
- Texas**
ARNOLD & MORGAN: Dallas, Garland
AUDIO CONCEPT: Austin
AUDIO CONCEPTS: San Antonio
AUDIO SYSTEMS: Laredo
AUDIO VIDEO: College Station
AUDIOWORKS: Lufkin, Nacogdoches
CUSTOM CAR STEREO: Houston
EL CENTRO SOUND CENTER: McAllen, Pharr
EARMARK: Addison
ELECTRONIC SERVICE CENTER: Odessa, Midland
HIGH FIDELITY: Austin
HI FIDELITY OF LUBBOCK: Lubbock
HILLCREST HIGH FIDELITY: Dallas
HOME ENTERTAINMENT: Houston
MARVIN ELECTRONICS: Fort Worth
MUSIC SYSTEMS: El Paso
SOUND ROOM OF SOUTHWEST MUSIC: Amarillo
TAPE TOWN: Corpus Christi
- Utah**
AUDIOWORKS: Salt Lake City
AUTO SPECIALTIES: Provo
- Vermont**
AUDIO DEN: South Burlington
- Virginia**
GARY'S STEREO: Richmond
MYER EMCO: Falls Church
- Washington**
HAL'S STEREO: Spokane
MAGNOLIA HI FI: Bellevue, Lynnwood, Seattle
O.C. STEREO: Bellingham, Mount Vernon, Oak Harbor
STEREOCRAFT: Walla Walla, Yakima, Ellensburg
- Washington D.C.**
MYER EMCO
- Wisconsin**
EME AUDIO SYSTEMS: Strum, Eau Claire
HI FI HEAVEN: Green Bay

If a local dealer is not listed, please contact Nakamichi U.S.A., 1101 Colorado Ave., Santa Monica, CA 90401, (800) 421-2313 in California and Hawaii call (213) 451-5901 for the dealer nearest you.



COMPUTER-AIDED FILTER



DESIGN

Richard Kaufman

The multiple-feedback filter is a useful design, offering a number of advantages over other types of active filters. But the design is neither simple nor straightforward, and requires tedious calculation. This computer program eliminates the chore of computation, allowing the designer to quickly evaluate many design alternatives and choose those best suited to his application. This program was written for the Apple II+, but with a minimum amount of translation will run on any machine equipped with BASIC.

A major advantage of the multiple-feedback filter is that it runs in the inverting mode. This reduces common-mode errors, resulting in less noise. Smaller capacitors than in other designs can often be used; such caps are more readily available and cost less. The gain of this filter can be set independently of other parameters,

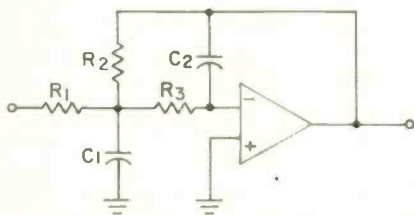

Fig. 1—Low-pass, multiple-feedback filter.

and so gain need not be set elsewhere in the system.

The Filter Circuit

Figure 1 shows a low-pass multiple-feedback filter. The associated design formulas are:

- Passband gain = $H_0 = R_2/R_1$

- High cutoff frequency =

$$f_c = \frac{1}{2\pi} \sqrt{\frac{1}{R_2 R_3 C_1 C_2}}$$

- $C_2 = \frac{C_1}{4Q^2(H_0 + 1)}$

- $R_1 = R_2/H_0$

- $R_2 = \frac{1}{4\pi f_c Q C_2}$

- $R_3 = \frac{1}{4\pi f_c Q C_2 (H_0 + 1)}$

The usual procedure is to choose a likely value for C_1 , then calculate the values for the other components. If these values are not practical (the resistors often come out too large or too small), then choose another value for C_1 and start over. This is tedious and frustrating, even with a scientific calculator.

Multiple-feedback filters offer several advantages over other active types, and their tedious design can be rapidly solved with this computer program.

Figure 2 shows the corresponding high-pass filter. Its parameters are:

- Passband gain = $H_0 = C_1/C_2$

- Low cutoff frequency =

$$f_c = \frac{1}{2\pi} \sqrt{\frac{1}{R_1 R_2 C_2 C_3}}$$

- $C_2 = C_1/H_0$

- $C_3 = C_1$

- $R_1 = \frac{1}{2\pi f_c Q C_1 \left(2 + \frac{1}{H_0}\right)}$

- $R_2 = \frac{Q(2H_0 + 1)}{2\pi f_c C_1}$

The design procedure is similar to the low-pass filter's.



A major advantage of the multiple-feedback filter is that it runs in inverting mode, reducing common-mode error and thus noise.

Using the Filter

The filter should be buffered, since the input network could react unfavorably with the signal source. An inverting buffer is shown in Fig. 3; the result will be correct absolute phase, if the rest of the system is noninverting. The values of the resistors are not critical, but they must match; 5% or better tolerance is desired. The input impedance equals the resistor value chosen. Any value between 10 and 100 kilohms will work well with the majority of modern audio circuits.

The resistors for the filter should preferably be within the same range of

values, though resistances as low as 1 kilohm or as high as 1 megohm are acceptable, if such values prove necessary to keep capacitor values reasonable. The capacitors should be plastic-film types or silver mica; ceramic discs and electrolytics are unacceptable. Ten-percent tolerance resistors will keep the response flat to within

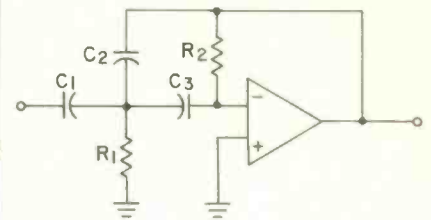

Fig. 2—High-pass, multiple-feedback filter.

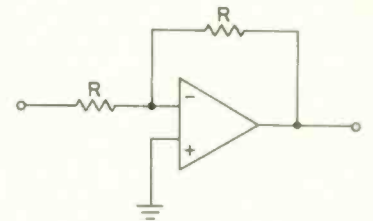

Fig. 3—Inverting buffer for use with filters.

1 dB for second- and third-order filters, though 5% tolerance is preferable.

Filter Order and Q

The order of a filter determines its rate of attenuation; multiple feedback via R2 and C2 makes this a second-order circuit, with an attenuation rate of 12 dB/octave. Q is a dimensionless parameter that determines the "peakiness" of the filter's response near cutoff. The best value of Q for a second-order filter is generally 0.707; this gives a "Butterworth" response.

The attenuation of third-order filters is 18 dB/octave, making them superior for high-pass and subsonic filters. For speaker crossover networks, third-order networks offer better phase coher-

THE PROGRAM

←LIST

```

5 HOME : REM CLEAR SCREEN
10 PRINT "MULTIPLE FEEDBACK FILTER"
20 PRINT "DESIGN ROUTINE"
23 PRINT
25 PRINT "BY RICHARD KAUFMAN"
26 PRINT : PRINT "HIGHPASS(H), LOWPASS(L), OR BOTH(B)": INPUT RSP$: PRINT
30 PRINT "WHAT IS THE FILTER FREQUENCY"
40 PRINT " IN HERTZ"
60 INPUT " ?":FC
62 PRINT
65 Q = .707
70 INPUT "IS THE Q = .707? (Y OR N)":Q$
80 IF Q$ = "Y" THEN 100
85 PRINT
90 INPUT "WHAT IS THE VALUE OF Q ?":Q
100 PRINT : PRINT "WHAT IS THE DESIRED GAIN"
110 PRINT " (VOLTAGE RATIO, NOT DECIBELS)"
120 INPUT " ?":HO: PRINT
130 PRINT "THE CAPACITOR VALUE FOR C1 IS IN"
140 PRINT " PICO FARADS (P)"
150 PRINT " MICRO FARADS (M)"
160 INPUT " ?":C$
170 IF C$ < > "P" AND C$ < > "M" GOTO 130
180 IF C$ = "P" THEN CF = 1E - 12
185 IF C$ = "M" THEN CF = 1E - 6
190 PRINT : INPUT "WHAT IS THE VALUE OF C1?":C1
200 C2 = (C1 * CF) / (4 * Q + 2 * (HO + 1))
210 R2 = 1 / (4 * 3.1416 * FC * Q * C2)
220 R1 = R2 / HO

```

```

230 R3 = 1 / (4 * 3.1416 * FC * Q * C2 * (HO + 1))
235 IF RSP$ = "H" THEN GOTO 310
240 PRINT : PRINT "LOW PASS VALUES": PRINT
250 PRINT "C2="C2 / CF:" ";C$:"FD"
260 PRINT "R1=" INT (R1):" OHMS"
270 PRINT "R2=" INT (R2):" OHMS"
280 PRINT "R3=" INT (R3):" OHMS"
290 PRINT : INPUT "ARE THESE VALUES OK? (Y OR N)":ANS$: PRINT
300 IF ANS$ = "N" THEN 130
305 IF RSP$ = "L" THEN 10000
310 C3 = C1 * C2 = C1 / HO
320 R1 = 1 / (2 * 3.1416 * FC * Q * C1 * CF * (2 + 1 / HO))
330 R2 = (Q * (2 * HO + 1)) / (2 * 3.1416 * FC * C1 * CF)
335 PRINT
340 PRINT "HIGH PASS VALUES": PRINT
350 PRINT "C2="C2:" ";C$:"FD"
360 PRINT "C3="C3:" ";C$:"FD"
370 PRINT "R1=" INT (R1):" OHMS"
380 PRINT "R2=" INT (R2):" OHMS"
390 PRINT : INPUT "ARE THESE VALUES OK? (Y OR N)":ANS$: PRINT
400 IF ANS$ = "N" THEN 130
10000 INPUT "WOULD YOU LIKE TO DESIGN ANOTHER FILTER?":ANS$
10010 IF ANS$ = "Y" THEN 5
10020 PRINT : PRINT "BYE!"
10030 END

```

ency, smoother pressure response, less interference between drivers, and reduced demands on the tweeter. The proper value of Q for a third-order network is 1. The third-order network consists of the multiple-feedback filter with a simple first-order filter substituted for the inverting buffer of Fig. 3. Inverting first-order networks are shown in Fig.

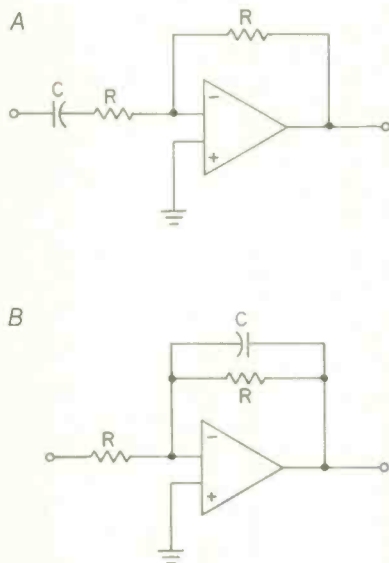

Fig. 4—Inverting first-order filters, high-pass (A) and low-pass (B).

4. The cutoff frequency is determined by the formula:

$$F = \frac{1}{2\pi RC}$$

This can easily be programmed in BASIC, an exercise that will be left to the reader. (Note lines 120 to 185 for determining how many zeros are needed for the capacitor value.) For a 2.5-kHz cutoff, $R = 56$ kilohms and $C = 1,100$ pF. There will be no problem driving a pair of these in parallel from a preamp if you want to biampify your system.

Using the Program

Filter design with this program should be self-explanatory. The sample run shown here is for the design of a speaker crossover for biampification, using a third-order network at 2.5 kHz. The high-pass values are calculated first; at a 2.5-kHz crossover frequency, $Q = 1$, with unity gain. A

SAMPLE RUN

*RUN
MULTIPLE FEEDBACK FILTER
DESIGN ROUTINE

BY RICHARD KAUFMAN

HIGHPASS(H), LOWPASS(L), OR BOTH(B)
?H

WHAT IS THE FILTER FREQUENCY
IN HERTZ
?2500

IS THE Q = .707? (Y OR N)N

WHAT IS THE VALUE OF Q? 1

WHAT IS THE DESIRED GAIN
(VOLTAGE RATIO, NOT DECIBELS)
?1

THE CAPACITOR VALUE FOR C1 IS IN
PICO FARADS (P)
MICROFARADS (M)
?P

WHAT IS THE VALUE OF C1?1000

HIGH PASS VALUES

C2=1000 PFD
C3=1000 PFD
R1=21220 OHMS
R2=190985 OHMS

ARE THESE VALUES OK? (Y OR N) N

THE CAPACITOR VALUE FOR C1 IS IN
PICO FARADS (P)
MICROFARADS (M)
?P

WHAT IS THE VALUE OF C1?1800

HIGH PASS VALUES

C2=1800 PFD
C3=1800 PFD
R1=11789 OHMS
R2=106103 OHMS

ARE THESE VALUES OK? (Y OR N) Y

WOULD YOU LIKE TO DESIGN ANOTHER
FILTER? Y
MULTIPLE FEEDBACK FILTER
DESIGN ROUTINE

HIGHPASS(H), LOWPASS(L), OR BOTH(B)
?L

WHAT IS THE FILTER FREQUENCY
IN HERTZ
?2500

IS THE Q = .707? (Y OR N)N

WHAT IS THE VALUE OF Q? 1

WHAT IS THE DESIRED GAIN
(VOLTAGE RATIO, NOT DECIBELS)
?1

THE CAPACITOR VALUE FOR C1 IS IN
PICO FARADS (P)
MICROFARADS (M)
?P

WHAT IS THE VALUE OF C1?1800

LOW PASS VALUES:

C2=225 PFD
R1=141470 OHMS
R2=141470 OHMS
R3=70735 OHMS

ARE THESE VALUES OK? (Y OR N) N

THE CAPACITOR VALUE FOR C1 IS IN
PICO FARADS (P)
MICROFARADS (M)
?P

WHAT IS THE VALUE OF C1?4700

LOW PASS VALUES:

C2=587.5 PFD
R1=54180 OHMS
R2=54180 OHMS
R3=27090 OHMS

ARE THESE VALUES OK? (Y OR N) Y

WOULD YOU LIKE TO DESIGN ANOTHER
FILTER? N

BYE!

1,000-pF capacitor (0.001 μ F) is tried, but the value for R2 is a little high, so 1,800 pF is entered. Working with a 5% tolerance, 12 kilohms can be used for R1; R2 can be built up by 100 and 5.8 kilohms in series. This design is satisfactory.

Next, 1,800 pF is tried for the low-pass filter, but the resistor values are too high and are awkward to obtain. A value of 4,700 pF is better: 56 kilohms

can be used for R1 and R2; the difference from the calculated value is less than 5%. A 27-kilohm resistor for R3 is a standard value. Capacitor C2 can be built up from 470 and 100 pF in parallel.

More information on different types of filters you can build using multiple-feedback circuits can be found in the many books available on active filter design. **A**

COMPUTER-AIDED CALCUL



AUDIO

ATIONS

Leonard Feldman

I have finally succumbed! After resisting the temptation to get involved with computers for several years, I finally admitted to myself that I'd better learn a little about computers or be left out in the cold. So, after much agonizing and mind-changing about what to buy, I ended up with a dual-disc-drive, CP/M-based unit equipped with a 9-inch CRT, 64K of RAM, and lots of ready-to-run software. (See how quickly I'm learning the jargon?) Actually, this is my second computer. The first cost only \$100 and was used primarily as a learning tool on which to do homework as I took a couple of courses in elementary (and then not so elementary) programming.

Not content with just the computer package as it came, I also decided to purchase some "peripherals," as they say in the computer game. To start with, I bought a good-quality dot-matrix printer and a modem, for future communications with publishers who can accept manuscripts by wire (*Editor's Note*: Including *Audio*, eventually), and for accessing those data bases that I keep seeing advertised everywhere.

After getting all this stuff home, I quickly discovered that, compared with computer and software manuals, audio equipment manuals are veritable masterpieces of lucidly clear prose. The ones I got with certain of my software discs were written by and for computer scientists with at least two (and possibly more) Ph.D. degrees in the subject. Since I don't even possess one such degree, I hurried out to my

local library and then to my not-so-local bookstore to purchase a somewhat more decipherable book on CP/M (the operating system of my computer). After several frustrating weeks of effort, I had gotten to the point where I could begin to do some elementary programming on my fancy computer—albeit in BASIC, which I am told is *not* the most efficient or fastest language to use. Nonetheless, it is a language I now understand how to "speak" and use, and it's also the language built into most lower cost computers, especially those which don't use disc drives like mine but which store programs on cassette tapes.

I suspect that there are thousands of you out there who, after following pretty much the same course that I did, suddenly are faced with the question of what to do with the new home computer. To be sure, I thought, the software supplied with it would be great for creating an inventory of everything I possess, for filing names and addresses of all my friends and relatives, for creating "what if" business spreadsheets and more. If I become proficient enough, I may even be able to save some time in calculating my income taxes *once a year* with this dandy machine. But surely, I figured, there must be some tasks associated with my daily work that can be eased with the aid of this not inexpensive adult toy.

Back to the library again, and to the book shops, to discover that there are any number of great (and elaborate) programs written for electronic circuit *designers*. There are complex pro-

This all-in-one program handles nine common audio calculations, faster than a scientific calculator and with no need to remember which formula lurks behind which calculator button. Written in Microsoft BASIC, it can be modified easily for other BASICs.

grams for Fast Fourier Transform analysis of transient pulses (great for measuring speaker frequency response in non-anechoic environments). I ran across a program (actually a fairly simple one) for calculating the optimum speaker cabinet enclosure, given certain parameters of the driver to be used, all based on the famous Thiele/Small equations. Unfortunately, while these programs are certainly well conceived, they are of little use to me, since I haven't been involved in the design of speakers or audio electronics for some years.

Mostly, my job is to measure performance. To do that, I use relatively few formulas which, until recently, were all stored in my Hewlett-Packard printing/programmable calculator. The problem had always been the slow speed with which the H-P executed those pro-



Nothing is as unforgiving of typos or incorrect punctuation as a computer, so the program listing is a reproduction of the original printout. All parts should work—if you enter it correctly.

grams, and the fact that I could never remember which code number applied to which program without looking at a scrap of paper I had pasted to the back cover of the calculator. When you have to convert a bunch of voltage readings to power across a known impedance, or a bunch of microvolt sig-

nal levels to dBf, all of that can become pretty tedious and time-consuming. So, I decided that my first use of my new computing power would be to create an all-in-one program to take care of my daily (if simple) electrical calculations in the lab. As the program became more and more refined, I became so excited about it that I decided to share it with readers of *Audio*—with no license or royalty fees expected.

Before we get to the program itself, let me state up front that I'm certain there are a bunch of computer freaks out there who will be tempted to write and tell me that I wasted a lot of memory and could have written the program in a much more sophisticated manner. My answer to them is, "The program works!" and is simple enough for any neophyte (such as myself) to understand and use. There'll be time for fancier programs later, I'm sure.

The Program

Figure 1 is a copy of the "menu" that appears on my CRT when I call for the program to be run. Basically, it gives me a choice of nine calculations which I have to make practically every time I work at the lab bench on audio equipment. You select which calculation you

need by typing in the appropriate numeral (1 through 9). If you type in a zero (meaning that you've changed your mind and don't want to do any audio calculations after all), the program ends with a courteous message. If you try to outsmart the computer and type a number greater than 9, the computer simply questions your entry and waits for you to stop fooling around and enter a legal number.

Figure 2 is what appears on my printer (and on the CRT of my computer) when I run programs 1 through 9. (I added the numerals at the left of each program run later, just to identify the program. They will not appear in your printout or on your CRT.) After each calculation has been completed, the program asks the user if he or she wishes to return to the menu. Typing the letter "y" (for "yes"), in lower case letters, causes the menu of Fig. 1 to reappear on the screen. You are now ready to have the computer do another calculation—either the same type, or a new type if you now select another number.

After you are through using the program, when the computer asks you if you want to return to the menu, you simply type a lower case "n" (for "no"). This terminates the program, and the message "Happy to have been of service! SEE YOU LATER!!!" appears on your screen (and, if you have a printer connected, prints out as well). Pretty neat, eh?

Actually, I wrote two versions of the program. The one published here, as Fig. 3, is intended for use with a system that also has a printer hooked up to the computer. A simpler one omits all the printing steps; I use it in the lab when it isn't important to make a hard copy of all the calculations and their results. If your computer has no printer, all you have to do when you type in the program is to omit every step that begins with the word LPRINT. That's the BASIC command for most computers that sends whatever follows to your line printer. For example, if you don't own a printer or don't want the program to send data to your printer, you would omit lines 340, 360, 390, 400, 430, etc. Should you elect to omit the LPRINT lines, I would suggest that you not renumber all the other lines in the program, but keep the number order

PROGRAM MENU

Fig. 1—Audio lab program "menu," as it appears on the computer's CRT when a program run has been called up.

```
                AUDIO LAB PROGRAM
Select the program you require from the following menu:

(0) Exit from the program. (Changed my mind)
(1) Calculate power, given voltage and impedance.
(2) Calculate voltage, given power and impedance.
(3) Calculate the dB ratio of two voltages.
(4) Calculate the dB ratio of two power values.
(5) Change percent (%) to dB.
(6) Change dB to percent (%).
(7) Calculate dBf, given a number in microvolts.
(8) Calculate microvolts, (uV), given dBf.
(9) Damping factor of an amplifier, with 8-ohm loads.
ENTER THE NUMBER OF YOUR CHOICE AND PRESS RETURN
```

shown in Fig. 3. That way, if you do run into problems and the program needs debugging, your computer will refer to "problem" lines using the same numbers appearing in Fig. 3—and you'll have an easier time finding your typing or syntax mistakes.

Not All BASICs Are Identical

Unlike audio equipment, which is almost always completely compatible with other audio equipment, there are

differences between computers and even between the versions of the BASIC language which they understand. Not all computer keyboards are alike either. As a result, you may find that some of the numbered command lines shown in the complete program of Fig. 3 cannot be entered as written on your particular computer. Or, in some cases, if they can be entered as shown, they won't run properly and the program will "hang up" at a given line.

The BASIC language that I use on my computer is known as Microsoft BASIC, and it's one of the more popular versions of BASIC around. Still, here are some possible keyboard problems you may encounter in trying to type in and run the program.

In line 270 I used the BASIC command "ON _ GOTO ###, ###, ###, etc." where "_" represents a variable (in this case, C) and the "###s" represent line numbers. There

SAMPLE RUN

Fig. 2—A sample run of all nine parts of the program. All indented numerals are user entries.

To calculate POWER, enter the voltage.

20 volts.

Now enter the impedance, in ohms.

8 ohms.

Power equals 50 watts.

Do you wish to return to the menu?(y/n..lower case letters.)

y

To calculate VOLTAGE FOR A GIVEN POWER, ENTER POWER IN WATTS.

100 watts.

Now enter the load impedance in ohms.

4 ohms.

Voltage for that power equals 20 volts.

Do you wish to return to the menu?(y/n..lower case letters.)

y

To calculate the dB ratio of two voltages, enter larger voltage.

100 volts.

Now enter the smaller voltage.

10 volts.

The voltage ratio, in decibels, is 20 dB.

Do you wish to return to the menu?(y/n..lower case letters.)

y

To determine the dB ratio of two powers, enter larger power.

100 watts.

Now enter the smaller power value.

10 watts.

The power ratio, in dB, is 10 dB.

Do you wish to return to the menu?(y/n..lower case letters.)

y

To change percent to dB, enter the percentage (numerals only).

.5 %.

The equivalent decibel ratio is 46.0206 dB.

Do you wish to return to the menu?(y/n..lower case letters.)

y

To change dB to percent, (%), enter the value in dB.

30 dB.

The equivalent percentage is 3.16228 %

Do you wish to return to the menu?(y/n..lower case letters.)

y

To convert microvolts (uV) to dBf, enter value in uV.

2.1 uV.

For a 300-ohm input, the dBf value is 11.6371 dBf.

If the input impedance is 75-ohm, the dBf value is 17.6371 dBf.

Do you wish to return to the menu?(y/n..lower case letters.)

y

To convert dBf to microvolts (uV), enter the number of dBf.

65 dBf.

For a 300-ohm input, the microvolt value is 978.054 uV.

Do you wish to return to the menu?(y/n..lower case letters.)

y

To calculate damping factor of an amplifier working into

8-ohm loads, ENTER VOLTAGE UNDER NO-LOAD CONDITIONS.

1.025 no-load volts.

Now ENTER VOLTAGE WHEN LOAD IS APPLIED.

1 volts, under load.

The damping factor for the amplifier is 40 .

Do you wish to return to the menu?(y/n..lower case letters.)

n

Happy to have been of service! SEE YOU LATER!!

are a few computers which do not recognize this useful command. If yours does not, you can substitute the following individual line numbers:

```
270 IF C=1 GOTO 290
271 IF C=2 GOTO 420
272 IF C=3 GOTO 550
273 IF C=4 GOTO 680
274 IF C=5 GOTO 810
275 IF C=6 GOTO 900
276 IF C=7 GOTO 990
277 IF C=8 GOTO 1110
278 IF C=9 GOTO 1220
```

That will use up a tiny bit more computer memory, but the program will work just as well. With all of the above

command lines, as well as in lines 260 and 280, some computers will require the word "THEN" with the "IF" command. In such computers, these lines would have to be written, to give an example, as:

```
260 IF C=0 THEN GOTO 1430, etc.
```

In line 370, an upward-pointing arrow stands for exponent—in other words, $P=V$ raised to the second power divided by R . Some computers use a double asterisk (**) to denote exponents, instead of the upward-pointing arrow. For such computers, line 370 would read:

```
370 LET P=V**2/R.
```

Incidentally, many forms of BASIC (including mine) do not require the word "LET" when setting up a variable or an equation. Because so many others do, however, I have chosen to include the word "LET" in all lines involving variable identification or equation defining.

If you are familiar with the various formulas involving decibel (dB) calculations, you may be wondering why, in lines 630 and 760, for example, it is necessary to divide the logarithm expression by the logarithm of 10. That's because, while most computers using BASIC are able to calculate loga-

THE PROGRAM

Fig. 3—Complete listing of the nine-part audio lab program. If you don't need a printout of the program runs, program length can be reduced by omitting all "LPRINT" lines.

```
10 REM Audiolab Program
20 PRINT TAB(30): "AUDIO LAB PROGRAM"
25 REM-----Menu-----
30 PRINT "Select the program you require from the following menu."
40 PRINT
50 PRINT TAB(10): "(0) Exit from program. (Changed my mind)"
60 PRINT
70 PRINT TAB(10): "(1) Calculate power, given voltage and impedance."
80 PRINT
90 PRINT TAB(10): "(2) Calculate voltage, given power and impedance."
100 PRINT
110 PRINT TAB(10): "(3) Calculate the dB ratio of two voltages."
120 PRINT
130 PRINT TAB(10): "(4) Calculate the dB ratio of two power values."
140 PRINT
150 PRINT TAB(10): "(5) Change percent (X) to dB."
160 PRINT
170 PRINT TAB(10): "(6) Change dB to percent (X)."
180 PRINT
190 PRINT TAB(10): "(7) Calculate dBv, given a number in microvolts."
200 PRINT
210 PRINT TAB(10): "(8) Calculate microvolts, (uV), given dBv."
220 PRINT
230 PRINT TAB(10): "(9) Damping factor of an amplifier, with 8-ohm loads."
235 PRINT
240 PRINT "ENTER THE NUMBER OF YOUR CHOICE AND PRESS 'RETURN'"
250 INPUT C
260 IF C=0 GOTO 1430 REM (Exit)
270 ON C GOTO 290, 420, 550, 680, 810, 900, 990, 1110, 1220
280 IF C>9 GOTO 20
285 REM-----Power/Voltage
290 PRINT "To calculate POWER enter the VOLTAGE."
300 LPRINT "To calculate POWER enter the VOLTAGE."
310 INPUT V
320 LPRINT V;" volts."
330 PRINT "Now enter the impedance, in ohms."
340 LPRINT "Now enter the impedance, in ohms."
350 INPUT R
360 LPRINT R;" ohms."
370 LET P=V^2/R
380 PRINT "Power equals "IP1" watts."
390 LPRINT "Power equals "IP1" watts."
400 LPRINT
410 GOTO 1370 REM (Again? or Exit Program?)
420 PRINT "To calculate VOLTAGE, for a given power, enter POWER, in watts."
430 LPRINT "To calculate VOLTAGE, for a given power, enter POWER, in watts."
440 INPUT P
450 LPRINT P;" watts."
460 PRINT "Now enter the load impedance, in ohms."
470 LPRINT "Now enter the load impedance in ohms."
480 INPUT Z
490 LPRINT Z;" ohms."
500 LET V=SQR(P*Z)
510 PRINT "Voltage for that power equals "IV1" volts."
520 LPRINT "Voltage for that power equals "IV1" volts."
530 LPRINT
540 GOTO 1370
545 REM-----dB/voltage ratios-----
550 PRINT "To calculate the dB ratio of two voltages, enter larger voltage."
560 LPRINT "To calculate the dB ratio of two voltages, enter larger voltage."
570 INPUT V1
580 LPRINT V1;" volts."
590 PRINT "Now enter the smaller voltage."
600 LPRINT "Now enter the smaller voltage."
610 INPUT V2
620 LPRINT V2;" volts."
630 LET DB=20*LOG(V1/V2)/LOG(10)
640 PRINT "The voltage ratio, in decibels, is "IDB1" dB."
650 LPRINT "The voltage ratio, in decibels, is "IDB1" dB."
660 LPRINT
670 GOTO 1370
675 REM-----db/power ratios-----
680 PRINT "To determine the dB ratio of two powers, enter larger power."
690 LPRINT "To determine the dB ratio of two powers, enter larger power."
```

rithms, they only "know" natural logarithms—those that use the base "e" (2.30259). Since decibel calculations all require the use of logarithms to the base 10, it is necessary to divide the log expression in these equations by the natural log of 10.

Most authors (or at least this one) aren't too careful about punctuation. After all, isn't that what good editors are for? (*Editor's Note: Well, . . . I.B.*) The first thing I learned about programming is that there is nothing as unforgiving of incorrect punctuation as a home computer. The program in Fig. 3 has been reproduced from my original

printout, so its "syntax" is correct and all parts of the program will work. If you leave out a semicolon, or a quotation mark, or even a space, the computer will mess things up and, of course, we always blame the computer.

If you find this sort of program useful, let us know, and perhaps when I become more proficient I can create a few more useful audio programs that may be of interest to you. By the same token, if you have come up with a program or two that you think might be useful to me (or to other readers of *Audio*), perhaps you'd like to share them with us. **A**



If you try to outsmart the computer, it simply questions your entry and waits for you to stop fooling around.

```

700 INPUT P1
710 LPRINT P1;" watts."
720 PRINT"Now enter the smaller power value."
730 LPRINT "Now enter the smaller power value."
740 INPUT P2
750 LPRINT P2);" watts."
760 LET DB=10*LOG(P1/P2)/LOG(10)
770 PRINT"The power ratio, in dB, is "IDB;" dB."
780 LPRINT "The power ratio, in dB, is "IDB;" dB."
790 LPRINT
800 GOTO 1370
805 REM-----dB/percent-----
810 PRINT"To change percent to dB, enter the percentage (numerals only)."
```

```

820 LPRINT "To change percent to dB, enter the percentage (numerals only)."
```

```

830 INPUT P
840 LPRINT P;"%."
850 LET DB=20*LOG(1/(P/100))/LOG(10)
860 PRINT"The equivalent decibel ratio is "IDB;" dB."
870 LPRINT "The equivalent decibel ratio is "IDB;" dB."
880 LPRINT
890 GOTO 1370
900 PRINT"To change dB to percent, (%), enter the value in dB."
910 LPRINT"To change dB to percent, (%), enter the value in dB."
920 INPUT DB
930 LPRINT DB;"dB."
940 LET P=100*10^(-DB/20)
950 PRINT"The equivalent percentage is "IP;"%."
960 LPRINT "The equivalent percentage is "IP;"%."
970 LPRINT
980 GOTO 1370
985 REM-----uV/dBf-----
990 PRINT"To convert microvolts (uV) to dBf, enter value in uV."
1000 LPRINT "To convert microvolts (uV) to dBf, enter value in uV."
1010 INPUT UV
1020 LPRINT UV;"uV."
1030 LET DB=20*LOG(UV/.55)/LOG(10)
1040 PRINT"for a 300-ohm input, the dBf value is "IDB;" dBf."
1050 LPRINT "for a 300-ohm input, the dBf value is "IDB;" dBf."
1060 PRINT
1070 PRINT"if the input impedance is 75-ohms, the dBf value is "IDB*5;" dBf."
1080 LPRINT "if the input impedance is 75-ohms, the dBf value is "IDB*5;" dBf."
1090 LPRINT
1100 GOTO 1370
1110 PRINT"To convert dBf to microvolts (uV), enter the number of dBf."
1120 LPRINT "To convert dBf to microvolts (uV), enter the number of dBf."
1130 INPUT DB
1140 LPRINT DB;"dBf."
1150 LET UV=10^(DB/20)*.55
1160 PRINT"for a 300-ohm input, the microvolt value is "IUV;" uV."
1170 LPRINT "for a 300-ohm input, the microvolt value is "IUV;" uV."
1180 PRINT
1190 PRINT"if the input impedance is 75-ohms, the microvolt value is "IUV/2;" uV."
1200 LPRINT
1210 GOTO 1370
1215 REM-----Damping Factor-----
1220 PRINT"To calculate damping factor of an amplifier working into "
```

```

1230 LPRINT "To calculate damping factor of an amplifier working into "
```

```

1240 PRINT"8-ohm loads, ENTER VOLTAGE UNDER NO LOAD CONDITIONS."
1250 LPRINT "8-ohm loads, ENTER VOLTAGE UNDER NO-LOAD CONDITIONS."
1260 INPUT V1
1270 LPRINT V1;" no-load volts."
1280 PRINT"now ENTER VOLTAGE WHEN LOAD IS APPLIED (should be lower value)."
```

```

1290 LPRINT "now ENTER VOLTAGE WHEN LOAD IS APPLIED."
1300 INPUT V2
1310 LPRINT V2;" volts, under load."
1320 LET D=V2/(V1-V2)
1330 PRINT"The damping factor for the amplifier is "ID;"."
1340 LPRINT "The damping factor for the amplifier is "ID;"."
1350 LPRINT
1360 GOTO 1370
1370 PRINT
1375 REM----Reselect/Exit-----
1380 PRINT"Do you wish to return to the menu?(y/n)"
1390 LPRINT"Do you wish to return to the menu?(y/n)"
1400 INPUT A$
1410 LPRINT A$
1420 IF A$="y" GOTO 20
1430 PRINT"Happy to have been of service! SEE YOU LATER!!"
1440 LPRINT "Happy to have been of service! SEE YOU LATER!!"
1450 END

```

TDS COMPUTING

Gerald Stanley

In the fall of 1967, an important chapter in the history of audio measurements began with the unveiling of Time Delay Spectrometry (TDS) at the 33rd Convention of the Audio Engineering Society by its inventor, Richard C. Heyser [1].

TDS allowed the response of loudspeakers, and other systems that are noisy and reverberant, to be quickly and accurately analyzed in situ. Each

signal, ranging in time from the direct sound to the reverberated, could be studied independently of all other signals having different propagation delay times.

Audio readers have been privileged to have numerous loudspeaker reviews by Dick Heyser. TDS and other ingenious techniques have revealed much about speaker behavior [2 to 7].

A simple conceptualization of TDS is

that of an FM transmitter of variable frequency scanning the band of interest, with a precisely delayed receiver tracking the transmitter and observing the transmission's response.

TDS can also be visualized with the aid of Fig. 1. The line AB extending from (t_1, f_1) to (t_2, f_2) represents the sinusoidal test sweep signal. Delayed in time by t_d , a narrow-band receiver tracks the test signal to observe any



Crown
System 10
TEF computer

signal that appears with a delay of t_d . This is represented by line CD. The dashed lines which parallel AB and CD represent delayed responses of the system under test to the stimulus AB. These signals, except the one at CD, are all rejected by the analyzer.

An implementation of the measuring apparatus is shown in Fig. 2. This would typically be made by modifying a commercial spectrum analyzer, add-

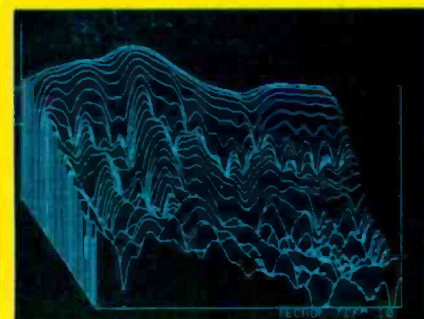
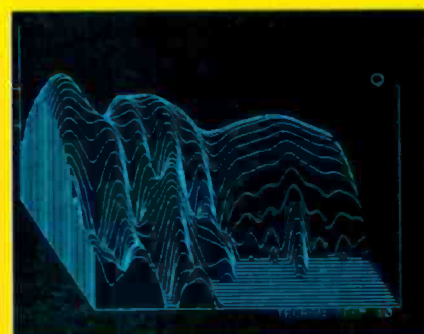
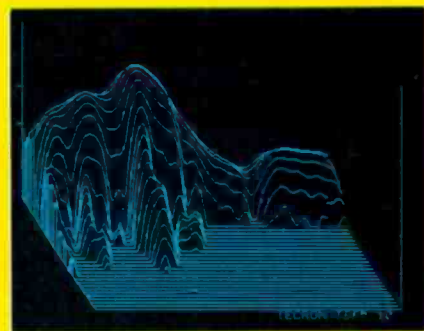

ing some external circuitry, and using a Fast Fourier Transform (FFT) analyzer, storage oscilloscope, phase meter, and frequency synthesizer.

When the *JAES* published the paper on TDS, I studied the paper and the possibilities of implementing such instrumentation. Unfortunately, the required instrumentation was at that time very expensive and well beyond the means of most of its potential users.

This was not to deter a few determined individuals. Having obtained a license to make the measurement (the measurement is patented and held by Cal. Tech. and Jet Propulsion Laboratory), these individuals modified and interconnected the needed instruments. As much as \$50,000 worth of complex equipment was often required for a fully implemented TEF (Time, Energy, Frequency) measurement.

Some might ask, why make such expenditures if all that is needed is to program a microprocessor to pulse the system and then Fourier analyze the system output at progressive delays? This technique is well known and can be cheaply implemented with microprocessors plus analog-to-digital conversion hardware.

The answer is that such simple techniques perform well in textbooks but rarely so in the real world. Noise and distortion are not easily overcome in such systems, and valid measurements take very large amounts of test averaging and test time. Clearly, some insight into the problems of real-world measuring is required.

Scientific observations may be classified as either passive or active measurements. In a passive system, no deliberate disturbance to the system being measured is provided except for the extraction of the amount of energy necessary to activate the observation's sensors.

TDS is an active measurement that provides a stimulus (external energy input) to the system under observation.

Active measurements are preferred to passive measurements if the energy needed to perturb a system is safely and reasonably available. For example, it is not possible to test theories of stellar composition by extracting a core sample from the center of the sun.

The quality of an active measurement can be classified by the degree of success obtained in the following:

- The stimulus energy should be directed at the desired characteristics of the system you wish to study. For example, the response of an elephant to a tiger cannot be ascertained by presenting a kitten (or even 500 pounds of kittens) to the elephant.

- The greater the amount of such well-directed energy that can be delivered to a system without altering its nature (i.e. breaking it, making it perform in a nonlinear manner), the larger the valid observed effects can be.

- The more the observation (analysis) is able to distinguish the results of the stimulus from other activities of the system (noise and distortion), the more valid the observation, i.e. the greater its signal-to-noise ratio.

If a measuring technique is deficient in any of these aspects, the loss of observational quality cannot be recovered by any means other than possibly increasing the amount of testing, and thus the total energy used to test.

The success of TDS is a direct result of its excellence in all of the above areas [9].

- Audio systems are characterized by their useful bandwidth when using frequency-domain models. This means that audio systems should be subjected to energy which stimulates those frequencies desired for study and no

Gerald R. Stanley is Head of Research and Resources for Crown International, which makes the System 10 TEF computer, a dedicated unit for Time Delay Spectrometry (TDS) measurements.

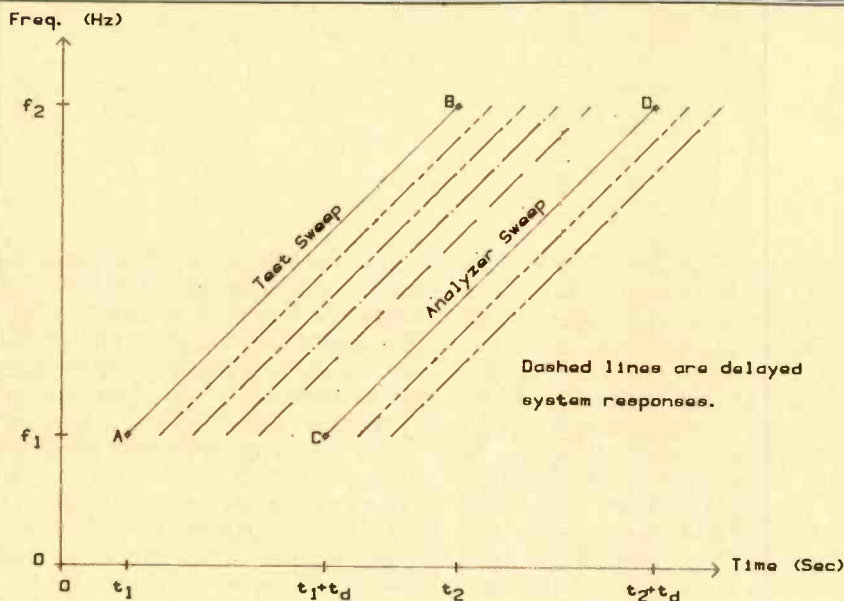

Fig. 1—TDS on the frequency-time plane.

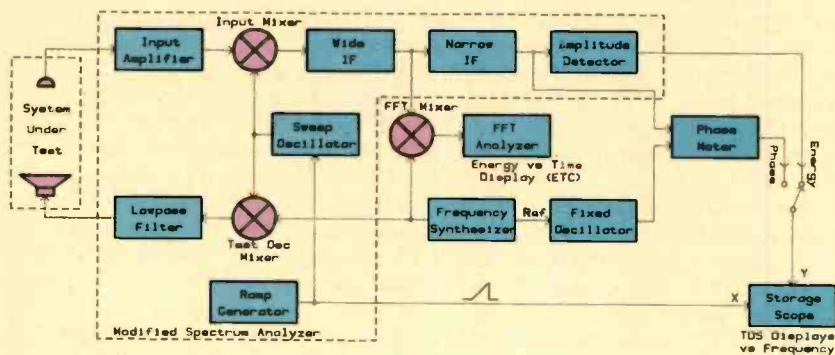

Fig. 2—TDS implementation by traditional means.

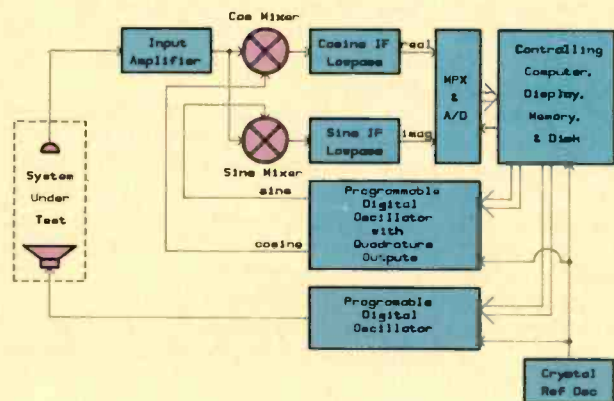

Fig. 3—Block diagram of the TEF 10.

other. In TDS, a linear FM sinusoidal sweep is used as a stimulus, and the resulting frequency range covered is the range swept.

- TDS presents the test stimulus throughout the entire observation time and thus accumulates a large total amount of energy, all of which is useful to the test. The test signal also presents the system a low crest factor (peak to rms ratio) of the test signal. High crest-factor signals evoke increasingly nonlinear behavior in many systems, such as loudspeakers, and may make the observations invalid as observations of supposed linear behavior.

- The TDS observation system has a matched receiver which is tuned to accept the desired stimulus and simultaneously reject noise and undesired distortion products. (Note that the distortion can be selected and the linear responses rejected in TDS systems if so programmed.)

Acoustic test environments are noisy. Even in an anechoic environment (not permissible if the object of the test is a listening space), the noise of the microphones is non-trivial if dynamics equivalent to human hearing are required.

It is not unusual to make TDS measurements in noisy areas with equipment running and people talking without any need to average multiple measurements. The consequence is fast and accurate analysis in the real world.

In 1978, Don Davis of Synergetic Audio Concepts, who was actively involved in licensing and training TDS users, approached Crown International and myself to develop a cost-effective TDS analyzer. He was not then aware of my previous interest in TDS and the (by then) bulging file of Dick Heyser's papers in my file cabinet [1 to 8].

It has been rightly said that inspiration is more perspiration than revelation. The development both of TDS by Dick Heyser and of the TEF System 10 computer are both cases in point. What is now obvious to the casual observer was not so at the beginning.

The first design attempts were directed along the lines of previous implementations. Not only must the proposed instrument be less expensive than its forebears, it must be in one portable box small enough to fit under

an airline seat and flexible enough to support a variety of computations, such as Hilbert and Fourier transforms. The future demands on an emerging technology dare not be excessively confined by hardware constraints.

It soon became clear that a general-purpose computer system with a large amount of mass storage was required. Only with software and floppy disks was the requisite flexibility and storage possible. The standard densities used in home computer disks would not be adequate, however, as some measurements would store over 64K (65,536) bytes with each task. Subsequently, 1-megabyte mini-floppies were chosen.

It is necessary to perform a 1,024-point, 16-bit FFT computation to produce what is known as the Energy Time Curve, or ETC. The ETC is the magnitude of the impulse response and doublet (a figure derived by a Hilbert transform of the impulse response). To be user-acceptable, the computation must be done in less than 2 seconds. By using an LSI math processor in conjunction with a 4-MHz, Z80A microprocessor, it has been possible to do the FFT in approximately 0.6 second. (Z80 is a registered trademark of Zilog Inc.)

The solution is shown in Fig. 3. Not one but three Z80As are used to implement the TEF analyzer. The test signal and analyzer signals are each created at the actual frequencies of use by digitally computing the instantaneous phase 70,175 times per second. Sixteen-bit computations of phase are performed using downloaded programs which create linear FM sweeps. The analyzer is d.c.-coupled and can measure from d.c. to 31.6 kHz. By using two sweeps (in quadrature), it is possible to accurately measure response at d.c. This capability was not available previously without computing capacity.

The computer implementation is very flexible in that the phase angle between test and analyzer oscillator signals, as well as the time delay, can be programmed.

The needed time delay between test signal and analyzer signal is provided by software routines which are executed before the oscillator routines begin. Time delay is adjustable in 1-microsecond steps from 0 to 240 seconds. This

constitutes a much wider range of delay than had been previously possible.

The intermediate frequency (i.f.) amplifiers are not the band-pass amplifiers of traditional spectrum analyzers, which do not allow sufficiently narrow bandwidths for high time-resolution, slow-sweep measurements. Instead, they are low-pass filters. Very narrow, Gaussian-shaped bandwidths are possible without using difficult-to-control, temperature-compensated crystal band-pass filters or multiple conversion techniques. The functional Q of Fig. 2's filters would otherwise need to be in the millions to construct a bandwidth of 0.115 Hz, which is the minimum bandwidth of the TEF 10. The TEF's maximum Gaussian bandwidth is 20 kHz.

The analyzer is truly portable, as it contains batteries and a charger. Operation can continue for 15 minutes after power loss, making the unit both brownout-proof and useful for quick measurements in environments where there is no external power. In vehicles, or wherever else 12-V d.c. is available, the unit may be powered from that instead of a.c.

The TEF System 10 computer is not organized like traditional instruments. Internal switching and adjustments are all computer-controlled. Operator con-

trol is via a QWERTY (typewriter-like) keyboard. A standard disk operating system, CP/M, is used, which also allows the TEF 10 to use a wide variety of common programs, including word-processing and several computer languages. (CP/M is a registered trademark of Digital Research Inc.)

The TEF software uses a menu-directed approach, so "controls" not relevant to the present mode of operation

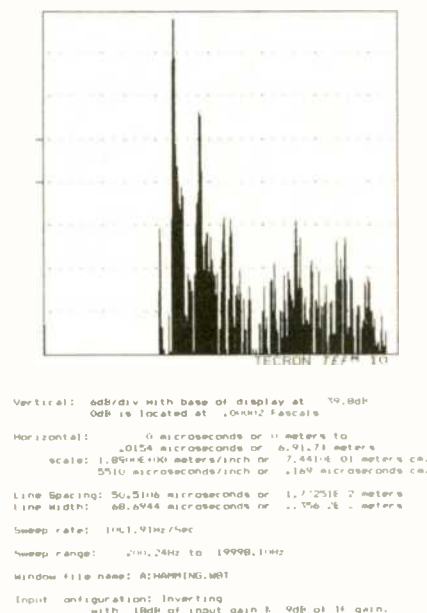
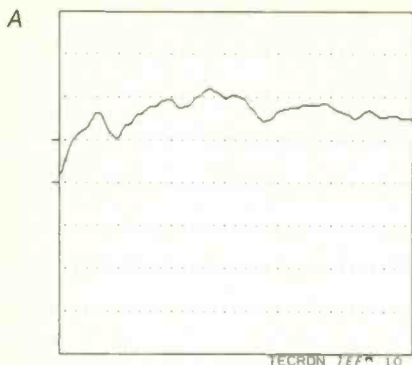

Fig. 4—An Energy-Time Curve (ETC).



Fig. 5—Energy vs. time and frequency, with early arrivals in front (A) and late arrivals in front (B).



Vertical: 6dB/div with base of display at 45.9dB
0dB is located at .00002 Pascals

Horizontal: Auto 0.00Hz to 1999.10Hz
scale: 567.68Hz/inch or 2152.63Hz/cm.

Resolution: 3.1952E-01 meters & 1.0735E-03Hz

Time of test: 7390 microseconds, 2.5348E+00 meters

Sweep Rate & Bandwidth: 10734.80Hz/Sec & 1.0000E-01Hz

Input configuration: Inverting
with 18dB of input gain & 9dB of IF gain.

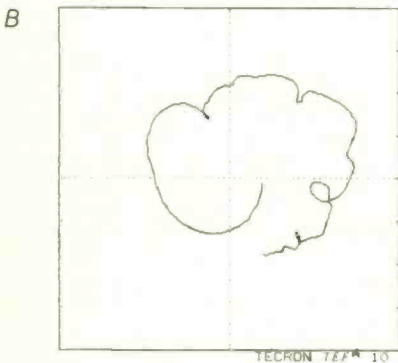

Resolution: 3.1952E-01 meters & 1.0735E-03Hz

dB of automatic screen gain.

Frequency range: Auto 0.00Hz to 1999.10Hz

Time of test: 7390 microseconds, 2.5348E+00 meters

Sweep Rate & Bandwidth: 10734.80Hz/Sec & 1.0000E-01Hz

Input configuration: Inverting
with 18dB of input gain & 9dB of IF gain.

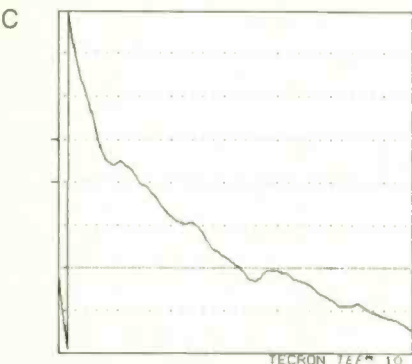

Vertical: 45 degrees/div.
0 degrees is at the dashed horizontal line.

Horizontal: Auto 0.00Hz to 1999.10Hz
scale: 567.68Hz/inch or 2152.63Hz/cm.

Resolution: 3.1952E-01 meters & 1.0735E-03Hz

Time of test: 7390 microseconds, 2.5348E+00 meters

Sweep Rate & Bandwidth: 10734.80Hz/Sec & 1.0000E-01Hz

Input configuration: Inverting
with 18dB of input gain & 9dB of IF gain.

Fig. 6—Three interpretations of one direct-arrival sweep: Energy vs. frequency (A), Nyquist display (B), and phase vs. frequency (C).

are not visible to confuse the beginning operator. An operator's manual is available on line. Every menu has a help file which may be read and edited if desired.

The data is documented automatically. Data and settings are saved with each measurement. Setups may be loaded from disk and, upon beginning measurement, the last settings used are restored from disk. The operator may add text remarks to the measurements by using a built-in screen editor.

If calculations are needed, an RPN (Reverse Polish Notation) calculator program may be brought on screen.

The graphic data display has a resolution of 256 by 512 pixels (picture elements) on a high-resolution, 7-inch green CRT. Data on the screen can be output to a dot-matrix printer to yield hard copy, as shown in Figs. 4 to 6. (Figures 4 to 6 are reproduced half of original size; one inch here is two inches on original drawing.)

Figure 4 is an Energy Time Curve of a stereo system. The display is of energy (shown in dB on the vertical axis) versus time (on the horizontal axis). The highest feature is the direct signal arrival. To the right are reverberant signals, with the dominant reflected signal being from the floor. A small, pre-direct-arrival signal appears to the left of the main signal arrival, approximately 30 dB down. This was caused by an unintentional panning of the test signal into the undriven stereo channel, whose speaker was about 11 inches closer to the listening position than the test channel's speaker. This signal is clearly seen, due to the ETC's large dynamic range.

Data may be displayed in a variety of ways. Figure 5A shows energy versus time and frequency for the system of Fig. 4. The horizontal axis is frequency, and the depth axis is time, with early arrivals shown in front. Figure 5B is of the same data with the time axis reversed. Note that comb-filtering effects are clearly seen when reverberant signals are combined in common time slices. The pre-direct-arrival signal is also seen as ripples on the front of the direct-arrival response. Any one of the 32 sweeps which compose this display may be shown individually.

Figures 6A to 6C show individual interpretations of a single sweep of the

direct-arrival signal from one tested system. They include energy-versus-frequency, Nyquist (real-versus-imaginary), and phase-versus-frequency displays, respectively. The frequency axis may be shown as log frequency; however, linear display is more often diagnostic in allowing the recognition of periodic (comb-filter) behavior.

Equalization of sound systems has historically been done by using third-octave real-time analysis. Such methods equalize the averaged response of the direct and reverberant sound fields and not the more pertinent direct-arrival response. The total time-blindness of such methods has sometimes produced results where the system sounded better without the equalization. At no time was it possible to rapidly quantify the contributions of multipathed acoustic signals. It is no longer necessary to accept these measuring limitations.

The marriage of TDS and a computer have made real-world, time-frequency domain analysis more than a gleam in the eye of a theoretician. After 16 years, TDS has arrived. **A**

References

1. Heyser, Richard C., "Acoustical Measurements by Time Delay Spectrometry," *Journal of the Audio Engineering Society*, Oct. 1967.
2. Heyser, Richard C., "Loudspeaker Phase Characteristics and Time Delay Distortion," *JAES*, Part I, Jan. 1969; Part II, April 1969.
3. Heyser, Richard C., "Determination of Loudspeaker Signal Arrival Times," *JAES*, Part I, Oct. 1971; Part II, Nov. 1971; Part III, Dec. 1971.
4. Heyser, Richard C., "Breakthrough in Speaker Testing," *Audio*, Nov. 1973.
5. Heyser, Richard C., "Speaker Test Impedance," *Audio*, Sept. 1974.
6. Heyser, Richard C., "Crescendo Test," *Audio*, May 1976.
7. Heyser, Richard C., "Time and Frequency in Loudspeaker Measurements," *Audio*, July 1977.
8. Heyser, Richard C., "The Delay Plane, Objective Analysis of Subjective Properties," *JAES*, Part I, Nov. 1973; Part II, Dec. 1973.
9. Biering, H. and O. Z. Pedersen, "System Analysis and Time Delay Spectrometry, Part I," *Bruel & Kjaer Technical Review*, No. 1, 1983.

For years you have been fed some pretty tall stories about cassette tape. Denon only makes one claim for DX-Series Cassettes. We don't say they will play on the moon, we don't say they will survive being baked in ovens. We hope that they won't tip over your chair or shatter your stemware. We only say that Denon DX-Series Cassette Tape will sound more like real music than any other brand on the market.

**"YOU DON'T LISTEN TO SPECIFICATIONS;
YOU LISTEN TO MUSIC."**

Most cassette tape advertising tries to impress you with specifications. The trouble is that specifications do not

necessarily equate to musicality.

Most manufacturers' specifications are based on static measurements, the tape's response to steady test tones. Denon DX-Series Cassette Tape goes one step further: it also minimizes Dynamic Distortion, the distortion created by actual musical signals.

**"DENON WILL BECOME
THE AUDIOPHILES CASSETTE TAPE."**

True audiophiles realize the A-B testing is not the real gauge of sound quality. Only extended listening can tell you if a component—or a tape—is superior.

Perform this test for yourself. Make a recording on Denon DX-Cassette Tape. First listening to the source. Then playback your DX-Tape recording and compare the two experiences. The message is in the music.



**"YOU WILL DISCOVER A CASSETTE TAPE
THAT SOUNDS LIKE REAL MUSIC."**

SON OF DIRECTORY

BLANK TAPE

MANUFACTURER	Brand	CASSETTE TAPE TYPE CODE I — Normal Ferric II — Chrome/Chrome Equivalent III — Ferrichrome IV — Metal Particle	CASSETTES						OPEN-REEL				Notes	
			Tape Type—See Code						1200 Feet	1800 Feet	2400 Feet	3600 Feet		
			C-30	C-45 or C-46	C-60	C-90	C-120							
BASF	Performance 1 Pro I Super Pro II Chrome Ferrochrom Metal IV Ferro Super LH Ferro LH Chrome EE Extra Efficiency	I II III IV			2.99 4.49 4.69 4.49 8.59	4.19 5.99 6.29 5.99 11.49	5.19 13.99			11.99 9.99 19.99	11.99	31.99 49.99	True chrome. As above; back-coated, 7- and 10½-inch metal reels.	
B.T.M.	E.S.T. E.S.T. E.S.T. MB	I II I			5.98 6.49 1.49	6.98 1.89								
CERTRON	Ferex II Ferex I High Energy High Density	II I I I	1.29	1.39	3.00 3.00 1.99 1.59	3.99 3.99 2.59 2.09	2.99 2.49							
COLUMBIA MAGNETICS	Ultra II, III, IV Reel to Reel	I												
DENDON	DX8 DX7 DX4 DX3 DX1 DX-551 DX-11018	II II I I I I I			6.00 5.00 4.35 3.99 2.75	8.00 7.00 5.99 5.60 3.85							†Open. Back-coated.	
DIRECT-TO-TAPE RECORDING	Agfa PEM 369 Agfa PEM 468 Agfa PEM 468 ½" Ampex 642 Ampex 407 Ampex 456 Direct II Direct I API	I I I I I I II I I			3.75† 2.95† 2.10	4.50†† 3.50†† 2.50	3.70	8.65 9.15	10.30 5.85 10.60	21.70 36.15	24.00 15.75 24.20	†C-66; ††C-96.		
ELECTRONIC HOMES CO.	Correct Replacement GST Toyota Grandmaster Lear Jet Stereo Lear Jet Stereo	I II I II I II			2.99 2.99 1.99 1.99 1.99 2.99	3.99 3.99 2.99 2.99 2.99 3.99	4.99 3.99 3.99			100.00				
FUJI	FR Metal FR-II FR-I ER DR GT-I	IV II I I I I			7.15 4.90 4.90 3.60 2.95 5.55	7.95 5.45 5.45 4.10 3.40 6.20	10.75 7.50 7.50 5.75 4.75 6.60						For car stereo.	
JVC	F1 DA1 DA3 DA7 ME-90P II	I I I II IV			2.95 3.85 4.75 5.25	3.95 5.25 6.95 7.45 16.95								
KONICA	ML GM-I GM-II Metal	I I II IV			2.09 2.69 3.49 5.99	2.59 3.59 3.99 7.49	3.59							
LORANGER	Loran High Bias Loran Normal Bias Loran Metal	II I IV		5.25 5.25	5.75 5.75 12.70	7.95 7.95 15.75								
MAXELL	LN UD UDXL-I XL-IS UDXL-II XL-IIS MX UD XL-I XL-II	I I I I II II IV I I II		2.19 3.19	2.39 3.49 4.59 5.29 4.59 5.29 9.99	3.59 5.19 6.39 7.29 6.39 7.29 11.99	4.69 6.99			8.99 11.29	10.39 12.69 19.99	12.99 30.59	14.99 34.99 54.59	For EE-capable decks.

BLANK TAPE

CASSETTE TAPE TYPE CODE I — Normal Ferric II — Chrome/Chrome Equivalent III — Ferrichrome IV — Metal Particle	MANUFACTURER	Brand	Tape Type—See Code	CASSETTES					OPEN-REEL				Notes	
				C-30	C-45 or C-46	C-60	C-90	C-120	1200 Feet	1800 Feet	2400 Feet	3600 Feet		
	MEMOREX	Metal IV High Bias II MRX I dB Series	IV II I I	2.79	2.99	4.59 3.19 3.19 2.59	6.29 4.79 4.79 3.79	6.39						
	3M	Scotch XSM IV Scotch XS I Scotch XS II Scotch CX Scotch BX Scotch 206 Scotch 207 Scotch Dynarange	IV I II I I I I		2.99 1.89	7.99 4.49 4.79 3.29 2.19	10.29 5.79 5.99 4.79 3.29	6.59 4.79	9.39 6.29	10.79 8.39				7-Inch reel, 60 minutes @ 7½ ips. 7-Inch reel, 90 minutes @ 7½ ips. 600 feet, 5-inch reel, 30 minutes, \$4.09; 900 feet, 5-inch reel, 45 minutes, \$4.89.
	MIS	XR XRC	I II	1.44 1.74	1.59 1.89	1.74 2.04	2.04 2.19							
	NAKAMICHI	EXII SX SXII ZX	I II II IV			3.70 4.00 5.85 6.50	5.40 5.85 8.00 9.00							
	PD MAGNETICS		I II IV			3.49 4.69 8.99	4.99 6.79 11.99							
	PRD-FI	One Two Three Reference/Meta	I II III				2.79 4.29 5.99							
	REALISTIC	SuperTape SuperTape SuperTape Realistic SuperTape Realistic ConcertTape	IV II I I I	1.59	2.69	5.99 3.99 2.99 1.99	6.99 4.69 3.99 2.79	4.99 3.49	5.79	6.49 5.49 2.49	6.49	11.49 7.99		Head-cleaning leader. As above.
	REVDX	631										44.00		
	RKO TAPE	Ultrachrome Broadcast I Xtra Dynamic	II I I		2.49	4.49 3.99 2.99	5.99 5.49 3.99							
	SONY	LNX BHF AHF UCX UCX-S FECR Metallic ULH FECR LC-SLH LC-FECR	I I I II II III IV I I II		2.05	2.25 3.10 3.80 4.15 5.00 4.45 8.45	3.15 4.25 5.20 5.75 7.00 6.10 11.50	4.05		9.00	11.50 14.00	31.00 39.00		Head-cleaning leader. As above. As above. As above. Eicaset. As above.
	SWIRE MAGNETICS	Laser XL Laser UHD I Laser UHD II	I I II		1.39	1.49 1.99 1.99	1.89 2.59 2.59	2.49						Non-chrome.
	TDK	MA-R SA-X AD-X MA SA AO D SA GX LX	IV II II IV II I I I I	2.09	2.29	8.99 4.99 3.89 6.69 4.59 3.29 2.49	11.99 6.99 5.49 8.99 6.49 4.79 3.39	3.99		10.95† 9.95†	12.95† 10.95†	29.95†† 27.95††	41.95†† 30.95††	C-180, \$5.59. †7-inch plastic reel; ††10½-inch metal reel; for EE-capable decks. Back-treated. As above; without back treatment: 1800 feet, \$9.95; 3600 feet, \$27.95.
	TEAC	CDC CRC	I II			5.75 5.95	6.00 6.50							Reel-type cassette. As above.
	TEI ELECTRONICS	43-101 43-102 43-103 43-2C9 43-3C6	I I I I I	.97 2.31		1.19 2.31†	1.81 1.92†							†2 pack. †3 pack.
	YAMAHA	MR CRX CR NRX NR	IV II II I I			6.71 5.05 4.40 4.10 3.40	9.03 6.97 6.20 5.45 4.90							

NOISE-REDUCTION UNITS

MANUFACTURER	Model	MP Type	Function: Closed Loop = C, Open Loop = O, Transient = T		Application: Tape Rec. = R, Photo = P, FM = F, Video = V	Universal = U	Simultaneous Encode/Decode?	Degree of Noise Reduction, dB @ Hz	Record = R, Play = P, Both = RP	THD, %	Frequency Response, Hz to kHz, ±dB	Price, \$	Notes
ADVANCED AUDIO SYSTEMS	DNR-911	DNR	C	U				18 @ 1k	RP	0.13	10-20 ± 0.5	249.95	
AEG-TELEFUNKEN	cDM	Telcom	C	U	No			30 dB	RP	0.2	30-20 ± 0.5	833.00	Professional system.
BURWEN	DMF 1201 TNE 7000	Burwen Transient Noise Eliminator	D T	U P				30 (or 5k)	RP RP	0.02 0.02	10-20 ± 0.5 20-20 ± 0.5	289.00 289.00	Play only; does not require encoding. As above.
CARVER	TX1-11	†	C	F				20 @ 20-20k		0.05	5-60 + 0, -3	249.00	†Asymmetrical charge-coupled FM decoder; for FM tuners.
DBX	224	dbx Type II	C	RP	Yes			40 @ 30-20k	RP	0.15	40-20 ± 0.5, -2 dB @ 30 Hz	259.00	dbx-disc playback; rack mountable.
	222	dbx Type II	C	RP	No			40 @ 30-20k	RP	0.15	40-20 ± 0.5, -2 dB @ 30 Hz	219.00	As above.
	228	dbx Type II	C	RP	Yes			40 @ 30-20k	RP	0.15	40-20 ± 0.5, -2 dB @ 30 Hz	499.00	As above; 18X expander, full- band expansion to 50% (1:1.5) inc.
	NX-40	dbx Type II	C	RP	Yes			30 @ 50-15k	RP	0.5	50-15 ± 1.5	129.00	dbx-disc playback.
	21	dbx Type II	C	RP	No			40 @ 30-20k	P	0.3	40-20 ± 1	109.00	Plays dbx-encoded discs and tapes.
	PPA-1	dbx Type II, dbx B	C	R	No			40 @ 50-15k (Type II), 6-10 @ 1k + (dbx B)	P	0.3	50-15 ± 1.5 (Type II)	49.00	Decoder for personal portable cassette players; dbx B gives good results with Dolby B-encoded tapes.
	18X Series Two	dbx Downward Expansion, Variable	D	U	No			20 Max. @ 20-20k	P	0.15	40-20 ± 0.5, -2 dB @ 20 Hz	249.00	One-band (full-band) dynamic- range expander.
38X Series Two	dbx Downward Expansion, Variable	D	U	No			20 Max. @ 20-20k	P	0.15	20-20 ± 0.5	549.00	Three-band dynamic-range expander.	
48X	dbx Downward Expansion, Variable	D	U	No			20 Max. @ 20-20k	P	0.15	20-20 ± 0.5	799.00	As above; wireless remote with volume control; Impact Restoration circuit.	
INTEGREX	DFM 4 CH	Dolby B Dolby B	C	RF	No			9 @ 4k	P	0.05	20-16 ± 1	120.00	Decode only.
			C	RF	Yes			9 @ 4k	RP	0.05	30-20 ± 1	150.00	Kit, wired unit, special order.
LT SOUND	NR-2	2:1 Compressor/ Expander	C	O	U	No		30 @ All	RP	0.06	20-23	350.00	Built-in expander/compressor.
	NR-4	2:1 Compressor/ Expander	C	R		No		30 @ All	RP	0.06	20-23	425.00	4-channel, compatible with pro dbx system.
	NR-8	2:1 Compressor/ Expander	C	R		No		30 @ All	RP	0.06	20-23	795.00	As above, but 8-channel.
MXR	119	Expander			RPF	Yes		21 dB	RP	0.15	30-20 ± 1	175.95	
	132	Expander			RPF	No		20 dB	RP	0.05	20-20	365.95	
	156	CX			P	No		20 dB	P	0.05	20-20 + 0, -1 + 0, -0.5	119.95	
NAKAMICHI	NR-100	Dolby C	C	R	Yes			20 @ 2k-8k	RP	0.1	20-20 ± 1	230.00	For Nakamichi 700ZXE, 700ZXL, 1000ZXL decks.
	High-Com II	Dual-Band Telefunken	C	R	No			20 @ 20-20k	RP	0.1	20-20 ± 1	480.00	
PHENIX SYSTEMS	P-518-S P-82-CX	2:1 Compressor CX	C	R	No			30 @ 1k	RP	0.5	20-20 ± 1.5	65.00	Kit.
			C	P	No			20 @ 1k	P	0.5	20-20 ± 0.5	69.00	As above.
RG DYNAMICS	Pro-20 Signature Series Dne VC-1	Expander Expander	D	RPF	No			10 dB	RP	0.04	20-20 ± 0.2	449.00	
			D	RPF	No			12 dB	RP	0.02	20-20 ± 0.08	695.00	
			D	V	No			10 dB	P	0.1	20-20 ± 1	199.00	
SAE	5000A	Impulse			RP				RP	0.1	20-20 ± 1	199.00	
SOUND CONCEPTS	SX-80	CX	C	P	No			2 @ 20-20k	P	0.01	10-30 ± 0.2	119.00	Peak expander; may be modified for videodisc standard.
SYMMETRIC SOUND SYSTEMS	ASRU EX-1 LFF-1	DNR & Expander Expander Subsonic	D	U				18 @ 20-20k	P	0.2	20-20 ± 1	120.00	Kit.
			D	U				8 @ 150-20k	P	0.2	20-20 ± 1	60.00	As above.
			D	U				20 @ 20	P	0.02	20-20 ± 1	50.00	As above.



WHY BUY "BUDGET" LOUDSPEAKERS, WHEN FOR THE SAME PRICE YOU CAN OWN KEF?

Today many speaker companies are offering budget loudspeakers, but which of them has ever produced products of the calibre of KEF's world-acclaimed Reference Series?

Which of them can draw from this Reference technology to produce affordable products that do not compromise sound quality?

Only KEF, manufacturers of the world's most thoroughly engineered loudspeakers.

The new "Standard Series" represents one of KEF's most significant accomplishments—solid and attractively built loudspeakers that deliver true KEF performance, yet have a suggested retail price *per pair* of \$300 (Coda); \$500 (Carina) and \$750 (Carlton).

The new KEF "Standard Series." For people with higher standards.

KEF KEF
The Speaker Engineers

SON OF DIRECTORY

DIRECTORY OF MANUFACTURERS

Advanced Audio Systems

4010 Moorpark Ave.
Suite 105
San Jose, Cal. 95117

AEG-Telefunken

See Gotham Audio

BASF Systems

Crosby Dr.
Bedford, Mass. 01730

BTM Engineering

2005 Lincoln Ave.
Pasadena, Cal. 91103

Burwen

See Infinity

Carver

P.O. Box 664
Woodinville, Wash. 98072

Certron

1701 S. State College Blvd.
Anaheim, Cal. 92806

Columbia Magnetics

1801 Century Park West
Los Angeles, Cal. 90067

dbx Inc.

71 Chapel St.
Newton, Mass. 02195

Denon

27 Law Dr.
Fairfield, N.J. 07006

Direct-to-Tape Recording

14 Station Ave.
Haddon Heights, N.J. 08035

DLK Acoustical Products

1405 Mendota Heights Rd.
St. Paul, Minn. 55120

Electronic Homes Co.

234 Fifth Ave.
New York, N.Y. 10001

Fuji

350 Fifth Ave.
New York, N.Y. 10018

Gotham Audio

741 Washington St.
New York, N.Y. 10014

Infinity Systems

7930 Deering Ave.
Canoga Park, Cal. 91304

Integrex

P.O. Box 747
Havertown, Pa. 19083

JVC

41 Slater Dr.
Elmwood Park, N.J. 07407

Konica

440 Sylvan Ave.
Englewood Cliffs, N.J. 07632

Loranger Entertainment

38 Clark St.
Warren, Pa. 16365

LT Sound

P.O. Box 338
Stone Mountain, Ga. 30086

Maxell Corp.

60 Oxford Dr.
Moonachie, N.J. 07074

Memorex

Memtek Products
P.O. Box 988
Santa Clara, Cal. 95052

3M Co.

Magnetic AV Products Div.
2501 Hudson Rd.
St. Paul, Minn. 55119

MIS

Magnetic Information Systems
415 Howe Ave.
Shelton, Conn. 06484

MXR Innovations

740 Driving Park Ave.
Rochester, N.Y. 14613

Nakamichi U.S.A. Corp.

1101 Colorado Ave.
Santa Monica, Cal. 90401

PD Magnetics

P.O. Box 4499
Wilmington, Del. 19807

Phoenix Systems

91 Elm St.
Manchester, Conn. 06040

Pro-Fi Tapes

See DLK

Realistic

Radio Shack
300 One Tandy Center
Fort Worth, Tex. 76102

Revox

1425 Elm Hill Pike
Nashville, Tenn. 37210

RG Dynamics

6440 North Ridgeway Ave.
Lincolnwood, Ill. 60645

RKO Tape

3 Fairfield Crescent
West Caldwell, N.J. 07006

SAE

Scientific Audio Electronics
P.O. Box 60271
Terminal Annex
Los Angeles, Cal. 90060

Sony

Sony Dr.
Park Ridge, N.J. 07656

Sound Concepts

P.O. Box 135
Brookline, Mass. 02146

Studer Revox

See Revox

Swire Magnetics

301 East Alondra Blvd.
Gardena, Cal. 90248

Symmetric Sound Systems

856 Lynn Rose Court
Santa Rosa, Cal. 95404

TDK

12 Harbor Park Dr.
Port Washington, N.Y. 11050

TEAC

7733 Telegraph Rd.
Montebello, Cal. 90640

TEI Electronic Products

570-72 West 18th St.
Hialeah, Fla. 33010

Yamaha

6600 Orangethorpe Ave.
Buena Park, Cal. 90620

© 1983 R. J. REYNOLDS TOBACCO CO.



You've got what it takes.

Salem Spirit

*Share the spirit.
Share the refreshment.*

10 mg. "tar", 0.8 mg. nicotine av. per cigarette by FTC method.

Warning: The Surgeon General Has Determined
That Cigarette Smoking Is Dangerous to Your Health.



1

NEC CD-803E COMPACT DISC PLAYER

Manufacturer's Specifications

Frequency Response: 5 Hz to 20 kHz.

Dynamic Range: More than 90 dB.

Signal-to-Noise Ratio: More than 90 dB.

THD: Less than 0.01% (5 Hz to 20 kHz).

Channel Separation: More than 70 dB (5 Hz to 20 kHz).

Wow and Flutter: Below measurable limits.

Output Level: 1.5 volts, fixed; 0 to 1.5 volts, variable.

Access Time: 3 seconds average.

Power Requirements: 120 V, 50/60 Hz, 48 watts.

Dimensions: 16.93 in. (43 cm) W x 5.9 in. (15 cm) H x 14.17 in. (36 cm) D.

Weight: 26.4 lbs. (12 kg).

Price: \$1,300.00.

Company Address: 1401 West Estes Ave., Elk Grove Village, Ill. 60007.

For literature, circle No. 90

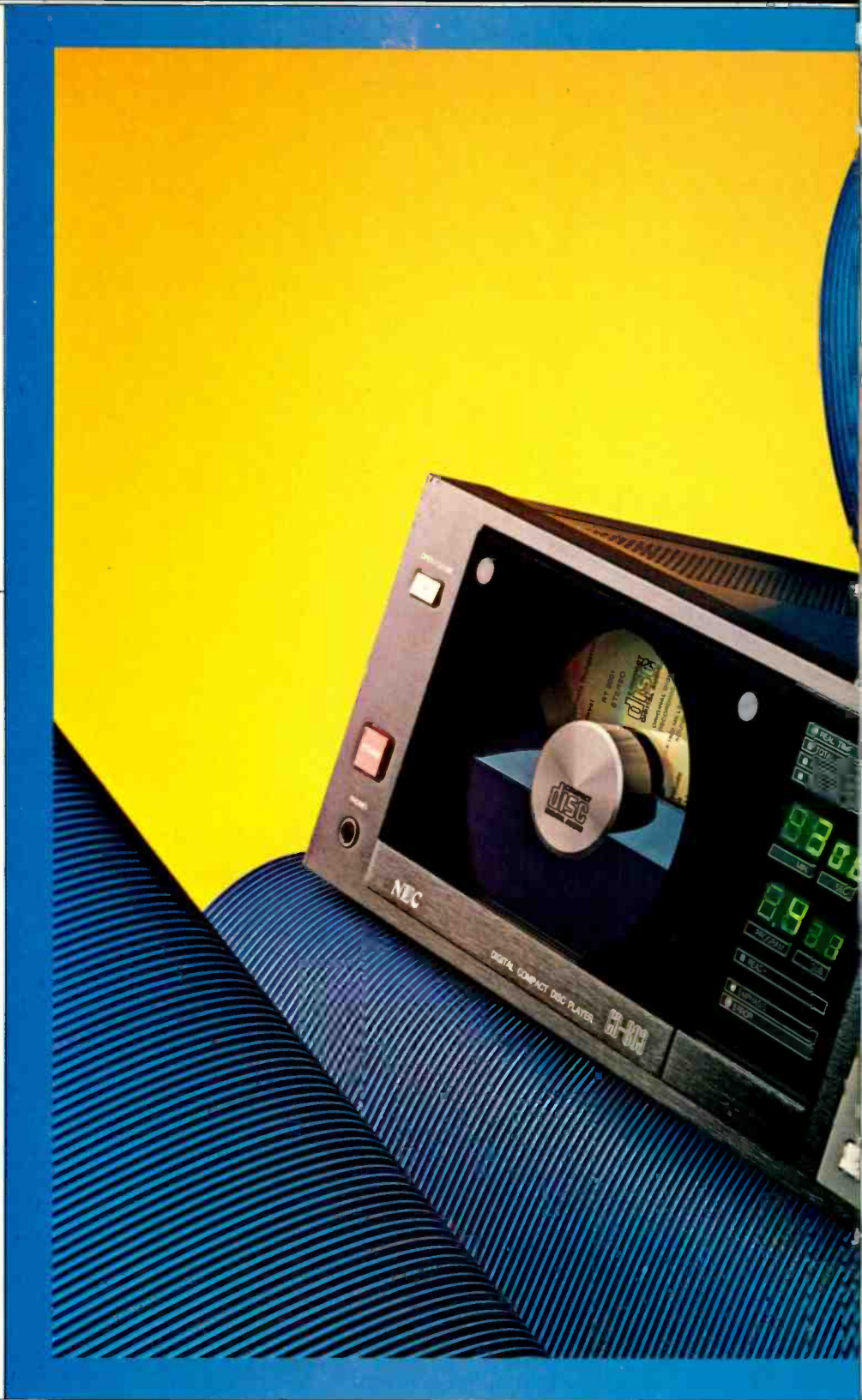

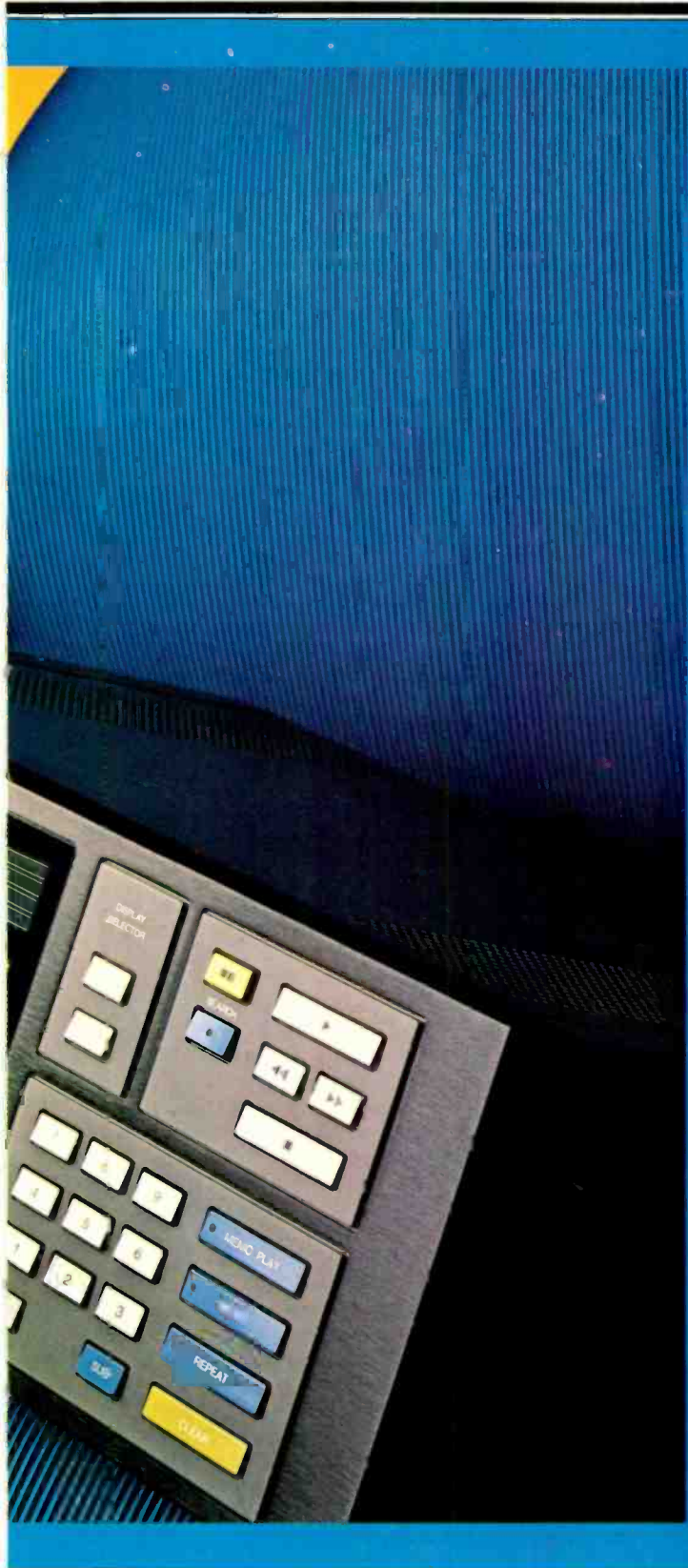

Although exact circuit details for this CD player were not made available to me, I suspect that NEC's approach to Compact Disc decoding and playback is more like that of Philips (and in the U.S., of Magnavox) than, say, of Sony. NEC has paid considerable attention to pre- and post-D/A conversion filters which cut off frequencies above 20 kHz. In the case of the CD-803E, the designers say they have developed what they call ND (non-delay) filters which, to quote them, results in "the reproduction of sound" that "is clear and utterly devoid of phase distortion throughout the entire audible frequency range. This high-performance filter can extract and reproduce faithfully all of the musical information stored on the Compact Discs, down to the subtlest nuance." I'll have more to say about sonic nuances, subtle and otherwise, later on.

Some of the most obvious (and less subtle) features of the CD-803E include a "search and play" system which allows you to search backwards for the beginning of a selection you're currently listening to or forwards for that of the next selection. Up to 99 selections can be programmed into the player's memory, via a numeric keypad, for playback in any order. Repeat play of selections is also possible. An elaborate display area offers a wealth of information, such as elapsed time since the beginning of the current selection, total elapsed time from the beginning of the disc, remaining time to the end of the current selection, and total remaining time to the end of the disc. Additional displays show the program number of the selection being played, whether the disc being played was recorded (and is being played) with pre-emphasis/de-emphasis, and whether a programming error has been made.

Variable and fixed sets of output jacks are provided, so one set can be connected to the rest of your audio system while another set might conceivably be connected directly to a tape deck for dubbing or copying discs onto tape. Headphone listening is also possible, and headphone output level is adjustable.

Front Panel Layout

The power switch, disc compartment open/close switch, and headphone jack are located near the left edge of the front panel. NEC elected to use the swing-out door type of disc holder which we have already seen from Technics, Hitachi and several other manufacturers. The disc is simply dropped vertically into the slot along the top edge of the swing-out door. When the door switch is touched a second time, the disc slides down into the door as it closes. I find it difficult to extract a disc from this type of loading door without getting fingerprints on the outer edge of the disc, since the arrangement makes it impossible to grasp the disc across the entire diameter, as I am able to do with the sliding drawer units like the Sony or exposed spindle arrangements such as the Magnavox or Yamaha.

The various illuminated displays already described are located just to the right of the disc compartment door, while further to the right are all of the operating and programming controls for this player. A "Time" selector selects the desired mode of time display referred to earlier. A "Memory List" key causes the numbers of the pre-programmed selections to appear in the order in which they were entered. A

"If I were to judge a CD player on its square waves (which I don't), I would have to give NEC the highest grade."

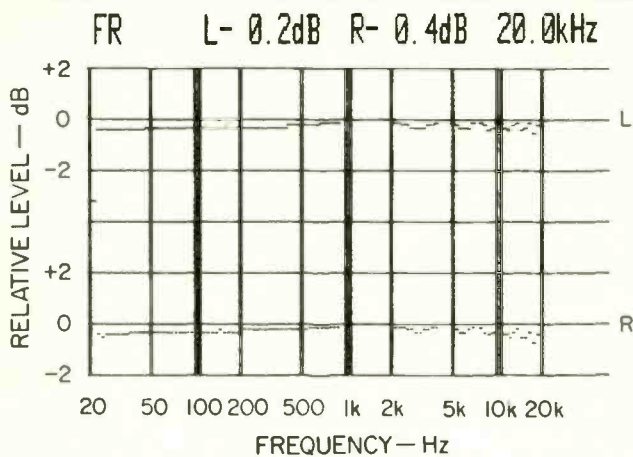

Fig. 1—Frequency response, left (top) and right channels, at 0 dB level.

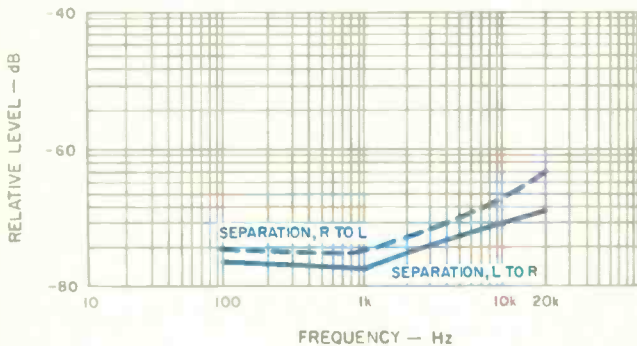

Fig. 2—Separation vs. frequency.

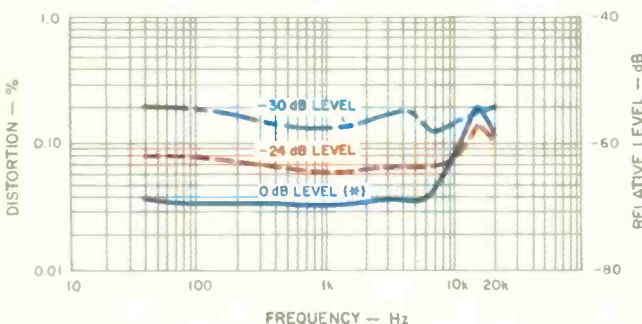

Fig. 3—THD vs. frequency at levels of (from top to bottom) -30 dB, -24 dB and 0 dB (*see text).

keypad numbered 0 through 9 is used to program the player. Near it is a "Sub" key which allows the user to program not only by track number but by index numbers within a long track. (So far I have run across only a very few discs, all classical, which use this sub-indexing system, but since indexing within a track is "built into" the CD Standard, such indexing is likely to appear commonly on future discs.) Laser-pickup transport buttons include play, fast forward, reverse, stop, and pause. If either the fast forward or reverse button is touched and then the play and "Search" keys are activated together, playback will start from the next selection or restart from the beginning of the current selection. A "Repeat" key, a "Memo" key (for entering into memory the desired programs after they have been keyed in by number), a "Memo Play" key (for initiating playback of pre-programmed selections in order), and a "Clear" key (for erasing any program information stored in memory) complete the front-panel layout.

A battery-powered, infrared, wireless remote-control unit duplicates many of the controls found on the front panel. Specifically, all the pickup transport buttons and the number, "Sub" (index), "Memo," "M Play," "Repeat," "Search" and "Clear" keys are all available on the tiny remote-control unit, which operates over an angle of up to about 30° off-axis from the player and at distances of up to 15 feet or so.

The rear panel of the CD-803E is equipped with two sets of output jacks (fixed-level and variable), an output level control for the latter pair, a headphone output level control, a voltage selector switch, and an "Auto Start" switch for use in conjunction with an external timer. Setting this switch to "On" will cause playback to start automatically when power is applied via the external timer.

Measurements

Using my standard Philips test disc, I plotted frequency response for both channels of the NEC CD player. Results are shown in Fig. 1. Note that the vertical scale of this graph has been expanded to 2 dB per division so as to show up even small deviations from absolutely flat response. At 20 kHz, response in the left channel was down only 0.2 dB, while attenuation in the right channel was 0.4 dB. The slight ripple effect in response noticeable at the high end may well be caused by the special "no delay" filters which NEC has developed for this product, but since no circuit details were provided, I can only conjecture about this.

I then switched to a new Sony test disc (their number YEDS-7) which, incidentally, contains spot frequencies at 20 and 40 Hz. You may recall that my earliest tests of CD players showed response only down to 100 Hz, because at that time the only test disc I had, from Sony, did not contain lower frequencies. In this instance, however, I did not use the new Sony disc for frequency-response checking, but rather for checking separation. The Philips disc does have separate left and right spot frequencies, which I use for checking harmonic distortion versus frequency, but I find it a bit faster and more convenient to use the new Sony test disc for making separation measurements. A plot of separation versus frequency (for four significant spot frequencies only) is shown in Fig. 2, for both channels. Slight but insignificant differences in separation were noted for the left-to-

"I find it difficult to extract discs from swing-out loading doors without getting fingerprints on them."

right versus right-to-left measurements, though separation at mid- and low frequencies measured well over 70 dB.

Figure 3 is a plot of total harmonic distortion versus frequency. The higher than claimed values shown for the "0 dB" output level in these plots are not actually the result of out-of-spec levels of harmonic distortion. Rather, I observed a sort of random "hash"-like noise which was the main contributing factor to the higher than normal readings. Actual harmonic distortion, if I could have isolated it from the rest of the output products that were not harmonics of the test signals, was probably well below the 0.01% claimed by NEC. At lower signal levels (the -24 dB test signal level), where we would normally expect an increase in true harmonic distortion of about 10 to one, you will note that the distortion figures are only slightly higher than they were for the 0 dB level, confirming my suspicion that the results obtained for the 0 dB level signals were not really made up entirely of harmonic distortion.

Output linearity was accurate to within 0.5 dB from 0 dB down to -80 dB signal levels. A signal on my test disc at -90 dB was played back at a level of -86.5 dB, which I attribute not so much to nonlinearity as to my bench test setup, minute amounts of noise pickup, and residual noise level of the player and test instruments themselves.

SMPTE-IM distortion measured 0.55% at 0 dB output levels, but dropped to an insignificant 0.04% at -20 dB playback levels. Signal-to-noise ratio measured 92.5 dB (relative to a 0 dB maximum output signal level) unweighted, and 98.5 dB using an A-weighting filter.

Figure 4 is a 'scope photo of a 1-kHz square wave as recovered from the test disc. The wave shape is distinctly different from that obtained from players using conventional sharp-sloped filters and is, again, reminiscent of the wave shape I obtained when I tested the Magnavox, Kyocera, and Phase Linear players; these three use a more "gentle" analog filter approach at the input to their final analog audio output stages. If I were to judge a CD player on the basis of its ability to reproduce accurate square waves (which I definitely am not doing), I would have to give the NEC player the highest grades of all.

As you can see from Fig. 5, the single-pulse test (a single sample at full scale output, followed by 127 samples of zero amplitude), NEC's unique approach to filtering results in a reproduced pulse having far less ringing and overshoot than is typically observed from units having more traditional filter designs.

The phase check signals, consisting of a 2-kHz tone on one channel and a 20-kHz tone on the opposite, were used to determine phase delay for this player. In Fig. 6, low-frequency crossing of the zero axis in a positive direction is supposed to correspond with high-frequency zero-axis crossing in the same direction. As near as I could figure it, the phase delay for the 20-kHz signal, compared with the 2-kHz signal, was no more than about 4.1 μ S—nothing to get really upset about!

What did concern me a bit was the rather poor showing of this player when it was subjected to my error-correction test disc. Using this disc (with its opaque wedge, black dot dust simulations and fingerprint smudge simulation), I noted that the player began to "miss" and occasionally mute for brief

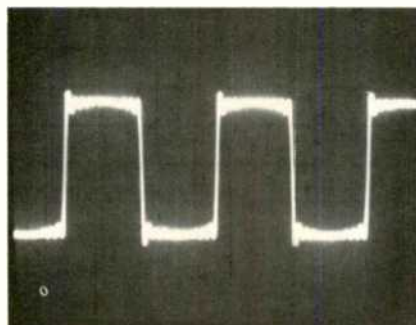

Fig. 4—Response to 1-kHz square wave.

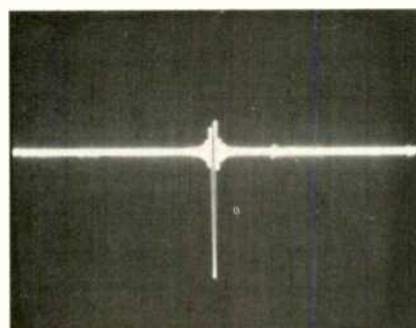

Fig. 5—Single-pulse reproduction.

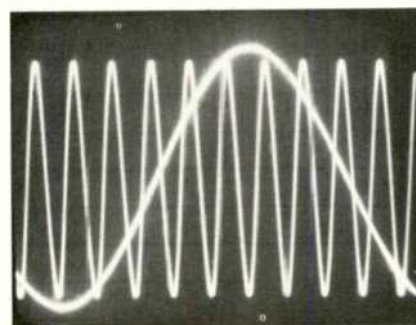

Fig. 6—Two-tone phase check (2 kHz left, 20 kHz right).

“My few criticisms are not with the sound quality (which can't be faulted), but with the NEC's front-panel complexity and error correction.”

periods when traversing the opaque wedge at its 700-micrometer width. As for the dust simulations, I detected failure to properly correct or mask missing data for the smallest of the black dots inscribed on the surface of the test disc, the one measuring only 300 microns in diameter. The player had no problem playing through the entire fingerprint smudge simulation, but I was, frankly, disappointed at its performance when attempting to play through the other built-in defects in the test disc.

Use and Listening Tests

My listening tests confirmed what I have believed for many years, that measurements alone don't tell the whole story. To put it succinctly, the sound quality delivered by the NEC unit was excellent; certainly as good—in every nuance—as that of any CD player I have tested thus far. My collection of CDs keeps growing, and besides playing some of the earliest discs in my collection because of familiarity with them and how they sounded on other CD players, I'm gradually introducing newer discs into my listening routine. I'm happy to report that software is getting better and better, as so many of us said it would be. I was particularly thrilled with my new copies of the Bach Brandenburg Concertos (on two Philips discs) and of Mozart's Piano Concertos, Nos. 15 and 21 (also on a Philips/Polygram disc) obtained during my recent trip to Philips and Polygram. These discs, played on a CD player such as the NEC CD-803E, ought to silence these analog die-hards who still insist that digital discs are not all they're cracked up to be.

What little criticism I have of the NEC player has to do not

with its sound quality (which cannot be faulted in any way) but with its front panel complexity and with its failure to accomplish the same degree of error correction that other players have managed. I found it somewhat exasperating to try to use the fast-forward and reverse features of the system. For one thing, operation of these features was sometimes erratic. On occasion, when I wanted to advance to the next track, the laser pickup insisted on bouncing back to the track currently being played. Search and scanning features did not operate quite as quickly as claimed, and programming, though certainly more elaborate (and capable of handling more tracks) than any other machine tested to date, was a bit too complicated for my taste. The same functions have been incorporated into other machines and, somehow, seem simpler to use. The unit is also extremely large and heavy compared with other players which offer essentially the same playing and programming features. If space is not at a premium, the size of the CD-803E will not pose a problem, but I wondered why it had to be quite so large and so heavy.

I don't want to leave you with the impression that the NEC unit is not worth its asking price. Its sound is superb and if you have the patience to master its front panel buttons and lights, so are its programming features. And many prospective purchasers of CD players will prefer the rugged, somewhat bulky look of this player over some smaller configurations. After all, if each of us favored exactly the same designs in all products, all audio components would look alike and have exactly the same buttons and switches. Then people like me would be out of a job! *Leonard Feldman*

The numeric keypad allows up to 99 selections to be programmed into memory, in any order. The lower display shows what selection's playing.



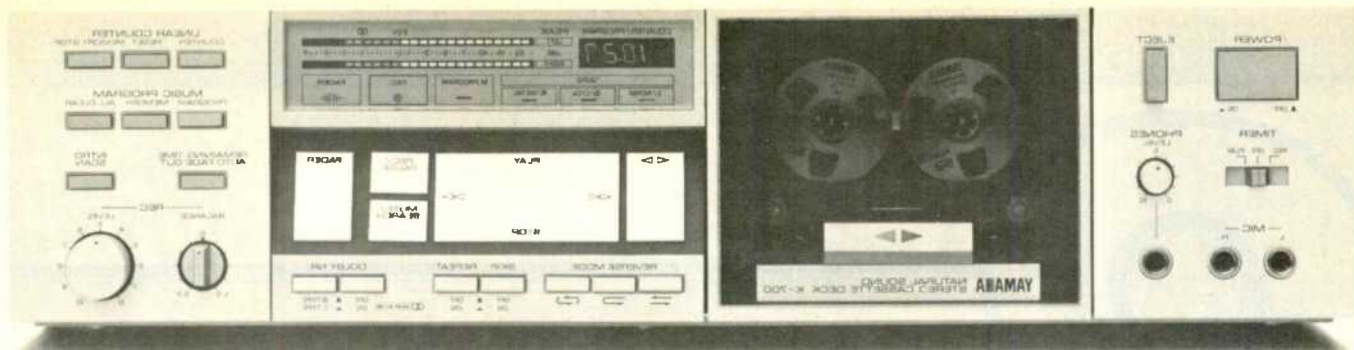

THE REVERSE IS ALSO TRUE.

Most audio manufacturers don't provide for automatic azimuth adjustment in their auto reverse cassette decks. So side B never sounds as good as side A. Yamaha doesn't do things like most audio manufacturers. Introducing the K-700 auto reverse cassette deck. The only one that sounds as good as a Yamaha — in both directions.

To insure reproduction accuracy, we developed a special high-precision rotating head mechanism that permits precise, independent adjustment of head azimuth in both directions. And the head itself is the same pure Sendust type used in our top-of-the-line deck. The result is uncompromised sound quality with auto reverse convenience.

But that's just the beginning of the K-700's convenience. During recording, the K-700 counts down remaining tape time, automatically fades out at the end of the tape, then automatically fades back in after the tape is reversed and continues recording. Another fader button allows professional sounding fade-ins or fade-outs at any point during recording. You can also preprogram up to 15 selections to be recorded or played back in any order.

Then there's Intro Scan, Search, Blank Skip, Repeat, Auto Source Change, Auto Tape Selector, Dolby* B and C, Real-time Digital Counter, and an optional remote control unit.

How much for all this? Much less than you'd expect to pay for this much deck. The K-700. It's all true. Find out at your Yamaha dealer. Or write for complete information: Yamaha Electronics Corporation, USA, P.O. Box 6660, Buena Park, CA 90622.

*Dolby is a registered trademark of Dolby Labs, Inc.

2

LINN SONDEK LP12 TURNTABLE

Manufacturer's Specifications

Speeds: 33 $\frac{1}{3}$ rpm.

Drive Type: Belt.

Rumble: -70 dB unwt'd.

Wow and Flutter: 0.02%.

Speed Accuracy: \pm 0.02%.

Dimensions: 17 $\frac{1}{2}$ in. (44.5 cm) W x
14 in. (35.6 cm) D x 5 $\frac{1}{2}$ in. (14.0
cm) H.

Price: \$995.00.

Company Address: Audiophile Sys-
tems, 6842 Hawthorn Park Dr., India-
napolis, Ind. 46220.

For literature, circle No. 91



Back in 1972, while working as a tool maker in his father's engineering company, Ivor Tiefenbrun decided to build a turntable for his personal use. One thing led to another and Linn Products, Ltd. was formed in 1973 to manufacture the Sondek LP12 turntable as its first product. The company is located in Scotland and has expanded its products to include tonearms, phono cartridges and loudspeakers. Ivor Tiefenbrun, the Managing Director of Linn Products, has become known as an iconoclast as far as turntables are concerned. His ideas about the importance of the turntable in extracting information from recordings, while first received with skepticism, have caused a lot of rethinking on the part of turntable designers. He was able to demonstrate what he termed "Loss Of Information" (LOI) from other turntables when compared to the Sondek LP12.

Ivor's approach to the problems of LOI seems to consist of looking at what a turntable is meant to do from a different perspective than that of the past. For example, if you consider that a 60 dB dynamic range from a recording means that the groove modulation for the softest signal is about one millionth of an inch, you can see that very small vibrations

can tend to obscure detail. The LP12 is designed with such things in mind. Also, since he was realistic enough to know that every detrimental vibration could not be totally eliminated, he designed the LP12 so that such vibrations would occur where they would cause the least LOI.

The Linn Sondek LP12 gives the appearance of being a very simple design, which belies its many, very carefully executed design factors. Only a single 33 $\frac{1}{3}$ rpm speed is offered as standard, although a special pulley and drive belt are available for 45 rpm. Since the latest versions of the turntable feature electronic motor drive, you might expect the speed to be electronically selectable; however, the policy of Linn Products has always been to make any improvements to the LP12 available to owners of earlier versions. Retrofitting an electronic speed control switch would have been a difficult task and, in the interests of uniformity, it was decided not to offer electronic speed selection. The electronic-drive retrofit kit is still available for older versions of the LP12 and is called the Valhalla kit. Another revision which is incorporated in all new LP12 turntables is called the Nirvana kit and consists of suspen-

sion parts which improve the isolation of the motor and platter suspension. Both of these retrofits can be installed on older LP12 turntables by Linn dealers.

As you might gather from the above, Linn shows a high regard for their turntables and the customers who have bought them. If you decide to buy the LP12, the Linn dealer should set up and adjust the turntable for you and install the tonearm and cartridge which you select. For, while the technical manual (available on request) is excellent and very detailed, the dealer's experience in adjusting the turntable/tonearm/cartridge combination for optimum performance is very valuable. Of course, this is true of any combination which you might buy, but the adjustments necessary to obtain optimum performance from the LP12 are particularly fussy.

Features

The main bearing of the LP12 is a conically machined point on a hardened tool-steel shaft. This tiny point rides on a steel thrust plate which is machined, hardened, ground and then lapped to a mirror finish. The shaft is oil lubricated and is supported by two low-friction plastic bearing inserts in the side of the bearing well. The platter is made as two concentric pieces, the inner being driven by a belt, much the same as the old AR turntable designed by Ed Villchur back in the early '60s. The platter is machined on all surfaces to within 0.001 inch (0.025 mm) from a zinc-aluminum alloy casting. The flat drive belt is made of chloroprene rubber and couples the drive from a pulley on the 24-pole, 300-rpm synchronous motor. The drive pulley is machined from the same material as the turntable platter to within 0.0004 inch (0.01 mm), which causes the coefficient of expansion to be the same for both. This means that the speed will remain constant with changes in temperature. The motor mounting is adjustable to provide the correct tension for the belt between the pulley and the turntable hub. This not only provides the proper speed and isolates the motor vibrations from the platter, it also tunes the resonance of the belt compliance and the platter mass to a frequency high enough to minimize flutter oscillations, which can be caused by dynamic groove modulation drag effects. A felt mat is provided, which will be discussed later.

The electronic speed control is meant primarily to provide a source of undistorted a.c. power to drive the motor. As time goes on, the difficulty of obtaining undistorted a.c. power becomes more difficult, and in many places the power line to which you connect your audio system is far from clean. This can be a definite problem, especially for turntable and tape-machine drive motors. While more people are becoming aware of the problems which can result from distorted a.c. power lines (mainly due to the widespread use of computers, which are easily affected by power-line surges and spikes), the problem is really not new.

I remember a story told to me by Bob Fine, who engineered the pace-setting Mercury Living Presence recordings of the '50s-'60s era and who died just recently. He told me that he and George Piros, one of the unsung heroes of the disc cutting art, were doing a tape-to-disc transfer one day and noticed that the sound was really "grungy." They

checked out everything and found that the power line waveform was distorted. The power company was not able to cure the problem, so Bob called Larry Scully, the designer and manufacturer of the famous Scully disc-cutting lathe. Larry came down from Bridgeport, Conn. to Fine Studios in New York City, and between them, they installed a power-conditioning interface for the drive motors on the lathe. This cleaned up the sound of the disc master.

The effect of distorted a.c. power can vary from one brand of turntable to another, and I always monitor the a.c. power when testing or auditioning them. The LP12 should be little affected by a.c. power problems but since I have, at present, no way to supply the motor with distorted a.c. power, I can't positively verify this with a controlled laboratory test.

The platter/bearing assembly and tonearm board are mounted on a steel subchassis which is isolated from the motor and main chassis by three conically wound springs. The springs have rubber inserts at each end, and their tension can be adjusted to achieve a low-Q resonance at about 5 to 6 Hz. The base plate is made of nonmagnetic stainless steel which acts as shield for motor hum and as an absorber of motor vibrations. The arm mounting board is three-ply and is designed to absorb vibrations from the tonearm in the region around 200 Hz to 1 kHz. The LP12 is sold with an integral mounting base made of seasoned hardwood, which means that stress-causing warps, which

MEASURED DATA

Specification	Claimed	Measured	Comment
Speed	33 $\frac{1}{3}$ rpm	See text	See text
Speed Stability	—	0.38%	Very Good
Wow, DIN Unweighted	0.03%	0.025%	Excellent
Wow, DIN Weighted	—	0.01%	Excellent
Flutter, DIN Unweighted	0.015%	0.036%	Excellent
Flutter, DIN Weighted	—	0.02%	Excellent
Wow & Flutter, DIN Unweighted	0.04%	0.048%	Excellent
Wow & Flutter, DIN Weighted	—	0.011%	Excellent
Drift, Short Term	—	+0.32% -0.27%	Good
Drift, Long Term	0.04%	±0.2%	Very Good
Rumble, Unweighted	-60 dB	-58.6 dB	Good
Rumble, Weighted	—	-65.5 dB	Good
Suspension Resonance	5-6 Hz	5.75 Hz	Damped

"This is the turntable that set the trend for improved performance which other designers have tried to match or beat."

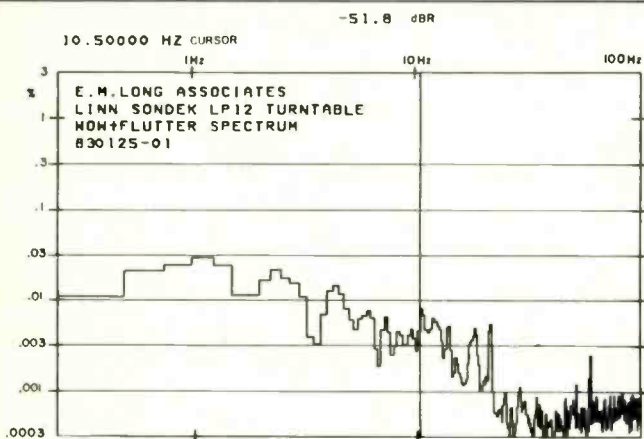

Fig. 1—Computer plot of wow and flutter spectrum, components are evenly distributed and very low in level, both excellent.

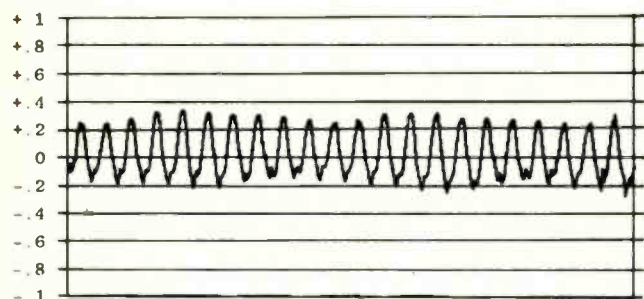

Fig. 2—Speed drift over a revolution at 33 1/3 rpm. The drift varies between +0.32% and -0.27%.

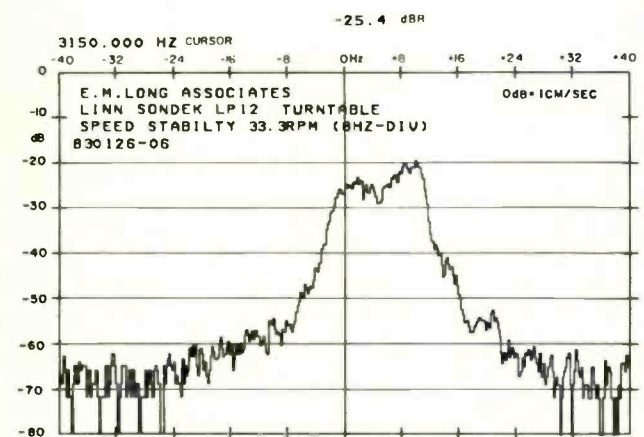

Fig. 3—Speed stability referenced to 3,150-Hz tone on B & K 2010 test record. The speed tends to vary on the fast side.

might develop later, are pretty well eliminated. This might seem like a minor point, but makers of fine musical instruments would certainly agree that such procedures will help eliminate changes in sound quality caused by temperature and humidity. The bottom cover is made of soft hardboard, which also plays a part in absorbing unwanted vibrations. The hinged cover is of clear plastic which needs about 10 inches (250 mm) above and 2.5 inches (64 mm) to the rear when open.

Measurements and Listening Tests

As in past reports, I will try to relate the listening panel's comments about the sound quality to the data gathered from the technical measurements, presenting them simultaneously. There is a continuing debate over relative merits of technical measurements versus listening evaluations, but I think that the issue is over-worked and I contend that both have validity and are complementary if done properly.

The effect upon sound quality of a very small amount of wow and/or flutter can be extremely subtle and hard to detect. This is certainly the case with the LP12 turntable. The measured numbers for wow and flutter in the table are excellent. This single-number way of rating wow and flutter is fairly crude however, and therefore very hard to correlate with effects upon sound quality. Figure 1 shows the spectrum of the wow and flutter and is more revealing. The wow (that is, the cyclical variations in turntable speed occurring at a rate of 10 times per second or less) was very low and fairly evenly distributed. This means that slow, wavering effects should be inaudible, and this was confirmed by the listening panel: No one made any comments about this, even when they were listening for such effects, particularly during piano selections. The flutter (variations in speed at a rate higher than 10 times per second) was a possible cause for the comments made by one panel member about the lack of clarity in the sound of the piano as compared to our reference turntable. I have some doubt that this is the sole cause for the comment, as we shall see later.

Figure 2 shows the cyclical variation in speed of the LP12 over a 41-second period. The main variation occurred at 1.8 seconds per cycle; this is directly related to the speed of the turntable at 33 1/3 rpm, since 1.8 seconds is the time for one complete revolution. There is evidence of some uncertainty in the electronic speed control as it tried to correct for the slowing down of the turntable. (Positive values indicate that the speed is faster than 33 1/3 rpm and negative values indicate that the speed is slower than 33 1/3.) This cogging was much less than I have measured for most electronic speed-control turntables. The value of the electronic speed control in isolating the turntable from dirty a.c. power lines far outweighs this minor effect and is certainly worthwhile. This measurement was obtained from the Drift output of the wow and flutter meter, while the number read from its Drift meter is listed in the table as Drift (short term).

A very high resolution measurement of speed variations is shown in Fig. 3. The shift in frequency of the 3150-Hz wow and flutter test signal on the B & K 2010 test record is shown as it varied over a long period of time. The change in frequency was converted to a speed variation and is shown as Drift (long term) in the Measured Data table. The average

"The effect on sound quality of a very small amount of wow and/or flutter can be extremely subtle."

speed as indicated by Fig. 3 was 3154 Hz or 0.13% fast. This was then used as the center frequency for the Drift (long term) calculation which is $\pm 0.2\%$. I have measured at least one turntable with $\pm 0.1\%$, but this is extremely rare and the LP12 has to be ranked very high in this regard. Those listeners with sensitivity to long-term pitch variations should have no problem using the LP12.

The measurement of rumble can be extremely frustrating if it is done without a clear understanding of the factors which contribute to the final number. I have long felt that a simple rumble specification number for a turntable can be quite misleading. I therefore sympathize with turntable manufacturers who must, out of long standing tradition, provide such a number. The simple, unweighted rumble number I measured is shown in the Measured Data table as -58.6 dB. This is 1.4 dB worse than specified by Linn but is relatively meaningless. The spectrum of the rumble shown in Fig. 4 indicates that most of the energy is centered at 12.5 Hz which is the frequency of the tonearm/cartridge resonance. This means that it was the tonearm/cartridge resonance which provided most of the energy which produced the final rumble number! The rumble actually caused by the turntable itself is much lower than either the Linn specification or my measurement indicates, and the rumble measurement would give different results for different tonearm/cartridge combinations. As might be expected, no comments were made by any listening panel members which would indicate that rumble was a problem.

Since the effects of turntable mats and clamping systems are so pronounced, and because Linn eschews the use of clamps and weights, I decided not to use any clamping system or weights on either the LP12 or reference turntable during the listening evaluations. After all, it is the turntable that is being evaluated, and the effects of various vacuum or mechanical record-clamping systems and weights should be evaluated separately from the effects of the basic turntable. I am convinced, though, that the removal of stored energy in the record by the use of correctly adjusted clamping devices is truly worthwhile. (However, I must admit that I apparently confused the issue in a recent report. The very slight additional brightness attributed to the SOTA turntable by listening panel members was due to the fact that the reference turntable had a highly effective clamping system while the SOTA did not. I understand that SOTA is now offering a vacuum clamping system and perhaps we will be able to report on it.)

Figure 5 shows the spectrum of the energy caused by a mechanical impulse applied to the edge of a stationary record with the stylus in a quiet groove. The absorption of energy was quite uniform, with a slope indicating that the felt mat was more effective in removing energy from the record at higher frequencies than at lower ones. However, the energy picked up by the stylus was quite high, and there are peaks of energy at 100 and 200 Hz. The output versus time produced by the mechanical impulse is shown in Fig. 6. This also indicates that the LP12 gave a smooth performance in energy control but with a high level of lower frequency energy. Comments made by listening-panel members correlated well with the data in these figures. The LP12 produced more upper-bass sound when reproducing such recordings as *Dark Side of the Moon* by Pink Floyd,

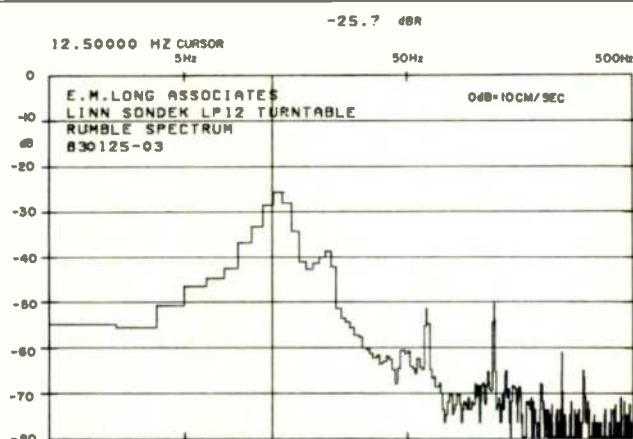

Fig. 4—Rumble spectrum, to 500 Hz. Main output is from tonearm/cartridge resonance at 12.5 Hz.

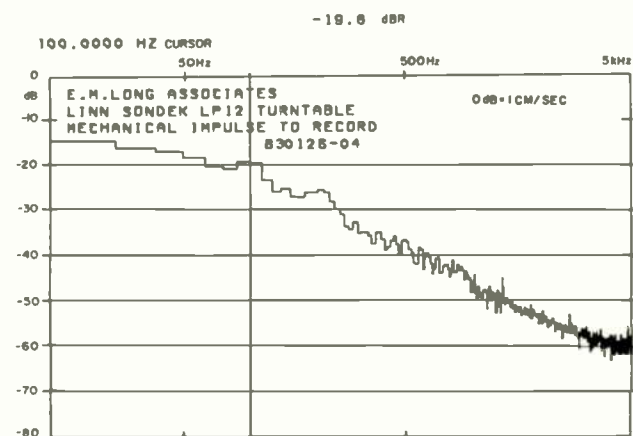
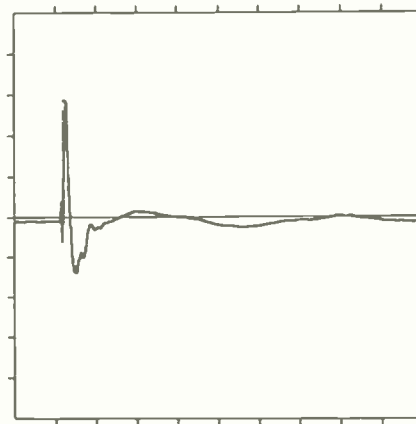

Fig. 5—Spectrum, to 5 kHz, due to mechanical impulse applied to edge of stationary record with stylus in groove. Though not great, the damping is very uniform except around 100 and 200 Hz.

Fig. 6—Output vs. time response of the impulse of Fig. 5 (which was derived from this, using a Fast Fourier Transform analyzer). The shape of this pulse is very good. Total measurement period shown is 0.205 S.



"The measurement of rumble can be frustrating if done with no clear understanding of the contributing factors."

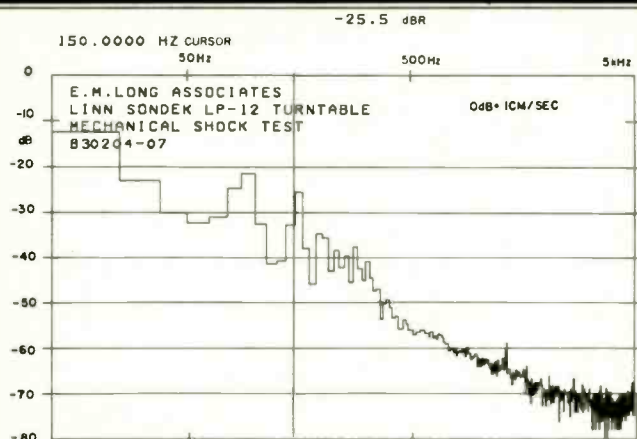

Fig. 7—Spectrum, to 5 kHz, due to mechanical shock applied to massive platform on which the turntable rested during

test. The turntable shows good resistance to mechanical shock, but should be placed carefully.

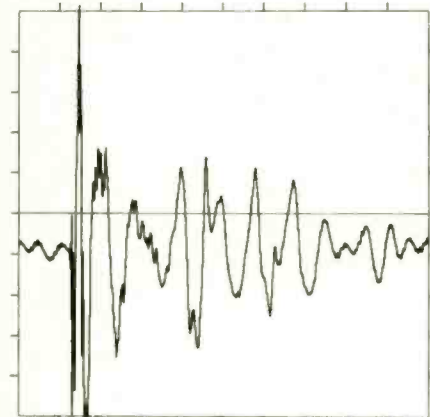

Fig. 8—Output vs. time response of the mechanical impulse of Fig. 7. Many vibration modes are indicated. The period of measurement is 2.05 S.

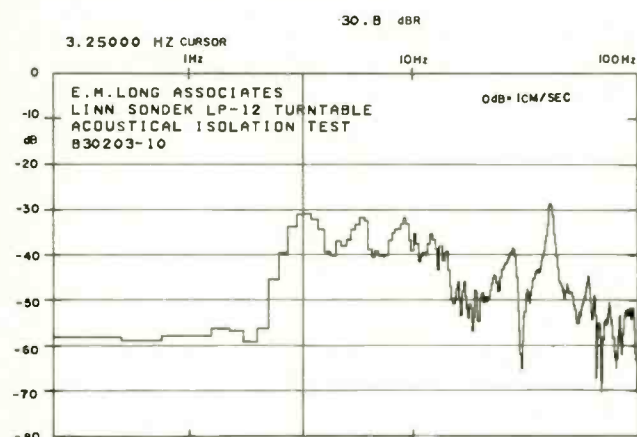

Fig. 9—Spectrum, to 100 Hz, due to a 100 dB SPL acoustic field at the cartridge position. Cartridge is resting in a

groove near the middle of a record, and isolation from the acoustic field is excellent.

while the reference turntable produced a more-solid low-frequency output for symphonic recordings with 36-inch bass drum. Apparently, the energy storage at 100 and 200 Hz is heard as an increase in output in this range. At higher frequencies, the delayed energy, which was not removed, was most probably responsible for the comments by the listening panel about a very slight lack of clarity or blurring of the piano sound, rather than the extremely low amount of flutter mentioned earlier. This delayed energy was most likely responsible for the comments that classical guitar sounded just a tiny bit more harsh with the LP12 than with the reference turntable.

Figures 7 and 8 show the output versus frequency spectrum and the output versus time response of the LP12 suspension caused by a mechanical impulse applied to the massive platform upon which the turntable rested during the technical measurements. The stylus is still in a quiet groove of a stationary record. The suspension shows resonances at 75 to 87.5 Hz and at 150 Hz, which would also tend to cause upper-bass response to be reinforced a bit as heard by the listening panel.

Figure 9 shows the output-versus-frequency spectrum of the LP12 caused by a 100-dB SPL acoustic field at the position of the cartridge, with the stylus still in a quiet groove of a stationary record. This is one aspect of performance in which the LP12 excels. The LP12 could be operated in very high-intensity sound fields with little effect upon the quality of sound reproduction, as long as it was well isolated from mechanically transmitted energy.

Conclusions

I realize that, like me, the majority of people who read reports such as this go right to the last part, hoping to find a capsule summary. If you have done this, I would like to tempt you to read the complete report by saying that I have made some comments about rumble measurements and energy-storage effects which you should find interesting. I would also caution you that anything I say in this section must be tempered by what I have said above in the body of the report. After all, you must remember that the panel members are being asked to compare turntables which have an exceptional level of performance compared with the vast majority of available turntables. The panel's ability to hear tiny differences is remarkable. The fantastic resolution of the technical measurements should also be appreciated. Figure 3 is a good example; the center frequency is 3150 Hz while the total window for the measurement is 80 Hz wide and each data point represents 0.2 Hz! We can see a change in frequency of 0.0063%! With this kind of resolution, we can see truly minuscule defects.

So what can we say about the LP12 which will put all this in perspective? The balance of design and performance aspects is very good to excellent. This is the turntable that set the trend for improved performance which other designers have tried to match or beat. The LP12 will improve the sound of the majority of music reproducing systems, but at this price level only you can determine its value for the money. I can say that there are few turntables which can legitimately claim to be as good, and even fewer that can legitimately claim to beat it.

Edward M. Long

CAMEL LIGHTS



9 mg tar

Camel Lights.
Low tar. Camel taste.

9 mg "tar", 0.9 mg. nicotine av. per cigarette by FTC method.

Warning: The Surgeon General Has Determined That Cigarette Smoking Is Dangerous to Your Health.



Only in



a Jeep![®]

Jeep  CJ



Jeep[®] is a registered trademark of Jeep Corporation.

3

AUDIOSOURCE EQ-ONE EQUALIZER and SPECTRUM ANALYZER

Manufacturer's Specifications Equalizer Section

Frequency Response: 3 Hz to 100 kHz, ± 0.75 dB.

Distortion: 0.035%.

Hum and Noise: -90 dB re: 1 V, -96 dB re: 2 V.

Maximum Input/Output: 5 V.

Impedances: Input, 100 kilohms; output, 68 ohms.

Filter Control: ± 12 dB at 31.5, 63, 125, 250 and 500 Hz and 1, 2, 4, 8 and 16 kHz.

Subsonic Filter: -18 dB/octave below 20 Hz.

Analyzer Section

Display Range: ± 8 or ± 16 dB (2 or 4 dB/step).

Input Impedance: 100 kilohms.

Pink-Noise Generator Output Level: 100 mV.

Microphone Frequency Response:

30 Hz to 16 kHz.

Directionality: Omnidirectional.

Dimensions: 19 in. (483 mm) W \times 5.22 in. (133 mm) H \times 8.36 in. (212 mm) D.

Weight: 8.4 lbs. (3.8 kg).

Price: \$399.95.

Company Address: 1185 Chess Dr., Suite G, Foster City, Cal. 94404. For literature, circle No. 92



The AudioSource EQ-One adds to the growing number of components which combine an octave-band equalizer with a real-time analyzer (RTA) and pink-noise generator. The pairing is a good one, as the RTA and noise generator help the user get the best results from the equalizer section.

The RTA display at the left of the front panel consists of 10 LED columns corresponding to the center frequencies of the 10 analyzer filters. Each column is nine LEDs high, with a switch selecting ranges of -8 to $+8$ dB at 2 dB/step, or -16 to $+16$ dB at 4 dB/step. Small LEDs under the vertical scales at the left of the display show which calibration is in use. The LEDs in the analyzer itself are red, except for those at "0," which are green—a handy reference.

Six pushbutton switches select scaling (2 or 4 dB/step), display decay (slow or fast), display condition (continuous or "Pause," which holds the reading on the display), indication on the left-most analyzer column (31.5 Hz or average level for all bands), and two which select left or right line inputs to the RTA. When both of these are in, left and right inputs are summed to drive the display; when both are out, the display is fed from the front-panel microphone jack (a microphone is supplied). The "Pause" switch is momentary-contact, which makes it difficult to copy down the RTA reading, if that is desired. A level-adjust pot controls the vertical position of the spectrum levels on the display in all modes.

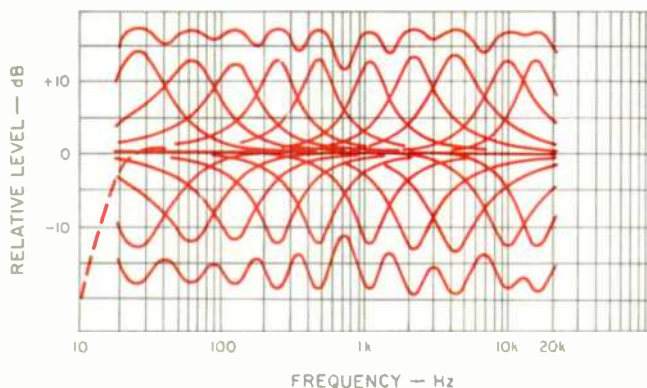

Fig. 1—Swept-frequency responses of each filter at maximum boost and maximum cut, and with all sections at these maximums. The dashed line is the subsonic filter response.

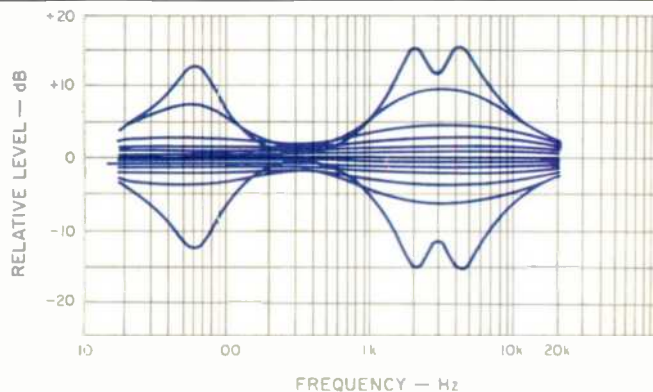

Fig. 2—Swept-frequency responses with the 63-Hz and 2- and 4-kHz filters set successively at 2-dB steps (as indicated on the control panel) from -12 to +12 dB.

There are 10 vertical sliders for each equalizer channel. They are labelled "Bass" (31.5, 63, 125 and 250 Hz), "Mid" (500 Hz, 1 and 2 kHz) and "Treble" (4, 8 and 16 kHz). There are also four vertical, 2 dB/line scales for each channel. Both of these features are aids to practical use.

Four pushbutton switches choose EQ in/bypass, subsonic filter in/out, tape monitor in/out and "EQ Rec" on/off. With "EQ Rec" switched in, any equalization that is set by the sliders affects the signal from the preamp (or receiver) that is fed to the tape recorder connected to the back-panel jacks. When the pink-noise generator is activated by its pushbutton switch, its output is connected to both line outputs of the equalizer. The power on/off switch has a good-sized red button, and the display-range LED just above also serves as a power-on indicator. As mentioned above, and as usual for equalizer-RTAs, the stereo-pair phono jacks for line in/out and tape recorder in/out are all on the back panel.

Most of the circuitry was contained on two p.c. boards, one for the EQ filters and pink-noise generator and the other for the RTA. The two boards for the vertical sliders and the RTA display were much simpler. Soldering was fairly good, with flux residue noted at many spots. All of the parts were identified on the two main cards, with interconnections made with multi-conductor cabling and a number of single wires. There was one fuse in a clip. The back panel was springy without the enclosing side and top cover, and the chassis provided very limited support for rack mounting: The EQ-One should, therefore, only be rack-mounted when used in stable, nonmovable systems.

Equalizer Measurements

The frequency responses were very flat and extended, with responses at 20 Hz and 20 kHz within 0.14 dB with EQ switched in (sliders in detent) and within 0.03 dB with EQ bypassed. The 3-dB points were at 1.7 Hz and 200 kHz with EQ in, and at 0.6 Hz and about 2.3 MHz with it out. Figure 1

shows the frequency responses of each filter section at its maximum positions and with all sections at the extremes. The subsonic filter response was plotted on the same figure, and the 18-dB/octave slope below 20 Hz is clearly demonstrated. The filter outputs combine quite well, as shown by the relatively small ripple at the extremes, but there are inconsistencies in filter shape and in the spacing of the center frequencies. Most of these were within 7.0% of the specification, which is good, but the 8-kHz filter was 15.8% high at 9.26 kHz, which is just fair. The maximum boosts and cuts were all at least 12.0 dB, and the total spread in values (1.6 dB) was quite acceptable.

With the 500-Hz filter, a non-ringing limit of $Q = 1$ was reached with a boost of +7.7 dB. The exact point was difficult to find because of the touchiness of the slider. This characteristic is further evidenced in Fig. 2, which shows the responses of the 63-Hz and 2- and 4-kHz filters set by the unit's scale for 2-dB steps from -12 to +12 dB. The changes up to ± 8 were *much* less than indicated graphically. In the region between ± 8 and ± 12 , however, the amount of boost or cut changed greatly with small shifts in the position of the slider(s). There are further comments on this excessive sensitivity and graphical inaccuracy later.

The changes in level between EQ in and bypass were 0.1 dB or less for both channels. There is no direct method for in-out gain matching when the sliders are out of detent, but some practice with the RTA, perhaps with the left-most display column set to show overall level instead of level in the 31.5-Hz band, would provide some guidance. The maximum input/output voltage for 20 Hz to 20 kHz was 7.0 V open-circuit, dropping very slightly to 6.8 V with a 10-kilohm load. The input impedance dropped steadily with increasing frequency: 55 kilohms at 20 Hz, 24 kilohms at 1 kHz, and 16 kilohms at 20 kHz, somewhat low for use with some preamps. The output impedance changed similarly with frequency, but it was a low 104 ohms, even at 20 Hz.

The distortion was 0.0032% or less from 20 Hz up over

"Flattening out the simulated speaker curve became a fussy task, mainly because of the sliders' touchiness."

much of the band, but rose to 0.027% at 20 kHz (all figures for 2 V). These figures are excellent, and I should note that noise is included. Slew-rate limiting did not appear until the frequency of the 2-V test signal was increased to 60 kHz, fairly good. The signal-to-noise ratio was 99.7 dBA relative to 1 V, 93.7 dBA relative to 0.5 V. Checks with various slider positions established that 87 dBA relative to 0.5 V would be more likely in practice, still excellent.

Analyzer Measurements

The center frequencies of the RTA filters were all within 5.1% or less (good) with the exception of the 500-Hz filter at 540 Hz (+8.0%), which was still close enough for audiophile purposes. The peak responses were very consistent from filter to filter, with a total spread of only 1.2 dB. With a test tone centered in the 500-Hz filter, the level in the adjacent bands was down 15 dB, lower than in many such units. The crossovers (equal levels in adjacent bands) were down about 9 dB, also lower than many other RTAs. The design makes for good rejection of out-of-band energy, but the in-band response shape was more pointed than is desirable. With a pink-noise input and a flat indication on all 10 bands, the 31.5-Hz column indicated about 2 dB high when switched to "Level," acceptable as a rough indicator.

The turn-on thresholds of the display LEDs were accurate enough to be quite acceptable at 2 dB/step, but at 4 dB/step there was confusion in the testing. I had difficulty finding the thresholds because as many as three LEDs (vertical) would be flickering with the test tone. The steps appeared to be acceptably accurate from -4 to +16, but there was noticeable compression below -4, with the threshold for -16 just 8 dB below the zero reference. A change from 2 to 4 dB/step caused the displayed spectrum to jump upward unless it was already close to the top: I would have much preferred the no-shift level at the green center LEDs. For a 20-dB change in displayed level, the tone-burst on-time in "Fast" was 200 mS for 31.5 Hz, falling to 110 mS at 16 kHz. For "Slow," the required on-time was 330 mS across the band. For a 20-dB drop in level, the off-times were 0.8 S for fast and about 7 S for slow.

The pink-noise generator output level was 170 mV rms. The spectrum was within ± 1 dB except for the bands for 2 kHz up, which were all about 2 dB too high. This is shown similarly both on the reference Ivie IE-30A and the EQ-One's own display.

The supplied microphone was typical of those of inexpensive design: Quite flat in a reverberant field, but with about 6 dB of peaking at the highest frequencies if pointed at a loudspeaker source. Flatter response was secured with the microphone close to grazing (with its axis about 75° from the speaker). Checks with the Ivie revealed that at least 70 dB SPL was required for an acceptable display: This is very good performance, as at least 80 dB would normally be required to adequately raise responses out of background noises.

The input sensitivities for a 0-dB indication, with both channels driven, were 18 mV for a single test tone and 62 mV for pink noise, with "Fast" speed and 2 dB/step. Just about half these levels were required for zero indication with 4 dB/step.

Fig. 3—System equalization. One-third octave simulated speaker response (top); response after analysis and equalization (middle); actual equalization introduced (bottom). Lab analyzer set to 5 dB/div, vertical and 1/3-octave horizontal, from 25 Hz to 20 kHz.

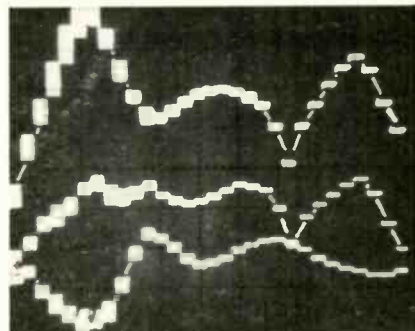

Use and Listening Tests

The instruction manual is just six pages long, too brief to cover the many facets of an equalizer/RTA. The basic guidelines were only fair, and the recommendation to start the procedure with 31.5 Hz must be questioned. The instructions did not mention that it is possible to monitor the equalized tape playback and also to equalize the playback itself. The space used for schematics would be better used for more information pertinent to the general user.

All of the controls and switches were completely reliable throughout the testing. The combinations possible made for a good deal of flexibility in using the equalizer—much better than indicated by the limited instructions. There was a slow decay in the display when using "Pause," but that did not bother me as much as did the fact that the button would not latch in for easier note taking. Relatively dim lighting was best for easy viewing of the display. As would be expected, 4 dB/step and "Fast" were best for music monitoring and 2 dB/step and "Slow" were the preferred combination for equalizing.

A simulated speaker response (used in previous profiles) was created with an MXR 1/3-octave equalizer. With a pink-noise test source, the EQ-One was used to smooth the response. This task was rather fussy, mostly because of the touchiness of the sliders. I also concluded that a longer charge time in "Slow" would have made a steadier and easier-to-correct display. Figure 3 shows the simulated response (top), the resulting response after correction (middle) and the EQ that was inserted (bottom) to make the corrections. The corrected response is certainly better, but greater smoothness would provide sonic benefits. For music monitoring, I found the response in "Fast" rather slow, and I missed the LED column-type display provided by some other units.

The AudioSource EQ-One equalizer and spectrum analyzer is a good combination of basic facilities, and it does have good responses and low noise and distortion. The touchy action of the sliders, however, could make it difficult to exactly obtain a particular equalization. The RTA display's dynamic responses also limited one's use of the device's electronic capabilities. The price is attractive, but the unit should be used for a trial period, to make certain that its limitations are acceptable.

Howard A. Roberson

It took a touch of
genius to fill this
house with music.

As you might expect, the curators of Mozart's residence in Salzburg, Austria, attach considerable importance to the quality of music reproduction in the museum. Their overriding concern is the faithful re-creation of Mozart's works.

They chose JBL loudspeakers.

JBL engineers share the concerns of the curators. JBL loudspeakers deliver not only the notes but the spirit of great musical performances. From wax cylinders to the latest digital and advanced analog recordings, JBL loudspeakers will help you appreciate musical genius.

For a demonstration, visit the audio specialists at your nearest JBL dealer. Or the Mozart museum in Salzburg.

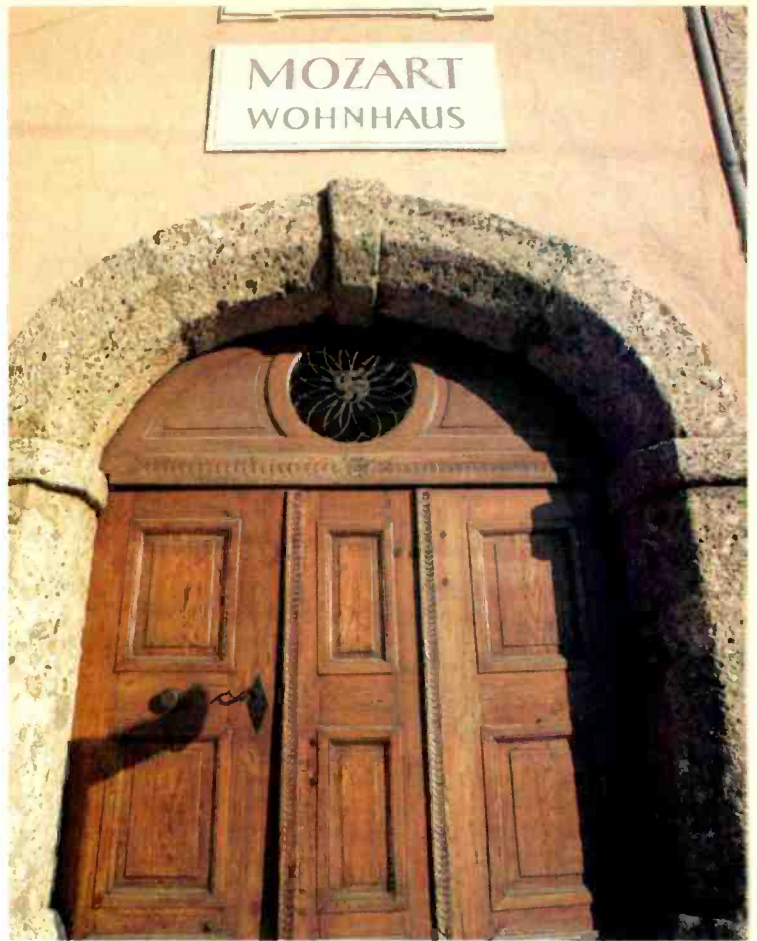

JBL incorporated, 8500 Balboa Boulevard,
P.O. Box 2200, Northridge, California 91329 U.S.A.

JBL/harman international

Enter No. 21 on Reader Service Card



4

JVC R-X80 RECEIVER

Manufacturer's Specifications

FM Tuner Section

Usable Sensitivity: Mono, 10.3 dBf (1.8 μ V/300 ohms).

50-dB Quieting Sensitivity: Mono, 14.8 dBf (3.0 μ V/300 ohms); stereo, 37.2 dBf (40 μ V/300 ohms).

S/N: Mono, 83 dB; stereo, 74 dB.

THD: Mono, 0.1% at 1 kHz; stereo, 0.15% at 1 kHz.

Frequency Response: 30 Hz to 15 kHz, +0.5, -0.8 dB.

Alternate Channel Selectivity: 75 dB.

Capture Ratio: 1.5 dB.

Image Rejection: 80 dB.

I.f. Rejection: 100 dB.

Stereo Separation: 45 dB at 1 kHz.

AM Tuner Section

Sensitivity: 50 μ V/meter.

Image Rejection: 50 dB.

I.f. Rejection: 60 dB.

Distortion: 0.5%.

S/N: 50 dB.

Amplifier Section

Power Output: 70 watts per channel, 8-ohm loads, both channels driven, 20 Hz to 20 kHz.

Rated THD: 0.008%.

SMPTM IM: 0.008%.

Damping Factor: 45 at 8 ohms, 1 kHz.

Sensitivity for Rated Output:

High level, 240 mV; MM, 2.5 mV; MC, 250 μ V.

Frequency Response: Phono, RIAA \pm 0.5 dB; high level, 5 Hz to 50 kHz, +0, -1.0 dB.

S/N: High level, 75 dB; MM, 80 dB.

Graphic Equalizer Center Frequencies: 63 Hz, 250 Hz, 1 kHz, 4 kHz, and 16 kHz.

Graphic Equalizer Control Range: \pm 12 dB.

Loudness Control: +7 dB at 50 Hz, +4 dB at 10 kHz, at -40 dB volume control setting.

General Specifications

Power Requirements: 120 V a.c., 60 Hz.

Dimensions: 17 $\frac{1}{8}$ in. (43.5 cm) W x 4 $\frac{5}{8}$ in. (11.7 cm) H x 15-11/16 in. (39.8 cm) D.

Weight: 20.9 lbs. (9.5 kg).

Price: \$570.00.

Company Address: 41 Slater Dr., Elmwood Park, N.J. 07407.

For literature, circle No. 93



JVC was promoting the idea of graphic equalizers long before this type of tone control refinement appeared as a consumer product in component form, and certainly long before integrated amplifiers or receivers with built-in graphic equalizers appeared. It's still an unusual feature to be found in a receiver, let alone a unit with a suggested retail price under \$600, but this top-of-the-line receiver has one. JVC, however, insists on calling it an "S.E.A." equalizer, which stands for "Sound Effects Amplifier," believe it or not.

There are other advanced features about this receiver worth noting. The tuner section uses quartz-PLL, digital frequency-synthesized tuning with eight FM and eight AM presets. The R-X80 employs a high-gain equalizer that accepts both moving-magnet and moving-coil cartridges. Other features are a motor-assisted volume control and large fluorescent displays for power output, tuner frequency, signal level, stereo reception, and source selection. A wired remote-control unit is supplied, and it allows you to control program source selection, select the tape 1 monitor loop, adjust volume, and tune up/down for AM or FM stations.

Control Layout

JVC was, to the best of my recollection, the first company to come up with a receiver control panel completely free of projecting rotary knobs, which made for a very handsome and clean-looking design. Happily, they have continued that approach in this latest model. The five-band graphic equalizer's calibrated slide levers are located at the left end of the panel, and just below them are a power on/off pushbutton and two speaker-selector pushbuttons. One or two sets of speakers may be activated at one time. The headphone jack, also in this area, is concealed by a flip-up plastic cover—an aesthetic touch, I suppose, designed so a phone jack hole would not gape on the otherwise uninterrupted panel expanse.

A muting switch, slider balance control, S.E.A. record switch (which places the graphic equalizer circuitry ahead of the record-out jacks), tape 2 monitor switch, loudness switch, mode/scan switch (which selects automatic or manual step-by-step scanning during tuning and also mono or stereo reception), MM/MC phono switch, up/down tuning buttons, and a memory button are all arranged along the lower edge of the front panel. A bit higher up, below the major display area of the panel, are a volume up/down rocker bar, the tape 1 selector, and four additional program selector buttons (video/AUX, phono, FM and AM). Selected volume level is indicated by a series of fluorescent bar indicator lights in the display area, which also incorporates a three-step signal-strength meter, a power-output meter (calibrated in dB below rated output), the digital frequency indicator (which also tells you whether you are listening to AM or FM), and an assortment of other indicators (source, stereo, tape, and memory). When the "memory" indicator illuminates, the tuner is ready to preset frequency information for future instant recall of desired stations.

The rear panel of the JVC R-X80 receiver is equipped with the usual phono and high-level input jack pairs, tape-output jacks, antenna-input terminals (300- and 75-ohm for FM, ground and AM for external AM), polarized speaker terminals for connection of two pairs of speaker systems, a pair

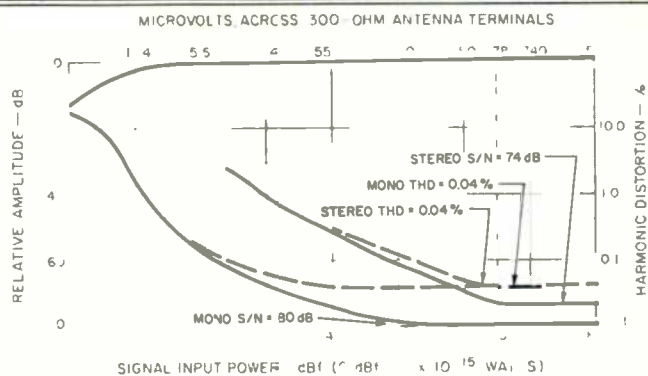

Fig. 1—FM quieting and distortion, mono and stereo.

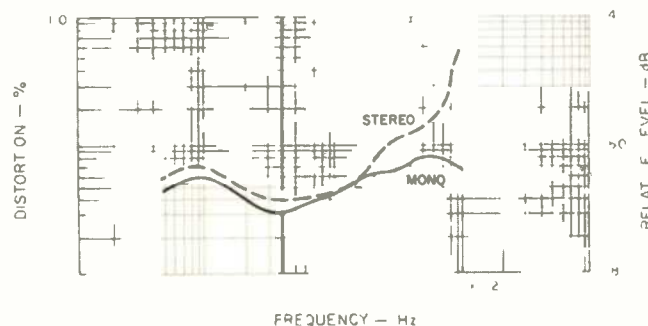

Fig. 2—Distortion vs. frequency for stereo and mono FM.



Fig. 3—FM frequency response (top trace) and separation vs. frequency.

"I was pleased that the loudness circuit uses relatively small amounts of bass and treble boost. Some makers overdo it."

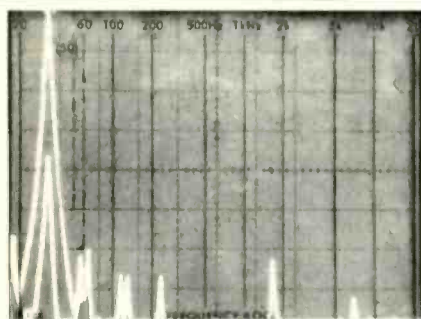

Fig. 4—Stereo FM crosstalk for 5-kHz modulation.

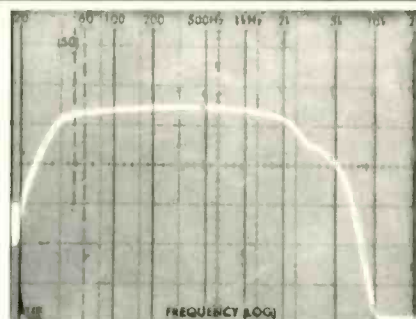

Fig. 5—AM tuner frequency response.

of auxiliary a.c. outlets, and a multi-pin socket for connection of the wired remote-control unit. An AM loopstick is installed in a universal ball joint so that it can be positioned at any angle for best AM reception. An AM channel-spacing switch is also found on the rear panel. Many European countries have adopted 9-kHz spacing between AM channels, whereas the countries of the Western Hemisphere, including the U.S. and Canada, maintain 10-kHz spacing. Since the AM section of this receiver tunes by discrete channel increments, it was necessary to provide a switch for selection of the appropriate channel spacings. Tuning for FM, incidentally, is in 100-kHz increments for the U.S. version of the receiver, even though our channel spacing is at 200-kHz intervals. Some cable systems are positioning their optional FM signals at even-numbered 100-kHz increments (101.2, 101.4, etc.), while broadcast FM stations are all assigned odd-numbered 100-kHz increments (101.1, 101.3, etc.). Therefore, JVC's decision to have the frequency-synthesized tuner progress in 100-kHz increments was a wise one in my view. A line fuseholder completes the rear panel.

The R-X80's amplifier section utilizes JVC's "Super-A" amplifier circuitry which has been discussed in reviews of earlier JVC components. Super-A, JVC's low-distortion amplifier technology, utilizes an active or dynamic bias circuit. This circuit varies the bias current applied to the output transistors of the power-amplifier section in accordance with the input level, reducing switching distortion and increasing amplifier efficiency. The circuit is a variation on the dynamic bias circuitry incorporated in many recent low-distortion amplifiers from several manufacturers, each claiming its approach is better than that of its competitors. I suppose if ultra-low, statically measured distortion is the criterion by

which these circuits are judged, then JVC's version is among the best.

FM Measurements

Usable FM sensitivity in mono measured 10.8 dBf (1.9 μ V/300 ohms), close enough to the claimed 10.3 dBf (1.8 μ V) so that I won't quibble. Stereo threshold occurred at 25 dBf, making that signal strength the effective stereo usable sensitivity. Fifty-dB quieting in mono measured 13.5 dBf (1.6 μ V/300 ohms); for stereo, the 50-dB figure was 38.0 dBf (43.7 μ V/300 ohms). Under strong-signal conditions, signal-to-noise ratio increased to 80 dB in mono, 74 dB in stereo. I consider these to be very good results for a frequency-synthesized tuner section of such a moderately priced receiver. Total harmonic distortion for a 1-kHz modulating signal was an amazingly low 0.04% in mono and an even more impressive 0.04% in stereo. Quieting and mid-frequency distortion, as a function of input-signal strength, are plotted in Fig. 1. Figure 2 shows graphic plots of harmonic distortion versus modulating frequency for mono and stereo operation of the FM tuner section. In mono, THD figures were 0.07% at 100 Hz and 0.15% at 6 kHz.

Figure 3 is a 'scope photo of a logarithmic frequency sweep made with a spectrum analyzer, from 20 Hz to 20 kHz. The upper trace represents stereo frequency response at the output of the modulated left channel, while the lower trace shows crosstalk, or separation, as measured at the output of the opposite (right) channel. At the specific test frequencies called for by the EIA Tuner Measurement Standards (100 Hz, 1 kHz and 10 kHz), I obtained separation figures of 51.5, 50.5, and 34 dB for the left channel and 49.0, 50.5, and 32 dB for the right channel.

Figure 4 shows what happened when I applied a 5-kHz modulating signal to one channel of the FM generator at 100% modulation level. The tall spike, seen at the left in this linear (0 Hz to 50 kHz) sweep, represents the desired signal. A second sweep was made while observing the opposite (unmodulated) channel output. It shows separation at 5 kHz (the short spike nestled within the taller one at the left) as well as such crosstalk components as harmonic distortion, residual 19-kHz output, and 38-kHz output.

Capture ratio measured 1.5 dB, as claimed. Alternate-channel selectivity was 78 dB, somewhat better than claimed. Image rejection measured 85 dB, while i.f. rejection measured in excess of 100 dB. Although not specified by JVC, AM suppression measured an acceptable 58 dB. Spurious-response rejection was a very high 98 dB.

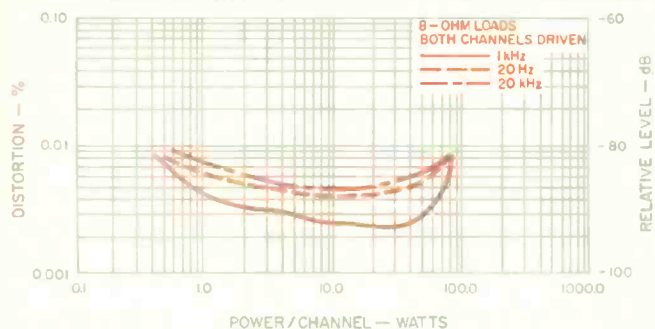

Fig. 6—Power output vs. distortion, 8 ohms.

"JVC was promoting the idea of graphic equalizers long before anyone else. It's still an unusual feature in a receiver."

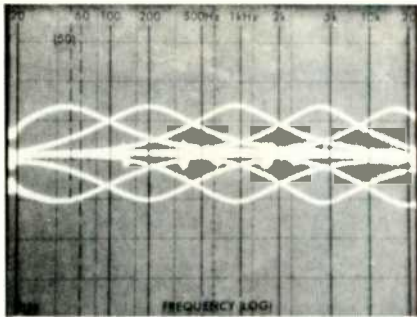

Fig. 7— Boost and cut range for the five graphic equalizer controls.

Fig. 8— Loudness-compensation characteristics.

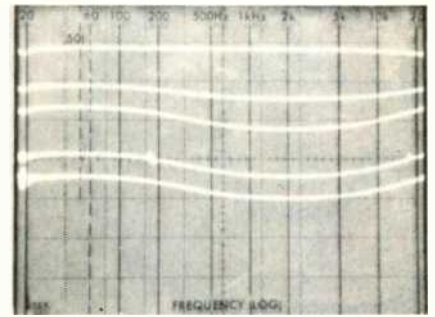

Figure 5 is a plot of frequency response for the AM tuner section. It is not particularly impressive, but it is a bit better than that found on many other receivers, with the -6 dB cutoff point occurring at just over 3 kHz.

Power Amplifier and Preampifier Measurements

The power-amplifier section of the JVC R-X80 receiver delivered just over 75 watts per channel for its rated THD of 0.008% when a 1-kHz test signal was applied. At the frequency extremes, however, power output was limited to the rated 70 watts per channel for that same level of distortion. Figure 6 is a plot of harmonic distortion as a function of power output, for test frequencies of 1 kHz, 20 Hz and 20 kHz. Damping factor measured just slightly higher than the 45 specified, but I measure this parameter at a frequency of 50 Hz (with an 8-ohm load), while JVC's specification refers to a 1-kHz test signal (also with 8 ohms).

Compared with some recently measured amplifiers, dynamic headroom was on the low side. It measured 0.83 dB, which means that for short-term signal peaks the amplifier can be expected to produce as much as 85 watts per channel without evidence of peak signal clipping. CCIF-IM distortion measured a minute 0.003%, while IHF IM measured exactly 0.03% at rated output. SMPTE-IM distortion at rated output was 0.008%, exactly as specified by JVC.

Figure 7 is a 'scope photo showing the boost and cut characteristics of each of the R-X80's five graphic equalizer controls. Center frequencies for each control were extremely precise, as was the amount of available boost and cut for each control, which measured almost precisely ± 12 dB. Figure 8 is a plot of response at various settings of the volume control, with the loudness circuit activated. I was pleased to see that relatively small amounts of bass and treble boost are used in this circuit. Some manufacturers tend to overdo these fixed loudness-compensation settings, perhaps to make sure that the user will hear a big change in sound when the loudness switch is depressed.

Input sensitivity was 0.24 mV for the moving-magnet phono inputs, 0.024 mV (24.0 μ V) for the moving-coil inputs, and 25 mV for the high-level inputs. All of these measurements were made with respect to 1-watt output rather than rated output. RIAA equalization was accurate to within 0.6 dB at the high end and to within 0.3 dB at the bass. Frequency response via the high-level inputs was flat within 1 dB from 5 Hz to 50 kHz, and within 3 dB from 3 Hz to 110 kHz.

Signal-to-noise ratio for the MM phono inputs measured 78 dB, referred to a 5-mV input signal and 1 watt of power

output. For the MC inputs, S/N measured 73 dB, while for the high-level inputs, signal-to-noise measured 80 dB, referenced to 0.5-V input and 1-watt output. Residual noise, with the volume control turned down to minimum, was 85 dB below 1 watt. Phono overload was on the low side, though marginally acceptable, measuring 100 mV for the MM inputs. Overload figure was proportionately better for the MC input, measuring 15 mV.

Use and Listening Tests

I particularly liked the action of the five-band graphic equalizer in this receiver. It is far more effective than any combination of bass and treble controls or even bass, treble and midrange controls. Even the purists among us will have to admit that there are instances when program sources (not to mention speaker systems and listening rooms) need a bit of help at the extreme bass and treble ends. The 63-Hz and 16-kHz controls of JVC's graphic equalizer are a tremendous aid here; they don't mess up tonal balance anywhere else in the spectrum.

FM reception was excellent, and I found the tuning to be precise, with minimum distortion always occurring when the frequency shown on my FM signal generator agreed with that shown on the display of the R-X80. I used the generator in a closed-circuit arrangement to listen to music via FM, and results were outstandingly good. This method eliminates the "unknowns" inherent in trying to test FM tuners using over-the-air material.

As for the amplifier section, it delivered extremely clean sound, particularly at low listening levels where some receiver amps tend to become a bit muffled or raspy in the sound they deliver to loudspeakers. Using speakers of medium to high efficiency, I think most listeners will find that the power output of the R-X80 is adequate, even when listening to Compact Discs with their wide dynamic ranges. If you own low-efficiency speakers, however, the 70 watts provided by the R-X80 (coupled with its relatively low dynamic headroom figure) may be a bit too low. Much will depend upon the level at which you play such discs.

My overall reaction to the R-X80 is one of wonder at how much JVC is able to offer for the under-\$600.00 price that, just a few years ago, would have delivered a low-powered set, with a conventional analog tuning system and dial, ordinary tone controls, and few, if any, of the useful displays which abound on the front panel. All this and good cosmetics besides make the R-X80 a receiver worth looking into—and listening to.

Leonard Feldman

5

ESB 7/06
SPEAKER**Manufacturer's Specifications****System Type:** Four way, pneumatic suspension.**Drivers:** 12.6-in. (320-mm) cone woofer; 7.9-in. (200-mm) cone mid-bass; 2-in. (51-mm) dome mid-high, and 1-in. (26-mm) dome tweeter.**Crossover Frequencies:** 500, 2000, and 5000 Hz.**Nominal Impedance:** 6 ohms.**Sensitivity:** 89 dB SPL at one meter for 2.83 V pink noise.**Power Handling:** 250 watts, 8 ohms.**Dimensions:** 55.1 in. (1400 mm) H x 18.9 in. (480 mm) W x 11.4 in. (290 mm) D.**Weight:** 105.6 lbs. (48 kg).**Price:** \$3,000.00 per pair.**Company Address:** 692 Central Ave., Cedarhurst, N.Y. 11516.

For literature, circle No. 94

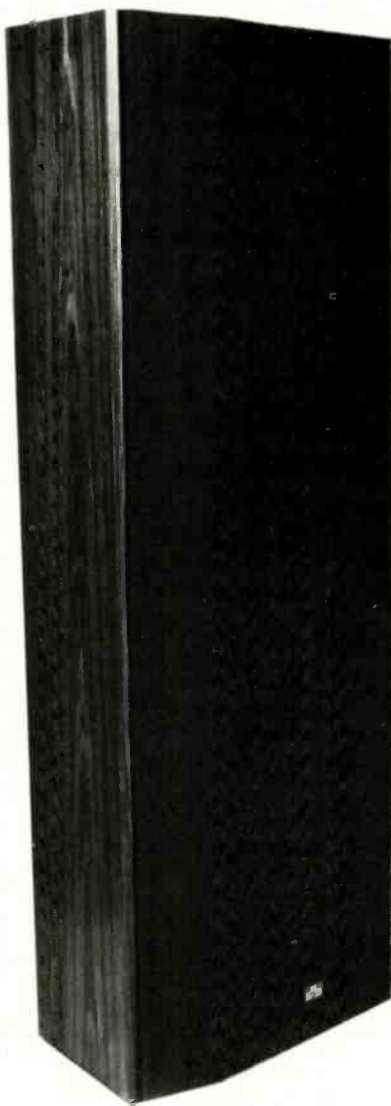

Electroacoustic Systems Building, a manufacturing company just outside Rome, has been building quality loudspeakers under the ESB label for almost 12 years. Only recently introduced into the United States, the flagship of their fleet of high-quality loudspeakers has been the Series 7 line. The second model in this line, the ESB 7/06, is specifically intended for the home environment.

Utilizing what ESB calls their "Distributed Spectrum" technology, the ESB 7/06 stands an imposing 140 cm in height and covers the audible range with a geometric configuration of a four-way system. These drivers are vertically aligned in order to maintain the same azimuth of radiation centers and to minimize destructive interference for off-axis listening positions. In addition, the drivers are mounted such that an off-axis listening position is intended to produce a change in the direct-sound frequency response which compensates

for that change in position. If, for example, one sits directly on the line of center between a stereo pair of ESB 7/06s, the responses from the left-channel and right-channel speaker are the same. If one then moves his listening position toward the right of center, so as to sit more nearly in front of the right speaker, the higher frequency direct response from this right speaker is actually reduced slightly, while the left-channel high-frequency response is correspondingly increased. This, according to ESB, compensates for the fact that one is closer to the right-channel speaker, and, rather than perceive a stereo image shift with change in position, the listener perceives the same stereo illusion over a wide range of positions. An interesting concept.

Bass response is handled by a 320-mm woofer operating in a closed system. A 200-mm mid-bass cone, a 51-mm mid-high dome, and a 26-mm dome cover the rest of the

range between 25 Hz and 20 kHz. In the system tested, the top three drivers have individual equalizer switches behind the grille. Each has six switched positions, though the current version has continuously variable controls. On the system tested, the equalizers are labelled "Mid-Low," "Mid-High," and "High-Range," with reference positions of "Norm," "Norm," and "Lab. Ref." respectively. Each of these three drivers has a separate fuse mounted on the front next to the equalizer switches; furthermore, each of these fuses has an indicator light to show if an overcurrent has occurred. A single 4-amp fuse is mounted adjacent to the speaker connector on the rear of the enclosure and protects the woofer. Obviously, ESB is accustomed to purchasers who play music "pedal to the floor." The system is rated at 6 ohms impedance and is claimed to handle amplifiers of up to 250 watts per channel into 8 ohms.

The construction is sturdy, the cabinet is beautiful, and the system has a business-like appearance, but there are two precautions I must pass along. The shipping container, as we received it, is marginal in its structural rigidity, and the loudspeaker, particularly its grille, can be damaged unless care is taken to remove it properly from the container. The system is far too heavy (48 kg) to be lifted from the box, unless, of course, one is an Olympic weight lifter. It's better to first place the box flat on the floor with its back downward; open the long side to expose the ESB, and then carefully remove the rather fragile wood-frame grille assembly; finally, tip the box on its side and slide the ESB out of the container. Do not under any circumstance attempt to remove the speaker from an upright container position.

The second comment I feel obligated to make is that the center of mass is too high, and the bottom support pedestal is too small, to allow safe placement on a carpeted floor. Not only will this tall enclosure emulate another famous Italian structure to the north of Rome, but it will take only a modest nudge from a toddler or pet to cause this unit to topple. This speaker *must* be placed on a solid flat surface in a location well away from inquisitive toddler hands or away from places where it may be bumped accidentally.

Measurements

The ESB 7/06 provides six positions of control in each of its three equalization ranges. As with most speaker systems, the actual impedance presented to a power amplifier will depend upon the particular equalization setting selected by the user. Figure 1 is the measured impedance for two particular equalizer combinations. The curve marked "Normal" is taken for all controls set to the reference position. The curve marked "0 dB" is taken for all controls in the maximum position and corresponds to the lowest net impedance presented to a power amplifier. Figure 2 is the complex impedance plot for the "Normal" position of equalizer settings.

Although rated by ESB as a 6-ohm system, I recommend that it be considered a 4-ohm system from the standpoint of amplifier and cable hookup. Following a principal resonance of 36 Hz, the impedance quickly drops to slightly above 4 ohms at 100 Hz, then rises for frequencies above this value. Although the level of impedance again drops to moderate values at higher frequencies, the associated capacitive phase angle remains less than 30° throughout the

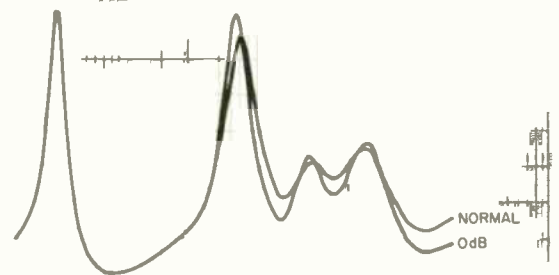

Fig. 1—Impedance for two settings of the equalizers (see text).

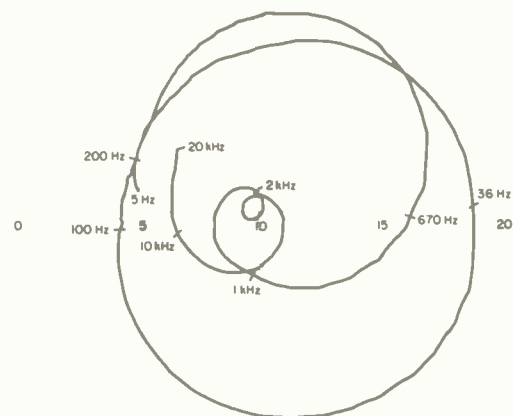

Fig. 2—Complex impedance for the "Normal" settings of the equalizer switches.

usable audio frequency range. This means that the ESB presents a load which most power amplifiers can handle near their maximum voltage drive levels without the difficulties that might otherwise exist were they to drive a highly reactive load.

The one-meter frequency response is plotted in Figs. 3 and 4. Because of the substantial spacing between drivers in this system, and of the intent that the listening axis be essentially aligned with the upper cluster of drivers, the measurement was taken at greater than one meter distance along the listening axis recommended by ESB and corrected for spherical loss to give the proper one-meter SPL. The listening test had demonstrated the desirability of removing the grille assembly for smoother sound and, accordingly, Figs. 3 and 4 were taken with the grille removed.

Bass response extends down to around 38 Hz and then

"Crown's System 10 let me show just the *difference* in response between two equalizer settings."

falls uniformly below that frequency, approaching an asymptotic frequency slope of 12 dB per octave. There is a modest bass rise at 80 Hz and shallow dip at 400 Hz, with a rising characteristic of 4 dB per decade that begins at 800 Hz and extends to the high-frequency cutoff of 18 kHz. The dip in response at 700 Hz is due to phase cancellation between the low-frequency and midrange drivers. This is accompanied by a 180° rapid change of phase at 700 Hz.

The phase measurement of Fig. 4 is taken in two parts in order to correct for the arrival time difference between midrange and tweeter elements. Tweeter measurements are corrected for an equivalent time delay of 3.0093 mS for a microphone placed one meter in front of the loudspeaker. The midrange phase measurements are corrected for an equivalent time delay of 3.5322 mS. The difference of 0.5229 mS corresponds to a time delay offset between the tweeter and midrange driver for this measurement position.

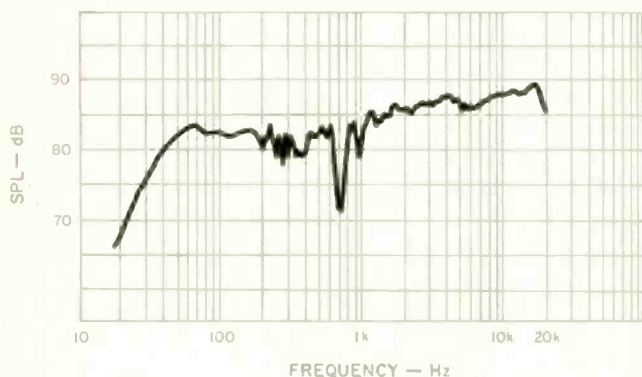

Fig. 3—One-meter on-axis sound pressure level for a constant-voltage drive corresponding to 1 average watt into 4 ohms.

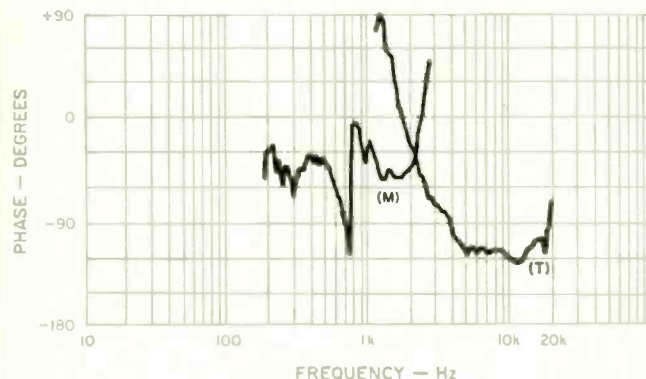

Fig. 4—One-meter on-axis anechoic phase response corrected for midrange time delay of 3.5322 mS and tweeter time delay (T) of 3.0093 mS.

Several of the newer computer audio measurement methods are discussed elsewhere in this issue. I thought it might be of interest to readers of *Audio* to see the application of one of these computer devices for a slightly more detailed analysis of the ESB 7/06 loudspeaker. Figures 5 and 6 show changes in frequency response caused by altering the equalizer controls from the "Normal" position. I first measured the one-meter SPL with the Tecron System 10 TDS computer. I put all controls in their indicated "Normal" positions and left the grille in place for this one-meter measurement. Because I wanted to see what *changed* when the equalizer settings are altered, I put this first frequency response in memory. Then I removed the grille, increased the mid-bass presence control to its "0" position, and replaced the grille. Then I duplicated the frequency measurement and asked the computer to print only that part of the frequency response that *changed*. The result is the plot of Fig. 5. In this plot, the *difference* in amplitude is plotted vertically (3 dB/division, 24 dB full scale), and the frequency is plotted horizontally, though it is on a linear scale (d.c. to 20 kHz). In the unlikely event there were no amplitude changes at all between the two settings of the equalizer control, we would then see only a dotted horizontal line halfway up the amplitude scale.

It can be seen that changing the mid-bass control from "Normal" to "0," while keeping the "Mid-High Presence" and "High Range Clearness" controls (as ESB labels them) at "Normal," causes an increase in response at 700 Hz by 2 dB, with virtually all of its effective range below 2.6 kHz. What is technically significant about this measurement is the fact that the actual free-field response, measured by the microphone, and stored in memory, is fluctuating at least ± 6 dB over this range and would look like an Alpine mountain range on this scale. What we see in Fig. 5 is how the sound will change when we change the equalizer. Incidentally, measurement repeatability in this case was checked at slightly better than ± 0.15 dB, including background noise and grille replacement.

Figure 6 is the change in response from the "Normal" to "0" positions of the "High Range Clearness" equalizer control. The scales, 3 dB per vertical division, and from d.c. to 20 kHz full scale, are the same as for Fig. 5.

During the earlier listening test, I had felt that the grille assembly detracted from the quality of reproduction which could be obtained from the ESB 7/06. Figure 7 is a Tecron System 10 measurement which verifies this subjective feeling. This time the grille was removed and the one-meter anechoic frequency response measured by TDS. Then the grille was replaced and the difference which this causes in the sound was plotted. The grille frame assembly is a rather complicated unit on which to support fabric; sound scatters not only from the interstices of the fabric but also from the supporting structure. Figure 7 is the change which the grille assembly causes on the first 10 mS of sound; the deviations from perfection are of the order of +1.2, -3 dB. Note that the fabric is essentially transparent to sound, even at 20 kHz, causing less than 1 dB loss on average; the culprit is reverberation, not loss. I recommend removing the grille assembly from the ESB 7/06 for more accurate sound.

The three-meter room response is shown in Fig. 8. The

left-channel speaker is properly identified by ESB and definitely has a more uniform frequency response when placed in a left-channel listening position. This measurement displays the frequency spectrum of the first 13 ms of sound which reaches a listening position that is three meters away and one meter above a carpeted floor. The wide vertical dispersion pattern of the higher frequency drivers leads to a modest amount of upper register raggedness due to sound which reflects off the ceiling of the measurement room which has a 2.5-meter floor-to-ceiling height. As is our custom, the data of these measurements is displaced 10 dB on the scale of Fig. 13 to allow ease of interpretation. On average, the room response of the ESB is very uniform.

Measured horizontal and vertical polar-energy dispersion patterns are shown in Figs. 9 and 10, respectively. These were made on the left-channel speaker with the grille in place. Sound is launched slightly upward and toward the traditional listening position for stereo reproduction. Horizontal dispersion is smooth, with no apparent beaming. Vertical dispersion is somewhat more directed because of the vertically stacked configuration of loudspeaker elements. This loudspeaker should be placed well away from large objects, either to the side or above, in order to preserve the uniformity of early sound.

Harmonic distortion for the tones of E_1 , A_2 , and A_4 is shown in Fig. 11. With the exception of the second harmonic of E_1 , this loudspeaker has very low harmonic distortion over most of the usable range up to average powers of 100 watts. It is also significant that the distortion rises uniformly with increase in power level, which is subjectively more acceptable than distortion products that, for example, decrease with increasing power and, hence, have few counterparts in natural sound.

During the listening test I sensed an upper mid-range harshness that "came on" at higher sound levels and which seemed concentrated in a relatively narrow pitch range. I went looking for this later during the measurement session and found it at 1.1 kHz. Whereas all tones within several octaves of this frequency had less than a quarter percent total distortion at 10 watts, the 1.1-kHz tone exhibited 4.08% second-harmonic distortion and 0.3% third-harmonic distortion. At 2.5 watts, the 1.1-kHz tone exhibited 2.6% second and 0.27% third. Much like a "wolfnote" in a stringed instrument, this maverick discord was distinctly audible only at robust listening levels. Both loudspeakers had, to me, the same subjective problem, but, in fairness, I must point out that I only used one speaker for this distortion measurement. A brief word on this particular measurement is also in order, since it used another measurement device. I used a Bruel & Kjaer Model 2033 FFT Analyzer to find this wolfnote. With its large digital

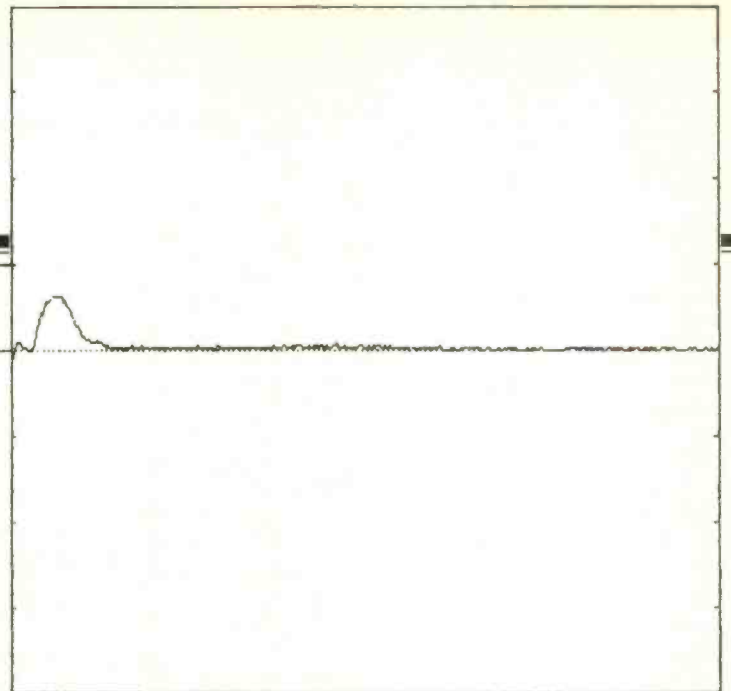

Fig. 5—Measurement with Crown TEF System 10 computer system showing "differenced data" from "Norm" to "0 dB" equalizer settings of "Mid-Low Presence" control.

TECRON TEFSM 10
 Vertical: 2dB/div
 Differenced data
 Horizontal: Auto 0.00Hz to 20011.00Hz
 scale: 5471.20Hz/inch or 2154.01Hz/cm.
 Resolution: 2.6316E+00 Feet & 4.2939E+02Hz
 Time of test: 3414 microseconds, 3.8575E+00 Feet
 Sweep Rate & Bandwidth: 10734.00Hz/Sec & 2.5000E+01Hz
 Input configuration: Non-inverting
 with 12dB of input gain & 12dB of IF gain.

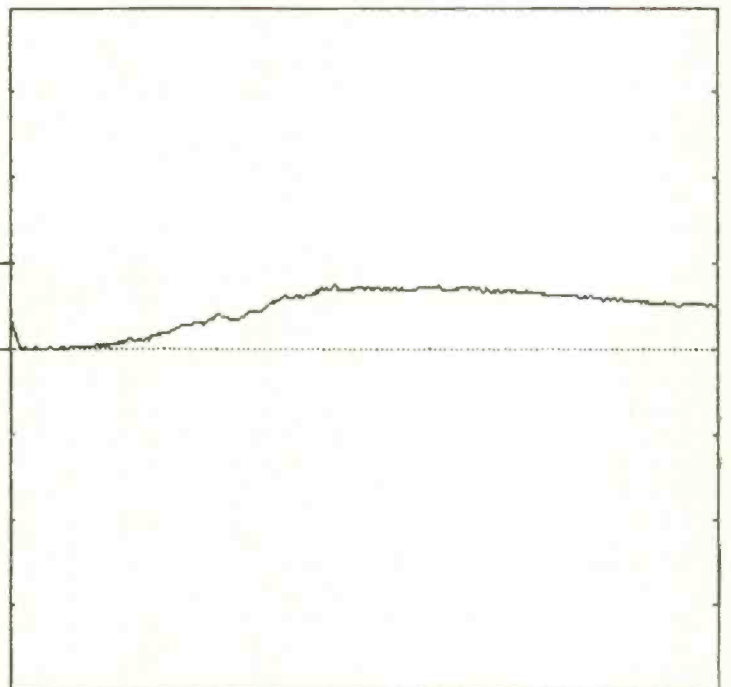

Fig. 6—Measurement as in Fig. 5 but "High-Range Clearness" control from "Norm" to "0 dB."

TECRON TEFSM 10
 Vertical: 2dB/div
 Differenced data
 Horizontal: Auto 0.00Hz to 20011.00Hz
 scale: 5471.20Hz/inch or 2154.01Hz/cm.
 Resolution: 2.6316E+00 Feet & 4.2939E+02Hz
 Time of test: 3414 microseconds, 3.8575E+00 Feet
 Sweep Rate & Bandwidth: 10734.00Hz/Sec & 2.5000E+01Hz
 Input configuration: Non-inverting
 with 12dB of input gain & 12dB of IF gain.

“On average, the room response of the ESB is very uniform. I take the measurement at three meters and use only the first 13 mS of sound.”

memory and nearly 80 dB of dynamic range, this particular FFT made the job duck soup. Exciting the speaker with a short duration tone burst, I digitally captured the signal from the measuring microphone, then stepped through the “time bins” with the FFT analysis portion of the instrument. This reduces the spectral smear which might otherwise be caused by analyzing tone fragments containing the turn-on and turn-off transients. It also allows inspection of the change of distortion components as a function of time duration following the tone’s sudden application to the speaker at a power level which, if maintained at steady state, would fry the voice-coil. This is a valid test because, after all, this is how we listen to the speaker.

The intermodulation distortion induced on a tone of A_4 by a superimposed tone of E_1 is plotted in Fig. 12. As with harmonic distortion, the IM distortion is quite low over most of the usable dynamic range of this speaker. IM distortion at levels below 50 average watts is principally due to phase modulation of A_4 caused by E_1 . An additional property that comes into play at very high sound levels is a small displacement of the average position of the sound source away from the listening position. This implies that the arrival time of higher pitched instruments is very slightly retarded during substantial bass passages. The actual retardation is quite small, amounting to a phase shift of the order of 5° on 440 Hz at 100 average watts. This is probably not audible.

Acoustic transfer with gain is within 0.1 dB of perfect for the test tones of A_2 , Middle C, and A_4 up to 30 average watts and for single bursts of one second duration or less. The ESB exhibits a progressive gain-transfer compression for longer duration tones above 10 average watts. The result is a hysteretic property in acoustic gain transfer such that loud sustained passages will cause quiet passages which follow them to be reproduced at slightly lower level than they would have been if the loud passage had not been present. This effect persists for a brief time before subsequent quiet passages come up to their proper level. At 40 average watts, a 50% duty cycle consisting of one second of loud followed by one second of soft sound, with this sequence repeated twice, produces a 1-dB compression on Middle C; a duty cycle of one second of loud followed by three seconds of soft, repeated twice, has less than 0.05-dB compression. I did not sense this effect during the earlier listening test, although it does show prominently in the measurements.

The same tones of A_2 , Middle C, and A_4 show less than a 0.1-dB change in level when a sudden broadband noise of 20 dB higher average power is suddenly superimposed. Taken together, these two distortion measurements imply that the ESB 7/06 will reproduce orchestral dynamics very well, with no change in stereo lateralization or depth during crescendo, but heavy sustained passages may cause temporary lateral shift for instruments whose stereo position is near the far left or right.

The one-meter on-axis energy-time cure (ETC) for the

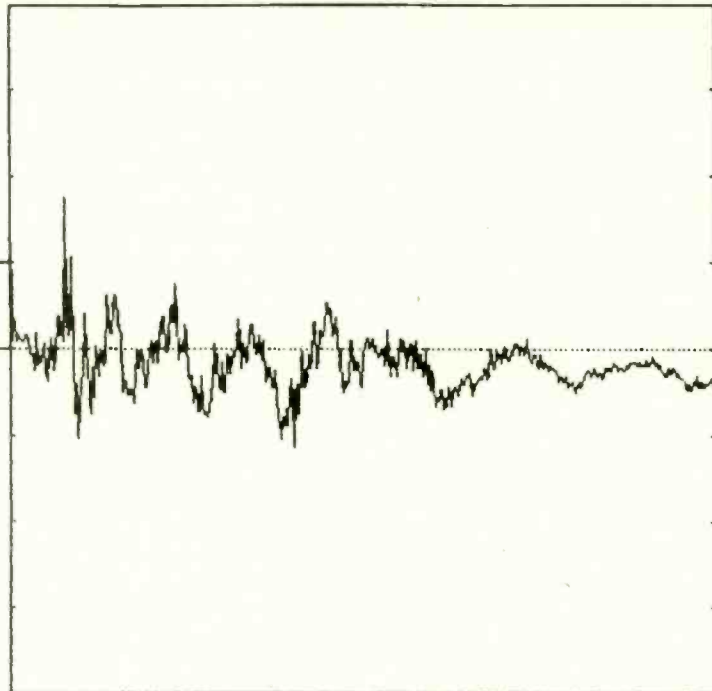

Fig. 7—Measurement as in Fig. 5 but showing effects of grille on first 10 mS of sound.

Vertical: 3dB/div
Differenced data
Horizontal: Auto 0.00Hz to 20011.00Hz
Scale: 5471.20Hz/Inch or 2154.01Hz/Div.
Resolution: 1.0980E+01 Feet & 1.0362E+02Hz
Time of test: 3818 microseconds, 3.8575E+00 Feet
Sweep Rate & Bandwidth: 10734.00Hz/Sec & 1.0362E+02Hz
Input configuration: Non-inverting
with 12dB of input gain & 12dB of IF gain.

ESB 7/06 is shown in Fig. 13. This measurement was made with the grille in place. The first sound, which occurs at 3.0 mS, contains the frequencies between 2 and 20 kHz. The frequencies below 2 kHz arrive at around 3.5 mS, but due to the combined effect of, one, containing only 10% of the full 20-kHz energy spectrum, and, two, the upper and lower frequency roll-off of the Hamming weight used to get this ETC, their arrival is obscured by the reverberation pattern caused by the grille assembly. Signals at about 3.2, 3.25, 3.4, and 3.6 mS are principally due to reflections and scatter from the grille fabric and the frame which holds that cloth. This measurement also implies that more accurate transient reproduction will result if the grille assembly is removed. Even with the acoustic problems caused by the grille, the ESB 7/06 has a very good transient response.

Use and Listening Tests

I cannot urge too strongly that, in my opinion, the ESB 7/06 is structurally top-heavy and should not be placed directly on a deep pile carpet. Simple experience showed that the ESB could topple if placed directly on the carpeted floor of my listening room. This condition was eliminated by placing the speakers on 30-cm-square wood base plates which I cut from conventional wood shelfboards. These provided a stable base without acoustic interaction, al-

“With the exception of the second harmonic of 41.2 Hz, the ESB has very low harmonic distortion over the useful range of input.”

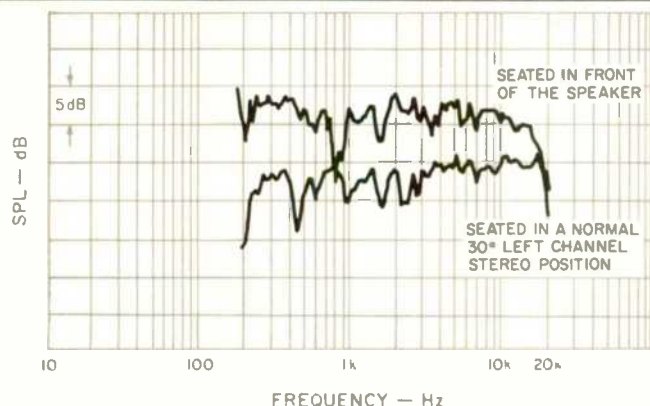

Fig. 8—Three-meter room test for left-channel unit, with plots separated 10 dB for clarity.

though they did increase the furniture-moving aspects of trying the ESBs in various room locations.

These loudspeakers must not be placed in or near a corner. Bass response, which is reasonably balanced if these speakers are placed flat against a wall, can become excessively dominant if corner positioning is chosen. When the ESBs are placed against a wall, there still is a mild bass dominance, to my ears. Lower registers are well reproduced, with no apparent need for a sub-bass augmentation on even the lowest notes.

It was apparent early in the listening test that the grille assembly was causing a small problem in the sound. When seated in a position symmetrically located with respect to the left and right channels, the sound was not substantially altered by removal of the grille. But walking through the

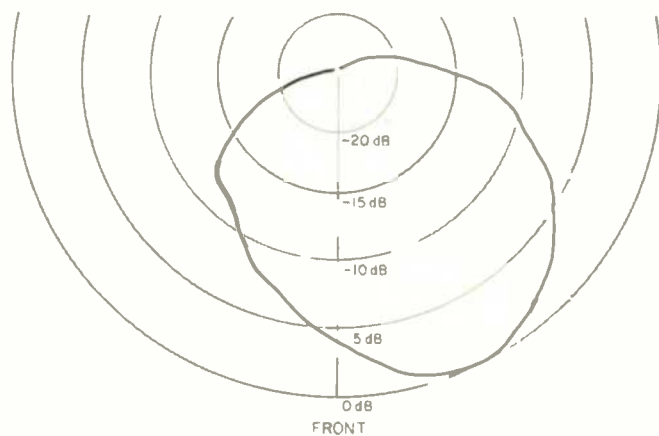

Fig. 9—Horizontal polar-energy response for the left-channel unit.

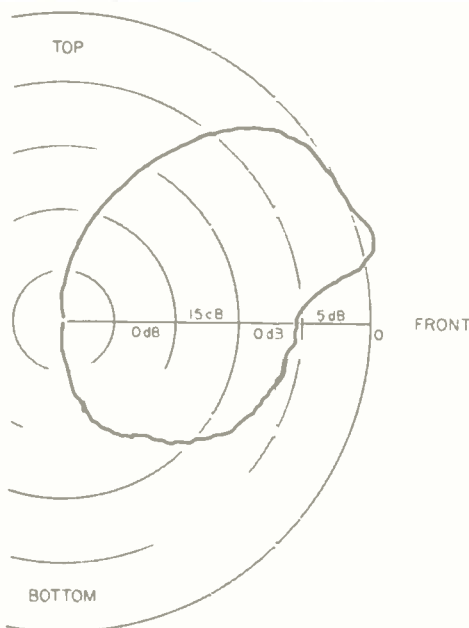

Fig. 10—Vertical polar-energy response for the left-channel unit.

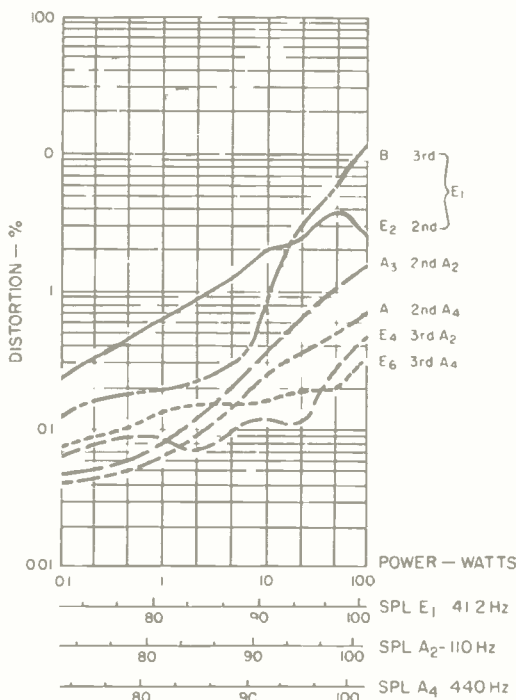

Fig. 11—Harmonic distortion for the tones E₁ or 41.2 Hz, A₂ or 110 Hz, and A₄ or 440 Hz.

"Piano and human voice, the two most difficult sources, are accurately reproduced, with no change in sound balance over the range around middle C."

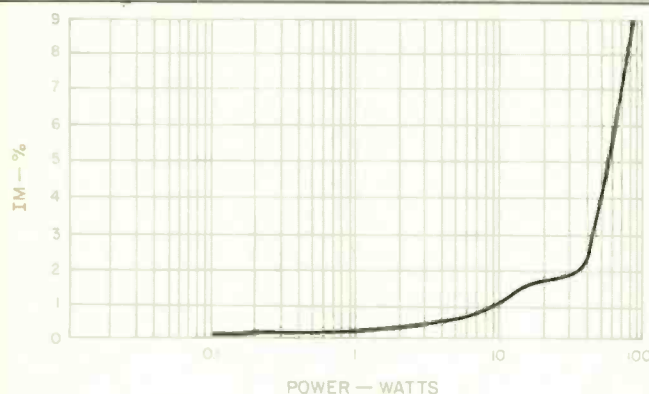

Fig. 12—IM distortion on A_4 or 440 Hz caused by E_1 or 41.2 Hz when both are mixed in a one-to-one ratio.

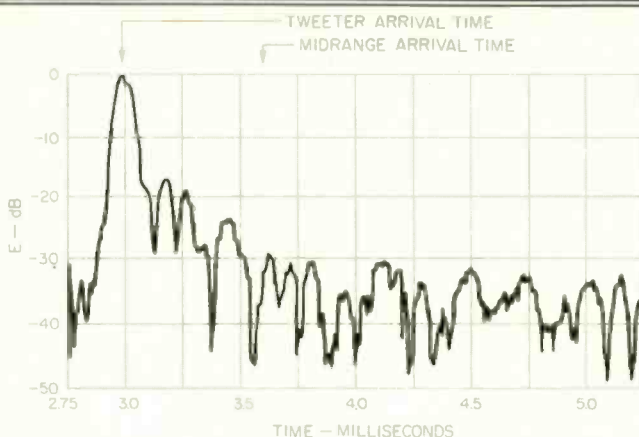

Fig. 13—Curve of energy vs. time taken at one meter on axis.

listening position and noting the difference with and without the grille in place, it became apparent that the grille changed the stereo illusion and slightly modified instrumental timbre. All subsequent listening was done with the grille removed.

Piano and human voice, the two most difficult sources, are accurately reproduced, with no change in sound balance over the important frequency range which covers the octave below Middle C through the octave above Middle C. Spectral response in the frequencies above this range suffer from small irregularities, but, on the whole, these frequencies are reproduced well. I tried various combinations of the three equalizer settings, and I believe that the best overall spectral balance is obtained with the reference positions identified by ESB as "Normal."

This system can handle very high sound pressure levels with ease, but I sensed a tendency for certain program

material to get "blasty" at high levels; female vocal and horn seemed to be the most bothered by this problem, in my opinion. Subsequent technical measurements revealed this to be the equivalent of a "wolf tone" about two octaves above Middle C. (This is discussed under "Measurements.")

Stereo imaging is excellent, and the stereo illusion remains intact at all reproduction levels—soft to extremely loud. I cannot say whether ESB's "Distributed Spectrum" concept was the cause, but the stereo image is solid and not materially influenced by where one sits.

I was favorably impressed by the sound of the system when I first heard it at the January 1983 CES, and remained impressed when given the opportunity to run it through its paces. If one places it on a firm platform, so it will not readily topple, and throws the grille away, the sound is excellent.

Richard C. Heyser

Model AT152LP
Vector Aligned™ Dual Magnet™
Stereo Phono Cartridge

"I would rank it... among the best phono cartridges now available, and...suited for use in the finest of systems."

—NORMAN EISENBERG
Ovation Magazine

Direct Plug-in to P-Mount arms plus universal mounting adapter

audio-technica

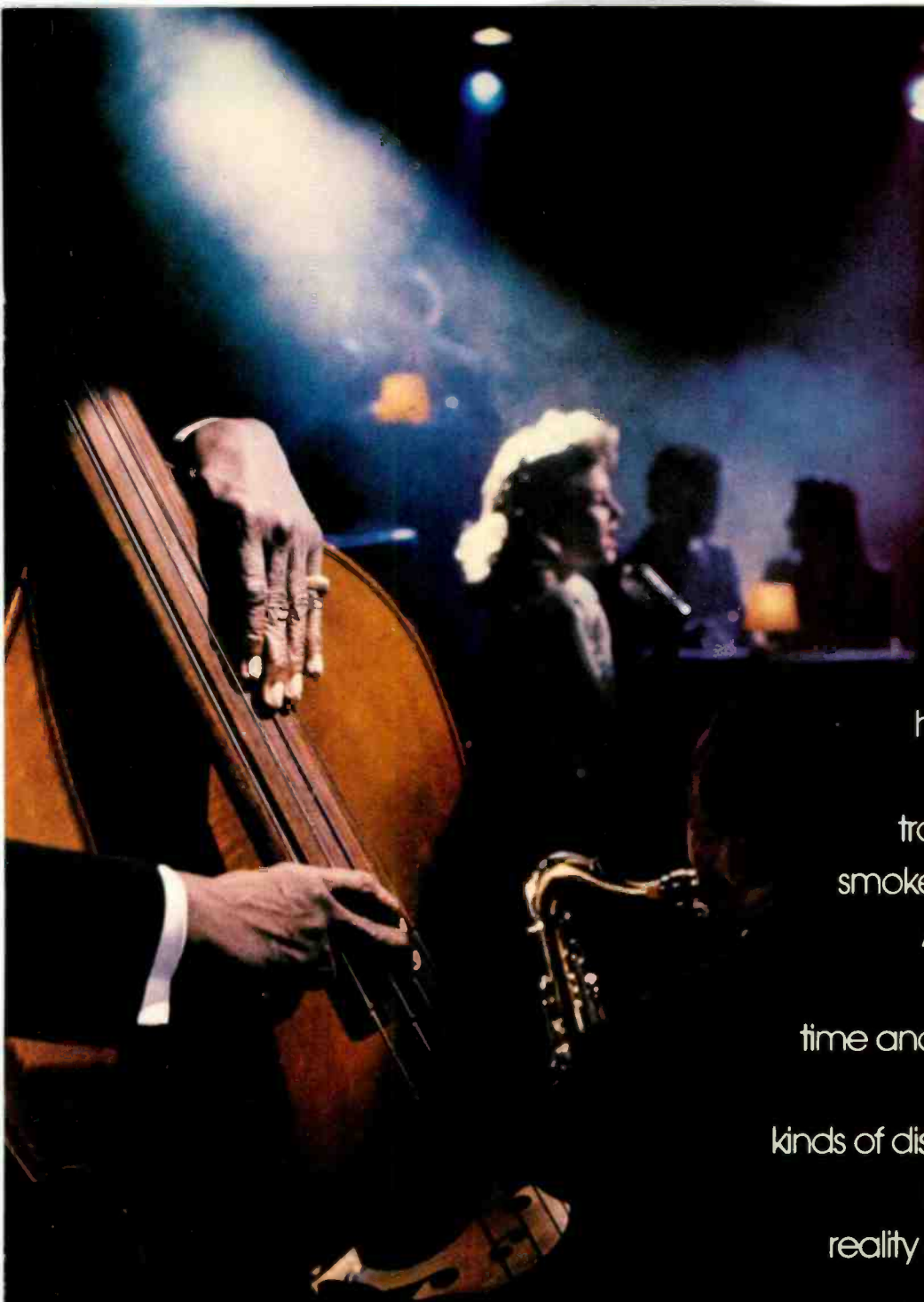

"That night
I was listening to
the bass player cook.
As his hands went
spidering up and down
the strings
his thum-thum-thum
became the group's
heartbeat – and mine too.

In my living room, I had
traveled once again to that
smokey little jazz club long ago."

A JVC High Fidelity System
can take you to another
time and place, with components
that reduce six different
kinds of distortion down to inaudible.

Nothing interferes with the
reality of your music. You're there.

We take you there.



JVC® JVC JVC JVC JVC JVC JVC JVC

JVC COMPANY OF AMERICA, High Fidelity Division, 41 Slater Drive, Elmwood Park, N.J. 07407 JVC CANADA INC., Scarborough, Ont.

Enter No. 22 on Reader Service Card

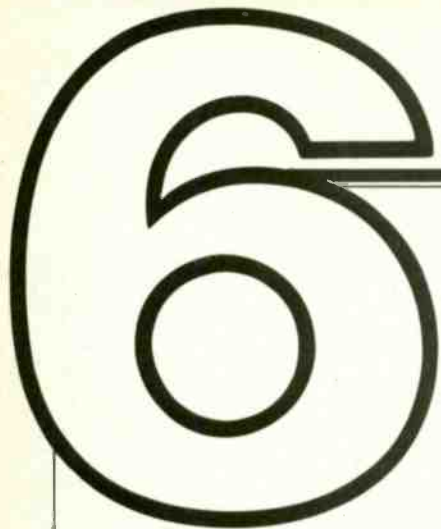

TANDBERG TPT 3001A TUNER and TIA 3012 AMP

Manufacturer's Specifications TPT 3001A Tuner

(Note: All specifications are listed for wide/normal/narrow i.f. settings.)

Usable Sensitivity, Mono: 7.5/6.8/8.2 dBf.

50-dB Quieting Sensitivity: Mono, 11.3/10.3/9.3 dBf; stereo, 32.1/32.1/32.1 dBf.

S/N at 65 dBf: Mono, 95/95/95 dB; stereo, 82/82/82 dB.

Muting Threshold: 1 μ V to 3 mV, variable (all i.f. bandwidth settings).

Stereo Threshold: 5 μ V (all i.f. bandwidth settings).

Frequency Response: Mono and stereo, 30 Hz to 15 kHz, +0.2, -0.5 dB, all i.f. bandwidth settings.

Distortion at 65 dBf, Mono: 0.03%/0.06%/0.12% at 100 Hz; 0.03%/0.06%/0.25% at 1 kHz; 0.03%/0.06%/0.45% at 6 kHz.

Distortion at 65 dBf, Stereo: 0.04%/0.05%/0.08% at 100 Hz; 0.04%/0.05%/0.2% at 1 kHz; 0.1%/0.25%/1.0% at 6 kHz.

IM Distortion: Mono, 0.1%/0.15%/0.5%; stereo, 0.1%/0.15%/0.8%.

Capture Ratio: 0.4/1.0/3.0 dB.

Adjacent Channel Selectivity: 3/12/40 dB.

Alternate Channel Selectivity: 30/90/90 dB.

AM Suppression: 70 dB (all i.f. bandwidth settings).

I.f. Rejection: 135 dB (all i.f. bandwidth settings).

Spurious Response Rejection: 135 dB (all i.f. bandwidth settings).

Stereo Separation: 60/60/55 dB at 100 Hz; 70/60/55 dB at 1 kHz; 50/45/35 dB at 10 kHz.

Subcarrier Product Rejection: 95 dB (all i.f. bandwidth settings).

Power Consumption: 34 watts.

Dimensions: 17 $\frac{1}{8}$ in. (43.5 cm) W \times 13 $\frac{3}{4}$ in. (35 cm) D \times 3 $\frac{1}{4}$ in. (8.3 cm) H.

Weight: 15.3 lbs. (7 kg).

Price: \$1,195.00.

TIA 3012 Integrated Amplifier

Power Output: 100 watts continuous average power per channel, 8-ohm loads, 20 Hz to 20 kHz.

Rated THD: 0.02%.

Dynamic Headroom: 0.35 dB.

Frequency Response: Linear inputs, 5 Hz to 100 kHz, +0, -3 dB; MM and MC phono inputs, RIAA 20 Hz to 20 kHz, \pm 0.2 dB.

Input Sensitivity: MC phono, 16 μ V; MM phono, 190 μ V; high level, 15 mV.

S/N: MC phono, 73 dB; MM phono, 78 dB; high level, 84 dB.

Maximum Input Signal: MC phono, 20 mV; MM phono, 250 mV; D.D. and AUX, greater than 20 V; tuner and tape, 5 V.

Dimensions: 17 $\frac{1}{8}$ in. (43.5 cm) W \times 3 $\frac{1}{4}$ in. (8.3 cm) H \times 13 $\frac{3}{4}$ in. (35 cm) D.

Weight: 22 lbs. (9.7 kg).

Price: \$995.00.

Company Address: Labriola Court, Armonk, N.Y. 10504.

For literature, circle No. 95



I had the good fortune of visiting the Tandberg factories in Norway a few years ago. During that factory-sponsored junket I was shown some magnificent prototypes of audio components, each of which had been painstakingly designed by Tandberg's dedicated staff of engineers. Those prototypes were later to become the 3000 series of components, of which the TPT 3001A tuner and the TIA 3012 integrated amplifier are the latest examples. Since these two units are so obviously made for each other, *Audio's* editors thought it would be a good idea to evaluate them as a pair, and I heartily agree. That's not to suggest for a moment that each of these magnificent examples of Scandinavian craftsmanship doesn't deserve its own detailed test report and analysis. The new 3001A tuner is, in my opinion, one of the finest FM tuners I have ever tested, while the 3012 integrated amplifier was obviously designed to take into account the demands of new and better program sources, such as Compact Discs. Further, it incorporates the latest thinking concerning the influence of components on ultimate sound quality, the desirability of eliminating protection circuitry components from the signal path, the superiority of MOS-FET output devices and much, much more.

Tuner Layout

The front panel bespeaks the simple elegance typical of Tandberg products. At the upper left are eight small station preset buttons. Below these are a power switch and an output level control, plus a "Store Program" button. A small display area nearby shows either an F (for manual tuning on the main FM dial scale), a P (for programming a preset station) or a number from 1 to 8 (indicating which of the preset buttons has been depressed). The signal-strength meter just to the right is an auto-ranging type, providing accurate signal-strength readings in microvolts (across 75 ohms). If signal strength exceeds 1,000 μV , a light comes on, telling you to multiply all readings by 1,000. A second meter, just to the right of the signal-strength meter, serves either as a center-of-channel tuning indicator (top scale) or as a frequency meter (lower scale), when using the preselect mode of tuning. The manual frequency scale and dial pointer are further to the right, with a large, machined tuning knob to its right. Two indicator lights are located just below the left edge of the tuning dial. The first lights when approaching proper center-tuning of a station, telling the user that the center-tune function of the dual-purpose meter is now operative. The second indicator is the usual stereo multiplex light.

Four pushbuttons below the main tuning dial handle mono/stereo selection, automatic noise-cancelling circuit activation, a.f.c. (which Tandberg prefers to call "Servo"), and muting on/off. A continuously variable muting control knob sets desired muting threshold over a very wide range. Finally, a three-position bandwidth selector offers choices of wide, normal or narrow i.f. response to meet the precise requirements of any reception condition or environment.

The rear panel of the 3001A is equipped with a 75-ohm coaxial cable connection. Since there are no 300-ohm antenna terminals, Tandberg supplies a 75/300-ohm matching transformer for those who prefer to use 300-ohm twin-lead transmission lines. In addition to a fixed and a variable pair

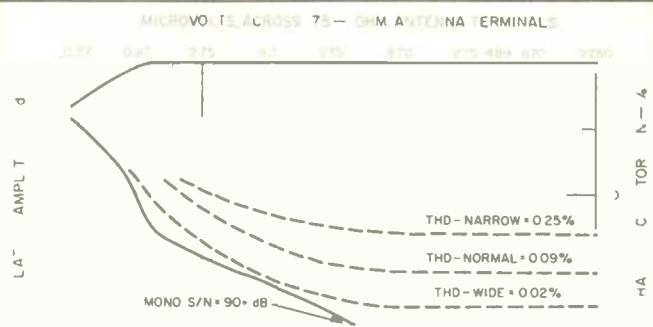

Fig. 1—FM quieting and distortion characteristics, monophonic mode.

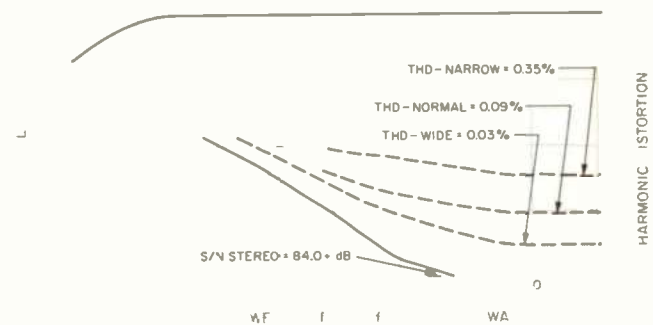

Fig. 2—FM quieting and distortion characteristics, stereo mode.

of audio output jacks, the rear panel also houses a pair of horizontal and vertical output jacks intended for connection to an oscilloscope for observation of multipath effects. A detector output jack delivers a signal ahead of any de-emphasis network and ahead of the built-in multiplex decoder. It might find application in the future for some sort of four-channel decoding, should such discrete multi-channel broadcasting ever become a reality in this country. A three-position de-emphasis selector switch (25, 50 or 75 μS), line fuseholder, and detachable power cord complete the rear panel layout.

Tuner Circuit Highlights

The varactor diodes used in the tuning circuitry of the 3001A are equivalent to an 8-gang tuning circuit. Dual-gate MOS-FETs are used in the r.f. and mixer stages. The pre-tuning circuitry used for the eight station presets is based upon the voltage-synthesis principle combined with a fast analog servo loop, which Tandberg feels is a better approach to achieving high S/N ratios and frequency stability than the more familiar frequency synthesizing circuits.

The i.f. system includes phase-linear block filters and pure LC filters. Tandberg uses a decoder consisting of discrete components, rather than the usual single IC chip. The chief advantage of their design is the great reduction in

"I measured an S/N of 90 dB for this tuner in mono and 84 dB in stereo—the highest (for mono) I've ever read."

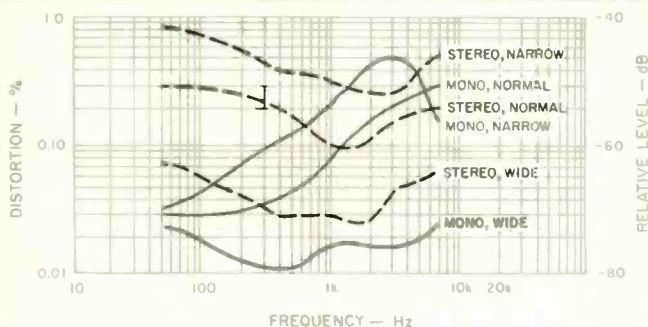

Fig. 3—Distortion vs. frequency, TPT-3001A tuner.

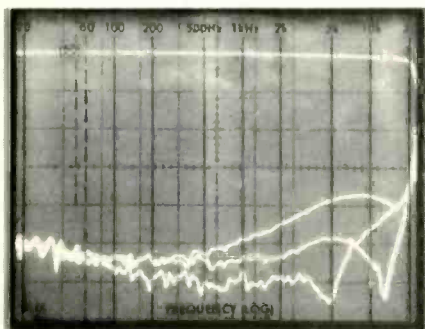

Fig. 4—Tuner frequency response and stereo separation.

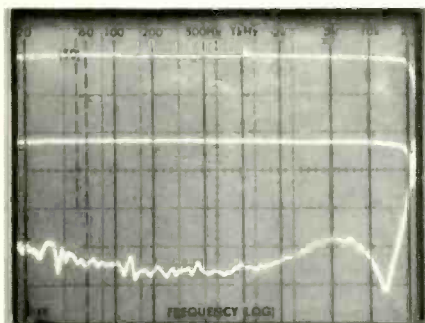

Fig. 5—Action of automatic noise-cancelling circuit. Center curve is separation with noise-canceller activated.

beats observed when treble tones are received in the stereo mode. Tandberg attributes this improvement in part, at least, to the use of C-MOS technology. An automatic noise-cancelling circuit comes into play during weak signal reception, improving signal-to-noise ratios at the expense of stereo separation, which then drops to around 10 dB.

The servo tuning system uses a type of frequency feedback to lock the tuning to station frequency after the incoming signal has been properly tuned in. This servo action is automatically disabled when you touch the tuning knob.

Tuner Measurements

I was actually able to measure a signal-to-noise ratio of 90 dB for this tuner in mono and 84 dB in stereo. I strongly suspect that these measurements were limited by my signal generator, since they are the highest (for mono) that I have ever read for any tuner. While signal-to-noise characteristics did not vary much as I switched from wide, through normal, to narrow i.f. bandwidth, distortion did increase as I switched to the narrower bandwidths, as is to be expected. Plots of noise and distortion versus signal input for mono operation are shown in Fig. 1, while stereo performance with respect to noise and mid-frequency distortion is plotted in Fig. 2, for the sake of clarity. In the wideband mode, I measured the lowest distortion I have ever recorded for any tuner: 0.02% in mono and 0.03% in stereo for a 1-kHz modulating test signal. While distortion rose when I switched to the narrow bandwidth setting, it was still quite acceptable, with readings of 0.25% in mono and 0.35% in stereo for a 1-kHz test signal.

More significant differences in tuner performance show up when a high-frequency modulating signal is used (see Fig. 3). With a 6-kHz modulating signal, THD in the stereo mode measured only 0.06% in the wide setting, but increased to 0.5% when the bandwidth was switched to the narrow mode. That, however, is still far better than I often measure for tuners having only one bandwidth setting. Bear in mind, too, that in the narrow setting it is actually possible to separate stations that are only a single channel (200 kHz) apart, thanks to the high adjacent-channel selectivity, which I measured at 42 dB as against Tandberg's 40 dB claim.

Figure 4 is a spectrum-analysis multiple-sweep 'scope photo in which the upper trace represents frequency response of the desired, modulated stereo channel, while the three lower curves show separation versus frequency. As you might have guessed, the highest separation (lowest trace on the photo) was achieved with the wide setting, with somewhat poorer separation occurring in the normal mode and some further decrease in separation (particularly at the higher frequencies) occurring in the narrow-bandwidth setting. In the wide-bandwidth mode, I measured a separation of 62 dB at mid-frequencies, 50 dB at 100 Hz, and 48 dB at 10 kHz. Figure 5 shows what happens when signal levels are decreased sufficiently for the automatic noise-cancelling circuit to take over. The lower curve is identical to that obtained for the normal bandwidth setting shown in Fig. 4, while the curve midway between the desired channel output response and the normal separation shows the sacrifice in separation that occurs when this noise-cancelling circuit is operating. Typically conservative, Tandberg stated that

“To handle high input levels, the special digital-disc input has *no* amplification before the volume control and power amp.”

separation would be reduced to something around 10 dB. In fact, separation remained greater than 20 dB (my scope photos here have a vertical sensitivity scale of 10 dB per division). Furthermore, unlike many simple blend circuits (which this definitely is *not*), channel separation remains virtually constant over the entire frequency range from 30 Hz to 15 kHz.

Figures 6 and 7 show crosstalk and distortion products observed at the output of the unmodulated right channel when a 5-kHz signal is used to modulate the left channel 100%. In Fig. 6, the tuner was set to its wide-bandwidth mode, while in Fig. 7, the narrow setting was employed. These two photos demonstrate most dramatically, I think, the advantages of using a wideband tuner where reception circumstances permit. The undesired crosstalk and distortion products emanating from the output of the unmodulated channel are often audible since they are not masked by other sounds coming from that same loudspeaker when the primary program content is coming from the opposite channel.

Trying to measure capture ratio while in the wide mode was next to impossible. When capture ratio gets this low, I find that I have difficulty getting the same results twice in a row. Suffice it to say that capture ratio under those conditions was well under 1.0 dB, though I was able to confirm a consistent 1.0 dB for the normal mode and a 2.8 dB figure for the narrow mode.

I measured AM suppression slightly higher than the 70 dB claimed by Tandberg, as high as I have ever measured for any tuner. As usual, I could not confirm the claim of 135 dB for i.f., image and spurious response rejection, since 100 dB is about the best I can measure in my lab. Nor could I confirm subcarrier product rejection, except to say that it was superb, and below the 84 dB noise floor imposed by my signal generator. SCA rejection was better than 70 dB.

As for sensitivity, I suspect that the matching transformer supplied by Tandberg introduces a couple of dB of loss. Unfortunately, since my generator has a 50-ohm output and is coupled to a 50/300-ohm transformer, it was necessary to use Tandberg's 300/75-ohm transformer to get a correct match to their antenna connector. As a result, I was unable to precisely verify sensitivity and 50-dB quieting figures. I can state, however, that if you allow about 2 to 3 dB for transformer losses, Tandberg's figures come out right on the money. Of course, once full limiting is achieved, the slight amount of loss induced by those transformers becomes negligible, so you can take Figs. 1 and 2 as being essentially accurate above around 15 dBf.

Amplifier Layout

The front panel layout of Tandberg's 3012 integrated amplifier blends nicely with the 3001A tuner. The on/off power switch and a headphone jack are located at the left, with a four-position rotary speaker-selector knob nearby. Further to the right are a pair of peak clipping indicators, one for each channel. A tone control defeat button comes next, followed by a bass turnover selector (100 or 200 Hz), the bass control itself, a treble control, a treble turnover selector (3 or 6 kHz), and a loudness control button. Separate five-position record and program selector knobs come

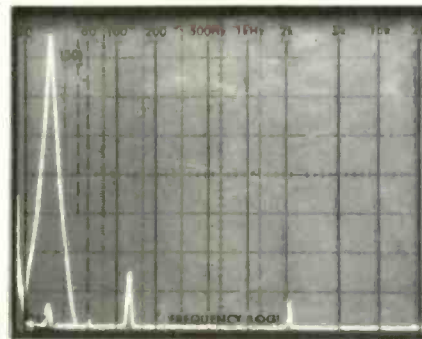

Fig. 6—Crosstalk for a 5-kHz modulating signal, wide i.f.-bandwidth setting.

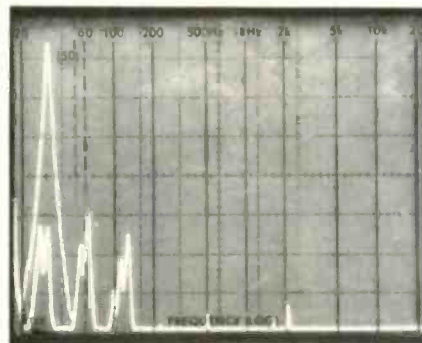

Fig. 7—Crosstalk for a 5-kHz modulating signal, narrow i.f.-bandwidth setting.

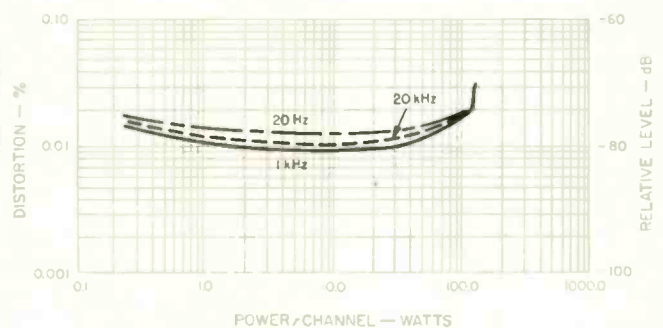

Fig. 8—Power output vs. THD, TIA 3012 amplifier.

"Tandberg is one of the very few companies to conform in every last detail to the EIA amp-specification standards."

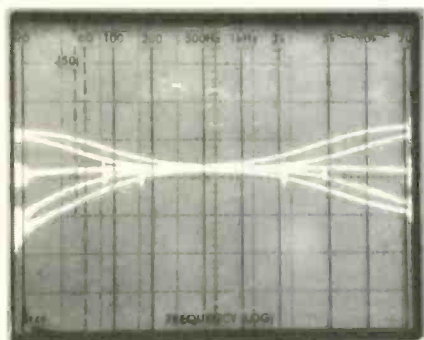

Fig. 9—Tone control characteristics.

next, allowing the user to record one program source while listening to another. At the extreme right are concentrically mounted balance and volume controls.

The rear panel of this amplifier is equipped with the usual array of input and tape output jacks. Two tape monitor circuits are provided. Separate pairs of jacks for MM and MC phono cartridges are located at the extreme left of the rear panel, together with chassis ground terminals. There is no front-panel switch to select the correct (MM or MC) phono preamp circuit. Color-coded binding posts are supplied for two pairs of speaker systems; switched and unswitched convenience a.c. receptacles, a line fuseholder, and a detachable power cord make up the balance of the rear panel layout.

Amplifier Circuit Highlights

Tandberg's engineers, in a white paper issued recently, discussed the design philosophy behind this newest amplifier of theirs. They cited a series of design steps and features which they feel distinguish this amplifier from other units which might offer similar or identical bench measurements.

Because MOS-FET power transistors are used in the 3012, there is no need for current or voltage limiting of the output, and therefore, the 3012 is very suitable for use with electrostatic speakers, which often trigger such limiting devices and cause audible distortion.

Direct current must never be allowed to appear at an amplifier's output. In the 3012, d.c. voltage is controlled by Tandberg's new "Thermic Servo Loop" (pat. pend.), which utilizes heat-difference sensing devices to detect d.c. offset voltage and to adjust operating parameters so as to eliminate any d.c. voltage at the output. This system, unlike any other, has no direct connection to the audio signal path and therefore it cannot degrade sound quality.

The tone control circuitry of the 3012 is passive, with 1% calibrated resistors providing 2-dB steps and switchable turnover; these controls can be totally bypassed. The loudness compensation function increases bass response by up to 6 dB at low volume settings. The phono preamplifiers employ semi-passive RIAA equalization and conform with the new recommendations for phono equalization of IEC

Amendment 4, 1976, specifying a roll-off of at least 12 dB per octave below 20 Hz. There are very good reasons for this modified equalization curve since part of the signal of a phono cartridge is produced by record warps and center-hole offset, and such signals in the infrasonic region carry no music program information. They can, however, load down a power amplifier, limit its usable output power, and cause in-band intermodulation products which are audible. In addition to causing problems within the amplifier's power stages, the infrasonic content of this cartridge signal has a tendency to force the woofer's voice-coil out of its linear operating region, causing increased intermodulation and harmonic distortion. The addition of an infrasonic (or subsonic) filter avoids these problems.

The MC and MM sections of the 3012 have three stages. First, there is a linear stage with moderate gain, to optimize the signal-to-noise ratio and overload margin. This is followed by the 18 dB/octave subsonic filter. Finally, a passive 75- μ S RIAA treble equalization section, followed by an amplifier with active RIAA bass and midrange equalization, completes the system. The first linear stage is automatically matched to the MM or MC cartridge. It has a low impedance push-pull output to minimize distortion and effectively drive the subsonic filter which follows. The high-level tuner and tape inputs have separate input buffers with low-impedance push-pull outputs to prevent crosstalk or bleed-through from one program source to another. The special digital-disc input, however, has no amplification at all before the volume control and power amplifier. Furthermore, it can handle the extremely high input signal levels such as are likely to occur with digital program sources having extremely high dynamic ranges.

Amplifier Measurements

The 3012 delivered just under 109 watts of power per channel at mid-frequencies into an 8-ohm load for its rated THD of 0.02%. At 20 kHz, output for this level of THD reached 106 watts while at 20 Hz, the amplifier delivered just a bit over its rated 100 watts per channel. The stiff power supply did, indeed, limit dynamic headroom, but I measured a full 1.0 dB for this parameter as opposed to Tandberg's conservative claim of only 0.35 dB. Figure 8 is a graphic plot of power output versus distortion for 20 Hz, 1-kHz and 20-kHz test signals. CCIF (twin tone) IM measured a negligible 0.0086%, while IHF-IM was less than 0.01% (the lowest level I am able to detect using my spectrum analyzer, which has a dynamic range of 80 dB). SMPTE-IM measured 0.06% at rated output and decreased rapidly at lower power output levels.

Overall frequency response, using the high-level inputs, extended from 3 Hz to 105 kHz for the -3 dB cutoff points and from 6 Hz to 55 kHz for a -1 dB roll-off. My own inverse RIAA filter does not incorporate the new IEC subsonic roll-off characteristic. As a result, though the phono response was absolutely flat (to within 0.1 dB) above 100 Hz and all the way out to 20 kHz, I did measure a deviation of -0.7 dB at 30 Hz, which is just about what you'd expect when a preamplifier employs the modified IEC version of the RIAA curve.

Input sensitivity measured 0.17 mV for the MM phono

"Why \$1,195 for a tuner? A Mercedes or Rolls can't get you through rush-hour traffic any faster, but some want the best."

inputs, 15 μ V for the MC inputs, and 16 mV for the high level inputs. I should point out that Tandberg is one of a very few companies that conforms in every last detail to the EIA standards for specifying amplifier performance. I don't have to apologize, therefore, for any difference in reference levels between my readings and their published specs; they are one and the same, making it simple to compare their claims with my measured results. Other companies who continue to ignore these standards, please take note!

Signal-to-noise measurements turned out to be consistently better than claimed. I measured 83 dB for the MM phono inputs, 79 dB for the MC inputs, 84 dB (as claimed) for the high level inputs, and 91 dB for minimum settings of the volume control. All S/N measurements are with respect to 1-watt output levels. The carefully configured tone control characteristics are shown in the multiple frequency sweeps of the spectrum analyzer display in Fig. 9. Loudness control action was extremely minimal and affected only bass tones.

Use and Listening Tests

At a recent digital audio seminar which I presented, the Tandberg 3012 integrated amplifier was specifically chosen by the management of the audio dealership as the amplifier to use when demonstrating Compact Discs. Having now had an opportunity to listen extensively to this remarkable amplifier, I can see why that choice was made. The amp delivers an open sound that is ideally suited to the new, noise-free, wide dynamic range Compact Discs. Where I disagreed with the recording engineers' ideas of sweetening, the simple but versatile tone control arrangement on the 3012 allowed me to adjust tonal balance without upsetting half the audio spectrum. Certainly, there may be instances where 100 watts per channel will not be enough to handle

the dynamics of CDs (especially if you own an inefficient set of loudspeakers, as I do), but so long as you keep levels below clipping (the 3012 warns you about this with a reliable indicator for each channel), you're not likely to find an integrated amplifier that delivers cleaner, more accurate sound. Tandberg has never been known as a company that grinds out new models year after year, in a big hurry. In the case of the 3012, the long gestation period was justified. It's a top-performing amplifier well worth its price.

As for the 3001A tuner, here the answers are not all that simple. I think \$1,195.00 is a lot of money to pay for any FM tuner—especially when there are some superb FM tuners around which sell for less than half that price (Sony, Carver and NAD, to name just a few). Certainly, the Tandberg has a few more things going for it than any of the above-named lower cost tuners, but the question is, will these extra features result in audibly better FM reception or sound quality? Are there enough high-quality FM stations around to justify such an expenditure? I asked these questions of Joel Rosenblatt, Director of Sales and Marketing for Tandberg, and, as is typical of Tandberg people, he gave me a very honest answer, with absolutely no hype attached. He pointed out that a Mercedes or a Rolls-Royce can't get you through rush-hour traffic any faster than a lower cost automobile and yet, as he put it, there are some people who just have to have the best there is, no matter what it costs, even if there's no way to avail themselves of all its inherent benefits. Evidently enough people feel that way about this new tuner to make it worthwhile for Tandberg to produce and sell it. Being a dedicated FM listener, I wouldn't mind owning one of these Norwegian tuner masterpieces myself. I'm willing to wait until station practice catches up with it!

Leonard Feldman

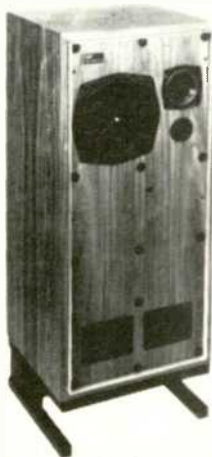

IMF
ELECTRONICS

HAVE YOU CHECKED THE PRICE OF A GOOD SUB-WOOFER LATELY?

They certainly are not inexpensive. To use sub-woofers optimally, a pair of them are necessary. Most loudspeakers on the market require sub-woofers for extended bass response.

This is not the case with **IMF Electronics Studio Monitor** loudspeakers. Their one-eighth wavelength tapered and heavily damped transmission-line bass loading of the 8" polymer cone woofer provides low frequency response down to 23 Hz! With the inherently low distortion of transmission-line bass, coupled with ultra-rigid construction, bass sounds are reproduced with exceptional clarity and control, free of overhang and resonant colorations.

The vital mid-range of the **Studio Monitor** is reproduced by our 4" engineered polymer cone driver, ferro-

fluid damped to provide higher power-handling and lower distortion. This driver is mounted in its own tapered and damped line whose non-parallel walls ensure freedom from standing waves. Our 3/4" chemical cone tweeter is also ferrofluid damped, and affords extremely linear response from 3 kHz to 40 kHz. The design of the mid-range and tweeter drivers permits "in-line" close mounting for improved acoustical coupling. Exceptionally smooth, high definition sound, with precise stereo imaging and the stunning power and clarity of transmission-line bass characterizes the **Studio Monitor** loudspeakers.

Even the most severe critics of the CD digital discs concede that their bass response is phenomenally clean and extended. The **Studio Monitor** has the "built-in" sub-woofer capability to effortlessly reproduce these low frequency sounds. The **Studio Monitor** loudspeakers are the least expensive and smallest embodiment of **IMF Electronics** transmission-line design.

For a dramatic and revealing experience, audition the **Studio Monitor** at selected dealers.

IMF ELECTRONICS, INC. 5226 State Street
Saginaw, Michigan 48603 Tel (517) 790-2121 Telex 227461

IMF ELECTRONICS, LTD. Richardson Street, High Wycombe
Buckinghamshire, England HP11 2SB Tel (0494) 35576 Telex 83545





“EVERY ALPINE/LUXMAN PRODUCT COMES WITH A VERY SPECIAL FEATURE: AN ALPINE/LUXMAN DEALER.”

—Reese Haggott,
Executive VP/General Manager
Alpine Electronics of America

Anyone who knows audio will tell you there's something special about the way Alpine Car Audio and Luxman High Fidelity products perform. And in the way they look. And even a difference in the way their controls feel when you touch them.

But that's just part of what makes us unique.

The other difference is in the special people who sell, install and service our products.

You see, Alpine Car Audio and Luxman High Fidelity components are available only at a select number of dealers: Audio specialists, whose performance standards are as selective as those which we set for ourselves.

So it isn't enough to be knowledgeable about electronics. Every one of our dealers is also hand-picked for the way he works with people.

Which is why your Alpine/Luxman dealer will go out of his way to treat you like a valued client, instead of a customer.

And why he'll work with you to

help design the Alpine Car or Luxman High Fidelity System that's exactly right for your particular listening environment.

And why he'll also go to the time and effort to install your system so that it performs to your expectations.

And why he'll make himself available to answer any question along the way.

If you have a question or an idea you'd like to share, please get in touch with me at 1-800-421-2284.

The way we look at it, we want you to feel good about Alpine/Luxman products.

And those of us who bring them to you.



ALPINE / LUXMAN
AUDIO SPECIALISTS

For the Alpine/Luxman dealer nearest you, call: 1-800-421-1395. In California call: 1-800-262-4150.
Alpine/Luxman Electronics of America, 19145 Gramercy Place, Torrance, CA 90501

Enter No. 23 on Reader Service Card

BERT WHYTE
JOHN M. EARGLE
C. VICTOR CAMPOS

DIGITAL STEPPES

Marche Slav & Other Russian Favorites: The St. Louis Symphony Orchestra, Leonard Slatkin.
Telarc CD-80072, \$17.95.

This potpourri of orchestral showpieces is another winner from Telarc! This time we have the up-and-coming Leonard Slatkin conducting the St. Louis Symphony Orchestra, and the recording venue was their own Powell Symphony Hall.

Once again Jack Renner, of Telarc, has positioned his three Schoeps omnidirectional mikes in spaced array to good advantage. The spacious acoustics of Powell Hall lend a warm ambience to the well-defined orchestral sound. A realistic perception of depth is readily apparent in the recording.

The "Marche Slav" and the "Russian Easter Overture" are sonic blockbusters, especially the finale of the "Marche Slav" with its massive outpourings of brass and thunderous accents of bass drum. The overall sound is very clean and transparent, with high strings having a lovely sheen, free of any stridency. Dynamic range is very wide indeed. Rumors have been circulating that some classical CD recordings have had their dynamic range reduced to about 45 to 50 dB. Such an idea is totally alien to Jack Renner and Bob Woods, who have personally assured me that they do not indulge in such musically emasculating practices.

Slatkin's performances are quite good, although his "Russlan and Ludmila" is a bit tame compared to the free-wheeling, frenetic pace of the Solti/London Symphony version.

Be advised that playback of this CD, at good room-filling levels, will require a big amplifier and speakers capable of high input capacity.

Musically and sonically a very exciting CD; certainly one of the very best currently available. *Bert Whyte*

Stravinsky: The Rite of Spring. The Cleveland Orchestra, Lorin Maazel.
Telarc CD-80054.

From the high-C bassoon opening passage all the way to the crashing final section, this is one of the most gripping recordings of recent years. There is absolutely no artificial high-lighting of musical details—yet they



Illustration: Rick Tulka

are all there. This is a tribute to fine engineering in a sympathetic acoustic environment and, of course, to the masterful combination of conductor and orchestra.

As good as Telarc's LPs of the larger orchestral works are, their CDs are glorious. In their LPs, there were often traces of edginess, due to the rather high transfer levels. But, of course, this problem does not exist in CD, and the high end is as smooth and natural as you could ask for. Another bonus is the bottom end; it is even tighter and more solid than you remember from the LPs.

Since there is no compression of the dynamic range, average levels on this CD are lower than usual to preserve headroom for the occasional really big peaks that come along. So, raise the playback level just a little bit—and be prepared for a rare listening experience!

John M. Eargle

Friday Night in San Francisco: Al DiMeola, John McLaughlin, Paco DeLucia.
CBS/Sony DP 9.

This was recorded on an analog tape recorder during a concert by Al DiMeola, John McLaughlin, and Paco DeLucia in 1980. These gentlemen are considered among the foremost virtuosos of the guitar on the current scene.

Their dazzling pyrotechnical finger work on the music on this CD is amazing, a fact much appreciated by their enthusiastic audience. The transfer to CD has been very well done, and the transients of the guitars are sharply etched and most realistic.

A unique feature of the program notes is that the positions of the players in the stereo field are noted for the various selections. Thus, for the "Fan-



John McLaughlin

TAKE YOUR SYSTEM TO THE EDGE!

With these powerful new releases from Warner Bros., Elektra/Asylum and Atlantic on Compact Digital Audio Discs.

From Asia to Abba, from Jarreau to Janacek...take your system and senses to where they've never been before. The Compact Digital Audio Disc is the ultimate in high fidelity. Each disc provides up to one hour of sound quality unparalleled in the history of prerecorded entertainment.

The reason: The Compact Digital Audio Disc is read by a laser instead of a stylus. There is no physical contact with the disc; therefore no friction, wear or loss of quality.

With a minimal amount of care this disc will virtually last forever.

Experience the sound, immediacy and emotional high that can only be recreated on the Compact Digital Audio Disc...you'll hear your favorite artists...as you've never heard them before...including new releases from Quarterflash, Linda Ronstadt, Stevie Nicks, Talking Heads and others.

These artists and many more have committed their music to the Compact Digital Audio Disc.

Together, we make lasting impressions!



Foreigner
Records



Teresa Stratas
Unknown Kurt Weill



Stevie Nicks
Wild Heart



Genesis
Abacab



George Benson
Breezin'



Asia
Alpha



Christopher Cross
Christopher Cross



Tango Project



Jarreau
Jarreau



Linda Ronstadt
Greatest Hits Vol. 1



Quarterflash
Take Another Picture



LA Chamber Orch.
Janacek: Mladi



Talking Heads
Speaking In Tongues



Abba
Greatest Hits Vol. II

WE MAKE LASTING IMPRESSIONS



WARNER BROS.
ELEKTRA/ASYLUM
ATLANTIC RECORDS

COMPACT digital audio DISCS

Enter No. 24 on Reader Service Card

"The 20-year-old engineering holds up remarkably well on Getz/Gilberto, a landmark recording on CD."

tasia Suite," we are told that Paco is on the left channel, John is on the phantom middle channel, and Al is on the right channel.

Unquestionably a fine recording of its type, but I find it hard to digest all that guitar music in one dose!

Bert Whyte

**Man with the Horn: Miles Davis.
CBS DP-16.**

Miles Davis, the *Man with the Horn*, wrote and arranged all but two numbers on this CD.

This is typical Miles Davis, surrounded by some good sidemen, and to-

gether they blow up quite a hard-driving, punchy brand of jazz. There is heavy emphasis on Fender bass and drums, which are very cleanly reproduced on this CD. Miles plays a muted trumpet on most of the selections on this recording. In fact, he uses open trumpet in just one number.

Good overall sound, robed in selective reverb, and while dynamic range is limited, it does serve to hide the residual hiss of the analog original. A treat for devotees of Davis. *Bert Whyte*

Most of your present record library will never reappear as digital discs.

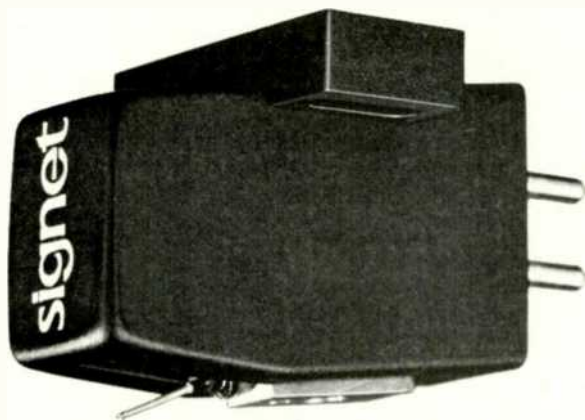

With the Signet TK10ML you probably won't care!

Until you hear the Signet TK10ML, you may not fully appreciate how superb today's analog recordings can be. And how little may be gained by going all-digital.

The single most significant advance in the Signet TK10ML is its unique new *MicroLine*™ stylus ... with the longest, narrowest "footprint" ever achieved! Its scanning radius is a mere 2.5 microns, half that of the best ellipticals, while its vertical contact footprint is *three times longer* than the elliptical. The Signet *MicroLine* stylus tracks very high frequencies better—at lower groove pressure—than any other design.

Even with repeated playings, the *MicroLine* stylus maintains its shape, without "spreading" like all other tips.

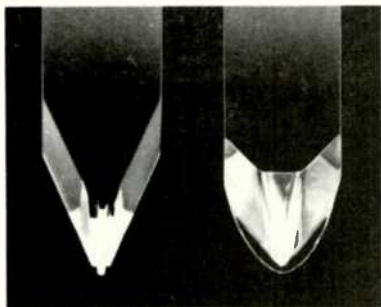

So grooves sound new, long after other styli are threatening irreparable damage to your record collection.

Each Signet TK10ML *MicroLine* stylus is created from a whole, natural octahedral diamond, oriented for longest life, and with a square shank to precisely fit the laser-cut hole in our unique, ultra-rigid low-mass boron cantilever. You get perfect alignment. Period.

But the proof of quality is in the playing. With the new Signet TK10ML, older records literally come back to life. New records transcend the limits of ordinary technology. Your entire system gets a new lease on life.

Visit your Signet dealer. Peek into his microscope to see this fantastic stylus. Then get the *real* proof. Listen.



SIGNET, 4701 HUDSON DRIVE, STOW, OHIO 44224

**Getz/Gilberto: Music of Antonio Carlos Jobim.
Verve 801 048-2.**

Dating from 1963, this is the classic recording that ushered in the Bossa Nova era in pop-jazz. This was a refreshing trend, and many of its elements are still with us today. You may remember this series on Verve because of the flashy, Rouault-like paintings of Olga Albizu which were used as cover art.

There is a refreshing simplicity to the music-making; nothing seems planned or studied. The 20-year-old engineering holds up remarkably well. Congratulations to Polygram for putting this landmark recording out on CD. May there be others, please?

John M. Eargle

**Mozart: Symphonies Nos. 40 & 41.
The Bavarian State Radio Orchestra,
Kubelik.
CBS/Sony 38DC 5.**

The warm, glowing sound of this recording should dispel the notion still held by many audiophiles that digital does something bad to strings. The balance between the orchestra and the room is just about ideal, and Kubelik's easygoing approach is appreciated in this age of so much frantic Mozart playing.

John M. Eargle

**Handel: The Water Music (complete).
The Los Angeles Chamber Orchestra,
Schwarz.
Delos D/CD 3010.**

All three suites are presented here in the accepted Schwarz style: Brisk without being rushed, and not a trace of anything academic. The ensemble

While history has been repeating itself, we've been busy working on the future: perfecting the best color video picture there is.

In fact, the Proton 600M Monitor below was rated "the best we've tested" by *Video* magazine. For good reason.

From its inception, Proton Video was designed to deliver more resolution, greater detail, more broadcast image, more depth and correct shapes. For a picture of outstanding color and clarity. With *two separate* audio and video circuits to make picture *and* sound the best they can be.

Ask to see our pure black television receiver/monitors, matching video components and speakers at your nearby Proton Dealer. For his location, call us toll-free, 800-772-0172. ©1983 Proton Corporation. 19600 Magellan Drive, Torrance, California 90502.



Sony® is a registered trademark of the Sony Corp.

SORRY, SONY

"Many of the major labels who have tried *Carmina Burana* in recent years will hang their heads in shame when they hear this CD."

is lean, and intonation is impeccable. Courtesy of the conductor, we hear a good bit of ornamentation in the brass instruments that will come as a pleasant surprise to many listeners. My personal taste runs to this kind of playing of baroque music, as opposed to the performances by early groups who

make use of instruments of the period. This is often the excuse for faulty, less-than-virtuoso playing and a studied approach to the music. With Schwarz and the Los Angeles Chamber Orchestra, you will always hear it with vigor and accuracy.

The recording was made in the

Bridges Hall of Music at Pomona College, with its intimate but warm ambience.
John M. Eargle

Orff: *Carmina Burana*. The Atlanta Symphony Orchestra and Chorus, Robert Shaw. With the Atlanta Boy Choir; Judith Blegen, soprano; Hakan Hagegard, baritone; William Brown, tenor.

Telarc CD 80056.

This is doubtless the finest *Carmina* available. As I understand, the choral resources were separately miked at their position behind the orchestra, but this in no way runs counter to Telarc's basic three-microphone preference. The result is a balance of chorus and instrumental resources that is perfectly natural and in which all details are clear. Many of the major labels who have tried their hands at this work in recent years will hang their heads in shame after they hear Telarc's CD. This one wins hands down, primarily for Shaw's choral professionalism and the quality of soloists. There is an added bonus. You might recall that the LP version required two discs, because of the length. Here, the playing time of about 55 minutes is comfortably contained on one CD. *John M. Eargle*

Beethoven: *Symphony No. 5*. The Boston Symphony Orchestra, Seiji Ozawa.

Telarc CD-80060, \$17.95.

Beethoven: *Symphony No. 5*. The Staatskapelle Berlin, Otmar Suitner.

Denon C37-7001, \$17.95.

Two contrasting views of the Beethoven 5th Symphony. I would rate Ozawa and the Boston Symphony at 100 proof, while Suitner and the Staatskapelle Berlin are a somewhat less potent 86 proof.

In the first and second movements, Ozawa and Suitner are within seconds of each other in respect to tempo. However, in the two allegro movements of the "Finale," which are played without pause, Suitner's performance is much slower paced, being more than five minutes longer than that of Ozawa. Thus, Suitner takes a more structured and traditional view of this great work, while Ozawa opts for the more dynamic approach, and his propulsive momentum is only possible

FOR THE SHEER LOVE OF MUSIC

The Linn Sondek

The master link in a delicate chain of superb sound retrieval. A turntable of such remarkable distinction that it can transform recorded sound, and enrich the capabilities of your entire system.

Linn Sondek. It must be heard.

We wish you the best.



For further information contact:
AUDIOPHILE SYSTEMS LTD., 6842 HAWTHORN PARK DRIVE,
INDIANAPOLIS, INDIANA, USA 46220
ALDBURN ELECTRONICS LTD., 50 ROLARK DRIVE,
SCARBOROUGH, ONTARIO, CANADA M1R 4G2

"The quality of this Tchaikovsky disc lays a convincing mantle of credibility over the whole CD process."

with a superstar orchestra. The Staatskapelle Berlin is a fine orchestra, but it can't quite match the Boston Symphony in refinement of playing, especially in respect to intonation. The Denon recording is quite good, with warm, spacious acoustics coupled with good orchestral definition. String tone is clean, albeit slightly on the bright side. There are some marvelously hushed pianissimos in the pizzicato sections of the first allegro of the "Finale." Telarc has the splendid acoustics of Boston Symphony Hall. Here the sound is slightly more close-up, with plenty of definition. String tone is very clean, but also a tad on the bright side. Telarc's tympani are better focused, cleaner, and more articulate than on the Denon recording. On the other hand, those fiendishly difficult contrabass passages in the third movement are well delineated in the Denon recording, and the playing is of very high order in both orchestras. The Telarc sound is very clean, orchestral balances are excellent, and dynamic range is very wide. Ozawa gives a taut, exciting reading, and with the precision and elan of the Boston playing, this is great music making. The overture to *Egmont* is a bonus filler on this CD, and this piece receives a bravura treatment. Suitner's performance is very well done, and will appeal to those who like a more traditional approach to this music. *Bert Whyte*

Tchaikovsky: Nutcracker Suite, Romeo & Juliet. The Cleveland Orchestra. Maazel.

Telarc CD-80068, \$17.95.

Playing this CD recording of Tchaikovsky's "Romeo & Juliet" and the "Nutcracker Suite" is a sheer delight and is extremely reassuring. How so? Because the quality is so high, the sound so splendid, that it lays a convincing mantle of credibility over the whole CD process.

Yes, it is that good! Telarc's Jack Renner found that magic combination which makes for a great recording. The reverberation time of Masonic Auditorium in Cleveland allowed for a most judicious placement of the orchestra in the hall. The precise positioning of the three spaced-array omnidirectional Schoeps microphones completed the equation. These three elements com-

bined synergistically to produce that elusive blend of warm, spacious acoustics and orchestral definition which most closely simulates the concert-hall listening experience.

In "Romeo & Juliet," and in the "Nutcracker Suite," the string sound is smooth, sweet, and musical without a

trace of edginess. Not a hint of coarseness mars the smoothness of the woodwinds. Brass is what brass should be—bright, brazen, richly sonorous and well-projected. Percussion is crisp, clean, and controlled, with great weight and impact. Dynamic range is given full expression and, in "Romeo &

All This For Under \$300?



The NAD 7125 RECEIVER gives you:

- digitally synthesized tuning—for accurate reception of your favorite stations
- state-of-the-art phono preamp—provides ultra-quiet playback for your records with any cartridge
- below 2 ohm capability—assures that you can use any speaker with your system
- 3 dB of dynamic headroom—plenty of power for even the newest digital discs
- bass EQ—helps small bookshelf speakers create satisfying deep-bass response

Before you spend more than \$300.00 on any receiver or amplifier/tuner combination, be sure you hear the NAD 7125. We know of no other receiver in or close to its price range that audibly outperforms this remarkable component. Because of its low price, the NAD 7125 can serve as the centerpiece of a budget system that offers true state-of-the-art performance.

For more information and a list of our dealers, send us this coupon.

Name _____ State _____ Zip _____
 Address _____
 City _____

We make high-end audio affordable



NAD (USA), INC., 675 Canton Street, Norwood, MA 02062

"Typical Santana—a plethora of percussion, heavily oriented to the Latin style, with spirited and upbeat playing."

Juliet," the noiseless pianissimos are as impressive as the orchestra in full cry, with thunderous punctuations of the bass drum. With the intelligent use of the three mikes, the various parts of the score are well delineated. A harp can be heard in its proper perspective—no need to assign a separate mike to it. Similarly, the dark sonority of the contrabasses comes through without the aid of spotlighting microphones. Perspectives stay natural and the sense of reality is heightened.

As a bonus to all this, there are the excellent performances of Maazel, and the superlative playing of the great Cleveland Orchestra. *Bert Whyte*

Shango: Santana.
CBS CK38122.

Here is a typical Santana recording—a plethora of percussion, heavily oriented to the Latin style. As usual, the playing is very spirited and upbeat with emphasis on the rhythmic aspects.

Carlos Santana



Also, as usual with rock, the music is new to me.

For some reason, the title piece, "Shango," is the last number on the disc. The sound is a good example of a contrived studio product—in this case, the work of the well-known Automat in San Francisco. Every number has lots of punch, sharp transients, and selective reverb and EQ, which makes for some interesting effects. However, the arrangements make frequent use of the fuzz-box, something that is anathema to me. I still insist that eliminating this noxious instrument

would make pop/rock music more accessible. *Bert Whyte*

Tchaikovsky: 1812 Overture, Capriccio Italien, Cossack Dance from Mazeppa. The Cincinnati Symphony Orchestra, Erich Kunzel.
Telarc CD-80041.

Well, at least your tracking problems are over. The laser won't skip, but your amplifiers might clip or do something worse. Watch the playback setting carefully on this one; the average levels are low, and there will be a tenden-

DBX INTRODUCES NOTHING FOR LESS.



The new NX-40. It eliminates noise and tape hiss at an unheard of price.

Only \$129.

The NX-40 virtually eliminates the noise a built-in Dolby* system merely reduces.

It also records and reproduces a wider dynamic range than other noise reduction systems, matching the full range of digital recordings.

So instead of recording noise, try recording music.

The new NX-40. Nobody gives you less for less.

For literature on the new NX-40, call or write: dbx, Incorporated, 71 Chapel Street, Newton, MA 02195. (617) 964-3210.

*Dolby is a registered trademark of Dolby Laboratories Licensing Corporation.



Music can't live without us. **dbx**[®]

"Too bad about the engineering, because once again Suitner turns in a really worthwhile performance."

cy to crank up your system. But follow the label's warning and do this in steps. If you have the headroom in your loudspeakers, along with adequate power, you'll hear those cannon shots as never before.

The LP version has not lost its appeal over the years as a demo disc at various audio shows, etc., and the CD version will give the music new life for this application, inasmuch as everyone will now have access to the digital original.

John M. Eargle

Music of Holst, Bach and Handel.

The Cleveland Symphonic Winds, Fennell.

Telarc CD-80038.

Many of you will remember this as the recording which introduced Telarc to the world back in 1978. In particular, the beginning of the March movement of Holst's Suite in E-flat created quite a stir with its whopping bass drum whack, which most major labels would have mercilessly attenuated. This disc was followed shortly by the famous Atlanta recording of the "Firebird," and Telarc was off and running.

The music holds up extremely well and is played with the panache which Fennell has always given to wind music, from the early Mercury Eastman recordings onward.

John M. Eargle

Beethoven: Symphony No. 3, "Eroica." Staatskapelle Berlin, Otmar Suitner.

Denon 38C37-7011, \$17.95.

Here is another in the series of Beethoven symphonies recorded by Denon with the Staatskapelle Berlin conducted by Otmar Suitner.

This is one of a very puzzling group of recordings. One would presume that the same recording engineer and the same techniques would be employed for the entire series, but the inconsistency between the various symphonies is considerable. As reviewed in past months, the Beethoven 5th and 6th Symphonies were excellent recordings, with generally good balances and clean sound. However, the Beethoven 7th was not at all satisfactory, and I wondered if the engineering team was different from that used on the 5th and 6th Symphonies.

This "Eroica" has many faults, not the least of which is rather thin, quavery-sounding first and second violins with a decidedly unpleasant edginess. There were times when I detected obvious distortion in the strings and in the woodwinds as well. The acoustic perspective on this CD also seemed com-

pressed as compared to the 5th and 6th Symphonies. Too bad, because once again the relatively unknown Mr. Suitner turns in a really worthwhile performance and the orchestra plays exceptionally well. Something obviously must have gone amiss here, or I may have a defective copy.

Bert Whyte

ALLISON

FIRST IN TECHNOLOGY

Allison has earned an international reputation for accuracy in reproducing the sound of live music.

Superior technology is one reason for its recognition. Much of the technology stems from our own fundamental research; we hold the basic patents on Foom-Matched design.

For example, we've learned that the response of every speaker changes dramatically with its position in the room.

For flat response in your room, therefore, the speaker must be designed for use where you intend to place it. We offer several different Room-Matched models, each optimized for one general location.

We also make available three distinctly different cabinet styles: The Traditional Series, the Designer Series (shown), and the low-cost Series 100.

For information write or call Allison Acoustics. Toll free 1-800-225-4791. In Massachusetts 617-257-2670. Allison Acoustics Inc., Seven Tech Circle, Natick, MA 01760.



NAME _____
 STREET _____ CITY _____ STATE _____ ZIP _____

ROCK/POP RECORDINGS

JON & SALLY TIVEN
MICHAEL TEARSON

TURNTABLEAUX

Word Jazz: Ken Nordine and The Fred Katz Group
MCA-1551, \$5.98.

Sound: A- Performance: A+

Reissues seldom merit notice in these pages, but this one sure does. *Word Jazz*, first issued in 1957 and decades out of print, features Ken Nordine, perhaps the greatest artist of the skewed and bizarre world of television and radio commercials. His voice, usually coupled with strange and dazzling visuals, has, for many years, sold you Levi's, Taster's Choice coffee, Gallo wines, Fab detergent, and countless other products.

There were four *Word Jazz* albums on Dot Records back then. In that space Ken had the opportunity to give his whimsy and imagination an open throttle, and he spun some incongruous, often funny, sometimes sad tableaux. "The Sound Museum," for instance, takes you on a visit to a museum of sound paintings, each one behind a colored door that Ken describes just before opening it to let us hear what is beyond. He also gives some insights about the purported artists of the paintings. (Special mention must go to engineer James Cunningham, who crafted the sound collages. Ken

credits him by name during the bit, and he richly deserves it.) "What Time Is It?" is the story of a practical joke victim. Someone calls up at 2:00 a.m. to ask what time it is, and when the calls stop coming, the victim has to wake up and blurt out "It's 2:00 a.m.!" before he can sleep. Then he discovers his true obsession with time and... well, more would be telling. "Hunger is from" is about getting hungry in the middle of the night (I especially love when Ken eats the leaves of the celery). Perhaps best of all is the parable about fame, "Flibberty Jib," which years later became the basis for Ken's first spot for Levi's, the one that started "One day a pair of blue jeans came into our town...."

The musical backings to Ken's words came from the wonderfully creative Fred Katz Group, which included the very young Paul Horn on woodwinds.

But this is Ken Nordine's album. His voice is an awesome instrument of amazing emotional range, from light-hearted to gravely sonorous. His vision is startling and fresh, even more than 25 years after these recordings were made.

In fact, how well *Word Jazz* wears the mantle of time is the most surpris-

ing aspect of the reissue. Most spoken-word albums, especially comedy, lose a lot when separated from the times which produced them. Nordine's *Word Jazz* is remarkably free of references to things lost in time. It really is timeless material. And finding this treasure back in print, with original liner notes intact, is wonderful. Now, MCA, the gauntlet is thrown for you to do your stuff on the other three albums.

By the way, Ken, how are things in your town?
Michael Tearson

Lawyers in Love: Jackson Browne
Asylum 60268-1, \$8.98.

Sound: B Performance: C-

I had already completed my review of *Lawyers In Love* when, during a subsequent listening, a line from Jackson Browne's "The Pretender" came rocketing back at me, changing my whole perception of this album. It was that line about the missing colors in paint-by-numbers dreams, and I thought, "Damn, this album is paint-by-numbers songs."

What I had written about as typically sincere/austere songs, look, through the looking glass of that line, like formula constructions, not a whole lot unlike Journey. Jackson Browne has always focused songs on the turning points of relationships, the moments when commitment is either made or broken. And he is still doing it on *Lawyers in Love*, with songs about the day you fall in love and the day your heart is so broken you want to cut it out, all stuff covered extensively in his previous album, *Hold Out*.

What is new this time is the energy Jackson brings to the album's side-closers, "For a Rocker" and the cityscape song "Downtown." These two show more spunk and punch and fun than anything else on the record. And as a satire, that title song is still somewhere between silly and inane but is fun in a goofy, clunky way.

The production of the album by Browne and long-time collaborator/engineer Greg Ladanyi is standard California squeaky clean, but with more bite than Jackson usually allows. Especially much more than the very mannered sound of *Hold Out*.

As you keep maturing (read that as aging), it can easily get harder to tap

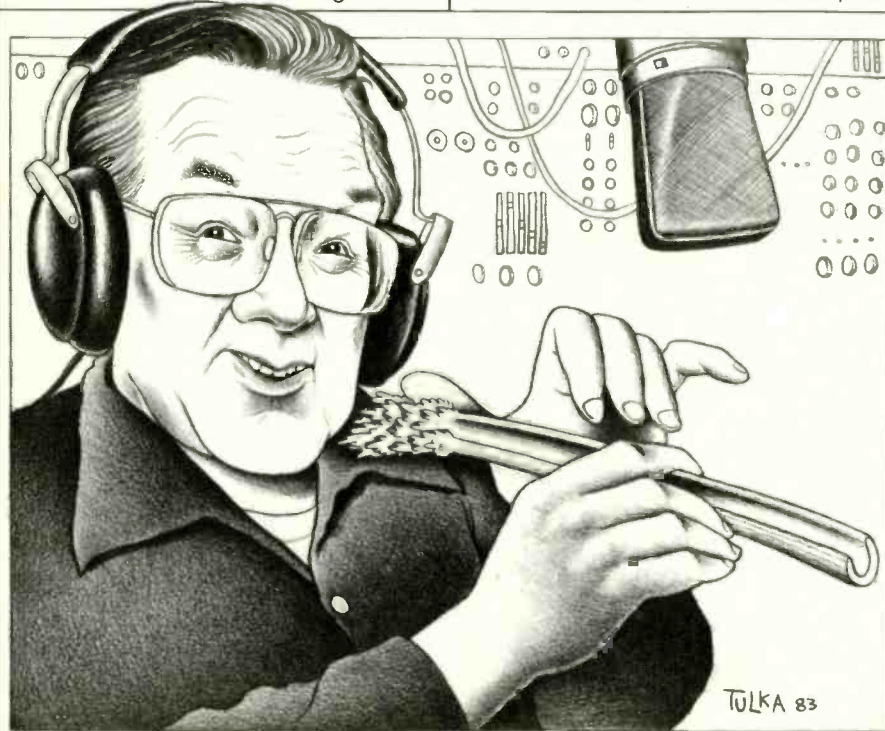
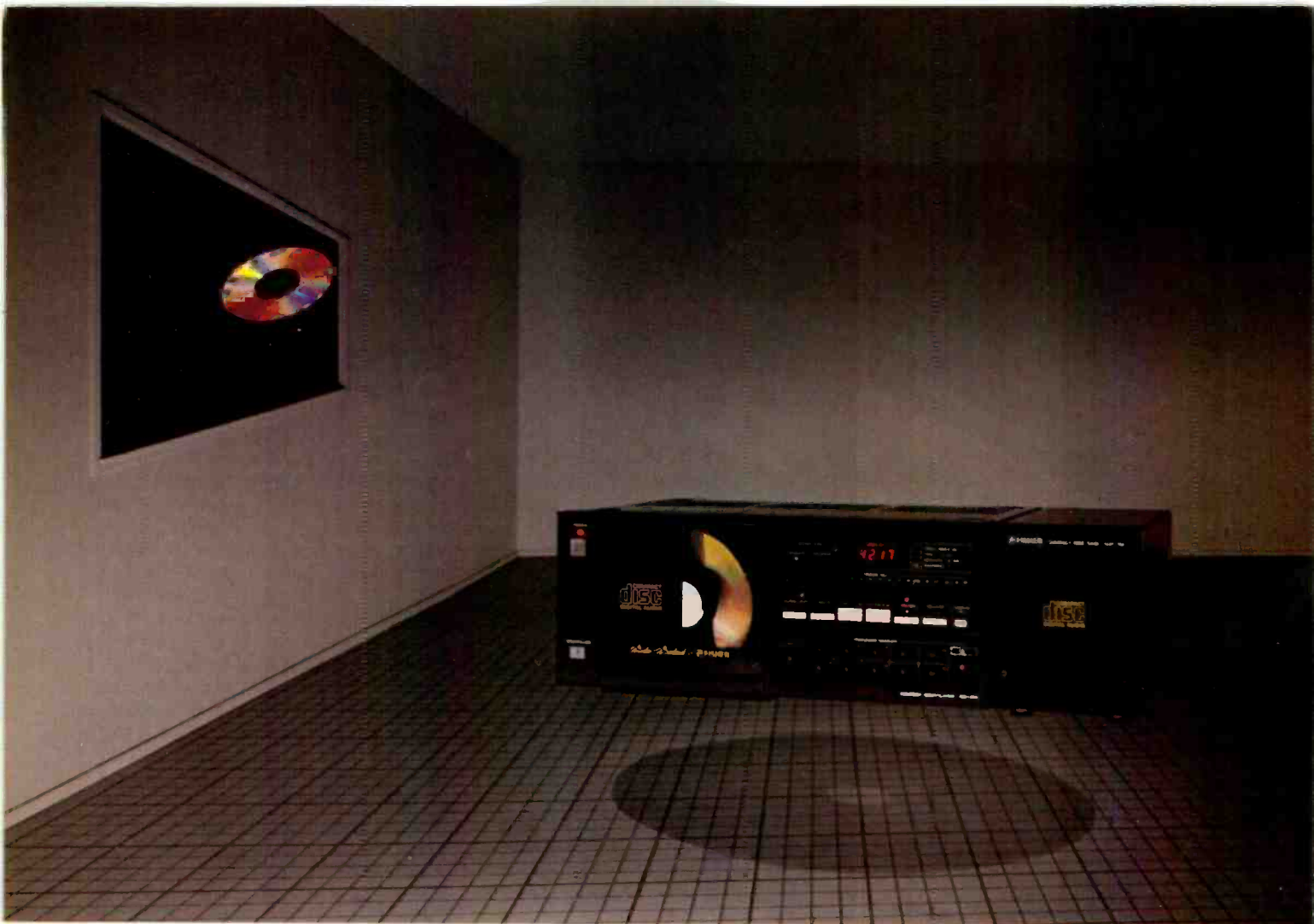

Illustration: Rick Tulka



THE STATE OF THE ART HAS JUST BEEN ELEVATED.

In 1937, Fisher introduced high fidelity. And changed the world.

This year, Fisher has taken another step into the future to produce perhaps the highest fidelity ever.

The AD850 Compact Digital Disc Audio Player.

It utilizes the latest space-age technology to produce a degree of sonic perfection that's almost inconceivable.

A laser beam scans the computer-encoded surface of an encased disc to pick up audio signals and deliver them through a digital filter.

Since nothing touches the disc, surface noise and wear-out are things of the past. The 60 minutes of playback on each 4 $\frac{3}{4}$ " disc is reproduced at the original digitally recorded specifications almost indefinitely.

And as both player and disc offer dynamic range of more than 90 dB, the sound is almost indistinguishable from a live performance.

As well as perfecting its reproduction, we've also endowed the AD850 with the most sophisticated features and virtually faultless human engineering. Via soft-touch controls, you have instant command of random access, sample scanning, auto-search plus pre-programmed automatic playback.

But perhaps the AD850's most convenient feature is synchronous recording. Used with compatible Fisher components, it makes recording a simple pleasure.

In spite of all this advanced technology, the front-loading AD850 will fit most of today's rack systems. Once there, we're confident you'll find your entire hi-fi system taken to levels you've never imagined.

Let alone experienced.

 **FISHER**
THE ULTIMATE EXPERIENCE.



**RESOLUTION:
"the ability to
bring details
into focus"**

Resolution. Focus. Clarity. Whatever you call it, the meaning is the same. Hearing subtle nuances; hearing the spaces between the sounds. Don't settle for less than you deserve. Spica's new TC-50 speaker has it. You can too, for about half of about what you'd expect to spend. Of course, you could choose to live without it. But why would you want to?

SOUND COMPANY
3675 Sports Arena Blvd.
San Diego, Ca 92110
(619) 244-2844
5079 El Cajon Blvd.
San Diego, Ca 92115

spica
HIGH RESOLUTION LOUSPEAKERS

2886-A TRADES WEST RD
SANTA FE, NEW MEXICO
505-471-7728
TELEX 296480 SPICA UR



Jackson Browne

into that muse that lets you wildly spew out songs as a youth. It happened to Bob Dylan after his celebrated motorcycle accident following *Blonde on Blonde*. He has said that he had to learn to do consciously what he had always done instinctively until that time. Something similar might have happened to Jackson Browne.

And then there are times when, muse or no, you just don't have a lot to say. I think *Lawyers in Love* is one of those albums. *Michael Tearson*

The Principle of Moments: Robert Plant

Atlantic 7-90101, \$8.98.

Sound: B Performance: B+

When Led Zeppelin died, it seemed highly unlikely that Robert Plant would rise like a phoenix from the ashes and become the world's foremost hard-rock singer, but indeed he has. Zeppelin had seemed to belong to Jimmy Page, since he'd been the man in charge of production, songwriting, chores on the lead instrument, and group business. You would have expected that Page would have been the one to continue the Zeppelin lineage. Instead, Page has strayed from the limelight, indulging in the occasional soundtrack and jam, while Plant has assembled a group which seems to have little trouble creating a rock sound not far removed from that of Led Zeppelin's *Physical Graffiti* days. This is no small accomplishment; it took Billy Squier four albums.

With nary a nod to the so-called new music (and for that we're grateful), Plant does his best to approximate the good ol' Led Zep sound. Despite a few handicaps—the drums by Phil Collins

are nowhere near Bonham's and the songs are structurally weak—this LP still delivers *The Voice* and an imitation of *The Guitar* so that the entire sound isn't far removed from its now-outdated model.

Robbie Blunt does a cleaned-up Page impression, heavy on the Eastern scales, that's longer on technique and shorter on fire than the standard whose shoes he's trying to fill. But Blunt's fluid playing is an apt backdrop for Plant's crooning. No screaming blues on this album. In fact, side two gets nearly contemplative in mood, with its Spanish guitar flourishes, minor chord progressions, and meandering vocal melodies. Still, rock 'n' rollers should be happy with the more driving numbers, "In the Mood," "Messin' with the Me-kon," and "Wreckless Love," which show that Plant isn't too old to crank it out. *The Principle of Moments* is a successful musical outing that proves the man's instincts—to explore the context of his tried-and-true sound rather than attempting a fling at current musical styles. Right on the mark, and on the money, judging by the record-buying public.

Hearing this sound again, one is reminded of Zeppelin's greatness—no matter what chord structures were dictated, they would throw in the weird note. Regardless of how heavy they played, they would be making a musical statement. The problem with most current heavy-metal groups is that they strictly adhere to form but have no content. Plant has enough sense to continue to push the borders of rock music. Of all the Jimmy Page students, Robert has done his homework the most dutifully. This first-hand transfer of information has no substitute, and Plant might even get an A next time.

Jon & Sally Tiven

Back It Up; Robin Trower
Chrysalis FV 41420, \$8.98.

Wonderland; Nils Lofgren
Backstreet BSR-5421, \$8.98.

Sound: A- Performance: B+

These two fellas come from an age when the lead-guitar player was every young musician's model. But that era has come and gone, and Trower and Lofgren have both faded in popularity.

Their flirtations with less straight-ahead rock and semi-obscure projects turned their audiences over to the next contenders. Although these guys are still respected vets on a dying scene, they've got to try extra hard to remain the reigning Stratocaster Masters. Each of them is now aiming his power trio at the heart of Middle America; perhaps this is why each of these albums is so good—they sound a little hungry.

Trower has been dismissed as a mere Hendrix copycat, and the resemblance of their tonality is more than mere accident. However, the sound of the Trower Band—fronted by Paul Rodgers-clone Jim Dewar—has a distinctive characteristic that rates a place of its own. Trower's guitar technique has grown over the years, and this album features some of his best playing since *Broken Barricades*. His songwriting isn't always the greatest—too often he's merely paying tribute to *Cry of Love* period Jimi—but on a song

like "River," the band can stretch out and sound positively inspired. As far as being a showcase for his guitar work, *Back It Up* could well be his best album to date, certainly miles ahead of his collaborations with Jack Bruce.

Nils Lofgren is of a slightly more recent vintage, as his guitar rabbi is Keith Richard. He's also absorbed some of the more mainstream British influences (such as The Pretenders' late, great, and underrated Jim Honey-moon Scott) and is a bit more serious about his songwriting. Whereas Trower seems to approach writing as something one has to do to finish a record, or a jam that a singer can throw lyrics onto later, Lofgren tries to make the songs themselves count. After a bevy of truly stinko albums, Nils has made a record worthy of his guitar ability. He still isn't the world's greatest singer, but he's better than bearable, and his band (featuring legendary drummer Andy Newmark) rocks their arses off. Songs like "Across the Tracks," his



Robin Trower

version of "It's All Over Now," and "I Want For You" show that he's still got something special inside him. Lofgren really makes the guitar scream—few know their way around the guitar's harmonics the way he does—and he projects a positive persona without being too sticky. We had almost given up on this guy, but right now he sounds like he's just waiting to happen, and we hope it ain't too late. *Jon & Sally Tiven*

THE 600 SERIES STATE-OF-THE-MIND TECHNOLOGY

30 years ago Harman Kardon introduced the world's first high fidelity receiver. It was built on the philosophy that quality audio must evolve from quality state-of-the-mind thinking.

Today, the 600 Series Integrated Amplifiers and Tuners represent the highest level of state-of-the-mind thinking. This is typified by the fact that the 600 Series Amplifiers have been designed with as much as 60 Ampe of High instantaneous Current Capability (HHC). HCC eliminates dynamic distortions by providing the current needed to properly drive your loudspeakers. The 600 Series also combines low negative feedback for immeasurable TIM distortion, Ultrawideband frequency response for the elimination of any audible phase



shift, and a unique active/passive phono circuit for precise transient response. Together, these features deliver louder, cleaner sound than any other integrated amplifier of equal or often greater power ratings.

Any 600 Series Amplifier is a perfect match for

either the 600 Series Analog or Digital Tuner.

So, while other manufacturers continue to pile on unnecessary features and gimmicks, Harman Kardon continues to fine tune the basics and develop fundamentally advanced audio equipment.

The 600 Series: Amplifiers — FM660, PM650, PM640 — Tuners — TU615 Digital, TU610 Analog

harman/kardon

Our state-of-the-mind is tomorrow's state-of-the-art.

"It's hard to conceive of Asia setting out to make music this bombastic and boring when they have the talent to do otherwise."

Alpha: Asia
Geffen GHS 4008, \$8.98.

Sound: C+ Performance: D-

Incorporating the worst elements of today's corporate-rock bands, Asia sounds like Brian May's worst nightmare of what Queen would sound like

if they got any more ponderous and pretentious. By comparison, Boston is street-level, gut-wrenching punk rock.

In all fairness, Asia owes more to Barry Manilow than anybody else, as John Wetton's plaintive vocals are somewhere in between Greg Lake and That Man Manilow. Wetton's former

compatriots (from King Crimson, Family, and a host of other well-respected Britbands) must be falling down laughing at this stuff, whilst kicking themselves in the pants for not putting the guy up front and taking the money.

Second most heinous offender is keyboardist Geoff Downes, who left The Buggles (a relatively progressive pop band) to co-write this synthetically-orchestrated dreck. Carl Palmer was heavily in debt pre-Asia, so one can pardon his participation or at least understand his motivation. Steve Howe, on the other hand, is a talented and respected player who shouldn't have to condescend like this just to pay the bills—unless he got totally screwed while in Yes, which is a possibility. We'd hope that Palmer and Howe are gritting their teeth and counting their money more carefully this time.

As for how *Alpha* stacks up, no one could do worse lyrics than on their debut—but they've come close. "I would never leave you, I would never go, I would never leave you, Never in a million, Never in a million, NEVER IN A MILLION YEARS" (capitalization not our own). There's no trace of any musical influence by any new music, black music, or, for that matter, any other good music. The album is more of a testament to how bad mass-appeal music can get.

It's hard to conceive of someone setting out to make music this bombastic and boring when they have the talent to do otherwise. But Asia isn't a band that's about music, but a band that's in business. And business usually isn't much fun to listen to. *Jon & Sally Tiven*

The Final Cut: Pink Floyd
Columbia QC 38243.

Sound: A Performance: D

The Final Cut has brilliant production values, astonishing sound replete with Holophonics by Zuccarelli Labs, and the most turgid, least memorable cycle of songs Pink Floyd has ever done. For the last, place the blame squarely on Roger Waters, writer of *The Wall*. *The Final Cut* is an anti-war tract that is so depressive and oppressive it makes *The Wall* seem like a garden party in May.

Technologically the album is abso-

Acoustat electronics bring you dramatically closer to the musical source with startling innovations in solid state technology. Now the limits of bipolar transistors have been overcome with a fundamentally new FET topology to bring you "tube-like" sound that is astonishingly transparent and pure.

**TRANS-NOVA®
PREAMPLIFIER**

Designed to meet the demands of today's audio/video and digital applications, Acoustat's Trans-Nova Preamp is exceed-

ingly neutral yet versatile. With moving coil capability and a vast array of switching functions, the Trans-Nova preamp contains features not normally found in an audiophile preamp while preserving the sonic integrity of the signal path.

**TRANS-NOVA® TWIN-200
POWER AMPLIFIER**

Two hundred watts per channel never sounded so pure and clean. Unique complement feedback circuitry provides zero output stage distortion and true "dual-mono" construction yields

excellent dynamic range and stereo separation. Complex loads are comfortably handled due to infinite damping in a revolutionary output stage design.

HEAR FOR YOURSELF

Find out why the most demanding audiophiles choose Acoustat speakers and electronics for musical enjoyment that is unequalled at any price. Perhaps in time all components will be built this way. Until then, call toll-free for the name of the Acoustat dealer nearest you.

The Musical Source



ACOUSTAT
SPEAKERS ELECTRONICS

Revolutionary by Design

3101 Southwest First Terrace
Fort Lauderdale, FL 33315
Telephone 305/462-6700
(Toll Free 800/327-3136)

"*The Final Cut* is an anti-war tract that is so depressive and oppressive it makes *The Wall* seem like a garden party in May."

lutely state of the art, as Pink Floyd albums traditionally are. The sound is extra clean and, with the Holophonics, more than feels "in the room." Occasionally it gives some feeling of added depth of field. Special effects take on excellent verisimilitude as well, things like the shattering explosion at the opening of side two and the almost subliminal spoken passages of news broadcasts hidden in the mix. A fact sheet notes that the Holophonics are lost in FM broadcast transmission due to the compression most FM stations use to process their sound, and thus to be heard properly the album must be played in the home. All this makes *The Final Cut* a wonderful album on which to test a system.

What it isn't is a satisfying and engaging musical experience. Waters' music is virtually devoid of melody and energy. No song leaps out from the flow until "Not Now John," placed next to last on side two, and for radio this song faces severe language problems, such as repeated profanities. *The Wall* may have been awfully depressing, but at least it was full of memorable songs sprinkled liberally throughout four sides. *The Final Cut* is quite free of them.

Obviously, the reports of Pink Floyd's final demise have not proved true. One member, Richard Wright, has departed due to "musical differences." The band has announced intentions of a more active posture—more frequent albums and even touring, which surely gladdens longtime fans.

As a "comeback" album, however, *The Final Cut* is a surefire, long-term dud.

Michael Tearson

Joey Harris & The Speedsters
MCA 39006, \$6.98.

Sound: B+ Performance: B

Joey Harris' debut album manages to convey a fair amount of earnest emotion and talent, and it could easily be the most interesting debut album by an MCA artist, with the possible exception of Elton John.

Though musicians aren't properly credited, it's the same bass, drums, keys, and vocals/guitar setup that you find in many contemporary rock

The leader in equalizers still stacks up best with improved specs, more features and a new look.

ADC's new line of Sound Shapers® prove that the best just got better. Again. Our stereo frequency equalizers incorporate the superb electronics, reliability, and high performance technology that have made ADC famous. Plus we've improved them with new refinements that offer you more control and a new design that makes them look as good as they function.

Our top-of-the-line SS-315 offers a unity gain of +1 dB and the best signal-to-noise ratio in the industry. For the utmost in versatility, the range of each frequency control is an extra wide +15 dB, far more than the 12 dB of lesser equalizers. Tape monitoring and two-way dubbing capabilities for two decks are available. LED indicators for each control let you see the selected frequency curve at a glance. The SS-315 includes a built-in real-time spectrum analyzer, pink noise generator and calibrated electret microphone enabling you to attain flat response in minutes. Other features include external noise reduction and sound processor loops to accommodate time-celley, subharmonic synthesizer, dynamic range expander or reverb units. There's also a subsonic filter that gets rid of damaging, power-robbing subsonic frequencies.

The other models in our Sound Shaper line offer the same fine ADC quality, with similar features geared to your equalization and budget needs.

If you've been waiting for the right stereo frequency equalizer for your system, don't wait any longer. With ADC Sound Shapers, the odds are stacked in your favor. (And if you're into video, be sure to see and hear what our new ADC Video Sound Shapers can do to improve your video performance.)

Sound Shaper® Frequency Equalizers

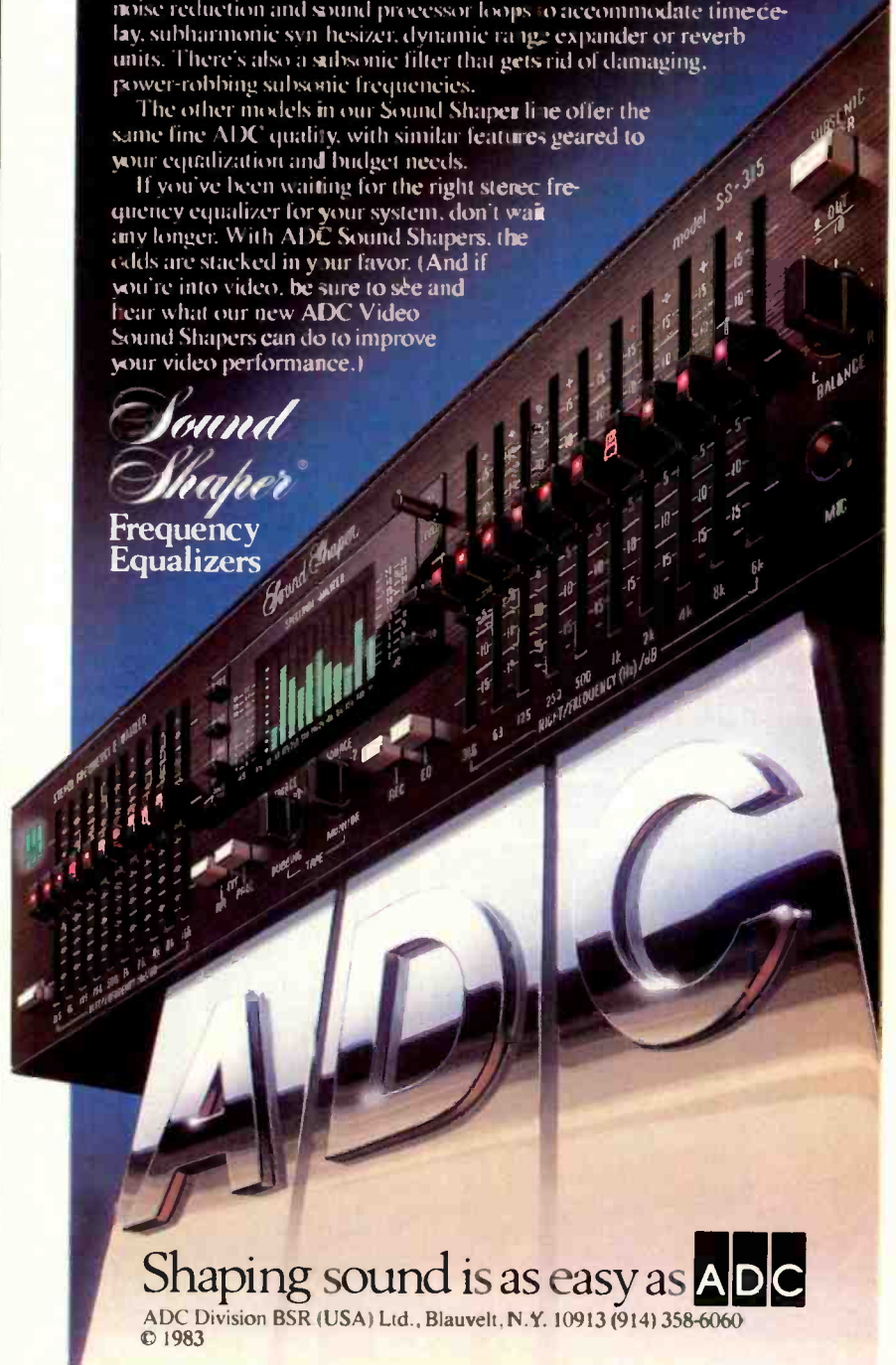

Shaping sound is as easy as **ADC**

ADC Division BSR (USA) Ltd., Blauvelt, N.Y. 10913 (914) 358-6060
© 1983



Elvis Costello

bands. Harris' most noticeable influence in terms of singing style and songwriting is Elvis Costello, but his approach is much more mainstream and better focused than recent Elvis. Lyrically, he isn't nearly as thoughtful, but songs like "Two People Talking" and "Do You Want To" show a knack and a style with much promise. Besides, he's an Australian, and America's current love for Aussie-rock shows no sign of dropping off.

Jon & Sally Tiven

Punch the Clock: Elvis Costello & The Attractions

Columbia FC 38897.

Sound: C— Performance: C

Okay, Elvis has failed to come up with the goods from time to time (witness *Trust*) because he's continually looking for a hit in America. When you

get down to it, this search for the Top 40 success is the major conflict in this guy's life. He makes album after album that the critics love, but the public buys in only modest amounts. His decision to chuck his buddy Nick Lowe as producer resulted in his best album in years (*Imperial Bedroom*). But we've seen him shift from Stax-Volt reincarnate to country crooner without making much more of a dent in the American market than previous albums. The guy looks like a twerp, is stuck with a handle worthy of a novelty act, has a chip on his shoulder that gets both his audiences and record company peeved with him, refuses to tour regularly, and he expects to connect with R.E.O. Speedwagon-country? Surely he jests.

So, for this album, he's recruited Dexys Midnight Runners producers (Clive Langer and Alan Winstanley), a bunch of horn players, and came up with a mess. Many of the songs sound

as if they were finished only so that he wouldn't have to deal with them anymore. The few that have any kind of bite to them—"Pills and Soap," "Shipbuilding," and "Everyday I Write the Book"—are hampered by the production or lack of it. The usually steady beat of Pete Thomas falters from time to time, bassist Bruce Thomas seems to be fighting his way out from behind the brass section, and Steve Nieve (who absolutely shone on the last LP) is just going through the motions. Elvis only succeeds when his introversion, self-pity, and contempt for the human race can focus into some meaningful statement about his own life; here he's just out to impress. These 13 songs are as empty and unmemorable as any of the dinosaurs he's trying to replace.

Is Elvis still New Music, or is he bound for the same extinction that the crop of singer/songwriters he sought to displace have now found? It seems Deke McManus is completely out of touch with himself, the contemporary music reality, and the five or six great albums he has created. Fortunately, lapses like this are to be expected from those who don't wait for the muse in order to be prolific. Hopefully, by the next album Elvis will come to his senses, chuck it all away, and come up with something completely different. Because *Punch the Clock* bites.

Jon & Sally Tiven

If we made them look like other loudspeakers... that's all they would sound like.

New PS-8 and PS-10 Point Source Loudspeaker Systems

DCI DESIGN ACOUSTICS
An Audio-Technica Company

THE BEST TIME TO DESIGN THE MUSIC SYSTEM IS WHEN YOU DESIGN THE CAR.

Music is truly an art. However, bringing that art to you in your car is pure science. No one knows that better than Delco Electronics.

For example, Delco engineers work with General Motors divisions when a car is still on the drawing board to scientifically design the loca-

tion, mounting, size and shape of every speaker to match that vehicle's acoustics. A Delco Music System is not an afterthought. It is literally designed into the car.

And because we know the electrical system of GM cars, we also build impulse noise blankers into Delco Music Systems to minimize interference.

Finally, Delco's Electronically Tuned Receiver (ETR™)

contains audio-processing and computerized signal-processing circuits that help improve reception and automatically lock in a station, keeping it from "drifting"



as you drive.

Delco Electronics is truly a leader in automotive electronics technology. When you buy your new car or truck, ask your dealer to demonstrate the science of a Delco Music System (including the incredible Delco-GM/Eose Music System).



Delco Electronics

BRINGING YOU *THE ART OF MUSIC* THROUGH THE SCIENCE OF SOUND.

SYMPHONIC WITCHERY

Berlioz: *Symphonie Fantastique*.

Utah Symphony Orchestra, Varujan Kojian

Reference Recordings RR-11, two discs, 45 rpm.

This unusual recording of the *Symphonie Fantastique* is a joint venture between Reference Recordings, a small San Francisco-based label, and Varese Sarabande Records of Los Angeles. Keith Johnson was the engineer, and the Reference Recording version, reviewed here, was recorded on Johnson's own focused-gap analog tape recorder. Transfer to 45-rpm discs was done by Doug Sax at the Mastering Lab, and metal work was done at KM Recorders. The pressings were made in Japan by JVC.

By comparison, the Varese Sarabande release was recorded digitally on Soundstream, and the finished product will be contained on one 33 $\frac{1}{3}$ -rpm disc. Comparisons will be inevitable, but are really beside the point, since there are too many variables.

In any event, we are examining here a product which is analog all the way, and enough care has been lavished on it to make it truly state of the art.

Johnson kept things quite simple, beginning with the mike placement. Essentially, it is an array of three or four microphones across the front of the orchestra, and the delineation of instrumental resources, left-to-right, as well as fore-aft, is just about as natural as it is possible to realize. The recording was made in the Utah Symphony's new home, and the concert hall produces a nice and not excessive ambience. The texture of the recording is natural and seamless, with only a slight edge to the massed strings, something that can be easily corrected with a downward nudge of the treble control.

The first three movements of the work occupy the first two sides, while the last two movements, "March to the Scaffold" and "Witches' Sabbath," occupy the third. The spare side is a repeat of side three, giving the buyer in effect an extra copy of the last two movements. These will undoubtedly get played most often because of their eminent suitability as demo material.

The bottom end on this release has to be heard to be believed. It is not just full—it is awesome. The bass drum



Illustration: Rick Tulka

sounds like some gigantic battering ram from the netherworld, but it is always in proper proportion to the music.

Pressing quality is excellent in all respects but one. There is too much groove echo, and many of the big attacks are heard three and four turns ahead of time. This is nothing that can't be lived with, however.

There is no doubt in my mind that this production represents analog, in every way, just about as well as it can be done, and the producers of these discs are making their own statement about the virtues of analog in a marketplace which is inexorably shifting to digital. Thus, the real comparison to be made here is between this product and a future Compact Disc version made via the Soundstream master, bypassing altogether the 33 $\frac{1}{3}$ -rpm LP version. I hope that Varese Sarabande has such a project in their plans. The superb quality of the recording deserves to see the light of day on Compact Disc as well as its present form.

John M. Eargle

Backwater: The Tony Rice Unit
Rouder 0167, digitally mastered,
\$8.98.

Sound: A Performance: A+

Tony Rice is a former member of the celebrated David Grisman band that

crystallized the fusion of bluegrass and jazz which has come to be known as Dawg Music. Here, with his own band, Rice has made a shimmering, positively brilliant album of flat-out great playing and amazingly translucent, digitally mastered sound.

The best indication I can give of *Backwater's* musical direction is to cite two covers included: A John Coltrane arrangement of "My Favorite Things" and a Miles Davis-flavored run-through of "On Green Dolphin Street." Besides Rice on guitar, the band includes Todd Phillips on bass, John Reischman on mandolin, brother Wyatt Rice on rhythm guitar, and Fred Carpenter and Richard Greene sharing violin spots and a duet on "Green Dolphin Street." There is no percussion.

Backwater is an album I've been playing a lot at home, especially for periods of solitude and introspection. It lets me feel at peace with the world for a while.

Michael Tearson

Moeran: Symphony in G minor. The English Sinfonia Orchestra, Neville Dilkes

Mobile Fidelity MFSL 1-524, \$17.00.

I doubt that many readers of this review have ever heard of the English composer Ernest John Moeran. I first heard this work on 78s in 1950, the

year Moeran died, but the piece did not find its way into my record collection until this version came out. A comparison of the old EMI pressing with the present one shows the obvious improvements we have come to expect of Mobile Fidelity's treatment of original master tapes. As with most of their classical releases, I feel the need to roll off a little high end for most satisfactory spectral balance.

Moeran's musical vocabulary is largely modal and draws from folk sources. You might think of him as a lighter-weight Vaughan Williams, but there is always a disarming freshness to his writing.

The recording presents a natural perspective on the orchestra, and there is especially good fore-aft imaging. This is an odd choice musically for Mobile Fidelity's classical catalog, but it is an excellent one sonically. Highly recommended.
John M. Eargle

Schubert: Sonata in D Major, "Arpeggione," D. 821; Berg: Four Pieces, Opus 5; Douglass: Improvisations III and Vajra. Peter Serkin, piano; Richard Stoltzman, clarinet; Bill Douglass, piano
Sine Qua Non Seven Star Series 79009, cassette, \$6.98.

Performance A+ Processing: C-
Recording: C+

These are superb performances, with exquisite cooperation on the part of the performers—not surprising, since they were among the founding members of the famous group Tashi. The Schubert is an adaptation of the famous "Arpeggione Sonata," done for the clarinet by Stoltzman himself. It actually adapts surprisingly well and adds an interesting color to a well-known piece. The Berg is rather unlike most of Berg's compositions; it's more akin to the compositions of the late Romantic period. Incidentally, Bill Douglass substitutes in his own compositions for Serkin, but the performances are excellent, nevertheless.

The recording is very close-up, too much so, and it appears that the piano is predominantly on one channel while the clarinet is on the other, almost like two mono recordings. The dynamic range in the original appears to be very wide. The cassette itself had the



If you're a friend of Jack Daniel's, let us hear from you.

WE DON'T HAVE MEETING ROOMS in Jack Daniel's Hollow. But there are plenty of nearby places to hold discussions.

You see, making good whiskey doesn't call for meetings. What you need is clear water and choice grain; experienced Tennesseans to distill your whiskey; and a rickyard for making charcoal to mellow its taste. Happily, we don't have to leave our distillery for any of these good things. And with Cashion's Service Station down the road, we can even hold a meeting now and then.



CHARCOAL
MELLOWED



DROP



BY DROP

Tennessee Whiskey • 90 Proof • Distilled and Bottled by Jack Daniel Distillery
Lem Motlow, Prop., Route 1, Lynchburg (Pop. 361) Tennessee 37352

Placed in the National Register of Historic Places by the United States Government

"The performance of 'El Amor Brujo' is outstanding, with such unique Spanish flavor that one can almost taste it."



Enrique Batiz

extreme top end missing. There appeared to have been trouble with the intermaster, and there is plenty of very annoying flutter. On side two the clarinet overloads and the piano distorts in the Berg pieces, while there are ticks and thumps at the beginning of each side.

C. Victor Campos

Vivaldi: The Four Seasons, Opus 8, Nos. 1 to 4. The Cambridge Chamber Orchestra, Emanuel Borok, violin
Sine Qua Non Seven Star Series 79003, cassette, \$6.98.

Performance: B+ Processing: D+
Recording: B-

This is a very good performance with some excellent playing, particularly on Borok's violin parts—not strange, considering Borok is Assistant Concert Master of the Boston Symphony and the staff of this orchestra is made up of Boston Symphony players. Nevertheless, the ensemble playing gets a little plodding in the tuttis, and the record-

ing and processing do not help clarity. For my money, though, the microphone pick-up is too close, imparting an unnatural shrillness to the strings.

C. Victor Campos

De Falla: El Amor Brujo (1915); Nights in the Gardens of Spain (1909-1915). The Orquesta Sinfonica Del Estado de Mexico, Enrique Batiz
Sine Qua Non Seven Star Series 79027, cassette, \$6.98.

Performance: B Processing: C+
Recording: A-

Funny thing! Although this cassette does contain "Nights in the Gardens of Spain," no mention is made of this piece anywhere on the packaging. It's sort of a surprise when you look on side two. Also, no credit is given to the pianist, nor is the mezzo-soprano identified (which is too bad because she sings superbly), and to finish, the word *Orquesta* is misspelled throughout the copy on the cassette.

The Varese-Sarabande recording appears to be very good, although the just-fair processing makes it difficult to evaluate. The performance of "El Amor Brujo" is outstanding, with such unique Spanish flavor that one can almost taste it. The "Nights," on the other hand, suffers by comparison. It's a good performance but not up to the level of the lead piece. Not a bad deal, overall.

C. Victor Campos

Please remain seated for this performance.

When you audition the new 200 Series separates from Revox, you will enjoy a musical experience rarely encountered outside the concert hall.

First, listen to the new Revox B251 Integrated Amplifier. It offers a switching power supply for more power reserves; a new power output stage with a faster rise time for accurate transient reproduction; and a signal-to-noise ratio at low output (better than -80 dB at 50 mW) that makes it an ideal companion for digital disc players.

When you audition the B261 Digital Synthesizer FM Tuner, you'll notice how it locks in weak FM signals - even when adjacent to strong ones - that other tuners mute or mask with noise. The B261's signal-to-noise and distortion specs are so low that they challenge the limits of test instruments. So the music you hear is the music being broadcast. No more, no less.

Finally, you may switch back and forth among the B251's six source inputs. Choose any of the B261's 20 pre-set stations. Adjust the volume and balance. Monitor the separate record-out circuit. Or operate the Revox turntable, open reel recorder, and cassette deck. You may do so without leaving your easy chair.

The 200 Series from Revox of Switzerland. A quantum leap forward in sonic accuracy. With the convenience of infrared remote control. Contact your Revox dealer for an audition session.



B201 remote transmitter and wood cabinet optional. Remote capability retrofitable into most Revox turntables and tape decks.

STUDER REVOX

1425 Elm Hill Pike, Nashville, Tennessee 37210

"Brian Culverhouse, the engineer-producer, shows a remarkable consistency in his approach to these Sefel discs."

Kodály: Háry János Suite; Janaček: Sinfonietta for Orchestra
Sefel SEFD 5001, \$15.98 (150 Simcoe St., Toronto, Canada M5H 3G4).

Brahms: Symphony No. 4
Sefel SEFD 5002, \$15.98.

Tchaikovsky: Romeo & Juliet Overture-Fantasy; Theme & Variations from Suite No. 3
Sefel SEFD 5003, \$15.98.

Ravel: Daphnis & Chloe, Suite No. 2; Pavane pour une Infante Defunte; Bolero
Sefel SEFD 5004, \$15.98.

Sefel is a relatively new Canadian record company. While most labels begin on a shoestring and work their way up from there, Sefel has begun very near the top. These four records are full-blown digital productions of the London Symphony Orchestra. In matters of packaging, the records are first-rate. The albums are printed on the

finest coated stock, and the liner notes are concise but informative. All details of graphic design have been well attended to, but this degree of care has not been extended to the label copy on the discs themselves. There are no dicritical marks, and there are sequencing errors in both the Ravel and Brahms label copy.

Sefel Records seems to have been created for Arpad Joó, the young Hungarian conductor of the Calgary Philharmonic Orchestra. Both the back liner and a loose-leaf insert with each record carry very arty pictures of him. All in all, he gets more attention than either the music or the orchestra. Maestro Joó should consider himself indeed fortunate to have this relationship with Sefel Records. There are doubtless scores of competent young conductors who would gladly make a pact with the devil for such an opportunity!

The well-known engineer-producer Brian Culverhouse was responsible for making these recordings. There is a

remarkable consistency about his approach in these four discs; they sound as if they were made in successive recording sessions with few if any miking changes in between. Culverhouse's multi-mike approach is a restrained one, maintaining a good front-to-back perspective on the orchestra. Balances are quite musical throughout all the records. Those listeners with subwoofers may note an occasional emphasis of low string bass lines (notably when the low-C extension is used) which give an organ-like underpinning to the orchestra.

Subsequent disc transfers were made at IAM in Irvine, Cal., and the excellent pressings were made by KM Records in Burbank, Cal., on Teldec vinyl.

The Kodály-Janaček album is probably the most successful record of the set. Both composers' works are given distinctive readings, and in the Janaček, Joó does not allow the motivistic, fragmented writing to detract from the

The Adcom GFP-1A.

There's never been a preamplifier to match it for flexibility, sonic performance and affordability.

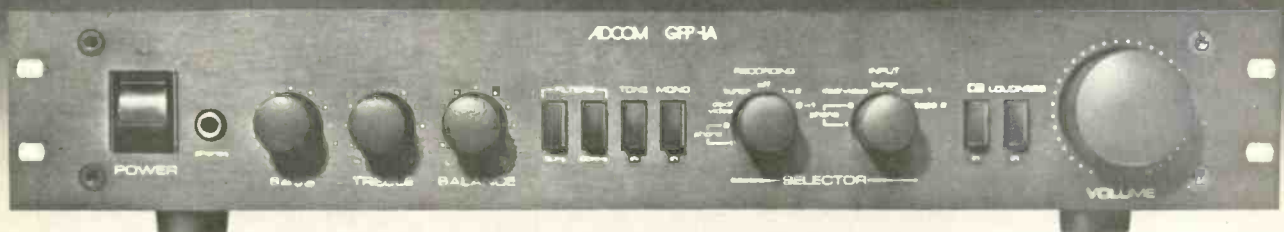

The all-new GFP-1A is virtually two preamplifiers in one. With its two functionally separate phono preamplifiers, you can listen to one disc while taping another. You can also dub recordings from one deck to another while listening to a broadcast or disc.

Other operating features include: an external processor loop; CX noise-reduction decoding circuits; a built-in separate amplifier for the headphone-output; FET differential-input tone control circuits with defeat switch; and two separate phono-input circuits—moving magnet (with selectable capacitance) and low-output moving coil cartridges. And more.

Signal-to-noise ratio at the high level inputs is greater than 100 dB—important for reproducing compact digital discs and the new wide-range audio VCR systems. And all function switching action takes place directly on the circuit board, minimizing capacitive-coupling and noise pickup problems.

As for sonic performance, just listen. And compare. And as for affordability, that's easy to describe: \$375.

ADCOM[®]

11 Elkins Road, East Brunswick, NJ 08816

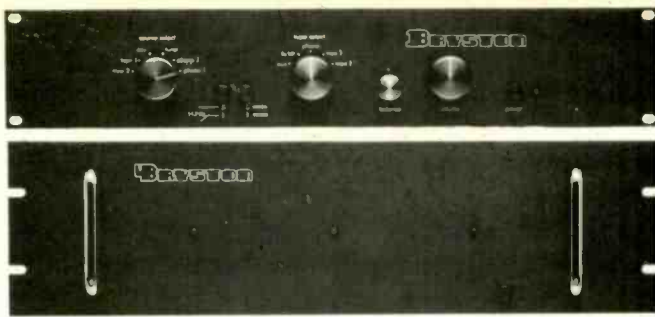

the perfect combination...

The musical accuracy of Bryston components is a revelation. Every note emerges with perfect clarity from a background of silence, then vanishes. The progression of musical events seems real, tangible, almost visual in its presentation....

Bryston believes there is a need for reference standards of musical accuracy. That is why we designed our Models 2B, 3B and 4B power amplifiers, and our Model 1B preamplifier. Their only reason for existing is to provide the most faithful electronic rendition of a musical signal possible within the bounds of available technology. Write to us and we'll tell you how we do it, and where you can listen to our perfect combination.

IN THE UNITED STATES:

BRYSTON VERMONT
RFD#4, Berlin, Montpelier, Vermont 05602
(802) 223-6159

IN CANADA:

BRYSTON MARKETING LTD
57 Westmore Dr., Rexdale Ont., Canada M9V 3Y6
(416) 746-0300

Enter No. 36 on Reader Service Card



The Argent series of moving coil cartridges was developed to offer the audiophile a state of the art component capable of reproducing acoustical detail with astonishing accuracy and clarity.

ARGENT DIAMOND Sapphire mounting base—
Solid diamond cantilever—
Vital parabolic nude diamond stylus

MC110 Sapphire mounting base—
Tapered titanium cantilever—
Line contact nude diamond stylus

MC300 Boron cantilever— Parabolic nude diamond stylus

MC310 Aluminum cantilever— Elliptical nude diamond stylus

NEW **MC500H** Super boron cantilever—
Parabolic nude diamond stylus, high output

DIRECT SOUND CORP. 150 FIFTH AVE. SUITE 516, NEW YORK, N.Y. 10011 (212) 807-1598

Enter No. 37 on Reader Service Card

"The real winner here is 'Theme & Variations.' What a lovely work it is, and one not played nearly enough."

overall form of the work. These are pieces Joó knows very well. The last movement of the Janaček has always been difficult to transfer to disc because of high woodwind and string figurations, which give ample opportunity for intermodulation distortion to show up. I doubt that any analog disc will ever avoid this problem completely, but this one comes as close as any.

The Brahms has a competent but not exceptional reading. There are certainly more masterful versions in the Schwann Catalog. Maestro Joó romps through the loud sections of the "Romeo & Juliet Overture" with more boom and tizz than anyone since Bernstein; but then, isn't that what this piece is about? The real winner here is the "Theme & Variations." What a lovely work it is, and one not played nearly enough! Joó's rollicking Polonaise finale has all the exuberance it needs.

"Dáphnis & Chloe" lacks the Gallic touch necessary to make it soar. As with the Brahms, the competition in the Schwann Catalog is fierce. The "Pavane" drags too much and is not helped by an out-of-tune horn solo at the start. The "Bolero" builds nicely, and its dynamics are well handled in the disc transfer. *John M. Eargle*

Moussorgsky: Pictures at an Exhibition; Chopin: Andante Spianato and Grande Polonaise, Opus 22. Paul Schenly, piano

Sine Qua Non Seven Star Series 79004, cassette, \$6.98.

Performance: B- Processing: D
Recording: C

The interesting part of this recording is that I am convinced two different pianos were used to make it. Each of the two pianos seems to be used for different pictures. Paul Schenly appears to be a very talented pianist, but his interpretation of "Pictures" is rather shallow, maybe indicating that it is just not his cup of tea. There certainly are better performances of this music on cassettes with better processing.

It's difficult to describe the timbre of the piano(s) because of definitely erratic frequency response on the copy. There were also great gulps and ticks at the beginning of the cassette (when the slave went into record), and the level on side two was lower than that of

Use your convenient Mastercard, Visa, American Express, Diners Club. Ask about details on COD orders. Money orders accepted. Allow 4 weeks clearance on personal checks

LABELLE

CAMERA & STEREO OF MAINE

155 MAIN STREET • BIDDEFORD, MAINE 04005
Prices And Products In Effect Oct. 20 To Nov. 20, 1983

FOR MAIL ORDERS
CALL TOLL FREE:
1-800-341-0783

In Maine, Alaska and Hawaii, Call 1-207-283-1401
Call For Shipping
And Handling On Mail Orders

OPEN SUNDAYS
10 A.M.-8 P.M.

STEREOS-TO-GO

STEREOS-TO-GO

STEREOS-TO-GO

SONY Walkman 4 Cassette Stereo
\$499⁹⁵
Complete Set

WM5 \$79.95
WM7 \$119.95
PROWD6 \$239.95
WM-R2 \$129.95

SONY FM Stereo Cassette FM-1
\$779⁹⁵
Complete Set

FM2 \$129.95
WA33 \$119.95
WA55 \$129.95
SRF 80W \$99.95
SRF 30W \$49.95

TOSHIBA FM Stereo Cassette KT-53
\$549⁹⁵
Complete Set

KTA-SI \$109.95
KT-VSI \$79.95

SANYO AM/FM Stereo Cassette MG-31A
\$499⁹⁵

MG 10 \$44.95 MG-7 \$24.95
MG 90 \$69.95 MG-100 \$99.95
MG 15 \$49.95 MG-1 \$59.95
MG 12 \$44.95 MG110DT \$109.95
MG34DT \$89.95 M5550 \$59.95

AIWA AM/FM Stereo Cassette W/Recording & Auto Reverse HS-J02
\$1349⁹⁵
Complete Set

HS-T02 \$109.95

TURNTABLES

RECEIVERS

CASSETTE DECKS

Technics

SL-5 Linear \$114.95
Tracking
SL-B100 \$62.95
SL-B200 \$72.95
SL-B300 \$82.95
SL-Q200 \$79.95
SL-Q300 \$89.95
SL-QX200 \$139.95
SL-QX300 \$149.95
SL-6 \$164.95
SL-1200 \$309.95
SL-7MD \$199.95
SL-10 \$399.95
SL-V5 \$129.95
SL-DL5 \$129.95
SL-BL3 \$119.95
SL-QL15 \$179.95
SL-B5 \$139.95
SL-D5 \$169.95

PIONEER

PL-2 CALL
PL-4 CALL
PL-5 CALL
PL-800 CALL
PL-88F CALL

SONY

PSLX-500 CALL
PSLX-55 CALL
PSFL-1 CALL
PSFL-77 CALL

JVC

L-A100 CALL
QLA-200 CALL
QLF-300 CALL
LE-22 CALL
LE-33 CALL
L-L1 CALL

Technics

SA110 \$109.95
SA210 \$139.95
SA310 \$169.95
SA410 \$199.95
SA510 \$279.95
SA810 \$339.95
SA1010 \$519.95

PIONEER

SX202 CALL
SX303 CALL
SX6 CALL
SX7 CALL
SX8 CALL

marantz

SR1000 CALL
SR2000 CALL
SR520 CALL
SR620 CALL
R620 CALL
SR-7100 CALL
SR-8100 CALL

NIKKO

ALPHA 230 CALL
ALPHA 450 CALL
BETA 30 CALL
BETA 50 CALL
BETA 50 CALL
GAMMA 30 CALL
GAMMA 50 CALL

SONY

STR-VX250 CALL
STR-VX350 CALL
STR-VX450 CALL
STR-VX550 CALL
STR-VX750 CALL

Sansui

Z-3000 CALL
Z-5000 CALL
Z-7000 CALL
Z-9000 CALL

PIONEER

CT-4 CALL
CT-5 CALL
CT-6 CALL
CT-7 CALL
CT-8 CALL

TEAC

V-300 CALL
V-350C CALL
V-400X CALL
V-500X CALL
V-2RX CALL
V-4RX CALL
V-707RX CALL
V-909RX CALL

SONY

TCFX-25 CALL
TCFX-44 CALL
TCFX-500R CALL
TCFX-600 CALL
TCFX-555 CALL
TCFX-1010 CALL

JVC

KD-V11 CALL
KD-V22 CALL
KD-V33 CALL
KD-V40 CALL
KD-V44 CALL
KD-D55 CALL
DD-V7 CALL
DD-V9 CALL
KD-W5 CALL

Sansui

D-55MS CALL
D-77R CALL
D-77R CALL
D-99D CALL
D-W9 CALL
D-370 CALL
D-570 CALL
D-770 CALL
D-970 CALL

Technics

RS-M205 \$99.95
RS-M224 \$119.95
RS-M222 \$229.95
RS-M227X \$139.95
RS-M234X \$159.95
RS-M235X \$179.95
RS-M245X \$209.95
RS-M253X \$299.95

AKAI

HX-1 \$109.95
HX-2 \$159.95
HX-3 \$129.95
GX-7 \$287.95
GX-F-31 \$209.95
GX-F-91 \$497.95
HX-R5 \$239.95
GX-R6 \$279.95

BLANK TAPES

DISC WASH ACCESSORIES

STEREO SPEAKERS

EQUALIZERS

RECORDERS

TDK

SA-C90 \$2.39
SA-XC90 \$3.49

MAXELL

UDXL11C90 \$2.49
UDXL11SC90 \$3.19

Minimum Order 10 Tapes

D'Stat II \$7.95
D4 \$11.99
CPR \$8.99
D4 Record Care \$12.99

Zerostat \$17.95
Perfect Path \$6.95
D'Mag \$18.95
V.R.P. \$3.79

TECHNICS

SBL-51
3-Way Speaker
9" Woofer
75W Each
\$119⁹⁵ pr.

SONIC

PHASE III
4-Way Syst.
100W Per Speaker
\$189⁹⁵ pr.

KOSS

Koss Fire 110 System
3-Way Speaker
100W Channel
\$219⁹⁵ pr.

ADC S55 \$79.95
ADC S5115 \$159.95
ADC S5215 \$219.95
ADC S5315 \$269.95
ADC S520 \$189.95

AUDIO SOURCE
EQ-ONE \$269.95



We carry a full line of recorders by Panasonic • RCA • JVC • Sony • Zenith • Sharp • Sanyo • Olympus • Pentax • Canon • Minolta

AM/FM CASSETTE CAR STEREO IN-DASH

CAR SPEAKERS

PIONEER

KPA700 \$179.95
KP2205 \$109.95
KPA400 \$139.95
KPA600 \$169.95
KPA500 \$149.95
UKE3100 \$179.95
KE5100 \$179.95
KE6100 \$199.95
KP7500 \$169.95
UKE7200 \$249.95

JENSEN

RE-530 \$309.95
RE-520 \$259.95
RE-518 \$239.95
RE-512 \$219.95
RE-508 \$179.95
R-408 \$179.95
R-220 \$149.95
EQA5000 \$89.95
A-35amp \$49.95

CONCORD

HPL-101 \$149.95
HPL-112 \$179.90
HPL-118 \$249.90
HPL-118F \$279.95
HPL-122 \$299.95

Call For New Models

MITSUBISHI CAR AUDIO

RX-735 \$209.95
CZ-725 \$149.95
RX-707 \$154.95
RX-726 \$129.95
RX-723 \$99.95
RX-909 \$209.95
RX-755 \$169.95
CV-23 \$89.95

SANYO

FTV-100 \$159.95
FTC-1 \$49.95
FTC-28 \$69.95
FTC-38 \$89.95
FTC-120 \$199.95
FTX-140 \$229.95
FTX-160 \$249.95
FTC-180 \$289.95

PIONEER

TS-1633K \$59.95 pr.
TS-6905 \$74.95 pr.
TS-6906 \$89.95 pr.
TS-6907 \$99.95 pr.
TS-6904 \$49.95 pr.
TS-T3 \$32.95 pr.
TS-168 \$69.95 pr.
TS-1655K \$74.95 pr.
TS-167 \$49.95 pr.
TS-108 \$39.95 pr.

J3033 \$99.95 pr.
J2020 \$79.95 pr.
J3013 \$69.95 pr.
J2037 \$69.95 pr.
J2094 \$34.95 pr.
J3003 \$56.95 pr.
J1242 \$84.95 pr.
J3005 \$59.95 pr.
J1401 \$69.95 pr.
J1405 \$44.95 pr.

BLAUPUNKT

Seattle \$189.95
Richmond \$239.95
Manhattan \$239.95
CR-3003 \$279.95
Tucson \$359.95
Washington \$439.95
Chicago \$249.95
BEA155 \$129.95
BE-55 \$69.95
BPA-430 \$219.95

Clarion

5100R \$119.95
5150R \$129.95
5300R \$139.95
5550R \$139.95
5700R \$179.95
7500R \$189.95
5500R \$139.95
5900R \$209.95
9300T \$239.95

SONY

XR-100 XR-55
XR-85 XR-45
XRM-10 XR-25
XR-75 XR-15
XR-65

Call For Best Selection, Lowest Price And Availability

PANASONIC

CQS818 CQS788
CQS958 CQS903
CQS768 CYSG100
CQS747

Call For Best Selection, Lowest Price And Availability

RADAR

Whistler
Spectrum \$229.95
Z-70 \$79.95
Q2000 \$199.95
Q1200 \$119.95
Intercept \$219.95
Fuzzbuster
Het Model2 \$169.95
Call For Other Models & Prices

Send \$2 for your copy of Labelle's catalog, over 200 pages of super buys.

Name _____
Address _____
City _____
State _____ Zip _____

35MM CAMERAS

35MM CAMERAS

Canon

AE 1 with 50mm 1.8 FD Lens \$179.95
AE 1 PROGRAM w/50mm 1.8 FD Lens \$219.95
1 w/50mm 1.8 FD Lens \$259.95
SURE-SHOT 35M w/Case \$109.95
CASES FOR CANON \$15

MINOLTA

XGM w/50mm f2.... \$169.95
X700 w/50mm f2.... \$219.95
XG-1 w/50mm f2.... \$149.95
CASES FOR MINOLTA \$15

PENTAX

K 1000 w/50mm f1.7 \$119.95
ME SUPER w/50mm f1.7 \$159.95
ME F w/50mm f1.7 \$219.95
CASES FOR PENTAX \$15

NIKON

FE w/50mm 1.8E... \$239.95
FM2 w/50mm 1.8E... \$239.95
FG w/50mm 1.8E... \$234.95
F3 Body Only \$369.95
CASES FOR NIKON... \$15

FAMOUS MAKER

80-200mm
MACRO ZOOM
 \$69.95

30 day return policy. All returns must be phoned in for prior authorization. All products must be returned in original factory packaging, clean and unscratched. Do not write, tape, or deface manufacturers original cartons. Please include blank warranty cards. If there should be a problem or a question upon receipt of your order, please feel free to call our customer relations dept. toll free 1-800-528-6800 or write to us.

Open Mon. Thru Fri. And Sunday, 9:30 A.M.-8 P.M. E.D.T. Closed Saturday

These Products Are For Mail & Phone Orders Only • All Merchandise Is New And Guaranteed • Quantities Are Limited And Subject To Availability

CALL TOLL FREE
800-221-8180
IN N.Y.C. AREA
1-212-732-8800

23 PARK ROW,
NEW YORK CITY
NEW YORK 10038



THIS MONTH'S SUPER SPECIALS!

RECEIVERS	SOUND ENHANCERS
TECHNICS SA1010 120W/Ch. Digital \$889.95	AUDIOSOURCE 801 10-Band EQ \$259.95
TECHNICS SA810 80W/Ch. Digital \$269.95	NUMARK EQ2600 10-Band EQ \$159.95
MARANTZ SR8100 90W/Ch. EQ \$349.95	ADC 32715 12-Band EQ w/Analogue \$199.95
PIONEER SA600 80W/Ch. Digital \$299.95	TECHNICS SH8055 12-Band EQ \$229.95
SANSUI SR2000 120W/Ch. Digital \$559.95	NUMARK DM1550 Pro Mixer/EQ \$169.95
SANSUI SR7000 90W/Ch. Digital \$449.95	SONY PT777 Program Timer \$4.95
SONY STRV550 90W/Ch. Digital \$238.95	DBX NX40 Tape Noise Reduction \$109.95
	WINCEKAD FM4400 FM Antenna \$49.95
CASSETTE	ACCESSORIES
TEAC V2090X A-Rev/ODI \$399.95	DISCWASHER OXIDE \$33.99
TEAC V2092 Dotry/ODI EQ \$299.95	DISCWASHER Record Cleaning Sys \$8.99
TECHNICS SM222 200W Deck \$399.95	SHURE 5622 Stylus Force Gauge \$8.99
TECHNICS SM275 Dolby B/C \$359.95	ALLSOP Orbitrac Record Cleaner \$14.99
AKAI CX7 3-1/2" Dolby B/C \$289.95	TEAC E3 Wind Derrag \$22.99
AKAI CX991 3-1/2" Dolby B/C \$459.95	NOTONICS DM211 Bulk Eraser \$39.99
SONY TCFS1010 Self Monitor \$379.95	CARTALCAN Cart. Alignment Sys \$22.95
SONY TCFS55 Dolby B/C \$269.95	
TURNTABLES	HEADPHONES
TECHNICS SL0300 DD/Auto \$159.95	KOSS PRO4AA \$29.95
SONY PSR77 Linear Tracks/Load \$189.95	SENNHEISER HD400 \$49.95
SONY PL707 Quartz/DD/Auto \$199.95	SENNHEISER HD300 \$69.95
PIONEER PL88F F-Load w/Cartr. \$249.95	SENNHEISER HD224 \$74.95
SONY PL855 Auto/Linear/Trak \$119.95	SONY MDR40T \$64.95
TECHNICS SL6 Linear/PROG \$169.95	SONY MDR40T \$29.95
CARTRIDGES	AUDIO TAPES
SHURE V15VM (B&C) Ridge \$139.95	CASSETTE
SHURE V15N Type M \$69.95	MAXELL UD11 of B C 90 \$2.59
MICRO ACCOUSTIC 3002 \$69.95	MAXELL UD11 of B C 60 \$2.29
OTTOMO AKC70M Moving Coil \$179.95	MAXELL UD11 of B C 90 \$2.89
STANTON 8815 \$79.95	TDK SAC90 \$2.59
PICKERING 13V3000 \$95.95	TDK SA390 \$2.89
AUDIO TECHNICA AT152LP (I&M) \$79.95	TDK AD390 \$1.39
	TDK DC90 \$2.49
STEREO-TO-CO	SONY UCX590 \$1.99
SONY WM7 Cass. Dolby A-Rev \$109.95	SONY UCX560 \$1.99
SONY WM6 Walkman Pro \$234.95	SONY UC160 \$1.99
SONY S6050 Walkman EQ \$39.95	FUJI FR MFM30 C90 \$3.49
ANWA HSJ01 AM FM/CASS/REC. \$119.95	FUJI FR C90 \$1.99
ANWA SC45 Sony's for Portables \$84.95	BASE PRON C90 \$2.49
JVC CC312 AM/FM Cass. Modular \$124.95	MEMOREX High Bias 90 \$2.49
PANASONIC RP20X Cass./ODI \$119.95	
TEAC PC78X AM FM Cass. ODI \$139.95	REEL-TO-REEL
KENWOOD CP20 Mini/A-Rev Cass. \$84.95	MAXELL UD35-90 7" 1800 \$4.99
DBX PPA1 ODI Adap. for Portables \$159.95	MAXELL UD35-180 10" 1800 \$14.95
SONY PD210 Walkman TV \$259.95	MAXELL UD35-95-908 7" 1800 \$8.95
	MAXELL UD35-180 10" 3600 \$26.95
	TDK SA55-90 7" 1800 \$7.95
	TDK SA55-180 10" 3600 \$18.95

WE ALSO CARRY A COMPREHENSIVE SELECTION OF PRO AUDIO SUCH AS A & B SYSTEMS, BEYER, CERWIN VEGA, CELESTION, ELECTRO-VOICE, BOW, PHASE LINEAR, G.I. GUS, PURMAN, TAPCO, TASCAM, DELTALAB, SHURE

HOW TO ORDER BY MAIL: FOR PROMPT AND COURTEOUS SHIPMENT, SEND MONEY ORDER CERTIFIED CHECK, CASHIER'S CHECK, MASTERCARD, VISA, INCLUSIVE CARD NUMBER, INTERBANK NO. EXPIRATION DATE AND SIGNATURE. DO NOT SEND CASH. PERSONAL AND BUSINESS CHECKS MUST CLEAR OUR BANK BEFORE PROCESSING. \$25 MINIMUM. SHIPPING CHARGES CONTINENTAL U.S., ALASKA, HAWAII, PUERTO RICO AND CANADA ONLY. (CANADIAN ORDERS add 10% SHIPPING WITH A 7.95 MINIMUM CHARGE.) For shipments by air, please double these charges. BEYER, NO. C.O. S., NEW YORK STATE RESIDENTS PLEASE ADD SALES TAX. ALL MERCHANDISE SHIPPED BRAND NEW, FACTORY FRESH AND 100% GUARANTEED.

23 PARK ROW, DEPT. A11, NYC, NY 10038
SEND FOR FREE 300 PAGE AUDIO/VIDEO CATALOG

Enter No. 38 on Reader Service Card

Excellence

HEYBROOK HB-3 SERIES II
imported from England by

D'Ascanio Audio

11450 Overseas Hwy.
Marathon, FL 33050
Tel.: 305-743-7130

Enter No. 39 on Reader Service Card

"Try listening, in 'Alborada,' for an array of inner voices which you may never have been aware of before."

side one, perhaps to accommodate the dynamics in "The Great Gates of Kiev." There was a great deal of flutter on this tape, particularly during the end of "Pictures," imparting an unpleasant watery sound to the piano.

The "Andante Spianato" is very nicely played, and its volume level was higher than "Pictures" end; the flutter was still evident. The "Grande Polonaise," however, was a disappointment, perhaps because Mr. Schenly excels in predominantly lyrical music.

C. Victor Campos



Charles Dutoit

Williams: The Empire Strikes Back.
The National Philharmonic Orchestra, Charles Gerhardt
Sine Qua Non Star Series 79030, cassette, \$6.98.

Performance: B+ Processing: C+
Recording: A-

This is what appears to be a very good Varese-Sarabande original recording of music some people will enjoy tremendously. Here, it gets a good reading and the musical values emerge clearly. Gerhardt has been doing similar work for years for RCA and Reader's Digest, among others. The National Philharmonic is a house name, which can stand for any of the well-known London orchestras. The balances are quite good in the recording, although the 20th Century-Fox theme at the beginning seems to have come from an optical soundtrack rather than magnetic-strip-on-film.

The cassette had no extreme top end. It was very dull-sounding and only provided a glimpse of what the original must be like.

C. Victor Campos

Ravel: La Valse; Rhapsodie Espagnole; Bolero; Alborada del Gracioso. Montreal Symphony Orchestra, Charles Dutoit
London LDR 71059, digital.

While the world hardly needs another "Bolero," however well performed, the remainder of the works on this disc represent a high point in interpretation, recording, and quality of playing. A sticker on the front of the album quotes a *Gramophone* review of the orchestra, calling it "... the finest French orchestra today ..."

This may well be true, since the or-

chestra, under Dutoit, speaks with a true Gallic accent—but with the streamlined precision of the better American ensembles.

Dutoit does magical things with these works, bringing out details that normally remain hidden. He produces a fabric which is detailed and cohesive at the same time. Try listening, in "Alborada," for an array of inner voices of which you may never have been aware before.

Producer Ray Minshull and engineer John Dunkerley must take their share of credit for the superb sound of this record, which is, I am happy to say, scheduled for Compact Disc release in the near future.

John M. Eargle

Music for Guitar & Mandolin: Beethoven, Vivaldi, Bartok, Carulli, Barber and Others. Marilyn Mair, mandolin; Mark Davis, guitar
Sine Qua Non Seven Star Series 79007, cassette, \$6.98.

Performance: B+ Processing: C
Recording: B+

This cassette features some music written for the mandolin, other selections transcribed for it in some cases, and for the guitar-mandolin duo in others. The performers have good ensemble and rapport and play the wonderful music very nicely, making one wish for a better cassette; mine had absolutely no top end. It should sound acceptable on a Walkman-type player with Dolby NR off.

C. Victor Campos

CLASSIFIED ADVERTISING RATES EFFECTIVE JANUARY 1984 ISSUE

BUSINESS ADS—\$1.25 per word, MINIMUM charge PER AD \$30. All centered or spaced lines \$10.00.

NON BUSINESS ADS—85¢ per word, MINIMUM charge PER AD \$15. All centered or spaced lines at \$8.00.

ALL LINE ADS—First line set in bold face type at no extra charge. Additional words set in bold face at \$1.50 extra per word. One point ruled box is \$10.00.

CLASSIFIED LINE ADS ARE PAYABLE IN ADVANCE BY CHECK OR MONEY ORDER ONLY. (Sorry, we cannot accept credit cards or bill for line advertising.) **ALL LINE ORDERS** should be mailed to:

AUDIO MAGAZINE
P.O. Box 1790V
Greenwich, CT 06836

ORDERS WILL NOT BE PROCESSED WITHOUT ACCOMPANYING CHECK OR MONEY ORDER FOR FULL AMOUNT.

CLOSING DATE—First of month two months preceding the cover date. If the first of the month falls on a weekend or holiday, the closing date is the last business day preceding the first. **ADS RECEIVED AFTER THE CLOSING DATE WILL BE HELD FOR THE NEXT ISSUE UNLESS OTHERWISE STATED.**

FREQUENCY DISCOUNTS—3 times less 5%, 6 times less 15%, 12 times less 20%. These discounts apply to line ads only. Ads submitted for a three time frequency are unchangeable. Frequency discounts not fulfilled will be short rated accordingly. Agency discounts do not apply to line advertising.

BLIND ADS—Audio box numbers may be used at \$5.00 extra for handling and postage.

GENERAL INFORMATION—Ad copy must be typewritten or printed legibly. The publisher in her sole discretion reserves the right to reject any ad copy she deems inappropriate. **ALL ADVERTISERS MUST SUPPLY:** Complete name, Company name, Full street address (P.O. Box numbers are insufficient) and telephone number. Classified LINE ADS are not acknowledged and do not carry Reader Service Card Numbers. **AGENCY DISCOUNTS** do not apply to line advertising. **FREQUENCY DISCOUNTS** not fulfilled will be short rated accordingly. Only those advertisers who have prepaid for their entire contract time will be **RATE PROTECTED** for the duration of that contract, in the event of a rate increase.

CLASSIFIED DISPLAY RATES

1 col x 1 Inch	\$250.
1 col x 2 Inches	\$395.
1 col x 3 Inches	\$565.
2 cols. x 1 Inch	\$450.
2 cols. x 2 inches	\$760.

One column width is 2 1/8". Two columns wide is 4 1/2". For larger display ad rates and 6, 12, 18 and 24 times frequency rates call (212) 719-6338.

DISPLAY ADVERTISERS should make space reservation on or before the closing date. Ad material (film or velox) may follow by the 10th. **DISPLAY ADVERTISERS MUST SUPPLY COMPLETE FILM NEGATIVE READY FOR PRINTING OR VELOX.** PRODUCTION CHARGES WILL BE ASSESSED ON ANY AD REQUIRING ADDITIONAL PREPARATION.

ALL DISPLAY CORRESPONDENCE should be sent to:

Laura J. Lo Vecchio
AUDIO MAGAZINE
1515 Broadway
New York, NY 10036

FOR ANY ADDITIONAL INFORMATION contact Laura directly at (212) 719-6338

FOR SALE

HOW TO ANSWER BOX NUMBER ADS
When replying to an Audio Box Number Ad, please use this address Box No. c/o Audio, 1515 Broadway, New York, N.Y. 10036

AAAAABSOLUTELY BEST PRICES: NAKAMICHI, TEAC, DIGITAL Players, BETA Hi-Fi, PCM, Accuphase AC-1 \$200, AC-2 \$265, Grace F9E Ruby \$165, Grace Level II Ruby \$120, Tailsman, ETC. **VISA/MC, COD.** AudioWorkShop (206) 323-4987, (206) 323-2676.

AAAA AMAZING JAPANESE STEREO EQUIPMENT. PCM, Digital Players and Discs, cassette decks, fantastic amps, pre-amps. Anything on sale in Japan is available, low direct prices. Shop from U.S. just as though in downtown Tokyo. Mid-range to absolutely the finest reference quality audio, most unavailable overseas until now. We are your agents in Japan **SONY CDP-101 \$665 AKAI 747DBX** professional reel-to-reel \$995. Information free. Catalog 53, refundable. **JAPANESE STEREO MUKASHI-YA**, 1-14-32-210 Jingumae, Shibuya-Ku 150, Tokyo.

AAAA—AUDIOPHILES—We have changed our name, but we are still offering SOTA audiophile equipment at lowest possible prices. Why shop overseas? Write for catalogue. **EXCLUSIVE AUDIO—107—2929** Nootka St., Vancouver, B.C., CANADA. V5M 4K4.

FOR SALE

AAA AUDIO DISCOUNTS OFFERS THE FINEST lines of audio components (INCLUDING THE ESOTERIC) at **DISCOUNT PRICES.** If you're in the market for speakers, receivers, cassette decks, to the best in separate components including amps, pre-amps, turntables, cartridges etc. or a new **CAR STEREO** our knowledgeable sales staff will be glad to assist you. For more information Monday thru Saturday **PLEASE CALL 301-593-8833** or write to **AUDIO DISCOUNTS**, 1026 McCeney Avenue, Silver Spring, MD 20901. We honor **VISA-MC** and **COD** for your convenience.

AAA PS IV PRE-AMP. Lg. XFMR. \$420. 313-532-1510. Before 7:30 EDT

AAA RATED! ESOTERIC AUDIO COMPONENTS for the audiophile at substantial savings. Let our experienced sales staff help you select from the finest audio components available. Call to discuss products or prices. The Audio Advisor Inc. 616 451-3868 M-F 10-6 EDT. **VISA/MC AMEX** Accepted.

AAAA—PRECISION AUDIOPHILE COMPONENTS. Q/LC Audio has Vandersteen, PS Audio, Haller, Precision Fidelity, Audire, Grace, CJ Walker and more. Q/LC Audio 1006 Berkshire Road, Dayton, Ohio 45419 (513) 293-7287.

HERE'S WHAT HAPPENS WHEN YOU GIVE THE WORLD'S FINEST AUDIO ENGINEERS CARTE BLANCHE.

The team of engineers that developed Sony Esprit was not asked to work within the narrow confines of a budget.

Nor were they asked to adhere to the compromising deadlines of some production timetable. Or to the arbitrary figures of a spec sheet.

They were asked, quite simply, to develop components that would approach, to the closest possible degree, perfect sound.

There is no gimmickry in Esprit components; only those technological improvements that contribute to sound quality were considered meaningful.

There are no question marks either. For the Esprit engineers fully research their equipment before production. Not afterward.

For more information write Sony Esprit Sony Drive, Park Ridge, New Jersey 07656.

SONY ESPRIT.



ALTERMAN AUDIO
3213 17th Street
Metairie, LA 70002
(504) 834-7772

PARIS AUDIO
12401 Wilshire Blvd.
Los Angeles, CA 90025
(213) 820-2578

PEERLESS ELECTRONICS
15093 West Eight Mile Road
Detroit, Michigan 48235
(313) 342-0500

Q. AUDIO
959 West Moana Lane
Reno, Nevada 89509
(702) 827-4434

D S AUDIO
545 Penn Avenue
West Reading, PA 19611
(215) 376-4917

PARK AVENUE AUDIO
425 Park Avenue South
New York, NY 10016
(212) 685-8101

PROFESSIONAL PRODUCTS AUDIO CENTER
4964 Fairmont Avenue
Bethesda, MD 20014
(301) 657-2141

RECORDER CENTER
2003 North Henderson
Dallas, TX 75206
(214) 826-8700

© 1982 Sony Corp. of America. Sony and Sony Esprit are registered trademarks of the Sony Corp.

IF YOU CARE ENOUGH TO HEAR THE VERY BEST—



MODEL BPA-100B

LISTEN TO THE **SPECTRASCAN** BPA-100B (BASIC) AND BPA-100M (METERED) HIGH TECHNOLOGY, HIGH DEFINITION AMPLIFIERS • MEETS ALL DESIGN CRITERIA OF OTALA AND CHERRY • NESTED MULTIPLE FEEDBACK LOOPS. WIDE BANDWIDTH, HIGH SLEW RATE • 15KHZ DOMINANT POLE. CONSTANT FEEDBACK, ZERO PHASE-SHIFT AND HIGH DAMPING FACTOR FROM DC TO 20KHZ • REGULATED POWER SUPPLY FOR TRUE DC COUPLING AND INCREDIBLY SOLID BASS • FULL PROTECTION CIRCUITRY, ACTS ON POWER SUPPLY, NOT AMPLIFIERS • 100 W/CH, 8 OHMS • 175 W/CH, 4 OHMS • 350 W, 8 OHMS. BRIDGE/MONO

• COMING SOON: TWO PREAMPLIFIERS. (MODELS LCA-10 AND LCA-20) ONE 150 W/CH AMPLIFIER (MODEL BPA-200B) AND A PAIR OF SPEAKERS (ASHLEY-100L). WRITE OR CALL FOR BROCHURES AND PRICES

SPECTRASCAN INC

5923 N. NEVADA AVE.
COLORADO SPRINGS COLO. 80907
303-599-9254

DEALER AND REPRESENTATIVE INQUIRIES INVITED

FOR SALE

AAAUDIOPHILE SPEAKER BUILDER? JORDAN MODULES exclusive importer. STRATHEARN midribbon, Polypropylene Drivers, EMIT Tweeters, Domes, IBM Computerized Designs, Capacitors, Low DC Coils, Crossovers. (Dealers inquire on letterhead) CATALOG \$2.00 Soundbox, 841A-A S. American Street, Philadelphia, 19147

ABARGAIN: STAX SIGMA \$247., LAMBDA \$162. SRX/MK3 \$132., SRD-7 \$68., ALL UNUSED/WARRANTY. (212) 784-2929 EVES: (305) 487-1048 EVES

A BARGAIN SUPLEX SDX2000 \$299, 901 E Super \$120, 900 E Super \$130; Grace F9E \$99, F9E Ruby \$165, Ruby stylus \$115; Accuphase AC2 \$275, AC-1 \$189; Technics EPC205CIII \$130, Technics stylus gauge \$49; Denon 103D \$170; Dynavector 23R \$175, 17 DS \$365, 10X3 \$89; Koetsu Black \$445; Kiseki Blue \$445; Formula IV \$85; Technics EPA 100 MKII \$495; Fidelity Research 64 FX \$385; Linn Ittok \$445; Grace 707J1 (Black) \$145, 747 \$170; All Unused/Warranty (212) 784-2939 Eves.; (305) 487-1048 eves.

ABARGAIN: CD Disc \$17 each; Dynavector DV501, \$315.; Coral MC82 (MIT Van der Hull) \$210.; Send SASE, Box 6312. L.I.C., NY 11106, (212) 784-2939 (eves); Box 273179 Boca Raton, FL 33427 (305) 487-1048 (eves)

FOR SALE

A BETTER SYSTEM? PEOPLE WHO KNOW STEREO BUY THEIR SOUND DIRECT. Now you can buy the finest in high fidelity components, including esoteric and auto-sound at unheard of prices. **DIRECT SOUND MARKETING** provides sensible expert advice, in-house service facilities, and factory fresh components on an in stock basis. Discover America's best kept audio secret. Send for our FREE catalogue to **DIRECT SOUND MARKETING**, Dept. A, 3095 Bolling Way, Atlanta, Georgia 30305 or call 404-233-9500. MC/Visa/Amex accepted. Sales tax charged to GA. residents only.

ABSOLUTE AUDIO: ROBERTSON, SPICA, AMBER, COUNTERPOINT, ORACLE, CONRAD-JOHNSON (including PREMIERS), DYNAVECTOR, NAD, OHM, RGR, SNELL, VPI, THIEL, THRESHOLD, MAGNEPAN, MIRAGE, WALKER, ETC. AUDIO FILE, 1202 S. Congress, Austin, Texas 78704, (512) 443-9295

ABSOLUTELY UNBEATABLE VALUE reviewed November 82 'Gramophone' "indeed the combination Mayware MKIV tonearm \$125 & MC-2V 'Vital' stylus \$89 + T-24 transformer \$150 reproduced my Test records with unusual accuracy and tonal naturalness. Worlds best loudspeaker manufacturer says "combination performed extremely well & cures mistracking that occurred with SME." New MC-3L/11 High output MC \$89. Paying more is futile. VISA/MC accepted. Info \$1 bill. Mayware P.O. Box 58, Edgware, Middx. England.

ACES OVER EIGHTS SYSTEM

(UNDER \$8200)

Turntable: Linn Sondek Lp-12
Tonearm: Syrinx PU-3
Cartridge: Talisman S
Preamp: Counterpoint SA-5
Headamplifier: Counterpoint SA-6
Tuner: Adcom GFT-1A
Amplifier: Krell KSA-50
Speakers: Symdex Simga/Omega

SOUND BY SINGER

227 Lexington Avenue
New York, NY 10016
(212) 683-0925

ACOUSTAT SPEAKERS—SUPERB!

Free shipping! Fast service! **READ BROTHERS STEREO**, 593 King Street, Charleston, South Carolina 29403, (803) 723-7276. Also Sony ES digital (and PCM-F1).

ACOUSTAT TNT200 POWERAMP. Call Terry 402-391-3842

CROWN BEST QUALITY AMPLIFIERS, TUNERS, PREAMPLIFIERS. PROFESSIONAL CONSULTATION—BEST PRICES. EAST: (904) 262-4000; WEST: (213) 840-0878.

ADS MODEL 10 DIGITAL TIME DELAY, \$750.00 312-343-8553

ADVENT 350 RECEIVERS—50/50W deluxe, Holman pre-amp, retail: \$600. 3-yr. warranty. Special: \$299.00! SCC, Box 551 (Am983), Dublin, OH 43017; (614) 889-2117, VISA/MC.

ELECTRO-VOICE INTERFACE AND CD SERIES QUALITY SPEAKER SYSTEMS. PROFESSIONAL CONSULTATION—BEST PRICES. EAST: (904) 262-4000; WEST: (213) 840-0878.

AEOLIAN LOUDSPEAKERS LTD offers the most advanced drive units in the world: from England, the high power, wide dispersion **SHACKMAN ELECTROSTATIC**, and a high power modified **JORDAN 50mm MODULE**. From France, the next step beyond Bextrene or polypropylene, the Neoflex cone, dual voice coil bass/mids from **FOCAL** open totally new design areas. Plus, an incredible concave tweeter. Available only from Aeolian Loudspeakers Ltd., Box 1005, W. Newbury, MA 01985 (617)-363-5495

A FREE CATALOG—CARTRIDGES, tonearms, turntables, electronics, Denon, Grace, Supex, Dynavector, Thorens, Michell, Ariston, Signet, Stax, lustre. All with USA Warranty. Audio Unlimited, 1798B Technology Drive, San Jose, CA 95110 408-279-0122 11-6M-Th.

LEGENDS EVOLVE AND IMPROVE.

Chestnut Hill Audio is at the leading edge of musical technology. Hear our new Sony CDP-101 Compact Digital Disc Player as well as legendary products from: Accuphase, Acoustat, Acoustic Electronics, Adcom, Amber, Apature, BK Components, Bering, Cabasse, Cotter, Denon, Dynavector, EMT Euphonics, Fourier, Fried, Grace, Halfer, Infinity, Janis, Kenwood/Purist, Koetsu, Kiseki, Krell, LAST, Leach, Linn Sondek, J.A. Michell, Monster Cable, Music Reference, NAD, Oracle, Origin, PS Audio, Pioneer Video, Proton, Pyramid, Quad, RGR, Rogers, Signet, Sony, Spectral, Spondor, Syrinx, Tandberg, Thorens, Threshold, 3D Acoustics, VPI, VSP Labs and Vandersteen. 311 Cherry Street, Philadelphia, Pa. 19106. (215) 923-3035.

CHESTNUT HILL AUDIO LTD.



Series 140 Power Amplifier

The power amplifier combination you have been searching for . . . excellent music reproduction at an affordable price.

In the Series 140 Power Amplifier, B & K Components, Ltd. has developed a simplified design concept and produced it with rigid quality controls. The result — a highly reliable unit with Class "A" capability for under five hundred dollars.

Check these outstanding features:

- 3.2 db of Dynamic Headroom;
- All 1% Metal Film Resistors;
- Class "A" complementary symmetry up to the driver stage;
- Seventy watts per side mosfet design;
- Outstanding linearity and wide bandwidth capability through the use of a Cascode differential;
- A 47,000 MFD power supply guarantees peak demand performance;
- Digital Audio Disc Compatability for optimal system flexibility;
- Matched pair transistors in front end circuitry assures absolute D.C. stability;
- Gold-plated connector posts.

Call toll-free or write today for information.

B & K Components, Ltd.

P.O. Box 331
Orchard Park, N.Y. 14127 U.S.A.
Toll-Free: 1-800-543-5252

716-652-7650 (New York State only) 1-800-235-5020 Telex: 466482

FOR SALE

**ATTENTION ADVERTISERS!
SEE CLASSIFIED RATE BOX ON
PAGE 111 FOR NEW RATES, EF-
FECTIVE JANUARY 1984 ISSUE.**

**HAFLER, REVOX, TANBERG, CARVER, DBX AND OTH-
ER QUALITY COMPONENTS. PROFESSIONAL CON-
SULTATION—BEST PRICES. EAST: (904) 262-4000;
WEST: (213) 840-0878.**

**HARMAN-KARDON SEPARATES, RECEIVERS, CAS-
SETTE DECKS, TURNTABLES, PROFESSIONAL CON-
SULTATION—BEST PRICES. EAST: (904) 262-4000;
WEST: (213) 840-0878.**

**ALL NEW! DYNAVECTOR 23R \$179, 17D \$369, 20A2
\$139, 20B2 \$179, 10 X 3 \$99, Denon 103D \$179, 302
\$269, ASAK \$289, FR 64FX \$999, JVC 7045 \$159, Grace
727/747 \$189, 707 \$149, F10L \$139, Koetsu black \$479,
Gold onyx \$999, C.O.D. & Free Shipping! 713-728-4343,
Maury Corb.**

**ALTEC LANSING MODEL 19 SPEAKER—\$800 pr. Call
Terry 402-391-3842**

AMBER PREAMP/AMP—\$598. Call Terry 402-391-3842

**AMPLIWIRES, PREAMPLIWIRES (ELECTROCOMPANET)
at Audio Connection, NJ 201-239-1799**

APPALLING? ISN'T IT?

How many esoteric audio products look and feel as if they were made by orangutans with screwdrivers. If you are fed up with sacrificing reliability, aesthetics and quality of construction to obtain purer sound, don't despair!

There are many high end audio components built by small yet solid professional companies which not only express the utmost in musicality but also reflect the highest level of design integrity, craftsmanship and quality control. At Sound by Singer we select and blend only such components into systems designed to extract the most music from your audio dollars.

ACOUSTAT • ADCOM • AMPLITON • AUDIO DESIGN •
AUDIOQUEST • AUDIBLE ILLUSIONS • AUDIO NOTE •
AUDIO INTERFACE • BEARD • BELLES • BERNING •
COUNTERPOINT • DYNAVECTOR • FRIED • FUSELIER •
GRACE • GRADO • ITC • KISEIKI • KLOSS • KRELL •
KYOCERA • LINN SONDEK • LIVE WIRE • MERIDIAN •
MICRO SEIKI • MONSTER CABLE • NAD • NAIM AUDIO •
NITTY GRITTY • PARADIGM • PIONEER VIDEO •
PRECISION FIDELITY • PROTON • REGA • SNELL
ACOUSTICS • STAX • SUPEX • SYMDEX • SYRINX •
TALISMAN • THRESHOLD

SOUND BY SINGER

227 Lexington Avenue
New York, NY 10016
(212) 683-0925
WE SHIP ANYWHERE

ARC D-120, SP-6B: Tympany I-D: Thorens TD-126. 7331
Greenwood, Lincoln, NE 68507

ARC SP-6B \$1000; ARC D-120a \$1300; Tympany I-D
\$1100.; Thoms TD-126 with ruby \$700.; All Mint! (402-467-
1518)

**ARE YOU INTERESTED IN QUALITY, USED STE-
REO EQUIPMENT?** Send for the **PLAY IT AGAIN
SAM** newsletter—hundreds of listings—items for
sale—items sought—published 6 times per year. \$6.
1-year subscription. Send today to **PLAY IT AGAIN
SAM**, 12611 Madison Avenue, Lakewood, Ohio
44107. (216) 228-0040. Master Charge and Visa ac-
cepted.

**AR TURNTABLES—Best Buy, \$279 without tonearm,
\$429 with. Audio Doctor. 417-345-7245**

**ALLISON I SPEAKERS AND ALLISON SUBWOOFER.
215-LO7-4626 EVES/WKENDS.**

A&S OFFERS HIGH-END SPEAKER KITS, raw drivers
and auto speaker systems from the world's finest manufac-
turers. Meeting the needs of beginners and audiophiles, we
carry Audax, Dynaudio, Dalesford, Jordan, Peerless, JVC,
SEAS, Jordan-Watts, Morel, Pyle, Volt, Siara. Featuring
the new "Jack Caldwell" Compact Monitor and Dynaudio's
"Authentic Fidelity" kits. Free price list. A&S SPEAKERS,
Box 7462A, Denver, CO 80207. (303) 399-8609.

FOR SALE

ATTENTION DYNA AND HAFLER OWNERS

We build new circuits into most Dyna and Halfer units. We transform Dyna ST-80, ST-120, ST-150, ST-300, ST-400, ST-416, SCA-50, and SCA-800 amplifiers into modern POWER MOS-FET amps with new PC cards, precision parts, and low inductance power supplies. We install five new PC cards in Halfer DH-200 and DH-220 amplifiers with ground plane output networks for much improved transient performance. We install new circuits in DH-101, PAT-5, PAT-4, and PAS-3X preamplifiers with exact RIAA equalization, matched precision parts, precision controls, and complete freedom from transient and digital overload. Audiogram said we make the world's best tuner in the FM-5 chassis. Sensible Sound has reviewed several of our amplifiers. Our \$99 phono cartridge has a satisfaction guarantee or your money back. Call or write for free catalog and sample copy of our monthly newsletter, Audio Basics. We ship worldwide and have new 120 and 240 volt equipment available.

**JENSENS STEREO SHOP
2202 RIVER HILLS DRIVE
BURNSVILLE, MINN. 55337, (612) 890-3517**

AR TURNTABLE MODEL XA, \$65. 408-867-0341

Quality Tapes

BELOW WHOLESALE SPECIALS!

TDK		DISC WASHER			
MAR C-90	6.39	ADX C-90	2.65	DISC KIT	33.49
SAX C-90	3.09	D C-90	1.15	D-4 SYSTEM	9.49
SAX C-60	2.39	D C-60	.99	DISCSET	16.49
SA C-90	2.15	LX 35-90	5.15	16 OZ FLUID	9.99
SA C-60	1.85	LX 35-90B	5.85	FUJI	
MA C-90	4.29	SA 35-90	9.49	FR II C-90	2.75
AD C-90	1.85	T-120	8.45	METAL C-90	4.45
AD C-60	1.45	T-120HG	10.95	T-120	8.45
				T-120 HG	10.95
MAXELL		SONY			
UDXL II C-90	2.49	UD 35-90	5.25	UCXS C-90	2.45
UDXL II C-60	2.25	XLI 35-90B	6.45	LNK C-90	1.10
XL II SC-90	3.29	XL II 35-90	11.49	L-750	8.45
MX C-90	4.69	T-120	8.45	L-750 HG	9.95
UD C-90	2.15	HGX T-120	10.95		

TO ORDER BY PHONE CALL **212-434-3417** OR ORDER BY MAIL -
ON ORDERS UP TO \$70 ADD \$3.50 SHIPPING - OVER \$70 ADD 5%
OF TOTAL ORDER - OUTSIDE UPS ZONES DOUBLE ABOVE - OUT-
SIDE USA WRITE FOR SHIPPING CHARGES - MASTERCARD/VISA
ORDERS ADD 3% EXTRA FOR HANDLING - PRICES SUBJECT TO
CHANGE

QUALITY TAPES

864 East 7th Street, Dept. A11, Brooklyn, NY 11230

Stereophile

SAVVY EQUIPMENT REPORTS AND SPIRITED EDITORIAL CONTENT

Send \$20 for 10 issues. Stereophile, 1107c Early Street, Santa Fe, NM 87501 or
Call toll-free 800/821-3528

MEET THE
DIGITAL
CHALLENGE



WITH THE ALPHA 1 MOVING COIL CARTRIDGE BY MONSTER CABLE

Analog or digital?

The Alpha 1 meets the digital challenge by reproducing your conventional analog disks with unprecedented accuracy. The new Alpha 1 incorporates the latest design techniques, utilizing sophisticated computer analysis of amplitude and phase response, to produce superb dynamics, smooth quick transients, and a panoramic soundstage that recreates the original musical event with startling reality.

A rigid boron cantilever with a unique dual damper provides exceptional clarity and dynamic range without the "harsh" sound typical of moving coil designs. So meet the digital challenge.

Audition the new Alpha 1 at your nearest Monster Cable dealer. And rediscover how good your analog records can sound.

Monster Cable Co. 101 Townsend St.
San Francisco CA USA 94107
(415) 777-1355 telex: 470584 MCSYU1

alpha 1
by MONSTER CABLE USA

electronics
BRYSTON
 DENON • LUXMAN
 PLEXUS • SAE II

loudspeakers
 ALLISON
 DESIGN ACOUSTICS
 I.T.C. • M&K • SNELL
 3D "CUBE"
 THIEL

turntables, cartridges,
 and tape decks
 ADCOM • ASTATIC
 AUDIOQUEST
 DENON
 DYNAVECTOR
 GRACE • GRADO
 ORACLE
 PREMIER • THORENS

SUPERB MUSIC REPRODUCTION VS. HIGHEST-COST HARDWARE

"The music...nothing matters but the music..." If you have seen the movie *The Red Shoes*, you probably remember that famous line. We believe that a true reference quality audio system can properly have but one reason for its existence: to reproduce music so convincingly, so accurately, that you, the listener, will completely forget about equipment, about amps, speakers, & turntables, and will come to feel, truly, that only the music matters. We also believe that such a system need not cost \$10,000 or more, need not require servicing every few months, and need not be something that might look very interesting in a hardware store, but very out of place in your home.

THIEL CS3: The phase coherent and time coherent technology made so famous by the Thiel 03a speaker (\$1,120/pair) has now been brought to the pinnacle of achievement in the new CS3 (\$1,800/pair). **SNELL type C:** All of the quality and most of the performance of the famous Snell type A speaker is now being offered in a more moderately priced (\$1,500/pair), much easier to drive, more compact, very handsome new model. **BRYSTON:** Lately, several manufacturers have begun trumpeting the importance of high amplifier output current capability. Meanwhile, for over seven years Bryston has been building, very quietly, without fanfare, amplifiers with much higher current capability than is being offered by the Johnny-come-latelies. The 4B (\$1,450) delivers 16 amps of continuous current, with 45 amps peak-to-peak. **ORACLE:** The Delphi (\$1,150 without tone arm), is, simply, everything a turntable should be. The new Alexandria (\$1,000 with auto-lift tone arm) is a joy to use, to look at, and to listen to. Watch for news of upcoming personal appearances by James Thiel, Peter Snell, John Russell of Bryston, and Jacques Riendeau of Oracle.

1067 MONTAUK HIGHWAY, WEST BABYLON, NEW YORK 11704 (516) 661-3355



FOR SALE

ATTENTION EVERYBODY!!!

ACQUSTAT	COUNTERPOINT	KYOCERA
ACOUSTIC ELECTRONICS	CJ WALKER	LINN SONDEK
AUDIO QUEST	DAHLQUIST	MUSIC REFERENCE
ADS	DCM	NAD
AUDIO RESEARCH	DENON	ORACLE
B&O	DYNAVECTOR	PETERSON
BOSTON ACOUSTICS	HAFLER	ALPHASON
CARVER	KISEKI	GRACE
VPI	HELIUS	SIGNET
QUICKSILVER	PENTAGRAM	RGR

CSA AUDIO

193 Bellevue Ave, Montclair, NJ 07043
 The audio professionals since 1972! Complete customer satisfaction. VISA, Mastercharge accepted!
 201-744-0600
 SERIOUS INQUIRIES BY PHONE, NO MAIL!!!

ATTN: EXPORTERS, COMMERCIAL USERS, others—
 McIntosh MC2205 w/box, packing: Mint. Best offer over \$1200.00, Call evens. 207-797-3975. J. Vacchiano, 175 Hennessy Drive, Portland, ME 04103

PAY DEALER COST

On Video & Stereo equipment. All top brands. No deposit, same day shipping, no lemon guarantee. Full lifetime service. Call 9am to 9pm daily, til 5pm Saturday. 1-301-488-9600

INTERNATIONAL HI FI DISTRIBUTORS
 BALTIMORE, MD. 21206

FOR SALE

ATTRACTIVE PRICES: DYNAVECTOR, GRACE, DENON CARTRIDGES, FULTON, LINN, KOETSU, AC-CUPHASE, FR, STAX, SOTA SAPPHIRE, QUAD 63, WALKER, BRB SYSTEMS. COD SHIPPING, SASE QUOTES. (713) 728-4343. MAURY CORB 11122 ATWELL, HOUSTON, TEXAS 77096

AUDIO CONCEPTS has the finest esoteric speaker kits. Dynaudio, Morel, Strathearn, Wonder Cap, Peerless, Shadow. Electronic crossovers, audio grade capacitors, coils, etc. cabinets. Best products, service for speaker builders. Catalog \$2.00 refundable 1631 Cal-edonia St. LaCrosse, WI. 54601 (608) 7812110

**AUDIO CONNECTION
 in Northern New Jersey**

TURNTABLES: Denon, Heybrook, Linn, VPI
TOEARMS: Helius, Linn, Souther SLA-3i, Zeta
CARTRIDGES: Argent, Grado, Linn, Promethean, Win

ELECTRONICS: Beard, Bedini, Belles, Electrocompaniet, FM Acoustics, Magnum, Naim, PS Audio
 Denon, Electrocompaniet, Magnum, Rogers

TUNERS: Denon, Electrocompaniet, Magnum, Rogers

SPEAKERS: Fuselier, Heybrook, Kindel, Linn, Spica Melos Audio PT1 (Ribbon-speaker), Rauna Spectrum, Vandersteen

ACCESSORIES: Last, VPI, N.G., PS Interconnect, G&B Clamp, Kimber Cable, Audiophile Discs
 201-239-1799
 We offer single-speaker demonstration and request that you schedule an appointment.

FOR SALE

AUDIO DIMENSIONS HAS SPENDOR
 SP-1, BC-1, LS 3/5A, Prelude

794 North Woodward
 Birmingham, Michigan (313) 482-4801

**AUDIOPHILE START
 UP SYSTEM**

(\$700)
 Turntable: NAD 5025
 Receiver: NAD 7150
 Speakers: PARADIGM 5's
SOUND BY SINGER
 227 Lexington Avenue
 New York, NY 10016
 (212) 683-0925

AUDIO PULSE SERVICE. Factory trained technicians. Write us about Model One update kits. White Labs, 10528 Lower Azusa Rd., Suite 192A, El Monte, CA 91731. (213) 446-5346.

AUDIO REFERENCE SYSTEMS. Precision components by Audioquest, Belles, Berning, Dayton Wright, Dennesen, Perreaux, Spica, and more. Pre-owned KEF, Oracle, SOTA, Paragon. Trades accepted. 1420 Latham Place, Rockford, ILL 61103. 815 964-9634, 815 963-9258.

AUDIO RESEARCH D-150 \$2250., Sony 880-2 \$950., Sony #EL-7 + remote + 18 new + 18 used FECC tapes \$500., Shure Audio Analyzer \$175., Sansui P-1 parametric E.Q. \$400., JR 149's \$250., All excellent—mint. 914-986-6672

AUDIO RESEARCH D76—\$495, SP3A—\$395 Call Terry 402-391-3842

AUDIO RESEARCH in Texas at Audio Pro/Philes 713-973-0000

AUDIOQUEST, GRADO, TECHNICS U205CMKIII CARTRIDGES (303) 963-3269.

BANG & OLUFSEN PLUS—Finally, audiophile sound quality coupled with elegant styling. Made in Denmark, you can have European craftsmanship at very affordable prices. Now available—B&O's newest products in stock! PLUS quality control to assure optimum performance. Shipping anywhere in the continental U.S.. **DESIGNATRON'S STEREO STORES INC.,** 260 Old Country Road, Hicksville, NY 11801. (516) 822-5277.

BARGAINS-GD COND. DYNA ST-70 AMP \$150; Pas-2 preamp \$40; FM-3 Tuner \$40; Empire 208 Turn w/Shure cart \$40; Garrard 82 Auto Turn w/Picker cart \$40; Advent 100 Noise Red \$75; Tandberg 64 r/r deck \$150; **OR BEST OFFERS—215-627-0608-EVE.**

BEARD TUBE ELECTRONICS at Audio Connection. Verona, NJ 201-239-1799

BEARD AUDIO SYSTEMS TUBE ELECTRONICS: Experience the power-and hear the glory. For dealer list, contact IAI, 723 Bound Brook Road, Dunellen, NJ 08812, or call 201-968-8771.

CARVER C-9, BRAND NEW, \$170. Call Don 606-255-7850.

DISCOUNT WORLD

CAR STEREO SPECIALS

CONCORD HPL 122
SONY XM 45
COMPLETE \$319

WRITE FOR FREE CATALOG

SONY XR-75 Black
SONY XM-45
SONY XM-120
COMPLETE \$529
 PKG. PRICE

Pioneer Car Stereo KP5500 . . . \$129.
 Pioneer Car Stereo KPA400 . . . 139.
 Pioneer Car Stereo KE5100 . . . 179.
 Pioneer Car Stereo UKE7100 . . . 229.
 Sony Car Stereo XR15 129.
 Sony Car Stereo XR25 149.
 Concord Car Stereo HPL122 . . . 289.
 Superfox Remote Radar Detector 189.

Pioneer Car Speaker TS108 \$39.
 Pioneer Car Speaker TS6905 . . . 69.
 Pioneer Car Speaker TS6906 . . . 89.
 Pioneer Car Speaker TS6907 . . . 99.
 Sony Car Speaker XS102 49.
 Sony Car Speaker XS301 59.
 Jensen Car Speaker J1069 45.
 Altec Car Speaker 6X94C 89.

DISCOUNT WORLD, P.O. BOX 191, MINEOLA, N.Y. 11501 516-294-6136
 Shipping charges are \$4.00 per order to continental U.S.A. We accept money orders, cashiers or certified checks.
 Personal checks - 3 weeks delay. N.Y.S. Residents add sales tax. Write for FREE catalog.



**The Best
 Doesn't Mean the
 Most Expensive.**

Low prices on a huge selection of name brand hi-end. All units are new with full warranty. Let our experts guide you to the best sounding system for your dollar. Call for information or write for a free catalog.

Nationwide Delivery
 VISA MasterCard Amex.

audio advisor, inc.
 Box 6202 Grand Rapids, MI 49505 (616) 451-3868

FOR SALE

BEST SOUND PER DOLLAR SYSTEM

(UNDER \$2100)

- Turntable: Rega Planar 3
- Cartridge: Dynavector 10X3
- Receiver: NAD 7150
- Speakers: Snell Type E's

SOUND BY SINGER

227 Lexington Avenue
New York, NY 10016
(212) 683-0925

BEST TRADES OFFERED. Trade for Acoustat, Bedini, David Berning, Futterman, PS, Perreux, Counterpoint, Classe, Rega, Sola, Spica, Rogers, AR turntables, Souther, Precision Fidelity, Quicksilver, Dynavector, Audioquest, Belles, Rauna, Spondor, Pentagram, Goetz Snell, Pyramid, VPI, Oracle, Nitty Gritty and more. Audio Doctor, P.O. Box 390, 1518 Commercial, Buffalo, MO 65622, 417-345-7245.

BIG TEN SYSTEM

(UNDER \$10,000)

- Turntable: Linn Sondek Lp-12
- Tonearm: Syrinx PU-3
- Cartridge: Kiseiki Blue
- Tuner: Adcom GFT-1A
- Preamp: Krell PAM 1-A
- Amp: Krell KSA-100
- Speakers: Snell Type A's

SOUND BY SINGER

227 Lexington Avenue
New York, NY 10016
(212) 683-0925

B&K IMPORTS—High quality audio products at affordable prices! Most belt drive turntables. Most quality tonearms. The finest phono cartridges, pre-amplifiers, head amplifiers, amplifiers, interconnects & speaker cables, loudspeakers. Incredible inventories of high performance equipment! Call or write for our low prices. 1-313-553-0508. 24160 Twin Valley Ct., Farmington, Mich 48024. Free Catalog. British hi-fi mags, old and new.

BOSTON ACOUSTICS PLUS—Dollar for dollar, one of the most exceptional speaker lines to come along in years. Boston Acoustics delivers unbelievable performance at very reasonable prices. All models in stock. DESIGNATRON'S STEREO STORES, INC. 260 Old Country Road, Hicksville, NY 11801 (516) 822-5277.

BOZAK CONCERT GRANDS, CLASSIC. Highly modified. Sonically and aesthetically excellent. Jim - (215) 687-3609.

Music Lovers & Audiophiles
Take Notice!
We are proud to announce the

GRAND OPENING of APPLE AUDIO

- featuring the finest names in audio such as
- ADS • Amber • Audio-Pro • Audio Control
 - Beyer • Celestian • Dynavector • D.C.M.
 - F.A.S. • Grace • H.K. • Last • Monster Cable
 - Ortofon • Ungo Box • Pyramid • Sonus
 - Sumiko • Sherwood • Thorens
 - 3D Acoustics • And More
- Prompt, Courteous Service • Free Shipping in the U.S.A.
Feel Free to call for Information
MC/VISA 110-220 VOLTS



74-18 37th Ave.
Jackson Heights, N.Y. 11372
(212) 507-0561 • Open 7 Days
Exit Broadway-Roosevelt on 80E
278

No one even comes close.



Just ask any PS owner, then add up our features, sonics and low price. Unbeatable. *Moving coils* are used straight in, with no head amp required. MC performance is phenomenal.

- Passive RIAA
- 32-position Noble volume control
- Line amp by-pass switch
- Relay controlled outputs
- Star grounds
- High-current remote supply, standard
- Cartridge loading
- High impedance moving coil input

Sonically, the PS IV stands alone. At \$656 (including remote supply), no other preamp even comes close. If you love music, you owe it to yourself to audition a PS preamp.

Write us for our new 20-page brochure and free technical series, or see your local PS dealer.

PS Audio, Inc., 3130 Skyway Drive #301, Santa Maria, California 93455

FOR SALE

BREAKTHROUGH DEVELOPMENT!!!!

Cables That let you hear your system for the first time!! Four years in the making! Discreet Technology Audio Interconnects!!! The difference will startle you. Money gladly returned if you don't feel totally satisfied!! Send \$50.00 for 3 Ft; \$60.00 for 4 Ft. Plus \$1.75 shipping (no C.O.D.'s) to CSA AUDIO 193 Bellevue Avenue, Montclair, New Jersey 07043

CABLE TV DESCRABLERS AND CONVERTERS.

Plans and parts. Build or buy. For Information send \$2.00. C&D Electronics, Inc., P.O. Box 21, Jenison, MI 49428.

CASSETTE TAPES

PREMIER QUALITY—NORMAL BIAS
COMPARE TO YOUR FAVORITE BRAND
C60 @ \$14.00/10; C90 @ \$17.00/10; ADD \$2.00 P/H
COMMUNICATION INNOVATIONS, P.O. BOX 11712-A
MARINA DEL REY, CA 90295



SONY CDP-101

New England's headquarters for Compact Disc players, software, and associated components.

Sound & Music

92 King St. Northampton, MA 413-584-9547

FOR SALE

CALL TOLL FREE 1-800-826-0520 For Acoustat, Dahlquist, NAD, Carver, Haller, B&W, Tandberg, Denon, Astatic, Amber, Oracle, Perreux, Proton, Snell, 3D, Grace, VSP, Bellies, Pyramid, Sola, Audioquest, M&K, Bedini, dbx, Thorens, Stax, Nitty Gritty, Dynavector, CWD, Grado, The Sound Seller, 1706 Main St., Marinette, WI. 54143 (715) 735-9002.

BRYSTON 3B—\$800, DYNA 400—\$350, (215) 736-0789, Eve.

KIMBER KABLE

HIGH PERFORMANCE SPEAKER WIRE

Strong in the West, headin' East.

ASK YOUR DEALER

Manufactured by:

RKB Industrial, Inc.
2058 Harrison Blvd.
Ogden, Utah 84401
(801) 621-5530

NY METRO AREA

- ADS, AGI, APT, Astatic, Audio Control, Audi-onics, Audio Pro, Audio Research, Audio Technology, Beyer, Blaupunkt, B&O, Burwen, B&W Carver, CAT, Colter, CWD, Dahlquist, DCM, Denon, Dynavector, EV, Fidelity, Research, Grace, Grado, Haller, Janis, KEF, Koetsu, Linn, Sondek, Lye Wire, Lustr, Nakamichi, Pyramid, Quad, Queen, Linn, Revox, RG Dynamics, RGR, RH Labs, Rogers, Snell, Stax, Symmetry, Tandberg, 3D Acoustics, VPI, Yamaha

Audiocom
high technology audio

SERVICE ON PREMISES • CUSTOM INSTALLATIONS
THREE LISTENING ROOMS ON TWO LEVELS
LARGE INVENTORY • PROMPT DELIVERY
INFORMATION LINE 203-637-3821

177 Sound Beach Avenue, Old Greenwich, CT 06830
Major credit cards honored. Open 10 AM-6 PM Mon-Sat.

VMPS AND VALUE

The design philosophy behind each VMPS Speaker system is simple and straightforward: offer more and better sound per dollar than any other manufacturer. Our five and six-way floor-standing systems utilize only the finest quality components, including large-magnet polypropylene cone woofers (made in our own factory), mylar and polypropylene crossover networks, Monster Cable as internal wiring, zero group delay crossover networks and driver configurations for true minimum phase response, solid hand-finished veneer cabinets, and more:

Lower Loudspeaker Distortion

The exclusive resonance-free VMPS multi-band bass technique with separate integral subwoofers, lowbass and midbass drivers in each cabinet results in dramatically lower THD fullrange. Example: the VMPS Tower II (\$419 ea kit, \$599 ea assem) is rated at no more than 0.7% THD from 22Hz - 30KHz with 1W input, about **one-fourth** as much distortion found in competing systems twice its price.

Greater Dynamic Range

VMPS loudspeakers typically exhibit 10-15dB more usable dynamic range than competing systems now proclaiming themselves "digital-ready." Example: The VMPS Super Tower/R (\$679 ea kit, \$969 ea assem) produces 128dB/1m SPL (for no more than 5% THD), and has an outstanding high sensitivity of 100dB/1m SPL with no more than 0.5% THD 22Hz - 30KHz for 1W input.

Wider Bandwidth

Most high-output speaker systems sacrifice both linearity and several octaves of bass response in order to generate high sound pressure levels. The larger VMPS systems, such as the Super Tower IIa/R (\$999-1199 ea kit, \$1499-1699 ea assem depending on finish) truly give you all the music (17Hz to 50KHz, -3dB), including a thunderously clean, realistic first octave, plus response linearity equal to the finest audiophile monitors.

Better Imaging

Only a truly minimum-phase speaker systems with all drivers in proper polarity and *d* linear phase crossover will produce a stable and correct stereo image, and VMPS speakers give you just that: an image with pinpoint accuracy of placement, wide horizontal spread beyond the plane between the speakers, and the important vertical image component lost in most other systems. In addition, the VMPS Widerange Ribbon, (\$4795 kit, \$5995 assem) with its four-piece, fullrange columns plus Space Boxes configuration generates the deepest, most tactilely three-dimensional stereo image ever achieved in a home loudspeaker system. See our ads in April/May 83 *Audio*.

New Products

VMPS now offers the VMPS Subwoofer (\$225 ea kit, \$375 ea assem), with flat response from 19Hz to 600Hz (-3dB), high input sensitivity 194dB/1W/1m, and high undistorted output (126dB/1m); and two Electronic Crossovers, the 6dB/oct Model 1 (\$250) and the 12dB/oct, transient-perfect Model 2 (\$395) both designed by John Curl.

VMPS AUDIO PRODUCTS

div Itone Audio

1016 Contra Costa Dr., El Cerrito, CA 94530 (415) 526-7084

Hear VMPS at: The Listening Studio, Boston; Mike Hilliard Audio, Shreveport La; Audio Labs, Des Moines Io; Efficient Stereo, Torrance Ca; M. Ellwood Meyers, Johnstown Pa; Woodland Stereo, Woodland Hills Ca; The Long Ear, Big Bear Lake Ca; Sounds Unique, San Jose Ca; The Listening Post, San Francisco; Itone Audio, El Cerrito Ca; A-Vidd Electronics, Long Beach Ca.

FOR SALE

CROWN BEST QUALITY AMPLIFIERS, TUNERS, PRE-AMPLIFIERS, PROFESSIONAL CONSULTATION—BEST PRICES. EAST: (904) 262-4000; WEST: (213) 840-0878.

HAFNER, REVOX, TANBERG, CARVER, DBX AND OTHER QUALITY COMPONENTS. PROFESSIONAL CONSULTATION—BEST PRICES. EAST: (904) 262-4000; WEST: (213) 840-0878.

CHESTNUT HILL AUDIO HAS SPENDOR
SP-1, BC-1, LS 3/5A, Prelude

311 Cherry Street
Philadelphia, PA (215) 923-3035

C.J. WALKER TURNTABLES (303) 963-3269

CONNECTICUT AUDIO SOCIETY. Recruiting new members. Contact John McBride, 33 Perry Dr., New Milford, CT 06776 (203) 355-2032.

CONRAD-JOHNSON MV75A-1 poweramp with rack case and new tubes \$900.00. PV2ar preamp with new tubes \$450.00. Plus extra bonus items. call John Jr. at (504) 392-2536.

COUNTERPOINT. Audio's best value in tube electronics including the new output transformerless SA-4 by Roger Madjeski on display at Audio Pro/Philes Houston, Texas

COUNTERPOINT: ELECTRONICS THIS EXCEPTIONAL DESERVE careful, detailed, private auditions. Audio Nexus, NJ (201) 464-8238, (201) 474-2910.

COUNTERPOINT, QUICKSILVER, VSP LABS. PS Audio. (303) 963-3269.

CROWN DL2 PREAMP—\$1,200. SX824—tape deck, with remote, counter and walnut cabinet—\$995 Call Terry 402-391-3842

DYNACO OWNERS: 60,000 LBS parts/accessories kits. Free catalog. SCC, Box 551 (AM 1183) Dublin, Ohio 43017, (614) 889-2117

FOR SALE

DB SYSTEMS GOLD PLATED AUDIOPHILE CONNECTORS INCLUDE: DBP-9AU(8) (eight pack) BANANA PLUGS—solderless setscrew type \$14.95, DBP-9H(8) BANANA HANDLES—red black \$5.50, DBP-9P (2) DOUBLE BANANA PLUG—stackable—red black \$14.95, DBP-9J(2) BANANA JACKS—dual binding posts—30 Amperes/1000 Volts \$15.95, DBP-13J(8) PHONO JACKS—1/4" Mounting Hole \$12.95, DBP-13JR(8) PHONO JACKS—3/8" Mounting Hole \$15.95, DBP-13JC(8) PHONO JACKS—circuit board mount \$7.95, DBP-13P(8) PHONO PLUGS—gleaming ebony hydrocarbon cap \$8.95, DBP-13PM(8) PHONO PLUGS—fully shielded—gold plated cap—red black \$21.95, DBP-14(8) SPADE PLUGS—crimp/solder—10/12 gauge \$5.95, DBP-15(2) "Y" ADAPTORS—phono plug(1) to phono jacks(2)—cable assembly 22 picoFarads \$11.95. For Galilmaufry #6 and complete information write DB SYSTEMS, Main St., Rindge Center, NH 03461 (603) 899-5121. Enclose \$1.00 for color photograph, non-refundable. Orders under \$45 add \$2.50 Handling. Dealer inquiries invited.

DEEP SIX SYSTEM

(ABOUT \$6000)

Turntable: Linn Sondek Lp-12
Cartridge: Talisman S
Tonearm: Linn Basik LV-X
Tuner: Adcom GFT1-A
Preamp: Acoustat TNP
Amplifier: Acoustat TNT-200
Speakers: Acoustat 2 + 2

SOUND BY SINGER

227 Lexington Avenue
New York, NY 10016
(212) 683-0925

DIRECT-TO-DISC SUPER DEAL! 3 brand new albums (our choice)—one each: jazz, rock, classical—\$45-\$60 retail. \$15.00 postpaid! Satisfaction guaranteed! SCC, Box 551(AM983), Dublin, OH 43017; (614) 889-2117. VISA MC.

aq audioquest

The AudioQuest stable of products includes the famous AQ series of moving coil cartridges with hollow sapphire cantilevers. The AQ404, AQ606 and AQ808 are high output models designed to feed a normal phono input. The AQ505, AQ707 and AQ909 are low output models requiring an extra gain stage. The new AQ1.1 is a medium output model designed for the new generation of "high gain" preamps. We also make the remarkably inexpensive GroovDancer MC+ high output moving coil and the GroovDancer IM+ induced magnet cartridge. The AQ Shadow tonearm along with the AQ 317/LW and AQ 407/LW all come with LiveWire headshell leads and a LiveWire tonearm cable. Whether you are spending \$325, \$575 or \$825 these arms will let you hear what your cartridge is supposed to sound like instead of the harshness and resonance-induced mistracking so common in other arms. Don't forget the superb LiveWire interconnecting and speaker cables, the only good looking sound paneling, AudioQuiet One and Two, the AQ record brush and AQ stylus cleaner. The latest AQ product is an extremely effective record mat which supports and damps for the least colored sound possible.

AT AUDIOQUEST WE TALK MERIT — NOT MARKETING!

3857 birch street, #610

newport beach, california 92660

714 / 720-1995

LIVE WIRE™

FOR SALE

DB SYSTEMS ELECTRONICS

(201) 445-5006 (201) 891-4745 (215) 725-1177
 (301) 428-0393 (305) 921-5751 (313) 655-8639
 (404) 449-4343 (404) 659-1114 (415) 593-9724
 (504) 866-3457 (603) 357-5040 (617) 277-0111
 (617) 395-3367 (617) 641-0490 (803) 524-7934
 (808) 847-0104 (809) 787-8552 (914) 623-3983
 DB SYSTEMS Rindge Ctr NH 03461 (603) 899-5121

DEMO SALE: ARC D79C 3750, ARC D70 1600, ARC SP-10 2795 ARC SP-12 800, ARC D-120 used 1350, ARC SP-7 used 700, ARC MCP-2 used 900, Counterpoint SA-2 725, Counterpoint SA-P 210, KEF 105.2 2400, KEF 105.4 1600 with bonnets, KEF Carlton 600, Thiel Q3a rosewood 1050, Thiel Q4 rosewood 625, Thiel Q2 rosewood 350, CJ Walker 55 with MAS 282 475, Dynavector 23R new 195, Dynavector 10X3 new 110, Acoustat 3MH black/rosewood 1295, Quad 63 2450, Threshold FET1 1900, Threshold S-300 1650, Oracle Delphi 925, Oracle Alexandria 850, Dynavector 17D 350 demo, Audio Pro/Philes, 12651 Memorial Dr., Houston, TX. 77024. 713-973-0000. Subject to prior sale.

DIAMOND NEEDLES and **STEREO CARTRIDGES** at **DISCOUNT PRICES** for SHURE, PICKERING, STANTON, EMPIRE, GRADO, AUDIO TECHNICA, ORTOFON, MICRO-ACOUSTICS, SONUS, ADC and LAST, send S.A.S.E free catalog. LYLE CARTRIDGES, Dept. A., Box 69, Brooklyn, NY 11218. For fast COD service Toll Free 800-221-0906. N.Y. State (212) 871-3303. 9AM - 8PM except Sunday.

ELECTRO-VOICE INTERFACE AND **CD SERIES QUALITY SPEAKER SYSTEMS**. PROFESSIONAL CONSULTATION—BEST PRICES. EAST: (904) 262-4000; WEST: (213) 840-0878.

EFFECTIVELY REDUCE HIGH FREQUENCY NOISE. New single-pass dynamic noise-reduction system works with any source. Greatly reduces record surface noise, hiss from tapes, FM, TV audio, etc. Passes full audio bandwidth. Beautiful enclosure with walnut end panels. 14 day free trial. \$159 includes shipping. Write for information. Accusonics, P.O. Box 20661, SLC, Utah 84120

DYNACO S170, PAS 2 (315) 896-2052.

FOR SALE

ELECTRONIC CROSSOVERS

have been the choice of state-of-the-art speaker system designers for at least a decade. They offer significant advantages over passive crossovers, and this is becoming more apparent as listener sophistication grows. For a copy of **WHY AN ELECTRONIC CROSSOVER?** Send a self addressed, stamped, business size envelope to Symmetry White Paper #1, PO BOX 210465, San Francisco, Ca. 94121

★ELECTRONIC REPRESENTATIVES NEEDED!★
LOWEST POSSIBLE PRICES!! OVER 100 BRANDS! AUDIO—VIDEO—CAR STEREO—COMPUTERS ELECTRONIC EXPERTS 1000 ORANGE AVE., WEST HAVEN, CT 06516

ELECTRONIC X-OVERS: 6, 12 AND 18DB/OCTAVE. Kits from \$106.50. Also Transient-Perfect Crossover model 6000-6, \$175.00. Filters. Free folder w/reviews. ACE AUDIO CO. #532-5th Street, E. Northport NY 11731-2399. (516) 757-8990.

ESOTERIC AUDIO SPEAKERCABLE 50¢ ft! Matches others costing \$1.50+. Gold Spades 80¢ ea. \$2.50 shipping. SOLID WALNUT cassette, VCR tape cases, Plateau speaker stands, turntable accessories. Best prices anywhere! AAA Audiophile Accessories P.O. Box 1204A, Elgin, IL 60120

EXCEPTIONAL AUDIO REPRODUCTION SYSTEMS
 HEYBROOK, REGA, ARISTON, AR, THORENS, DUAL turntables; ZETA, SYRINX, HELIUS-HEYBROOK, PREMIER, REGA tonearms; ARCAM, AUDIRE, CREEK, COUNTERPOINT, KENWOOD PURIST, KYOCERA, SHERWOOD, VSP LABS, ADCOM electronics; FRIED, HEYBROOK, ORIGIN speakers; SUPEX, TALISMAN, GRADO SIGNATURE, REGA, ARCAM cartridges and many accessories. EARS, P.O. BOX 658-U, W. COVINA, CA 91790. 213-961-6158 EVENINGS, WEEKENDS. MC/VISA. MONTHLY SPECIALS.

FM ACOUSTICS FROM SWITZERLAND now available in the metro New York area exclusively at Audio Connection. Designed for mature and advanced audiophiles and music lovers, as well as for professional use. FM is the final word in state-of-the-art electronics. By appointment please. 201-239-1799

The Small Yet Surprising Morel MLP-202.



THESE ARE THE REMARKABLE small loudspeakers whose smooth response and open, dimensional sound are at least on a par with the finest units of many times the 202's size and price.

Morel has designed and built speakers and driver units in Israel for over eight years. Now, with the U.S. introduction of the model MLP-202, Morel is prepared to offer the demanding audiophile the highest possible quality at an extremely reasonable cost. (\$198. each)

Morel's drivers, manufactured to the strictest tolerances in our own factory, incorporate several notable technological advancements. Utilizing hexagonal voice-coil wire, unique magnet structures having no stray magnetic fields, and special adhesives and coatings, the Morel drivers are exceptional in rise time and coherence.

Also, the oversize (3") voice coil in our woofer and the ferrofluid tweeter will allow Morels to handle the wide dynamic range of your digital recordings with plenty of room to spare.

Please write for details:



morel acoustic ltd

industrial area b, p.o.b. 140, ness ziona
 70 451 israel. tel. 054-70796, telex 31951

morel acoustic usa

414 harvard street, brookline, mass. 02146
 u.s.a. tel. (617) 277-0111



ZETA

probably the best tonearm in the world?

'the Zeta is the best sounding arm I've tried... capable of bringing a whole new dimension to disc reproduction.' — HIFI ANSWERS.

'more dramatic in resolution, dynamic range enhanced, general sharpening of instrumental positions.' — HIFI NEWS.

'bass was exceptionally good, deep, powerful, tight & articulate... treble was sweet & transparent.' — HIFI CHOICE.

'the sound overall was gratifyingly delicate... stereo imagery I frankly thought superb... good subjective dynamic range... excellent trackability... the Brier is a superb pickup.' — HIFI NEWS



GOLDBUG

hand building sweeter MC cartridges

REFERENCE MONITOR INT. INC. 6074 CORTE DEL CEDRO, CARLSBAD, CA 92008

FOR SALE

**ATTENTION ADVERTISERS!
SEE CLASSIFIED RATE BOX ON
PAGE 111 FOR NEW RATES, EF-
FECTIVE JANUARY 1984 ISSUE.**

FOCAL LOUDSPEAKERS AND KITS FROM FRANCE
Featuring: Neoflex cones, Fiberglass domes, Flatwound wire, Active or passive crossovers, Compound woofer systems. Extensive design parameters. Available in the US from **MADISOUND SPEAKER COMPONENTS** 8982 Tablebluff, Box 4283, Madison, Wisconsin 53711 608-767-2673.

FOR OVERSEAS USE & EXPORTS We supply NTSC/PAL/SECAM TV's, VCR's, Video Cameras & Acces., Stereos, SW Radios & Appliances 110-220V, 50/60Hz. Best prices, Prompt delivery. Contact: Roma Entp., P.O.B. 41127, Cincinnati, OH-45241, (513) 769-5363

*Electrified
Discounters*

203-937-0106

Lowest Possible Prices !!

AUDIO VIDEO CAR PRODUCT
COMPUTERS — (HARWARE - SOFTWARE)
VIDEO GAMES TELEPHONES MORE

FULL WARRANTY — FAST DELIVERY
SEND FOR FREE CATALOG !!



996 ORANGE AVE.
WEST HAVEN, CT. 06516



High Performance Review

Recent reviews include: Mark Levinson ML-9, ML-11, ML-12; Accuphase AC-2; Dynavector 17D, 23R; Snell Type E, Celestion SL-6; Sony Esprit TA-E900. Coming next: Conrad-Johnson Premier 3, Levinson ML-7, Audible Illusions Modulus, Quad 405-2, Infinity RS3a, Nakamichi Dragon, B&W 801F. Our unique combination of listening evaluation (with up-scaled comparison systems) and leading edge laboratory tests gives you an uncompromised view of these high-end products. Interesting and stimulating, audiophiles and professionals respect and praise our in-depth reviews: "Precise evaluations...Outstanding." Published quarterly, **H/PR** is guided by an expert technical advisory board. Issues average 160 pages (no ads). Extensive photographs and graphs. Subscribe today!

High/Performance Review

Box 2989; Stanford, CA 94305 U.S.A.
 Yes, start me with Volume 2. \$26.00 check or money order enclosed.
 I want both Volumes 1 & 2. \$50.00 enclosed.
 Overseas and Canadian subscribers: Check in US Funds net on US Bank or International Postal Money Order. Add \$4.00 for non-US surface mail.

Name _____
 Street _____
 City _____
 State _____ Zip _____
 For Questions: Telephone: (408) 446-3131, M-F 10-4 (Pacific Time)

FOR SALE

FOR SALE: RACK MOUNT FACEPLATE SCREWS. 10-32 x 3/4 Flat Head for Allen Wrench, Black Finish. Write for Info. P & S Audio, P.O. Box 2131 Joliet, IL 60434

FOR THE BEST IN HIGH END—David Berning, Audioquest, Spondor, Audionics, Pentagram. Top Dollar Paid for Trades. Audio Den (412) 852-1134

FREE SPEAKERKIT CATALOG! 17 proven designs. Also, 42 pages on 400 components. (JBL crossover parts, polypropylene woofers). \$2. GOLD SOUND. Box 141A. Englewood, CO 80151. (303) 789-5310.

FRIED LOUDSPEAKERS IN NJ: AUDIO NEXUS has them all. (201) 464-8238, (201) 474-2910.

FRIED SPEAKERS & KITS

State-of-the-art sound. Try our prices! Free shipping. **READ BROTHERS STEREO**, 593 King Street, Charleston, South Carolina 29403, (803) 723-7276. Also Halfer, Mitsubishi, Nakamichi, Carver, Sony ES digital (and PCM-F1).

GENE RUBIN AUDIO—LOS ANGELES

NAIM AUDIO	LINN SONDEK	ISOBARIKS
PS AUDIO	THORENS	ACOUSTAT
NAD	CJ WALKER	THIEL
KYOCERA	LS3/5A	SPENDOR

Prepaid shipping (213) 571-1299 (Pacific Time)

GOLD LION POWER TUBES: KT88, KT77, Premium 12Ax7, and 6DJ8 available from IAI, 723 Bound Brook Rd. Dunellen, NJ 08812, or call 201-968-8771.

GOLDMUND. The Incomparable Studio/T3B on display in Texas and the Greater Southwest only at Audio Pro/Philes. Deposits being taken for November/December delivery of the new Goldmund Studietto/T5 tonearm. Linns, Oracles, etc. accepted on consignment. 713-973-0000

GRACE CARTRIDGES: HAND PICKED FOR THE BEST. Read Outs For Channel Balance, Crosstalk, and Frequency Response. F9E \$120.00, F9E Ruby \$165.00 ETC. VISA. MASTERCHARGE. COD. AudioWorkshop, Box 18009, Seattle, WA 98118 (206) 323-4987.

ESOTERIC AUDIO SYSTEMS

Accuphase • Adcom • Apt • Ariston • Audio Interface • Beveridge • Classe Audio • Clear Audio
 Counterpoint • DB Systems • D & K Imports • Dynavector • Electrocompaniet • Electron Kinetics
 Entec • Esoteric Audio Research • Grace • Halfer • Helius • Kiseki • Kimber Cable • Klyne
 Koetsu • Lustre • Microseki • Ortofon • Orsonic • Pink Triangle • Precision Fidelity • Profile
 Sideral Akustic • SME • Snell • Sonographe • Souther • Spica • Stax • Supex • Symmetry
 Thorens • Triad • VPI • VSP Labs

Call for appointment and/or information or send \$2.00 (Refundable) for product brochure.

Complete Shipping and Export Facilities Available
 Bank Cards Accepted

GREENFIELD EQUIPMENT

BOX 225D RIVER FOREST, IL 60305 (312) 771-4660

FOR SALE

GOLDMUND STUDIO/T3 \$2995. Koetsu Onyx Gold \$750. Electrocompaniet Ampliwire IIs (mono) \$1750/pr. Keith Monks record cleaning machine \$995. (405) 341-7980.

GRADO TURNTABLE AND ARM, \$65. 408-867-0341.

HAFLER DH-220 \$275, DH-500 \$400, 4-MACINTOSH MC-30 TUBE AMPS \$150 EA. MODIFIED CITATION 1 \$200, MODIFIED CITATION IV \$150. 602-445-6999.

HAFLER IN THE SOUTH!

In stock, the superb Halfer pre-amps, amplifiers, tuner and equalizer. Immediate, FREE shipping. Also Fried, Carver, Acoustat, Mitsubishi, Nakamichi, Audire, PS, Vandersteen, Klipsch, Sony ES digital (and PCM-F1). **READ BROTHERS STEREO**, 593 King Street, Charleston, South Carolina 29403, (803) 723-7276.

HAFLER PLUS—The new Halfer DH220 power amplifier—replacing the DH 200, reinforces David Halfer's commitment to quality in every product he designs. We carry the full Halfer line, available in either kit or factory assembled. Own some of the finest audio equipment! Now at extra savings! **PLUS-FREE** shipping anywhere in the continental U.S. **DESIGNATRON'S STEREO STORES, INC.**, 260 Old Country Road, Hicksville, NY 11801, (516) 822-5277.

HAFLER—3 YEAR WARRANTY

Assembled units are now warrantied for three years. We should have the following in stock: DH-100K \$149.95, DH-100A \$199.95, (NEW PREAMPS); DH-110K \$299.95, DH-110A \$399.95, DH-112 \$74.95, DH-160K \$299.95, DH-160A \$399.95, DH-220K \$349.95, DH-220KE \$359.95, DH-200A \$449.95, DH-220AE \$459.95, DH-330K \$299.95, DH-330A \$399.95 (NEW TUNERS), DH-500K \$599.95, DH-500KE \$619.95, DH-500A \$749.95, DH-500AE \$769.95. Accessories for above units. **FREE SHIPPING IN US AND PR. WORLDWIDE EXPORTING.** Visa and MasterCard. **OXFORD AUDIO CONSULTANTS, INC.**, Box 145, Oxford, OH 45056, 513-523-3333, TLX427791.

HELIUS DESIGNS TONEARMS: EASY TO SET UP; easy to listen to. For dealer list, contact IAI, 723 Bound Brook Road, Dunellen, NJ 08812, or call 201-968-8771.

HEYBROOK at Audio Connection 201-239-1799

Looking for Tube Quality Sound? ...at transistor prices?

NOW YOU CAN HAVE BOTH. Dramatic breakthroughs by Kinergetics in signal processing technology have made this possible.

The new amplifier, the **KBA-100**, advances the technology developed in the Kinergetics Dynamic Circuit Processor (KDP). The **KBA-100** combines the low distortion of transistors with the cleanliness and transient qualities of vacuum tube amplifiers.

Suggested retail — **less than \$800.**



6029 Reseda Blvd. • Tarzana, CA 91356 • (213) 345-2851

FOR SALE

HAFNER, REVOX, TANBERG, CARVER, DBX AND OTHER QUALITY COMPONENTS. PROFESSIONAL CONSULTATION—BEST PRICES. EAST: (904) 262-4000; WEST: (213) 840-0878.

HARMAN-KARDON SEPARATES, RECEIVERS, CASSETTE DECKS, TURNTABLES, PROFESSIONAL CONSULTATION—BEST PRICES. EAST: (904) 262-4000; WEST: (213) 840-0878.

HI-C STEREO HAS SPENDOR

SP-1, BC-1, LS 3/5A, Prelude

116 E. Market Street
Leesburg, VA (703) 777-7799

HIGH END EQUIPMENT

All kind of American, Japanese, English and German audiophile products like: Audio-Research, Audiostatic, Acoustat, Conrad-Johnson, Esoteric A.R., EMT, Goldmund, Infinity, Kliseki, Krell, Koetsu, Linn, Magneplanar, Oracle, Plasmatronics, Quad, Revox, Stax, Snell, Threshold, Thorens, Vernissage, Zen and many others at lowest export prices. Ask for latest price list and details. WE SHIP WORLD-WIDE! HiFi Systems, Lengsdorfer Hauptstrabe 75, 53 Bonn 1 West-Germany. Tel. 0228-253111 or 253314, Tlx. 886646 hfss d.

INTERSONICS—YOU'VE HEARD OF US: direct-export specialists: Japanese high-end/esoteric audio components, accessories, parts, Japanese pressings, OEM sourcing, more. Serving audiophiles and dealer/distributors with exceptional volume pricing, prompt delivery, responsible backup. An AMERICAN enterprise: INTERSONICS, PO Box 113, Toyohashi 440, JAPAN.

JACK CALDWELL RIBBON SYSTEM and smaller Caldwell dynamic speakers (303) 963-3269.

JANIS BASS SYSTEM. A classic. Audio Pro'Philes

JANIS WOOFERS & INTERPHASE CROSSOVER/AMP
The Janis bass systems are the finest universal subwoofer systems available. FREE SHIPPING IN US AND PR. Visa and MC. WORLDWIDE EXPORTING. OXFORD AUDIO CONSULTANTS, INC., Box 145, Oxford, OH 45056-0145, 513-523-3333, TLX427791.

JBL COMPONENTS: All new items. 408-867-0341

JBL HARTSFIELDS, EV PATRICIANS, W'DALES. 408-379-7965; 408-371-3512 PO Box 1211 Campbell CA 95009

J.B.L. SPEAKER SYSTEMS AND COMPONENTS
bought, sold and traded. 1-313-229-5191 or 5115 Red Fox, Brighton, MI 48116.

A SINGER'S DREAM!



REMOVES VOCALS FROM RECORDS!

Our VOCAL ELIMINATOR can remove most or virtually all of a lead vocal from a standard stereo record and leave most of the background untouched! Record with your voice or perform live with the backgrounds. Used in Professional Performance yet connects easily to a home component stereo system. Not an equalizer! We can prove it works over the phone. Write or call for a free brochure and demo record.

Write to: **LT Sound, Dept. AU, PO Box 338**
Stone Mountain, GA 30086
In Georgia Call (404)493-1258

TOLL FREE: 1-800-241-3005 — Ext. 43

FOR SALE

JULIUS FUTTERMAN OTL AMPLIFIERS ©
Peter Moncreiff says "1A". Since 1954, the Futterman OTL amplifier has received state of the art awards because it is a tube amplifier that has no output transformer. It has the speed and dynamics of a transistor amplifier and the harmonic correctness of tubes. For information on OTL amplifiers, and our 72 page book, "Understanding Tube Electronics", an education in proper engineering of tube circuits, and must be read by serious audiophiles, send \$2.00 to New York Audio Laboratories, Inc. 33 North Riverside Avenue, Croton-on-Hudson, New York 10520.

KEF 103.2 \$550.00 TANBERG 3034 w/warranty \$398.00. Adcom GFT-1 w/warranty \$290.00. Nad 1020 & 2150 w/warranty \$390.00. EPI 100's w/warranty \$150.00. Mitsubishi DAR8 \$100.00. Hafner 101 \$125.00. Audio Den (412) 852-1134.

LEVINSON HQD WOOFERS. 24" drivers in oak cabinets w/casters. Great with Quads, Magnaplanars. \$1495/pr. (213) 934-1817 (eves. weekends), (213) 736-7504 (weekdays)

LEVINSON HQD, QUADS, STANDS, Hartley woofers. Decca tweeters. LNC-2s, new system (201) 746-2794

LINN DMS SPEAKERS, stands; cables, Naim 250, SNAPS, 42s Pre-Amp, Perfect, 516-931-7039 \$5400 or best offer.

LINN & NAIM—NEW PRODUCTS

We are pleased to announce the NEW Linn TRAK cartridge \$225 and the NEW Naim NAIT integrated amplifier \$399. Yes, you can have a Linn Naim System on a budget. We also offer the complete line of Linn/Naim products. Call or write us for details. Visa and MC. FREE SHIPPING IN US AND PR. OXFORD AUDIO CONSULTANTS, INC., Box 145, Oxford, OH 45056, 513-523-3333, TLX427791.

LINN PRODUCTS & NAIM AUDIO:
Simply The Best Available
GENE RUBIN AUDIO (213) 571-1299

LINN SONDEK LP12 TURNTABLE—used. Call Terry 402-391-3842

LYRIC HI FI HAS SPENDOR
SP-1, BC-1, LS 3/5A, Prelude

1221 Lexington Avenue
New York City (212) 535-5710

146 E. Post Road
White Plains, New York (914) 949-7500

LOOKING FOR THE BEST TUBE ELECTRONICS? Contact Esoteric Audio Components (512) 837-9629. 3:30-10:00

MAGNEPLANAR MG18 USED. Call Terry 402-391-3842

MONEY BACK! MINT USED EQUIPMENT

14 DAY MONEY BACK 1 Year Limited Warranty

McINTOSH MA6100 \$399	McINTOSH MA5100 \$249
MCINTOSH MPA-4 \$899	KLH NINE \$599
MAGNEPLANAR T-1d \$749	HAFNER DH200 \$249
APT/HOLMAN ONE \$349	MISSION 774 \$269
AUDIO RESEARCH D76A \$749	GRACE 70711599
AUDIO RESEARCH SP6A1 \$749	THIEL O3A \$699
AUDIO RESEARCH D79A \$1699	REVOX A771V \$699
AUDIO RESEARCH D100 \$599	CROWN D150A 10c \$379
DAHLQUIST D010 \$499	DRACO MICRO CPU100\$499
ADS MODEL 10 \$749	DYNACO ST70/Mod \$279
RABCO SLBE/DKL \$99	FIDELITY RESEARCH FR665 \$699

SUBSTANTIAL SAVINGS ON NEW SYSTEMS:

ACOUSTAT KRELL SOTA SAPPHIRE HAFNER P5
SONY/DIGITAL PYRAMID KYOCERA GRADO
DBX DAVID BERNING DB SYSTEMS SOUTHERN
DYNASTOR
THORENS GRACE EUPHONIC AUDIO
INNOTEC SUPEX DAHLQUIST DENNESEN
SPENDOR KISEKI KLYNE JENSEN
SONY/BETA HIFI SYRINX SEQUERRA FMI



Q Audio



95 Vassar St. Cambridge, MA 02139 617-547-2727

FOR SALE

LP12 OWNERS! Let Nirvana/Valhalla bring new life to your table. Excellent workmanship. Audio Connection Verona, NJ 201-239-1799

LUCKY 16 SYSTEM

(ABOUT \$1650)

Turntable: Rega 2
Cartridge: Adcom GFCE + 1
Receiver: NAD 7150
Speakers: Snell Type J's
SOUND BY SINGER
227 Lexington Avenue
New York, NY 10016
(212) 683-0925

EMPIRE SHURE

DIAMONDS ARE NOT FOREVER!

A worn stylus can do damage to your priceless record collection. It is more economical to replace your stylus periodically (every 500-600 hours) than to ruin your records — especially at today's prices! We are specialists and carry in stock FACTORY ORIGINAL REPLACEMENT STYLUS for most of the popular lines.

For those with new Technics turntables we have Pmount cartridges in stock from \$14.95 & up.

Call Toll Free
for Price Quotes & C O D Orders
(800) 221-0906
N.Y. — (212) 871-3303

for FREE Catalog send Self-Addressed Manila Envelope To:
LITTLE CARTRIDGE'S
Dept. A Box 69
Brooklyn, N.Y. 11218

Phones Open Mon. - Sat. 9am - 8pm

audio-technica

AUDIO KITS STEREO PREAMPLIFIER

Unbelievable
value
at only



\$69.95

Model UC1

Compact stereo preamplifier demonstrating ILP's commitment to state-of-the-art performance at bargain prices! Simple-to-build kit features PRE-ASSEMBLED and TESTED module for complete assembly in a couple of hours, even with minimum previous experience. Features include inputs for magnetic cartridge, tuner, and tape with full monitor facilities; No tone controls ensure clearest possible performance; frequency response DC to 100kHz (to -3db), phono distortion 0.005%, signal-to-noise ratio 90db. The UC-1 draws its power from any ILP power amplifier; in other applications it requires an unregulated DC power supply voltage between ± 15V and ± 30V at 20ma (optional, extra \$27.90).

The ILP UC-1 is only one example of ILP's outstanding range of quality products including power amplifier kits, modules, and toroidal transformers. All carry a limited 5-year warranty. Available direct and at selected dealers. Write for details.

CALL TOLL-FREE TO ORDER 800-833-8400
In New York call (716) 874-5510

Mail orders accepted. VISA, Mastercard or checks.

GLADSTONE ELECTRONICS, INC.

1585 Kenmore Avenue Buffalo, New York 14217

In Canada: Gladstone Electronics, Toronto 800-268-3640

The VPI HW-19 Simply Dynamic

For years now, VPI has been world renowned for its superb turntable isolation base, the VPI HW-2. Now, after over 3 years of exhaustive research and engineering, VPI has introduced a turntable based on the outstanding isolation properties of the HW-2. VPI went back to basics in its approach to produce the ultimate turntable, using only the finest materials, but, more importantly, using dynamic 15 ips master tapes as a reference.



*The HW-19
Redefines The State Of The Art
In Turntable Design.*

VPI uses only high precision machined parts in its construction, no stampings or castings. For example, a space-age, self lubricating material is used for both the vertical and horizontal bearings. The 12 lb. platter is lathe-turned from solid aluminum, then its rim is laminated with lead to achieve greater moments of inertia and superb non-resonant qualities.

The result—a precision analog turntable capable of extracting all the information contained on your records—right down to the lowest frequencies. The HW-19 allows dynamic range response unavailable with other turntables—paralleled only by 15 ips master tapes. Simple, yet dynamic—the VPI HW-19 has it all, and for only \$665.*

Listen to the unique experience of the HW-19 and all the other VPI quality products at your local audio specialty dealer. Call 212-738-3269 for his name and address, or write to VPI, P.O. Box 159, Dept. A8, Ozone Park, NY 11417.

*Suggested retail price.

FOR SALE

MALOR AUDIO—CANADA—1-519-337-7112
offering DYNAVECTOR DV-23R—\$225. CDN. An example of the quality and value that can be expected from this registered Direct Mail Marketing company. We also handle—
ARISTON J.A. MICHELL PS AUDIO
ALPHASON ROGERS HAFLER
SPENDOR ADCOM RAM
British Hi-Fi mags. All prepaid. MC, Visa accepted.
Call (1pm-9pm. Mon-Sat.) or write MALOR AUDIO,
PO Box 120, Bright's Grove, Ontario NON 1C0.

MARANTZ, MAC, LEVINSON, ARC, etc., bought, traded at better prices for you. Only used equipment. Satisfaction guaranteed. Spkrs: JBL Paragon \$1850. Quad ESL \$695. Pyramid III \$650. Fried M2 \$695. AR LST \$550. Nastrovic large \$350. Tech R&B EAS10TH1000 tweeters \$390. Amps: Meridian 105s \$500 pr. Sumo 9 \$295. JVC M7070 \$1050 pr. Scott LK150 \$125. ARD150 \$2200. Dyna MKVI w/mod \$795. RCA M19289C 240w monos \$650. Preamps: Sony TAE 8450 \$285. Paragon 12 \$395. Stax 12s \$250. SP3a-1 \$475. Beveridge RM1/2 \$1125. Sony Esprit TA-E900 \$1500. Hd amps Powerlite 4E \$125. mod. 3 \$100. Phonos: Denon DP7000 w/base \$400. Rabco ST4 \$50. Marantz 12U \$175. Thorens 124 w/arm \$195. Gale GT2101 \$500. Auto Linear \$115. JVC QL10 w/arm on VIP base \$575. Revox S315. Arms: Syrnx PU2 \$250. Dynavector 505 \$170. Tech EPA 500 w/Hube \$200. LOCI \$125. FR64S w/B60 base \$255. Black Widow II \$85. Cotter B 2 base \$110. Tuners: Kenwood KT 7000 \$40. Sherwood CPU100 \$495. Fisher FM 1000 b/o Marantz 10B b/o R.E.L. mono b/o, Fisher 500C w/case Rec. \$200. Sansui 9700 \$395. Tape: Uher CR240 #395. Nac 700II \$495. HK 2000 \$85. Ampex 445 w/console \$695. Misc. Marantz 10B tube (new) \$125. Sansui QSI \$100. 3BX w/remote \$320. Call noon till 3PM Mon-Fri only. (212) 377-7282 NYC. SOUND INVESTMENTS.

MARANTZ, McIntOSH original tube covers, cabinets, manuals. Reasonable (805) 646-5862

McIntOSH BOUGHT, SOLD AND TRADED. 1-313-229-5191 or 5115 Red Fox, Brighton, MI 48116.

FOR SALE

MCINTOSH MR71 W/CABINET MINT \$400, 1900 receiver perfect \$800, 1700 receiver w/cabinet \$425. Teac AL700 ELCASET originally \$1,100 factory sealed #349. Elcaset are 1/4" wide playing at 3.75 ips with lower wow, flutter, more dynamic range than cassette, signal to noise just under 100 dB w/RX10, 3 motor 3 head, diecast frame. RX10 matching DBX factory sealed \$250. Sony EL-4 \$139. ELCASET tape. Phase Linear 4000MK2 preamp w/auto-correlator, w/new walnut panels \$200, 3000MK2 w/head-amp \$200. Aiwa 6700 cassette \$275. minis: A60 amp \$80, tuners R80 \$110, TX100 \$100, R50 \$150, GE80 equalizer \$100, cassettes L80 \$150, FX100 \$200 L50 cassette \$150, R300 receiver \$200, C30 preamp \$75, RB10 battery pack \$85. Nakamichi 700 \$425, 550 \$425, 680ZX mint \$800. Crown SS1444 recorder 4 speed, takes 14" reels, 4 channel mint \$1800. ReVox A77MK3 \$550, HTHS \$700, w/Kent mod. \$800. B77's QTLX mint \$1,000, HTLS \$1,000, A700 1/2 track \$2,000, B790 table demo \$500. Dyna pas3x factory assembled mint \$140, MK3's \$190, FM3 \$60. Ortofon STM72 \$35. RCA 77DX ribbon microphones museum quality pair \$1,000. Stax SR44 phones new \$55. Panasonic SH3433 quad scope \$300. Audiopulse 1 \$300. Mullard 12ax7's \$5.95, 5,000 original factory service manuals. 300 prerecorder r/r tapes \$6.00 each. Everything is money back guaranteed. Many other items call or write for list now. Trades welcome. I will trade new computer equipment for your surplus audio equipment. Martin Gasman 779 Worcester St. Wellesley MA 02181 617-CEL-TICS.

MCINTOSH PLUS—McIntosh instruments are the Laboratory Reference Standard for the world. McIntosh designs their equipment for a long life with low maintenance and high quality performance. **PLUS-FREE** test report on your new McIntosh equipment, on request, **FREE** shipping anywhere in the Continental U.S., Prompt delivery. Credit cards accepted. DESIGNATRON'S STEREO STORES, INC., 260 Old Country Rd., Hicksville, N.Y. 11801 (516) 822-5277

MCINTOSH MC 240, Bedini 25/25 (both mint), Tandberg L040 receiver, Luxman PD272 turntable, Denon 103-C, Marcoff PPA-1. (301) 490-4935.



THE STANDARD OF EXCELLENCE

Pianist James Gala has established a unique and extraordinary audio salon in Rochester, New York.

GALA SOUND sells correctly engineered and musically accurate audio components. We are involved in the recording — both analog and digital — of philharmonic orchestras, have a continuing dialogue with the worlds preeminent audio engineers, and Mr. Gala performs in concert regularly.

We fly our customers round trip at our expense from anywhere in the continental U.S. to our store for the selection of an audio system of \$5,000. or more.

The staff at GALA SOUND understand what criteria need to be met in each link of the audio chain, and will help you select the audio system that is definitive for your needs.

Phone (716) 461-3000 today and ask for Mr. Gala. If music is significant in your life, then you deserve a stereo system from GALA SOUND.



Jim Gala (left) discusses wave propagation and polar characteristics of the KEF 105 II, MAGNEPLANAR MGII B, and B & W 801 Loudspeakers with store manager Maitland Lawson.

**MARK LEVINSON KEF
THRESHOLD B & W
QUAD McIntOSH
MAGNEPLANAR BRYSTON
BELLES ORACLE**

GALA SOUND

(716) 461-3000 650 Monroe Avenue Rochester, New York 14607

FOR SALE

MCINTOSH XR-19 4-WAY SPEAKERS Inc. equalizer. Large, powerful. \$2,995.00 617-428-9733

MERRILL AR MODIFICATION

Subchassis Kit \$75. Replacement Base \$145. Platter Coating \$10. Replacement Spindle \$25. Spring Kit \$8. High Torque Motor \$45. Platter Balancing Service \$10. Tuning Kit \$48. For more information contact: Under-ground Sound, 2125 Central Ave., Memphis, TN 38104. (901) 272-1275

MERRILL TURNTABLE

Features: Beautiful hand built oak base. Lead and foam lined for deadness and shielding. Seven layer laminated plinth. Sophisticated suspension tuning system will accept arms weighing 7 ounces to 2 pounds. Three point energy absorbing subchassis with 6 cycle resonant frequency. Subchassis and arm mounting system designed to absorb tone arm release energy. Twenty-four pole synchronous motor. Two piece platter with lead damping ring. Comes with 10 gauge soft vinyl dust cover. Price: \$435. **FOR MORE INFORMATION AND A PICTURE:** Please send a business size self-addressed stamped envelope to: UNDERGROUND SOUND, 2125 Central Ave., Memphis, TN 38104. (901) 272-1275

NEW: WALKER CJ55 \$280; Technics SP10MKII w/VPI base \$750; Grant Lumley CL50A \$500, GL100A \$900, GL100MA \$600; Dalesford (British) 8" woofer \$37. MINT: Series 20 X-over \$495; Lux 3045 \$450, CL-32 \$250; Promethean (G2+) \$130; Paragon 12A \$395; Marantz 20 Tuner \$150; Audiolab min/monitor \$198; Ionavac tweeter \$325; Supex SDX1000 \$155; ST-70 \$60, ST416 (C-100) \$675 (212) 784-2939 (eves)

MISSION 770 SPEAKERS walnut with stands mint condition, \$875. Call Pete 716-773-7087.

mitsubishi Tuner, Preamp, Amplifier, Power meter—\$995. Call Terry 402-391-3842

FOR SALE

MONSTER CABLE'S ALPHA 1 MC CARTRIDGE: Audio Connection In NJ 201-239-1799

MONSTER CABLE .69¢ PER FOOT CUT TO ANY LENGTH. We carry all Monster Cable accessories. Hafler, Precision Fidelity, Systemdek, Alpha 1 moving coil cartridge. **MAXELL UDXL11S C90 \$2.99** each min. of 12. \$3.00 shipping charge. Call or write for other great prices. VISA and MC. TROLLEY STEREO 451 Moody St. Waltham, MA 02154 (617) 924-3336.

MCINTOSH MR65 STEREO TUNER (1962) stored, beautiful. \$170 shipped. 201-756-1784.

MORE WITH FOUR SYSTEM

(UNDER \$4300)

Turntable: Linn Sondek Lp-12
Tonearm: Linn Basik LV-X
Cartridge: Audioquest 404
Tuner: Adcom GFT1-A
Preamp: Counterpoint SA-7
Amplifier: Robertson 2140
Speakers: Fuselier 3.3

SOUND BY SINGER

227 Lexington Avenue
New York, NY 10016
(212) 683-0925

ATTENTION ADVERTISERS!
SEE CLASSIFIED RATE BOX ON PAGE 111 FOR NEW RATES, EFFECTIVE JANUARY 1984 ISSUE.

The art of shaping sound.

Does your music sound better in the next room? Pro audio kills resonances with SONEX acoustic foam, and now you can too. Control acoustics and turn your room into a studio. At midrange, SONEX has twice the sound absorption of good carpeting for about the same cost. If your dealer doesn't have SONEX, send us \$40 for a sample box of four 24" x 24" sheets, or write for our color brochure.

illbruck/usa
techniques with foams

3800 Washington Ave. N. Minneapolis, MN 55412



WHAT YOU DON'T SEE MAKES THE ENTEC SUB CLEARLY THE BEST

ACCURATE BASS.
15 Hz-100 Hz, with excellent transient detailing. Authoritative, tight bass.

BUILT-IN SERVO ANALOG COMPUTER. Controls woofer behavior, maintains perfect linearity.

POWERFUL AMP INCORPORATED. Dedicated 250-watt amplifier for 126 dB SPL. Less than 3% distortion.

TRANSPARENT CROSSOVER. Built-in active network for best sound.

WHAT YOUR AUDIO SYSTEM NEEDS III ENTEC DOES BEST.

ENTERTAINMENT TECHNOLOGIES
1016 MORSE AVE., NO. 12
SUNNYVALE, CALIF. 94086

• ACOUSTIC ELECT • B&W • THE DAVID BERNING CO. • CRAMOLIN • DENON • DYNAVECTOR • ELITE FURNITURE • ENERGY LOUDSPEAKERS • FULTON • GOLDMUND • GRACE • GRADO • HAFLER • HILL PLASMATRONICS • JANIS • KEITH MONKS • KINDEL • KOETSU • KYOCERA • LAST • LINN SONDEK • LIVE WIRE • LUSTRE • MARCOF • MEGASONICS • MONSTER CABLE • MUSIC REFERENCE • NAD • NAKAMICHI • NITTY GRITTY • PENTAGRAM • PLATTER MATTER • PSE • POLK AUDIO • PRECISION FIDELITY • PROMETHEAN • PROTON • P.S. AUDIO • PYRAMID • QUICKSILVER AUDIO • SIGNET • SNELL ACOUSTICS • SPICA • STAX • SUMO ELECTRIC • SUPEX • TANDBERG • THETA ELECTRONICS • VPI • C.J. WALKER

the listening room

590 Central Park Avenue
Scarsdale, N.Y. 10583

Mon, Thurs, 10-9 PM
Tues, Wed, Fri, 10-7 PM/Sat 10-6 PM

Credit Cards Accepted
We ship FREE Anywhere in the
Continental U.S.A.

914-472-4558

FOR SALE

MUSIC REFERENCE ELECTRONICS AND TUBES available thru Esoteric Audio Components (512) 837-9629, 3:30-10:00

NAKAMICHI PLUS—Featuring the incredible BX-1 cassette deck. Now you can have Nakamichi performance for under \$300. We also carry the full line of Nakamichi products. **PLUS-FREE** calibration and bias adjustment, on request, **FREE** shipping anywhere in the continental U.S. DESIGNATRON'S STEREO STORES, INC., 260 Old Country Road, Hicksville, NY 11801, (516) 822-5277.

NAKAMICHI: SHAMEFULLY LOW PRICES. New And Used. BX-2, LX-3, LX-5, ZX-7, ZX-9, Dragon. AudioWorkshop (206) 323-4987

NAKAMICHI 600II, BLACK WALNUT CASE, absolutely mint. \$400, best offer, (203) 889-1937

NAKAMICHI 680 ZX CASSETTE DECK, HALF-SPEED, MINT. 700II w/REMOTE CONTROL, EXCELLENT CONDITION. (507) 423-5368 AFTER 5:00.

NAKAMICHI—682 ZX CASSETTE DECK RM-580 wireless remote control and DM-10 head demagnetizer. One year old. Excellent condition, \$1,100 (615) 584-2804

NAKAMICHI 700 ZXE cassette deck and NR-100 Dolby C processor. List \$2,630.00, sell both for \$1,400.00. (504) 272-8678, (504) 291-3300. (504) 291-1376. Ask for Mark.

NEW 83 RAW LOUDSPEAKER CATALOG, 25c. Meniscus Systems, Dept A. 3275 Gladiola, Wyo., MI 49509

ORACLE DELPHI, MAGNEPAN UNITRAC, Dynavecator 23R, Vandersteen OL-1, used only 6 months—\$1,200 919-851-8616

FOR SALE

ONE STEP UP SYSTEM

(UNDER \$1200)

Turntable: Rega 2
Receiver: NAD 7120
Speakers: Snell Type K's
SOUND BY SINGER

227 Lexington Avenue
New York, NY 10016
(212) 683-0925

ORACLE "DELPHI" OWNERS. You won't get the best sound your turntable can produce without our beefier, low ripple power supply. Improved imaging, dynamic range and instrument timbre guaranteed! THE MOD SQUAD, 144 Athena Street, Leucadia, CA 92024, (619) 436-7666

ORACLE TURNTABLE, Fidelity Research FR-12 tone arm, Fidelity Research MC-201 cartridge, QMI GC-2 class A moving coil preamp, Discwasher Disc kit, plus extra bonus items. All for \$1,100.00. call John Jr. at (504) 392-2536.

AUDIO PERFECTION HAS SPENDOR
SP-1, BC-1, LS 3/5A, SA-2, Prelude

7401 Lyndale Ave. South
Minneapolis, MN (612) 866-0083

PERFECTIONIST AUDIO—Two new storefronts. PS Audio, Audre, Hafler, VSP, Crown, Kyocera, Denon, Microseiki, Walker, Oracle, Ariston, Lustre, Grace, Dynavecator, Acoustat, KEF, Vandersteen, Spendor, DCM, Apature, Infinity, 11 A.M.—9 P.M. CST Daily except Monday 1221 Caledonia, Mankato, Minn. 56001 1-507-345-7186.

Nothing does it like a ribbon ...

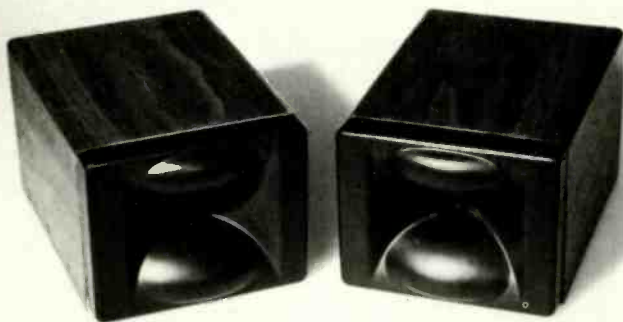

Nobody does ribbons like jumetite!

Jumetite Laboratories is the Canadian company that produces more kinds and models of ribbon driver-based speaker systems than any other company in the world. This ribbon-driver technology is now available in an add-on super-tweeter module, the RM-1. You can have the thrilling sound of a ribbon high-end without changing your speaker system (2500 Hz and up).

You've been reading about the RM-1 add-on in *Stereo Review*, *Popular Science*, and a host of other magazines. RM-1s install easily, and are fully compatible with your current speaker system.

You can own a pair of these ribbon add-on drivers, direct from the factory, for only \$590. It's the perfect way to "tune-up" your system for digital. Satisfaction is Guaranteed.

jumetite
LABORATORIES LTD.

943 BOBLETT ST. • BLAINE, WA 98230

Yes! I want to order the RM-1s! Please rush me a pair. Enclosed is my check or money order for \$590. TO ORDER BY MAJOR CREDIT CARD CALL: (201) 343-8819. No COD's Please.

NAME: _____
SHIPPING ADDRESS: _____
CITY: _____ STATE: _____ ZIP: _____
PHONE: () _____ MY SPEAKERS ARE: _____

Brand, Model

Please send more information

PHILADELPHIA AUDIOPHILES

We invite you to visit our establishment to hear a selection of the finest State-Of-The-Art audio components. Our knowledgeable staff will be glad to assist you in choosing the proper equipment for your specific needs.

We have over 2 decades of experience, plus a complete in house service department. We will be pleased to set-up and calibrate your system without charge.

We proudly represent:

ALPHASON	HEGEMAN	NITTY GRITTY
ANDANTE	MELIUS	ONKYO INTEGRA
AUDIOQUEST	IMF	PINK TRIANGLE
BEARD	KENWOOD PURIST	PROTON VIDEO
BEYER	KIMBER KABLE	PS AUDIO
BRYSTON	KOETSU	REGA PLANAR
BURWEN	LINN ISOBARIK	ROBERTSON
CLESTON	LINN SONDEK	ROGERS
CREEK AUDIO	LIVEWIRE	SOUNDCRAFTSMAN
CJ WALKER	LUSTRE	SPECTRUM
DB SYSTEMS	MARCOF	SPICA
DYNAVECTOR	MARIAH	STAX
ELECTROCOMPANET	MICRO SEIKI	SUMIKO
ELECTRO RESEARCH	MUSIC & SOUND	SUPEX
FOURIER	NAD	TALISMAN
FUSELIER	NAGAOKA	TAMANTON
GOLDRING	NAGATRON	TANGENT
GRACE	NAIM AUDIO	THIEL

SOUND SERVICE COMPANY

8010 Bustleton Avenue
Philadelphia, PA 19152
(215) 725-1177-8

PINK TRIANGLE In Texas only at Audio Pro/Philes. 713-973-0000

We specialize in Phonograph Needles & Cartridges.
Toll Free: 800-368-3506

Featuring the cartridges of

Boston Acoustics

Needle in a Haystack, Inc.

P.O. Box 17435 • Washington, DC 20041

"We're Needling the World"® Send for a free catalog.



FOR SALE

PINK TRIANGLE TURNTABLES: THE FOUNDATION of your HI-FI system. For dealer list, contact IAF, 723 Bound Brook Road, Dunellen, NJ 08812, or call 201-968-8771.

PLANS, CIRCUIT BOARDS, AND KIT PARTS (author approved) for M. Leach's home audio projects. Power amps, preamps, pre-preamps, and loudspeakers. Send SASE for information. Custom Components, Box 33193, Decatur, GA 30033.

PORTABLE EQUIPMENT: UHER, Sony, Sennheiser, AKG, Beyer-Dynamic, Fostex, Accessit, GLL, Send SASE, (Specify Model), Carpenter Sound Sales, Box 1321, Meadville, Pa. 16335-0821

PRECISION FIDELITY ELECTRONICS AT GENE RUBIN AUDIO (213) 571-1299 (PAC)

PROMETHEAN AT AUDIO CONNECTION 201-239-1799

PS AUDIO AT AUDIO CONNECTION 201-239-1799

PS AUDIO—FANTASTIC!

In stock! Fast, FREE shipping. READ BROTHERS STORE, 593 King Street, Charleston, South Carolina 29403, (803) 723-7276.

PS AUDIO = SUPERB VALUE

Gene Rubin Audio (213) 571-1299 (PAC.)

QUAD. Back in Houston only at Audio ProPhiles.

QUAD ELECTROSTATIC SPEAKERS, Excellent condition; black screens \$900 pr. Mike (713) 961-4700.

THE MARRIAGE OF AUDIO AND VIDEO
UNPARALLELED ABILITY TO TRANSPORT YOU TO THE LIVE PERFORMANCE.

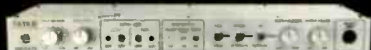

TATE II SURROUND STEREO SYSTEM MODEL 101A TATE II SURROUND STEREO SYSTEM DECODES SURROUND ENCODED OR NON-ENCODED HOME VIDEO, NORMAL STEREO, AND SO SOURCE MATERIAL INTO A 360° MULTI-CHANNEL SOUNDFIELD WITH GREATER DIRECTIONAL ACCURACY, SEPARATION, FREQUENCY RESPONSE, THAN ANY OTHER SYSTEM. CLASS "A" AMPLIFICATION, FILM CAPACITORS IN SIGNAL PATH FOR INCREDIBLE OPENNESS AND SPACIALITY. OPTIONAL REMOTE CONTROL. CD DISC COMPATIBLE. 5-PATENTS. MADE IN USA. RECEIVED 1982 HI-FI GRAND PRIX, 1983 CES DESIGN AWARDS. HARRY MAYNARD SAID... "THE 101A IS THE MOST VERSATILE, SOPHISTICATED, HIGH QUALITY SURROUND SYSTEM I'VE YET ENCOUNTERED. THE 'YOU ARE THERE' QUALITY IS TREMENDOUS, OFTEN BETTER THAN BEING THERE." FREE BROCHURE 602-445-6999.

FOSGATE RESEARCH INC.
215 W. LEROUX PRESCOTT, ARIZONA 86301

FOR SALE

QUAD OWNERS CLUB

If you want to maximize the enjoyment of this state of the art speaker, join the club and get bountiful newsletter. Room acoustic, electronics, modifications, and how to make the best, better. Information from "QUAD OWNERS CLUB", New York Audio Laboratories, Inc. 33 North Riverside Avenue, Croton-on-Hudson, New York 10520.

QUAD 405 MODIFICATION. We've compared this beauty with the finest amplifiers and walked away smiling. It's a knock-out! Solid-state authority, combined with tube sweetness and musicality. THE MOD SQUAD, 144 Athena Street, Leucadia, CA 92024m (619) 436-7666.

RANDALL RESEARCH

"Indispensable These cables, individually or in tandem, evoked a great many superlatives regarding the quantity and quality of sound an absolute advance in cable performance." These are statements expressed by the editor of Audiogram, Gary Vart, after reviewing our new Symmetrical TX Interconnect and 32 TBC Speaker Cable systems. Send or phone for this review. Better yet, listen for yourself in one of our dealer sound rooms!

RANDALL RESEARCH

719 Fernleaf
Corona Del Mar, CA. 92625
(714) 760-1539

CROWN BEST QUALITY AMPLIFIERS, TUNERS, PRE-AMPLIFIERS. PROFESSIONAL CONSULTATION—BEST PRICES. EAST: (904) 262-4000; WEST: (213) 840-0878.

REVOX-A77 TAPEREORDERER recent set up \$450.00, Kenwood 600 Direct Drive \$200.00, Infinity Black Widow 2-tone arm \$125.00. Respond Audio Box No. 1083

REVOX B77 REEL TO REEL with extras \$1,100.00. call John Jr. at (504) 392-2536.



Sideral Akustic™

Recently, there have been great advances made in passive network design for audio crossovers. Our filter is a computer derived phase coherent, quasi-second order design with 6db/octave filter slopes. This network consists of fine, audio grade air core inductors and metallized polypropylene/polystyrene capacitor composites for unequalled reproduction of the original sound field. As a result, the Sideral Akustic Model Four will present the beauty and excitement of live music in a size and price range that is easy to live with.

Write or call for free literature, and information.
Dealer inquiries invited.

Sideral Akustic..

Audio Systems Inc.
4035 Oceanside Blvd. Unit G-57
Oceanside, CA 92054. (619) 726-3150

FOR SALE

HAFLER, REVOX, TANBERG, CARVER, DBX AND OTHER QUALITY COMPONENTS. PROFESSIONAL CONSULTATION—BEST PRICES. EAST: (904) 262-4000; WEST: (213) 840-0878.

HARMAN-KARDON SEPARATES, RECEIVERS, CASSETTE DECKS, TURNTABLES. PROFESSIONAL CONSULTATION—BEST PRICES. EAST: (904) 262-4000; WEST: (213) 840-0878.

SANTA BARBARA HIGH-END: SOTA, Souther Linear Arm, Vandersteen, Monster Alpha 1, Perreaux, Accuphase, Precision Fidelity, Sonographe, Audre, Kimber Kable, Audioquest, Sumiko, Nitty Gritty, ProAc, Aiwa, and more. Free shipping anywhere in continental U.S. **COMING:** the fabulous **AUDIRE RIBBON SPEAKER SYSTEM**—the only true, full-range ribbon system which uses no crossovers, no transformers, no equalizers, in short, nothing of any kind in the signal path. **THE RECORD PLAYER,** P.O. Box 2574, Goleta, CA 93118, (805) 685-5522.

CROWN BEST QUALITY AMPLIFIERS, TUNERS, PRE-AMPLIFIERS. PROFESSIONAL CONSULTATION—BEST PRICES. EAST: (904) 262-4000; WEST: (213) 840-0878.

SEE UNDER CATEGORY "WANTED TO BUY" David Yo

ATTENTION ADVERTISERS!
SEE CLASSIFIED RATE BOX ON PAGE 111 FOR NEW RATES, EFFECTIVE JANUARY 1984 ISSUE.

\$2000 SOUND

For Less Than \$800

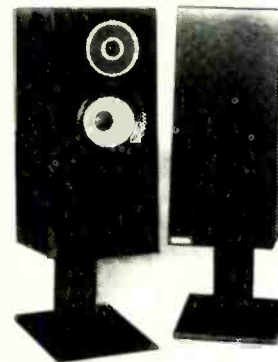

ENERGY 22

The **ENERGY 22 PRO MONITOR** loudspeaker, considered by many as one of the most accurate, technically advanced speaker available today at any price. We at **PERFORMANCE AUDIO** also share that opinion. "Must be auditioned before you purchase any audiophile quality speaker." **ENGINEERED AND MANUFACTURED IN CANADA.**
\$798 per mirror imaged pair.

SEE IT! HEAR IT! EXPERIENCE IT! IT'S HOT!

Also Featuring:

- ADS
- Advent
- Alpine
- Amber
- Blaupunkt
- Celestion
- CJ Walker
- DBX
- Denon
- Dynavector
- Grace
- Grado
- Harman/Kardon
- Kycocera
- Mitsubishi
- Phase Linear
- Pyramid
- Signet
- Soundcraftsman
- Supex
- Thorens & more

CALL HAROLD MINTO

PERFORMANCE AUDIO

365 S. Bayview Ave. • Freeport, Long Island
N.Y. 11520 516 378-4389
Hours: 12 NOON-7PM SAT 11AM-6PM
Free shipping in the continental US

The Classic Combination.

Combine the finest products in the audio industry, an educated and perceptive staff, in-house Technical Service, and 11 years of the most reputable and reliable customer service, and you get what you've been looking for — a combination ensuring satisfaction to the most demanding audiophile!

woodbridge stereo center.

Snell • Koetsu • Accuphase • Oracle • Souther • VPI • Yamaha
B&O • Magnepan • Infinity • Threshold • Kycocera • Bryston
Audio Research • Conrad Johnson Premelr • Tandberg
Apl • Nakamichi • Dahlquist • Boston Acoustics

751 Amboy Avenue (Rt. 35)
Woodbridge, NJ 07095
(201) 636-7777

FOR SALE

SEQUERRA FM-1. When only the finest will do. Custom finishes available. Audio Pro/Philes 713-973-0000

ELECTRO-VOICE INTERFACE AND CD SERIES QUALITY SPEAKER SYSTEMS. PROFESSIONAL CONSULTATION—BEST PRICES. EAST: (904) 262-4000; WEST: (213) 840-0878.

HAFLER, REVOX, TANBERG, CARVER, DBX AND OTHER QUALITY COMPONENTS. PROFESSIONAL CONSULTATION—BEST PRICES. EAST: (904) 262-4000; WEST: (213) 840-0878.

HARMAN-KARDON SEPARATES, RECEIVERS, CASSETTE DECKS, TURNTABLES, PROFESSIONAL CONSULTATION—BEST PRICES. EAST: (904) 262-4000; WEST: (213) 840-0878.



The NEW Speakerlab K.

16" of exponential bass horn folded into a 4" high enclosure for awesome impact and dynamic range, high efficiency and power handling. We updated a time-honored design with a 15" woofer, 7" midrange, and horn tweeter for a digital-ready speaker for the 80's. Learn more in our FREE 32-page catalog. (Allow 4 - 6 weeks for delivery. Send \$1.25 for faster, 1st. class.)

speakerlab

Dept. A311, 735 N. Northlake Way
Seattle, Washington 98103

FOR SALE

SONY ES DIGITAL (AND PCM-F1)

Newest digital models! In stock. Free shipping. READ BROTHERS STEREO, 593 King Street, Charleston, South Carolina 29403, (803) 723-7276.

SONY TC-142 PORTABLE 3 HEAD MONO CASSETTE Recorder. \$95. 408-867-0341.

SOUTHER SLA-3i—RIGHT ON TRACK! Hear it at Audio Connection in New Jersey 201-239-1799

SPEAKER KITS! Best quality available. Modified Grado cartridge plus correction circuit. Free cable plans and more coming. SUPERPHON, 2375 W. 21st Ave., Eugene, Oregon 97401 Dealers welcome.

SPICA TC-50, a giant leap forward in speaker design. Audio Connection, NJ 201-239-1799

SPICA TC-50 SPEAKERS (303) 963-3269.

START WITH SEPARATES SYSTEM 1

(UNDER \$2700)

Turntable: Rega Planar 3
Cartridge: Dynavector DV-10X3
Preamp: Adcom GFP-1A
Tuner: Adcom GFT1-A
Amplifier: Adcom GFA-2
Speakers: Snell Type E's

SOUND BY SINGER

227 Lexington Avenue
New York, NY 10016
(212) 683-0925

FOR SALE

STATE OF THE ART IS NOW AFFORDABLE

—**MAS BELT DRIVE TURNTABLE:** Designed and manufactured for us in Great Britain, this new belt drive turntable offers a fully adjustable suspension, at its \$289. price it leaves most other turntables standing still. It is available both with and without the famed mas 282 tonearm.

—**CREEK 4040T:** This is the long awaited partner to the incredible CAS 4040 integrated amp. This digital tuner offers sound reproduction at a price to which all others will be compared.

—**MAS 925 LOUDSPEAKER:** This loudspeaker features 2-way design with 8 inch passive radiator housed in an oak veneer enclosure. Performance never before achieved at so reasonable a price—only \$529. pair. Our other products: Walker C.55 Belt Drive Turntable, mas 282 Precision Tonearm, Alphason HR100S Precision Tonearm Dealer Inquiries invited. **FOR MORE INFORMATION PLEASE CALL 516-585-4746 OR 215-357-7858** or write **MUSIC AND SOUND IMPORTS, 30 Snowflake Road, Huntingdon Valley, PA 19006**

SYMMETRY CROSSOVER CLOSEOUT. AC 1a reg. 800.00, now 300.00. AC 2a reg. 1200.00, now 450.00. Lmt'd to stk on hand, (415) 777-1113 Ernie

STATIC ELECTRICITY.

Is the primary source of noise and wear in analog disc sound reproduction. With one application of **NEUTRASTAT**, a monomolecular cationic deposition is achieved on the record surface which completely neutralizes static charges for the life of the disc. **NEUTRASTAT.** \$15.00. P.O. Box 724, Corpus Christi, Texas 78403

ATTENTION ADVERTISERS! SEE CLASSIFIED RATE BOX ON PAGE 111 FOR NEW RATES, EFFECTIVE JANUARY 1984 ISSUE.

Honest: Did you hear that?...

- If you think most digitally-recorded discs released today sound unnatural (ambience-shy, threadbare, and metallic)
- If you find even good contemporary analogue recordings to be only distant memories of the sound of real musicians playing in real space
- If you hear "differences" in the musical truth told by components in home systems
- And if you're just not satisfied with the way most records and stereo systems sound today

You are not alone!

THE ABSOLUTE SOUND is the first American audio magazine to report authoritatively on the High End of audio. TAS tells it like it is, without fear or favor. We are the only audio review, unimpeded by commercial considerations, to offer critical insight into the machinations of the audio industry. You won't be reading about the emperor's new clothes. If you'd like to sample a single issue, please send us \$6.00. If you'd like to subscribe for a year, the costs are \$20.00 US; \$22.00 Canada; \$35.00 Overseas (US Funds only).

Name _____

Address _____

City, State _____ Zip _____

Please send check or money order to:

the absolute sound

P.O. Box 247, Gracie Station
New York, N.Y. 10128

Visa and Mastercard accepted
or call (516) 671-6342 and ask for Eden

Threshold STASIS amplifiers

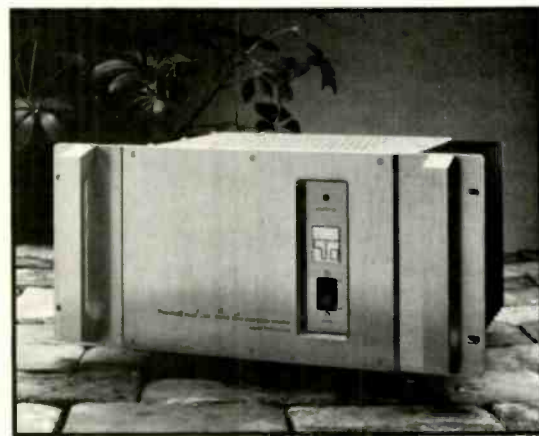

Threshold
model S/300
STASIS power amplifier

Their extraordinary musical accuracy has earned them inclusion in the monitoring and production facilities of:

*The Saint Louis Symphony Orchestra
Telarc Records
20th Century Fox (scoring studio)
Stevie Wonder's Wonderland Studios
JVC Cutting Center (cutterhead drive)
En Pointe Productions*

as well as the listening rooms of music lovers around the world.

For a color brochure and a technical paper on contemporary amplifier design write

Threshold Corporation
1832 tribute road suite e sacramento california 95815



FOR SALE

SUPERPHON: High value, high tech. Check us out. Dealers welcome. 2375 W. 21st Ave., Eugene, Oregon 97401

SYRINX PU-3. Great value at \$800, unbeatable at only \$700. In stock Audio Pro/Philes 713-973-0000

TALISMAN SAPPHIRE: CROWN JEWEL OF MOVING COILS. Audio Nexus, NJ, (201) 464-8238. (201) 474-2910

TANDBERG TPA3003 POWERAMP/TC3004 cassette deck Call Terry 402-391-3842

TELEFUNKEN, AMPPEREX, GENALEX and other top quality audio tubes available. Contact S.J. Wallace, 1203 Success St., Pittsburgh, PA 15212.

THE MONOLITH LOUDSPEAKER

It redefines the state of the art for affordable loudspeakers. Its clarity, transient response, imaging, and cabinet construction are virtually second to none. You have been waiting for this one for a long, long time. Literature \$3. Monolith, P.O. Box 222, W. Springfield, Massachusetts 01090

THE PROJECTION SERIES LOUDSPEAKERS BY SPEAKER DESIGNS. WE WON'T PRESENT YOU WITH HYPE, just the opportunity to decide for yourself. Try any of our models in your home for 15 days, listen critically, compare with anything you wish. If you think you can find a better value, ship them back.

Write: Speaker Designs, 528 Demmler Drive, Pittsburgh, Pennsylvania 15237. Phone (412) 367-1573 from 10 a.m. to 5:30 p.m. or 367-8066 after 5:30 p.m.

THORENS TD126SME—\$795, Call Terry 402-391-3842

THRESHOLD, including the S/1000 in Houston. Audio Pro/Philes

THRESHOLD S-1000 MONO AMPS \$5,200, Magnapan MG-11B's \$850, Cotter System 2 pre-amp \$1,650, Yamaha CT-7000 \$500. 518-438-0180

THRESHOLD 800A 200W CHANNEL CLASS A. Call Terry 402-391-3842

VAN DEN HUL EMT. Need we say more. Audio Pro/Philes in Houston

DISCOUNT CAR STEREO 30 DAY MONEY BACK GUARANTEE

PRICES TOO LOW TO LIST
MANUFACTURER'S NAMES

NEW BREED MOST MAJOR BRANDS FOR PRICES AND INFORMATION
800-645-6607
NY (516) 665-6670
P.O. Box 3370 • Bay Shore, NY 11708

FOR SALE

TIPTOES: The Perfect Platforms for High Quality Components. Put your system on our "TOES and we guarantee you'll hear more clarity, better resolution, greater dynamic range. **THE MOD SQUAD,** 144 Athena Street, Leucadia, CA 92024, (619) 436-7666.

LISTENING POST HAS SPENDOR

SP-1, BC-1, LS 3/5A, Prelude

1128 E. Loyola Dr. (By Appt.)
Tempe, Arizona (602) 967-1250

THE AUDIBLE DIFFERENCE HAS SPENDOR

SP-1, BC-1, LS 3/5A, SA3, BC3

805 El Camino Real
Palo Alto, Calif. (415) 328-1081

TUBE LOVERS! (matched pairs): Amperex EL34/6CA7 @ \$19.50 MP; Gold Lion KT-88 @ \$79.00 MP; GE 6550 @ \$38.00 MP. (single tubes): Mullard EL34/6CA7 @ \$8.00; Mullard 6550 @ \$29.00; Tunggram 12AX7/ECC83 @ \$2.50. (tube preamp kit): Dyna PAS-3X (complete), \$149.00. (tube amp kit): Dyna Mk4 40W mono (complete), \$199.00. All brand new! Any Dyna assembly/repair manual @ \$4.50 postpaid. \$2 shipping on tubes. SCC, Box 551 (1083AM), Dublin, OH 43017 - (614) 889-2117; VISA/MC/COD.

TUBE PREAMP MODIFIERS: We have limited quantities of shielded chokes, good selector switches, and more. Send 40¢ stamp for details. Thermionic Designs, Box 342, Athens, GA 30603.

WALKER CJ55 & LINN BASIK LV-X with the NEW Basik cartridge is an extremely effective disc system—only \$598.00 delivered in the US or PR. Visa or MC. **OXFORD AUDIO CONSULTANTS, INC.,** Box 145, Oxford, OH 45056, 513-3333. TLX427791.

RARE FIDELITY from RARE COMPONENTS

Accuphase	Audioquest
Adcom	Beard
Conrad-Johnson	Pink Triangle
Robertson	Perreux
Souther	Spica
Pro Ac	VPI
	and others

AUDIO VISION 40 Mass. Ave.
Lexington, MA 02173
617 863-5221

“ If you could make your phono cartridge last up to 10 times longer, and enjoy improved tracking and lower distortion... simply by using the right stylus treatment... wouldn't you go out and buy it? ”



STYLAST Stylus Treatment

This remarkable scientific formulation is now available at audio stores everywhere or directly from the factory.

CALL NOW, TOLL-FREE
800-223-5278

IN CALIFORNIA DIAL
800-222-5278



COD/MO/CHECK accepted
Minimum Order \$15.00
Shipping/Handling extra.

California residents add 6 1/2% sales tax.
Foreign orders not accepted.
In Canada, call (514) 621-4087

LAST Record Preservation
Kit, \$18.95

LAST Record Preservative
Refill, \$14.95

LAST Collector's Kit, \$120.00

LAST Metering Dispenser, \$30.00

LAST Power Cleaner Kit, \$9.95

LAST Record Cleaning Kit, \$5.95

LAST RCM fluid, \$20.00

LAST Record Care Brushes,
Pack of 10, \$9.95

STYLAST Stylus Treatment, \$15.95

LAST Stylus Cleaner, \$4.95

LAST

Liquid Archival Sound Treatment
P.O. BOX 41 LIVERMORE CA 94550

VANDERSTEEN AUDIO DIMENSIONAL PURITY

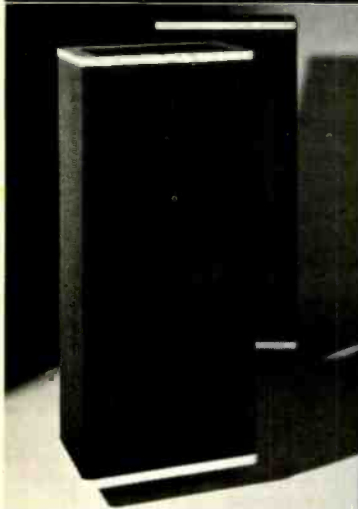

Vandersteen Audio was founded in 1977 with the commitment to offer always the finest in music reproduction for the dollar. Toward this goal there will always be a high degree of pride, love, and personal satisfaction involved in each piece before it leaves our facilities. Your Vandersteen dealer shares in this commitment, and has been carefully selected for his ability to deal with the complex task of assembling a musically satisfying system. Although sometimes hard to find, he is well worth seeking out.

Write or call for a brochure and the name of your nearest dealer.

VANDERSTEEN AUDIO
116 WEST FOURTH STREET
HANFORD, CALIFORNIA 93230 USA
(209) 582-0324

MODEL 2C

FOR SALE

VANDERSTEEN 2C'S—hear them demonstrated superbly at Audio Connection, NJ 210-239-1799

1-800-245-6000 TAPE WORLD

JVC: or Sony T-120	8.29
TDK: MA-90	4.39
TDK: SAX-90	3.19
MAXELL: ADX-90	2.99
TDK: SA-90	2.19
TDK: SA-60	1.89
TDK: AD-90	1.89
TDK: AD-60	1.49
TDK: D-90	1.29
TDK: D-60	1.15
MAXELL, TDK: T-120, L-750 Hi-Grade	10.49
MAXELL, TDK: T-120, L-750	8.49
MAXELL: XLI or IIS-90	3.49
MAXELL: UDXL I or IIC-90	2.49
MAXELL: UDXL I or IIC-60	2.29
MAXELL: UD-90	2.19
MAXELL: XL I 35-90B	6.49
MAXELL: UD35-90	5.39
SONY: UCXS-90	2.59
TDK: HD-01 (Head Demag.)	13.99

WE WILL HONOR ANY COMPETITORS PRICE OF THE TOTAL ORDER. \$3.75 Shipping any size order in US, VISA, MC no extra charge. COD add \$1.65. Minimum COD order \$40.00. PA ad Sales Tax. Allow 2 weeks for delivery.

323 Brown Ave., Box 361, Butler, PA 16001
412-283-8621

VANDERSTEEN LOUDSPEAKERS 1B & 2C

We are pleased to offer the new 1B's \$600, the 2C's \$990, and 2C stands \$75. Prices per pair. Visa and MC. FREE SHIPPING IN US AND PR. WORLDWIDE EXPORTING. OXFORD AUDIO CNSLTS., INC. Box 145, Oxford, OH 45056, 513-523-3333, TLX427791.

the SOURCE

IF YOU'RE WISE

SUBSCRIBER'S RETAIL COST

RECEIVERS/AMPS	
Yamaha R700	\$450. \$327.
Denon DRA-600	540. 398.
Luxman RX-102	599. 446.
Sansui AU-D9	650. 323.

TURNTABLES	
Denon DP-60L	\$585. \$389.
Sony PSX-800	850. 427.
Technics Q200	140. 79.
Technics SL-10	630. 252.
Thorens TD-115 II	435. 299.

CARTRIDGES	
Otofono OM10/20/30	\$38./\$66./\$86.
Dynavector DV10XIII	150. 82.
SupeX SDX-2000	600. 216.
Grace F9E	200. 118.

CASSETTE DECKS/TAPE	
Anwa ADF-660	\$395. \$274.
H/K CD-191	330. 246.
Nakamichi 480Z (dolby B/C)	495. 338.
Sansui D970B	680. 358.
MAXELL UDXL2C90/TK SA90	1.99

SPEAKERS	
AR28B	\$298./pr. (ship. incl.)
B&W DM110	300./pr. \$218./pr.
DCM QED	504./pr. (ship. incl.)
MISSION 700s	399./pr. 292./pr.
Rogers LS3/5A	640./pr. 467./pr.

CAR STEREO	
Alpine 7327	\$300. \$182.
Alpine 3000 (18 WX4 amp.)	220. 129.
Alpine 3502 (50 WX2 amp.)	350. 197.

VIDEO/BLANK TAPE/CD PLAYERS	
RCA VJ7900 — \$845.	• Sony KV1220 — \$285
Panasonic PK700 (DLX color cam.)	284
Panasonic PV3100 (complete portable)	319
Sony L500 — \$5.99	• TDK VAT 120 — \$7.95
Philips CD-100 — \$588.	• Sony CDP-701 — \$1.197

* All offers subject to availability.
\$15.00/yr. subscription fee not included.
20 Nassau St., Princeton, N.J. 08540 • 609-921-0800

**ORDERS ONLY CALL
1-800-443-HIFI**

FOR SALE

VANDERSTEEN 4. Finally available. On display and taking orders for late 1983 delivery. Audio Pro Phils. 713-973-0000

WILSON'S AUDIO HAS SPENDOR

SP-1, BC-1, LS 3 5A, Prelude
8001 Maple Street
New Orleans, LA (504) 866-3457

HAFLER, REVOX, TANBERG, CARVER, DBX AND OTHER QUALITY COMPONENTS. PROFESSIONAL CONSULTATION—BEST PRICES. EAST: (904) 262-4000; WEST: (213) 840-0878.

HARMAN-KARDON SEPARATES, RECEIVERS, CASSETTE DECKS, TURNTABLES, PROFESSIONAL CONSULTATION—BEST PRICES. EAST: (904) 262-4000; WEST: (213) 840-0878.

VSP TRANSMOS AMPLIFIERS: TRANSCENDENTAL. AUDIO NEXUS, NJ, (201) 464-8238, (201) 474-2910.

1 (213) 652-7771 OR 885-0500 AUDIO ONE

Since 1974, our commitment has been to musical accuracy and you, the audiophile and music lover, Components offered, are selected without commercial and political influences. You'll find our unique approach, a refreshing change. Currency we recommend:

AR • ARMSTRONG
AUDIONICS • AUDIOSTATIC
BEDINI • BERNING
BEVERIDGE
CONRAD JOHNSON
COUNTERPOINT
DAYTON WRIGHT
DECCA • DENNESEN
ESOTERIC AUDIO RESEARCH
FRIED • GNP
GRADO • HAFLER
HILL PLASMA
LIVEWIRE • LUXMAN
MAVRICK AUDIO • NEC
NAKAMICHI • NITTY GRITTY
PERREAU • PS AUDIO
PROMETHEAN
RANDALL RESEARCH
SHAHINIAN • SHERWOOD
SONOGRAPH • SOTA
SPATIAL • SPICA
STAX • SUMIKO
SUMO • SYRINX
TECHNICS • WIN LABS & MORE

AUDIO ONE

8788 Sunset Boulevard
West Hollywood, CA 90069
(213) 652-7771

MC/VISA/FINANCING FREE SHIPPING (USA)

Luxman
Harmon Kardon
Tanberg
Boston Acoustics
Audio Control
Sherwood
Hitachi
Denon
Revox
Onkyo
Ortofon
Hafler
Thorens

Get It Free!

ADS
AIWA
Grace
M&K
B&O
SME
& Many More

We Deliver FREE
Anywhere in the
Continental USA!

the SOUND Approach
6067 Jericho Tpke., Commack, NY 11725
Charge it...Call 516-499-7680

FOR SALE

21ST CENTURY AUDIO LTD IN PHILADELPHIA

For better selections and personnel service. We recommend some of the following brands for your listening enjoyment, Argent, Audible Illusions, Belles, Beveridge, Conrad-Johnson, DCM, E.A.R., Oracle, Perreux, Pyramid, RGR, SOTA, Spica, STAX ESL, SUMO, VPI and more.

We also have the new John Iverson Eagle 7A amplifier. At 97 lbs. It is no small amp.

Also available the new Kahn-Hazeltine AM Stereo-FM Stereo Tuner. Now listen to your AM in stereo. Priced at \$198.00 + UPS.

All this and much more at 5041 Rising Sun Ave, 19120. (215) 324-4457. Master Card and Visa Accepted.

3-D ACOUSTICS THREE PIECE system w/stands warranty \$400.00 OED 330 w/1 year warranty \$400.00 Audio Den 412-652-1134.

RECORDS

AUDIOPHILE ALBUMS, COMPACT DISCS, over 750 titles. Discount prices. For The Record . . . Box 21201WW, Columbus, Ohio 43221.

AUDIOPHILE RECORD GALLERY discounts on ultra sound direct disc, half mastered, digital, Japanese Imports, more! We specialize! Only the finest fidelity recordings. Catalog \$1.00 P.O. Box 1073, Vienna, VA 22180

CLASS-A-UNDERGROUND

discounts audiophile discs—current stock on

- Mobile Fidelity
- Sheffield Labs
- Nautilus Recordings

Send for FREE catalog: 35 North Greenbush Road, West Nyack, NY 10994

DON'T MISS our discount prices on our huge selection of **COMPACT DISC** and Audiophile recordings listed in the following catalogs:

- 1.) Audiophile classical and Jazz
- 2.) 1/2-speed master pop/rock
- 3.) DBX encoded records & tapes
- 4.) Japanese rock imports (stock list)
- 5.) Japanese jazz imports (stock list)
- 6.) Super cassettes
- 7.) Compact discs from Japan, Europe, U.S.A.

Send \$1 for each catalog (and receive free updates for six months) November Specials: MFSL Beatles Collection \$289. MFSL Sinatra Collection \$314. Supersound-Record Service. P.O. Box 82-A Forest Park, IL 60130, (312) 366-1300.

LOWEST IMPORT PRICES EVER! Japanese \$7.99 up, European \$4.99 up, CDs \$13.99 up. Thousands of Rock, Jazz, Classical titles. Send SASE for details. EARTH-TUNE, Box 42189, PORTLAND, OR 97242

MOBILE FIDELITY AUCTION. Sealed, most titles available. Send \$1 for list. D.B. Jones, Dept. A, Box 21-C, Convent Station, NJ 07961

PROTECT YOUR LPS POLY SLEEVES for jackets 13c. Poly lined paper 15c. Square bottom inner sleeves 8c. White jackets 35c. Postage \$2.50. House of Records, Hillburn, NY 10931

RARE O/P RECORDS: Warehouse stock reasonable prices. Catalog \$1., Melody House Records, Box 607, Ansonia Station, New York, NY 10021.

RECORD COLLECTORS SUPPLIES. ANTI-STATIC POLY LINED SLEEVES, REPLACEMENT CARDBOARD JACKETS, OPERA BOXES, 78 SLEEVES, ETC. FREE CATALOG. MC/VISA PHONE ORDERS, 614-299-0476, 614-272-6715. CABCO PRODUCTS, A-7, BOX 8212, COLUMBUS, OHIO 43201.

RECORD-TAPES! Discounts to 73%; all labels; no purchase obligations; discount dividend certificates; 100% guarantees. Free details. Discount Music Club, 650 Main St., P.O. Box 2000, Dept. 14-1183, New Rochelle, New York 10801.

SHEFFIELD LAB-THELMA HOUSTON. Dave Grusin. \$55 ea. ppd. Beatles Sgt. Pepper UHQ \$150. John Klemmer-Straight From Heart Nautilus D.D. \$35. William Wegner, 4373 Wayside, Saginaw, Mi. 48603. 517-793-4218.

RECORDS

SHEFFIELD "MISSING LINC", Lincoln Mayorga & Distinguished Friends. Vol. VIII, "Discovered Again—Dave Grusin"—unopened; \$300, \$300, \$200 OBO. Complete back issues Audio 1972-1983, \$100 plus shipping. Stek, 19 Mayfield, Regina, Saskatchewan. 306-352-7184.

SHEFFIELD MISSING LINC, VOL. II (S-10). Unopened. \$400 or best offer. Karl, 204 Hillside Dr., Smithfield, NC 27577 (919) 934-2575.

THOUSANDS OF LIKE NEW LP's and prerecorded tapes. Catalogue—\$2.50. House of Records, Hillburn, New York 10931.

YSL RECORDS (Japanese pressings exclusively)—NEW 1983 11,000-plus title catalog. \$3.00 Postpaid. **YSL STYLE**—top quality, great selection for most popular magnetic cartridges. Free list. **YSL RECORDS**, Box 8330-U, Van Nuys, CA 91409.

COMPACT DISCS

COMPACT DIGITAL DISCS exclusively—in stock—catalog \$1, refundable with order—Ethel Enterprises, P.O. Box 3301, Dept. A, Falls Church, VA 22043

COMPACT DISCS-350 TITLES-AVAILABLE NOW! Immediate delivery! Classics—Pop—Jazz!—FREE Catalog available. Phone or mail orders—Master Card & Visa. **LAURY'S RECORDS** 9800 North Milwaukee. Des Plaines, IL 60016 (312) 296-0420

CD DISCS!

The first compact disc dealer in North America (see Billboard cover story 3/12/83), and still the best. We have inventory! Nearly 500 titles in stock, or readily available. Fair prices. Same day shipping. Our stock changes daily; phone orders a must.

Capitol Record Shop
7 Capitol Ave., Hartford, CT 06106
203-278-6530

COMPACT DIGITAL DISCS AND PLAYERS!

In stock! Many titles. Fast, FREE shipping. **READ BROTHERS STEREO**, 593 King Street, Charleston, South Carolina 29403. (803) 723-7276.

WANTED TO BUY OR TRADE

ATTENTION WANTED: MCINTOSH, MARANTZ, WESTERN ELECTRIC, ARC, BERNING, ETC. TUBE EQUIPMENT. (713) 728-4343. MAURY CORB 11122 ATWELL, HOUSTON, TEXAS 77096

AUDIO INTERNATIONAL COMPANY SINCE 1974. All items listed by Aberst, Corb, Yo. Highest price, Integrity. (805) 646-5862

DYNACO ELECTRONICS, SPEAKERS, PARTS BOUGHT, SOLD, TRADED, REPAIRED. Free "buy sell" pricelist. CASH for "blown" Dyna components! SCC, Box 551 (1083AM), Dublin, OH 43017- (614) 889-2117.

IT'S WORTH IT CALLING ME: MCINTOSH, Marantz, Quad, Leak, Tube Components, Thorens TD-124, Garrard 301, Altec 604BCDE, Goodman AXIOM-80, Wharfedale Super-12, Old Tannoy Monitor Speakers, EV Patricians, JBL Hartfield D-30085, Western Electric Equipments (Tubes, Amps, Consoles, Mixers, Drivers, Tweeters, Horns, Speakers) Tel: 213/576-2642 David Yo POB 832 Monterey Pk, Ca. 91754

MCINTOSH, MARANTZ TUBE COMPONENTS, Western Electric speakers, amps, etc. John Conrad 1178 Blackbird St. El Cajon, CA. 92020 (619) 449-9155

MCINTOSH, MARANTZ TUBE EQUIPMENT, Thorens TD-124, Western Electric, Altec/JBL/EV/Tannoy/Stevens raw speakers, etc. Top cash. Scott Dowling, 9908 Dalnes Dr., Temple City, CA 91780 (213) 286-9122

TOP PAID! WESYAN ELECTRIC TUBES 300A-B, 274A-B, 252A, MCINTOSH C-22, MC-275, MARANTZ 2, 7C, 9, 10B, ALTEC 830A LAGUNA SYSTEM, 604 SERIES. Must be in good shape and reasonable. **SOUND INC.** PO Box 34, Shimodate, JAPAN 308.

WANTED: HARMAN KARDON 430 RECEIVER—Call T. Moore collect 702-293-4795

WANTED TO BUY OR TRADE

QUADRAPHONIC OPEN REEL TAPES, records, Q-8's, equipment. Some for sale also. Michael Robin, 120 Atlanta Place, Pittsburgh, PA 15228, 412-341-1686

WANTED—Esoteric tube equipment, Western Electric Audio products, parts & literature, E.V. Patricians, J.B.L. Hartfields & raw components, Altec Laguna, 604's 51's and components, Thorens TD124, Tannoy Monitors, RCA Credenza. Kurluff Ent., 4331 Maxson Road, El Monte, CA 91732, (213) 444-7079

WANT JENSEN G-600 15" TRIAX. UNIVERSITY M-15T 15" Coaxial. 408-867-0341

WANT JENSEN SG-88, 8" COAXIAL. UNIVERSITY 308, 8" Coaxial. LAFAYETTE SK-212, 8" Coaxial. 408-867-0341

WANT KNIGHT KN-800A 12" COAXIAL JENSEN CX 225 12" Coaxial. 408-867-0341

KENWOOD KT7000, KT7001, KA7002, KC6060, KF8011, KM8002, KA6000, (201) 671-8699

SERVICES

AUDIO PULSE REPAIR SPECIALISTS. Model One's modified. Wall's Audio Service, 111 E. Riatio Ave., Riatio, CA 92376 (714) 875-0776

ATTENTION AUDIOPHILES-MITSUBISHI, KENWOOD, AUDIO PURIST, HARMAN KARDON, SOUNDCRAFTS-MEN, BOSTON ACOUSTICS, GRADO, JANSZEN, & CUSTOM SPEAKER RECONING FOR OVER 25 YEARS. NEAL'S SPEAKERS & STEREO 1728 FULTON AVE, SACRAMENTO, CA 95825 (916) 486-9372.

GAS REPAIR SPECIALISTS ... your Ampzilla, son of, and grandson of are repairable! We have the parts in stock (no meters) Park Ave. Audio Services, 434 Park Ave., Worcester, Mass. 01603 (617) 757-1188

HOUSTON

Comes of Age

The nation's fourth-largest city proudly welcomes a truly distinctive audio dealer.

AUDIO PROFILES

Fully authorized dealer representing:

Audio Research	Threshold
Counterpoint	PS Audio
Sequera	Tandberg
DCS/Gestalt	Musical Fidelity
Amber	Hofler
Harman Kardon	Kyocera
Quad	Acoustat
Vandersteen	Thiel
KEF	Dahlquist
Spica	Janis
Goldmund	Oracle
Walker	VPI
Syrinx	Hellus
Sumiko	Lustre
van den Hul/EMT	Kiseki
Marovskis MIT	Dynavector
Grace	Signet

Kyocera DA-01 digital Compact Disc player
Audioquest/Live Wire - Sonex Professional

Five listening rooms on two levels
Spacious, relaxed atmosphere
Knowledgeable, experienced staff
Wide selection of audiophile recordings

Hear the finest music system
in the entire Southwest.

Quad ESL-63s • Janis W-1/1A subwoofer
Goldmund Studio T30 • van den Hul/EMT
Audio Research SP-10 and D79C electronics
Sequera FM-1 • Tandberg TD20A SE tape
Sonex Professional "L.E.D.E." listening room

audio profiles inc.

12651 Memorial Drive, between Gessner & W. Belt
Houston, Texas 77024 (713) 973-0000
Mon.-Thurs. 10 am-8 pm, Fri 10-7, Sat 10-6
MasterCard, Visa and American Express accepted

ATTENTION ADVERTISERS!
SEE CLASSIFIED RATE BOX ON
PAGE 111 FOR NEW RATES, EF-
FECTIVE JANUARY 1984 ISSUE.

SUMO-NIZE!

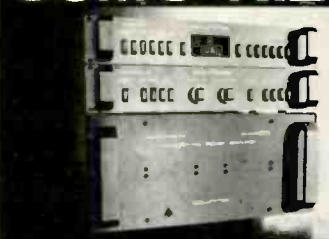

For the past 6 years, SUMO electronics audio components have been engineered to reproduce your music perfectly, effortlessly. New SUMO's continue that tradition: The ELECTRA full-featured preamp preserves every electron of information passed through it. CHAR-IE, our first FM tuner, reveals that FM broadcasts can represent a truly high fidelity alternative to LPs and tapes. And ANDROMEDA, 200 watts per channel (FTC) of high power amp, exercises such complete control over any loudspeaker, that your listening room will come alive.

Write to SUMO INC., at the following address for more details. Some representative territories still available.

ALL AMERICAN AUDIO, INC.

31316 Vth Colinas, Suite 103, Westlake Village, CA. 91362
Phone (213) 991-5330 • Tlx 658234 SUMOCORP WKVG

In New England...



The knowledge, creativity and dependability you expect from a dealer who represents these manufacturers.

Acoustat	Kiseki
ADS	Magnepan
Alpha	Mission
Audio Interface	NAD
Audio Pro	Nakamichi
Audioquest	Niles
Bang & Olufsen	Nitty Gritty
Boston Acoustics	Oracle
Bryston	Plexus
Carver	Proton
Counter Point	Pyramid
C.J. Walker	Signet
Dennessen	SOTA
Denon	Siex
Dynavector	Sumiko
Energy	Tandberg
ESB	Threshold
Grace	Vandersteen
Hofler	VPI
KEF	Wooden Images
Keith Monks	...and more

3 listening rooms ... New England's largest Audiophile record dealer ... Keith Monks record cleaning ... In-store service ... All shipments pre-paid and insured in the continental U.S.

5 TAKE AUDIO

105 Whitney Ave., New Haven, CT
(203) 777-1750
Mon., Tue., Wed., Fri. 10-6, Thurs. 10-8, Sat. 10-5

SERVICES

CHROME BIAS, TRUE-SPEED, DOLBY CASSETTE COPIES from your tapes. Top Quality, Fast Service, Low Prices. Dealers Welcome. Send \$5.00 (refunded with order) for sixty minute sampler and complete data to Donald Ozga Recording, 13169 Cloverlawn, Sterling Heights, MI 48077

G.A.S. REPAIRS—ALL MODELS

4 Month Limited warranty—Parts Labor

For more information write or call between 10:00 & 6:00 E.S.T. Audio Diagnostics, Inc. 19888 Kelly Rd. Harper Woods, MI 48225, (313) 527-5400

LOST AND FOUND. NATIONAL SECURITY SERVICE. Protect components, tapes, video, computers. Call 804-424-5800. SASE. "Finders", Box 2500-A, Chesapeake, VA., 23320.

TAPE RECORDINGS

DIRECT-TO-TAPE RECORDINGS: REAL TIME DUPLICATED REELS (2/4 track, Dolby B/C, TypeX), CASSETTES (Dolby B/C, TypeX), and DIGITAL CASSETTES from MASTER TAPES. FREE CATALOG. Direct-to-Tape, 14-R Station Ave., Haddon Heights, NJ 08035.

OPEN REEL TAPES from studio masters, Catalogue \$1.00. Barclay-Crocker, 313-A Mill Street, Poughkeepsie NY 12601.

BUSINESS OPPORTUNITIES

BUSINESS CONNECTION WANTED with serious HiFi video dealers especially for buying special offers (e.g. remainder models, also in great quantity) and High-end products, especially compact DISC and blank cassettes, 220 V/50 Hz, under the condition of adaptation. Please address your offer to Bernhard Vehns, Springerstrabe 4, 8000 München 71, West Germany.

SPEAKERS

ELECTRO-VOICE INTERFACE AND CD SERIES QUALITY SPEAKER SYSTEMS. PROFESSIONAL CONSULTATION—BEST PRICES. EAST: (904) 262-4000; WEST: (213) 840-0878.

ELECTRO-VOICE INTERFACE D equalized ultra-high-performance speakers. We have the last pair from E.V. (201) 561-8123.

TAPE AND TAPE RECORDERS

AMPEX PROFESSIONAL SERIES AUDIO TAPE SALE High quality open reel 1800' or 2400' on 7" reels, used once. Case of 40, \$45.00, 10 1/2" x 3600' and cassettes available. Master Card/Visa. Valtech Electronics, Box 6-A, Richboro, PA 18954 (215) 322-4866.

SURPLUS AMPEX 671 SCOTCH 24 00' box of 62, \$56. SCOTCH 3600' box of 30, 75. COD or check. CK Ltd., P.O. Box 527, Cottondale, Florida 32431

MISCELLANEOUS

IDEAS, INVENTIONS, NEW PRODUCTS WANTED! Industry presentation/national exposition. 1-800-528-6050. X831.

ATTENTION ADVERTISERS! SEE CLASSIFIED RATE BOX ON PAGE 111 FOR NEW RATES, EFFECTIVE JANUARY 1984 ISSUE.

AD INDEX

Firm (Reader Service No.)Page

ADC (31)	101
Adcom (35)	107
Acoustat.	100
ADS	13
Allison Acoustics (27)	95
Alpine Luxman (23)	86 & 87
AMC Jeep	62 & 63
Apt (7)	12
Audiophile Systems (26)	92
Audio-Technica (19)	78
B&K Components (16)	25
B & W Loudspeakers (9)	16
BASF (12)	20
Bryston Manufacturing (36)	108
Camels	61
Carver Corp. (14)	23
Custom Woodworking & Design	22
D'Ascanio (39)	110
dbx	94
Delco/Bose	103
Denon (6,17,40)	12, 17, Cov. III
Design Acoustics (32)	102
Direct Sound (37)	108
Discwasher	Cov. IV
Fisher (28)	97
Franklin Mint	18 & 19
Harman/Kardon	5, 99
IMF Electronics (20)	85
Jack Daniels	105
J&R Music World (38)	110
JBL (21)	67
JVC (22)	79
KEF (18)	47
LaBelle	109
McIntosh (13)	22
Magnepan (8)	15
Maxell (5)	11
NAD (41)	93
Nakamichi	26 & 27
Proton	91
Revox (34)	106
Salems	49
Sansui (2)	3
Signet (25)	90
Sony (1)	Cov. II & Pg. 1
Soundcraftsmen (30)	9
Spica (11,15,29)	21, 24, 98
Studer-Revox (34)	106
Tandberg (4)	10
TDK (10)	17
Technics (3)	6 & 7
Warner/Elektra/Atlantic (24)	89
Yamaha	55

Audio

BACK ISSUES/ BOUND EDITIONS/ BINDERS



BACK ISSUES

Single copy back issues of AUDIO for 1981 and 1982 are available. (NOTE: Jan-Aug '81 issues are in limited supply.) **\$5.00 per issue postpaid.**

BOUND ISSUES

A ready reference for audiophiles! A full year of AUDIO is carefully hard-bound for easy reference. Complete volumes for the years '77, '79, '80, '81 and '82 are available. **\$40.00 each plus \$2.50 for postage and handling.**



BINDERS/ SLIPCASES

Maintain your AUDIO collection in these top quality binders or slipcases. **Binders \$9.00 each, 3/\$26.00, 6/\$50.00. Slipcases \$7.65 each, 3/\$22.00, 6/\$40.00. \$2.50 per order handling and postage.**



TO ORDER indicate issue/book/binder/slipcase. Include proper amount for postage and handling. California residents must include 6% sales tax. Allow 4 weeks for delivery. Make check/money orders payable to: **Old Del Mar Emporium (ODME), P.O. Box 2512, Spring Valley, CA 92077. DIRECT TOLL-FREE ORDER NUMBER: 1-800-833-6363. In California call: 1-619-466-0866. Call Mon-Fri, 8:00 AM—6:00 PM PST. Use your Visa, Mastercard, or American Express card. \$15.00 MINIMUM CREDIT CARD ORDER.**

DESIGN INTEGRITY:

WHAT MAKES DENON RECEIVERS UNCOMMON IS HOW MUCH THEY HAVE IN COMMON.

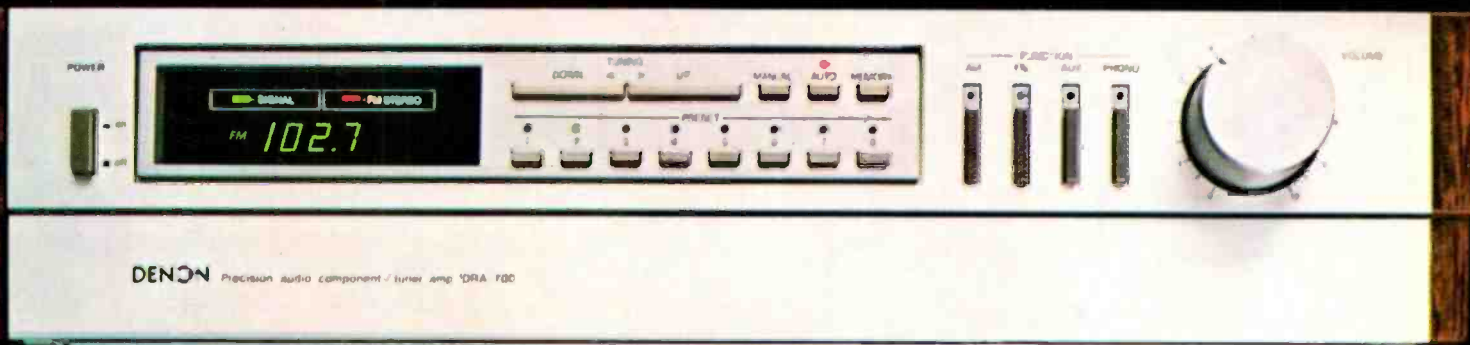

Denon DRA-700 AM/FM Stereo Receiver \$549
 Non-NFB 0dB Amplifier; Quartz PLL Synthesized FM Tuning; MC Head Amp; 60 Watts* per Channel.



Denon DRA-300 AM/FM Stereo Receiver \$299
 Non-switching A Amplifier; Quartz PLL Synthesized FM Tuning; 33 Watts* per Channel.



Denon DRA-400 AM/FM Stereo Receiver \$399
 Non-switching A Amplifier; Quartz PLL Synthesized FM Tuning; MC Head Amp; 45 Watts* per Channel.

The DRA-700 Receiver incorporates the same 0dB Non-NFB circuitry that earned Denon special recognition by *Audic Video International* magazine in their Hi-Fi Grand Prix Competition. This straight-forward circuit design makes the DRA-700 the most electronically sophisticated receiver on the market today.

The DRA-400 actually won the *AVI* Hi-Fi Grand Prix Award, and was cited for its Non-Switching A Amplifier (which eliminates Switching and Crossover distortions) and Quartz PLL Synthesized FM Tuning System (which improves tuning accuracy and eliminates station drift).

The DRA-300 also offers a Non-Switching A Amplifier and Quartz PLL Synthesized Tuning, but for under \$300.

Denon products share more than names alone.

Denon America, Inc., 27 Law Drive, Fairfield, N.J. 07005

*Prices for comparison purposes. Side panels optional except on DRA-700. All power ratings at 8 ohms, 20 Hz-20 kHz; THD 0.05% (DRA-700, 0.015%).

Enter No. 4C on Reader Service Card

DENON

Imagine what we'll do next.

After
two years
of research

The Discwasher Brand D'MAG is not just a head demagnetizer ... it's a cassette deck demagnetizer.

Magnetic fields surround not only tape heads but capstans, guides and other steel portions of a cassette deck as well; and all of these magnetized parts are capable of reducing high frequencies on recorded tapes by as much as 4dB with only a single playback.

Discwasher D'MAG utilizes permanent high energy samarium cobalt magnets for both efficiency and consistency in demagnetizing effect. With a single pass, D'MAG will neutralize magnetic fields from any cassette deck, whether home or car.

And permanent magnets mean that D'MAG doesn't require batteries or power cords.

**IT'S BEEN WORTH
THE WAIT**

**discwasher[®]
D'MAG[™]**

**Cassette Deck
Demagnetizer**



Write Discwasher
for your free copy of
"Guide to Tape Care".

discwasher

1407 NORTH PROVIDENCE ROAD, P.O. BOX 6021, DEPT. AU, COLUMBIA, MO 65205
A DIVISION OF JENSEN an ESMARK Company