

The  
Authoritative  
Magazine  
About  
High Fidelity

# Audio

6TH  
ANNUAL  
CAR STEREO  
DIRECTORY

JULY 1980 • \$1.25 • ©06030

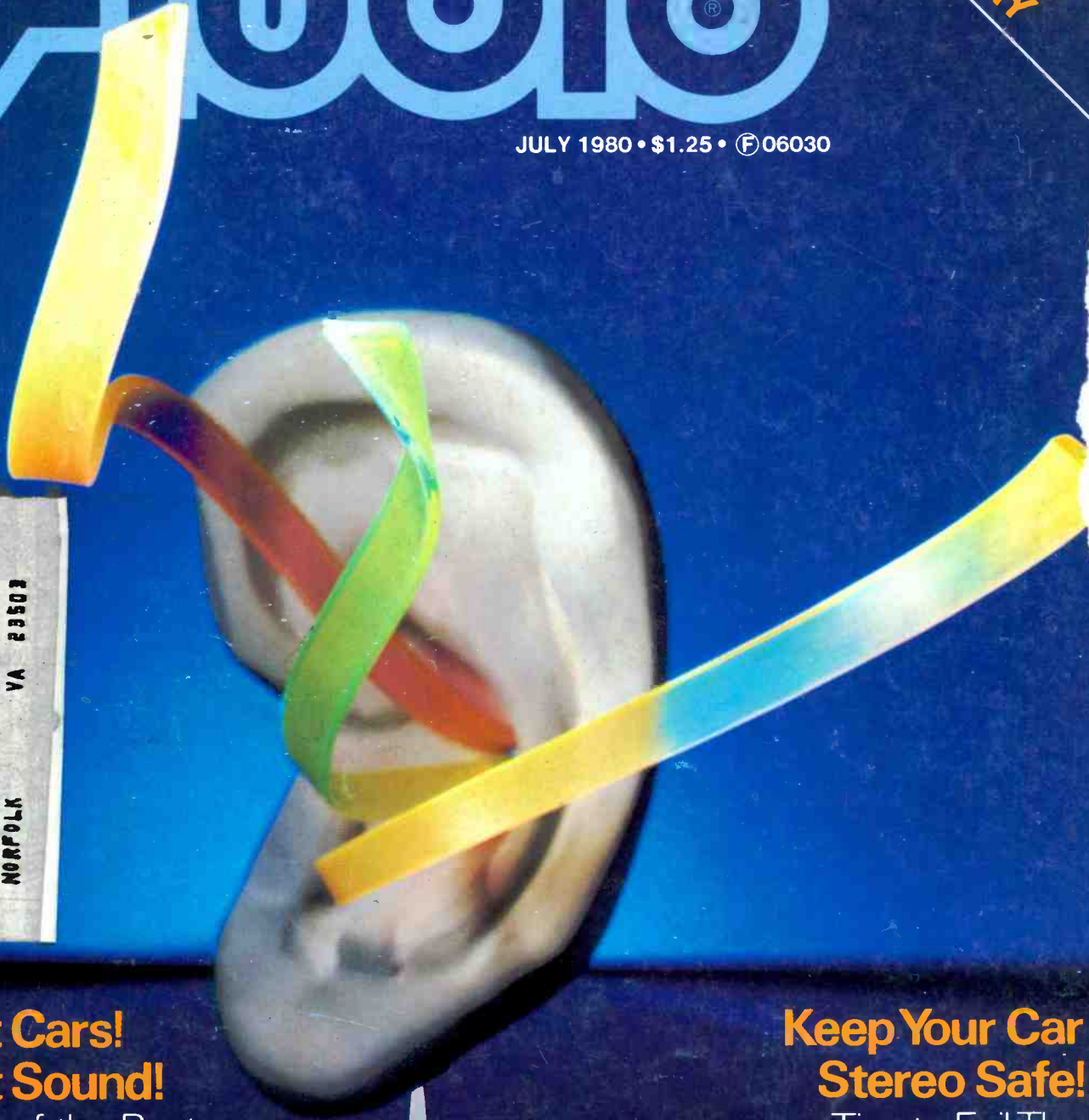

03 79 6622 KAY178YH01 OCT05  
WILLIAM W KAYSER P  
197 W-BAYVIEW BLVD  
NORFOLK VA 23503

**Great Cars!**  
**Great Sound!**

Photos of the Best  
In Auto Hi-Fi

**Keep Your Car  
Stereo Safe!**

Tips to Foil The  
Professional Thief



changes in temperature. But even the best of them just seem to reduce drift instead of eliminate it.

The Pioneer PL-400, on the other hand, has a Quartz PLL servo system that keeps rotational speed at a constant. And keeps the PL-400 unaffected by temperature changes, voltage fluctuations and other powerline anomalies.

These features work to keep the PL-400 sounding like a much more expensive turntable. But without our specially designed Coaxial Suspension system, they wouldn't be nearly as effective.

This free floating suspension system isolates the platter and tonearm from the rest of the turntable. So even if the base vibrates, the platter and tonearm don't.

This means you can shake, rattle and roll a lot more with a lot less worry that your turntable is doing the same thing.

Even the tonearm of the PL-400 is designed to give you better sound. Its

new "Mass Concentrated" design improves crossmodulation distortion and tracking accuracy. So you get more sound clarity and better channel separation.

All these features on a turntable the price of the PL-400 is unheard of. But Pioneer didn't stop there. The PL-400 also has full automatic controls. Including automatic lead-in, viscous damped cueing, automatic return, and automatic repeat. An easy to read one-stripe strobe that confirms platter speed accuracy. A quick start mechanism that starts the platter revolving as soon as the tonearm begins to move. And more.

So if you want to buy a \$200 turntable and are just interested in great specs, there are any number you can buy. But if you're interested in a \$200 turntable that will give you great sound, there's only one.

The Pioneer PL-400.

**PIONEER**<sup>®</sup>

We bring it back alive

©1979 U.S. Pioneer Electronics Corp. 85 Oxford Drive, Moonachie, N.J. 07074  
Manufacturer's suggested retail prices. Actual prices will be set by individual dealers.

Enter No. 15 on Reader Service Card



# INTRODUCING THE NEW PIONEER PL-400.

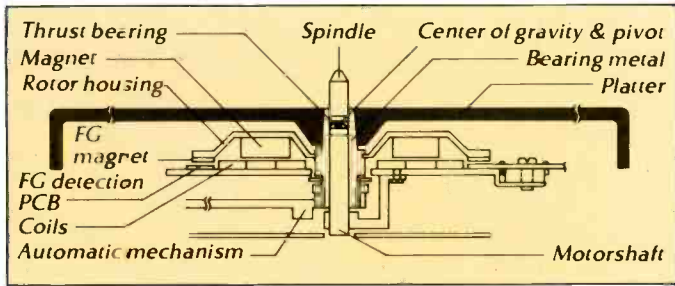

PIONEER'S NEW STABLE HANGING ROTOR. BY RAISING THE CENTER OF GRAVITY, WE LOWERED THE RATE OF DISTORTION.

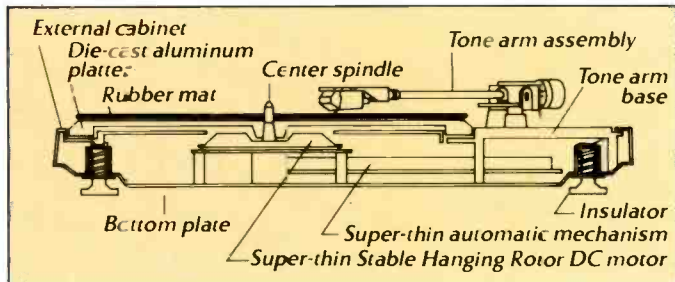

PIONEER'S COAXIAL SUSPENSION SYSTEM. IT VIRTUALLY ELIMINATES VIBRATION AND RUMBLE.

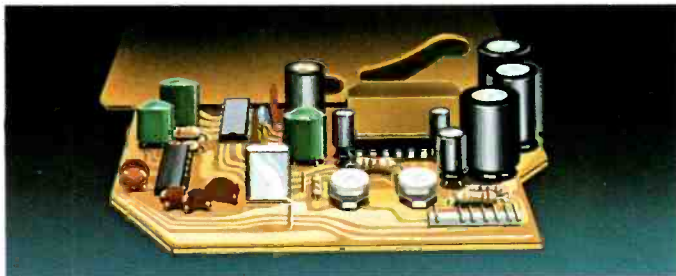

THE PIONEER QUARTZ PHASE LOCK LOOP SYSTEM. BY AUTOMATIC MONITORING, ROTATIONAL SPEED IS KEPT CONSTANT TO REDUCE WOW AND FLUTTER.

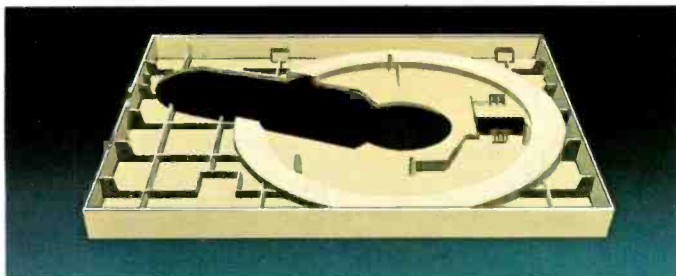

THE PIONEER COMPUTER-DESIGNED HOWL-PROOF ENCASUREMENT. BY SLIMMING DOWN THE SIZE, WE SLIMMED DOWN ACOUSTIC RESONANCE.



PIONEER'S BEST-SOUNDING REASON OF ALL: THE PRICE. UNDER \$200.

Today, most turntables in the same price range look practically the same on paper. But they don't sound at all alike in your home.

Because equal specs don't necessarily mean equal sound. In fact, specs are just a measure of the distortion caused by your turntable itself. They tell nothing about how your machine prevents distortion caused by your environment.

Pioneer's new PL-400 turntable was designed to also keep external interference from coming between you and great sound.

Much of the success of our new PL-400 turntable revolves around our all new "Stable Hanging Rotor." The world's thinnest direct drive motor.

Unlike more massive conventional motors, the motor in the PL-400 is so thin, it allows the center of gravity to be at the pivot point of the rotating mechanism. So instead of the platter wobbling like a top, the platter on the PL-400 acts like a gyroscope to stabilize itself.

Although this technology is very difficult to understand, the result of it is very easily appreciated. You no longer are bothered by distortion caused by stylus mistracking or speed deviations. So you get just what's on your record. Nothing added to it. And nothing taken away.

But this super thin motor does more than eliminate distortion. It also eliminates any space wasting elements used in conventional motors. And because it's so much thinner than any other motor, the cabinet around the PL-400 is also a lot thinner. This 20% reduction in cabinet size means the PL-400 is 20% less likely to suffer from acoustic distortion.

Many turntables in this price range are direct drive. Some of them offer DC motors. Some of them have servo motors aimed at eliminating drift caused by

**IF ALL \$200 TURNTABLES HAVE  
THE SAME SPECS, HOW COME THE PL-400  
SOUNDS BETTER?**





**PIONEER** QUARTZ-PLL FULL-AUTOMATIC **PL-400**

REPEAT

START/OUT

12:30 10:25 7:17

# Audio

"Successor to **RADIO**, Est. 1917"

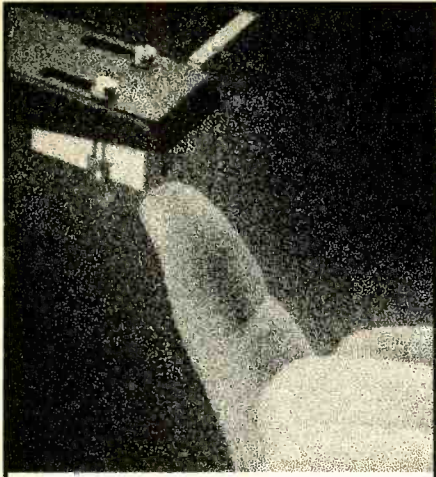

## SC-2 gives your cartridge more than The Finger!

The famous SC-1 stylus brush (standard of the record and hifi industries) now has a synergistic fluid called SC-2.

SC-2 Fluid enhances and speeds cleaning and yet protects diamond adhesives, cartridge mounting polymers and fine-metal cantilevers against the corrosive effects of many other "cleaners."

The Discwasher SC-2 System. Stylus care you can finger as clearly superior.



**discwasher**<sup>®</sup>  
PRODUCTS TO CARE FOR YOUR MUSIC

1407 N. Providence Rd.  
Columbia, Missouri 65201

### Car Stereo Directory

Manufacturers Index	28
Radios/Tape Players	29
Speakers	35
Amps & Equalizers	44

### Feature Articles

Great Cars! Great Sound!	52	Gary Stock
Keep Your Car Stereo Safe	60	Bob Curtis

### Equipment Profiles

JVC A-X9 Amplifier	68	Leonard Feldman
Dynavektor DV/Karat Diamond Cartridge and DV-6A Transformer	71	B. V. Pisha
Connoisseur BD2A Turntable	74	George W. Tillett

### Record Reviews

The Column	76	Michael Tearson & Jon Tiven
Jazz & Blues	79	John Diliberto & John Lissner
Classical Reviews	81	Edward Tatnall Canby

### Audio in General

Audioclinic	6	Joseph Giovanelli
Audio ETC	8	Edward Tatnall Canby
Tape Guide	18	Herman Burstein
Behind The Scenes	20	Bert Whyte
Dear Editor	26	
Classified Advertising	82	
Advertising Index	93	

**About the Cover:** As you travel down that ribbon of highway, consider a car stereo system from among those included in our 6th Annual Directory, beginning on page 28. And for tips to avoid having your components ripped off, consult Bob Curtis' article on page 60. Construction by Nick Aristovulos; photograph by Shig Ikeda.



Audio Publishing, Editorial and Advertising Production Offices,  
1515 Broadway, New York, N.Y. 10036.  
Subscription Offices, P.O. Box 8167, 1 Fawcett Place, Greenwich, Conn. 06830  
Subscription Inquiries, (800) 243-8002; in Connecticut, (800) 852-8593.  
Postmaster: Send Form 3579 to above address.

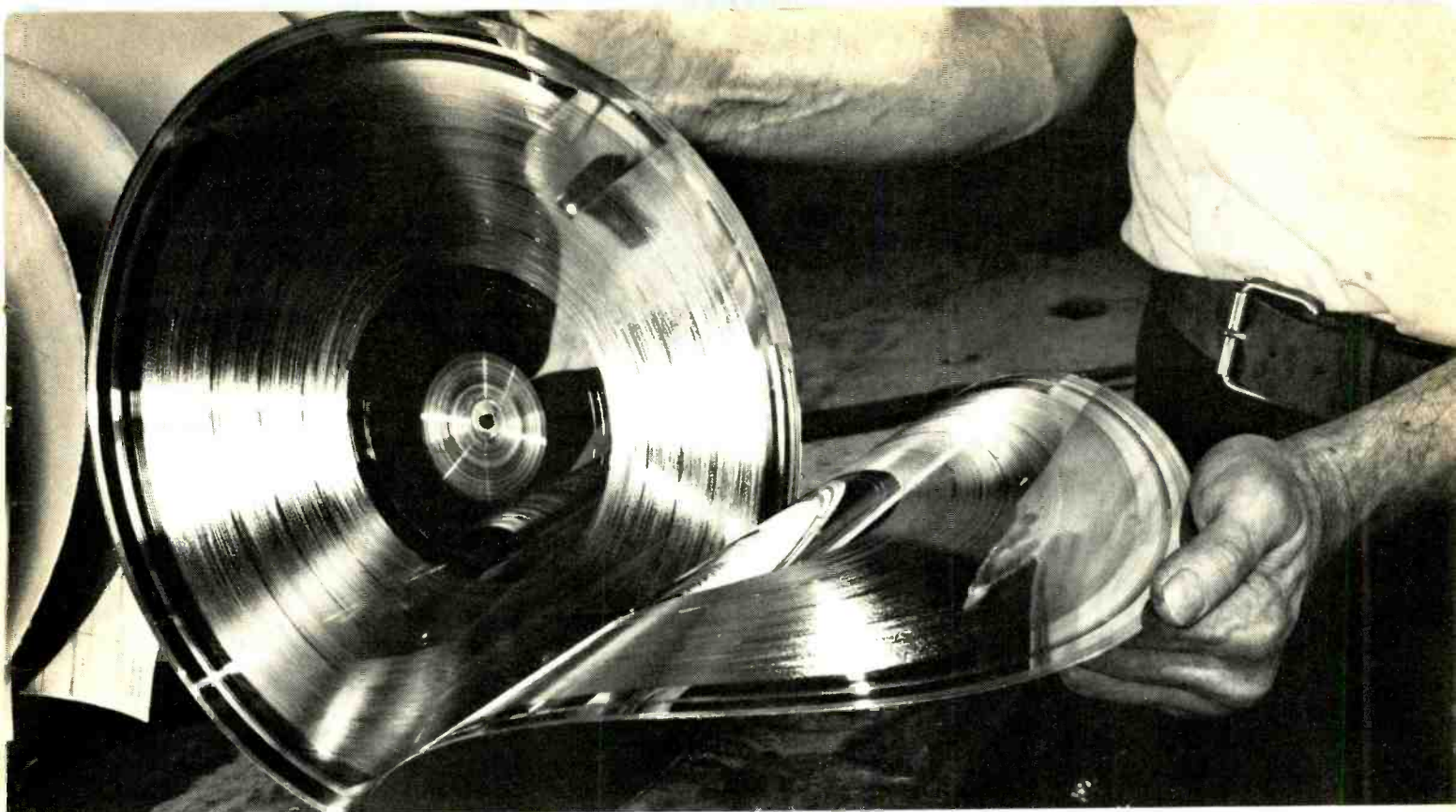

Separating the mother from the master



Stanton's 881S

# Stanton-The Professional in The Recording Industry

Application — The Metal Mother — Stanton plays it back

Once the recording studio has delivered the lacquer disc to the plating plant it is sprayed with liquid silver making it electroconductive, and then electroplated with nickel, which is separated from the lacquer. The nickel is now a negative image called a master, and has, instead of a groove, a ridge that comes to a point. The master is treated and nickel plated again and upon separation forms a mother, a positive metal record. Engineers rely on the Stanton 881S cartridge in playback evaluation of the mother.

Stanton's 881S Professional Calibration Standard Cartridge is a sophisticated, low mass phono pickup that features the patented Stereohedron® stylus tip for

truest fidelity and gentlest possible treatment of the record groove. Lightweight, high energy magnets allow reduced mass and higher output than conventional magnets. And each Stanton 881S that comes off the production line has been tested and individually calibrated with the test results packed in each unit to assure the very finest professional quality product regardless of application. *From disc cutting to disco to home entertainment your choice should be the choice of the Professionals...* Stanton cartridges. © 1979 STANTON MAGNETICS



## STANTON

THE CHOICE OF THE PROFESSIONALS™

For further information contact: Stanton Magnetics Inc., Terminal Drive, Plainview, New York 11803

Enter No. 24 on Reader Service Card

# Enjoy a profoundly moving, intimate experience.



Model ATH-7  
Electret Condenser  
Stereophones \$149.95.

Other A-T models  
from \$29.95.

It's all too rare when you can fully immerse yourself in music. There are so many distractions... even at home. Household noises, traffic, and perhaps acoustics or loudspeakers which limit enjoyment.

Now we've made it simple. Audio-Technica ATH-7 Stereophones were created for those moments when you yearn to close your eyes to the world and find a private space occupied only by you, the composer, and the performers.

So light, comfortable, and cool you are hardly aware of their presence. With the outside world muted as you concentrate on every nuance, every transparent detail... or simply luxuriate in the conductor's

close-up world of sonic pleasure.

Best of all, with ATH-7 Stereophones you give up nothing in sound quality. Nothing. Listen critically to the frequency response range, dynamic range, output level, and overall freedom from distortion. ATH-7 Stereophones have proved themselves in direct comparison with the most distinguished loudspeaker systems yet developed, regardless of price.

Enter our private world of audio pleasure today. You'll never want to leave. AUDIO-TECHNICA, U.S., INC., 1221 Commerce Drive, Dept. 70A, Stow, Ohio 44224. In Canada: Audio Specialists, Inc., Montreal, P. Q.

**audio-technica**

AUDIO-TECHNICA PROFESSIONAL AND HOME PRODUCTS FOR BETTER SOUND



## Audio

**Editor**  
Eugene Pitts III

**Assistant Editor**  
Kay Blumenthal

**Editorial Assistant**  
Deirdre Frank

**Art Director**  
Cathy Cacchione

**Production Manager**  
Carol Schlossman

**Advertising Coordinator**  
Carolynn Sumner

**Associate Editors:**  
Edward Tatnall Canby, Bert Whyte

**Senior Editors:**  
Richard C. Heyser, B. V. Pisha  
Howard A. Roberson

**Contributing Editors/Artists:**  
Tom Bingham, Herman Burstein,  
Ted Costa, John Diliberto,  
Leonard Feldman, Joseph Giovanelli,  
Edward M. Long, C. G. McProud,  
Gary Roseman, Jon Sank,  
Donald Spoto, Gary Stock,  
Michael Tearson, George W. Tillett,  
Jon Tiven

**Publisher**  
Jay L. Butler

AUDIO (ISSN0004-752X) is published monthly by CBS Publications, The Consumer Publishing Division of CBS Inc., 1515 Broadway, New York, N.Y. 10036.

Robert J. Krefting, President  
George H. Allen, Senior Vice President/Magazines  
Francis P. Pandolfi, Vice President and Group Publisher  
Michael Brennan, Vice President and Gen. Manager  
Leon Rosenfield, Circulation Marketing Director  
William Ganz, Advertising Marketing Director  
John J. Miller, Business Manager  
Marlene Jensen, Group Business Manager  
Gertrud Borchardt, Production Director

### ADVERTISING SALES

Audio, 1515 Broadway, New York, N.Y. 10036  
Jay L. Butler, Publisher  
Telephone (212) 975-7247  
Stephen W. Witthoft, Eastern Adv. Mgr.  
Telephone (212) 975-7654

### West Coast Sales Office:

Audio, 3807 Wilshire Blvd., Suite 1201  
Los Angeles, Calif. 90010.  
Jay Martin, Western Adv. Mgr.  
Telephone (213) 487-5880.

### Classified Advertising:

Audio, 1515 Broadway, New York, N.Y. 10036  
Carolynn Sumner, Classified Adv. Mgr.  
Telephone (212) 975-7530

**Continental European Representative:** V. B. Sanders, International Publishers Advertising Service, Raadhuisstraat 24, P.O. Box 25, Graft-De Ryp, Holland. Telephone, 02997-1303

**England:** The Paul Singer-Lawrence Media Group, 54 Burton Court, London SW 3 5Y4, England. Telephone, 01-730-3592

©1980, CBS Publications, The Consumer Publishing Division of CBS Inc. All rights reserved.

Dewey Decimal Number 621.381 or 778.5

Editorial Contributions are welcomed but should be accompanied by return postage. Submissions will be handled with reasonable care, but the publisher assumes no responsibility for safety or return of manuscripts, photographs, or artwork.

Printed in U.S.A. at Columbus, Ohio. Controlled circulation postage paid at Columbus, Ohio and New York, N.Y.

U.S. Subscription Rates: 1 year \$11.94, 2 years \$19.94, 3 years \$25.94.

Other Countries: Add \$6.00 per year.

Back Issues, when available, \$5.00 postpaid.

Audio Publishing, Editorial and Advertising Production offices, 1515 Broadway, New York, N.Y. 10036.  
Audio Subscription Offices, P.O. Box 8167, 1 Fawcett Place, Greenwich, Conn. 06830

Postmaster: Send Form 3579 to above address.





# The secret of Onkyo.

Let Onkyo transport you to a world beyond electronics... to a world of more perfect sound. Where you'll hear music of such stunning purity and sensual richness, that you'll forget you're listening to an audio system.

That's the secret of Onkyo... and Onkyo's dramatic success. The unique ability to take you several steps beyond pure technology... to experience more exciting sound. And you'll find it in all our components... including all four of our new receivers.

The Onkyo TX-7000 Quartz-Locked AM-FM Stereo Receiver is an outstanding example. Both its power amplifier and FM sections are rich with important new design concepts.

The TX-7000's power amplifier provides two major innovations never before present in a stereo receiver. The first is called Super-Servo and it totally eliminates the sonic "ghost signals" common to DC power amplifiers. As a result, each instrument and voice sounds purer and more individually real...

regardless of volume level. Perhaps for the first time, you'll experience stereo with true depth, spaciousness, and a remarkably discernable third-dimension.

The second innovation

is Linear-Switching which lets us provide Class A amplifier sound quality with Class B power efficiency. Crossover distortion is significantly reduced. And output power is very highly efficient... 90 watts per channel with no more than 0.02% THD.\*

The TX-7000's FM section is also clearly superior... picking up weak stations noiselessly and strong stations without distortion.

A unique Human Touch Sensor automatically controls the Quartz-Locked system for more reliable and convenient operation... releasing the system instantly when it senses your touch on the tuning knob... engaging it again as your fingers leave the knob.

Special circuits also monitor both channels... detecting and cancelling out sound distorting FM signal noise. Other circuits cancel out appliance noise.

Digital FM readout... separate bass, mid and treble controls... 2-way tape dubbing facilities... and dozens of other important features are all found in the TX-7000. And the TX-7000 is just one of four new receivers from Onkyo.

Hear "the secret of Onkyo". Hear receivers so advanced, they transcend mere technology. Onkyo USA Corporation  
42-07 20th Avenue  
Long Island City, N.Y.  
11105, (212) 728-4639



\* Minimum RMS at 8 ohms both channels driven from 20 to 20,000 Hz.

**The Onkyo TX-7000**  
A remarkably advanced new stereo receiver  
that provides dramatically superior sound quality.

# Original.

original *n*: that from which a copy, reproduction or translation is made. (Webster's Collegiate Dictionary)



The ALLISON: ONE® Room Matched® loudspeaker system was introduced in 1974. It was the first direct-radiator system ever designed to use room-boundary reflections constructively, so that flat acoustic power could be radiated into a listening room throughout the full frequency range.

Now, more than five years after, we are pleased to see systems based on this concept being marketed by AR, Design Acoustics, and Snell (if we've omitted anyone, our apologies). To all such we say, "Welcome aboard." The more of us there are, the better.

But imitation does not mean replication. Only Allison® loudspeaker systems are manufactured under U.S. Patent No. 3,983,333, which teaches the most effective and least costly ways to make Room Matched loudspeakers. Only Allison systems have convex-diaphragm tweeters and mid-range drivers, which combine high output capability and unmatched dispersion. And only Allison systems are available in models designed for use with one, two, or three intersecting room boundaries.

Information on the complete line, including specifications, a list of authorized dealers, and details of our Full Warranty for Five Years, is available on request.

ALLISON: ONE \$460/\$483 (each)  
(Price varies with shipping distance)

## ALLISON ACOUSTICS

Seven Tech Circle/Natick, MA 01760, U.S.A.  
Telephone: (617) 237-2670

For literature and information call (800) 225-4791  
In MA (617) 237-2670

Enter No. 2 on Reader Service Card

# Audioclinic

Joseph Giovanelli

## RIAA Specifications

**Q.** For the past 1½ years, I have noticed increasingly "tight" RIAA equalization figures on phono sections of preamplifiers (e.g.  $\pm 1/4$ ,  $1/2$  dB, etc). My preamp is  $\pm 1$  dB. Can these differences really be heard? At what point does RIAA equalization become audible? — Bob Hoffman, Worth, Ill.

**A.** I would have to say that under some circumstances you are not likely to hear much difference between a phonograph having a "tight" RIAA spec and one having a "looser" spec, where the so-called loose specification is  $\pm 1$  dB.

The question really comes down to how much deviation from flatness of response can be detected by the ear. This is the issue if we are discussing RIAA or any other parameter in a system. Further, it depends on the frequency range where the curve departs from flatness. If it occurs at the high end, where there is very little recorded energy, we will not notice much of a difference with a total shift of 2 dB — which is what  $\pm 1$  dB can bring about. However, if the most serious departure of the curve takes place at perhaps 3 kHz, even 1 dB can make a considerable difference. This portion of the frequency spectrum is most sensitive to human hearing.

If the departure from flatness occurs at the very low end of the audio spectrum, again a 2-dB change probably won't be noticed — partly because of the lack of hearing sensitivity. If the frequency at which the 2 dB is measured is really low, it may well be that this shift won't matter since most recordings don't contain any significant bass energy at this point.

If you have a graphic equalizer which can be switched in and out, set it for a flat response and then introduce some small changes in response, at various portions of the spectrum. For simplicity, introduce just one boost or cut at a time. Note the audible differences when the equalizer is in or out, and, of course, use really wide-range material for the program source.

*Editor's Note:* Two dedicated audiophiles associated with the Univ. of Waterloo in Canada, Stanley Lipshitz and John Vanderkooy, recently made strenuous tests under double-blind conditions, and they conclude that as

little as 0.1 dB RIAA deviation can be heard reliably. It is well known that detection of such deviations is much easier with steady-state tones than with music, and some tests indicate that at least 3 dB of deviation on music is necessary before it can be detected reliably. What this matter comes down to then, is whether you, the listener, can hear such a difference and, perhaps more importantly, whether it bothers you.

## Masking of Music

**Q.** Do you think that most musical information on recordings is masked? Some instruments get covered up unless one listens very carefully with a good pair of headphones.

**A.** Should we not put all this "masked" music to good use? — Bob Hoffman, Worth, Ill.

**A.** To some extent musical information is always masked. Sit in a live concert and note the lack of absolute localization of some of the instruments. Some of the notes played may be blurred because of room reverberation; the faster the musical passages being played, the greater this kind of blurring will be.

The blurring is very evident when listening to music in large cathedrals. Pains were always taken by composers whose works were primarily intended for performance in such environments. They had to write so that the listeners would hear a minimum of masking and blurring.

In popular music this masking effect is introduced by the artist or the producer through special effects. These devices are used to heighten the effect, or mood, of the music being recorded and have proved to be beneficial in terms of increased sales of such recordings. A study of a number of albums will disclose that, at times, there is no masking, that all musical instruments do stand out. Indeed, entire albums are sometimes made in this manner. Sometimes, however, the so-called masking is alternately used and then removed, perhaps in the same musical selection, providing yet another means of contrast. 

If you have a problem or question about audio, write to Mr. Joseph Giovanelli at AUDIO Magazine, 1515 Broadway, New York, N.Y. 10036. All letters are answered. Please enclose a stamped, self-addressed envelope.

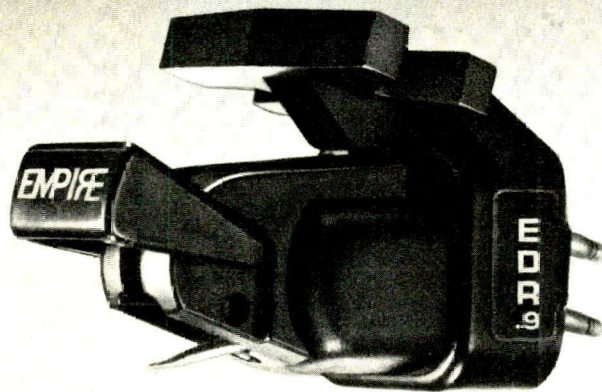

## INTRODUCING THE EMPIRE EDR.9 PHONO CARTRIDGE. IT SOUNDS AS GOOD ON A RECORD AS IT DOES ON PAPER.

It was inevitable . . .

With all the rapid developments being made in today's high fidelity technology, the tremendous advance in audible performance in Empire's new EDR.9 phono cartridge was bound to happen. And bound to come from Empire, as we have been designing and manufacturing the finest phono cartridges for over 18 years.

Until now, all phono cartridges were designed in the lab to achieve certain engineering characteristics and requirements. These lab characteristics and requirements took priority over actual listening tests because it was considered more important that the cartridges "measure right" or "test right"—so almost everyone was satisfied.

Empire's EDR.9 (for Extended Dynamic Response) has broken with this tradition, and is the first phono cartridge that not only meets the highest technological

and design specifications—but also our demanding listening tests—on an equal basis. In effect, it bridges the gap between the ideal blueprint and the actual sound.

The EDR.9 utilizes an L. A. C. (Large Area Contact) 0.9 stylus based upon—and named after—E. I. A. Standard RS-238B. This new design, resulting in a smaller radius and larger contact area, has a pressure index of 0.9, an improvement of almost six times the typical elliptical stylus and four times over the newest designs recently introduced by several other cartridge manufacturers. The result is that less pressure is applied to the vulnerable record groove, at the same time extending the bandwidth—including the important overtones and harmonic details.

In addition, Empire's exclusive, patented 3-Element Double Damped stylus assembly acts as an equalizer. This eliminates the high "Q" mechanical resonances typical of other stylus assemblies, producing a flatter response, and lessening wear

and tear on the record groove.

We could go into more technical detail, describing pole rods that are laminated, rather than just one piece, so as to reduce losses in the magnetic structure, resulting in flatter high frequency response with less distortion. Or how the EDR.9 weighs one gram less than previous Empire phono cartridges, making it a perfect match for today's advance, low mass tonearms.

But more important, as the EDR.9 cartridge represents a new approach to cartridge design, we ask that you consider it in a slightly different way as well. Send for our free technical brochure on the EDR.9, and then visit your audio dealer and listen. Don't go by specs alone.

That's because the new Empire EDR.9 is the first phono cartridge that not only meets the highest technological and design specifications—but also our demanding listening tests.  
Empire Scientific Corp.  
Garden City, N.Y. 11530 **EMPIRE**

Enter No. 7 on Reader Service Card

# Audio etc.

Edward Tatnall Canby

I had to omit a few items of audio interest from last month's account of the Canby Singers' bout with big-time television so this month's contribution is going to be articulated: Segment One, more TV.

I must say again that I really got a strange feeling at that TV taping as I came up against genuine, all-out, single-channel professional recording of audio for the first time since around 1960! I'm sure most of our pros who are into recording of sound alone would have had the same reaction. ONE master channel! One-channel miking, one-channel cabling, one-channel everything, even a one-channel mixing board (plenty of inputs but the output was strictly singular). Think of the enormous complex of audio problems this avoids! No phasing, no cancellations, no this, no that....It must have been nice in the old days.

The man in charge of our TV audio, whose name I neglected to grab in all that hurrying and scurrying, though he may have lived in a mono world much longer than the rest of us, was not only amiable and cooperative but able to show a few tricks of his own. I was merely a musician, but he was receptive to my suggestions and had already taken care of one urgent request I had relayed in ahead of time — please, for our small chorus, keep the mikes away, no close-up effect, so we can blend together as the music requires. Vital.

On two disastrous earlier TV occasions in which I had been involved, the mikes were operated exactly like TV cameras — a sort of sonic-zoom close-up technique, magnifying individual voices, arm's length, at the expense of any sort of musical blend. We

were nice to look at, but we sounded just awful. The close-up technique is excellent for the video half of TV, but audio is another medium with utterly different needs. The sync is in time and in content, NOT in technique.

In all of the joint media featuring both sound and picture, we must keep in mind the needs of each of these in its own terms and keep them independent, though tied together. So it

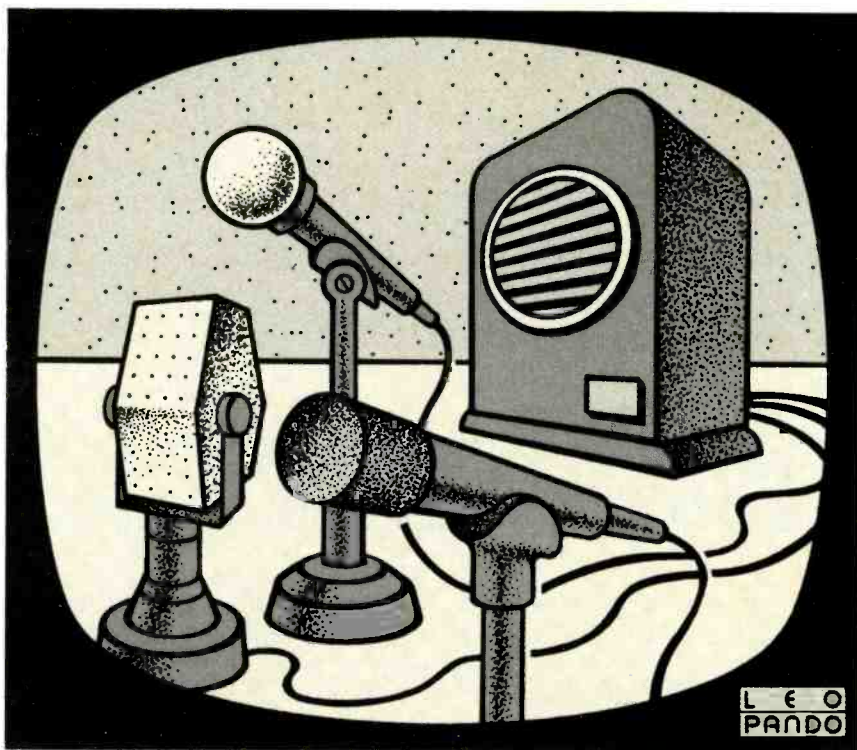

always is in the movies, you will note, where experience goes back a full half century. Just watch and listen and you'll see how cleverly it is done there today. TV is younger. They'll learn.

Anyhow, ours was not going to be a multi-mike job, you can be sure. We had just one, single microphone, but it was duly placed well out, overhead, so that the singers did blend correctly, like the strings in a string orchestra. This choral sound, of course, went on unchanged throughout our "act" while the cameras, a number of them, rightly used the opposite technique, zeroing in on individual faces or close-up groups of singers for maximum visual interest. Good sound pickup. But

how about that very dead studio?

Our first offering, in fact, was a couple of pieces of Spanish cathedral music out of the 16th century, just crying for a vast and stony reverberation. And there we were in a padded box. So I asked my audio friend at the board whether he just might have a delay line or something (on that ancient equipment!) to give us a bit of synthetic church. By golly, he did have just that, no problem. Evidently the old board had been updated after all. We would need it throughout, I said, but maybe even a bit more strongly for that first cathedral music.

I had no chance to monitor the result (the chorus singing minus conductor out in the studio), not with five other musical acts all trying to get things together at the same time on the various sets around the studio's perimeter. So I left things to the audio man's good judgment, and it wasn't until Christmas morning that I heard the results, as finally broadcast. Not bad!, as I noted at the end of my first

installment last month. The man had the sense not to overwhelm us with synthesized glop-reverb; he added just enough to take us out of the anechoic and into a reasonable studio environment, if not exactly a church. Good compromise. And when you consider that this was mono reverb, 1940 style, he really did it OK. No surround sound, no fancy-phase ambience, not even the inestimable ordinary advantage of conventional stereo space.

## Compressed Canby

So I was happy. We had a good mike placement for a fine blend, a reasonable ambience, if synthetic, and we were singing well; everything should

# Morning Concert



You've driven to the end of the world. Alone.  
The engine is still warm.

Amid the roar of the waves and the cries of the gulls, you fire up your mobile high-fidelity system for a morning concert.

What will it be? Bach? Mozart? Perhaps some Keith Jarrett.

Whatever you choose, your system is equal to the task because you've chosen ADS.

The ADS Power Plate 100 Automotive Amplifier and the ADS 300i Automotive Loudspeaker System, deliver the kind of power it takes to be heard above road noise, engine noise, and ocean waves. And it's not just brute power, but power with performance, subtlety and nuance — qualities collectively known as musical accuracy.

Easily the most sophisticated automotive audio components available today, the Power Plate 100 amplifier and 300i speakers are exactly what you'd expect from ADS, the company that literally invented mobile high-fidelity.

To find out more about putting an ADS system in your automobile, write ADS, Department AU16, or call 1-800-824-7888 (California 1-800-852-7777) toll free and ask for Operator 483.

The more time you spend with your automobile, the more you owe it to yourself to listen to ADS.

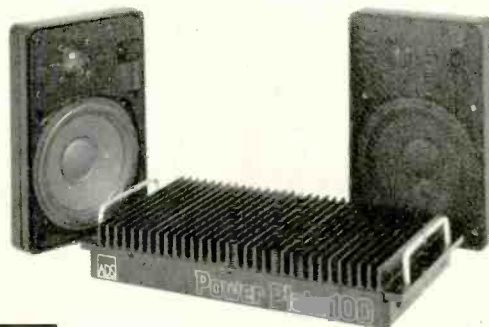

Audio for the critically demanding

Analog & Digital Systems, Inc., One Progress Way, Wilmington, MA 01887 (617) 658-5100

have been splendid in spite of the lo-fi broadcast chain. Except for one element I had entirely overlooked — never even thought of it. Compression. Wow, was there compression.

To be sure, I can't prove it. As I say, my thoughts were quite elsewhere as I listened to our broadcast and began to wonder why it was so disappointing in the sonic effect. We had worked hard, we did well, we should have *communicated*, in sound as well as sight. We did in the pictures. But our singing was lackluster, monotonous. I couldn't believe it.

Then it hit me what was wrong. We came to a work by the 16th-century Englishman Thomas Tallis, a stately hymn in which the last line of music is repeated as a sort of echo, very beautiful. We ALWAYS sing that echo as it should be, much less loud than the first time; indeed, we do it just as softly as we dare and the effect can be magical.

Now, as I listened to the TV broadcast, I heard us singing that second echo phrase *exactly as loudly as the first one*. No echo. Just a mechanical repetition. I was disgusted. After all

that rehearsal, couldn't we do a bit better than THAT? Then I thought, NO! I was there. I conducted. And we definitely did it the right way. Then, you see, I understood what had happened. Or must have happened. Electronic compression. We definitely did sing that echo phrase softly. But the **##\*\*#** compression circuit brought it crudely up so there was no echo effect, just a repeat at the same volume. Magic departed.

No wonder the entire performance seemed on the dull side. Everything we sang, apparently, was compressed to a stringent TV "normal" volume, the same monotonous level from start to finish. When we sang louder, we were implacably pulled down; when we sang softly, we were pulled up. Deadly — for our music. So I figure it out.

No, I am not blaming TV—for this is the sort of treatment that TV sound in fact requires, especially on a show that is normally done "live" (on tape) in real time, and thus is full of unexpected peaks and valleys of sound that could distract from the more important visual aspect. Face it, in this TV medium the audio is always going to be subservient, and has to be. Oddly enough, even when the audio—music like ours—is supposedly the main feature. So I am not criticizing, I am merely telling you. Moral: Don't sing Spanish cathedral music on TV if you want people to listen as well as watch.

Some of our audio techniques, for that matter, can actually enhance the impact, or at least favor the effect, of music that was not originally intended for reproduction (almost all classical material). This we should know. Even compression can be helpful, when used WITH CARE as an aid to the "compression" of some enormous musical work like an opera or a symphony to fit into a small living room where it was never supposed to be heard in the first place. All of which, of course, calls for our very best understanding and judgment in our record/broadcast procedures for such music. Right? So if you still think that most LP records are ruined by too much compression, just listen to the Canby Singers on TV. Maybe next Christmas morning?

#### Four, Three, Two, . . . A

P.S. You might be amused as to how the great pitch-pipe controversy ended. You'll remember that in the original real-time recording we were not going to be allowed to blow our pitch pipe (we sing entirely without accompaniment) in order to get ourselves started in the right key, and yet I knew that we HAD to blow it somehow—we do not all have absolute pitch (and we

**GUARANTEED to improve —and enhance—  
any fine stereo component system!**

# Soundcraftsmen's NEWEST, the ULTIMATE EQUALIZER—

(Complete Equalizer AND complete 0.1dB accurate Real Time Analyzer)



**THE SOUNDCRAFTSMEN AE2420-R "SCAN-ALYZER" is a completely self-contained, superb stereo 10-BAND OCTAVE EQUALIZER and a REAL-TIME FREQUENCY ANALYZER, w/case, Computone Charts. \$499**

The Patent-Pending DIFFERENTIAL COMPARATOR circuitry of the "SCAN-ALYZER" EQUALIZER IS THE KEY TO HIGH PRECISION ACCURATE EQ analysis. The basic simplicity of the DIFFERENTIAL COMPARATOR circuitry makes it possible for even a novice to accurately EQ his room and his system, yet that same circuitry is so highly accurate it can actually be used for 0.1 dB laboratory measurements in EQ analysis. This combination of equalizer and analyzer creates a functional component that should be an integral part of every high quality home stereo system. The "SCAN-ALYZER" EQUALIZER with its accompanying COMPUTONE CHARTS, can be used in a home stereo system for so many important functions we can't begin to list them here. DATA: S/N 100 dB, THD < .01% FREQ. RESP. ± ¼ dB 5 Hz-100 KHZ. SIZE: 5¼" x 19" x 11"

**PRO 750 W. @ 8Ω MONO  
BRIDGED AMP, \$799.00**



750 watts RMS minimum 20-20KHz @ 8 ohms, less than 0.1% THD. T.I.M. better than 0.02% with optional stereo operation 375 watts @ 4 ohms, for professional/commercial high-power requirements. Rugged heavy-duty chassis, CLASS "H" ANALOG logic Vari-Portional circuit with AUTOCROWBAR protection circuits, input level controls, clipping indicators. NON-LIMITED output circuitry assures crisp clean peaks. Balanced or unbalanced inputs, any impedance 2 ohms or more.

**FREE! 16-Page  
Full-Color Brochure**

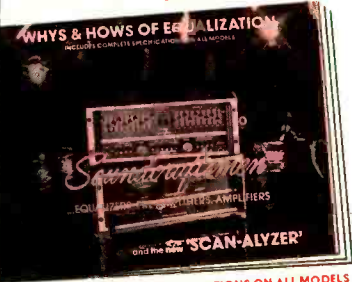

INCLUDES COMPLETE SPECIFICATIONS ON ALL MODELS Also includes TEST REPORTS, AMPLIFIER CLASS "H" ENGINEERING REPORT, EQ COMPARISON CHART, and a 10-POINT "DO-IT-YOURSELF" EQ evaluation checklist.

SEND \$6.00 FOR EQ-EVALUATION KIT:

1-12" LP "FREQUENCY SPECTRUM ANALYZER" TEST RECORD, 3 CHARTS, 1 CABLE, INSTRUCTIONS.

Made in U.S.A. by SOUNDCRAFTSMEN • 2200 South Ritchey • Santa Ana, CA 92705 U.S.A.

Enter No. 22 on Reader Service Card

# Technics

Everyone knows what Technics direct drive does for performance and accuracy in our turntables. That's why 73 of the top 100 radio stations that use turntables use Technics direct-drive turntables. Now, for only \$330\*, you can record your cassettes with the accuracy of Technics direct drive. And that says a lot about the Technics RS-M45.

So does its tape transport system. Especially when you consider what the RS-M45 has going for it: An FG servo DC direct-drive capstan motor. And while 0.035% wow and flutter can tell you a lot about our direct-drive performance, the world's only limited 3-year motor warranty† tells you a lot more.

Equally impressive are the RS-M45's solenoid controls. They not only make switching from one mode to another simple and accurate, they also put minimal strain on the tape transport system.

And to put minimal strain on you, there's the optional RP-9645 remote control unit. With it, all transport functions, as well as record mute, can be operated from your easy chair.

Just as special are the RS-M45's fluorescent VU meters with auto-reset peak-hold. They're fast, electronic and highly accurate. You'll also like Dolby's NR and a S/N ratio of 68 dB.

And if our SX record and playback heads make CrO<sub>2</sub> tape sound great (20 Hz-18 kHz), wait until you hear the increased frequency response (20 Hz-20 kHz) and extended dynamic range of metal.

Technics RS-M45. Direct drive and solenoid controls say it isn't your typical \$330 cassette deck. In fact, compared to the leading brands, it's one of a kind. And that's very typical of Technics.

\* Technics recommended price, but actual price will be set by dealers.

† Limited 3-year warranty on the direct-drive motor and limited 2-year warranty on the deck. Includes labor and parts. Carry-in service. Proof of purchase required. Warranty is void for commercial use. § Dolby is a trademark of Dolby Laboratories.

## How to tape your records as accurately as Technics direct-drive turntables play them.



Enter No. 27 on Reader Service Card

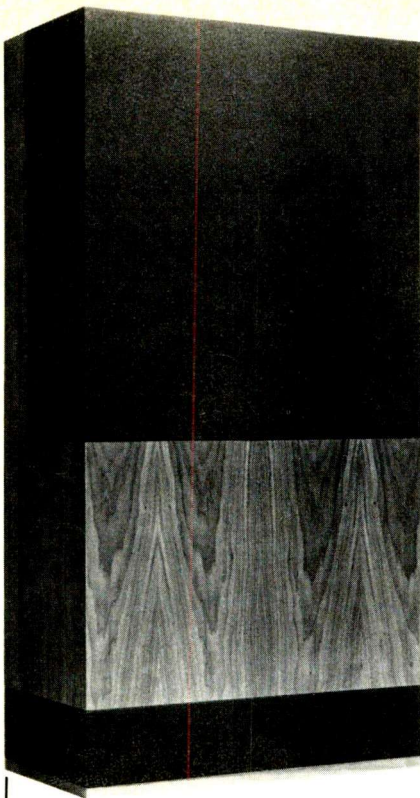

## The Snell Type A

- Flat power response and flat early arrival response
- Freedom from room boundary interference effects
- Near total elimination of diffraction delayed signals
- Correct reconstruction of spatial information through frequency-constant ratio of early arrival and reverberant sounds
- Optional bi-amplification with Snell Acoustics Electronic Crossover
- Extremely wide dynamic range

The Snell Acoustics Type A Loudspeaker is designed for convenient placement near a rear or side wall so as to control room boundary reflections and augment bass performance. Individual tuning of crossovers to drivers in each speaker, together with exhaustive testing including listening comparisons with our reference Type A result in closer quality/performance tolerances than are obtainable through large scale assembly line production.

The theoretical benefits of the 5 year development of the Type A can be examined in more detail by requesting our brochure, or experienced directly by an audition at one of our dealers.

**Snell Acoustics**  
10 Prince Place, Newburyport, MA  
01950 617-462-3194

Distributed in Canada by Esoteric Audio Systems, Milliken, Ontario

# SNELL ACOUSTICS

would disagree, even if we did, depending on whether A is 435 or maybe 445). So I bided my time. There would be a way out—somehow.

When at last (after those four hours of snafu) we shifted from real-time recording to the new game plan, so much more practical (as we in audio know)—the editing-together of separately recorded segments—I was waiting and my pitch pipe blower, one of the basses, right with me. The instant I heard the producer start a sonic count-down for the opening segment of our part of the show, leading to the spoken introduction by the little lady host who stood beside me in front of the chorus, trailing her lavalier cable behind her—I knew I had it. “Four, Three, Two, ...” intoned the producer over the talkback from inside the control room, omitting “One,” and in that second of silence that stood for “One” I hissed in my loudest stage whisper, “Pitch!” and the pipe blew. Nobody flinched, the host began her spiel, and we were ready to sing.

I didn’t even bother to consult with the authorities afterwards; here was one area where audio and TV techniques agreed. On the TV air, as I expected, there was no pitch pipe sound, nor any hiss from me. Edited neatly out. So simple.

### Switching Made Simple

Now for the articulation. Two brief items, too long postponed, each involving a useful piece of equipment and both of them passive, no plug in the wall, no current drain. Is that rare. First, after an unconscionable time, the Russound TMS-2, a small switching box framed in good hardwood that could help you keep sane when you get involved in complicated switchings of numerous inputs and outputs in your home equipment. Too often, this sort of thing involves a bewildering number of levers and buttons too far apart to be easily reached, plus cables pulled out and re-inserted, usually into the wrong holes and by blind feel behind the units. It can be agonizing, as you surely know, especially if you are in a hurry. This switcher, like a number of others in the Russound line for different types of switching, is the home equivalent of those elaborate buses and cabled patchboards that used to be standard in much professional audio. (Now we use the new-type boards, to the tune of a few hundred thou per.)

I was in the throes of trying to reconnect a new version of my equipment via the usual mass of disconnected cables when I saw the Russound publicity and, in desperation, asked for one of these switchers to see if it

might help. Well, my cable spaghetti was too eccentric even for Russound—strictly my fault—and the TMS-2 didn’t happen to fit my then-current requirements; it was temporarily put aside. And so, of course, out of mind. But I am now looking straight at the thing in front of me, and indeed it is an ingenious consolidation of a lot of switching functions, for such a small box.

On the back of the TMS-2 are no less than 30 inputs, phono type, in stereo pairs, R and L, lined up neatly against white marking lines for the eye. On the left are three pairs of “add-on jacks,” *IN-BUSS*, *COPY-BUSS* and *OUT-BUSS*. Next to these, in the middle, are two more pairs, *TAPE MONITOR OUT*, and the same for in. Then, moving on to the right, you will see no less than five pairs of source inputs in a line on top, 1,2,3,4,5, and below them another five pairs of outputs, for the same. Count ‘em, 20 more. You can thus plug in up to five of your components, both in and out or either way, for treatment via the switches on the front.

On the front the switches, 10 three-way and one two-way, are neatly lined up in stagger formation, the positions connected by five white guide lines, the central one a fat line marked *COPY*. The top five switches, *RECORD*, one for each of your components, operate over the three uppermost white lines, from the top position, *IN*, to *OFF*, and then to *COPY* in three steps. Between each of these are the *PLAY* switches, staggered two lines downwards so that they move from *COPY* downwards to *OFF* and, at the bottom, *MONITOR*. To one side is a master two-way monitor switch marked *COPY* and *PLAY*.

Enough! It sounds awful but the eye can easily take in what the printed word can scarcely describe. In 10 minutes, I expect, you could be operating those switches with no trouble at all and in a half second you could do switching that might take a quarter hour on the original equipment, perhaps ending in chaos at that. I assume, though there might be a few bits of signal loss here and there with so much switching, that there is total absence of undesirables like hum — otherwise Russound would hardly have lasted so long in the market. So if you think that this model or maybe one of the others in the line might help you, then contact the outfit. Russound/FMP Inc., P.O. Box 204, Stratham, N.H. 03885. Or maybe your local dealer.

### On The Beam

The other item, on hand since late last year, has the slightly odd title of The Beam Box, which sounds as if it



# More recorders ask for Fuji by name than any other brand.

Recorders are very outspoken in their preference of tapes.

Take video recorders.

They insist on Fuji VHS and Beta videocassettes. Put in anything less and they may give you snow. Washed-out or shifted colors. Or all kinds of distortion.

Unhappy audio recorders without Fuji audiocassettes stubbornly give you less music in return. Plus distortion on loud music. Noise during soft passages. And limited frequency response. Problems our premium FX-I, FX-II and our low-noise FL help you overcome.

Then comes new Fuji Metal Tape. Cassette recorders equipped for metal are all in love with it. Not just because it won't clog heads or jam. But because of its inaudible noise. Greatly expanded dynamic-range. And smooth, ultra-wide response.

So watch and listen.

If you see or hear your recorder talk, you'll know what it's asking for. Fuji. The tape that makes it look and sound its best.

## FUJI TAPE

One brand fits all. Better.

Magnetic Tape Division, Fuji Photo Film U.S.A., Inc.  
350 Fifth Avenue, New York, New York 10001 (212) 736-3335



might be a tweeter twin to the dbx superbass Boom Box. It isn't — it's an indoor FM antenna with interesting abilities, a serious and useful device.

It is an antenna inside a square box no bigger than a good tuner, which can replace a cumbersome outdoor monster and a heavyweight rotator with remarkably good results. This box antenna is not only small but it is also directional — and even more remarkable, it "rotates" its directionality, though there are no moving parts other than the controls. The box just

sits there and you twiddle its knobs. No power requirement either; only the pair of FM antenna connections.

I'm going to be careful not to get in over my dizzy head, since B•I•C includes very little information as to how their gadget works, but I do get the general idea and it is good. Those who are into the math of signal propagation will know that you can tune an antenna electronically as well as by shaving off pieces of wire or rod to the right length; also that you can fold an antenna up and still have it work, in a

smaller space. This one, if I see it rightly, is a double-folded dipole, a pair of them set at right angles and neatly fitted inside the box under a transparent top cover. The tuning and switching is entirely electronic. Nothing moves at all. Yet the antenna's directionality revolves all the way around, in 90-degree jumps, the box staying put. Surprising, if you didn't know it could be done.

We quickly found (myself and a knowledgeable hi-fi neighbor) that The Beam Box has a "ribbon" pattern of sensitivity rather than "cardioid." That is, instead of the primarily frontal directionality of the yagi type of antenna with reflectors, like a cardioid mike (you must move that one bodily around to change direction), The Beam Box has equal front and back sensitivity, in opposite directions, while the sides are very noticeably less sensitive — you can read this right off your signal strength meter, as you "revolve" the antenna through its four electronic positions. This type of directionality, to be sure, is not quite as versatile as the cardioid when it comes to reducing interference from unwanted stations, but you can still do a lot by shifting the antenna through its positions, as we immediately found. It fails only when two stations are exactly in opposite directions from your location. Most won't be.

At my 100-mile range (80 to 120 miles to the stations I most want to hear) The Box did remarkably well, though it could not match my big rooftop yagi, understandably. I got all my favorite distant stations with complete limiting and silence — in mono. As might be expected, stereo was a bit noisy. Even so . . .

I'd recommend The Beam Box for anyone living in the larger fringe, say from 10 to maybe 40 miles out from major FM sources. In this vast area the indoor antenna should be excellent, with both extra sensitivity and adjustable directionality. (In the city a directional antenna isn't much use, with too many steel buildings around, and you really need multipath rejection.)

I should mention an excellent extra reason for Beam Box power — the antenna can be electronically fine-tuned to match the frequency of each station. Just peak up the signal on your signal strength meter. All the others merely average things out. A typical bit of thoroughness, and if this adds one more minor chore, it is surely worth turning one more knob for a better sound. These people really get the most out of their design. And so will you. ▲

# TAKE CONTROL OF YOUR SOUND!

For those wanting to hear better sound for their investment, consider auditioning Spectro Acoustics at your nearest audio dealer.

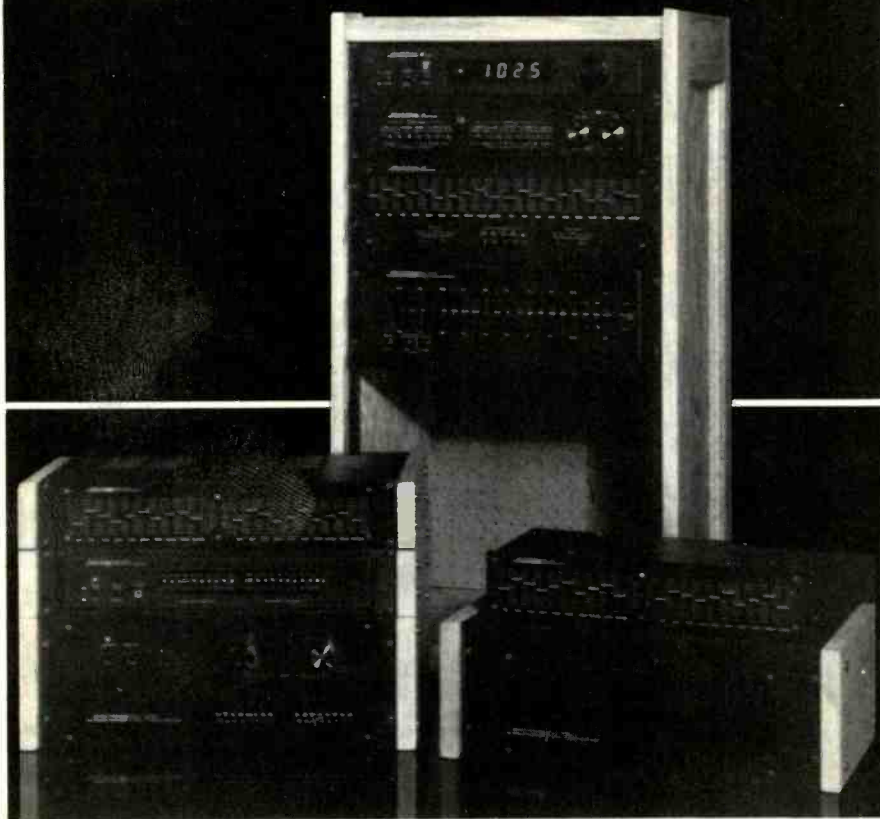

**SPECTRO  
ACOUSTICS**   
Built for enjoyment™

An American Manufacturer of  
High Fidelity Components  
4500 - 150th Avenue N.E.  
Redmond, WA 98052 USA  
(206) 882-1890

# Music sculptor.



Meet the music sculptor. The new EQ400 car stereo graphic equalizer. Sensitive. Perceptive. And remarkably precise. Simply connect it between your stereo source and power amplifier.

Then reshape the response of your music to your own taste. Enhanced mid-bass... a little more sheen to the strings... a bit more bite on the brass. Contour, mold, enhance the music until it's just right for your ears.

## 15 bands: total control.

That's right. A full *fifteen* bands are at your command with this graphic equalizer. To shape your music like no other car equalizer can.

Looking at the EQ400 you'll see five sliding controls with a  $\pm 12$  dB range. Look closer, and for each control lever there's a selector for three different bands. Fifteen in all.

Center frequencies controlled are:

60 Hz	80 Hz	125 Hz
160 Hz	250 Hz	400 Hz
630 Hz	1000 Hz	1600 Hz
2400 Hz	3500 Hz	5000 Hz
7000 Hz	10,000 Hz	14,000 Hz

## Even more precision.

Our desire for precision doesn't stop with the fifteen bands.

The EQ400 offers you more precise tuning *within* each band as well.

The top-mounted sliding scales on the EQ400 are physically almost twice as long as the short, front-mounted controls on most other equalizers. Which means far better resolution. For much more precise adjustments... and much more precise sound.

You can instantly compare any boost or attenuation you

the dash equalizer.

The EQ400 rests unassumingly under the dashboard. That is, until you're ready to use it.

Then... a slight pull slides it out to reveal a full, top-mounted illuminated control panel.

The top-mounted controls are easier to see, easier to reach and easier to use.

When you're finished adjusting, just slide the unit back under the dash. That way the controls aren't exposed where they can be accidentally bumped out of position. And meanwhile, an LED on the front glows to indicate the unit is on.

The same bracket can also be used to mount the equalizer right at your fingertips, between the bucket seats of smaller cars and vans.

## Your own kind of sound.

No longer do you have to settle for someone else's interpretation of your music.

Because now you can shape it and enhance it with music sculptor. The Jensen EQ400 graphic equalizer. Or the EQA3000 5-Band Graphic Equalizer with built-in dual 12-watt power amplifiers. Hear what they can do... soon.

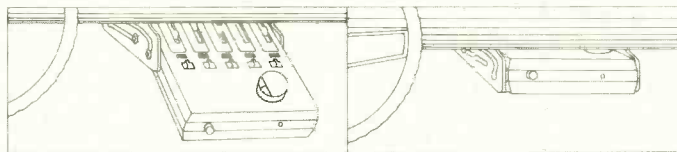

The EQ400 has a special under dash mounting. This enables you to slide it out for easy adjustment. When you're finished, slide it back. The controls then can't be accidentally knocked out of adjustment.

make with the equalization defeat switch. A front-to-rear fader control offers additional flexibility. And with its switchable 10/47 ohm input impedance, the EQ400 can be connected to any low impedance stereo source.

## Slide out, tune in.

This is no ordinary under

**JENSEN**  
SOUND LABORATORIES  
AN ESMARK COMPANY

Enter No. 10 on Reader Service Card

# McIntosh

## "A Technological Masterpiece..."



McIntosh C 32

### "More Than a Preamplifier"

McIntosh has received peerless acclaim from prominent product testing laboratories and outstanding international recognition! You can learn why the "more than a preamplifier" C 32 has been selected for these unique honors.

Send us your name and address and we'll send you the complete product reviews and data on all McIntosh products, copies of the international awards, and a North American FM directory. You will understand why McIntosh product research and development always has the appearance and technological look to the future.

Keep up to date.  
Send now - - -

McIntosh Laboratory Inc.  
Box 96 East Side Station  
Binghamton, NY 13904

Name \_\_\_\_\_

Address \_\_\_\_\_

City \_\_\_\_\_ State \_\_\_\_\_ Zip \_\_\_\_\_

If you are in a hurry for your catalog please send the coupon to McIntosh. For non-rush service send the Reader Service Card to the magazine.

Enter No. 15 on Reader Service Card

Herman Burstein

# Tape guide

## Equalizing Recordings

*Q. I am interested in an equalizer to clean up some muffled and boomy tape recordings. What features should I look for? — Wendy Rickert, Boulder Creek, Calif.*

A. Generally speaking, you should look for at least five bands of equalization in each channel (10 bands are preferable), very low distortion, absence of ringing effects, wide and flat frequency response when filter action is inactivated, high signal-to-noise ratio, and at least 12 dB of boost and cut in each band. The ability to change the filter "Q" or relative width of the filter is also of value, as you may wish to equalize only a narrow portion of the frequency spectrum; this is available in a parametric equalizer.

## High-Level Noise

*Q. After more than a year of consideration, comparison, conversation, reading, and budgeting, I decided that a particular model was far and away the best open-reel tape deck available for the money. I took the plunge. I like the unit. It's everything it's claimed to be — except for the very noticeable noise in the playback amplifier at relatively high levels after recording in the normal manner. My dealer recommended that I tape at a high level using a good-quality tape. After some experimentation I can record just below tape saturation and get away from the noise. But taping at such a high level seems to change the overall response of the machine — highs are attenuated and lows are accentuated. What would you recommend? Live with my present situation? Change internal alignment for correct response? Or what? — Skip Laughlin, Tulsa, Okla.*

A. I suggest that you take your tape deck, together with the tape you plan to use, to a competent technician and have him optimize the machine's performance in terms of adjusting bias, record equalization, audio drive current, and record level indication in accordance with the instructions of the tape deck's manufacturer. Even if it turns out that no changes have to be made in these adjustments, the expense is still apt to be worthwhile for the peace of mind it will give you.

Any tape machine will produce noticeable noise in playback at very loud levels. The S/N ratio of the best tape decks isn't up to that of the best amplifiers, although this differential is steadily diminishing. When you record at a level close to tape saturation for the body of the signal, chances are that you are getting into saturation at the high frequencies. Saturation of the high frequencies, therefore, accounts for your impression of attenuated highs. And attenuated highs, in relative terms, give an impression of emphasized bass.

## Flip-Side Crosstalk

*Q. I have an open-reel tape deck which is truly wonderful in all respects but one. The problem is what I feel to be an unacceptable level of crosstalk from the flip-side program material. Especially prominent are bass and percussion instruments, and the problem is particularly annoying during quiet portions of the side that I am listening to. Is there some defect in the deck? Since the deck is still under warranty, should I have it checked out by an authorized repair shop? — James Engel, Uniondale, N.Y.*

A. Your crosstalk problem is definitely not normal and should not occur to an audible extent in open-reel decks with any pretension to quality.

The problem appears to lie in vertical mispositioning of the record head with respect to the playback head so that tracks recorded on side B (flip side) are partially scanned by the gaps of the playback head. From top to bottom of the tape, which is assumed to be running from left to right, the tracks are numbered 1, 2, 3, 4, with three "islands" separating them. Tracks 1 and 3 are for recording in direction A; tracks 2 and 4 are for direction B (flip side). If the record head, say, is vertically mispositioned, some of the signal intended for tracks 1 and 3 may get on or near tracks 2 and 4. Definitely have your deck checked and corrected by an authorized service shop. 

If you have a problem or question on tape recording, write to Mr. Herman Burstein at AUDIO, 1515 Broadway, New York, N.Y. 10036. All letters are answered. Please enclose a stamped, self-addressed envelope.

DO YOUR TAPE  
PARTICLES  
EVER TAKE  
A HIKE?  
DO YOU PLAY?

If lately your favorite recordings sound like they're gradually unrecording, it could be the tape they're on.

You see the oxide particles on some tapes just aren't bound on very well. And when the oxide particles come off, your music could come off sounding faded and weak.

Maxell, however, has developed a unique binding process that helps stop those oxide particles from taking a hike. We also polish our tape to a mirror finish to reduce friction, the major cause of oxide shedding.

So with Maxell, even if you play a tape over and over, the music won't disappear before your very ears.



**IT'S WORTH IT.**

Maxell Corporation of America, 60 Oxford Drive, Muenchich, N.J. 07074

Enter No. 14 on Reader Service Card

# Behind the scenes

Bert Whyte

What do the Westbury Theater in Huntsville, Alabama, the Plaza Theater in Owensboro, Kentucky, the Radio City Music Hall in New York, the Europa Theatre in Duesseldorf, the Yurakuza Theater in Tokyo, and the Empire Theatre in London all have in common? Their marquees are emblazoned with the legend "Dolby Stereo," proudly proclaiming their ability to show films with this new kind of motion picture sound. In more than 1,800 theaters in the United States and around the world, theater owners have learned that being equipped to show films with Dolby stereo sound is a definite "plus" in attracting movie fans.

Part of this attraction is undoubtedly due to the movie patrons' familiarity with the Dolby name, as exemplified in the cassette recorders incorporating Dolby B noise reduction they use in their homes and in the Dolby B prerecorded cassettes they play back on these machines. With more than 100 licensing agreements with companies throughout the world, who manufacture more than 650 different Dolby B-Type products, ubiquitous is the word for Dolby. Indeed, the name Dolby in its various audio processing and equipment embodiments has nearly become a generic part of the language. It is also interesting to note that this not inconsiderable Dolby "industry," that now encompasses many aspects of the audio, motion picture and television business, all began with a young engineer's basic dislike of the tape hiss produced by magnetic tape recorders. That young engineer, of course, was Dr. Ray Dolby, who at that time was living in London. Dr. Dolby's development of his A301 Noise Reduction System has been well document-

ed in the audio press, and I am sure most readers are familiar with its genesis.

As I write this, I have just returned from a week-long visit to London, where I had the pleasure of a chat with Arthur Haddy, the brilliant engineer who guided the technical destinies of Decca Records for 52 years. As a friend of 25 years standing, I was saddened by the circumstances that resulted in the recent sale of Decca to

Georg Solti conducting the Chicago Symphony Orchestra.

End of one era, and the beginning of another? In a symbolic sense, yes. If digital recording becomes the universal standard for master recording, then ultimately it would make obsolete all forms of tape noise reduction . . . Dolby, dbx, Telcom or whatever. However, even if we assume the audio consumer finally has access to true digital playback systems, it will take years before an adequate library of digital recordings of the "basic" classical repertoire is available. Meanwhile, the average music lover will continue to use analog stereo discs and Dolby B prerecorded cassettes. In the case of this new digital recording of Mahler's *2nd Symphony*, it will be used to produce an analog stereo disc recording and ultimately a digital disc — but it will also be used to produce a prerecorded cassette with Dolby B noise reduction.

While Ray Dolby is keeping a close eye on digital developments and is quite aware of their implications, he uses this information to expand his business in logical directions. Hence, his deep involvement in Dolby processing and equipment manufacturing for motion picture sound and his latest development for consumer audio, the Dolby "HX" headroom extension system.

While Ray Dolby is keeping a close eye on digital developments and is quite aware of their implications, he uses this information to expand his business in logical directions. Hence, his deep involvement in Dolby processing and equipment manufacturing for motion picture sound and his latest development for consumer audio, the Dolby "HX" headroom extension system.

## Dolby Headquarters

I have known Ray Dolby since 1968—before the B-Type noise reduction system came into being. Even back then, I had been involved in tape recording for nearly 20 years and had also developed an abiding hatred of tape hiss. When I heard about the Dolby A noise-reduction system, and



Polygram, the death of Decca's founder, Sir Edward Lewis, and the subsequent retirement of Arthur Haddy. It was Haddy, the "father" of Decca *ffrr* recording, who recognized the value of Ray Dolby's A301 Noise Reduction System and after extensive tests ordered nine of the systems in November, 1965. In November of 1966, Decca issued the first recording made with the Dolby A system, Mahler's *2nd Symphony* conducted by Georg Solti. Now, 14 years later, as Arthur and I were chatting, he told me that the Decca recording team (Jim Lock et al., kept intact by Polygram) were in Chicago making a digital recording of . . . Mahler's *2nd Symphony* with Sir

Illustration: Leo Pando

# KEF Reference Model 105 Series II: Unique Protection, Extraordinary Performance

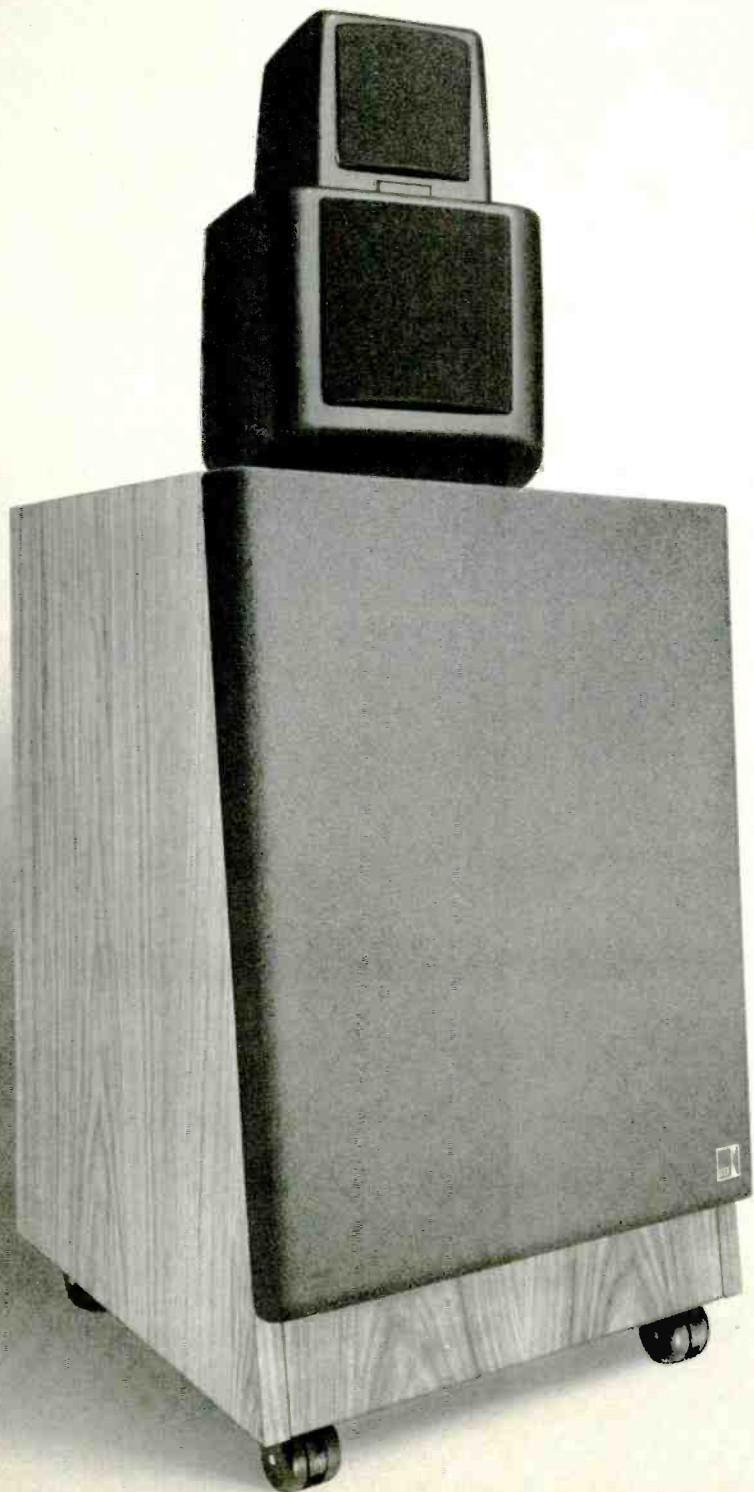

The KEF Model 105 is now acclaimed as one of the most respected and reliable speaker systems. Since its introduction in 1977, the Model 105 has been adopted by audio testing laboratories and speaker manufacturers as a reference for evaluating other loudspeakers and audio products.

KEF now introduces the Model 105 Series II, embodying several significant technical features and improvements never before available.

## Acknowledged Technical Capability

KEF was the first company to develop computer-aided digital analysis for loudspeaker research and evaluation.

The impulse measuring method which the company pioneered in the early 1970's is far more accurate and comprehensive than conventional analog techniques, and has been widely adopted throughout the audio industry.

The benefits of digital techniques are not confined just to research & design alone. KEF's leadership position in this field has enabled the company to employ similar methods to production processes, revolutionizing the standards of quality and consistency that can be achieved in production quantities.

Every vital characteristic is monitored by computer during the entire manufacturing and assembly process. Drive units and filter networks are measured individually. Performance data is recorded digitally and used to group carefully matched sets of components prior to assembly.

Completed speakers also undergo rigorous measurement. Paired Model 105's differ in frequency response by less than 0.5dB, and vary from the original prototype by only 1dB over the entire frequency range.

Thus, for the very first time, it can be claimed that the standard of performance achieved in the original prototype is assured for each and every purchaser.

## Electronic Protection Circuit

The Model 105 Series II is fully protected against accidental overload by a self-powered electronic device called S-STOP (Steady State and Transient Overload Protection). This KEF development provides comprehensive protection against excessive voltage, thermal overload, and low frequency excursion:

**PEAK:** The peak protection mode causes the S-STOP circuit to operate whenever peak voltages to the system are so high as to be damaging to the dividing network, or likely to cause unacceptable distortion levels on program peaks.

**THERMAL:** The input level to each drive unit voice coil is continuously monitored, and whenever a safe operating temperature is exceeded, S-STOP is activated.

**LOW FREQUENCY EXCURSION:** The excursion of the low frequency unit is also monitored, and S-STOP is again activated whenever the input level on program peaks is sufficient to cause the maximum linear excursion of the bass unit to be exceeded.

The original Model 105 has become an industry reference point. KEF's continuous research & development has now produced the Model 105 Series II—a home speaker system that promises to be even more remarkable.

We would recommend that you visit your authorized KEF dealer for a thorough demonstration of the Model 105 Series II. The speaker system is available with an optional



full grille (not shown) and in various wood finishes. For the name of the dealer nearest you, write: KEF Electronics, Ltd., c/o Intratec, P.O. Box 17414, Dulles International Airport, Washington, D.C. 20041. Available in Canada.

© 1980 KEF Electronics, Ltd.

Enter No. 11 on Reader Service Card

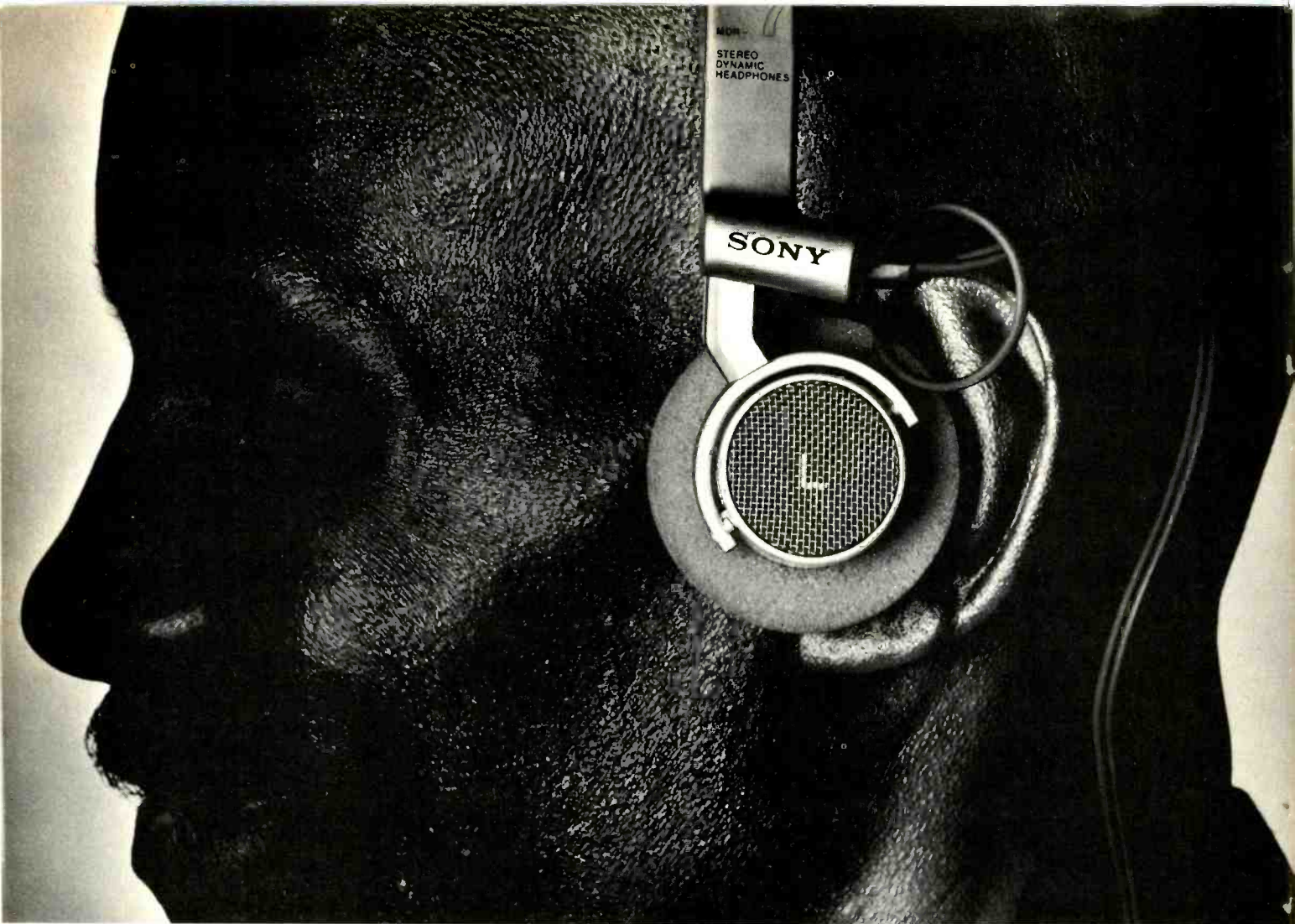

## **KOSS THINKS THIS KIND OF SOUND WEIGHS 385 GRAMS MORE THAN SONY DOES.**

The MDR-7 Sonyphones deliver the same extra-wide frequency response as the Koss Pro/4 headphones.

The MDR-7 Sonyphones deliver all the smoothness, crispness, depth and tonal color Koss built a business on.

But unlike Sony, it takes our competition 440 grams of metal and molded plastic to do it. That's almost a pound.

On the other hand, MDR-7 Sonyphones weigh 1.9 oz.

And the MDR-5a, MDR-3 and MDR-2 Sonyphones are even lighter.

In short, with Sonyphones, a new generation of headphones is born. Sonyphones mean the end of sacrificing great sound to comfort. Or great comfort to sound.

Because never before has so little weight delivered so much sound.  
Sonyphones by Sony.

**SONY**  
Professional Audio

©1980 Sony Industries, a Division of Sony Corporation of America, 9 West 57th Street, New York, N.Y. 10019. Sony is a registered trademark of the Sony Corporation.

Enter No. 21 on Reader Service Card



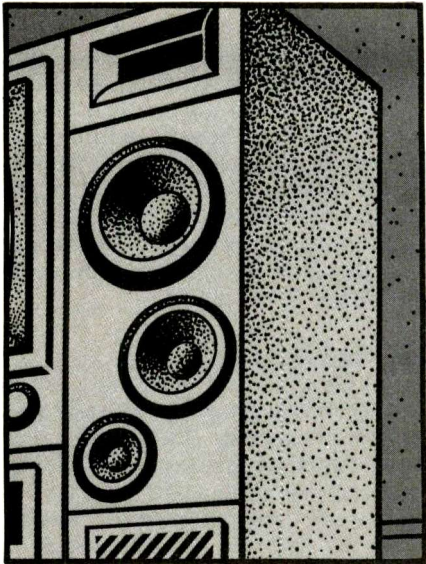

subsequently found how effectively it dealt with the pernicious malady of tape hiss, I became an immediate and enthusiastic booster of the system. Since then, I have visited Ray and his charming wife Dagmar at their London headquarters on a number of occasions and have had the pleasure of having them as guests in my home on Long Island. In January of 1976, the Dolbys took up residence in San Francisco and opened a new headquarters office in that city. The San Francisco operation encompasses administration, research and development, new market development, international licensing, and United States sales. The London factory and offices continue to manufacture all Dolby professional equipment and handle international sales of same. Some months ago, Ray Dolby invited me to the new San Francisco headquarters, and I can tell you it was a rewarding experience.

In the Dolby building in downtown San Francisco, the two points of interest for me were the research and development lab, presided over by David Robinson, VP for Engineering and long-time associate of Ray Dolby, and a most elaborately equipped "mini-theater" projection room. As you might expect, the R&D lab is replete with the cool green color of precision Bruel and Kjaer oscillators and graphic recorders, spectrum analyzers, etc. as well as the precision 'scopes and lab exotica from other manufacturers. These days, David Robinson is kept busy with new developments in noise reduction for motion picture sound, as exemplified by the new CP200 Cinema Processor, an elaborate unit capable of reproduction of any of the Dolby encoded mono or stereo, optical or magnetic sound tracks. Of late, there has been new emphasis on Dolby noise-reduction equipment for video-tape

recorders. For example, the Dolby NRU-10 is an outboard A-Type two-channel audio noise-reduction system for professional video-tape recorders, providing 10 dB of noise reduction from 20 Hz upwards, and rising to 15 dB at 9 kHz and above. Then there is the Dolby Catalog No. 155, a two-channel audio noise-reduction unit with specifications similar to the NRU-10; the 155 is specifically designed to be incorporated in the Sony BVH-1000 video-tape recorder.

As you are probably aware, for some time now Japan has been broadcasting TV programs with stereo sound, and in fact there are TV sets on the Japanese market incorporating stereo audio systems. You may also know that a proposal to provide stereo audio for TV broadcasts in this country is now before the FCC. The general opinion is that action favorable to this proposal will be forthcoming within two years.

#### Noise Reduction in VCRs

Obviously, with TV stereo audio already being broadcast in Japan, those consumers who want to make home video recordings with the stereo sound will need new models of the video-cassette recorders incorporating stereo audio facilities. Furthermore, it is expected that many will want to play back these stereo recordings over their higher quality stereo component systems, rather than through the speakers in their TV sets. Since the VCR machines have narrow-track audio channels and operate at even slower speeds than an audio cassette, in order to avoid unacceptably noisy sound with higher levels of distortion, the new VHS two-channel video recorders will be equipped with Dolby B-Type noise reduction. Thus far, such VHS VCR manufacturers as JVC, Matsushita, Hitachi, Akai, Sharp, and Mitsubishi have agreed to incorporate Dolby noise reduction in their new stereo VCRs.

If I were a Texas oil baron, one of the things I would want in my home is a projection room just like the one at Dolby Laboratories in San Francisco. Here is a purpose-built room approximately 25 feet wide by 35 feet deep with 9-foot ceilings. It is acoustically treated for maximum intelligibility of dialogue and high-quality music sound. There is a wide-aspect-ratio projection screen, and in the projection booth are two modern, professional 35-mm projectors equipped for the showing of Dolby mono and stereo optical prints and a 70-mm projector with magnetic head for six-channel "surround" stereo playback of films like "Apocalypse Now." Needless to say, the room is equipped with a generous number of very comfortable

# FREE

84 PAGE CATALOG

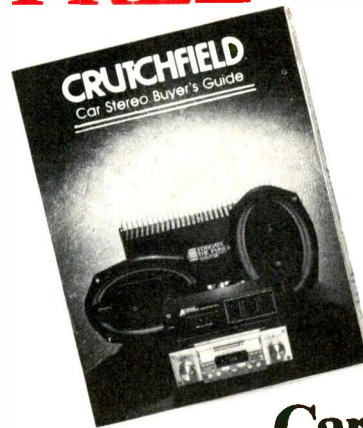

## Car Stereo Buyer's Guide

### Get Yours Now!

- ★ photos, comments, your best possible prices on over 200 all-new car stereo products!
- ★ dimensions charts, fitting charts, "how-to-install easily" articles!
- ★ THE ONLY published source of true performance tests and specification comparisons!
- ★ all finest brands, including Blaupunkt, Clarion, Craig, Concord, Fosgate, Jensen, Linear Power, Marantz, Pioneer, Sanyo... many more!

Send NOW for YOUR **FREE** Catalog...

We'll rush it to you by first class mail, or if you can't wait, call our WATS line (free call):

## 800-446-1506

In Virginia Call 800-552-3961

Summer System Special From

**PIONEER**

The KE-5000 in-dash AM/FM cassette car stereo featuring electronic tuning and high fidelity specifications with TS-202 8" two-way speakers with 20 ounce magnets.



**Yes!** Send me my FREE copy of the famous CRUTCHFIELD Car Stereo Buyer's Guide!

Name \_\_\_\_\_

Address \_\_\_\_\_

City \_\_\_\_\_

State \_\_\_\_\_ Zip \_\_\_\_\_

# CRUTCHFIELD

1 Crutchfield Park, P.O. Caller 1, Department A  
Charlottesville, Virginia 22906

Enter No. 6 on Reader Service Card



THE AUDIO PRO TA-150  
AM/FM RECEIVER

## The finest audio component must do more than merely sound good.

*For an audio component to be the absolute finest, it must satisfy all design parameters.*

*Audiophiles tell us the ideal component is a straight wire with gain. The TA-150's all-electronic design comes closest, which helps explain why its sound rivals the finest separates.*

*Scientists tell us the perfect machine would have no moving parts. The TA-150 has but one, a single programmable knob.*

*Designers tell us that form must follow function. The beauty of the TA-150 is that the world's most sophisticated receiver is also the easiest to operate.*

*Sound, science, and style. The total design approach to audio.*



For more information and  
your nearest dealer  
CALL TOLL FREE 800-638-0228.  
Maryland: 0-459-3292 COLLECT.  
Metro D.C. 459-3292



seats. Ray Dolby treated me to one of the most stunning audio-visual experiences I have ever had. A demonstration film of excerpts from a number of productions was shown, and while the first two clips were interesting, the third clip from the picture "Days of Heaven" was simply mind-blowing. Now the speaker layout in this projection room has five speakers up-front behind the wide screen and a number of small, high-Q speakers mounted above the heads of the audience and disposed in a "string" starting about halfway back on each side of the room and continuing around to the back of the room. There may be as many as 14 small speakers mounted on each side and rear in this configuration. In this setup tracks 1, 3 and 5 are respectively left, center, and right screen. Speakers 2 and 4 carry bass-enhancement information below 100 Hz, which is combined with non-directional bass from track 6 and subsequently can be fed to subwoofers for ultra-low frequency effects. Mid- and high-frequency stereo surround information, which has been phase matrixed into tracks 2 and 4, is fed to the left and right, side and rear "strings" of speakers respectively.

The key scene in "Days of Heaven" shows some farmers surveying a sea of lush, golden wheat somewhere in the Midwest about the turn of the century, when to their horror, the wheat fields are attacked by a plague of locusts. While the farmers are frantically beating at the voracious insects, an old-fashioned steam tractor comes on the scene, somehow catches on fire, and the driver jumps for his life. The tractor, now an out-of-control juggernaut, careens through the wheat fields, which sets the wheat ablaze. Well . . . between the speakers up-front and all the surround speakers, the whir and buzz of countless billions of locusts is chillingly real. Then, add to this the cries of the farmers, the clanking and snorting sounds of the steam tractor,

and the crackle and pervasive low-frequency roar of the fire. The brilliance and clarity of the projection, the purity of the color, and the startling realism of all the sonic elements combine into an emotional experience of tremendous impact. If all motion pictures could be presented to the public with such outstandingly good audio and visual quality, the movie houses would be packed to the rafters!

### HX-ing Bias and EQ

On the consumer audio front, Dolby is concentrating on the HX headroom extension system. This system has been described in these pages before, but evidently quite a few people have the wrong impression about what it does. For example, some people think it is a new type of Dolby noise-reduction system. Rather, it is a rather clever adjunct to existing B-Type Dolby noise reduction, which through use of the control signal in the B-Type circuitry allows varying record bias and record equalization on a dynamic basis. This permits dramatically increased headroom in recording the very short wavelengths of high-level, high-frequency signals, and thus avoids tape saturation. The increase in high-frequency headroom can be as much as 10 dB above 10 kHz. With an increasing number of audiophiles recording their direct-cut and hybrid digital/analog discs to cassettes, the increased high-level, high-frequency energy on these discs has been causing severe problems with tape saturation. Many rock and pop albums, which make liberal use of electronic synthesizers, are nightmares to record cleanly because, unlike conventional musical instruments which have relatively low levels of high-frequency overtones, a synthesizer can easily produce a 15-kHz signal at very high level. . . . One of the most intriguing aspects of the Dolby HX system is that cassettes recorded with it can be played back on any cassette deck equipped with Dolby B noise reduction. In other words, there is no special HX playback circuitry involved. This naturally gives rise to the thought that one of these days we may have ultra-high-quality prerecorded cassettes using chromium dioxide or even metal-particle tape, which have been recorded with Dolby B-Type noise reduction and the HX headroom extension system. On the better cassette decks, this should enable music to be reproduced with a dynamic range of better than 70 dB! I'm sure even Ray Dolby didn't envision this kind of performance from a tiny cassette operating at 1 7/8 ips when he invented his noise-reduction system. **A**

# Why we created our own total system.

We simply had to. Because no chain is stronger than its weakest link. And no music system is better than the distortion or noise coming from any of its components.

We wanted to make sure that when you choose one Revox you get all that it has to offer.

The total Revox system delivers virtually distortion-free music from every source and in any mode—music reproduction so true that it is unmatched by any other system available today.

All the components in the Revox system are designed to meet the professional quality standards that have been set by the Revox B77 open reel recorder with its ingenious logic control system. The B750 integrated amplifier, for example, is renowned for its fast transient response to all musical signals and for its low TIM. It is paired with the incredible B760 digital synthesizer FM tuner with the unusual capability of programming 15 stations which you can recall at the push of a button. The B790 direct drive, quartz controlled turntable reduces tracking distortion to an absolute minimum using a revolutionary new system called Linatrack.

For an unmatched musical experience, listen to our matched components at your franchised Revox dealer. Or write to us for details.



Revox  
Audio-Rack

## STUDER REVOX

Studer Revox America, Inc.  
1425 Elm Hill Pike, Nashville, TN 37210, (615) 254-5651  
Offices: Los Angeles (213) 780-4234 / New York (212) 255-4462  
In Canada: Studer Revox Canada, Ltd.

# Dear editor

## Lirpa MADness

I went to school (impressed?) and studied under Prof. I. Lirpa (even more impressed?). I'm glad to see he's getting the recognition he deserves. (Actually if he got the recognition he deserved, he'd be in jail.)

Anyway, I subscribe to and read Audio — and at times you guys are bananas. Maybe you'd like to review a record that lasts a half hour (some think it lasts for three days) and sells for only two bucks, with a free magazine attached

I'm talking about the MAD disco record for which I served as lyricist and creator.

It's a floppy disc, "floppy" referring to the disc, not the sales of the disc. Believe it or not we made it from a 24-track master, which meant using 24 paper cups and strings — quite an accomplishment not to get them all tangled up, which would put a knot in the fidelity!

Look for the MAD disco special issue on the newsstand.

Dick DeBartolo  
MAD Magazine  
New York, N.Y.

## Lirpa Tape Deck

Dear Editor:

In response to your review in the April, 1980 Equipment Profiles section, I suggest you check with Lirpa Labs and get more information on the Lirpa NUT-5 tape deck.

This unit utilizes a spring-mounted flywheel motor with special balsa-wood heads and accepts Lirpa Labs' new SADEX Cr<sub>2</sub>O<sub>3</sub> paper tape with micro sand particles. I believe Lirpa Labs has also developed a splicing medium of 100 percent pure pulp resin — Sap-Splice.

Jeffrey LeBrun  
Somers Point, N.J.

## Resolving the TIM/SID Controversy

Dear Editor:

In recent years one of the more controversial audio topics has been the subject of Transient Intermodulation Distortion (TIM) or Slewing Induced Distortion (SID) and their bearing on audio. While controversy surrounding

an issue has a positive result in openly airing differing views held, it has a more negative one in that it can potentially impede progress towards other equally serious problems. The undersigned authors, all having been principals to this issue, would like at this time to extend the following joint resolution towards ending controversy in this subject area.

The recent two-part article by Robert R. Cordell in *Audio* [12] can be interpreted to imply that there exists disagreement among these authors on this issue. We feel it is fitting that the public understand that there is in fact no controversy among us. We agree upon the distortion mechanism which gives rise to TIM and/or SID, as may be evidenced by our papers, with appropriate allowances for semantic differences, and different boundary conditions.

While we do not necessarily agree completely with the "view" of TIM as presented by Mr. Cordell, or some manners of his presentation, we have no strong desire to prolong arguments on this issue which might result only in further public confusion and controversy. We would refer those interested in technical details to some papers on amplifier designs [2, 9, 13, 19, 21, 22, 23], program rate-of-change characteristics [14, 15, 16, 20, 26, 27], measurements [10, 18, 19], and listening tests [24, 25, 26, 27].

We sincerely hope that debates upon these issues may be finally laid to rest, and look forward to working further in unison, as we examine in detail the many other technical problems facing high-quality audio reproduction.

John Curl  
Audio Consultant  
Berkeley, Calif.

Walter G. Jung  
Consulting Author

W. Marshall Leach, Jr.  
Associate Prof.  
Georgia Inst. of Technology  
Atlanta, Ga.

Matti Ojala  
Professor  
Tech. Research Centre of Finland  
Oulu, Finland

## References

- 1 through 11, contained in [12].
12. Cordell, R.R., "Another View of TIM," *Audio*, Part I, Feb., 1980, pp. 38-49; Part II, March, 1980, pp. 39-42.
13. Leach, W.M., "Suppression of SR and Transient IM Distortion in Audio Power Amplifiers," *Jour. of the Audio Engineering Soc.*, Vol. 25, No. 7/8, July/August, 1977.
14. Lammasniemi, J. and K. Nieminen, "Distribution of the Phonograph Signal Rate of Change," presented at the 62nd AES Convention, Brussels, March, 1979 (to be published in *JAES*).
15. Pass, N., "The Pass/A40 Power Amplifier," *Audio Amateur*, Issue 4, 1978, p. 12.
16. Groh, A.R., "Address to Nov. 1976 Boston Audio Society," *BAS Speaker*, Dec., 1976, pp. 17-21.
17. Cordell, R.R., "Comments on 'A Method for Measuring Transient Intermodulation Distortion (TIM),'", *Jour. of the Audio Engineering Soc.*, April, 1979, pp. 295-296.
18. Ojala, M., E. Leinonen, and J. Curl, "Reply to Comments on A Method for Measuring TIM," *Jour. of the Audio Engineering Soc.*, April, 1979, pp. 296-297.
19. Jung, W.G., M.L. Stephens, and C.C. Todd, "An Overview of SID and TIM," *Audio*, Part I, June, 1979, pp. 59-70; Part II, July, 1979, pp. 38-47; Part III, August, 1979, pp. 42-59.
20. Curl, J., "Omitted Factors in Audio Design," 1978 IEEE Conference on Acoustics, Speech and Signal Processing, April, 1978; published in *Audio*, September, 1979, pp. 20-24.
21. Leach, W.M., Jr., "Build a Double-Barreled Amplifier," *Audio*, Part I, April, 1980, pp. 36-51; Part II, May, 1980, pp. 44-60.
22. Ojala, M., "Circuit Design Modifications for Minimizing TIM in Audio Amplifiers," *Jour. of the Audio Engineering Soc.*, Vol. 20, No. 5, June, 1972, pp. 396-399.
23. Lohstroh, J. and M. Ojala, "An Audio Power Amplifier for Ultimate Quality Requirements," *IEEE Transactions on Audio and Electroacoustics*, Vol. AU-21, No. 6, Dec., 1973, pp. 545-551.
24. Jung, W.G., "Slewing Induced Distortion in Audio Amplifiers, Part IV, Listening Tests," *The Audio Amateur*, Issue 4, 1977, pp. 22-28.
25. Lewitt, H., C.A. McGonegal, and L.I. Cherry, "Perception of Slope-Overload Distortion in Delta Modulated Speech Signals," *IEEE Transactions on Audio and Electroacoustics*, Vol. AU-18, Sept., 1970, pp. 240-247.
26. Petri-Larmi, M., M. Ojala, E. Leinonen, and J. Lammasniemi, "Audibility of TIM," *IEEE Transactions on Acoustics, Speech and Signal Processing*, Vol. 28, No. 1, Feb., 1980, pp. 91-96.
27. Petri-Larmi, M., M. Ojala, and J. Lammasniemi, "Psycho-Acoustic Detection Threshold of TIM," *Jour. of the Audio Engineering Soc.*, Vol. 28, No. 3, March, 1980, pp. 98-105.

don't be  
penny-wise  
and  
sound  
foolish

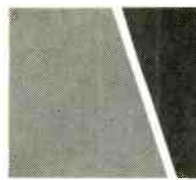

## fact: a Shure stylus is a sound investment

A new stylus (needle) can actually save you money. Even a precision crafted diamond stylus eventually wears out, and a worn or broken stylus tip can damage your records in a single play! Protect your records by checking your stylus at least once a year. Your Shure dealer can inspect it, and if necessary, replace your stylus with a Genuine Shure replacement stylus that will bring your cartridge right back to its original specifications.

protect your  
valuable  
record  
collection!

...and improve  
your listening  
pleasure

with a  
**GENUINE**  
**SHURE**  
Replacement Stylus

**FREE! Shure  
Music-Lovers Stylus Guide**

Cartridges don't wear out: styli do! This and many other helpful facts are discussed in a new pamphlet recently prepared by Shure. It includes everything you need to know to keep your Shure cartridge in perfect operating order. It even contains details on how you can improve the performance of some Shure cartridges beyond their original specifications. To get your copy, stop in at your Shure dealer, or write to Shure at the address listed below and ask for AL633.

**GENUINE**  
**SHURE**

Shure Brothers Inc., 222 Hartrey Ave., Evanston, IL 60204

In Canada: A. C. Simmonds & Sons Limited Outside the U.S. or Canada, write to Shure Brothers Inc., Attn: Dept. J6 for information on your local Shure distributor.

Manufacturers of high fidelity components, microphones, sound systems and related circuitry.

Enter No. 18 on Reader Service Card

# 6th ANNUAL CAR STEREO DIRECTORY

Our 6th Annual Car Stereo Directory reflects the attempt on the part of most firms in this industry to reach consensus on a set of measurement standards. However, there still are some discrepancies in certain specifications, largely in the amplifier power and tuner sensitivity areas because of the lack of a common basis for testing. We have made every effort to accurately transfer the manufacturer-supplied data to the

page, with the thought that some data is better than no data. We do urge the reader to contact companies and local dealers directly, since a listing of specs of radios/tape players, loudspeakers, and equalizers and amplifiers cannot do full justice to the increasingly advanced and sophisticated components becoming available for mobile installations. For a look at several of these, see "Great Cars! Great Sound!" on page 52.

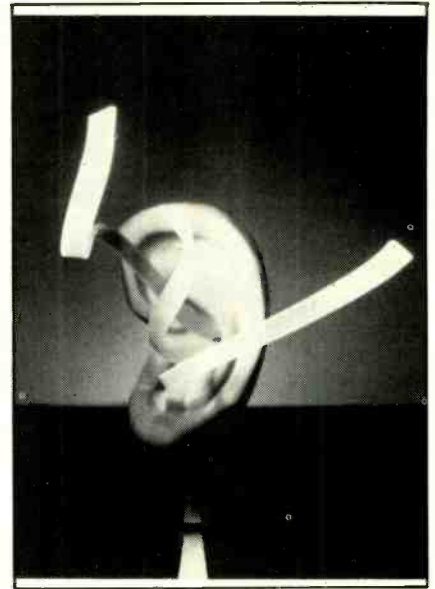

**AAL**  
629 West Cermak Rd.  
Chicago, Ill. 60616

**Adcom**  
9 Jules Lane  
New Brunswick, N.J.  
08901

**ADS**  
One Progress Way  
Wilmington, Mass. 01887

**Advent Corp.**  
195 Albany St.  
Cambridge, Mass. 02139

**Afs Kriket**  
Acoustic Fiber Sound  
Systems  
P.O. Box 50829  
Indianapolis, Ind. 46250

**Afco Electronics**  
471 Roland Way  
Oakland, Cal. 94621

**Aiwa**  
35 Oxford Drive  
Moonachie, N.J. 07074

**Alpine**  
3102 Kashiwa St.  
Torrance, Cal. 90505

**Altec Lansing**  
1515 South Manchester  
Anaheim, Cal. 92803

**AudioMobile**  
3221 West MacArthur  
Santa Ana, Cal. 92704

**Audiotex**  
See: GC Electronics

**Audiovox**  
150 Marcus Blvd.  
Hempstead, N.Y. 11787

**AutoMate**  
See: Elite Marketing

**Avid Corp.**  
10 Tripps Lane  
East Providence, R.I.  
02914

**Bon Sonic**  
See: Hanabashiya

**Bose Corp.**  
100 The Mountain Rd.  
Framingham, Mass.  
01701

**Braun**  
See: Adcom

**Canton**  
See: Adcom

**Car Tapes Inc.**  
1000 East Del Amo Blvd.  
Carson, Cal. 90746

**Cerwin-Vega**  
12250 Montague St.  
Arleta, Cal. 91331

**Clarion Corp.**  
5500 Rosecrans Ave.  
Lawndale, Cal. 90260

**Cobra**  
See: Dynascan Corp.

**Craig Corp.**  
921 West Artesia Blvd.  
P.O. Box 5664  
Compton, Cal. 90220

**Custom Craft**  
819 South Kraemer Blvd.  
Placentia, Cal. 92670

**Dahlquist**  
601 Old Willett's Path  
Hauppauge, N.Y. 11787

**Dimension**  
See: Custom Craft

**Dynascan Corp.**  
6460 West Cortland  
Chicago, Ill. 60635

**Elite Marketing**  
P.O. Box 3602  
Hollywood, Cal. 90028

**EPI**

**Epicure Products**  
1 Charles St.  
Newburyport, Mass.  
01950

**ERA**  
Electronic Research  
Associates  
Poly-Planar Div.  
311 East Park St.  
Moonachie, N.J. 07074

**Fujitsu Ten**  
1135 East Janis St.  
Carson, Cal. 90746

**Fultron**  
Arthur Fulmer Com.  
260 Monroe Ave.  
Memphis, Tenn 38103

**GC Electronics**  
400 South Wyman St.  
Rockford, Ill. 61101

**General Sound**  
2434 South 24th St.  
Phoenix, Ariz. 85034

**Grundig**

**GR Electronics**  
635 Madison Ave.  
New York, N.Y. 10022

**Hanabashiya Ltd.**  
39 West 28th St.  
New York, N.Y. 10001

**Hi Comp**  
See: Audiovox

**Infinity Systems**  
7930 Deering Ave.  
Canoga Park, Cal. 91304

**Intervox**  
Int'l. Components Corp.  
105 Maxess Rd.  
Melville, N.Y. 11746

**JBL**  
8500 Balboa Blvd.  
Northridge, Cal. 91329

**Jensen**  
4136 North United Pkwy.  
Schiller Park, Ill. 60176

**Jet Sound Labs**  
See: Car Tapes Inc.

**Kenwood**  
1315 E. Watsoncenter Rd.  
Carson, Cal. 90745

**Kraco Enterprises**  
505 East Euclid Ave.  
Compton, Cal. 90024

**Linear Power**  
11545 D Ave. East  
Auburn, Cal. 95603

**Marantz**  
20525 Nordhoff St.  
Chatsworth, Cal. 91311

**Marume Corp.**  
7022 Alondra Blvd.  
Paramount, Cal. 90723

**Matrecs Electronics**  
805 Woodman Ave.  
Windsor, Ill. 61089

**Melco Sales Inc.**  
3030 East Victoria St.  
Compton, Cal. 90221

**Mesa Electronic Sales**  
2940 Malmo Dr.  
Arlington Hts., Ill. 60005

**Micron**  
See: General Sound

**Mitsubishi**  
See: Melco Sales

**Motorola**  
Automotive Prod. Div.  
1299 East Algonquin Rd.  
Schaumburg, Ill. 60196

**Northstar Electronics**  
20850 Leapwood Ave.  
Carson, Cal. 90746

**Numark Electronics**  
P. O. Box 493  
Edison, N.J. 08817

**Orovox Sound**  
11545 Tuxford St.  
Sun Valley, Cal. 91352

**Panasonic**  
1 Panasonic Way  
Secaucus, N.J. 07094

**Pioneer**  
1925 East Dominguez St.  
Long Beach, Cal. 90810

**Polk Audio**  
1205 South Carey St.  
Baltimore, Md. 21230

**PSB Speakers**  
P. O. Box 144  
St. Jacobs, Ontario  
Canada NOB 2N0

**Pyle Industries**  
501 Center St.  
Huntington, Ind. 46750

**Pyramid Mobile Audio**  
P. O. Box 7338  
Arleta, Cal. 91331

**Quam-Nichols**  
234 East Marquette Rd.  
Chicago, Ill. 60637

**RCA Autosound**  
2000 Clements Bridge Rd.  
Deptford, N.J. 08096

**Radio Shack**  
14001 Tandy Center  
Fort Worth, Tex. 76102

**Royal Sound**  
200 Industrial Way West  
Eatontown, N.J. 07724

**Sanshu (America) Inc.**  
2814 Imperial Hwy.  
Brea, Cal. 92621

**Sanyo**  
P. O. Box 51777  
Compton, Cal. 90220

**Sharp**  
10 Keystone Place  
Paramus, N.J. 07652

**Sony**  
9 West 57th St.  
New York, N.Y. 10019

**Sparkomatic Corp.**  
Routes 6 and 209  
Milford, Pa. 18337

**Speco**  
Div., Component  
Specialties  
P. O. Box 624  
Lindenhurst, N.Y. 11757

**Trusonic**  
10530 Lawson River Ave.  
Fountain Valley, Cal.  
92708

**Ultralinear Loudspeakers**  
3228 East 50th St.  
Los Angeles, Cal. 90058

**Vikyo**  
See: Sanshu (America)

**Visionik**  
701 Heinz St.  
Berkeley, Cal. 94710

**Zapco**  
Zeff Advanced Products  
5018 Paradise Rd.  
Modesto, Cal. 95351

# RADIOS/TAPE PLAYERS



Alpine 7307



Clarion PE958A



Cobra 221



Craig T690

MANUFACTURER	Model	Price		Stereo (S), Mono (M), or 4-Channel (C)	FM Sensitivity, $\mu$ V (For 30dB Quieting)	Selectivity	Average Watts/Channel, At Rated Distortion	% Distortion at Rated Watts	Local/Distance Switch	Preset/Station? If Yes, Number AM, Number FM	Bass Control	Treble Control	Cassette	8-Track	Auto Reverse	Fast Forward	Fast Rewind	In-Dash (I) or Under-Dash (U)	Dimensions, Inches
AFCO	IDC-750A	179.95	S			6	10	Yes	No	No	No	Yes	No	Yes	Yes	Yes	I		7x1 1/2x5 1/2
AIWA	CT1060Y	120.00	S			7	10	No	No	No	No	Yes	No	Yes	Yes	Yes	Yes	U	5 1/2x1 1/4x6 1/4
	CTR2030F	170.00	S			5	10	No	No	No	No	Yes	No	Yes	Yes	Yes	I		6 1/2x2x6
	CTR2060Y	190.00	S			7	10	No	No	No	No	Yes	No	Yes	Yes	Yes	I		7 1/2x1 1/4x6
	CTR3030		S			7	10	No	12	Yes	Yes	Yes	No	Yes	Yes	Yes	I		7 1/2x1 1/4x6
ALPINE	7307 Preamp	379.95	S	2.5	75				Auto	1 AM, 4 FM or 1 FM, 4 AM	Yes	Yes	Yes	No	No	Yes	Yes	I	7 1/2x2x5 1/4
	7123	319.95	S	2.5	75	2.2	0.8	No	No	1 AM, 4 FM or 1 FM, 4 AM	Yes	Yes	Yes	No	No	Yes	Yes	I	6 1/2x2x5 1/2
	7327	279.95	S	19.2 dBf	60	2.2	0.8	Auto	No	4 AM	Yes	Yes	Yes	No	No	Yes	Yes	I	6 1/2x2x4 1/2
	7128	299.95	S	23.2 dBf	60	2.2	0.8	Auto	5 AM, 5 FM	No	No	Yes	Yes	No	Yes	Yes	Yes	I	7x2x5 1/4
	7124	199.95	S	19.2 dBf	60	2.2	0.8	Auto	No	No	No	Yes	No	Yes	Yes	Yes	I	6 1/2x2x4 1/2	
AUTOMATE	AC-10	37.95	S			4	2.0	No	No	Yes	Yes	Yes	No	No	Yes	No	U		4 1/2x1 1/4x6
	AC-1000	95.95	S	5	50	4	2.0	Yes	No	No	No	Yes	No	No	Yes	No	I		7x1 1/2x5
	AC-3000	133.95	S	5	55	4	2.0	Yes	No	No	No	Yes	No	Yes	Yes	Yes	I		7 1/2x1 1/4x5 1/2
	AC-5000	179.90	S	5	55	4	2.0	Yes	5AM or FM	No	No	Yes	No	Yes	Yes	Yes	I		7x1 1/4x5 1/2
BON SONIC	AC-7000	199.90	S	2.5	60	10	1.0	Yes	No	Yes	Yes	Yes	No	No	Yes	Yes	I		7x1 1/4x5 1/2
	433AF		S			3		Yes			Yes	Yes	Yes	No	No	Yes	No	I	
	H850		S			3		Yes			Yes	Yes	No	No	No	No	I		
	R455		S			3		Yes			Yes	Yes	Yes	Yes	Yes	Yes	I		
CLARION	PE958A	422.95	S	2.5	60			Yes	Yes	5AM or FM	Yes	Yes	Yes	No	Yes	Yes	Yes	I	5 1/2x7x2 3/4; for use with GA301E or GA302E amp.
	PE751B	389.95	S	3	60	12		Yes	Yes	5AM or FM	Yes	Yes	Yes	No	Yes	Yes	Yes	I	6 1/4x7x2
	PE765B	284.95	S	3	60	3	3	Yes	No	5AM or FM	No	Yes	Yes	No	Yes	Yes	Yes	I	7x5 1/2x2
	PE560A	215.50	S	3	60	3	3	Yes	No	No	No	Yes	No	Yes	Yes	Yes	Yes	I	5 1/2x7 1/2x2
	PE550A	278.95	S	3.5	60	3	3	Yes	No	No	No	Yes	No	Yes	Yes	Yes	Yes	I	7x6 1/2x2
	RE-338D	118.95	S			4		Yes	Yes	Yes	No	No	No	No	No	No	No	I	
	RE-436A	118.95	S			4		Yes	Yes	Yes	No	No	No	No	No	No	No	I	
	RE-338DV	124.95	S			4		Yes	Yes	Yes	No	No	No	No	No	No	No	I	
	PE-683A	128.95	S			4		Yes	Yes	Yes	Yes	No	No	No	Yes	Yes	Yes	I	
	PE-676	184.50	S			4		Yes	Yes	Yes	Yes	No	No	Yes	Yes	Yes	Yes	I	
	PE-666B	215.50	S			4		Yes	Yes	Yes	Yes	No	No	Yes	Yes	Yes	Yes	I	
	PE-559A	184.50	S			4		Yes	Yes	Yes	No	No	No	Yes	Yes	Yes	Yes	I	
	PE-765A	284.95	S			4		Yes	Yes	5	No	No	No	Yes	Yes	Yes	Yes	I	
	PE-840A	71.50	S			4						Yes	No	Yes	Yes	Yes	Yes	U	
	PE-828A	126.95	S			4						Yes	No	Yes	Yes	Yes	Yes	U	
	PE-838	226.95	S			10			Yes	Yes	Yes	Yes	No	Yes	Yes	Yes	Yes	U	
	PE-684A	253.75	S			10		Yes	Yes	Yes	Yes	Yes	No	Yes	Yes	Yes	Yes	U	
	PE-624	128.95	S			4			Yes	Yes	No	No	Yes	No	Yes	Yes	Yes	I	
PE-623B	150.95	S			4					No	No	Yes	No	Yes	Yes	Yes	I		
PE-703A	194.95	S			4				5	No	No	Yes	No	Yes	Yes	Yes	I		
PE-450	70.75	S			4					No	No	Yes	No	Yes	Yes	Yes	U		
PE-453A	126.95	S			10					Yes	Yes	No	Yes	No	No	No	I		
COBRA	93	99.95	S	1.9	50	4	10	Yes	No	No	No	Yes	No	No	Yes	No	I		1 1/2x6 1/4x4 1/2
	94	99.95	S	1.9	50	4	10	Yes	No	No	No	No	Yes	No	No	No	I		1 1/2x6 1/4x4 1/2
	105	179.95	S	1.9	50	12	10	Yes	No	No	No	No	Yes	No	Yes	Yes	I		1 1/2x6 1/4x4 1/2
	98	189.95	S	1.9	50	12	10	Yes	No	No	No	No	Yes	No	Yes	No	I		2 1/2x7 1/2x6 1/4
	99	199.95	S	1.9	50	12	10	Yes	5AM or FM	No	No	Yes	No	No	Yes	No	I		2 1/2x7 1/2x6 1/4
	221	329.95	S	1.9	50	12	10	Yes	5AM or FM	Yes	Yes	Yes	No	Yes	Yes	Yes	I		2 1/2x7 1/2x5 1/4
	222	299.95	S	1.9	50	12	10	Yes	5AM or FM	Yes	Yes	No	Yes	No	No	No	I		2 1/2x7 1/2x5 1/4

# RADIOS/TAPE PLAYERS



Fujitsu Ten DP-644



Hi Comp HCC-1030

MANUFACTURER	Model	Price		Stereo (S) Mono (M) or L-Channel (L) FM Sensitivity (uV) (For 30-dB Selectivity)	Selectivity	Average Watts (Channel, A Rated Distortion, % Distortion at Rated)	Local/Distance Switch	Pushbutton? If Yes, Number AM, Number FM	Bass Control	Treble Control	Cassette	& Track	Auto Reverse	Fast Forward	Fast Rewind	In-Dash (I) or Under-Dash (U)	Dimensions, inches		
CRAIG	R200	269.95	S	4.0@ 50 dB	70			Yes	No	Yes	Yes	Yes	No	Yes	Yes	Yes	I	2x7 1/2x5 1/2	
	R230	309.95	S	3.5@ 50 dB	70			Yes	5	Yes	Yes	Yes	No	Yes	Yes	Yes	I	2x7 1/2x5 1/2	
	S609	119.95	S	15.0@ 50 dB	50	4.0	5.0	Yes	No	No	No	No	Yes	No	No	No	I	1 1/2x5 1/2x5	
	S632	169.95	S	3.2@ 50 dB	60	4	5.0	Yes	5	Yes	Yes	No	Yes	No	No	No	I	2 1/2x7 1/4x5 1/2	
	S686	324.95	S	4.0@ 50 dB	70	12	5	Yes	5	Yes	Yes	No	Yes	No	No	No	I	2 3/4x7 1/4x5 1/2	
	T621	119.95	S	6.3@ 50 dB	60	4	5.0	Yes	No	No	No	Yes	No	No	Yes	No	I	1 3/4x6 3/4x4 1/2	
	T639	159.95	S	8.9@ 50 dB	60	4	5.0	Yes	No	No	No	Yes	No	No	Yes	No	I	2x6 3/4x5	
	T610	119.95	S	4.4@ 50 dB	60	4	5.0	Yes	No	No	No	Yes	No	No	Yes	Yes	I	2x7 1/2x5 1/2	
	T617	159.95	S	2.8@ 50 dB	60	4	5.0	Yes	No	No	No	Yes	No	Yes	Yes	Yes	I	1 3/4x7 1/2x5 1/2	
	T640	189.95	S	4.4@ 50 dB	60	4	5.0	Yes	Yes	No	No	Yes	No	Yes	Yes	Yes	I	2x7 1/2x5 1/2	
	T681 A	189.95	S	4.0@ 50 dB	65	12.0	5.0	Yes	No	Yes	Yes	Yes	No	No	Yes	Yes	I	2x7 1/2x5 1/2	
	T689	229.95	S	4.3@ 50 dB	65	12.0	5.0	Yes	No	Yes	Yes	Yes	No	Yes	Yes	Yes	I	1 3/4x7 1/2x5 1/2	
	T690	314.95	S	5.0@ 50 dB	65	12.0	5.0	Yes	5	Yes	Yes	Yes	No	Yes	Yes	Yes	I	2x7 1/2x6	
	T687	599.95	S	6.3@ 50 dB	60	12.5	1.0	Yes	5	Yes	Yes	Yes	No	Yes	Yes	Yes	I	2 3/4x7 1/2x5	
	T614	159.95	S	3.4@ 50 dB	60	4	5.0	Yes	No	No	No	Yes	No	No	Yes	Yes	I	2x7 1/2x5 1/2	
	T618	189.95	S	5.0@ 50 dB	60	4	5.0	Yes	No	Yes	Yes	Yes	No	Yes	Yes	Yes	I	1 3/4x7 1/2x5 1/2	
	T638	189.95	S	3.6@ 50 dB	60	4	5.0	Yes	5	No	No	Yes	No	No	Yes	Yes	I	2x7 1/2x5 1/2	
	T634	239.95	S	5.0@ 50 dB	60	4	5.0	Yes	5	Yes	Yes	Yes	No	Yes	Yes	Yes	I	2x7 1/2x6	
	T619	279.95	S	5.0@ 50 dB	65	8	5.0	Yes	No	Yes	Yes	Yes	No	Yes	Yes	Yes	I	2x7 1/2x5 1/2	
FUJITSU TEN	DP-644	249.95	S	20 dB	64	16	10	No	No	Yes	Yes	Yes	No	Yes	Yes	Yes	I	1 3/4x7x5 1/2	
	DP-620	149.95	S	18 dB	64	5	10	No	No	No	No	Yes	No	Yes	Yes	Yes	I	1 3/4x7x5 1/2	
	DP-7871	179.95	S	18 dB	64	5	10	No	No	No	No	Yes	No	Yes	Yes	Yes	I	1 3/4x7x5 1/2	
	DP-7872	179.95	S	18 dB	64	5	10	No	No	No	No	Yes	No	Yes	Yes	Yes	I	1 3/4x7x5 1/2	
	GP-7881	279.95	S	18 dB	64	4x5	10	Yes	No	5 FM, 5 AM	Yes	Yes	Yes	No	Yes	Yes	Yes	I	2 3/4x7 1/2x5 1/2
	EP-820	569.95	S	20 dB	64			Yes	No	7 FM, 7 AM	Yes	Yes	Yes	No	Yes	Yes	Yes	I	2 3/4x7x6 1/2
	Preamp																		
	DL-7841	129.95	S	18 dB	64	5	10	No	No	5 FM, 5 AM	Yes	Yes	No	Yes	No	No	No	I	2x7 1/2x6 1/2
	GL-7851	199.95	S	18 dB	64	5	10	Yes	No	5 FM, 5 AM	Yes	Yes	No	Yes	No	No	No	I	2x7 1/2x6 1/2
	EP-750-S1	489.95	S	20 dB	64			Yes	Yes	5 FM, 5 AM	Yes	Yes	Yes	No	Yes	Yes	Yes	I	2 3/4x7 1/2x5 1/2
FULTRON	16-6800	399.95	S			9	0.01	Yes	7 AM, 7 FM		Yes	Yes	No	Yes	Yes	Yes	I	2 1/2x7x5 1/2	
	16-6615	199.95	S			5	0.01	Yes	5 AM or FM		Yes	Yes	No	No	Yes	Yes	I	2 1/2x7x5 1/2	
	16-6100	159.95	S			4	0.01	Yes	5 AM or FM	No	No	Yes	No	No	Yes	No	I	2 1/2x7x4 1/2	
	16-5200	149.95	S			4.5	0.01	Yes	No	No	Yes	No	No	Yes	Yes	No	I	1 3/4x6 3/4x4 1/2	
	16-5000	99.95	S			4	0.01	Yes	No	No	Yes	No	No	Yes	No	No	I	1 3/4x6 3/4x4 1/2	
	16-8600	499.95	S			4	0.01	Yes	4 AM or FM	No	No	No	Yes	No	No	No	I	2 3/4x7x7; plus CB.	
	16-6500	189.95	S			5	0.01	Yes	5 AM or FM		Yes	No	Yes	No	No	No	I	2 3/4x7x6	
	16-6300	159.95	S			4	0.01	Yes	5 AM or FM	No	No	No	Yes	No	No	No	I	2 1/2x7x5 1/2	
	16-5600	119.95	S			4.5	0.01	Yes	No	No	No	Yes	No	No	No	No	I	1 3/4x7x4 1/2	
	16-5300	99.95	S			4	0.01	Yes	No	No	No	Yes	No	No	No	No	I	1 3/4x6 3/4x4 1/2	
16-8400	399.95	S			3	0.01	Yes	5 AM or FM	No	No	No	No	No	No	No	I	2 3/4x7x6; plus CB.		

(continued)



# RADIO/TAPE PLAYERS

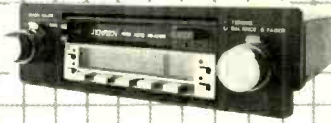

Jensen R406



Jet Sound Labs JS-6200



Kenwood KRC-711

MANUFACTURER	Model	Price		Stereo (S), Mono (M), or 4-Channel (Q)	FM Sensitivity (uV For 30-dB Quieting)	Selectivity	Average Watts/Channel At Rated Distortion	% Distortion at Rated Watts	Local/Distance Switch	Pushbuttons? If Yes, Number AM, Number FM	Bass Control	Treble Control	Cassette	8-Track	Auto Reverse	Fast Forward	Fast Rewind	In-Dash (I) or Under-Dash (U)	Dimensions, inches
FULTRON (continued)	16-4200	99.95	S			4	0.01	Yes	5 AM or FM	No	No	No	No	No	No	No	No	I	1 5/8x6 1/2x4 1/4
	16-3405/15	119.95	M			4	0.01	Yes	5 AM or FM	No	No	No	No	No	No	No	No	I	2 1/8x7 1/8x5
	16-3200	69.95	M			4	0.01	Yes	5 AM or FM	No	No	No	No	No	No	No	No	I	1 1/8x6 1/2x4 1/4
	16-2200	44.95	M			4	0.01		5 AM or FM	No	No	No	No	No	No	No	No	I	1 1/8x6 1/2x4 1/4
GRUNDIG	GCM 4650	187.00	S	2.3		7	10	Yes	No	Yes	Yes	Yes	No	No	Yes	Yes	Yes	I	7 1/8x1 1/4x5 1/4
	GCM 8100	250.00	S	2.5		7	10	Yes	No	No	No	Yes	No	No	Yes	Yes	Yes	I	7 1/8x1 1/4x5 1/4
	GCM 8200	259.00	S	2.5		7	10	Yes	No	No	No	Yes	No	Yes	Yes	Yes	I	7 1/8x2x5 1/8	
	GCM 9200	390.00	Q			20	10	Yes	No	No	No	Yes	No	Yes	Yes	Yes	Yes	I	7 1/8x2x5 1/8
	GCP 9300	329.00	S	2.3		7	10	Yes	5 AM or FM	Yes	Yes	Yes	No	Yes	Yes	Yes	Yes	I	7 1/8x1 1/4x5 1/4
	GEM 5000	139.00	S	2.5		7	10	Yes	No	No	No	No	Yes					I	7 1/8x1 1/4x5 1/8
HI COMP	HCC-1020	332.00	S	1.2		15	1	Yes	No	Yes	Yes	Yes	No	No	Yes	Yes	Yes	I	2 1/8x7x6 1/8
	HCC-1025	380.00	S	1.2	70	15	1	Yes	No	Yes	Yes	Yes	No	Yes	Yes	Yes	Yes	I	2 3/8x7x5 1/2
	HCC-1030	420.00	S	1.2	70	15	1	Yes	5	Yes	Yes	Yes	No	Yes	Yes	Yes	Yes	I	3x7 1/2x5 1/4; Dolby NR.
	HCM-005	550.00	S	2.0	65			Yes	6 AM, 6 FM	Yes	Yes	Yes	No	Yes	Yes	Yes	Yes	I	2x7x6
	HCM-0010	650.00	S	1.2	70			Yes	6 AM, 6 FM	Yes	Yes	Yes	No	Yes	Yes	Yes	Yes	I	2 3/8x7x4 3/8
JENSEN	R430	469.95	S	2.5	60	30	0.4	Yes	No	Yes	Yes	Yes	No	No	Yes	Yes	Yes	I	2 1/8x6x7
	R420	369.95	S	2.5	60	18	0.4	Yes	No	Yes	Yes	Yes	No	No	Yes	Yes	Yes	I	2 1/8x6x7
	R410	299.95	S	2.5	60	5	0.4	Yes	No	Yes	Yes	Yes	No	No	Yes	Yes	Yes	I	2 1/8x6x7
	R406	289.95	S	2.5	60	5	0.6	No	5 AM/FM	Yes	Yes	Yes	No	Yes	Yes	Yes	Yes	I	1 3/8x6x7
	R405	279.95	S	2.5	60	5	0.4	No	No	Yes	Yes	Yes	No	Yes	Yes	Yes	Yes	I	2x5 1/8x7
	R402	239.95	S	2.5	60	5	0.4	No	No	Yes	Yes	Yes	No	No	Yes	Yes	Yes	I	2x4 1/8x7
	R400	199.95	S	2.5	60	5	0.4	No	No	No	No	Yes	No	No	Yes	Yes	Yes	I	2x4 1/8x7
JET SOUND LABS	JS-6200	299.95	S	1.5	70	15	1.0	Yes	5 AM, 5 FM	Yes	Yes	Yes	No	Yes	Yes	Yes	Yes	I	2 1/4x7x4 3/8
	JS-9700	179.95	S	1.7	40	8	1.0	Yes	5 AM or FM	No	No	Yes	No	Yes	Yes	Yes	Yes	I	2x6 1/8x5 1/2
	JS-9400	129.95	S	1.7	40	8	1.0	Yes	No	No	No	Yes	No	Yes	Yes	No	I	1 3/8x6 3/8x4 1/4	
	JS-8002	159.95	S	1.7	40	8	1.0	Yes	No	No	No	Yes	No	Yes	Yes	Yes	I	1 1/4x7x5 1/8	
	JS-8001	129.95	S	2.0	40	8	1.0	Yes	No	No	No	Yes	No	Yes	Yes	Yes	I	2x7x6 1/8	
	JS-8250	99.95	S	2.0	40	8	1.0	Yes	No	No	No	No	Yes	No	No	No	I	1 1/8x7x4 1/4	
	JS-9350	99.95	S	2.0	40	8	1.0	Yes	No	No	No	Yes	No	No	No	No	I	1 3/8x6 3/8x4 1/4	
	JS-600	89.95	S		5	1.0	No	No	No	No	No	Yes	No	Yes	Yes	Yes	Yes	U	2x7x6 1/2
JS-3500	119.95	S	2.5	40	5	1.0	Yes	No	No	No	Yes	No	Yes	Yes	Yes	Yes	U	2x7x6 1/2	
KENWOOD	KRC-711	449.00	S	1.5	65	†	1	No	5 FM, 5 AM	Yes	Yes	Yes	No	Yes	Yes	Yes	Yes	I	2 3/8x7 1/8x5 1/8; † 4 front, 15 rear.
	KRC-511	379.00	S	1.5	65	4	1	No	5 FM, 5 AM	Yes	Yes	Yes	No	Yes	Yes	Yes	Yes	I	2 3/8x7 1/8x5 1/8
	KRC-311	269.00	S	1.7	65	4	1	Yes	5 FM, 5 AM	No	No	Yes	No	Yes	Yes	Yes	Yes	I	2x7 1/4x5 1/8
	KRC-721	399.00	S	1.5	65			Yes	5 FM, 5 AM	Yes	Yes	Yes	No	Yes	Yes	Yes	Yes	I	2 3/8x7 1/8x5 1/8
	KTC-767	299.00	S	1.1				Yes	5 AM, 6 FM, 6 AM	Yes	Yes	No	No					I	2 1/8x6 1/8x6 1/2
	KTC-757	269.00	S							Yes	Yes	Yes		Yes	Yes	Yes	Yes	I	2 1/8x6 1/8x6 1/2
																			I
KRACO	KGE-801	199.95	S	10	50	10	1.0	Yes	No	No	No	Yes	No	No	Yes	No	No	I/U	2x7x5
	LED-501	249.95	S	2.5	45	3.6	1.0	No	No	No	No	Yes	No	No	Yes	No	No	I/U	2x7 1/8x6
	LED-500	249.95	S	2.5	45	3.6	1.0	No	No	No	No	No	Yes	No	Yes	No	No	I/U	2x7 1/8x6
	KID-588	159.95	S	3	45	3.6	1.0	Yes	No	No	No	Yes	No	Yes	Yes	Yes	Yes	I/U	2x7 1/8x5 1/2
	KID-575	169.95	S	2	45	3.6	1.0	Yes	5 FM, 5 AM	No	No	No	No	Yes	No	No	No	I/U	2 3/8x7 1/8x6 1/4
	KID-566	129.95	S	2.5	35	3.6	1.0	Yes	No	No	No	No	Yes	No	No	No	No	I/U	2x7x5 1/4
	KID-565	119.95	S	3	35	3.6	1.0	Yes	No	No	No	No	Yes	No	No	No	No	I/U	2x7 1/8x5 1/2
	KID-587	169.95	S	2	45	3.6	1.0	No	5 FM, 5 AM	No	No	No	Yes	No	No	Yes	No	I/U	2x7 1/4x5 1/2
	KID-585	129.95	S	2.5	45	3.6	1.0	Yes	No	No	No	No	Yes	No	No	Yes	No	I/U	2x7 1/4x5 1/2
	KID-589	199.95	S	2.0	45	3.7	1.0	No	No	No	No	No	Yes	No	Yes	Yes	Yes	I/U	2x7 1/4x5 1/2

# RADIOS/TAPE PLAYERS



Kraco KGE-801



Marantz CAR-427



Mitsubishi RX-723

MANUFACTURER	Model	Price		Stereo (S), Mono (M), or 4-Channel (C)	FM Sensitivity (µV For 30dB Quieting)	Selectivity	Average Watts/Channel, All Rated Distortion	% Distortion at Rated Watts	Local/Distance Switch	Pushbuttons? If Yes, Number AM, Number FM	Bass Control	Treble Control	Cassette	8-Track	Auto Reverse	Fast Forward	Fast Rewind	In-Dash (I) or Under-Dash (U)	Dimensions, Inches
MARANTZ	CAR-427	625.00	S	1.0	70			No	5 AM, 5 FM	Yes	Yes	Yes	No	Yes	Yes	Yes	I	2 1/2 x 7 1/2 x 5 1/2	
	CAR-400	500.00	S	1.5	65	4	0.9	No	6 AM, 6 FM	Yes	Yes	Yes	No	No	Yes	Yes	I	2 1/2 x 7 1/2 x 5 1/2	
	CAR-410	390.00	S	1.1	60	4	0.9	Yes	6 AM, 6 FM	No	No	Yes	No	No	Yes	Yes	I	1 3/4 x 7 1/2 x 6	
	CAR-302	300.00	S	1.5	60	4	0.9	No	5 AM, 5 FM	Yes	Yes	Yes	No	No	Yes	Yes	I	2 1/2 x 7 1/2 x 4 3/4	
	CAR-301	270.00	S	1.1	70			No	5 AM, 5 FM	Yes	Yes	Yes	No	No	Yes	Yes	I	2 1/2 x 7 1/2 x 4 3/4	
	CAR-300	220.00	S	1.8	60	4	0.9	Yes	5 AM, 5 FM	No	No	Yes	No	No	Yes	Yes	I	2 1/2 x 7 1/2 x 5 1/2	
MARUME	M-P880	109.95	S	5		8	2	Yes	5 FM, 5 AM	No	No	No	Yes	No	No	No	I	2 x 5 1/2 x 6 1/2	
	M-5300/A	69.95	S	3.2		7	2.0	Yes	No	No	No	Yes	No	No	Yes	No	I	2 x 5 1/2 x 7 1/2	
	M-7700	109.95	S	5		7	2.0	Yes	No	No	No	Yes	No	Yes	Yes	I	2 x 5 1/2 x 6 1/2		
	M-P550	129.95	S	5		8	2.0	Yes	5 FM, 5 AM	No	No	Yes	No	No	Yes	Yes	I	1 3/4 x 5 1/2 x 6 1/2	
	M-999P	69.95				7				No	No	No	No	No	No	No	I		
MITSUBISHI	CZ-747	479.95	S	4	80			Yes	5 AM & FM	Yes	Yes	Yes	No	Yes	Yes	Yes	I	2 x 7 1/2 x 4 3/4	
	CZ-692	299.95	S	4	80			Yes	5 AM or FM	Yes	Yes	Yes	No	Yes	Yes	Yes	I	2 1/2 x 7 1/2 x 4 3/4	
	RX-691	249.95	S	4	80	4	1.0	Yes	5 AM or FM	No	No	Yes	No	Yes	Yes	Yes	I	2 1/2 x 7 1/2 x 4 3/4	
	RX-752	229.95	S	4	86	4	1.0	No	5 AM or FM	No	No	Yes	No	Yes	Yes	Yes	I	2 x 7 1/2 x 6	
	RX-723	149.95	S	4	70	4	1.0	Yes	No	No	No	Yes	No	No	Yes	No	I	1 3/4 x 6 1/2 x 4 1/2	
	RX-2	299.95	S	4	75	4	1.0	Yes	6 AM & FM	No	No	Yes	No	Yes	Yes	Yes	I	2 1/2 x 7 1/2 x 6 1/2	
	RX-79	259.95	S	4	75	11	1.0	Yes	5 AM or FM	Yes	Yes	Yes	No	Yes	Yes	Yes	I	2 1/2 x 7 1/2 x 6 1/2	
	RX-73	179.95	S	4	75	4	1.0	Yes	5 AM or FM	No	No	Yes	No	No	Yes	No	I	2 1/2 x 7 1/2 x 4 3/4	
	GX-101	99.95	S			7	1.0			No	No	Yes	No	No	Yes	No	U	2 x 5 1/2 x 6 1/2	
	GX-102	149.95	S			7	1.0			Yes	Yes	Yes	No	Yes	Yes	Yes	U	1 3/4 x 5 1/2 x 6 1/2	
RX-103	159.95	S	2	70	7	1.0	No	No	Yes	Yes	Yes	No	Yes	Yes	Yes	U	2 x 5 1/2 x 6 1/2		
MOTOROLA	700SX	129.95	S	2.5		4	10	Yes	No	No	No	Yes	No	Yes	No	Yes	I	4 1/4 x 6 1/2 x 1 1/2	
	600SX	129.95	S	2.5		4	10	Yes	No	No	No	Yes	Yes	No	Yes	No	I	4 1/4 x 6 1/2 x 1 1/2	
	TC894	389.95	S	7.5@50dB		12	10	Yes	No	Yes	Yes	Yes	Yes	Yes	Yes	Yes	I	2 1/2 x 7 1/2 x 7 1/2	
NORTHSTAR ELECTRONICS	NS 2000	99.95	S	3	20	4	10.0	Yes	No	No	No	Yes	No	No	Yes	No	I	1 3/4 x 6 1/2 x 5	
	NS 2500E	159.00	S	2.0	20	4.5	10.0	Yes	No	No	No	Yes	No	Yes	Yes	Yes	I	1 3/4 x 6 1/2 x 5 1/2	
	NS 3040E	199.00	S	3.5	25	15	10.0	Yes	No	Yes	Yes	Yes	No	Yes	Yes	Yes	I	1 3/4 x 6 1/2 x 5 1/2	
PANASONIC	CQ-8700	649.95	S	15dBf @30dB				Yes	5 FM, 5 AM	Yes	Yes	Yes	No	Yes	Yes	Yes	I	2 x 7 x 5 1/2	
	CQ-7600	359.95	S	19dBf @50dB				Yes	No	No	No	Yes	No	Yes	Yes	I	2 x 7 x 5 1/2		
	CQ-7400	299.95	S	19dBf @50dB				Yes	No	No	No	Yes	No	Yes	Yes	I	2 x 7 x 5 1/2		
	CQ-6600	239.95	S	26dBf @50dB	4	5		Yes	5 AM or FM	No	No	Yes	No	No	Yes	Yes	I	2 x 7 x 5 1/2	
	CQ-6800	149.95	S	27dBf @50dB		3.75	5	Yes	No	No	No	Yes	No	No	No	No	I	1 3/4 x 7 x 1 1/4	
	CQ-S680	179.95	S	19dBf @50dB	55	4	1.0	No	5 AM or FM	No	No	Yes	No	No	Yes	Yes	I	2 1/2 x 7 x 5 1/2	
	CQ-S700	199.95	S	19dBf @50dB	55	4	1.0	No	5 AM or FM	Yes	Yes	Yes	No	No	Yes	Yes	I	2 1/2 x 7 x 5 1/2	
	CQ-S710	209.95	S	19dBf @50dB	55	4	1.0	No	No	Yes	Yes	Yes	No	Yes	Yes	Yes	I	2 1/2 x 7 x 5 1/2	
	CQ-S740	239.95	S	19dBf @50dB	55	4	1.0	No	5 AM or FM	Yes	Yes	Yes	No	Yes	Yes	Yes	I	2 1/2 x 7 x 5 1/2	
	CQ-S780	279.95	S	19dBf @50dB	55	4	1.0	No	5 AM or FM	Yes	Yes	Yes	No	Yes	Yes	Yes	I	2 1/2 x 7 x 5 1/2	
	CQ-4600	239.95	S	26dBf @50dB	4	5.0		Yes	5 AM or FM	No	No	No	Yes	No	No	No	I	2 x 7 x 5 1/2	
	CQ-2800	139.95	S	27dBf @50dB		4.25	5.0	Yes	No	No	No	No	Yes	No	No	No	I	2 x 7 1/2 x 4 3/4	
	RM-310 Cockpit	599.95	S	19dBf @50dB		10		Yes	No	No	No	Yes	No	No	Yes	Yes	†	2 1/2 x 27 1/2 x 8 1/2; † over head.	

(continued)

# RADIOS/TAPE PLAYERS

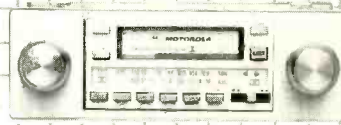

Motorola TC894

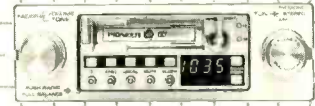

Pioneer KE-5000

MANUFACTURER	Model	Price		Stereo (S), Mono (M), or A-Channel (O)	FM Speciality (O) (For 30-dB Quieting)	Selectivity	Average Watts/Channel at Rated Distortion	% Distortion at Rated Watts	Local/Distance Switch	Pushbuttons? If Yes, Number AM, Number FM	Bass Control	Treble Control	Cassette	8-Track	Auto Reverse	Fast Forward	Fast Rewind	In-Dash (I) or Under-Dash (U)	Dimensions, inches	
PANASONIC (continued)	Cockpit	599.95	S	18dBf @50dB		10		Yes	No	No	No	Yes	No	No	Yes	Yes	†		2½x7½x8½; † over head.	
	RM-610	999.95	S	18dBf @50dB		30		Yes	3 FM	Yes	Yes	Yes	No	Yes	Yes	Yes	†		3x27¼x9; † over head.	
	Cockpit CQ-8530	449.95	S	10dBf @50dB		12.5		Yes	6 FM, 6 AM	Yes	Yes	Yes	No	Yes	Yes	Yes	I		2¾x7½x6½	
PIONEER	TP-727	104.95	S	14.3	74	4		Yes	No	Yes	Yes	No	Yes		Yes		U		2½x6½x6¼	
	TP-900	179.95																	3x7½x7½	
	KP-272	89.95																	2x5½x6½	
	KP-373	114.95	S	14.3	74	4	4		Yes	No	Yes	Yes	No	No	Yes	Yes	Yes	U		2x4½x6½
	KP-575	139.95																		2x6½x4¾
	KP-250	144.95																		2x6½x6¾
	KP-500	189.95	S	14.3	74	4	4		Yes	No	Yes	Yes	No	No	Yes	Yes	Yes	U		3x7½x7½
	KP-6006	129.95																		2x7½x7½
	TP-7007	149.95																		2x7½x7½
	TP-9004	199.95	S	14.3	74	4	4		Yes	5FM, 5AM	No	No	No	Yes		No		I		3¼x7½x7¾
	TP-9005	199.95																		3¼x7½x7¾
	TP-9006	199.95																		3¼x7½x7¾
	KP-1500	119.95	S	20.7	50	5	5		Yes	No	No	No	Yes	No	No	Yes	No	I		1¾x6½x5¾
	KP-2500	139.95																		2x7½x7½
	KP-4500	159.95																		2x7½x7½
	KP-5500	179.95	S	14.3	74	5	5		No	5	No	No	Yes	No	No	Yes	Yes	I		2x7½x7½
	KP-8500	199.95																		3x7½x7½
	KE-2100	249.95																		2x7½x7½
	KE-3000	339.95	S	14.3	65	4	4		Yes	5FM, 5AM	No	No	Yes	No	No	Yes	Yes	I		2x7½x7½
	KE-5000	399.95																		3x7½x7½
	KP-3500	179.95																		2x7½x6¾
KP-4502	199.95	S	19.2	50	5	5		Yes	No	No	No	Yes	No	No	Yes	Yes	I		1¾x7½x6¾	
KP-8000	219.95																		2x7½x6½	
KE-2002	299.95																		2x7½x6¾	
KP-66G	129.95	S	14.3	74	74	74			No	Yes	Yes	Yes	No	No	Yes	Yes	U		2x4½x6½	
KP-77G	159.95																		2x6x6½	
KP-88G	159.95																		2x6x6½	
KPX-600	189.95	S	14.3	74	74	74			No	Yes	Yes	Yes	No	No	Yes	Yes	U		2¾x7½x6¾	
KP-707G	229.95																		2x6x6½	
KPX-9000	269.95																		2x7½x7½	
KPX-9500	299.95	S	14.3	74	74	74		No	5	Yes	Yes	Yes	No	No	Yes	Yes	I	3x7½x7½		
RCA	12R812	414.00	S	3	50	5	10	Yes	5FM or AM	No		Yes	No	Yes	Yes	Yes	I		3x7x5½	
	12R712	388.00																	3x7x6	
	12R807	255.70																	1¾x7x5½	
	12R806	180.40																	1¾x7x5½	
	12R704	158.90																	2¾x7x6	
	20C505	165.20																	2¾x7x6	
	12R210	110.15																	1¾x4¾x6¾	
	12R711	110.20																	1¾x6¾x4¾	
	12R610	179.70																	2¾x7½x4¾	
	12R612	104.65																	1¾x7x4½	
	12R611	84.75																	1¾x7x4½	
ROYAL SOUND	RS-2510	150.00	S	1.9	60	4	3	Yes	No	No	No	Yes	No	No	Yes	No	I		1¾x7x5¾	
	RS-2010N	150.00																	1¾x7x4¾	
SANYO	FT C6	109.95	S	3.0	50	4.5	10	Yes	No	Yes	Yes	Yes	No	Yes	Yes	Yes	I		6¼x4¾x1¾	
	FT C8	159.95																	6¼x4¾x2	
	FT2200	349.95																	6¼x5x2	
	Preamp																			
	FT1490-2	239.95																	7x6x3	
	FT 1498	329.95																	7x6x2	
12-1886	179.95	S		50	12	10	10	Yes	5FM, 5AM	Yes	Yes	Yes	No	No	Yes	Yes	I/U		2¾x7x7½	
12-1887	179.95																		2¾x7x5½	

(continued)

# RADIOS/TAPE PLAYERS



Royal Sound RS-2010N



Sparkomatic SR-303

MANUFACTURER	Model	Price		Stereo (S), Mono (M), or 4 Channel (O)	FM Sensitivity (O) (For 30dB Quieting)	Selectivity	Average Watts (Channel, All Rated Distortion)	% Distortion (Channel, Watts)	Local/Distance Switch	Pushbuttons? If Yes, Number A.M. Number F.M.	Bass Control	Treble Control	Cassette	8-Track	Auto Reverse	Fast Forward	Fast Rewind	In-Dash (I) or Under-Dash (U)	Dimensions, Inches
SANYO (continued)	12-1889	179.95	S	3		7	10			No	No	Yes	No	No	Yes	Yes	I	1 1/4 x 4 1/8 x 1 1/8	
	12-1890	149.95	S			6	10			No	No	Yes	No	Yes	Yes	Yes	I/U	1 1/4 x 7 1/8 x 5 1/8	
	12-1891	129.95	S			4	10					Yes	No	No	Yes	Yes	I	2 1/8 x 7 x 5 1/8	
	12-1809	99.95	S			12	1.0			Yes	Yes	Yes	No	No	Yes	Yes	U	7 x 1 1/8 x 6 1/8	
	12-1884	99.95	S			4.0	10			No	No	Yes	No	No	Yes	Yes	I/U	1 1/4 x 7 1/8 x 5 1/8	
	12-1885	99.95	S	65		4.8	10			No	No	No	Yes	No	No	No	I/U	2 x 8 x 4 1/4	
	12-1892	99.95	S			4	10			Yes	No	Yes	No	No	Yes	No	I	1 1/4 x 6 1/8 x 4 1/4	
	12-1806	69.95	S			4	10	No		No	No	Yes	No	No	Yes	Yes	U	1 1/4 x 5 1/8 x 5 1/8	
	12-1805	64.95	S			4	10	No		No	No	Yes	No	No	Yes	Yes	U	1 1/4 x 6 1/8 x 5 1/8	
	12-1803	59.95	S			4	10	No		No	No	Yes	No	No	No	No	U	1 1/4 x 5 1/8 x 5 1/8	
	12-1801	42.95	S			4	10	No		No	No	No	Yes	No	Yes	No	U	2 1/4 x 4 3/8 x 6 1/8	
	SHARP	RG-3550	219.95	S	3.0		8	10	Yes		Yes	Yes	Yes	No	No	Yes	Yes	I	7 1/8 x 2 x 5 1/8
RG-3400		189.95	S	3.0		8	10	Yes		Yes	Yes	Yes	No	Yes	Yes	Yes	I	7 1/8 x 2 x 5 1/8	
RG-3200		169.95	S	3.0		8	10	Yes		Yes	Yes	Yes	No	No	Yes	Yes	I	7 1/8 x 2 x 5 1/8	
SONY	XT-1 Preamp	329.95	S	1.5	92				Auto	10 FM								I	5 1/4 x 1 1/2 x 7
	XT-22 Preamp	159.95	S	2	60				Yes	No								I	5 1/4 x 1 1/2 x 7 1/8
	XK-23 Preamp	249.95	S								Yes	Yes	Yes	No	Yes	Yes	Yes	I	5 1/4 x 1 1/4 x 7 1/8; Dolby NR.
	XK-21 Preamp	199.95	S								Yes	Yes	Yes	No	Yes	Yes	Yes	I	5 1/4 x 1 1/4 x 7 1/8
	XK-M11	259.95	S			6	0.8				Yes	Yes	Yes	No	Yes	Yes	Yes	I	5 1/4 x 1 1/4 x 8 1/4; Dolby NR.
	GD-R41	209.95	S			6	0.8				Yes	Yes	Yes	No	Yes	Yes	Yes	I	5 1/4 x 1 1/4 x 8
	XR-77		S	2	92		0.2	Yes		5 FM, 5 AM, 5 AM	Yes	Yes	Yes	Yes	No	Yes	Yes	I	
XR-70 Preamp		S	2	92		0.05	Yes		5 FM, 5 AM, 5 AM	Yes	Yes	Yes	No	No	Yes	Yes	I		
XR-50		S	3	75	6	0.9	Yes		No	Yes	Yes	Yes	No	No	Yes	Yes	I		
SPARKOMATIC	SR-3400	269.95	S	1		45	10	Yes	No	Yes	Yes	Yes	No	No	Yes	Yes	I	1 1/4 x 7 x 5 1/8	
	SR-3300	249.95	S	1		45	10	Yes	No	Yes	Yes	Yes	No	Yes	Yes	Yes	I	1 1/4 x 7 x 5 1/8	
	SR-3100	219.95	S	1		45	10	Yes	No	Yes	Yes	Yes	No	No	Yes	Yes	I	1 1/4 x 7 x 5 1/8	
	SR-2400	269.95	S	1		45	10	Yes	No	Yes	Yes	Yes	No	Yes	No	No	I	1 1/4 x 7 x 5 1/8	
	SR-2100	219.95	S	1		45	10	Yes	No	Yes	Yes	Yes	No	Yes	No	No	I	1 1/4 x 7 x 5 1/8	
	SR-303	159.95	S	7		10	10	Yes	No	Yes	Yes	Yes	No	Yes	No	Yes	Yes	I	1 1/4 x 7 x 4 3/8
	SR-302	159.95	S	7		10	10	Yes	Yes	Yes	Yes	Yes	Yes	No	No	Yes	No	I	2 1/4 x 7 1/8 x 4 3/8
VIKYO	AR-31	189.95	S			8	0.3	Yes	No	No	No	Yes	No	Yes	Yes	Yes	I	7 1/4 x 1 3/8 x 5 1/8	
	900S	99.95	S			4	0.35	Yes	No	No	No	Yes	No	No	Yes	No	I	7 1/4 x 2 x 4 3/8	

# SPEAKERS



Alpine 6204



ADS 300i

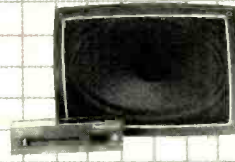

Altec Lansing SW-1

Afs Kriket Domax III



MANUFACTURER	Model	Price, \$ (If Sold Individually)	Price, \$ (If Sold in Pairs)	Recommended Max. Power, Watts	Woofer Size, Inches	Magnet Size, Oz.	Impedance, Ohms	Frequency Response, Hz to kHz, ± dB	Two-way (2) or Three-way (3)	Flush Mount (F) or Surface Mount (S)	Overall Dimensions	Notes
AAL	Micro 100	109.00	50	4	4	4	50-20 ±3	2	S	7¼x4½x4½		
	Micro 100B	119.00	50	4	4	4	50-20 ±3	2	S	7¼x4½x4½		
ADCOM	ELF-1	200.00	40	4	8	8	40-20	2	S	4¼x7x4¼		
ADS	200C	250.00	50	4	4	4	55-22 ±5	2	S†	6¼x4¾x4¾	Opt. flush-mount frame.	
	300C	310.00	75	5½	4	4	40-23 ±5	2	S	8½x5¼x5¼	As above.	
	300i	250.00	100	5¼	4	4	50-20 ±3	2	F	8½x5¼x1½	3-position high-freq. contour switch.	
ADVENT	EQ-1	180.00		6x9					F	6x9x4	Built-in amp.	
AFS KRIKET	DOMAX III 8976	159.95	100	6x9	20	4	35-40	3	F	6x9x3¾		
	DOMAX II 8974	129.95	90	6x9	20	4	40-22	2	F	6x9x3¾		
	8272	84.95	35	5¼	20	4	70-20	2	F	5¼x2¾		
	8311	34.95	20	3½	3	8	80-18		F	3¾x1¾		
AIWA	SC16Y	80.00	30	6x9		4	90-20	3	S	10¾x1½x6¾	3-way treble control.	
ALPINE	6204	199.95	65	7	25	4	40-20 ±3	2	F	6¼x3¾		
	6302	119.95	50	6½	10	4	55-20 ±3	3	S	6½x2		
	6202	49.95	20	4	7	4	100-17 ±3	2		4x1¼		
ALTEC LANSING	TK1	69.95	2	3		4	5k-18k ±4	†	S	3½x3½x2¾	†Built-in 5-kHz crossover for AL1 system.	
	SK1	99.95	2	5¼	10	4	100-10 ±5	†		5½x5½x2¾	As above.	
	SW-1	219.95	†	6x9		1k	50-150Hz ±4			6½x9¾x4¼	As above; † built-in 40 W rms amp.	
	4A	159.95	2	6x9	15	4	80-18 ±6	2	S	6½x9¾x3½		
AUDIOTEX	30-3074	41.55	95.80†	30	6 x 9	20	4-8	40-20	3	F		†Kit with grilles and hardware.
	30-3072	41.15	91.35†	35	6 x 9	25	4-8	40-18	2	F		
	30-3071	33.20	75.40†	25	6 x 9	20	4-8	45-18	2	F		
	30-3070	29.15	68.25†	20	6 x 9	10	4-8	50-18	2	F		
	30-3054	23.55	57.20†	25	6 x 9	20	4-8	40-16	2	F		
	30-3053	19.75	51.15†	20	6 x 9	10	4-8	50-16	2	F		
	30-2648		97.85†	25	4 x 10	20	4-8	70-20	3	F		
	30-2647		85.70†	25	4 x 10	20	4-8	70-20	2	F		
	30-2646		56.85†	25	4 x 10	20	4-8	70-16	2	F		
	30-3056	18.45		15	4 x 10	10	4-8	60-14	2	F		
	30-3066	33.80	78.20†	25	5¼ rd.	20	4-8	50-20	2	F		
	30-3065	23.55	53.75†	25	5¼ rd.	20	4-8	50-16	2	F		
	30-3064	18.85	46.90†	20	5¼ rd.	10	4-8	55-15	2	F		
	30-3063	17.20	43.75†	16	5¼ rd.	5½	4-8	60-15	2	F		
	30-3047	18.85		15	5 x 7	10	4-8	50-14	2	F		
	30-5121		99.95	25			4-8	55-20	2	S	7¼x4¾x4¼	

# SPEAKERS



**Audiovox HI Comp HCS-342**

**Avid 10+**

**Canton AC-200**

MANUFACTURER	Model	Price \$		Recommended Max. Power, Watts	Woofer Size, Inches	Magnet Size, Oz.	Impedance, Ohms	Frequency Response, Hz to kHz, ± dB	Two-way (2) or Three-way (3)	Flush Mount (F) or Surface Mount (S)	Overall Dimensions	Notes
		(If Sold Individually)	(If Sold in Pairs)									
AUDIOVOX	TRYVOX-40	69.00	25	4x10	20	8	70-17.5	3	F			
	COMP-100	126.00	50	4x4	10	8	50-20	2	S			
	DOME-20	93.00	40	6x9	20	8	60-18	2	F			
	COMP-60	100.00	50	6½	20	8		2	F			
	COID-69/20	52.00	20	6x9	20	8	60-16	2	F			
	TRYVOX-25	60.00	25	5½	20	8	65-16.5	3	F			
	TRYVOX-20	69.00	30	6x9	20	8	60-17	3	F			
	TRYVOX-30	84.00	30		20	8	65-18	3	F			
	HCS-59	100.00	60	5½	20	8	70-18	3	F			
	HCS-342	116.00	60	4x10	20	8	16-18	3	F			
	HCS-362	116.00	70	6x9	20	8	50-18	3	F			
	COSC-20	43.00	25	5½	20	8	70-15.5	2	F			
	CSW-40	37.00	15	5	10	8	100-15	2	F/S			
	COSC-5A	43.00	20	5	5	8	125-14	2	F			
	COID-41/20	52.00	15	4x10	20	8	85-16.5	2	F			
	COID-57/20	52.00	15	5x7	20	8	85-16.5	2	F			
	AVID	Ten	225.00	5	6½		4	50-20 ±3	2	F	11½x7½x1½	
Five		175.00	4	4½		4	60-20 ±5	2	F/S	9¼x5½x1	Adapts to 6x9, 4x10, 5x7, 4x7.	
One		60.00	4	6x9		4	70-16 ±5		F	6½x9½		
RD-5		60.00	4	4½		4	60-8 ±5		F	5½x5½		
Ten+		275.00	4	6½		4	50-20 ±3	3	F		Combo of models Ten & RD-5.	
BON SONIC	IS700		20	6x9	20	8		3	F			
BOSE	1401	259.00†		4½	9.1		40-17		F	4½x1½	†Includes booster/EQ (see "EQ/Amps" section.)	
BRAUN	Output C	299.95	50	4		4	50-25	2	S	4¼x6¾x4¼		
CANTON	HC-100	249.90	50	4		4	48-30	2	S	7¾x4¾x5¾	Wedge-shaped.	
	AC-200	379.90		4			48-25	2	S	7¾x4¾x5¾	Self-amplified, 30 W/ch.	
CERWIN-VEGA	CS-7	90.00	40	6x9	24	4	50-16	2	F	6½x9½x3		
	CS-18	150.00	75	6x9	88	4	40-20	2	F	6½x9½x4½		
CLARION	SK102	149.95	25	4x10	10	8	70-15 ±5	3	F	14x4½x1½		
	SK103	166.50	30	6x9	20	8	50-15 ±5	3	F	13x7¼x2¼		
	SK105	69.95	40	3	5	8	1k-19k ±5	2	S	5½x3½x1½	Tweeter for SK106 or SK107.	
	SK106	69.95	50	6x9	20	8	50-4 ±5		F	9½x6¾x4	Woofer for SK105.	
	SK107	69.95	80	6	16	8	70-3 ±5		F	6½x6½x4	As above.	
	SK99B	136.95	25			8	60-20	3				
	SK95	37.95	30		10	4		2				
	SK40C	38.95	20		10	4		2				
	SK42C	36.95	30		4	4						
	SK44C	57.50	30		10	4		2				Door applications.
SK45C	63.50	35		20	4		2					
SK89C	66.95	40		20	4		2					
COBRA	SP-552-20	49.95	30	5½	20	6	70-15	2	S			
	SP-553-20	69.95	30	5½	20	6	65-18	3	S			
	SP-692-20	59.95	30	6x9	20	6	50-15	2	S/F			
	SP-693-20	79.95	50	6x9	20	6	50-18	3	S/F			
	SP-402-20	59.95	25	4x10	20	6	70-15	2	S/F			
	SP-403-20	79.95	25	4x10	20	6	70-18	3	S/F			
CRAIG	R731	99.95	50	5½	11	6	60-17 ±6		F	5½x2½		
	R732	119.95	50	5½	20	6	50-17 ±6		F	5½x2½		
	R771	129.95	50	6x9	20	6	50-17 ±6		F	6x9x3¾		
	R772	119.95	50	6x9	20	6	45-17 ±6		F	6x9x2½		

(Continued)

# SPEAKERS

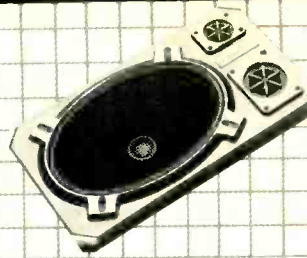

Cerwin-Vega CS-18

Clarion SK103

Cobra SP-403-20

MANUFACTURER	Model	Price, \$ (If Sold Individually)	Price, \$ (If Sold in Pairs)	Recommended Max. Power, Watts	Woofer Size, Inches	Magnet Size, Oz.	Impedance, Ohms	Frequency Response, Hz to kHz, ± dB	Two-way (2) or Three-way (3)	Flush Mount (F) or Surface Mount (S)	Overall Dimensions	Notes	
CRAIG (Continued)	V190	29.95	10	5½	3	6	100-15 ±6		S	6½x6½x4¼			
	V240	29.95	25	4x10	10	4	80-15 ±6		F	4¾x10x2½			
	V300	22.95	15	3½	5.4	8	130-13 ±6		F	3½x3½x1½			
	V301	34.95	15	4	8	6	120-20 ±6		F	4x4x2			
	V304	39.95	25	5¼	13	8	70-16 ±6		F	6½x6½x2½			
	V362	59.95	25	6x9	20	6	60-20 ±6	2	F	6¾x9¾x3½			
	V380	44.95	20	6½	10	8	80-10		S	9¼x7½x6			
	V451	179.95	40	4	20	4	60-20	4	F	†		†Three pieces.	
	V480	159.95	40	4	10	4	120-20	2	S	10½x4¾x6¼			
	V321	49.95	25	5¼	10	6	70-20 ±6	2	S	6½x6½x2½			
	V341	29.95	15	4x6	5.4	6	90-20 ±6		F	4x6x2			
	V350	74.95	25	6x9	20	6	65-16 ±6	3	F	6¾x9¾x3¾			
	V360	39.95	25	4x10	10	8	70-18 ±6	2	F	4¾x10½x2¾			
	R780	129.95	50	5¼	11	4	80-17 ±6		S	11¾x6¾x9			
	V101	18.95	8	4	4	6	120-14 ±6		F	4x4x2½			
	V102	19.95	8	5¼	3.6	6	90-16 ±6		F	6½x6½x2½			
V103	29.95	10	5¼	5.4	6	80-17 ±6		F	6½x6½x2½				
V180	22.95	7	3x5	4	4	140-15 ±6		S	7x3½x4				
DAHLQUIST	ALS-3	250.00	40	4		4	45-22	3	S	7½x4½x4			
DIMENSION	MK 100-2	109.95	60	5¼	30	4	55-20	2	F	5¼x5¼x3½			For use w/ASW-50 combining network. As above.
	MK 200-2	139.95	60	6x9	30	4	40-20	2	F	6½x9½x4¼			
	MK 200-3	159.95	60	6x9	30	4	40x22	3	F	6½x9½x4¼			
	MK 100-¼	49.95	60	5¼	30	4	55-5		F	5¾x5¾x3¾			
	MK 200-W	59.95	60	6x9	30	4	40-5		F	6½x9½x4			
	MK-IV	49.95	40	4	8	4	95-20 ±3	2	S	7½x4¾x4¾			
	MK-IB	99.00	45	4½	8	4	89-20 ±3	2	S	7¼x5¼x4½			
	MK-IBB	125.00	45	4½	8	4	89-22 ±3	2	S	7¼x5¼x4½			
EPI	LS-70	75.00	60	6	18	8	70-20 ±3	2	F or S	9¾x6¾x3¾		Add-on system with level control.	
	LS-81	190.00	60	4½	12	4	80-20 ±3	2	F or S	7¾x4¾x2½			
	CSS	90.00	60	3½	6	4	125-5		F	6x1¼			
ERA	A500	37.95	10	4½x8½		8	80-20		F,S	¾x6x10			
	A2000F	35.50	10	5¼		8	70-20		F	6½x7¾			
FUJITSU TEN	SSB-4B39	159.95	60	4	8	4	70-22	2	S	9x5x6¼			
	SSB-8G3	24.95	20	5	8	8	50-15		F				
	SSB-8G4	30.95	20	5¼	10	8	50-20		F				
	SSB-8G5	25.95	20	5x7	6.6	8	80-15		F				
	SSB-4G24	19.95	10	5	5.4	4			F				
	SSB-4G25	26.95	10	5¼	10	4			F				
	SSB-4G31	23.95	10	5x7	6.3	4			F				
	SSB-8B5	139.95	20	4	8	8	70-20	2	S				
	SSB-8G11	42.95	20	4	6.6	8	90-15		F				
	SSB-8G12	124.95	20	6x9	20	8	45-20		F				
	SSB-8G13	89.95	20	4x10	10	8	60-20		F				
	SSB-8G15	99.95	20	6x9, 6x8	8	8	50-20		S				
	FULTRON	15-9220	14.95	5	5	3	8	70-14		S	3½x7½x6¾		Treble control.
15-9240		21.95	7	5	5	8	60-14		S/F	5x6¼x6½			
15-9260		129.95	45	4	10	4	60-14.5	2	S	3¾x9½x6½			
15-9420		15.95	5	5¼	3	8	80-12		F	5¼x2			
15-9430		24.95	10	4	10	8	50-13		F	4¾x1¾			
15-9440		26.95	10	5¼	10	8	50-13		F	5¼x2½			

# SPEAKERS



Craig V451



Dimension MK-1 B

MANUFACTURER	Model	Price \$ (If Sold Individually)	Price \$ (If Sold in Pairs)	Recommended Max. Power, Watts	Woofer Size, Inches	Magnet Size, Oz.	Impedance, Ohms	Frequency Response, Hz to kHz, ± dB	Two-way (2) or Three-way (3)	Flush Mount (F) or Surface Mount (S)	Overall Dimensions	Notes
FULTRON (Continued)	15-9460	36.95	10	5 1/2	10	8	50-15	2	F	5 1/2 x 2 1/2	Alum. voice-coil.	
	15-9470	46.95	25	5 1/4	20	8	30-15	2	F	5 1/4 x 2 1/2	Alum. voice-coil.	
	15-9660	39.95	10	6x9	10	8	40-14	2	F	6x9x3 1/4	Alum. voice-coil.	
	15-9670	49.95	25	6x9	20	8	40-15	2	F	6x9x3 1/2	Treble control.	
	15-9665	79.95	25	5 1/4	10	8	45-16.5	3	F	10x6 1/2 x 2 1/2	Treble control.	
	15-9690	69.95	30	6x9	20	8	30-16	3	F	6x9x3 1/2	Alum. voice-coil.	
	15-9696	79.95	35	6x9	30	8	30-16	4	F	6x9x3 1/2	Alum. voice-coil.	
	15-9490	59.95	30	5 1/4	20	8	30-16	3	F	5 1/4 x 3	Alum. voice-coil.	
	15-9560	36.95	10	4x10	10	8	35-14.5	2	F	4x10x3 1/2	Alum. voice-coil.	
	15-9590	69.95	30	4x10	20	8	30-16	3	F	4x10x3 1/2	Alum. voice-coil.	
15-9610	24.95	5	6x9	3	8	50-13		F	6x9x3			
GRUNDIG	3050	43.95	60	4 1/2	15	4	50-20		F			
	3060	39.95	60	5 1/4	15	4	40-5		F			
	3070	44.95	60	6 1/2	15	4	30-5		F			
	GLA 1230	41.95	30	4 1/2	6	4	50-16		F			
	GLA 1640	24.95	40	5 1/4	9	4	65-19		F			
GLA 1845	32.95	45	5 1/4	12	4	65-20	2	F				
INFINITY SYSTEMS	Infinitesimal	184.00	100	5	18	4	65-32 ± 2	2	S	11x6x5 1/4		
INTERVOX	K6X9T20	94.35	25	6 x 9	20	8	60-20	3	F			
	K400C10	60.65	20	4	10	8	95-17	2	F			
	K525C20	62.50	25	5 1/4	20	8	95-18	2	F			
	K4X10C20	72.10	25	4 x 10	20	8	65-16.5	2	F			
	K500T10	77.65	15	5	10	8	70-17	3	F			
	K525T20	83.15	25	5 1/4	20	8	65-20	3	F			
	K4X10T20	94.35	25	4 x 10	20	8	65-20	3	F			
	K5X7T20	94.35	25	5 x 7	20	8	65-20	3	F			
	K6X9C20	72.10	20	6 x 9	20	8	60-17	2	F			
	B400C10	165.55	50	4	10	4-8	80-20	2	S			
JBL	A15	179.95	30	5 1/2 rd.	14	4	40-15	2	F	5 1/2 rd.		
	A30	219.95	40	6x9	20	4	30-15	2	F	6 x 9		
	LEBT-H	135.00	50	8	6 lb.	8	35-15		F	8 x 3		
	D208H	90.00	50	8	2 1/2 lb.	8	60-10		F	8 x 3 1/2		
	LE10H	125.00	150	10	10 1/4 lb.	8	30-3		F	10 x 4 1/2		
	LE5H	60.00	50	5	1 1/2 lb.	8	300-15		F	5 x 1 1/2		
LE21H	45.00	35	1 1/2	1 1/2 lb.	8	2-15		F	1 1/2 x 7/8			
JENSEN	J1033 Triax II	149.95	100	6x9	20	4	40-20	3	F	6 1/2 x 9 1/2 x 3 1/2		
	J1065 Triax I	119.95	50	6x9	20	4	40-20	3	F	6 1/2 x 9 1/2 x 3 1/2		
	J1201 Coax II	99.95	50	6 1/2	16	4	55-20	2	F	6 1/2 x 6 1/2 x 1 1/2		
	J1186 Coax I	69.95	40	4 1/2	10	4	65-18	2	S/F	4 1/2 x 4 1/2 x 2 1/2		
	J1044	74.95	35			4-8	1k-40k		S	3 x 5 1/2 x 1 1/2		
	JET SOUND LABS	JSL-1511	99.95	50	5 1/4	20	8	55-18	3	F	2 1/4 x 6 1/2 x 10 1/4	
JS-5010		25.95	15	5 1/4	10	4	90-12		F	6 1/2 x 2 1/2		
JSW-500		12.95	8	5	5	8	100-10		F/S	6 x 5 1/4 x 4		
JSW-1200		25.95	20	5	10	8	100-12		F/S	6 x 5 1/4 x 4		
JS-25		9.95	8	5	3	8	100-10		F	6 1/2 x 2		
JSL-563TX		49.95	50	5 1/4	20	8	55-18	3	F	6 1/2 x 2 1/2		
JSL-980TX		69.95	50	6x9	20	8	50-18	3	F	6 1/4 x 9 1/4 x 3 1/2		
JS-560CX		29.95	20	5 1/4	20	4	70-14	2	F	6 1/4 x 2 1/2		
JS-950CX		39.95	20	6x9	20	4	50-15	2	F	6 1/4 x 9 1/4 x 3 1/2		
JSL-1043TX		59.95	50	4x10	20	8	60-15	3	F	10 1/4 x 4 1/4 x 3 1/2		
JS-350		17.95	12	3 1/2	3	8	100-10		F	3 1/2 x 2 1/2		
KENWOOD	KSC-701	229.00	70	4		4	60-21	3	S	9x7 1/2 x 5		
	KSC-501	149.00	40	4		4	60-20	2	S	8 1/2 x 4 1/4 x 5		
	KFC-692	139.00	70	6x9	20	4	40-20	3	F			
	KFC-693	119.00	70	6x9	20	4	40-20	2	F			
	KFC-694	65.00	25	6x9	10	4	45-20		F			
	KFC-161	79.00	25	6 1/2	20	4	55-20	2	F			
	KFC-162	69.00	25	6 1/2	10	4	80-18	2	F			
	KFC-163	49.00	25	6 1/2	10	4	55-20		F			
	KFC-121	39.00	15	5	4.3	4	100-20		F			
	KRACO	TRI-469	89.95	40	5 1/4	20	8	70-19 ± 5	3	S	6x9x2 1/4	
TRI-369		69.95	20	6 x 9	20	8	60-17 ± 5	3	F	3 1/4 x 6 1/2 x 9 1/4		
TRI-3-410		69.95	30	4 x 10	12	8	150-20 ± 5	3	S	4 1/4 x 10 1/4 x 2 1/4		
CX-410-20-F		49.95	25	4 x 10	20	8	100-19 ± 5	2	F	4x10x3 1/2		
CX-269-20-F		49.95	15	6 x 9	20	8	150-15 ± 5	2	F	3 1/4 x 6x9 1/4		



# SPEAKERS

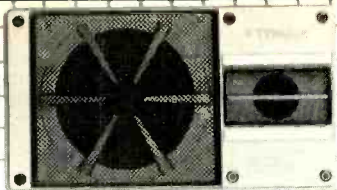

Fujitsu Ten SSB-4B39



Infinity Infinitesimal



JBL A15

MANUFACTURER	Model	Price, \$ (If Sold Individually)	Price, \$ (If Sold in Pairs)	Recommended Max. Power, Watts	Woofer Size, Inches	Magnet Size, Oz.	Impedance, Ohms	Frequency Response, Hz to KHz, ± dB	Two-way (2) or Three-way (3)	Flush Mount (F) or Surface Mount (S)	Overall Dimensions	Notes
KRACO (Continued)	VCS-2000	149.95	40	4 1/2	8	8	120-20 ±5	2	S			
	TRI-359	59.95	25	6 1/4	20	8	75-17 ±5	3	F	6 1/4 x 3 1/4		
	CX-1-20-F	39.95	10	5 1/4	20	8	150-6.5 ±6	2	S	6 1/4 x 2 1/2		
MARANTZ	SS-5000	300.00	15	6x9	13	4	30-20	2	S		7 1/4 x 1 1/4 x 7 1/4	
	SS-5100	250.00	15	6x9	13	4	30-20	2	F		1 3/4 x 1 1/4 x 7 1/4	
	SS-825	90.00	15	6 1/4	20	8	50-20	3	F		6 1/4 x 6 2 1/8	
	SS-725	70.00	15	6 1/4	20	4	50-16	2	F		6 1/4 x 6 x 2 1/8	
	SS-569	130.00	15	6x9	20	8	40-20	4	F		9 3/8 x 6 1/8 x 4	
	SS-469	110.00	15	6x9	20	8	40-18	4	F		9 3/8 x 6 1/8 x 3 3/8	
	SS-269	70.00	15	6x9	20	4	40-15	2	F		9 3/8 x 6 1/8 x 3 3/8	
	SS-169	60.00	15	6x9	20	4	40-13	2	F		9 3/8 x 6 1/8 x 3 3/8	
	SS-3469	110.00	15	6x9	20	8	40-18	4	F		9 3/8 x 6 1/8 x 3 3/8	
	SS-3269	80.00	15	6x9	20	4	40-15	2	F		9 3/8 x 6 1/8 x 3 3/8	
	SS-3410	80.00	10	4x10	20	4	50-20	2	F		10 x 4 1/4 x 2 1/8	
	SS-3357	100.00	15	5x7	20	8	50-20	3	F		7 1/4 x 5 x 3	
SS-140	40.00	4	4	10	8	40-13		F		4 x 1 1/8		
MATRECS	Domeplex 20	89.95	40	6x9	20	8	35-20	2	S		6 x 9 x 4 1/4	Alum. voice-coil with ferrofluid.
	Domeplex 30	119.95	75	6x9	25	8	40-20	2	S		6 x 9 x 4	As above.
	Domeplex 40	179.95	150	6x9	38	8	35-20	2	S		6 x 9 x 4 1/4	As above.
MESA ELECTRONICS	15	140.00	30	3		4-8	60-20 ±6	2	S		6 x 3 3/8 x 3	
	30	69.95†	110.00	50	4	4-8	60-25	2	S		7 1/4 x 4 3/8 x 4 1/4	† Kit.
	MB5	74.95†	15	5 1/4	30	4-8	42-200Hz		F		5 1/2 rd.	
	MB6		30	6x9	30	4-8	37-200Hz		S		6x9	
	25-E	140.00	35	3		4	60-20	2	S		3 3/8 x 8 x 3 3/8	
20-ZX	110.00	30	3 1/2		4	60-20	2	S		8 1/2 x 4 1/4 x 6		
MICRON	400 Series	125.00	100	4		4-8	125-20	2	S		7 1/4 x 5 1/8 x 6 1/8	Opt. walnut, black, or white finish.
	500 Series	150.00	120	5 1/4		4-8	100-20	2	S		9 x 5 1/4 x 7 3/8	As above.
	600 Series	200.00	200	6 1/2		4-8	70-20	3	S		11 1/8 x 7 1/8 x 7 3/8	As above.
MITSUBISHI	SX-30SA	149.95	50	4	6.5	4	80-20	2	S		4 1/2 x 7 1/8 x 5 1/2	
	SX-10BA	129.95	50	4	6.5	4	95-15	2	S		4 1/2 x 7 1/8 x 5 1/2	
	SB-25A	39.95	20		0.028	4	5-20		S			Signal indicator.
	SG-69QA	119.95	20	6x9	21	4	50-20	4	F			
	SG-69TA	99.95	20	6x9	21	4	50-20	3	F			
	SG-69CA	79.95	20	6x9	21	4	50-20	2	F			
	SG-40CA	69.95	20	4x10	10	4	50-20	2	F			
	SG-13WA	49.95	20	5 1/4	6.4	4	75-15	2	F			
	SG-10WA	39.95	20	4	5.3	4	100-7	2	F			Waterproof cover.
	NORTHSTAR ELECTRONICS	NS 3296	49.95	15	6x9	20	8	30-19 ±5	3	F		6 x 9 x 3 1/2
NS 1196		29.95	12	6x9	10	8	30-18 ±5		F		6 x 9 x 3	
NS 155T		24.95	6	5 1/4	5.4	8	80-16 ±5		F		5 1/2 x 5 1/2 x 1 1/2	
NUMARK	MS100	149.95	50	4		4	40-25	2	S		7 x 4 x 4	
OROVOX	M 124	195.80	85	6x9	30	8	35-22	3	F		6x9, 3 1/2 x 7	
	M 112	179.80	80	5 1/4	30	8	45-22	3	F		5 1/4 x 3 1/2 x 7	
	M 120	159.25	80	6x9	30	8	35-22	2	F		6x9	
	XL 620C	103.20	50	6x9	20	8	50-22	2	F		6x9	
	M 75	171.20	40	4	10	8	75-22	2	S		8 x 4 x 4	
PANASONIC	EAB-915	29.95	10	4	7	4	50-15		F			
	EAB-752A	69.95	10	6x9	20	4	45-20	2	F			
	EAB-814	64.95	10	4x10	10	4	60-20	2	F			
	EAB-920	159.95	50	6x9	30	4	30-25	3	F			
	EAB-911	34.95	10	5	7	4	50-15		F			
	EAB-940	99.95	50	6x9	20	4	40-20	2	F			
	EAB-930	89.95	50	5 1/4	20	4	50-20	2	F			
	EAB-050	44.95	10	5	4.7	4	50-16		F			
	EAB-030	19.95	10	3 1/2	3.2	4	100-20		F			Built-in water shield. Rear deck application. Door application. Waterproof cone, door application. In-dash mounting. Door application.
	EAB-914	24.95	5	4	3	4	65-14		F			

# SPEAKERS



Jensen JT201 Coax II



Kenwood KSC-701



Mitsubishi SX-30SA

MANUFACTURER	Model	Price \$ (If Sold Individually)	Price \$ (If Sold in Pairs)	Recommended Max. Power, Watts	Woofer Size, Inches	Magnet Size, Oz.	Impedance, Ohms	Frequency Response, Hz to kHz, ± dB	Two-way (2) or Three-way (3)	Flush Mount (F) or Surface Mount (S)	Overall Dimensions	Notes	
PIONEER	TS-M2	44.95	10	2%	3	4	450-20			S	3x1 1/4x4 1/2		
	TS-T3	59.95	30	3 1/2	6 1/2	4	250-20			F	4x4 1/2x2 3/4		
	TS-W203	169.95	30	8	20	4	28-10			F	8 1/4x7 1/2x3 3/4		
	TS-202	199.95	30	8	20	4	30-20	2		F	8 1/4x7 1/2x3 3/4		
	P-10L	24.95	4	4	3 1/4	4	70-12			F	4 1/2x4 1/4x1 1/2		
	P-16L	27.95	4	6 1/2	3 1/4	4	60-13			F	6 1/2x1 1/4		
	TS-100	29.95	4	4	7	4	50-14			F	4 1/2x4 1/2x1 1/2		
	TS-120	36.95	4	5 1/2	3	4	80-16			F	5 1/2x1 1/2		
	TS-160	39.95	8	6 1/2	10	4	40-20			F	6 1/2x2 1/2		
	TS-121	41.95	8	5 1/2	4	4	80-16			F	5 1/2x1 1/2		
	TS-106	44.95	10	4	7	4	50-16			F	4 1/2x4 1/2x1 1/2		
	TS-107	49.95	10	4	6 1/2	4	50-20			F	6 1/2x2 1/2		
	TS-162DX	55.95	8	6 1/2	10	4	40-20	2		F	6 1/2x2 1/2		
	TS-164	59.95	8	6 1/2	10	4	40-16	2		F	6 1/2x2 1/2		
	TS-165	69.95	8	6 1/2	20	4	30-16	2		F	6 1/2x2 1/2		
	TS-167	72.95	8	6 1/2	10	4	30-20	2		F	6 1/2x2 1/2		
	TS-168	124.95	20	6 1/2	10	4	35-20	3		F	6 1/2x2 1/2		
	TS-410	44.95	10	10	10	4	45-13	2		F	10x4 1/2x2 1/2		
	TS-411	69.95	10	10	10	4	45-18	2		F	10x4 1/2x2 1/2		
	TS-571	59.95	10	8	10	4	50-18	2		F	8 1/2x5x2 1/2		
	TS-681	69.95	10	8	10	4	45-18	2		F	8x5 1/2x2 1/2		
	TS-691	49.95	8	6x9	10	4	40-16	2		F	9 1/2x6 1/2x3		
	TS-692	63.95	10	6x9	20	4	35-16	2		F	9 1/2x6 1/2x3		
	TS-693	71.95	8	6x9	10	4	40-16	2		F	9 1/2x6 1/2x3		
TS-694	85.95	10	6x9	20	4	35-18	2		F	9 1/2x6 1/2x3 1/2			
TS-696	119.95	20	6x9	20	4	30-20	2		F	9 1/2x6 1/2x3 1/2			
TS-695	139.95	20	6x9	20	4	30-20	3		F	9 1/2x6 1/2x3 1/2			
TS-5	29.95	4	5 1/4	3	4	180-13			S	8 1/2x5 1/2x4 1/4			
TS-35	44.95	20	5 1/4	5	4	180-13			S	8 1/2x6 1/4x4 1/4			
TS-X6	104.95	4	5	4	4	80-20	2		S	9 1/2x5 1/2x6 1/4			
TS-X9	209.95	20	3 1/2	7	4	50-22	2		S	8 1/2x5 1/2x7 1/4			
POLK AUDIO	Mini-Monitor II	114.95	60	4 1/2	6		60-20.5 ±2	3		S	13 1/2x6x4 1/4	Fluid-coupled sub-bass radiator.	
PSB SPEAKERS	Alpha II	220.00	15	4	4		100 - 21 ±2.5	2		S	9 1/2x5 1/4x5 1/4		
PYLE INDUSTRIES	F52C165-FP	49.60	110.85	30	5 1/4	16	4-8	60-20	2	F	5 1/2x5 1/4x2 1/2		
	F52C165-FP4	50.40		30	5 1/4	16	4	60-20	2	F	5 1/2x5 1/4x2 1/2		
	F69C190-FD	72.10	154.15	60	6x9	20	4-8	50-20	2	F	6 1/2x9 1/2x4		
	F69C290-FD	82.50	170.00	100	6x9	30	4-8	50-20	2	F	6 1/2x9 1/2x4 1/4		
	F69C290-FD4	83.25		100	6x9	30	4	50-20	2	F	6 1/2x9 1/2x4 1/4		
	F410C160-FP	49.90	109.90	30	4x10	16	4-8	60-20	2	F	4 1/2x10x3		
	F52C100-FP	42.50	95.85	20	5 1/4	10	4-8	65-20	2	F	5 1/2x5 1/4x2 1/2		
	F69C100-FP	49.90	110.85	30	6x9	10	4-8	55-19.5	2	F	6 1/2x9 1/2x3 1/4		
	F69C190-FP	59.90	129.15	60	6x9	20	4-8	40-19.5	2	F	6 1/2x9 1/2x4		
	F69C290-FP	68.25	147.50	100	6x9	30	4-8	50-19.5	2	F	6 1/2x9 1/2x4 1/4		
	F410C100-FP	43.25	99.15	30	4x10	10	4-8	65-20	2	F	4 1/2x10x3		
	F35C30-WF	19.60		16	3 1/2	3	4-8	50-17.5	2	F	3 1/2x4 1/2x1 1/2		
	F5C99-WF	22.90		18	5	10	4-8	90-18	2	F	5x2 1/2		
	F6C100-WF	25.60		30	6	10	4-8	30-18	2	F	6 1/2x2 1/2		
	F57C100-WF	25.60		28	5x7	10	4-8	60-18	2	F	5x7 1/2x2 1/2		
	F69C100-WF	24.15		30	6x9	10	4-8	55-18	2	F	6 1/2x9 1/2x3		
	F69C100-WF	26.60	69.90	30	6x9	10	4-8	55-18	2	F	6 1/2x9 1/2x3		
	F410C100-WF	26.25	65.60	30	4x10	10	4-8	65-18	2	F	4 1/2x10x2 1/2		
	P-G52N		11.25		5 1/4						F	6 1/2 rd.	
	G69ND	6.60			6x9						F	6 1/2x9 1/2	
G410ND	6.25			4x10						F	5 1/2x10 1/2		
W6C170-F	33.25		70	6	16	4-8	45-7.5		F	6 1/2x3 1/2			
W69C190-F	39.90		70	6x9	20	4-8	45-7.5		F	6 1/2x9 1/2x3 1/2			
W69C290-F	50.85		100	6x9	30	4-8	40-7		F	6 1/2x9 1/2x4			
W69C290-F4	51.60		100	6x9	30	4-8	40-7		F	6 1/2x9 1/2x4			
P-T3PA		31.60		3			3k-30k		F	3 1/2x 1/2			
PYRAMID MOBILE AUDIO	MA-TC1	374.56	100	6 1/2	20	4	35-22 ±3	3		F	7x11 1/2x3		
QUAM-NICHOLS	30C25Z8	8.75	3	3 Sq.	2.35	8-10		200-12			3x3x1 1/4		
	3C3Z8U	10.60	4	3 1/2 Sq.	3	8-10		180-9			3 1/2x3 1/2x1 1/2		
	5C3Z8	9.75	4	5	3	8-10		90-13			4 1/2x4 1/2x1 1/2		
	52C10Z8	14.95	10	5 1/4	10	8-10		125-9			5 1/2x5 1/4x2 1/2		
	52C10FEX	17.25	15	5 1/4	10	8-10		75-15			5 1/2x5 1/4x2 1/2	Air suspension.	
	52C10FEXZ4	17.25	15	5 1/4	10	3-4		75-15			5 1/2x5 1/4x2 1/2	As above.	
	68C20FEX	23.85	15	6x8	20	8-10		45-17			5 1/2x8x3 3/4	As above; Ford replacement	
	69C10FEX	19.25	15	6x9	10	8-10		45-17			6 1/2x9x3 1/2	Air suspension.	
	69C10FECO	33.95	15	6x9	10	8-10		45-20	2		6 1/2x9x3 1/2	As above.	
69C30FEX	37.75	40	6x9	28	4-8		35-15			6 1/2x9x3 1/2	As above.		

# SPEAKERS

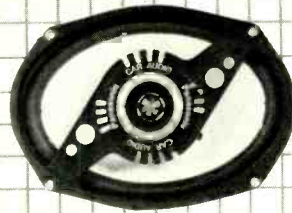

Panasonic EAB-940



Pioneer TS-W203

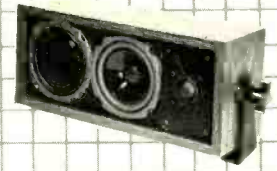

Polk Audio Mini-Monitor II

MANUFACTURER	Model	Price, \$ (If Sold Individually)	Price, \$ (If Sold in Pairs)	Recommended Max. Power, Watts	Woofer Size, Inches	Magnet Size, Oz.	Impedance, Ohms	Frequency Response, Hz to kHz, ± dB	Two-way (2) or Three-way (3)	Flush Mount (F) or Surface Mount (S)	Overall Dimensions	Notes
RCA	12R410	39.75	30	6½	20	4	65-15	2	F	6x2¼	Alum. voice-coil.	
	12R411	53.95	30	6½	20	4	65-18	3	F	6x2¼		
	12R412	47.75	30	6x9	20	4	65-15	2	F	6x9x3½	As above.	
	12R413	64.50	30	6x9	20	4	65-18	3	F	6x9x3½		
	12R414	47.75	30	4x10	20	4	65-15	2	F	4x10x2½	As above.	
	12R415	64.50	30	4x10	20	4	65-18	3	F	4x10x2½	Dual cone.	
	12R400A	19.50	10	5¼	4.6	3.2	50-10		F or S	6¼x6¼x3½	As above.	
	12R401E	17.50	10	5¼	4.6	3.2	50-10		F	5¼x5¼x1½	As above.	
	12R409	14.30	25	3	5	4	90-13		F	4¼x1½	As above.	
	12R405A	29.00	25	6x9	10	4	50-15		F	6¼x10x3½	As above.	
	12R406A	35.00	25	6x9	20	4	50-15		F	6¼x10x3½	As above.	
	12R416	21.00	30	4	10	4	65-15		F	4¼x1½	As above.	
	12R408A	23.00	25	6	10	8	80-11		F	6½x2½	As above.	
	RADIO SHACK	40-1297	12.95	30	4x10	10	8			F		
12-1844		17.95	20	5¼	4¼				S	7x7¼		
12-1843		17.95	20	5¼	4¼				F			
40-1280		16.95	30	6x9	10	8	40-16		F			
40-1288		12.95	30	5x7	10	8			F			
40-1000		24.95	30	6x9	20	8	20-20		F			
40-1340		19.95	35	6x9	16	8	40-40		F			
12-1851		10.95	5	5					F			
12-1852		10.95	5	5					F			
12-1848		29.95	30	5¼	10				F			
40-1010		29.95	50	6	16	8		2	F			
12-1849		27.95	20	5¼	8				S			
12-1855		27.95	20	5¼					F		Moisture seal for doors.	
12-1854		79.95	40	5¼				3	F			
12-1853		59.95	40	5½				2	S			
40-1256		49.95	60	6x9	20			3	F			
40-1255	39.95	60	6x9	20	8		2	F				
ROYAL SOUND	RS-6045N	150.00	50			8	80-20		S	6¼x4x4¼		
	RS-1000	300.00	100	10		8	20-15		F	11¼x6¼		
	RS-6030	120.00	30			4	100-20		S	6x3¼x3		
	RS-800	135.00	75	8		8	20-13		F	8¼x3¼		
	RS-6100	200.00	100			4	45-20		S	7¼x4¼x5½		
	RS-35B	70.00	100	2½		8	1.4k-5k		F	1¼x4½		
	RS-25CA	45.00	75	2		8	1.2k-20k		F	3¾x1¾x3¾		
	RS-10B	90.00	75	1		8	1.5k-20k		F	1½x4½		
SANYO	SP412	99.95	30	4x10	16	4	70-20	3	F	4x10x3		
	SP40	59.95	30	4	8	4	70-20	2	F	4 dia.		
	SP69A	219.95	120	6x9	30	4	40-20	3	F	6x9		
	SP90	219.95	120	4	12.6	4	80-20	2	S	9¼x7x5¼		
	SONY	XS-1	299.95	100	5		4	90-40 ±3	2	S	10½x5½x 7¾	
XS-11		229.95	70	5		4	90-19 ±3	2	S	9x5½x7¾		
XS-21		199.95	50	4		4	80-20 ±6	2	S	8¾x5¾x4¾		
XS-M33		199.95	70	6½		4	35-30 ±6	2	F	7¼x7¼x6¼	Self-contained amp, 12 W/ch. into 4 ohms, 30-20k, 0.8% THD. As above.	
XS-M31		159.95	50	5		4	40-18 ±6		F	5¼x5¼x5		
XS-62		109.95	40	6x9	20	4	55-18 ±6	2	F	6¼x9¼x4		
XS-63		139.95	40	6x9	20	4	55-18 ±6	3	F	6¼x9¼x4		
XS-66		159.95	80	6x9	40	4	50-18 ±6	3	F	6¼x9¼x4¼		
XS-43		139.95	40	4x10	20	4	65-18 ±6	3	F	4¼x10¼x3¾		
XS-611S		39.95	25	6½	6.5	4	70-15 ±6		F	7¼x1½		
SX-613S		64.95	25	6½	6.5	4	70-18 ±6	2	F	7¼x1½		
XS-601		149.95	70	6½		4	70-20 ±6	3	F	7¼x7¼x3¾		
XS-602		129.95	70	6½		4	70-19 ±6	2	F	7¼x7¼x3¾		
XS-201		79.95	50	5		4	80-17 ±6		F	5¼x5¼x2½		
XS-202		99.95	50	5		4	80-19 ±6	2	F	5¼x5¼x2½		
XS-203	49.95	25	5		4	80-18 ±6		F	5¼x2½			

# SPEAKERS



PSB Alpha II

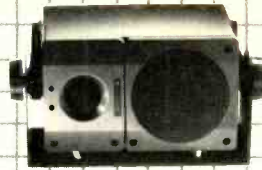

Royal Sound RS-6100



Sparkomatic SK-6950

MANUFACTURER	Model	Price, \$ (If Sold Individually)	Price, \$ (If Sold in Pairs)	Recommended Max. Power, Watts	Woofer Size, Inches	Magnet Size, Inches	Impedance, Ohms	Frequency Response, Hz to kHz, ± dB	Two-way (2) or Three-way (3)	Flush Mount (F) or Surface Mount (S)	Overall Dimensions	Notes
SPARKOMATIC	SK-6950	99.95	100	6x9	20	4	50-20	4	F	6 1/2 x 9 1/2 x 4		
	SK-650	69.95	100	6	20	4	70-20	4	F	6 1/2 x 9 1/2 x 4		
	SK-600	39.95	15	5x7	20	4-8	70-15	2	F	6 1/2 x 6 1/2 x 1 1/2		
	SK-522T	59.95	40	5x7	20	4	60-17	3	S	8 x 6 x 5 1/2		
	SK-4120C	47.95	25	4x10	20	4	50-15	2	F	4 1/2 x 10 x 3 3/4		
SPECO	DMS-2	125.00	30	3 1/2	5	8	60-20	2	S	5 7/8 x 3 7/8 x 3		
	DMS-3	165.00	50	4	10	8	55-20	3	S	7 1/2 x 4 3/4 x 4 3/4		
	SK6930TD	155.00	100	6x9	30	4x8	50-20	3	F	6x9		
	SK6930CD	138.00	100	6x9	30	4x8	50-20	2	F	6x9		
	SK5A5S	35.75	20	5	8	8	110-10	2	F	5 dia.		With rainshield.
	SK69CA20Q-G	103.95	60	6x9	20	8	50-20	4	F	6x9x4		
	SK69CA20T-G	86.00	60	6x9	20	8	50-20	3	F	6x9x3 1/2		
	SK69CA20C-G	69.35	50	6x9	20	8	50-20	2	F	6x9x3 1/4		
	SK69CA10C-G	58.35	30	6x9	10	8	55-20	2	F	6x9x3 1/4		
	SK69CA27W-G	70.20	50	6x9	27	8	50-15	2	F	6x9x3		
	SK69CA20W-G	54.15	50	6x9	20	8	55-15	2	F	6x9x3		
	SK69CA10W-G	44.35	30	6x9	10	8	55-15	2	F	6x9x2 1/4		
	SK410CA20C-G	69.35	40	4x10	20	8	50-20	2	F	11 1/4 x 12 1/4 x 3 3/4		
	SK410CA20W-G	56.90	35	4x10	20	8	50-18	2	F	11 1/4 x 12 1/4 x 3 3/4		
	SK410CA10W-G	47.10	30	4x10	10	8	50-15	2	F	11 1/4 x 12 1/4 x 3 3/4		
	SK410CF10W-G	41.50	20	4x10	10	8	140-18	2	F	4 1/2 x 11 x 4 1/4		
	SK410CF5W-G	36.00	10	4x10	5	8	140-18	2	F	4 1/2 x 11 x 4 1/4		
	SK51CA20T-G	86.00	50	5 1/2	20	8	80-20	3	F	5 1/2 dia.		
	SK51CA20C-G	58.15	30	5 1/2	20	8	130-20	2	S	14 x 7 1/4 x 3 1/2		
	SK51CA10C-G	52.65	20	5 1/2	10	8	130-20	2	S	5 1/2 dia.		
	SK51CA10W-G	41.50	30	5 1/2	10	8	80-15	2	S	5 1/2 dia.		
	SK51CF5W-G	30.40	10	5 1/2	5	8	125-20	2	S	5 1/2 dia.		
SK51CF3W-G	27.65	10	5 1/2	3	8	125-20	2	S	5 1/2 dia.			
SK4CA10C-G	51.25	4	4	10	8	30-17	2	F	11 1/4 x 5 x 3 3/4			
SK4CA10-G	41.50	4	4	10	8	90-18	2	F	11 1/4 x 5 x 3 3/4			
SK4CF3-G	26.25	4	4	3	8			F	6 1/4 x 5 1/2 x 4			
TRUSONIC	K6943	199.00	10	6x9	40	4	25-25	3	F	6x9x4 1/4		Waterproof, bi-amp capable, alum. voice-coil.
	K6942	169.00	10	6x9	40	4	25-25	2	F	6x9x4 1/4		As above.
	K6923	174.00	10	6x9	20	4	30-25	3	F	6x9x3 3/4		As above.
	K6922	144.00	10	6x9	20	4	30-25	2	F	6x9x3 3/4		As above.
	K5722	124.00	10	5x7	20	4	40-25	2	F	5x7x3 3/4		As above.
	K6042	149.00	10	6 1/2	40	4	35-25	2	F	6 1/2 x 3		As above.
	K6022	124.00	10	6 1/2	20	4	40-25	2	F	6 1/2 x 2 1/2		As above.
	K6941	145.00	10	6x9	40	4	25-2	1	F	6x9x4		As above.
K6021	110.00	10	6 1/2	20	4	40-2	1	F	6 1/2 x 2 1/2		As above.	
ULTRALINEAR	M14	149.95	40	4	16 1/2	4-8	53-18	2	S	7 1/2 x 4 3/4 x 4 3/4		
VISONIK	D 4000	110.00	50	4	4	4-8	50-25	2	S	6 3/4 x 4 1/2 x 4 1/2		
	D 5000	130.00	50	4	4	4-8	+4, -8	2	S	6 3/4 x 4 1/2 x 4 1/2		
	Tri-phase Components	200.00	100	6x9	4	4	40-18	3	F	±4		
Co-Phase Components	150.00	80	6x9	4	4	40-18	2	F	±4			
ZAPCO	W6915304	46.00	75	6x9	30	4			F			
	W6915308	46.00	75	6x9	30	8			F			
	W815308	46.00	75	8	30	8			F			
	T-108	48.00					5k-20k		F			

# JVC introduces a tonearm that out-thinks warps and resonances.

Ideally, a stylus should operate in a resonance-free environment where it can respond to groove modulations and nothing else.

That, unfortunately, has been a tall order for tonearm designers. Because minimizing one kind of resonance makes the arm susceptible to other kinds.

Low-mass arms are the least susceptible to warp-induced resonances. But they're the most likely to have structural resonances which color the sound of the music.

Higher-mass arms are less likely to have structural resonances. But they may have trouble negotiating warps and large groove modulations, especially with high-compliance cartridges.

JVC engineers have attacked this problem by developing a tonearm that "thinks". Called the Electro-Dynamic tonearm, it causes the stylus to "see" ideal effective mass, even though the arm itself is medium-mass and very rigid.

Whenever a surface warp or eccentricity begins to create abnormal arm movement, two motors provide instant dynamic compensation. So the arm is not "thrown"

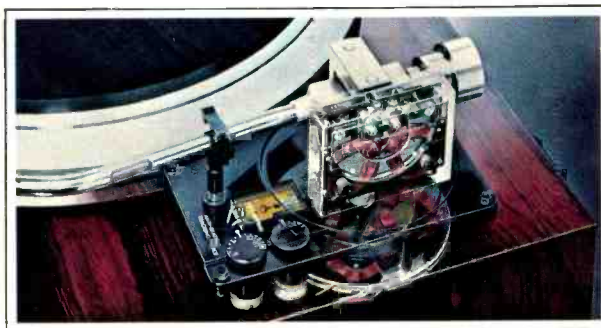

by forces of inertia, momentum and gravity. The stylus remains properly seated in the groove. As a result, you hear stunning clarity (because of reduced IM distortion), stable stereo imaging and superb tracking of even the most difficult groove modulations.

As exciting as our E-D system is, you should not overlook the qualities of the turntables that feature it.

The QL-Y5F, for example, includes a double-servo quartz system which regulates platter rotation with greater accuracy than single-servo systems. The heavy platter and high-torque, coreless DC direct drive motor sustain a very high moment of inertia, avoiding the transient speed variations that can color sound timbres. Front-panel switches control the up/down and left/right movement of the arm, without the user ever having to touch the arm itself.

If your system can benefit from a turntable of this caliber, you will undoubtedly want to evaluate the QL-Y5F and its E-D tonearm for yourself. Please dial 800-221-7502 for the location of your nearest JVC dealer (in New York State 212-476-8300).

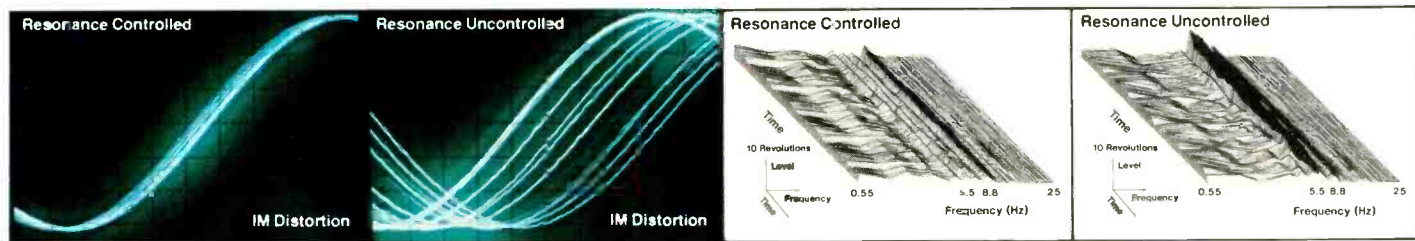

58-75 Queens Midtown Expressway, Maspeth, N.Y. 11378.

**JVC**  
US JVC CORP.

Enter No. 9 on Reader Service Card

# AMPS/ EQUALIZERS

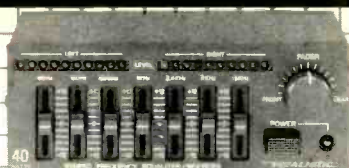

Radio Shack 12-1862



Sparkomatic GE-1000



Zapco PEQ

MANUFACTURER	Model	Price	Amp=Amplifier; EQ=Equalizer; Both=Both	Number of Bands of EQ	Separate Controls for Each Stereo Channel?	Boost/Cut Range, dB	Watts into 4 ohms	% THD at Rated Output	Dimensions, inches
PYRAMID MOBILE AUDIO (continued)	MA-7P	99.95	EQ	7	Yes	±12			1½x5½x1¼
	MA-100	174.95	Amp				50	1	2x4x6
	MA-100B	217.96	Amp				50	0.03	1½x4x6
	MA-270	399.90	Amp				135	0.05	3x6x11
RCA	12R906	44.75	Amp		No		20	10	5½x4x1¼
RADIO SHACK	12-1860	27.95	Amp	5	No	±12	12	10.0	
	12-1861	69.95	Both	5	No	±12	20	10.0	
	12-1863	49.95	Both	5	No	±12	20	10.0	
	12-1862	79.95	Both	7	No	±12	20	10.0	
ROYAL SOUND	EA-600	120.00	Both	5	No	±12	20	0.3	2½x7½x6¾
	RA-6000	350.00	Amp				60	0.2	2½x7½x9¾
	RC-2000	350.00	EQ	7	No	±12			2½x7½x5¾
	RA-600N	130.00	Amp				20	0.2	1½x6¾x5¾
SANYO	PA6060	219.95	Amp				30	0.05	3x4½x7¾
	PA6120	279.95	Amp				60	0.05	3½x7½x14
	EQZ6200	79.95	EQ	7	No	±12		0.1	2x6½x4¾
	EQZ6400	109.95	EQ	7	No	±12		0.1	2x7½x5
SONY	XE-9 Preamp	114.95	EQ	9	No	±12		0.05	5½x1½x7¾
	XM-1	299.95	Amp				70	0.08	5½x1¼x10¼; Class "D" digital.
	XM-41	89.95	Amp				20	0.06	5½x1½x6¾
	XM-21	59.95	Amp				6	0.06	5½x1½x4¾
	GB-40	99.95	Amp				20, 4x6	0.5	5½x1½x7¾; mtkc mixing, fader.
SPARKOMATIC	GE-1000	189.95	Both	7	No	±12	100	0.01	7½x2½x9¼
	GE-500	89.95	Both	5	No	±12	45	10	Visual response curve on illuminated screen.
	LC-101	49.95	Amp		No	±10	36	10	5½x1½x6¾
	LC-50	29.95	Amp				36	10	4x1½x5
VISONIK	A-401	128.00	Amp		No	±12	40	0.25	2½x5½x6
	AS-2000	120.00	Bass Amp				60 (Mono)	0.25	5½x6½x2; resp. 30Hz-160Hz.
	PA-1	130.00	EQ Preamp	3	No	±15		0.01	7x1½x4
ZAPCO	150-L	375.00	Amp				150	0.2	5½x5½x1¼; power supply, 7x8x2½.
	150-L w/ESM	440.00	Amp				165	0.2	Units as above.
	150-LA incl. ESM	460.00	Amp				155	0.08	Units as above.
	PEQ	265.00	EQ	9	Yes	±18			1½x4½x8¾; incl. preamp, sep. vol. contr., var. gain, clipping ind., on/off switch.

# JBL's new L112.

Lower, higher, faster, flatter.



Listen to years of research at the leading edge of transducer engineering.

Lasers, holography, computers and the human ear interfacing toward one end: a new state-of-the-art in bookshelf loudspeakers. ... JBL's new L112.

**Lower.** The L112's Symmetrical Field Geometry 12" woofer, with its larger 3" voice coil and specially-coated cone, delivers the low notes of music with extremely low distortion. Lower than any other bookshelf speaker we've ever tested. You'll hear crisp, clean, powerful bass all the way down to the

lowest notes.

**Higher.** A new vapor aluminum-coated lightweight phenolic Dome Radiator was developed through the use of laser holography. This laser research helps our engineers examine tweeter cone movement like an X-ray allows physicians to examine the human body. Diaphragm excursions have been refined for exceptionally smooth response, maximum stereo imaging and high-power handling. You'll hear harmonics you've never heard before.

**Faster.** JBL's new High Resolution Dividing Network enables

the L112 to deliver transients with startling immediacy. It controls each of the L112's drivers throughout their full operating range. You'll hear sound so coherent, it will seem that only one extremely wide-range transducer is responsible—not three!

**Flatter.** The flat frequency response measurements of the L112 qualify this speaker as the most accurate bookshelf performer we've tested in JBL history.

The L112 represents more than engineering excellence. It's also excellence in quality assurance and manufacturing. In JBL's ma-

chine shop, we hold tolerances on the L112 components such as pole pieces to 2/10,000ths of an inch! These are tolerances normally found only in aerospace technology.

Each speaker is crafted in the USA at our Northridge, California facility, inspected and tested at over 50 test stations and beautifully hand-finished with oiled and rubbed American walnut veneer.

Listen to musical reproduction at technology's leading edge. At your JBL dealer.

James B. Lansing Sound, Inc.,  
8500 Balboa Blvd.,  
Northridge, CA 91329.

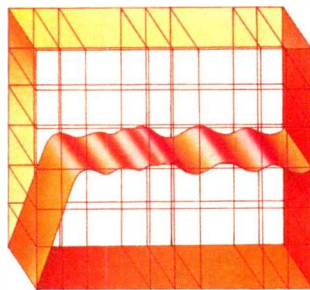
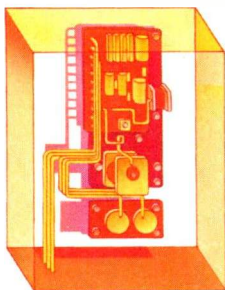
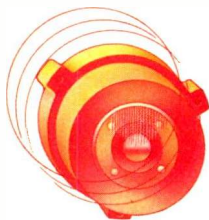
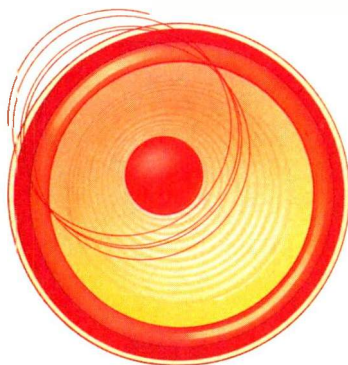

JBL First with the pros.

Enter No. 8 on Reader Service Card

© 1980 James B. Lansing Sound, Inc.

# DON'T LET YOUR EGO STAND BETWEEN YOU AND BETTER SOUND.

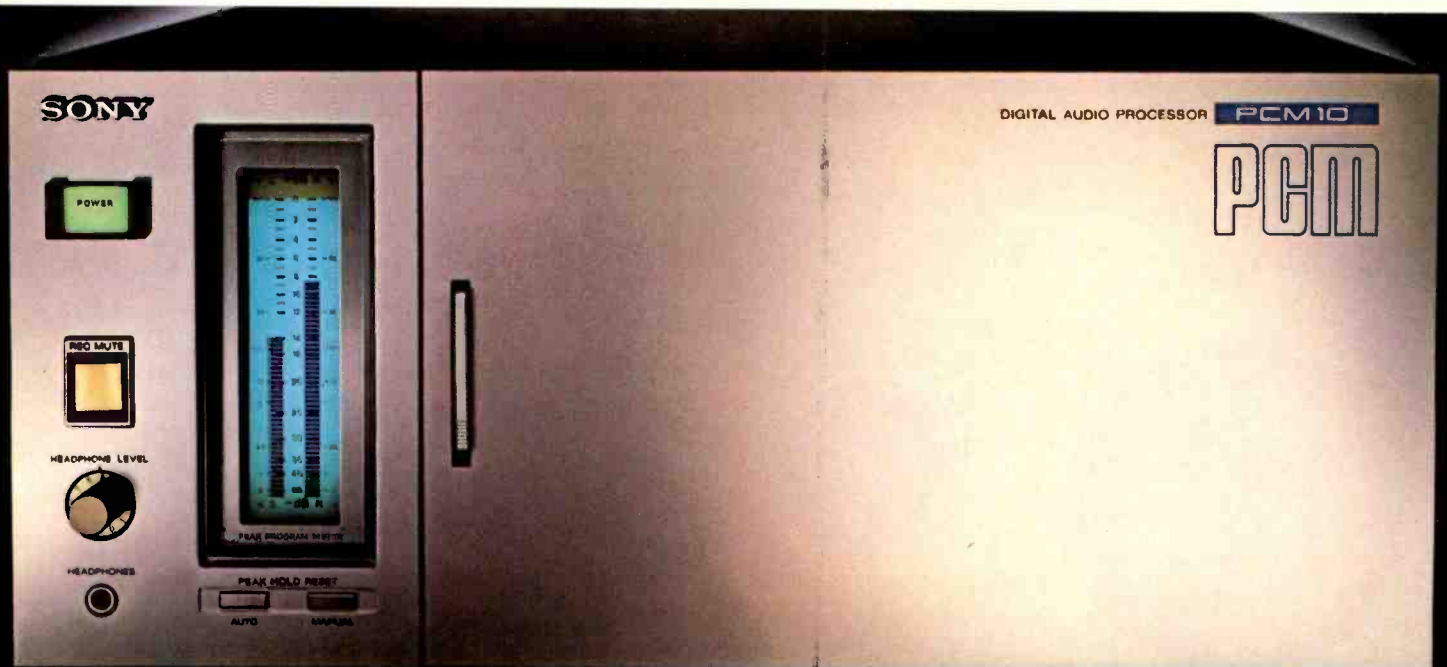

PCM 10 TWO CHANNEL DIGITAL AUDIO PROCESSOR: Advanced sampling and quantization of musical signals / Specially designed to be used with home-use video tape recorders such as Sony Betamax™ / 14-bit quantization (12-bit, 3 polygonal linear) provides better than 85 dB dynamic range / Frequency response DC-20 kHz  $\pm$  1 dB / Features include liquid crystal (LCD) Peak Program Meters and Record Mute control / Conforms to EIAJ standard form at.



PS-B80 TURNTABLE: Velocity Feedback (VFB) electronically controlled tone arm system allows automatic tracking, antiskating, and tone arm damping operation / Microprocessor-programmable functions and replay flexibility / Quartz X-tal locked, fully automatic DD turntable, with high-torque BSL motor and Magnedisc servo control / SBMC chassis material, with height-adjustable viscous feet.

XL-55 PRO CARTRIDGE: Sony developed figure 8 moving-coil voltage generating system / 'Air core' armature design, with multiple cantilever construction / Integrated magnesium die-cast low-resonance head shell.



There are those who insist that the most sophisticated audio equipment can only be produced by relatively unknown companies.

At Sony, we take exception to this unwarranted position.

First, because there's probably no audio company in the world that can match the technological resources and research facilities of Sony.

Second, because it is our contention that the Sony Audio Lab components pictured here represent the absolute state of the audio art.

And finally, because no other audio company can match Sony's record for innovation and quality.

So the point of all this is simple.

If you're looking for the ultimate in audio equipment and you find yourself unduly prejudiced at the sight of our name, do us both a big favor.

Close your eyes. And just listen.

**SONY**  
High Fidelity

© 1980 Sony Industries, a division of Sony Corp. of America, 9 West 57th Street, New York, N.Y. 10019. Sony is a registered trademark of the Sony Corporation.

Enter No. 20 on Reader Service Card



TC-K88B CASSETTE DECK: Sendust & Ferrite record / playback head / Metal tape capability / 3 BSL motors, quartz lock direct drive / Micro-processor-IC solenoid logic controls, with Automatic Music Sensor / Power Loading Cassette Module / 33-element LCD Peak Program Meters.



ST-J88B TUNER: Quartz lock frequency synthesis tuner / Varactor diode-MOS FET front end, with Uni-Phase IF filters / Auto and manual 'step' tuning or full 8-station memory with nonvolatile Sony MN-OS memory IC / 2 discrete IF circuits for narrow and normal modes.



TA-E88B PREAMPLIFIER: All-stage DC configuration / 'Dual mono' straight-path-signal design / Subchassis isolated dual power supplies / Built-in self-powered head amplifier using Sony LEC low-noise transistors / Selectable phono impedance and capacitance.



TA-N88B AMPLIFIER: Pulse Width Modulation (Class D) amplifier design / Vertical FET (M-FET) power output transistors / High regulation Pulse Locked Power Supply (PLPS) / 'Dual mono' amplifier configuration / 3-stage protection circuitry.



TA-D88B ELECTRONIC CROSSOVER NETWORK: Plug-in filter modules offer choice of 12 crossover points / Bessel-function filters provide up to 24 dB per octave slopes / Up to -30 dB attenuation range / 'Dual mono' configuration, with subchassis isolated power supply.

# Great Cars! Great Sound!

## Photos of the Best In Auto Hi-Fi

Gary Stock

Ah, the auto shows of our youth. A noisy auditorium or armory on the wrong side of town was transformed for a day or two into motoring nirvana. Endless arrays of chrome-plated accessories gleamed like constellations under the lights. Soot-streaked racing machines crouched close to the floor while drivers in fireproof suits autographed photos of their crashes. Detroit's latest offerings revolved slowly on mammoth platforms as languorous, alabaster-skinned models in evening gowns posed on their contours. A thousand teenage boys took turns at the wheels of the sports models, each lost in fantasies of speed and automotive glamor. And at the center of it all, the show cars, experimental one-of-a-kind dream machines constructed by the automakers to try out exotic styling on the public, to cast a golden glow of association on the family sedans that bore the same name, and to prove that Detroit was capable of anything that could be conceived by the mind of a designer. Cars that were never to be mass-produced, built only to fire the imaginations of those who saw them.

The auto shows are still with us, though with reduced splendor. The cars are slower, smaller, lumpier in appearance, and equipped not with super-engines but with the less-than-glamorous equipment needed to reduce pollution and improve mileage. The chrome widgets are gone, victims of a downturned

economy and the end of mass adolescent fascination with the automobile. And the show cars are largely gone too, at least as we knew them. The few styling studies that do turn up at auto shows are usually egg-shaped electric or propane econo-cars, interesting exercises, but hardly the stuff that dreams are made of.

Another kind of show car is turning up in growing numbers, however — the auto sound show car, usually assembled by a manufacturer of hi-fi automotive equipment as a means of demonstrating its products at trade conventions and the like. The best of these are as dreamlike as the high-performance show cars of the '50s and '60s. Subwoofers, fully metal-compatible cassette decks, and tri-amplification are common, as are maximum sound levels guaranteed to take your brain away and blur your vision (presumably not while in motion). In some cases, the total value of the sound system exceeds that of the car itself.

A whole fleet of these supercars turned up at the recent Consumer Electronics Show in Las Vegas, and we found them intriguing enough to merit showing to our readers because of the high level of engineering sophistication, their outstanding sonic performance, and because they're just plain fun to look at inside and out. Herewith, then, **Audio's** own auto show, five audiophile dream-machines.



## Altec's BMW 320i

**The Car.** To aficionados of Grand Touring cars, the name BMW needs little introduction. The German company has established itself as the premier producer of performance sedans and coupes for long-distance, high-speed driving. The model pictured here, the 320i, is the successor to BMW's 2002, which was largely responsible for the development of that reputation. The 320i is powered by a two-liter, fuel-injected inline four, and also incorporates independent suspension on all four wheels, as well as BMW's characteristically superb gearbox and instrument panel layout. Not your typical family sedan.

Altec has taken this 320i even further in the direction of sporting performance through the addition of a number of interesting options, including Recaro "N" seats in front (with Recaro upholstery on the rear seats as well), a special sport suspension that lowers the car by two inches, a Bavarian Motorsports air dam, a Momo steering wheel, and Dunlop SP Sport Super tires. In addition, the car was repainted in Altec's corporate colors by noted Southern California custom paint shop, Jeff's Place.

**The Sound System.** As the front end of this system, Altec used Alpine's 7307 cassette/receiver unit, mounted in the standard center-console position, and connected to an Alpine 3003 four-channel equalizer/amplifier, which has five bands of equalization and a total of 80 watts continuous power. The system's bass end is handled by Altec's own SW-1 Power Bass system, comprised of a control unit (also mounted in the center console) and 6x9 subwoofer, with integral power amplifier, mounted in the center of the rear deck. For rear-channel reproduction of midrange and treble, two Altec 6x9 48 Duplex speakers are used. Frontal speakers are Altec SK-1 midrange drivers and TK-1 treble units, mounted in separate enclosures in each of the doors. Owners of the 320i may note that the door map pockets were removed to permit optimal positioning of the midrange drivers. One other interesting point about this 320i is the example of egalitarianism it will set for the hi-fi industry. Rather than eventually becoming the plush perk of some corporate executive, the car is being given away — as the grand prize in Altec's contest for retail salespeople.



## Blaupunkt's B&B/Mercedes CW 311

**The Car.** The B&B CW 311 harkens back to an earlier era, in that it is a one-off experimental car built to demonstrate a company's capabilities — in this case, however, the capabilities of a West German aftermarket modification company rather than an auto manufacturer. B&B's stock-in-trade is the sophisticated reworking of high-performance European cars (primarily Porsche, BMW, and Mercedes-Benz, we are told) to further improve their road performance. The CW 311 is an extension of that capability, designed by B&B and constructed around a 6.3-liter Mercedes-Benz V-8 engine and a hand-built tubular space frame. The specifications of the car — 375 brake horsepower, a 0 to 60 time of 4.5 seconds, and a top speed of 200 miles an hour — clearly proclaim it as an extraordinary vehicle and also consign it, alas, to countries with less restrictive regulations. The 311 designation, by the way, refers to the car's incredibly low 0.311 drag coefficient. Price? \$340,000, but you needn't have asked. Only one currently exists.

**The Sound System.** B&B turned to Blaupunkt for the 311's components, using the European, stalk-mounted "Berlin" cassette/receiver combination, a unit that has been de rigueur among European driving enthusiasts for years, but has become available in the U.S. only recently. The Berlin's stalk is flexible, permitting the control head to be moved to any convenient position for the driver. In addition to a six-station memory (activated by the buttons on top of the control head), station scanning, and reception on short- and long-wave bands as well as FM stereo and AM, the Berlin can record either off the air or from a microphone and has a control which automatically varies volume to compensate for changes in ambient noise level. The system's gain is controlled by a bar on the head's front face, tone and balance by knobs inset into the rear panel of the head, and station-seeking by another front-face bar, so there is little need to touch the dash unit except when inserting or removing a cassette. The Berlin has four channels of amplification, each rated at 20 watts continuous. Both of the two door-mounted speaker systems



consist of six 4-inch bass drivers and a one-inch fabric dome tweeter, with a passive crossover network. Maximum

sound pressure levels are in the 120-dB SPL range, by this journalist's estimate.



## Zapco's Firebird Formula

**The Car.** Although not quite as exotic as a Ferrari or the one-off B&B, the Firebird Formula is regarded as one of the better examples of "American Iron" available today, a very good Grand Touring car by any standard. It is also by far the most accessible of the automobiles in this group, and therefore serves as a good rational (as opposed to sky's-the-limit) benchmark for the systems assembled by mere mortals. Zapco's version is mechanically stock, powered by GM's venerable overhead-valve 350 cubic inch V-8, with a live rear axle and three-speed automatic transmission. The car has been outfitted with a full complement of fiberglass fender flares, and both front and rear spoilers, along with wire wheel covers and Goodrich T/A 50-series tires. In short, a classic Boulevard Racer, perfect for Saturday nights in midsummer.

**The Sound System.** Zapco began with the Concord 505 cassette/receiver combination (mounted in the dashboard). Signals from this unit are preamplified and equalized by Zapco's Model PEQ preamp/equalizer, which incorporates nine bands of equalization, clipping indicators, and the master volume control. As installed in this car, the PEQ pops up out of the center armrest and may be folded out of view. The touch-tone pad located in front of the PEQ is a code-punch anti-theft device, by the way. The system's power amplification is mounted in the trunk: Two Zapco Model 150L amplifiers with separate switching power supplies and ESM Energy Storage Modules, each rated at 160 watts continuous, for a total of 320 watts system power. Four 8-inch Zapco W815308 bass drivers are mounted in the rear deck and fed by the low-pass section of two Zapco PEX electronic crossovers. Two Zapco T108 horn tweeters are also mounted on the rear deck. The door-mounted front speakers each consist of one T108 and two Jensen five-inch midrange drivers, mounted in separate enclosures. Total price (excluding the rather exotic alarm system) would run in the \$2,100 range, according to Zapco. An entirely reasonable price, given that the system demonstrated at the Consumer Electronics Show was capable of 130 dB plus levels!

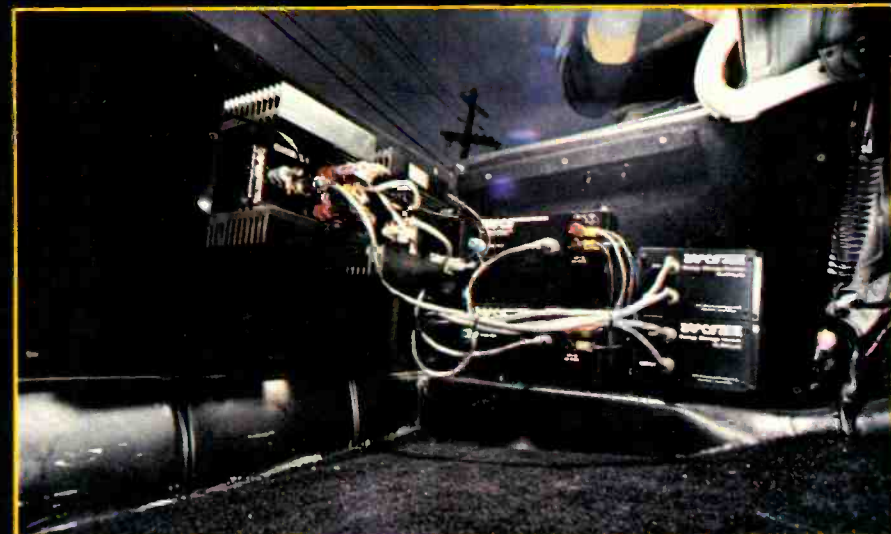

## Audio Interiors' Ferrari 308 GTB

**The Car.** No group of exotic cars would be complete without a Ferrari; this one, interestingly enough, was outfitted not by an autostereo manufacturer but by one of the more prominent custom installers in the West, Audio Interiors of Englewood, Colorado. As befits the name, the car itself has all of the right stuff — a three-liter aluminum engine mid-mounted and topped by a whole gang of thirsty Weber carburetors, a five-speed gearbox, fully independent suspension, huge disc brakes, Cromodora wheels, and Michelin's best sport tires, along with a control console that is widely viewed as the best man-machine interface on wheels. Enough said.

**The Sound System.** Audio Interiors began their installation with an Alpine 7307 cassette/receiver combination, bypassing some of that unit's functions and using an AudioMobile SP300 preamplifier for level control. Both units were mounted in the car's center console. The remainder of the system is quad-amplified, with crossover points at 120, 1500, and 5,000 Hz. Due to the lack of available interior space, a single JBL LE 10H 10-inch bass driver was mounted in a covered sub-enclosure near the front end of the passenger-side compartment (about where the passenger's feet would be). This subwoofer is fed by an AudioMobile SA2000 200-watt amplifier in bridged mono mode, coupled to the remainder of the system via an AudioMobile CXE-2 electronic crossover. Mid-bass and lower midrange frequencies are handled by two JBL 2108 eight-inch bass drivers, mounted in the car's doors, and fed by another SA2000 power amplifier in conventional stereo configuration (in this mode the amplifier has 50 watts continuous power per channel) and the high-pass section of the same CXE-2 electronic crossover. Two EPI LS-35 four-inch midrange drivers were installed at the outer ends of the dash, and two Audax HD 100 25 A one-inch fabric dome tweeters in place of the power window switches at the extreme upper front corner of the doors, thus placing the two drivers very close together when the doors are closed. The power window switches were reinstalled further back on the doors. The midrange and treble units are each fed by one channel of an AudioMobile SA-

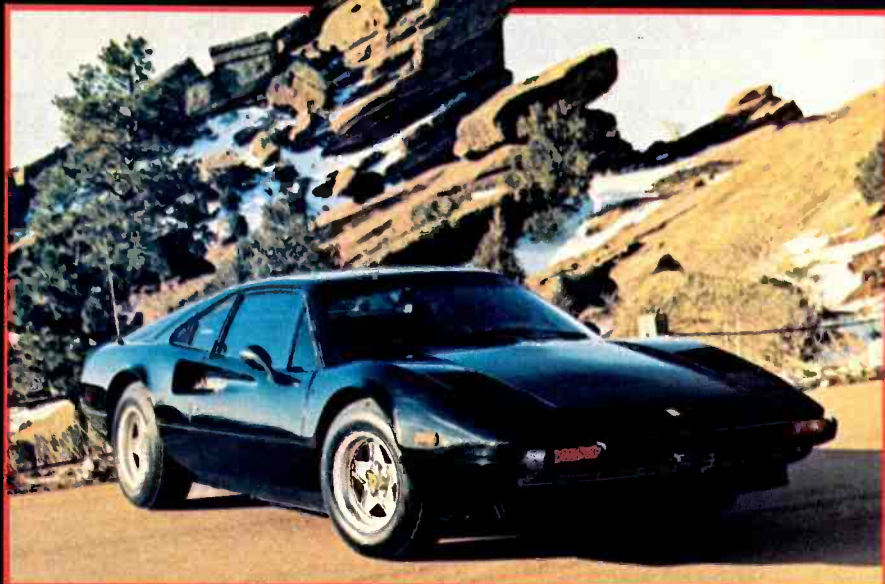

400 power amplifier (20 watts per channel in stereo mode), and by an AudioMobile CXE-2 electronic crossover. Total power for the system is 380 watts continuous, and Audio Interiors has used real-time analysis to verify that the system response is within  $\pm 6$  dB from 35 to 19,000 Hz, with a maximum output of 130 dB "A" at two percent total harmonic distortion. Price of the system, if it were to be installed in another 308 GTB, would be about \$5,200, not counting string-back driving gloves.



Upgrade to...

# AIWA

## AIWA AD-M700 3-HEAD METAL TAPE COMPATIBLE CASSETTE DECKS

### We'll go head to head with anyone

Aiwa's AD-M700 cassette decks in contemporary-styled silver or in a black rack-mount handle cabinets have a 3-head Double Dolby\* NR configuration. So do some high-priced decks. What the high-priced decks don't have is Aiwa's unique V-cut head geometry to cancel out low-frequency contour effect, i.e., get rid of the roughness. While the record and playback heads are placed in single housing, they are completely separate, allowing each head to have the ideal gap width for its specific purpose. This provides low noise recordings with extended frequency response.

To match this supreme head-system performance, we've used a 2-motor tape transport for dependability and smoothness as well as a phenomenal 0.04% Wow and Flutter WRMS.

Enter No. 1 on Reader Service Card

Finally, to make the most of Aiwa's superb heads and transport system, we've put in a continuous variable bias adjust control for the optimum flat response regardless of what—or whose—tape you use, including metal particle tape.

All of this gives you terrific sound with a frequency response of 20-19,000Hz with metal tape; S/N ratio of 65dB (Dolby\* on, FeCr tape). Then we added these fine touches for convenience and versatility...feather-touch logic controls, continuous repeat and memory replay, 5-point multi-color peak reading LEDs, REC/MUTE edit replay and a host of other high-priced features that come with any Aiwa cassette deck. Look for Aiwa's AD-M700J in silver; AD-M700BJ in rack-mounting black. We've used our heads. For you.

\*Dolby is a trademark of Dolby Laboratories, Inc.

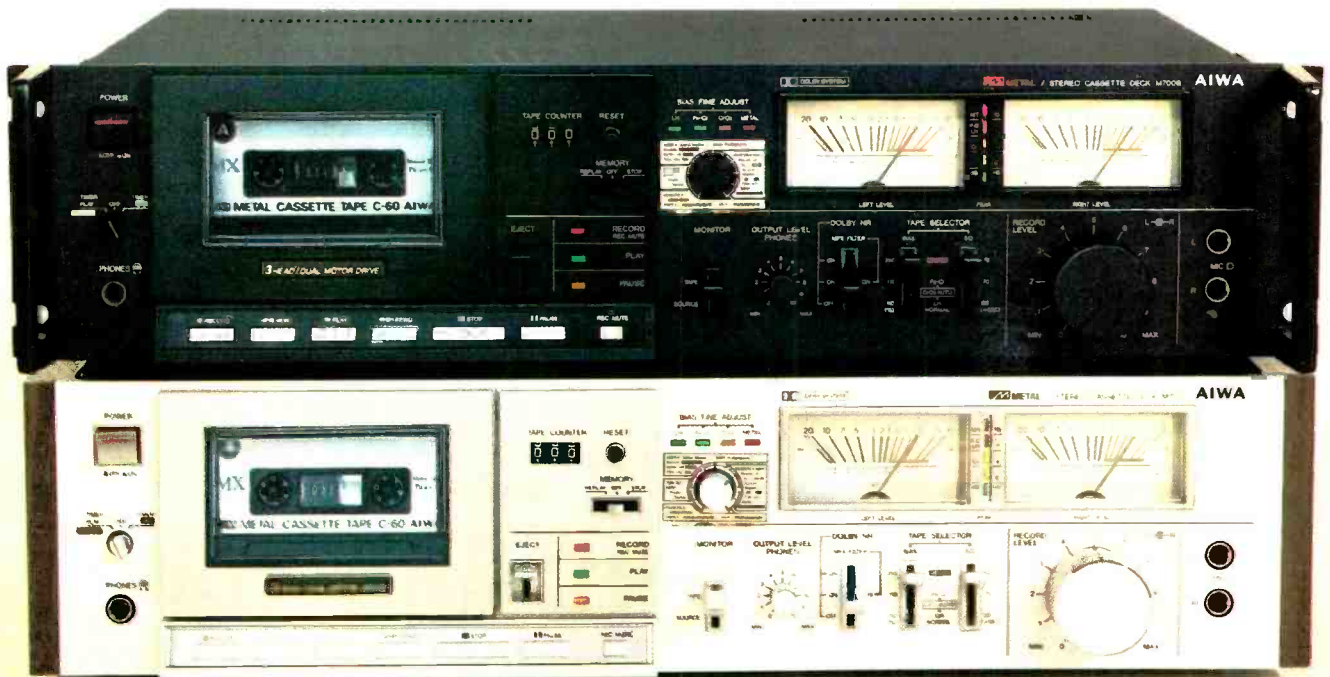

Upgrade to...

# AIWA®

AMERICA, INC.

35 Oxford Drive

Moonachie, New Jersey 07074

## AudioMobile's Rolls Royce Corniche

**The Car.** A Rolls Royce; 1976 vintage, to be precise. Little more need be said, except by way of background information. The car belongs to a West Coast disco producer who commissioned AudioMobile to develop a sound system good enough for high-volume evaluation of album mixdowns — a particularly critical element in developing successful disco material. The AudioMobile factory undertook the project as a design exercise, detailing the installation's many difficult aspects in a white paper on mobile system design that they prepared for their dealers. Among the system requirements established by the owner were a maximum sound pressure level of no less than 120 dB SPL at frequencies below 150 Hz, and a minimum degree of alteration to the automobile's Connolly leather and burl walnut interior.

**The Sound System.** After some evaluation, AudioMobile elected to split the front end of the Corniche's sound system into two elements. As the FM source, they retained the Blaupunkt "Frankfurt" fitted by Rolls Royce at the factory, modifying it internally to match the FM de-emphasis characteristic used in American broadcasting. For cassette playback, a Nakamichi 250 deck was mounted in a semi-exposed position on the center console. Switching between the two units is accomplished with an AudioMobile-built electronic switch/muting circuit. The system's preamplifier is an AudioMobile SP300, which incorporates clipping indicators, a switching supply with high noise isolation, and a three-band equalizer with fairly broad slopes, into a single small unit (front panel dimensions of 1.6x4.5 inches). The system is tri-amplified using three AudioMobile CXE-2 electronic crossovers and a total of six power amplifiers, with crossover frequencies at approximately 150 and 2,000 Hz; cut-off points for the high- and low-pass sections of the crossovers were deliberately made asymmetrical to further smooth the system's total response. Two Altec 417 12-inch bass units, each driven by a 200-watt AudioMobile amplifier in bridged mono mode, were installed in a custom-built trunk enclosure and act as the system's subwoofer. Four midrange-treble speaker systems, each consisting of a



Danish SEAS 4½-inch midrange and a French Audax one-inch fabric dome tweeter, cover the remainder of the audio spectrum; two were mounted in the rear-seat armrest and two at an upward-firing angle in the doors. Each pair of these systems is powered by a 50-watt/channel AudioMobile SA200 midrange amplifier and a 20-watt/channel AudioMobile SA400 treble amplifier. Total power is 720 watts

continuous, adequate, according to the system's designers, for painfully high-level playback with the car's top either up or down. Reproducing this system in your Corniche would cost a mere \$12,000 and take six weeks. Or, second thought, you might add \$4,000 or so to that figure to cover the cost of a Honda or Toyota to drive in the interim. After all, it only raises the system budget by 33 percent! *A*



# Is true "high fidelity" sound really feasible in a small car? Yes, says Audiovox Hi-Comp. But be careful.

By Robert Harris, Technical Director

It has always been a tricky business to create crisp, clear perfect sound in the confined space of a small car. The results have often been painfully amateur.

Audiovox takes it for granted that you understand the importance of matched, compatible components. What it dreads seeing is overpowered units combined with underpowered speakers, and incorrectly placed.

Here, from the Hi-Comp division of Audiovox, is an advanced system that will deliver that true high fidelity sound you want for your domestic or imported compact car. To extract the

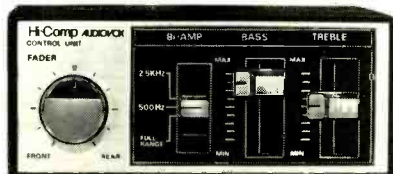

HCE-720 Hi-Comp passive equalizer.

best possible sound from it – clean, directed sound – write for a free copy of "The Dynamics of Speaker Placement in an Automobile."

## The cornerstone

This Hi-Comp system begins with the HCC-550 AM/FM multiplex radio with auto-reverse stereo cassette player.

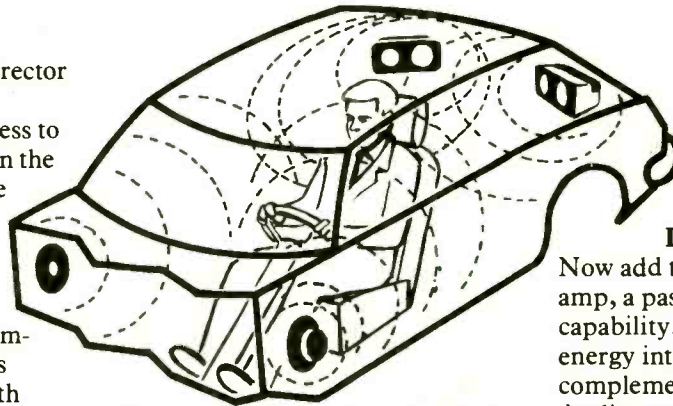

Illustrated: a well-balanced four speaker system, you're surrounded with sound.

Examine the illustration below and you'll discover the major features that are built into this unit.

## The heart of the matter

Additional power for the system is supplied by a 36-watt stereo amplifier – the HCB-820. A few impressive specs: 15-30,000 hz frequency response range +1 db... 18 watts RMS per channel from 20-20,000 hz at less than .1% THD into 4 ohms... powerful direct-coupled complimentary bridge audio output.



HCB-820 Hi-Comp 36-watt 2-channel amplifier.

Couple a pair of these amplifiers together and you've got power to spare.

## Last. But not least.

Now add the HCE-720 dual slide pre-amp, a passive equalizer with bi-amp capability. And, to convert all that energy into pure sound, a full complement of Hi-performance Audiovox Hi-Comp speakers.

You'll want a pair of HCS-10 4" round speakers with 7 oz. strontium magnets, capable of handling 20 watts with 120-15,000 hz frequency

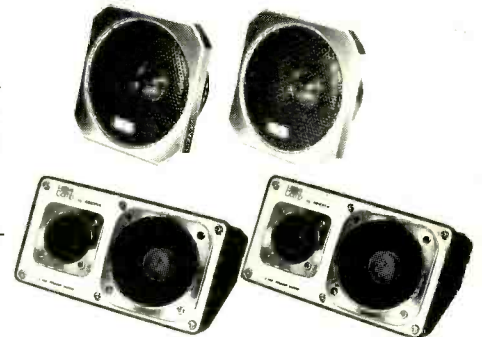

HCS-10 & HCS-90 Hi-Comp high-performance speakers.

response; to put in the door or kick panel, plus a pair of 2-way surface-mount HCS-90 speakers with 4" woofer and 2½" tweeter and a capability of 60 watts with 110-23,000 hz frequency response. They're perfect where space doesn't permit a flush mount installation.

## The sound you want

The Audiovox Hi-Comp system recommended here isn't cheap, about \$500.00; you're paying for high technology. But it will produce optimal super sound in a small car... provided you don't goof when it comes to the placement of the speakers.

For further information, write to:  
R. Harris, Technical Director, Dept. 11N,  
Hi-Comp Division, Audiovox Corp.,  
150 Marcus Blvd., Hauppauge, NY  
11787 © Copyright 1980, Audiovox Corp.

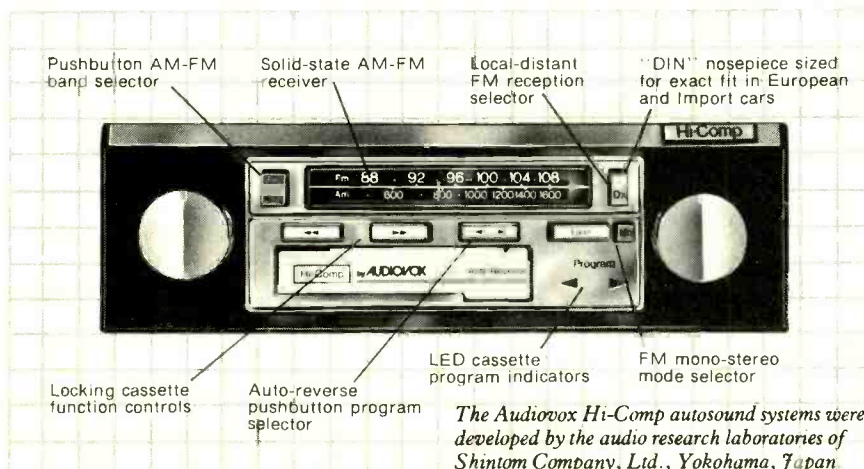

- Pushbutton AM-FM band selector
- Solid-state AM-FM receiver
- Local-distant FM reception selector
- "DIN" nosepiece sized for exact fit in European and Import cars
- Locking cassette function controls
- Auto-reverse pushbutton program selector
- LED cassette program indicators
- FM mono-stereo mode selector

The Audiovox Hi-Comp autosound systems were developed by the audio research laboratories of Shintom Company, Ltd., Yokohama, Japan.

Enter No. 4 on Reader Service Card

The man pulled his coat tight against the night wind and shrank back into the doorway, waiting. The parking lot near the back of the motel was lonely and dark. As he silently watched and waited he saw tired travelers struggle out of their cars, grunt and stagger as they unloaded heavy luggage and trudged wearily into the motel. He envied them their soft beds.

Patiently John watched. Patiently John waited.

After an hour had passed with no more late arrivals, John moved quietly out from the shadows. In his hand he grasped a slender piece of metal with a hook cut out of one end.

Looking around carefully, his glance darting into every nearby shadow, John moved stealthily up to the side of a maroon car parked in the deeper shade under a leafy maple tree. With the quickness of an expert, he slid the metal bar between the glass and the body of the car's right front door. Deftly he slipped the bar downward and forward until it caught under the locking mechanism. It only took a moment.

Suddenly, with a sharp upward snap of his wrist, John pulled. There was a loud pop, and the lock-plunger sprang up unlocking the door. Instantly he was inside the car, skillfully disconnecting and removing the expensive car stereo set hanging below the dashboard.

Within 90 seconds from the time John left his hiding place along the wall of the motel, he had disappeared across the nearby field to his waiting car parked along the highway; under his arm he carried a \$1,500.00 car stereo system.

Car thieves take pride in the speed with which they can get into a locked car, any locked car. Some boast they can do what John did in less than 60 seconds. By their standards John would be considered slow at his job.

### The Hand is Quicker . . .

Why is speed so important? Speed isn't always important, though it can be if the car has an alarm. However, the true pro doesn't care whether the car has an alarm or not, because even if the siren hoots, bells ring, and rockets start to blaze into the heavens, the thief knows he'll be gone before there's time for anyone to act.

Of course, John had picked his victim carefully. The stereo set was mounted beneath the dashboard and his small crowbar had made it easy to pry the set loose from its mounting. But even installing the stereo into the

dashboard doesn't stop a determined thief. One salesman I know was shocked to find his built-in stereo gone. The thief had used a power saw and neatly cut the car dashboard around the stereo console, leaving a gaping hole.

Spring and early summer are the time of year when flowers spring out of the good earth and stereo car thieves spring from the swamps. It's the time of year when you'll be planning vacation trips, and visits to

is estimated at \$700. That's a solid investment and one you want to protect.

Is protection that important? Indeed it is. Experts in the field—and their findings are confirmed by stores that sell mobile hi-fi units—estimate that at least 15 percent of all such systems being bought and installed today are sooner or later ripped off by the professional gangs of car thieves. As one store owner put it: "We find at least two sales a day of car stereo equipment are to people purchasing re-

# Keep Your Car Stereo Safe!

## Tips To Foil The Professional Thief Bob Curtis\*

\*Security consultant, author and lecturer Dayton, Ohio

friends and relatives, in addition to your usual trips to the local shopping mall.

Thieves will also be doing some shopping, and you'll want to keep your car stereo equipment off their shopping list. To do this isn't easy, but perhaps one basic principle should be kept in mind. Car crooks are lazy people, and they look for jobs that take the least effort. That's a clue for you. To protect your valuable car stereo, make it tough for them. If you do so, chances are you'll keep your set.

Today's hi-fi mobile stereos generally range in price from a low of \$200 to a high of \$2,000. The average value

placement sets for the components that have been stolen from their cars."

As hi-fi sales to car owners continue to grow, these rip-offs will become even more prevalent. Until recently the big thefts were of CBs, but with the growth of the hi-fi car stereo market, the percentage of mobile equipment is now larger for hi-fi equipment than it is for CBs.

### Where it Goes

What do larcenists do with their hi-fi loot? Fences handle much of it. Some is sold to individuals, friends or contacts looking for a bargain who don't ask where the equipment comes

from. But much is sold to a few shady installation firms that have a tie to professional crime. At the moment CBs are a drug on the market, but the more valuable and still relatively rare hi-fi units, particularly the top-of-the-line units, are much in demand, so thieves find a ready market for these wares. Some owners of stereo equipment are getting desperate in their attempts to protect it. One van owner I know installed a neat alarm that he personally designed. Once a crook gets into his

clauses written into their policies to that effect. Insurance may cover hi-fi equipment built into the car by the manufacturer, or at least installed in the dashboard space provided for this by the car maker. But even such coverage often requires an additional rider on the policy and an extra fee. The AAA in Ohio, for example, will cover stereo equipment built into the dashboard in the space provided by the car maker, but charges an extra fee of \$25.00. Before you rely on your car in-

out by removing only eight screws, but it is a considerable improvement over past years. Under-dash users would be wise to remove rack-mounted sets when leaving the car, and lock them in the trunk.

### Protecting Yours

Direct alarm security of the hi-fi equipment in cars is not the usual approach. Instead, an alarm system should be used to protect the car itself and thereby protect the hi-fi units.

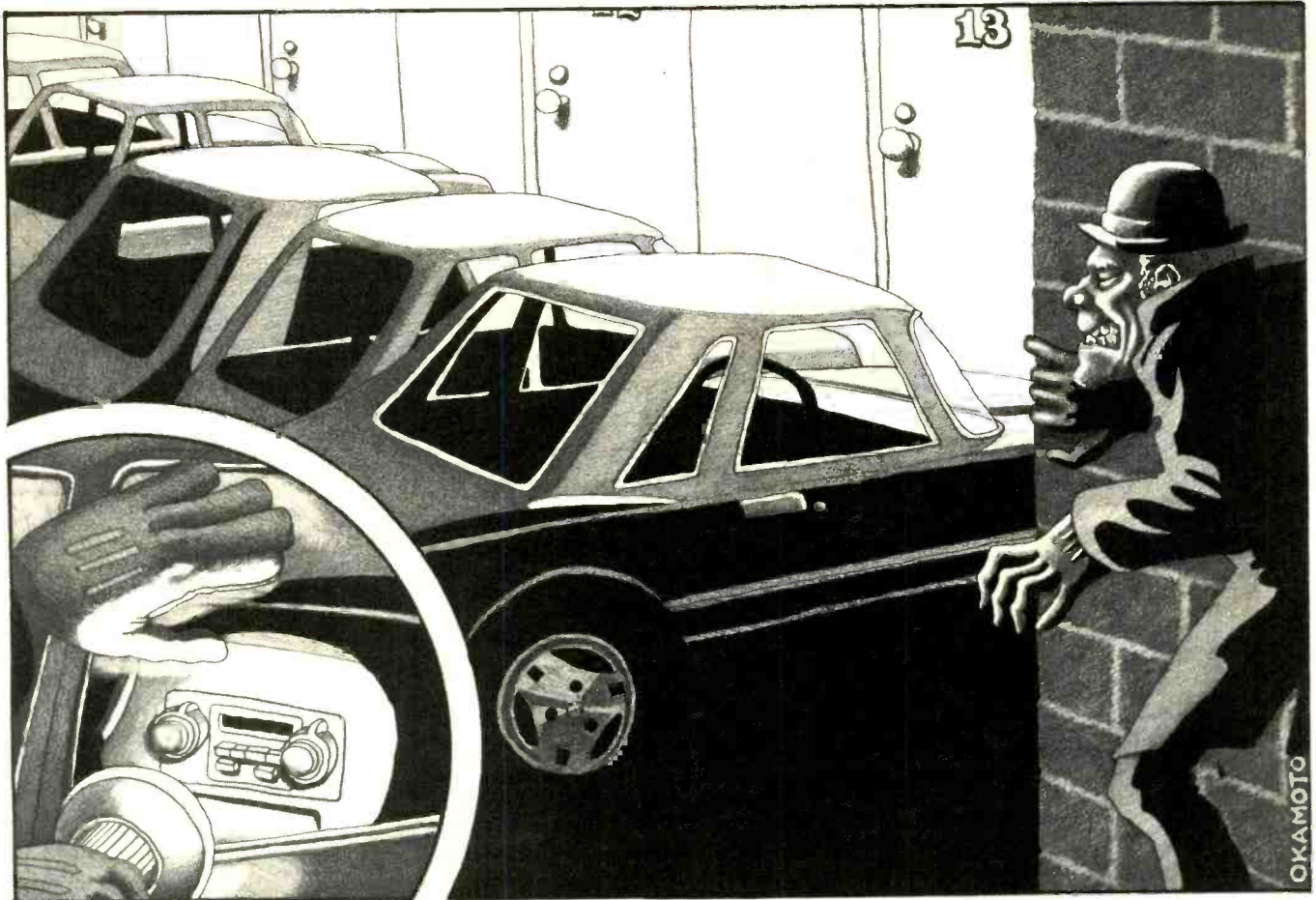

van and starts to fool with his set, an alarm goes off triggering a mammoth explosion of tear gas inside the van. Clever, yes? Effective? No doubt!

Tear gas sounds neat, and probably is useless . . . in an accident the force of the crash triggers the device. Or perhaps while storming down an interstate highway the alarm malfunctions, exploding a cloud of tear gas into the eyes of the driver. (That's a picture to reckon with!)

Some people mistakenly believe they are covered against mobile stereo theft by their car insurance policy. For the most part insurance firms will not cover such accessories and have

insurance or home-owners policy, be sure to check with your insurance agent.

Car manufacturers are becoming aware of the consumer's need to protect car stereo equipment. While older car models usually had a simple hole for such installations, the newer models provide better mounting protection. A chassis mounting bracket is provided by the car makers so equipment can be bolted into it, and a face plate is provided to cover the edges of the hi-fi unit once it is slipped into the dashboard. The mounting is still no great challenge to the professional thief, since he can get the equipment

Alarms come in several types. Of critical importance is the kind of sensor selected for the alarm system. Many car alarms use a plunger unit. (A glance at the inside of the car door will reveal the plunger used to switch on the car's overhead interior light when the door is opened.) The built-in plunger for the car ceiling light can be tied into the alarm system; a similar plunger can be installed to protect the car hood and thereby also guard the car battery. A plunger can also be used in the trunk to trigger an alarm should that lock be tampered with.

Other units use a touch-sensitive sensor to trigger the alarm. This can be

a capacitor system that reacts to human touch of the door handle or to the body of the car. Your hand on the door can, of course, set off the alarm or the hand of a passer-by can also send your alarm system into a tizzy. After all, the touch of a thief intent on larceny or that of a passer-by intent on preventing a fall are all the same to such an alarm system.

Vibration switches can also be used to trigger the alarm. Unfortunately they can respond to a nervous or incompetent car-jockey who carelessly backs into your bumper. Any such smack will set the vibration alarm screaming as loudly as a kicked dog.

Sonic transducers mounted at the end of each side of the car's front seat will register the sound of clashing metal . . . or the click of the door lock being jimmied open. The sensitivity of sound and movement sensors can usually be set by the car owner and will determine the extent of false alarms as well as the degree of protection the sensor provides against the unwanted intruder. Just don't park next to a construction site.

Another type of sensing device is a voltage sensor. This one's tied into the car electrical circuits and reacts to any changes in the voltage of the car's electrical current once it is activated. It can read the current flow and detect tampering with any part of the car wired for protection including the hood, doors, trunk and even lights, brake pedal, glove compartment light, and the stereo components inside the car itself.

Some thieves use a tow truck to lift up one end of the car and then simply tow it away. A simple mercury switch tied into the alarm can be used to trip the siren should this occur. These switches have a small problem, however, in that you can't park your car on a hill and set the alarm because that little pool of liquid mercury inside the capsule can't tell the difference between the tilt of a hill and the tilt of a tow truck.

Depending upon the alarm you purchase, once the sensor is tampered with by accident, by nature, or by a thief, one or more of several things happen. In some systems the car horn starts to blow to attract the attention of passers-by. Other alarms include a siren that screams with the zing of sharp nails scratched over a blackboard. Some combine the sounds of a buzzer or siren alarm with flashing headlights, a sure rouser after dusk.

Whatever the screams and lights activated by the alarm, once triggered

you can be sure of one thing: They will be draining the car battery. And the louder and longer the racket, the more juice is pulled off the power source. Invariably all car alarm systems use the auto's own battery as its power source. Alarms that run continuously until shut off are rough on the battery. Assuming the owner doesn't return right away (and that passers-by do nothing to stop the screaming), the driver may later come back to a silent car with a dead battery which, much to his chagrin, refuses to start. Not a pleasant surprise on top of having his stereo ripped off.

To offset this power loss problem many alarms today sound intermittently. One, for example, blasts its signal for 30 seconds, then is silent for 30 seconds, and repeats this cycle continuously until turned off. Another alarm currently on the market sounds continuously for four minutes, then shuts itself off and rearms its sensors, waiting for any further attacks.

Certainly when buying an alarm system for your car, it is best to consider the possible battery drain and related effectiveness of the alarm signals.

### Advanced Warning Systems

One particularly sophisticated alarm system that has recently reached the market is the "Autoalert" or "Mobile-Alert Vehicle Security System." (Each maker uses a different trade name for its product.) This new type of alarm provides a pocket pager so the car owner can be made aware his car is being tampered with as long as he has the pager on his person and is within a reasonable distance from his car. One unit claims the pager can receive an alarm signal up to a half mile from the car under favorable conditions. Another company boasts that a farmer can receive a signal up to seven miles from the parked vehicle. Both distances are, of course, subject to problems of land contour, electrical interference, and so on. These units can only be legally operated if the car owner has a CB license as they broadcast on the citizen's band.

The system consists of a mini-transmitter mounted behind the dash which receives a triggering signal from whatever sensors you have wired into it. One unit provides two transducers to measure sound and these are mounted either on the dashboard or on the car seat near the car doors.

The mini-transmitter is powered by the car battery and is tied into the car antenna which is used for broadcasting the warning signal to a pocket re-

ceiver carried by the car driver. The pocket receiver uses two AA batteries that will last up to three months if the pager is used 20 hours a day. Sensitivity of the transducers can be set by the car owner.

One good source of data on alarm systems, as well as technical data on car stereos, is Crutchfield Corp., which maintains toll-free telephone lines to answer questions. These phone numbers are (800) 446-7072 and, in Virginia, (800) 552-3961.

Considering that over a million cars were stolen last year in our country and that many thousands of cars had their CB and stereo equipment ripped off, the use of an alarm system to protect your car and its accessories is well worth considering.

But when selecting an alarm system, keep some of the obvious problems in mind. The wrong type of sensor may provide undesirable false alarms. The mercury switch for defeating tow-truck thieves is particularly vulnerable, as are capacitor-type sensors. The voltage sensor and the old reliable plunger types may be more practical in the long run. A sonic transducer type can work well if properly designed and tuned to proper sensitivity, but a vibration sensor may be difficult to tune to a point where it is sensitive enough to detect a thief but not so sensitive that it is triggered by accidental touch from a car being carelessly parked.



T E A C

# TEAC TODAY: THE ALL-TIME LOW IN TAPE NOISE.

On paper, the specifications\* look unbelievable:

80dB signal-to-noise ratio, 95dB dynamic range and 15dB more headroom than you've ever had. The sound is so noise-free, it's scary. And once you listen to the audio performance of the A-550RX, you'll know that cassette recording will never be the same.

You'll hear signal without noise or hiss. Louder louds and softer softs. And you'll never have to be bothered by tape saturation again. All this because the A-550RX is the only mid-priced cassette deck ever to include integral dbx\*\* noise elimination plus complete metal tape capabilities.

A few years ago, the dbx system helped us revolutionize professional recording. Now the same technology is helping us move cassette performance into a new era. On the A-550RX, dbx II gives you broadband noise elimination and dramatically improved dynamic range. Signal articulation that's better defined than anything you've ever heard from a cassette tape. And the A-550RX doesn't stop there.

Full logic micro-switches control the high-stability transport. The A-550RX accepts our RC-90 remote control unit. And rack mounting hardware is available optionally. So listen to something you've never heard before.

The amazing A-550RX. You'll hear completely noise-free cassette recordings with the broadest dynamic range available.

So listen to something you've never heard before.

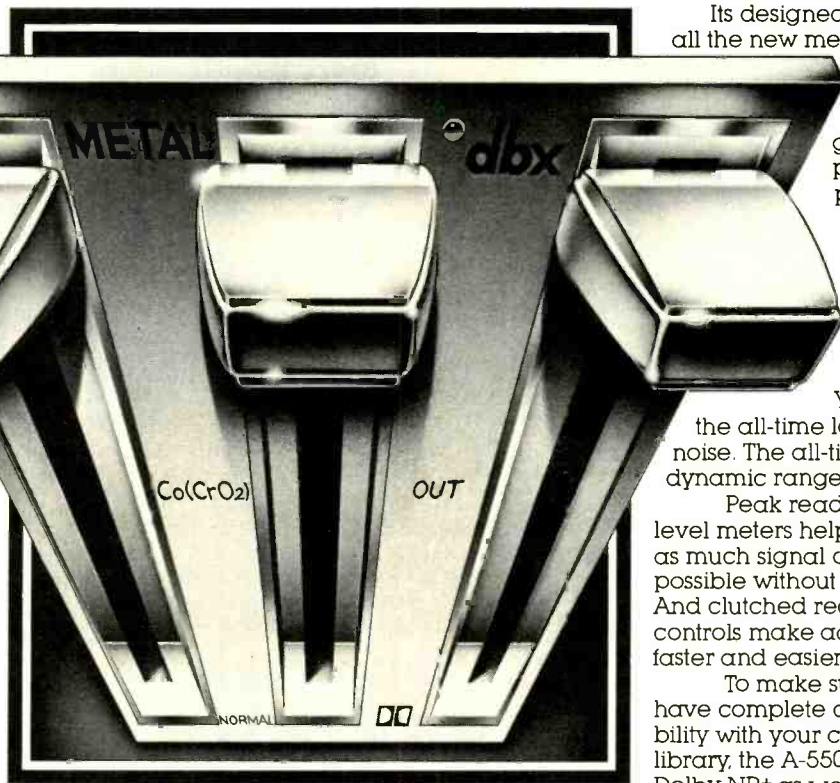

Its designed to handle all the new metal tape formulations. Which means you get the unprecedented performance of dbx II with the additional improvements provided by metal tape. You'll hear the all-time low in tape noise. The all-time high in dynamic range. Peak reading dB level meters help you get as much signal on tape as possible without distortion. And clutched record level controls make adjustments faster and easier.

To make sure you have complete compatibility with your current tape library, the A-550RX has Dolby NR† as well.

So listen to something you've never heard before.

The amazing A-550RX. You'll hear completely noise-free cassette recordings with the broadest dynamic range available.

So listen to something you've never heard before.

The amazing A-550RX. You'll hear completely noise-free cassette recordings with the broadest dynamic range available.

## TEAC®



\*Measurements made with metal particle tape  
\*\*dbx is a trademark of dbx, Inc.  
†Dolby is a trademark of Dolby Laboratories

All alarms have one Achilles' heel, their power source. In theory at least, a car alarm should have its own battery supply and not be tied into the car battery. A second-best arrangement, if the car battery must be used, is to make sure the battery is protected from criminal sabotage. Once the thief can gain access to battery wires running to the car's electrical system or can get his metal claws onto the battery terminals themselves, he can defeat any alarm system by simply cutting off the source of its power. A siren

without a battery makes a silent scream.

In addition to draining the car battery, car alarms that ring bells, blow horns, and screech with sirens face another difficulty, one shared by building owners with proprietary alarms using a bell on the outside of the building. The problem is one of public indifference.

We are in the era of indifference. When a car alarm goes off, what do passers-by do? Most glance at the car, smile wisely, and shuffle on their way.

After all, who wants to get involved?

What do you do when you hear a car alarm go off? You glance at the car, assume it is a malfunction of some sort that's triggered a false alarm, or decide that some good citizen is already phoning the police, and you go on your way with the screams of the siren growing fainter. The pager system has a major advantage here because the alarm signal alerts at least one person who cares that something is going on that's not right and that involves his car.

But in the end an alarm system is still more of a deterrent than anything else; it does not offer complete protection for your stereo equipment.

### Parking Problems

Where you park is often more important than installing an alarm. As one crook explained: "Any car I spot on a dimly lit street with a door unlocked or the window ajar, belongs to me if I want it." This guy had over 25 years experience as a car thief, so his words are worth remembering.

If you park your car in a driveway beside your home, face the nose of the car toward the street so any tampering under the hood is easily visible to a passer-by.

If you park on the street or in a shopper's parking lot, put your car in a brightly lit and busy spot. Only the dumbest car thieves ever try to rip off a car parked in a busy, well-lit location. Don't park in a dark alley or at the back of a large parking lot.

When traveling on a trip be aware of the "watchers" like John. These thieves let their victims come to them. They hang around rest areas or restaurants along busy interstate highways or turnpikes. When a family goes in a restaurant to eat, the thief knows he has at least 30 minutes to get to work with his iron. Often the thief will be into the car and gone with the loot before the family has ordered its meal. Remember that out-of-state license plates shout to a thief.

Parking at an airport can be dangerous too. Be sure windows are rolled up tight, doors are locked, and that the parking lot claim check is tucked safely away in your wallet.

Use tapered "anti-theft" door lock knobs to further hamper access with a coat hanger or other device. Tuck everything of value into the trunk when you leave the vehicle. Car boosters usually steal what they can see.

Try and avoid public parking where you have to leave the car keys in your car. Even leaving keys with an attendant is a risky business. Find a lot where



The new  
clean look,  
clean sound  
from Crown.

The Crown Power Line One amp and Straight Line One pre-amp were designed for people who seek accurate sound, whose joy is in listening and to whom simplicity of operation is important.

Such listeners have usually learned to listen with tone controls set flat. Those who did want a different response curve were frustrated with the usual tone controls, since only a limited roll-off pattern was available. Accurate sound could be achieved most satisfactorily with a separate equalizer.

So, by design, and for such people, we did not put tone controls on either of these particular Crown units. We did, however, build in important improvements in sonic quality. Frequency response on both units is  $\pm 0.1$  dB, 20 Hz-20 KHz with 1M distortion below .001%, as acoustically transparent as you can get.

The Straight Line One phono pre-amp module is a separate unit to be mounted close to the turntable. This solved an RF interference problem, and enabled Crown to engineer the quietest circuitry ever included in a phono pre-amp. Your

cartridge will generate more thermal noise than the circuitry in the SL-1 phono module.

The separation of phono module and pre-amp also gives you greater system flexibility, since any or all of the inputs can be used for turntables. There's also a moving-coil phono module available.

You'll find distortion indicators on the front panel of both units, to help you achieve optimum system balance. There's front panel speaker switching, the Crown IOC distortion detection circuit, peak output LED's, and a new concept in DC speaker protection.

The SL-1 and PL-1 are available in silver-colored front panels to match other Crown units, or in black.

Best of all, these are Crown units, built in the USA, and incorporating everything Crown has learned in thirty years of building state-of-the-art audio components.

If you're prepared to invest about \$1100 in really fine audio, visit your Crown dealer for a full hearing on this great combination from Crown. Listen carefully, and enjoy clean, clear sound.



1718 W. Mishawaka Road, Elkhart, Indiana 46514

Innovation. High technology. American. That's Crown.

Enter No. 5 on Reader Service Card

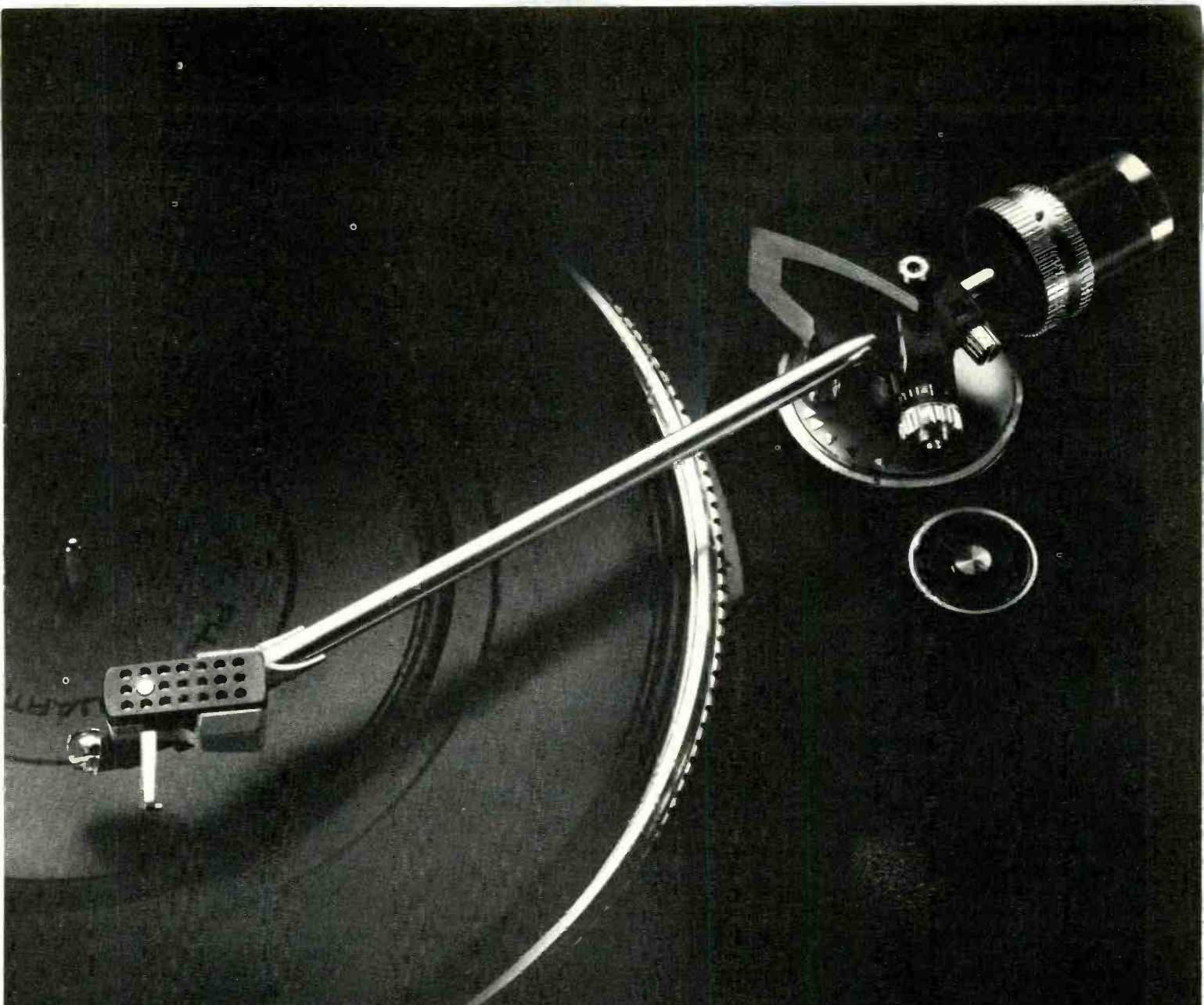

### **The 731Q is the finest turntable Dual has ever made.**

There is always a special attitude at Dual about the turntable that is to represent the most advanced thinking and accomplishments of Dual's designers and engineers.

The materials, the care in manufacturing, assembly and quality control must exemplify a standard that has made Dual precision and reliability so highly regarded throughout the world.

And in every measure of performance, this model must set the standard by which other fine turntables are judged. Even more, it must make a significant contribution to the art of record playback.

This year, the quartz PLL direct drive 731Q, with its ultra-low-mass (ULM) tonearm and cartridge system, expresses our attitude perfectly.

If your other components and your record collection warrant consideration of such a turntable, we invite you to visit your franchised Dual dealer. And if you have a record that is warped to marginal playability, but too valuable to discard, bring it with you.

That's all you will need to share our attitude and sense of pride about the Dual 731Q.

For the complete ULM story, please write directly to United Audio, 120 So. Columbus Ave., Dept. Q, Mt. Vernon, New York 10553.



# Interface: C

## Series II It sounds like music.

Interface: C Series II is the fulfillment of our six-year association with optimally vented speakers based on the theories of A.N. Thiele—speaker designs first introduced by Electro-Voice in 1973: The Interface: C offers you a unique combination of high efficiency and high power capacity—the only way to accurately reproduce the 120+ dB peak sound pressure levels found in some types of live music.

The SuperDome™ tweeter, an E-V exclusive, and the VMR™ vented midrange driver, the first to apply optimally vented design to mid frequencies, ensure your music is reproduced without the coloration normally found in other high-efficiency drivers. An honest 30 Hz low end totally eliminates the need for expensive subwoofer assemblies.

When you spend \$1,000 for a speaker system, get your money's worth. Audition the Interface: C Series II at your nearest Interface dealer. If you want a speaker that sounds like music, the Interface: C Series II is the one you'll buy.



**Electro-Voice**  
a **gibson** company

600 Cecil Street, Buchanan, Michigan 49107

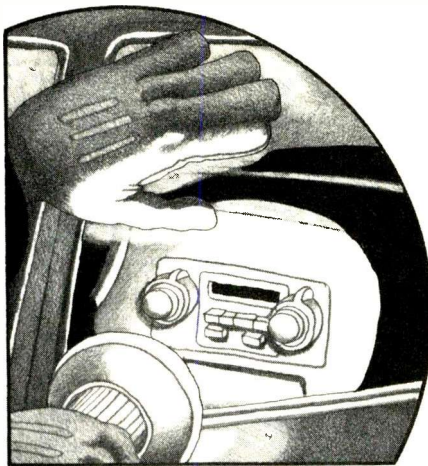
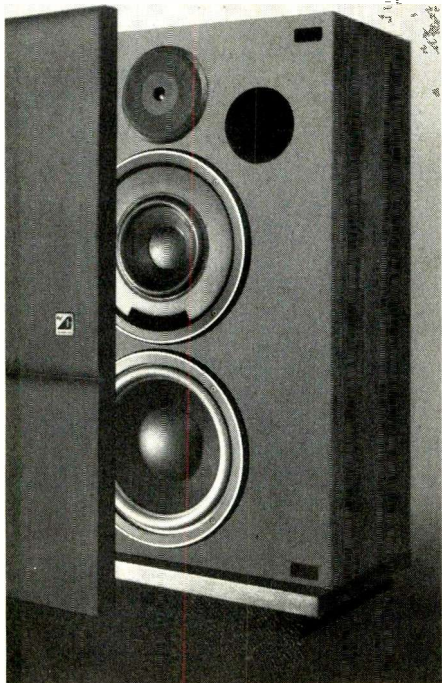

you can lock your car and take away the key. If you must leave a key, leave only the ignition; don't leave the trunk key or your house or office keys because that invites duplication and later burglary. Cases have been uncovered in which the lot attendant worked with a gang of criminals who drove the customer's car from the lot to the customer's home. It caused no suspicion to have the car parked in the driveway of the customer's home since the car was often seen there. The gang looted the house and then returned the car to the lot. It's bad enough to have burglars rip off your home, but to carry away their loot in your own car, that's heavy stuff indeed!

Never leave a car title or registration in the glove compartment, and keep all gasoline credit cards on your person. If your car is stolen, these items make the thief appear to be the lawful driver of your car; it's also easier for a thief to sell your car.

Make sure you have a couple of copies of a list of the serial numbers on your stereo equipment. Keep this list in the house and another copy at your office. Don't leave it in the car.

If your stereo equipment is stolen and later recovered by the police, you cannot reclaim it unless you can positively identify it as yours. Therefore, it is wise to get an inexpensive engraving tool and mark your name or some secret symbol onto each of your hi-fi units. A motorized engraver costs less than \$20 and has a stroke adjustment to regulate the depth of engraving from deep to delicate. It comes complete with a carbide engraving point (carbide being second only to diamond in toughness), so you can put your mark onto metal or glass as easily as writing with a pen on paper.

### Plain Clothes or Uniform?

Whether you have an alarm or not,

some people suggest you put a sticker on your car window or windshield warning would-be burglars the car is alarmed. I personally don't go for that bit, as my experience is that stickers of this kind work against you. It tells the thief you feel you have something valuable in the car to protect and this makes him curious to find out what that precious thing is. I'd prefer not to whet the crook's curiosity. Leave those stickers off the car. Let the alarm system speak for itself. Pretend there's nothing worth breaking into the car for.

And that brings me to a neat idea used by some hi-fi buffs for protecting their equipment. They subscribe to the school of camouflage. Remember the way tanks and ships were painted during the war? And how GI ground troops were disguised with battle fatigues that look like an LSD trip?

This same camouflage principle can protect your dashboard hi-fi from prying eyes. One fellow I know got a clip to hold a Kleenex tissue box on his dashboard. He emptied the tissue box, then cut out a square hole in the back of the box so it fitted down over the tuning strip and dials on his hi-fi set. The finishing touch was a single Kleenex tissue sticking up out of the slot in the top of the box. Whenever he parked his car, he simply dropped the tissue box into place and a casual viewer peering into the car never suspected he was the owner of a costly car stereo set.

You can disguise your hi-fi in a variety of ways limited only by your imagination. A phony segment of dashboard can slip up from underneath to conceal your set, or a hanging sign pretending to be cute ("Closed for Operations," "Don't Disturb," "Shhhh Mayonnaise is Dressing" or whatever) may give protection from prying greedy eyes.

Take your pick: Alarm system, proper parking in a busy place, pocket pager, camouflage, and so on. Of course, for the ultimate buff looking for absolute protection, I have little to offer.

Let's face it, if the professional thief has his mind set on ripping off your stereo set, he's probably going to do it. But using some of these suggestions along with a dose of common sense (don't leave cassette tapes loose and visible on the seat of your car as that's too inviting to the thief), you can protect yourself from most of these crooks.

Whatever you do, don't make their job easy. A



# LOUDSPEAKERS ARE NOT PURESPEAKERS.

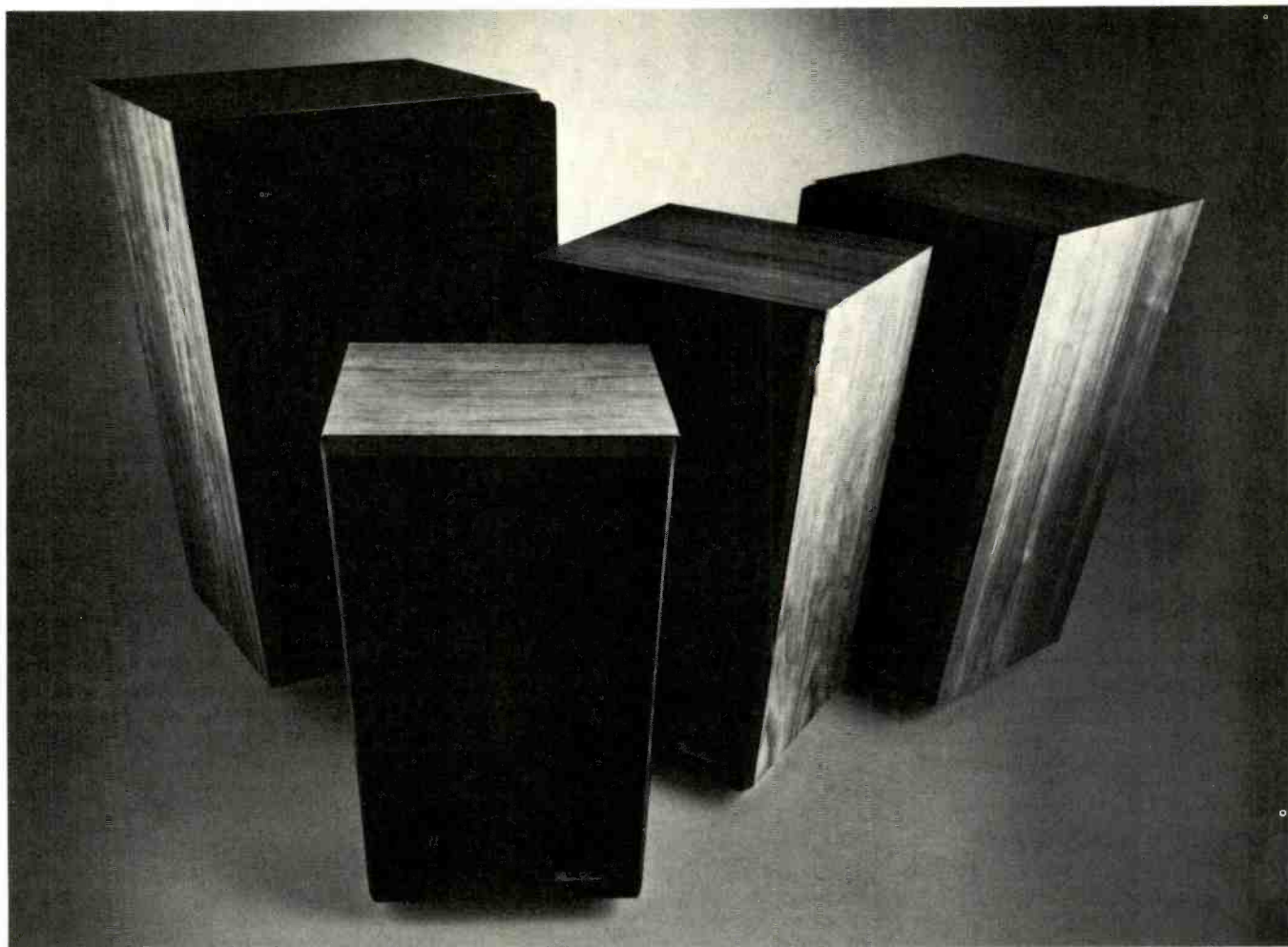

## INTRODUCING THE PHASE LINEAR P-500 SERIES PURESPEAKERS.

**Why Loudspeakers?** It's a fact: Most speakers that sound good at loud listening levels don't sound the same during a soft musical passage. And vice-versa. The drivers are simply not capable of reproducing such a wide dynamic range with clarity and accuracy. Until now.

**Purespeakers. Not loudspeakers.** If you love music as we do, you know that a hi-fi system is only as good as the "weakest" component. And for the most, it's the speakers. *Clearly, it was time we addressed the task of advancing the "state-of-the-art" in speaker and driver technology.* We began by identifying design objectives through a careful analysis of how we experience music. Then we got very serious, indeed, about meeting those objectives by:

- Applying every computer-aided technique available, including extensive laser-holographic analysis.
- Utilizing the lightest, strongest materials in the world.
- Pursuing "no-compromise" quality at every stage of design, prototype development, test and manufacturing.

The result was an exact discipline of speaker design that far exceeds anything ever produced. Or heard. In fact, anything less and the listener invariably experiences *the speakers*. Instead of *the music*. We urge you to contact your Phase Linear audio dealer and audition the Phase Linear P-500 Purespeakers.



### **P-580 System Specifications:**

Frequency Response: 28Hz-120,000Hz  $\pm$  2.5dB.  
Total Harmonic Distortion Content: 20Hz-20kHz, less than 0.3%  
Intermodulation Distortion: (SMPTE) less than 0.03%  
Sensitivity: 91dB, 1 watt at 1 meter.  
Driver Complement: 9mg. Ribbon Tweeter, 2½" Beryllium Dome Midrange with Cantilever Suspension, 15" Concentric Rib Woofer.

*Phase Linear*  
20121 48th Ave. West, Lynnwood, WA 98036

Enter No. 29 on Reader Service Card

# Equipment profiles

## JVC Model A-X9 Stereo Integrated Amplifier



### Manufacturer's Specifications

**Power Output:** 100 watts per channel, 8-ohm loads, 20 Hz to 20 kHz; 105 watts at 1 kHz.

**Rated THD:** 0.005 percent.

**SMPTE IMD:** 0.002 percent.

**Frequency Response:** High level, d.c. to 200 kHz, +0, -3.0 dB; phono, RIAA,  $\pm 0.2$  dB.

**Damping Factor:** 200 at 1 kHz, 8 ohms.

**Input Sensitivity:** MM phono, 2.5 mV; MC phono, 200  $\mu$ V; high level, 200 mV; all for rated output.

**Phono Overload:** MM, 350 mV at 1 kHz; MC, 26 mV at 1 kHz.

**S/N Ratio:** MM phono, 82 dB; MC phono, 75 dB; high level, 85 dB; all rated via new IHF.

**Tone Control Range:** Bass,  $\pm 8$  dB at 100 Hz; treble,  $\pm 8$  dB at 10 kHz.

**Subsonic Filter:** 18 Hz, 6 dB per octave.  
**Muting:** -20 dB.

**Power Requirements:** 120 V, 60 Hz, 400 watts (505 VA).

**Dimensions:** 17 $\frac{3}{4}$  in. (44.375 cm) W x 6 $\frac{1}{4}$  in. (15.625 cm) H x 16 $\frac{3}{4}$  in. (41.875 cm) D.

**Weight:** 36.5 lbs. (16.6 kg).

**Price:** \$900.00.

JVC's Model A-X9 integrated amplifier is one of several products produced by that company which employs their newly developed "Super A" circuit. This circuit is said to provide the benefits of Class A operation (no notch or switching distortion) with efficiency approximating that of a conventional Class B circuit. Essentially, the Super A circuit employs a novel variable bias system for the output stages which keeps them in a state of conduction at all times, as would be the case in ordinary Class A operation. We will describe this circuit in some detail shortly.

Physically, Model A-X9 looks more like a sleekly designed basic power amplifier than a full-featured integrated amp. That is because most of the less-often-used controls are concealed behind a hinged door panel which is normally closed, providing an uncluttered appearance.

The controls that remain visible with the hinged door snapped shut include a massive master volume control, calibrated in dB with reference to maximum setting, and six slim, vertically oriented, bar-type touch switches which handle power on/off, audio muting, tape monitor selection, and

auxiliary, tuner or phono program-source selection. Secondary controls and features behind the closed door include the usual phone jack, two separate speaker selector buttons, a subsonic switch, a tone defeat switch, bass and treble tone controls, tape-2 in-and-out jacks (which parallel similar in-and-out jacks located on the rear panel), a balance control, and eight more small push buttons at the lower right of the panel. These switches include a *Record Off* switch which physically disconnects the record-out jacks from the rest of the circuitry to prevent possible loading effects when connected tape decks are turned off. A tape/record source switch follows (it reconnects the record-out jacks), then comes a dubbing switch, a tape-2 front-back switch (which selects the correct front or back terminals for tape deck connection), a tape 1/2 switch, a switch which selects moving-magnet or moving-coil circuitry for the phono inputs, and a phono selector switch which chooses phono 1 or phono 2 inputs. Since the MC/MM switch is separate from the phono 1/phono 2 switch, either set of inputs can accommodate either type of phono cartridge, MM or MC.

The rear panel of the A-X9 is equipped with the necessary phono 1 and phono 2 terminals, chassis ground terminals, a cartridge load selector switch (with settings for 47 kilohms, 100 kilohms and 100 ohms for MC cartridges), high-level input jacks and two sets of tape-out, tape-in jacks. The two sets of speaker connection terminals at panel-center are clearly labelled as to channel and polarity. A line fuse holder and three convenience outlets (two switched, one unswitched) complete the rear panel layout.

### Construction and Circuit Highlights

The high-capacity (380 VA) power transformer visible in the photo of the internal layout of the A-X9 is constructed with two sets of secondary windings. One of these is for the voltage amplifying stage, while a separate winding is used for output stage powering. For the early-stage supply, a constant-voltage circuit with a cascode amplifier is provided for low-impedance operation (less than 0.01 ohm) across a frequency range from 10 Hz to 100 kHz.

The most interesting circuit feature of the A-X9 is, of course, the Super A principle developed by JVC. Figure 1 shows a highly simplified circuit diagram of the Super A power stage. The portion within the dotted lines corresponds to the Super-A bias circuit, in which  $A_1$  and  $A_2$ , on the one hand, and  $VB_1$  and  $VB_2$  on the other, have identical functions and are arranged symmetrically in relation to the NPN and PNP side of the output stages.

The circuit operates as follows:  $A_1$  and  $A_2$  detect current variations of the power stage and apply input in the form of current output to  $VB_1$  and  $VB_2$ .  $VB_1$  and  $VB_2$  receive current output from  $A_1$  and  $A_2$  and perform current-to-voltage conversion, thereby varying the bias voltage applied to the power stage. The current detection amplifiers at  $A_1$  and  $A_2$  have logarithmic input/output characteristics in order to properly control bias-voltage variation characteristics.  $E_1$  is a voltage-regulated circuit, the principal functions of which are to determine the amount of idle current at the power stage and to adjust that idle current for any wide temperature variations which might occur within the amplifier.

JVC has also come up with an innovative cascode amplifier circuit for use in earlier stages and in the driver stage of the A-X9 which, according to the company, reduces various

forms of early-stage distortion that have previously not been dealt with. The basic circuit of this cascode amplifier is shown in simplified form in Fig. 2. This amplifier circuit is said to provide excellent linearity through a combination of the common-emitter and common-base circuits, since the forms of distortion created by each of these circuits individually are cancelled by each other. In this cascode circuit, input signal  $I_b$  is first amplified  $\beta$  times by the common-emitter circuit  $Q_1$  which provides a large current gain. The signal is then applied to the emitter of the common-base circuit,  $Q_2$ , where it is amplified  $\alpha$  times, thereby producing an output voltage across  $R_L$  which is equal to:

$$V_0 = \alpha \beta R_L I_b.$$

According to JVC, this type of driver stage takes complete advantage of the properties of cascode operation and reduces the distortion figure in the voltage and driver stages of an amplifier by a complete order of magnitude compared with conventional amplifiers.

### Performance Measurements

The power amplifier section of the A-X9 delivered 107 watts per channel at mid-frequencies for its ultra-low rated distortion of 0.005 percent. At 20 kHz, the amplifier was able to deliver just a bit more than its rated 100 watts for the same low distortion level. IM distortion was less than 0.002 percent, lower than the residual IM distortion component present in our test signal source. We attempted to measure other forms of IM distortion, using our two-tone distortion measurement system, such as CCIF IM and IHF IM, but in all cases we were limited by the test signals and the measurement equipment, rather than by the amplifier's actual performance. There would be no point in presenting graphs of power output versus distortion or of distortion versus frequency at rated output, since such curves would, in reality, be nothing more than graphs of the distortion of our own test equipment!

IHF dynamic headroom measured approximately 0.8 dB, while damping factor, at 50 Hz, was in excess of 150 for an 8-ohm load. Slew rate for the amplifier, measured from AUX in to speakers out was in excess of 50 volts per microsecond. We made an attempt to measure TIM, per the square-wave/sine-wave method which seems to be gaining general ac-

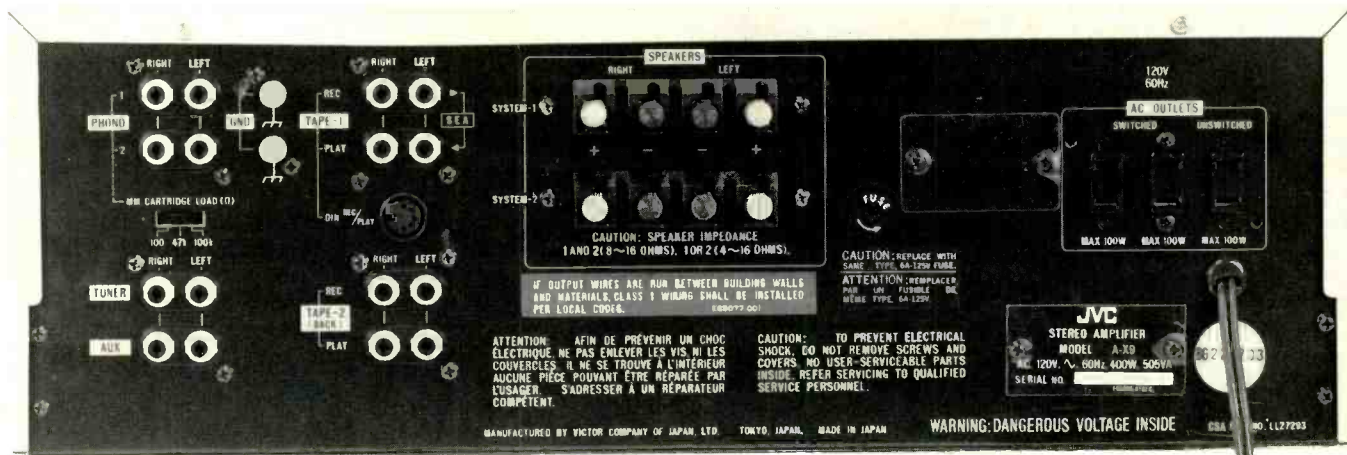

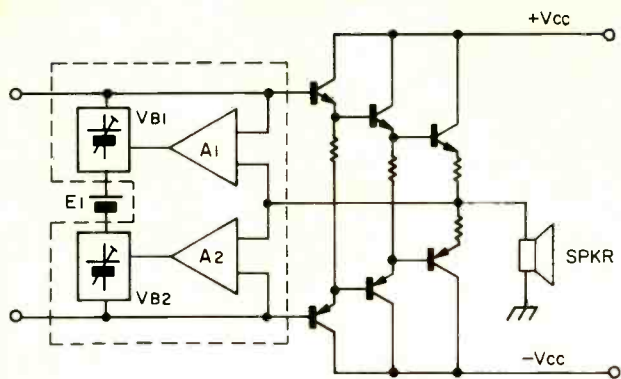

**Fig. 1 — Simplified schematic of JVC Super A output stage.**

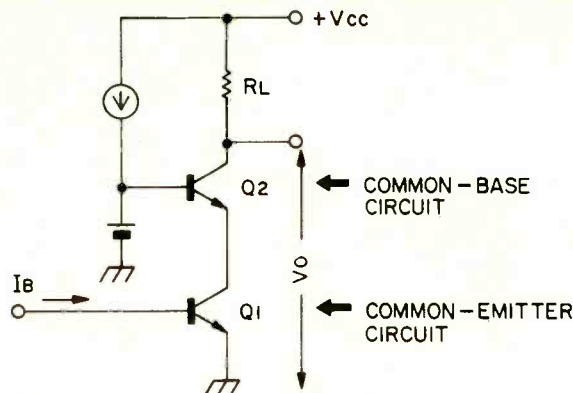

**Fig. 2 — Simplified schematic of cascode voltage amp/driver stage used in Super A amplifiers.**

ceptance, but here, again, we could detect no evidence of TIM distortion contributed by the A-X9 amplifier itself. Frequency response was confirmed as extending from near-d.c. up to 220 kHz for the -3 dB roll-off points.

In measuring the phono preamp section, we found that RIAA equalization was accurate to better than 0.2 dB from 20 Hz to 20 kHz. Phono overload at 1 kHz using the MM input configuration was 380 mV, well above the 350 mV claimed by JVC, while for the MC inputs it measured 30 mV. Input sensitivities, translated to the new 1-watt output reference, worked out to be 0.25 mV for the MM inputs and 20  $\mu$ V for the MC inputs. Signal-to-noise ratio was 84 dB for the moving-magnet phono inputs, a bit better than the 82 dB claimed, while for the MC inputs we measured 68 dB, somewhat poorer than the 75 dB claimed. S/N via the high-level inputs (referenced to 0.5-volt input and 1-watt output) measured 88 dB, as against 85 dB claimed, while residual hum and noise at minimum volume was an impressive 113 dB below rated output.

Tone control range is shown in the spectrum-analyzer sweep photo of Fig. 3. Note that JVC chose to limit the maximum range of the bass and treble controls to a moderate  $\pm 8$  dB at the frequency extremes even though the A-X9 is a fairly powerful amplifier — a design approach with which we fully agree. Whether this moderate approach arises out of design philosophy on the part of JVC or out of some circuit necessity is really of no great concern to us, but we note that the A-X9 has no tone-control amplifier stage per se. Instead, the tone control circuit is incorporated as part of the negative feedback network of the power amplifier. One advantage of this approach, which does seem to be valid, is that all high-level signals, such as those from a tuner or tape deck, are directly

fed to the power amp for true d.c. operation from input to output and with no intervening coupling capacitors.

### Use and Listening Tests

We found the JVC A-X9 amplifier to be a versatile unit that manages to incorporate just about every feature that a serious audiophile might deem to be important in an integrated amplifier. While it does lack secondary tone controls, such as a midrange or presence control, and variable turnover frequencies, it more than makes up for these minor deficiencies in its ultra-low distortion characteristics, whether measured statically or under dynamic conditions. Musical reproduction, using the A-X9 coupled to a pair of Phase Research RT speaker systems, was especially good when the amplifier was called upon to reproduce some of the more complex signal structures contained in many of our master tape recordings and in some of our new digitally mastered, high-dynamic-range discs. We cannot honestly say that sound quality was noticeably better specifically because of the Super A circuitry, but we certainly can have no objection to an amplifier which operates with the efficiency of a Class B unit, yet eliminates any possibility of switching distortion by always keeping its output transistors in a conducting mode. There has been a lot of controversy lately concerning the question of whether this design and other similar quasi-Class A amplifier design approaches deserve to be called Class A amplifiers. As far as I am concerned, that is purely a semantic question, and one that I'll leave to language authorities. My own feeling about the JVC A-X9 integrated amplifier is that it is a superbly designed piece of equipment that delivers good performance at any listening level, whether you call it Class A or Class Z.

*Leonard Feldman*

Enter No. 90 on Reader Service Card

**Fig. 3 — Range of tone control operation; vertical scale is 10 dB per division.**

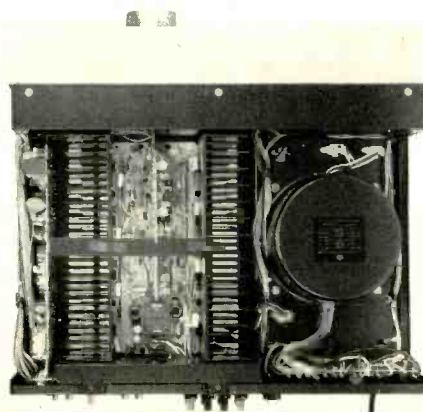
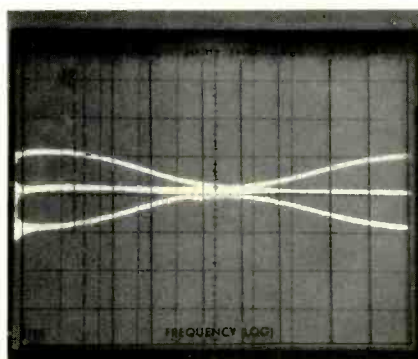

## Dynavector DV/Karat Diamond Moving-Coil Phono Cartridge

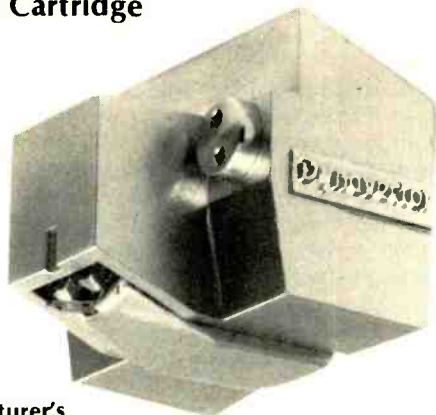

### Manufacturer's Specifications

**Output Voltage:** 0.2 mV at 1 kHz, 5 cm/S.

**Frequency Response:** 20 to 70,000 Hz.

**Separation:** 20 dB at 1 kHz.

**Channel Balance:** 1 dB at 1 kHz.

**Stylus:** Line Contact (0.1 x 0.1 mm), naked diamond.

**Cantilever:** 0.4 x 0.4 x 2.5 mm oblique-cut, solid diamond.

**Compliance:**  $15 \times 10^{-6}$  cm/dyne.

**Impedance:** D.c. resistance, 30 ohms; inductance, 80  $\mu$ H.

**Tracking Force:** 1.5 (+1.0, -0.3) grams.

**Vertical Tracking Angle:** 20 degrees.

**Weight:** 5.3 grams.

**Price:** \$1,000.00.

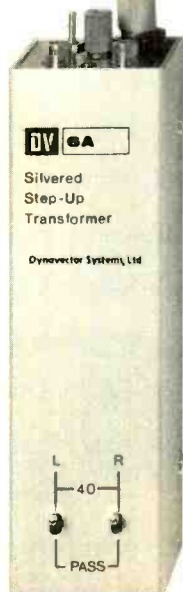

## DV-6A Silver Wire Transformer

**Input Impedance:** 3 to 40 ohms.

**Output Impedance:** 9,000 ohms.

**Load Resistance:** 30 to 47 kilohms.

**Step-Up Ratio:** 1:13.

**Frequency Response:** 10 to 70,000 Hz, +0, -1 dB.

**Crosstalk:** Lower than 75 dB.

**Maximum Input:** 300 mV (50 Hz).

**Distortion:** Less than 0.01 percent at 5 mV input.

**Switchable Connections:** Balanced or unbalanced, pass or 3 to 40 ohm input.

**Dimensions:** 2¼ in. (5.2 cm) W x 7⅞ in. (19.1 cm) D x 3 in. (7.5 cm) H.

**Price:** \$450.00.

For those who will not simply pass out at the thought of a phono cartridge costing a cool \$1,000.00 and still needing an outlay of at least another \$200.00 before it will interface with a standard phono input, the following report will be of interest. It is of the Dynavector DV/Karat Diamond cartridge.

The outward appearance of this cartridge is of unusual design. The gold-color body shell is made from fiberglass — reinforced polycarbonate which has a metallic-like hardness and low mass. The main body dimensions are 19 mm wide by 10 mm long, with the stylus assembly being 15 mm long by 8 mm wide. The overall height is 15 mm, and the mounting centers are the standard 12.5 mm. To mount the cartridge, the mounting screws are inserted through the top of the headshell directly into the threaded mounting holes in the cartridge body. This mounting process makes it easier to mount the cartridge than if the usual screws and nuts are required. The front of the cartridge has an indexing slot for locating the stylus during cueing.

The unique and expensive feature of the DV-Karat Diamond phono cartridge is its cantilever, which is made entirely from a natural octahedron diamond to a size of 0.4 x 0.4 x 2.5 mm. This 2.5 mm long cantilever has its 0.1 square mm stylus mounting hole precision cut by a YAG laser beam machining process. The line-contact shaped 0.1 square mm nude diamond stylus is carefully mounted in the cantilever for the unique stylus-cantilever assembly. The armature for the moving coil is 1 mm square and 0.5 mm thick, upon which are wound 40 turns per channel of 11 micron thick silver wire whose purity is 99.99 percent. The magnets are made from very strong but lightweight rare earth magnetic material.

Just about every cartridge, from moving magnet to moving

coil, is designed for as flat a frequency response as possible between 20 Hz and 20 kHz or better. However, no two cartridges sound alike nor does their reproduction of a square wave look alike. These differences are probably caused by the differences in damping material, cantilever material and design, and stylus shape — all within the physical rather than electrical parameters of the cartridge. In recent years there have been many stylus and cantilever designs, but still no change of major importance since the introduction of the Shibata stylus. Currently, Dynavector design engineers have taken another look at the cantilever design, particularly at the wave propagation along the cantilever. To improve the wave propagation problem, the Dynavector engineers have reduced the length of the cantilever to an unprecedented 2.5 mm instead of the usual 5 to 7 mm length and made it entirely from a solid natural diamond. Dynavector claims that the very short cantilever markedly reduces the dispersion of the propagation wave form of the musical signal along the cantilever, leading to a more realistic sound from the modulated grooves of a record. Further, because of the very small size of the cantilever, the resonant frequency is claimed to be higher than 50 kHz. With this design, the usual rubber damping is not necessary, thus ambient temperature has no deleterious effect upon the damping material used. Rubber material is used only for the suspension of the cantilever to overcome its tendency toward upward movement while playing a record — this use is not a damping action.

The Dynavector DV-Karat Diamond is packed in a gold-colored box which contains a frequency response curve plotted for the individual cartridge as well as the usual mounting hardware.

## Measurements

As is our practice, measurements were made on both channels, but only the left channel is reported. During the test period, the ambient temperature was 71 degrees F. (21.67 degrees C) and the relative humidity was 59 percent,  $\pm 2$  percent. The DV-Karat Diamond cartridge was mounted in a Technics headshell and used with the Technics EPA-100 tonearm mounted on a Technics SP-10 Mk II turntable. Voltage step-up was made using the DV-6A silver wire, 3 to 40 ohm impedance transformer. Since this transformer was specifically designed for the DV-Karat Diamond cartridge, all measurements and listening tests were made using the DV-

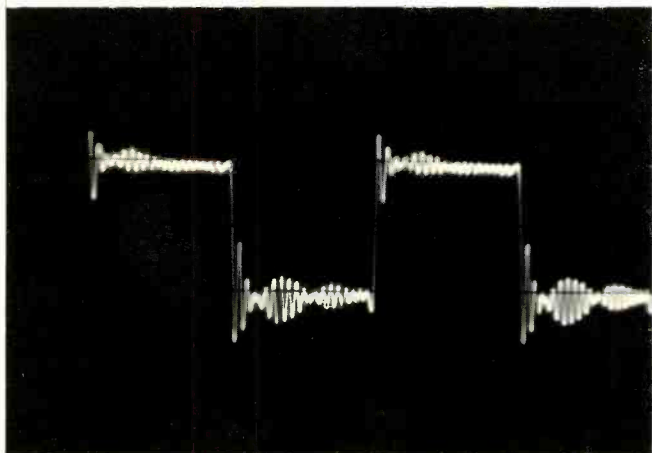

Fig. 1—Response to 1-kHz square wave.

6A silver wire transformer. The transformer's frequency response measured -1 dB at 20 Hz, flat from 40 Hz to 20 kHz, -1 dB at 30 kHz, and -3 dB at 50 kHz. The gain of the DV-6A transformer measured 22 dB.

All measurements of the cartridge were made at the recommended vertical tracking force of 1.5 grams. The optimum anti-skating force for this cartridge was found to be 1.8 grams. The cartridge was oriented in the headshell and tonearm for correct lateral alignment with the Dennesen Geometric Soundtractor, which automatically sets the appropriate overhang for any pivoted tonearm effective length.

Frequency response, using the Columbia STR-170 test record, is -2.25 dB at 40 Hz and then  $\pm 0$  dB from 60 Hz to 20 kHz (truly ruler flat). This is one of the flattest frequency response measurements we have ever encountered. Frequency response was checked out to 50 kHz, using the JVC TRS-1005 test record, and found to be  $\pm 0$  dB from 1 kHz to 18.5 kHz, +0.5 dB at 20 kHz, +1.6 dB at 30 kHz, then flattening out at +1.8 dB for 40 kHz and 50 kHz. This is a truly remarkable frequency response. Separation is 21.5 dB at 1 kHz, 21.75 dB at 10 kHz, 17.25 dB at 15 kHz, 14.25 dB at 20 kHz, 14.75 dB at 30 kHz, 14.5 dB at 40 kHz, and 13 dB at 50 kHz. This amount of separation is more than adequate for a well-defined stereo effect on playback.

The response to a 1-kHz square wave shows some overshoot followed by ringing that decayed rapidly. This type of square wave appearance is not uncommon with a moving-coil cartridge that has an extended high-frequency response to 50 kHz. The stylus resonance is around 41 kHz. The cartridge-arm low-frequency resonance was at 10 Hz laterally with an amplitude of about +0.7 dB and about 13 Hz vertically, using the Technics EPA-100 tonearm. Because of the low-frequency resonance, it is suggested that this cartridge be used only in tonearms of medium to low mass.

The following test records were used in making the reported measurements: Shure TTR-103, TTR-109, TTR-110, and TTR-115; Columbia STR-170, STR-100, and STR-112; Deutsches Hi-Fi No. 2; Nippon Columbia Audio Technical Record (PCM) XG-7002, and the Ortofon Direct-Cut Pickup Test Record 0001.

Wt., 5.25 g; tracking force, 1.5 g; opt. anti-skating force, 1.8 g; output, 77  $\mu\text{V}/\text{cm}/\text{S}$ , with DV-6A transformer, 0.90 mV/cm/S; IM distortion: (4:1) +9 dB lateral, 200/4000 Hz, 2.2 percent, +6 dB vertical, 200/4000 Hz, 4.3 percent; crosstalk (using Shure TTR-109), 26 dB; channel balance, better than 0.1 dB; trackability: high freq. (10.8 kHz pulsed), 30 cm/S, mid-freq. (1000 + 1500 Hz, lat. cut), 25 cm/S, low freq. (400 + 4000 Hz, lat. cut), 24 cm/S; Deutsches Hi-Fi No. 2 300-Hz test band was tracked cleanly to 86  $\mu\text{m}$  (0.0086 cm), lateral at 16.20 cm/S at +9.60 dB and 43  $\mu\text{m}$  (0.0043 cm), vertical at 8.12 cm/S at 3.64 dB. The latter measurements are excellent inasmuch as there are very few cartridges that can track the higher 300-Hz bands on the test record.

The DV-Karat Diamond cartridge with its DV-6A silver wire transformer was able to breeze through the Shure Obstacle Course—Era III test record. The Shure Obstacle Course—Era IV caused no problem except for band 5 of the harp test, where just a hint of possible mistracking was heard. This cartridge performed exceptionally well, particularly so since only an occasional cartridge can reproduce all the levels of the various bands on these two test records.

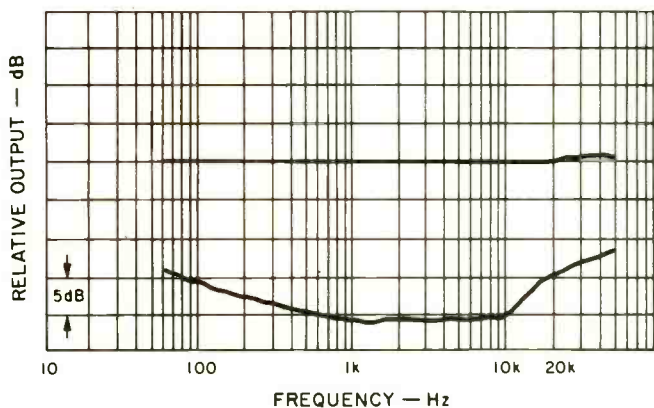

Fig. 2—Response of left channel and separation.

## Listening and Use Tests

As usual, we performed our listening evaluation both before and after measurement. The very first record we played with the DV-Karat Diamond cartridge and the DV-6A transformer combination impressed us with its extraordinary sonic clarity, bass response, transient response, and transparency of sound. Sonically, the cartridge was found to be wholly neutral, adding no coloration nor audible distortion to the reproduced sound. For what it's worth, the DV-Karat Diamond cartridge encountered no difficulty in reproducing the cannon shots on the Telarc 10041 Tchaikovsky: "1812" Overture, Op. 49 recording and the 19.2-Hz organ pedal in the Franck: *Pastorale in E Major* as recorded on the Hammond Castle Pipe Organ by Decibel Records DB 1000 (Box 631, Lexington, Mass. 02173). Without a doubt, this cartridge will cleanly reproduce any recorded sound.

After a period of prolonged listening, we are of the opinion that musically it is one of the most rewarding phono cartridges we have thus far encountered. For those who do extensive listening it can be particularly recommended for its non-fatiguing characteristics.

B. V. Pisha

Enter No. 91 on Reader Service Card

## Evaluation Equipment and Records

The following equipment and specific records listed below, as well as many discs listed in past reports, were utilized in the listening evaluation of the Dynavector DV-Karat Diamond phono cartridge: Technics SP-10 MkII turntable Technics EPA-100 tonearm, Nikko Beta 1 preamplifier, Crown IC-150A preamplifier, Audionics of Oregon Space and Image Composer, Audire DM-700 power amplifier, Audio Innovations LED 2C Dynamic Power Display, and a pair of stacked Duntech DL-15B speakers in each channel. Each pair of speakers was connected to the Audire DM-700 power amplifier with Monster Cable. The turntable was equipped with the Hiraoka Disk-SE22 turntable mat.

The following records were among those used to aurally assess the performance of the Dynavector DV-Karat Diamond phono cartridge:

### Stereo

*The Manhattan Transfer-Live*— Mobile Fidelity Sound Lab MFSL 1-022.  
 The Crusaders, *Chain Reaction*—Mobile Fidelity Sound Lab MFSL 1-010.  
 Mahler: *Symphony No. 4*, Karajan, Berliner Philharmoniker—Deutsche Grammophon 2531 205.  
*Virtuose Kammermusik*, Wolfgang Schulz, Querflöte—Telefunken 6.42364A.P.  
 Bach: *Die Dreifaltigkeitsorgel zu Ottoburen*, Ton Koopman (organist)—Telefunken 6.35375DX.  
 Indianapolis Symphony Orchestra, *Fifty Colorful Years*— RCA DPL2-0432.  
*Parnassus Ensemble*— Accent Acc 7806.  
 Kabi Laretei (piano), *Close-Ups, The Film Music of Ingmar Bergman* — Proprius: Prop 7829.  
 Mozart: *Requiem*, The Stockholm St. Jacob Choir, Stefan Skold—Proprius Prop 7815.  
 Pavarotti, *O Sole Mio, Favorite Neapolitan Songs* — London OS 26560.  
 Mendelssohn: *Symphonien Nos. 4 & 5*, Bernstein, Israel Philharmonic Orchestra—Deutsche Grammophon 2531 097.  
 Handel: *Organ Concertos*, George Malcolm (organ)—Argo ZRG 888.  
**Direct to Disc**  
 Spaccò Organ, Jonas Nordwall (organ)—Crystal Clear Records CCS 6003.  
 Laurindo Almeida, *New Directions*— Crystal Clear Records CCS 8007.  
 Tractin, Lew Tabackin Quartet—RCA (Japan) RDC-3.

Vivaldi: *Concerto in E, Op. 8, No. 1 "Spring"/The Beatles Medley*, M. Hayakawa, Vivaldi Ensemble, Tokyo—RCA (Japan) RDC-2.  
 Montgomery and Lytle, *Ragtime Piano for Four Hands*— Sonic Arts Laboratory Series No. 6.  
*Woofers, Tweeters and All That Jazz* (Binaural) — Sonic Arts Lab. Series No. 7.  
 Beethoven: *Piano Sonata No. 23 in F Minor, Op. 57 "Appassionata"*, I. Kamiya, pianist playing the Bosendorfer Imperial piano — RCA (Japan) RDC-4.  
 Vivaldi: *Four Seasons*, M. Hayakawa, Vivaldi Ensemble, Tokyo — RCA (Japan) RDCE-301-2.  
*New Baby*, Randi and Quest — Sheffield Lab. 12.  
*Introducing Bosendorfer (Imperial) and Kimball (Professional): The State of the Art in Recording Piano* — Kimball Piano & Organ Co., Jasper, IN 47546.

### Pulse Code Modulation (PCM) Digital to Analog

Ravel: *Daphnis et Chloe, Mata*, Dallas Symphony Orchestra and Chorus — RCA ARC1-3458.  
 Stravinsky: *The Firebird: Suite (1919); Symphony in Three Movements*, Mata, Dallas Symphony Orchestra—RCA ARC1-3459.  
*Digital Spectacular*, Stanley Black—His Piano and Orchestra—London LDP 30001.  
 Mozart: *Symphony No. 38 in D Major ("Prague") and Symphony No. 36 in C Major ("Linz")*, Suitner, NHK Symphony Orchestra—Denon OX-7156-ND.  
*Famous Classical Music on Screen*—Denon OX-7146-ND.  
*Beloved Screen Music*— Denon SX-7008.  
*Screen Music for Lovers*— Denon SX-7007.  
 Schubert: *Sonata in A Minor for Arpeggione and Piano; Vextemp: Sonata in B-flat Major for Viola and Piano*— Denon OX-7154-ND.

Proprius and Accent records are distributed by Audio Source, 1185 Chess Dr., Suite C, Foster City, Cal. 94404.

Sonic Arts Corp. and RCA (Japan) direct-to-disc records are distributed by Audio Technica U.S., 33 Shiawasee Ave., Fairlawn, Ohio 44313.

Denon records are distributed by American Audioport, 1407 North Providence Rd., Columbia, Mo. 65201.

# Control your reality.

Let's face it. Nobody has to tell you what sounds good. You know what you like to hear. But sometimes that can be a problem. You're listening in a room with poor acoustics, bad speakers, or inferior program source quality. You need some way to control the sound so you can hear the music the way you like it.

The MXR Stereo 10-Band Graphic Equalizer gives you that control. With it you can alter tone, get rid of noise, or bring out a part in the music that you really like. The Stereo 10-Band

Graphic Equalizer enables you to adjust the music to meet your special tastes. It lets you control your reality.

MXR Innovations, Inc., 740 Driving Park Ave., Rochester, New York 14613, (716) 254-2910

**MXR** Consumer Products Group



Enter No. 13 on Reader Service Card

## Connoisseur Model BD2A Turntable



### Manufacturer's Specifications

**Speeds:** 33 $\frac{1}{3}$  and 45 rpm.

**Wow & Flutter:** Less than 0.065 per cent.

**Rumble:** -65 dB per DIN 45-539.

**Features:** Auto lift, belt drive, 45-degree gimbal arm suspension.

**Dimensions:** 18 in. (45 cm) W x 15 in. (37.5 cm) D x 6 in. (15 cm) H.

**Voltage Required:** 200/250 or 100/125 a.c.

**Power Consumption:** Less than 5 watts.

**Price:** \$220.00.

Connoisseur is one of the oldest manufacturers of turntables anywhere in the world, and it is interesting to recall that the firm's founder, Arnold Sugden, was making stereo records long before they were generally available commercially. The company is situated in Yorkshire, England, not far from some other British hi-fi equipment manufacturers including Rank/Wharfedale, Fane Acoustics, Richard Allen, and Castle Acoustics.

The Connoisseur turntable selected for this review is the Model BD2A, and I must say it right at the outset—the design will not appeal to those who are addicted to lights, bells, whistles, and other sorts of fluff which do not, at least in my opinion, affect the basic performance. There is no digital read-out, variable speed control, logic circuitry, or rows of

shining push buttons. The BD2A doesn't even boast a calibrated tracking-force dial or a strobe light speed indicator.

Rather, the design will appeal to those who are interested in a simple, no-frills concept—a good basic design, providing first-rate basic performance, but no more. Through the use of a small a.c. motor with a belt drive, to the platter, and by application of a healthy dose of common sense and lots of precision engineering, better than average results are obtained. And all of this comes in at what must be considered these days to be a rather moderate cost.

The motor is a synchronous constant-speed type with self-aligning bearings made of bronze, and it rotates at 450 rpm when running on 60-Hz current. The drive is taken from a twin-stepped pulley wheel to the platter by a rubber belt,



which is round in cross-section and treated with a silicon compound. Speed changes are effected through a lever which moves the belt by means of a fork. The motor itself is suspended on a sort of rubber bushing, and there is a bias tension to offset any pressure from the driving belt. Such a tension will help keep the bearing in proper round and prevent any asymmetrical wear.

The platter is made from a lathe-turned aluminum casting, weighs 2¾ lbs., and rotates on a manganese-bronze bearing fitted with a hard steel thrust ball. Following what is the most common European practice, the arm uses a straight-line tube design, while the angled headshell simply plugs in. The counterweight is mounted at the rear of the arm and, as stated earlier, is not calibrated. The correct tracking force is obtained by use of the high-precision balance supplied with the BD2A. An unusual feature of the arm is the use of 45-degree pivots which allows the connecting leads to be brought through the center and thus avoid torsional twisting. Anti-skating bias is provided by means of a tiny rod and weight which are carried on a concentric gimbal.

The cue lift platform is located just in front of the arm base, and it is operated by a knob on the right-hand side of the unit, up near the front. The height setting is controlled by a small thumb wheel at the base of the lift platform, which also contains a reed switch for operating the automatic arm lift at record ending. When the stylus enters the run-out groove, a tiny magnet mounted under the arm triggers the switch, which then discharges a capacitor through a solenoid. The on/off switch is at the front, to the left, and it controls a mechanical brake, as well as switching the power off.

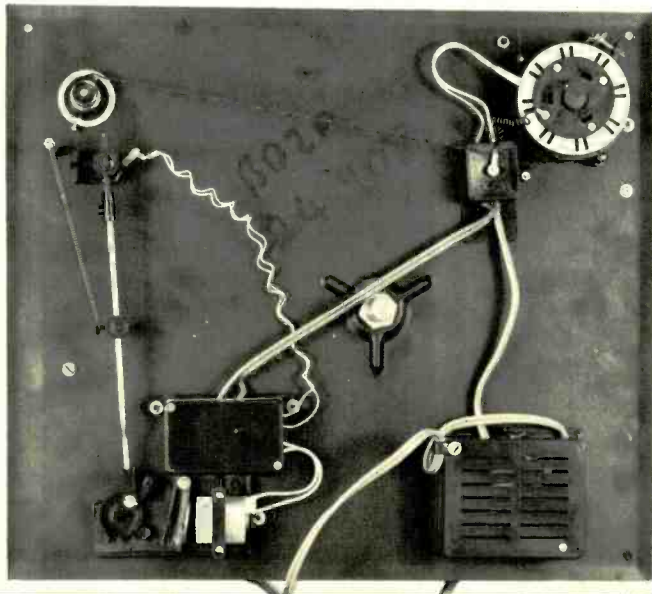

Styling is clean and uncluttered, with a matte-black vinyl covering on the base and top plate contrasting nicely with the aluminum rectangle going around the top plate and the aluminum plate carrying the *On/Off* and *Cue* levers. The friction lid hinges are more substantial than those commonly used, while two black plastic buttons allow the dust cover to be lifted without leaving fingerprints. The unit stands on four acoustically sprung and damped isolation feet, and it comes complete with mounting hardware for the cartridge, a small bottle of oil, a tube of silicon compound for the belt, extra weights for tracking and anti-skating adjustments, the aforementioned balance scale, and a cardboard protractor.

### Measurements and Use Tests

For test purposes a Stanton 881S phono cartridge was mounted in the low-mass headshell and aligned as suggested in the instructions. This gave a maximum error of five degrees, which is fairly typical of arms with a length of 8¼ inches with an overhang of 9/16 inch. Tracking force was set to 1½ grams (after checking the balance for accuracy, which was extremely good, by the way), and the anti-skating weight adjusted accordingly.

Wow and flutter measured 0.06 percent (DIN 45-507), and rumble was a low -63 using the ARRL weighting. The ARRL weighting, as most will know, is not strictly comparable to the DIN method used by Connoisseur for their specification. However, the two methods are sufficiently alike that it is to be expected that the BD2A should be pretty well on spec.

Arm resonance with the Stanton cartridge came out at 10.5 Hz, with a rise of 4 dB. Both lateral and vertical bearing friction were insignificant. Speeds were less than 0.1 percent fast, and torque was apparently unaffected by use of a Dust Bug or similar device, which does not always happen with belt-driven turntables. The cue lift was nicely done, quite positive to the touch, and I found the backlash negligible when the control was adjusted for minimum height. Although the initial tests were made with a tracking force of 1½ grams, I found later on that the cartridge performed quite happily at 1 gram in this arm. However, to be on the safe side, I would recommend that both tracking and anti-skating forces be set at 1¼ grams. Acoustic feedback proved to be less of a problem with the BD2A than with many other turntables, apparently because of the good design of the isolating feet. Mechanically, the unit is remarkably quiet, while the unit as a whole is well engineered and made. The low-friction, low-mass tonearm can be used with confidence in combination with most any high-compliance phono cartridge.

To sum up: This turntable represents good value for dollar in that it provides good basic performance at a price which must be considered as moderate to low in these days of heavyweight inflation. It is not for everyone; those who are after a turntable with *everything* will be turned off by the economy of this straightforward design. But, to others, design simplicity and engineering elegance are virtues, which lead to the truly good standards of performance, and the BD2A will appeal to folks such as these.

George W. Tillett

Enter No. 92 on Reader Service Card

Jon Tiven

Michael Tearson

# The column

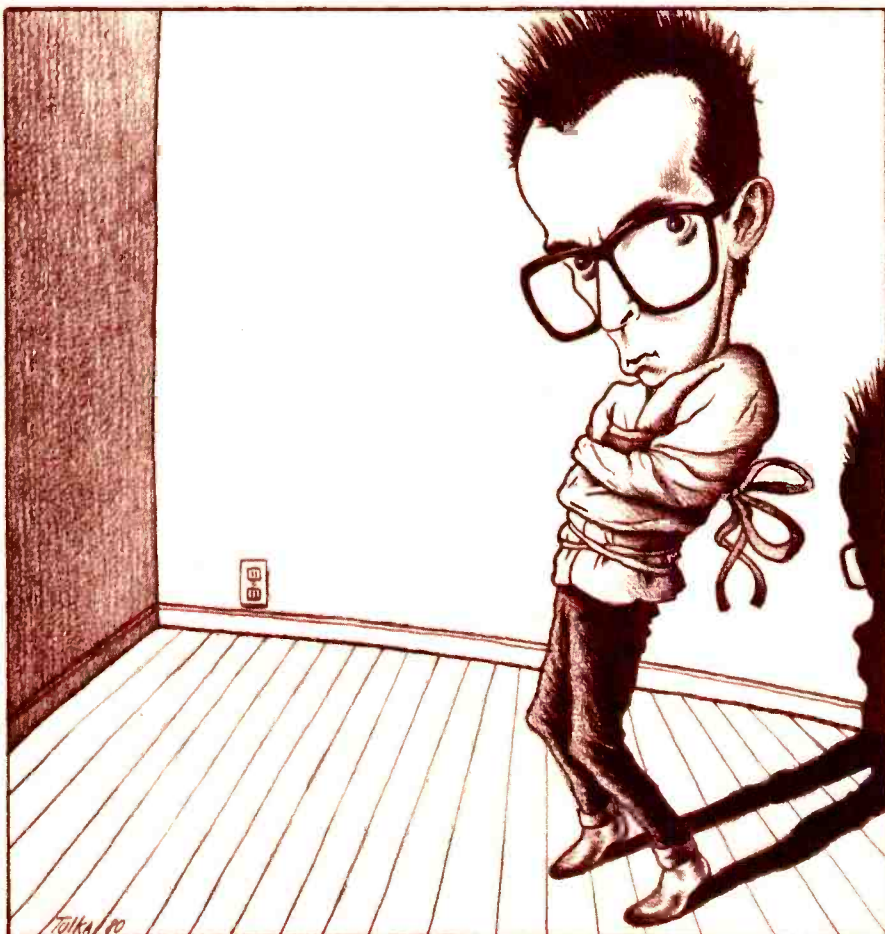

**Get Happy:** Elvis Costello & The Attractions

Columbia JC 36347, stereo, \$7.98.

Any review of Elvis Costello should, I feel, be prefaced by a disclaimer: This is Perhaps the Most Important New Artist to Emerge in the Past Five Years and All Criticisms Should Be Taken with a Grain of Salt. The guy created a style which has been aped by many more successful (financially) than himself, but he has chosen not to dilute his art and has made four non-compromising albums that are all humanly flawed but will most likely stand the test of time long after Joe Jackson's in the ground. Elvis is obviously a gifted songwriter of many dimensions, a highly complex individual with tons of personal problems, and for some convoluted reason he lets it all out on his records, articulating his confusion in a code that makes Bob Dylan's language seem comparatively

transparent. Despite the fact that I'm a little tired of trying to listen to Elvis through Nick Lowe's production, and regardless of my personal opinion that many of the 20 songs on **Get Happy** aren't as strong as the others, and even though there may not be any hit singles on it, I must say that I enjoy the record more than just about any I've heard this year. Although the contents haven't completely settled yet, I look forward with eager anticipation to Elvis' next record.

Probably the most revolutionary thing about the album is that it's got 10 tunes per side, the first album of this length since Todd Rundgren's **Initiation** (I guess anybody who goes out with Bebe Buell for any time eventually gets an attack of longwindedness), and I'd guess that this is only a third of the songs Elvis has written since the last album (he's legendary for throwing out a tune a day).

Musically speaking, **Get Happy** isn't a major departure for Elvis. There are a few reggaefied/ska-ish tunes, as the current English bluebeat revival has his involvement (he produced *The Specials* and also had a single out called *Watching the Detectives* which was highly reggaed). Whereas the last album was somewhat keyboard dominated, this one tends toward emphasizing the bass guitar (the best musician in the group). **Get Happy's** hooks tend to be slightly more obscure than usual, but maybe because it's more difficult for 20 or so refrains to sink in. My personal favorites from the album are *Love for Tender* (Declan McManus meets the Jackson Five), *Riot Act* (wonderful chord progression), *Motel Matches* (one of his better ballads), *New Amsterdam* (can't wait for Crosby, Stills & Nash to cover it), *Secondary Modern* (seemingly a sequel to *Green Shirt*), and *The Imposter* (Elvis about Elvis, sort of like *Big Boys*). The cover tunes are OK, although I prefer Heads Hands & Feet's *I Stand Accused* to the British single, *I Can't Stand Up for Falling Down* (not a song about impotence).

It's interesting to note that the sides are listed one way on the jacket and the other way on the record, i.e. what is side one on the jacket is side two on the label. This is either part of the artist's decision to confuse listeners and radio folks, or the record company's decision (at the last minute) that the side labeled one on the jacket is the weaker of the two (which is, in fact, true). In any case, Elvis once again treats us to an album which has us hopefully awaiting his next, in the expectation that he will finally come up with the LP which truly represents the high points of his talent. In the meantime, we have **Get Happy**, which almost comes close. J.T.

Sound: B-

Performance: A-

**Get Happy:** Elvis Costello & The Attractions

Columbia JC 36347, stereo, \$7.98.

Elvis Costello's fourth album, **Get Happy**, could hardly have been more different from the third, **Armed Forces**. **Forces** was very carefully crafted, very much a studio and stereo creation

Illustration: Rick Tulka

with very good sound. **Get Happy** is very ambitious, containing 20 songs, ten per side. By aural appearances the album was mostly recorded live in the studio with minimal overdubbing and done rapid-fire, one song after another. The sound is tough and raw. Costello's voice is most often buried in the mix and undecipherable while the band has never sounded muddier.

As for the songs, 18 are originals and two are covers, one an obscure Sam & Dave B-side, the other a Mersey Beats song. Oddly, Costello seems intent on undermining some of his best ideas either through the deliberately cheesy recording or opaque arrangements. *B Movies* is an excellent example. When I first heard it played as a brand new song, it was an angry, driving, full-throated rocker written right after the infamous remark about Ray Charles and the ensuing incident with Bonnie Bramlett—which had occurred only a week before. Now on the record the

melody is a different, cuter one that forces the words into a jumble. The voice of fury gives way to a petulant whine.

Frankly, out of 20 songs, some are awfully good. With that many so it should be. Two ballads—*Motel Matches* and *Riot Act*—stand out. *High Fidelity* is a wonderful song with an insistent catch line in "Can you hear me?" *Beaten to the Punch* is spunky, and *Black and White World* is challenging. But the overall impression, an unavoidable one, is confusion amidst all the '60s sounds.

Costello and producer Nick Lowe have admirably reached for a lot, but they've made it as difficult as they could for a listener to absorb. Producer Lowe has written some brief notes for the album's back cover, obviously tongue in cheek, but they bear quoting: "Elvis and I talked long and hard about the wisdom of taking this unusual step [of putting 10 songs on a

side], and [we] are proud that we can now reassure hi-fi enthusiasts and/or people who never bought a record made before 1967 that with the inclusion of this extra music time they will find no loss of sound quality due to 'groove cramming' as the record nears the end of each face (i.e. the hole in the middle)." I must read this note as sardonic, contemptuous and damn near downright insulting. In fact, the songs are all so short that while **Get Happy** does have an admittedly generous amount of playing time, it by no means represents a breakthrough of any kind. Further, the sound, as I've already noted, is so muddy and impenetrable that the album is no less than a gratuitous slap in the face, particularly after the technical excellence displayed on **Armed Forces**. And it is not anywhere near as much fun either.

M.T.

Sound: D

Performance: C-

#### Mad Love: Linda Ronstadt

**Elektra/Asylum SE-510**, stereo, \$8.98.

Any New Wave fan worth his weight in safety pins is going to take offense at this record, the mere concept of Elvis Costello-written tunes appearing with those by Los Angeles Knack-clones The Cretones being too much to stomach. One would have hoped that the influx of punk and its garbaged-out friends would have led the Jackson Browne/Eagles/etc. school of rock out of their laid-back stupors and merely encouraged them to rediscover their American rock 'n' roll roots. After all, the successful English bands of today are just aping Yank rock of the Fifties and early Sixties, and that certainly would be easier for Russ Kunkel to relate to than Gary Numan or Rat Scabies. Unfortunately, these Los Angeles types don't have enough imagination to put all that together, and when Linda Ronstadt decided to make herself a New Wave album her role models were handpicked from the British charts. Her backing band/songwriters were Wendy Waldman's band, who must have recently discovered the wonders of punk, chopped off their beards and dropped all their augmented sevenths in a bucket.

**Mad Love** isn't a terrible album, but it doesn't stand a chance of ringing true. Instead of making the Elvis Costello songs sound like they were written for her, Linda sings them in a

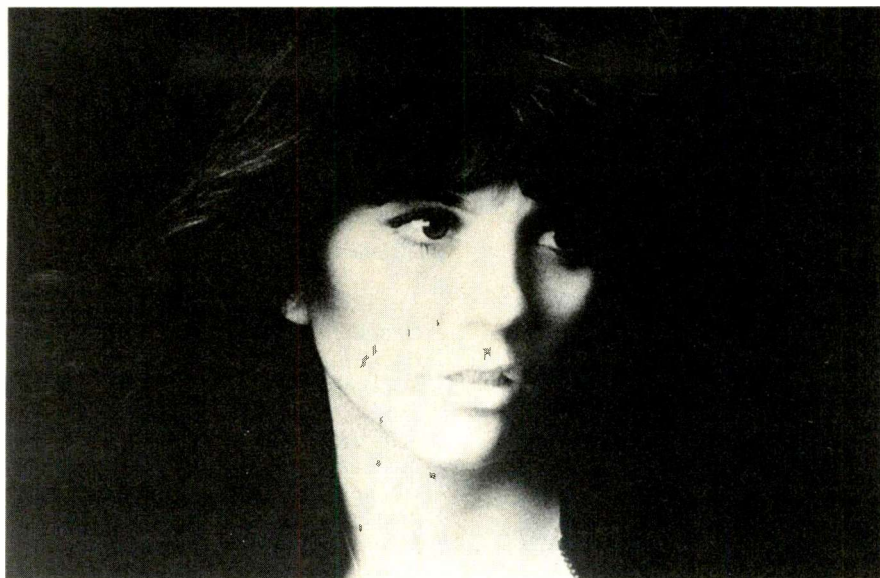

hyper style, with Peter Asher's arrangements note-for-note from the originals. This is most unfortunate, as (a) there was plenty of room for interpretation and improvement and (b) Linda's not exactly the most comfortable vocally when she sings frenetically. As far as the Cretones-penned tunes, well, they ring with as much authenticity as you'd expect from someone who was playing Eagles-rock all his life and then discovered Blondie.

However, I must say that I don't mind at all. I'd rather Linda be carrying

the New Wave banner and make the genre a little more acceptable to AM radio disc jockeys than continue flogging a long-dead horse, even if it doesn't exactly suit her personally. One day she might discover what she really wants to sound like and be more than a mere reflection of whatever's trendy, but if she wants to be a 12-inch ad for Elvis Costello, that's her prerogative. I suggest you purchase the original myself.

J.T.

Sound: B-

Performance: B-

## The Audio Critic reports a major speaker development.

In its forthcoming ninth issue (Vol. 2, No. 3), The Audio Critic acquaints you with a new speaker system that just might shake up the whole speaker world.

Although of conventional woofer/midrange/tweeter configuration and no costlier than dozens of other medium-sized floor-standing dynamic speakers currently sold to audiophiles, the new system is distinguished by its avoidance of the typical design errors, large and small, that The Audio Critic's comprehensive laboratory tests and listening evaluations have uncovered in all such speakers reviewed until now, even in the recommended models. The resulting sound quality is equaled or exceeded only by the most expensive full-range electrostatics—and not all of them.

The Audio Critic prints absolutely no commercial advertising and is the only "underground" review for which the top technologists and academicians of the audio world have the slightest respect. We recommend that you start your subscription retroactively with the sixth issue, which is a cumulative reference work with over 150 equipment reviews.

Send \$30 for 6 consecutive issues by first-class mail (no Canadian dollars, \$6 extra for overseas airmail) to The Audio Critic, Box 392, Bronxville, NY 10708.

# IT'S US. OR DUST.



Goodbye to "snap, crackle and pop". Scotch® DustGuard mat suppresses static, helps keep record surface dust-free, in use. You get better performance, longer-lasting records. Your record collection needs DustGuard for true, pure sound. At local record and hi-fi stores.

Scotch® Record Care. The truth comes out.



Enter No. 12 on Reader Service Card

### Sylvain Sylvain RCA AFL1-3475, stereo, \$7.98.

A veteran of The New York Dolls, Sylvain comes on like some Sal Mineo-styled squirt who rocks his little Manhattan butt off, but he's got his share of problems getting the news out on his debut solo effort. First off, his band sounds like the lamer side of yesterday, in most cases failing to give him the proper drive and power that his songs and vocal delivery require. Secondly, he co-produced the album with two engineers, and the result is a disappointingly thin-sounding record with vocals which are a little too strong emotionally at times and could have used an edit here and there. And to add insult to injury, the strongest tunes are almost all on side two, which puts little Syl at quite a disadvantage with the DJs of the world who might needledrop on side one and just say forget it.

All this considered, **Sylvain Sylvain** is a collection of some very hot rockers and no shortage of personality — considering that the boy was born in the Middle East, you wonder how he ends up sounding like he's ready to do for Brooklynese what Wreckless Eric does for Cockney. Not that he needs an interpreter, but his vocals lay the accent on a little thick so get ready for it, nasality and all. But skip side one and go straight to *Every Boy and Every Girl* which, with a few embellishments, could actually end up as a hit single, sounding like an outtake from **The Beatles' Second Album**. *14th Street Beat* is a little mindless, but the rhythm'll get you every time. *Deeper and Deeper* sounds like a classic from 20 years ago, even though it's only two

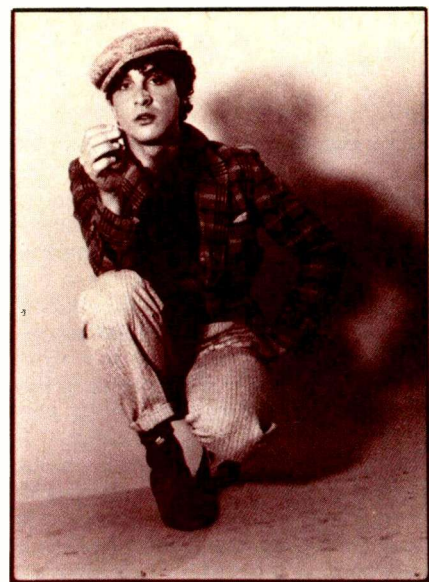

or three years old — it's the strongest ballad on the album; *Without You and I'm So Sorry* on side one are completely overdone in the sappy arrangements department. Finally on side two, *Ain't Got No Home* is a raver in a way that The Band never got close to with their cover. Now skip to side one again, play *Emily*, and you've got five killer tunes — but five killers doth not an album make. Unfortunately, **Sylvain Sylvain** is a terrific EP and once he gets his ensemble together (word is that he's sacked his entire band), a great second album could be in the works. It's not inevitable, mind you, but somewhere Sylvain has got a definite rock album in him, and one of these days he might even put it out. *J.T.*

Sound: C

Performance: B

### Dancing in the Dragon's Jaw: Bruce Cockburn Millenium/RCA BXL1-7747, stereo, \$7.98.

If there was justice in the music business, Bruce Cockburn would not still be Canada's best kept secret south of the border. At home he is regarded as almost a national treasure who performs regularly to packed halls. In the U.S. several of his 10 albums have been released, most notably the wonderful *In the Falling Dark*, but none has made the slightest dent, which is a pity. As a poet, Bruce is at the very least the equal of Joni Mitchell and very possibly better. His writing has true substance and meaning and depth. The music he sets his lyrics to is richly textured and jazz-tinged, and the musicians he attracts are Canada's cream, sensitive and probing players.

**Dancing in the Dragon's Jaw** is surely one of Cockburn's very best albums. It boasts liberal doses of every element

I've mentioned: Probing songs with excellent lyrics and breathtaking instrumental performances, not the least by Cockburn himself on guitar — he is a dazzling player himself who can cascade notes at will. As is also usually the case with Bruce's records, the album boasts crystalline recording and excellent production by Eugene Martynec who has handled most of Cockburn's output to date.

If this was a fair world, there would be no question about **Dancing in the Dragon's Jaw** finally bringing Bruce Cockburn's extraordinary talent the recognition and appreciation so long and so obviously overdue him in the States. Canada has given us Joni Mitchell, Gordon Lightfoot and Neil Young, to name only a few. Cockburn is at least the equal of any of them, and he should be heard. *M.T.*

Sound: A

Performance: A

John Lissner

John Diliberto

# Jazz & blues

**The Harmonica According to Charlie Musselwhite:** Charlie Musselwhite  
**Kicking Mule 305**, stereo, \$7.98.

Soaring, exhilarating, swooping harp lines are what his fans have come to expect from blues harp master Charlie Musselwhite, and that's just what he delivers on this album. He's back in fighting form after his lackluster Crystal Clear set, and harp fans will find this disc an absolute joy.

The album was cut in England with a pickup band of local musicians who are competent enough, but don't quite measure up to Musselwhite's best bands of the past. As if to prove the point, he's remade *It Ain't Right*, (here called *Pistol in Your Face* but musically virtually identical) which first appeared on his landmark **Takin' My Time**. On that earlier record, Musselwhite and his sidemen raced through the tune with a frantic urgency, as though only four minutes of studio time remained in which to cut a five-minute song.

This time out, the level of teamwork is not as high. His band seems content to merely lay down a workman-like rhythm and leave all the instrumental chores to Musselwhite, who predictably comes through with flying colors. The key to the difference between the two versions rests in the virtues of road-seasoned sidemen, as opposed to pickup bands. Musselwhite's best work has been done with groups that had worked with him extensively before recording, allowing an almost intuitive interaction in the studio that's largely absent on this set.

The album greatly benefits from a diverse selection of material which ranges from rave-up amplified harp showcases, reflecting the influence of Little Walter Jacobs and Shakey Horton, to acoustic numbers modeled on traditional themes. Of special interest is *Tuff*, originally an instrumental by saxophonist Ace Cannon, which is a prototypical end-of-the-night bar song. Musselwhite's full-bodied wailing rendition of it recalls Junior Wells' description of a blues harp as a "Mississippi saxophone."

**The Harmonica According to Charlie Musselwhite** offers further proof (not that true believers needed any)



that few living harp players can compare to this 35-year-old veteran of Chicago's clubs.  
Roy Greenberg

Sound: B                      Performance: A-

**Bloomfield/Harris:** Michael Bloomfield and Woody Harris  
**Kicking Mule KM 164**, stereo, \$7.98.

This is an unusual record, to say the least. Who would have guessed that one of America's most respected neoblues guitarists (Bloomfield) would team with a woefully under-recognized composer (Harris), whose normal concern is a cross-fertilization of folk-guitar concepts with chamber music, to play a series of instrumental duet arrangements of traditional gospel songs?

Truth be told, this will not be to ev-

eryone's liking, at least not right away. It has to sink in, if only because the duo's approach to the material is far removed from the virtuosic flashiness normally expected from such "super sessions," and is instead very sober and dignified. In addition, the fact that the first cut, *I'll Overcome* (of which the more familiar *We Shall Overcome* is a slight variation), is also the most technically flawed lends an unfortunate impression of what is to come. But live with it awhile, for the more one listens, the more one realizes that this is a very special record.

Bloomfield assumes the lead on most of the tracks, dividing his time between acoustic (picked on three cuts, slide on one) and heavily reverberated electric slide guitar. He states the melody in a direct, unaffected manner, then proceeds to thoroughly



investigate the theme, extracting from it a wealth of nuances, subtleties, and implications without straying far from the song's original intentions. Harris provides a simple, steady, sensitive, and supportive backdrop, supplying not so much rhythm as body, structure, and guidance to Bloomfield's thematic improvisations. It all sounds so easy and unsophisticated, though actually a great deal of thought, care, inspiration, and discipline has gone into this quietly emotional and ultimately moving music.

Most of the songs originate in the black gospel tradition, except for two — *I Am a Pilgrim* (played with a livelier-stepping bounce than the other tunes, as befits a Merle Travis favorite) and The Country Gentlemen's beautiful bluegrass hymn, *Have Thine Own Way* — which come from country-gospel. Each guitarist has a solo track; Harris tastefully embellishes Joseph Spence's *Great Dreams from Heaven*, while Bloomfield plays an eerily tremulous *Peace in the Valley* on electric slide over his own acoustic accompaniment. It should be noted that the titles of *Just a Closer Walk with Thee* (given a unique Hawaiian-blues interpretation) and *Farther Along* are reversed in the title listing and on the label, but are in the correct order in the liner notes.

This is hardly a record to turn to for instant gratification. Nevertheless, it shouldn't be long before many people will be listening to **Bloomfield/Harris** with the same esteem that Bloomfield and Harris have themselves accorded their sources for the songs on this one-of-a-kind record. *Tom Bingham*

Sound: B Performance: B+



**Pick 'Em:** Ron Carter  
Milestone M-9092, stereo, \$7.98.

Ron Carter is a formidable bassist whose broad, rich sound and distinctive intonation have imbued even the most pedestrian sessions with a feeling of vitality. His work with the decidedly non-pedestrian Miles Davis is, of course, legendary.

On his own albums Carter seems to founder in an absence of inspiration, yet they all have unique facets as he places his bass in different settings, often with strings. His working quartet is an unusual assemblage that has Carter pairing his piccolo bass with the standard upright of Buster Williams, in addition to pianist Kenny Barron and drummer Ben Riley. On the **Piccolo** album he proved that this could be a dynamic combination, but most of his albums fall in the area of sophisticated background music, and **Pick 'Em** is one of those.

His "piccolo" quartet is augmented on all tracks by a cello quartet. The arrangements are tasteful and avoid the syrup, but the effect is somnambulant. Even Miles' *All Blues* is given a walk-through performance. The title piece seems to jump off the disc by comparison. It plays like a soundtrack to western Americana with cellos sawing and Hugh McCracken's open-road harmonica. But the road goes nowhere, and it is followed by the aptly titled *Tranquil*.

The album is crisply recorded with the strings integrated with Carter's quartet. But easy playing, no matter how great the chops, can yield only easy-listening music. *John Diliberto*

Sound: B+ Performance: C



**Fine and Mellow:** Ella Fitzgerald  
Pablo 2310 829, stereo, \$8.98.

Fine and mellow is right; this is Ella's best album in years. These sessions were actually recorded by Norman Granz in 1974 at the MGM studio in Los Angeles with Ella in full command of her vocal powers. **Fine and Mellow** may be the finest jazz album she has ever made, and ranks with her superb pop efforts like *Ella Sings Gershwin*, recorded some years ago for Decca. The session is wonderfully relaxed, and Ella and the musicians seem to be having a ball.

One of the most striking things about **Fine and Mellow** is the marvelous vocal and instrumental partner-

ship. Ella is sustained and complemented by an outstanding rhythm team — Louis Bellson, drums; Ray Brown, bass; Joe Pass, guitar, and her own accompanist, Tommy Flanagan on piano. The four horns are superb — Zoot Sims and "Lockjaw" Davis on tenors; Clark Terry and "Sweets" Edison, trumpets. Beautifully backed by this cohesive group, the First Lady of Song floats through numbers like *I'm Just a Lucky So & So*, *I Don't Stand a Ghost of a Chance*, *I'm in the Mood for Love*, and *Polka Dots & Moonbeams* with skillful phrasing. Her rendition of Monk's *Round Midnight* is feelingful and evocative as she gently entones the lyrics and colors the melodic line to the accompaniment of beautiful obligatos by Clark Terry, Sweets Edison, and Jaws Davis.

She really swings up a storm on Ellington's *Rockin' in Rhythm*, plunging exuberantly ahead, accompanied by Flanagan's crisp, jaunty piano and with some fine choruses by Zoot, Sweets, and Jaws dancing alongside her. She does some fine scatting here, wailing like a hot tenor sax. Her earthy approach to *Fine and Mellow*, a blues forever identified with Billie Holiday, is as fine as Lady Day's classic version. Engineer Ed Greene is responsible for the admirable recorded sound.

*John Lissner*

Sound: A Performance: A+

# Classical reviews

Edward Tatnall  
Canby

**Vivaldi: The Four Seasons.** Performed on authentic instruments by the English Concert, Trevor Pinnock, dir. Vanguard VSD 71257, stereo, \$7.98.

You have never *heard* this familiar work until you have heard this extraordinary performance — extraordinary in three ways. First, it makes use of strings in the original unaltered “Baroque” condition, as they existed (here in originals and modern copies) before all the strings were beefed up for louder, stronger sound in the early 19th century. A mild difference on records (we cannot hear the difference in absolute volume) but a wonderfully subtle one in terms of tone color. Second, these strings are played with very little of the modern vibrato, for a sound that is most unusual and, I strongly feel, indeed the kind of sound that would have been produced in Vivaldi’s day from a string orchestra. Vibrato is a matter of choice, via the fingers.

Third, Trevor Pinnock, celebrated British harpsichordist, has worked out with this small orchestra an absolutely remarkable interpretation of the music, awesomely dramatic. You won’t believe it, if you have heard the music in “ordinary” recordings with standard modern string players. Too dramatic? One might think so, but not really. These “nature” effects, thunderstorms, depictions of spring and summer and winter, were surely a new sort of excitement for the musical audiences and we can assume that Vivaldi knew exactly what he was doing and how to wring every bit of drama out of his pictorial effects. That is what happens right here. You’ll never want to play your other versions again — unless as so much hi-fi sound.

Sound: B+ Recording: A- Surfaces: B

**Dussek: Complete Piano Sonatas, Vol. 3.** Frederick Marvin. Genesis GS 1071, stereo, \$6.98.

I look forward to each of the volumes in this series, which intends to cover no less than 49 works by this too-neglected big composer (and virtuoso pianist) of the turn of the 19th century. The music is really fascinating, out of the Mozart-Beethoven-



Weber period, and Frederick Marvin’s dedicated and passionately Romantic playing is immensely communicative. Dussek is no Mozart, nor yet a Beethoven, but these were the super-unusual types of their day; other excellent composers of a milder but still highly original nature were writing top-level music. Dussek was one of the best.

The early sonata here, the short Op. 10, number 2, distinctly suggests the late Mozart of the serious piano *Fantasies* as well as Haydn in a similar vein — Dussek was four years younger than Mozart. But the middle-period Op. 35 (1797) and particularly the big late piece, Op. 75, are very much of the early 19th century, the time of Beethoven and even of Weber and Schubert, suggestions of which are everywhere

in this work. Remarkable, since Dussek was 10 years older than Beethoven and no less than 26 years older than Weber, who was at this time still in his early career. As for Schubert — a mere 37 years younger than Dussek! Which merely shows that this man, in his last year of life, was very much up on current musical thinking of the time, hinting at Schubert (and even Chopin) before Schubert even arrived. It was the younger composers who did the borrowing.

Very good piano recording here and the piano itself is excellent for the music, rather hard and clanky in the loud parts, muffled in the soft. As would be Dussek’s own piano, circa 1811.

Sound: B+ Recording: A- Surfaces: B+

# Classified

## CLASSIFIED ADVERTISING RATES

**BUSINESS ADS-** For Sale, Help Wanted, Services, Business Opportunities, Tape Recordings, etc. etc. \$5.25 per line. First line set in bold face type at no extra charge. Extra lines \$9.60 per line. One point ruled box, extra charge \$8.00. **Full payment must accompany order.**

**NON BUSINESS ADS-** Situations Wanted, used equipment for sale by private individuals \$3.50 per line. First line set in bold face type at no extra charge. Extra lines set in bold face type \$7.00 per line. **Full payment must accompany order.**

**FREQUENCY DISCOUNT-** 3 times, less 10%. 6 times, less 15%. 12 times, less 20%. (line copy ads only)

**DEADLINE-** 1st of two preceding months. (Dec. 1 for Feb. issue).

**BLIND ADS-** Box numbers may be used at \$5.00 extra for handling and postage.

**GENERAL INFORMATION** Ad copy must be typewritten or printed legibly and received on or before the 1st of the month, two months preceding the cover date. Display advertisers must make a space reservation on or before the closing date, material (Camera Ready Only) may follow by the 10th. The Publisher, in his sole discretion, reserves the right to reject any ad copy he deems inappropriate. All advertisers must supply: Complete name, Company name, Street address (P.O. Box is insufficient), and telephone number before ads can be published. Classified ads are not acknowledged and do not carry Reader Service Card Numbers. Frequency contracts not fulfilled will be short-rated accordingly. Ads submitted for a 3 time frequency or less are unchangeable. Classified ads are payable in advance (Sorry, we can not accept credit cards.). Additional information available upon request. Contact: Carolyn Sumner, Advertising Coordinator, 1515 Broadway, NYC 10036... Direct Dial (212) 975-7530.

### MAIL ORDER AND DISPLAY CLASSIFIED RATE

1 col x 1"	\$150
1 col x 2"	\$225
1 col x 3"	\$300
2 col x 1"	\$225
2 col x 2"	\$395

Advertiser must supply complete film negative ready for printing for display ads.

**AUDIO Magazine**  
1515 Broadway  
New York, N.Y. 10036

### HOW TO ANSWER BOX NUMBER ADS

When replying to an Audio Box Number Ad, please use this address Box No. — c/o Audio, 1515 Broadway, New York, N.Y. 10036

## FOR SALE

**Absurdly low prices on Audio/Video equipment!** Call B&J Inc. (212) 845-2861 Weekdays 4-8 P.M. EST.

**ACCUPHASE P-300** Power amp. 150 watts 5 year warr. dealer demo, \$487. **ALTERMAN AUDIO** 7323 Freret 504-834-7772

## FOR SALE

**AABCO AUDIO CLOSEOUT LIQUIDATION:** 2 ea TAPCO 2202 stereo octave E.Q. \$174, 4 ea TAPCO 6000cf mixer \$195, 2 ea TAPCO 6000R mixer \$243, 2 ea JBL 2203A 12" LF Speakers \$105, 20 ea JBL 3120 passive crossovers \$42, DBX 503 3-BAND expander \$497, DBX 501 1-BAND expander \$192, 3 ea DBX 500 Boom Box \$179, 4 ea DBX 505 expander-Boom Box \$331, 4 ea DBX 164 stereo limiter \$287, 8 ea Audio Technica ATM 41 mikes \$75, 2 ea Ashly SC77 stereo 3-way electronic crossover \$260, 28 ea JBL 2440 replacement diaphragms \$33. Barney O'Kelly (614) 268-5643.

### A BARGAIN INDEED FROM BALTIMORE!

Apt/Holman Preamp, Sonic Integrity, versatility and outstanding reliability. Only \$493. Apt One Amplifier. More of the same magic! Polk, Marcof, Amber, KEF, Dahlquist, Rogers, Spondor, Grace, G.A.S., Yamaha, H.K., Lux, Philips, Thorens. Various moving coil cartridges. Audio Pulse, Soundcraftsmen, Alpine Car Audio. All shipped freight prepaid in continental U.S. **UNSURE OF YOUR CHOICE?** Many items available with 30 day full refund (However you assume freight cost both ways. Example: 25lb coast to coast round trip is \$17.90. A Fair Deal!) Fifty years continuously in audio electronics retail. References. **SOUNDSCAPE**, 406 W. Coldspring Lane, Baltimore, MD 21210 (301) 889-1134 12-8 pm E.S.T. M-Fri.

### ABATE THE HIGH COST OF YOUR NEXT AUDIO PURCHASE!

**DIRECT DISCOUNTS LTD.** offers many of the finest lines of audio gear from budget equipment to typically non-discounted components and cartridges. But more important is our concerned attitude that your next audio purchase be best suited for your individual needs. Whether you're a novice or seasoned audiophile, we believe that our wide selection, low prices and helpful advice could make us your one-stop audio bargain place. As an added service to our customers we also offer top-notch camera equipment, TV's, video recorders, and many interesting gift items including the new wireless extension telephone from ATE. Just call us at 212-254-3125 for prices and information, or send \$2.00 for our current brochure to Direct Discounts Ltd., P.O. Box 841, Cooper Station, NY 10003. Shop with us by phone with your M/C or VISA. We ship worldwide! Foreign inquiries invited.

**Acoustat Electrostatic, Theta Preamp, Lux PD121, Yamaha T-1, as new.** (716) 647-2055.



Audio Research	G. A. S.	Mitch Cotter
Acoustat	Grace	Nakamichi
Advent	Grado Sig.	Polk Audio
ADS	Hafner	QMI
Apt/Holman	Kenwood	Rega
Beveridge	Koetsu	Revox
Denon	Linn/Sondek	Rogers
Electro Research	M&K	Shure/SME
Fidelity Research	Magneplanar	Signet
FMI (Fullton)	Marcof	Sony
		Stax
		Sumo
		Symmetry
		Tandberg
		Ultracraft

2858 W. Market St., Akron, Ohio 44313 Phone (216) 864-4411

## FOR SALE

**ABSOLUTELY THE FINEST QUALITY AUDIO COMPONENTS AVAILABLE.** UNBEATABLE PRICES, WARRANTIES, AND SERVICE. INCLUDING AR BOSE ESS JBL & PRO AIWA SAE H.K. PHASE-LINEAR HATACHI AND MORE, FOR MID AND HI-END LINES WE DONT ADVERTISE. FOR PRICES CALL 301-593-8244 OR SEND \$2.00 TO: AUDIO DISCOUNTS, 1026 McCENEY AVE., SILVER SPRING, MD 20901 FOR PRODUCT LIST AND SPECIFIC PRICE QUOTES, MON. THRU SAT. 10AM to 9PM SUN 11AM to 8PM EST ALL ORDERS FACTORY SEALED SHIPPED WITHIN 48 HRS. C.O.D. FOR YOUR CONVENIENCE.

**ACCURATE AFFORDABLE AUDIOPHILE EQUIPMENT** at lowest prices available ex. SME 3009III \$196 100+ brands specialists in turntables-arms-cart. Call/write for quotes: HCM Audio, P.O. Box 2029, Chico, CA 95927. (916) 343-0558 7-9 pm.

**ACCURATE, QUALITY AUDIO - REASONABLE PRICES!** Car/Home components. Send stamp, call: Denco Audio, P.O. Box 6104-U, El Monte, CA 91734. (213) 444-9978 evenings, weekends. Monthly specials.

**ADIRONDACK AUDIOPHILES** Northern New York State House of Hi-Fi is now open with Hegeman, Conrad Johnson, Fidelity Research, Marcof, Grafyx, Hafner, D.C. Time Windows, Ampzilla (G.A.S.) Polk Audio Monitors, KEF, Harman Kardon ST8, Sleeping Beauty, Audionics, N.A.D., Mayware formula 4 tonearm, Signet moving coils, AKG cartridges, Toshiba, Sony, and Aiwa. For info. call 518-793-6639 Mon. to Fri. 11-9 Sat. 10-6. House of Hi-Fi, 50 Miller Rd. (Rt. 9), Glen Falls, NY 12801.

Advent, Nakamichi, Yamaha, Tandberg, Denon, ADS, Crown, Rogers, B&O, Lux, Revox, Celestion, Infinity, others. Low Prices! **AUDIO AMERICA** (Virginia). Call (804) 793-3820.

**Advent 300 owners-Upgrade with new modification.** Dramatic increase in bass response, improved midrange clarity and openness. Instructions only \$10.00, modification performed \$95.00 Amoeba Systems. 1201 Addison Dr., Reynoldsburg, Ohio 43068. (614) 861-8710.

### AFFORDABLE ESOTERICA

Central N.Y. State  
Audionics • Apt-Holman • Hafner • Dahlquist  
NAD • Spectro-Acoustics • Mordant/Short  
Reference Recordings • Ortofon  
Cizek • Grace • B&O • KEF • Crown  
**STELLAR STEREO**  
384 Elmira Rd. Ithaca, N.Y. 14850 607-272-2644

**AGAIN AVAILABLE - "BASIC DISC MASTERING"** NOW IN ITS THIRD PRINTING. THIS BOOK DEALS WITH DISC RECORDING AND RECORD PRESSING. OVER 70 PICTURES AND ILLUSTRATIONS MAKE IT A MUST FOR THE RECORD CONNOISSEUR. INNER WORKINGS AND PERFORMANCE LIMITATIONS OF THE STEREO GROOVE EXPLAINED. USED BY MAJOR RECORD LABELS, RECORDING STUDIOS, PRESSING PLANTS AND TURNTABLE MANUFACTURERS. \$12.50 POSTPAID. L. BODEN, BOX 3043, GLENDALE, CA 91201.

## LEGENDS MOVE AND GROW.

Chestnut Hill Audio has moved and grown. We now represent Audionics, Bowers & Wilkins, Bryston, Cotter, DCM, Denon, Fidelity Research, Grace, Grado, Hafner, Hegeman, Impulse, Janis, JR149, Linn Sondek, Levinson, Marcof, Precedent, Quad, Rappaport, Revox, Rogers, Sequerra, Snell Acoustics, Sony/Pro, Spondor, Symdex, Symmetry, TVA, Tandberg, Tangent, Technics/Pro, Theta, Threshold and Vandersteen. All of these legends at 311 Cherry Street, Philadelphia, Pa. 19106. (215) 923-3035.

## CHESTNUT HILL AUDIO LTD.



## FOR SALE

**AGFA—THE BEST OPEN REEL TAPE! CASSETTES:** ASF (C66 & C96) and DIRECT TYPE II (C96) are the best available! Direct-to-Tape Recordings offer the finest sound available only on reels, cassettes & cartridges. Ampex video cassettes also available. WRITE for FREE brochure & current special offers. Direct-to-Tape Recording Co., 14 Station Ave., Haddon Heights, NJ 08035.

### AMBER SERIES 70 POWER AMP

Q/LC Audio, 1006 Berkshire Rd., Dayton, OH 45419 (513) 293-9330, (513) 293-7287 M-F 5-10 SAT 10-6.

**AMBIENCE DECODER FOR REAR CHANNELS, \$149.95.** Literature 50c. Huntington Electronics, Box 2009-A, Huntington, Conn. 06484

**AMPZILLA All A \$700, QUAD ELS \$850,** Weathers mint tt system B.O., Dahlquist DQ 10A \$625, Phase Linear 400 A \$375, Mc C20 \$250, Lux PD 441 tt \$375, Grace 704 arm \$125, Levinson LNC-2 xover \$825. LISTENING ROOM, INC. (205) 939-0702.

**AN AUDIOPHILE TURNTABLE FOR \$299? WITH A GRACE** tonearm? Impossible you say? Call or write: HCM Audio, P.O. Box 2029, Chico, CA 95927. (916) 343-0558 7-9 pm.

### ANNOUNCING-PHOENIX AZ AUDIOPHILES

Audire, Audio Pro subwoofers, Adcom, Hafler, Denon, LS3/5A, Obelisk, Supex, Grace, KM Labs, etc. Shipped U.S.A. THE LISTENING POST (602) 967-1250 Tempe, AZ.

### ANOTHER AUDIOPHILE PUBLICATION?

AUDIO UPDATE is published ON TIME. This bi-monthly includes modifications construction projects, improvement methods, data available nowhere else. It's provocative, informative, and a MUST if you enjoy audio. Annual: \$12.00 USA/Canada, \$14.00 elsewhere. MasterCharge/Visa welcome. AUDIO DIMENSIONS, 8888 Clairmont Mesa Blvd., San Diego, CA 92123. (714) 278-3310. TF

### AUDIO RESEARCH WAS ADVANCING BEYOND STATE-OF-THE-ART BEFORE YOU EVER HEARD OF "STATE-OF-THE-ART"

From the introduction of the SP-3 pre-amplifier and the D-76 power amplifier, to the introduction of the SP-6B pre-amplifier and the D-79 power amplifier, Audio Research has been in the forefront of technological advancement geared towards one goal: To capture the essence, color and sound of live music. Although perfection is never cheap Audio Research has made it easily affordable. Through the medium of the SP-5 pre-amplifier and D-52B Power amplifier Audio Research has enabled the serious music lover to obtain STATE-OF-THE-ART performance at a fraction of what you may think it costs. Why not find out? AUDIO RESEARCH is available in NEW YORK City Exclusively at:

**SOUND BY SINGER**  
227 Lexington Avenue  
NYC, NY 10016  
(212) 683-0925

**ANTHINFLATIONARY PRICES.** Cut the high cost of speakers - save 30 to 50%. State of the Art Speaker systems featuring high efficiency, low distortion, phase coherency and quality enclosures. Seven models in five finishes. For information write: D.S.R.P., P.O. Box 75, Webster City, IA 50595.

**ANTI-SKATING for AR TURNTABLES!!** Proven counterweight design of nickels steel & aluminum construction. Install yourself in minutes. \$7.95 postpaid. (Dealer inquiries invited.) AUDIO INNOVATIONAL PRODUCTS, P.O. Box 1607, Portsmouth, N.H. 03801.

## FOR SALE

### A PRACTICAL REFERENCE SYSTEM

#### FOR THE MUSIC LOVER

1 pr. Beveridge System 3 loudspeakers

1 Beveridge RM-1 tube preamplifier

1 Levinson ML-3 power amplifier

1 FM Acoustics 212 preamplifier

1 Linn Sondeck LP-12 turntable & tonearm

1 Levinson MLC-1 moving coil cartridge

For further information & literature, please call or write.

**SOUND COMPONENTS INC.**  
2710 Ponce de Leon Blvd.

Coral Gables, FL 33134  
(305) 446-1659

### APT/HOLMAN Power Amp HERE!

Tom Holman's incredible APT ONE Power Amp is waiting for you. The APT ONE eliminates current limiting that can rob you of sound. The APT ONE gives you a full 3 db of headroom to deliver all the dynamics of your music. Rated at a min. of 100 watts RMS/Channel. Write for Details and Lit. APT MODEL ONE AMP only \$641. Shipped prepaid and insured in Cont. USA from Designatron's Stereo Store, Inc. 260 Old Country Road, Hicksville, N.Y. 11801 (516) 822-5277

### APT/HOLMAN Preamp in Stock

Tom Holman rocked the audio industry with this revolutionary preamp. While other manufacturers charge over \$2000.00 for this quality and performance, you can own an APT for under \$500! Incredible Sound PLUS you control capacitance and resistance for your cartridges. Full complement of controls and there's no program leak-thru to tape circuits. The APT Preamp from DESIGNATRON'S STEREO STORE, Inc. 260 Old Country Road, Hicksville, N.Y. 11801 (516) 822-5277. Write for info and a quote. Shipped prepaid and insured in Cont. USA.

**APT-HOLMAN PREAMP, Excel. \$425 (201) 572-5515.**

**ARC SP5 \$450, D-100 \$550. (901) 754-3010.**

### Bob Heenan Sells Great Used Equipment

AR	Mark Levinson	GAS
dbx	Magneplanar	SME
KLH	QUAD ESI.	Denon
Bose	Rappaport	Dynaco
Advent	Bryston	Thorens
McIntosh	LS3/5A	Dahlquist
APT/Holman	Hafler	Nakamichi
Bang & Olufsen	JB1	Marantz (tubes)
Audio Research	DB	and much more

**Sound Advice**  
Box 782  
Brookline Village  
MA 02147

**Equipment bought, sold  
traded & brokered  
(617) 969-2727**

## FOR SALE

**ARC SP6A \$750, D52B \$865, Cotter NFB w/PW2 \$625.** MK2L \$575, Koetsu \$650, Audio Stndrds MX10A \$265, Breuer 5A \$1095, Levinson ML-1 sn # 2508 w/A cards, extra lemos \$950, Win Trmtbl \$2250, Win arm/cart. \$1150, FR B-60 \$240, Pyramid T-1 tweeters w/Janis active crsvr. 6300Hz \$1175, Audionics CC2 \$350. (315) 437-3357 or 637-8119. EDT.

**ARC 52B \$850, Mc 240 \$350, JC 2 \$700; LISTENING ROOM, INC. (205) 939-0702.**

### ARIZONA STEREO BUYERS

AUDIO TECHNICA	CARVER	A.D.C.
DAHLQUIST	REVOX	STAX
NAKAMICHI	CROWN	KLIPSCHE
SENNHEISER	YAMAHA	J.B.L.
STANTON	THORENS	A.D.S.
TOSHIBA	AIWA	LUXMAN
DBX	SIGNET	B & O
MITSUBISHI	SONY	SHURE
BOSE	KENWOOD	MICRON

J.A.E. INC., 332 E. Camelback Rd., Phoenix, Arizona 85012  
Mail-order hotline Mr. WOZ 602-265-4830.

### ATTENTION DYNA ST-120 OWNERS.

Frank Van Alstine announces an incredible POWER MOS FET modification for any Dyna ST-120, working or not. All new complementary power Mos Fet output amplifiers, all new power Mos Fet regulated power supply. Unbreakable, absolutely stable into capacitive loads, no output inductors or R-C network. More musical than any amp you have ever heard at any price. Cost to rebuild any Dyna ST-120, working or not is \$185.00. Unit must have good transformer and be complete. You won't believe it until you hear it.

JENSENS STEREO SHOP 2202 River Hills Dr Burnsville, Minn. 55337 612-890-3517

## Western Pennsylvania's Quality Audio Dealer

Threshold	Watson Labs
Bryston	M&K Systems
Apt/Holman	Magneplanar
Nikko	Polk
Sony	DCM Speakers
Hafler	Rogers LS3 5A
Duntech	Infinity
Linn Sondeck	Altec Lansing
Grado	Janis
Denon	Thorens
Fidelity Research	ADC
Supex	SAE
Ariston	Visonik
Grace	Baupunkt
Scheiber Decoder	Grundig
Cotter	AIWA
Marcoff	Sony
Symmetry	Technics Pro

plus much more...

Direct-To-Disc Recordings

SHIPPED PREPAID & INSURED

## ORATION AUDIO

6019 Broad St. Mall  
Pittsburgh, Pa. 15206

(412) 441-4550



## Connecticut's Progressive Audio Store

Acoustat/ADS/Apt-Holman/Audionics/Axiom/Bryston/Carver/Connoisseur/Conrad Johnson/M.A. Cotter/Dahlquist/Denon/DCM/Grace/Hafler/JVC Laboratory/KEF/Marcoff/Mirage/M & K/NAD/Nakamichi/Pyramid/RH Labs/Signet/Supex/Symdex/Win Labs/Yamaha 400 titles of direct-digital discs Audiophile accessories Keith Monks record cleaning All shipments prepaid and insured

# TAKE 5 AUDIO

105 whitney ave., new haven, ct 06511 203-777-1750 m-w 10-6 th&f 10-8 sa 10-5 mc/visa/amex

## FOR SALE

### AUDIO EXCELLENCE IN N.E. PENNA!

Stock: Hafler, Rogers, SME, JR, Sonus, The Dalco/Dynaco A30XL, Technics, NAD, Alpine Car Audio, Gold Line Analyzers and more. JANNEN SYSTEMS, Hazleton, PA. Free shipping. Call (717) 459-5722.

### ACTIVE ELECTRONIC CROSSOVERS

Plug-in Butterworth (maximally flat) filters in 6 db., 12 db., or 18 db., per octave attenuation, any frequency specified. Filters flat beyond 100 KHz.

Complete crossover in attractive metal cabinet with all terminations and regulated power supply;

### STEREO BI-AMP \$139

Tri-amp, quad-amp, and monaural types available at comparable prices. Other available features: Summer for "single woofer" systems, Subsonic noise elimination filters supplied with or without bass boost, level controls.

### FOR OEM'S AND HOME ASSEMBLERS

500 Series dual filters and/or plug-in filters, regulated power supplies.

FREE CATALOG & PRICE SHEET  
Write to:

**DeCoursey** ENGINEERING LABORATORY

11828 Jefferson Bl. • Culver City, CA 90230  
Phone: (213) 397-9668

## FOR SALE

### ATTENTION DCM TIME WINDOW OWNERS

We now offer a convenient and attractive way to improve the sound of your speakers. The DCM Time Window, when raised 9 inches off the ground, has an airier and tighter sound: the image is raised and standing waves reduced.

THE DCM TIME WINDOW PEDESTALS are made of heavy duty wrought iron and suit the shape and appearance of the Time Window perfectly. They sell for \$65. per pair. If there is no dealer nearby, order postpaid (Master Charge & Visa accepted) from

### R. S. PARK AUDIO ASSOCIATES

5 SUNRISE PLAZA, VALLEY STREAM, NY 11581

(516) 561-7555

DEALER INQUIRIES INVITED

### ATTENTION SOUTHERN AUDIOPHILES

Yamaha	Great American Sound
Dahlquist	Ortofon
Polk Audio	Denon
Bang & Olufsen	Klipsch
Advent	Technics
M & K	Visionik
Aiwa	Sonus
Philips	Maxell

Available at Sound Advice

Village Plaza Ruston LA. 71270 (318) 255-8000. 9-9

## FOR SALE

**AUDAX AND SEAS DRIVERS FOR THE SPEAKER BUILDER.** SEAS speaker kits and crossover networks. Dynaco replacement woofers and tweeters. We sell both wholesale and retail! For literature and information, send \$1. refundable upon purchase, to: The Speaker Works, P.O. Box 303, Canaan, OH 03741 (603) 523-7389.

### AUDIO ALTERNATIVE—SPECIALTY AUDIO SHOP

serving Colorado and Rky. Mtn. area audiophiles. Grado, Signal, Supex, Grace, Denon, Dynavector, Thorens, Mission, Micro-Seiki, Oracle, Hafler, PS Audio, Conrad-Johnson, NAD, Audible Illusions, Bedini, Marcof, Musical Fidelity, Rogers, Audio Pro, Vandersteen, Mordaunt-Short, Phantom spks., Goldline, Spectra, Dennison, A-T accessories. Prompt, knowledgeable, friendly service. Brochure and sales specials on request. Audio Alternative, 1124 East Elizabeth, Fort Collins, Colorado 80524 (303) 221-1496.

Audio and TV tubes factory boxed, speakers, semiconductors—low prices, free price list. Transistronic Inc., 1365-39th St. Brooklyn, N.Y. 11218 212-633-2800 TF

### Audio Consultants, Inc. El Paso, TX.

Quality Audio Equipment

LUX NAD CARVER ADVENT THORENS

NAKAMICHI SONUS AMBER STAX

DCM Time Window and Time Bass

Audio Consultants, Inc., 3824 Montana, El Paso, TX 79903  
Call Rony (915) 565-1405

### AUDIO DEN AND POLK AUDIO

The Audio Den is proud to have on display and demonstration the amazing Polk Audio Monitor Series. Our customers say "Fantastic! Compares with the finest loudspeakers I have heard. Probably the best value in the history of Audio!!!" Audiogram®, from the Audio Advisor said, "We were so impressed that we could not believe the prices . . . Other \$200 speakers simply do not come close to the standards set by the Model 10 . . . And at their price, they are simply a steal." Come in for an audition or write us for information on Polk or our other state-of-the-art products. Polk is shipped free in the continental U.S. Audio Den Ltd. 1320-34 Stony Brook Rd., Stonybrook L.I., N.Y. 11790, 516-751-3350. TF

## AUDIO FOUR PAGE REPORT

on

### Stan White, Rohrenverstärker

HI FI Exklusiv (Germany 5/79) reports on Stan White, Inventor of the GLASSCONE™ speaker: "Stanley White der Konstrukteur des vorliegenden Veteranen, zählt neben Paul Klipsch, Saul Marantz and Avery Fisher zu den Wegbereitern der High Fidelity. Er baute neben einer Reihe von Vorund Endverstärkern den ersten Motional Feedback Hochtöner und einige zu ihrer Zeit unter Audiophilen hochgeschätzte Lautsprecher wie den Mach I und den 4000 Mark teuren 4-D." Write TACHYON, P.O. Box 204, Bloomingdale, IL 60108. 10-0

# The Nature of Music.

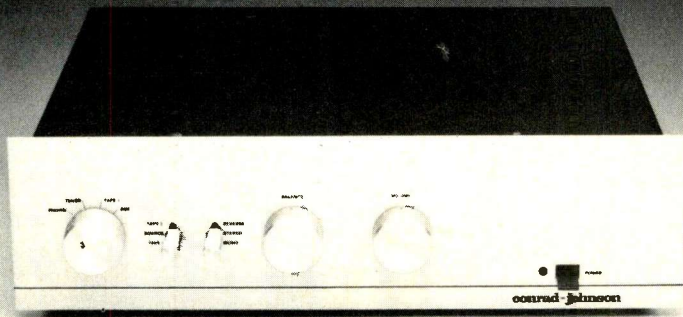

It's all you hear with the new Conrad-Johnson vacuum tube preamplifier.

Write for information on this and other Conrad-Johnson vacuum tube electronics.

**conrad-johnson design, inc.**

1474 Pathfinder Lane • McLean, Virginia 22101 • (703) 528-8650

### the audio advocate

SME	Conrad-Johnson
Polk	Keith Monks
Gale	Nakamichi
Cizek	Acoustat
Supex	LS3/5A
Ariston	Onkyo
Magnepan	Hafler
Apt Holman	Grado
Fulton Cable	Rega
Audio Research	ADC

505 Millburn Avenue Millburn, NJ  
(201) 467-8988

## FOR SALE

### AUDIO DEN LTD.

Long Island's leading audio store has on demonstration  
 THE STATE OF THE ART  
 AUDIO RESEARCH ELECTRONICS  
 THE NEW SP6 TUBE PREAMP  
 THE NEW D79 TUBE AMPLIFIER  
 THE NEW SCHEIBER 4 CHANNEL DECODER  
 THE NEW ACOUSTAT MONITOR III'S  
 THE NAKAMICHI 680  
 CONRAD-JOHNSON ELECTRONICS  
 GRADO SIGNATURE CARTRIDGE  
 FULTON CARTRIDGE AND TRANSFORMER  
 LINN-SONDEK

(AUDIO CRAFT) ULTRA CRAFT UNI-PIVOT TONEARM

We also have the following lines, Connoisseur, Denon, Grace, Luxman, Magneplanar, Magnepan, Polk, Quad, Rogers, Sherwood, Sonus, Thorens, Yamaha, the largest selection of Audiophile Recordings on Long Island.

FREE "SET UP" IN NY AREA

UTILIZING IVE SPECTRUM ANALYZER

COME IN WITH 2 RECORDS AND WE WILL DEMONSTRATE THE WORLDS FINEST RECORD CLEANING MACHINE BY KEITH MONKS.

AUDIO DEN LTD.

1320-34 Stony Brook Road  
 Stony Brook, New York 11790  
 516-751-3350

10-0

### Audio House — Flint Mich

Mordant Short	Conrad-Johnson	Linn Sondek
Rogers LS3/5A	Audionics	Marcof
Linn Isobariks	Symmetry	Bryston
Theta	DB Systems	Leach LSR+0
M & K Volkwoofers	Adcom	Audio Linear

TMA Record Cleaning Machine \$695. Record Sleeves 100 for \$25 ppd. 4304 Brayan Drive, Swartz Creek, Mich. 48473 (313) 655-8639 by appointment.

### Audio Ltd.

in Central Illinois

Audio Research	KEF	Snell Acoustics
David Hafler	IMF	Marcof
DB Systems	STD	Carver
Symmetry	SME	Grace
Supex	Win Labs	Quad

and more. 115 N. Walnut, Champaign 61820 (217) 359-3774

AUDIO MAGAZINE (Germany 2/78) reports on Stan White SHOTGLASS loudspeaker. "You can locate each musical instrument as it plays. The stereo effect whereby you can visually place the actual players is a UNIQUE feature of the speaker. If we may borrow a simile the effect is such that if you can picture an orchestra in the dark as each note is struck, the orchestra lights up in such a way that each separate player is spotlighted this is the effect of the SHOTGLASS. TAHCYON, P.O. Box 204, Bloomington, IL 61018.

AUDIONICS CC-2 \$350. (415) 376-8305.

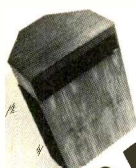

**LOUD AND CLEAR.**  
 Read all about the K—the amazing speaker that has the power to reproduce even the lowest bass notes—loud and clear. Features the brilliant cone-horn design with Speakerlab innovations like Magnar™ damped horn drivers. One of the only kits available for this unique loudspeaker. Read about K's and all the other great Speakerlab speakers and parts in our free catalog.

**Speakerlab**  
 To get yours write  
 SPEAKERLAB Dept A07/2  
 735 N Northlake Way  
 Seattle WA  
 98103

## FOR SALE

### AUDIONICS BA-150

This analog-digital hybrid (Class A solid state input tube output) amplifier offers the musical performance of the best tube and solid state designs. The BA-150 represents a new state of the art. It is superb on both dynamic and electrostatic speakers. We offer the BA-150 at \$3250. Free air freight. Worldwide shipping. OXFORD AUDIO CONSULTANTS, Box 145, Oxford OH 45056, (513) 523-3333, 523-3895.

### AUDIONICS-NEW PRODUCTS & Lower Prices

We offer the NEW LK-1 turntable, the NEW RS-1 preamp, the CC-2, the BT-2 and the incredible BA-150. Free shipping in the U.S. Worldwide shipping. Visa & M.C. OXFORD AUDIO CONSULTANTS, Box 145, Oxford, OH 45056, (513) 523-3333, 523-3895.

### AUDIONICS RS1-C22

ROGERS LS3/5A

at LISTENING ROOM, INC., 2764 Hanover Circle, Birmingham, AL 35205 (205) 939-0702 by appt.

### AUDIONIC=VALUE

Audionics continues to stand the test of time as a cost effective product. If you are new to high end audio or an old audiophile, consider a product that you will want to keep. Audionics BA-150, CC-2 amps, RS-1 and BT-2 preamps and the composer. FREE shipping and advise from Audio House, 4304 Brayan Drive, Swartz Creek, MI 48473 (313) 655-8639 by appointment.

**AUDIOPHILES!** Direct-Disc, Digital, Mobil Fidelity-All labels-Low Prices Fast Service. Send 30¢ in stamps for catalog. Direct Discounters, 2245 New Hope Church Rd., Raleigh, NC 27604. 9-9

### AUDIO PRO SUBWOOFERS AND BBC LS3/5A

A musical experience in Phoenix AZ exclusively at THE LISTENING POST (602) 967-1250.

Audio Research and Fulton Premiere Loudspeakers in S. Florida. We offer these other quality products for people interested in music. Kenneth Wagner Audio Systems, 841 S. Dixie Hwy., West Palm Beach, FL 33401 (305) 833-0448. Free shipping in USA - MC/Visa.

## FOR SALE

AUDIO RESEARCH D-110 mint \$1700 (603) 224-6721.

### AUDIO RESEARCH DEMONSTRATOR CLEARANCE SALE

D52B (2).....\$725.00 ea.  
 D100B (2).....\$837.00 ea.  
 D110B (1).....\$1650.00  
 D350B (1).....\$2100.00

Prices are firm and sales are final. Purchaser liable for shipping charges.

SOUND COMPONENTS INC.

2710 Ponce De Leon  
 Coral Gables, FL 33134  
 (305) 446-1659

**christopher  
 hansen  
 ltd**

Mark Levinson/Sales & Service  
 in the West

On Display: Mark Levinson Audio Systems—HQD Reference System, Goldmund Tone Arm, Fidelity Research, Koetsu, Linn Sondek, Rega Planar, Pyramid Metronome, Rogers LS3/5A

Showroom Open: M-F 10-5 and  
 by appointment

9014 Burton Way  
 Beverly Hills, California 90211  
 213-858-8112

We ship prepaid within the U.S.

## AT SOUND COMPONENTS, INC. WE'VE GOT IT ALL...

ADCOM... APT. CORPORATION... AUDIONICS... AUDIO PRO...  
 AURAL ACOUSTICS... BANG & OLUFSEN... BEDINI... BRAUN...  
 BRYSTON... DCM... DENON... EMT... FIDELITY RESEARCH... GRACE...  
 GRADO SIGNATURE... GOLDMUND... HAFLE... HAROLD  
 BEVERIDGE INC... HARTLEY... H. Q. D. REFERENCE SYSTEM...  
 JANIS... JVC... KEF... LINN PRODUCTS... MAGNEPAN... MARK  
 LEVINSON... MICHAELSON & AUSTIN... PYRAMID METRONOME...  
 QUAD OF ENGLAND... REGA RESEARCH... ROGERS... SEQUERRA...  
 SCHEIBER... SOUND CONNECTIONS... STAX... SYMMETRY... TANDBERG...  
 TRILOGY... YAMAHA... Also a large selection of specialty records.

And the highest quality music recording services available. We ship prepaid in the U.S. Spanish spoken and complete export facilities.

Serving the  
 Audio Community  
 for five years.

**Sound  
 Components, Inc.**

2710 PONCE DE LEON BLVD, CORAL GABLES, FL 33134

Visa, Master Charge, American Express & Diner's Club accepted (305) 446-1659.

## FOR SALE

**AUDIO RESEARCH D76A**, \$750; EC-2 x-over w/rack mount panel, \$150. (816) 363-2412 after 6 pm CST.

**AUDIO RESEARCH D100B amplifier, latest model.** Mint Cond. \$995. (301) 384-2969.

## AUDIO SALON

We care about quality components, accurate music and satisfied clients. We are a very small company and will serve your needs on an individual basis. Call or write for our assistance. See our Ads through the classified section. 608 Pecan Ave., Charlotte, NC 28204 (704) 377-6590. A comfortable show-room is open by appointment.

## AUDIRE COMPONENTS IN PHOENIX AZ

Exclusively at THE LISTENING POST (602) 967-1250.

**BATTERY, 5-in-reel halftrack, stereo deck, 7 1/2-3 3/4 ips. 3 heads. Pitch. Direct drive. FET mike inputs. FeCro bias. 20-32kHz. 64 db S/N. .05% WRMS. Overseas model. 1 only. SONY TC-510-2. \$1000. ALTERMAN AUDIO New Orleans 504-834-7772**

**Bryston 4B \$800. (216) 531-1780.**

## A SINGER'S DREAM!

**REMOVES VOCAL FROM MOST STEREO DISCS**  
The Thompson Vocal Eliminator can actually remove most or virtually all of a solo vocalist from a standard stereo record and yet leave most of the background music untouched! Not an equalizer! We can prove it works over the phone. Write for a brochure and demo record below. COST: \$249.00

## YOU SHOULD SEE US

For:

- Delay and Ambience
- Studio Echo/Reverb
- Tape Noise Reduction
- Parametric Equalization
- Electronic Crossovers
- Comp/Limiters
- Mic Preamp/Mixers
- Patch Bays

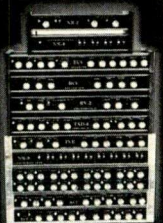

We manufacture a full line of high quality audio and recording equipment. You will probably have to pay twice as much elsewhere to obtain comparable quality. Only Direct Sales make our prices and quality possible. Send \$1 for a 20 page brochure and 20 minute demonstration record.

Write to: **LT Sound**, Dept. AU, P.O. Box 729, Decatur, GA 30031. (404) 284-5155

## FOR SALE

### BERNING TF-10 Pre-amplifier

- Passive network phono equalization
  - Direct coupling to the output
  - A "High level gain" stepped attenuator switch
  - Electronic "Mute" is provided to allow remote control of the mute function
  - The greatest attribute of the TF-10 audio amplifier is its ability to give the user listening experience surpassed only by a live unamplified performance.
- Contact: THE LISTENING ROOM INC., 590 Central Park Ave., in Scarsdale, NY 10583 or call us at (914) 472-4558

**BEST TONEARM IN THE WORLD: SME 3009 Series III**, unused with full warranty. Best offer . . . Palounek, 2804 Erwin Rd., Durham, NC 27705.

**Big, Safe, Twisted #12 Gauge Gonza Speaker Wire \$40 per 100 ft.** Keith Monks Record Sleeves 100 for \$25, FREE shipping, COD O.K. Sample \$1.00. Audio House, 4304 Bray-an Drive, Swartz Creek, Mich. 48473 (313) 655-8639.

**B & O USES "ANY" CARTRIDGE** with standard mounting centers after our modification kit or at factory. Effective mass 2.5 grams. Adjustable silicone damping. \$199.00 with money back guarantee. JML Company, 39,000 Highway 128, Cloverdale, CA 95425. TF

**Breuer Dynamic tonearm type 5A (short)** with both counter weights \$850, Breuer Dynamic tonearm type 6A (long) \$1100, M & K modified RABCO tonearm with all counter weights \$450, Fidelity Research FR66S long stainless steel arm \$900, Micro Seiki DDL-150 large platter direct drive turntable with dust cover, will only accept long tonearms such as FR66S or Micro 505L \$800. (916) 481-0392.

**BRITISH AMERICAN SOUND — SOUTH CAROLINA's** only high-end store: Threshold, Beveridge, Snell, Spendor, Linn-Sondek, Rega, Quad, Conrad-Johnson, Grafyx, Hafler, B&W, Symdex, Sonus, Grace, Supex, and others. Special prices on demonstrators and selected new equipment. P.O. Box 1247, Charleston, SC 29402. (803) 723-6025.

### CAMPUS REPS FOR ESOTERIC EQUIPMENT

We need campus reps immediately to sell esoteric as well as a vast selection of major brands. We have an unusually high selection of high end equipment, excellent prices, and unique advertising program.

### AUDIO SYSTEMS II

200 WEST 57th STREET, Suite 1004  
New York, N.Y. 10019

9-0

**CARBON FILM RESISTORS 5¢ EACH. QUANTITY DISCOUNTS.** SEND 15¢ stamp for list. Richard Leggon, 2233 E. 90th St., Cleveland, OH 44106.

## FOR SALE

### CARVER Sonic Hologram PREAMP Now IN STOCK at DESIGNATRON

You've heard about it, you've read about it, NOW YOU CAN OWN IT: The Carver 4000 Preamp with built-in Sonic Hologram, built-in Time Delay and rear amplification, Peak Unlimiter Circuits and the AUTO-CORRELATOR System! All this and full control flexibility in one knock-out preamp! The CARVER 4000 from DESIGNATRON'S STEREO STORE, INC. 260 OLD COUNTRY ROAD HICKSVILLE, NY. 11801 (516) 822-5277. SHIPPED PREPAID & INSURED in Cont. USA. Write for literature and quote.

## CHARLOTTE, NC

HAFLER		PS AUDIO
FULTON		SME
THORENS	(704) 377-6590	SYSTEMDEK
MORDAUNT-SHORT		SUPEX
DECCA		GRACE

FRIED SPEAKER KITS  
AUDIO SALON, 608 PECAN AVE., 28204  
SHIPPED PRE-PAID

### CIVILIZED DEMONSTRATIONS — BY APPT. ONLY

Personalized Service  
Acoustical Consultations  
In-home Demonstrations

Rega Research • Mordaunt-Short Ltd. • PSE  
Harbeth • Chartwell LS3/5A • Rogers Electronics  
Musical Fidelity • Supex • Grace

THE LISTENERS SHOP  
Falls Church, VA (703) 734-0887

### COMMONWEALTH LOUDSPEAKERS

Fine quality loudspeakers also drive units, walnut veneer cabinets, air core inductors, mylar capacitors, crossover networks. Choose from famous manufacturers like: Decca, Coles, Dalesford, Richard Allan, Jordan, Schackman, Radford, and more. Send \$3.00 for design, reprints, plans and catalog (refundable with first purchase.): COMMONWEALTH ELECTRONICS, 300 N. Allen, Pasadena, CA 91106, (213) 793-5184. 11-0

### COMPONENTS FOR THE AUDIOPHILE

Q/LC Audio has Precision Fidelity, Amber, Marcof, Hafler, Vandersteen, DCM, Axiom, Lustre, Thorens, Nakamichi, Audire, Grace, Supex, Bass Mint, Adcom, Hitachi, and more. Write or call: Q/LC Audio, 1006 Berkshire Road, Dayton, OH 45419 (513) 293-7287, (513) 298-9330; M-F 5-10 SAT 10-6. World wide shipping.

**CONNECTICUT:** A.D.S., Advent, A.P.T. Holman Audio Pulse, B&O, B.I.C., Carver, Citation, Dahlquist, D.C.M. Time Windows Polk, Hafler, Harman/Kardon, J.B.L., Mitsubishi, Nakamichi, Ortofon, Phase Linear, Micro-Acoustics, N.A.D., Stax, Tandberg, Yamaha, Cizek, Signet. Will ship prepaid. Sounds Incredible, 39 Federal Road, Brookfield, CT., 06804. (203) 775-1122—phone quotes only. TF

**CONNOISSEUR BD1 TURNTABLE** Belt Drive, 37 logged hours. w/mtg hole for Grace 707. \$75 408-279-1425, 259-9648.

## CREATIVE COMPONENTS

*Build your own speakers, save 50%.*

We've made it easy for you with the latest in advanced speaker technology like Wave Aperture™ Drivers and the patented Nestorovic Woofer System™. Top quality speakers & design information. Write for FREE 48 page color

catalog/design manual from the largest, most experienced speaker kit manufacturer in the world.

**Speakerlab**  
Dept. A07/1 N. Northlake Wy.  
Seattle, Washington 98103

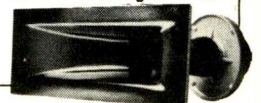

Adcom  
Allison  
Audio Pro Sub-Woofer  
Bryston  
Connoisseur  
Conrad-Johnson  
Dennesen  
Grace  
Hegeman  
KEF  
Kenwood-Purist  
Linn-Isobarik  
Linn Disc Playback  
Marcof  
Mission  
Mitchell A. Cotter  
NAD  
Naim  
PSE  
Pyramid Metronome  
Rega  
Rogers  
Shahinian Obelisk  
Signet  
Snell Type A  
Supex  
Symdex  
Thiel  
3D Acoustics  
VPI

Joshua David Cohn • Brian Michael Ahearn • Alice Berman

# ears NOVA

749 middle neck road • great neck, ny 11024 • (516) 466-5674

Sunday thru Wednesday by appointment

Thursday & Friday noon to 8pm • Saturday 10am to 5pm

## FOR SALE

**COTTER MKII "L", LUSTRE GST 801, SUPER SDX 1000 LISTENING ROOM, INC.** 2764 Hanover Circle, Birmingham, AL 35205 (205) 939-0702.

**CRITICAL RECORD REVIEW** in bimonthly newsletters offers Bill's Corner (controversy, comment), new equipment news, our renown record reviews, and much more. Subscribe now and watch us grow! Only \$6/year; P.O. Box 8766, Jacksonville, FL 32211.

**CRITICS CHOICE TANGENT RS2 \$560/pr PPD, DCM Time Window \$680/pr PPD.** Woodburn Sound Service, 400 Highland Ct., Iowa City, Iowa 52240.

### CROWN DISTINCTION SERIES from DESIGNATRON

The ultimate expression of Crown's Expertise! Super Quality, Super Durable. Computer controlled DL-2 Amplifier; Fun-to-use, magnificent sounding SA-2 Preamplifier; Incomparable EQ-2 Equalizer. All available from DESIGNATRON'S STEREO STORE, INC. 260 OLD COUNTRY RD., HICKSVILLE, N.Y. 11801 (516) 822-5277 Shipped Prepaid & Insured in Cont. USA

**Custom made foam speaker grills.** Any size, color, pattern, quantity. Send 15¢ stamp for information: Custom Sound, Algonac, MI 48001.

### CUSTOM WOOD STEREO CABINETS

Beautiful solid wood custom component cabinets. Stock units and designed to specification. SWCC, 608 Pecan Ave., Charlotte, NC 28204 (704) 377-6590 Cabinet work completed by North Carolina Mountain Craftsman.

**Dahlquist DOLP-1 xover** \$200, Dyna MKIII \$150 pr., Sony 2020 4 channel decoder \$50. Fred Newhart, 325 Hook Pl., Ithaca, NY 14850 (607) 237-1553.

**Dahlquist DO-10 Speakers w/stands** \$680, Audionics CC-2 amp 70 w/ch \$360, matching LED 2C power display 20 les's per ch. \$105, Pioneer TX-9100 tuner \$160. (816) 931-0257.

### DAVID HAFLER IS BACK!

The man who brought you the original Dynakit is back with the New HAFLER POWER AMPLIFIER and PREAMPLIFIER KITS. They offer the best sound for the least money anywhere! Hafler Kits are easy to assemble and the PC boards are pre-wired. Don't wait! Write for a Quote Today: AUDIOKIT, 260 Old Country Road, Hicksville, N.Y. 11801 (516) 822-5749. Kits Shipped Prepaid & Insured in Cont. USA.

**DAYTON-WRIGHT XG8's** (latest), mint; (317) 463-4457.

**Dayton Wright XG-10 Electrostatic Speakers** \$2000; Breuer Dynamic tonearm 5A (short) with both counter weights \$850; Breuer Dynamic tonearm type 6A (long) \$1100; M&K modified Rabco tonearm with all counter weights \$450. (916) 481-0392.

**DBX-3BX \$400, MINT** (315) 479-7973.

**Denon DP-40F tt, \$480; Audire Model 2 w/Capacitance Mod., \$500; Threshold 400 A, \$925; DBX 118, \$150; STAX AS44 phones, \$120. Eddie, evenings (904) 724-8765.**

**ELIMINATE YOUR  
"PATCHCORD HEADACHE"  
with a CPM-31 Universal  
Component  
Patching  
Matrix.**

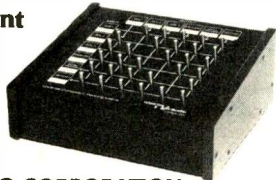

For more information, write or call:

**NILES AUDIO CORPORATION**  
Dept. A/P.O. Box 160818  
Miami, FL 33116/(305) 271-9181

## FOR SALE

... DEAR AUDIO CONNOISSEUR ...

Why has our electronic crossover created such a stir in the audio world? Beauty-Performance-Finesse

Quanics manufacturers truly exceptional audio products, in limited editions only. They are Innovative, Refined, Precise, Distinctively Built, Beautifully Styled, and Uncompromised.

To find out more about us and our crossover we invite you to send for our brochure.

It also contains an invaluable candid discussion about crossover facts, selection, use. Enclose \$3.50 for brochure: Crossovers One 80

... We Thank You ...

Tastefully Yours,

**QUANICS MFG. CO., LTD.**

**BOX 77068/SEATTLE, WA 98133 USA**

### DEMO, SCRATCH & DENT SALE

**PREAMPS:** Audionics RS-1 \$524, AEA 520 \$299, AMPS: Audire Model 2 \$299, Denon PMA-630 \$279, Electrocompaniet \$489, STEP UPS: Denon TU-630 \$204, NAD 4020 \$99, CASSETTES: DR-350 \$249, SPEAKERS: SYMDEX SIGMA \$344 pr., SONEX II \$299 pr., THIEL 01 \$199 pr., TURNTABLE: Denon DP-7000 w/2 arm base \$599. All new or demo. All prices firm.

**PERFECTIONIST AUDIO LTD.**

P.O. Box 250

Pleasant Gap, PA 16823

(814) 238-4071

**DIAMOND NEEDLES** and Stereo Cartridges at Discount prices for Shure, Pickering, Stanton, Empire, Grado, Audio Technica and ADC. Send for free catalog. LYLE CARTRIDGES, Dept. A, Box 69, Kensington Station, Brooklyn New York 11218. For fast service call toll free 800-221-0906. TF

### DISCO: MOBILE OR FIXED=CASH START

your own disco business. Complete start-up manual explaining sound and lighting systems installation, written by professional disco DJs and designers, \$5. J.C. Enterprises, Dept. A1, P.O. Box 234, Apalachin, NY 13732.

**DYNACO/HAFLER ACCESSORIES:** Genuine walnut veneer cabinets (dramatically improves appearance!) — Dyna (mention models): single, \$19.95; double, \$24.95. Hafler (DH-101): \$19.95. DYNA ACCESSORIES, RCT-5 Preamp Relay, \$29.95; PPM-5 Phono Module, \$29.95; BI-FET Conversion Kit, \$49.00; MBI-400 Mono Bridging, \$18.00; Meters: MC-2 \$49.00, MC-3 \$79, MC-4 \$69; PBK-400 Rackmount (ST400), \$29.95, FREE LIST. Postpaid! SCC, Box 8014, Canton, OH 44711

## FOR SALE

**DOLBY DECODERS FOR FM OR TAPE — ALSO KITS** encode/decode. Reviews. Dolby calibration tapes. AJ Integrex, P.O. Box 747, Havertown, PA 19083

**DYNACO/HAFLER GENUINE WALNUT CABINETS** — Dramatically improves appearance! Dynaco: (single) \$19.95, (double) \$24.95; Hafler (DH-101) \$19.95. Mention models owned. Postpaid, SCC, Box 8014, Canton, OH 44711

**DYNACO OD-1 Ambience Recovery Unit.** Dramatically improves spacial realism! \$19.95/Kit; \$24.95/Wired. Postpaid! SCC, Box 8014, Canton, OH 44711

**DYNACO PARTS & ACCESSORIES** — Million-plus parts "in stock." Try us! (Supply Dyna part numbers for quote). Free list. SCC, Box 8014, Canton, OH 44711

**Dynaco ST-416 power amp (factory assembled)** with C-100 energy storage, mint \$595. (901) 754-3010.

**ELECTRONIC CROSSOVERS — ALL TYPES** Updated definitive booklet describes applications, how to improve speaker systems; \$5.00 postpaid, credited to first purchase. Huntington Electronics, Box 2009-A Huntington, Conn. 06484.

Where Music  
Comes To  
Life In . . .

KENTUCKY

Threshold, Magneplanar, Signet, Apt/Holman, Yamaha, Bang & Olufsen, NAD, Dahlquist, Snell Acoustics, Lux Audio, Alpine, Concorde, Pioneer, Phase Research, Boston Acoustics, Polk Audio, and many more.



**Ovation**  
AUDIO SYSTEMS, INC.

140 Moore Drive, Lexington, KY 40503 606-278-0333

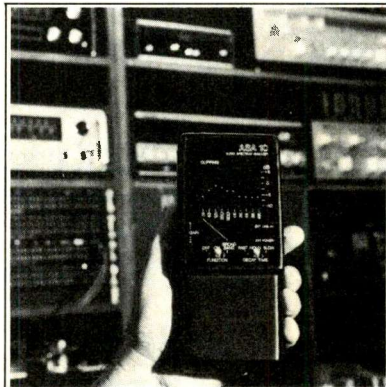

**Analyzer ASA-10 . . . . . \$199.95**  
**Pink/White Noise Generator . . 49.95**  
**DEALER INQUIRY INVITED**

### SPECTRUM ANALYSIS SYSTEM

The ASA-10 is a true professional quality analyzer that offers:

- A 10-Octave Spectrum Analyzer covering the full audio range
- Built-in flat response microphone
- Adjustable dynamic range display up to 35dB
- Selectable detector response times for either pink noise or signal monitoring
- A Hold Mode for easier analysis

P.O. Box 115 · West Redding, CT 06896  
203-938-2588

**GOLD LINE**

## FOR SALE

### ELECTROSTATIC TRANSLATORS ARE HERE

Come and audition this fine new line of electrostatic loudspeakers along with: Audire, Audio Technology, Celestine, Clarke, Decca, Grado, Braun Satellites and subwoofer Chartwell, ADCOM, Burhoe, Toshiba, Car F1, Monster Cable PERSONALIZED AUDIO

723 Bound Brook Rd., Dunellen, NJ 08812  
Appointments available call 201-752-3883

**Emperic Audio Components in Central New York**  
Win Laboratories Turntable and Arm  
Koetsu MC Cartridge  
Mitchell A. Cotter MC Transformer and PSC-2  
call for our mailing list: (315) 437-3357 M-F  
REFERENCE AUDIO of Dewitt, division on GM/GP, Ltd.

**ESOTERIC COMPONENTS AT TREMENDOUS SAVINGS.**  
Free Price List. Demos and Weekly Specials. Fast, Knowledgeable Service. AudioWorld Box 7518 G.R. MI. 49510. 616-241-2994, M-F 1-8, Sat. 1-5. Visa/Master.

### AUDIOPHILE ACCESSORIES

- DBP-4 PHONO EQUALIZATION KIT** ..... 27.95  
Allows adjusting the input capacitance of the phono input of every preamp and receiver with low loss Polystyrene Capacitors. Gold plated connectors.
- DBP-11 CAPACITANCE LOADING SWITCH BOX** ..... 79.95  
Features selectable loading for two moving magnet cartridges. Gold plated connectors.
- DBP-8 SPEAKER WIRE** ..... 6.95  
12 gauge with tinned ends one/pack ..... 11.95  
9 meter ..... 16.95
- DBP-9 BANANA PLUGS** ..... 2.85  
Set of four solderless connectors.
- DBP-10 PHONO ALIGNMENT PROTRACTOR** ..... 19.95  
Allows adjusting the lateral tracking error of a mounted cartridge to within 1/4 of one degree. Non-technical instructions and carrying case included.
- DBP-12 AUDIO CABLE: Low capacitance (400pF) 9 meter (30 ft.) stereo audio cable: terminated with rugged gold plated phono connectors.** ..... 39.95
- MODIFICATION AVAILABLE: DB-1 to DB-1A** ..... 52.80  
Improved turn on/off transient suppressor on DB-6 or DB-6M Power Amplifiers ..... 45.00

At your Dealer or direct. Orders under \$45. add \$2.00 handling.

### DB SYSTEMS

Box 347C, Jaffrey, NH 03452 (603) 899-8121  
Dealer inquiries invited. Overseas distributors in: Benelux, W Germany, Scandinavia, Japan, Hong Kong, Singapore, Taiwan, France.

## FOR SALE

### ELECTROSTATIC PERFECTION

The "RENAISSANCE SERIES" electrostatic panels and subwoofers from Sound Lab, Inc. are the finest speakers available. Immediate delivery.

Precision Fidelity — Fidelity Research — Bedini — Audionics — Harbeth HL Monitors — Symmetry — Ultracraft — TMA Disc Cleaner — R H Labs — Koetsu.

PACIFIC IMAGE, INC. (415) 488-0293  
P.O. Box 169 By Appointment  
Woodacre, CA 94973 Prepaid Shipping

**FRANK VAN ALSTINE HAS DONE IT AGAIN.** All new ZERO SLEW INDUCED DISTORTION modifications for DYNACO and other equipment. Wait Jung is right of course, but he overlooks a few things we have not, such as the small signal effects of RFI and the low frequency analogy to S. I. D., which relates to the time constant ratio between low frequency cut-off and power supply stiffness after regulation (we can prove that DC coupled inputs guarantee high distortion at low frequencies) Our new mods guarantee zero T. I. M. and until you hear an amp or preamp achieving this, you haven't heard anything yet. For example our all new SUPERPAS mod will outplay any other vacuum tube preamp and its only our fourth best preamp design. Write for our detailed explanation that may shake the world of high end audio.

JENSENS STEREO SHOP 2202 RIVER HILLS DRIVE  
BURNSVILLE, MINN 55337 612-890-3517

Fried M-2's used 1 yr. excellent cond \$1000, Austin Texas  
(512) 459-8172.

Fulton moving coil cartridge is available at **Kenneth Wagner Audio Systems**. No other cartridge is as musically correct. Also in stock:

SPEAKERS	ELECTRONICS	TURNTABLES Etc.
Fulton	Audio Research	Systembek
B&W	Crown	STD
KEF	N.A.D.	Micro Seiki
Dahlquist	Audionics	Supex
J-R	Bravura	Koetsu
Snell		Grace
Spendor		Signet

Visa & M.C. Free Shipping in U.S.  
Kenneth Wagner Audio Systems  
841 S. Dixie Hwy.  
West Palm Bch., FL 33401  
Tel: (305) 833-0448

## FOR SALE

### FRIED SPEAKER KITS

We have the D.O, BII, C, E and Super Monitor in stock. We supply QUALITY custom cabinets at the lowest price in the USA! You may choose pre-cut unassembled wood and assembled cabinets in particle board, wood veneers or solid oak or walnut. Prices start at \$330 per pair. Truly accurate sound and beautiful speaker cabinets. AUDIO SALON, 608 Pecan Ave., Charlotte, NC 28204 (704) 377-6590.

Fulton - The full line of Fulton products (speakers, cables, cartridges) are now available at PAIDE ELECTRONICS, 2028 Sandstone Ct., Silver Spring, MD 20904. Hours by appointment, call (301) 384-2969 eves. or weekends.

**GET ACQUAINTED WITH TRANSCENDENTAL AUDIO'S** line of exciting advanced raw speakers, many used in systems by Tangent, Plasmatronics, Symdex, DAC etc., Bextrene cone models in 5" to 10" most w/magnet, voice coil layer & lgh. options. Very neutral SD tweeters plus a fascinating new driver w/1.3 gms moving mass that "traces" signal detail like the best electrostatic headphones, will definitely spoil you. Design & application assistance from our lab available to help you realize the dream system you are planning from mini monitors, satellites, car systems to sub woofers. X' over designs & parts including Mylar caps up to 10uf. Your inquiries & orders receive our prompt attention, send \$1.00 for literature. Transcendental Audio, 6550 Indiana Street, Golden, CO 80401. Innovative components & designs in high-end audio. Polydax (Audax), Decca, E.J. Jordan, Dalesford. 303/420/7356.

**GET INTO BROADCASTING!** Learn how to receive free records, tapes, get an FCC broadcast license, start your own station. Free details. "Broadcasting", Box 130-N5, Paradise, CA 95969.

**GOING TO COLLEGE:** Technics SL 1300 MK II — \$350; Pioneer CT-F1000 — \$400; SAE 1800 Parametric Equalizer \$300. (907) 442-3665 after 8:00 pm PST.

### GRACE SME THORENS STD SYSTEMDEK

All at reasonable prices. AUDIO SALON, 608 Pecan Ave., Charlotte, NC 28204 (704) 377-6590 Shipped Pre-paid.

### GRACE & SUPEX

We offer the Grace 707MK2, 704, F9-E, F9-L, Linn mods for the 707MK2, Supex SDX-1000, SD-900MK2 & SD-900E+Imp. Free shipping. Visa & M.C. OXFORD AUDIO CONSULTANTS, BOX 145, Oxford, OH 45056 (613) 523-3333, 523-3895.

**GUSS 3-D SPEAKERS — A SONIC REVELATION.** From \$3000. See this space in August issue for details.

### Hafler: Amp and Preamp

Audio Ltd., 115 N. Walnut, Champaign, IL 61820 (217) 359-3774.

### HAFLER COMPONENTS IN PHOENIX AZ

Exclusively at THE LISTENING POST (602) 967-1250.

### HAFLER DH-101 PREAMP

We expect to be in stock on this exciting new preamp by Dec. 12th. Kit price is \$199.95. Custom wired and tested, \$299.95. Immediate prepaid prepaid shipment shipment via UPS. THE AUDIBLE DIFFERENCE, 435 Tasso, Palo Alto, California 94301. (415) 328-1081. TF

Hafler DH101 ultraHigh definition modification - instructions only \$10.00. Modification \$100.00 Amoeba Systems. 1201 Addison Dr., Reynoldsburg, Ohio 43068. (614) 861-8710.

### HAFLER DH 200

Call or write for quote. Audio Salon, 608 Pecan Ave., Charlotte, NC 28204 (704) 377-6590 Shipped Pre-paid.

**HAFLER HEADQUARTERS IN CANTON, OHIO** - The Listening Room, 1807 Cleveland Ave. NW. (216) 452-6332. TF

## Audiocom High Technology Audio

ADS, Allison, Apt, Audio Pulse, Audionics, B&W, Bruer, Burwen, Cotter, Dahlquist, DCM, Denon, Draco, EMT, EV, Eumig, FR, GAS, Grace, Grado, Janis, JR, KEF, Mitsubishi, MK, NAD, Nakamichi, Ortofon, RH Labs, Revox, Rogers, Snell, Spectro, Stax, Symmetry, Tandberg, VA Systems

Major credit cards honored. Phone orders shipped promptly.

177 Sound Beach Avenue, Old Greenwich, CT Phone: (203) 637-3621

# POSITIVE FEEDBACK...

"no unwanted side effects...  
the best device of its type we have used"

JULIAN HIRSCH  
Popular Electronics Feb. 1980

**RG** RG DYNAMICS INC.  
4448 West Howard Street  
Skokie, IL 60076

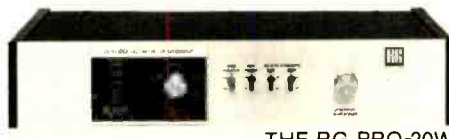

THE RG PRO-20W

## FOR SALE

### HAFLER IN THE SOUTH

In stock, the superb Hafler DH-101 preamp. Kit \$199, factory assembled \$299. New: DH-200 amp. Immediate free shipping. Also Fried, Aduionics, Vandersteen, NAD, Advent, Klipsch, more. READ BROS, STEREO, 593 King St., Charleston, S.C. 29403 (803) 723-7276. 7-9

### HAFLER PRODUCTS & MODIFICATIONS

We have in stock the following: DH-101K \$199.95, DH-101A \$299.95, DH-101AP \$399.95, DH-102 \$74.95, DH-103 \$19.95, DH-104 \$24.95, DH-105 \$24.95, DH-106, mod kit for 101's produced before May, 1979, \$19.95, DH-202 bridging kit \$24.95. As for the DH-200's, the supply has been low and the demand high. When this appears we HOPE to have in stock the DH-200K \$329.95, DH-200KE \$339.95, DH-200A \$429.95, DH-200AE \$439.95 & DH-201 rack mount, \$24.95. Free shipping in U.S. We ship Worldwide. Visa & M.C. OXFORD AUDIO CONSULTANTS, Box 145, Oxford, OH 45056. (513) 523-3333, 523-3895.

**HEAR TRUE DIGITAL IN NEW ORLEANS**, ultimate playback system. Recordings of Richie Heavens, New Orleans Symphony, Jazz artists, Al Hirt, and even New Wave. (recordings Not For Sale) ALTERMAN AUDIO, 7323 Freret New Orleans.

**HEATHKIT TV CABINET**, GRA-602-25 for GR-2000 or 2001 TV's. \$150. NO SCRATCHES. 408-279-1425 day. 408-259-9648, eves.

**HI-FI Enthusiasts** — Experience what in-house service facilities, quick shipments, low prices and brand selection can mean to you. Team your abilities with the best supplier to make selling discounted hi-fi a pleasure. Write Hi-Fi Warehouse Dept. 20, 1006 Haddonfield Road, Cherry Hill, NJ 08002.

### HIGHEST QUALITY USED EQUIPMENT FOR SALE:

McIntosh C28, \$400; Yamaha AI amp, \$450; Crown 150, \$175; Nakamichi 580 deck, \$450; Yamaha C1, \$1000; Yamaha C2, \$400; Tandberg TCD 330, \$5.25; RG Pro 16, \$140; Sony TA 3200F, \$200; Phase Linear 4000 preamp, \$300; AR 11 spkrs, \$300 pr.; B&W DM 70 spkrs, \$800 pr.; IMF TLS 80 spkrs, \$1200 pr.; Yamaha B1, \$1000; Satin M18 E cars (new) \$150; Marantz 2325, \$400. All used equipment guaranteed 90 days parts and labor. Audio Consultants, 1014 Davis St., Evanston, IL 60201, (312) 864-9565; and 757 N. Milwaukee Ave., Libertyville, IL 60048, (312) 362-5594.

**HIGH PERFORMANCE LOUDSPEAKERS** factory direct. LS3/5A and other equivalents. European drivers, speaker enclosures, kits, finished systems. Student reps needed. Box 18009 Seattle, Wn. 98118 and Box 12242 Jacksonville, FL 32209.

**HIGH QUALITY, LOW DISTORTION AMPLIFIERS** at low cost. These amplifier modules are pre-assembled, tested and ready to mount and connect, with simple instructions.

PGAS-AS20 20 WATT STEREO POWER AMP \$39.95  
PGAS-AS40 40 WATT STEREO POWER AMP \$49.95  
PGAS-AS60 60 WATT STEREO POWER AMP \$96.95  
PGAS-AS100 100 WATT STEREO power amp \$99.95  
Power supplies and other related equipment are available. Send check or money order to: PRECISION GAIN AUDIO SYSTEMS, P.O. Box 91, Hadley, PA 16130

H/K CIT. 11 (225), CIT. S11S (40), CIT. 19 (325). Larry, (412) 846-7419.

H/K CIT 16, \$400; RAPPAPORT PRE-1 \$400. (302) 368-9854.

**HORNS-WOOFERS-MIDS-TWEETERS** at tremendous OEM savings. A1tec, CTS, Electro-Voice, Pioneer, Panasonic, Peerless, Phillips, Polydax and many others. Dozens of hard to find items. Huge selection of crossover network components, automobile systems, and musical instrument loudspeakers. Send \$2.00 for catalog, refundable with purchase: SRC Audio, Dept. AD, 3238 Towerwood Dr., Dallas, TX 75234.

**IMAGINE** . . . A speaker with all the advantages of electrostatics, BUT . . . Excellent transient low bass response, medium efficiency, high power handling ability, very linear response. PLUS . . . Minimum box reflections, driver alignment, and is affordable. ALTERMAN AUDIO 7323 Freret New Orleans 505-834-7772

## FOR SALE

**INFINITY QUANTUM LINE SOURCE 1A SPEAKERS, IMMACULATE, WARRANTY, \$1500.00.** (1-813) 461-5758.

**INFINITY SS1 rose screens \$400.** (608) 782-5845.

**INFLATION FIGHTING "HIGH END" DEMO, SCRATCH & DENT SALE**

AMPS: Electrocompaniet \$485; QMI (Quatre) DG-250-C \$499; Denon PMA-630 \$279; Quad 303 \$238; Quad 405 \$407; NAD 3020 \$109; RECEIVERS: Wintec R1060 \$359; TUNERS: Denon TU-630 \$207; NAD 4020 \$109; CASSETTE: Denon DR-350 \$279; ARMS: Denon 307 \$165; STEP UPS: Cotter P \$350; AEA 515 \$109; Marcof \$79; Denon 310 \$59; PREAMPS: Audionics BT-2 \$299; Audionics RS-1 \$524; Audionics Space & Image Composer \$630; AEA 520 \$299; SPEAKERS: Theil 10 \$199 pr.; Sonex II \$399 pr.; Monitor Audio MA-4 \$149 pr.; CARTRIDGES: Denon 103D \$160; Audio-Technica AT30E w/xformer \$65; All units under full warranty & perform as new. Prices firm.

Perfectionist Audio Ltd.  
P.O. Box 250  
Pleasant Gap, PA 16823  
(814) 359-3007

**IVIE ELECTRONICS REAL TIME ANALYZERS**, etc. Some very slightly used demonstrators at discount. Full factory warranty. Money-back guarantee. JML Company, 39,000 Highway 128, Cloverdale, CA 95425.

**IVIE IE-10A octave band analyzer**, Bruel and Kjaer 2305 chart recorder, Phase Linear 400 Amplifier, TEAC A1200 V tape recorder. Richard Cabot, 12820 SW Washington St., Beaverton, OR 97005 (503) 644-9727.

### JANIS WOOFERS

are the best universal subwoofers available. Hear them together with the Interphase crossover amp at OXFORD AUDIO CONSULTANTS, Box 145, Oxford, OH 45056. Free shipping in U.S. We ship worldwide. (513) 523-3333, 523-3895.

**JAZZ/AUDIO INSTITUTE** — July 14-Aug. 80 live improv/rehearsal/concerts recorded/critiqued by participants 4 studios. API. In Pacific Northwest for info and applications contact: Dave Englert, Evergreen State College, Olympia, WA 98505.

**JBL PARAGON STEREO SPEAKER SYSTEM**, oiled. Walnut, like new. Call (315) 689-9290; \$3,500.00.

**JBL SA660 amp, LX5, xovers**, Hartsfields SME 3009, Formula-4, MAC SCR-1. 1-313-229-7378.

**JBL spkrs. Hartsfield Electronics.** (415) 488-0961. Box 8, San Geranimo, CA 94963.

**SUPERIOR AUDIO COMPONENTS:** Audio Pulse; Audio Research SP-6 tube preamp and D-110 amp; Badap 1; Celestion; Cizek; Crown Distinction Series DL-2, SA-2, and EQ-2; Dayton Wright; dbx; Decca; Denon; Dynavector; EMT; Formula 4; Grace; Hafler kits; KEF; Kenwood Purist; Lux LRS; Magneplanar; Mitsubishi; Mobile Fidelity records; Nakamichi; Plasmatronics; RTR; Verion; Watson speakers.

**Barclay**  
RECORDING & ELECTRONICS

233 East Lancaster Avenue, Wynnewood, Pa. 19096.  
(215) 667-3048 or 649-2965.

## FOR SALE

**KEF Cantata \$420 ea, 104ab \$285ea, DN 12 \$22 ea, DN 13 \$15ea, McIntosh 2505 w/case \$400, Dynaco 150 \$200.** Tony Thomas, 3303 E. Denny Way, Seattle, Wash. 98122, (206) 323-4987 eves.

**Klipach La Scala's; B&O 4002, Crown 16-150 and D-150, QMI 300.** Will sell all or any part, best offer. (406) 784-2252.

### LEARN RECORDING ENGINEERING

- One month, full time
  - In-studio, Hands-on
- Call or Write for Brochure:  
Full Sail Recording Workshop  
1221 Lee Rd.  
Orlando, FL 32810  
(305) 299-1076

**LEVINSON LNC-2 \$900, SME III NEW \$175, Yamaha C2 pre \$350, Mc 225 tubes \$150, Pio TX9100 tuner \$150, Tandberg 10XD \$250, Mc C20 \$200. LISTENING ROOM, INC. (205) 939-0702.**

**Linn-modified Grace 707 MK2 with Fulton Head Shell Leads**, correctly mounted on Linn Board (will sell with or without Board), \$130, (919) 967-4425.

### A UNIQUE AUDIO STORE

Goodwin's is unique among audio dealers, offering a few products which are acknowledged to be the best values or simply the best available. These components are properly set-up and may be auditioned in a comfortable, relaxed living room environment. Our reference is the Mark Levinson HQD system and the ML-5 (Studer A-80) with 30 ips master tapes. We operate by appointment to ensure a meaningful demonstration under nearly ideal conditions.

Goodwin's sales & service for: The reference Mark Levinson ML-1 & ML-6 preamps; ML-2 mono & ML-3 stereo power amps. The best sound/dollar Bryston 2B, 3B & 4B power amps.

The Linn Sondek LP-12 and the best value Rega Planar 3 turntables. The Goldmund straight-line tracking tone arm — our reference.

We also recommend: Symdex, Quad, Scheiber 360° decoder, Win Labs, Linn Ittok arm, Mitchell Cotter, FR, Sequerra, & Vandersteen.

If you would like to avoid the planned obsolescence of most stereo components and are interested in the finest music reproduction, please call Goodwin's for an appointment.

Goodwin's Inc. 33 Newbury St.  
(617) 266-0608 Boston, MA 02116  
Canadian export specialists

# POSITIVE FEEDBACK...

"The actual total harmonic distortion...works out to an infinitesimally low .00363%. RIAA equalization was so accurate that we cannot assign a plus or minus tolerance to this response..."

LEN FELDMAN-  
Audio Magazine May 1980



For information write: RG Dynamics  
4448 W. Howard St., Skokie, IL 60076

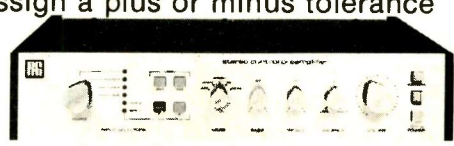

THE NEW RGD3-W PREAMPLIFIER

## FOR SALE

**LISTENING ROOM INC**  
590 Central Park Avenue  
Scarsdale, N.Y. 10583  
(914) 472-4558

Cordially invites you to audition our fine line of equipment.  
THRESHOLD · BRYSTON · SPATIAL · HILL TYPE-1 PLASMA  
SPEAKER SYSTEM · PYRAMID SPEAKERS · SNELL ACOUSTICS · DAHLQUIST · KEF 105 · B & W 801 · LINN SONDEK · GOLDMUND T-3 TONEARM · QUAD ESL · YAMAHA · TANDBERG · NAKAMICHI · KEITH MONK · PERSPECTIVE SPEAKERS · MARCOF · MUSICAL FIDELITY · ULTRACRAFT · STAX · JANIS · R.H. LAB · GAS · SEQUERRA · POLK AUDIO · DENON · GRACE · GRADO SIGN. III · DYNAVECTOR · KARAT DIAMOND · MICRO-ACOUSTIC · JVC MC-1 MOVING COIL · VISIT OUR PRIVATE STUDIOS ·

We ship free anywhere in the Continental U.S. We invite inquiries.

## Audio Polygraph

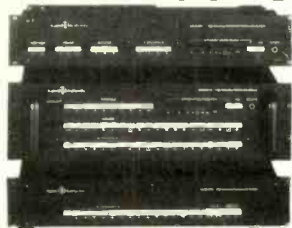

Can you believe what you hear when shopping for home or car stereo equipment? It can be confusing. All those different products. Unfamiliar switching systems. And some products sound so much better it's hard to believe.

If your dealer uses Audio Authority comparators and switching systems you have not been misled. You can believe what you hear.

## Audio Authority

140 Moore Drive, Lexington, KY 40503  
606/277-7189

## FOR SALE

### LINN DISC SYSTEM, ISOBARIKS & NAIM

We know that some components reproduce sound much more faithfully than others. For those who can hear the difference we offer the Linn Disc System: Linn Sondek LP-12, LV-II arm & Asak Cartridge; the Linn Osobariks: PMS, DMS & S.A.R.A. (uni- or bi-amped); and Naim electronics: head amp, preamps & amps. Free shipping in U.S. OXFORD AUDIO CONSULTANTS, Box 145, Oxford, OH 45056, (513) 523-3333, 523-3895.

**LOWEST PRICES! HIGHEST RELIABILITY. SOUND SHED HIFI has stereo, esoteric, auto, disco, and video. Over 150 brands - Bose, Cerwin Vega, DCM, DBX, Denon, GAS, Hafler, Infinity, Lux, Nakamichi, Onkyo, Phase Linear, Pioneer, Tandberg, Technics, Thorens, Yamaha, and many others. All factory fresh, all guaranteed, shipped fast with no deposit required on most items! For quotes and orders call (914) 258-4342 9am-9pm Monday-Friday. For catalog, call or write SOUND SHED HIFI, Merritts Island Rd., Pine Island, NY 10969.**

**"LOWEST PRICES: BOSE, SAE, NAKAMICHI, YAMAHA, ADVENT, THORENS AND MORE. DYNAMIC SOUND, BOX 168, STARKEVILLE, MS 39759. (601) 323-0750. 1pm-9pm."**

### LOW NOISE AUDIO TUBES

TYPE	BRAND	PRICE
KT88	Genelex	\$30.00 Ea.
KT88Mp	Genelex	\$65.00 Pair
12AX7	K Type (Low Noise)	\$ 2.65 Ea.
12AT7	K Type	\$ 3.90 Ea.
12AU7	K Type	\$ 3.90 Ea.
6L6GC	K Type	\$ 3.90 Ea.
6550A	GC	\$ 7.00 Ea.
6550Mp	GC	\$15.50 Pair
7027/12AX7A	GC	\$ 6.75 Ea.
6CA7	Amperex	\$ 4.75 Ea.
6CA7/EL34Mp	Amperex	\$ 9.95 Pair

**\*\*PLUS MANY OTHER TYPES AVAILABLE\*\***  
TEMTRON ELECTRONICS LTD., 15 Main Street,  
East Rockaway, NY 11518  
CALL TOLL FREE 800/645-2300  
IN NEW YORK 516/599-6400  
\$25.00 Minimum; C.O.D. or NET 30 with references  
FOR C.O.D. add \$1.50 for shipping and handling

# Audio

## SUBSCRIBER SERVICE

Place label here

**MOVING?** Please give us 8 weeks advance notice. Attach label with your old address, and write in new address below.

**RENEWING?** Check box below and attach label with corrections marked, if any.

**SUBSCRIBING?** Check box and fill in coupon. For gift subscriptions attach a separate sheet.

Send Audio for 1 year at \$11.94

- New subscription     Renewal  
 Payment enclosed     Bill me

Outside the U.S.: add \$6.00 per year.

Name \_\_\_\_\_

Address \_\_\_\_\_

City \_\_\_\_\_

State \_\_\_\_\_ Zip \_\_\_\_\_

AOCOAO

For faster service call toll-free any business day, 9:00 A.M.-5:00 P.M. Eastern time.

**800-243-8002**

(In Connecticut 800-852-8593)

**AUDIO**

1 Fawcett Place  
P.O. Box 8167  
Greenwich, CT 06836

## AUDIO HORIZONS

P.O. BOX 10973  
St. Louis, MO 63135

Issue #3 is now available. It contains reviews of the AUDIO STANDARDS MX-10A pre-amplifier, the DENNESEN Soundtractor, the DENON PCC-1000 phono crosstalk canceller, the JML protractor, and the THETA preamplifier. Issue #3 also features reviews of the BREUER 5C, DENON DA-307, DYNAVECTOR DV-505, FIDELITY RESEARCH FR-64s, GRACE G-707/MKII, G-704 and G-714, HADCOCK GH-228 Super, INFINITY "Black Widow" GF, JH Audio Labs, LUSTRE GST-1 and GST-801, MAYWARE Formula IV Series III/MICRO MA-505X, MISSION 774, SME 3009 Series III, STAX UA-7cf-m, SYRINX PU1, WOODLESS LURNE WLP-1, and ULTRACRAFT AC-3000MC pickup arms, plus reviews of the DENON DL-303, FIDELITY RESEARCH FR-1 MK3F, FULTON RS, GRADO Signature III, KOETSU MC ONE, LINN ASAK DC-2100K, MISSION 773, ORTOFON MC-30, PRECISION FIDELITY, SUMO II, SUPEX SD-900 Super II and SDX-1000, WIN LABS SDT-10 Type IIC, and YAMAHA MC-1S phono cartridges.

Subscription rates to AUDIO HORIZONS™ for six issues are: U.S. - \$18, Canada and Mexico - \$20, and outside North America - \$26 (AIR MAIL). Please remit in U.S. funds only. Sample copies of all issues of AUDIO HORIZONS are available for \$4.50 each (U.S., Canada, and Mexico), and \$6.00 each (outside North America).

**Now in Fort Lauderdale...**  
**State of the art components for the audio perfectionist and serious listener.**

Audio Research • Acoustat • Denon • B & W • Armstrong • Chartwell • Lux  
Tangent • Polk • GAS • Conrad Johnson • Audire • Ariston • Connoisseur  
ADC • Grace • Supex • Grado • Goldring • DB Systems • Quatre • Stax  
Theta • Plasmatronics • Transcriptors • Dynavector • Vandersteen  
Complete selection of direct to disc recordings.

## AUDIO INSIGHT

The Promenade at Bay Colony  
6286 N. Federal Hwy., Ft. Lauderdale, FL 33308 • 305/491-7677





# Advertising Index

<b>Firm (Reader Service No.)</b> .....	<b>Page</b>
ADS.....	11
AIWA (1) .....	57
Allison (2) .....	6
Altec Lansing (3) .....	45
Audio Critic .....	78
Audio Pro .....	24
Audio-Technica .....	4
Audiovox (4) .....	59
Crown (5) .....	64
Crutchfield (6) .....	23
Discwasher .....	2, Cov. IV
Electro-Voice .....	66
Empire (7) .....	7
Fuji .....	15
JBL (8) .....	49
JVC (9) .....	47
Jensen (10) .....	17
KEF (11) .....	21
3M (12) .....	78
MXR (13) .....	73
Maxell (14) .....	19
McIntosh (15) .....	18
Onkyo .....	5
Phase Linear (29) .....	67
Pioneer (16) .....	Cov. II, 1
ReVox .....	25
Sansui (17) .....	43
Shure (18) .....	27
Snell Acoustics (19) .....	14
Sony/Audio Lab (20) .....	50&51
Sony/Headphones (21) .....	22
Soundcraftsmen (22) .....	12
Spectro Acoustics (23) .....	16
Stanton (24) .....	3
Studer ReVox .....	25
TDK (26) .....	Cov. III
TEAC .....	63
Technics (27) .....	13
United Audio/Dual .....	65

## FOR SALE

**LOWEST PRICES ON STEREO-ESOTERIC COMPONENTS & Tapes.** Over 150 brands. Send #10 SASE for quotes. Audio Unlimited, 401 Reynolds Circle, San Jose, CA 95112 (408) 289-8875 1-6 Monday thru Thursday.

**LOWEST PRICES ON MAXELL, BASF, TDK, FUJI, AMPEX,** tapes. Send #10 SASE for free catalog. Guaranteed!! Audio Unlimited, 401 Reynolds Circle, San Jose, CA 95112.

**LS3/5A • SATTERBERG WOOFERS - THE LISTENING ROOM, INC.** (205) 939-0702.

**LUXMAN C-1010 PREAMP,** new with warranty cards, \$450. Yamaha C-2 preamp, mint condition, \$325. (215) 797-4076 (Scott).

**Lux 5T10 tuner \$465, late Nakamichi 700 with remote \$750, Phase 400-120Kuf power supply \$425, Revox tt + Grado Sig. II \$765, Sony PS2251 turntable \$150, Rabco SL8E \$95.** All excellent with instructions and orig. box. (415) 941-4763 eves. keep trying.

### L.A. — SOUTHERN CALIFORNIA

We carry the smallest selection of only the best values and the best equipment. We demonstrate by appointment to insure a meaningful demonstration.

Linn Sondek turntable, Linn Asak cartridge, Spatial Coherence TFEF Valve preamp, Rogers BBC LS3/5A speaker, PSE Studio One preamp & Studio Two power amp, Stax headphones, Musical Fidelity preamp, Denon tables, arms, cartridges, Meridian amp, preamp, tuner, Decca Ribbon Tweeters, Koss Electrostatic speakers, Satterberg Subwoofers, SAEC metal record pad & cables, Chartwell polypropylene speakers, LiveWire & Live Wire Litz, Peterson Audio Link cables, Hafler amp & Preamp, Osawa record pad.

### EXECUTIVE AUDIO

BY APPOINTMENT ONLY (213) 395-6400  
2210 Wilshire Blvd. suite #207 Santa Monica, CA 90403

**MAGNEPLANAR Tympani IIIB Speaker System \$1295.** (305) 987-7819.

**MAIL ORDER DIRECT FROM AKIHABARA TOKYO:** All Japanese brands; Tonearms, Cartridges, Transformers, etc. Latest Quotations sent for free. Please write & ask! Hi-Fi Express, P.O. Box 28 Shitaya, Tokyo, 110-91, Japan.

## FOR SALE

**MCINTOSH EQUIP. BOUGHT-SOLD-TRADED** eves. wkends: (607) 865-5387; SDR, Box 387, Walton, NY 13856.

### METRO-NEW YORK CITY

G.A.S., FR, Dahlquist, B&O, Lux, Linn Sondek, AVID, Janis, Baure & Wilkens, Grace, Tangent, R.H. Labs, Direct Discs, Grado, many others. All issues of Absolute Sound.

UNIVERSITY STEREO-Ridgewood, N.J.,

57 E. Ridgewood Ave.(201) 447-5700

20 minutes from G.W. Bridge

12-9

**MULTI-TRACK AND SEMI-PROFESSIONAL AUDIO EQUIPMENT: BEST PRICES!** Prompt Delivery! AKG, DBX, TEAC/Tascam, Sound Workshop, DeltaLab, Maxell, others. Call (919) 467-8113. To Order call toll-free 1-800-334-2483. WYCO SALES, Dept. AD, Box 887, Cary, NC 27511

**NAKAMICHI 1000, Spec's OK'd with remote control,** (509) 586-2566.

## Get with the Audio Pros!



**AUDIO CONCEPTS**

- Franchised Dealer
- Full Warranty Service
- Highest Quality Lines
- Same Day Shipment

VISA®    master charge

1127 W. Huntington, Arcadia, CA 91006  
Tollfree California  
**(800) 423-4170 (213) 445-3663**

**Call for best price!**

The people who publish The Audio Amateur announce a NEW publication . . .

# SPEAKER BUILDER

ONE HALF THE CASH you spend on your audio system should be invested in your speaker, so why not build it yourself? You can save up to **two thirds of the cost of the speakers**—which translates to almost one third of your outlay for your stereo system. Nearly 100,000 Americans will build their own cabinets this year—and you can too! Your dream speaker is probably well within reach if you build it yourself. There's a lot of help around already and now this new quarterly publication from the publishers of *The Audio Amateur* brings it all together in an assortment of articles that are comprehensive and a mix of both simple and advanced projects to help you choose and build the best type for your listening room.

- ★ Bass Reflex                      ★ Horns
- ★ Electrostatics                    ★ Transmission Lines
- ★ Infinite Baffle
- ★ Specials: Ribbon, Air motion transformers
- ★ Basic data on passive and electronic crossovers.

There will be reports on building the many kit speakers and enclosures now available, and a roundup of suppliers for drivers, parts, and kits. We have articles in hand that range

from the ultimate (650 Lbs each) to very simple extension speakers. From time delayed multi-satellites to horn loaded subwoofers, as well as modifications of many stock designs.

### ORDER BLANK A7

#### SPEAKER BUILDER Magazine

P.O. Box 494A, Peterborough NH 03458 USA

Enter my charter subscription to **SPEAKER BUILDER** for one year at the special introductory rate of \$10.00.

Make that a two year charter subscription at \$18.00.

Check enclosed     Charge to my

MasterCard     Visa     charge card.

#  
Expire \_\_\_\_/\_\_\_\_/\_\_\_\_                      Phone Orders (603)924-6526  
Name \_\_\_\_\_

Street & No. \_\_\_\_\_

Town \_\_\_\_\_ State \_\_\_\_\_ ZIP \_\_\_\_\_

I understand that the unexpired portion of my subscription will be refunded after my first issue if the magazine is unsatisfactory for any reason. Make checks and money orders payable to Speaker Builder. Rates above are for USA only. Outside USA add \$1.50 per year for postage. Non U.S. checks must be drawn in U.S. currency only.

## FOR SALE

**MILWAUKEE! THE AUDIO EMPORIUM:** Acoustat, Amber, Audio Perfection Cables, Audio Pulse, Audire, B&O, Beyer, Connoisseur, Conrad-Johnson, Dahlquist, Denon, Dynavector, Genesis, Grace, Grado, Hafler, Linn, Lux, Magnepan, Marcof, Mayware, Musical Fidelity, NAD, Peterson Links, Polk Audio, RH Labs, Revox, Rogers, Snell, Sonus, Stax, Sumo, Technics, Threshold, wide assortment of accessories and direct discs. Open Tues, Wed, Fri, Sat 10-6, Thurs 10-8. Closed Sun & Mon. 6900 W. Brown Deer Rd., 354-5082.

## The KA/STAT



The **NEW** most definitive miniature monitor in the world

Dealer Inquiries Invited

**KINETIC AUDIO INTL., LTD.**  
6624 W. IRVING PARK RD.  
CHICAGO, ILLINOIS 60634  
312-685-6609

## FOR SALE

### MICHIGAN AUDIOPHILES

Apt Holman	Hafler	Revox
Bryston	Hitachi	Sumo
Cabasse	Linn Sondek	Sherwood
Denon	M & K	Sonus
Dahlquist	NAD	Snell
DB Systems	Nakamichi	Spendor
Grace	Onkyo	Soundcraftsmen
Grado Signature	Polk	Stax
Grace	Pyramid	Threshold
GAS	Rega	Visonik

### ABSOLUTE SOUND

"Michigan's High Accuracy Audio Dealer"

Detroit, 12400 Morang Ave. (313) 527-2244  
Royal Oak, 4354 N. Woodward (313) 549-7550  
Ann Arbor, 312 S. Stae St. (313) 662-2026  
Shipping Prepaid

**MIXER** made especially for tape duplication. Will produce enhanced high quality second generation tapes. **KUHN ELECTRONICS**, 1801 Mills Ave., Norwood, OH 45212. TF

### MONTANA AUDIOPHILES ROCKY MOUNTAIN HI-FI

Brings you the Best

NAKAMICHI	HAFLER	MAGNEPAN
DAHLQUIST	ALPINE	HARMON/KARDON
HEGEMAN	G.A.S.	TIME WINDOWS
ACOUSTAT	DENON	MICRO SEIKI
B & W	POLK	AUDIONICS
FULTON	ADCOM	APT HOLMAN

812 Central Ave., Great Falls, MT (406) 761-8683

**NEW AMPEX MASTERING TAPE 406 (7") 2.25, 407 (7") 3.25 New Scotch or Ampex LN-HO 1200x7 1.50, 1800x7 2.25, 4000x10 5.00 min. 20 pp. all boxed. New type 10" metal Reels Boxed \$4 min. 10 pp. other tapes Avail. Large SASE for Details. MJS, 2514 Seaboard Ave., SJ, CA 95131 408-262-8793.**

## FOR SALE

**NIGHTINGALE NMI \$650, GRACE 860 \$80. STEPHEN SUN (212) 446-3760.**

### NORTHERN CALIFORNIANS

It is our goal to make the joy of music possible for everyone. At any price we offer solid value, superior performance, and traditional service.

We operate on the theory that you as our customer will achieve the greatest long term satisfaction only through a careful analysis of your audio requirements. We strive to offer sober, highly cost effective solutions to meet your specific needs. Please stop in for a refreshing experience with music.

### OUR SELECTION INCLUDES:

Magnepan	Audiodisc	Dahlquist
Tandberg	Threshold	Chartwell
Onkyo	Audire	B&W
JVC	Hafler	Cizek
AKG	P.S.E.	AVID
Denon	Lux	Stanton
Micro	Grado Sig.	AIWA
Connoisseur	Sonus	M&K
Soundcraftsmen	Grace	Rogers

**HIGH FIDELITY SHOPPE**  
1511 North Main Street  
Walnut Creek, Calif. 94596  
(415) 932-2242

"WE BUILD BETTER SYSTEMS FOR YOU"

**Northern N.J.'s finest store-Lux**, Mod DQ-10, Grace, B&W, G.A.S. Sleeping Beauty, FR, B&O, Linn, Sondek, Janis, Tangent, R.H. Labs, Grado, AVID and more. University Stereo, 57 E. Ridgewood Ave., Ridgewood, N.J. 07450. 20 minutes from the G.W. Bridge. 201-447-5700. TF

### NORTHERN N.J.'s BRAND NEW AUDIO SALON The Sounding Board, Inc.

Linn Sondek, Chartwell LS3/5A, B&W, Spendor, Great American Sound, Supex, Stax, Adcom, Ultracraft, Mitsubishi, Decca, Tandberg, D.B. Systems, I.M.F. Electronics, Grado Sig., Obelisk, Monster Cable, Dahlquist, Audio Pro, Grace, Cizek, Avid, Marcof, Micro Acoustics, Dual, Strathclyde (S.T.D.), Audio Source.

We Ship Anywhere in the United States.

**THE SOUNDING BOARD, INC.**

(201) 445-5006

Ridgewood, N.J.

**NORTHWEST! The Tin Ear:** Audio Research, Audionics, B&W, Grado, LUX, Magnepan, Polk Audio, RH Labs, Rogers, Supex, Technics, Yamaha and Audiophile recordings. 704 Symons, Richland, WA 99352. 509-946-4459. 9-0

### OBELISK SPEAKERS IN PHOENIX AZ

Exclusively at THE LISTENING POST (602) 967-1250.

**One of the World's Most Musical Transducers, The SONY XL-55 MOVING COIL CARTRIDGE.** With integral headshell: XL-55PRO. Either: \$300. Alterman Audio 504-834-7772 New Orleans.

**PAIDE ELECTRONICS** features Fulton cables and speakers, Rega Planar turntables, Lustre GST-801, Supex, and Grace arms and cartridges. The highly reviewed Grace F9E cartridge now in stock. Write or call evenings or weekends: 2028 Sandstone Ct., Silver Spring, MD 20904 (301) 384-2969.

**Pair Kenwood L-07M's - \$600 or best offer (219) 362-2635.**

**POWER AMPS AT BARGAIN PRICES!** Audio Research; Dual 350B, \$1750 (half price.); Threshold 4000, latest model, \$1460. FOB L.A. (213) 473-9813 eves.

**PROBLEM: THE HIGH COST OF PREMIUM CASSETTES** "The Audiophile's Choice" has the solution with its guaranteed 20 to 20 cassette. Send \$2.00 for a C-60. Box 888, Kingsport, TN 37660.

**PROTECT YOUR LPs. POLY SLEEVES FOR JACKET 10", ROUND BOTTOM INNER SLEEVES 9", SQUARE BOTTOMS 6", POLY LINED PAPER SLEEVES 15", white jackets 35", POSTAGE \$1.50. HOUSE OF RECORDS, HILLBURN, NEW YORK, 10931.** TF

# POSITIVE FEEDBACK...

"...the superiority of the D3 over what I had regarded as my reference phono preamp in the lab was just as obvious with my own selected recordings..."

LEN FELDMAN-  
Audio Magazine May 1980



For information write: RG Dynamics  
4448 W. Howard St., Skokie, IL 60076



THE NEW RGD3-W PREAMPLIFIER

# Audio Excellence

A UNIQUE STEREO SHOWROOM DEDICATED TO THE PERFECTIONIST

Presenting Components from the Prestigious Companies of

THRESHOLD	ROGERS	MAGNEPAN	KOETSU
AUDIONICS	SNELL	PYRAMID	SIGNET
WIN LABS	DENON	OBELISK	HAFLER
BEVERIDGE	AXIOM	SYMDEX	BRYSTON
LINN SONDEK	DCM	MARCOF	SPATIAL
M.A. COTTER	PSE	SUPEX	SYMMETRY
PLASMATRONICS	LUX	TVA	FID. RES.

584 Washington Street. San Francisco 94111 415-433-1335

## FOR SALE

**PROPER TONEARM GEOMETRY!!** Optimum offset angle, overhang, vertical pivot height and angle. Resonance damping construction. Jewelled pivots. Height adjustable while playing records. Effective mass 2.5 grams. Damped cueing. Anti-skate bias. TA-3A with silicone damping, \$249.00. "Universal" nylon hardware, \$1.00; alignment protractor, \$3.00. Prices include postage and money-back guarantee. JML Company, 39,000 Highway 128, Cloverdale, CA 95425 TF

## PS AUDIO

Don't opt for Hapi nor Apt for Hafler, get the best — PSII Pre-amp and Model One Amp. WAYNE BELL'S AUDIO SALES, 608 Pecan Ave., Charlotte, NC 28204 (704) 377-6590 Shipped Pre-paid.

**QUAD ELECTROSTATICS:** 1 pair demo, 2 pair new in box. Full warranty. Authorized dealer. THE SPEAKER COMPANY, 20 E. 13th Ave., Columbus, OH 43201 (614) 299-0565.

**QUICKEST AIRMAIL DIRECT FROM TOKYO:** All brands of Cartridges & Arms of Japan. Ask for latest Quotations with \$1 for postage. JAPAN AUDIO TRADING CO., LTD., Sakkaen Bldg., 4-33-21, Kamimeguro, Meguro-Ku, Tokyo 153 Japan.

**RAW FRAME SPEAKERS-ALL TYPES-ALL SIZES.** PHILIPS C.T.S. - PEERLESS - POLYDAX - DEALER PRICING. APOLLO ELECTRONICS, 1437 SANTA MONICA MALL, SANTA MONICA, CAL 90401 (213) 393-0794 MON.-SAT.-STUART.

**RAW SPEAKERS AND FINISHED SYSTEMS** for Hi-Fi and Sound Reinforcement. Also cabinet plans, hardware, grille cloth, crossovers, microphones, accessories, much more. Information packed catalog, \$1. Universal Discount Sound, Dept. AO, 2243 Ringling Blvd., Sarasota, FL 33577

**REGA PLANAR** turntables are now available from PAIDE ELECTRONICS, 2028 Sandstone Ct., Silver Spring, MD 20904. Hours by appointment call (301) 384-2969 eves or weekends.

**REINFORCEMENT, RECORDING DISCO** equipment featuring Electro-Voice, Tapco, Numark, Whirlwind, etc. Competitive prices with fast competent mail order service is our specialty. Write or call SONIX CO., Dept. A, Box 58, Indian Head, MD 20640, (301) 753-6432. 10-0

**RENOUNCE ROTTEN RECORDINGS!** Read selected British reviews in the bi-monthly EURO-DISC GAZETTE, then order these European discs judged the finest in technical and musical excellence. Selections mainly classical. Send for free sample issue. No obligation. EURO-DISC GAZETTE, PO Box 337-A, Peterborough, NH 03458. TF

**REVOX A77 w/Dolby Deluxe As New, Accessories, Svc. Man.** \$800 (213) 991-5227.

**ROGERS EXPORT MONITOR SPKRS.** \$425; (212) 724-9843 EVES.

### ROGERS REFERENCE MONITOR SYSTEM

is a bi-amplified system designed by Rogers using the incredible LS3/5A's. We offer this system as well as the complete line of Rogers speakers and electronics. Free shipping in U.S. Visa & M.C. OXFORD AUDIO CONSULTANTS, Box 145, Oxford, OH 45056. (513) 523-3333, 523-3895.

**SIEMENS, TELEFUNKEN, GENALEX AND AMPEREX** and other top quality audio tubes available at very competitive prices. Contact Jim Wallace at 1203 Success St., Pittsburg, PA 15212 or (412) 322-4706 TF

**SME 3009 ARM, \$75.** (518) 371-1371.

**SNELL "A" spkrs. Exc. Cond., great sound!** (612) 252-2985.

**SONY TAE-88B \$800; TAN-88B \$730; ST-J7 \$640; ST-J60 \$300; X-70 \$350; JBL L-300/4333A \$975; FRIED H/2 \$975; Q \$200; B/2 \$355; T \$750; DYNA ST-120 \$100; (203) 777-1476.**

## FOR SALE

### SOLID WOOD CABINETS FOR YOUR EQUIPMENT

We offer a selection of matched solid Walnut or solid Oak cabinets to house your SOA Stereo Equipment and Accessories. Adjustable shelves standard, EIA Rack mounting available. Write or phone for details. Maryland Sound Industries, Inc., 4900 Wetheredsville Rd., Baltimore, MD 21207 (800) 638-9078 (in Maryland: (301) 448-1400) Visa and Master Charge accepted.

Some insist that the most musical audio equipment is produced by relatively unknown companies. But it takes more than a dedication to music to produce musical audio equipment... it takes advanced technology in semiconductors, mechanical engineering, circuit design, transducers, and pure research. Sony has all this, and is why Sony can produce an amplifier like the TAN88B, Pulse Width Modulation, Class D, VFET, switching amp. sound it out at ALTERMAN AUDIO New Orleans.

**SOUND ADVICE AND POLK AUDIO LOUDSPEAKERS** We have the incredible Polk Audio Monitor Series loudspeakers in stock. The Polk's are definitely the best performance per dollar value ever offered in a truly accurated inexpensive loudspeaker. State of the art sound is now available from less than \$200 per pair. We ship freight prepaid anywhere in the U.S. within 24 hours upon receipt of order. Write or call for information on the Polk Audio Monitor Loudspeakers.

### SOUND ADVICE

Village Plaza Ruston, LA 71270  
(318) 255-8000 9-9

**SOUTH CAROLINA'S ONLY HIGH-END STORE** the finest audiophile equipment: British American Sound, P.O. Box 1247 186 King Street, Charleston, SC 29402 TF

### SOUTHERN CALIFORNIA — L.A.

GAS, Cizek, Chartwell LS3/5A, Spondor, Thiel, Connoisseur, Grace, Goldring and more. GENE RUBIN AUDIO (213) 571-1299.

## FOR SALE

**Speaker Builder** the new quarterly can save you one-third on your audio system: build ribbon tweeters, Thiele aligned reflexes, a wall of electrostatics, giant subwoofers, update cheap bookshelves. You'll find it all in Speaker Builder. \$10/ four issues, \$18 for eight. Box 494AU, Peterborough, NH 03458. MC/Visa orders: (603) 924-6526.

**STAX DA300 CLASS A** power amp \$1450; McIntosh MC2125 power amp \$800; Burwen DNF 1201A NRS \$180; GAS Son of Ampzilla power amp \$300; Bang & Olufsen 2400 turntable w/4000MMC cartridge \$230. All units in excellent shape. Money order, M.C., or Visa, we pay shipping. Audio Replay, 252 Park St., New Haven, CT 06511; (203) 787-1558.

## New Ears in Old York

Adcom • Allison • Audio Pro  
Berning • Bryston • Connoisseur  
Conrad-Johnson • Denresen • Grace  
Keith Monks • Kenwood Purist  
Linn-Asak • Linn-Isobarik  
Linn-Sondek • Mitchell A. Cotter  
NAD • Naim • Precedent  
Professional Systems Engineering  
Pyramid • Shahinian Obelisk • Signet  
Snell • Symdex • Thiel • V.P.I.

**A new approach to presenting  
fine high fidelity components  
and recordings.**

## ears nova

749 middle neck road/great neck, ny 11024  
(516) 466-5674

# POSITIVE FEEDBACK...

"In sum then, we find this possibly the best expander on the market...one to which listeners will relate in very individual ways..."

High Fidelity Magazine  
December, 1979



RG DYNAMICS INC.  
4448 West Howard Street  
Skokie, IL 60076



THE RG PRO-20W

In today's ever changing field of audio there exists a storm of hype and confusion. By adhering to certain guidelines we have clearly found our calm in the eye of the storm.

Honesty, integrity, and expertise have helped us to create a unique audio environment that is indeed professional in the true sense of the word.

The lines we represent speak for themselves.

Audio Research B & W  
Vandersteen KEF  
Linn Sondek Dayton Wright  
Theta Denon  
Dahquist Grace  
Audire Grado Signature



Pyramid Nakamichi  
Promethean Luxman  
GAS Bang & Olufsen  
Dynavector RH Labs  
EMT Yamaha  
Marco Advent

We ship prepaid throughout the U.S. (714) 897-0166  
15102 Bolsa Chica Suite A Huntington Beach, CA 92649  
Store Hours - Mon. thru Fri. 1:00-9:00 Sat. 10:30-5:00 Sun. 12:30-5:00

# PRESS COMMENT ON VMPS

## 1980 CES Show, Las Vegas

"Itone Audio was gleefully demonstrating the capabilities of the VMPS Super Tower II. This 6½ft tall speaker, employing a total of 16 drivers, looks at first glance like one of the monster disco systems a la Cerwin-Vega. But extended listening proved otherwise. In addition to practically knocking down the walls with Telarc's *1812 Overture* (and this using only a total of 125 watts per bi-amped side), it is also a good performer at low levels with Mozart as program material."

Fanfare Magazine, 3/4 1980

## Bert Whyte, dean of American audio critics, in his column "Behind the Scenes":

"TOWERS OF POWER: For some time now, a company named VMPS Audio Products has been advertising columnar type loudspeakers, utilizing multiple driver units and making some fairly outrageous claims for performance, and all at quite modest prices. Lo and behold I found a demonstration room for this company (at WCES), and asked for a demonstration. Well!!! It is rare that anything in audio surprises me after all these years, but I was literally flabbergasted by hearing some of the best sound at the Show!... The top-of-the-line VMPS Super Tower II was demonstrated in the bi-amp mode using Bedini Class A, 100W/ch and 25W/ch amplifiers. Doesn't sound like much power? Well, the efficiency is 103dB at 1W/1m. If you would like to feed in the maximum 500W, you will get a chest-squeezing 132dB output! (We) played a variety of music, all of which was very smooth and clean, highly detailed with tight, rock-solid bass fundamentals, minimal coloration, and in spite of the multiple drivers, no sense of disparate sound sources. Imaging, in fact, was quite good. Then we played the Telarc *1812 Overture*, and not only were the cannon reproduced with gut-thumping power, but you heard the real low-frequency fundamental with no doubling. I am certain that this speaker is one of the few that will have no difficulties handling the dynamic range of true digital recordings when they finally arrive on the scene."

Audio Magazine, May 1980

VMPS manufactures the lowest distortion, most powerful, and widest bandwidth speaker systems available. There are nine models priced from \$76 to \$1649ea assembled, and kits are available for the Mini-Tower II (\$259ea), Tower II (\$369ea), Super Tower (\$499ea) and the Super Tower IIa (\$849ea in theater black, \$999ea in rosewood). Kit prices include fully assembled cabinets, plus shipping. Write for full reviews and brochures.

**VMPS AUDIO PRODUCTS**  
A division of Itone Audio  
7301 Rockway El Cerrito, CA 94530  
(415) 526-7084

## FOR SALE

### STEREO STUFF—ANNUAL AUDIOPHILE SALE:

Audio Research SP-5 (495); McIntosh C-28 (295); Phase Linear 700B (575); Marantz 2500 Receiver (895); M&K Rabco Arm (395); Magneplanar 1-D, in white (895); Ortofon MC-20 (new, 145); ARC 100 hz crossover (45); SAE 31, 30 (195 pair); M&K Subwoofer (125); JBL 212 (895); JBL 4350 (3950); Levinson ML-1 (995) & more. Demo price on Plasmatronics Speaker; Mitch Cotter units in stock. Trades and offers accepted. After 4 & wknd. (614) 486-1267.

**SUBSONIC FILTER ACE-INNOTECH FILTERS BELOW ORIGINAL DEALER COST - only \$45.00 including shipping costs in continental U.S. New York residents add 8% tax. Supply limited Innovative Audio 182 Henry Street Brooklyn, New York 11201**

**SUPEX SDX 1000 UNUSED, FULL WARRANTY \$260. STEPHEN SUN (212) 446-3760.**

**TANDBERG 9200 XD 7" r. to r. stereo tape deck, barely used, pristine cond. Perf. copy at 3¼ IPS. Crossfield and Dolby for computer-logic operation, \$695. (313) 822-8546 after 8 pm EST.**

## FOR SALE

**TAPCO and ELECTRO-VOICE**, mixers, equalizers, amps, mics, and raw loudspeakers. Write for low mail order prices, Sonix Co., P.O. Box 58, Indian Head, MD 20640 8-9

**TAPE HEAD REFINISHING** - Precision method full frequency response. \$15.00 ea. One day service. E. Maher, 5 Evans Place, Orinda, CA 94563.

**THE AUDIOGRAM**, an independent newsletter with critical integrity and realistic sense of proportion for buyers of the newest and best components. Double issue No. 13 & No. 14 contains:

- Snell Type A Speakers
- Symdex Sigma Speakers
- INTTRA Sound Rack
- Fulton Cables
- TVA-1 Amp
- Theta preamp

A new article by Paul Messenger \$10/4 issues/1 year. AUDIOGRAM, Box 27406, St. Louis, MO 63141.

# Not Just Speaker Wire



Conventional speaker wire limits the performance of your sound system by decreasing power output, restricting dynamic range, and reducing clarity and definition.

You can significantly improve the performance of your audio system simply by switching from your present speaker wire to Monster Cable.

Constructed of over 500 strands of high purity copper in a unique configuration, Monster Cable is specifically engineered for low resistance, low capacitance, and low inductance. The Results?

- Deeper, tighter bass.
- Maximum power transfer.
- Increased clarity and definition.
- Wider dynamic range.

Even low-powered systems show a remarkable improvement. Recommended by leading audio manufacturers, Monster Cable is safe to use with all amplifiers and receivers, regardless of design.

Hear the difference Monster Cable can make in your system... you won't believe what you've been missing.

Available in pre-cut lengths or custom terminated by your dealer.

**MONSTER CABLE**

101 Townsend St., San Francisco, CA 94107

## FOR SALE

### THE THETA PREAMPLIFIER

is a six tube device having a passive RIAA network & using NO feedback! This remarkable component is the most musical preamp that we have ever heard. Hear it at OXFORD AUDIO CONSULTANTS, Box 145, Oxford, OH 45056. Free shipping in U.S. We ship worldwide. (513) 523-3333, 523-3895.

**THOUSANDS OF LIKE NEW LP's** and prerecorded tapes. Catalogue—\$2.00. House of Records, Hillburn, New York 10931. TF

**TO NEARMS-CARTRIDGES-TURNABLES** at lowest prices. Most brands available, including MC. Send #10 SASE for quotes. Audio Unlimited, 401 Reynolds Circle, San Jose, CA 95112.

### TOP QUALITY SPEAKERS AND KITS

Send \$1.00 for catalogue. Speaker Warehouse, 809 N. State Rd. 7, Hollywood, FL 33021.

### TOP-RATED CARTRIDGES UP TO 70% OFF!!

We feature just about all of the finest phono cartridges on the market at the lowest possible prices. Our selection includes cartridges that are normally sold for the full retail price! Our most popular lines include Acutex, ADC, Crado, Nagatron, Ortofon, Shure, Sonus, Stanton and many others that we can't even mention by name. Just call us at 212-254-3125 for more information or write to Direct Discounts Ltd., P.O. Box 841, Cooper Station, NY 10003. We accept phone orders with your M/C or VISA.

**Undergrounds/Audio's outdated (1941) Tonearm Geometry** gives MAXIMUM distortion from the Critical Listening area instead of required MINIMUM. The Alignment Protractor by Percy Wilson M.A. (MK II with Stevenson 1966 Zero error points) \$10 Bill. Mayware, P.O. Box 58, Edgware Middx. England.

## FOR SALE

### TRADE UP to the MICRO CPU 100 fm tuner

It may have been out of the question at \$2000. but the new retail is \$995. Subtract even more for your trade-in and this magnificent tuner can be yours at a surprisingly low price. We offer very generous trade-in allowances on your old tuner or other audio equipment. A rare chance to own the best at a reasonable price (see Audio, Nov. '77). Write us for a quote, or better yet, phone after business hours and we can discuss your trade-in: (617) 874-0706, mon.-fri., 6-8 pm. (ask for Dick) **AUDIO CALIBRATION**, box 250, Westminster, MASS 01473. TF

### NEW DV/KARAT-RUBY and DV/KARAT DIAMOND

now available Dynavector moving coil cartridges: very stiff, very small (2.5mm), undamped cantilevers — flat response to 50kHz. Also available, the Mk II versions of the renowned 20A & 20B high-output moving coils with 3.6mw output, high compliance, and flat, peak-free, response. To order or for information call or write. (617) 874-0706, mon.-fri. 6-8 pm, (ask for Dick). **AUDIO CALIBRATION**, Box 250, Westminster, MASS 01473.

### TURN YOUR LIVING ROOM INTO YOUR LISTENING ROOM!

You can spend thousands on the finest audio components, but without the proper "set up" they can still sound merely average. Get the most listening pleasure for your hard earned money! Our plans will make any stereo system sound better no matter what your taste in music. Send \$3.00 plus SASE to: Ideas, Box 680-1, c/o Audio Magazine, 1515 Broadway, NYC 10036.

## FOR SALE

**VACUUM TUBES**, tube-peculiar parts. All kits/parts for circuits described in our 230+ page Modification Manual. Write for list to **AUDIO DIMENSIONS**, 8888 Clairemont Mesa Blvd., San Diego, CA 92123. (714) 278-3310. 9-0

**Van Alstine Double Dyna 400** (A Modified ST-416 with L.E.D. Display and Power Supply Box - 100,000MF) Very Latest Zero TIM Version. Better than MNT. (215) 623-0752 evenings or weekends.

### VANDERSTEEN IN THE SOUTH!

In stock, the celebrated Mod. 2A. Fast, free shipping. **READ BROS. STEREO**, 593 King St., Charleston, SC 29403 (803) 723-7276. (We accept VISA and M/C.)

### VANDERSTEEN 2A SPEAKER SYSTEM

Q/LC Audio, 1006 Berkshire Rd., Dayton, OH 45419 (513) 298-9330, (513) 293-7287 M-F 5-10 SAT 10-6.

### WALT JUNG & RICHARD MARSH (Feb. & Mar. Audio) ARE RIGHT

of course, so we now have POLYPROPYLENE & POLYSTYRENE PREMIUM Audio Grade capacitors for new construction, preamp mods & crossovers. Use for replacements or shunts. Values from .47 to 5uf 200VDC 10%. Also Mylars for economy from 1 to 30uf. Make up shunt composites, hear the difference immediately. Send \$1.00 for details which includes info on the Jordan 50mm Module, a miniature wide range dynamic speaker with 1.3 gms moving mass, 150 to 22,000Hz range, that requires only narrow band woofers for building phase coherent systems. Line source array designs for SOTA LP's wide dynamic range app. notes, x'overs, super air cores, parts, bextrenes, soft domes, assistance. **TRANSCENDENTAL AUDIO**, 6796 Arbutus St., Arvada, CO 80004. E.J. Jordan, Decca, Polydax (Audax), Unbox Enclosure Systems. (303) 420-7356.

# MC CARTRIDGES: MEET YOUR MATCH.

You name the cartridge, we've got the perfect match.

The FRT-3G toroidal core, step-up transformer for MC cartridges is switchable from 3 to 10 ohms and from 15 to 40 ohms. So, with the FRT-3G, you can match the impedance of any moving coil cartridge made, including Denon, Supex, Satin and others.

Expect ultra-low distortion with the FRT-3G, since it introduces no sound of its own into the system. Its toroidal core provides extremely fast transient response and helps prevent the kind of non-linear distortion that is characteristic of the hysteresis curve common to laminated core designs—even at low levels.

Though you may use any MC cartridge with your FRT-3G, you should consider our FR-lmk3F — one of the world's finest MC cartridges.

The FR-lmk3F uses pure silver wire in coreless coils for greater efficiency. The cartridge also employs a solid

diamond with a line contact tip for improved high range response.

The same high quality and attention to pure sound reproduction is also available in our more moderately priced FR-lmk2 MC cartridge. It has a coreless coil design and low mass for excellent transient response.

Now you have three more reasons why our product philosophy at Fidelity Research is "The Best There Is."

Write to us for additional information, specifications and complete catalog with dealer listings. Your music will live happily ever after.

**FIDELITY RESEARCH OF AMERICA**  
P.O. Box 5242,  
Ventura, CA 93003  
(805) 642-9277

**FR** fidelity-research  
of america

## FOR SALE

**Wisconsin Has;** Audionics, Denon, Luxman, Hafler, Polk, NAD, Aiwa, Connoisseur, Braun, STAX, Nagatronics, Grado, R.G., Grafy, Soundcable and more. Write or call for prices and literature: Sound Seller, Box 224, Marinette, WI 54143. (715) 735-9002.

**WISCONSIN'S ONLY SENSIBLE AUDIO DEALER.** PRODUCTS FROM: Audionics, AudioPro, Yamaha, Hafler, Connoisseur, Great White Whale, GAS, Ortofon, Technics, DBX, Stax, DCM, Dahlquist, SAE, Audio Pulse, Koss, Draco, MXR, Shure/SME, Soundcraftsman, Grace, Thorens, and much, much more. TAPE RECORDERS FROM: Akai, Sony, JVC, Tandberg, Technics Pro, Revox, Uher and many more. Send SASE for our "blow-out" list. RECORDS FROM: Telarc, Mobile Fidelity, Sheffield, Orion/Nautilus and more. Also, one of the largest dealers for used high-end electronics in the country. WACK ELECTRONICS, INC., 5722 W. NORTH AVE., MILWAUKEE, WI 53208. (414) 442-3441.

**WORLDS GREATEST SPEAKER KITS, KITS, P.O. Box 12242, Jacksonville, FL 32209.**

**Would you like data on a handcrafted, wideband mid-range/ tweeter from England that "signal traces" like fine electrostatics & ribbon tweeters w/useful range of 150 Hz to 22,000Hz, & has only 1.3 gms. moving mass? This driver eliminates mid & upper x' over points, which rids system of phase errors, providing seamless sonic purity. Data also available on our line of other exciting, advanced raw speakers, many used in systems by Snell, Symdex, Tangent, Thiel, M & K etc. Subwoofers, bextrenes, & S.D. Tweeters available along w/designs & application assistance to help you get the most from your "dream system". X' over parts incl. mylar caps to 10mf & low DCR "Super Air Core" inductors to 5 mh. Your inquiries & orders receive our prompt attention. Send \$1.00 for info to: Transcendental Audio, 6796 Arbutus St., Arvada, CO 80004 — 303-420-7356 innovative components & designs in high-end audio. Polydax (Audax), Decca, E.J. Jordan, Eminence. Soon available — Cylindrical, sandwich construction, "un-box" enclosures for bextrene drivers.**

**YAMAHA B2 POWER AMP 100 WATTS per channel, like new; \$690.00 or best offer. (614) 451-1890, (614) 261-2348.**

**YAMAHA CR2020 Receiver \$425, exc. cond. D. Altman, 770 Ocean Parkway, Brooklyn, NY (212) 853-1478.**

**YAMAHA CT-700B, C-1, B-1, UC-1, RG-1, YP-801BL-MINT \$2900; SANSUI BA-2000, CA-2000, TU-9900-MINT \$750; SAE MK VI DIGITAL/O'SCOPE TUNER (RARE BLACK RACK MOUNT)-MINT \$600; THORENS TD-126C MK II (BOXED \$450), USED-MINT \$375; TEAC AN-300 (BOXED \$275), USED-MINT \$225; SANSUI QSD-1 MINT \$175; TECHNICS RS-1506-MINT \$950; TECHNICS RS-9900US-MINT \$1000; TECHNICS RS-678US-MINT \$290; TECHNICS SH-9020-MINT \$190; TECHNICS SL-1000 MK II, (SP-10 MK II, EPA-100 ARM, SH-10B3 OBSIDIAN BASE), GRACE 714 (NEW), GRACE 707 MK II BLACK (NEW)-\$1100; CROWN CS-844 \$1900; CROWN CS-824 \$1300; CROWN PRO 800 SERIES (LATEST MODEL, FULL LOGIC) \$500; MAGNACORD 1048 TRANSPORT/HEADS \$350; AMPEX 350C TRANSPORT/HEADS \$600; AMPEX 351-2 (RARE 3 SPEED), INCLUDING MASTER AND SLAVE METER UNITS, EQ UNIT, PRE AMP UNIT-ALL AMPEX, IN AMPEX CONSOLE \$2100; UHER SG-510 \$175; HEWLETT-PACKARD 395B; 3-M (M-60); LING REAL TIME SPECTRUM ANALYZER; OPEN REEL DUPLICATING SYSTEM; MUCH MORE. COLUMBUS, OHIO (614) 864-9777 ANYTIME.**

**Yamaha C-2, Absolutely Mint Condition, \$650.00 list; selling for \$325.00 (215) 797-4076 Scott.**

**YAMAHA C-2 \$500, MODIFIED KD 500 \$300. GRACE 704 \$150. CANADA. (819) 827-1418.**

**Yamaha C-4 preamp \$450. SAE 2200 Amp \$300. Both barely used. Jeff (916) 345-1762 or (916) 891-5881.**

**2 IONOFANE TWEETERS, 1 AUDIO RESEARCH EC4A ELECTRONIC CROSSOVER, 1 CROWN SA30.30 POWER AMP. BEST OFFER (415) 526-3831 EVES, 727 CRESTON RD., BERKELEY, CA 94708.**

## FOR SALE

**8 Altec 515B Woofers \$125 ea, 6 Altec IN 800F crossovers \$25 ea, 4 Soundcraftsmen RP 2215-R EQL \$200 ea, 6 Marantz Model 1 Preamps \$500 lot, 1 Altec N500F crossover \$100, 9 Altec 15067 XFMR \$25 ea, Tektronix 561A scope with 3A72 vert and 2B67 horiz \$300. Reply Box 7801, c/o Audio Magazine.**

### ATTENTION AUDIOPHILES:

#### SPECIAL OFFERING OF VERION PRODUCTS

General Resistance, Inc., the ONLY manufacturer of Verion MK1 Stereo Pickup Transformers, Triaxial Audio Cables, and GS1 Ground Strips has been authorized by Stipulation to sell the remaining inventory of those products:

MK1 Stereo Pickup Transformers (specify pickup impedance): \$350 each.

Triaxial Audio Cable pairs: \$30 per one meter, plus \$5 for each ½ meter added to the pair. All Triaxial cables have RCA-type connectors, at one end, and either bare leads, RCA-type connectors, or male or female DIN connectors at the other. Be sure to specify length and choice of connector.

GS1 silver-plated 12" solid copper Ground Strips with hardware and grounding pig-tail: \$20 each.

All above carry 5-year manufacturer's warranty.

Quantities are limited since there will be no further production.

Send official bank check or postal money order immediately to avoid disappointment. Orders shipped prepaid UPS in the USA. Others add shipping. No telephone orders accepted.

#### GENERAL RESISTANCE, INC.

130 S. Columbus Ave.

Mt. Vernon, NY 10553

**WHOLESALE PRICES ON STEREO-ESOTERIC COMPONENTS & TAPES.** Over 150 brands. Send for price list or call 707-963-5335 or 963-5893, 9-9 Mon.-Thurs.

**WEST COAST AUDIO, INC., 1130 Main St., St. Helena, California 94574.**

**Transistors are critical for low-noise.** Sony makes their own. Sony HA-55 ultra low noise, ultra linear moving coil headamp. \$300. Alterman Audio 7323 Freret New Orleans 504-834-7772

## RECORDS

**AUDIOPHILE RECORDS: Save 20% to 40%.** Free catalog. Foreign customers also invited. Super Sound Record Service, P.O. Box 411237, Chicago, IL 60641.

**AUDIOPHILES!** Direct-Disc, Digital, Mobil Fidelity-All Labels-Low Prices Fast Service. Send 30¢ in stamps for catalog. Direct Disc Discounters, 2245 New Hope Church Rd., Raleigh, NC 27604. 9-9

**DIGITAL CLASSICAL RECORDS! ... ALL LABELS! ... REAL SAVINGS!**

Over 100 "demonstration quality" discs now available. Send 50¢ today for detailed illustrated catalog. Classics Only, Box 14196AM, Columbus, Ohio 43214.

**DIRECT TO DISC AND DIGITAL RECORDINGS:** All labels at low prices. Telearc, Discwasher, Audio-Technica, Sheffield, Denon PCM, Crystal Clear, Mobile Fidelity Labs... WE HAVE THEM ALL!! (and more!!) Send for FREE price list and Newsletter or \$2.00 for descriptive cataloge DISConnection, P.O. Box 10705 Tampa FL 33679.

**MERLIN RECORDS OF ENGLAND** are now available direct from the importer or from quality audio dealers. Our Bach is the first audiophile record to receive STEREO REVIEW's "Best of the Month" award. Send SASE for details: Merlin, Box 80559, Baton Rouge, LA 70898.

## RECORDS

**FREE SOUNDTRACKS & CASTS CATALOG!** Personalities! ST/OC Valuebook: \$4. RTSA 711 W. 17th G-1 Costa Mesa, CA 92627. TF

**Jazz and classical music recordings from Europe and Japan.** Labels include: Proprius, Lyricon and Opus 3, from Sweden, Mark Levinson, Astree, and Sarastro from France, Accent of Belgium, Merlin and Nimbus from England, Phillips RCA, East Wind Three Blind Mice, and Audio Lab from Japan. Analog and direct-to-disc. Pure virgin vinyl pressings, beautifully packaged. Send one dollar for catalog, and a one-dollar-off coupon to: AudioSource, 1185 Chess Dr., Foster City, CA 94404.

**OLDIES - Original reprints (45's):** over 4,000 to choose from, \$1.30 ea., send \$1 for catalog to order ALARM RECORDS, P.O. Box 323, Commack, NY 11725.

### Realistic Perspective . . . not a "Sonic Spectacular"

Sound Storage Research Ltd. exclusively uses the Blumlein two microphone system for recording which in theory is the most accurate method and subjectively is the most realistic sounding within the limitations of the stereo medium.

SSR2010 Brahms Piano Trio No. 2 in C Major, Op. 87

The San Francisco Trio

SSR2020 Bondon "Le Soliel Multicolore"

Debussy Sonata for Flute, Viola and Harp.

The Carter Chamber Ensemble

These 33 ½ TELDEC vinyl recordings are available at audio and record stores or can be ordered direct from SSR Ltd. for \$13. each (CA add tax). Overseas \$18. each (by air). Sound Storage Research Limited, 166 Homestead Boulevard, Mill Valley, CA 94941.

**RECORD HOUND, Box 88A, Eagleville, PA 19408.** Fills want list? Doggone right!!!! 33 ½ specialist. Fast, friendly service. 10-0

**"RECORD JACKETS.** Replace old, torn, LP jackets with clean, glossy, pure white or black jackets. Plastic lined inner sleeves, 78 sleeves, opera boxes. Free catalog. CABCO A6, Box 8212, Columbus, Ohio 43201." TF

**WANTED: FLAMENCO RECORDS, SABICAS JUAN SER-RANO, PACO DIE LUCIA, OTHER ARTISTS. RICH QUILL, 1006 BERKSHIRE RD., DAYTON, OH 45419 (513) 293-7287 after 5 pm.**

## WANTED TO BUY OR TRADE

**I want McIntosh C22, 240, 275, 3500, Marantz 7C, 8, 9 BEST PRICE 713-729-1658, Texas.**

**Manufacturer Seeking Inventions.** Advantek, 1100 17th NW, Washington, DC 20036. 10-0

**MARANTZ MODELS 2, 3, 6, 7, 8, 9 & 10B; MCINTOSH C-22, MC240, MC275 & MC3500.** Sam Aberst, P.O. Box 5455, Beverly Hills, CA 90210 (213) 858-8255.

**Mark Levinson ML-2 amplifiers.** Want pair with serial no.'s over 1900. Will partial-trade Win Labs trntbl. (315) 437-3357.

**Nakamichi 680, demo, used, etc. Kim (808) 732-5294.**

**WANTED — JBL HARTSFIELD, MINIGON RAW SPEAKERS + DRIVERS.** 1-313-229-7378.

**WANTED: Later editions BRAUN LV-1020 speakers.** Name your price. Must be flawless. John Lloyd, 231 Plainview, Manitou, CO 80829 (303) 633-9492.

**WANT: FM STEREO MPX TEST GENERATOR, OLDER MODEL. SEND SPECS & PRICE.** 1050 Foothill, Box # 245, S.L.O., CA 93401.

## PLANS & KITS

**TAPE-SLIDE SYNCHRONIZER,** multiprojector lap-dissolve plans, \$5.50. With mixer, compressor, preamp schematics, \$8.50. The Millers, 1896 Maywood, S. Euclid, OH 44121. TF

## PLANS & KITS

**SPEAKERPLANS** — Build ANY size speakers without special tools, experience, FOOLPROOF, illustrated instructions, parts sources. 80% SAVINGS! Rush \$4. **SPEAKERPLANS**, 334 Pur-sel, Dept. A80-1, Phillipsburg, NJ 08865.

## BUSINESS OPPORTUNITIES

**CABLE FM BROADCAST STATION.** Unique no investment/experience business makes money! Others work for you! Free Details "CAF.M," Box 130-N3, Paradise, CA 95969

**CAMPUS REPS TO SELL VIDEO EQUIPMENT** in your area. Serious inquiries only. Corbell Electronics, 113 S. Division, Carterville, IL 62918. (618) 985-6367.

**FIELD REP WANTED FOR SAVARD SPEAKER SYSTEMS.** Fast-growing company needs ambitious rep. Dealer inquiries welcome. (504) 383-0474.

**HOW TO PROFIT USING YOUR OWN HOME EQUIPMENT FOR PART TIME RECORDING BUSINESS.** FREE INFORMATION: HSC, Box 4870-A, Austin, TX 78765.

**REPS & COLLEGE DEALERS:** Sell exclusive lines of Hi-fi. Request application: A & B Distributors, P.O. Box 2232, Boulder, CO 80306. (303) 443-1386.

**Want money? Hate hard work? Lazy way to big money.** Cleaver plan \$2.00 (Refundable) Noble, Box 10033, Houston, TX. 77206.

**\$1400.00 MONTHLY Clipping Newspapers at home!!!** Start now. No experience required. Valuable free information. Send self-addressed stamped envelope: Horizon, P.O. Box 1685-WHDD, Las Vegas, NV 89101.

## HELP WANTED

**Electronics Design Engineer;** Career position designing SOTA Amplifiers and Preamplifiers at the rapidly growing David Haffler Co. Previous audio circuit design experience required. Contact: Ed Gately, 5910 Crescent Blvd., Pennsauken, NJ 08109 (609) 662-6355.

**Tuner Design Engineer;** Career position designing SOTA Tuners at the rapidly growing David Haffler Co. Previous tuner design experience required. Contact: Ed Gately, 5910 Crescent Blvd., Pennsauken, NJ 08109, (609) 662-6355.

## TAPE RECORDINGS

**CHRISTMAS CAROLS CASSETTE** . . . 60 minutes . . . \$2.95 plus 50c postage ... EKR Classics, GPO Box 1977A0, New York City, 10001. 10-0

**ON OPEN REEL from master tapes.** Argo, Telefunken, Vanguard, Unicorn, MHS. Catalogue \$1.00. Barclay-Crocker, Room 1470-A, 11 Broadway, NYC, 10004. TF

**OPEN REEL TAPES.** 7½ips, Dolbyized releases from RCA, London, DG, Warner and others. Airline tapes, quad. Catalog and updates, \$1. THE REEL SOCIETY, P.O. Box 55099-A, Valencia, CA 91355. 9-9

## MUSICAL INSTRUMENTS

**"FREE LIST! MUSICAL MERCHANDISE CLOSEOUTS!** NEW, USED, SURPLUS. GUITARS, AMPS, ACCESSORIES, ROMACO, P.O. Box 734, LAWRENCEVILLE, GA 30246."

## RADIO PROGRAMS

**CATALOGS.** Broadcasts, soundtracks. Personalities of Thirties, Forties. Box 225, New York, N.Y. 10028. TP

**GOLDEN AGE RADIO.** Your best source for radio tapes, reels or cassettes. Box 25215-D, Portland, Oregon 97225. 9-0

**RENT RADIO SHOWS:** Make your own copies or just listen. Great way to build your collection reasonably. Catalog \$1 refundable. OTR Rental, Box 1146, Livermore, Ca. 94550 TF

**VINTAGE RADIO and T.V.** -Lowest rates. Post Free, Trading, Video too; Signals, Box 5063 Station E., Edmonton, Alta. Canada T5P 4C1. U.S. Inquiries.

## RADIO PROGRAMS

**YESTERDAYS RADIO ON TAPE.** Reels-Cassettes. Quality Sound. Reliable Service. Giant catalog \$1.00 refundable with first order. ADVENTURES, Box 4822-A, Inglewood, California 90302. TF

## TAPE AND TAPE RECORDERS

**NAME-BRAND RECORDING TAPE,** custom loaded. Available in cassettes, reels, cartridges. Huge savings from manufacturer. Also low everyday prices on Maxell, TDK, Ampex, Scotch, BASF, etc. New catalogue now available. MJS, 2514 Seaboard Ave., San Jose, CA 95131. (408) 262-8793.

**PROBLEM: THE HIGH COST OF PREMIUM CASSETTES** "The Audiophile's Choice" has the solution with it's guaranteed 20 to 20 cassette. Send \$2.00 for a C-60. Box 888, Kingsport, TN 73660.

**SCOTCH RECORDING TAPE,** lowest prices TAPE CENTER Box 4305B Washington, D.C. 20012. USA, APO, FPO 5-9

Free 5.00 T-Shirt	
TDK: SA-C90 (SALE) . . . . . 2.80	AMPEX: GRANDMASTER I-90 . . . . . 2.59
TDK: AD-C90 (SALE) . . . . . 1.99	AMPEX: GRANDMASTER II-90 . . . . . 2.99
TDK: D-C90 . . . . . 1.69	Scotch: 212-7R-1800 . . . . . 4.29
TDK: SA-C60 . . . . . 2.25	Soundguard: Record Pres. Kit . . . . . 4.59
BASF: PRO I C-90 . . . . . 2.79	TDK: LB-1800 . . . . . 5.39
BASF: PRO II or IIC-90 . . . . . 2.89	TDK: LB-1800 . . . . . 6.69
BASF: Studio I or IIC-90 . . . . . 2.65	AMPEX: Grandmaster 1800 Hi Reel . . . . . 5.95
SCOTCH: Master II or IIC-90 . . . . . 3.15	SCOTCH: 207-7R-1800 . . . . . 5.09
SCOTCH: Master IC-90 . . . . . 2.69	BASF: Ferro 7' 1800 (New) . . . . . 7.49

Free T-Shirt with every order over 40.00. All tapes can be assorted. No min. Add 3.00 shipping; or write for free catalog of 250 items plus lowest prices on all Maxell products. 100% guaranteed. 411-283-8621. M-Th 9-3:30  
Tape World 220 Spring St. Butler, PA 16001

# innovative audio

DEDICATED TO MUSICAL EXCELLENCE

OUR DEMONSTRATIONS OF AUDIO EQUIPMENT ARE UNIQUE. WE OFFER UNLIMITED TIME TO EVALUATE THE VERY FINE COMPONENTS WE FEATURE. OUR EXTENSIVE LIBRARY OF QUALITY RECORDINGS ENABLES YOU TO DETERMINE WHICH COMPONENTS ARE OPTIMUM. OUR EXPERTISE WILL HELP YOU TO DECIDE WHAT IS BEST AS WELL AS TO ENSURE A PERFECT MATCH TO YOUR LISTENING ENVIRONMENT.

YAMAHA, NAKAMICHI, BRYSTON, APT-HOLMAN, COTTER, BANG & OLUFSEN, DAHLQUIST, NAD, BOWERS & WILKINS, SHAHINIAN-OBELISK, BOSTON ACOUSTICS, PYRAMID-METRONOME, OHM, KLIPSCH, LUX, INNOTECH, DENON, MARCOF, ADS, LS3/5A, REVOX, DECCA, AKG, FIDELITY RESEARCH, SIGNET AND MANY OTHER FINE COMPONENTS. DIGITAL AND DIRECT DISC RECORDINGS.

TRADE INS . . . BUY-SELL USED EQUIPMENT . . . PROFESSIONAL REPAIR SERVICE & HOME INSTALLATION . . . CREDIT CARDS ACCEPTED. FINANCING AVAILABLE.

182 HENRY STREET • BROOKLYN HEIGHTS, NY 11201 • (212)596-0888

**Audio**, the original magazine about high-fidelity, is edited for involved, knowledgeable hi-fi enthusiasts, professional recordists, and commercial sound users—people who appreciate the finer points of audio equipment performance.

We speak their language

... and for this reason your ad in Audio's Classified section will draw serious inquiries and rapid response.

Fill in coupon, with check or money order attached, and send to:

Audio  
Classified Advertising Department  
1515 Broadway  
New York, N.Y. 10036

For additional information call Carolynn at (212) 975-7530

COPY: \_\_\_\_\_

\_\_\_\_\_

\_\_\_\_\_

\_\_\_\_\_

Name \_\_\_\_\_

Company \_\_\_\_\_

Address \_\_\_\_\_

City/State/Zip \_\_\_\_\_

Phone \_\_\_\_\_

Signature \_\_\_\_\_

(Order must be signed)

Payment must accompany order

## TAPE AND TAPE RECORDERS

### The Saxitone Hotline 800-424-2490



IT'S HERE! Saxitone, America's #1 merchandiser of recording tape, has just put in new TOLL FREE Phone Order Lines to serve you better. Call now for America's lowest prices on top name recording tape, video tape, recorders, tape decks and recording accessories. Order from a full inventory of TDK, Maxell, BASF, Scotch, Sony, Superscope, B-I-C, Sanyo, EV, Telex & others. Most orders shipped same day! FREE 32-page catalog. Master Charge & Visa honored. Call now and find out why Saxitone is #1.

## SAXITONE TAPE SALES

1776 Columbia Road NW, Washington, DC 20009  
In Washington metropolitan area call 462-0800

## SERVICES

**CUSTOM RECORDING SERVICE**, Tapes, discs, and cassettes. Stereo and mono. Live and copies. Editing, Masters and pressings. High quality at reasonable rates. Joseph Giovanelli, Audio-Tech Laboratories, 2819 Newkirk Ave., Brooklyn, N.Y. IN9-7134 TF

Mount your Audio System professionally  
Send Name/Type of equipment, plus \$3.50 to: J. Miller, 4336 Vanderbilt Pl., Bham, Ala. 35217.

NASHVILLE RECORD PRODUCTIONS WILL PRESS HIGH QUALITY PURE VINYL RECORDS FROM YOUR TAPES. SEND FOR SAMPLE RECORD AND PRICE LIST. ALSO FINEST DISC MASTERING. 469 CHESTNUT ST., NASHVILLE TENNESSEE 37203 TF

## MISCELLANEOUS

**COLLEGE STUDENTS!** Improve your grades. Send \$1.00 for 356-page, collegiate research papers catalog, 10,250 available. RESEARCH ASSISTANCE, Box 25918AD, Los Angeles, California, 90025. (213) 477-8226. 9-0

## PUBLICATIONS

**HOW TO ENHANCE/** Cassette Recordings, Get Cleaner Sound And Less Noise; Judge, Select, And Save Money On Equipment; Understand Technical Information! 30 Day Guarantee! Send \$2.98 To: CRG Publishers, P.O. Box 115-D, Redondo Beach, CA 90277.

**TERRIFIC SWAP OFFERS NATIONWIDE**  
Rcvrs., amps, TTs, Audio, Ham Gear, Etc. 5 issues \$2! "Electronic Trader," Box 73-A, Folly Beach, SC 29439. T.F.

## ANNOUNCEMENTS

**Free Promotional Albums, Concert Tickets, Stereos, Etc.**  
Information: Barry Publications, 477 82nd Street, Brooklyn, NY 11209.

## EMPLOYMENT INFORMATION

**JOURNEYMAN CREDENTIALS GRANTED LEGITIMATE!**  
Write: National Craftsman Union, 210 Fifth Avenue, Suite 1102, New York, NY 10010. 10-0

**Speaker Driver Engineer;** Well known Hi Fi Electronics manufacturer desires to expand into speaker business. Previous driver design experience a must. Reply Box 780-2, c/o Audio Magazine.

## SPEAKERS

**ELECTRO-VOICE INTERFACE** and **SENTRY SPEAKER SYSTEMS, RAW SPEAKERS, AND PRO-MUSIC PRODUCTS.** IMPRESSIVE DISCOUNTS. PROMPT DELIVERY TO ALL U S A AND FOREIGN DESTINATIONS. (305) 462-1976.

**VENEER SPEAKER CABINETS** Hardwood Walnut Speaker Cabinets with grill. Routed or unrouted, front baffles, or complete **SPEAKER KITS.** Send \$1.00 for complete brochure. **KUSTOMIZED SPEAKER SYSTEMS, 260-A, GLENN CIRCLE, POWELL, TN 37849.** (615) 945-3138 after 6:PM.

## Buy with confidence

**fact: the IV does more!** Send for Quotes & Price List on Shure & Over 100 Other Famous Brands

**SHURE**  
V15 Type IV  
**SUPER TRACK IV**  
Stereo Dynetic Phono Cartridge

Consistent record tracking has always been challenged by such ever-present factors as warp, static, lint and dust—especially when these factors combine with today's "hot" recordings.

**CARSTON DISCOUNT CENTER** 146 OLD BROOKFIELD RD Danbury, Conn. 06810 (203) 744-8421 (212) 369-6212

MON., TUE, WED., FRI. 9:00-5:30  
THUR. 9:00-8:00 P.M. SAT. 9:00-4:30

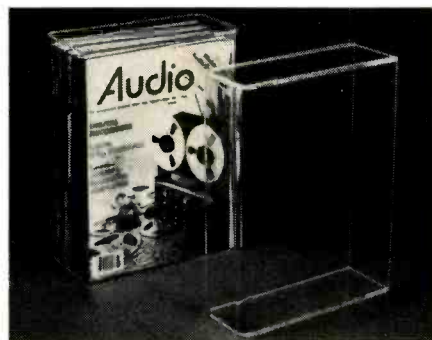

## Collector's Magazine Case

These "Modern See-Through" cases measure 11 1/2" high x 8 1/4" deep x 4" wide and hold a complete year's supply. Constructed of clear, sturdy 1/2" acrylic, they are a great way to keep your back issues intact for easy reference. Order more than one—and save money.

1 case	60292	\$ 8.95
2 cases	60291	\$16.95
3 cases	60290	\$24.95

**TO ORDER:** Print the words **COLLECTOR'S MAGAZINE CASE**, the quantity, number and price on a piece of paper along with your name and address. Enclose check or money order for the cost, plus S/H: \$1.50 for orders to \$10; \$2 for orders \$10.01-20; \$2.50 for orders \$20.01-\$50. Add local sales tax.\* Mail to:

**HAMILTON HOUSE, (a CBS Company)**  
32275 Mally Rd., P.O. Box SG, Dept. 9000  
Madison Heights, MI 48071

U.S. and Canadian residents only; offer expires Sept. 30, 1981

\*The government requires us to collect sales tax in all states except AK, DE, MT, NH, and OR.

# Audio

## Subscriber Service

**MOVING?** Please give us 8 weeks advance notice. Attach label with your old address, and write in new address below.

**RENEWING?** Check box below and attach label with corrections marked, if any.

**SUBSCRIBING?** Check box and fill in coupon. For gift subscriptions attach a separate sheet.

Send Audio for 1 year at \$11.94

Outside the U.S.: add \$6.00 per year.

New subscription  Renewal  Payment enclosed  Bill me

Name \_\_\_\_\_

Address \_\_\_\_\_

City \_\_\_\_\_ State \_\_\_\_\_ Zip \_\_\_\_\_

AOCOAO

For faster service call toll-free any business day, 9 A.M.-5 P.M. Eastern time.

**800-243-8002**

(In Connecticut 800-852-8593)

AUDIO, 1 Fawcett Place, P.O. Box 8167, Greenwich, CT 06836

Place label here



# The continuing story of TDK sound achievement.

## Part One.



Music has gone through many transitions. Its rhythms, tones and forms have changed dramatically. As have the means of reproducing it. From the first wax cylinder to today's music machine: the TDK cassette.

TDK pioneering in ferrite technology began over forty years ago. This led TDK engineers to develop microscopic particles which, through their long shape and uniform size,

could translate magnetic energy into flawless sound. By 1968 TDK had created TDK SD. The world's first high fidelity cassette. In 1975, TDK created a

revolution. Super Avilyn. Ultra-refined gamma-ferric oxide particles were bombarded with cobalt in a proprietary ion-adsorption process. The resulting TDK SA cassette had higher signal to noise. Higher coercivity. Low noise. A maximum output level superior to anything heard before. Overnight, TDK SA became the high bias reference.

TDK has a philosophy of sound. A belief that total performance is the outcome of a perfect interplay between the parts. It all begins with *Part One*, the TDK tape. Magnetic powder is first converted into TDK magnetic material in the form of a coating paint or binder. On a giant rotary press and in a dust-free atmosphere, jumbo rolls of tensilized polyester are coated evenly with TDK binder. The tape rolls are edited and leader is inserted at precise intervals. Surgically sharp knives then cut the tape into predetermined widths. The edges perfectly straight. All along the way, TDK tape undergoes thousands of checks. It's polished to micron smoothness to give better head contact, increase sensitivity and maintain stable output. TDK binder, recently improved, packs more particles on the tape surface. And the whole process is done automatically. Controlled by a central computer brain. From

the very first, TDK tape runs true. And so does the sound.

The TDK story will unfold in future chapters. You'll learn about other key parts and their sound synergy in a TDK cassette. And you'll draw only one conclusion. Music is the sum of its parts.



 **TDK**  
The machine for your machine

# DISCWASHER D4 SYSTEM



# A NEW STANDARD OF RECORD CARE

## **NEW D4 FLUID**

Inherently more active against record contamination. Inherently safe for record vinyl. Preferentially absorptive formula carries all contamination off the record.

## **NEW D4 FABRIC**

Unique directional fibers preferentially remove fluid and contamination. D4 fabric results in clearly better cleaning, better drying and ultimately residue-free surfaces.

## **UNMATCHED VALUE**

The Discwasher D4 System is enhanced by the durability and aesthetics of the hand-finished walnut handle. Included in the D4 System are the DC-1 Pad Cleaner and new instructions.

**discwasher<sup>®</sup>**  
PRODUCTS TO CARE FOR YOUR MUSIC

Discwasher, Inc., 1407 N. Providence Rd., Columbia, MO 65201