

WITH ONLY ONE EXCEPTION, THIS IS THE MOST REMARKABLE TAPE DECK IN THE WORLD.



But without exception it's the most remarkable cassette deck.

Today, a thousand dollars or more is standard fare for a professional quality cassette deck. But when Pioneer designed the new CT-F1250, they not only raised the performance standards of high quality decks, they also lowered the standard price.

Metal tape capability is something most new high quality cassette decks have in common. But while many of them have just been modified for this advancement, the Pioneer CT-F1250 has been specially designed for it.

Instead of the two heads found in most metal capable tape decks, the CT-F1250 has three. And it's these three heads that keep us way ahead of the competition.

Our new "small window" erase head makes a big difference in making sure all metal tapes are wiped completely clean. And our Uni-Crystal Ferrite recording and playback heads give you greater frequency response and better wear-resistance than the ordinary ferrite and Sendust alloy heads you'll find on most other tape decks.

But you don't get distortion-free recordings just by using your heads.

Instead of the single capstan tape transport system you'll find on some tape decks that are nearly twice the price, the CT-F1250 has a closed-loop dual capstan system, similar to that found in our remarkable RT-909 open-reel deck. This system

keeps the tape in perfect contact with the heads at all times. So you are assured of getting everything that's on

the tape. Nothing more; nothing less. What's more, the CT-F1250 has a Quartz-Locked Direct Drive capstan motor that senses the slightest deviation in speed and automatically corrects it to keep wow and flutter down to an unbelievable 0.03%.

It's engineering innovations like these that make the CT-F1250 so remarkable. But equally remarkable are the features that make the CT-F1250 so easy to operate.

Like our specially engineered Tape Calibration System that lets you quickly set bias level, Dolby adjustment, and record equalization for the best possible signal-to-noise ratio, the lowest distortion, and the best high frequency response.

And our 24 segment Fluroscan meter that works on Pioneer's own microprocessor to give you a more accurate reading of what you're listening to. It even has

Peak, Peak Hold, and Average Buttons that let you record without fear of overload.

In addition Pioneer's CT-F1250 has a digital brain with a memory that controls four different memory functions. Plus pitch control. Mic/line mixing. Independent left/right input/output controls. And more.

By now, it must be obvious that the CT-F1250 was designed to push up the limits of cassette deck performance. But only Pioneer would do it, without pushing up cassette deck prices.



Metal tape capability for far greater dynamic range and far less distortion.

Pioneer's 24-Segment Fluroscan Meter gives you an instantaneous picture of what you're listening to.

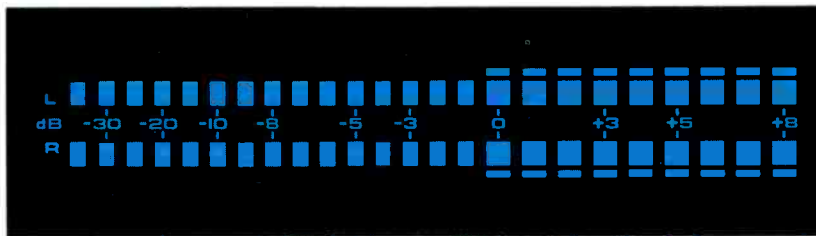

the tape. Nothing more; nothing less. What's more, the CT-F1250 has a Quartz-Locked Direct Drive capstan motor that senses the slightest deviation in speed and automatically corrects it to keep wow and flutter down to an unbelievable 0.03%.

It's engineering innovations like these that make the CT-F1250 so remarkable. But equally remarkable are the features that make the CT-F1250 so easy to operate.

Like our specially engineered Tape Calibration System that lets you quickly set bias level, Dolby adjustment, and record equalization for the best possible signal-to-noise ratio, the lowest distortion, and the best high frequency response.

And our 24 segment Fluroscan meter that works on Pioneer's own microprocessor to give you a more accurate reading of what you're listening to. It even has

Peak, Peak Hold, and Average Buttons that let you record without fear of overload.

In addition Pioneer's CT-F1250 has a digital brain with a memory that controls four different memory functions. Plus pitch control. Mic/line mixing. Independent left/right input/output controls. And more.

By now, it must be obvious that the CT-F1250 was designed to push up the limits of cassette deck performance. But only Pioneer would do it, without pushing up cassette deck prices.

PIONEER®
We bring it back alive.

©1980 U.S. Pioneer Electronics Corp., 85 Oxford Drive, Moonachie, N.J. 07074



Pioneer's easy-to-use Tape Calibration System guarantees optimum performance from every tape.

**WITH ONLY ONE EXCEPTION,
THIS IS THE MOST REMARKABLE
TAPE DECK IN THE WORLD.**



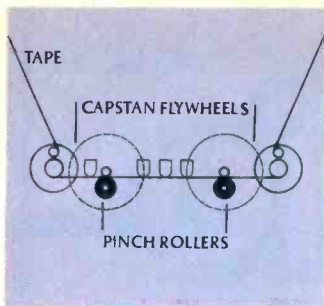

Pioneer's Closed-Loop Dual Capstan Tape Transport System ensures constant tape to head contact.

But without exception it's the most remarkable reel-to-reel.

Today, many audio manufacturers are putting a lot less into their tape decks and charging a lot more for them. But when Pioneer designed their new RT-909 open-reel tape deck they made certain it had every conceivable feature an audiophile could expect.

And one feature that was totally unexpected. A reasonable price.

Even if you pay \$1500 or more for a so called "professional" quality tape deck, you'll probably still be getting a conventional single capstan tape transport system that is prone to wow and flutter.

Pioneer's RT-909 has a specially designed closed-loop dual capstan system that isolates the tape at the heads from any external interference. So you get constant tape-to-head contact. And constant, clear, accurate sound.

And while many of the expensive new tape decks have old fashioned drive systems that drive up heat and distortion, the RT-909 doesn't. Instead, it has a far more accurate DC motor that generates its own frequency to correct any variations in tape speed. And keeps wow and flutter down to an unheard of 0.04% at 7½ ips.

What's more, the drive system of the RT-909 is unaffected by fluctuations in voltage. So a drop in voltage doesn't mean a drop in performance. The RT-909 also has a logic system that ensures smooth, accurate speed change.

Most professional quality tape decks are designed for use outside the home. So the convenience features

most audiophiles enjoy are nowhere to be found. The RT-909, on the other hand, offers automatic reverse, automatic repeat, and a timer controllable mechanism that lets you record a midnight concert even if you can't stay awake for it.

Examine our heads and you'll see Pioneer engineers at their very best. Our playback heads, for example, have a new "contourless" design that makes them more sensitive. They increase frequency response upwards to 28,000 hertz, and extend it all the way down to 20 hertz. So you not only get greater range than any other tape deck, but also any other musical instrument.

Of course, these features alone would make Pioneer's RT-909 quite a remarkable tape deck.

But the RT-909 also has a Fluroscan metering system that gives you an instantaneous picture of what you're listening to. A pitch control that lets you listen to music in perfect pitch even if it was far from perfectly recorded. Four different bias/equalization selections so you can use many tapes and get maximum performance from them all.

Obviously these advancements are very impressive. But there's still one thing even more remarkable than the technology we feature. It's the price we feature.

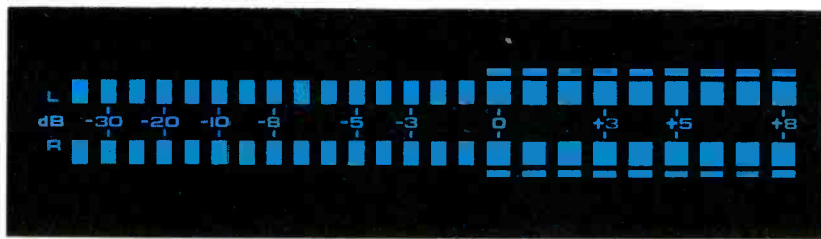

Pioneer's 24-Segment Fluroscan Meter gives you an instantaneous picture of what you're listening to.

PIONEER®

We bring it back alive.

©1980 U.S. Pioneer Electronics Corp., 85 Oxford Drive, Moonachie, N.J. 07074

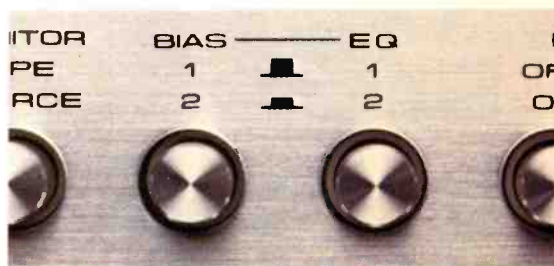

Independent bias and equalization for maximum performance from any tape.

Enter No. 29 on Reader Service Card

DISCWASHER

presents

**The Clean Truth
About Your
Naked Stylus**

When your stylus plays over one light fingerprint or one tiny "bead" of vinyl stabilizer, the clean naked diamond becomes a glazed, dust-holding abrasive weapon wearing away at your records and masking their true sound. This unseen build-up may actually hold the tracking tip of the diamond out of the record groove.



Accumulated grit on stylus that looks "clean" to the naked eye.

The SC-1 Stylus Cleaner from Discwasher is designed with a brush that is stiff enough to remove harmful accumulation, but gentle enough to avoid damaging delicate cartridge assemblies. Two drops of Discwasher's D3 Fluid add extra cleaning action to the SC-1 without the side-effects of alcohol, which can harden rubber cantilever mountings.

After cleaning with SC-1 and D3 Fluid by Discwasher.



The retractable, walnut-handled SC-1 includes a magnifying mirror for convenient inspection of stylus/cartridge alignment and wiring.

Get the clean truth from your records; get the SC-1.

**SC-1 STYLUS
CLEANER**

discwasher® inc.
1407 N. Providence Rd.
Columbia, MO 65201

Audio

"Successor to **RADIO**, Est. 1917"**Feature Articles**

Another View of TIM—Part I	38	Robert R. Cordell
Picking Capacitors—Part I	52	Walter G. Jung and Richard Marsh

Equipment Profiles

Audio-Technica Lifesaver Record Care System	64	Leonard Feldman
B•I•C T-4M Cassette Deck	68	George W. Tillett
ADC Sound Shaper Two Mark II Equalizer	73	Howard A. Roberson
Apt/Holman Control Preamplifier	76	Edward M. Long

Workbench Profile

BASF DIN Calibration Cassettes	82	Howard A. Roberson
-----------------------------------	----	--------------------

Record Reviews

The Column	84	Michael Tearson & Jon Tiven
Jazz & Blues	90	John Diliberto & John Lissner
Classical Reviews	93	Edward Tatnall Canby

Audio in General

Tape Guide	6	Herman Burstein
The Audio Interview/ Dr. Thomas Stockham	8	Gary Stock
Audio ETC	18	Edward Tatnall Canby
Behind The Scenes	26	Bert Whyte
Audioclinic	32	Joseph Giovanelli
The Forum	34	Tomlinson Holman
Classified Advertising	96	
Free Information Service	106	

About the Cover: Although nobody's going to hand you the facts about capacitor selection on a silver platter, Walter G. Jung and Richard Marsh come close in the first part of their article on this subject on page 52. Model: Ben Fine. Photo: Photographic Illustrations, Philadelphia.



Audio Publishing, Editorial, Subscription and Advertising Production Offices,
1515 Broadway, New York, N.Y. 10036.
Postmaster: Send Form 3579 to above address.

The Evolution of Excellence

In 1947, Pickering built the first magnetic cartridge and holds 13 U.S. and numerous foreign patents on cartridge design. In 1976, Pickering launched a new modern high fidelity era by introducing the first of a new generation of phono cartridges, the Pickering XSV/3000, acclaimed a top performer by critics and reviewers worldwide.

Now Pickering takes the Stereohedron® Series one step beyond excellence with the new XSV/4000. Technical advances in both design and construction have made this degree of perfection possible.

A lightweight, high energy, samarium cobalt magnet and shaped-for-sound Stereohedron Stylus tip are major innovations that eclipse previous performance standards in four crucial areas. Improved tracking ability. Expanded frequency response range. Wider channel separation. And featherlight treatment of the record groove.

XSV/4000... the next generation of sound.

For further information write to: Pickering & Co. Inc., Sunnyside Blvd., Plainview, N.Y. 11803

 **PICKERING**

"for those who can hear the difference"



A Letter To Our Readers

In this our 33rd year, *Audio* is pleased to announce the name of our new parent company, CBS Publications, Inc. Since their first publishing venture in 1971, the acquisition of *Field & Stream*, CBS Publications has experienced continual growth. By the end of 1973, they had acquired five magazines including *Road & Track*, *Cycle World*, *Sea*, *World Tennis*, and *Pick-Up, Van & 4WD*.

With the acquisition of Fawcett Publications in 1977, CBS experienced exceptional expansion. Included in this acquisition (one of the largest in CBS' 50-year history and one of the largest in publishing history) were *Woman's Day*, *Rudder* (later merged with *Sea*), *Mechanix Illustrated*, and the Fawcett paperback book line, which publishes over 1,300 titles annually. Most recently they began a newspaper magazine group with the acquisition of *Family Weekly*, the Sunday supplement which appears in 350 newspapers throughout the U.S. In addition, CBS publishes more than 60 newsstand specialty magazines.

This year they bring *Audio* into their ever-expanding magazine fold under the auspices of the CBS Consumer Publications Division. It is only natural that CBS — with its background in broadcasting, recording, research and development, consumer audio products from manufacture through sale, and publishing — should round out their Special Interest Magazine Group with *Audio*, the original magazine about high fidelity.

Looking forward to the '80s, we feel that the resources of CBS Publications, Inc. (one of the largest magazine publishing companies in the U.S.) will enable us to expand, improve, and at the same time retain the high standards set by you, our readers.

Jay L. Butler
Publisher

Editor
Eugene Pitts III

Assistant Editor
Kay Blumenthal

Design
Frank Moore

Design Assistants
Barbara D'Aprile, Mark Collins

Production Manager
Margaret Zibelman

Associate Editors:
Edward Tatnall Canby, Bert Whyte

Senior Editors:
Richard C. Heyser, B. V. Pisha
Howard A. Roberson

Contributing Editors/Artists:
Tom Bingham, Herman Burstein,
Ted Costa, John Diliberto,
Leonard Feldman, Joseph Giovanelli,
Edward M. Long, C. G. McProud,
Gary Roseman, Jon Sank,
Donald Spoto, Gary Stock,
Michael Tearson, George W. Tillett,
Jon Tiven

Publisher
Jay L. Butler

AUDIO (ISSN0004-752X) is published monthly by CBS Publications, The Consumer Publishing Division of CBS, Inc., 1515 Broadway, New York, N.Y. 10036.
Robert J. Krefling, President
Francis P. Pandolfi, Vice President and Group Publisher
Leon Rosenfield, Circulation Marketing Director
William Ganz, Advertising Marketing Director
Gary Fisher, Director of Business Operations
Marlene Jensen, Business Manager
Gertrud Borchardt, Production Director

ADVERTISING SALES

Jay L. Butler, Publisher,
1515 Broadway, New York, N.Y. 10036
Telephone (212) 975-7247

West Coast Sales Office:

Jay Martin, AUDIO, CBS Publications,
3807 Wilshire Blvd., Suite 1201,
Los Angeles, Calif. 90010.
Telephone (213) 487-5880.

Classified Advertising:

Carolynn Sumner, AUDIO,
1515 Broadway, New York, N.Y. 10036
Telephone (212) 975-7530

Continental European Representative: V. B. Sanders,
International Publishers Advertising Service,
Raadhuisstraat 24, P.O. Box 25, Graft-De Ryp, Hol-
land. Telephone, 02997-1303

England: The Paul Singer-Lawrence Media Group,
54 Burton Court, London SW 3 5Y4, England. Tele-
phone, 01-730-3592

©1980, CBS Publications, The Consumer Publishing
Division of CBS, Inc. All rights reserved.

Dewey Decimal Number 621.381 or 778.5

Editorial Contributions are welcomed but should be accompanied by return postage. Submissions will be handled with reasonable care, but the publisher assumes no responsibility for safety or return of manuscripts, photographs, or artwork.

Printed in U.S.A. at Columbus, Ohio. Application to mail at controlled circulation postage rate is pending at Columbus, Ohio and New York, N. Y.

U.S. Subscription Rates: 1 year \$11.94, 2 years \$19.94, 3 years \$25.94.

Other Countries: Add \$6.00 per year.

Back issues, when available, \$5.00 postpaid.

Audio Publishing, Editorial, Subscription, and Advertising Production offices, 1515 Broadway, New York, N.Y. 10036.

Postmaster: Send Form 3579 to above address.

A Telarc Digital

Tour De Force!



Tchaikovsky "1812" Overture; Capriccio Italien; Cossack Dance from Mazeppa Erich Kunzel conducting the Cincinnati Symphony Orchestra

 It's stirring, familiar music. Superbly played by the Cincinnati Symphony under the sensitive baton of Erich Kunzel. And captured with all its warmth and emotion in the 100-year-old Cincinnati Music Hall. But what of the huge bells? And what of the fabled cannon? They are there—literally in full force—providing dramatic proof of the superiority of digital mastering of the untapped capabilities of today's disc recording.

Not For Every System

We'll be perfectly frank: not every system—even some of the finest—will be able to successfully track the remarkable grooves on this record. And even if your cartridge and tone arm can track the record, the full impact of the sound may escape you unless you own an outstanding amplifier and speaker system. In short, this record will challenge every part of your system in every respect.

Most difficult to track and reproduce is the authentic 19th century cannon whose initial "crack" as the powder is ignited is



This 12x enlargement shows the incredible groove modulations during the cannon shots... probably the most demanding low frequency signals ever cut on disc.

followed by pressure waves as low as 6 Hz which can easily be seen on the finished disc. Even with maximum recommended tracking force, many tone arm/cartridge combinations may be incapable of following these remarkable groove excursions*. And the "boom" is well below the useful range of all but the most sophisticated speaker systems, coupled to amplifiers with generous reserves of power.

At the other end of the scale, the tumultuous bells provide a challenge to high frequency tracking and a stringent test of the mid-range and tweeter components. Add the full resources of the Cincinnati Symphony—captured as only the Soundstream digital system and Telarc microphone technique can—and the

result is a record which will challenge your ideas about equipment performance and the limits of disc recording capabilities.

This landmark recording is just one of several new digitally-mastered Telarc releases. Available at most Audio-Technica dealers and wherever audiophile recordings are sold. If not available locally, write us today for our current StandardDisc catalog of digital, direct-to-disc, and advanced analog recordings. AUDIO-TECHNICA U.S., INC., 33 Shawassee Ave., Fairlawn, Ohio 44313. Dept. 2QA.

**If your cartridge/tone arm combination is unable to track this spectacular recording, your Audio-Technica dealer can recommend several A-T cartridges and tone arms capable of meeting the rigors of this advanced digital recording technique.*

audio-technica



ADD THESE EXCITING TELARC DIGITAL RECORDINGS TO YOUR COLLECTION

TCHAIKOVSKY Symphony No. 4,
Lorin Maazel, Cleveland
Symphony TEL-10047

MOUSSORGSKY Pictures at an
Exhibition/Night on Bald Mountain
Lorin Maazel, Cleveland
Symphony TEL-10042



AUDIO-TECHNICA PROFESSIONAL AND HOME PRODUCTS FOR BETTER SOUND



Tandberg has been one of the world's foremost manufacturers of high performance audio equipment for almost 50 years. Renowned for decades in the United States for the outstanding performance and reliability of their high fidelity instruments, the Tandberg heritage has now grown to encompass a full line of audio components, including open-reel and cassette tape recorders featuring the exclusive ACTILINEAR Recording System (Patented) & DYNEQ Record Equalization (Patented), plus three stereo receivers offering ultra-low distortion and superior FM performance.

TANDBERG
HIGH FIDELITY

Write for the name of your authorized Tandberg dealer: Tandberg of America, Inc. Labriola Court Armonk, N.Y. 10504 (914) 273-9150

Tape guide

Herman Burstein

Exercising Your Options

Q. The owner's manual for my tape deck calls for microphones with impedance of 10,000 ohms or less. Would you explain the difference that the mike impedance makes in recording? The mikes I am using now have dual impedance of 150/50,000 ohms, so I use the 150-ohm option. But when recording, I turn the mike level to maximum and still do not get a very high level indication on the VU meter. Is this due to the low impedance? What would happen if I tried to use the 50,000-ohm connection of my mike? — Tom Bouts, Arvada, Colo.

A. A microphone with low-impedance output supplies a small signal, but in exchange you can run a long cable to the tape recorder without significant treble loss. There is also less danger of hum pickup. A microphone with high impedance provides a greater amount of signal voltage, but requires a short cable — at most 20 feet — to prevent treble loss. I suggest that you consult your local audio dealer for a step-up transformer with 150-ohm primary and approximately a 10,000-ohm secondary. If your dealer can't help, write to the manufacturer of your microphones. There is a possibility, although I am dubious of it, that you can use the 50,000-ohm output of your mikes without significant problems of distortion or treble loss. Try it and see.

Tap Toe Through the Playback

Q. When I play a disc, all sounds fine. But if I make a tape recording of the disc and press the monitor button on my preamp, each little bounce of the tonearm makes the recording sound as if the tape is bouncing up and down on the playback head. If I record but leave the monitor button in the out position (thus listening to the program source instead of the tape playback), then the tape machine records very little of the bouncy sound. — David Mann, Pasadena, Calif.

A. Your trouble may originate in a microphonic component in your tape deck or preamp, more likely the latter. Perhaps you can expose the insides of

your equipment while in operation and go tapping around with a pencil eraser to see if this guess is correct. Should tapping accentuate the problem, you may have located the source of the problem.

Pick Up a Piezo

Q. Why is it that a turntable with a magnetic cartridge cannot be used for recording 8-track tapes directly on my 8-track recorder? — Marc Kelley, Kenosha, Wisc.

A. The problem probably lies in the fact that the output of a magnetic pickup requires equalization (bass boost and treble cut), whereas your recorder does not supply such equalization. Also, the voltage output of the pickup is quite low, and your recorder probably does not provide enough amplification. If you employ a piezoelectric (crystal or ceramic) pickup, you would probably have a signal with sufficiently flat response and enough voltage for recording. If you don't get enough bass response with the piezoelectric pickup, try mounting a capacitance of several hundred pF between the hot and ground terminals of the pickup (one capacitor for each channel). You'll have to experiment to discover the proper value of capacitor for flattest bass.

Digit Counter Usage

Q. Is the digit counter on most tape recorders used as an index for each particular machine, or does the counter actually measure footage? — Arthur Pushkin, West Hempstead, N.Y.

A. The digit counter is usually hooked up to the mechanism that turns the take-up reel and normally does not measure actual footage. Therefore you may easily get different counts on different machines for the same tape footage. (However, one or two expensive decks recently introduced do count actual footage.)

If you have a problem or question on tape recording, write to Mr. Herman Burstein at AUDIO, 1515 Broadway, New York, N.Y. 10036. All letters are answered. Please enclose a stamped, self-addressed envelope.

AFTER 500 PLAYS OUR HIGH FIDELITY TAPE STILL DELIVERS HIGH FIDELITY.

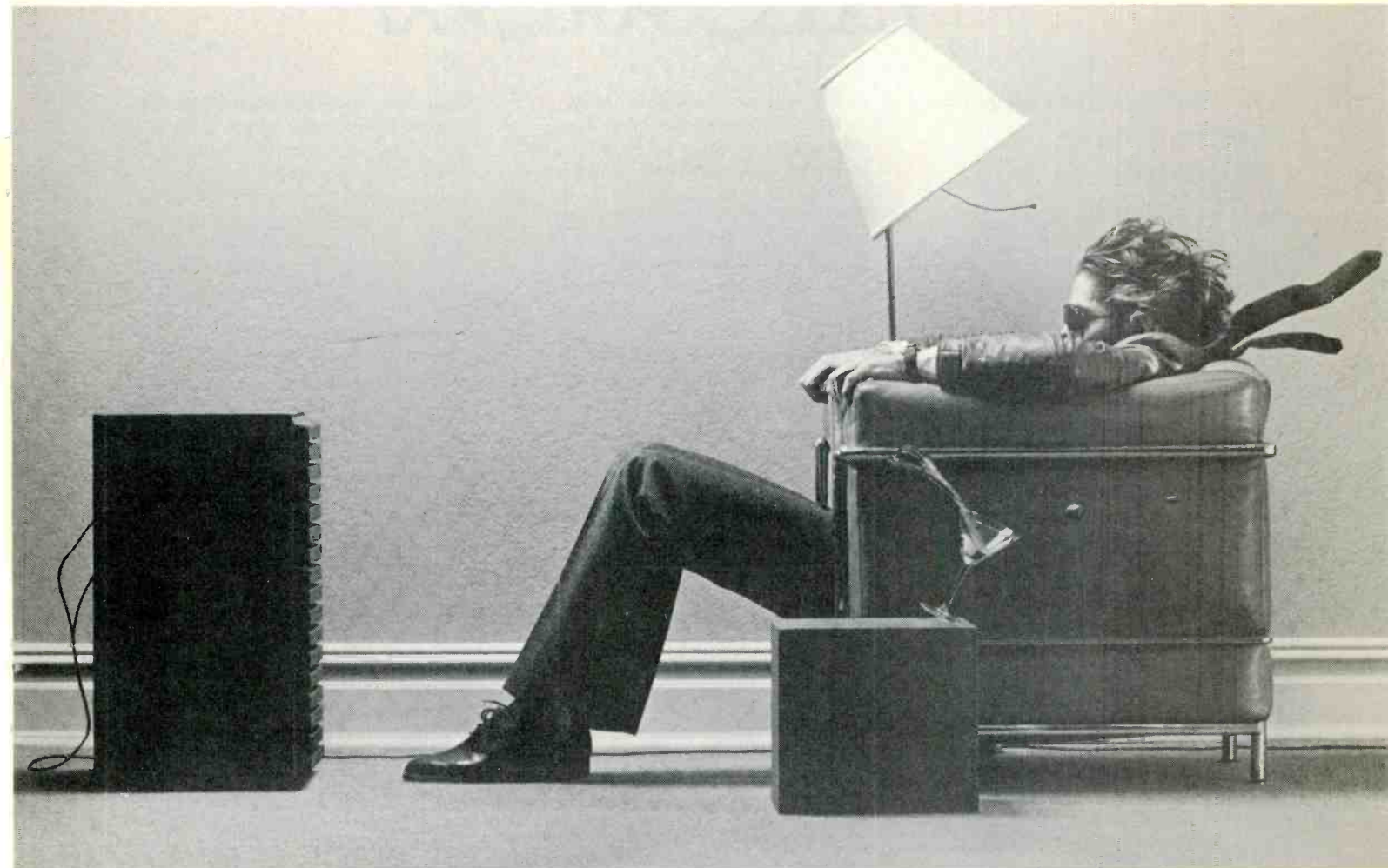

If your old favorites don't sound as good as they used to, the problem could be your recording tape.

Some tapes show their age more than others. And when a tape ages prematurely, the music on it does too.

What can happen is, the oxide particles that are bound onto tape loosen and fall off, taking some of your music with them.

At Maxell, we've developed a binding process that helps to prevent this. When oxide particles are bound onto our tape, they stay put. And so does your music.

So even after a Maxell recording is 500 plays old, you'll swear it's not a play over five.

maxell
IT'S WORTH IT.

The Audio Interview

Gary Stock

Dr. Thomas Stockham— On The Future Of Digital Recording

**One of a series of interviews
with the audio industry's
innovators and thinkers.**

Dr. Thomas Stockham is uniquely qualified to comment on the future of high fidelity. In 1968, as a professor at the Univ. of Utah, he developed one of the first digital recorders capable of high-quality music reproduction. The company he founded and now heads, Soundstream, Inc., of Salt Lake City, Utah, specializes in digital recordings produced using equipment designed by him and his company. Among the 50 records produced via the Soundstream system are a widely acclaimed RCA series of Caruso transcriptions, restored using digital sound processing, and the master tape of Fleetwood Mac's recent Tusk album. The company is among the best-known recording firms in the world.

Stockham talked with Audio at the recent Audio Engineering Society Convention in New York, in the Waldorf Astoria's Cole Porter Suite (graciously made available by the Society). There the conversation ranged over a broad spectrum of topics, from the sound system for Disney's classic "Fantasia" to some suggestions to help recording engineers maintain musical objectivity. Excerpted here are Dr. Stockham's thoughts on high fidelity's direction in the coming decades.

Audio: As you view the future of audio, how do you see the musical storage media—disc, tape, credit card-style plate, whatever—shaping up over the next 10 or 15 years?

Stockham: First, I do not see video cassettes adapted to digital being a substantive and permanent addition. The main problem is the problem of copying. High-speed duplication of digital is even more difficult than duplication of analog, because the bandwidth of the basic digital information—not the sound but the

**“... size and shape
and feel can be
as important as
any of the
technical
characteristics.”**

codes—is much greater than in analog. The bandwidth of a basic audio code at normal speeds is equal to the bandwidth of a high-speed analog duplication. Some fundamental breakthroughs in tape copying could change this, but in spite of promises over the years, there has not yet been anything demonstrated that is really practical. So, I see the adapted video cassette as a kind of bridge, and perhaps it could hang on as a home recording vehicle.

Relative to a disc format, I find it curious and at the same time natural

that video discs should be adapted to digital-audio applications. Technically, it is an obvious direction to go in, and there are as you know, two fundamental approaches. One is to take the video disc player and create audio discs and a digital adaptor of some sort, perhaps built-in. This will allow you to play television programs and digital audio on the same machine. And then there is the alternative approach, which for example the Philips Compact Disc has taken (See "Audio ETC," *Audio*, Sept., '79), to use video technology but reshape it completely for audio only. Perhaps both of these approaches have a place. I personally prefer the audio only direction, because one of the things we have learned in the last decade or two about new storage media is that the shape and size and feel can be as important as the technical characteristics. Why, for example, should the Philips Compact Cassette have been of any usefulness or had any success in the record business? For the most part the technical quality of a cassette is somewhat poorer than that of a disc. Well, it's compact, easy to carry around, one can quickly take it out of the player, and so on. In short, it has appealing physical characteristics above and beyond the sound characteristics.

Audio: You then think that smaller is the route we may take?

Stockham: I think that we may see a smaller digital record, of higher quality than today's records, with nominally the same amount of program material,

8



MEMOREX HIGH BIAS TEST NO. 2.

WHICH HIGH BIAS TAPE WINS WITH "LUCILLE"?



The legendary "Lucille" is a Gibson ES 355 made especially for B.B. King.

Select any blues solo where B.B. King really lets "Lucille" sing, and record it on your favorite high bias tape.

Now record the same solo on MEMOREX HIGH BIAS tape, and listen to the two tapes back to back.

We're convinced you'll have a new favorite for two important reasons:

1. At standard record levels, no high bias tape has a flatter response across the entire frequency range.
2. The signal/noise ratio of MEMOREX HIGH BIAS is unsurpassed by any other high bias tape at the critical high end.

In short, you can't find a high bias cassette that gives you truer reproduction. And, after all, isn't that what you buy a high bias tape for?

Is it live, or is it
MEMOREX



MEMOREX 90

HIGH BIAS
Memorex

minutes
tion



For unbeatable performance in a normal bias tape, look for Memorex with MRX₂ Oxide in the black package.

The new



Direct Drive and solenoid controls in a new cassette deck.

Here is the very latest cassette deck technology. The new Fisher DD300 Cassette Deck has direct drive tape transport for lasting, unvarying performance, feather-touch solenoid electronic controls for superior operation and metal tape compatibility for the ultimate in frequency response. There's an incredible amount of advanced engineering packed into this new Fisher cassette deck.

Direct Drive tape transport.

The rugged capstan on the DD300 is directly driven by a high-torque 18-pole brushless, coreless DC flywheel motor, optimized for the critical record and play transport functions. It glides silently at a steady 360 RPM. And, it eliminates the problems of conventional high speed DC brush motors and drive belts. Wow and flutter are down to an amazingly low 0.04%. A separate motor is provided for fast forward and rewind. No compromise.

Feather touch electronic controls.

Goodbye to the old "clunk-clunk" of

manual controls. A feather-light fingertip touch sets the DD300 in motion. An IC logic circuit actuates the solenoid transport function for instant, silent, positive action. LED's light up to continuously display what functions are in operation.

Metal tape compatibility. If you want to try the new metal particle tape you've been hearing so much about, the DD300 is ready. Get set for an astonishing improvement in signal-to-noise, dynamic range and a frequency response of 30Hz-18kHz \pm 3dB.

Get set, too, to make recordings that rival studio-produced tapes.

FISHER

Studio-Standard BY  **FISHER**

DD-300

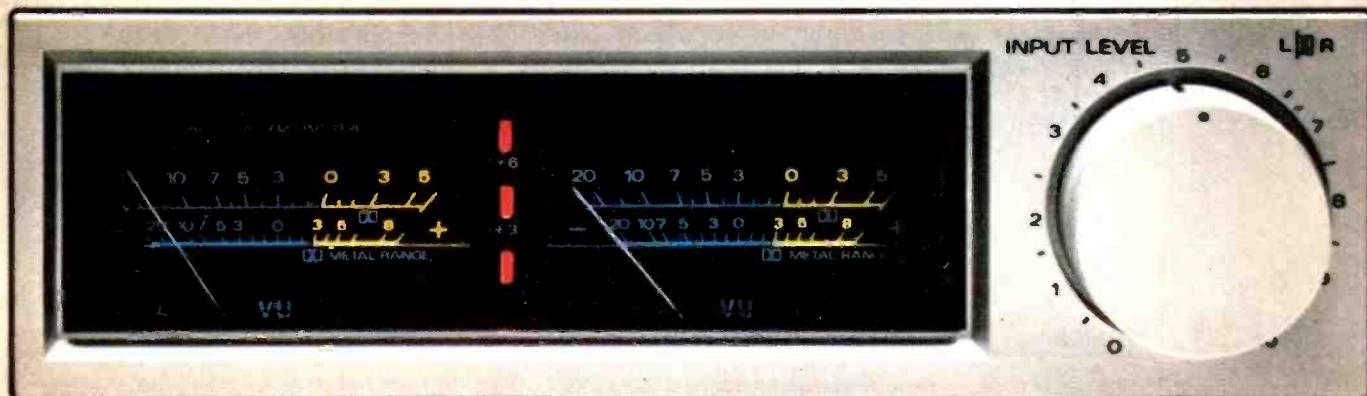

OUTPUT LEVEL

TIMER STAND-BY

DOLBY NR

TAPE SELECT

INPUT SELECT

MIC



REC OFF PLAY



MPX
ON ON
OFF ON



NORMAL
METAL FeCr
CrO₂ EQUAL



LINE MIC



LEFT MONO



RIGHT

Drive coils provide pulsating magnetic field to propel flywheel.

18-pole permanent ring magnet is bonded to back of flywheel.

Separate motor operates fast forward and rewind functions.

Sensing coil between driving coils and flywheel magnet continuously monitors speed in DC servo circuit.

Dynamically balanced flywheel weighs over 1/2 lb., helps maintain speed accuracy, low wow and flutter.

Capstan shaft is directly connected to, and is part of the flywheel. There are no belts, no pulleys.

Instant, silent, positive tape transport functions are operated by solenoids.

It's what you'd expect from the new Fisher. We can't have the space to list all the other features of the new Fisher DD300. Features that are indicative of the high technology of the new Fisher. We invented high fidelity over 40 years ago. And we've never stopped innovating. If you're ready for the latest cassette deck technology, see the new DD300 at your Fisher dealer.

Fisher Corporation, 21314 Lassen Street, Chatsworth, CA 91311

 **FISHER**
The first name in high fidelity.®

© Fisher Corporation, 1980

or even more. But who is to say that we won't have a multiplicity of digital audio media? We have at least three analog media that are commercially viable right now, and I would think that one would expect more than one medium in digital, certainly not right away but after a while.

Audio: Have you at Soundstream done any work relative to digital disc development?

Stockham: Soundstream has done no explicit product development as far as a digital disc is concerned. However, we are extremely interested in this and active in the area.

Audio: How fully is digital audio developed at this point, in your view?

Stockham: Well, nothing is ever fully developed. If you mean by fully developed that digital recording is capable of doing something interesting for the consumer, then I would say "yes." We have produced with our customers, to date, 50 long-playing records, all hybrids— analog records with digital mastering and recording. Nippon Columbia has produced twice that or more. 3M has done some; Sony has done some. Digital is taking its place in the entertainment industry, so it is in that sense developed.

“ . . . a properly designed digital system should not sound any different from a direct connection to the source . . . ”

Audio: Do you think that there is likely to be any significant audible improvement as time goes on, or do you think the present specifications place digital audio systems essentially beyond the discrimination of the human ear? Are there any audible differences between the various available digital recording systems, for instance?

Stockham: I have not heard them all together, so I couldn't tell you. I believe, however, that the properly designed digital systems available today are developed enough, from the point of view of audio fidelity, that the differences between them are comparable to the differences between high-quality amplifiers of different brands.

Audio: Extremely subtle, then.

Stockham: Well, subtle, let's say, or at least rather small. That does not mean, of course, that all of the available systems have been properly designed. I've heard some that sound very good, some that don't sound very good at all. I do not imagine that the sound of a digital system would be an area in which one would expect a big stride forward from the best we have now.

Audio: And yet there has been some resistance to digital on the part of some engineers and reviewers, who claim it sounds artificial in some way. How do you feel about that?

Stockham: The best information I have is that a properly designed digital audio system should not sound and does not sound, in my experience, any different from a direct connection to the source or a very, very high-quality amplifier. Within the scope of the experiences that I've had, I cannot detect any differences between the direct and the digitized material.

Audio: Then you're inclined to think that these remarks are "politically" motivated?

Stockham: I don't know what basis they have. I suspect a bit of skepticism, a bit of nervousness, a bit of "digital isn't good for my business" motivation. Whether that is really true

Transform your home into a nightclub, concert hall or cathedral.



Even the finest stereo cannot create the illusion of "being there" in the same acoustic space as the musicians.

Now you can experience the impact of hearing sound in three dimensions with the ADS 10 Acoustic Dimension Synthesizer. The ADS 10 uses sophisticated digital time delay techniques to recreate the ambient sound field which surrounds the listener in any real acoustic space.

Stereo Review on the ADS 10 experience: "... a totally unobtrusive, natural ambience can be achieved — and once you've experienced it, it's very difficult to give up."

*The Complete Buyer's Guide to Stereo Hi-Fi Equipment** put it this way: "... If you have a good stereo system and ask yourself, 'Is there anything I could do for under \$1200 that would do so much to improve the realism of music reproduction in my home as the ADS 10?', the answer is certain to be 'no'. It's that good."

For more information, write ADS, Dept. A111 or call 1-800-824-7888 (California 1-800-852-7777) toll free and ask for Operator 483. Or better yet, take your favorite records to your ADS dealer and let him demonstrate how the ADS 10 can recreate the live musical experience in your home.

* Quoted by permission, *Stereo Review*, April 1979, and *The Complete Buyer's Guide to Stereo Hi-Fi Equipment*, November 1978.



where technology serves music

Analog & Digital Systems, Inc., One Progress Way, Wilmington, MA 01887 (E17) 658-5100

TDK's new improvement has nothing to do with the sound. It's the package.



Each TDK package is now designed to catch your eye as never before. Clean, modern lines. Bright new colors. Bolder designations in front. Full tape description in back, including sound characteristics, formulation, bias and a frequency response chart to let you know precisely what you're buying without having to hunt for a salesman.

And don't expect the improvements to stop there. Inside there are complete recording and cassette care tips. Invaluable for preserving the life of each cassette, even though each TDK cassette is protected by a full lifetime warranty.* There's also a convenient, tear-out index card to help you build a perfect reference system.

Once inside, TDK couldn't stop improving. There's now a wider cassette window.

Through it you'll be able to watch two red double hub clamps registering tape direction as they turn. Just when the improvements seem to end, TDK tape technology begins. TDK SA's cobalt adsorbed gamma ferric formulation continues to set the high bias standard around the world. TDK AD, the tape with the hot high end, is now Acoustic Dynamic. You'll see it in brand new blue and silver colors. TDK D, another member of TDK's dynamic series, makes many premium normal bias cassettes sound ordinary and overpriced.

That's all we have to report for now. But there will be more to come. Part of TDK's philosophy is: when every improvement has been made, improve again.



Supplier to the U.S. Olympic Team



TDK
The machine for your machine

*In the unlikely event that any TDK cassette ever fails to perform due to a defect in materials or workmanship, simply return it to your local dealer or to TDK for a free replacement.

ALLISON™: leaders in acoustic research

In 1954 Edgar Villchur, by means of his revolutionary acoustic suspension design, demonstrated the advantages of treating the woofer and its enclosure as a system rather than as separate components. Today, nearly all loudspeakers embody this concept. Roy Allison (a professional associate of Mr. Villchur for many years) has now extended the "system" one logical step further, to include the listening room itself. The result is

an improvement by one order of magnitude in the accuracy of the reproduced sound field.

Allison Acoustics manufactures six models of Room Matched loudspeaker systems priced from \$125 to \$441 each. Visit your Allison dealer or contact us directly for literature which includes complete specifications.



ALLISON: FIVE \$160/168
price varies with shipping distance

ALLISON ACOUSTICS INC. 7 Tech Circle, Natick, Massachusetts 01760

or not, some people may reach that conclusion.

Audio: Where you stand depends on where you sit.

Stockham: That's right. I have no truly objective evidence that any of the comments are true, and I've never had anyone offer to show how I or anyone else can hear the difference. I know that objective, measurable differences exist; you put a signal through any device and what comes out will be different in some way from the signal that goes in. The question is whether or not these are audible, either on an absolute scale or in a way that anybody, even a finicky person, really cares about. I've concluded that the differences between direct and digital are either subjectively null or very, very trivial. Even if we say that there are some differences, which I claim there aren't, I'm absolutely certain that with digital you get a big bushful of benefits, and whatever you give up is mighty small.

Audio: How do you, as someone who has contributed to the state-of-the-art technology, envision the home music system changing during the next couple of decades? What sort of sequence do you see?

Stockham: I see the next major change being probably in the area of the digital audio disc we have discussed. You will be able to go to the store and buy a piece of plastic with digits on it, and a player to play it on. It will be connected to your present hi-fi system much like a cassette deck. And you will be able to play these records. It won't mean that you cannot play analog cassettes also or the analog records you have. It will be simply another input source.

But I envision another funny phenomenon happening when this disc player becomes available. I don't think people understand yet just how good these digital discs really are. For those who are really into listening and into hi-fi, as your magazine's readers are, the experience of hearing a digital master-tape-quality record is going to be the wave of the future. Just as an example, I was playing a high-quality direct-to-disc record in my home one evening, and I had some guests in — 10 or 20 couples. We had recorded the same piece of music at the same time on digital tape, and I had set up the digital recorder in the back room. When I started the disc, I pushed the start button on the digital tape recorder, so they would be in synchronization, then came out and let the disc play for awhile. During a quiet passage I just switched over without anybody noticing, in a place

where the music did not change character in any way. Conversations were going on, and a few true-blue audiophiles were listening at the front of the room. When the digital music came up, fully 70 percent of the people in the room just fell silent.

Audio: Dumbstruck, as it were.

Stockham: Something happened.

There was an involvement, a force of presence, something, that just enveloped them. And I've seen this again and again in playing our digital tapes. The involvement level goes way up; people are no longer exposing themselves to the music. They are becoming involved in it.

"...I'm absolutely certain that with digital you get a big bushful of benefits, and whatever you give up is mighty small."

Audio: And you believe the advent of digital audio will involve a larger number of people more deeply?

Stockham: Right. Involve a much larger number of people who will feel that listening to recorded music is a more involving experience.

Audio: After the digital discs become available, what then?

Stockham: The major technological advances that still have to be made have to do with recording techniques, including microphone development and mike placement techniques, and with loudspeaker development, the whole transducer field. Attention is going to be returned to the sound radiation problem, new solutions to the questions of how you take the recorded sound and display it in the air. That will involve the loudspeakers themselves, and also the loudspeaker placement. It will involve a certain amount of signal and ambience processing. And, while I'm not advocating that multiplicities of channels should be aggressively sought by people, I think that it is an area that will receive a lot of attention. There are substantive improvements to be made here. We have made some progress on the problem of how to launch sound into the air, but we remain as far from being where we want to be as the mid-'50s mono record was from today's audiophile discs. 

AUDIO • February 1980

DON'T BELIEVE EVERY DIGITAL READOUT YOU READ.

When you tune to 102.7, you want to stay tuned to 102.7.

Toshiba has solved the problem of mistuning by eliminating the need for a center channel tuning meter. Instead, digital frequency synthesis uses a carefully selected quartz crystal to produce a stable reference frequency. In plain English, this system constantly corrects tuning errors. The result is the lowest possible distortion and absolutely no drift. Toshiba was the first to utilize this system in a receiver, and now we're using it again in our SA-850 receiver.

Digital frequency synthesis not only makes us accurate, it also makes us more convenient.

No unnecessary parts.

We've eliminated the center channel tuning meter, FM/AM dial scale and tuning knob. So you can tune automatically or manually with the ease of pushbutton selection. You get LED digital readout and 5 LED signal strength indicators.

You'll thank us for the memory and scan.

Actually, you'll thank digital frequency synthesis. Because only with



1. Behind this digital readout is a conventional tuning system. It requires a center channel tuning meter and manual tuning.



2. Behind this digital readout is a quartz-locked tuning system. More accurate, but it still requires a center channel tuning meter. And it still requires manual tuning.



3. Behind this digital readout is the Toshiba quartz PLL digital frequency-synthesized tuning system. A totally electronic system that's never subject to manual mistuning. Accurate to 0.0025%.

this process can you store 6 FM and 6 AM stations for instant recall tuning at the touch of a memory button.

And in the automatic FM mode, digital frequency synthesis allows the tuner to scan until it stops at the next listenable station. FM stereo S/N ratio is 68 dB. FM selectivity is a high 80 dB. Frequency response is 20 to 15,000 Hz + 0.2 - 0.8 dB.

But there's more to this receiver than just a superb tuning system.

Power you'll respect.

We're talking about 50 watts rms per channel into 8 ohms from 20-20,000 Hz.

This is provided by full complementary direct-coupled power amplifiers. And couple that with an ultra-low THD of 0.03%.

A preamp you'll appreciate.

Along with provisions for attaching two tape decks, we give you full monitoring controls. Plus duplication switching between the decks.

Our special subsonic filter switch helps eliminate low-frequency warp distortion.

And our receiver looks as good as it sounds. With a sleek slide-away cover that conceals a full

range of controls, including tone/defeat switch and a dual speaker selector.

The Toshiba SA-850 digital frequency-synthesized receiver.

The next time you're looking at receivers, don't believe every digital readout you read.

Except ours.

TOSHIBA
Again, the first.

Toshiba America Inc. 280 Park Ave., New York, NY 11710

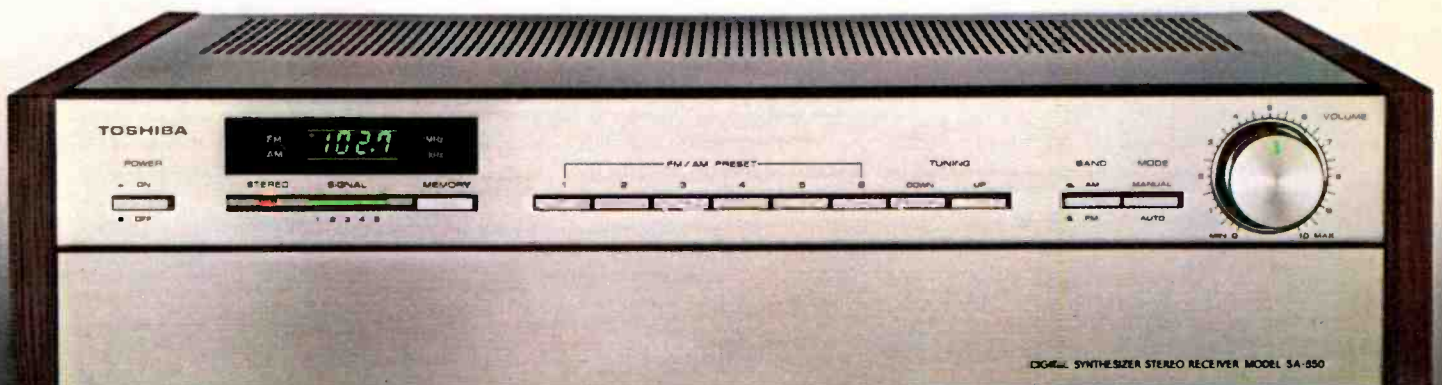

Enter No. 40 on Reader Service Card

Audio etc.

Edward Tatnall Canby

Distortion! A fascinating subject both for the audio engineer and the avid listener. It is the very obverse of fi.

At last fall's AES Convention in New York, for instance, there was a memorable give-and-take at one of the morning technical sessions on a new aspect of this old subject, TIM. "TIM" for Timothy, otherwise known as Transient InterModulation. I'm not about to enter the Timothy fray nor any other of the sort, but I do approve. I also love to argue about distortions and I have my own ideas, as derived from the listener's hot seat. TIM has merely reached that point where before we can cope with it, even measure it, we have to codify and standardize and fence it in. It happens all the time and it needs to. Hence the big arguments.

Of course audio distortions tend to occur simultaneously, all at once, in the natural audio state. But we don't work that way. We have to isolate before we can measure, and we have to discover before we can isolate. So each of the great major types of distortion, the obverse of fi, has had its big moment in the engineering limelight over these years, almost like a series of high-level fads. If they're arguing TIM right now, wasn't it Ph.D. last year? That's phase distortion. And some time before that, quite awhile, we went into a prolonged hassle over plain IM, without the T, measured by nice continuous pairs of clean sine waves. Then there was T by itself, minus IM. Big thing, back then, even if TIM would seem to be a close younger relative. Transients, mixed, all kinds, like mixed nuts.

Back at our beginnings came the granddaddy of all distortions, the old original, now shortened to HD. It was the only kind I ever heard about when

I got into this biz, and my earliest power amps were proud of their low, low four or five percent harmonic distortion. Honestly, truly. And don't think it wasn't audible. Most people enjoyed the sound, not having heard anything different other than live, which didn't really count. Good, solid harmonic distortion gave you a bright, metallic sound that could cut through the soggy layers of early audio out of low-pass pickups, cactus needles, and tubby speakers minus tweet. It was good. And it sounded loud, too. Sometimes I really miss it.

and totally unrelated to the music. These are sum and difference tones, which is to say, IM, but they are *not* distortion; they are "natural." You often hear them, too, in brass ensembles. (Oddly, a similar effect can be electronically generated — pure distortion — in faulty audio playback of the same music.)

Call Me Reproducible

Transients have any number of names in music, which is overpoweringly full of them — that's what we try so hard to reproduce. The now prized

"chiff" of the old or Baroque organ is one transient that the 19th-century organ builders (misguidedly, according to present thought) were able to eliminate via "nicking" of the pipes, bleeding away the transients in favor of steady state. Then there is piano. I will not forget my first piano edits. Turn a piano tape backwards and you have a sort of wheeze box — no transients at the

beginning and a sort of subdued cough (transients in reverse) at the end. But turn it frontwards, cut off the transient "head" — and you still have a piano sound. I was dumbfounded, the first time I heard this. The original transient burst is merely replaced by an electronic burst of distortion caused as the sharp edge of the steady tone goes by your tape head. But is it distortion? A question. Plenty of extant piano notes on a million different records have at least a few of these synthetic tone bursts, masquerading as perfectly good signal.

In singing and speaking there are glottal sounds, a breathy transient from down in the throat. And consonants — what else is a consonant but a bundle of transients? In almost every musical instrument there are deliber-



I take pleasure in the audible audio distortions because when they go away I can always hear the difference. Also, and maybe more important, because I find to my pleasure that each and every type of electronic distortion has its fair analog in live musical sound, not as distortion at all but as *part of the signal*. That's interesting.

Take IM, for instance. As I see it, IM corresponds to what musicians call beats. Sure, there might be a few li'l technical differences, but have you ever played a recorder (finger holes and no cassette) right next to someone else who is also playing a recorder? What you hear, in addition to the musical notes, is a shattering series of loud buzzes and beeping, seemingly inside your head, *bzzz, BZZZZZ, bheeee, Brrrr*, wildly different in pitch

Sansui is breaking up a very successful relationship. The TU-717 has a new mate: The AU-719.

Sansui has just introduced an exciting new integrated amplifier, the AU-719. It represents the very latest developments in audio and electronics technology. It is so good, in fact, that it has replaced its rave-reviewed, best-selling predecessor as the partner of the TU-717 tuner.

The TU-717's performance has been extravagantly praised by professional critics and knowledgeable consumers alike. With advanced features like switchable IF bandwidth and specs like 81dB signal-to-noise ratio and 0.06% THD, it's only natural.

We expect the tuner's new mate to receive a tremendous reception and set industry amplifier standards for a long time to come. Here's why.

INTRODUCING DD/DC

What particularly distinguishes the new AU-719 amp is Sansui's patent-pending DD/DC (Diamond Differential/DC) circuitry that provides the extremely high drive current needed to reduce THD by adding large amounts of negative feedback without compromising slew rate or adding TIM.

Slew rate refers to an amplifier's ability to respond to rapidly changing musical signals. The slew rate of the AU-719 is an astounding $170V/\mu\text{Sec}$.

MAGNIFICENT MUSIC

Many modern amplifiers have extremely low total harmonic distortion specs. And that's important. But THD is measured with steady test signals and is not really representative of an amp's ability to deal

with music. Sansui alone, with its DD/DC technology, is able to provide both low THD and lowest TIM simultaneously. Instead of the harsh metallic sound you sometimes get on a conventional amp when the musical signals are complex, with the AU-719 you hear only magnificent music.

THD is less than 0.015% at full rated power of 90w/channel, min. RMS, both channels into 8 ohms from 10 - 20,000 Hz. Overall frequency response is awesome: DC - 400,000 Hz, +0, -3dB. Hum and noise are a super-silent -100dB on aux and -88dB on phono. The phono equalizer, which adheres to the standard RIAA curve within $\pm 0.2\text{dB}$ from 20 - 20,000 Hz, also uses our unique DD/DC circuit for record reproduction that's second-to-none.

CONTROL YOURSELF

The unit is equipped with a full complement of versatile controls and connections to create the system and sound that's right for you, including two phono and two tape inputs, defeatable tone controls with switchable center frequencies, deck-to-deck tape dubbing and a very convenient 20 dB muting switch.

Audition the new AU-719 and matching TU-717 at your authorized Sansui dealer. We think it will be the start of a very successful relationship.

SANSUI ELECTRONICS CORP.

Lyndhurst, New Jersey 07071 • Gardena, Ca. 90247
Sansui Electric Co., Ltd., Tokyo, Japan
Sansui Audio Europe S.A., Antwerp, Belgium
In Canada: Electronic Distributors

Sansui



Enter No. 31 on Reader Service Card

ately induced percussive transients, from the bounce of a violin bow on the string to the *takataka* tonguing of wind instruments. As for nonpitched percussion, notably the drum, the sound is a mass of transients and not much else. So we musicians are quite familiar with transients, though not as distortion.

All of which I think makes clear what we mean by distortion. We are trying to be faithful to an original, a "given," and that includes the faithful reproduction of all these sound effects. We can only define distortion, then, in terms of a *prior model*, and the definition of that model can be a tough problem. Oversimplification is our greatest trap, the easy way out. The trouble with IM is that it doesn't include TIM; we get false readings when it comes to actual listening sound. On the other hand, what do you do about reproducing an "original" that is distributed over 24 separate tape tracks? Or how about the hi-fi reproduction of those electronic fuzz noises in pop music, deliberate electronic distortions (are they, though?) which must be distortionlessly reproduced! It's a slippery world, and no wonder there are arguments. I think, though, that it is reassuring to know that real-life natural sound so neatly parallels the unwanted, falsely generated electronic signals which in fact do constitute our carefully studied types of distortion.

As a listener, I tend to make my own categories of audible distortions, just as I hear them out at the very end of the long audio chain. I fancy that these categories do indeed have some relationship to those of the engineers in our business — that is, I am hearing what *they* are talking about. But as a musician I can never be sure; I only know what I like, as the music hater says.

Categorically Speaking

I have assembled for this month no less than three Canby Categories of audible distortion, and you may make what you will of them. The first, shall I say my "first-order" category, is the kind which, if I am right, is caused by harmonics generated in the system, here, there, everywhere. It is very uncommon now, and usually unmeasurable, but it wasn't so in the past. We used to hear positively enormous quantities of this distortion back in the 78-rpm days, early through late. Vast harmonic content, variably transient, via the old shellac disc and its crude "needle" and cartridge and via many a brave new early loudspeaker. I can hear all those sounds in my head and

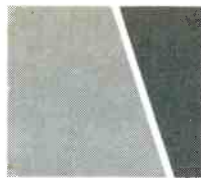

fact: ERA IV Began...

and nothing remained the same

fact:
viscous-damping
straightens out
all your records

your favorite record may be a tangle of warps

The Shure V15 Type IV viscous-damped cartridge is the most advanced in the world. It features a new, unique design that allows it to track the grooves of warped records with a precision and accuracy that is simply unmatched. The result is a sound that is clear, clean, and free of the distortions and warps that have plagued other cartridges for years.

the role of the Dynamic Stabilizer:

The Dynamic Stabilizer is a unique feature of the Shure V15 Type IV. It is designed to absorb and dampen any unwanted vibrations or warps in the record, ensuring that the stylus remains in perfect contact with the groove. This results in a more accurate and detailed reproduction of the original recording.

V15 Type IV...the stabilized cartridge by SHURE

Shure Brothers Inc., 722 Harvey Ave., Evanston, IL 60004, in Canada: A. G. Simmonds & Sons Limited, Manufacturers of high-fidelity components, microphones, sound systems and related products.

fact:
calling this a "brush"

is like calling this a "radio"

we call it a Dynamic Stabilizer...critics call it a major innovation

Each time you hear a Shure V15 Type IV, you are hearing a sound that is truly unique. The Dynamic Stabilizer is a major innovation in the world of audio, and it is the reason why the Shure V15 Type IV is the most advanced and accurate cartridge in the world. It is the only cartridge that can reproduce the sound of a record with such clarity and detail.

V15 Type IV...the stabilized cartridge SHURE

Shure Brothers Inc., 722 Harvey Ave., Evanston, IL 60004, in Canada: A. G. Simmonds & Sons Limited, Manufacturers of high-fidelity components, microphones, sound systems and related products.

ERA IV BEGINS!

fact:
the IV does more...
...much more!

The evolution of the new Shure V15 Type IV is a true milestone in the history of audio engineering. It is the most advanced and accurate cartridge in the world, and it is the reason why the Shure V15 Type IV is the most advanced and accurate cartridge in the world.

- Permanently mounted, rigidly secured, shock-resistant, heavy-duty, diamond-tipped stylus
- Permanently mounted, rigidly secured, shock-resistant, heavy-duty, diamond-tipped stylus
- Permanently mounted, rigidly secured, shock-resistant, heavy-duty, diamond-tipped stylus
- Permanently mounted, rigidly secured, shock-resistant, heavy-duty, diamond-tipped stylus
- Permanently mounted, rigidly secured, shock-resistant, heavy-duty, diamond-tipped stylus
- Permanently mounted, rigidly secured, shock-resistant, heavy-duty, diamond-tipped stylus

New! Shure V15 Type IV SUPER TRACK-IV Stereo Dynamic Phono Cartridge SHURE

Shure Brothers Inc., 722 Harvey Ave., Evanston, IL 60004, in Canada: A. G. Simmonds & Sons Limited, Manufacturers of high-fidelity components, microphones, sound systems and related products.

The V15 Type IV astounded the audio community with such technological breakthroughs as the Dynamic Stabilizer, the telescoped stylus shank, and the Hyperelliptical stylus tip. It was these innovations that helped the V15 Type IV set new standards of performance in trackability, ultra-flat frequency response, and low distortion.

The result: incredible critical acclaim; an enthusiastic audiophile following. The New Era had begun!

NOW! ERA IV continues in five new mid-priced cartridges!

Introducing: Five new Shure Cartridges that feature the technological breakthroughs of the V15 Type IV

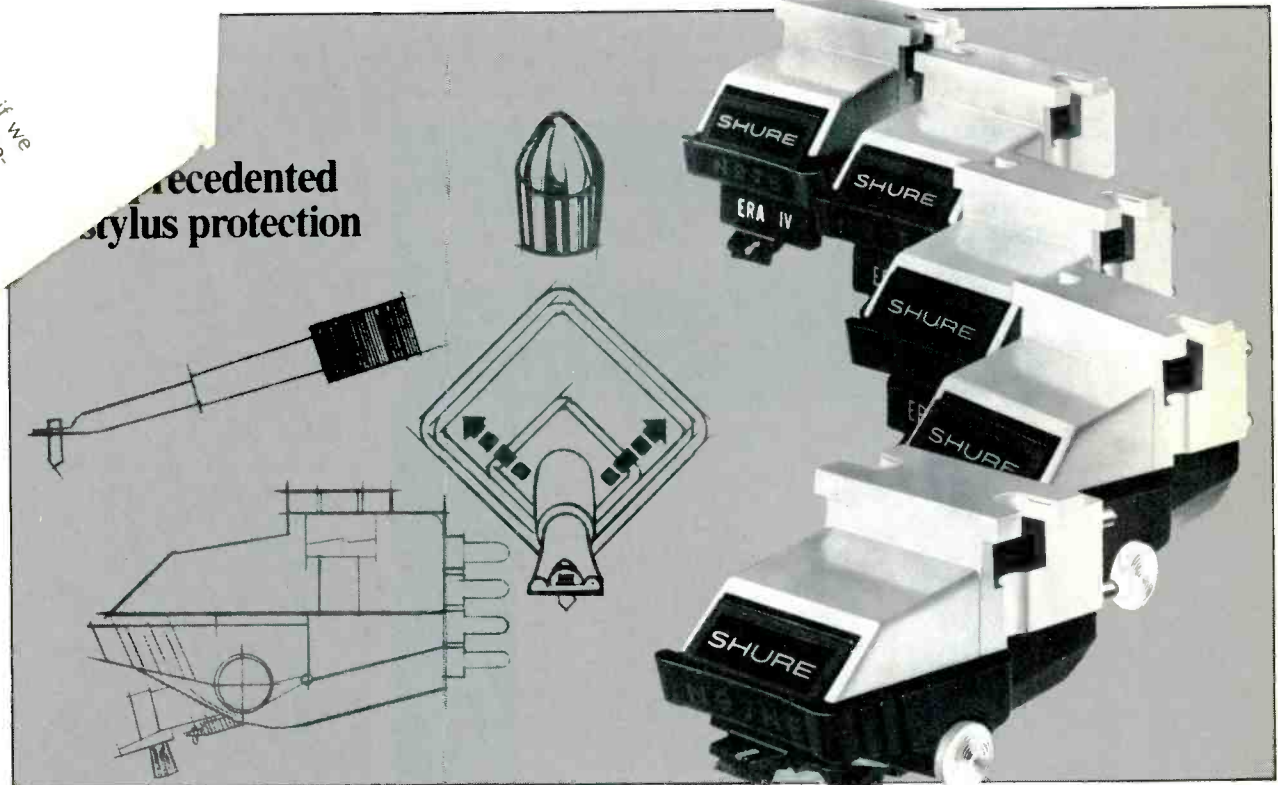

the M97 Era IV Series phono cartridges

Model	Stylus Configuration	Tip Tracking Force	Applications
M97HE	Nude Hyperelliptical	3/4 to 1 1/2 grams	Highest fidelity where light tracking forces are essential.
M97ED	Nude Biradial (Elliptical)	3/4 to 1 1/2 grams	
M97GD	Nude Spherical	3/4 to 1 1/2 grams	
M97EJ	Biradial (Elliptical)	1 1/2 to 3 grams	Where slightly heavier tracking forces are required.
M97B	Spherical	1 1/2 to 3 grams	
78 rpm Stylus for all M97's	Biradial (Elliptical)	1 1/2 to 3 grams	For 78 rpm records.

Shure has written a new chapter in the history of affordable hi-fi by making the space-age technological breakthroughs of the incomparable V15 Type IV available in a *complete line* of high-performance, moderately-priced cartridges: the M97 Era IV Series Phono Cartridges, available with five different interchangeable stylus configurations to fit every system and every budget.

The critically acclaimed V15 Type IV is the cartridge that astonished audiophiles with such vanguard features as the Dynamic Stabilizer—which simultaneously overcomes record-warp caused problems, provides electrostatic neutralization of the record surface, and effectively removes dust and lint from the record—and, the unique telescoped stylus assembly which results in lower effective stylus mass and dramatically improved trackability.

Each of these features... and more... has been incorporated in the five cartridges in the M97 Series—there is even an M97 cartridge that offers the low distortion Hyperelliptical stylus! What's more, every M97 cartridge features a unique lateral deflection assembly, called the SIDE-GUARD, which responds to side thrusts on the stylus by withdrawing the entire stylus shank and tip safely into the stylus housing before it can bend.

NEW! M97 Series Era IV Phono Cartridges...
Five new invitations to the new era in hi-fi.



Shure Brothers Inc., 222 Hartrey Ave., Evanston, IL 60204 In Canada: A. C. Simmonds & Sons Limited
Outside the U.S. or Canada, write to Shure Brothers Inc., Attn: Dept. J6 for information on your local Shure distributor.

Manufacturers of high fidelity components, microphones, sound systems and related circuitry.

Enter No. 33 on Reader Service Card

they weren't always so bad. Various terms come to mind, pro and con — we talked about buzz, blast, grind, needle chatter, and about worn grooves and worn needles, sometimes minus their points, or the tips bent into a hook. There were cracked crystals, strained speaker cones, tired tubes, and I don't know what else — the resulting sounds had a clear family relationship, from the gentlest to the most raucous. Harmonic? Mainly.

If so, that is important. Because every such distortion is directly related, for the ear, to the "fundamental"

sound, the original signal. Harmonics make not only harmony but, more importantly, the whole range of audible tone color. So we were able to "read" this distortion to a remarkable extent as a kind of added coloration, often grotesque and hideous, but often relatively pleasant. Some brand-new speakers in early hi-fi were actually advertised as "golden" in sound — note the coloration — though this was perhaps to avoid the thought of a less flattering term, "tinny."

Yes, there must have been plenty of the other known distortions in these

"The ne...
to tru...
in our media
the more
we must be
the tiny no
that are sti...
strictly signal."

SUPER DISCS

Quality Music, Quality Pressings, Quality Sound

Nautilus Half-Speed Mastered Series



This is the rumour to listen to: Nautilus Recordings announces the release of its newest Half-Speed Mastered Superdisc, RUMOURS by Fleetwood Mac. Produced from the original master tape and pressed on the finest 100% virgin vinyl available.

Also available at your dealers: (Half-Speed Mastered Recordings) **DREAMBOAT ANNIE** by Heart and **THE CAPTAIN AND ME** by the Doobie Brothers; (Digital Recording) **TIP OF THE WEISBERG** by Tim Weisberg; (Direct-to-Disc Recording) **STRAIGHT TO THE HEART** by John Klemmer.

Expect more from Nautilus Recordings.

Nautilus Recordings
761 Shell Beach Road
Shell Beach, CA 93449
(805) 773-1848
Dealer Inquiries Invited



Free Catalog available.

earlier reproduced sounds, even did not then recognize them. But...ly the biggest factor was harmonic...ortion in enormously high perce...tages. So I would think.

I cannot say exactly how my "second-order" category of audible distortion will look in the figures, but it is certainly a very different kind of unpleasantness, a new sound, cropping up mostly via late-model advanced circuitry though I first heard it myself on early FM. I still do. Strong adjacent FM station tries to butt in on your music. *Sput, sputter, splat!* Unmistakable and most unattractive. There is no harmonic message in this ugly sound and no coloration. It is just loud, jagged, a shattering, tearing noise that is completely destructive. I hate it. But I hear it more and more often.

Definitely this is the ugliest of all the gross distortions, far more unpleasant than any ordinary buzzing or blasting. If there is music in its origin, an occasional bit of musical pitch often gets through with the splat, but it is no more than a hideous gargle, not music. Purely indigestible, this stuff, and you can give me Caruso on an acoustic portable with a broken needle any day.

A particularly jarring example of this sputtery distortion was to be heard a good while back via those brave earlier four-channel "discrete" record systems. It came at the dramatic peaks of volume and particularly via the innermost record grooves. Few of us would care to listen to any music with that sort of loud sputter coming through every so often! The CD-4 people made heroic efforts to improve, and in their later demodulators the splats were gone. But, alas, it was too late. No more. Curious that here we were also dealing with FM circuitry, via the CD-4 supersonic modulation of the groove walls. Curious, too, that none of the "matrix" decode equipment I ever tried produced this splatty sort of distortion, not even those with logic. Probably just didn't happen to have the right elements in their circuits to

AUDIO • February 1980



All you feel is the music.

Music should be a sensory delight. But it can't give you the pleasure you deserve if your headphones squeeze your ears and hurt your head.

The **Beyer DT 440** is quite probably the world's most comfortable headphone. At 9 ounces, it's not quite the world's lightest (that record belongs to our Beyer DT 302). But with its sponge-padded ear-cups and low-pressure air-filled headband, it's so beautifully balanced it just about disappears.

When you plug in the DT 440 you'll be part of an almost unbelievably realistic musical experience. The strong bass, high efficiency and

fast transient response have all been acclaimed by sophisticated audiophiles, audio critics and musicians worldwide. And the DT 440's open-air, high-velocity design gives you a perfectly natural balance between recorded and environmentally-present sound.

The overall sound is absolutely clear, yet at the same time, warm and rich. With smooth, undistorted reproduction across the entire audible spectrum.

Stereo imaging approaches the ideal, providing accurate and dramatic locating of each and every sound source.

Please visit your Beyer dealer.

He'll make you feel better.

Beyer 
Dynamic

BURNS AUDIOTRONICS, INC.

5-05 Burns Avenue, Hicksville, NY 11801 • (516) 935-8000
In Canada, H. Roy Gray, Ltd.



An acknowledged world leader in loudspeaker design and engineering, KEF has developed a monitor-standard speaker system that is both small — only ¼-cubic foot in size — and truly “high” fidelity. While these objectives are not new, the Reference Series Model 101 speaker system represents the first time that both are available in one product.

The Model 101 is, therefore, ideal for use in locations where an accurate small speaker is required in keeping with the rest of a high quality audio system.

System Design

Despite all the ingenious ideas that have been proposed by various speaker manufacturers over the years, the three basic parameters of Enclosure Volume, Bass Response and Efficiency are still related by unchanged physical laws. What is different is the thorough manner in which KEF engineers have, with the use of advanced technology, optimized the relationships between these parameters.

Starting with the premise that prospective Model 101 users will have substantial amplification available, KEF engineers achieved a response from this small enclosure of 90Hz–30kHz ± 2 dB (–10dB at 47Hz).

KEF's leadership in computer-aided digital analysis techniques enabled them to optimize the design of the drivers, crossover network and enclosure to achieve a Target Acoustic Response without repetitious trial and error experimentation. Much of this technology, which did not previously exist, has been applied to the design and production of a small high fidelity speaker system for the first time in the Model 101.

Once the desired prototype was completed, KEF applied the same unique computer-aided techniques developed for the production of the critically acclaimed Model 105, so that the sound quality originally achieved in the laboratory prototype will be available to every user.

In addition, the high standards of the computer-aided production and assembly procedures enable precision-matched pairs of stereo loudspeakers to now be offered. For example: every Model 101 driver is tested and matched to tolerances of better than 0.5dB, and crossover networks to tolerances of 0.1dB; each pair of drive units is matched not only to each other, but to the other components in the system as well.

Loudspeaker Protection

The major problem with small, relatively less efficient loudspeakers is thermal overloading of the voice coils. KEF engineers have developed a unique self-powered electronic overload protection circuit, S-STOP (Steady State and Transient Overload Protector).

Musical peaks are generally of short duration, so tweeters can handle far in excess of their normal program rating. A similar situation exists with low frequencies and their effect on the bass unit. Consequently any form of fuse protection can reasonably limit the instantaneous peak handling ability of the system, yet fail to protect the system against a very high average power level. KEF's solution is to incorporate a protection circuit which takes into account the instantaneous power applied to each drive unit and also computes the length of time the signal is applied. The law under which it operates resembles very closely the temperature rise within the voice coil. A potentially damaging signal is immediately attenuated by about 30dB, and the full signal is automatically reconnected when it is safe to do so.

As a result, the Model 101, although only ¼-cubic foot in size, is fully protected against fault conditions when used with amplifiers of up to 100 watts per channel.

The Model 101 is obviously not your average “miniature” speaker system where the quality of sound or power handling capacity is compromised by the small size of the enclosure. Nor is it inexpensive. If you require a speaker system that is both small and truly high fidelity, visit your authorized KEF dealer for a thorough demonstration. For his name, write: KEF Electronics, Ltd., c/o Intratec, P.O. Box 17414, Dulles International Airport, Washington, DC 20041.

KEF Reference Series Model 101:

Accurate, Small, Protected.

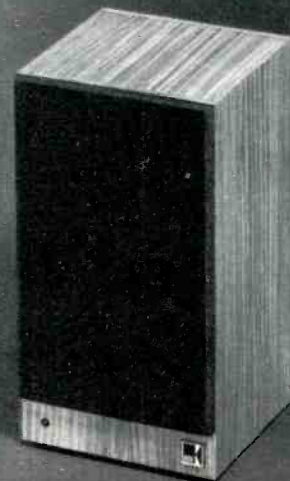

Enter No. 19 on Reader Service Card

Whatever my matrix mild exam-
 at-like, came dbx noiseless
 del 21, before I ed up as to levels
 y overload, proba- did emit just two
 istakable, before it subsequently perfect
) criticism — but, en- nely indicated that
 here, too, was a modern circuit which
 if forced to malfunction would give
 forth not a harmonic blast but a second-order splat. There must be a lot
 more of this around, at least in the potential. Can any reader pin it down?

D-Lightful

I won't dwell long on my "third-order" audible distortion because, well, it gets into aesthetics. But I have to bring it up because it just happens to be our greatest concern these days — the hi-fi reproduction of unwanted noise, the sounds we never asked for but get anyway. Our equipment can't tell the diff. between noise and signal, and that is the rub. We are frantically going this way and that in our search for the means to get rid of noise without getting rid of signal too. We have gone far. Autocorrelators (excellent), new metal tapes, plus hopefully better disc surfaces, Dolby, dbx, direct-to-d, digital, maybe even some more uses of the letter "D" for all I know. Yet at home I still hear unwanted noises, just as you do. They are terrifyingly diverse — we have to scatter our fire. FM stereo may give out splats but it is also still pretty hissy. Even the natural ambient sound of a concert hall or church can get to be a big problem — but there we get into the aesthetics because that ambience is *part of the signal*, even a part of the musical effect, and therefore we must treat it with deference.

The nearer we come to true silence in our media background, the more careful we must be of all the tiny noises that are still strictly signal. Where we now have that new silence, in all-digital recording, via dbx encoded discs, even in a few direct-to-disc releases (by no means all of them!), we suddenly find exasperating new problems thanks to the ear's uncanny ability to hear ultra-low-level residual noises once they are unmasked.

Don't misunderstand me—I have been fascinated by my first batch of dbx noiseless discs and am certain that this is the most important new system we have seen in recent years that uses the still-viable LP record as its base. It

has caused me absolutely no trouble since I got the levels of in and out adjusted properly—never a splat again. But there are a few mighty interesting further items to be noted in connection with dbx.

For example, on a number of dbx discs from various labels, I became aware that some tape editor had repeatedly cut off the die-away reverbs at the end of the musical segments before they had quite disappeared. Now that is an old fault, seldom heard today thanks to more aware and careful editing. So why here? I suspect that the answer is as you might guess—the noiseless disc has uncovered a new area of audible die-away where formerly the sound merged into general surface noise. Now we have to edit further down, virtually to zero. It's astonishing the way the ear can pick up these tiny faults, down in what used to be (still normally is) the proverbial mud. Caveat editor!

I also noticed on the dbx discs that the problem of built-in hall ambience is not always adequately solved. It is quite normal today for a record producer to fade hall noise down to zero between movements, where there is normally a strip of leader tape inserted to fill up the time. OK—we mostly don't notice this because once again the ambient noise blends into the surface sound. Now, alas, we must rethink this problem. On a number of dbx discs I became unpleasantly aware of these between-movement breaks, because not only is the ambient sound nakedly clear—distant buses, cars, faint clunks and bumps, even maybe the ghost of a voice or two—but the sudden fade-out for the leader strip leaves you thinking your system has just died. Total, disconcerting silence. And a clear disruption of the musical continuity.

We'll have to devise better ways, once it is established for the ear, to keep this ambient signal noise going (or fade it with care when it does have to go). In that way it is subliminal, which is the way it must be.

Well, the direct-to-disc boys and girls should be happy with this. No editing. Just one continuous play, straight through in real time, and ambience all the way. Just don't be tempted to close down your pots between numbers, you people. I'd much rather hear a few discreet coughs and a creaking chair than have to go through more of that unnerving sudden total silence in midstream. Aren't coughs and chair scrapes a part of musical performance? Is not silence, in this case, a clear distortion? You'd better start thinking so. A

Empire's revolutionary cleaning method peels off every trace of dirt, dust and oil from deep down in your record's grooves.

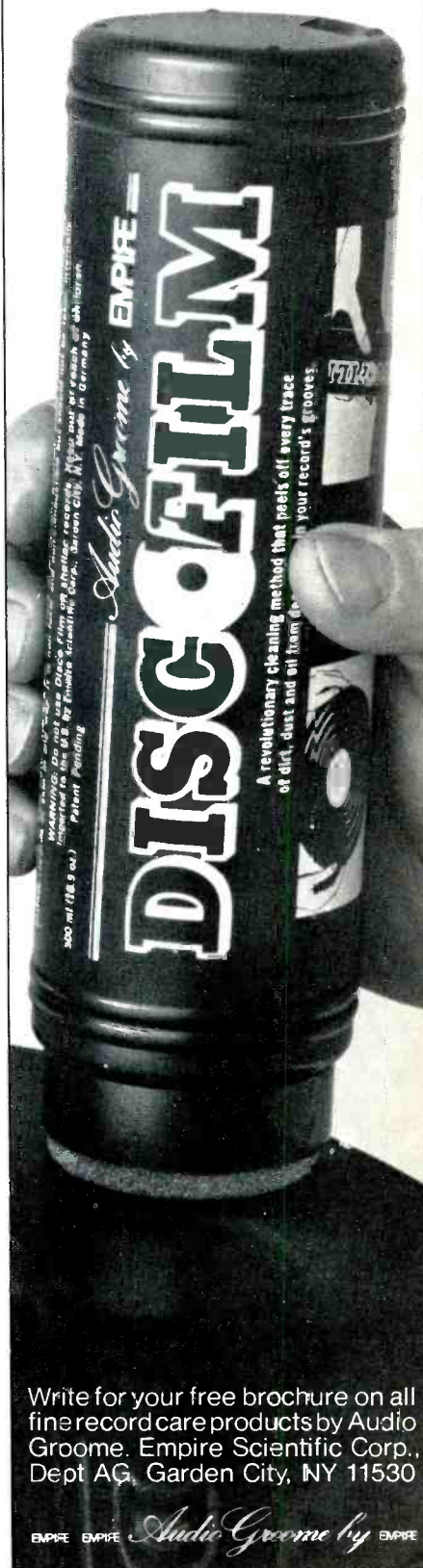

Write for your free brochure on all fine record care products by Audio Groomer. Empire Scientific Corp., Dept AG, Garden City, NY 11530

EMPIRE EMPIRE *Audio Groomer by EMPIRE*

Enter No. 12 on Reader Service Card

Behind the scenes

Bert Whyte

Recessionary influences notwithstanding, the Audio Engineering Society held its 64th Convention, November 2 to 5, amid the somewhat faded splendors of the Waldorf Astoria in New York. Although rated as "the biggest AES Convention ever," there is no doubt that the present economic uncertainties are being closely monitored by many manufacturers. Let us say that the audio industry is sipping champagne, but it is of the domestic variety, not vintage French!

As you might expect, digital recording technology still holds the spotlight as the major topic of interest. 3M, which has been offering its 32-channel pre-mix digital recorder and 4-channel master recorder on a lease basis, is now making these units available on a direct sale basis. The 32-channel unit is priced at \$115,000 and the 4-channel master recorder at \$35,000. At the Convention, 3M introduced a 16-channel pre-mix digital recorder at \$72,500, and a 16-channel update kit (to convert the 16-channel recorder to 32 channels) for \$53,200. These new digital recorders are said to be available for immediate delivery. Also new from 3M were two digital-delay preview units for disc-cutting, a 1.3-second preview unit for \$5,500, and a 1.96-second-delay preview unit for \$7,400. The electronic editing system introduced at the 63rd AES Convention is priced at \$7,500 and has recently been made available.

Much interest was shown in the new Mitsubishi X-80 digital recorder. This is a two-channel stereo recorder



using quarter-inch tape at a speed of 15 ips. Its stationary head unit affords one hour of recording on a 10½-inch reel. The X-80 is a relatively light and transportable 143 pounds, lending itself to location recording. The unit uses 16-bit linear encoding with a sampling frequency of 50.35 kHz. The PCM signal is subjected to modified frequency modulation and is distributed among eight tracks on the quarter-inch tape, with a high recording density of 797 bit/mm. One auxiliary analog track and one SMPTE code address track are provided outside the digital tracks. The analog track permits normal tape-cut editing, with special circuitry allowing continuous phase-lock control across the splice point. The SMPTE code track allows electronic editing. Drop-out error correction is via cyclic redundancy check code, with interleaving and interpolation. Click-noise generation incidence is said to be extremely small. Frequency response is claimed to be within ± 0.3 dB from 20 Hz to 20 kHz, while the dynamic range is said to be over 90 dB, with less than 0.02 percent distortion at peak levels. To make their digital recording system complete, Mitsubishi

also offers the XE-1 electronic editor and a disc-cutter preview unit with delay times adjustable from 0.8 to 1.8 seconds. What caused quite a stir among the smaller independent recording companies were the Mitsubishi prices—"around \$20,000" for the X-80 digital recorder, with the electronic editor at \$8,000, and the disc-cutter delay unit at \$7,000. In other words, for around \$55,000 you

get two X-80 recorders (one for recording, one for editing layout), the editor, and preview unit. This presently makes the Mitsubishi digital system the least expensive entry into digital recording.

Several From Sony

Sony continues to concentrate on digital recording technology. In fact, they now bill themselves as the "world's largest producer of digital recording equipment." Their exhibit in the ballroom of the Waldorf was almost entirely devoted to digital units, and they introduced a number of new products. Of prime interest was the PCM-3324 digital recorder. The system consists of a 24-channel transport with fixed heads, using half-inch video tape at 30 ips, with a separate rack mount for the digital audio processor. At 30 ips, this machine can record for 60 minutes on a 14-inch reel of Sony V-16 video tape. The recorder uses 16-bit linear encoding and has the facility of switchable sampling frequencies of 32 (some Europeans favor this), 44.056 (EIA standard), 44.1, 48, 50.0, 50.35, and 50.7 kHz. The track format is two digital tracks per channel, one track for SMPTE time code, and two tracks for

AUDIO • February 1980

LUX

TOMORROW'S TECHNOLOGY IN TODAY'S SYSTEMS

THE PERFECT SYSTEM BLENDING TODAY'S TECHNOLOGY AND GOOD MUSIC FOR A PLEASURABLE LISTENING EXPERIENCE.

High fidelity is the sum total of audio experience. It means not only superb styling but ease of operation. It also means the joy of listening, even in the midst of a frenetic work schedule. Just turn on the system, relax and forget your problems and experience an audio happening.

The total audio experience can't be gleaned from specifications. It must be heard...felt. Because many Lux original technical developments enhance the experience, they are not easily specified.

The Lux L-11 Integrated Amplifier uses Realtime Processed DC Amplification. In a conventional amplifier, a capacitor is used in the negative feedback loop to eliminate wave form distortion, but it in turn triggers time lag causing phase distortion in the lower frequency and transient distortion in the higher frequency. Lux's approach to this problem as seen in the Model L-11 was to drop the capacitor from the negative feedback loop; thus erasing the time lag causing phase and transient distortion. DC drift was solved by the use of Lux's exclusive DML-IC (dual monolithic linear integrated circuit).

Lux 5K50 Cassette Deck uses our ERBS System. Building a superb cassette deck needs more technology than standard decks. To make the most of the unit's 3-head design, the BRBS variable bias system is provided. This Bridge Recording by Bias Current and Signal Current avoids transient and phase shift distortion.

Lux R-1120A Tuner/Amplifier and our T-12 Tuner both use the Closed Lock Loop Tuning System. Since it's impossible to enjoy mistuned FM, or to relax when you have to jump up and retune, Lux has perfected frequency control.

While most quartz lock systems operate on the front end only, Lux goes further, with Closed Lock Loop controlling the front end, the IF and detector circuits, with strong, instantaneous corrective feedback to the exact center of the desired frequency range. Another locking circuit, Accu-lock™ physically locks the tuning knob at the desired point. Not only does Lux's system deliver perfect tuning, it retains the last tuned frequency even when the power is turned off and on.

Lux PD-277 offers quality and convenience. Using a Lux designed, servo-controlled brushless, slotless motor, wow and flutter is extraordinarily low at 0.03%, while signal-to-noise ratio is 60dB.

Other outstanding features are a straight low mass tonearm™ and vertical pivot construction for minimizing resonance and instability.

Quality and convenience are evidenced by electronic controls for all major functions and a separate motor for the tonearm eliminates noisy, friction-producing linkage.

These and other innovations are typical of Lux's outlook. But none of this shows up on spec sheets. Only listening will prove that all of Lux is for your pleasure.

See your nearest Lux dealer for a unique listening experience.



LUX AUDIO OF AMERICA, LTD.

160 Dupont Street, Plainview, NY 11803 (516) 349-7070
11200 Chandler Blvd., North Hollywood, CA 91603 (213) 985-4500
In Canada: Lux Audio of Canada, Ltd., Ontario

Due to the tremendous response from consumers, Lux has decided to extend the Great Rebate Program from December 31, 1979 to January 31, 1980.

analog audio. The analog tracks permit normal tape-cut editing, while the SMPTE track affords electronic editing and multi-deck synchronization. Punch in/out recording is also provided. There are analog as well as digital input/output connections for interfacing with existing analog and new generation digital studio systems. Sony has a new correcting code and modified cross-word error-correcting system in this unit. With the data blocks incorporating internal as well as external error-checking, there is a total of 41.7 percent redundancy for synchron-

ization and correction. Sony claims this new PCM-3324 recorder affords digital-to-digital duplication with no signal quality deterioration.

While the Sony 1600 PCM with U-Matic VTR is now on the market and has been used for digital location recording, their new portable digital recorder, the PCM-3204 introduced at this AES Convention, would seem to be even more suitable for this type of use. The PCM-3204 is a 4-channel, fixed-head unit using quarter-inch video tape at 15 ips. At this speed, two hours of recording are possible with



Sony PCM-3324

14-inch reels of tape. As with the PCM-3324, the tape format is two digital tracks per channel, one SMPTE time code track, and two analog audio tracks. Thus, both tape-cut and electronic editing are possible. The PCM-3204 also uses the new error-correcting code. This recorder uses 16-bit linear quantization, with the same switchable sampling rates as the PCM-3324. Complete A-D and D-A conversion facilities and all digital circuitry are integral in the portable case. At nearly 250 pounds, it might be better to call this recorder "transportable," rather than portable! No pricing given yet, but this attractive "purpose-built" digital recorder would seem to be well-suited to classical location recording, especially of the minimum microphone "purist" variety. When available, I'd love to give this unit a good workout with something like *The Rites of Spring* or the Mahler 3rd Symphony!

Another item Sony introduced was their DRE-2000 digital reverberation system. This is a two-channel delay and reverberation unit, with a micro-computer to preprogram up to nine different modes of reverberation. Delay time range is from 0 to 255 milliseconds, with reverberation times from 0.1 to 9.9 seconds. The unit accepts 16-bit digital input and output signals directly and has built-in A/D and D/A converters. A single-cable remote control is supplied. Also new from Sony was the DSX-87 sampling rate converter. This two-channel unit with its own internal clock can convert in real time from 44.056 (for video-based PCM converters) to the 50.35 kHz sampling rate used in Sony's 3300 series open-reel digital recorders. Inputs are also available for external system clocks, allowing interconversion between other sampling frequencies in 7:8 or 8:7 ratios up to a maximum frequency of 55 kHz. The DSX-87 avoids the problem of leaving the digital domain, going to analog, and returning to digital when dubbing between recorders with different sampling rates.

AUDIO • February 1980

FINALLY, THE EGG.

Leigh pioneers the new shape of sound.

Leigh is proud to lead the way into the Eighties with a shape that will revolutionize the world of speakers. The new shape of sound: The Leigh ECD. You'll probably call it The Egg. It represents the breakthrough in speaker design that everyone has been waiting for.

We've put our 56 years of experience into producing this speaker. The ECD is molded from energy absorbing compounds

*Elliptically Controlled Diffraction

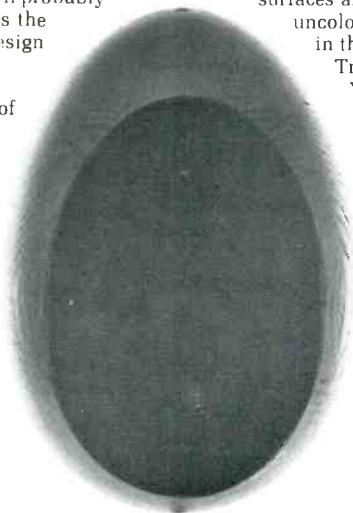

which permit the use of continuous interior curves and create its unique sound.

Sound so pure, sound unfettered by flat surfaces and sharp edges. Sound so uncolored it seems to just appear in the air.

Try a pair.

You can position them almost anywhere... floor, ceiling, walls. Then sit back and let the new shape of sound wash over you. Unforgettable!

Available at leading audio dealers in Canada and the U.S.
For the name of your nearest dealer.

write to Audio Marketing Group, Leigh Instruments Limited, Audio and Power Division,
350 Weber St. North, Waterloo, Ontario, Canada, N2J 4E3
Telephone: (519) 884-4510. Telex: 069-55440

LEIGH

Listen to Leigh

Enter No. 20 on Reader Service Card

The weakest link in your hi-fi system isn't in your system.

You could spend thousands of dollars on your stereo system and still not hear its full musical potential. That's because all hi-fi systems, even the most sophisticated, have one weak link — *the music source itself.*

Dynamic range (the difference between the loudest and quietest music passages) is one of the primary elements that creates the power and excitement of a live performance. Records (even digital and direct-to-disc), pre-recorded tapes and radio broadcasts sound lifeless in comparison because they're missing

more than 1/3 of this vital dynamic range. But add a dbx Dynamic Range Expander to any system, large or small, and the missing dynamics are amazingly restored.

dbx offers three state-of-the-art expanders that let every stereo system flex its musical muscles. The 1BX, 2BX, 3BX Dynamic Range Expanders provide as much as a 50% improvement in dynamic range, with the additional benefit of up to 20dB reduction of background noise. Any

mode will let you enjoy *all the music* you never heard from your record and tape library.

Don't let the weak link make your investment in a good stereo system worthless. Visit your nearest dbx dealer for a demonstration of the dbx dynamic range expander that best fits your budget. Experience all the emotional impact and realism that was missing from your music. Records, tapes and radio broadcasts never sounded so good.

dbx, Incorporated, 71 Chapel St., Newton, MA 02455. (617) 964-3210.

dbx

Making Good Sound Better

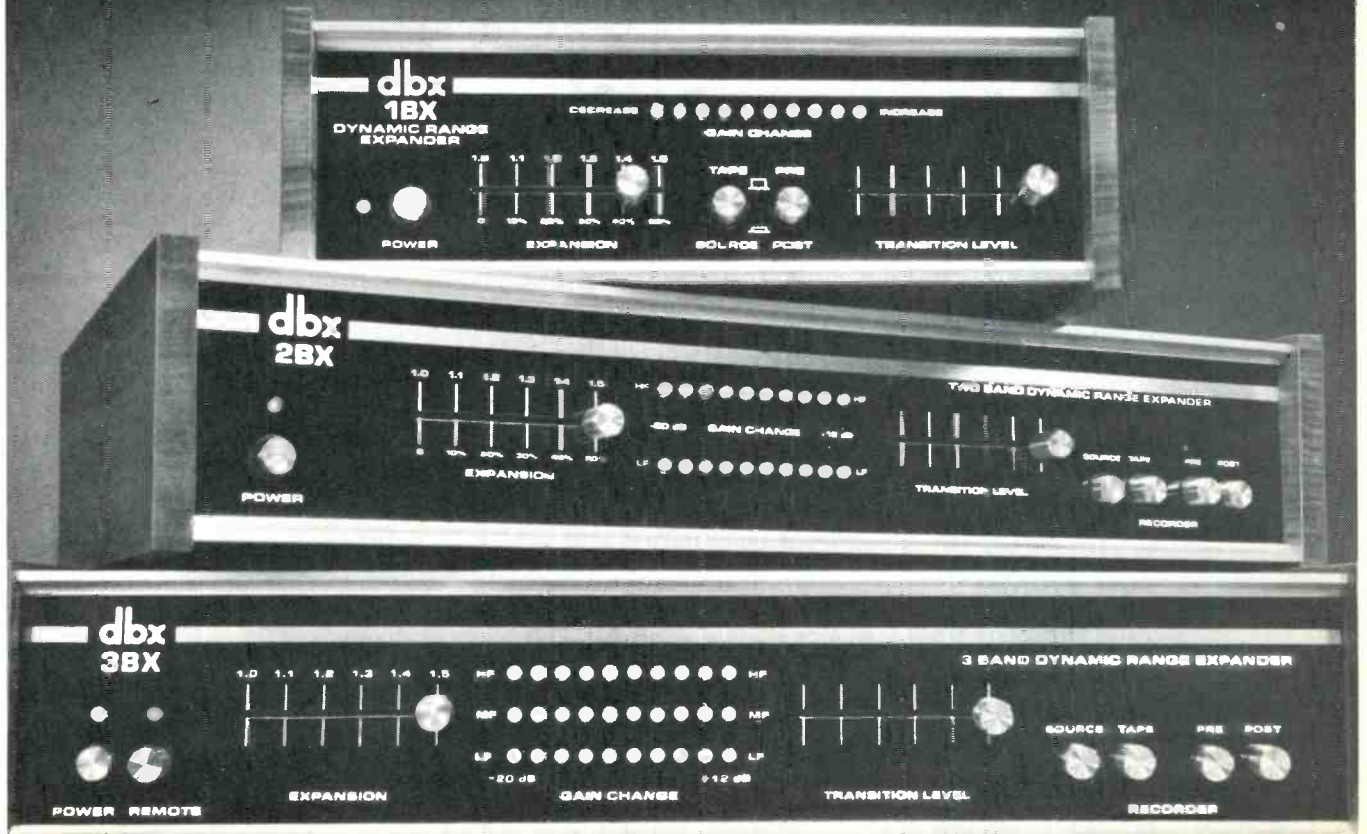

Enter No. 9 on Reader Service Card

Interface: C

Series II It sounds like music.

Interface: C Series II is the fulfillment of our six-year association with optimally vented speakers based on the theories of A.N. Thiele—speaker designs first introduced by Electro-Voice in 1973. The Interface: C offers you a unique combination of high efficiency and high power capacity—the only way to accurately reproduce the 120+ dB peak sound pressure levels found in some types of live music.

The SuperDome™ tweeter, an E-V exclusive, and the VMR™ vented midrange driver, the first to apply optimally vented design to mid frequencies, ensure your music is reproduced without the coloration normally found in other high-efficiency drivers. An honest 30 Hz low end totally eliminates the need for expensive subwoofer assemblies.

When you spend \$1,000 for a speaker system, get your money's worth. Audition the Interface: C Series II at your nearest Interface dealer. If you want a speaker that sounds like music, the Interface: C Series II is the one you'll buy.



Electro-Voice
a gulton company

600 Cecil Street, Buchanan, Michigan 49107

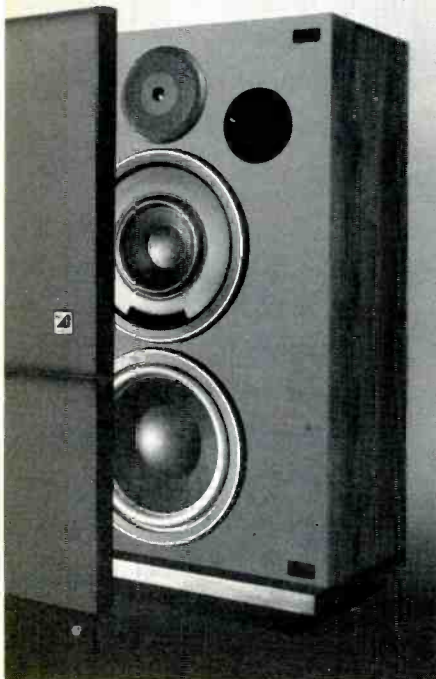

Enter No. 10 on Reader Service Card

Lastly, Sony showed their new PCM-100 digital audio processor, a sort of upgraded version of their original "consumer" PCM-1 unit. The PCM-100 can be used with either Betamax or U-Matic video recorders. The PCM-100 uses the new Electronic Industries Association of Japan (EIAJ) standard of 14-bit linear quantization with the usual 44.056-kHz sampling frequency. Dynamic range is claimed to be greater than 85 dB, with less than 0.05 percent peak harmonic distortion, and a frequency response flat within ± 2 dB from 3 Hz to 20 kHz. It is interesting that Sony suggests that the PCM-100 is especially suited to mass duplication of digital music VCR tapes. One PCM-100 unit between two VCRs is all that is needed for digital-to-digital dubbing. Sony claims that even multigeneration dubs will be identical to the digital master.

Over At Pioneer

In other digital activity at the Convention, Pioneer made a very strong case for the dual-purpose PCM disc, showing their laser/optical PCM player for video and PCM audio discs. While their player can handle laser-scanned video discs and may have some compatibility with the Sony video disc, they emphasized its digital audio playback capabilities. The quantization is 16-bit uniform, with a sampling frequency of 50.35 kHz. Pioneer claims a dynamic range of 96 dB and a frequency response of ± 0.5 dB from 2 Hz to 20 kHz. They also note their optical disc system has a bandwidth of 10 MHz, three times greater than ordinary home VCR systems. Playback is via a diode laser on the disc spinning at 1800 rpm. Interestingly, the Pioneer disc has four channels with more than 80 dB separation between channels. Now that is what you call discrete! With four-channel sound, playback time is one hour per side; with stereo playback, it is two hours per side. Imagine—most operas could be recorded on one disc of 301-mm diameter! I should note that at the recent Japan Audio Fair, JVC showed a 4-channel version of their PCM capacitance audio disc.

There was no digital recorder shown by Ampex. They actually have tested several experimental units but feel further research into digital technology is required to satisfy their criteria for a digital recorder. In the meanwhile, realizing that analog recording is very much with us and will be around for some time to come, they introduced a new generation analog recorder, the ATR-124. This is, in essence, a 24-channel version of the ATR-100 using two-inch tape. Ed Engberg, the Ampex de-



Ampex ATR-124

sign engineer who originally worked on the ATR-100 and is their newly appointed audio products manager, was kind enough to give me an operating run-through on this incredibly versatile machine, which appears to do everything for the studio recording engineer but shine his shoes! Even though 2-inch tape is used, the ATR-124 has the same kind of closed-loop, d.c. servo transport that maintains constant dynamic tape tension at each reel; in all operating modes, without pinch rollers. New flux gate record heads combine recording and sync playback windings on one head. As in the ATR-100, recordings are phase equalized. Input and output modules are transformerless. The ATR-124 handles up to 16-inch reels for longer recording time at 30 ips. There is programmable monitoring with memory, with a battery-powered backup memory in case of a.c. power failure. If there is something wrong with a particular channel (or channels), the VU meter for the channel in question will flash a red warning. With dynamic reel-tension controls, it is possible to intermix reel sizes, i.e. 5-inch with 16-inch. The ATR-124 "Setup Memory" will store four individual setups of 24 channels each. All controls are touch-sensitive membrane types, linked to microprocessors. The same is true in the remote control unit. There is a "rehearse" control button, permitting manual rehearsal of a setup before actually committing it to final recording. And on and on. Quite a machine!

Next month I'll wind up the AES 64th Convention report with a number of interesting items, including a new addition to the ultra versatile BADAP unit from Barclay Analytical that shows a color stereo display on a CRT and the *out-of-phase* components in a contrasting color display!

AUDIO • February 1980

TEAC TODAY: THE X-SERIES.

You're looking at four new machines that have more in common with data recorders than audio recorders. Together they are called the X-Series. And they bring a totally new kind of technology to the open reel format.

Each X-Series transport is an instrumentation mechanism. For 15 years, this TEAC design has stood the grueling test of time in computer installations where dependability is worth millions.

The basic configuration is closed-loop dual capstan. It's extraordinarily quiet, stable and precise. Wow & flutter is very low. Speed accuracy very high.

Three DC motors drive the tape. They're used to keep changes in motor temperature to a minimum under different loads so constant torque is maintained.

Our Magnetfloat flywheel assembly, a completely new concept, uses magnetics rather than mechanics to eliminate problem-causing springs and pressure plates. Axial variations between the tape and capstans are prevented so proper tracking is assured. The result is highly accurate audio reproduction even after years of hard use.

The X-Series transport maintains ideal tape-to-head contact. Audible drop-outs, level and frequency losses are absolutely minimized. Frequency response is wide and flat. And signal articulation is unusually clear.

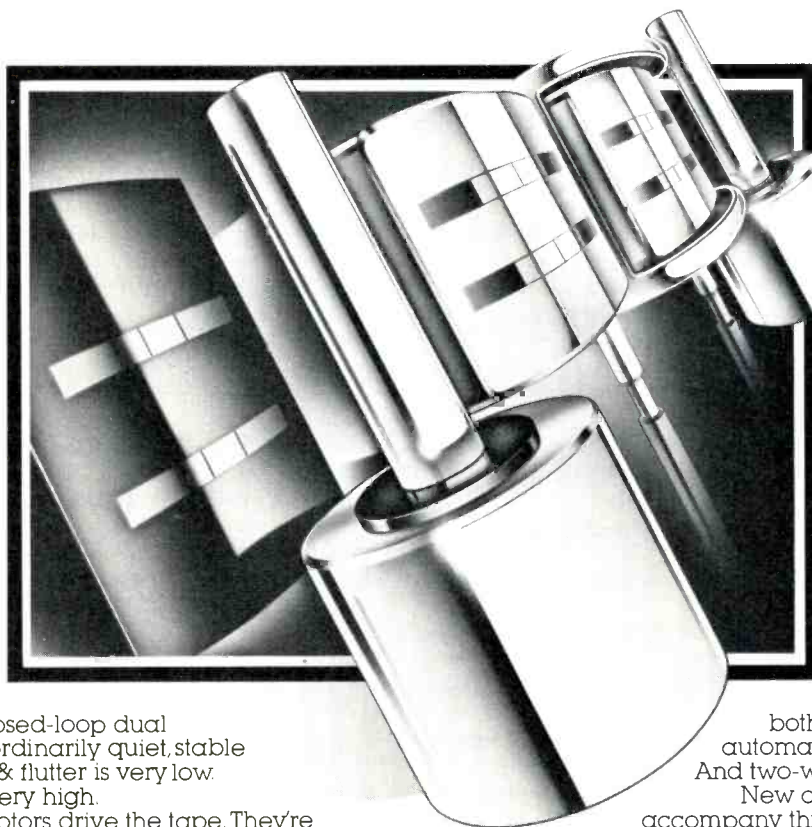

The brain behind the transport is our LSI control chip. It eliminates the need for mechanical relays so transport control is faster, more positive and reliable. The LSI also lets us provide full motion-sensing in the X-10 and X-10R.

Within the X-Series, machines have been specifically designed for bi-directional record and playback. Perfectly symmetrical head stacks (6 heads in all) assure top performance in

both directions. There's automatic reverse and repeat. And two-way cue monitoring.

New audio electronics accompany this new transport technology. Record and playback amplifiers are quieter and completely free of audible distortion. The sound is cleaner, more faithful to the source. The fidelity is unsurpassed.

An option previously available only on our professional recorders can now be added to any X-Series machine. Called dbx 1,* this noise elimination system adds 30dB to the already high S/N and over 10dB of headroom to give you master-quality recordings.

If your audio perception is critical, your listening standards high, audition an X-Series recorder. The performance is flawless. The sound peerless.

TEAC®



*dbx is a trademark of dbx, Inc.

Real Power for the Real World: The Apt 1 Amplifier



Apt Corporation believes there's only one good reason to create a new product: a genuine need. The Apt 1 Amplifier is just such a product. With 3 dB of Dynamic Headroom, it can deliver as much as *twice* its 100w average rated power (20 Hz–20 kHz @ 0.03% THD) on musical peaks—just as program material so often requires. And, it can deliver this extra performance into any actual loudspeaker, not just on the test bench. The Apt 1 also incorporates new approaches to power supply, driver stage, and protection circuit design, which all contribute to a uniquely *useful* amplifier.

Problem Solving in a Real System: The Holman Preamplifier



You don't live in an ideal world—neither does your stereo music system. The Holman Preamp is the result of over 2 man-years of research into how and why components behave in real-world hifi systems. As such, it provides an unprecedented balance of features and performance, which combine toward a common goal: *sonic excellence*.

The Holman Preamplifier and the Apt 1 Amplifier; individually or together they make music systems work better, and *sound* better.

For information, check the appropriate box(es) below and send with your name and address to:

Apt Corporation

Box 512
Cambridge, Massachusetts 02139

- Apt 1 Amplifier brochure and the name of your local dealer.
- Holman Preamplifier brochure.
- For an Apt 1 Owner's Manual, please send \$4 (\$5 foreign).

Audioclinic

Joseph Giovanelli

FM Distortion vs. Signal Strength

Q. I notice a peculiar effect from my tuner. I have it connected to a simple dipole antenna made from a 60-in. length of twin lead. I get plenty of volume and a strong signal on the tuning indicator from most New York-area stations, although I live 20 to 30 miles away. There seems, however, to be a harshness in the upper midrange and treble passages during the playing of orchestral music. The harshness does not seem to be present in solo and voice passages. I believe that I get a definite improvement when I connect my TV antenna to the tuner.

— Name withheld

A. The distortion you notice on your FM tuner may, in part, be caused by insufficient signal strength. In some tuners, the i.f. bandwidth increases with signal strength. This increase takes place even when the limiters begin working. I have noticed that in some tuners, especially those of older design, the i.f. bandwidth may be narrow enough under weak or even moderately strong signal conditions that the i.f. system cannot accommodate a fully modulated FM signal.

By connecting your tuner to an outdoor antenna, signal strength is increased, and i.f. bandwidth will increase. Hence, audio quality improves.

It may also be that the outdoor antenna is less subject to multipath reception than the indoor antenna. Such reception problems can lead to distortion. If possible, therefore, use the outdoor antenna. If this is not possible for some reason, try orienting the indoor dipole for best signal quality, regardless of signal strength.

Loudspeakers and SPL

Q. I have heard from friends that the Dahlquist DQ-10a speaker would create too much sound pressure for my neighbors to endure at "normal" listening levels, which for me are 85 to 90 dB as indicated on my SPL meter. I have been told that I should live in a detached home to use such a speaker. Is this true? — B.L. Byrns, Beltsville, Md.

A. Any speaker — Dahlquist or otherwise — can produce listening levels which will annoy neighbors. This fact is not a reason to buy or not buy any given speaker. For example, a stove is

capable of heating up a frying pan to a point where the fat can catch fire. This is not a reason to get rid of the stove; rather, it tells us to use the stove with care. This same logic applies to the use of a loudspeaker system. Of course, any reasonably good (or better) speaker can be made to produce high SPL, but by turning the volume control down, the sound level won't be too loud for you or your neighbors. Use your sound system to suit your particular circumstances.

Tube Substitution

Q. Being of the old school, I still like and use tube amplifiers. The tube line-up of my present amplifier is: EF86, 6SN7GTB, two-6L6GBs and a 5U4GB.

I would like to have a complete kit of spare tubes. I have been considering the purchase of a pair of 6L6GCs and a GZ34 and substituting these for the 6L6GBs and for the 5U4GB.

Is there a reason why these substitutions should not be made? Do these tubes produce any change in operating conditions such as undesirable increased voltages? — John Kogler, New York, N.Y.

A. I see no reason why you cannot substitute the tubes as you have outlined. The GZ34 has a definite advantage over the 5U4. This tube will not warm up until the other tubes in the amplifier have done so, which will eliminate the high, no-load voltage that stands across the filter capacitors when the quick-heating 5U4 is used.

Eliminating this no-load voltage is especially useful now, inasmuch as the filter capacitors in your amplifier are, no doubt, quite old. The high, no-load voltage could otherwise cause these capacitors to break down.

The internal resistance of the GZ34 is a bit lower than that in the 5U4. This will result in slightly higher operating voltages, but will in no way impair the operation of your amplifier.

The 6L6GC is a bit more rugged than its predecessor, so this is a good change, too. A

If you have a problem or question about audio, write to Mr. Joseph Giovanelli at AUDIO Magazine, 1515 Broadway, New York, N.Y. 10036. All letters are answered. Please enclose a stamped, self-addressed envelope.

AUDIO • February 1980

The Universal Expander

Dynamic range limiting during the production of records (and of FM broadcasts) has long been a source of irritation for music lovers. As playback equipment improves, the limitations of most program material become more and more obvious. The vast majority of records are produced with the lowest common denominator in mind—a system that is restricted in its ability to recreate natural dynamic range.

With the introduction of the Dynamic Expander, MXR's Consumer Products Group has achieved its goal of providing a signal expansion technique for all types of music compatible with the finest audiophile equipment available.

Enter the typical dynamic range expander: While dynamics are restored, a series of disturbing side effects becomes apparent. Because typical expanders cannot distinguish scratches, ticks, pops, and rumble from music, these noises trigger the expansion circuitry. More importantly, because most existing expanders have a fixed value release time, they seem to 'pump' with some music, and hiss or 'breathe' with other kinds of music.

In most cases these drawbacks have outweighed the advantages of expansion for the critical listener.

Enter MXR's Dynamic Expander: a linear signal processor with up to 8 dB upward expansion (restoring musical peaks) and as much as 21 dB downward expansion (reducing noise). MXR has solved the problem of 'breathing and pumping' by providing a variable release-time control that tailors the response characteristics of the expander to the program material.

A sophisticated level detection circuit discriminates between music and unwanted information such as

rumble and scratches. To monitor gain changes, a unique LED display accurately indicates the expander's effect on the signal whether in or out of the circuit. A level control adjusts the detector's sensitivity to optimize the expansion for varying signal levels, and additional controls provide in/out bypass switching and versatile taping facilities.

The MXR Dynamic Expander preserves the bandwidth, stereo image, and spectral balance of the original signal even after processing. Dynamic range expansion that is musically natural will restore the excitement and nuance that makes live music so emotionally satisfying, and will let you rediscover your cherished recordings. Harnessing innovative technology and sophisticated production techniques, MXR continues its commitment to the music lover.

The expanding universe of signal-enhancing equipment from MXR's Consumer Products Group gives demanding music listeners maximum performance from their playback systems regardless of room acoustics or program deficiencies. The MXR Comander allows you to maintain the dynamic range of source material through open reel or cassette tape decks. Environmental equalization is easily achieved with your choice of stereo 10 band (full octave), stereo 15 band (two-third octave) or professional one-third octave equalizers all built to the exacting performance specs for which MXR is famous. See your MXR dealer.

MXR Innovations, Inc., 247 N. Goodman Street, Rochester, New York 14607, (716) 442-5320

MXR Consumer Products Group



The forum

Equipment Directory Specs

The Annual Equipment Directory published each October by *Audio* is certainly a service to the buying public since it contains so many specifications on so many pieces of equipment. But the reader clearly is invited to make comparisons among brands, and within a brand, using the published specifications as guidance. For example, a listener could rightly want to know how much money needs to be spent to achieve a certain level of performance, or where more money spent yields ever decreasing returns.

Unfortunately, in several key areas there is much left to be desired to make such comparisons useful. Obviously it is the manufacturers who must supply accurate data to *Audio*; no one organization could hope to make the 40,000 measurements necessary to publish such a comprehensive listing. But there are often conflicting standards which result in measured, but not real, differences. Even within one standard, setup conditions can also influence the results.

Outlined below are some of the more obvious areas where comparisons must be made with a grain (should I say a shaker?) of salt.

Phono Signal-to-Noise Ratio. Phono signal-to-noise is the specification with the largest deviation from reality. This is clear in just glancing down the

range of stated signal-to-noise ratios; the range encompasses figures from 60 to 160 dB! This should be and is unbelievable, and the principal problem with it is that it sours people on the ability of competent engineers to make real, valuable measurements. We often hear the argument voiced that measurements don't mean anything because the instruments do not measure anything like the way we hear. In fact, IHF Standard A-202 specifies a "dummy" source impedance and appropriate psychometric weighting to closely associate measurements and listening.

The extreme range of the signal-to-noise specifications should give away the fact that manufacturers are not uniformly using the standard. While probably none of the measurements is an outright lie, the range itself should tell us that the results are not credible for comparison. And this indeed is the case.

The problem is that some manufacturers are measuring with a shorted input, while others employ the cartridge-like source impedance specified by IHF A-202. The *real* problem here is that one can actually design for better performance with a short circuit than with a cartridge, then measure with a shorted input and get phenomenal signal-to-noise ratios which are not in any way achievable in practice.

The only way to obtain a signal-to-noise ratio, re: 5 mV, "A" weighted, with the IHF source impedance connected, would be to reduce the temperature of the source impedance to within 2 millionths of a degree of absolute zero! Any actual source impedance has associated with it a certain amount of noise due to the random motion of electrons in a conductor at room temperature (similar to the Brownian motion of electrons in the atmosphere). The only way to eliminate this noise would be to reduce the temperature of the source impedance or cartridge to absolute zero (one visualizes mad-scientist experiments with tanks of liquid nitrogen connected to tubes running down the tonearm to supply the cartridge with cold).

The noise level of the IHF standard source-impedance terminated with 200 pF and 47 kilohm is 78 dB below a 5-mV, 1-kHz input when "A" weighted. Since any realizable circuit will add some noise, signal-to-noise ratio numbers close to this have likely been measured in accordance with the standard and may be compared. Of course, some manufacturers are more conservative than others: Some give the limit of production, while others give the average.

Conclusion: One should look on all numbers greater than 78 dB as probably representing a shorted input con-

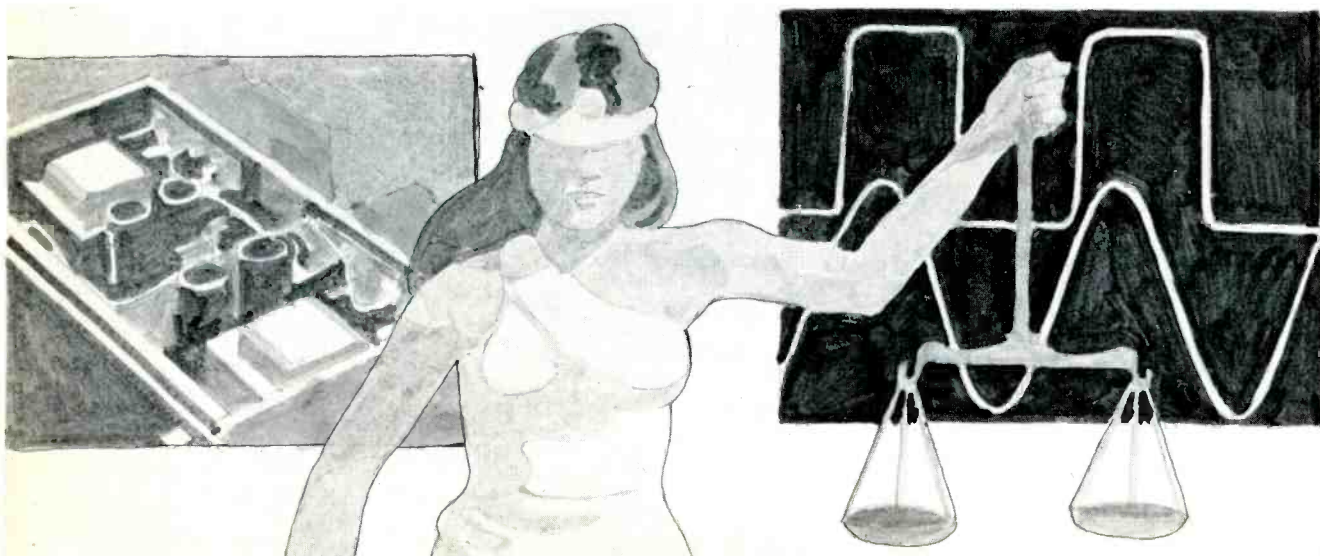

Why Yamaha speakers sound better than all the others. Even before you hear them.

To make a speaker that produces accurate sound is not simple. It requires painstaking attention to detail, precise craftsmanship, and advanced technology.

And that's where Yamaha comes in. We build all our speakers with the utmost precision in every detail.

As the premier examples of Yamaha loudspeaker craftsmanship, read what goes into the two speakers shown, the NS-690II and the NS-1000M. Then you'll understand why Yamaha loudspeakers sound better. Even before you hear them.

Precision Yamaha crafted cabinetry – (1) The walls on these, and all Yamaha speaker cabinets, are sturdily braced and crossbraced at every possible stress point. (2) The corner seam craftsmanship is so fine that it looks like the cabinet is made from one continuous piece of wood.

The back panels on these speakers are flush-mounted for maximum air volume within the cabinet. (3) Inside, a 3/4" felt lining "decouples" the cabinet from the drivers to achieve acoustic isolation of the woofer from the cabinet. (4) Thick glass-wool also aids in damping the woofer for maximum performance.

Lift one of these Yamaha speakers. It's uncommonly heavy and sturdy. (5) We even glue and screw the woofer cutout from the baffle to the inside rear panel for greater cabinet rigidity.

Now knock on the cabinet. It will sound as solid and substantial as it is.

Precision Yamaha Drivers – (6) The drivers are mounted on computer-cut baffle boards with exacting, critical tolerances to insure precision fit. All Yamaha speakers are acoustic suspension design, and this precise fit is critical for an airtight seal and optimum woofer recovery.

The drivers on these, and all Yamaha speakers, are flush-mounted on the baffle board to avoid unwanted diffraction of the sound waves. (7) This is especially important because all our tweeters and mid-high range drivers are the maximum-

dispersion dome type for the most natural reproduction of voice and instruments.

(8) We use chrome-plated machine screws (rather than wood screws) with two washers (regular and lock) to insure an unyielding mounting.

(9) The speaker frames shown are die cast rather than stamped. That's so they won't twist and alter the voice coil alignment during assembly and use.

Other Precision extras – All terminals are quick connect, screw-mounted assemblies.

(10) The wire leads are carefully soldered, not clipped.

All our speakers use full LRC crossover networks. These crossover networks are among the most advanced available.

Precision that stands alone – There's more. Much more. But, there is another fact of Yamaha loudspeaker construction that simply stands alone in the industry. Each component used in the two Yamaha speakers shown is manufactured by Yamaha. From the hefty die-cast speaker frames to the unique, ultra-low mass beryllium dome diaphragm.

That's a statement no other manufacturer can make.

And therein lies Yamaha's story. If we put this much care and craftsmanship into the making of our components and cabinet structures, then imagine the care, precision and craftsmanship that go into the quality of the final sound. A sound built upon Yamaha's unique 98-year heritage as the world's largest and most meticulous manufacturer of musical instruments. From our most economical loudspeaker to our top-of-the-line models shown here, Yamaha retains the same attention to detail and craftsmanship.

Look before you listen. You'll be convinced that Yamaha loudspeakers sound better than the rest. Even before you turn them on. Then ask for a personal demonstration of these and

other Yamaha loudspeakers at your Yamaha Audio Specialty Dealer, listed in the Yellow Pages. Or write us: Yamaha, Audio Div., P.O. Box 6600, Buena Park, CA 90622.



dition and therefore not accurately reflecting the real-world condition of having a cartridge source impedance connected. Remember that design for a shorted input can yield worse results when a cartridge is connected than design for a cartridge source impedance.

Frequency Response. In the section on power amplifiers, "frequency response" was taken by many manufacturers to mean "power bandwidth." This was because of the inclusion of the phrase "at rated power" in the description of the column for frequency response, which implies that the question really asks for the "power bandwidth" rather than the "frequency response." Unfortunately, a number of manufacturers ignored the "at rated power" statement and provided a specification for low-level frequency response. This is clear because some of the claims stretch out to 250 kHz; I am certain they didn't intend this to mean that the unit will produce rated power at rated distortion, or lower, at that frequency! Furthermore, a specified frequency response without a statement of the deviations from flat in dB is practically useless.

Another influence on frequency response measurements, especially of preamplifiers and integrated amplifiers, is the fact that the setup conditions may change the response dramatically. For example, one could choose to rate the response only with a tone-defeat switch engaged. Or one could rate the response with the tone controls in but adjusted to give the flattest response, whether that response corresponded to the position marked flat or not. Also, naturally enough, most frequency response measurements are made with all filters disengaged, even though the action of the filters is intended to be infra- or ultrasonic and engaged in normal operation of the unit. Thus, the manufacturer who gives response under the standard operating conditions is penalized.

Wow and Flutter. *Audio* clearly calls for wow-and-flutter measurements to be made to the internationally recognized DIN 45 507 standard (which corresponds to the American IEEE and many other standards). Yet, it is obvious to anyone who has ever made these measurements that the quoted specifications greatly exceed those that could be expected to be realized in practice.

For example, in a recent Boston Audio Society test clinic, I measured one turntable-arm combination of Japanese origin which produced 0.12 per-

cent DIN-weighted peak wow and flutter. The specification for this combination listed in *Audio* was 0.03 percent. Neither of these numbers would be important if both were inaudible. But Stott and Axon of the BBC found that the threshold for the perception of flutter among the most sensitive group of listeners was in the range of 0.12 percent peak. Thus, what we measured is probably audible wow and flutter to sensitive listeners with piano music program material, but 0.03 percent weighted peak is probably inaudible to listeners on music (although it could probably be heard on pure tones).

The difficulty is that there is a competing standard called JIS. This Japanese standard produces numbers which are highly optimistic compared with DIN-weighted peak measurements. Some manufacturers have signaled their use of the Japanese standard by adding the term "W rms," standing for weighted rms to the number, but others, however, clearly have not. In our measurements on 28 cartridge-arm-turntable combinations, the best measurement we got was 0.044 percent. The worst was 0.17 percent; the average was 0.09 percent.

Another difficulty is that the wow-and-flutter measurements on a turntable are influenced by the choice of arm and cartridge. If, for example, the peak in the frequency response (which occurs as a result of the resonance between the tonearm, plus cartridge effective mass, and the cartridge compliance) happens to land near a frequency equal to the eccentricity of a motor pulley, the flutter will be exacerbated. So a wow-and-flutter measurement without reference to a tonearm and cartridge is not too meaningful.

Also, in our measurements we used an aluminum-backed lacquer master which is very flat physically. We expect that slight warps on vinyl pressings would increase measured wow and flutter. If the frequency of the warp should land near the frequency of the tonearm/cartridge resonance, we might expect a fairly large factor of increase. So what we were measuring (and the way things are usually measured) may be hopelessly optimistic compared to practice.

These are but a few of the more blatant areas where specifications from one manufacturer do not correlate with specifications from another. And, of course, any such survey which can devote only limited space to an individual product does not tell the entire story on specifications for a unit. For example, most engineers believe that

distortions other than total harmonic distortion are more annoying to the listener, yet THD persists as most important nowadays by government decree. The only hope of covering all of the various distortion mechanisms which are known is to conduct a large variety of tests; such a variety could not be published in a format like *Audio's* Equipment Directory, yet a variety is almost certainly more important than the THD numbers published.

Tomlinson Holman
Apt. Corp.
Cambridge, Mass.

References

1. Maxwell, John, "Phono Cartridge Noise," *Audio*, March, 1977, pp. 40-42.
2. Holman, Tomlinson, "Noise in Audio Systems," AES Preprint No. 1418 (N-2) presented at the 61st Audio Engineering Society Convention, New York, November, 1978.
3. "Audible Effects of Mechanical Resonances in Turntables," Bruel & Kjaer Application Note.

The Editor Replies: Touché, Mr. Holman, and thank you for expressing one small part of the difficulties we have in putting together our Annual Directory. We do indeed ask for power bandwidth in an ambiguous manner, and it shall be changed this year.

While in the past we have viewed many specifications with a raised eyebrow, we have also treated them as axiomatically true — so long as they were responsive, that is in dB, rather than watts, if an answer in dB were being asked for. If the maker supplying the answer apparently knew what the question was, we have left the answer alone. Questioning the manufacturers' specifications, we have felt, is more properly left to reviewers in our Equipment Profiles section.

Each year, we hear from a number of irate readers (not to mention public relations agencies) asking why their favorite manufacturer has been omitted from the Directory. For the past three years, we have been fortunate to have enough space to reply that "neither makers nor products are deleted; we simply received no material." This year the deadline was some seven weeks after the Directory forms were sent out; phone calls were made and mailgrams sent as the absolute deadline approached. In the absence of material, we have felt that no listing is better than repeating that of an earlier year, and we do, of course, publish an Addenda. We are mightily sorry to leave anyone out, but we think it would be worse to include outdated specifications and old price information. Δ



Breakthrough

is a word that Realistic[®] uses very very very rarely. But nothing else describes our new STA-2200 all-digital receiver.

Could Radio Shack have scooped its peers (like Pioneer, Technics and Kenwood) in technology as well as features? Before you buy a conventional receiver that may be old-fashioned before 1980 is over, you can see what's really new at any of our stores. And decide for yourself!

The Computerized Tuner. Quartz-locked, microprocessor-controlled digital synthesis circuitry ends mechanical tuning errors and problems. No dial, no knob, no tuning meters. Instead, bright fluorescent digits display each station's frequency with absolute accuracy. Computer-type "feather-touch" tuning automatically scans up or down the FM and AM bands. Or you can select manual tuning. Store any six FM and any six AM stations in the microprocessor memory for instant recall. Even command the receiver to sample the stations in the memory, then touch-select the program of your choice. There's also battery back-up memory protection, Dolby[®] FM noise reduction, LED signal level indicators, and dual-sensitivity muting. And the display "off" is a quartz clock.

The High-Technology Amplifier. The Realistic STA-2200 uses a new generation of power transistors called MOSFETs. Their ultrahigh-speed operation brings you stunningly accurate sound reproduction through superior linearity, superior slew rate and inaudible TIM. They are more reliable than ordinary transistors and generate less heat. The amplifier features go on and on. 11-step bass and treble controls with turnovers for controlling ranges below 150 Hz and above 6 kHz. Tone control defeat. Hi-MPX filter. Monitoring and dubbing controls. And more. Power is 60 watts per channel into 8 ohms, 20-20,000 Hz, with no more than 0.02% THD. And one more thing: it's made by the same company that makes the breakthrough TRS-80[™] microcomputer.

STA-2200 is 599.95, at participating stores and dealers, price may vary. [®]TM Dolby Laboratories.



Radio Shack[®]
The Nationwide Supermarket of Sound[®]

ANOTHER VIEW OF

TIM

Part I

Robert R. Cordell

In recent years the use of large amounts of negative feedback in audio amplifiers has become controversial. Several people have examined the time-response properties of feedback amplifiers and have concluded that amplifiers which employ large amounts of negative feedback are prone to a form of high-frequency distortion called "transient intermodulation distortion" (TIM) [1-4]. Simply put, this distortion is said to occur when a signal changes too quickly for the amplifier to follow it properly.

The observation that a large amount of negative feedback causes TIM tends to run counter to the conventional wisdom that increased negative feedback generally improves a given amplifier's performance, so long as adequate stability is preserved. Several other researchers have recently questioned these findings and conclude that large amounts of negative feedback do not increase the possibility of TIM and can in fact improve amplifier performance as long as the amplifier has an adequate slew rate [5,6].

TIM is thus a popular subject surrounded by a certain amount of controversy. It has also become a frequently cited reason for degraded sound. Advertisements indicate that several manufacturers have been influenced by the discussions as well, some proudly pointing out that they use very little negative feedback.

Much of the misunderstanding and disagreement surrounding the subject seems to stem from inadequate consideration of the trade-offs and constraints involved in the application of negative feedback, especially as it relates to contemporary, real-world amplifier circuits. This is particularly true of feedback compensation. For this reason, we will take the time to review important negative feedback principles where necessary. Given a good understanding of negative feedback as it is applied to audio amplifiers, some of the TIM issues should become easier to resolve.

Before proceeding, we should point out that TIM, which is associated with negative feedback and its compensation, is only one form of high-frequency intermodulation distortion. The term "dynamic intermodulation distortion" (DIM) has been used to describe the general class of intermodulation distortions which depend on frequency as well as amplitude. TIM is thus one form of DIM. Since the product of frequency and amplitude implies rate-of-change, and since the maximum rate-of-change that an amplifier can follow is called its slew rate, the term "slew induced distortion" (SID) has also been used as a label for DIM. These distinctions are, however, relatively weak and unimportant, referring more to the mechanism than to the measured or audible effect. Because it is the source of most of the controversy, we will concentrate on TIM; however, our discussion will consider other sources of DIM as well, some of which may in practice be more serious.

Transient Intermodulation Distortion

First, let's take a look at the popular TIM arguments to get some background. What follows is a sort of composite paraphrasing of many of the arguments which have appeared.

Feedback amplifiers operate on the principle that a large portion of the input signal is cancelled by feedback from the amplifier output, leaving a small signal-plus-error which drives the amplifier so as to produce the desired output. In amplifiers with large amounts of negative feedback, this signal-plus-error is forced to be very small and thus, in theory, low distortion results. Under these conditions, the net gain with feedback (closed-loop gain) depends almost exclusively on how much of the output signal is fed back; i.e., if one-tenth of it is fed back, the gain will be 10. The large feedback factor (ratio of gain without feedback to gain with feedback) is obtained by putting a large amount of gain in the forward-path or open-loop amplifier. The open-loop amplifier is thus very sensitive and will overload if the error, for some reason, gets at all appreciable.

All amplifiers have a finite delay from input to output. If a feedback amplifier is driven with a signal having a very fast rise time (like the leading edge of a square wave), there will be a brief interval during which the open-loop amplifier sees the full input signal, undiminished by negative feedback which hasn't yet gotten back to the input. Overload will thus occur and distortion will result. The more sensitive inputs of amplifiers with high feedback factors are that much more prone to such an overload.

Since this form of distortion is brought about by fast transients in the input signal and because an overload condition causes intermodulation distortion, the phenomenon is referred to as transient intermodulation distortion (TIM).

Returning to the origins of TIM, the situation is further aggravated by the additional slowness of response introduced in the open-loop amplifier by necessary feedback compensation. Each stage in a multi-stage amplifier introduces phase shift that increases with frequency. Feedback compensation rolls off the open-loop response so that the feedback factor falls below unity before enough excess phase shift accumulates to cause instability or peaking in the closed-loop response. The frequency where the feedback factor falls to unity is called the gain crossover frequency. In order to achieve a stable gain crossover frequency, the 6 dB/octave compensation roll-off must begin at some lower frequency. Amplifiers with large feedback factors (at low frequencies) have more gain to "get rid of" and must start their compensation roll-off at a lower frequency, resulting in a smaller open-loop bandwidth. An amplifier with 20 dB of feedback needn't start its roll-off until 100 kHz for a 1-MHz gain crossover, while one with 60 dB of feedback must start at 1 kHz. The latter amplifier, with heavier feedback compen-

IS THIS THE BEST CARTRIDGE IN THE WORLD?

There are any number of cartridges available today that perform exceedingly well on paper.

On the other hand, the Adcom Crosscoil moving coil cartridge was designed to demonstrate its superiority in the only place it really counts, the record groove.

A superiority that becomes immediately apparent the first time you lower the Adcom Crosscoil onto a record and experience its uncanny ability to reproduce every nuance of the original performance with a clarity and subtlety of detail other designs don't begin to approach.

In fact, in a widely publicized challenge to other cartridge manufacturers* the Adcom Crosscoil out-measured and outperformed the entire field, more than 50 of the world's most highly acclaimed designs.

An impressive achievement? Just ask the also-rans.

No less impressive, however, is the innovative thinking and engineering that went into creating the Adcom Crosscoil. For it was decided that the Crosscoil would be the first cartridge to fully translate the theoretical advantages of the moving coil design into real world performance.

The cartridge takes its name from the unique "X" shaped armature upon which its generating coils are wound. The "X" shape permits many more turns of wire to be wound on each of the cross pieces as compared to conventional moving coil designs. In this way, output is increased significantly, while the overall weight of the cartridge is reduced.

In practice, the Adcom Crosscoil generates enough output to drive a standard phono input with-



out the need of an expensive transformer or pre-preamp. Thus, aside from the obvious cost savings, the Crosscoil eliminates a major source of noise and distortion.

Not only does the Adcom Crosscoil provide more output, but its moving mass is extremely low permitting its use in a whole new generation of low mass, high performance tone arms.

Additionally, a newly developed "controlled compliance" cantilever assembly with an optimized stiffness to mass ratio insures that the cartridge/tone arm resonance will fall exactly where it

should, above record warp and below audibility.

Finally, the Adcom Crosscoil's specially contoured LineTrace diamond stylus which is grain oriented and nude mounted, provides greater contact area between stylus and record groove minimizing record wear and extending bandwidth to beyond 60k Hz while reducing all forms of distortion to insignificant levels.

If you've read this far, it should be apparent that the Adcom Crosscoil is a signal advance in moving coil technology.

Is it the world's best cartridge? We think so. But we want you to make that happy discovery for yourself.

For additional information and an ear opening demonstration, write us for the name of your nearest Adcom Crosscoil dealer.

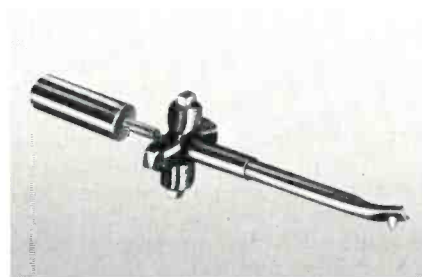

*A public demonstration at the Consumer Electronics Show in Chicago, June 1979

ADCOM CROSSCOIL™

ADCOM, 9 Jules Lane, New Brunswick, N.J. 08901

Enter No. 1 on Reader Service Card

© Adcom 1979

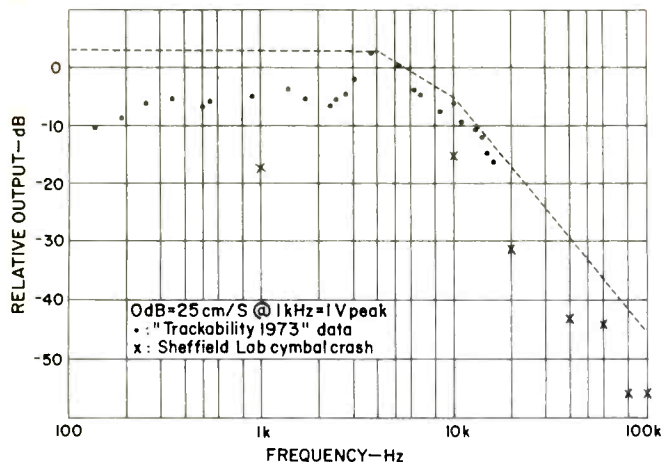

Fig. 1—Post-RIAA spectral distribution for phonograph records.

sation and a long open-loop time constant, is thus slower in responding to input signals.

In responding to a fast input signal (e.g., a square wave), a large internal voltage or current overshoot will be produced in order to quickly charge the compensating capacitor and overcome the effect of the long time constant it introduces. The large overshoot is produced during the interval between the fast input change and the time when the feedback catches up with the input, when a large difference or error signal is applied to the open-loop amplifier.

In some cases this overshoot may be 10 to 100 times as large as the nominal signal levels at that point. Unfortunately, the stages prior to the compensation point cannot always handle such a large signal without nonlinearity or outright clipping. If the overshoot causes these stages to clip or generate distortion, TIM results. When these overshoots are clipped, the amplifier is into the well-known phenomenon of slew-rate limiting.

It can be shown mathematically that if the input signal is bandlimited to a frequency less than the open-loop bandwidth of the amplifier, no overshoot can occur, even if the input signal is a bandlimited square wave. Thus, wide open-loop bandwidth eliminates the possibility of TIM caused by overshoots. Having wide open-loop bandwidth, in turn, places a limit on the feedback factor for a given gain crossover frequency. For example, if we choose an open-loop bandwidth of 20 kHz and a gain crossover frequency of 1 MHz, then we are limited to a feedback factor of only 34 dB.

The above explanation of TIM seems plausible enough, and it has appeared in various forms in many places. It is the origin of the popular belief that small feedback factors and wide open-loop bandwidth are necessary for minimizing TIM. Although it may at first glance seem convincing, this explanation is somewhat oversimplified and misleading. While some of the issues have been analyzed in great detail in technical papers, other more important considerations have been ignored. In several respects, the problem seems to lie with not seeing the forest for the trees. A few more recent papers have, however, done a very good job in lending insight and perspective to some of the more important issues [5,6].

The approach taken here will involve less detail and more scope and perspective. For example, we'll attempt to determine just how fast audio program signals really are. The length of the unavoidable time delay in the amplifier and how it is affected by feedback compensation is another important area in need of discussion. We will also examine the conditions governing overload of an amplifier's internal stages. This will be done in the context of a practical amplifier

topology with realistic combinations of feedback factor and open-loop bandwidth. Recognizing that in addition to limits on amplitude, amplifiers are limited to providing a maximum rate-of-change at their output, much attention will be paid to amplifier slew-rate performance and its relationship to TIM. Finally, techniques for measuring amplifier TIM performance will be discussed.

Program Characteristics

Just as all real amplifiers are bandlimited, so are all real program sources. No program source will ever produce a square wave with razor-sharp edges. In fact, not only are program sources bandlimited in the small-signal sense, but they are more seriously limited in large-signal bandwidth, or power bandwidth. As an example, a fine tape machine might be flat to 20 kHz at low levels, but it typically cannot produce anywhere near full output at 20 kHz. Such restrictions are usually due to equalization which pre-emphasizes the high frequencies so that the subsequent de-emphasis at the reproducing end will reduce high-frequency noise. High frequencies will, therefore, overload the medium more readily than low frequencies. Such equalization characteristics are common to almost every type of program source, including phonograph, FM, and tape. As a result, the maximum high-frequency output of each program source is constrained to rather well-defined limits.

Since signals with a large rate-of-change or "time derivative" are generally the cause of TIM, we need a way of characterizing the tendency of a given program source to produce them. Such a measure should not be absolute, like time derivative, but rather should be relative so that it can be applied equally well at different points in the system regardless of signal level. We will therefore use the ratio of peak time derivative to peak amplitude expressed in "volts-per-microsecond per volt" ($V/\mu s)/V$, and call it the normalized time derivative. The inverse of this quantity is similar to, but not quite the same as large-signal rise time. Knowing the normalized time derivative, we can go to any point in the system and, given the maximum amplitude at that point, determine the commensurate maximum time derivative.

With the exception of a microphone, the best source of fast program signals in the home is probably the phonograph. However, its performance is well-constrained by mechanical processes such as tracking. The performance is also well characterized. In Fig. 1, the dots are a scatter plot of maximum observed output levels at various frequencies from a survey of many records. These data were taken from the familiar trackability diagram widely published by Shure Bros. [7]. While the usual presentation is in terms of groove velocity, this information has been RIAA equalized and normalized to 25 cm/S at 1 kHz and 1 V peak. It shows what actually can be expected at the output of one's phono preamp (as shown, the data are not useful for points in the system prior to RIAA equalization, such as the phono preamp input). The data represented by the X's are spectral data for a single cymbal crash and were presented by Tomlinson Holman [8]. The crash is one from a Sheffield Lab direct-to-disc recording which is noted for its tracking difficulty.

With reference to Fig. 1, we see that the highest amplitude occurs at 4 kHz and is 1.35 V peak, while the highest time derivative occurs at 10 kHz and is $0.035 V/\mu s$. This results in a normalized time derivative of only $0.026 (V/\mu s)/V$. Thus, in a system subjected to a wide variety of material such as represented by the dots of Fig. 1, a point in the system which must handle an amplitude of 1 V peak with low distortion must handle a time derivative of $0.026 V/\mu s$ with equally low distortion.

Before proceeding further, we should take note of the fact that an advanced treble control will tend to increase the nor-

You know what they say about imitation.

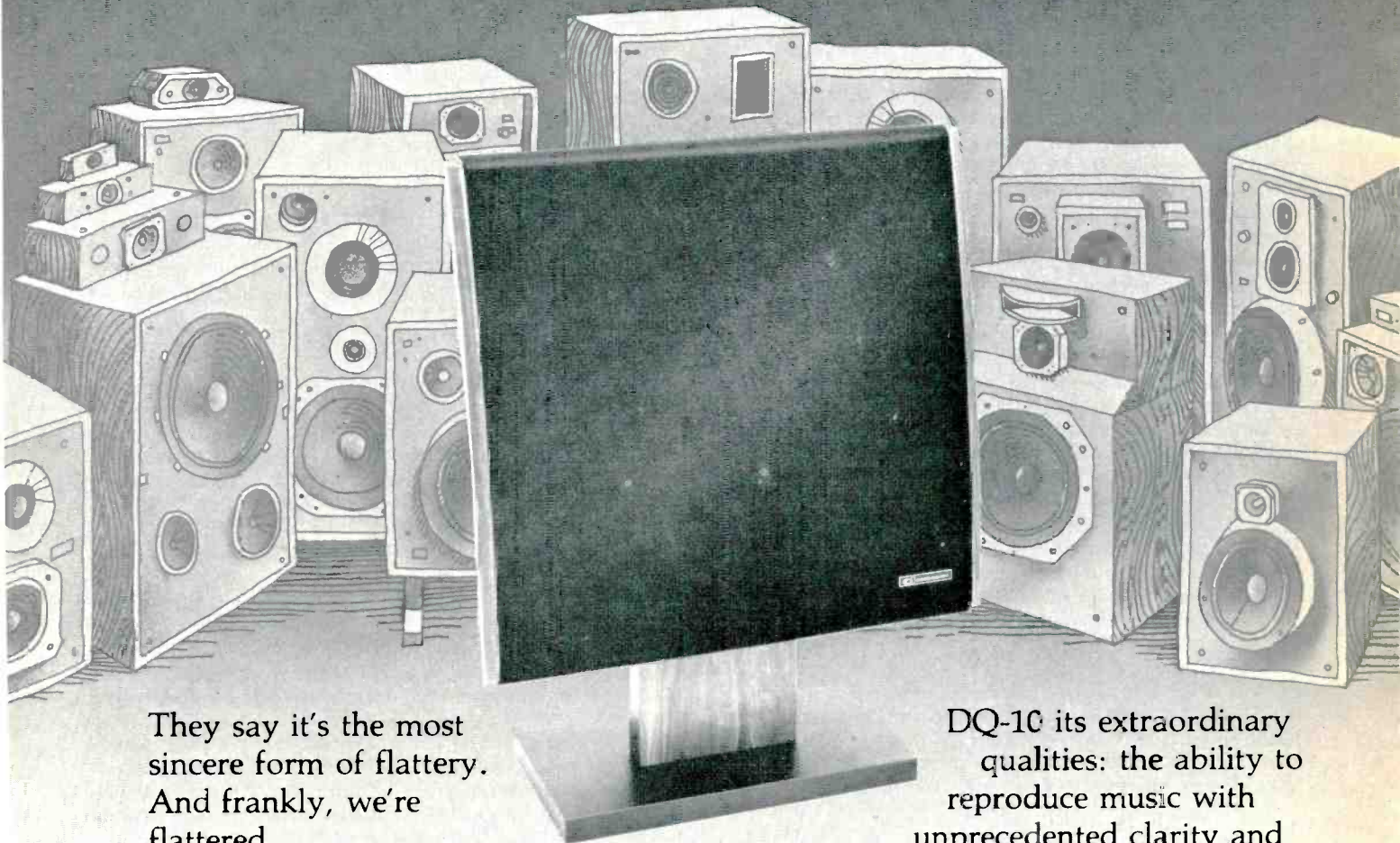

They say it's the most sincere form of flattery. And frankly, we're flattered.

The Dahlquist DQ-10 has become the most imitated speaker system in high fidelity. There's been a cascade of obvious imitations, with prices going up and down the scale.

But the Dahlquist approach is locked into patents embodying the solution to the critical problems of time delay *and* diffraction delay distortion. Thus, the impersonators can offer only the words, not the music of the original.

The Dahlquist Phased Array and Open Air Mounting patents give the

DQ-10 its extraordinary qualities: the ability to reproduce music with unprecedented clarity and spaciousness. It just doesn't make sense to spend hard-earned money for an imitation (at any price), when you can have a pair of the original at surprisingly low cost.

Write to us and we'll send complete information on why the DQ-10 sounds the way it does. Or better still. Ask your dealer for a demonstration. You may find that you don't care *why* it sounds so great. Only that it does.

DAHLQUIST

601 Old Willets Path, Hauppauge, New York 11787

Enter No. 45 on Reader Service Card

malized time derivative of the program, but not as much as one might at first think. The reason for this is found upon further examination of Fig. 1. The peak time derivative will increase in proportion to the greater amplitude of the high-frequency signals. However, most treble control action occurs between 2 kHz and 10 kHz, meaning that the overall peak amplitude (occurring at 4 to 5 kHz in Fig. 1) will increase somewhat as well. Based on these observations, we can conclude that 6 dB of treble boost will increase the normalized time derivative by perhaps 50 percent.

While the cymbal crash exhibits substantial ultrasonic content, its amplitude generally lies below the envelope of the other points. Notice that its mid-band recording level is actually rather low in comparison. Taken alone, the normalized time derivative for the cymbal crash might be fairly high, but the ratio of interest must be based upon the peak amplitude for all the music.

Even if the three highest points on Fig. 1 are ignored, an overall power bandwidth of less than 10 kHz is obtained, and a maximum normalized time derivative of approximately 0.05 (V/μS) /V results. By comparison, a 20-kHz sinusoid has a normalized time derivative of 0.126 (V/μS) /V.

Music, of course, produces many simultaneous points whose amplitudes and time derivatives add in some fashion to produce a total amplitude and a total time derivative for the complete spectrum. We can gain further insight by recognizing that for mid-band frequencies between about 500 Hz and 2 kHz, post-RIAA amplitude is directly related to recorded velocity. Above 2 kHz, post-RIAA time derivative and recorded velocity are directly related, i.e., a 50-cm/S, 10-kHz component produces the same time derivative at the output of the phono preamp as a 50-cm/S, 20-kHz component. This latter relationship is due to the integrating effect of the 2-kHz RIAA high-frequency roll-off. Knowing this, we can get a good idea of the normalized time derivative by assuming realistic values for the maximum total mid-band velocity and the maximum total high-frequency velocity. Notice that a smaller assumption for the maximum mid-band velocity yields a larger normalized time derivative. Keep in mind that the mid-band and high-frequency maxima need not occur simultaneously.

As an example, if we assume a maximum mid-band velocity of 25 cm/S and a large maximum high-frequency velocity of 150 cm/S (probably impossible to track), we arrive at a figure of 0.076 (V/μS) /V. Based on this figure, a 100-watt amplifier which can deliver 40 V peak with an 8-ohm load must cleanly reproduce signals with 3 V/μS time derivatives.

Fig. 2—Compensated and uncompensated power amplifier open-loop gain vs. frequency.

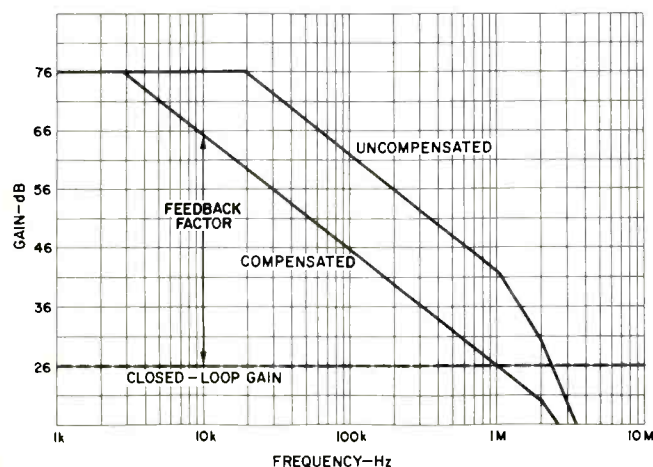

This figure may seem very small to some people, but the term "cleanly" is the key here. We are certainly not talking about the ultimate slew-rate capability of the amplifier, which generally occurs under nonlinear operating conditions. Clearly the amplifier must have some operating margin in order to satisfy the "cleanly" requirement. As we shall see later, in some cases this required slewing margin can be substantial.

Although it is very unlikely that any material will approach the 0.076 (V/μS) /V, figure, we can be even more conservative if we wish and simply say that a full-amplitude 20-kHz sinusoid, 0.125 (V/μS) /V, must be handled with adequate slewing margin. Requiring that a square wave bandlimited to 20 kHz, 0.25 (V/μS) /V, be handled cleanly would add yet another factor of two in conservatism.

Based on these observations, we may conclude that real audio signals are not nearly as fast as some would like to believe. However, this is not cause for complacency with respect to TIM. It merely gives us a more realistic perspective for dealing with the problem.

Low-Pass Filtering

It has often been suggested that a low-pass filter (LPF) be placed ahead of the power amplifier to assure that the program bandwidth does not exceed the open-loop bandwidth of the amplifier in order to minimize TIM [1-3]. Although we will see later that such a precaution has no bearing on TIM susceptibility, it is worth noting that the LPF will place a limit on the power bandwidth, and thus the time derivative, of signals applied to the power amplifier. In this latter respect, the LPF could prevent TIM if such a limitation were necessary. However, our earlier discussions showed that the power bandwidth of real audio signals is considerably less than 20 kHz. Assuming that an LPF cutoff of less than 40 kHz is unacceptable due to frequency-response error (-1 dB at 20 kHz assuming first-order cutoff), it is quite safe to say that such a filter will have no effect on TIM produced by program signals.

Ticks, pops, and mistracking may, however, produce considerably larger normalized time derivatives than program, at least in the case where wideband moving-coil cartridges are employed. Values as high as 0.1 to 0.2 (V/μS) /V may be encountered. However, even a step input will only be limited to 0.25 (V/μS) /V by a 40-kHz LPF. The filter will thus have only a limited effect on the smaller normalized time derivative of the ticks, pops, and mistracking. One also has to wonder how important TIM-free reproduction of these annoying signals really is. It is probably sufficient that slew-rate limiting not be encountered in the system under these conditions.

The only sensible reason for an LPF seems to be improved immunity to r.f. interference, if this is required.

Feedback Compensation

As mentioned earlier, feedback operates on the principle of feeding a portion of the output back to the input for comparison with the input signal. The loop so formed may be unstable if the phase of the signal is incorrect. Feedback compensation is employed to assure stability by controlling the net gain and phase shift a signal sees as it goes around the complete loop.

Since the role played by feedback compensation is crucial to the TIM distortion mechanism, and since in many TIM discussions it is not adequately considered, it is appropriate at this point to take a look at feedback compensation.

Because all real amplifiers have finite bandwidth, the gain and thus the feedback factor must begin to roll off at some frequency. In a multi-stage amplifier, each stage usually contributes one or more "poles" (6 dB/octave roll-offs) and accompanying phase shift. If at some high frequency we have

Very separate. Very together.



They're the Jensen Separates. An individual system of special high performance woofers, tweeters, and midrange drivers. And by separating them in your car, you'll come up with a very together sound.

Why separate them?

Because a car interior is acoustically very different from your living room. And in many cases a lot of the music may not even get to your ears.

Separating the drivers also opens up the chance to use bi-amplification. Which means better sound with better power level matching.

Divide and conquer.

We developed the Jensen Separates to deliver every last high, low and midrange signal your music contains. And to overcome any possible acoustic problem you may encounter.

Two individual 2" phenolic ring tweeter units are designed to be mounted high in the front doors. That way, every bit of their 4,000-20,000 Hz high frequency signals travel straight to your ears. With no stops in between.

Two 3½" midrange drivers

also mount in the upper front doors. And what a difference they make.

In this position their subtle 1,000-4,000 Hz middle tones fill in the gaps between treble and bass. While Flexair foam cone suspen-

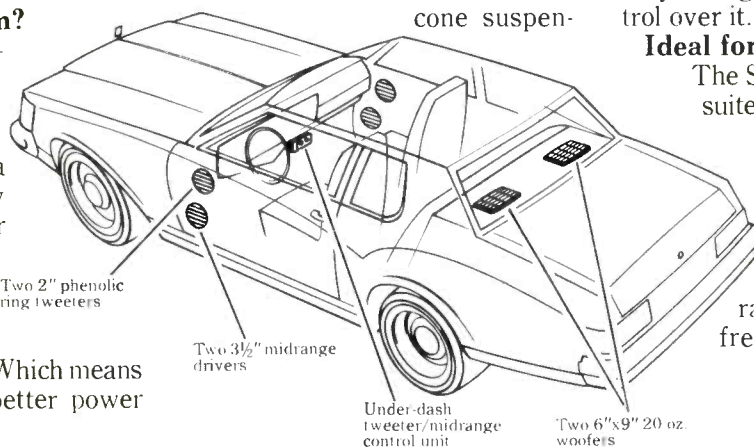

sion provides the extreme sensitivity needed for smoother sounding music.

For full, well-defined bass, a pair of 6"x9" woofers mount in your car's rear deck. There they can take advantage of the trunk's air space to create their magic.

New 20 oz. magnet structures give these woofers extra power handling capabilities and high efficiency. While the Flexair foam suspension affords low distortion from 35 to 1,000 Hz.

The control unit.

It contains two independent midrange and tweeter level controls for each channel.

So not only do the Jensen Separates deliver all of your music, they also give you the final control over it.

Ideal for bi-amplification.

The Separates are perfectly suited for a bi-amplified car stereo system. The woofers would then receive only the bass signals from one amp. While the tweeters and midranges receive the high frequency signals from another amp.

It gives the system much better power distribution for higher power levels, clearer music and less distortion.

Their time has come.

Experience the Jensen Separates. And discover how very together music in your car can be.

JENSEN

SOUND LABORATORIES

AN ESMARK COMPANY

Enter No. 41 on Reader Service Card

too much phase shift while we still have gain around the loop, we will have positive feedback and thus an oscillator. For this reason, the frequency at which the feedback factor has decreased to unity (i.e., the gain crossover frequency) is very important in determining amplifier stability. To prevent oscillation, the phase shift accumulated beyond the fixed 180-degree loop inversion must be less than 180 degrees at this frequency. In general, good engineering practice requires that less than about 135 degrees be accumulated, leaving a phase margin of at least 45 degrees. In order to obtain the required stability, feedback compensation is employed to deliberately roll off the gain so that the feedback factor goes below unity before too much phase shift accumulates.

The open-loop gain as a function of frequency for a typical power amplifier before and after feedback compensation is shown in Fig. 2. The closed-loop gain is shown as a dotted line at 26 dB, and the feedback factor is simply the distance between the solid and dotted curves. It is important to remember that each roll-off contributes phase shift (phase lag or delay) which increases with frequency, but which can never exceed 90 degrees. At its 3-dB point, or "corner frequency," each roll-off generates 45 degrees. The gain and phase characteristics for a single pole are shown in Fig. 3. Notice that a single pole placed at a low frequency can create a great deal of high-frequency loss without ever introducing

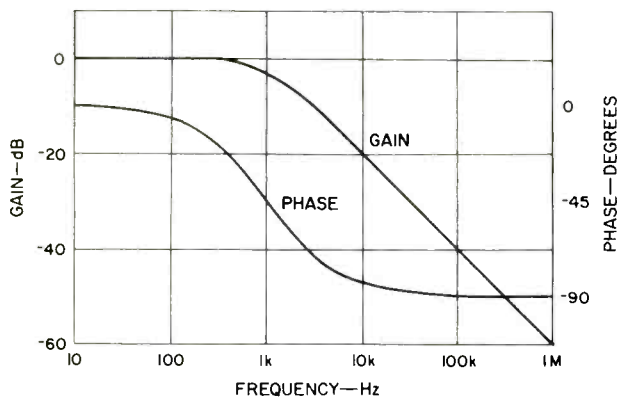

Fig. 3—Gain and phase characteristics for a 1-kHz pole.

more than 90 degrees of phase shift. This is the basis for what is called lag compensation.

A design with many poles situated below the gain crossover frequency will tend to be unstable, while one with only a single pole below this frequency will tend to be stable, even if that pole is at a very low frequency. The uncompensated amplifier in Fig. 2 crosses over at 2.4 MHz and has three poles below that frequency, while the compensated version crosses over at 1 MHz and has only one pole below the gain crossover frequency. As is the case in Fig. 2, the compensation network usually decreases substantially the frequency of one existing pole and may also significantly increase the frequency of another one. This effect is called pole splitting, and its double benefit further contributes to stability.

To summarize, the objective of feedback compensation is quite simple: Establish a gain crossover frequency low enough to achieve an acceptable phase margin. In a power amplifier, much of the phase shift at high frequencies is contributed by the output transistors, which typically have f_t 's (current gain-bandwidth products) of about 1 to 4 MHz. Output stages will tend to contribute rapidly increasing phase shift above this frequency. As a result, reasonable gain crossover frequencies for power amplifiers are generally in the range of 0.5 to 2 MHz.

A Typical Power Amplifier

To further put things into perspective, we'll now take a brief look at the operation of a practical power amplifier. This simple amplifier will provide a setting for the examples illustrating TIM considerations in the later sections. A simplified version of a popular amplifier topology is shown in Fig. 4. Transistors Q1 and Q2 form a differential amplifier which is the first stage of the open-loop amplifier. Here the feedback signal applied to the base of Q2 is subtracted from the input signal applied to the base of Q1. Notice that the feedback signal is divided down by R4 and R3, which set the closed-loop gain at about 20. Capacitor C2 allows full feedback at d.c. to assure a small output offset voltage.

The voltage difference between the bases of Q1 and Q2 is translated to a current signal which in turn drives the base circuit of the predriver, Q3. The resulting voltage signal at the collector of Q3 is delivered to the output with approximately unity gain by the complementary Darlington emitter-follower output stage. The primary purpose of the output stage is to provide current gain and thus present a relatively high-impedance load to the collector circuit of Q3. The collector current for Q3 is provided by a current source so that the only real load at Q3's collector is that presented by the output stage. This arrangement provides very high gain in the predriver stage, especially if the current gain in the output stage is high.

The uncompensated loop gain of this amplifier is shown in the top curve of Fig. 2 (assuming transistor betas of 50). Feedback compensation of this amplifier is provided by a single capacitor C3 connected from collector to the base of Q3. This type of compensation is often referred to as Miller-effect compensation.

At low frequencies, C3 is an open circuit and the gain is quite high. At higher frequencies, C3's reactance decreases, and it begins to form a tight negative feedback loop around Q3. At high frequencies, almost all of the signal current from Q1 flows through C3, rather than R2 and the base of Q3. Under these conditions, we can almost think of Q3 as an operational amplifier and its base node as a virtual ground. At mid- to high frequencies, the voltage at the collector of Q3 is then approximately the signal current from Q1 times the reactance of C3. Furthermore, the open-loop gain of the amplifier will simply be the transconductance (g_m) of the differential amplifier (here about 10 mA per volt) times the reactance of C3. Since this reactance is decreasing with frequency at 6 dB/octave, so will the open-loop gain of the amplifier. When this gain decreases to 20 we are at the gain crossover frequency (f_x), since the feedback path establishes a closed-loop gain (G_c) of 20. The choice of 84 pF for C3 yields a reactance of about 2000 ohms at 1 MHz, thus setting the gain crossover at that frequency and yielding the lower curve for open-loop gain in Fig. 2. Expressed in general terms,

$$C3 = \frac{g_m}{2\pi f_x G_c} \quad (1)$$

Notice that low-frequency considerations, such as feedback factor, do not influence the choice of C3.

Propagation Delay

Some authors have reasoned that an amplifier presented with a very fast transient will be without negative feedback for a short period of time until the feedback signal, having suffered inevitable delay, arrives to cancel most of the input signal [1,3]. During this delay time, it is reasoned, some stages in the open-loop amplifier may clip due to the unusually large input signal.

There is little question that such a problem will occur if a square wave with a 1 nS rise time is applied to an audio amplifier. However, to assess the practical likelihood of such

Revox B760. One touch tunes it. Perfectly.



Now there's a tuner that works as accurately as a radio transmitter and as easily as a car radio.

You can tune the B760 manually in increments of 25 or 50kHz, or program up to 15 stations in memory for instant selection. Just touch a button for the station you want, and in less than a second the muting light goes off and the digital readouts and tuning meters confirm your station selection.

Both memory and manual tuning are controlled by an advanced digital-frequency-synthesizing circuit with a differential phase-locked loop that compares the output of the master oscillator with a quartz crystal reference frequency. If there's any difference, corrections are made instantaneously, maintaining an accuracy of $\pm 0.005\%$. (That's better than many radio stations can achieve!)

The B760's CMOS memory is so sophisticated that it can automatically direct an antenna rotator toward each memorized station, and even has a battery pack to pro-

tect the memory if you unplug the tuner or lose AC power.

Other features include an optional plug-in Dolby circuit board, oscilloscope outputs to help you minimize multipath distortion, selectable 25, 50 or 75 microsecond FM de-emphasis, adjustable-threshold interstation muting, a headphone jack with level control and a high-blend switch to optimize reception of distant stations.

It's all put together with attention to detail and durability for which the Studer Revox company is so well known. With things like plug-in circuit boards, RF shields plated to resist oxidation and even a coaxial delay line to maintain proper phase, everything is made just a bit better than it has to be. Because we want everything to be perfect.

Studer Revox America, Inc.,
1819 Broadway, Nashville, TN. 37203 (615) 329-9576
Offices: Los Angeles (213) 780-4234
New York (212) 255-4462
In Canada: Studer Revox Canada, Ltd.

STUDER REVOX

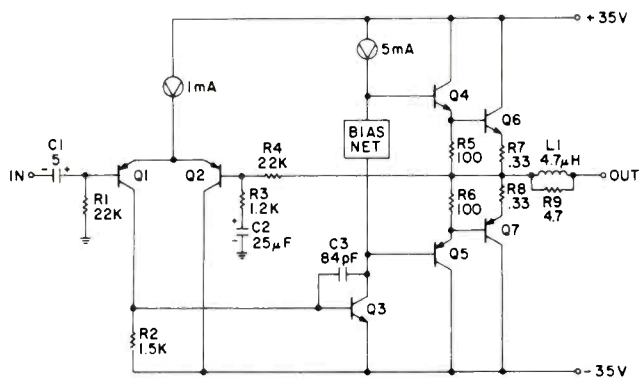

Fig. 4—Simplified schematic of a popular power amplifier design.

a problem, we must consider the time it takes a real program signal to rise, what the delay time really is (it is not the open-loop rise time as some have implied), and the overload mechanism of open-loop amplifier gain stages.

The open-loop amplifier can be modeled as a block of gain, a dominant first-order compensation roll-off, and a pure delay as shown in Fig. 5. Effects of the other nondominant poles are lumped in with the delay with little loss of accuracy. It is well-known that, following a step change at the input of a first-order RC low-pass filter, the output *begins to change* immediately, no matter how long the RC time constant; only the rate of change will depend on the time constant. Thus, after a sudden change at the amplifier input, the output will begin to change after the above-mentioned pure delay. This is the propagation delay time of the amplifier and is the delay time during which we must be concerned about overloading the amplifier in order to deal with the issue raised above.

The propagation delay time can be estimated by considering the phase margin of the feedback loop. If an amplifier has a phase margin of 45 degrees at a 1-MHz gain crossover, then the total forward path delay (assuming a flat feedback path) must be 135 degrees, of which about 90 degrees is from the compensation pole and 45 degrees is from the propagation delay. This works out to 125 nS. Most power amplifiers will have considerably less propagation delay than this.

It should be pointed out that it is incorrect to say that the amplifier is without feedback during this interval. The closed-loop amplifier is a linear system so long as the gain, roll-off, and delay elements of the model are linear. It is also

Fig. 5—A simple model of the open-loop amplifier showing time response to a step input. In practice, gain and delay are distributed throughout the amplifier.

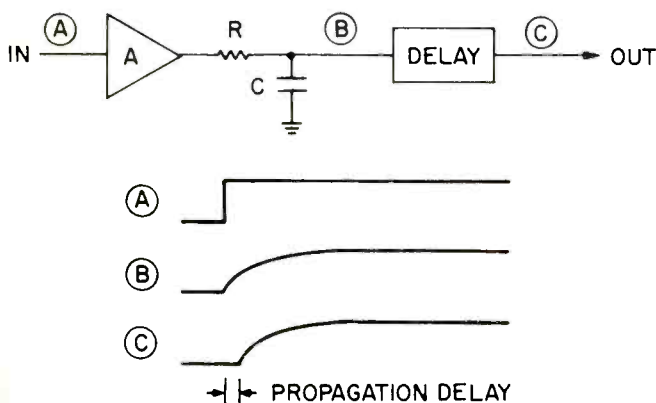

a continuous system in spite of the delay, and feedback is present 100 percent of the time as long as no stages are clipped. The feedback is, however, continuously "out of date" by a time equal to the delay. Fortunately, the feedback equations readily take this into account in both the frequency and time domains.

Can a full-amplitude input signal, such as a bandlimited square wave, rise far enough in 125 nS to cause any amplifier stages to become nonlinear or to overload? The integrating action of the compensation will prevent stages beyond the compensation from overloading, typically leaving only the input stage before it to worry about (see Fig. 4).

Consider as a worst case a 2-V peak square wave bandlimited to 20 kHz. It will rise about 63 mV in 125 nS, and this is enough to drive some input stages into nonlinearity. This is particularly true of the differential pair without emitter resistors (local feedback often called emitter degeneration), as shown in the design of Fig. 4. With a 63-mV error signal driving it, its small-signal gain is less than half its nominal value. This nonlinearity would result in "soft" TIM under these conditions. However, most high-quality amplifier designs have enough local feedback of one sort or another at the input stage to allow good linearity in handling such an error signal. As we will see momentarily, such feedback is usually also an important ingredient in achieving high slew rate.

Feedback factor and open-loop bandwidth are clearly not relevant here, since designs with different values for these parameters could easily have the same input stage design and propagation delay. The important criterion here is to have an input stage that can handle large input signals, at least under transient conditions.

Slew Rate

Real power amplifiers are not only limited in terms of output amplitude; they are also limited with respect to the rate-of-change or time derivative of the output. When an amplifier is asked to deliver more than its maximum amplitude, it clips and produces a constant amplitude independent of the input signal. Similarly, if an amplifier is called upon to deliver a greater time derivative than its slew rate, the amplifier will go into slew-rate limiting and produce an output rate-of-change independent of the input signal. As with amplitude-induced distortion, slew-induced distortion (SID), or (TIM), has a gradual onset. It is non-zero below the slew-rate limit and rises as the slew-rate limit is approached.

Having discussed amplifier behavior during the propagation delay interval following a sudden input change, we must now determine if the amplifier can keep up with the time derivative called for by the input signal without being driven into nonlinearity by internal error signals (i.e., overshoots). This is basically a question of margin against slew-rate limiting, since slewing is the result when the internal overshoots are so big they are clipped. Recall that these overshoots are generally the result of the circuit attempting to quickly charge capacitances, particularly the compensating capacitor.

At this point it is important to emphasize that it is the *magnitude* of these overshoots which is important, not percentage; many papers in the literature have erred in emphasizing the latter [1, 2]. It should be clear that good margin against slew-rate limiting guarantees that the overshoots will not be large enough to cause nonlinearity and thus TIM.

How does feedback factor affect slew rate? By itself, not at all. For example, amplifiers with high feedback factors usually have the extra open-loop gain *after* the point of compensation. The most common example is the use of a current source load on the predriver stage, as in Fig. 4. Suppose for the moment that the predriver stage has a shunt capacitor at its input (base) for compensation (unlike Fig. 4).

The best records you own were probably cut on our Mastering System.

Now you can get the turntable and cartridge designed by the same engineers.

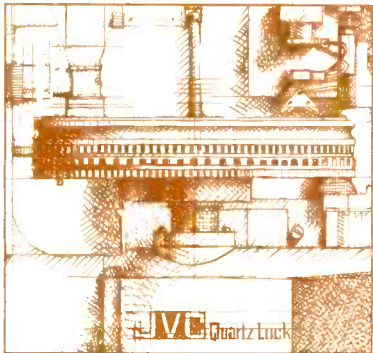

One reason discs from labels like Telarc and Mobile Fidelity sound so good is also the reason JVC's finest limited production turntable and cartridge are showing up in prestigious salons alongside Winn, Linn-Sondek, Denon and Koetsu: JVC research.

The JVC Lathe Drive. At our Cutting Center in California, we discovered that even in a state-of-the-art mastering lathe, such as the Neumann, its turntable revolution is slowed slightly when cutting deep grooves, an effect considerably magnified by the demands of digital masters and half-speed mastering.

This hesitation of even the massive Neumann platter — and the resulting wow — were corrected with a JVC logic-controlled DC drive motor which assesses its rotational speed five thousand times per second, and

then compensates instantly.

The JVC Turntable Drive. The same rotational drag is again encountered in playback of heavily-modulated grooves. While *no belt drive* is capable of compensation, the Phase Comparator logic system in the QL-10 virtually eliminates these instantaneous pitch variations and the audible textural colorations which result, while still allowing variable pitch in 1Hz increments *without defeating* the quartz monitoring circuitry.

The JVC Cutting Stylus. To complement our lathe drive system, we developed a special cutting stylus made from solid diamond, a first in the industry. The stylus has an extremely sharp cutting point (one micron radius) with highly polished facets. The result is extended high frequency response, better definition and reduction in distortion and surface noise.

The JVC Cartridge. The MC-1 moving coil cartridge brings an equally fresh approach to playback. Instead of a cumbersome coil, the MC-1 employs a tiny "printed circuit" weighing less than 1/100th of a typical wound inductor, enabling it to be placed considerably *ahead* of the pivot, just millimeters from the diamond Shibata stylus.

Reductions in cantilever whipping, ringing, resonances and crosstalk have led us to the conclu-

sion that the MC-1 is simply capable of extracting more music from well-cut grooves.

The JVC Laboratory. Only a company with a research facility large enough to undertake the redevelopment of mastering technology could have undertaken such a dramatic rethinking and execution of disc playback technology as well.

Yet, our size is so *inversely proportional* to the number of QL-10's we can laboratory fabricate that it may very well be the *rarest* production turntable on the market. A "spare-no-expense" indulgence enabled by our sheer size!

The Selected JVC Dealer. We invite you to audition the QL-10 and MC-1 alongside the best turntables and cartridges in the world. While subjective comparisons are inappropriate for us, *you* are free to test our somewhat bold assertions at selected audio salons across the U.S.

If you feel you'd appreciate such a comparison — and the price hand-built technology demands — call us for the location of your nearest JVC Professional Audio Representative.

Then call or write Vic Pacor, Pro Audio Sales Manager, who is personally interested to hear how you feel about our assertion that being the undisputed leaders in mastering technology will ensure our future leadership in disc transcription, too.

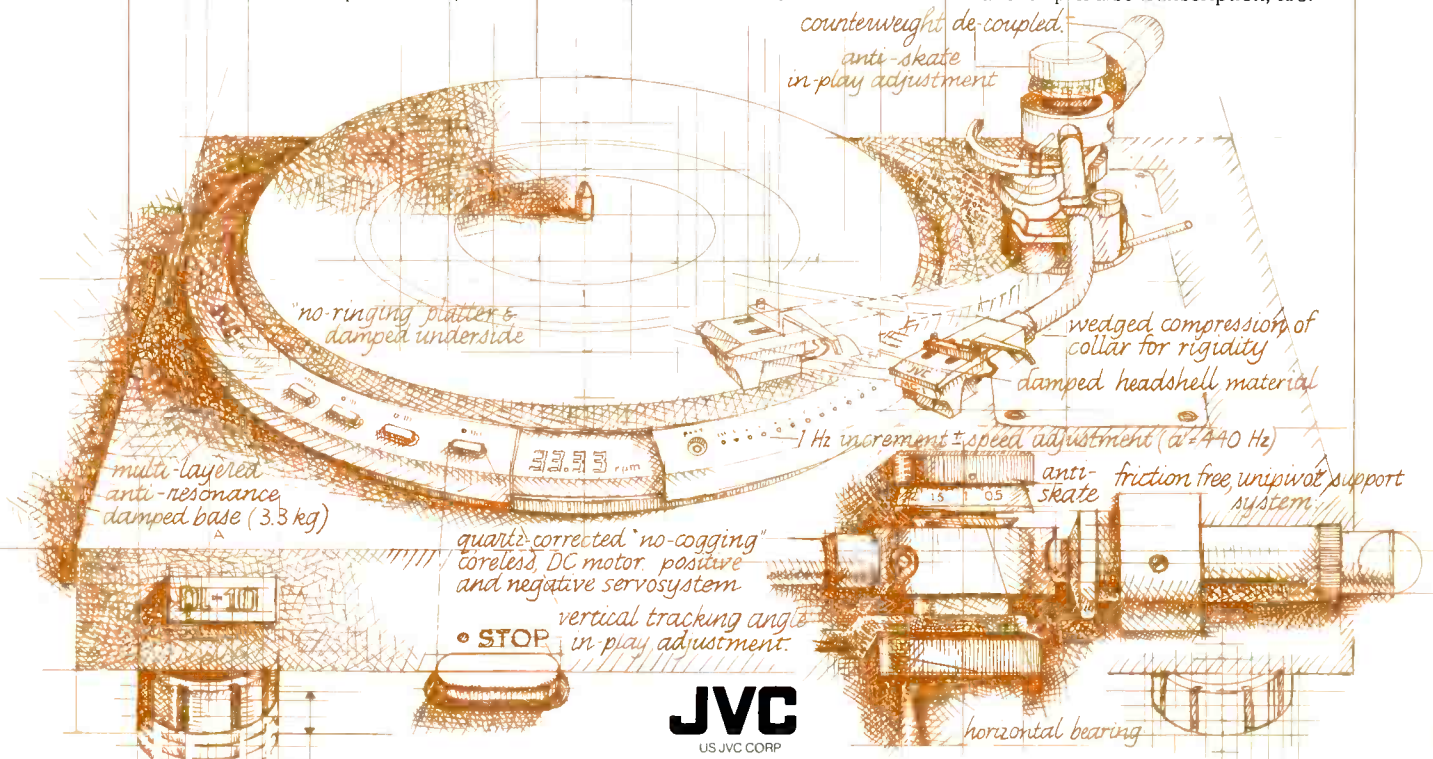

JVC
US JVC CORP

58-75 QUEENS MIDTOWN EXPRESSWAY, MASPETH, N.Y. TELEPHONE (212) 476-8300

Enter No. 18 on Reader Service Card

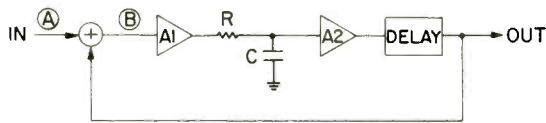

Fig. 6—A model of the feedback amplifier showing the error time response to a bandlimited step input for various combinations of feedback factor and open-loop bandwidth. Closed-loop bandwidth is held constant, and feedback is varied by changing only A2. Input level is assumed to be zero prior to the step.

If we double the gain after the compensation by some means, we must double the value of the compensating capacitor to restore the gain crossover frequency to its original value. However, the added gain means that we now need only half the time derivative on the capacitor to achieve the same output time derivative, so the magnitude of the current overshoot charging the larger compensating capacitor is unchanged. The percentage overshoot is approximately doubled, however, because of the *smaller final value* as a result of the doubled d.c. gain. This is illustrated in Fig. 6. Even though the open-loop roll-off starts one octave lower, the input stage doesn't have to work any harder to achieve a given slew rate.

The situation is the same for amplifiers using Miller-effect compensation as in Fig. 4. Here, even the capacitor value is unchanged as the feedback factor is raised or lowered by varying the load impedance of the predriver (Q3). This is so because the feedback action of C3 controls the high-frequency gain rather than the load resistance. Amplifiers which are deliberately designed with low feedback factors typically achieve this by placing a physical load resistance from the collector of the predriver to ground [9].

If we assume that all of the signal current from the input stage can flow into C3, then the slew rate for the amplifier in Fig. 4 is about $(0.5 \text{ mA}/84 \text{ pF}) = 6 \text{ V}/\mu\text{S}$. In practice, it will be somewhat less because of some current flow into R2 and Q3.

An improved amplifier is shown in Fig. 7 and is an example of an amplifier with a very high feedback factor. In addition

Fig. 7—Simplified schematic of an improved power amplifier.

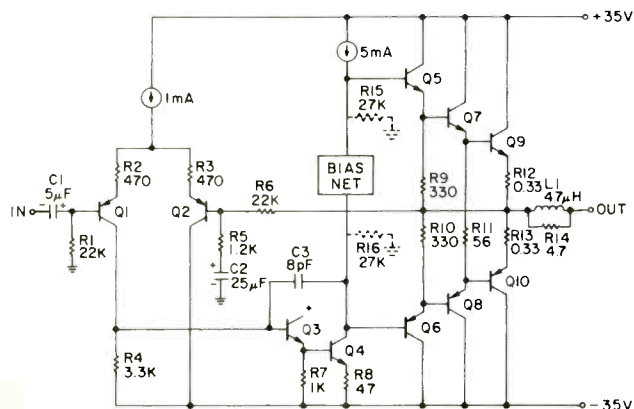

to using a high-quality current source load for the predriver, triple Darlington's are utilized in the output stage for extra current gain and hence a lighter load on the predriver collector node. Addition of the pair of dotted predriver load resistors, R15 and R16, will convert it to a low-feedback design with a 20-kHz open-loop bandwidth. The required compensating capacitance remains unchanged.

The open-loop gain for the high- and low-feedback versions of Fig. 7 is shown in Fig. 8. The gain crossover frequency for both designs is the same, and the only difference is increased loop gain at frequencies below 20 kHz for the high-feedback design. The slew rate for both designs is the same for a step input starting at zero volts. This further illustrates the fact that feedback factor and open-loop bandwidth have no effect on slew rate.

What does affect slew rate is the design of the input stage. For a given size compensating capacitor, an input stage with a higher output current capability will provide an increased slew rate. However, merely increasing the tail current of a simple differential pair stage, as in Fig. 4, will not work because that will increase the stage gain (transconductance) by the same factor. This would then necessitate a proportionately larger compensating capacitor to restore the gain-crossover frequency, and the slew rate would be back to where it was before. One popular solution is to use emitter degeneration. For example, we can keep the tail current the same, use emitter degeneration to reduce the gain, and then use a smaller compensating capacitor. This approach is used in Fig. 7, where R2 and R3 reduce the gain by a factor of 10. This permits a dramatic increase in slew rate. Local emitter degeneration is also desirable because it increases the overall linearity of the stage and permits linear operation up to a larger percentage of the ultimate slewing capability.

It is important to realize that the extra gain in most amplifiers with high feedback factors is not achieved by adding more voltage-gain stages, which would tend to increase non-linearity and propagation delay. As can be seen from Fig. 7, the only elements which need to be added to achieve very high gain are emitter-followers. These stages are practically delayless and actually tend to improve linearity by isolating driving stages from the input nonlinearities of the next stage. Nonlinearities resulting from transistor beta dependence on collector voltage (Early effect) and current and junction capacitance dependence on voltage are reduced in this way.

It was mentioned earlier that a 100-watt amplifier would have to cleanly handle time derivatives up to about $3 \text{ V}/\mu\text{S}$ for worst-case program material. How much margin against slew-rate limiting is required for clean, low-TIM operation? This depends very much on the particular amplifier design. A good design with plenty of local feedback and a linear open-loop response may require a margin of less than 1.5 to 1, while a really poor design with gross open-loop nonlinearity could require as much as 10 to 1. However, even the often-criticized 741 operational amplifier, when operated under reasonable conditions, requires less than a margin of 5 to 1.

A margin of 4 to 1 should be more than adequate for power amplifiers of reasonable design to guarantee that TIM produced by internal overshoots will be completely inaudible. Based on this and the previously discussed program characteristics, the 100-watt amplifier should provide a slew rate of at least $12 \text{ V}/\mu\text{S}$. This also gives us a 50 percent margin against slewing in the presence of a $0.2 \text{ (V}/\mu\text{S})/\text{V}$ full-amplitude pop or tick.

Notice that we've paid very little attention to what happens when outright slew-rate limiting occurs; rather, we've outlined the conditions required to stay in a rather linear region of operation where, at most, the nonlinearities are soft. This is mainly because TIM will become audible before slew-rate limiting occurs. However, it is worth noting that

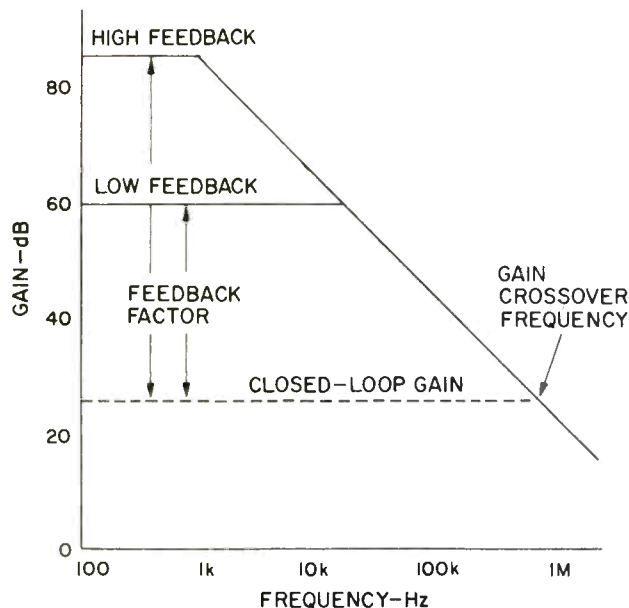

Fig. 8—Open-loop gain comparison of amplifiers with high and low feedback factors and equal gain crossover frequency. The major difference is the greater feedback in the audio band for the former case.

recovery from a slewing condition for most contemporary amplifier topologies is not affected by the open-loop time constant. This was not necessarily the case in some very early transistor amplifier designs in which a transistor could saturate during slewing and charge the compensating capacitor to an abnormal voltage. Recovery in modern amplifiers is not

significantly longer than the time it takes the output to slew to the new signal value.

At this point, it should be clear that slew rate is the most important single parameter governing TIM performance, while feedback factor and open-loop bandwidth have no bearing on TIM. In Part II, we'll continue by looking at other causes of high-frequency or dynamic intermodulation distortion (DIM), why a large feedback factor is good instead of bad, and techniques available for measuring TIM in the lab. Δ

References

- Otala, M., "Transient Distortion in Transistorized Audio Power Amplifiers," *IEEE Transactions on Audio and Electro-acoustics*, Vol. AU-18, pp. 234-239, Sept., 1970.
- Otala, M., and E. Leinonen, "The Theory of Transient Intermodulation Distortion," *IEEE Transactions on Acoustics, Speech and Signal Processing*, Vol. ASSP-25, No. 1, pp. 2-8, Feb., 1977.
- Leach, W. M., "Transient IM Distortion in Power Amplifiers," *Audio*, pp. 34-41, Feb., 1975.
- Greiner, R. A., "Amp Design and Overload," *Audio*, pp. 50-62, Nov., 1977.
- Jung, W. G., M. L. Stephens, and C. C. Todd, "Slewing Induced Distortion and Its Effect on Audio Amplifier Performance—With Correlated Measurement Listening Results," AES Preprint No. 1252 presented at the 57th AES Convention, Los Angeles, May, 1977.
- Garde, P., "Transient Distortion in Feedback Amplifiers," *Jour. of the Audio Engineering Society*, Vol. 26, No. 5, pp. 314-321, May, 1978.
- Kogen, J., B. Jacobs, and F. Karlov, "Trackability—1973," *Audio*, pp. 16-22, Aug., 1973.
- Holman, T., "Dynamic Range Requirements of Phonographic Preamplifiers," *Audio*, pp. 72-79, July, 1977.
- Leach, W. M., "Build a Low TIM Amplifier," *Audio*, pp. 30-46, Feb., 1976.
- Leinonen, E., M. Otala, and J. Curl, "A Method for Measuring Transient Intermodulation Distortion (TIM)," *Jour. of the Audio Engineering Society*, Vol. 25, pp. 170-177, April, 1977.
- Cordell, R. R., "A Fully In-Band Multitone Test for Transient Intermodulation Distortion," AES Preprint No. 1519 presented at the 64th AES Convention, New York, Nov., 1979.

The Tuneable Tonearm.TM Ultracraft.

It always happens. You put together your dream tonearm/cartridge combination. And along comes a new "super" cartridge with parameters that just won't work with your arm. Unless you own a tuneable Ultracraft—so adjustable you get the utmost performance from any cartridge.

The Ultracraft AC-30, AC-300 MK-II and AC-3000 MC all use our unique ADJUSTABLE DAMPING SYSTEM, with a control that lets you regulate clearance between the damping bowl and oil cup for perfect tracking and customized frequency response.

Our famed jewel-bearing UNIPIVOT DESIGN assures stylus freedom so you hear every nuance of every recording. AC-3000 MC and AC-300 MK-II accept interchangeable PLUG-IN ARM STEMS in straight and S-shapes, of different diameters and materials, with integral or separate headshells.

Ultracraft's uniquely precise lateral balancing device, and anti-skating system (never before used on a single-point suspension arm), plus features like a 650 gram stabilizer, special litz wires and a 3-step counterbalance, clearly make Ultracraft the ultimate tonearm. Let your Osawa dealer tune one up for you.

OSAWA & CO. (USA) Inc., 521 Fifth Avenue, New York, New York 10017
Distributed in Canada by Intersound Electronics, Montreal, Quebec



OSAWA
The Measure of Quality

Consider what it would be like to own the new Dual 839 cassette deck.

The new Dual 839 is so different from all other cassette decks that, rather than list its many features, we'll guide you through them as if the 839 were in front of you.

First, the 839 is bi-directional. In record and playback, the tape reverses automatically and stops at the end of the second side. This doubles the length of every cassette. (Reversing can also continue indefinitely if desired.)

You'll notice there's no door between you and the cassette compartment. Just a shield over the tape heads that swivels away when you switch on. Insert a cassette and it will lock in precise alignment. That's Dual's Direct Load and Lock system. (A subtle but important touch: any slack in the tape is immediately taken up.)

Follow us carefully on this next one. Even when the tape is in motion, you can pull it out and replace it with another . . . and the previous mode resumes automatically. Useful? When the tape nears the end, you can have a new tape in place without missing a beat.

Here's another innovation in playback. If a tape made on another deck is too sharp or too flat, or if you need to match pitch to a live instrument, no problem. Playback pitch can be varied over an eight percent range.

And previously recorded tapes with clicks, pops and disc jockey interruptions can be cleaned up electronically—smoothly and permanently. Dual's fade/edit control lets you do that with complete confidence, because it functions in playback.

The peak-level LED indicators react faster than any other metering system. And more accurately, because they're equalized. They read the full processed signal—including the high frequency boost other decks add but only Dual reads. No more risk of overloading a tape into distortion.

There's still more. Much more. Full metal record and playback. 6-way bias/equalization. Computer logic solenoid-activated controls. Switchable multiplex filter. Switchable limiter. Line and mic mixing. Two-way memory stop with automatic replay. Headphone level controls. And operation by external timer or optional wireless remote control.

Among the features you can't see are the two-motor, twin-capstan drive system and the electronic tape-tension sensor that guards against jams and spills.

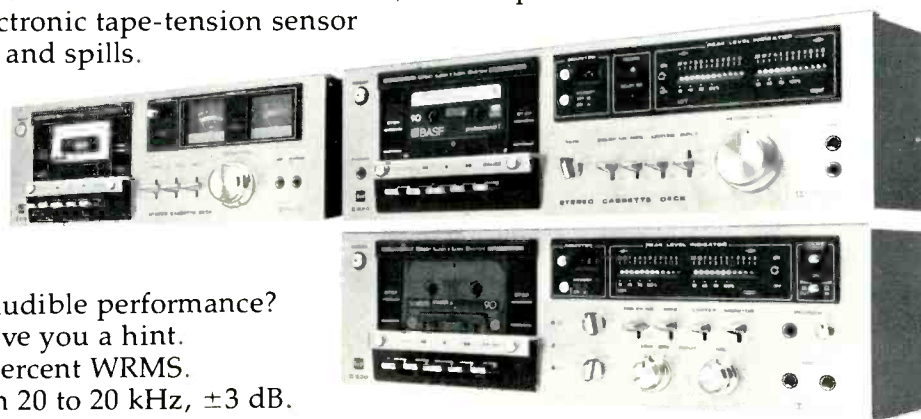

What about the 839's audible performance? The specifications can give you a hint. Wow and flutter ± 0.03 percent WRMS. Frequency response from 20 to 20 kHz, ± 3 dB. Signal-to-noise better than 69 dB.

Of course, there's a price for all the 839 offers: \$850. If that seems to be more deck than you really need, there are three other new Dual cassette decks. They start at \$330, and they all feature the Direct Load and Lock system, DC servo motors, twin-belt drive systems, tape-motion sensor/protectors and equalized meters.

For complete details on all four Dual cassette decks, please write to us directly. United Audio, 120 So. Columbus Ave., Mt. Vernon, NY, 10553.

Dual



From time to time we hear references to distortion and other nonlinear effects produced by passive circuit components, such as capacitors, used in audio circuits. However, only on rare occasion can anything be found in written form which attempts to quantify or otherwise document capacitor problems, particularly as they specifically relate to audio. Yet, distortions are produced by a wide variety of basic capacitor types, and in some cases forms of this distortion are rather easily measurable. Why there hasn't been more written on this topic is truly a good question, as in many instances the audible defects produced by capacitors can easily be the Achilles' heel of a given design. If this were not a truism, why else would there be so many audiophile modifications consisting essentially of capacitor upgrades only? The implications of this will be apparent when this article is fully appreciated.

While there has been no detailed overview or discussion of these problems in print, two articles are noteworthy, because they do in fact address this specific topic. In [1], Dave Hadaway gave a summary of relative quality rankings for capacitor types. More recently, John Curl [2] discussed some measured results for two capacitor types. Dick Marsh [3,4,5] has been specific in cautions against certain types, in several *Audio Amateur* letters.

What we hope to do in this article is cover capacitor basics, means of testing for impedance and distortion, and summarize with some selection criteria which will optimize sound quality. We will begin by discussing some simple (but deceiving, really) distortion tests. A summary of key capacitor performance defining terms is given in the sidebar entitled Capacitor Basics.

Signal Path Tests For Capacitor Distortion

One of the more frustrating aspects of the distortion problem vis-a-vis capacitors is that they do not always allow direct quantification as they typically operate in the signal path. A good example of this very point will be demonstrated below in the discussion of some THD tests on tantalum capacitors. By these THD results, one might be led to believe that tantalum types are adequate when suitably selected. Nevertheless, they still fail to measure up in auditioning and show poor electrical quality when measured by other methods—even though they may appear to be operating in a virtually distortionless fashion by THD tests.

Two series of THD tests were performed on two types of capacitors, tantalum electrolytics and ceramic discs. These tests seem to be representative, as different capacitors of the same variety produced similar results, and the results here generally correlate with Curl's [2].

*© Copyright by Walter G. Jung, Consulting Author, and Richard Marsh, Technical Specialist, Laurence Livermore Labs, Univ. of California, Berkeley, Calif.

Tantalum Capacitor Tests

In the tantalum tests, a circuit was built in the form of a simple high-pass filter, as shown in Fig. 1. The general test circuit used is shown in Fig. 1a, and the details of various capacitor connections are in 1b. The 3-V rms generator and meter is a THD oscillator/analyzer combination. The general goal of this test is to examine the distortion sensitivity of the polar tantalum capacitor in handling bipolar a.c. signals.

As the different connections of 1b indicate, there are various ways that a polarized capacitor such as this can be connected. The circuit as shown in 1a is a simple a.c.-only circuit with no d.c. polarizing bias applied to the capacitor in test condition A.

For such a mode of operation, a tantalum capacitor will generate appreciable distortion when the signal conditions are such that there is appreciable a.c. voltage dropped across

Fig. 1—Tests of tantalum capacitors.

Fig. 1a—General test circuit.

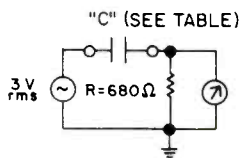
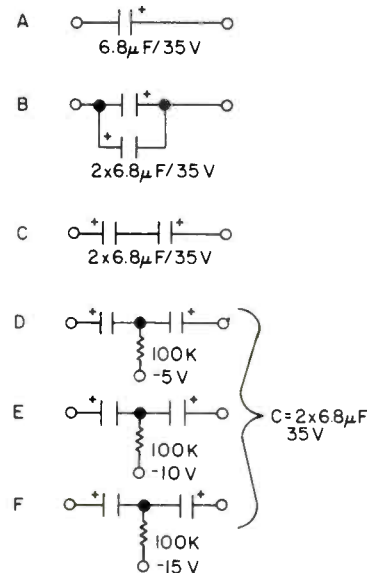

Fig. 1b—Test details of capacitor connections.



it. Or, stated another way, when its reactance becomes appreciable in relation to that of the load (here 680 ohms).

For condition A, the capacitor is a single 6.8-μF unit, and its reactance equals 680 ohms at about 35 Hz. To generalize, we will talk in terms of this frequency, which is the corner frequency, f_c . As will be seen, it is a key to understanding this particular pattern of distortion behavior.

THD data were taken on this and the remaining connections, as shown in Fig. 2. For condition A, it can be seen that distortion is low at frequencies above about 10 times f_c , but rises as f_c is approached and nears 1 percent in level below f_c when the capacitor sees a large a.c. voltage.

From these data, it seems somewhat analogous to regard a polarized tantalum operated thusly as a capacitor shunted by an imperfect diode. The distortion it produces is even order, which is shown in the distortion photos in Fig. 3. Since the device's a.c. characteristic is asymmetrical, it appears that circuit means which tend to minimize the asymmetry also tend to minimize the distortion produced.

As John Curl showed [2], a simple parallel connection of like capacitors, as in B, reduces distortion appreciably. Compared to condition A, condition B reduces the distortion at f_c by a factor of 2 to 3 (Fig. 2).



PICKING CAPACITORS

Walter G. Jung and Richard Marsh*

The series back-to-back connection of condition C can reduce the distortion further, if the two capacitors happen to have complementing characteristics. The distortion products for condition C are also shown in Fig. 3 (at fc). However, it appears this particular connection depends strongly on the match of the specific units used. Also, unlike the connection of B, the series connection of C increases the net equivalent series resistance (ESR), which is usually not desirable as discussed later.

If the series connection is so effective, the logical question is, then, does polarizing bias applied to the junction help further? The answer is yes, with increasingly better results

Capacitor Basics

A brief review of capacitor fundamental relationships is appropriate to a more complete understanding of the applications-oriented discussions of this article.

As can be noted from the physical diagram (Fig. B1), a capacitor consists of two plates or conductors separated by a dielectric or insulator and the whole is capable of storing electrical energy. Capacitance is determined by the area and spacing of the plates (dielectric thickness) and the dielectric constant which is symbolized by K. The K of a given material is a direct measure of its ability to store electrons as compared to air. Note that within a given size, capacitance can only be maximized by increasing K.

Table B1 is a short summary of some of the dielectrics used in audio work. As can be noted, all of the film dielectrics have relatively low Ks, while the remainder, such as aluminum and tantalum oxides, are quite a bit greater. This is the reason why a 10-µF polycarbonate capacitor is so much larger than a 10-µF aluminum or tantalum electrolytic for a comparable voltage.

All capacitors can be modeled electrically by the equivalent circuit in Fig. B2. The elements shown here are actually parasitic, with the exception of C, which is an ideal capacitor. In practice a parallel resistance, R_p (sometimes called IR or *Insulation Resistance*), shunts C, causing leakage. R_p is both temperature and voltage dependent. A series resistance, R_s (also often called ESR, for *Equivalent Series Resistance*) appears in series with C, limiting the minimum impedance. R_s is composed of plate, lead, and termination resistances primarily. For high-current circuits, R_s can represent a significant power loss, and it is desirably minimized. L represents the net inductance of the winding and leads. C is actually composed of C_1 and C_2 , where C_2 and R_{DA} comprise the dielectric absorption model (discussed fully in text).

The losses in capacitors are described by the real and reactive impedances, as shown in the vector diagram triangle, Fig. B3, with the respective impedances as described by equations 2, 3, and 4.

In capacitor specification literature, the angles θ and δ are often seen. Both are used to represent losses, which can be described either by the term power factor (PF) or dissipation factor (DF). As equations (5) and (6) indicate, they are trigonometrically related.

An important point to be appreciated is that for very small values of R_s , PF and DF are nearly the same. Note also that both PF and DF can also be expressed in percentage form, as DF (%), as noted in equations (7) and (8).

Capacitor losses are also sometimes expressed in terms of Q or quality factor, a general figure of merit. Q is simply the inverse of DF, as shown in equation (9). The practical expression of this is that low DF capacitors have high Q.

An appreciation for the interrelation of these various capacitor loss elements can be gained by regarding Fig. B4, a hypothetical capacitor impedance vs. frequency curve. At rel-

with more bias, as shown in conditions D, E, and F. However, even a relatively small bias, such as in D, is very effective, reducing THD at f_c to 0.01 percent. This bias level is 5 V or just in excess of the greatest signal peak swing. The distortion for test condition D is shown in Fig. 3 at f_c .

What this series of tests seems to say is that one should carefully control the a.c. signal developed across such a polar capacitor to minimize this distortion. If you use a simple single-capacitor connection with no d.c. bias, it appears that a just derating by a factor of about 10 times will minimize the distortion. In other words, if a given capacitor used for coupling is calculated to have an f_c of 10 Hz, making it corner at

actively low frequencies, the value of Z observed is equal to X_c and follows the inverse relationship of equation (2). At some higher frequency, it reaches a minimum value, due to R_s . At this minimum impedance frequency, the capacitor actually acts as a series-resonant circuit, with maximum current limited only by R_s . Note that only if the capacitor were truly ideal

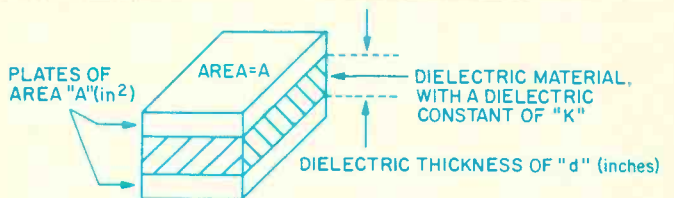

Fig. B1—Physical diagram of a capacitor.
 $C = (KA/d) (0.225 \times 10^{-12}) \text{farads}$ (1)
 See reference 15 for a thorough discussion of C.

Table B1—Dielectric constants of typical materials. Teflon through polyester are films.

Dielectric	K (vacuum = 1.0000)
Air (reference)	1.0001
Teflon	2.0
Polypropylene	2.1
Polystyrene	2.5
Parylene	2.65
Polycarbonate	2.9
Polyester	3.2
Glass	4.0 - 8.5
Mica	6.5 - 8.7
Ceramics	6 to several thousand
Al oxide	7
Ta oxide	11

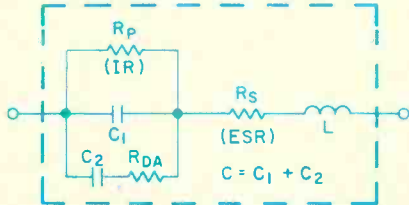

Fig. B2—Equivalent circuit of a real capacitor. C = capacitance in farads, L = inductance in Henrys, R_s = equivalent series resistance in ohms, R_p = parallel resistance in ohms, and C_2 and R_{DA} = dielectric absorption portion of equivalent circuit.

- Capacitor Terms**
 Capacitive reactance = $X_c = 1/2\pi fC$ (2)
 Inductive reactance = $X_L = 2\pi fL$ (3)
 (Note: equations 2 and 3 apply for sine waves—see text.)
 Impedance = $Z = \sqrt{R_s^2 + (X_c - X_L)^2}$ (4)

1 Hz will minimize the distortion produced by this particular mechanism. However, as alluded above, this is not the whole story, as the discussions later will show.

Ceramic Capacitor Tests

In a second series of tests, the distortion produced by a common ceramic disc capacitor was studied. Data in the form of the THD vs. frequency for this test are shown in Fig. 4. The first circuit used is a simple low-pass (LP) filter, with the capacitor under test as the shunt C arm. The values chosen for the test were $R = 1K$ and $C = 0.1 \mu F$. A 100-V type was used for the capacitor.

would its impedance continue to fall indefinitely with frequency. On a log-log scale, this is shown as a straight (non-curved) descending line with increasing frequency (shown dotted in Fig. B4). It should also be noted that R_s is both temperature and frequency dependent (although not shown here).

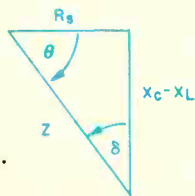

Fig. B3—Vector diagram of capacitor impedances.

$$\text{Power factor} = \text{PF} = \cos \theta = \sin \delta = R_s/Z \quad (5)$$

$$\text{Dissipation factor} = \text{DF} = \cot \theta = \tan \delta = R_s/(X_c - X_L) \quad (6)$$

Note: For relatively low values of R_s , Z is approximately equal to $X_c - X_L$. Therefore, θ approaches 90 degrees and $\cos \theta$ is approximately equal to $\cot \theta$. As a result, PF and DF are nearly equal for low R_s values.

$$\text{DF} (\%) = \text{DF} \times 100 = 100 [R_s/(X_c - X_L)] \quad (7)$$

$$\text{PF} (\%) = \text{PF} \times 100 = 100 (R_s/Z) \quad (8)$$

In practical terms, $\text{DF} = \text{PF}$ with a discrepancy of under 1 percent for PF (%) values of 14 percent or less.

$$\text{Quality factor or figure of merit} = Q = (X_c - X_L)/R = 1/\text{DF} \quad (9)$$

Example: A DF (%) of 0.1 percent in a capacitor results in a Q of 1000.

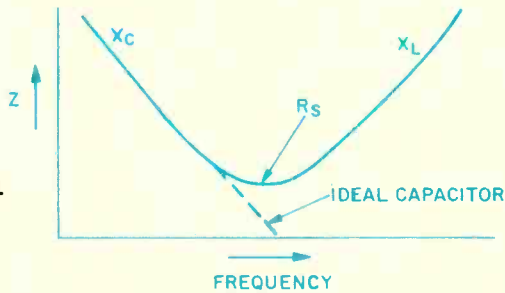

Fig. B4—Capacitor impedance vs. frequency.

A very interesting point which should be noted regarding equations (2) and (3) is that they specifically describe reactances for single-frequency, sine-wave conditions. In actual practice, music is comprised of a multiplicity of signal components simultaneously, and would be more accurately generally characterized as a transient waveform source.

As such, a transient pulse of period t is generally related to the f term more accurately, as

$$f = 1/2t \quad (10)$$

Note that for these conditions, we now must consider not only the fundamental frequency of repetition, but also all of the harmonics comprising the Fourier series with their exact phase and amplitude relationships if the waveform is to be transmitted accurately.

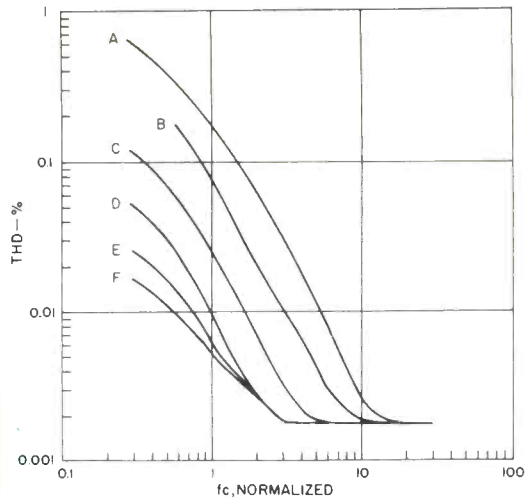
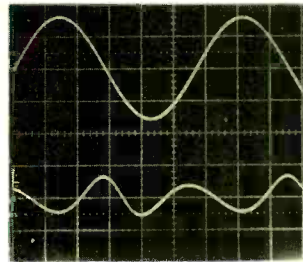
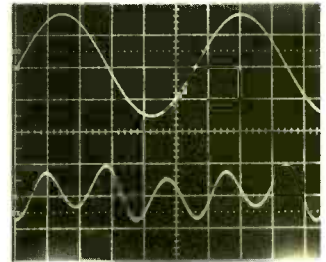

Fig. 2—THD in tantalum electrolytics as a function of corner frequency in a high-pass filter, various connections.

Fig. 3—Output vs. distortion photos for tantalum capacitors in a high-pass filter, various connections. For each photo, top is filter output; bottom is distortion products. Setup conditions as in Fig. 1b.



Condition A: $f_c = 35$ Hz, distortion about 0.2 percent.



Condition B: $f_c = 18$ Hz, distortion about 0.075 percent.

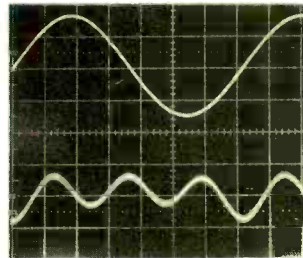

Condition C: $f_c = 70$ Hz, distortion about 0.025 percent.

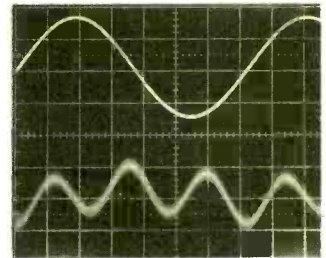

Condition D: $f_c = 70$ Hz, distortion about 0.01 percent.

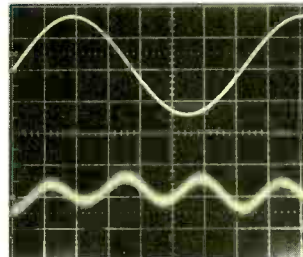

Condition E: $f_c = 70$ Hz, distortion about 0.005 percent.

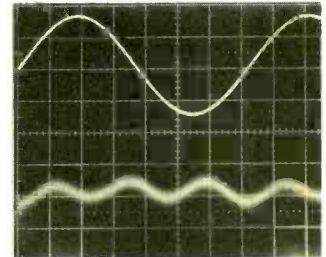

Condition F: $f_c = 70$ Hz, distortion about 0.003 percent.

As the LP data show, distortion is produced well below the corner frequency, which in this case is 1800 Hz. The data shown are corrected, so the THD 100 percent set level follows the LP roll-off. Even as such, however, the higher harmonics are attenuated, and this data may be a pessimistic representation. An IM test might show even worse performance for this LP filter. Figure 5 shows the nature of distortion in 5a; as can be noted, it is third harmonic. By contrast, a

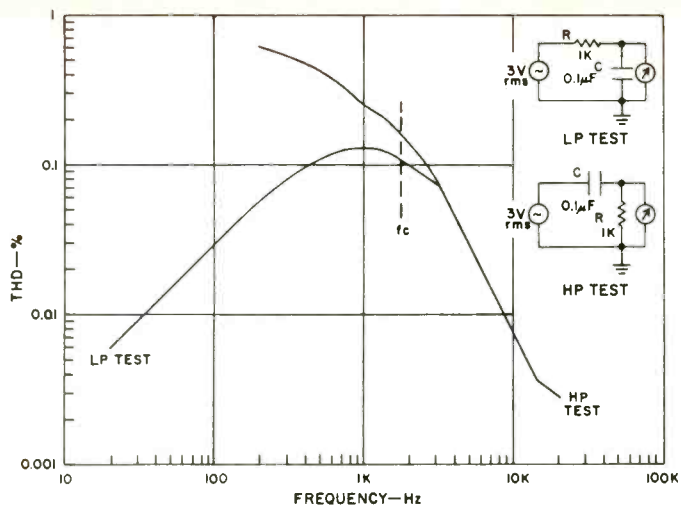

Fig. 4—THD produced by a ceramic disc capacitor as a function of frequency in low-pass and high-pass filters.

polyester type inserted into the circuit shows no discernible distortion (5b).

By placing the same ceramic capacitor in an HP filter circuit, the roll-off of harmonics can be circumvented. In this type of use, the voltage across the capacitor is highest at low frequencies. Thus nonlinearities will show up as higher harmonics, which are readily passed by the filter.

The data for the HP test show much stronger distortion at the lower frequencies, where the voltage is highest. We are not sure what should be interpreted as the common distortion-producing source in these two tests. One thing seems quite clear, however, and that is the simple fact that you cannot "work around" the distortion problem in ceramics. Our feeling is that they should simply be avoided anywhere near an audio signal path and probably just avoided altogether for audio. For example, some listening tests have indicated that they can produce audible distortion when used as supply bypasses, let alone coupling!

One obvious implication which emerges from the above is that a capacitor is not just a capacitor by any means. Of course, what we've discussed here are only two types of capacitors, and we really ought to make some general recommendations as to desirable types. This leads us more deeply into just what a capacitor is, and how this knowledge relates to audio.

Interpreting Capacitor Performance Data

One of the most important factors needed for a full and effective understanding of capacitor audio application criteria lies in interpreting data. Most of us have probably seen examples of impedance/frequency curves such as the one hypothesized in Fig. B4. However, considering such curves in the light of real data actually allows us to separate the men from the boys among capacitors — and also shows us which ones to use for audio.

Fig. 5—Output and distortion photos for ceramic and polyester capacitors in a low-pass filter circuit.

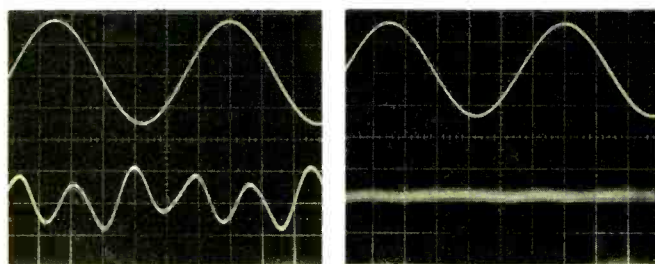

a—0.1-μF ceramic disc; f_c = 1.8 kHz, distortion is about 0.1 percent.

b—0.1-μF polyester; f_c = 1.8 kHz, "distortion" is at residual level; 0.01 percent full scale.

Typical data of this nature for tantalum capacitors are shown in Fig. 6. Regarding this data and recalling the model of a real capacitor (Fig. B2), we see that under d.c. or low-frequency conditions, R_s and L are negligible, compared to the C and R_p combination. As the frequency increases, particularly above a few kilohertz, the effects of both R_s and L increase.

In these practical cases shown here (one of which is typical of good-quality Ta units), it can easily be noted that X_c does not follow the ideal capacitor -6 dB-per-octave pattern with increasing frequency.

Further examination shows that as frequency increases, X_c tends to decrease, while X_L increases in value. This of course means that the $(X_c - X_L)^2$ term of the Z formula gradually decreases until at some frequency, the term $(X_c - X_L)^2$ disappears.

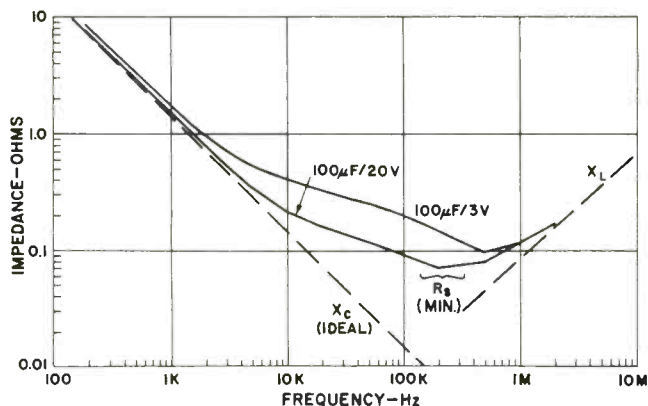
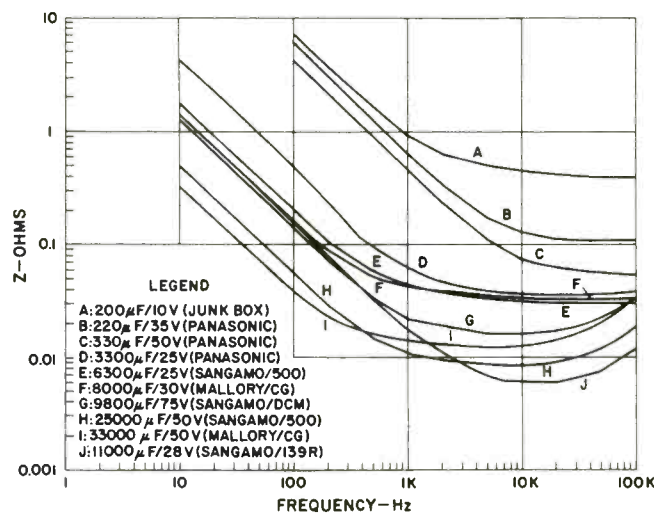

Fig. 6—Typical impedance vs. frequency curves for tantalum capacitors.

Fig. 7—Typical impedance vs. frequency curves for aluminum electrolytics.



Then the observed impedance is resistive or $Z = R_s$. This is the so-called series resonant frequency of the cap, which for tantalum and aluminum electrolytics will generally fall between 10 kHz and 1 MHz. From this, it should be apparent that if a capacitor is operated at a higher frequency than this, it will no longer be a capacitor to the circuit.

Although the discussion thus far has treated only tantalum electrolytics, this pattern of non-ideal Z vs. frequency behavior is actually inherent to all real capacitors to some degree. In the better quality dielectrics, R_s and L are lower and more closely controlled, and this is reflected in lower losses (DF), due to the lower parasitic parameters. This will be more apparent as we present data for other dielectrics.

The dawn of a new recording era

Auto Azimuth Alignment

Undoubtedly the most advanced and sophisticated innovation in cassette-recorder technology, *Auto Azimuth Alignment* launches a new era in high-fidelity recording. For the first time, you can be assured of perfect record-head azimuth alignment—on any cassette—at the flip of a switch. And, with that perfection comes an unprecedented frequency response—22 kHz at standard speed, 15 kHz at half speed!

Auto Azimuth Alignment—designated by the ZX in the model number—is available now on three revolutionary decks—the 680ZX, 670ZX, 660ZX. Each features exclusive Nakamichi Discrete 3-Head technology, 4-Motor, Dual-Capstan, Asymmetrical, Diffused-Resonance Transport, Random Access Music Memory and 22-kHz response at standard speed. And, the 680ZX—joining the popular 680 with manual alignment—matches its unique *half-speed* recording response of 15 kHz! *Auto Azimuth Alignment*—Nakamichi's commitment to excellence in the fine art of recorded sound.



680ZX Auto Azimuth Alignment

The premier Model 680ZX—half-speed response that rivals that of other decks at full speed! And, at standard speed, a full 22-kHz! High-resolution, wide-range FL level indicators and 18 program RAMM. Choose your speed, choose your program. The 680ZX does it all!

670ZX Auto Azimuth Alignment

Full off-tape monitoring facilities with Double Dolby[®] and two complete sets of electronics. Single-speed operation to an astounding 22 kHz! Nine program RAMM and wide-range, peak-responding meters. Outstanding performance.



660ZX Auto Azimuth Alignment

Performance identical to the 670ZX. Every feature except off-tape monitoring. Exclusive Nakamichi *Auto Azimuth Alignment* and Discrete 3-Head design. Master record-level fader too. An extraordinary value!

*Dolby is the trademark of Dolby Laboratories



For more information, write to Nakamichi U.S.A. Corp., 1101 Colorado Avenue, Santa Monica, CA 90401

Fig. 8—Variation of effective capacity with frequency in aluminum electrolytics.

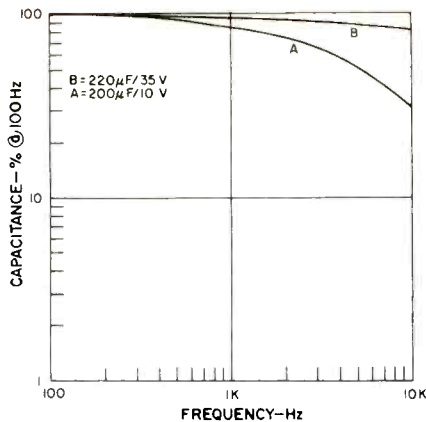

Aluminum electrolytics show a quite similar broadly resonant frequency, where $Z = R_s$ (or ESR). Data for a wide range of aluminum electrolytics are summarized in Fig. 7.

As can be noted from these data, the resonant frequency is typically between 10 and 100 kHz. Note, however, that the absolute level of impedance is much lower in the case of aluminum, due to the availability of much larger values. Also, many of the larger electrolytics are designed to handle large ripple currents and thus have very low values for R_s , as can be noted.

If these data are very carefully interpreted, a number of quite useful points can be drawn from it. Generally speaking, for two capacitors of similar value, the one with the higher voltage rating will show lower R_s (and DF, if viewed thusly). This can be seen, for example, between units A and B, as well as units F and G. And, it can also be seen in tantalum units (the two specific cases for comparison in Fig. 6 show this quite well).

One might at this point ask what is the disadvantage of a relatively high R_s (or high DF) in a capacitor used in audio.

Fig. 9—Impedance vs. frequency for film capacitors using various dielectrics.

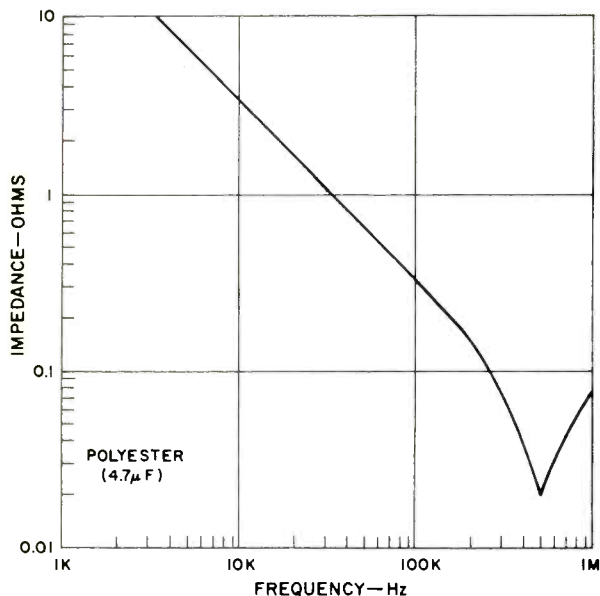

9a—Metalized polyester.

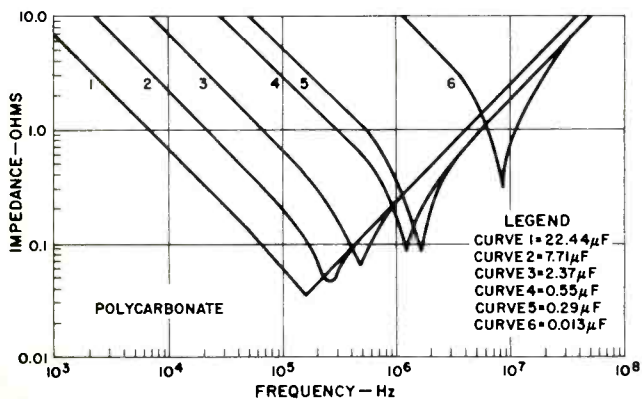

9b—Metalized polycarbonate. Material courtesy of Union Carbide.

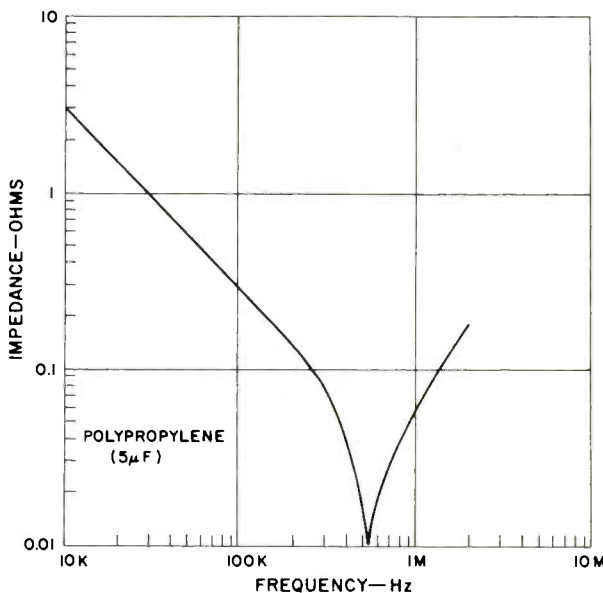

9c—Metalized polypropylene.

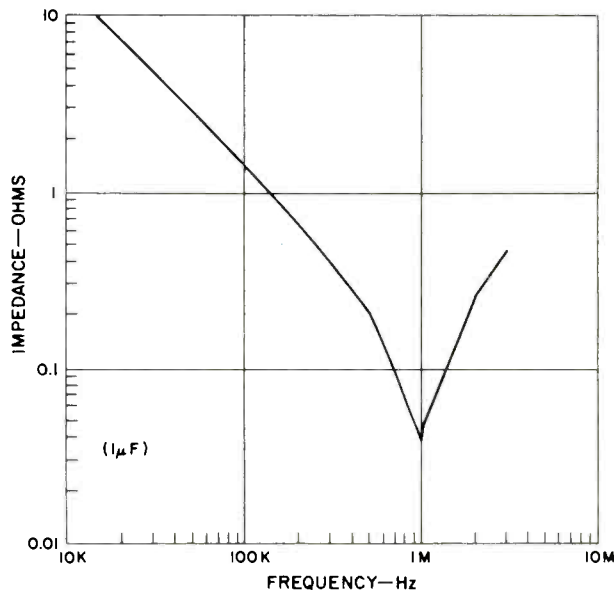

9d—Parylene.

Super D: the next step beyond Dolby and dbx?



Tape noise reduction for the home has been through two "generations" of development.

But now there's a third generation: Sanyo's new Super D. And to hear its awesome performance is to realize just how good cassette recordings can finally sound with all the noise gone.

Noise Elimination plus Headroom Extension – without audible side effects.

Super D's 2:1 "declinear" compression during recording and expansion on playback double the dynamic range of any reasonably good tape deck. So background noise simply disappears, and transient peaks are prevented from

satürating the tape, causing distortion and high frequency loss. And the declinear operation means there are no critical reference levels, and no recalibration every time you change tape types.

Other systems offer 2:1 compression/expansion, but Super D has the crucial advantage of band-splitting – with entirely separate processing of low and high frequencies (see diagram). So the attack and release times of the compressors can be optimized for each band – eliminating "pumping," drastically reducing odd-order bass distortion, and making the system far less susceptible to small tape dropouts.

Superb Specs... Easy to Operate.

The PLUS N55 Super D processor patches in between your existing cassette and your preamp or receiver. It's equipped with wide-range, instant-responding



fluorescent peak meters, and a 1 kHz oscillator for calibrating it to your tape deck.

After initial setup, you can ignore the record and output level controls on your deck, as well as the old-fashioned VU meters it's probably equipped with. The PLUS N55 encodes and decodes simultaneously, so with a 3-head deck you can monitor the beautifully clean playback while you're recording.

And it will be clean! The PLUS N55 has a dynamic range of 100dB, and typical harmonic distortion of 0.08% (1 kHz, nominal operating level). It's ideal for professional use, with supplied rackmount handles and low impedance outputs that let it drive long signal lines.

So before you invest in any noise reduction system, listen to the affordably priced Sanyo Super D.

And step up to total silence.

"Super D" Block Diagram

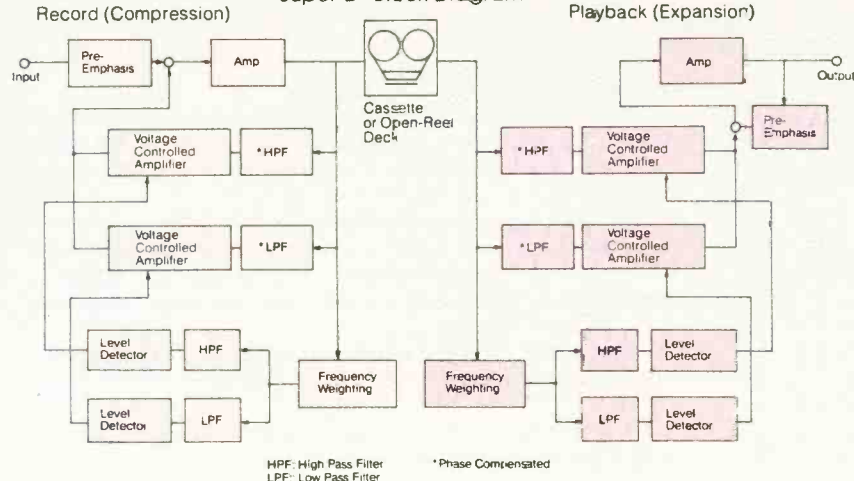

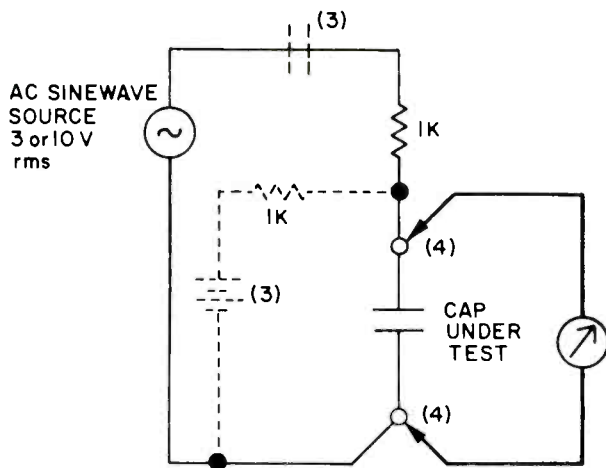

Fig. 10—Measuring capacitive impedance by oscillator and voltmeter method.

The answer can be had by regarding the data of Fig. 7 in a different light.

Using the capacitors A and B as illustrative examples, their actual effective capacitance values were calculated for various frequencies, using equation 4 to solve for C. The results, plotted in Fig. 8, clearly show the A unit (the higher R_s unit) to exhibit strong changes in capacitance with frequency. The B unit improves the situation relative to A, but still shows substantial capacitance change.

It is not at all hard to imagine how a capacitor whose value actually changes with frequency might distort an audio signal's integrity, particularly with regard to phase.

If we can visualize the complex frequency relationships of music passing through a capacitor (it doesn't really), while Z is simultaneously changing with the complex frequencies of the music, it is possible to appreciate how it can be relatively easy to upset the subtle harmonic/fundamental phase and amplitude relationships. Not only from the capacitance variation standpoint but also from the inductive behavior region. Used as a coupling capacitor, the resulting effects of high DF (L or R_s) are image blurring, and instrument harmonics/overtone are less accurately reproduced, with a general overall veiling of the sound. Use in a feedback path further complicates the matter, because we are using this signal to provide error correction. For example, if we consider the general transfer relationship for an amplifier where the gain = $Z_f + Z_{in}$, it is easy to see that variations in Z with frequency which depart from the ideal will distort the relationship.

When we talk of film capacitor types, we find that the situation of less than ideal behavior regarding impedance vs. frequency is improved greatly. This is simply due to the fact that film dielectrics, such as polystyrene, polypropylene, polycarbonate, and polyester, have much lower dielectric losses. This is reflected in lower DF and R_s , as well as generally much more stable parameters with respect to frequency and temperature.

The impedance vs. frequency characteristics of a number of film-type capacitors are shown in Fig. 9. In general, it can be noted that they all show lower minimum impedances (lower R_s), and sharper dips around resonance. These points underscore the fact that the resistive losses can be much lower, in many cases below 10 milliohms.

Film capacitors also appear inductive above their series resonant frequency, due to inevitable parasitic inductance of the winding and/or leads. However, the inductive effects can be minimized, by suitable winding and termination techniques, which can extend the usefulness of a capacitor to substantially higher frequencies. Useful cues to look for in this regard are specified noninductive winding techniques and extended foil-welded-lead attachments.

Measuring Capacitor Impedance Values

Since the above points are so basic to optimum capacitor selection, it logically follows that most audio experimenters will want to have the capability to measure the various capacitor performance parameters. Since few of us have access to the necessary bridges (and if so, many of them can't measure R_s or DF), it seems necessary to devise a setup to measure these parameters. A setup we find most convenient to these purposes is shown in Fig. 10, and it was actually used to gather all of the data for Fig. 8.

This setup basically measures impedance (Z) by the voltage divider method, using a sine-wave generator and voltmeter. From the impedance data, C, R_s , L and DF can be derived. Table I and the notes describe the details of the procedure, which is written for either a bench voltmeter or an oscillator-analyzer combination. You should, of course, take appropriate precautions regarding bias voltages, polarity, and so forth. Also, be sure to use shielded leads on the voltmeter and connections direct to the terminals on low R_s units.

You will be pleased with how much power this simple little setup gives you in grading capacitors, particularly electrolytics. For example, you can use it to quickly weed out poor-quality units, such as A (a junkbox special). Given a few

Table I—Voltage to impedance conversion chart, with notes for various test conditions and using the circuit shown in Fig. 10.

Voltmeter Scale (Full scale, volts or percent)		Equivalent Impedance (Full scale, ohms)
10-V Source ¹	3-V Source ²	
1	100	100
0.3	30	30
0.1	10	10
0.03	3	3
0.01	1	1
0.003	0.3	0.3
0.001	0.1	0.1
0.0003	0.03	0.03
0.0001	0.01	0.01

Notes:

- 1) This scale applies to a separate 10-V source and a.c. voltmeter. The 1-V full-scale range is equivalent to 100-ohms full-scale range. (Multiply numerical reading X100 to get ohms.)
- 2) This scale applies to a Sound Technology 1700B or equivalent operated as a 3-V source. Use the "dB Volts" scale with 0.3 V rms equal to 100 percent. The 100-percent full-scale range is then equivalent to 100-ohms full-scale range and ohms are read directly.
- 3) The d.c. bias source, if required. Use input blocking capacitor equal to or greater than 100 μ F, and OBSERVE POLARITIES!
- 4) On low ESR types, place the a.c. meter leads directly at the capacitor terminals for minimum lead length.

AKG[®]
ACOUSTICS

*K-340 - A "Realworld" Concert Hall
... of your very own!*



Be possessive. Curl up in the comfort of your favorite chair within a K-340 Concert Hall of your very own. There you can be sensually involved and you disturb no one else.

The new AKG K-340 is the first uniquely engineered headphones to combine the advantages of "electrostatic" and dynamic transducers together with passive diaphragms. The result of intensive studies in psychoacoustics, they are designed to effectively produce sound which precisely simulates the listening experience one enjoys from high quality speakers in free space. Their superior sound offers hours of contentment.

Listen to these "live" performance headphones at your AKG dealer today, or write us directly.

PHILIPS AUDIO VIDEO SYSTEMS CORP.
A NORTH AMERICAN PHILIPS COMPANY
91 McKee Drive, Mahwah, N.J. 07430 • (201) 529-3800



...the mark of professional quality

in microphones, headphones, phonocartridges, reverb units.

© AKG Akustische und Kino-Geräte GmbH, Austria

units of similar value, it is quite easy to select the lowest R_s unit, such as H versus I.

If you use an audio oscillator and meter, you will most probably be limited to upper frequencies below 100 kHz or 200 kHz. However, you can use the same basic technique with a wide-range function generator as a sine-wave source and a high-gain scope as the readout device. This will allow testing of the smaller value film capacitors, which typically are series resonant at appreciably higher frequencies. Δ

References

1. Hadaway, D., "Sources of Distortion in Preamps," *BAS Speaker*, Feb., 1977.
2. Curl, J., "Omitted Factors in Audio Circuit Design," 1978 IEEE Conference on Acoustics, Speech, and Signal Processing, April, 1978. Also published in *Audio*, Sept., 1979, p. 20.
3. Marsh, D., "Capacitor Fidelity," (letter) *The Audio Amateur*, 4/77.
4. Marsh, D., "Capacitor Caveats," (letter) *The Audio Amateur*, 2/78.
5. Marsh, D., and N. Pass, "Tantalum Capacitors: Yes or No?" (letter) *The Audio Amateur*, 2/79.
6. Bowling, E., "Look Out! All Electrolytic Capacitors Are Not Alike," *Electronic Design*, Jan. 4, 1974.
7. Cowdell, R., "Bypass Filters Extend to the GHz Range," *Electronic Design*, July 19, 1977.
8. Belcak, S., "Specifying Electrolytics," *Electronic Products*, Dec., 1978.
9. Doubrava, L., "Proper Handling of Voltage Spikes Safeguards Circuit Designs," *EDN*, Mar. 5, 1979.
10. Von Kampen, T., and P. Reeves, "Consider Polypropylene Capacitors," *Electronic Design*, Sept. 17, 1977.
11. Brokaw, P., "An IC Amplifier User's Guide to Decoupling and Grounding," *Electronic Products*, Dec., 1977.
12. Epand, D., and K. Liddane, "Selecting Capacitors Properly," *Electronic Design*, June 21, 1977.
13. Eimar, B., "Stretch Electrolytic Capacitor Life," *Electronic Design*, April, 1975.

14. Forsander, P., "Aluminum Electrolytics Are Hard to Beat," *Electronic Design*, Oct. 11, 1974.
15. Harper, C.A., *Handbook of Components for Electronics*, Chapter 8, McGraw-Hill, 1977.
16. "Parylene Film Capacitor Performance Data," Union Carbide Form F-2755.
17. "Film Capacitors," F-Dyne Electronics catalog.
18. "Precision Film Capacitors," PFC, Inc. catalog.
19. "Film Capacitors," Union Carbide catalog F-2871.
20. "Film Capacitors," Midwec catalog.
21. "X363UW Metalized Polypropylene Capacitor Technical Summary," TRW Capacitors.
22. Johnson, F.L., "Capacitors—What Are They?" *Electro-Cube Technical Bulletin* No. 1.
23. Johnson, F.L., "Capacitors—Capacitance Changes—Why?" *Electro-Cube Technical Bulletin* No. 3.
24. Johnson, F.L., "Capacitors—PF? DF? Q?" *Electro-Cube Technical Bulletin* No. 5.
25. Johnson, F.L., "Capacitors—Dissipation Factor," *Electro-Cube Technical Bulletin* No. 6.
26. Johnson, F.L., "Capacitors—The Metalized Dielectric—Friend or Foe?" *Electro-Cube Technical Bulletin* No. 9.
27. Johnson, F.L., "Capacitors—Dielectric Absorption," *Electro-Cube Technical Bulletin* No. 10.
28. Military Specification MIL-C-19978D. Capacitor, Fixed Plastic (or Paper-Plastic) Dielectric, General Specification for.
29. Johnson, F.L., "Which Capacitor?" Marshall Industries, Capacitor Div., 1965.
30. Buchanan, J.E., "Dielectric Absorption — It Can Be a Problem in Timing Circuits," *EDN*, Jan. 20, 1977.
31. Buchanan, J.E., "Recovery Voltage Measurements with Emphasis Below One Second for Class I NPO Ceramic Capacitors," *IEEE Transactions on Components, Hybrids, and Manufacturing Technology*, Vol. CHMT-1, No. 1, March, 1978.
32. Dow, P.C., "An Analysis of Certain Errors in Electronic Differential Analyzers, Part II — Capacitor Dielectric Absorption," *IRE Transactions on Electronic Computers*, Vol. EC7, March, 1958.



THE \$450 TUNER THAT CAN'T MISS.



Some tuners use a "digital readout" that looks precise, but the station can still be mistuned. But in the Phase 5100 Digital Synthesized Tuner, the digital frequency you select is referenced to a quartz crystal oscillator, and locked in by a Phase Lock Loop circuit. You tune with absolute accuracy, so you can't miss. You enjoy every broadcast with minimum distortion, and maximum signal/noise ratio. And the 5100 will never "drift" off-station.

The Phase 5100 has a memory that can store up to 6 FM stations and 6 AM stations, a total of 12 stations. Just touch a memory button, and a favorite station is immediately in perfect tune. Automatic scan up and down the band. Outrageous specs. And a price that'll make life tough for other tuners. Hear it at your Phase Linear audio dealer.

Phase Linear
20121 48th Avenue West,
Lynnwood, WA 98036

Put Sound Guard™ on trial.



Take up to 30 days to try Sound Guard on your records. Get your money back if not fully satisfied.

Judge the effectiveness of Sound Guard Record Preservative for yourself. Use it on your records for up to 30 days. See how the ultra-thin lubricant works to reduce static charges, cut down friction, virtually eliminate record wear—and provide your music with long-lasting protection.

Only Sound Guard has the confidence in their record preservative to make this money back trial offer. If you're dissatisfied for any reason, send us the product,* a copy of your

dated sales slip, and we'll refund your money, no questions asked. That's an offer no other record care product seems to be making.

Our confidence also extends to the entire line of Sound Guard record care products; like the Record Cleaning Kit, Stylus Care Kit and Total Record Care System that contains both the preservative and cleaning kits.

You could spend your hard-earned money on all those other record cleaners, preeners, washers and brushes—or you can try Sound Guard at absolutely no risk. We think our offer is the best way to decide which one to try. You've got everything to gain—clean, better-sounding records—and best of all, nothing to lose.



Sound Guard™ preservative — Sound Guard™ cleaner.
Sound Guard™ Total Record Care System.
Sound Guard is Ball Corporation's registered trademark.
Copyright © Ball Corporation, 1979. Muncie, IN 47302



*Return to Sound Guard, P.O. Box 5003, Muncie, IN 47302. Offer expires April 30, 1980.

Equipment profiles

Audio-Technica Lifesaver Record Care System



It has been several years since we performed comprehensive tests on a record preservative system from Ball Bros. known as Sound Guard. That product did an effective job of applying a dry lubricant coating to records to decrease stylus friction and thereby increase record life. More recently, we performed similar tests on an antistatic solution known as Permostat (distributed by Stanton Magnetics) whose primary function was to permanently reduce static charges on records. Both of these products accomplished their stated tasks in an exemplary manner, but serious record collectors intent on achieving best performance from their discs were faced with the need for two separate products, in addition to having to use a record-cleaning system.

Now Audio-Technica has come up with a record-care system which accomplishes both record preservation and almost total reduction of static charges on discs. Dubbed the Lifesaver system, it provides a slippery microscopic barrier against record surface damage and also contains a non-silicone antistat that disperses static charge fairly rapidly upon application.

Test Methodology

All of the tests undertaken by our lab involved the repetitive playing of specific test records. Although claims made for Lifesaver refer to 50 playings, our tests involved 100 repetitive playings of certain portions of the test records. Previous experience with similarly applied products has revealed that

this number of plays is required to reveal easily discerned differences between treated and untreated discs.

For each of our tests, an untreated control record was subjected to the same number of plays (100) as the treated record. All measurements were made both after the first playing of the treated and untreated records and after 100 playings of each.

Laboratory tests were conducted using a CBS Catalog STR-130 Test Record. Band 4 of Side A of this record contains spot frequency signals covering the range from 20 Hz to 20 kHz, while Band 7 of the same side offers a 1-kHz steady tone which we used for making harmonic distortion measurements. The lead-out groove of Band 7 is also sufficiently long to serve as a "silent groove" band which we used to examine surface noise content for the treated and untreated discs.

Test Equipment Used

The chief measuring instrument used in all the tests was our Model 5L4N Tektronix spectrum analyzer mounted in a Model 5100 storage scope mainframe. For all tests, the sweep rate was adjusted so that a complete horizontal analysis took place in 20 seconds. Sweep was set to the linear position, and the horizontal scale for all distortion measurements was 1 kHz per division, while for noise spectral analysis it was set to 2 kHz per division in order to observe the entire audio band (out to 20 kHz).

The turntable used was an ADC/BSR Accutrac Model 4000 equipped with its own ADC cartridge adjusted to a tracking force of 1.5 grams. This unit was chosen because its programming feature enabled us to "punch in" up to 24 playings of the same band of the record to accelerate the tests and so as not to require our presence while the repeated playing sequence took place. To avoid any possibility of vinyl deformation caused by too-rapid repeat playing of the disc, we programmed the turntable to alternately play Bands 4 and 7 of the disc (including the lead-out groove after Band 7). Thus, each cycle took approximately six minutes.

Since Lifesaver makes claims for reducing static buildup to negligible values, we acquired an electrostatic field strength

Fig. 1—Electrostatic field strength meter used to measure voltage charges on test records.

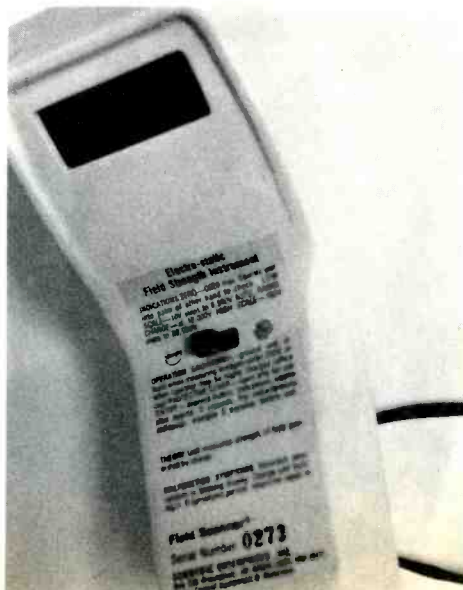

Table I — Electrostatic voltage readings (volts).

	Untreated Disc	Treated Disc
Removed from sleeve, held by edge	50,000	54,800
Placed on turntable	2,500	2,200
After first play, but before treatment, hand-held	43,000	33,000
After first play, but on turntable, before treatment	2,400	2,250
First post-treatment play, on turntable	N/A	390
First post-treatment play, hand-held	N/A	380
After 100 playings, on turntable	2,400	180
After 100 playings, hand-held	48,200	600

meter known as the Microstat Field Scanner, manufactured by Scientific Enterprises, Inc. (their Model 2B, pictured in Fig. 1). Via a digital readout, this instrument reads directly in volts over a range from 0 to 99,900 volts, positive or negative, when it is held at a distance of 10 centimeters from the surface to be measured.

Signals picked up by the cartridge were amplified and equalized by our laboratory reference preamplifier, the output of which was fed in parallel to a Sound Technology Model 1700B audio analyzer, a conventional oscilloscope (for monitoring results visually) and the aforementioned spectrum analyzer.

The Lifesaver Record Care System includes a two-ounce bottle of fluid (enough to treat approximately 30 discs on both sides), a velvet buffing pad into which one can slip the three middle fingers of one hand for effective buffing, and 30 small labels on which the date of treatment of each record can be noted. Suggested price for the kit is \$12.95, and a six-ounce replacement bottle of fluid is available for \$14.95. Treatment of the first 30 records costs around 43 cents, while subsequent treatments, using the six-ounce refill, would cost approximately 17 cents per disc.

The fluid of Lifesaver is applied by means of a jet spray pump which is affixed atop the bottle and manually operated. Once the entire surface of the disc is sprayed, the hand buffing device is used to thoroughly buff-in the product on the surface of the record. The liquid carrier of the solid lubricant evaporates quickly, leaving the microscopically thin coating uniformly distributed on the disc. Audio-Technica states that the coating is only three microns thick, but of course we had no way of measuring this.

Test Results

We first determined that frequency response, as plotted using the spot frequencies of Band 4 of the test record, was not materially affected by application of the liquid, either after the first playing following the treatment or after 100 plays. Such differences in response that were observed for the untreated and treated records alike were so minimal and random that they can only be attributed to tolerances in the measurement system and, perhaps, changing ambient conditions of temperature which might affect the test preamplifier or even the cartridge itself to a minute degree. Thus, it can be safely said that application of Lifesaver in no way degrades tonal response from a recording.

Using the Microstat Field Scanner, we measured the electrostatic voltage charge of the untreated and treated discs at various times during the tests. The untreated control record

was measured after rapid removal from its sleeve and, again, after placing it on the turntable. The disc was next measured after 100 plays, first while resting on the turntable and finally while held by its edge. The treated disc was similarly measured (including a before-treatment measurement to insure similarity between the two test discs). Results are shown in Table I.

It should be noted that immediately after buffing-in of the Lifesaver fluid, a charge is developed on the treated record. Initially, this voltage measured 22,500 volts when the record was hand-held by its edge. However, it quickly subsided, as shown in the graph of Fig. 2. After five minutes following treatment, the voltage charge, still measured with the record hand-held on edge, had decreased to a negligible 390 volts. Clearly, the fluid is an effective and long-term deterrent to static charge on records.

Fig. 2—Decrease in static charge after application and buffing of Audio-Technica's Lifesaver record preservative.

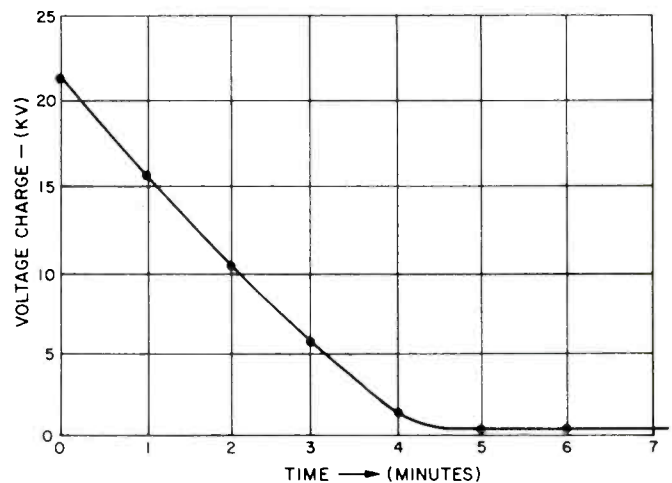

Harmonic Distortion Tests

Figures 3 through 6 reveal a clear picture of how harmonic distortion varies with repeated playings of discs, both for the untreated and treated test records used in these tests. In each of these spectrum analyzer 'scope photos, the spike at the extreme left is the desired 1-kHz test signal. The shorter spike immediately to the right of the fundamental is second-order harmonic distortion. This is largely a function of tonearm tracking geometry, and we will ignore it in this discussion since it remains fairly constant throughout the tests. Of interest, however, is what happens to higher order harmonics, beginning with the third spike from the left of each display. Figure 3 represents results obtained from a first playing of the untreated disc. Third-order component is down 51 dB compared with the fundamental (or 0.28 percent), fourth order is down 58 dB (0.13 percent), while fifth order is down 63 dB (0.07 percent). Combining these components mathematically (square root of the sum of the squares of each component

Wharfedale. First and everlasting.



The Wharfedale E's are the newest speakers in an unequalled tradition of excellence that goes back to the early days of music reproduction.

In those days, our speakers—like the unique sand-filled designs of Gilbert Briggs—were received with wide acclaim despite the limited technical resources of that era. Today's Wharfedale E's benefit from our space-age technology, and hold a special position of leadership in acoustic engineering.

The design goal for America's Wharfedale E's was to achieve that elusive combination of crystal-like clarity, strong bass and extremely high efficiency. We met this objective

using computer optimization and holographic research, developing speakers with extremely wide dynamic range and no coloration. They've won the praise of lovers of every kind of music. And seem destined to keep that praise for years to come.

A Wharfedale E can fill a room with just a couple of watts. Or handle hundreds for unusually large areas. At any level, with any music, you won't detect any of the harshness or roughness inherent in lesser speakers.

Each Wharfedale E goes through a stringent Quality Control procedure that rejects all but the most perfect speakers. Those that pass represent

the highest attainable audio technology, enhanced by the skills of old-world craftsmen who make each pair of perfectly matched hand-rubbed, fine wood veneer cabinets.

Many speaker makers have come and gone in the nearly 50 years since the first Wharfedale was made. And when you listen to the E's you'll know why Wharfedale lasts.

The new E90 measures 45-3/8" H x 15-3/16" W x 14-3/4" D and has a typical frequency response of 30–18,000Hz \pm 3dB. The E70 is 32" x 13-1/2" x 14" with frequency response from 35–18,000Hz \pm 3dB. The E50 measures 25" x 13-1/2" x 13-1/2" with a frequency response of 40–18,000Hz \pm 3dB. The new E30 is 22-3/4" x 13-3/16" x 10-5/16" with a 45–18,000Hz \pm 3dB frequency response. Efficiency is 94dB at 1 watt and 1 meter for the E30, and 95dB for the other models.

WHARFEDALE®



RANK HI FI Inc., 20 Bushes Lane, Elmwood Park, New Jersey 07407 (201) 791-7888

Enter No. 50 on Reader Service Card

Fig. 3—Harmonic distortion of the untreated disc during first playing.

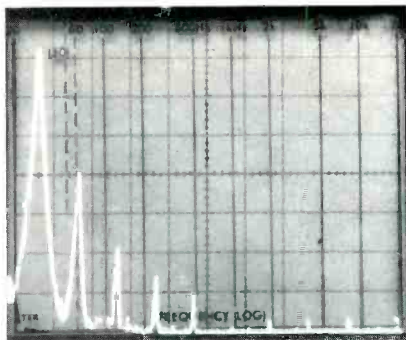

Fig. 4—Harmonic distortion of the untreated disc after 100 playings.

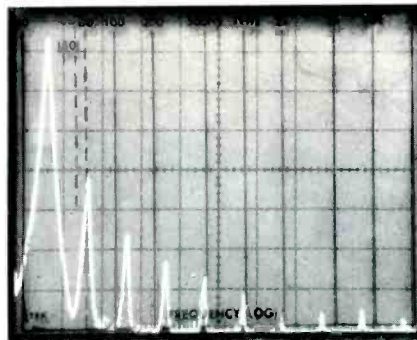

Fig. 5—Harmonic distortion of the treated disc, first play after application of Lifesaver.

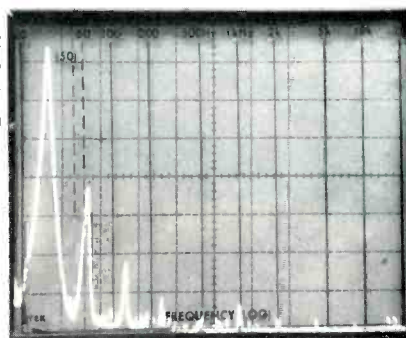
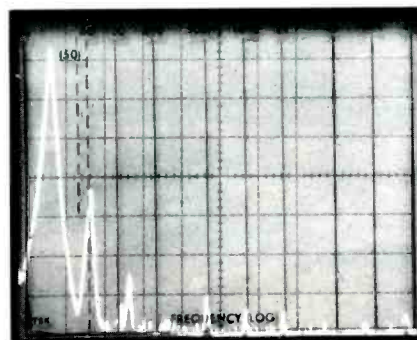

Fig. 6—Harmonic distortion of the treated disc after 100 playings.



divided by the fundamental amplitude), we come up with an overall distortion figure of 0.32 percent (ignoring the higher order components whose amplitudes are negligible in the calculation, as well as the aforementioned second-order component).

Figure 4 represents results obtained after 100 playings of the untreated disc. Third-order component has increased so that it is now down only 48 dB (0.4 percent), fourth order is at -55 dB (0.18 percent), fifth-order distortion is down 60 dB (0.1 percent) while sixth order, now significant, is at -63 dB (0.1 percent). The combination works out to a distortion figure of 0.45 percent — clearly an increase in distortion compared with the first playing.

Results obtained during first play of the disc after treatment with Lifesaver are shown in Fig. 5. Distortion components (ignoring second order) are at -56 dB, -65 dB and -67 dB, with no significant contributions of 5th, 7th, or higher orders. These values calculate out to a percentage figure of 0.21 percent. It should be noted that immediately prior to treatment, the record was similarly checked and yielded a figure of 0.34 percent, comparable with that of the control record. In other words, application of Lifesaver actually improved stylus tracking slightly even during first post-treatment play compared with that of an untreated record. The real payoff came after 100 playings, as illustrated in Fig. 6. Again, ignoring the almost constant second-order distortion components, other components observed were at -58 dB, -63 dB, -68 dB, and -68 dB (fourth-order component has virtually disappeared), adding up to a net distortion figure of only 0.16 percent — or approximately one-third as great as obtained after 100 playings of the untreated record.

Surface Noise Analysis

Figure 7 shows the distribution of surface noise on the untreated record during its first playing, from 20 Hz to 20 kHz. After 100 plays the experiment was repeated, and the results are shown in Fig. 8. Clearly, the noise level in the region from 5 kHz to 20 kHz is from 3 to 5 dB higher after this large number of plays.

The same experiment was now conducted with the treated disc. Figure 9 shows results obtained during the first post-treatment playing of the disc to which Lifesaver had been applied. Comparing these results with those obtained in Fig. 7, there is a very significant reduction in noise level in the region from 1 kHz to the end of the spectrum at 20 kHz. We made periodic observations of the noise level after 25, 50, 75, and 100 plays. At the 75th playing, the noise remained virtually as low as it was during the first post-treatment playing, and only after the full 100 playings did the noise level return to that which had been observed for the untreated disc. Compare the results shown in Figs. 8 and 10.

From these tests we concluded that Lifesaver significantly reduces surface noise on discs to which it is applied, but that the improvement is effective for between 50 and 75 playings, after which the product should be reapplied for further surface protection.

Subjective Tests

In addition to the laboratory tests described, we applied Lifesaver fluid to a variety of discs in our own record collection. While these discs were not subjected to multiple-play testing, we can verify that subjectively and audibly, Lifesaver did reduce surface noise content during playing of the treated records and, at least to our ears, in no way degraded performance quality. On the basis of these tests, we can sum up the benefits of Lifesaver as follows: It reduces static charge buildup on records to insignificant levels for up to 100 playings after application, it reduces the rate of increase of harmonic distortion during playback of discs for at least 100 playings after application, and it reduces surface noise heard during playback of discs for at least 50 playings.

As a final note, we found that Lifesaver is compatible with at least two of the most popular cleaning formulations, which should be applied to a disc prior to treatment with Lifesaver. Because of the antistatic protection afforded by Lifesaver, subsequent cleaning of records becomes much easier (the dust particles are not held so tenaciously to the surface as they are when records carry a high voltage charge),

Continued on p. 95

B•I•C Model T-4M Cassette Deck



Manufacturer's Specifications

Speeds: Two, 1 7/8 and 3 3/4 ips.

Frequency Response: 20 Hz to 21 kHz, ±3 dB, at 1 7/8 ips; 20 Hz to 24 kHz, ±3 dB, at 3 3/4 ips.

Signal-to-Noise Ratio: 68 dB at 1 7/8 ips, 72 dB at 3 3/4 ips, both with Dolby N-R.

Wow and Flutter: 0.05 percent at 1 7/8 ips, 0.03 percent at 3 3/4 ips, both W rms.

THD: 1.3 percent at 1 7/8 ips, 1.0 percent at 3 3/4 ips, both at 0 VU.

Dimensions: 17 1/4 in. (43.82 cm) W x 10 in. (25.54 cm) D x 6 1/2 in. (16.5 cm) H.

Weight: 18 lbs. (8.18 kg).

Price: \$849.95.

68

The B•I•C Model T-4M has to be one of the most sophisticated cassette decks to be reviewed in these pages, and some idea of its versatility can be had by a look at the controls. There are no fewer than 23—and that's not counting the tape transport buttons! Among the features of this "loaded" deck are metal-tape capability, a digital display instead of a rotary tape counter, built-in 400-Hz and 10-kHz signal generators, variable speed control, bias control, monitor head, dual capstans and, that B•I•C innovation, two speeds.

The front panel is finished entirely in black with white lettering, while the case is nicely made from rosewood. The cassette compartment is over on the left, and underneath is a row of feather-touch logic controls for tape transport plus an on-off switch. To the right are eight lever switches for speed change (1 7/8 and 3 3/4 ips), equalizing, bias, record, Dolby, MPX, monitor, and record calibration. The last-named switch activates the 400-Hz or 10-kHz generators, while the record switch has a third position marked *Mute* which stops the recording signal from reaching the tape. Next to the calibration control is the variable bias control followed by three 1/4-in. phone sockets, one for headphones and two for microphones. Above them are two large knobs and three small ones, the first two being dual-concentric mike-line input controls, while the other three govern the pitch and output, and headphone levels. At the top is the large digital-display tape counter, and next to it is a twin horizontal VU display consisting of 12 green and four red LED indicators for each

channel. The first red light marks the Dolby level and 0 VU, and the green ones are arranged in -3 dB steps down to -36 dB. In between the VU and tape counter displays are metal-tape and clipping indicators, both LEDs, and to the right is a group of six small buttons controlling a microcomputer circuit for auto rewind, auto play, tape counter clearing, and memory functions. And that's it for the controls—with the exception of the *Eject* button, which is located way over on the left-hand side of the cassette compartment, conveniently placed near the top, and the two 400-Hz calibration controls just below. There are two motors, a servo-controlled model for transport and a d.c. type for spooling.

One more thing: The bias adjustment switch is marked 400 Hz and 10 kHz, and it might be thought that alignment at these frequencies will not produce optimum results. However, the actual high-frequency signal was measured at just over 16 kHz, a modification which was confirmed by a footnote in the instruction manual, which mentions that the deck is set up for TDK AD and SA and for Scotch Metafine.

Laboratory Measurements

As usual, the first test was for playback response from a standard tape, and the output was within 1 dB from 70 Hz to 10 kHz, with a rise of 2 dB at 40 Hz as shown in Fig. 1. As the T-4 has metal-tape capability, one of the new TDK MA-R C-

Fig. 1 — Playback response from standard 40 Hz to 10 kHz test tape.

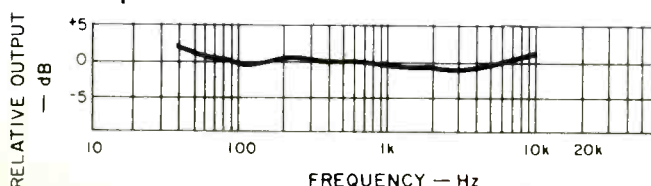
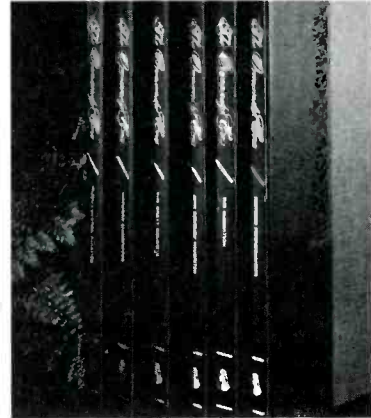
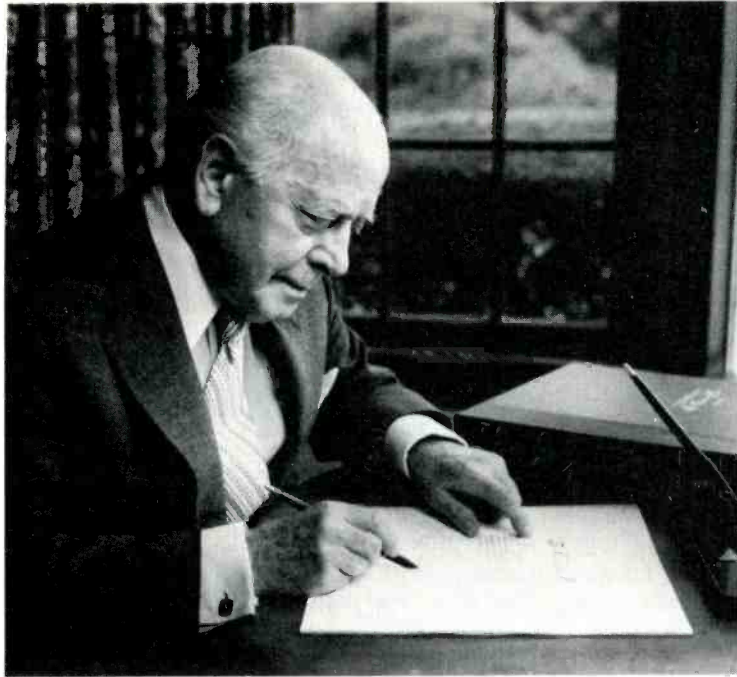

Table I — Signal-to-noise ratio, dB, referenced to 3 percent THD, "A" weighted. Add 8 to 9 dB for Dolby N-R.

Tape	1 7/8 ips	3 3/4 ips
TKD MA-R	53.5	56.5
Scotch Metafine	53.0	56.0
Fuji Metal	54.0	57.0
Maxell UD XL-I	55.0	58.0
Fuji FX-II	56.0	58.5



The Greatest Recordings Ever Made by Eugene Ormandy and the Philadelphia Orchestra

Personally Autographed by Maestro Ormandy

Single edition limited to 5,000
Please order by March 31, 1980

For more than four decades, Eugene Ormandy has conducted the Philadelphia Orchestra, considered by many to be the finest symphony orchestra in the world. During those years, he has earned the respect and admiration of millions.

Now, at the summit of his career, Eugene Ormandy has chosen to relinquish his role as Music Director of the orchestra. And on this occasion, The Philadelphia Orchestra Association will pay tribute to him by issuing an unprecedented record collection.

This historic collection, *The Ormandy Era*, will comprise the greatest recorded performances ever made by the Philadelphia Orchestra under the personal direction of Maestro Ormandy. And, as his expression of gratitude to those who have enjoyed the Philadelphia Orchestra over the past forty years, Eugene Ormandy will personally hand-sign each collection for each individual who acquires it.

For this reason, *The Ormandy Era* will be limited to a single edition of just 5,000. And it can be acquired only by subscription; it will not be sold in record stores.

There are thirty records in the collection, presenting classics like Tchaikovsky's *Pathetique*, Beethoven's Piano Concerto #3, Ravel's *Bolero* . . . and some Ormandy

recordings never publicly released before. Such as the *Academic Festival Overture* and *Carnival of the Animals*. Many recordings were made with world-famous soloists like Heifetz, Rubinstein, Serkin, Perlman, Flagstad and Stern.

Superior records of unique proof-quality

All of the records will be of superb *proof-quality*, produced exclusively by The Franklin Mint Record Society. These records are made of a special vinyl material which contains its own anti-static element. This material, combined with the meticulous process by which the pressing is made, results in a record that has true fidelity, clearer sound and is more durable and resistant to dust.

The records are pressed in a "clean room," which is totally dust-free and atmosphere-controlled. Here, exceptional care is taken to make sure that the full quality of each original recording is faithfully preserved.

Personally signed—and limited

These *proof-quality* records will be housed in six custom-designed library albums of five records each. Plus an *additional* volume—at no charge—featuring a personal message from Maestro Ormandy, hand-signed by him. It will also contain a biographical portrait of the great conductor, and the text of fascinating interviews with such personalities as Isaac Stern, Zubin Mehta and Rudolf Serkin.

IMPORTANT: There will be no more than

5,000 of these signed Ormandy collections produced. And when this number is reached, no further subscriptions will be accepted.

To obtain the collection, mail your order to The Philadelphia Orchestra Association, 1420 Locust Street, Philadelphia, Pa. 19102.

© 1980 FM

SUBSCRIPTION APPLICATION

THE ORMANDY ERA

Please mail by March 31, 1980
Edition limited to 5,000

The Philadelphia Orchestra Association
1420 Locust Street, Suite 400
Philadelphia, Pennsylvania 19102

Please enter my subscription for *The Ormandy Era*, consisting of six library albums containing a total of 30 proof-quality records. The issue price for each record is \$10.75* plus 95¢ for packaging, shipping and handling. The collection will include an *additional* volume (at no charge) with a personal message hand-signed by Maestro Ormandy.

No payment is required at this time. I will receive my 5-record library albums at the rate of one every other month, and will be billed for each album in two equal monthly amounts of \$29.25 each, the first in advance of shipment.

*Plus my state sales tax

Signature _____

Mr. _____
Mrs. _____
Ms. _____

Address _____

City _____

State _____ Zip _____

ALL SUBSCRIPTIONS ARE SUBJECT TO ACCEPTANCE.

PLEASE PRINT CLEARLY

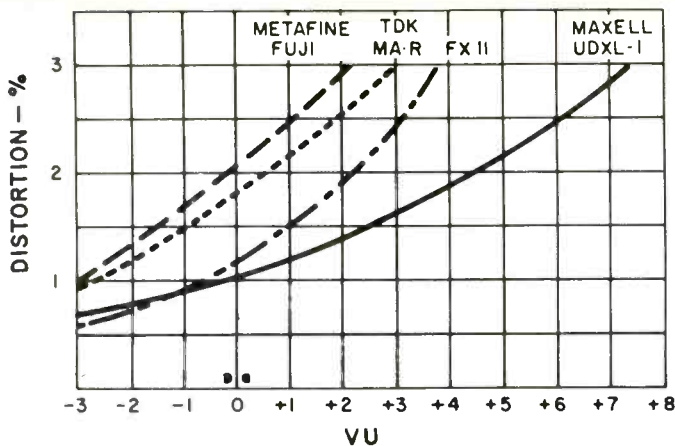

Fig. 6 — Distortion vs. level at 1 kHz for five tapes.

easy. I am sure many people will find the built-in microprocessor most useful as it enables many functions to be selected automatically. For example, there is a choice of automatic rewind, auto play, continuous play, or stop with two memory reference points selected with the aid of the counter display. As mentioned earlier, this is quite large and the brightly-lit half-inch figures can be seen from a considerable distance — unlike most conventional digital counters!

Now for a few words about the metal tapes: It is apparent that the designers of the T-4 have settled for a wider frequency range, with increased headroom at the higher frequencies, rather than taking advantage of better headroom in the midrange. Even so, the results show a significant midrange improvement over "ordinary" tapes. But note that the signal-to-noise ratio is not affected to any extent.

How about the 3 3/4 ips speed? Is it really worthwhile? Well,

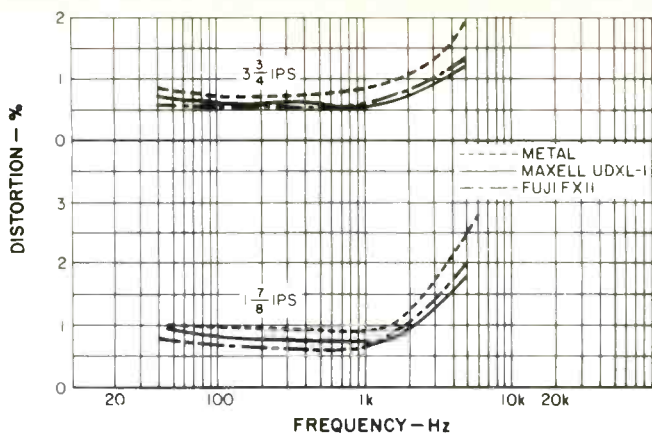

Fig. 7 — Distortion vs. frequency.

a glance at the graphs certainly confirms a wider frequency range, and recordings made at this speed have an audible extra brilliance and clarity — particularly noticeable with direct-cut discs, but the playing time is reduced by half. For most purposes, the 1 7/8 ips speed will be found to be perfectly adequate.

Overall, the deck must be considered as one of the very best available today, and it offers a surprisingly good value for dollar. (Editor's Note: A quick count of cassette decks priced at \$1,000.00 or more in our October Directory found some 18 decks in this price range — E.P.) Some features, such as the microprocessor unit, are almost unique to this deck, while others are more usual, but still quite well worked out. An extremely versatile and very sophisticated cassette deck, one which should appeal to the most discriminating user.

George W. Tillett

Enter No. 91 on Reader Service Card

IF YOUR DISKS MATTER, PUT A DISK MAT ON YOUR PLATTER

Your records are probably very important to you. You spend a lot of time and money building your collection, and you want to hear all that they have to offer.

Unfortunately, when you play your records, you often hear a lot more than music, because all kinds of noises slip through your sound system.

Disk Mats can clean things up for you.

An Osawa Disk Mat goes on your turntable platter, replacing the regular mat. Disk Mats are made of a special blend of natural rubber and a high density filler. The extra mass blocks resonant vibrations coming from your turntable motor and mechanism.

OSAWA & CO. (USA) Inc.
521 Fifth Avenue
New York, New York 10017
Distributed in Canada by
Intersound Electronics,
Montreal, Quebec

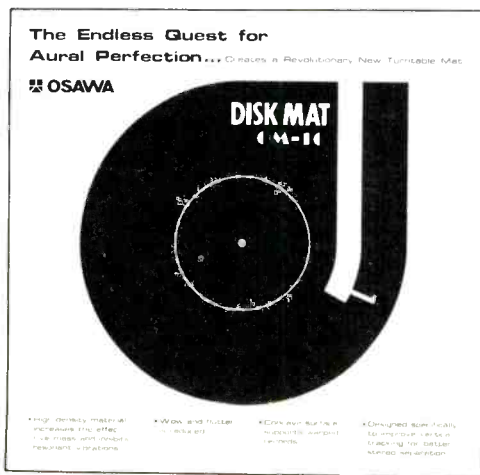

Enter No. 26 on Reader Service Card

Since the stylus moves free of interference, you get better high frequency response, wider dynamic range, improved stereo separation and imaging, and much more detail and realism. You can even play your records louder with a Disk Mat because it blocks feedback vibrations from your speakers.

As a bonus, the extra weight of the Disk Mats add to the platter's flywheel effect, lessening wow and flutter.

Disk Mats are available in two models. The Model SE-22 weighs 730 grams and is 5mm thick. The model OM-10 weighs 500 grams and is 3.5mm thick.

For better sound, flatter your platter. Get a Disk Mat at your Osawa dealer.

Disk Mat by
OSAWA

ADC Sound Shaper Two Mark II Stereo Equalizer

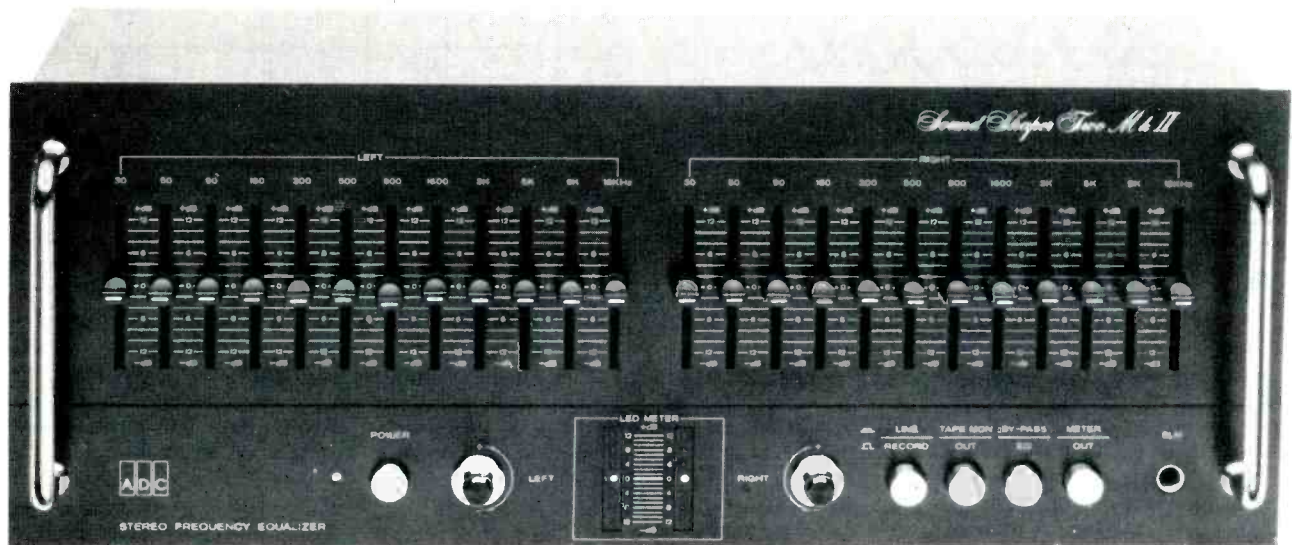

Manufacturer's Specifications

Frequency Response: 5 Hz to 100 kHz.

Control Frequencies: 30, 50, 90, 160, 300, 500, 900, 1.6k, 3k, 5k, 9k and 16k Hz.

Control Range: ± 12 dB.

Gain: Unity.

Output: 9 V min. into 10-kilohm load.

Harmonic Distortion: 0.02 percent.

IM Distortion: 0.02 percent.

Hum and Noise: -85 dBV.

Impedance: Input, 75 kilohms; output, 10 ohms at 1 kHz.

Dimensions: 16 $\frac{3}{8}$ in. (416 mm) W x 6 $\frac{1}{4}$ in. (159 mm) H x 6 $\frac{3}{4}$ in. (172 mm) D.

Weight: 7.2 lbs. (3.3 kg).

Price: \$280.00.

The ADC Sound Shaper Two Mark II stereo equalizer combines very good overall performance with unusual flexibility in providing 12 boost/cut controls per channel. Each of these vertical sliders is scaled ± 12 dB, with a worthwhile detent at the zero/flat-response position. Note that the spacing of the filter center frequencies is less than an octave, facilitating more accurate equalization. The large handles on the front panel appear appropriate for rack mounting, and there is an adaptor kit available as an option for that purpose. The left- and right-channel level meters are in a single assembly, with vertical, facing scales covering ± 12 dB. Adjacent pots set the LED metering sensitivity for zero indication over a range of input levels.

The Mark II is typical in that it is designed to be inserted into the tape monitor loop of a preamp or receiver. There are unity-gain adjustment pots and the required phono jacks on the back panel, as well as sets for tape recorder in and out, and an unswitched a.c. outlet of 200-watt rating. Push button switches on the front panel provide choices for EQ of program to tape recorder, EQ of program back to preamp/receiver, EQ on tape playback, or EQ bypass. The LED meters can also be switched off, if desired. A front-panel phone jack allows connection of the output of an SLM (sound level meter) to be indicated on the right-channel meter. ADC has an accessory SLM with test record available as an option.

With minor exceptions, all of the circuitry is on three PCBs, with some of the larger inductors mounted on the smallest of the three. A large vertical one is connected directly to the boost/cut sliders, with the RCL components mounted on the interior side of the card. The other large PCB has all other circuitry. Soldering was very good, and inter-board connections were with wirewrap. All parts and adjustments were clearly marked.

Performance

All filter center frequencies were close enough to the designations for EQ use. The attenuations in cut were just slightly greater than the scale indications. The discrepancies in boost were greater, with +13.5 dB actual at "+12," but this is still quite acceptable for high-fidelity system EQ. The shape and bandwidth of the filters were examined with varying degrees of boost and cut. The shapes were quite consistent from section to section, as shown in Fig. 1, the maximum boost and cut plots. At the maximum boost, filter Q was about 2.2 or, stated another way, the bandwidth was about $\frac{2}{3}$ octave. One-octave bandwidth (Q=1.4) was secured with 9 dB boost. These figures tell us that considerable boost can be introduced with limited ringing. This is a desirable characteristic, an advantage over some units that have very peaked responses. It is best, however, to restrict boost for a maximum Q=1, which was at +8 dB. With all sliders in detent, the response for either channel was flat from less than 10 Hz to 100 kHz, with small effects from loading.

The output impedance was only 8.2 ohms at 1 kHz, and fell slowly to 6.8 ohms at 20 kHz. It rose at the lowest frequencies, reaching 220 ohms at 20 Hz, certainly not to be challenged by the standard IHF load, 10 kilohms in parallel with 1,000 picofarads. The input impedance was satisfactorily high out to 20 kHz. The IM distortion at 1 V out was 0.029 percent with a high-Z load, 0.036 percent with the IHF load. These figures are a bit above the 0.02 percent specification, but the manufacturer's test conditions are not given in the instruction book. IM distortion of 0.1 percent was reached with 2 V out. With 1 V output, THD was 0.008 percent at 10 Hz, 0.01 percent at 1 kHz, 0.019 percent at 20 kHz, and 0.1 percent at 58 kHz. Distortion figures were slightly higher with the IHF load. With 2 V out, the results were 0.014 percent for 20 Hz,

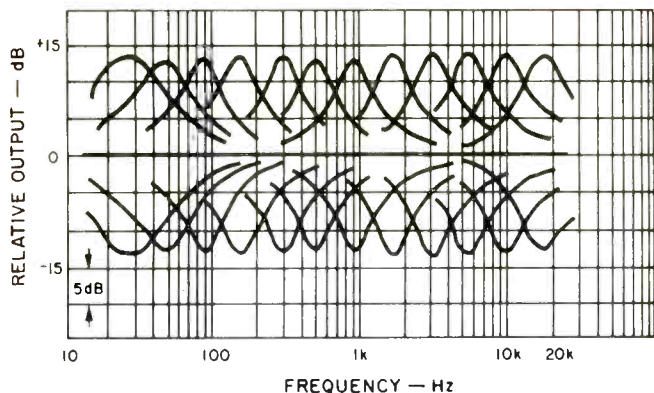

Fig. 1 — Frequency responses of individual filter sections at maximum boost and cut.

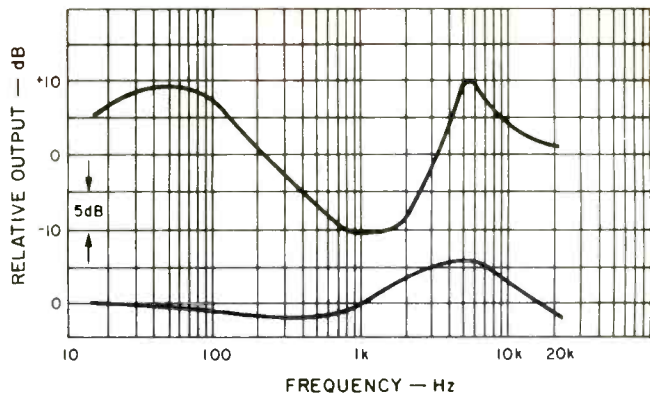

Fig. 2 — Top, swept frequency response with 50- and 90-Hz filters at +6, 300 Hz at -4, 900 and 1600 Hz at -8, and 5 kHz at +10; bottom; swept response of EQ used to improve system response (see text).

0.018 percent for 1 kHz, and 0.026 percent for 20 kHz with the high-Z load, certainly very good. With the IHF load, all figures were somewhat higher (0.022 percent at 1 kHz). The maximum output level of the Mark II was 10.2 V at 20 Hz, 11.1 V at 1 kHz, and about 8 V at 20 kHz, which is plenty high enough, even if the last figure is under the specified 9 V.

The 8-V output at 20 kHz showed what appeared to be current starvation on the positive peaks. Slew rate was checked with a 100-kHz square wave. In the positive direction, slew rate was 2.0 V/ μ S. In the negative direction, it was 10 V/ μ S. These results were consistent with the fact that THD was less than 1 percent at 111 kHz with 2 V out. At 1 V out, the response did not fall 3 dB until 400 kHz.

Excellent signal-to-noise ratios were measured with the ADC equalizer. With 1 V out, the figures were 99.3 dBA with that weighting, and 95.7 dB for CCIR/ARM weighting.

Unweighted, but with the measurement bandwidth restricted to 20 Hz to 20 kHz, the noise was down at -89.0 dBV. The values given here would change directly with changes in the output level relative to 1 V. With all of the filter controls in detent, there was a 0.3 dB drop in level when EQ was switched in, not significant.

The meter pots allowed setting the indications to zero for inputs from 70 mV to a very high 10 V. The scales cover ± 12 dB with markings every 2 dB, accurate within 0.2 dB. The dynamic response was very slow, requiring about 1 second for a charge of 20 dB, and about 2 seconds to discharge. This slowness, however, provides smoothing which facilitates reading the average levels of music or noise test signals. The meter indications are affected by the input level, the EQ slider settings, and the meter pot settings, but they do not necessarily show what the output levels are. It would be pos-

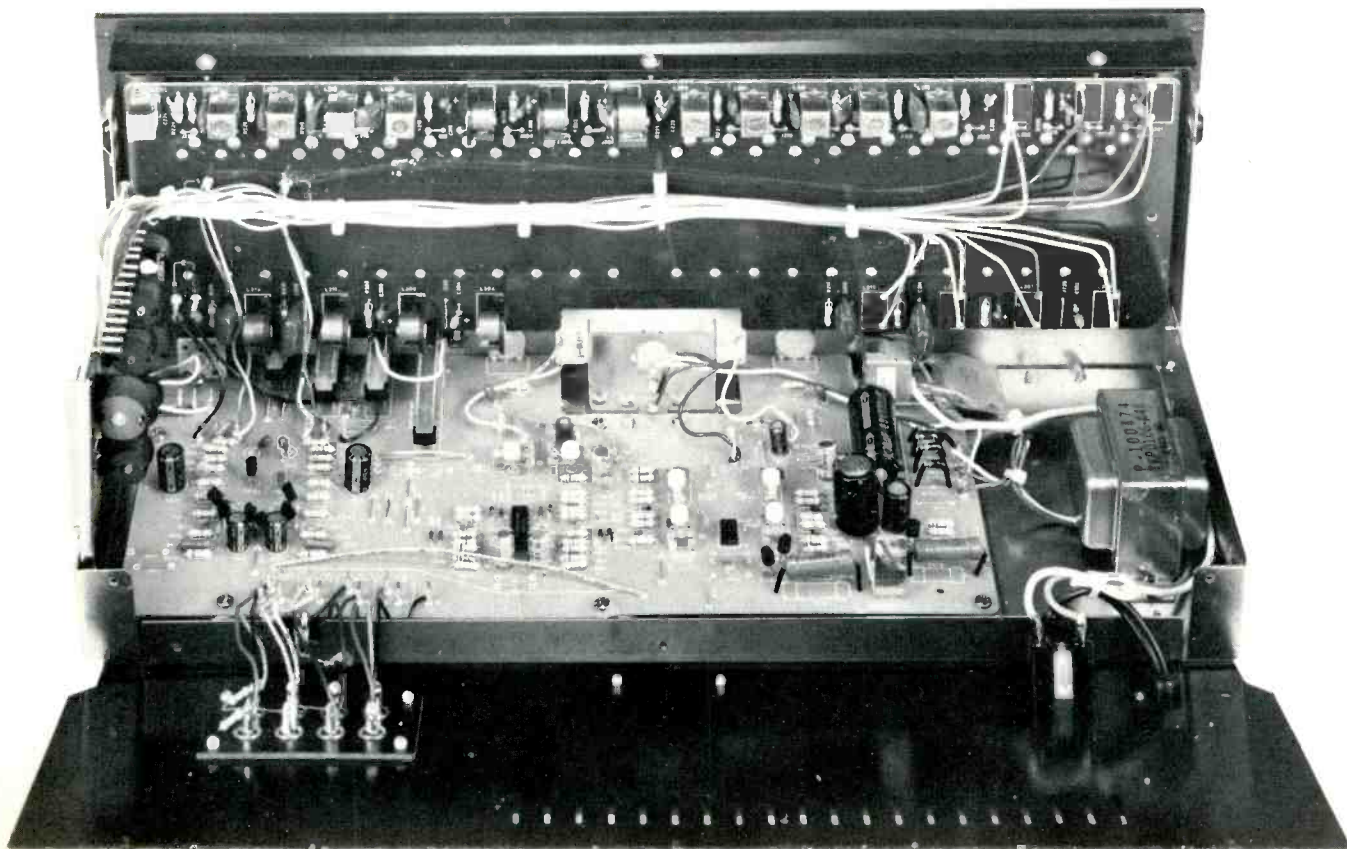

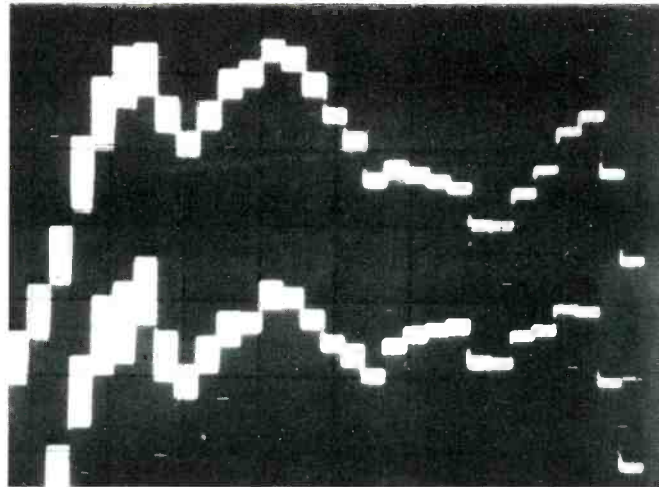

Fig. 3 — RTA display of system response. Top, before EQ; bottom, after EQ. (Vertical scale, 5 dB/div.)

sible to switch in EQ with a startling change in level, to say nothing of possible damage. If the meters are zeroed before making EQ adjustments, and the combination of boost/cut is made so that the meters stay at zero, the EQ in/out levels will match. The instructions do not suggest this procedure, but they do caution on the possible level shifts.

In-Use Tests

Equalizers can be fun to play with, but they really are much more than toys. For a little fun, however, some of the filters were arbitrarily boosted and cut, just to see the effects (Fig. 2). The swept-frequency plot shows that all of the transitions from one region to the next are smooth. For a practical case, the output from a small bookshelf speaker was displayed on a $\frac{1}{3}$ -octave RTA (Fig. 3). The response to the pink-noise drive showed a number of peaks and dips spread over 12 dB, but with fairly good output out to 20 kHz. While observing the display, the Sound Shaper was adjusted to reduce the peaks and bring up some dips: 30 Hz to +4 dB, 50 and 90 Hz to -3 dB, 160 Hz to +4 dB, 300 and 500 Hz to -3 dB, 3 and 5 kHz to +5 dB, 9 kHz to -2 dB, and 16 kHz to -4 dB. The net result was a reduction in the spread for the whole band down to 5 dB, a significant improvement, confirmed by

listening. A swept response of the Mark II with the EQ used is smooth and looks simpler than what might be expected with the 10 adjustments made. The reader should be aware of the fact that good, total sound-system response requires high-performance loudspeakers, well matched to the acoustics of the room. An equalizer can perhaps bring a fair speaker, as was used here, toward excellence, but it cannot solve severe problems such as crossover holes.

The instruction book has good text and illustrations, in general. The "typical response curves" shown are not really typical, because they show the results with maximum boosts and cuts, settings to be avoided if possible. There is a general discussion of possible applications and the sonic effects of adjustments in the various ranges. The manual would be of greater help with the inclusion of actual examples, e.g. improving speaker response with before and after curves, using EQ to match a tape type to a recorder, etc. The ADC Sound Shaper Two does its job well, and in use there was no sense of any extra complication in handling the 12 channel controls, rather than the usual 10. The Mark II does offer finer frequency resolution than other such units, along with low distortion, high signal/noise ratios, and high slew rates.

Howard A. Roberson

Enter No. 92 on Reader Service Card

Some companies, like some individuals, move along quietly, doing their 'thing' with a minimum of fanfare. At AUDIONICS of OREGON, we like to think that we work that way as well. Our products are sold in over thirty countries and consistently receive high praise from various audiophile publications. Our reliability and attention to customer needs are becoming legend and are unsurpassed in their price range. Our products offer performance that equals or surpasses that of far more expensive competitors. Whether you are looking for a state-of-the-art amplifier, preamplifier, or the world's most advanced four-channel/ambience recovery system, you can find it at your authorized AUDIONICS of OREGON retail dealer. Write or phone for a collection of test reports and product information ranging from our BA150 Hybrid Analog/Digital Amplifier to the Space & Image Composer incorporating the TATE Directional Enhancement System*. Now that our 'secret' is out, why not learn more about us? AUDIONICS of OREGON

Bldg. 160, 10950 SW 5th, Beaverton, Oregon 97005

Tel: 503-641-5225

*TM TATE AUDIO

AUDIONICS of Oregon

Enter No. 4 on Reader Service Card

Apt/Holman Control Preamplifier



Manufacturer's Specifications

Frequency Response: 20 Hz to 20 kHz, ± 0.5 dB.

Maximum Output: 7 volts.

THD: 0.01 percent.

IM Distortion: 0.01 percent.

Phono Sensitivity: 1.25 mV for 0.5 V output at 1 kHz.

Phono S/N: 74 dB, "A" wtd., for 5 mV input.

Phono Overload: 100 mV.

High Level Sensitivity: 0.32 V.

Dimensions: 15.04 in. (38.20 cm) W x 3.30 in. (8.38 cm) H x 9.32 in. (23.67 cm) D.

Weight: 12 lbs. (5.45 kg).

Price: \$493.00 East, \$502.00 West.

76

During the development of a rationale for generating new and more useful tests of the performance of control preamplifiers, it seemed wise to take a fresh look at the functions which they are meant to perform. A control preamplifier, such as the Apt/Holman unit which is the subject of this report, provides two main functions. Besides amplifying low-level signals, it provides control and switching functions. Many designers appear to concentrate most of their effort in designing excellent amplifiers while tending to ignore the control and switching functions. Others provide very good control and switching capabilities but provide less in terms of sonic quality.

It also seemed desirable to ascertain whether certain audibly perceived qualities might be related to technical measurements. Because of the high performance level of modern control preamplifiers, this is not an easy task. Certain data are presented in this report which may appear unusual at first, but by being able to compare them with similar data in future reports, it may be possible to more easily assess differences between units. Both the amplifying and the control/switching functions were investigated, and information is presented concerning the quality of each.

The Apt/Holman control preamplifier displays a high level of attention to design details related to both amplification and control/switching functions. It is definitely the result of extensive investigation into some very important factors which affect the quality of reproduction. Tomlinson Holman, who, while at Advent Corp., developed a novel phono preamplifier for the Advent Model 300 receiver, has done a great deal of just such investigation. In fact, a number of articles and technical papers by Holman and his colleague Frank Kampmann are available from Apt Corp. as reprints. The amount and quality of their research are very impressive. The separate Owner's Manual and Service Manual are also

worthy of mention, since they are truly exceptional in their thoroughness, detail, and clarity. It would be impossible to cover every detail of such an engineering tour-de-force as this unit represents in a short report. However, an attempt will be made to cover the most salient features and make appropriate comments. The reader is also advised to take advantage of the literature which is available from Apt Corp. or its dealers for there are features which we will not have adequate space to cover completely.

The Apt/Holman control preamplifier has a number of well-thought-out functions. Beginning at the phono inputs, of which there are two, a unique control is provided for each which allows the channels to be balanced for any phono cartridge. By using another unique control on the front panel, which allows a left-minus-right condition, the phono balance control can be adjusted for a null while playing a mono record. This feature provides a means of compensating for differences between the left- and right-channel outputs of phono cartridges, which are almost never exactly the same and will have a bearing on the accuracy of stereo reproduction.

The control on the front panel, which is definitely unique, is called *Mode*. This control provides a continuous change from *L+R* (full counter-clockwise) through *Stereo* (detented center position) to *L-R* (full clockwise). The *L+R* position provides minimum stereo separation (mono). As the control is rotated past the center or *Stereo* position, a reduction of the center or mono information is affected. Apt Corp. recommends its use for varying the depth of the apparent stereo image. Another use, which may prove to be disconcerting to many record companies, is for determining just how "stereo" a record really is. Since the *L-R* information represents the stereo information, as opposed to the *L+R* or mono information, listening briefly to any program material with the con-

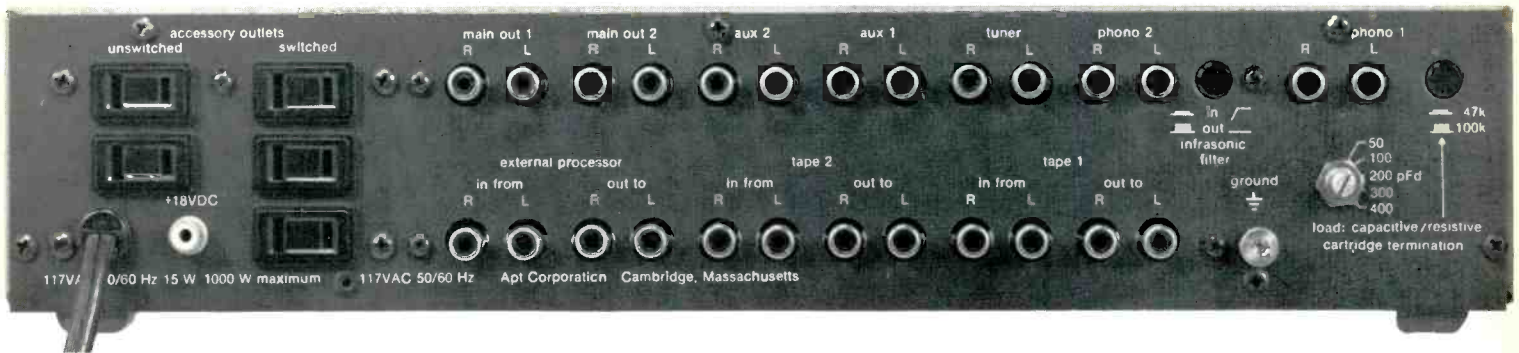

control in the L-R position will allow a determination as to just how much stereo information is really present. The Mode control is well designed from the standpoint that proper level is maintained while changing from L+R (mono) to Stereo. It reduces the level to each channel by -6 dB when in the L+R mode, which is proper. The L-R mode showed a reduction of -5.5 dB to each channel.

Phono 1 provides a switch selection of either 47 or 100 kilohms. A second switch provides for selection of 50, 100, 200, 300, or 400 pF. Apt Corp. also provides a listing of many cartridges and arms which is a great assistance in determining the correct matching required for optimum performance. A very helpful infrasonic filter is also provided, which is controlled by a switch on the back panel. It very effectively re-

duces the ill effects upon the system caused by record warps and eccentricity, cartridge/arm resonance, and turntable motor vibration. It is recommended by Apt Corp. that the filter be left in for all normal listening, which is why it is located on the back panel. It also functions on all inputs since, for instance, a radio station may have a cartridge/arm resonance situation which could degrade the sound. Figure 1 shows the effectiveness of this filter in removing these kinds of undesirable subsonic signals. Figure 2 shows the time delay of the infrasonic filter at 20 Hz for the left channel. The 15.5-mS delay should cause no serious problems. A 16.8-mS delay was found in the right channel with the filter activated. This means that there is an interchannel time differential of 1.3 mS. Without the filter, the delays are 3.25 and 3.35 mS for the

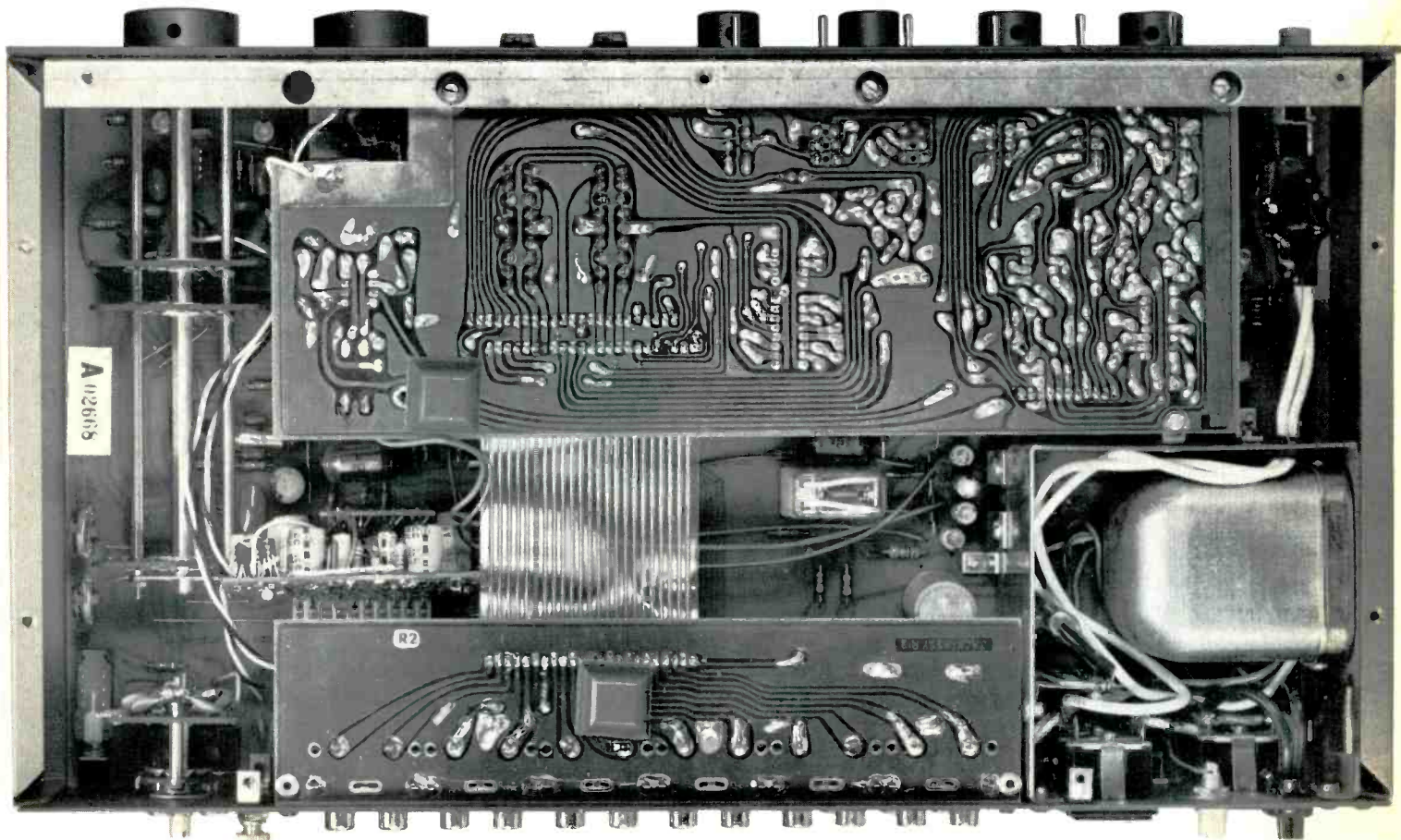

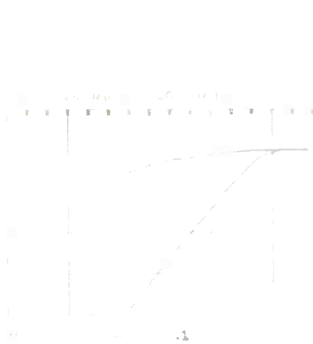

Fig. 1A — Frequency response with the infrasonic filter vs. response with no filter. (Note frequency scale multiplication factor of 0.1.)

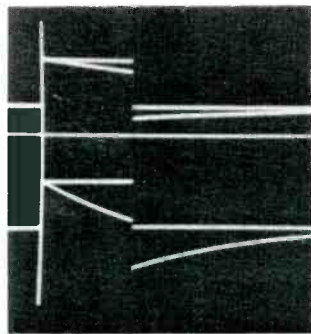

Fig. 1B — Response to 5-mS pulse, with input and output overlaid. Low-frequency components of the square wave are delayed.

left and right channels respectively, which might have some effect upon systems which use a subwoofer. Experimenting with the polarity of the loudspeaker leads between the subwoofer and the upper-range loudspeakers, plus careful room placement of the loudspeakers, should ameliorate any problem in the bass range due to this delay. The effect of phase shift or time delay between channels does not really affect localization; however, it can affect how well the bass is propagated in a given room by a pair of loudspeakers. Since the natural modes of a room and the location of the loudspeakers already play a major role in this, the interchannel delay should be just one more factor to consider. Common-bass subwoofers can be more directly affected by the interchannel time differential at these frequencies, since the output will not be added algebraically if the input from the two channels is not exactly in phase. (Editor's Note: The manufacturer points out that this amounts to a summing error of about 0.03 dB at 20 Hz.— E.P.)

Phono 2 may also be adapted for low-output moving-coil cartridges by using appropriate plug-in modules which Apt Corp. is making available for specific cartridges. During our evaluation, we used the Model 201A pre-preamplifier module, as we had a Denon 103D cartridge available, for which this model was specifically designed, and the combination provided excellent performance. Reproduction with records was very clear and detailed with good signal-to-noise ratio. Stereo imaging was excellent with true stereo recordings. (Besides using the Mode control, we use a stereo display to determine whether a source has time-differential information or whether it is mostly mono.)

Apt has paid a great deal of attention to eliminating such things as r.f. interference, crosstalk from unused channels, and extraneous signals, all of which would cause deleterious effects in the program. There are two high-frequency filters; a front panel switch selects either an 8-kHz filter, which is use-

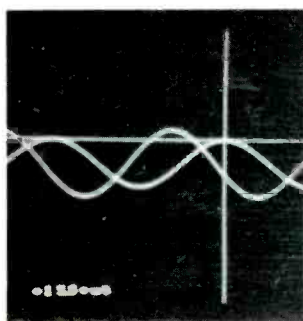

Fig. 2 — Response with the infrasonic filter to 20 Hz with input and output overlaid in the left channel, which shows a 15.5-mS delay. See text.

ful in removing noise and distortion from older records or poor radio broadcasts, or a 40-kHz ultrasonic filter, which can be used to reduce possible slew-induced distortion in the following power amplifier by band-limiting the signal being fed to it. These filters are removed from the circuit when the tone-control defeat switch is activated. If the signal to be amplified were composed of only frequencies from 20 Hz to 20 kHz, then this filter would be unnecessary. Unfortunately, this is not the case, since, particularly in high-quality, wide-band systems, higher frequency signals seem to abound. A good moving-coil cartridge can have strong high-frequency components as high as 200 kHz (see John Curl's *Forum in Audio*, Sept., 1979). The exact reason for this could be the subject of a separate article. Suffice to say, such high-frequency components can raise havoc in an audio system unless they are effectively dealt with, as they are by the Apt/Holman control preamplifier. We feel, as does Apt Corp., that the 40-kHz ultrasonic filter is best left in for most program material. The center, detented position of the tone controls provides absolutely flat response, so there should be no adverse effect from their being left in the circuit in order to utilize the 40-kHz filter. Amplitude vs. frequency-response

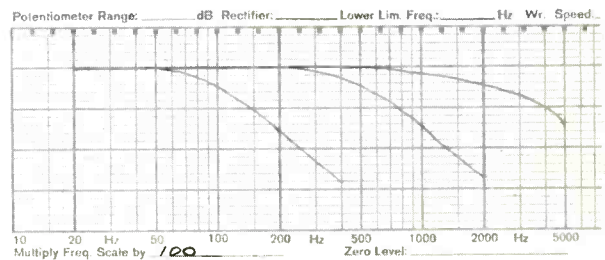

Fig. 3A — Frequency responses of the two high filters vs. response with no filter.

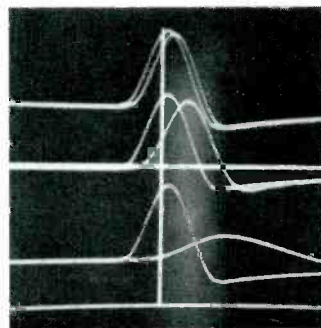

Fig. 3B — Response to 30-kHz cosine pulse for the two high filters and with no filter, input vs. output, showing time delay.

	1 kHz	10 kHz	20 kHz	40 kHz
No Filter, 2.5- μ S Delay	0°	5.6°	11.3°	28.1°
40-kHz Filter, 7.0- μ S Delay	0°	22.5°	50.6°	101.3°
8-kHz Filter, 20- μ S Delay	0°	95.6°	140.6°	168.8°

Fig. 3C — Phase delay.

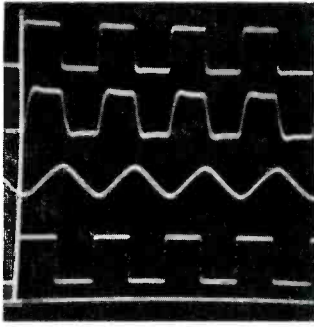

Fig. 4 — Response to 10-kHz square wave. From top, with no filter, with 40-kHz filter, with 8-kHz filter, and input.

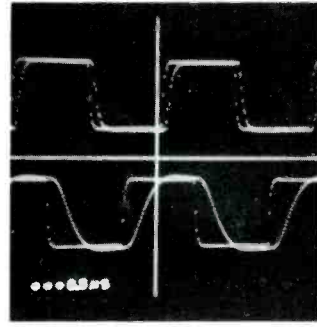

Fig. 5 — Rise time. Top is with no filter, 3.0 μ S. Bottom is with 40-kHz filter, 8.5 μ S. Both are overlaid on the input, a 20-kHz square wave with 1.5- μ S rise time.

curves for the Apt/Holman control preamplifier with no filter and with the 8-kHz and 40-kHz filters are shown in Fig. 3. Data are also shown for the time delay and phase delay. Figure 4 shows the effect of these filters upon a 10-kHz square wave. Figure 5 shows the rise-time with and without the 40-kHz filter. The rise-time for the 20-kHz input signal is also shown for comparison. There are some who will argue that the effect of the 40-kHz filter can be heard, and they are correct. However, the "edge" they may hear, without the filter, may be due, possibly, to the strain placed upon the power amplifier and loudspeakers in trying to cope with ultrasonic frequencies. Since it is a subjective judgment as to whether the 40-kHz filter is better left in or out in any given situation, we can only recommend that it be tried and thank the manufacturer for allowing us the opportunity to do so.

To clarify the reason why tone bursts are much less revealing than the tests we have chosen, Figs. 6 and 7 are presented. The output signal is shown as the upper trace, while the lower trace shows the input signal. This consists of 10 cycles of 10 kHz or a 1-mS burst. One has to look very closely at the trailing edge of the burst in the upper trace of Fig. 7 to see the tiny effect caused by the 40-kHz filter.

Figure 8 shows the effect of the 40-kHz filter upon the phase delay at 5, 10, and 20 kHz. The delay is fairly uniform over the audible range and should be as innocuous as the delay caused by playing a record a year or more after it has

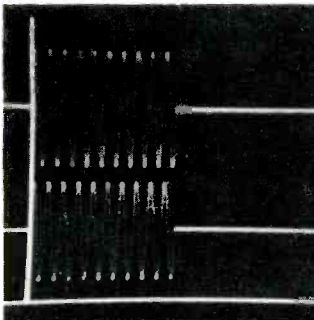

Fig. 6 — Response to 10-kHz tone burst of 1-mS duration. Top is response with no filter; bottom is input. No change is discernible.

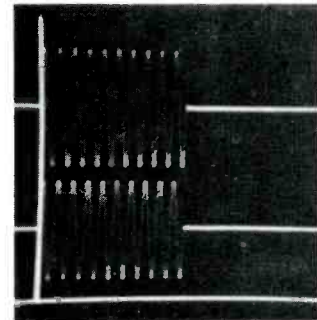

Fig. 7 — Response to 10-kHz tone burst of 1-mS duration. Top is response with 40-kHz filter; bottom is input. A very slight change on the trailing edge of the burst can be seen.

been recorded. Figures 9A, B, and C show the interchannel phase effects at 2 Hz, 20 Hz, and 200 kHz. All filters are removed except that Fig. 9B shows the effect of the phase difference between channels with the infrasonic filter activated.

Figure 10 shows the tone-control curves. The treble controls are moderately effective in adjusting for differences between records and even for loudspeakers with different high-frequency energy slopes. It might have been better to have moved the zero or "hinge" point up to 3 kHz so that high frequencies could be compensated without affecting the midrange. (*Editor's Note:* According to the manufacturer, the action of the treble control was chosen for best equalization of overly bright upper-midrange material without excessive loss of top-octave response.—E.P.) Two different switch-selectable bass contours are provided. One set of bass contour curves has been heavily researched by Holman and Kampmann and is the subject of an engineering report published in the *Journal of the Audio Engineering Society* (a reprint is available from Apt Corp.). The result is a bass con-

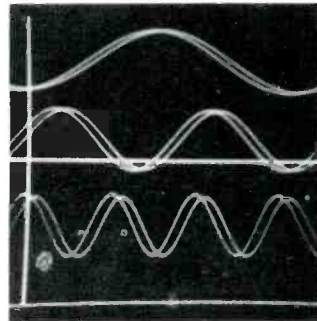

Fig. 8 — Response to various steady-state signals with the 40-kHz filter and the input overlaying the output. Top is 5-kHz signal; middle, 10 kHz; bottom, 20 kHz. A slight delay can be seen between the input and the output of each set of signals.

control which is actually usable by a serious listener. Figure 11 shows the last 22 steps of the 32-step volume control from full on to about the 9 o'clock position. Steps from about 4 o'clock to 12 o'clock are about 1.5 dB each and very uniform. For anyone concerned with playing back recorded material at realistic levels or evaluating different playback devices, with repeatability, this is a boon. More importantly, the channel-to-channel balance or tracking of this control, which affects stereo localization, is within 0.2 dB over the last 22 steps, from full on to about 10 o'clock, which is amazing. In fact, it is within 0.3 dB over the whole 32-step range, which is even more amazing.

Some other technical facts worthy of brief mention: The output overload point at 1 kHz was 7.75 volts rms into 300 ohms. The actual impedance was found to be 313 ohms. The overload appeared to be uniform from 20 Hz to 20 kHz. The input clipping points, for a 1-kHz input signal, were 144 mV rms at the Phono 1 input and 13 mV rms at the Phono 2 input which had the Model 201A pre-preamplifier module installed. The gains of the right channel of Phono 1 and 2 were variable over a total range of 5.8 dB and 5.5 dB respectively, which are more than adequate to balance the interchannel output difference of any phono cartridge. The output capability of the separate headphone amplifier is shown in Fig. 12. This lists the maximum output voltage just before clipping, for various resistive loads, which should represent most possible headphone impedances.

The compensation for the RIAA standard disc-recording characteristic curve is within the 0.2-dB tolerance claimed by Apt Corp. A great deal has been written lately concerning the necessity of achieving very close accuracy in RIAA compensation, and tolerances to within 0.1 dB and even less have been mentioned. This is really only necessary if one is com-

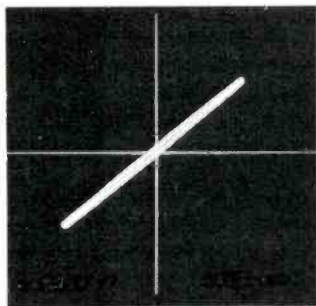

Fig. 9A — Interchannel phase, 2 Hz, no filter.

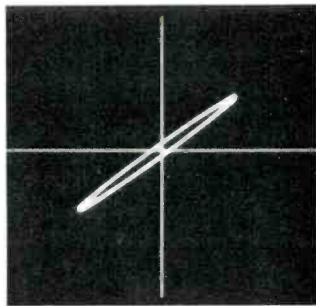

Fig. 9B — Interchannel phase, 20 Hz, infrasonic filter.

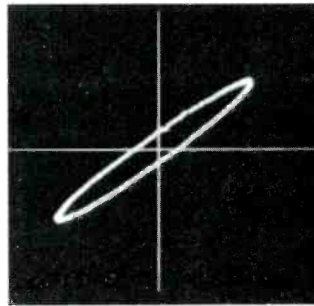

Fig. 9C — Interchannel phase, 200 kHz, no filter.

paring the audible differences between two preamplifiers while playing the same recording with the same phono cartridge/arm/turntable through the same loudspeakers during a comparison. In such a case, it is imperative that the amplitude vs. frequency response of the two preamplifiers be adjusted to be extremely close from the RIAA phono input to the output. It should be emphasized, however, that there are much greater differences between records due to the spectral balance adjustments made by the producer or engineer during recording. In fact, if the same master tape were used to generate disc masters by two different disc mastering facilities, they would have audible differences, due to different spectral balances, of far greater magnitude than that caused by a preamplifier having an RIAA compensation error of even ± 0.5 dB. A closely maintained tolerance of the RIAA compensation is certainly a worthwhile goal, however, and Apt Corp. is to be commended for their achievement.

The absolute polarity of signals is not affected by the Apt/Holman control preamplifier. Since almost all sounds in nature are unsymmetrical, that is, the air pressure variations around the normal ambient pressure may not vary up and down equally over the period of the sound, then this should be taken into account in any good sound-reproducing system. It turns out that a reversal of the polarity of reproduced sound opposite to that which it had in nature is clearly audible. Neglecting this fact has often caused judgments to be made as to the quality of reproduction which were erroneous, and this has been particularly true about judgments concerning the differences between sound-reproducing components. From our experiments over the past number of years, it also appears that listeners have no difficulty in determining the exact polarity which is the same as the polarity of the natural sound.

The Apt/Holman preamplifier was tested to determine if polarity reversals occurred between any input and output, including the tape dubbing and external processor loops. No reversals happen under any conditions. (During all auditions

Fig. 10 — Tone-control response curves. Maximum positions are shown. Two bass contours are switch selected, and a tone-control defeat switch also removes the high filter.

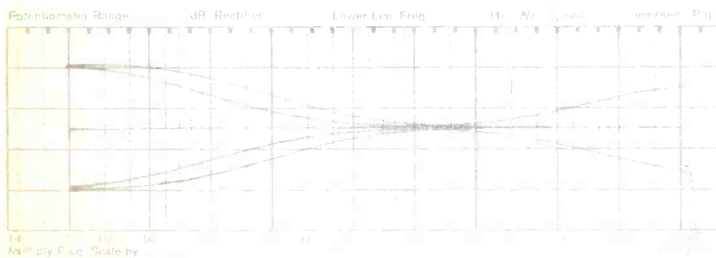

of equipment, attention is paid to the absolute polarity of signals through the total system. This has been the case for all previous reports generated by us for *Audio*.)

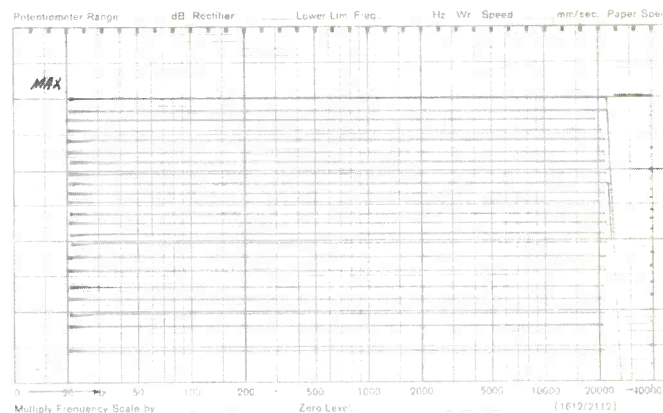

Fig. 11 — Volume control attenuation in the left channel, showing 22 steps of the 32-step control. Vertical scale is 1 dB per division. Tracking between left and right sections of the control is within 0.2 dB over this range.

Load, ohms	Output, V rms
100 k	9.40
1 k	6.80
500	5.60
200	3.28

Fig. 12 — Maximum output of the headphone amplifier at 1 kHz for various loads.

The Apt/Holman control preamplifier was auditioned in two ways. Listening comparisons were made with some other high-quality units during an extended audition over a period of months. Sources included radio, records, and tapes. Various cartridge/arm/turntable combinations and three different amplifiers were used as well as four different pairs of loudspeakers, including a pair of Time-Aligned® reference standard loudspeakers. A second Apt/Holman control preamplifier was also auditioned during this period. At the conclusion of all the testing and listening, it is our conviction that the Apt/Holman control preamplifier is capable of extremely high-quality sound reproduction given good ancillary equipment and program source material. The excellent channel-to-channel balance, stability while handling musical transients, and its ability to cope with less than ideal program material all make it an excellent choice. Its reasonable price simply constitutes "icing on the cake." *Edward M. Long*

Enter No. 93 on Reader Service Card

TIME LIFE VIDEO
presents:

A videocassette bargain to
bring you a great new idea
in home entertainment:

BETA for \$12 or VHS for \$15.

Why would TIME LIFE VIDEO sell a new
top-of-the-line name brand two-to-four
hour videocassette for up to 40% off?

Because we want to use a small portion of the
cassette (which you can, of course, erase later) to
present a message so exciting that we thought
a videocassette recording was a great way to bring
it to life.

We want to tell you how you can gain access to
the finest, *most comprehensive library of videocassette
programs ever assembled.*

You'll be getting a fantastic videocassette at
a tremendous discount and information about
a great new way to save a lot more.

So fill out and return the coupon with your
payment, stating whether you want your cassette
in the BETA or VHS format. Or call toll-free:

800-523-7600 (national) or

800-662-5180 (in Pennsylvania)

Act today! And take advantage of this terrific
offer.

FREE DUST-PROOF JACKET. Even if you don't
want to take advantage of our videocassette bar-
gain, you can get a free, durable dust-proof jacket
that fits both BETA and VHS videocassettes. Just
fill in the coupon or call the toll-free number.

Call toll-free, 24 hours a day, 7 days a week
800 523-7600 (national)
or **800 662-5180** (in Pennsylvania)
and ask for **operator number 197.**
Or fill out and return this coupon to:

 **TIME LIFE VIDEO**
Harrisburg, Pa 17105

Please send me the two-to-four hour cassette containing your
brief message and the free videocassette dust-proof jacket.

Check one: \$12 BETA \$15 VHS

Check method of payment:

Enclosed is my check or money order, including local tax (if
applicable). 0-06

Charge to my credit card, including local tax (if applicable).
0-06

VISA Master Charge

Diners Club Interbank # _____

Credit card _____ exp. date _____

Signature _____ date _____

Name _____

Address _____

City _____ State _____ Zip _____

Free dust-proof Videocassette Jacket

I do not wish to accept the special two-to-four hour cas-
sette offer, *but* please send the free dust-proof jacket to the
above address. 0-07

Act now! Offer limited.

Checks or money orders in U.S. currency only. Good only in conti-
nental U.S. Limit one per customer.

Workbench PROfiles

BASF DIN Calibration Cassettes

Manufacturer's Specifications

Recording Azimuth: 90 degrees, ± 2 minutes.

Reference Level: 250 nWb/m, ± 5 percent at 315 Hz.

Distortion: Less than 3 percent.

Frequency Deviation in Response Section: ± 3 percent.

Level Deviation: Less than ± 1 dB from 31.5 Hz to 2 kHz, less than ± 2 dB from 4 to 6.3 kHz, and within +2, -3 dB from 8 kHz up.

Reference Tape Section: To DIN Standard 45-512.

Track Configuration: Full width.

Prices: See text.



82

After commenting in recent past about the lack of availability of BASF calibration cassettes for a fair period of time, it was a distinct pleasure to receive two samples for evaluation. BASF Systems offers three calibration cassettes and one test cassette. There are DIN calibration tapes for 120- and 70- μ S equalizations, and the third calibration tape is a Dolby-level cassette with 400 Hz at 200 nWb/m. The test cassette is for wow and flutter checks with a 3,000-Hz tone recorded. The price for a DIN calibration tape is about \$100.00, and the Dolby-level and flutter tapes are about \$20.00 each.

At this point, it is appropriate to discuss "DIN" and what it means to tapes and tape recorders. First of all, "DIN" is the abbreviation for "German Industry Standard." It's not confusing when you know that "German Standard" in the original language is "Deutsche Normen." National standards in the United States are issued by ANSI (American National Standards Institute). These national standards are not

international standards unless they have also been issued by an international standards organization such as ISO or IEC (International Electrotechnical Commission). Standards are generated very slowly, however, particularly on the international level, and it has been substantially impossible to hold back design and manufacture of tapes and recorders until there was a collection of international guidelines.

Because DIN standards established the basic framework of necessary benchmarks early in the development of the cassette format, they became the international basis for design and test. They remain the reference for many manufacturers throughout the world, even though many of them are still available only in German. A DIN calibration tape, such as the ones made by BASF, has sections for azimuth alignment and frequency-response checks, but it includes more — a blank section of tape that meets DIN requirements. This blank section is used to establish references for bias and record sensitivity, which helps to

get consistent data reporting throughout the world. Here is a quote from one of 3M's Scotch data sheets which shows this manufacturer's reliance on DIN: "Using the blank section of DIN *Bezugsband* reference tape, the reference bias is determined looking at 6.3 kHz output peak bias, and then increasing bias until the output level drops 2.5 dB." That quote helps to point out the fact that if anyone needs to establish references to DIN requirements, he *must* have a DIN calibration tape with its blank tape section.

Performance

DIN-Calibration Tape (Fe): There is a considerable length of yellow leader at both ends of the tape, which helps to minimize tape-tension variations. There is also a section of leader between the test-tone section and the blank tape. Because of the probability that the user will record on the blank tape, the erase-prevention tabs have not been removed, so caution is in order. The first tone of 315 Hz (noted as an IEC standard) is at 0-dB reference

level, 250 nWb/m, and runs for 30 seconds. Then, for head alignment, there is a reference tone of 315 Hz for 8 S, followed by a 10-kHz tone for 60 S, both at -20 dB. The frequency response tones are all at -20 dB and have a duration of 8 S each. The order is as follows: 315, 31.5, 40, 63, 125, 250, 500, 1000, 2000, 4000, 6300, 8000 and 10,000 Hz, and a return to 315 Hz. Finally, the sequence from 4 kHz is repeated twice, very helpful if you have to recheck that data at the highest frequencies. A note enclosed by BASF states that a correction table was not included because flux deviations were controlled to be within ± 0.5 dB, and so the results confirmed. There was no evidence of distortion in any of the waveforms. The measured frequencies were very consistent, indicative of careful setting in the recording process. Indications were about 0.2 percent high, from a minor speed discrepancy. The azimuth of the recorded signal appeared to be a few minutes off, measurably different from the other calibration tape. The phase jitter between track outputs was very low, indicative of smooth tape motion.

DIN-Calibration Tape (Cr): Leader is used in similar fashion in this tape, but because it is red in color, it is somewhat difficult to differentiate the test-tone and blank-tape sections from the leader. Erase prevention tabs have not been removed. The levels, frequencies, and sequence of tones are exactly the same for this 70- μ S tape as for the 120- μ S tape above, with the exception that there is a 12.5-kHz tone added to the response test portion. Levels, waveforms, and responses showed the same high performance as the Fe tape. Indicated frequencies were about 0.4 percent higher than nominal, but were consistent in percentage offset, indicating a speed discrepancy. Recorded azimuth appeared to be very close, with acceptable phase jitter.

Although the price for a DIN calibration cassette may give some more than a little pause, it is good that BASF is offering them again in this country. For those who need to base tests upon DIN standards, these cassettes are quite essential. The present ones have both printed text and recorded instructions in English, which does make use more convenient than the earlier all-German versions. As reported above, all characteristics were equal to or better than specifications, with the exception of recorded azimuth (as played back) for the Fe cassette. It was plenty close enough for alignment by peaking amplitude, but would be misleading if inter-track phase comparison were used. *Howard A. Roberson*

Enter No. 95 on Reader Service Card

AUDIO • February 1980

THIS TIME MAKE THE RIGHT CONNECTION



Only the new MMC 20CL can give your turntable the performance levels of our unique single crystal sapphire cantilever and a micro-polished Contact Line diamond stylus. And our new universal connector makes proper installation an effortless task while it eliminates the weight and mass of the common headshell. If you have a high quality turntable, it probably deserves the MMC 20CL. See your Bang & Olufsen dealer to make the connection.

Bang & Olufsen

For Information Write To: Audry Athearn

Bang & Olufsen of America, Inc., 515 Busse Road, Elk Grove Village, Illinois 60007

Enter No. 5 on Reader Service Card

83

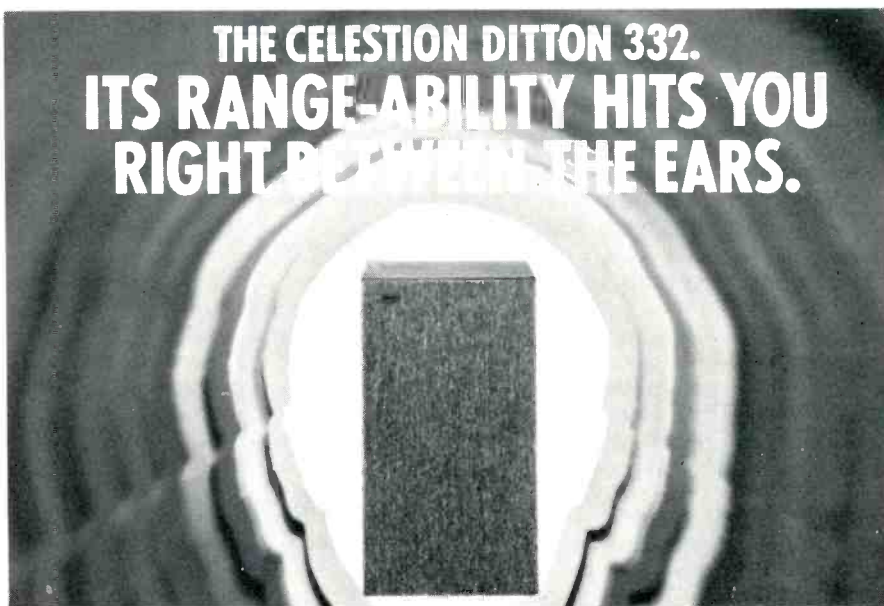

From the incredible bravura of a diva's high C to the seemingly subliminal low E of a string bass. From the explosion of a faraway cannon to the fragile ting of a triangle floating across the room.

That's Range-ability™ in the Celestion Ditton 332.

Celestion's Range-ability is also pure pronouncement at any volume—from a level barely perceptible to an overpowering 107dB. Through it all, the Ditton 332 maintains exceptional linearity, imaging, dynamic range and high efficiency.

Celestion manufactures each com-

ponent for its speakers. The result is an integrated acoustic suspension system of superbly efficient elements backed by over 55 years of speaker manufacturing craftsmanship.

Your pair of Ditton 332 cabinets will look as good as they sound. Finishes of oiled American walnut or elm are available.

Range-ability. Finally, listening becomes an experience.

celestion
international 

Enter No. 7 on Reader Service Card

The column

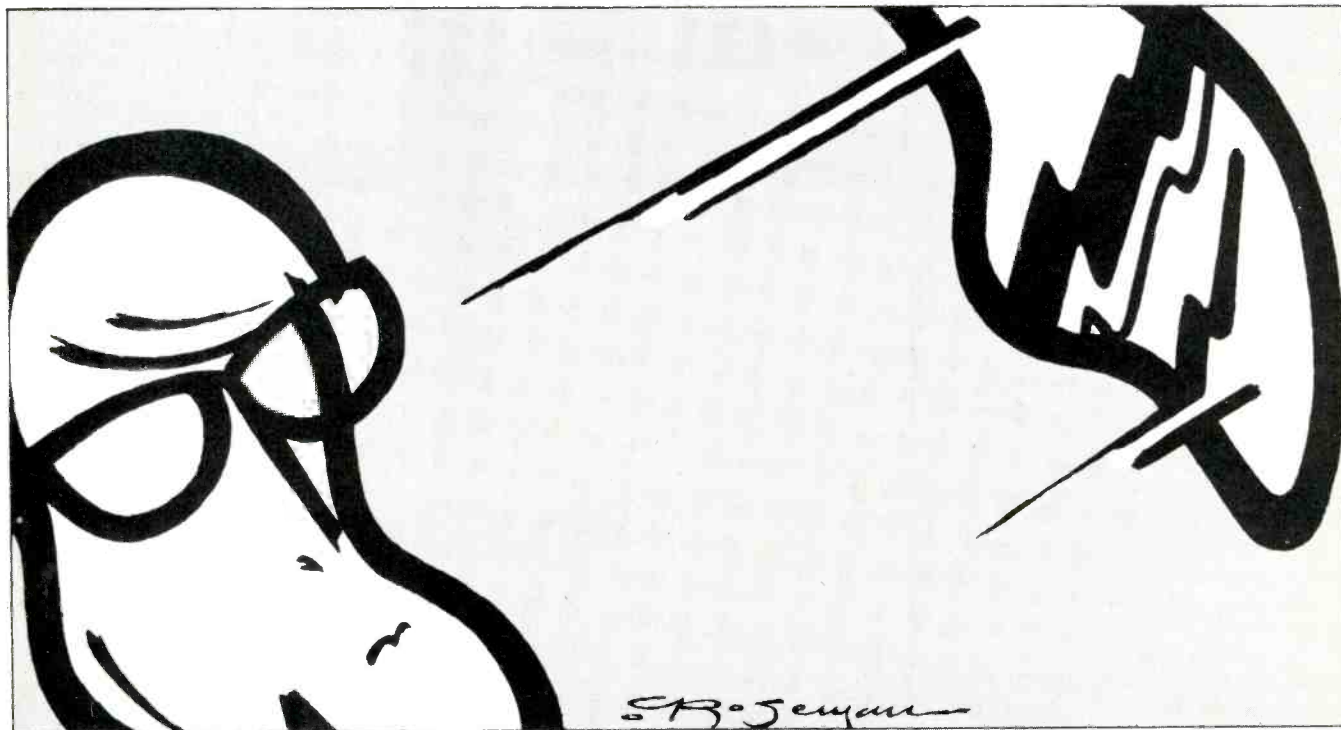

84

Freedom at Point Zero: Jefferson Starship
Grunt/RCA BZL1-3452, stereo, \$8.98.

At more than one time, in more than one incarnation, Jefferson Starship has been diagnosed as down for the count. In reviewing *Earth*, their last album, I referred to it as something like an overcooked, overdone turkey. Not long after the album came out, vocalists Grace Slick and Marty Balin both left the band. Then drummer Johnny Barbata was in a serious car crash. What would follow was open to speculation.

Aynsley Dunbar, veteran of much, became the new drummer, an inspired choice. Finally came the announcement that Mickey Thomas, the voice on Elvin Bishop's hit, *Foiled Around and Fell in Love*, would fill the remaining hole. Something of a shock, this 2-into-1 solution.

The new album is the vindication, for **Freedom at Point Zero** is an excellent, energized album of unabashed rock and roll music. Mickey Thomas couldn't fit into the group's sound better. He sings like neither Grace nor Marty, yet he can evoke both. His

backing parts echo Grace's soaring free-flight vocal lines, and he does them eerily Slickly. On his showcase *Just the Same*, he takes the kind of song that would have been Balin's big moment and does it so completely differently that not only is Marty not missed, the song takes on a whole new feeling for Starship.

I don't know if there are any long-term radio classics aborning on **Freedom**, but *Things to Come* has real majesty and *Girl with the Hungry Eyes* has all the signs of a fine Starship signature. The title song is a Paul Kantner showcase. The first single, *Jane*, uses the Tower of Power horns nicely, while *Lightning Rose* has a fine, funky sax kicking it along.

Freedom at Point Zero is a more aggressive, optimistic, exuberant album than any Jefferson Starship has made in too long. This time out they have utterly cut loose the silky slickness that kept their last album *Earthbound*. By comparison, the new shot from the gate, with its big, rocking juggernaut sound, positively flies free. M.T.

Sound: B+

Performance: B+

The Glow: Bonnie Raitt
Warner Bros. HS 3369, stereo, \$8.98

There are lessons to be learned here.

For years Bonnie Raitt has been an artist who has appeared to be on the brink of being a big seller. She has one of the most assured and distinctive vocal styles around. You can't mistake her touch, based in the blues with a real spontaneity. Clearly the idea behind **The Glow** is to give her at last the benefit of all the *right* packaging. Toward that end a new producer was brought into the picture with all attendant frills. The producer is Peter Asher who handles the records of Linda Ronstadt and James Taylor. Along with Asher comes crack engineer Val Garay, sessions cats like guitarist Waddy Wachtel, drummer Rick Marotta, sax player David Sanborn, bassist Bob Glaub, and keyboardist Billy Payne late of Little Feat and previous Bonnie Raitt albums. Another part of the package is cover designer John Kosh who has put a Ronstadt clone cover on the album very similar to his other current work for such pretty faces as Karla Bonoff, Carlene Carter, and Walter Egan.

Even the song selection echoes the formula Linda R. has followed to platinum heaven, altered slightly for Raitt's sensitivities. For instance, instead of Motown covers there are some Stax/Volt tunes. There are the chestnuts — Mary Wells' *Bye Bye Baby*. There is a Jackson Browne song, one from Tom Snow, a Tracy Nelson weeper, even a fashionable Robert Palmer song. Plus the first Bonnie Raitt original in ages.

But there is a serious central flaw to the master Plan: Bonnie Raitt is not Linda Ronstadt.

Yes, the album is real pretty and very well recorded. But its heart is cold and calculated, and that keeps the album earthbound. At times it is almost embarrassingly limp. Robert Palmer's *You're Gonna Get What's Coming* which *should* be an ideal vehicle for Bonnie instead is leaden and redundant. Jackson Browne's catalog has given Bonnie some of her best moments, but *Sleep's Dark and Silent Gate* is a very difficult song, a poor choice that just doesn't work. *The Boy Can't Help It* sinks beneath terminal cuteness. The closest the lady comes to cutting loose is on *Bye Bye Baby*

Jorma: Jorma Kaukonen
RCA AFL1-3446, stereo, \$7.98.

Like his first solo project, **Quah, Jorma** is a very polished solo album for the former lead guitarist of Jefferson Airplane and Hot Tuna, but **Jorma** is far more produced. Jorma still plays everything, but this time he has added extra guitar tracks for effect, and his reedy voice is usually filtered or doubled. At once, the album projects intricacy and simplicity.

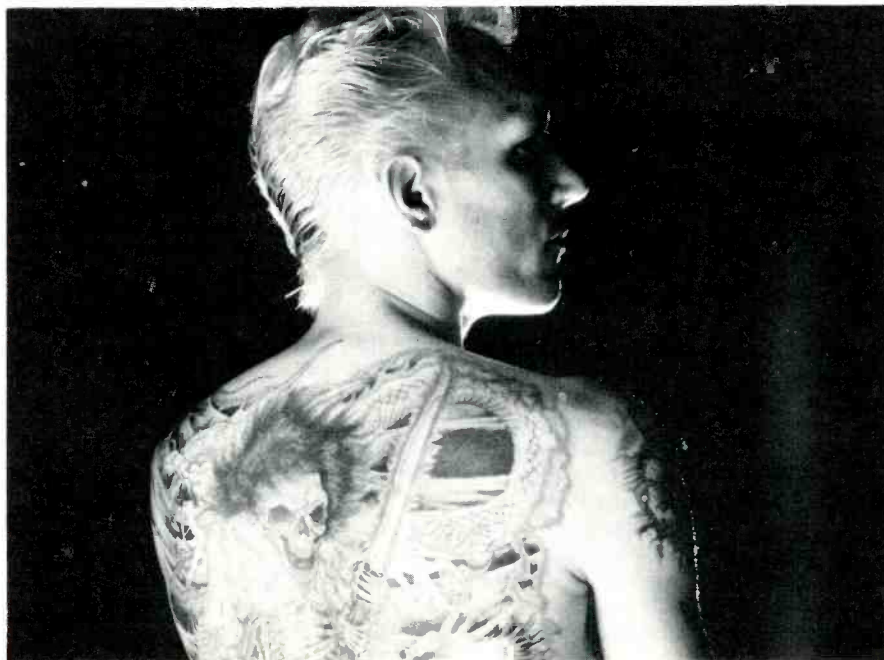

AUDIO • February 1980

and her own *Standin' By the Same Old Love*.

The last time they paired Bonnie Raitt with a Producer (with a capital P), he was soul legend Jerry Ragavoy. That promising union produced a forced and uneven album in 1974's **Streetlights**, ultimately a bitter disappointment. This time around the Producer is Peter Asher, and the result is **The Glow**, an album that suffers from terminal perfection. M.T.

Sound: B+ Performance: C+

Lost in Austin: Marc Benno
A&M SP-4767, stereo, \$7.98.

Marc Benno's **Lost in Austin** appears headed straight for obscurity. And it's a pity because the album has a lot of spirit and charm and good times.

Marc Benno has been around for years. At the end of the '60s he made two dandy albums with Leon Russell as The Asylum Choir, and several solo albums followed. **Lost in Austin** is his first in quite some time. His producer is the very tasty Glyn Johns, and his backup band is Eric Clapton's '79 tour-

The songs are all Kaukonen originals instead of the country blues of **Quah**. As a collection, they are as good as any Hot Tuna set. *Roads and Roads & Vampire Women*, and *Song for the High Mountain I* find the ones most attractive as songs. But the album cries out for a more full-blooded backing. M.T.

Sound: B Performance: B-

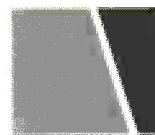

fact: this small record collection represents a \$1,000 investment



It's true—the largest investment in almost any hi-fi system is frequently the cost of the records played on it ... and it is equally true that a badly worn phono stylus tip may ruin a valuable (or irreplaceable) record in a single playing!

With the rising cost of new phonograph records—and the difficulty of replacing treasured, older favorites—it's the worst kind of false economy to risk damaging them with a worn stylus.

Check your stylus (needle) at least once a year

Always insist on a Genuine Shure replacement stylus. Substitutes will not restore the Shure cartridge to its original performance standards.

Look for the name "Shure" on the stylus grip.



Shure Brothers Inc., 222 Hartrey Ave. Evanston, IL 60204.
In Canada: A. C. Simmonds and Sons Limited
Outside the U.S. or Canada, write to Shure Brothers, Inc.
Attn: Dept. J6 for information on your local Shure distributor.
Manufacturers of high fidelity components, microphones,
sound systems and related circuitry.

Enter No. 34 on Reader Service Card

ing unit: E.C. and Albert Lee with Benno on guitars, Jim Keltner drumming, Carl Radle on bass, Dick Sims on keyboards, and Dickie Morrissey on sax.

Except for a goofy romp through *Splish Splash*, Bobby Darin's first hit, the album is all Benno songs. Some are real strong pieces of writing. Especially *Hey There, Senorita*. And *Hotfoot Blues*, too. *Last Train* and *Monterrey Pen* both chug along like the best J.J. Cale songs do. *Chasin' Rainbows* is a real pretty one.

As might be expected from the players, the playing is very tasty and loose, very much like Clapton's band sound-

ed on *Backless*, Eric's latest. Johns' production basically stays out of the way where a slightly more aggressive stance might have given the album more bite, more sock. As it is, it rides somewhere between rock and country music and is neither.

Funny, but *Lost in Austin* keeps gravitating over to my turntable. Partly because of its amiable personality. Partly because of the flawed production. It's a paradox I hope to solve. But I keep playing it, which surely says something. M.T.

Sound: C+ Performance: B

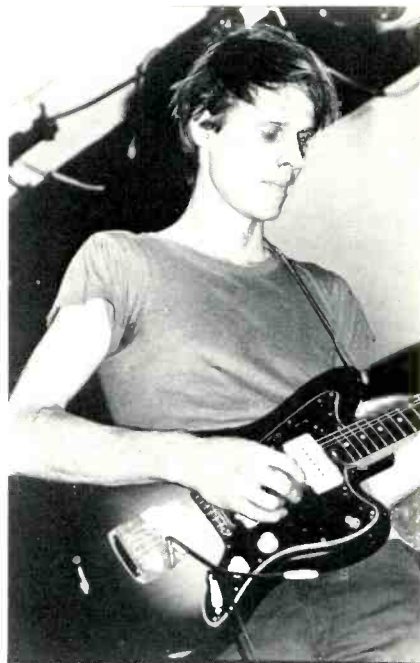

tunes like *Adventure* (a fine unrecorded Television song that resembled Z.Z. Top meets George Thorogood) or find someone to sing his tunes. As an artist, I can't see how he can find making records like this one and Television's swan song fulfilling — they seem to be experiments which result in a record, but the record never sounds like a finished or complete piece. Simply to be one of the pioneers of punk rock/New Wave is not enough, and the fact that his first two records, *Little Johnny Jewel* and *Marquee Moon* stand as his definitive works is evidence that he's got more to offer than this, however uncomfortable he must make himself to come across with it. J.T.

Sound: B+ Performance: B-

Two Sides To Every Woman: Carlene Carter

Warner Bros. BSK 3375, stereo, \$7.98.

Carolyne Mas

Mercury SRM1-3783, stereo, \$7.98.

Thanks to a soft-focus lens, Carlene Carter does a startling imitation of Rock Escort Extraordinaire Bebe Buell on the cover of her album, *Two Sides To Every Woman*. Since the release of her last LP, Carlene has married pop noteworthy Nick Lowe, but neither of these attempts to modernize her image have brought her any closer to actually arriving on the pop music scene. You can't take the country out of the girl, it seems, even if she puts on a punk tie and hangs around with our '70s equivalent of British mods.

Carlene has a passable, sometimes even pleasant voice that's sweet and

The Beckmeier Brothers

Casablanca NBLP 7147, stereo, \$7.98.

It's not that this is just an average band with no real distinction; what steams me is the rotten pressing and terrible, sibilant mastering job. Note that I checked three copies. The band never had a chance. M.T.

Sound: F Performance: C-

Tom Verlaine

Elektra 6E-216, stereo, \$7.98.

In his solo incarnation, ex-Televisionary Tom Verlaine seems totally insular, an untouched artistic aesthete seeking *The Ultimate Wandering Pitch*. While in his group, Verlaine was flanked by erratic players who on any given night could be as horrible or as exciting as their drug consumption permitted. But the solo boy is supported by a rhythm section that resembles nothing so much as a metronome — Allan Schwartzberg and Patti Smith's Jay Daugherty give Verlaine the drum solidity that, coupled with Fred Smith's simple basswork, makes T.V.'s fragility all the more pronounced. The resultant album is a bizarre mixture of songs which seem artificially propped up by regular rhythms, Bob Clearmountain's state-of-the-art mixing, and occasional production tricks which come off like someone trying to polish a pair of sneakers.

What it comes down to is that Verlaine's voice isn't particularly easy to take, sort of a Lou Reed meets Alex Chilton; his guitar playing is amusing but technically unimpressive and has been highly overrated; his single most important contribution is his songwriting. Unfortunately, even though some of his songs are interesting (particularly *The Grip of Love* and Television tunes like *Breakin' In My Heart* and *Kingdom Come*) and demonstrate a lyrical gift, his vocal talents aren't strong enough to carry his melodies — he should either stick to simple rock

Primo

A NEW WEAPON FOR THE WORLD OF SOUND!

Electret Condenser Microphone

Model PC-20



Model PC-20 has been exhaustively researched for frequency response, directivity and transmission characteristics for direct sound collection of string instruments in a concert hall. Clip it to any string instrument.

FEATURES

- Supercardioid characteristic and wide frequency response specially designed to match the directivity pattern of string instruments provide a sound quality boasting excellent reverberation of the middle and low regions.
- Microphone employs a clip type mounting system with freely adjustable angle. Can be mounted to the instrument with one touch. All mounting parts have a soft construction to prevent damaging precious instruments.

RATINGS

<ul style="list-style-type: none"> • Sensitivity: -74 dB ± 2dB • Directivity: Supercardioid characteristic • Output impedance: 250 Ω • Frequency response: 50 to 20,000 Hz • Noise: 22 dB SPL or less • Maximum input sound pressure: 120 dB SPL or greater 	<ul style="list-style-type: none"> • Power requirement: 1.5 V (UM-5) and 48 V phantom • Battery life: 2 months or more of continuous use • Output connector: XLR-3-12C equivalent • Cable: 3m • Weight: Microphone 25 g, power supply 160g
---	---



• For more information write or call us today.

PRIMO MICROPHONES, INC.
2468 DELTA LANE, ELK GROVE VILLAGE,
ILLINOIS 60007, U.S.A. TEL: 312-595-1022
TELEX: 28-3474 PRIMO MUS ELGR

PRIMO MICROPHONES SINGAPORE (PTE) LTD.
24B-27B BLOCK 3, KALLANG WAY, SINGAPORE 13
TEL: 803586 TELEX: 26131

PRIMO COMPANY LIMITED TOKYO, JAPAN
6-25-1 MURE, MITAKA-SHI, TOKYO, JAPAN
TEL: 0422-43-3121-9 TELEX: 2822-326 PRIMO J

Enter No. 30 on Reader Service Card

twangy, but it is incapable of the dirty sound she often tries to convey. The growling delivery on *Swamp Neat Rag*, for instance, is a vocal roller coaster ride from note to note. She fares much better on light numbers, such as the opening song *Do It In a Heartbeat* that was co-written with hubbie Nick, even if it is a rewrite of the Motown classic *The Way You Do the Things You Do*.

Carlene's own songs are pure country with all of that genre's drawbacks; yodelling of sappy lyrics and twangy guitars invade much of side two of an album whose opening side isn't exactly innovative. What this act needs more than anything else is musical direction — except for the first tune none of these compositions generates any excitement. The musicianship is standard session competence without flash, Carlene's vocals pretty but emotionally unconvincing, and the material is throwaway stuff. Carlene, get hip or get out of the race

The debut album of Carolyne Mas, on the other hand, shows the lady to be a real rocker. Carolyne writes, with the help of guitarist David Landau, great Springsteen-esque songs that convey considerable personality as well as musical expertise. The band on this LP plays tight and tough, notably guitarist Landau and sax player Crispin Ciao, the latter whose riff on *Stillsane* approximates the catchiness of the horn line on Rafferty's *Baker Street*.

Among the ballads in her repertoire, Carolyne performs *Snow* with the most beautiful and moving vocal on the album. She has a powerful voice and inventive singing style that never approaches the off-the-wall excesses of Lene Lovich or other New Wave atonals. As a former folk performer, her roots are closer to MOR than they

are to punk, but Carolyne is a girl who knows how to rock. It helps to have an experienced rock musician for a collaborator, but it's Carolyne's musical resources that provide the basis of this respectably rocking LP. Carlene, meanwhile, failed to make the transition from country to rock, despite holding hands across the mixing board with pop figurehead Nick Lowe.

Sally Young

Carlene

Sound: B- Performance: B

Carolyne

Sound: B+ Performance: A



Top Priority: Rory Gallagher *Chrysalis CHR 1235*, stereo, \$7.95.

If Eric Clapton followed through on what he started 10 years ago, **Top Priority** is probably what he'd sound like today—hard-hitting, blues-inspired rock with biting Stratocaster guitar. In fact, Rory's voice even sounds very much like Clapton's, which is not meant as a criticism since one would like to hear Eric the Cee singing something other than his laid-back hillbilly. Rory more than fills his shoes.

The group format is a simple three-piece, but they make enough noise to fill a room and a half; his rhythm section of long-time supporter Gerry McAvoy (bass) and former Alex Harvey Band drummer Ted McKenna are among rock's most solid and hard-hitting rhythm units. The biggest surprise here is that Rory's material is his strongest in years (particularly *Follow Me* and *At the Depot*), his guitar playing is in fine form, and there's a consistency to the elpee that his last few have lacked. True, there's very little new ground broken here, but as far as this approach can go, there's no one who takes it to the limits with as much gusto as Rory Gallagher. J. T.

Sound: A- Performance: A-

Carlene Carter



AUDIO • February 1980

McIntosh

"A Technological Masterpiece . . ."



McIntosh C 32

"More Than a Preamplifier"

McIntosh has received peerless acclaim from prominent product testing laboratories and outstanding international recognition! You can learn why the "more than a preamplifier" C 32 has been selected for these unique honors.

Send us your name and address and we'll send you the complete product reviews and data on all McIntosh products, copies of the international awards, and a North American FM directory. You will understand why McIntosh product research and development always has the appearance and technological look to the future.

Keep up to date.
Send now

McIntosh Laboratory Inc.
Box 96 East Side Station
Binghamton, NY 13904

Name _____

Address _____

City _____ State _____ Zip _____

If you are in a hurry for your catalog please send the coupon to McIntosh. For non-rush service send the Reader Service Card to the magazine.

Enter No. 22 on Reader Service Card

Ain't Living Long Like This: Rodney Crowell

Warner Bros. BSK 3228, stereo, \$7.98.

Right or Wrong: Rosanne Cash
Columbia JC 36155, stereo, \$7.98.

Homemade Songs: Tracy Nelson
Flying Fish 052, stereo, \$7.98.

Tracy Nelson has surprised a whole lot of people by never fulfilling her obvious potential as a major artist. **Homemade Songs**, 10 years after the first Mother Earth album **Livin' with the Animals**, is her first recording for a new label, Flying Fish, which alas is not by any stretch a major. Still, it is one of the best ones she has made.

Tracy has often been accused of singing with all the emotion of an ice statue, but here she has let go some of her reserve. She opens whole new possibilities in Randy Newman's *God's Song*, the best-known song of the set. Her duet with Carlene Carter on *Carlene's Friends of a Kind* is wonderful. *You Don't Have to Move a Mountain* and *The Summer of the Silver Comet* show off the most relaxed and interested Tracy Nelson vocals in far too long.

Now, the Rosanne Cash and Rodney Crowell albums have an important common thread, namely Rodney

Crowell who produced and supplied several songs for Ms. Cash's debut album.

Rosanne is from a musical family, to state the obvious. What else would you call it with parents like John Cash and June Carter? Her inclination to country music is quite natural. She takes to the setting of Emmylou Harris' Hot Band, the musical core of both Rosanne and Rodney's albums, like a fish to water. Like Emmylou's albums, there is not a note out of place or too unkempt. What matters most, I suppose, is that Crowell has gathered a marvelous batch of songs, half of them his own, and also that there are a few genuinely thrilling musical moments. Especially so when the key goes from G to C and Bobby Bare makes his vocal entrance in *No Memories Hangin' Round*. Also the country kick-ass version of *Man Smart, Woman Smarter* modeled after Robert Palmer's rock arrangement. Rosanne's original *This Has Happened Before*, a ballad, is a beaut.

It's a good debut album. The lady has the potential to be a voice we'll be hearing a lot more from, and she'll be more assertive with time.

We've heard more of Rodney Crowell than you might realize. Emmylou's albums, oddly excepting her "best of," contain at least one Crowell tune. And more and more discs from others have, too. But surprisingly, only six of the nine songs on Crowell's album are his own. The other three are all in the neglected chestnut category, and of them Dallas Frazier's *Elvira* stands out.

The really important stuff is the original material. Over and over Crowell finds a new casting and a new angle on the classic themes of country music, updating them gracefully into a current, ironic, gritty view. *Viola, an American Dream*, about a couple arguing about where to vacation on plastic money, could almost be country Randy Newman with its developed plot. *Leaving Louisiana in the Broad Daylight* is a superb song that Emmylou recorded. Here she and Nicolette Larson participate in the intricate harmonies. It's a violent slice of Cajun life played to a "T." Later on, Willie Nelson joins Emmy and Rodney on *Song for the Life*.

Ain't Living Long Like This could well be one of the long-term important debuts of 1979. Rodney dominates his album completely, in a way that Ms. Cash and Ms. Nelson just don't do on theirs. Indeed, Crowell dominates Rosanne's album, and very pleasantly so. He is a proven, quality songwriter who now demonstrates that he is a

88

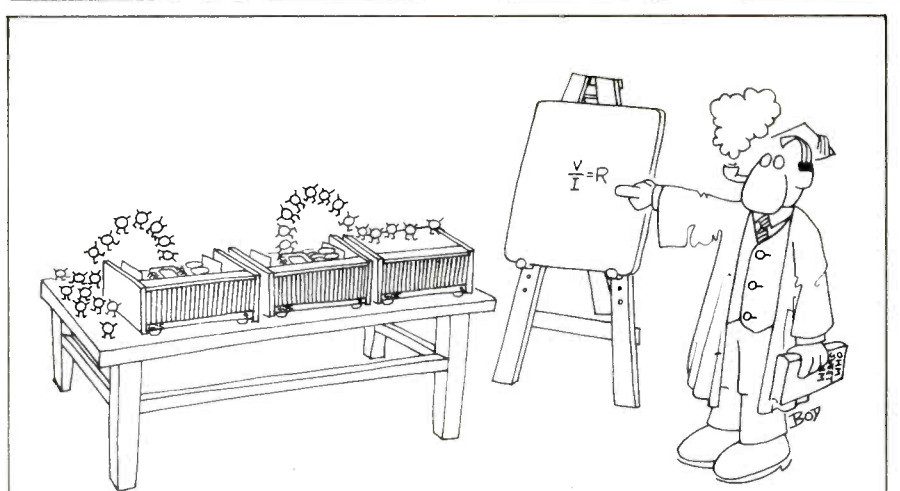

Ohms Law Rules O.K.

It is fashionable in avant-garde hi-fi circles to abandon the precepts of science and to endow equipment with personality.

Fortunately the electrons which whiz through the circuitry of your equipment are not conversant with fashion: if they were they'd probably die laughing and we would have H.I.D. (hysteria induced distortion) to add to T.I.D., T.P.D., B.L.T., and sundry other initial ailments which supposedly afflict your equipment. As it is, they behave predictably whatever others might wish to believe.

At Quad we apply the rules, rigorously, which largely explains why our products withstand the test of time.

For further details on the full range of QUAD products write to

The Acoustical Manufacturing Co. Ltd.,
Huntingdon, Cambs. PE18 7DB, England
Telephone: (0480) 52561

QUAD

for the closest approach to the original sound

QUAD is a registered Trade Mark



Enter No. 46 on Reader Service Card

singing talent worth watching. A newspaper friend wrote of Rodney that he is truly one of country music's hidden superstars. Hyperbole perhaps, but I'll buy it. M.T.

Nelson

Sound: B- Performance: B-

Cash

Sound: C+ Performance: B-

Crowell

Sound: B- Performance: B+

Here: Leo Sayer

Warner Bros. BSK 3374, stereo, \$7.98.

When Leo Sayer's first album came out he was often compared to Elton John, which was quite funny as Leo was almost an Elton-in-reverse: Elton writes the music and sings the tunes with a partner (most notably Bernie Taupin) who supplies the lyrics, while Leo writes the lyrics and sings them but needs a collaborator to provide the melodies. The Elton/Taupin partnership was so integral to Mr. John's success that once they went their separate ways both of their careers took an aesthetic nosedive. Although they carry on with their solo projects, neither will be able to recreate the glories of their past. Sayer's musical inspirator, Mr. David Courtney (who also lent a production hand on the first album), left after two albums, and although Sayer's had one or two hits since the split, he's drifted from one musical style to another with the only common factor from tune to tune being his raspy voice. At last, **Here** reunites singer with the tunesmith, as Courtney returns to co-author three songs with Sayer as well as to oversee the entire project. The result is easily the best record Leo's made since his first.

Initially I was surprised at Courtney/Sayer's choice for backing musicians, as they're primarily American, not to mention the fact that a few of them have contributed tunes to the album which are surprisingly good. In particular, Ray Parker, Jr.'s *When The Money Runs Out* is extremely strong — who says that session musicians can't write? The Courtney tunes are a delight to hear; in fact Courtney seems to have a good handle on what suits Leo's voice and lyrics the best. It might take another three years to get a public ready for the old Leo Sayer again, but it'll be well worth it to have the Courtney/Sayer complete artist rather than the occasional dance hit from the short guy. J.T.

Sound: B+ Performance: B+

AUDIO • February 1980



introducing...

The Bryston Preamp, Model 1B, long awaited by audio-philes, is a reality.

Employing novel, fundamentally correct signal-handling techniques, researched over a period totaling several years, the Model 1B sets new standards for overall musical ease, accuracy and resolution. The Bryston preamplifier is a statement of purpose, representing the same finality of design concept as the Bryston line of power amplifiers.

Write to us today and we'll tell you more.

BRYSTON MFG. LTD.

57A WESTMORE DR., REXDALE, ONTARIO, CANADA M9V 3Y6 TELEPHONE: 746-1800, CABLE BRYREXCAN

Enter No. 6 on Reader Service Card

See What You've Been Missing... Read Audio's Classified

89

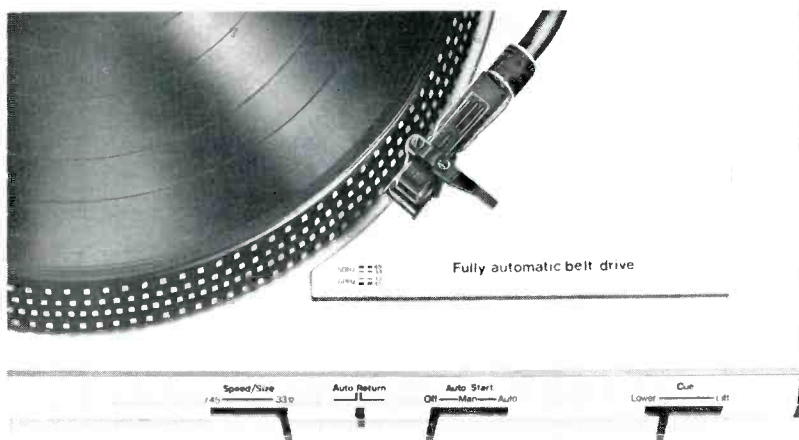

An elite team of designers and engineers — the Advance Design Group — keeps Garrard turntables at the frontier of technology and responsive to the needs of today's music lover. You can choose among belt or direct drive units, single or multiple play models. You can have carbon fibre headshells, super-light tonearms and the extraordinary Delglide® automatic system. Whichever turntable you choose, you're assured of unsurpassed performance and unprecedented reliability underscored by a 3-year limited warranty. Write to us for complete information.

Advance Design Group

Garrard Division of Garrard U.S.A. Dept. C, 100 Commercial Street, Plainview, N.Y. 11803

Enter No. 16 on Reader Service Card

The pre-eminent pick-up arm

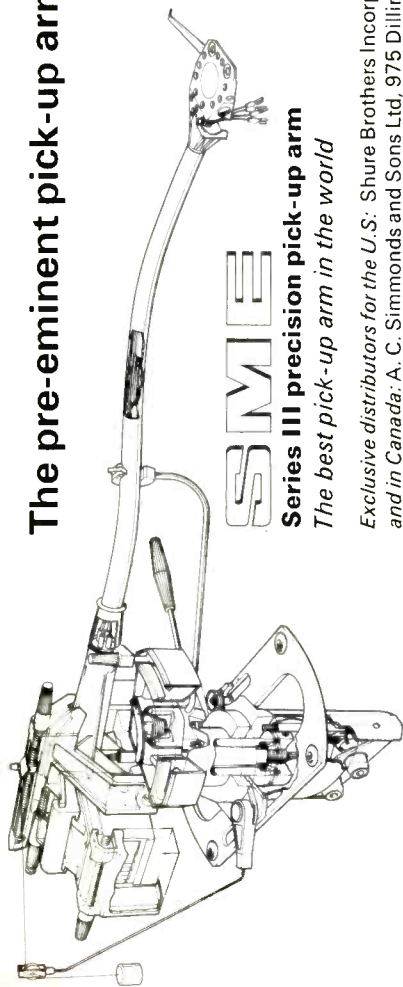

SME
Series III precision pick-up arm
The best pick-up arm in the world

Exclusive distributors for the U.S.: Shure Brothers Incorporated, 222 Hartrey Avenue, Evanston, Illinois 60204 and in Canada: A. C. Simmonds and Sons Ltd, 975 Dillingham Road, Pickering, Ontario, L1W 3B2

Whilst able to explore the best of the present, the Series III precision pick-up arm anticipates the greater engineering elegance of impending miniature cartridges which may weigh as little as one and a half grammes.

Its unique patented balance system minimises mass and inertia, presenting optimum conditions for even the most delicate transducer.

No other pick-up arm is as versatile, a reason why the Series

III is already playing its part in the development of tomorrow's cartridges.

Choose it for your listening pleasure today with confidence in the future.

** Another accolade for SME: the Series III precision pick-up arm was one of the Design and Engineering Awards at the 1979 U.S. Summer Consumer Electronics Show, the only pick-up arm to be acknowledged in this way.*

Write to Dept 1457, SME Limited, Steyning, Sussex, BN4 3GY, England

John Diliberto

John Lissner

JAZZ & blues

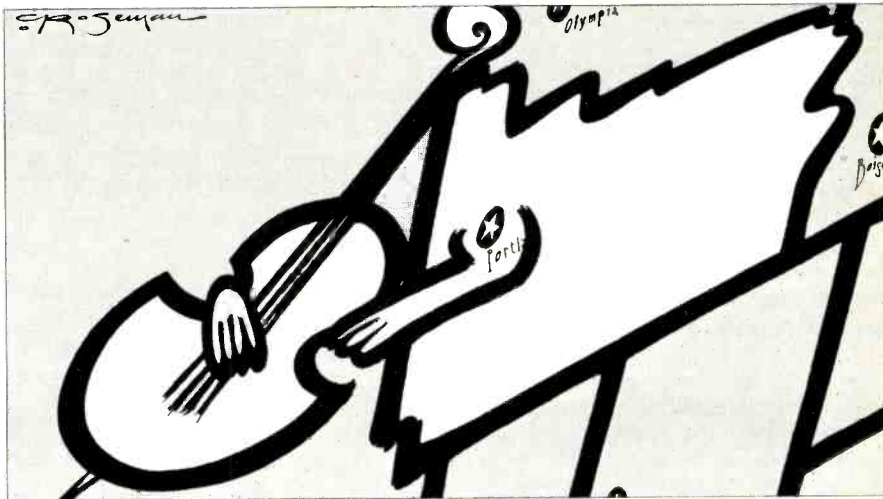

Roots in the Sky: Oregon

Elektra 6E-224, stereo, \$7.98.

Introducing Glen Moore: Glen Moore

Elektra 6E-19, stereo, \$7.98.

All the Mornings Bring: Paul McCandless

Elektra 6E-196, stereo, \$7.98.

The name Oregon not only defines a group, but a whole aesthetic for creating music. Using improvisation and the sensibilities of European chamber music as grounding points, Oregon embraces several traditions, cultures, disciplines, and philosophies. Their sound is made even broader by a multi-instrumental virtuosity. Although they have maintained the same style for over eight years and several albums, that style has enough dimensions to be explored forever. **Roots in the Sky** is another trip through their global synthesis. Released simultaneously with it are two solo albums from Oregon members. These are especially illuminating in isolating Oregon's interwoven components, while at the same time showing how their aesthetic works outside of the standard group context.

Glen Moore, the bassist, also doubles on piano, viola, and violin. His solo debut is a move away from many of Oregon's traditions in his use of Jan Hammer on drums on three selections. They are the least successful of the album, as Hammer's drumming, like much of his keyboard work, is pedan-

tic and rhythmically one-dimensional. His drumming is a lodestone to the otherwise dazzling string work of David Darling (cello), Zbigniew Seifert (violin), and Moore. In duet and trio settings with Darling and/or Seifert, Moore plays an introspective music reliant upon a balance between silence and sound, percussiveness and openness, improvisational intuitiveness and structural pliancy. On *Zbigy* they bring it all together in a misty dirge of long arco lines occasionally pierced by Moore's pizzicato bass.

All the Mornings Bring by Paul McCandless is more in the Oregon oeuvre because it is dominated by one of the instruments that makes Oregon's sound unique: McCandless' oboe. His distant cry dominates the album, but not to the exclusion of a carefully wrought concept. Extending Oregon's chamber aesthetic, McCandless employs trio and 10-piece settings, with a duo and solo thrown in to round things off.

His trios have that light movement and delicate interplay that mark the best Oregon work. Art Lande's piano is like liquid drops among the wood and metal of Dave Samuel's tuned percussion. McCandless' oboe swirls between Eastern dervishes and a Renaissance fair.

In his scoring for a 10-piece group, McCandless is able to translate Oregon's sound into a larger group set-

ting. Using four woodwinds, two French horns, bass and tuned percussion, he combines long, sustained melody lines with deft improvisations that weave themselves into the scored instruments. His moods are varied and provoking: In *Palimpsest* slow-moving lines and subtle shifts of color become the first morning sunrise after the holocaust; the title piece is bright and optimistic, and the final piece with this grouping, *Saraband*, is low, somber music to contemplate the turning of the earth.

Now that all its members have solo projects of their own (Ralph Towner and Colin Walcott have several solo albums under their own names), Oregon has collectively come up with a quintessential recording, **Roots in the Sky**. All the Oregon trademarks are there. Walcott's tablas, sitar, and percussion give them an Indian mystical quality. Towner's guitars have a pristine classical flavor that is sometimes countered and sometimes supported by Moore's bass. Finally, there is McCandless' oboe that cuts through it all with a universal appeal.

Roots in the Sky traverses many moods yet maintains a flow and unity. Oregon operates on several levels at once, and often seems to move into the area of visuals. The polyrhythms of the tablas are complex and energized. Coupled with Moore's often muscular bass work, Oregon seems to be flying over vast landscapes. American Indian flutes meet the African Doussn'gouni in an arid but percussively bubbling desert. The ominous *House of Wax* moves the sitar into an otherworldly setting stalked by the bass figure and odd sighs and scrapings. *The Roots in the Sky* are clawing for the ground in a piece driven by an ostinato bass line and hard, sharp soloing from Towner and Walcott.

The success of Oregon's synthesis is that it works on an unconscious level. Their music is as natural as the environments from which it is born, and the recorded sound reflects this. You feel as if they are playing in the middle of a quiet forest with clear reverberation and resonance. This is only marred by recording surfaces that are sometimes less than clean.

John Diliberto

Roots in the Sky

Sound: A Performance: A

Introducing Glen Moore

Sound: B+ Performance: B-

All the Mornings Bring

Sound: A Performance: A-

Milt Jackson & Count Basie, Volumes 1 & 2

Pablo 2310-822/3, stereo, \$8.98 each.

I'm sorry to have to report that this recent collaboration by two of my all-time favorite jazz artists is disappointing. Perhaps I've heard Basie do *Corner Pocket* and *Shiny Stockings* once too often, and yet when the Basie band is in full cry, particularly at a live performance, hearing these familiar numbers, along with such items as the *920 Special* and *Every Tub* out of the band's '40s book, can be a joyful and exhilarating experience. Unfortunately, on most of the tracks on these two Pablo albums, the Basie band doesn't rear up on its hind legs and wail.

As for Jackson, he certainly has been one of the most satisfying and inventive soloists on the jazz scene in the past 30 years. Moreover, he has been in such superlative form on record of late that my expectations may have been unreasonably high. The idea of Jackson and the Basie band cooking together does make for great expectations, but the Pablo offerings lack vigor; much of the playing is tepid, often bland.

Maybe it's because the material is overt familiar and lacks challenge; most of the selections are Basie classics or pop standards like *Moonlight Becomes You* or *On the Sunny Side of the Street*, with arrangements slightly revamped to allow Jackson room to maneuver his loping, sinuous solos through and around the Basie charts. The performances, of course, are always competent but lack the kind of joy and sheer kick that Jackson, Basie, and the Basie band can produce at their magnificent best. The Pablo sonics are not as scintillating as usual; the Basie brass passages in particular are a bit murky, lacking the detail and clarity that one expects in a big-band recording.

John Lissner

Sound: B Performance: B

Old And New Dreams

ECM ECM-1-1154, stereo, \$8.98.

If they were a rock band, Old and New Dreams would be called a supergroup. But these musicians are far beyond that transient category. Don Cherry, Dewey Redman, Charlie Haden, and Ed Blackwell have been exploring the outposts of jazz for the last 20 years. Many of their discoveries have been unearthed in the groups of Ornette Coleman, with whom they all played in different combinations.

Ornette's concepts serve as a point of departure for **Old and New Dreams**, and two of his songs strategi-

Empire's EDR.9 The Phono Cartridge Designed for Today's Audiophile Recordings

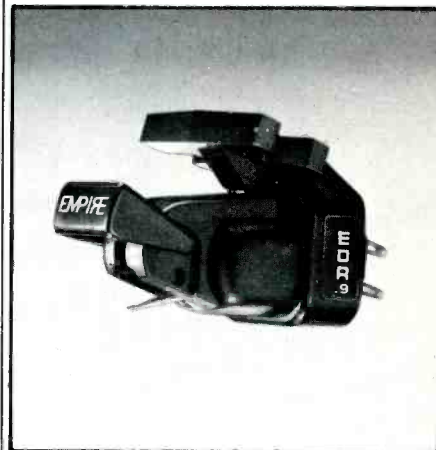

Direct-to-Disc and digital recording have added a fantastic new dimension to the listening experience. Greater dynamic range, detail, stereo imaging, lower distortion and increased signal-to-noise ratio are just a few of the phrases used to describe the advantages of these new technologies.

In order to capture all the benefits of these recordings, you should have a phono cartridge specifically designed to reproduce every bit of information with utmost precision and clarity and the least amount of record wear.

The Empire EDR.9 is that cartridge. Although just recently introduced, it is already being hailed as a breakthrough by audiophiles, not only in the U.S., but in such foreign markets as Japan, Germany, England, France, Switzerland and Sweden.

At \$200, the EDR.9 is expensive, but then again, so are your records.

For more detailed information and test reports, write to:

Empire Scientific Corporation
1055 Stewart Avenue
Garden City, New York 11530

EMPIRE



Enter No. 13 on Reader Service Card

YOU CAN TAKE IT WITH YOU!

Quality Sound takes
to the road . . . the sky . . .
and the ocean!

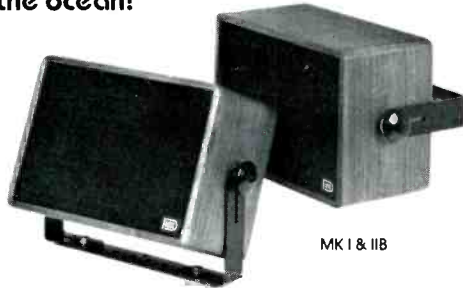

DIMENSION LAB SERIES

We wrote the book on miniature speakers, from Design to Production! Our five models speak for themselves in total performance, styling, and features that are found in no other speakers . . . such as, Solid Walnut Cabinetry, full 12 db cross-over network, a specially designed cone with our exclusive rubber surround, and a deep throw speaker basket. These are just a few of the reasons why our Bass is unequalled in the Industry. "Dimension Minis' are Proven best by listening test."

Come in for a demonstration and judge for yourself.
See and Hear the New Dimension in Sound at
Your Local Stereo Dealer.

DIMENSION

819 S. Kraemer • Placentia, CA 92670
(714) 630-5440

Representative and Dealer Inquiries Welcome



Enter No. 8 on Reader Service Card

cally open each side of the album. *Lonely Woman's* mournful lines echo off the walls of an empty room. Dewey Redman plays a supple and moody tenor that leads to Cherry's introspective trumpet. Charlie Haden's unaccompanied bass is sparse and points to the ends of desolation. *Open and Close* features one of those staccato Ornette heads that opens into a propulsive improvisation. Redman initiates the drive with a throaty, muscular tenor. Then Cherry takes over with a jagged foray that stops, starts, slides, and runs. Throughout these tunes, Ed Blackwell is a fount of percussive punctuations and commentary. His playing is spare, but perfectly placed.

From Ornette, *Old and New Dreams* moves into an area of more overt musical synthesis using various ethnic forms that the group has been experiencing over the years. Ed Blackwell's *Togo* uses a brief melodic head to frame a drum solo based on a Ghanaese traditional that sounds like a buoyant tribal dance rhythm. On *Orbit* Dewey Redman uses his musette, a double-reed instrument that sounds like the Indian shenai. He combines with Cherry's elephant trumpet calls over a rolling Middle Eastern rhythm. Don Cherry's meditative trumpet cry opens his lovely *Guinea* unaccompanied. The band joins him with a loping ostinato rhythm, and Redman takes another fine solo as Cherry switches to piano to flesh out the melody.

The album closes with Charlie Haden's haunting *Song for the Whales*. Haden is one of the few musicians able to infuse his music with politics and social consciousness, yet still make music that transcends all the rhetoric. He's done it with *Song for Che* and his *Music Liberation Orchestra* album, and now he does it with *Song for the Whales*. It begins with Haden's overdubbed bass quite accurately emulating the sounds of whales. Don Cherry comes in part way with his bleating trumpet joining in forlorn harmony. The entire band rolls in for a turbulent lament that closes with Haden's arco bass, alone once again.

As their name implies, *Old and New Dreams* embodies the past and points towards the future. That future is an exciting synthesis of ethnic music into a new-world music. Because of ECM's careful production, this music has an ephemeral quality that seems to be prodding the inside of our collective consciousness. This is yet another part of the synthesis, where technology doesn't just record the music, but adds to its dimensions. *John Diliberto*

Sound: A+

Performance: A

Only The Audio Critic would dare.

Can you imagine any audio publication, either commercial or underground, telling you that a new integrated amplifier under \$200 sounds unquestionably superior to many highly venerated preamp-power-amp combinations costing \$2000 and more?

Only The Audio Critic would have the integrity and self-confidence to take that credibility risk. Read all about it in the forthcoming Volume 2, Number 2 (the eighth issue since the start).

At the other end of the spectrum, a fairly simple new speaker system for \$3500 the pair is hailed in the same issue as the reference standard replacing The Audio Critic's previous "hybrid" reference speaker costing incomparably more.

As the audio community has come to appreciate, The Audio Critic is the only totally noncommercial, ad-free, consumer-oriented audio review with a decently equipped laboratory, merciless ears and an editorial mind unconfused about the laws of physics. You should probably start your subscription retroactively, with the sixth issue (Vol. 1, No. 6), which is a cumulative reference work with over 150 reviews.

Send \$30 for 6 consecutive issues by first-class mail (no Canadian dollars, \$6 extra for overseas airmail) to The Audio Critic, Box 392, Bronxville, NY 10708.

NEW FOR THE '80'S FROM PIA PROTEUS ITM PROGRAMMABLE PRESET LEAD SYNTHESIZER

- 2 exponential VCO's with Sync.
 - Noise source
 - 24 dB/octave low pass VCF
 - Wide range LFO
 - Wide range ADSR envelope generator
 - 3 octave digital keyboard
 - 16 programmable presets with ni-cad battery backup
 - Preset data and address port provided.
 - Liberal patch over hardware points
- QUESTIONS? How easy is it to assemble? How powerful and versatile? What are the interfacing details? The PROTEUS USING/ASSEMBLY MANUAL set answers these questions and many more.
Price—\$10.00 refundable with purchase.



No. 8750 PROTEUS KIT \$399.00;
Assembled \$499.00
(shipped freight collect)

- () Send the 8750 kit, \$399.00 enclosed.
- () Send the 8750 assembled, \$499 enclosed.
- () TELL ME MORE, send the 8750 Assembly & Using manual, \$10 enclosed.
- () Send FREE Catalog.

Name: _____

Address: _____

City: _____ State: _____ Zip: _____

PIA Electronics Dept. 2-A, 1020 W. Wilshire
Okla. City, OK 73116

Enter No. 27 on Reader Service Card

Classical reviews

Edward Tatnall Canby

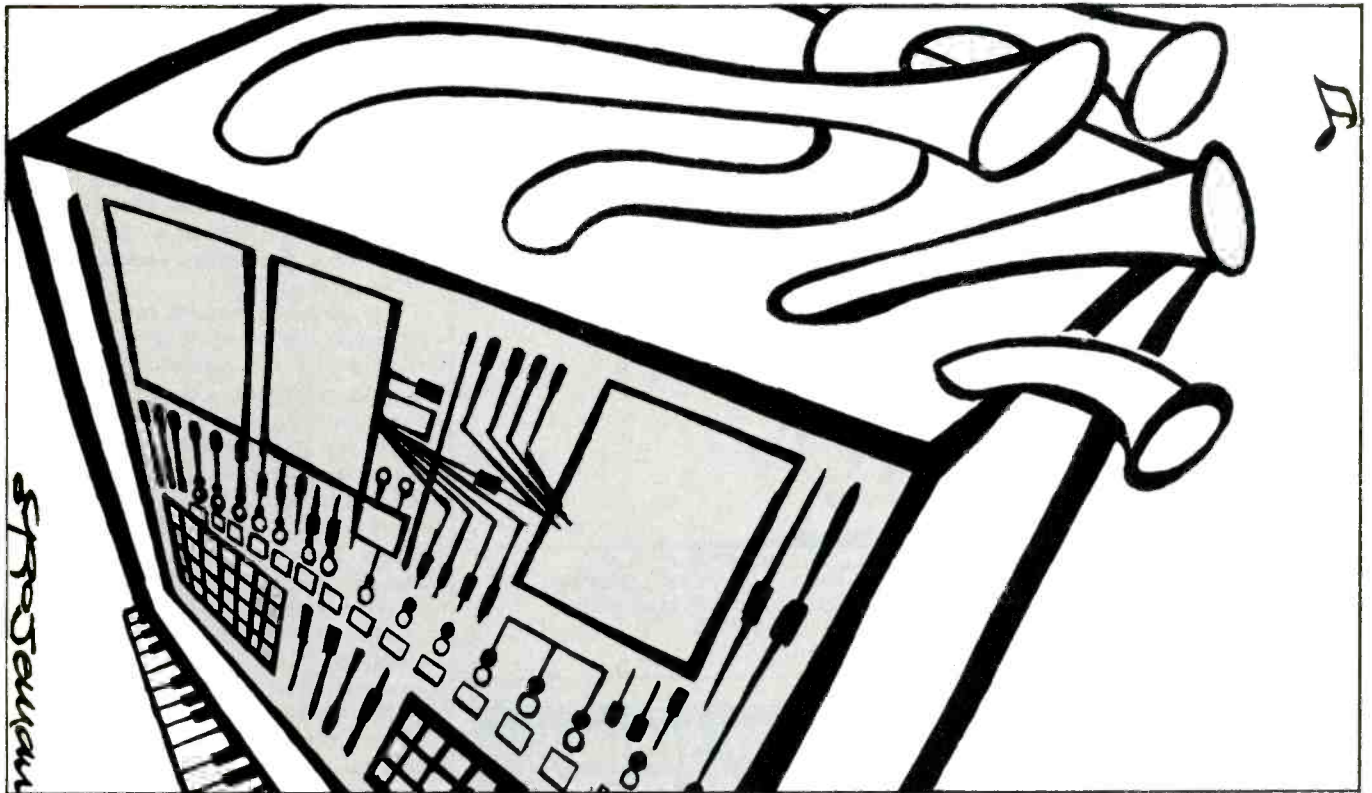

The Allen Computer Organ at Chichester Cathedral. George Thalben Ball. **Chalfont C77-007**, stereo, \$7.98.

COMPUTER organ? Here is a recital by an "eminent British organist" (since 1923) in a very eminent British cathedral of large size, playing an eminent and typical recital program for a large organ — BUT?

The big unanswered question is, are there pipes? Or is this an electronic organ? The Allen organ was one of the first electronic organs to attain real musical stature as a "classical" instrument, a very large and complex machine indeed, with a sound that satisfied most musicians who would not be caught dead near some other well-known electronic models. Is this that sort of Allen organ — a real monster in a very large cathedral space? Curiously, the record-liner notes say not one single word on the subject, though they do give a complete list of all 90 stops (including No. 90, Expression Off).

So, in the absence of such vital information, one listens! Good mystery sound. The organ is definitely a whopper and filling a very large space, with long reverb time. It is far from a "Baroque" type, rather of the old-fash-

ioned sort, the Romantic organ of the second half of the nineteenth century; as such (and ignoring the electronic-or-no aspect) I would rate it as a very good and interesting instrument, with lively, bright, mellow colors and excellent clarity, beautifully integrated into its own acoustic space. Frankly, in a thousand years I would never suspect that this is an electronic and/or computer-controlled instrument — if it is.

The eminent organist is old-fashioned but lively himself, too. He plays with verve, good phrasing, an excellent ear for registration. His program, like so many, starts with "old" music in assorted mod arrangements, anathema to serious-minded Baroque purists but fun if you aren't; then moves on to the expected later virtuoso stuff, Romantic and mildly modern, both light and heavy and all extremely deftly played. Dr. Thalben Ball does not in the least show his age, I must say. A fine musical entertainer.

So does it matter whether this is a "real" giant organ or an electronic machine? Well, it does make a difference. Or does it?

Sound: B Recording: B+ Surfaces: B

Renaissance Music for Two Lutes.

Catherine and Robert Strizich. **Titanic Ti 15**, stereo, \$8.00.

Two lutes. The lute, as you probably know, is the super-classical relative of the "classical" guitar, always an aristocratic instrument and for centuries one of the most sophisticated of all instruments, with many strings, wide range from high treble to low bass and an unusual capability for counterpoint, many strands of melody at once. Moreover, lutes are immensely varied in sound and structure and even in the tuning.

On this record a young husband-wife team plays two easily different sounding lutes—via stereo you can hear them on the left and right, each with its own different sound. The music is indigenous, out of the sixteenth century, both English and continental; the lutes are modern, 1973 and 1975, but patterned after old makers. It is highly ornamented frilly music, if you wish, full of scales and fast runs up and down, based on very simple almost folkish harmonies—except in the fantasies (fantasia, fancy), where counterpoint takes over. Some lovely names—*The Flatt Pavion* (shades of Lester Flatt), *The Gallyerd* (Galliard) to

The King of Valves



Genuine Gold Lion[™] valves – hand built, utilising advanced pumping techniques and individually tested to a tight specification – are your answer to the high quality sound demands made by musicians and listeners alike.

Gold Lion KT77's and KT88's covering 30-200 watts, are now available from M-OV along with data and distribution details. Find out all about the King of Quality – from M-OV.

™ Trade Mark of M-OV Audio Valves.

M-OV

A MEMBER OF THE GEC GROUP

Genalex

S 717

THE M-O VALVE CO. LTD., HAMMERSMITH, LONDON W6 7PE, ENGLAND. TELEPHONE: 01-603 3431. TELEX: 23435. GRAMS: THERMIONIC LONDON. Distributed in the USA by: EEV INC., 7 WEST CHESTER PLAZA, ELMSFORD, N.Y. 10523. TELEPHONE: 914 592 6050. TELEX: 710 567 1215.

Enter No. 15 on Reader Service Card

94

It's a musical instrument!

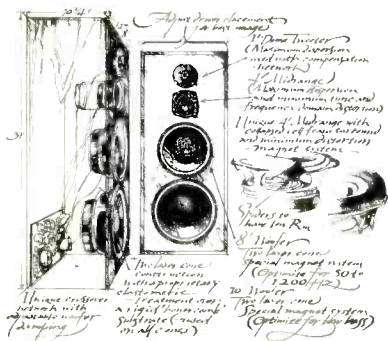

The handcrafted Speakerlab Thirties featuring the patented Nestorovic Woofer System[™] are unlike any speakers you've ever heard. Find out about Speakerlab's innovative speakers, kits, and raw speakers. You can save up to 50% when you build them yourself.

Read about all the details in our free catalog. Send for yours today!

118

name _____

address _____

city _____

state _____

zip _____

Speakerlab

Dept. 118, 735 N. Northlake Way
Seattle, Washington 98103

BIGGEST SAVINGS— SAME DAY DELIVERY

Call TOLL FREE 800-638-8806
or, if busy, 301-488-9600



- We have more of the components and manufacturers you are looking for.
- Our prices are the lowest you'll find anywhere.
- Your phone order is shipped the same day you call.
- In most cases you'll enjoy your equipment within 72 hours.
- We stand behind everything we sell with a "No Lemon" guarantee and a trained customer service department.
- Our Audio Advisors will help you select the right equipment at the best prices for the quickest delivery.

Call TOLL FREE 800-638-8806, or, if busy, 301-488-9600 for information on equipment, prices and ordering, or send for free brochure, tips on buying hi-fi equipment by mail, test reports and a \$2.00 merchandise certificate.



International Hi-Fi Distributors

Moravia Center
Industrial Park, Dept. A 2
Baltimore, Maryland 21206

the Flatt Pavilion, and Twenty Waies Upon the Bels.

The two young people are very serious and play perfectly together, but with a lot of "hesitation" in the rhythm and a certain slowness—common enough among classical guitarists as well as lutenists and in contrast, say, to the almost brittle verve of famed lutenist Julian Bream. Maybe these two are right—the lute never was an instrument for high jinks. If you find too much of a muchness, just don't play a whole side at a time. That's easy.

Sound: B Recording: A- Surfaces: B+

Stravinsky: Suite from The Firebird.
Mussorgsky: Pictures at an Exhibition.
Robin McCabe, piano. **Vanguard VSD 71264**, stereo, \$7.98.

It is always interesting to hear familiar music in alternative versions for orchestra and for piano — whichever version may have come first or become best known. Stravinsky mostly wrote his big scores out first on the piano, but the *Firebird* on this recording was transcribed for virtuoso piano in 1928 by an Italian pianist, Guido Agosti, presumably for his own playing. As for Mussorgsky, the original *Pictures* were composed for the piano — in numerous confusing and semi-complete versions, enough to baffle any publisher. Fortunately, the great orchestrator Ravel got hold of the music and made of it the marvelous orchestral piece we know so well; few pianists have tried any of the piano alternatives and Vladimir Horowitz took artistic advantage of the confusion to make his own version, elaborated with Horowitzian brilliance, enough to intimidate lesser artists of the keyboard.

The pianist here is an American prodigy, out of Washington state, and she sounds American, too. Fabulous technique and power — that's an American specialty. A somewhat hard, domineering sound 'mid all the brilliance, also an American trait. (We worship machismo, even among women!) An occasional ugly sound, a coarse bit of phrasing, a subtlety missed. But not by much. Mostly, this McCabe music is persuasive and powerful, and I greatly enjoyed it.

It is perhaps only natural that one senses an ear tuned to the orchestral versions of these two works, the piano sounding as much as possible like the orchestra. OK — but the music in both cases can be played as piano music *per se*. It tends to sound different, that way, and in all truth might not please the listening ear that knows the orchestral versions. But just try the finale — that's all piano!

Sound: B+ Recording: A- Surfaces: B

AUDIO • February 1980

Enter No. 17 on Reader Service Card

Fig. 7—Spectral noise analysis of the untreated disc during the first playing.

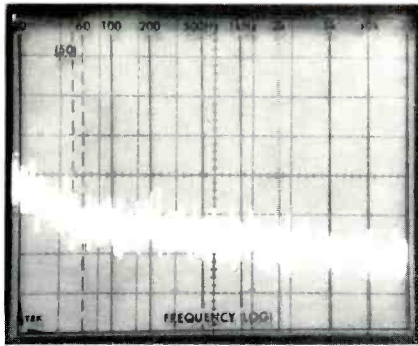

Fig. 8—Spectral noise analysis of the untreated disc after 100 playings.

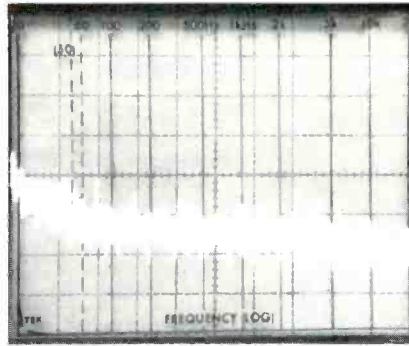

Fig. 9—Spectral noise analysis of the treated disc during the first playing after application of Lifesaver.

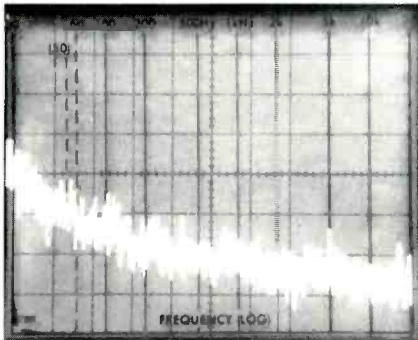
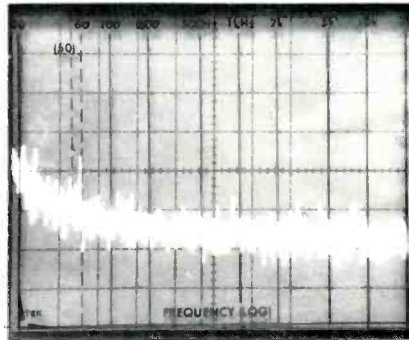

Fig. 10—Spectral noise analysis of the treated disc after 100 playings.



and dry cleaning is all that should be required if normal record care and storage are observed. All things considered, these are quite a number of benefits from a single record-care product. While we often take a skeptical view of any

product that offers 2-in-1 benefits, this one really delivers on both counts: Record preservation and destaticizing.

Leonard Feldman

Enter No. 90 on Reader Service Card

The Watts Parastat



In 15 seconds your records are clean, dry and ready to play.

With some systems you pour liquid on your records (and rub it into the grooves), while with others you brush the dirt around (and rub it into the grooves). The Watts Parastat is neither of these.

By placing a plush velvet pad on either side of a soft nylon brush and adding a drop or two of Parastatik® fluid, a

remarkably efficient system is created.

The brush bristles lift the rubbish to the surface. The pads collect and remove it. And the Parastatik® fluid supplies just the right degree of humidity to relax dust collecting static without leaving any kind of film or deposit behind.

No other system does so much for

your records in so little time.

So when you want the best, ask for the original. The Parastat, by Cecil Watts.

Watts products are distributed exclusively in the U.S. by: Empire Scientific Corp., Garden City, NY 11530.

EMPIRE EMPIRE EMPIRE EMPIRE EMPIRE EMPIRE EMPIRE EMPIRE EMPIRE EMPIRE

Cecil E. Watts Ltd

Enter No. 11 on Reader Service Card

Classified

FOR SALE

CLASSIFIED ADVERTISING RATES

BUSINESS ADS- For Sale, Help Wanted, Services, Business Opportunities, Tape Recordings, etc. etc. \$5.25 per line. First line set in bold face type at no extra charge. Extra lines \$9.60 per line. One point ruled box, extra charge \$8.00. Full payment must accompany order.

NON BUSINESS ADS- Situations Wanted, used equipment for sale by private individuals \$3.50 per line. First line set in bold face type at no extra charge. Extra lines set in bold face type \$7.00 per line. Full payment must accompany order.

FREQUENCY DISCOUNT- 3 times, less 10%. 6 times, less 15%. 12 times, less 20%. (line copy ads only)

DEADLINE- 1st of two preceding months. (Dec. 1 for Feb. issue).

BLIND ADS- Box numbers may be used at \$5.00 extra for handling and postage.

MAIL ORDER AND DISPLAY CLASSIFIED RATE

1 col x 1"	\$150
1 col x 2"	\$225
1 col x 3"	\$300
2 col x 1"	\$225
2 col x 2"	\$395

Advertiser must supply complete film negative ready for printing for display ads.

Carolynn F. Sumner
Classified Advertising Manager

AUDIO Magazine
1515 Broadway
New York, N.Y. 10036

HOW TO ANSWER BOX NUMBER ADS

When replying to an Audio Box Number Ad, please use this address Box No. — c/o Audio, 1515 Broadway, New York, N.Y. 10036

ABATE THE HIGH COST OF YOUR NEXT AUDIO PURCHASE!

DIRECT DISCOUNTS LTD. offers many of the finest lines of audio gear from budget equipment to typically non-discounted components and cartridges. But more important is our concerned attitude that your next audio purchase be best suited for your individual needs. Whether you're a novice or seasoned audiophile, we believe that our wide selection, low prices and helpful advice could make us your one-stop audio bargain place. As an added service to our customers we also offer top-notch camera equipment, TV's, video recorders, and many interesting gift items including the new wireless extension telephone from ATE. Just call us at 212-254-3125 for prices and information, or send \$2.00 for our current brochure to Direct Discounts Ltd., P.O. Box 841, Cooper Station, NY 10003. Shop with us by phone with your M/C or VISA. We ship worldwide! Foreign inquiries invited.

FOR SALE

ABSOLUTE BEST PRICES ALL ELECTRO-VOICE SENTRY AND INTERFACE SPEAKER SYSTEMS, E. V. RAW SPEAKERS AND PRO-MUSIC PRODUCTS. B.G.W. AMPS AND PRE-AMPS, OTARI RECORDINGS, H M E WIRELESS MICROPHONES, SHURE PRO-MASTER. PROMPT DELIVERY TO ALL U S A AND FOREIGN DESTINATIONS. PRODUCTS QUOTES CALL (305) 462-1976.

ABSOLUTELY THE FINEST QUALITY AUDIO COMPONENTS AVAILABLE. UNBEATABLE PRICES, WARRANTIES, AND SERVICE. INCLUDING AR BOSE ESS JBL & PRO AIWA SAE H.K. PHASE-LINEAR HATACHI AND MORE. FOR MID AND HI-END LINES WE DONT ADVERTISE. FOR PRICES CALL 301-593-8244 OR SEND \$2.00 TO: AUDIO DISCOUNTS, 0126 McCENEY AVE., SILVER SPRING, MD 20901 FOR PRODUCT LIST AND SPECIFIC PRICE QUOTES. MON. THRU SAT. 10AM TO 9PM SUN 11AM TO 8PM EST ALL ORDERS FACTORY SEALED SHIPPED WITHIN 48 HRS. C.O.D. FOR YOUR CONVENIENCE.

ABSURDLY LOW PRICES ON AUDIO/VIDEO Sample price Technics RS-M63 tape deck features metal tape ready, 3 heads, double Dolby, fluoroscan meters, etc. List \$450, sale \$299. Add \$10 shipping (USA only). Payment must accompany order! (N.Y. add 8% tax). Save also on:

AUDIO COMPONENTS & TAPE

Advent, AR, Akai, Altec, BIC, Electro-Voice, Empire, Ess, Grado, Harmon/Kardon, Infinity, JBL, Jensen, JVC, Marantz, Maxell, Micro-Acoustics, MXR, Onkyo, Ortofon, Phase Linear, Phillips, Pickering, Pioneer, SAE, Sansui, Sanyo, Scott, Sherwood, Sony, Sonus, Soundcraftsmen, TDK, Teac, Technics.

VIDEO COMPONENTS & TAPE

Ampex, JVC, Magnavox, Panasonic, Quasar, RCA, Scotch, TDK, Toshiba, Zenith. See sample prices listed under "TAPE" in this issue. For phone quotes and orders call area code (212) 845-2861 weekdays 4-8 and Saturdays 9-2 EST, or write to B&J Audio/Video Inc. P.O. Box 248, N.Y. Howard Beach, N.Y. 11414.

Accuphase C-200, New, Best Offer. 213-828-7604.

ADIRONDACK AUDIOPHILES Northern New York State House of Hi-Fi is now open with Hegeman, Conrad Johnson, Fidelity Research, Marcof, Grafyx, Hafler, D.C. Time Windows, Ampzilla (G.A.S.) Polk Audio Monitors, KEF, Harmon Kardon ST8, Sleeping Beauty, Audionics, N.A.D., Mayware formula 4 tonearm, Signet moving coils, AKG cartridges, Toshiba, Sony, and Aiwa. For info. call 518-793-6639 Mon. to Fri. 11-9 Sat. 10-6. House of Hi-Fi, 50 Miller Rd. (Rt. 9), Glen Falls, NY 12801.

AFFORDABLE ESOTERICA

Central N.Y. State
Audionics Apt-Holman Dahlquist Denon
Spectro-Acoustics Crystal Clear
Citation Grace Ortofon Cizek
B&O McIntosh Crown KEF
STELLAR STEREO
384 Elmira Rd. Ithaca N.Y. 14850 607 272 2644

AGFA — THE BEST OPEN REEL TAPE! CASSETTES:

ASF (C66 & C96) and DIRECT TYPE II (C96) are the best available! Direct-to-tape Recordings offer the finest sound available only on reels, cassettes, & cartridges. Ampex video cassettes also available. WRITE for FREE brochure & current special offers. Direct-to-Tape Recording Co., 14 Station Ave., Haddon Heights, NJ 08035. 2-0

FOR SALE

AKAI — 3 head cassette deck — logic — new \$750; \$350 A-1. Reply Box A20-1 c/o Audio Magazine.

ALPHA ELECTRONICS PREPREAMPLIFIER

This superb new step-up device produces low-level gain without phase distortion or signal degradation. You have not realized the potential of your moving coil cartridge until you have heard it through the Alpha AE-1. Available Exclusively at Q/LC Audio, 1006 Berkshire Rd., Dayton, Ohio 45419. or call (513) 293-7287 or (513) 298-9330.

AMBIENCE DECODER FOR REAR CHANNELS, \$149.95. Literature 50c. Huntington Electronics, Box 2009-A, Huntington, Conn. 06484

AMPEX TAPE—NEW 1800 on 7" reel 12 for \$18 POSTPAID, 1200' 12 for \$13 POSTPAID—free list—WIDE RESPONSE. 6114A, SANTA MONICA BLVD., HOLLYWOOD, CA 90038 TF

ANALYZE/EQUALIZE with the AUDIO CONTROL C101

Now available — the amazing model C101 combination octave-band spectrum analyzer, matching octave-band equalizer, pink noise generator, and calibrated microphone all in one handsome stereo component. An extremely versatile tool for room, speaker, and component analysis and correction. (And a dazzling light show on the hundred-LED analyzer grid.) All for \$550 postpaid. To order or for information call or write. (617) 874-0706, mon-fri, 6-8 pm (ask for Dick.) AUDIO CALIBRATION, Box 250, Westminster, MASS 01473.

A NEW SERVICE — THE AUDIO BROKER

Computerized matching of Buyers & Sellers Used Equipment. Send Mfg., Model, Price. Condition together with \$1 for each item for 12 months listing to: Box 1, Tennent, NJ 07763.

ANNOUNCING — PHOENIX AZ AUDIOPHILES

Audire or Hafler? These giant-killers are the best. In stock now. Marcof, Denon, Grace, AGI etc. Affordable esoterica our specialty. Shipped anywhere. THE LISTENING POST (602) 967-1250 by appt.

ANOTHER AUDIOPHILE PUBLICATION?

AUDIO UPDATE is published ON TIME. This bi-monthly includes modifications construction projects, improvement methods, data available nowhere else. It's provocative, informative, and a MUST if you enjoy audio. Annual: \$12.00 USA/Canada, \$14.00 elsewhere. MasterCharge/Visa welcome. AUDIO DIMENSIONS, 8888 Clairmont Mesa Blvd., San Diego, CA 92123. (714) 278-3310. TF

APT-Holman. Hafler. Dahlquist. Satin. Signet. Nakamichi. McIntosh. IMF Electronics. Bowers & Wilkins. Crown. Quad. Bryston. Revox. Lux. Mitchell Cotter. Pyramid.

Audio Consultants, Inc., 1014 Davis Street, Evanston, IL 60201 (312) 864-9565

Audio Consultants, Inc., 757 N. Milwaukee Ave., Libertyville, IL 60048 (312) 362-5594
Write for our monthly list of used equipment bargains.

PERSONALLY,
we're
at your service.

For prepaid shipment at guaranteed lower prices: Marantz, Harmon-Kardon, Hafler, Dahlquist, and many other fine "high-end" audio products. Ask us about new ways to stretch your audio dollar.
Call, toll-free today (800) 423-4885
(except Alaska, Hawaii and California)

10 to 6 PST Daily

THE STEREO SHOPPE

1244 E. COLORADO BOULEVARD
PASADENA, CALIFORNIA 91106

The best of Dallas/Fort Worth

Threshold • Magneplanar • Advent • G.A.S. • Denon • Ortofon • Harmon Kardon • B.I.C.
• Linn-Sondek • Cizek • Audio Standards • Marcof • Keith Monks • Dahlquist • Fulton • Sumo
• KM Systems • Advent Video Beam • N.A.D. • Hill Plasmatronic • Hafler • M & K • DCM Time Window

AudioVision

Carillon Plaza 13601 Preston at Alpha Dallas, TX 75240 (214) 233-8513
Master Charge and VISA accepted. Free delivery or shipment, at our option.

FOR SALE

ATTITUDE, a good one that is, makes **THE AUDIO JOURNAL** refreshingly different from all other audiophile publications. The only ego trip we know about is providing our readers with concise, fair, and informative reviews of the finest recordings and audio components. For this reason, The Audio Journal is fast becoming the leading publication for audio enthusiasts and music lovers everywhere. Our third issue contains reviews of the Threshold SL-10 preamp, the Audioetc/Rabco straight line tracking tonearm, the Dayton-Wright XG-10 electrostatic speaker system, the Magneplan MG-2A planar speakers, the Threshold 4000 amplifier, the Ortofon MC-30 cartridge, the Theta tube preamp, the Rogers LS3/5A mini monitors and more. Future issues will include reviews of components such as the Beverage Three cylindrical electrostatic, the Win SDC-10 turntable, the Threshold CAS-2 amplifier, the Acoustat Monitor Three electrostatic, and others. Four issues: U.S.A. - \$18 (first class), Canada - \$22 (first class), Outside North America - \$24 (air mail), U.S. Currency only. We accept check, money order, Master Charge, Visa, and American Express. Charge card holders please include account number, expiration date, signature, and interbank number (MC only). Send for your subscription today: The Audio Journal, P.O. Box 4205, Macon, GA 31208.

AUDIO ALTERNATIVE - A unique Specialty Shop Prompt, knowledgeable, friendly, reliable service. SASE mail inquiries welcome for product profile and advantageous prices. Prepaid shipping Cont. USA Mastercharge - Visa. Audio Alternative, 1124 East Elizabeth, Fort Collins, Colorado 80524.

Audio and TV tubes factory boxed, speakers, semiconductors—low prices, free price list. Transisleteronic Inc., 1365-39th St Brooklyn, N.Y. 11218 212-633-2800 TF

AUDIO BARGAINS — FREE LIST. Closeout/bankruptcy specials. SCC, Box 8014 (A-79), Canton, Ohio 44711. TF

AUDIO DEN AND POLK AUDIO

The Audio Den is proud to have on display and demonstration the amazing Polk Audio Monitor Series. Our customers say "Fantastic! Compares with the finest loudspeakers I have heard. Probably the best value in the history of Audio!!!" Audiogram®, from the Audio Advisor said, "We were so impressed that we could not believe the prices . . . Other \$200 speakers simply do not come close to the standards set by the Model 10 . . . And at their price, they are simply a steal." Come in for an audition or write us for information on Polk or our other state-of-the-art products. Polk is shipped free in the continental U.S. Audio Den Ltd. 1320-34 Stony Brook Rd., Stonybrook L.I., N.Y. 11790, 516-751-3350. TF

AUDIO FOUR PAGE REPORT

on

Stan White, Rohrenverstärker

Hi Fi Exklusiv (Germany 5/79) reports on Stan White. Inventor of the GLASSCONE™ speaker: "Stanley White der Konstrukteur des vorliegenden Veteraned, zählt neben Paul Klipsch, Saul Marantz und Avery Fisher zu den Wegbereitern der High Fidelity. Er baute neben einer Reihe von Vorund Endverstärkern den ersten Motional Feedback Hochtöner und einige zu ihrer Zeit unter Audiophilen hochgeschätzte Lautsprecher wie den Mach I und den 4000 Mark teuren 4-D." Write TACHYON, P.O. Box 204, Bloomington, IL 60108. 10-0

get with the Audio Pros
select from top quality brands

Franchised Dealers For: AR, BOSE, DAHLQUIST, AVID, ADS, NAKAMICHI, MMR, YAMAHA, ONKYO, OPTONICA, PHASE LINEAR, TANDBERG, DBX, WIN LABS, SONUS, MICRO ACOUSTICS, HARMON, KARDON, G.A.S., PULSE, VISONIK STAX, DENNON, HAFFLER, G.A.S., QVSONIC, SAE, ESS, CONNOISSEUR, OTHERS.

AUDIO CONCEPTS
(213) 445-3663
(800) 423-4170
1127 W. HUNTINGTON
ARCADIA, CA 91006

AUDIO • February 1980

FOR SALE

AUDIO DEN LTD.

Long Island's leading audio store has on demonstration

THE STATE OF THE ART
AUDIO RESEARCH ELECTRONICS
THE NEW SP6 TUBE PREAMP
THE NEW D79 TUBE AMPLIFIER
THE NEW SCHEIBER 4 CHANNEL DECODER
THE NEW ACOUSTAT MONITOR III'S
THE NAKAMICHI 680

CONRAD-JOHNSON ELECTRONICS
GRADO SIGNATURE CARTRIDGE
FULTON CARTRIDGE AND TRANSFORMER
LINN-SONDEK

(AUDIO CRAFT) ULTRA CRAFT UNI-PIVOT TONEARM
We also have the following lines, Connoisseur, Denon, Grace, Luxman, Magneplanar, Magneplan, Polk, Quad, Rogers, Sherwood, Sonus, Thorens, Yamaha, the largest selection of Audiophile Recordings on Long Island.

FREE "SET UP" IN NY AREA
UTILIZING IVIE SPECTRUM ANALYZER
COME IN WITH 2 RECORDS AND WE WILL DEMONSTRATE THE WORLDS FINEST RECORD CLEANING MACHINE BY KEITH MONKS.

AUDIO DEN LTD.
1320-34 Stony Brook Road
Stony Brook, New York 11790
516-751-3350

10-0

AUDIIONICS BT-2. ABSOLUTE MINT CONDITION. USED ONLY 5 MONTHS WITH WARRANTY \$260.00. EVENINGS (415) 657-3969.

AUDIIONICS CC-2 \$356, JBL L-300 \$950, FRIED B-2 \$380, T \$750, H-2 \$975, Q \$160. (203) 777-1476.

AUDIO PERFECTION MINNESOTA'S EXCLUSIVE MARK LEVINSON DEALER

Our other fine products include:

Bryston	G.A.S.	Pyramid
Cizek	Grace	Rega
Cotter	Janis	R.H. Labs
DCM	Linn Sondek	Snell Acoustics
Denon	Magneplanar	Spendor
Eumig	Marcof	Sumo
Fidelity Research	Micro Seiki	Threshold

We also have available Hafler products including the DH-200 in limited supply.

AUDIO PERFECTION
"The Real Audio Store"
8714 2nd Avenue South
Bloomington, Minnesota 55420
612-888-3224

FOR SALE

AUDIO REPORT

STAN WHITE Glasscone™ Speaker

AUDIO Magazine (Germany 2/78) reports on Stan White SHOTGLASS loudspeaker. "Er kling! so als ob ein im Halbdunkel spielendes Orchester poltlich von starken SCHEINWERFERN beleuchtet wurde, so dass jeder Mann mit seinen Instrument poltlich sichtbar wird." For further information write TACHYON, P.O. Box 204, Bloomington, Ill. 60109 Sole U.S.A. distributor. 312-529-9468.

AUDIO HOUSE—FLINT MICHIGAN

Acoustat	Theta	Audionics
Rogers	Linn Sondek	D.B. Systems
M & K S1 + Volkwoofer		Conrad - Johnson
Audio Control	Mordaunt - Short	Symmetry
JAMO	Keith Monks Record Sleeves 100 for \$25	

FREE Shipping 4304 Brayan Dr., Swartz Creek, Michigan 48473 313-655-8639 by appointment.



The gooseneck lamp you've been looking for! Great for turntables . . . pre-amps . . . keyboards . . . amps . . . music stands . . . lecterns . . . anywhere you need a little light.

Littlite-1: Detachable 12" lamp, bulb, base with dimmer, wall-plug-in power supply, storage clips and mounting hardware. \$44.95

Littlite-2: Same as Littlite-1, but with fixed lamp and high-low switch. \$34.95

Add \$1 per order, shipping

30 day money back guarantee.

Send check or money order to:
Custom Audio Electronics
Dept A1279 2828 Stommel Road
Ypsilanti, Michigan 48197

Send for our FREE catalog!

97

SPECTRUM ANALYSIS SYSTEM

The ASA-10 is a true professional quality analyzer that offers:

- A 10-Octave Spectrum Analyzer covering the full audio range
- Built-in flat response microphone
- Adjustable dynamic range display up to 35dB
- Selectable detector response times for either pink noise or signal monitoring
- A Hold Mode for easier analysis



Analyzer ASA-10 \$199.95
Pink/White Noise Generator . . . 49.95
DEALER INQUIRY INVITED

P.O. Box 115 · West Redding, CT 06896
203-938-2588

GOLD LINE

FOR SALE

AUDIONICS - NEW PRODUCTS

We have in stock the NEW RS-1 preamp, CC-2, the IMPROVED BT-2 and the INCREDIBLE BERNING BA-150. We hope to have the NEW LK-1 turntable in the spring. Free shipping in USA. World-wide shipping. Visa & M.C. honored. By appt. OXFORD AUDIO CONSULTANTS, Box 145, Oxford, OH 45056, 513-523-3895.

AUDIOPHILES! Direct-Disc, Digital, Mobil Fidelity-All labels-Low Prices Fast Service. Write for free catalog. Direct Discounters, 2245 New Hope Church Rd., Raleigh, NC 27604. 9-9

"A-1 SOLUTION TO MC CART./PREAMP INTERFACE consider the MGT-1, a passive device with twin transformers in mu-meatal containers. bandwidth, 0, -1db 10 to 20KH 25, to 22.5 volts out. \$299 Amer. \$340 Can. RWR Audio Ltd., Box 3080, Station D, Ottawa, Canada K1P 6H6 Or send for literature.

FOR SALE

Audio Research D-100a, D-100, SP-4a; Magneplanar T-1D, Bryston 3B, Dynavector DV-505 Van Alstine Model 1, Rappaport Pre 1, Grace 707, Rogers LS3/5A, Advent 300. 812-232-2927.

Audio Research SP6A, \$900.00. Audio Research D-100A, \$850.00 Magnepan Tympani IC. Loudspeakers, \$900.00. Equipment in mint condition. Harry H. Lawson, 3801 Hogue Rd., Evansville, IN 47712 (812) 422-5851.

BACK ISSUES OF AUDIO. MULTIPLES OF EA. MO. 70-79 USED BUT IN GOOD COND. \$2.25/ea. M. Simpson, 1300 W. 51st St., Austin, TX 78756.

Bass Mint

The state of the art sub-woofer, is now available at the only factory outlet in the world - Q/LC Audio. 1006 Berkshire Rd., Dayton, Ohio 45419 or call (513) 298-9330 or (513) 293-7287.

FOR SALE

BIG, SAFE, TWISTED #12 GAUGE SPEAKER WIRE 40¢ per FT. COD O.K. Free Shipping 100 Ft. or more. Keith Monks Record Sleeves 100 for \$20. Samples \$1.00. Audio House, 4304 Brayan Dr., Swartz Creek, Mich. 48473 313-655-8639. TF

B & O USES "ANY" CARTRIDGE with standard mounting centers after our modification kit or at factory. Effective mass 2.5 grams. Adjustable silicone damping. \$199.00 with money back guarantee. JML Company, 39,000 Highway 128, Cloverdale, CA 95425. TF

BRITISH AMERICAN SOUND — SOUTH CAROLINA'S only high-end store: Threshold, Rappaport, Qysonic, Snell, Symdex, Acoustat, Linn-Sondek, GAS, KA, Spondor, B&W, Rega, Precedent, Audio, Sonus, Hafler, Grace, Supex, JR, and others. Special prices on components used for demonstration and on selected new equipment; e.g. NEW Mitch Cotter transformer + Sleeping Beauty Shibata \$550. P.O. Box 1247; Charleston, SC 29402 (803) 723-6025.

BRITISH AND EUROPEAN EQUIPMENT DIRECT TO YOU. Most quality makes of equipment available at advantageous prices. For price list and price quotes send international Reply Coupon. Audio T, Dept. B, 190 West End Lane, London NW6 1SQ, England. Phone 01-794-7848. Visitors welcome. 4-0

CAMPUS REPS FOR ESOTERIC EQUIPMENT

We need campus reps immediately to sell esoteric as well as a vast selection of major brands. We have an unusually high selection of high end equipment, excellent prices, and unique advertising program.

AUDIO SYSTEMS II
200 WEST 57th STREET, Suite 1004
New York, N.Y. 10019

9-0

CHARLOTTE, NC

Audio Salon demonstrates selected audio products by appointment only 3-9 pm daily.

Fried		Hafler
PS Audio		Thorens
SME	(704) 377-6590	Grace
Decca		Supex

AUDIO SALON 2227 Greenway Avenue 28204
Prompt quotes & pre-paid shipping US & Canada 9-0

COMMONWEALTH LOUDSPEAKERS

Fine quality loudspeakers also drive units, walnut veneer cabinets, air core inductors, mylar capacitors, crossover networks. Choose from famous manufacturers like: Decca, Coles, Dalesford, Richard Allan, Jordan, Schackman, Radford, and more. Send \$3.00 for design, reprints, plans and catalog (refundable with first purchase.): COMMONWEALTH ELECTRONICS, 300 N. Allen, Pasadena, CA 91106, (213) 793-5184. 11-0

CONNECTICUT: A.D.S., Advent, A.P.T. Holman Audio Pulse, B&O, B.I.C., Carver, Citation, Dahlquist, D.C.M. Time Windows Epicure, Hafler Harman/Kardon, J.B.L., Mitsubishi, Nakamichi, Ortofon, Phase Linear, Micro-Acoustics, N.A.D., Stax, Tandberg, Yamaha, Cizek, Sonus. Will ship prepaid. Sounds Incredible, 39 Federal Road, Brookfield, CT. 06804. (203) 775-1122—phone quotes only. TF

SPATIAL



Exclusive patented circuitry optimizes stereo image.

For information write: RG Dynamics
4448 W. Howard St., Skokie, IL 60076

THE RG PRO-16B DYNAMIC PROCESSOR

98

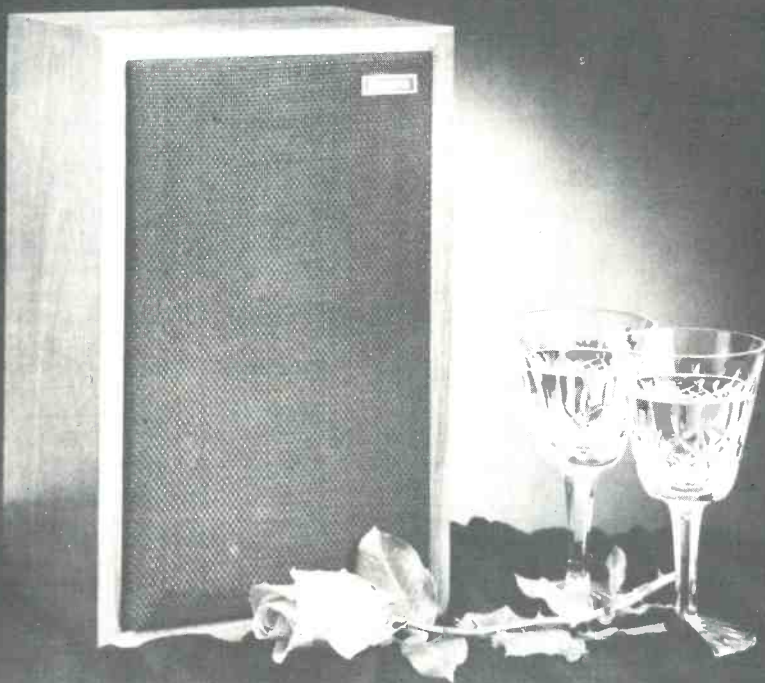

Rogers

BRITISH HIGH-FIDELITY

Reference Monitor Int. Inc., 2380 "C" Camino Vida Roble, Carlsbad, CA 92008

*The most accurate
mini monitor in the world.*

**WE WILL
NOT BE BEAT!**

1. Super Selection
2. Strong Guarantee
3. Fast Delivery
4. Full Warranty

CALL 203-932-4265

\$1 Rebate for all orders over \$50

MAC VISA COD

★ **AUDIO PEOPLE** ★

998 Orange Ave., West Haven, CT 06516

FOR SALE

CONNOISSEUR BD1 TURNTABLE Belt Drive, 37 logged hours. w/mtg hole for Grace 707. \$75 408-279-1425, 259-9648.

CONRAD JOHNSON

CJ tube amps & pre-amps now at AUDIO SALON, 2227 Greenway Ave., Charlotte NC 28204 (704) 377-6590. Shipped Pre-paid.

Crown Deck CX824 New, \$1800.00; Crown OC150 New, \$250.00. Audio Electronics, 9518 Nall, Overland Park, KS 66207 913-381-8585.

Crown SX-724, Marantz 71, Thorens TD-125 + Much more. Box 713, Des Moines, IA 50303 515-284-1723.

CROWN — SX724 Reel to Reel, Excellent Condition. Walnut cabinet, tape counter, tapes. (313) 474-7517.

CROWN SX-724 TAPE DECK —excellent. \$1200. Van Alstine Model 2 Amp —excellent. \$900. 304-422-1091.

Dave White and Walt Jung have started

a modification business in response to requests to modify PAT 5's as outlined in their latest "Audio Amateur" article. Initially they plan to specialize on PAT 5's although other preamp and amplifier mods will be available shortly. For further details send SASE to: D. White at 43 Royal Crest Dr., Nashua, NH 03060.

DAVID HAFLER IS BACK!

The man behind the original Dynakit is back with his own company and a new state-of-the-art preamplifier at a bargain price! Available as a KIT or CUSTOM ASSEMBLED by expertly trained wireers — each performance certified. For further details write or call AUDIOKIT—260 Old Country Road, Hicksville, N.Y. 11801 (516) 822-5749

DAVID HAFLER PREAMP

Now available at Audio Ltd.

115 N. Walnut, Champaign, IL 61820 (217) 359-3774

4-9

DAYTON-WRIGHT XG-8 Mk III SPEAKERS \$2200 PR. CROWN M-600 MONO AMP \$1300. THRESHOLD 400A AMP \$700. RTR-ESRIS TWEETER \$400 PR. 215-322-6350.

DESIGN ACOUSTICS DEMONSTRATED

NEW YORK AND NEW JERSEY

All Models in Stock

Phone your "MUSIC MAN" for demo appointment

212-463-1208 OR 516-621-2126

Custom Audio Systems Designed and Installed

DIAMOND NEEDLES and Stereo Cartridges at Discount prices for Shure, Pickering, Stanton, Empire, Grado, Audio Technica and ADC. Send for free catalog. LYLE CARTRIDGES, Dept. A, Box 69, Kensington Station, Brooklyn New York 11218. For fast service call toll free 800-221-0906. TF

DISCO: MOBILE OR FIXED—CASH START

your own disco business. Complete start-up manual explaining sound and lighting systems installation, written by professional disco DJs and designers, \$5. J.C. Enterprises, Dept. A1, P.O. Box 234, Apalachin, NY 13732.

L.A. — SOUTHERN CALIFORNIA

We carry the smallest selection of only the best values and the best equipment. We demonstrate by appointment to insure a meaningful demonstration.

Linn Sondek turntable, Linn Asak cartridge, Spatial Coherence TFEF Valve preamp, Rogers BBC LS3/5A speaker, PSE Studio One preamp & Studio Two power amp, Stax headphones, Musical Fidelity preamp, Denon tables, arms, cartridges, Meridian amp, preamp, tuner, Decca Ribbon Tweeters, Koss Electrostatic speakers, Satterberg Subwoofers, SAEC metal record pad & cables, Chartwell polypropylene speakers, LiveWire & Live Wire Litz, Peterson Audio Link cables, Hafler amp & Preamp, Osawa record pad.

EXECUTIVE AUDIO

BY APPOINTMENT ONLY (213) 395-6400
2210 Wilshire Blvd. suite #207 Santa Monica, CA 90403

FOR SALE

Dayton-Wright XG8s (latest) \$2000; 317-463-4457.

DUAL MONO TUBE PREAMPLIFIER. From the designer of the Precision Fidelity and Paragon preamps comes the latest in tube technology. For more information on this amazing product write to: Audio Illusions, P.O. Box 8707, San Jose, CA 95155.

DUAL MONO TUBE PREAMPLIFIER This new design provides for that all important long term listenability without the slightest sacrifice in inner detail, dynamic range or frequency response. This is all accomplished by a unique circuit that is actually two completely separate preamps on one chassis, with their own separate power supplies. The sound is the very best that tubes have to offer. Musical, extremely detailed, airy and three dimensional, is what people are saying about this preamp. Designed by the circuit designer of the Precision Fidelity and Paragon preamps, the Dual Mono is the ultimate tube preamp. For more information write to: Audible Illusions, 340G De La Cruz Blvd., Santa Clara, CA 95050. Dealer inquiries invited.

FOR SALE

DV505 \$285, SP3A \$450. Want 8B, 7C. (616) 683-6860.

DYNACO/DYNAKIT: SCA-800/K, \$97; PAT 5/A, \$177; ST-80/K, \$67; PAT 4/K, \$64. POSTPAID (U.S. only). Certified check/mo, SCC, Box 8014, Canton, Ohio 44711. TF

DYNACO FM-5 FANS: PLL Stereo Demodulator is assembled and tested, features the LM1800AN (THD-0.1%, Separation-45DB) for greatly improved sound quality and mounts directly to rear chassis panel. Models also for the FM-3, FM-1 and LT-110. Send for free info. VSM Audio, P.O. Box 114, Maspeth, NY 11378. 11-9

ELECTROSTATIC TRANSLATORS ARE HERE

Come and audition this fine new line of electrostatic loudspeakers along with: Audire, Audio Technology, Celestine, Clarke, Decca, Grado, Braun Satellites and subwoofer Chartwell, ADCOM, Burhoe, Toshiba, Car F1, Monster Cable

PERSONALIZED AUDIO

723 Bound Brook Rd., Dunellen, NJ 08812

Appointments available call 201-752-3883

ADDICTIVE

"Removing it from the signal path makes just about every program sound squashed and flat!"
Len Feldman

For information write: RG Dynamics
4448 W. Howard St. Skokie, IL 60076

THE RG PRO-16W DYNAMIC PROCESSOR

99

NOTHING FANCY

No MOSFETS, VFETS, RETS, Class D, G or whatever. The Model NC-1 Power Amplifier uses proven technology to achieve high performance optimised for long term reliability and stability into difficult loads. No meaningless specifications.

- Semiconductors are all hermetic.
- No nonsense, logical design approach.
- Highest quality parts and workmanship.
- Power output at low impedance is power supply limited.
- Over 1800 square inches of heat sink.

Write for complete data sheet on the NC-1 and the NC-2 preamp. Available for a limited time direct from the manufacturer. Dealer enquiries welcomed.

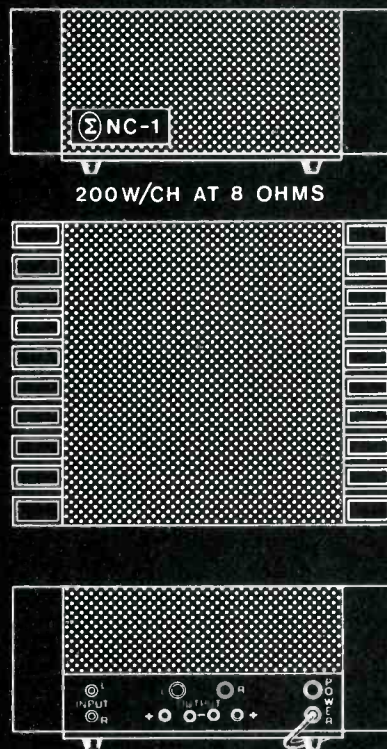

SIGMA Σ NULL CORP.

POST OFFICE BOX 489,
POSTAL STATION A,
TORONTO ONTARIO,
CANADA M5W 1E4

H&H INTERNATIONAL NEWSLETTER

New Products from H&H

JR 150 LOUDSPEAKERS

The long awaited JR 150 loudspeaker is now available and is receiving an excellent response both here and abroad. It will play approximately twice as loud as the JR 149 or the LS 3/5A and is much more efficient. The workmanship and design are impeccable. The speakers will retail for \$825.00 per pair. Attractive chrome or black stands are available.

DUNLOP SYSTEMDEK 2 SPEED TRANSCRIPTION TURNTABLE

The SYSTEMDEK is designed with advanced acoustic and engineering innovations that make it, quite simply, one of the best platforms for disc reproduction yet devised.

The plinth incorporates six highly damped acoustic barriers, which are specially designed to eliminate the effects of vibration and acoustic interference.

The turntable is finished in an attractive black and aluminum "Pagoda" styling.

A unique bush bearing that pumps oil and eliminates metal contact, thus eliminating friction and rumble, is part of the DUNLOP design philosophy. The precision 10mm stainless steel spindle is recessed to accept an 8mm ball thrust bearing which is seated in a self lubricating PTFE cup. The 10½ lb. (4.7 Kg) aluminum platter is individually balanced and is belt driven from 24 pole synchronous motor.

Another unique feature is that all adjustments can be made from above.

Mr. Peter Dunlop designed the original Ariston turntable. He has spent considerable time developing the SYSTEMDEK and feels, as do we, that it easily competes with or surpasses the older Fons, Linn, or STD designs.

Tables will be available momentarily and will sell for approximately \$650.00.

BAS, BEARD SOUND AMPLIFIERS

The BAS tube amplifiers and preamplifiers have quickly become the standard of reference in England and Europe. The amplifier features a dual power supply and a floating bias (no adjustments ever needed). All metal work is executed by computerized machinery and the design, parts and workmanship is of such extraordinary quality that no amplifier has ever failed.

PROFILE ACOUSTICS

The Profile loudspeaker is of large bookshelf configuration, and uses three very special drivers. The materials employed in the cabinet construction are unique. The workmanship is the finest we have ever seen. Needless to say, we feel that the sonic quality is most pleasing along with a superb bass response. The Profile loudspeaker will retail for over \$1000.00 a pair.

Please contact me for further information. Dealer inquiries welcome.

Best regards,

Paul Heath

H&H INTERNATIONAL
3047 W. HENRIETTA RD.
ROCHESTER, NEW YORK 14623
(716) 424-4827

FOR SALE

ELECTRONIC CROSSOVERS — ALL TYPES Updated definitive booklet describes applications, how to improve speaker systems: \$5.00 postpaid, credited to first purchase. Huntington Electronics, Box 2009-A Huntington, Conn. 06484.

ELECTRO-VOICE INTERFACE and SENTRY SPEAKER SYSTEMS, RAW SPEAKERS, AND PRO-MUSIC PRODUCTS. IMPRESSIVE DISCOUNTS. PROMPT DELIVERY TO ALL U S A AND FOREIGN DESTINATIONS. (305) 462-1976.

FINALLY AVAILABLE AGAIN IN U.S.A. MAYWARE, LTD.

Formula 4 Tonearm (Original)	\$149.50
MC-2C Moving Coil Cartridge	149.50
T-24 Transformer	224.50

EXCLUSIVE U.S.A. DISTRIBUTOR:

F&R AUDIO IMPORTS, INC.

P.O. Box 212

Somerset, New Jersey 08873

201-828-8075

Dealer Inquiries Invited....

For Sale one pair Infinity Monitor's QLSI Tower Speakers. Excellent Condition, Rarely Used, \$1800 pair or offer (1-414-367-1079).

FRIED SPEAKER KITS

Fried speakers are exceptional. We offer the ABSOLUTE lowest price on Fried speaker kits. Selection includes: (1) raw speakers, crossovers, hardware and assembled enclosures, (2) assembled enclosure ready for speaker & crossover attachment, and (3) custom built, finished complete speakers ready to connect to your amp. We have ready for delivery models BII, C, D, O, and the Super Monitor. All enclosures are made from solid wood in Oak, Birch, or Walnut. Shipping is free on several models. AUDIO SALON, 2227 Greenway Ave., Charlotte, NC 28204 (704) 377-6590.

FRIED SUPER MONITOR KITS, including pre-cut enclosures and veneers, plus the entire line of Fried speakers, shipped anywhere in the U.S. SOUND COUNSEL, 401 N. Fairfax Street, Alexandria, VA 22314 (703) 683-6433. MC/VISA Welcome.

FULTON PREMIERE speakers, 5 years of back issues - Absolute Sound, Stereophile, BAS speaker, and Audio. All mint. Best offer. (617) 593-5937.

GET ACQUAINTED WITH TRANSCENDENTAL AUDIO'S line of exciting advanced raw speakers, many used in systems by Tangent, Plasmatronics, Symdex, DAC etc., Bextrene cone models in 5" to 10" most w/magnet, voice coil layer & lgth. options. Very neutral SD tweeters plus a fascinating new driver w/1.3 gms moving mass that "traces" signal detail like the best electrostatic headphones, will definitely spoil you. Design & application assistance from our lab available to help you realize the dream system you are planning from mini monitors, satellites, car systems to sub woofers, X' over designs & parts including Mylar caps up to 10uf. Your inquiries & orders receive our prompt attention, send \$1.00 for literature. Transcendental Audio, 6550 Indiana Street, Golden, CO 80401. Innovative components & designs in high-end audio. Polydax (Audax), Decca, E.J. Jordan, Dalesford. 303/420/7356.

Now in Fort Lauderdale...

State of the art components for the audio perfectionist and serious listener.

Audio Research • Acoustat • Denon • B & W • Armstrong • Chartwell • Lux
Tangent • Polk • GAS • Conrad Johnson • Audire • Ariston • Connoisseur
ADC • Grace • Supex • Grado • Goldring • DB Systems • Quatre • Stax
Theta • Plasmatronics • Transcriptors • Dynavector • Vandersteen
Complete selection of direct to disc recordings.

AUDIO INSIGHT

The Promenade at Bay Colony

6286 N. Federal Hwy., Ft. Lauderdale, FL 33308 • 305/491-7677

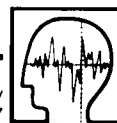

FOR SALE

GET INTO BROADCASTING! Learn how to receive free records, tapes, get an FCC broadcast license, start your own station. Free details. "Broadcasting", Box 130-N5, Paradise, CA 95969.

GOLD PLATED phono jacks \$1.00, plugs 85¢ ea., \$1.00 handling. Reference Audio, Box 368, Rindge, NH 03461. 2-0

GRACE & SME

Tone arms at a reasonable price. Also available: Thorens & Systemdek turntables. AUDIO SALON, 2227 Greenway Ave., Charlotte, NC 28204. (704) 377-6590 Shipped Prepaid.

GRAPHIC EQUALIZER KIT—ONLY \$100 PPD.

Twelve bands/channel, 100dB S/N. Free info or send \$2.50 for instruction manual with Len Feldman's review and copy of May 1978 Radio-Electronics cover story. (Refundable with purchase.) Symmetric Sound Systems, Dept. A, 912 Knobcone Place, Loveland, CO 80537. 4-0

GREAT GRACE & SUPER SUPEX

We have in stock the Grace 707MKII, 704, F-8L, F-9L, Linn Mods for the 707MKII, the Supex SD-900E+ Improved & SD-900MKII. Free shipping. Visa & M.C. honored. By appt. OXFORD AUDIO CONSULTANTS, Box 145, Oxford, OH 45056, 513-523-3895.

GUITARS - mint condition - 1 ea. - Cortez LP22BG, Epiphone FT-165 (12 string). \$150 ea/both \$250. 609-429-6472.

HAFLER: AMP AND PREAMP

Audio Ltd 115 N. Walnut Champaign Il 61820 217-359-3774. 11-0

HAFLER DH-101 PREAMP

We expect to be in stock on this exciting new preamp by Dec. 12th. Kit price is \$199.95. Custom wired and tested, \$299.95. Immediate prepaid shipment via UPS. THE AUDIBLE DIFFERENCE, 435 Tasso, Palo Alto, California 94301. (415) 328-1081. TF

HAFLER HEADQUARTERS IN CANTON, OHIO - The Listening Room, 1807 Cleveland Ave. NW. (216) 452-6332. TF

HAFLER IN THE SOUTH!

In stock, the superb Hafler DH-101 preamp. Kit \$199, factory assembled \$299. New:DH-200 amp. Immediate free shipping. Also Fried, Audionics, Vandersteen, NAD, Advent, Klipsch, more. READ BROS. STEREO, 593 King St., Charleston, S.C. 29403 (803) 723-7276. 7-9

HAFLER PREAMP CABINETS. Literature. GEOMETRIX, Box 612, Mexico, MO 65265 7-9

HAFLER PREAMP, HEAD AMP, AMP & ACCESSORIES

We have in stock the DH-101K \$199.95, DH-101A \$299.95, DH-102 head amp \$74.95, DH-101A/DH-102 \$399.95, DH-103 black knobs \$19.95, DH-104 rack mount \$24.95, DH-105 preamp cabinet \$24.95, DH-106 mod kit for 101 \$19.95, DH-200K \$299.95, DH-200A \$399.95, DH-201 rack panel \$24.95, DH-202 bridging kit \$24.95. Worldwide shipping. Free shipping in USA. Visa & M.C. honored. By appt. OXFORD AUDIO CONSULTANTS, Box 145, Oxford, OH 45056, 513-523-3895.

FOR SALE

HAFLER DH 200 AMPLIFIER

Write or call for quote. AUDIO SALON, 2227 Greenway Ave., Charlotte, NC 28204 (704) 377-6590. Shipped pre-paid.

HAVE AN AFFAIR

Listen to the PRECISION FIDELITY C7 tube preamplifier with innovative cascade circuitry. The real David against all the Goliaths. Let your ears as well as your pocketbook relax. State of the art affair at \$499.

PRECISION FIDELITY, 1169 E. CHESS DR.,
FOSTER CITY, CA, 94404

6-0

HAVING TROUBLE FINDING DIRECT-TO-DISC AND SOTA RECORDINGS? WE HAVE THEM ALL. SEND FOR FREE CATALOGUE. KNOT SO CHEAP RECORDS, 705 BIG BEND, DEPT. AM12, WEBSTER GROVES, MO 63119.

HEATHKIT TV CABINET, GRA-602-25 for GR-2000 or 2001 TV's. \$150. NO SCRATCHES. 408-279-1425 day, 408-259-9648, evs.

HI-FI ENTHUSIASTS WANTED!!! Earn more than just spare money in your spare time. We need campus representatives to sell name brand stereo components at discount prices in your area. No investment required. Serious inquiries only please. Contact: Mail Order Dept., K&L Sound Services Co., 75 N. Beacon St., Watertown, Mass. 02172 TF

HIGH-END AUDIO AT LOW LOW PRICES! Aiwa, Allison, Audio Pulse, Bose, DBX, Cizek, ESS, Luxman, Micro Seiki, SAE, Technics Pro and many more! All factory fresh with full warranty. For discount price call 212-254-3125. Or send \$2.00 for our catalogue and price list to DIRECT DISCOUNTS LTD, P. O. Box 841, Cooper Station, NY 10003.

HIGH END MINT EQUIPMENT. Levinson ML-1 (latest) with full selection of Lemo cables inc. special 30ft. pre to amp/xover and Verion-Lemo phono cable \$1600; Van Alstine double 400 with ¼ farad power supply (2 Dyna C-100) \$1150; Grace 707 MkII \$150; Technics EPA 100 (new) Universal Tone Arm with cont. var. VTA during play \$400; Technics Obsidian base for SP-10, inc. plate for EPA 100 \$200; Quantum Electronics DM IV mono tube amps with new tubes & lab checked \$1000/pr. DB 100Hz xover \$150; Burwen DNF 1201 \$150; Soundcraftsman 2212 \$150; evenings after 7:00 and weekends (617) 927-5464.

HIGH PERFORMANCE SPEAKER KITS AND DRIVERS, TRANSMISSION LINE
enclosures with Audax and Dalesford bextrenes, Decca Ribbons, and Jordan Modules. Finest transients, high definition, min. coloration at lowest prices. Design assistance and prompt service. Brochure \$1.00. Lazer Audio, 45383 Industrial Pl., Fremont, CA 94538.

High Performance Loudspeakers. LS3/5A and other equivalents. Dealers only. Box 18009, Seattle, WA 98118 (206) 323-4987.

FOR SALE

Highest Quality Used Equipment: B&W 70x's spkrs, \$400. ea; Yamaha B1 amp \$1000 Yamaha C1 preamp, \$1000; Crown SX 824 deck, \$1000; McIntosh ML2C spkrs, \$450 ea.; McIntosh ML1C spkrs, \$250 ea.; McIntosh XR5 spkrs, \$300 ea.; McIntosh C2B, \$400; Luxman T110 tnr, \$285; Luxman L100 amp, \$425; Luxman M4000 amp, \$950; Braun TG 1000 deck, \$500; Tandberg 10XD deck \$1000; Luxman 5C50 preamp, \$500; Audio Research D52B amp, \$925; Audio Research SP3 preamp, \$360; Yamaha CR 3020, \$1000; Nakamichi 730 rcvr, \$900; Tandberg 7075 revr, \$700; IMF TLS 50II, spkrs, \$900 pr.; Marantz 3600 preamp, \$270; SAE, mk 1M preamp, \$285; Bryston 4B, \$1000. All used equipment guaranteed 90 days parts and labor. Audio Consultants, 1014 Davis Street, Evanston, IL 60201, (312) 864-9565.

H/K CITATION 11/CABINET \$250. 215-459-5146.

How is it that the inefficient, noisy, distortion prone, archaic vacuum tube can retain any acceptance among serious audiophiles? Why do manufacturers, large & small still expend enormous creative energy in designing and making tube equipment? Who cares? We do . . . MR. AUDIO'S BIMONTHLY expounds the gospel of tube equipment but not at the exclusion of all else. We concede to permit solid state MC head amps, xovers, bass amps & the like in a music system. The tenacity with which tubes cling in spite of advanced solid state technology is a mystery to some — but not to us. MR. AUDIO'S BIMONTHLY — 6 issues 1st class \$15. Overseas \$18 — P.O. Box 3022, Monterey, Ca. 93940.

Incredible savings on famous manufacturers' video tape! Beta 30/60 \$7.95, 60/120 \$9.95; VHS 60/120 \$11.25; 120/240 \$15.25. Belmont Trading Co., 12 Flanders Rd., Belmont, MA 02178 (617) 489-3730.

INFINITY SERVO-1 \$850. Audio Research D-51 with fan base \$425. (804) 595-4509, 5:00-9:00 PM EST only. 12-9

INVISIBLE HANGERS FOR ADS, Braun, Visonik/David speakers. Pair \$12.00, \$1.00 postage. Plexiforms, 1016½ Gilbert Court, Iowa City, IA. 52240

IVIE ELECTRONICS REAL TIME ANALYZERS, etc. Some very slightly used demonstrators at discount. Full factory warranty. Money-back guarantee. JML Company, 39,000 Highway 128, Cloverdale, CA 95425.

JANIS WOOFERS

are the best universal subwoofers available. Hear them together with the Janis Interphase crossover amp at OXFORD AUDIO CONSULTANTS, Box 145, Oxford, OH 45056, 513-523-3895. Free shipping in U.S. Worldwide shipping available.

JBL DELPHI EQUIP. CAB. OILED WALNUT, MINT, \$250. LX-5 X-OVERS \$100 PR. 1-DRK MAHOGANY HARTSFIELD CAB. ONLY \$500. PR WALNUT NEW HARTSFIELD CAB OR INCL COMPONENTS. ALL F.O.B. BRIGHTON MI. 1-313-229-7378



KEF KITS



Now you can "build the best in confidence," as two of KEF's best-selling speaker systems—the Model 104aB and Cantata—are now available in kit form, enabling you to easily assemble a high quality speaker system at a considerable savings. And, because they are kit versions of two of our best-selling speaker systems, you can actually audition the units at your KEF dealer *before* buying and assembling.

KEF speaker systems are designed and built using a Total System Design Concept, whereby each part is developed to complement all others in the system so as to achieve the targeted performance.

The KEF Cantata kit consists of a bass unit, midrange unit, tweeter and an Acoustic Butterworth filter, and builds into an acoustic suspension loudspeaker system with a power handling capability of 100 watts.

The KEF Model 104aB kit consists of a bass-midrange unit, tweeter, Acoustic Butterworth filter section, plus an acoustic bass radiator to increase the bass response from such a modest-sized enclosure. The kit makes up into a bass reflex system with a power handling capability of 150 watts.

Both the kits include fuse units to protect the drive units, and contour controls to adjust the final acoustic output to suit the listening room.

Loudspeaker kit building has now been raised to a new level of ease and reproduction quality.

For more details and the name of your nearest KEF dealer where you can hear just how good our KEFKITS are *before* your purchase, write to us at the address below. Individual drive units and crossover networks are also available for your special custom requirements.

KEF Electronics, Ltd., c/o Intratec Department A, P.O. Box 17414, Dulles International Airport, Washington, DC 20041.

In Canada: Smyth Sound Equipment Ltd., Quebec.



AT SOUND COMPONENTS, INC. WE'VE GOT IT ALL

Audionics Bang & Olufsen Beveridge Cylindrical Bryston
. . . DCM . . . Denon . . . Dynavector . . . Fidelity Research . . . Fulton . . .
Grace . . . Great American Sound . . . Hafler . . . H.Q.D. Reference System
. . . Janis . . . KEF . . . Kenwood Purist . . . Linn Sondek . . . Magnepan . . .
Mark Levinson . . . Paragon . . . Pyramid Metronome . . . Quad . . . Rega
. . . Rogers . . . Sonex . . . Spendor . . . Stax . . . Verion . . . Yamaha . . .

Master Charge & Visa accepted

We ship prepaid within U.S.

SOUND COMPONENTS, INC.
2710 Ponce de Leon Blvd., Coral Gables, Fla. 33134
(305) 446-1659

FOR SALE

JBL L65 JUBALS MUST SELL MINT 215-459-5146.

JBL PARAGON STEREO SPEAKER SYSTEM, oiled walnut, new, perfect: \$3900.00. Call 203-929-5255 or write Box 2009 Huntington, CT 06484.

KIT BUILDERS SPECIAL

Hafner pre-amp & amp/Fried's BII speakers. All in kit form. Specially priced package. AUDIO SALON, 2227 Greenway Ave., Charlotte, NC (704) 377-6590. Shipped Pre-paid.

Klipsch Horn, 15 in. Driver, Send for details. O.D. Sledge, 2505 Campden Dr., Austin, TX 78745.

KOSS ONE A's, mint, \$1595 or best offer. (918) 299-1376.

KOSS 1-A's, sealed, save \$500, \$2950. (213) 925-2368.

New Ears in Old York

Adcom • Allison • Audio Pro
Berning • Bryston • Connoisseur
Conrad-Johnson • Dennesen • Grace
Keith Monks • Kenwood Purist
Linn-Asak • Linn-Isobarik
Linn-Sondek • Mitchell A. Cotter
NAD • Naim • Precedent
Professional Systems Engineering
Pyramid • Shahinian Obelisk • Signet
Snell • Supex • Syndex • Thiel • V.P.I.

A new approach to presenting
fine high fidelity components
and recordings.

ears nova

749 middle neck road / great neck. ny 11024
(516) 466-5674

FOR SALE

LAUGH AND THINK. The Hi-Fi Game: A board game of fun and thought. \$11.95 from Penijon Games, Box 2129, Martinez, CA 94553. Dealer inquiries welcome, too.

LINN SONDEK — NAIM — LINN MODIFICATIONS

We offer the remarkable Linn Sondek LP12, the superb Naim head amp, the detailed Linn Asak MC cartridge, the giant killing Naim NAC42/NAP110 preamp/amp, 45 rpm adapter, friction hinged dust cover & Linn mods for the Grace 707MKII. By appt. Free shipping in the USA. OXFORD AUDIO CONSULTANTS, Box 145, Oxford, OH 45056, 513-523-3895.

LOWEST DISCOUNT PRICES ANYWHERE on audio equipment. All major brands discounted. Write for quotes, K&L Sound Services, 75 N. Beacon St., Watertown, Mass. 02172. TF

LOWEST PRICES ON STEREO-ESOTERIC COMPONENTS & Tapes. Over 150 brands. Send # 10 SASE for quotes. Audio Unlimited, 401 Reynolds Circle, San Jose, CA 95112 (408) 289-8875 1-6 Monday thru Thursday.

"**LOWEST PRICES:** BOSE, SAE, DBX, HAFNER, GRADO, ADVENT, TANDBERG, AND MORE. DYNAMIC SOUND, BOX 168, STARKVILLE, MS 39759. (601) 323-0750." 1p.m.-9p.m. 4-0

MARANTZ MOD. 20 stereo tuner, made in Woodside N.Y., built-in scope, wood cabinet, exc. shape \$395 or best offer, Bill Mager, P.O. Box 97, Grand Rapids, MN 55744.

MARANTZ 33 PREAMPS (2) \$195. ea. **MARANTZ 16B** Amp 100 W/Channel \$225. **Marantz 250 Amp** \$325. Garrard Music Recovery Module, New \$90. All items perfect condition. Ctns. Pvt. 609 455-6627.

MARANTZ 7C, 9, McIntosh C22, MC275, MC240. J. Fong, 1238 Green St., San Fran., CA 94109. (415) 885-0596. 7-0

MARK LEVINSON ML-2 CLASS A AMPLIFIERS IN MINT CONDITION. GARLAND AUDIO (408) 244-6724. 2-0

McIntosh MA-6100 w/cab. \$400. Luxman 350 \$175, Teac AN-180 \$150. Unbuilt Dyna Pas-3 in box \$70, Revox B790 w/AGK P8-ES (demo) \$700, Harmon Kardon 16-As's (new) \$450, db pre-amp \$60, GAS Sleeping Beauty, new stylus \$60. Sound & Music, 90-92 King St., Northampton, MA 01060 (413) 584-9547.

FOR SALE

McINTOSH EQUIP. BOUGHT-SOLD-TRADED eves. + wkends: 607-865-5387 SDR, Box 387, Walton, NY 13856.

METAL FILM RESISTORS, RN55, 0.35 watt, 107 values from 10 ohms to 1 Meg., 25¢ ea., 10 per value/\$1.80, 50 per value/\$7.50. Send stamped self addressed envelope for list of values and order form. New gold plated brass rear mount phono jack, \$1.50 ea. Gold plated shielded RCA type phono plugs, \$1.75 ea. Minimum order \$10.00, quantity discounts available. Component Systems, 5556 Personality Ct., Indianapolis, Indiana 46227.

METRO-NEW YORK CITY

G.A.S., FR. Dahlquist, B&O, Lux. Linn Sondek, AVID, Janis, Baure & Wilkens, Grace, Tangent, R.H. Labs, Direct Discs, Grado, many others. All issues of Absolute Sound.

UNIVERSITY STEREO-Ridgewood, N.J.,

57 E. Ridgewood Ave.(201) 447-5700

20 minutes from G.W. Bridge

12-9

MILWAUKEE! — The Audio Emporium: Audio Perfection Cables, Audiopulse, Audio Research, B&O, Connoisseur, Dahlquist, Denon, Genesis, Grace, Grado, GAS, Hafner, Linn, Lux, Magnepan, Marcof, New Acoustic Dimension, Polk Audio, RH Labs, Revox, Rogers, Snell Acoustics, Sonus, Sumo, Technics and Threshold. Over 100 direct discs and the Keith Monks record cleaning machine. 6900 W. Brown Deer Rd. Open Tues. Wed. Fri. Sat. 10-6, Thurs. 10-8. Closed Sun.& Mon. (414) 354-5082.

MILWAUKEE & WISCONSIN'S ONLY TRUE AUDIOPHILE DEALER

Specialists in components by: G.A.S., Yamaha, KEF, Tandberg, Dahlquist, DCM, Fried, Quatre, Stax, SAE, Connoisseur, Transcriptors, Grace, Nakamichi, Infinity, Dynaco, Crown, Ortofon, Sonus, ADC, Hafner, DBX, Akai, Teac, Revox, MXR, Technics and many many more. Featuring a very unique switching system for instant component comparisons. Also, one of the largest tape recorder displays in the country, with over 130 machines on display. WACK ELECTRONICS, INC. 5722 W. NORTH AVE. MILWAUKEE, WI. 53208. PHONE: 414-442-3441 TF

MINI MITE IS HERE! We at Audible Illusions feel a real need for offering the music lover an alternative to high priced audio components. As a result we have developed a special line of low cost ultra musical components. The Mini Mite I is a basic preamplifier that costs under 350 dollars. The Mini Mite II is a 45 watt per channel amplifier that is less than 500 dollars. Both units are all tube and were designed by the Paragon and Precision Fidelity circuit designer. For more information write to: Audible Illusions, 3400 De La Cruz Blvd., Suite H, Santa Clara, CA 95050. Dealer inquiries invited.

MITSUBISHI DAC 20 Tuner-Preamp; \$385. Reply Box A20-1 c/o Audio magazine.

MIXER made especially for tape duplication. Will produce enhanced high quality second generation tapes. KUHN ELECTRONICS, 1801 Mills Ave., Norwood, OH 45212. TF

NORTH CAROLINA

A complete selection of high quality components for the discriminating music lover. For your pleasure, we offer two locations drawing audiophiles from the Blue Ridge to the Atlantic, knowledgeable staff with decades of combined experience and these fine products:

AVID	ANALOG ENGINEERING ASSOCIATES
STAX	DCM TIME WINDOWS
DENON	MICRO-ACOUSTICS
REVOX	CONNOISSEUR
SONUS	KEITH MONKS
LUXMAN	YAMAHA
VISONIK	HAFNER
ACOUSTAT	FRIED
RAPPORT	CROWN
AUDIONICS	ONKYO
DYNAVECTOR	GRACE
LINN SONDEK	SUPEX
PHASE LINEAR	REGA

PLEASE VISIT ONE OF OUR SHOWROOMS
STEREO SOUND

175 E. Franklin St. 3443 Robinhood Rd.
Chapel Hill, N.C. 27514 Winston-Salem, N.C. 27106
(919) 942-8546 (919) 768-0150

SUPERIOR AUDIO COMPONENTS: Audio Pulse; Audio Research SP-6 tube preamp and D-110 amp; Badap 1; Celestion; Cizek; Crown Distinction Series DL-2, SA-2, and EQ-2; Dayton Wright; dbx; Decca; Denon; Dynavector; EMT; Formula 4; Grace; Hafner kits; KEF; Kenwood Purist; Lux LRS; Magneplanar; Mitsubishi; Mobile Fidelity records; Nakamichi; Plasmatronics; Polk; RTR; Verion; Watson speakers.



233 East Lancaster Avenue, Wynnewood, Pa. 19096.
(215) 667-3048 or 649-2965.

Audio Excellence

A UNIQUE STEREO SHOWROOM DEDICATED TO THE PERFECTIONIST

Presenting Components from the Prestigious Companies of

THRESHOLD	ROGERS	MAGNEPAN	KOETSU
AUDIONICS	SNELL	PYRAMID	SIGNET
WIN LABS	DENON	OBELISK	HAFNER
BEVERIDGE	AXIOM	SYMDEX	BRYSTON
LINN SONDEK	DCM	MARCOF	SPATIAL
M.A. COTTER	PSE	SUPEX	SYMMETRY
PLASMATRONICS	LUX	TVA	FID. RES.

584 Washington Street, San Francisco 94111 415-433-1335

FOR SALE

Nakamichi 1000 MKII \$1100, Audio Research SP-4A Preamplifier with optional Head Amp MCP-1 \$795. Harry Lawson, 3801 Hogue Rd., Evansville, IN 47712. (812) 422-5851. 2-0

NEW AMPEX MASTERING TAPE 406 (7") 2.25, 407 (7") 3.25 New Scotch or Ampex LN-HO 1200x7 1.50, 1800x7 2.25, 4000x10 5.00 min. 20 pp. all boxed. New type 10" metal Reels Boxed \$4 min. 10 pp. other tapes Avail. Large SASE for Details. MJS, 2514 Seaboard Ave., SJ, CA 95131 408-262-8793.

NEW GOLD PLATED PHONO JACK. Rear mount, gold plated, solid brass jack, w/gold plated ground flag and hardware, \$1.50 ea. Will interchange with Audio Research SP3A-1's phono jacks. Gold plated solid brass shielded phono plugs, \$1.75 ea. Send stamped self addressed envelope for flyer and order form. Minimum order \$10.00. Component Systems, 5556 Personality Court, Indianapolis, Indiana 46227.

NORTHERN CALIFORNIANS

It is our goal to make the joy of music possible for everyone. At any price we offer solid value, superior performance, and traditional service.

We operate on the theory that you as our customer will achieve the greatest long term satisfaction only through a careful analysis of your audio requirements. We strive to offer sober, highly cost effective solutions to meet your specific needs. Please stop in for a refreshing experience with music.

OUR SELECTION INCLUDES:

Magnepan	Audionics	Dahlquist
Tandberg	Threshold	Chartwell
Onkyo	Audire	B&W
JVC	Haffer	Cizek
AKG	P.S.E.	AVID
Denon	Lux	Stanton
Micro	Grado Sig.	AIWA
Connoisseur	Sonus	M&K
Soundcraftsmen	Grace	Rogers

HIGH FIDELITY SHOPPE
1511 North Main Street
Walnut Creek, Calif. 94596
(415) 932-2242

"WE BUILD BETTER SYSTEMS FOR YOU"

Northern N.J.'s finest store-Lux, Mod DQ-10, Grace, B&W, G.A.S. Sleeping Beauty, FR, B&O, Linn, Sondek, Janis, Tangent, R.H. Labs, Grado, AVID and more. University Stereo, 57 E. Ridgewood Ave., Ridgewood, N.J. 07450. 20 minutes from the G.W. Bridge. 201-447-5700. TF

NORTHERN N.J.'s BRAND NEW AUDIO SALON

QYSONIC, CIZEK, LINN SONDEK, NAIM, CHARTWELL, STAX, AVID, TANDBERG, PIONEER, V. A. SYSTEMS, I.M.F., BEYER,

MITSUBISHI, SPENDOR

Obelisk, Hitachi, Marcof, Dahlquist, Supex, D.B. Systems, Nagatron, Sereis 20, Decca, Grado Sig., Micro-Acoustics, Grace, Ultracraft, ADCOM, Monster Cable, Connoisseur, A/T.

THE SOUNDING BOARD, INC.

(201) 445-5006

Ridgewood, N.J.

NORTHWEST! The Tin Ear: Audio Research, Audionics, B&W, Grado, LUX, Magnepan, Polk Audio, RH Labs, Rogers, Supex, Technics, Yamaha and Audiophile recordings. 704 Symons, Richland, WA 99352, 509-946-4459. 9-0

PROPER TONEARM GEOMETRY!! Optimum offset angle, overhang, vertical pivot height and angle. Resonance damping construction. Jewelled pivots. Height adjustable while playing records. Effective mass 2.5 grams. Damped cueing. Anti-skate bias. TA-3A with silicone damping, \$249.00. "Universal" nylon hardware, \$1.00; alignment protractor, \$3.00. Prices include postage and money-back guarantee. JML Company, 39,000 Highway 128, Cloverdale, CA 95425 TF

FOR SALE

PERFECTIONISTS PREFER DYNAKITS

Before Purchase You Owe Yourself Our Quote Mainline 1la, 971 Fronheiser, Johnstown, PA 15902 TF

POLYDAX (AUDAX) Bextrenes, soft domes etc., Decca Ribbon tweeters Leach Amplifiers. Catalog: TA Box 97A, W. Cornwall CT. 06796. Postage now 40c, please help with stamps. 9-8

PROTECT YOUR LPs. POLY SLEEVES FOR JACKET 10", ROUND BOTTOM INNER SLEEVES 9", SQUARE BOTTOMS 6", POLY LINED PAPER SLEEVES 15", white jackets 35". POSTAGE \$1.50. HOUSE OF RECORDS, HILLBURN, NEW YORK, 10931. TF

Quarterly demo dispersal; all items are mint and warranted. \$795 list LUX 1070 receiver \$635 demo, \$395 R.G. Pro 20 Processor \$305, \$485 NAD 3080 amp \$390, \$295 Source Eng. n.r. \$210, \$750 Quad ESL \$560, \$594 IMF super compact II \$475, \$399 Crown D-75 \$320, \$599 Crown D-150 \$475, \$850 Series 20 PLC 590 Table with PA-1000 arm and ZLM select cart. \$630, \$790 Series 20 M-22 amp \$450, \$390 Series 20 C-21 pre-amp \$235, \$1,000 Series 20 F-26 Tuner \$725, \$1,300 Eumig CCD deck \$1,040, \$285 Lux PD-270 Table \$245, \$944 Ariston Table with Grace 707 MKII and Sonus blue cart. \$725, \$350 NAD 5040 table with Sonus red cart. \$725, \$1,038 Cizek Model II's with M-27 subwoofers \$830. NEW ITEMS: Micro Seiki DDX 1000 table \$425, Micro Seiki DQ 43 with MA 707 arm \$580, Series 20 M-25 125 watt amp \$900. Contact us for Audio Pro, Mordaunt-Short, Crown, NAD, Meridian, Eumig, Quad, Gale, Sumiko, IMF, Dirksaeter, KEF, Ariston, Microtech. To order phone 612-475-3124. Inquiries write Esoteric Audio, 250 N. Central Ave., Wayzata, MN 55391.

QUICKEST AIRMAIL DIRECT FROM TOKYO: All brands of Cartridges & Arms of Japan. Ask for latest Quotations with \$1 for postage. JAPAN AUDIO TRADING CO., LTD. Saikaben Bldg., 4-33-21, Kamimeguro, Meguro-Ku, Tokyo 153 Japan. 2-0

RECORDS/TAPES. Major labels, top names at distributor prices. All categories. Complete set of catalogs \$1.00 (refundable) Box 1111, Chatsworth, Calif. 91311.

FOR SALE

RAPPAPORT PRE-1 \$475, Citation 16 \$410, AR-5 spkrs. & MA-1 twtrs. \$225. 302-368-9854. 2-0

REINFORCEMENT, RECORDING DISCO equipment featuring Electro-Voice, Tapco, Numark, Whirlwind, etc. Competitive prices with fast competent mail order service is our specialty. Write or call SONIX CO., Dept. A, Box 58, Indian Head, MD 20640, (301) 753-6432. 10-0

RENOUCE ROTTEN RECORDINGS! Read selected British reviews in the bi-monthly EURO-DISC GAZETTE, then order these European discs judged the finest in technical and musical excellence. Selections mainly classical. Send for free sample issue. No obligation. EURO-DISC GAZETTE, PO Box 337-A, Peterborough, NH 03458. TF

"STATE OF THE ART"
IN STOCK ALWAYS!

SHIPPED PREPAID
ANYWHERE IN U.S.

Credit Cards Accepted,
Trade Ins Welcomed.

Apt/Holman
Audionics
Audio Research
Dahlquist
Denon
Grado
Magnepan

Mitsubishi
M&K
N.A.L.
Nakamichi
Polk Audio
Quad
R.H. Labs
Yamaha

HAWTHORNE
STUDIO 1-503-292-4401

8680SWCanyonRd Portland,OR97225

Audiocom

High Technology Audio

ADS, Allison, Apt, Audio Pulse, Audionics, B&W, Bruer, Burwen, Cotter, Dahlquist, DCM, Denon, Draco, EMT, EV, Eumig, FR, GAS, Grace, Grado, Janis, JR, KEF, Mitsubishi, MK, NAD, Nakamichi, Ortofon, RH Labs, Revox, Rogers, Snell, Spectro, Stax, Symmetry, Tandberg, VA Systems

Major credit cards honored. Phone orders shipped promptly.

177 Sound Beach Avenue, Old Greenwich, CT Phone: (203) 637-3621

DISCLAIMER™

- Greatly enhances bass & mid transients
- Eliminates 80% of disc warp problems
- Vastly improves imaging
- All the benefits of platter weights without the weight
- Great holiday gift for the HI FI owner

\$14.00 plus \$1.00 postage and handling • Check or Money Order

Name _____

Address _____

Qysonic Import Company; 920 S. Placentia, Placentia, Calif.

FOR SALE

ROGERS REFERENCE MONITOR SYSTEM

This is a biamped system designed by Rogers using the incredible LS3/5a's. Hear this system as well as the Rogers Monitor II's, Compact Monitor's, A100 amp and T75 tuner. By appt. Free shipping. Visa & M.C. honored. OXFORD AUDIO CONSULTANTS, Box 145, Oxford, OH 45056, 513-523-3895

SACRIFICE — MUST SELL SME 3009 — SIII TONEARM (\$125). SHURE V-15 IV CARTRIDGE (\$150). BOTH BRAND NEW — NEVER OUT OF BOX. CALL MIKE 919-893-4885 AFTER 6 P.M.

SAEC 308N TONEARM-NEW \$79, JACK 156-979-6784 EVE.

MISSION

773—High Output MC Cartridge \$375
774—Tone Arm \$350
775—Turntable \$750 (est.)
771—Pre-Amp \$750 (est.)
772—Power Amp \$1600
770—Loudspeaker \$1000 (pair)

Individually, each Mission reference component represents a formidable achievement in musical performance. As a system, they combine to provide a truly stunning musical experience.

We ship prepaid and insured in the continental U.S.

Exclusively at

ears nova

749 middle neck road/great neck, ny 11024
(516) 466-5674

FOR SALE

SALE!!!!

TWO FOR LESS THAN THE PRICE OF ONE. Now you can buy two fine RCA (Japan) direct to disc records, Beethoven's appassionata and Lew Tabackin quartet's trackin' for only \$11.95 including postage. That's right. Two records for \$11.95! Rated as reference recordings in the Absolute Sound & Stereophile, these records retail for \$30 for both. Hurry, supply limited. Send check or money order to: Specs Corp., 130 Fallen Leaf Drive, Hillsborough, Calif. 94010 CA residents add Sales tax. 2-0

SAVE UP TO 69% ON OVER 100 TOP BRAND AUDIO COMPONENTS FROM CARSTON STUDIOS. NEW ENGLAND'S AUDIO SUPERMARKET ONE OF THE OLDEST MAIL ORDER FIRMS (EST 1952) AND CERTAINLY ONE OF THE MOST RELIABLE. ALL ORDERS SHIPPED FROM STOCKED WAREHOUSE. SEND FOR PRICE QUOTE AND PRICE LIST. CARSTON STUDIOS, OLD BROOKFIELD ROAD, DANBURY, CONN. 06810. TF

SIEMENS, TELEFUNKEN, GENALEX AND AMPEREX and other top quality audio tubes available at very competitive prices. Contact Jim Wallace at 1203 Success St., Pittsburg, PA 15212 or (412) 322-4706 TF

SOTA PRICE REDUCTION - NAIM 12S 22 - 160 - 120. Mint Cond. Call 615-373-4450 after 7pm only.

SOURCE ENGINEERING

offers all music-lovers and audiophiles:

- Preamplifier-Noise Suppressor (PNS)
 - Source Noise Suppressor (SNS)
 - Volume (dynamic) Range Expander (VRE)
 - NEW Accessory Switching Control (ASC)
- Unique products for collectors of records (78 rpm) and new include:
- Specialist collector's preamplifier
 - Equalizing amplifier (UEA)
- Write us: P.O. Box 506, Wilmington, MA 01887

SOUTH CAROLINA'S ONLY HIGH-END STORE the finest audiophile equipment: British American Sound, P.O. Box 1247 186 King Street, Charleston, SC 29402 TF

FOR SALE

SOUND ADVICE AND POLK AUDIO LOUDSPEAKERS We have the incredible Polk Audio Monitor Series loudspeakers in stock. The Polk's are definitely the best performance per dollar value ever offered in a truly accurate inexpensive loudspeaker. State of the art sound is now available from less than \$200 per pair. We ship freight prepaid anywhere in the U.S. within 24 hours upon receipt of order. Write or call for information on the Polk Audio Monitor Loudspeakers.

SOUND ADVICE

Village Plaza

Ruston, LA 71270

(318) 255-8000

9-9

SOUND COMPONENTS INC.

EXCLUSIVE SOUTHEAST DEALER FOR THE INCOMPARABLE MARK LEVINSON H.Q.D. REFERENCE SYSTEM

The H.Q.D. reference playback system consists of the following components:

- 2 Hartley 24 in sub-woofers
- 4 Quad ESL loudspeakers
- 2 Decca ribbon tweeters (modified)
- 2 Levinson LNC-2 Crossovers (100 Hz & 7 Khz)
- 1 Levinson ML-1 (LEMO) preamp
- 6 Levinson ML-2 amplifiers
- 1pr. Hand-crafted oak or ash trestle stands (for Quads & Decca)

THE H.Q.D. SYSTEM WITH GOOD SOURCE MATERIAL, WILL REPRODUCE A MUSICAL EVENT BETTER THAN ANY SYSTEM WE KNOW OF.

For more information, please write or call:

SOUND COMPONENTS
2710 Ponce de Leon Boulevard
Coral Gables, Florida, 33134
305-446-1659

TWX 812-848-7627

ff

STAN WHITE

Latest thoughts on loudspeaker enclosure Geometry OR 'Demise of the Theory of Relativity' Send \$1.00 to: Tachyon® P.O. Box 204 Bloomingdale, IL 60108.

STEREO REPRESENTATIVES NEEDED!!!

Sell 100 brands!! Lowest Possible Prices!! Krasco—REP DEPT. —998 Orange Ave. West Haven, Conn. 06516TFFILE

SUMO "THE POWER" AMPLIFIER, "THE MOAT" BRIDGE. NEW IN BOX — MAKE OFFER. ALSO USED ARC D-100 \$700, ARC D-100A \$850, Levinson ML-2 \$1425. (408) 244-6724 GARLAND AUDIO. 2-0

SUPER DISC REVIEWS

Vol. II of Critical Record Review has started. CRR is a bimonthly newsletter with sound reviews of today's audiophile discs. Jazz, Rock, and classical discs reviewed each issue. Vol. I was published on time. Only \$6/year. P.O. Box 8766, Jacksonville, FL 32211.

You can pay \$5.00 for an advanced state-of-the-art 60 minute cassette.

Why? Larksong will sell you one for \$1.30 or less.*

- * Pure Micro-Acicular Ferric Oxide
- * Fully Bias and Equalization Compatible
- * Five Screw Case
- * Outstanding Signal to Noise Ratio
- * Lifetime Guaranteed

Treat your hungry power-packed tape machine to a Larksong cassette and get a lot more entertainment for your money. No longer does its thirst for quality cassettes need to be limited by your lean budget.

Now you afford the best — Larksong. One top line of exceptional cassettes available in two styles of boxes. ★ **Dollar Special** — Your first Larksong C-60 cassette with complete tape specifications and postage-free order blank for only \$1. Limit one per customer. Larksong puts it all together so you get more music out. Larksong, Dept. IC, 10 Scott St., Point Arena, CA 95468.

Larksong

WHOLESALE INQUIRIES INVITED

The Real tape breakthrough you've waited for.



LOUD AND CLEAR.
Read all about the K—the amazing speaker that has the power to reproduce even the lowest bass notes—loud and clear. Features the brilliant horn design with Speakerlab innovations like Magnar™ damped horn drivers. One of the only kits available for this unique loudspeaker. Read about K's and all the other great Speakerlab speakers and parts in our free catalog.

Speakerlab®
To get yours write
SPEAKERLAB, Dept. 136
735 N. Northlake Way,
Seattle, WA
98103

FOR SALE

SUPEX SDX-1000 NEW IN SEALED BOXES \$250. STEPHEN SUN 212-677-299.

Tag Sale: parts, Test Equipment, back issues Audio. SASE to: A. Towbin, 436 Orange St., New Haven, CT 06511.

TANDBERG 6041X — overhauled 3 spd. reel to reel — \$250. Reply Box A20-1, c/o Audio magazine.

TAPCO and ELECTRO-VOICE, mixers, equalizers, amps, mics, and raw loudspeakers. Write for low mail order prices, Sonix Co., P.O. Box 58, Indian Head, MD 20640 8-9

TAPE HEAD REFINISHING - Precision method full frequency response. \$15.00 ea. One day service. E. Maher, 5 Evans Place, Orinda, CA 94563.

TEAC 2300S Tape Deck Good Condition. But Needs Heads. Best Offer Over \$200. DAVE (717) 244-1915.

THE AUDIOGRAM®, a pithy independent newsletter now in its third year, provides timely, money saving reports on the latest products and techniques. Our critical integrity and realistic sense of proportion fill the gap between the commercial magazines and the neurotic underground press. Our latest issue of number 12 contains reviews of:

- The best moving magnet cartridge
- The best headamps
- The best turntable mat
- The best tube preamp
- Ultracraft AC300 Mark II

A review of tonearms by Paul Messenger.

\$10/4 issues/1 year. AUDIOGRAM, Box 27406, St. Louis, MO 63141.

THE LISTENING ROOM INC.

590 Central Park Avenue
Scarsdale, N.Y. 10583
(914) 472-4558

Cordially invites you to audition our fine line of equipment. THRESHOLD · BRYSTON · SPATIAL · PYRAMID METRONOME 2+2 · PLASMATRONIC · SPEAKER · DAYTON WRIGHT ESL · QUAD ESL · SNELL ACOUSTICS · DAHLQUIST · KEF 105 · DYNAVECTOR · DENON · YAMAHA · TANDBERG · POLK AUDIO · GRACE · NAKAMICHI · STAX · R.H. LAB · S3/5A BBC MINI MONITOR BY CHARTWELL · KEITH MONK · SEQUERRA · HAFNER · JANIS · FONTEK HEADPHONES · AUDIO PUSLE · LINN SONDEK · OASIS · GREAT AMERICAN SOUND · EMT · HADCOCK · SRATHCLYDE · PSE · OBELISK · MARCOFF · ULTRACRAFT TONE ARM · AUDIO STANDARD · GRADO SIGNATURE III · IMPULSE · FIDELITY RESEARCH · TANGENT · DIRECT TO DISK RECORDS ·

Visit our private studios. We ship free anywhere in the Continental U.S. We invite inquiries. TF

TONEARMS-CARTRIDGES-TURNTABLES at lowest prices. Most brands available, including MC. Send #10 SASE for quotes. Audio Unlimited, 401 Reynolds Circle, San Jose, CA 95112.

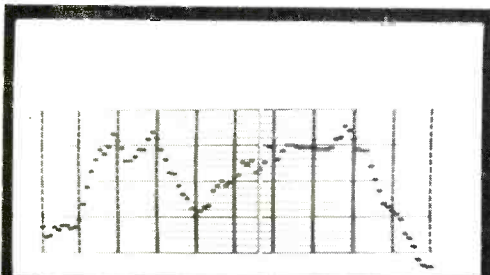

LOW-COST, HIGH-RESOLUTION SPECTRUM ANALYZER
1/9 octave, 0.2dB resolution. Full 20Hz to 20kHz range. Ideal for parametric equalizers but useful with any equalizer. Only \$1,195. Dealer inquiries invited.
Write for free details:

Spies Laboratories
P.O. Box 336
Lawndale, CA 90260
Phone: (213) 644-7047

FOR SALE

THE MONITOR SERIES FROM POLK AUDIO

AUDIO BREAKTHROUGHS now has on demonstration the remarkable new Polk loudspeakers priced from less than \$200 per pair. Compare them to the finest loudspeakers in the world. All Polk Audio Monitors utilize high definition polymer laminate bass-midrange drivers, wide dispersion soft dome tweeters and fluid coupled sub-bass radiators. They are capable of reproducing a highly defined phase accurate three dimensional sonic image which rivals the thousand dollar super speakers. They sound great with a small receiver, yet reveal the fine subtleties of state of the art electronics. Shipped free in U.S. Send for free brochures on Polk or our other fine lines. AUDIO BREAKTHROUGHS, 1534 Northern Blvd., Manhasset, LI, NY 11030 (516) 627-7333 TF

Three Phase Audio

104 Foreman Drive (318) 981-4951
Lafayette, LA 70503(318) 981-4952

Ariston	Mitsubishi Auto
Audio Technica	Mobile Fidelity
Becker	MXR
Berning	Osawa
B&W	Plasmatronics
BCW	Precedent Audio
Dual	PS Audio
Fuji	Quatre
Fulton	Revox
Hartley	Shure
Kenwood	Sonax
Keith Monks	Sony
Marcoff	Ultracraft
Meridian	

THRESHOLD 400A Cascade \$1000; 317-463-4457.

FOR SALE

THE THETA PREAMPLIFIER

is a six tube preamp which has a passive RIAA network which uses NO feedback! This remarkable device is the most musical preamp that we have heard. Hear it at OXFORD AUDIO CONSULTANTS, Box 145, Oxford, OH 45056, 513-523-3895. Free shipping in the U.S. Worldwide shipping available.

THOUSANDS OF LIKE NEW LP's and prerecorded tapes. Catalogue—\$2.00. House of Records, Hillburn, New York 10931. TF

A SOUND ALTERNATIVE
When you are ready for excellence
in audio...AUDITION

stereo one

perfectionist
audio...
affordably
priced...

Impulse
A.R.C.
Linn-Sondek
Janis
Marcoff
Chartwell
Theta
Rogers LS3 5A
Mordaunt-Short Ltd
Conrad-Johnson
Dahquist
Audionics
G.A.S.
Symmetry
Supex
Grace
Aiwa
Vandersteen
Dual
Ariston
Halter
Micro Seiki

3159 Winton Rd. S.
Rochester, N.Y. 14623
(716) 473-8895

PREPAID SHIPPING—
FULLY INSURED

105

GET IT TOGETHER...

with a

SEAS

Speaker Kit



Dealer Inquiries Invited

SEAS SPEAKER KITS use the finest Scandinavian drivers in computer optimized three-way designs, from \$59.00. For literature and information on SEAS Speaker Kits, raw drivers, and crossover networks, send \$1.00 (refundable upon purchase) to:

THE SPEAKER WORKS

Box 303
Canaan, N.H. 03741
(603-523-7389)

Free information service

To AUDIO readers . . . from AUDIO advertisers

- Look over the below list of advertisers and select those from whom you want more product information.
- Write the numbers on the Reader Inquiry Card and fill in all the information. We will rush your request to each company.

Advertiser	Page	Advertiser	Page	Advertiser	Page
ADS..... Hi-Fi Equipment Write Direct to Advertiser	14	Audio Vision..... Stereo Components Write Direct to Advertiser	96	Electro-Voice..... Hi-Fi Equipment Enter No. 10 on Reader Service Card	30
AKG..... Hi-Fi Equipment Write Direct to Advertiser	61	Ball..... Hi-Fi Equipment Write Direct to Advertiser	63	Empire..... Watts Record Cleaner Enter No. 11 on Reader Service Card Audio Groomer Record Care Enter No. 12 on Reader Service Card Cartridge Enter No. 13 on Reader Service Card	25, 91, 95
Acoustical Mfg..... Quad Hi-Fi Equipment Enter No. 46 on Reader Service Card	88	Bang & Olufsen..... Hi-Fi Equipment Enter No. 5 on Reader Service Card	83	Fisher..... Hi-Fi Equipment Write Direct to Advertiser	12, 13
Adcom..... Hi-Fi Equipment Enter No. 1 on Reader Service Card	39	Barclay Electronics..... Hi-Fi Components Write Direct to Advertiser	102	Franklin Mint..... Ormandy Recordings Enter No. 14 on Reader Service Card	69
Allison Acoustics..... Room Matched Speaker Systems Enter No. 2 on Reader Service Card	16	Bryston..... Model 1B Preamplifier Enter No. 6 on Reader Service Card	89	GE MO Valve..... Gold Lion Valves Enter No. 15 on Reader Service Card	94
American Audiophile..... Audio Store Write Direct to Advertiser	110, 116	Burns Audiotechnics..... Hi-Fi Equipment Write Direct to Advertiser	23	Garland Audio..... Audio Store Write Direct to Advertiser	111
Apt..... Hi-Fi Equipment Enter No. 3 on Reader Service Card	32	Celestion..... Hi-Fi Equipment Enter No. 7 on Reader Service Card	83	Garrard..... Hi-Fi Equipment Enter No. 16 on Reader Service Card	89
Audio Advocate..... Hi-Fi Components Write Direct to Advertiser	112	Chestnut Hill Audio..... Audio Store Write Direct to Advertiser	115	Goldline Connector, Inc..... Analyzer/Noise Generator Write Direct to Advertiser	97
Audiocom..... Audio Store Write Direct to Advertiser	103	Custom Audio Electronics..... Littlite Write Direct to Advertiser	97	Christopher Hansen, Ltd..... Hi-Fi Components Write Direct to Advertiser	111
Audio Concepts..... Hi-Fi Components Write Direct to Advertiser	97, 114	Custom Craft..... Dimension Speakers Enter No. 8 on Reader Service Card	92	Havens & Hardesty..... Audio Components Write Direct to Advertiser	114
Audio Critic..... Publication Write Direct to Advertiser	92	D.B. Systems..... Preamplifiers Write Direct to Advertiser	110	Hawthorne Stereo..... Audio Store Write Direct to Advertiser	103
Audio Den, Ltd..... KEF Speakers Write Direct to Advertiser	113	dbx..... Dynamic Range Expander Enter No. 9 on Reader Service Card	29	International Hi-Fi..... Distributors Enter No. 17 on Reader Service Card	94
Audio Excellence..... Hi-Fi Components Write Direct to Advertiser	102	Dahlquist..... Hi-Fi Equipment Enter No. 45 on Reader Service Card	41	Itone Audio..... Speakers Write Direct to Advertiser	112
Audio Horizons..... Publication Write Direct to Advertiser	115	De Coursey Engineering..... Electronic Crossovers Write Direct to Advertiser	114	JVC..... Hi-Fi Equipment Enter No. 18 on Reader Service Card	37
Audio Insight..... Audio Equipment Write Direct to Advertiser	100	Diafix..... Stylus Re-tipping Write Direct to Advertiser	111	Jensen Car Audio..... Hi-Fi Equipment Enter No. 41 on Reader Service Card	43
Audionics..... Crosscom Moving Coil Cartridge Enter No. 4 on Reader Service Card	75	Discwasher..... SC-1 Stylus Cleaner Write Direct to Advertiser	2	KEF..... Hi-Fi Equipment Enter No. 18 on Reader Service Card Speakers Write Direct to Advertiser	24, 101
Audio Technica..... Telarc Digital Recordings Write Direct to Advertiser	5	Ears Nova..... Audio Store Write Direct to Advertiser	102, 104		

Free information service

To AUDIO readers . . . from AUDIO advertisers

- Look over the below list of advertisers and select those from whom you want more product information.
- Write the numbers on the Reader Inquiry Card and fill in all the information. We will rush your request to each company.

Advertiser	Page	Advertiser	Page	Advertiser	Page
KLH.....	71	Paia.....	92	Speakerlab.....	94,104
Hi-Fi Equipment		Proteus I Lead Synthesizer		Speaker Kits	
Enter No. 44 on Reader Service Card		Enter No. 27 on Reader Service Card		Write Direct to Advertiser	
Kenwood.....	Cov. III	Phase Linear.....	62	The Speakerworks.....	105
Hi-Fi Equipment		Hi-Fi Equipment		Speaker Kits	
Enter No. 42 on Reader Service Card		Enter No. 28 on Reader Service Card		Write Direct to Advertiser	
Krasco Stereo.....	98	Pickering.....	3	Spies Labs.....	105
Hi-Fi Components		Hi-Fi Equipment		Audio Equipment	
Write Direct to Advertiser		Enter No. 35 on Reader Service Card		Write Direct to Advertiser	
L.T. Sound.....	116	Pioneer.....	Cov. II, II	Stereo One.....	105
Hi-Fi Components		Hi-Fi Equipment		Hi-Fi Components	
Write Direct to Advertiser		Enter No. 29 on Reader Service Card		Write Direct to Advertiser	
Larksong.....	104	Polyline Corporation.....	114	The Stereo Shop.....	96
Cassettes		Tapes - Audio/Video		Hi-Fi Components	
Write Direct to Advertiser		Write Direct to Advertiser		Write Direct to Advertiser	
Leigh Instruments.....	28	Primo.....	86	Studer ReVox.....	45
ECD Speakers		PC-20 Condenser Microphone		Hi-Fi Equipment	
Enter No. 20 on Reader Service Card		Enter No. 30 on Reader Service Card		Write Direct to Advertiser	
Lux.....	27	Qysonic Import Company.....	103	TDK.....	15
Hi-Fi Equipment		Disclamp		Hi-Fi Equipment	
Write Direct to Advertiser		Write Direct to Advertiser		Enter No. 36 on Reader Service Card	
MXR.....	33	R.G. Dynamics.....	98,99	TEAC.....	31
Universal Expander		Dynamic Processor		Open Reel Tape Recorders	
Write Direct to Advertiser		Write Direct to Advertiser		Write Direct to Advertiser	
Maxell.....	7	Radio Shack.....	47	Take 5.....	113
Hi-Fi Equipment		Realistic STA-2200 Digital Receiver		Audio Store	
Enter No. 21 on Reader Service Card		Write Direct to Advertiser		Write Direct to Advertiser	
McIntosh.....	87	Reference Monitor International.....	98	Tandberg.....	6
C 32 Preamplifier		Speakers		Hi-Fi Equipment	
Enter No. 22 on Reader Service Card		Write Direct to Advertiser		Enter No. 37 on Reader Service Card	
Memorex.....	11	SME.....	90	Tape World.....	113
High Bias Tapes		Hi-Fi Equipment		Blank Tapes, etc.	
Enter No. 23 on Reader Service Card		Enter No. 43 on Reader Service Card		Write Direct to Advertiser	
Nakamichi.....	57	Sansui.....	19	Technics.....	Cov. IV
Hi-Fi Equipment		Hi-Fi Equipment		Hi-Fi Equipment	
Write Direct to Advertiser		Enter No. 31 on Reader Service Card		Enter No. 38 on Reader Service Card	
Nautilus.....	22	Sanyo.....	59	Time & Life Video.....	81
Recordings		Hi-Fi Equipment		Hi-Fi Equipment	
Enter No. 24 on Reader Service Card		Enter No. 32 on Reader Service Card		Enter No. 39 on Reader Service Card	
Niles Audio Corporation.....	115	Saxitone.....	113	Toshiba.....	17
Audio Equipment		Tapes & Tape Recordings		Hi-Fi Equipment	
Write Direct to Advertiser		Write Direct to Advertiser		Enter No. 40 on Reader Service Card	
Osawa.....	49,72	Shure.....	20,21,85	United Audio (Dual).....	50,51
Hi-Fi Equipment		Hi-Fi Equipment		Hi-Fi Equipment	
Enter No. 25 on Reader Service Card		Enter No. 33 on Reader Service Card		Write Direct to Advertiser	
Hi-Fi Equipment		Hi-Fi Equipment		Yamaha.....	35
Enter No. 26 on Reader Service Card		Enter No. 34 on Reader Service Card		Speakers	
Ovation Audio.....	115	Sigma-Null Corporation.....	99	Write Direct to Advertiser	
Audio Components		Hi-Fi Components		Write Direct to Advertiser	
Write Direct to Advertiser		Write Direct to Advertiser			
Pacific Image, Inc.....	115	Sound Components.....	101		
Renaissance Series		Hi-Fi Components			
Write Direct to Advertiser		Write Direct to Advertiser			

FOR SALE

"TYMPANI 1-D, white, mint, with input jacks + feet, \$850. 919-449-6912."

AUDIOPHILE ACCESSORIES

- DBP-6 PHONO EQUALIZATION KIT..... 27.95
Allows adjusting the input capacitance of the phono input of every preamp and receiver with low loss Polystyrene Capacitors. Gold plated plugs.
- DBP-11 CAPACITANCE LOADING SWITCHING BOX... 79.95
Features selectable loading for two moving magnet cartridges. Gold plated jacks.
- DBP-8 SPEAKER WIRE..... 3 meter..... 6.95
12 gauge with tinned 6 meter..... 11.95
ends, one/pack. 9 meter..... 16.95
- DBP-9 BANANA PLUGS..... 2.85
Set of four solderless connectors.
- DBP-10 PHONO ALIGNMENT PROTRACTOR..... 19.95
Allows adjusting the lateral tracking error of a mounted cartridge to within 1/4 of one degree. Non-technical instructions and carrying case included.
- DBP-12 AUDIO CABLE: Low capacitance (400pF) 9 meter (30 ft.) stereo audio cable, terminated with rugged gold plated phono plugs..... 39.95
- MODIFICATION AVAILABLE: DB-1 to DB-1A..... 52.00
Improved turn on/off transient suppressor on DB-6 or DB-6M Power Amplifiers..... 45.00

At your Dealer or direct from Manufacturer (\$2.00 Handling)

DB SYSTEMS

Box 347A, Jaffrey, NH 03452 (603) 899-5121
Dealer inquiries invited. Overseas distributors in: Benelux, W. Germany, Scandinavia, Japan, Hong Kong, Singapore, Taiwan, France.

FOR SALE

TOP-RATED CARTRIDGES UP TO 70% OFF!!

We feature just about all of the finest phono cartridges on the market at the lowest possible prices. Our selection includes cartridges that are normally sold for the full retail price! Our most popular lines include Acutex, ADC, Crado, Nagatron, Ortofon, Shure, Sonus, Stanton and many others that we can't even mention by name. Just call us at 212-254-3125 for more information or write to Direct Discounts Ltd., P.O. Box 841, Cooper Station, NY 10003. We accept phone orders with your M/C or VISA.

TOURING SOUND SYSTEMS, 2, 4 and 8 Track Studios.
Disco Sound, Cerwin Vega BGW, Altec, Shure, AKG, Tapco, Dyna, Revox, EV, Beyer, Cetec, etc. K & L Sound Service, 75 North Beacon At., Watertown, Mass. 02172. (617) 787-4072.
Att: Ken Berger. TF

TURNTABLE RUMBLE OR FEEDBACK BLUES? After 2 yrs. of research, a suspension system has now been developed to eliminate vibration, allowing your turntable to perform at its best. The sound quality of any stereo system is greatly improved regardless of price! The DISK-FLOATER fits under any type or size turntable. Order now at only \$16.95 UPS prepaid from Grosberg Associates, 1226 E 85th St., Brooklyn, NY 11236.

VACUUM TUBES, tube-peculiar parts. All kits/parts for circuits described in our 230+ page Modification Manual. Write for list to AUDIO DIMENSIONS, 8888 Clairemont Mesa Blvd., San Diego, CA 92123. (714) 278-3310. 9-0

FOR SALE

USED AND DEMO SALE: Mark Levinson ML 1, \$1325; Spatial TVA 1, \$750; Luxman CL-35 Mk III, \$425; Threshold NS 10, \$800; Paragon 12A, \$550; G.A.S. Thadra II, \$750; Kenwood L-07-M, \$495 pr.; Audio Research D100A, \$775; Luxman M-2000, \$600; Threshold 4000, \$1600; Ariston RD 11s, \$225. **GOLDEN GRAMOPHONE, 2858 W. Market St., Akron, Ohio 44313 (216) 864-4411.** 2-0

WE HAVE THE NEW CARVER PREAMP. In stock for immediate delivery the amazing CARVER C-4000 sonic holography preamp. Free shipping within continental U.S. Call or write: **EARDRUM, 16 Eliot St., Cambridge, MA 02138 (617) 489-2504.**

WIN LABORATORIES

- emeric audio components in central new york
- SDC-10 Servo Reference Belt-Drive Turntable \$2500
- SDA-10 Servo Dynamic Arm 950
- SDT-10 Type IIC Semiconductor Disc Transducer 550
- SPG-10 Switching Passive Gain Control 350
- plus THE ARM and the KUETSU MC cartridge
- REFERENCE AUDIO of Dewitt, division of GM/GP, Ltd.
(315) 437-3357 — 8:30-5:15 EST/M-F
5982 E. Molloy Rd., Syracuse, New York 13211

Wisconsin Has; Audionics, Denon, Luxman, Hafler, Polk, NAD, Aiwa, Connoisseur, Braun, STAX, Nagatronics, Grado, R.G., Grafyx, Soundcable and more. Write or call for prices and literature: **Sound Seller, Box 224, Marinette, WI 54143. (715) 735-9002.**

THE NO-COMPROMISE APPROACH BY

AUDIONICS of Oregon

RS-1

REFERENCE STANDARD PREAMPLIFIER

- ALL CLASS-A OPERATION
- ULTRA-TIGHT RIAA EQUALIZATION
- HEAVILY REGULATED POWER SUPPLY
- GOLD-PLATED INPUT/OUTPUT JACKS
- RF-PROOF
- AXIAL TILT CORRECTION—MAXIMIZES CARTRIDGE SEPARATION AND MINIMIZES CROSSTALK
- CARTRIDGE RESISTIVE AND CAPACITIVE LOADING



BA-150

ANALOG-DIGITAL STEREO POWER AMPLIFIER

- HYBRID TUBE/SOLID STATE DESIGN
- C-MOS AUTO-BIAS^{T.M.} CONTROL CIRCUITRY
- USER-SELECTABLE NEGATIVE FEEDBACK
- LOW-POWER SELECTION SWITCH



AVAILABLE AT

AMERICAN AUDIOPHILE

5 SUNRISE PLAZA
VALLEY STREAM, NY 11581
(516) 561-7114

716 MADISON AVE.
NEW YORK, NY 10021
(212) 751-9733



MASTER CHARGE & VISA ACCEPTED



FOR SALE

ANOTHER NEW YORK CITY HIGH END AUDIO STORE?

Not really. Instead of rush A/B comparisons, electronics B.S., flashy switching systems, or high pressure salesmanship, we offer honest advice, audiophile to audiophile, and an open invitation to audition, at your leisure the finest components available in a comfortable setting on Manhattan's east side. Rapport Electronics, Snell Acoustics, Dynavector, KEF loudspeakers, Adcom, Linn-Sondek, Linn Isobarik, Naim, Marcof PPA-I, Meridian, Michaelson & Austin TVA-I, Spondor, Fried, Mordaunt-Short, Precedent Audio, Spatial Coherence, Van Alstine, Strelloff Systems, STD, Connoisseur, Rega Planar, Grace, Supex, Signet, Micro-Acoustics, NAD, AGI, Hadcock, CPU Micro-Tuner, Berning FT-10 and many others.

SOUND BY SINGER AN ALTERNATIVE

For information call or write: Sound by Singer, 227 Lexington Ave., New York, NY 10016. (212) 683-0925. (10:00 AM-10:00 PM) We ship anywhere. 11-0

ANTI-SKATING for AR TURNTABLES!! Proven counterweight design of nickels steel & aluminum construction. Install yourself in minutes. \$7.95 postpaid. (Dealer inquiries invited.) AUDIO INNOVATIONAL PRODUCTS, P.O. Box 1607, Portsmouth, N.H. 03801.

Attention Audio Dealers! Staticmaster Record Brush is Now Available in N.Y., N.J., and Conn. For info contact: Exclusive Representative George G. Angelastro, Jr., 78-39 147th St., 1P, Flushing, NY 11367.

**christopher
hansen
td**

Mark Levinson/Sales & Service
in the West

On Display: Mark Levinson Audio Systems—HQD Reference System, Goldmund Tone Arm, Fidelity Research, Koetsu, Linn Sondek, Rega Planar, Pyramid Metronome, Rogers LS3/5A

Showroom Open: M-F 10-5 and
by appointment

9014 Burton Way
Beverly Hills, California 90211
213-858-8112

We ship prepaid within the U.S.

FOR SALE

ARIZONA AUDIOPHILES

Dahlquist, S.A.E., Revox, Rabco, Nakamichi, Yamaha, Crown, Grace, Stax, Tandberg, Sonab, Supex, Gale, Klipsch, Phase Linear, Uher, Burwen, J.B.L., Harmon-Kardon Citation, A.D.S., Spectro Acoustics, Beveridge, Sennheiser, Teac, Thorens, Stanton, Aiwa, Stax, Micro-Seiki, Fidelity-Research, Genesis, Optonica, R.T.R., B&W, Toshiba, DBX, Signet, Mitsubishi and Mitsubishi V.S.S.

JERRY'S AUDIO EXCHANGE

PHOENIX—334 E. Camelback Rd. (602) 263-9410

TEMPE—130 E. University Dr. (602) 968-3491

TUCSON—5750 E. Broadway. (602) 622-7407

MAIL ORDER HOT LINE—MR. WOZ (602) 265-7841

TF

AT CUSTOM SOUND, we've spent more than two years developing the very best designed cabinet for housing stereo components. Before you invest in a rack or cabinet send 25¢ (stamps O.K.) for our color brochure. Custom Sound, 8460 Marsh Road, Algonac, Mich. 48001.

ARTHUR FIEDLER, THE KINGSTON TRIO AND Buddy Rich! Invite them all into your living room. Send \$1 for catalog offering these and over 250 different artists on Direct-to-disc, Digital and other specially-cut recordings. IMMEDIATE SERVICE! Send today. Sound Concepts, PO Box 7063, Eugene, OR 97401. 11-9

ATTENTION AUDIOPHILES: SPECIAL OFFERING OF VERION PRODUCTS

General Resistance, Inc., the ONLY manufacturer of Verion MK1 Stereo Pickup Transformers, Triaxial Audio Cables, and GS1 Ground Strips has been authorized by Stipulation to sell the remaining inventory of those products:

MK1 Stereo Pickup Transformers (specify pickup impedance): \$350 each.

Triaxial Audio Cable pairs: \$30 per one meter, plus \$5 for each ½ meter added to the pair. All Triaxial cables have RCA-type connectors, at one end, and either bare leads, RCA-type connectors, or male or female DIN connectors at the other. Be sure to specify length and choice of connector.

GS1 silver-plated 12" solid copper Ground Strips with hardware and grounding pig-tail: \$20 each.

All above carry 5-year manufacturer's warranty. Quantities are limited since there will be no further production.

Send official bank check or postal money order immediately to avoid disappointment. Orders shipped prepaid UPS in the USA. Others add shipping. No telephone orders accepted.

GENERAL RESISTANCE, INC.

130 S. Columbus Ave.
Mt. Vernon, NY 10553

FOR SALE

At Paragon of Sound: Berning TF10, Precision Fidelity C-4 and C-7, Conrad-Johnson preamps; MZ-Mod-3 and Panarama, Rogers LS3/5A, Koss Electrostatic speakers; M&K Volks woofer, Fundamental Research subwoofers; Armstrong tuner, Berning tube crossover and Stereo 20 amp; Hadcock tonearm, Denon, Grace, Supex, Dynavector products; and Monster Cable. Call 301-229-2676 (Bethesda, MD) or write P.O. Box 189, Cabin John, MD 20731.

ATTENTION DCM TIME WINDOW OWNERS

We now offer a convenient and attractive way to improve the sound of your speakers. The DCM Time Window, when raised 9 inches off the ground, has an airy and tighter sound: the image is raised and standing waves reduced.

THE DCM TIME WINDOW PEDESTALS are made of heavy duty wrought iron and suit the shape and appearance of the Time Window perfectly. They sell for \$65, per pair. If there is no dealer nearby, order postpaid (Master Charge & Visa accepted) from

R. S. PARK AUDIO ASSOCIATES

5 SUNRISE PLAZA, VALLEY STREAM, NY 11581

(516) 561-7555

DEALER INQUIRIES INVITED

ATTENTION OHIO AND INDIANA AUDIOPHILES

Q/LC has STATE-OF-THE-ART components at reasonable prices.

Precision Fidelity C7

Audionics, Hafler, Vandersteen, Marcof, and many more. Write: Q/LC Audio, 1006 Berkshire Rd., Dayton, Ohio 45419 or call (513) 293-7287, (513) 298-9330.

ATTENTION SOUTHERN AUDIOPHILES

Yamaha	Great American Sound
Dahlquist	Ortofon
Polk Audio	Denon
Bang & Olufsen	Klipsch
Advent	Technics
M & K	Visonik
Aiwa	Sonus
Philips	Maxell

Available at Sound Advice

Village Plaza Ruston LA. 71270 (318) 255-8000. 9-9

AUDIO ALTERNATIVE: A unique specialty audio shop featuring Grado, Promethean, Signet, Sumo, Supex, Denon, SMA, Hadcock, Ultra Craft, Fidelity Research, Ariston, Mission, Thorens, Micro-Seiki, Cotter, Hafler, Audionics, Sumo, Conrad-Johnson, TVA-1, Marcof, NAD, Harmon-Kardon, Rogers, J-R, Linn-Sondek, Infinity, Vandersteen, Thiel, Sigma, Snell, Leach. Advantageous pricing/Pre-Paid shipping cont. USA/Mastercharge-Visa.

Mail inquiries and orders promptly and courteously answered. 1124 East Elizabeth Street, Fort Collins, Colorado 80524.

12-9

ATTENTION PRECISION FIDELITY OWNERS: Have your C4 updated to a C4-A by the designer of the circuit. \$70 exclusive of shipping. Phone 408-255-8585 for scheduling.

STYLUS RETIPPING — NO GIMMICK!

ANY MAKE - ANY MODEL - NEW OR OLD

Our SHIBATA tips will improve response of your stylus

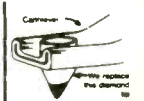

All Decca models	\$45.00	Standard Stylus	\$18.00
All Moving coils with metal tube	\$40.00	Shure Pickering	\$18.00
Empire Audio	\$40.00	Technical Stanton	\$18.00
Grace ADC	\$40.00	Micro Acoustic stylus	\$25.00
Specials: Oods 78 rpm and all others: please write for quotes or call (609) 443-5765			
Ships returned within 48 hrs			
Send to:			
DIARIX 99 Maple Street Rd			
Hightstown N.J. 08520			

GARLAND AUDIO, INC.

**WHERE ONLY THE FINEST
IS GOOD ENOUGH**

AUDIO RESEARCH
MAGNEPAN
LUXMAN
DENON
GALE
F.M.I.

B & W
ROGERS
NAKAMICHI
MITCH COTTER
FIDELITY RESEARCH
R.H. LABORATORY

MARK LEVINSON
SEQUERRA
QUATRE
GRACE
QUAD
G.A.S.

Call or write for a FREE subscription to our quarterly newsletter!

GARLAND AUDIO

2960 Stevens Creek Blvd. • San Jose • (408) 244-6724

Tues/Thurs, 11-8 — Wed/Fri, 11-6 — Sat, 10-5 — and by appointment —

FOR SALE

the audio advocate

SME	Conrad-Johnson
Polk	Keith Monks
Gale	Nakamichi
Cizek	Acoustat
Supex	LS3/5A
Ariston	Onkyo
Magneplan	Hafler
Apt Holman	Grado
Fulton Cable	Rega
Audio Research	ADC

505 Milburn Avenue Milburn, NJ
(201) 467-8988

WANTED TO BUY OR TRADE

"REMOTE CONTROL FOR DOKORDER 9200 WANTED. WRITE: Ocampo, 1346 Springvalley, Wheaton, IL 60187."

Wanted: ESS Elites, & ESS Transtatics. State Price & Condition. G. Beyer, SRA Box 4029-B, Anchorage, AK 99507.

WANTED: MARANTZ & McINTOSH TUBE EQUIPMENT. Sam Aberst, P.O. Box 480436, L.A., Calif. 90048 (213) 276-6727. 9.9

WANTED: McINTOSH C22 + 275 + 240 + MC 3500 and MARANTZ 7C + 9 + 8B 713-729-1658, TEXAS.

WANTED: Old microphones, pre 1940, for my microphone museum. Also mic related items and literature. Write: Bob Paquette, 443 N 31st St., Milw., WI 53208.

PLANS & KITS

FREE! Exotic Veneer Sample Plus Illustrated Supply Catalog With Simplified Instructions. Announcing! New Iron-On Veneering Technique. Learn How To Create Beautifully Veneered Furniture Quickly, Easily! Exotic Veneers, Inlays, Supplies. Hurry! Morgan Alk13, 1123 Bardstown Rd., Louisville, Kentucky 40204.

TAPE-SLIDE SYNCHRONIZER, multiprojector lap-dissolve plans, \$5.50. With mixer, compressor, preamp schematics, \$8.50. The Millers, 1896 Maywood, S. Euclid, OH 44121. TF

PLANS & KITS

UNCONVENTIONAL REPLACEMENT KIT for single-play turntable mat. Greatly reduces dust contact. \$3.50 postpaid. AUDIO PLEASURE, P.O. Box 498, Croton-on-Hudson, NY 10520. 2-0

BUSINESS OPPORTUNITIES

CABLE FM BROADCAST STATION. Unique no investment/experience business makes money! Others work for you! Free Details "CAFM," Box 130-N4, Paradise, CA 95969

CAMPUS REPS - High Performance Loudspeakers, Box 18009, Seattle, WA 98118 TF

DISTRIBUTORS to FOREIGN MARKETS who wish to sell refined speaker systems, audio furniture and accessories. Contact Sales office at: KA/KINETIC AUDIO/KUSTOM ACOUSTICS, 6624 W. Irving Park Rd., Chicago, IL 60634. (312) 685-6609, 6434.

RECORD LIVE MUSIC PART TIME FOR FUN AND PROFIT! USE YOUR OWN HOME SOUND EQUIPMENT. LEARN FROM OUR 15 YEARS EXPERIENCE. DEVELOP YOUR OWN RECORDING BUSINESS. SEND \$4.75 to HSC, Box 4870, Austin, TX 78765.

Want money? Hate hard work? Lazy way to big money. Cleaver plan \$2.00 (Refundable) Noble, Box 10033, Houston, TX. 77206.

HELP WANTED

AUSTRALIA—NEW ZEALAND WANT YOU!! 50,000 Jobs! Big Pay! Reports \$2.00. AUSTCO, Box 2069-K, La Puente, CA 91746 1-0

RADIO-TV Jobs... Stations hiring nationwide! Free details: "Job Leads," 1680-PH Vine Hollywood, CA 90028

TERRITORIES still available to REPRESENTATIVES and/or AGENCIES who wish to sell refined speaker systems, audio furniture and accessories. Send resume to: KA/KINETIC AUDIO/KUSTOM ACOUSTICS, 6624 W. Irving Park Rd., Chicago, IL 60634. (312) 685-6609, 6434.

TAPE RECORDINGS

CHRISTMAS CAROLS CASSETTE ... 60 minutes ... \$2.95 plus 50c postage ... EKR Classics, GPO Box 1977A0, New York City, 10001. 10-0

ON OPEN REEL from master tapes. Argo, Telefunken, Vanguard, Unicorn, MHS. Catalogue \$1.00. Barclay-Crocker, Room 1470-A, 11 Broadway, NYC, 10004. TF

OPEN REEL TAPES. 7½ips, Dolbyized releases from RCA, London, DG, Warner and others. Airline tapes, quad. Catalog and updates, \$1. THE REEL SOCIETY, P.O. Box 55099-A, Valencia, CA 91355. 9-9

Bob Heenan Sells Great Used Equipment

Tel: 617-734-2727
Sound Advice
Box 782
Brookline Village
MA 02147

AR	Mark Levinson	GAS
dbx	Magneplanar	SME
KLH	QUAD ESL	Denon
Bose	Rappaport	Dynaco
P & W	Bryston	Thorens
Advent	LS3/5A	Dahlquist
APT/Holman	Hafler	Nakamichi
Bang & Olufsen	JBL	Marantz (tubes)
Audio Research	DB	and much more

Equipment bought, sold,
traded & brokered
Money Back Guarantee

LOWER LOUDSPEAKER DISTORTION



The VMPS Tower II speaker system, with its unique multi-band bass technique—flat to 22 Hz—and aperiodic enclosure design generates **three times less** harmonic distortion (0.7% THD 22Hz - 20 kHz/1W input) than the best and costliest competitors.

Its output is completely minimum phase over the full musical range.

Efficiency (103dB/1W/1m), power handling (300W rms), maximum undistorted output (126 dB/1m with rated max input) and dynamic range are enormous.

Linearity and neutrality are the equal of the finest audiophile monitors.

Its periphonic dispersion pattern (bottom-firing slot-loaded subwoofer, top-firing supertweeter) is nearly ideal in any listening room.

The Tower II can be biamped **without** an external crossover, or operated full range from as little as 20W/ch.

Its cost is \$549ea. (optional with dealer) fully assembled, or \$369ea. in easy-to-assemble kit form.

We think this is the loudspeaker you've been waiting for.

There are nine VMPS speaker systems priced from \$72 to \$1499 each, including the Mini-Tower II (\$249ea. kit, \$389ea. assembled), the Super Tower (\$499ea. kit, \$799ea. assembled), and the fabulous 7ft. tall Super Tower II (\$799ea. kit, \$1299ea. assembled theater black, \$1499 in finishes). Kit prices plus shipping. 5 year warranty. Details: ITONE AUDIO, 7301 ROCKWAY, EL CERRITO, CAL. 94530 (415) 526-7084. Dealer and rep inquiries invited.

Western Pennsylvania's Quality Audio Dealer

Threshold	Watson Labs
Bryston	M&K Systems
Apt/Holman	Magneplanar
Nikko	Polk
Sony	DCM Speakers
Hafler	Rogers LS3 5A
Duntech	Infinity
Linn Sodek	Altec Lansing
Grado	Janis
Denon	Thorens
Fidelity Research	ADC
Supex	SAE
Ariston	Visonik
Crate	Blaupunkt
Scheiber Decoder	Grundig
Cotter	AIWA
Marcoff	Sony
Symmetry	Technics Pro

plus much more...

Direct - To-Disc Recordings

SHIPPED PREPAID & INSURED

OVATION AUDIO

6019 Broad St. Mall
Pittsburgh, Pa. 15206
(412) 441-4550

INSTRUCTION & EDUCATION

"PASS FCC EXAM" over 1200 questions, answers, discussions, illustrations. 3rd, 2nd, 1st, phone, radar, broadcast, endorsements. \$14.95. SPECIFIC SKILLS INTERNATIONAL Inc., P.O. Box 1233, Cocoa, Florida 32922. Mastercharge/VISA. 2-0

RADIO & TELEVISION BROADCASTING

hands-on course at professional studio. Placement, Accredited, Veterans. School of Communication Arts, Division Communication Arts, Inc., 2526 27th Avenue South, Minneapolis, MN 55406 - 612-721-5357. Free Catalog.

TAPE AND TAPE RECORDERS

SCOTCH RECORDING TAPE, lowest prices TAPE CENTER Box 4305B Washington, D.C. 20012. USA, APO, FPO 5-9

BLANK TAPE SALE

TDK SA-C90	3.05	AMPEX GRANDMASTER I-90	2.69
TDK AD-C90	2.45	AMPEX GRANDMASTER II-90	3.09
TDK D-C90	1.50	Scotch 212-7R-1800	3.99
TDK SA-C60	2.15	Soundguard Record Pres Kit	4.59
BASF PRO I C-90	2.79	TDK L-1800	5.13
BASF PRO II or III C-90	2.89	TDK LB-1800	6.31
BASF Studio II or III C-90	2.59	AMPEX Grandmaster 1800 ft Reel	5.95
SCOTCH Master II or III C-90	3.15	SCOTCH 207-7R-1800	5.09
SCOTCH Master I C-90	2.69	BASF Studio 1800 ft Reel	6.49

All tapes can be assorted. No minimum order. Shipping 3.00 per order. Or write for free catalog of over 250 products, including lowest prices on all Maxell products. All tapes 100% guaranteed. Free gift with every order. 412-283-8621 M-Th 9-4

TAPE WORLD, 220 Spring St. Butler, PA 16001

SAVE up to 80% BY MAIL on: SCOTCH, TDK, BASF, MAXELL, MEMOREX, CAPITOL MUSIC TAPE, CERTRON (over 180 different reel & cassette tapes to choose from), top brand recorders, America's largest collection of taping accessories, too. Same day service. **FREE catalog.**

America's Recording Tape Specialists

SAXITONE TAPE SALES

1776 Columbia Rd., Washington, D.C. 20009
(202) 462-0800

TAPE AND TAPE RECORDERS

ABSURDLY LOW PRICES ON AUDIO/VIDEO TAPES & MACHINES Panasonic (VHS) PV-1200 \$749, Panasonic (VHS) PV-1600 \$899. Add \$25 shipping (USA) & N.Y. add 8% tax. Tapes (lots of 10 only) TDK DC-90 \$1.49, SAC-90 \$2.90, T120 (VHS) \$15.25. Sony LNX-90 \$1.59, FECR-90 \$3.49, L500 (BETA) \$12.95, L750 (BETA) \$15.95. Add \$3 shipping for audio tape, \$5 for video tape & N.Y. add 8% tax. For phone quotes and orders call (212) 845-2861 weekdays 4-8. Saturdays 9-2 EST, or write to B&J Audio/Video Inc. P.O. Box 248, Howard Beach, N.Y. 11414.

NAME-BRAND RECORDING TAPE, custom loaded. Available in cassettes, reels, cartridges. Huge savings from manufacturer. Also low everyday prices on Maxell, TDK, Ampex, Scotch, BASF, etc. New catalogue now available. MJS, 2514 Seaboard Ave., San Jose, CA 95131. (408) 262-8793.

TDK, MAXELL, MEMOREX, BASF, cassettes, reels 8-tracks. Lowest prices. New, Guaranteed. **FREE CATALOG.** S & S Audio, P.O. Box 94485, Schaumburg, IL 60194 TF

SERVICES

CUSTOM RECORDING SERVICE, Tapes, discs, and cassettes. Stereo and mono. Live and copies. Editing. Masters and pressings. High quality at reasonable rates. Joseph Giovanelli, Audio-Tech Laboratories, 2819 Newkirk Ave., Brooklyn, N.Y. IN9-7134 TF

NASHVILLE RECORD PRODUCTIONS WILL PRESS HIGH QUALITY PURE VINYL RECORDS FROM YOUR TAPES. SEND FOR SAMPLE RECORD AND PRICE LIST. ALSO FINEST DISC MASTERING. 469 CHESTNUT ST., NASHVILLE TENNESSEE 37203 TF

SERVICES

JBL SPEAKER WARRANTY STATION- RCI, 8550 2nd Avenue, Silver Spring, Md. 20910. Mail orders Welcome.

Mount your Audio System professionally

Send Name/Type of equipment, plus \$3.50 to: J. Miller, 4336 Vanderbilt Pl., Bham, Ala. 35217.

!!!**QUAD LIVES!!!** For all the latest happenings on the surround-sound scene, tune into 4 QUAD/EVOLUTION. THE newsletter for the disc-discriminating Quadophile! Discounts on hard and software!!! 4 QUAD/EVOLUTION, 23757 Canzonet St., Woodland Hills, CA 91367. 2-0

MISCELLANEOUS

COLLEGE STUDENTS! Improve your grades. Send \$1.00 for 356-page, collegiate research papers catalog. 10,250 available. RESEARCH ASSISTANCE, Box 25918AD, Los Angeles, California, 90025. (213) 477-8226. 9-0

TURNTABLE DUST COVER POLISH. Eliminate scratches. 4oz. bottle, \$4.00. Barbalan Enterprises, Box 7278, Strn.M, Edmonton, Alta., Canada, T5E 6C8.

16mm Films, Videotapes. SAVINGS on reels, equipment. Big list. Urbanski, 8142 Kenneth, Chicago, IL 60652. 10-9

EMPLOYMENT INFORMATION

JOURNEYMAN CREDENTIALS GRANTED LEGITIMATE! Write: National Craftsman Union, 210 Fifth Avenue, Suite 1102, New York, NY 10010. 10-0

Connecticut's Progressive Audio Store

Over 350 Titles of Direct-Disc • Keith Monks Record Cleaning • 5 Listening Rooms

M-W 10-7, TH-F 10-8, S 10-5
All shipments pre-paid & insured
Master Charge/VISA/American Express

Acoustat • Apt Holman • Audionics • Bryston • Cizek • Cotter • Cybele • DAC • DCM Time Window • Denon • Grace • Grado • Hafler • JR • Levitation • KMAL • LS-3/5A • M&K • NAD • Pyramid • Quatre • Rappaport • Signet • Sounds Concepts • Supex • Symdex • Tangent • Yamaha • Audiophile Accessories.

TAKE 5 AUDIO 105 Whitney Ave., New Haven, CT 06511 (203) 777-1750

KEF KITS



audio den ltd.

Come Closer to the Real Sound with KEF Speakers. You can now build the famous British KEF 104AB and Cantata Speakers in kit form with savings up to 40%.

"Hearing is Believing"

audio den ltd.
1320-34 Stony Brook Rd.
Stony Brook, New York 11790
(516) 751-3350

PERSONALS

To Jimmy from Wheezle,
You are truly my State-of-the-Art. Happy New Year!

Zibby,
Our love has amplified: No Static, No Distortion!
Happy Anniversary!

Love
Maggie

ANNOUNCEMENTS

Free Promotional Albums, Concert Tickets, Stereos, Etc.
Information: Barry Publications, 477 82nd Street, Brooklyn,
NY 11209.

ACTIVE ELECTRONIC CROSSOVERS

Plug-in Butterworth (maximally flat) filters in 6 db., 12 db., or 18 db., per octave attenuation, any frequency specified. Filters flat beyond 100 KHz.

Complete crossover in attractive metal cabinet with all terminations and regulated power supply.

STEREO BI-AMP \$139

Tri-amp, quad-amp, and monaural types available at comparable prices. Other available features: Summer for "single woofer" systems, Subsonic noise elimination filters supplied with or without bass boost, level controls.

FOR OEM'S AND HOME ASSEMBLERS

500 Series dual filters and/or plug-in filters, regulated power supplies.

FREE CATALOG & PRICE SHEET
Write to:

DeCoursey ENGINEERING LABORATORY

11828 Jefferson Bl. • Culver City, CA 90230
Phone: (213) 397-9668

Buy with confidence

fact:
the IV does more!



Send for Quotes & Price List on Shure & Over 100 Other Famous Brands

SHURE
VI5 Type IV
SUPER TRACK IV

Stereo Dynamic Phono Cartridge

Consistent record tracking has always been challenged by such ever-present factors as warp, static, lint and dust—especially when these factors combine with today's "hot" recordings.

CARSTON 146 OLD BROOKFIELD RD
STEREO Danbury, Conn. 06810
DISCOUNT CENTER (203) 744-6421 (212) 369-6212

MON., TUE-WED., FRI. 9:00-5:30
THUR. 9:00-8:00 P.M. SAT. 9:00-4:30



RADIO PROGRAMS

CATALOGS. Broadcasts, soundtracks. Personalities of Thirties, Forties. Box 225, New York, N.Y. 10028. TF

GOLDEN AGE RADIO. Your best source for radio tapes, reels or cassettes. Box 25215-D, Portland, Oregon 97225. 9-0

RENT RADIO SHOWS: Make your own copies or just listen. Great way to build your collection reasonably. Catalog \$1 refundable. OTR Rental, Box 1146, Livermore, Ca. 94550 TF

1930-1962 RADIO PROGRAMS. Beats television!! Tapes. \$1.00 hour! Established esteemed dealer, informative 200 page catalog \$1.25. Cassette samples \$2.00. AM Treasures. Box 192AU, Babylon, N.Y. 11702 TF

Audio Video
Professional Quality
CASSETTES
TDK • 3M • AGFA
Call/write for free cassette catalog
Polyline 312/298-5300
20 Corp. 1233 RAND RD. • DES PLAINES, IL 60018

RADIO PROGRAMS

YESTERDAYS RADIO ON TAPE. Reels-Cassettes. Quality Sound. Reliable Service. Giant catalog \$1.00 refundable with first order. ADVENTURES, Box 4822-A, Inglewood, California 90302. TF

VINTAGE RADIO and T.V. -Lowest rates. Post Free, Trading, Video too; Signals, Box 5063 Station E., Edmonton, Alta. Canada T5P 4C1. U.S. Inquiries.

PUBLICATIONS

TERRIFIC SWAP OFFERS NATIONWIDE
Rcvrs., amps, TTs, Audio, Ham Gear, Etc. 5 issues \$2! "Electronic Trader," Box 73-A, Folly Beach, SC 29439. T.F.

MUSICAL INSTRUMENTS

ELECTRONIC MUSIC and home recording in Polyphony magazine. Advanced applications, interviews, projects, computer music. Sample, \$1.50. Subscription (6 issues), \$8 US/\$10 foreign. POLYPHONY, Box AM20305, Okla. City, OK 73156. 5-0

Houston and the Gulf Coast

Mark Levinson/Threshold/G.A.S./Apt/Hoiman/Hafler/Advent/Nakamichi/Dahlquist/Magneplanar/KEF/Acoustat/KM Systems/DCM Time Window/Cizek/Snell/Denon/Klipsch/Fidelity Research/Grace/Signet/Cotter/Ivie Analyzers

Audio Concepts

2200 SW Freeway at Greenbriar Houston, Texas 77098 713/527-0774

Credit Cards Accepted Freight Prepaid in Continental USA

In today's ever changing field of audio there exists a storm of hype and confusion. By adhering to certain guidelines we have clearly found our calm in the eye of the storm. Honesty, integrity, and expertise have helped us to create a unique audio environment that is indeed professional in the true sense of the word. The lines we represent speak for themselves.

Audio Research	B & W	Pyramid	Nakamichi
Vandersteen	KEF	Promethean	Luxman
Linn Soudex	Dayton Wright	GAS	Bang & Olufsen
Theta	Denon	Dynavector	RH Labs
Dahlquist	Grace	EMT	Yamaha
Audire	Grado Signature	Marcof	Advent

HALENG HALENG AUDIO SYSTEMS

We ship prepaid throughout the U.S. (714) 897-0166
15102 Bolsa Chica Suite A Huntington Beach, CA. 92649
Store Hours - Mon. thru Fri. 1:00-9:00 Sat. 10:30-5:00 Sun. 12:30-5:00

It's easy to include your message in

Audio

Just fill out this coupon and attach it to your typewritten copy. Presto! You're your own ad agency. Classified advertising is simple, fast, and inexpensive. Take advantage of it today!

AUDIO

1515 Broadway, New York, NY 10036

<input type="checkbox"/> For Sale	<input type="checkbox"/> Services	<input type="checkbox"/> Insert in next issue	<input type="checkbox"/> Insert in next 6 issues
<input type="checkbox"/> Wanted to Buy	<input type="checkbox"/> Situation Wanted	<input type="checkbox"/> Insert in next 3 issues	<input type="checkbox"/> Insert in next 12 issues
<input type="checkbox"/> Business Opportunities	<input type="checkbox"/> Help Wanted	<input type="checkbox"/> Assign box number	
Other (add 10% cost)		Additional cost \$5.00 per issue	

For further information, consult "Rates" at head of Classified Section

HIGH FIDELITY

BRITISH HIGH FIDELITY in El Paso, Texas. There are even fewer for sale second-hand. Ls3/5A Monitor. The much acclaimed BBC design for small speakers. Louis Peinado ("King's Kid") 915-542-1614.

UNZOO OBFUSCATION OF SALON AUDIO. State-of-the-art: Phaseliner II, ANALOG. TECHNICS PRO, NAKAMICHI, KENWOOD, PURIST, PSE, NIKKO, PRO DENON, RTR, MARK LEVINSON, VANALSTINE, DYNA, TANDBERG, KIRKSAETER, LECSON, NAD, MERIDIAN, ULTRASTAT, ONKYO, OTHERS: ADS, BOSE, B&O, MCINTOSH, LPSCH, AUDIO PULSE, BRYSTON, THRESHOLD, DAHLQUIST, KEF, SAE, YAMAHA, LUX, AND OVER 150 MORE. INCREDIBLE DISCOUNTS, PROFESSIONAL ENGINEER AVAILABLE TO GIVE FREE, NO B.S. ADVICE AND INFORMATION. SEND \$5.00 FOR NEWEST 36 PAGE CATALOG CONTAINING 3,000 HIGH-END AUDIO ITEMS; EVALUATED: G.A.E./E., DRAWER 33, (DEPT A), BLACKHAWK COLORADO, 80422, OR CALL (303) 582-5200, 1:00 p.m. until 9:00 p.m. (EST) GOLDEN EAR AUDIO/ELECTRONICS ACCEPTS: MC, VISA, CHECKS, TRADE-INS AND HOME TRIALS.

FOR SALE

AUDIONICS-BERNING

We have in stock the CC-2, the NEW IMPROVED BT 2 and the incredible BERNING BA-150. Free shipping in USA. World-wide shipping. Visa & M.C. honored. By appt. OXFORD AUDIO CONSULTANTS, Box 145, Oxford, OH 45056, 513-523-3895.

FOR SALE

ON OPEN REEL from master tapes. Argo, Telefunken, Vanguard, Unicorn, JHS. Catalogue \$1.00. Barclay-Crocker. Room 1470-A, 11 Broadway, NYC, 10004.

Audio Threshold's
Sensible Sound System
Vandersteen II Loudspeakers
Electrocompaniet Amp Class A
Electro Preamp Built in M.P.

Incredible!
Plus ESS Transar
Grado, Phillips, S.M.E.
Direct to Disc Records
36633 Gratiot, Mt. Clemens, MI 48043
(313) 791-1400

ACCURATE, QUALITY AUDIO EQUIPMENT DISCOUNTED!

Low prices on quality Car and Home Hi Fi Components. Send SASE, call for quotes and literature. Denco Audio, P.O. Box 6104-U, El Monte, CA 91734. (213) 444-9978 evenings, wknd. 9-9

AUDIOPHILES' HIGH FIDELITY COMPONENTS!

Bose, Tandberg, Revox, Nakamichi, Yamaha, ADS, Denon, Allison, Hafler, B&O, Ohm, GAS, Genesis, Rogers, Lux, Infinity, Advent, SAE, Nikko, others. Low, Low Prices! AUDIO AMERICA (Virginia). 804-793-3820. Hours: 10am-6pm. Call Today For Literature and Low Prices!

FOR SALE

LOWEST PRICES ON MAXELL, BASF, TDK, FUJI, AMPEX, tapes. Send #10 SASE for free catalog. Guaranteed!! Audio Unlimited, 401 Reynolds Circle, San Jose, CA 95112.

"**LOWEST PRICES: BOSE, SAE, DBX, TANDBERG, ADS, HK, JBL, AND MORE. DYNAMIC SOUND,** Box 168, Starkville, MS 39759. (601) 323-0705. 1P.M.-9P.M."

GUARANTEED LOWEST PRICES IN U.S.A. On huge selection of fine stereo and video equipment. Over 170 brands available for immediate delivery, including most esoteric lines. Credit cards. Defective exchange privileges. Please write today! Stellar Sound, 13906, Ventura Blvd., Suite 193, Sherman Oaks, CA 91423, (213) 766-9790.

TRADE UP to the MICRO CPU 100 fm tuner

It may have been out of the question at \$2000, but the new retail is \$995. Subtract even more for your trade-in and this magnificent tuner can be yours at a surprisingly low price. We offer very generous trade-in allowances on your old tuner or other audio equipment. A rare chance to own the best at a reasonable price (see Audio, Nov. '77). Write us for a quote, or better yet, phone after business hours and we can discuss your trade-in: (617) 874-0706, mon.-fri., 6-8 pm. (ask for Dick)
AUDIO CALIBRATION, box 250, Westminster, MASS 01473. TF

LEGENDS MOVE AND GROW.

Chestnut Hill Audio has moved and grown. We now represent Audionics, Bowers & Wilkins, Bryston, Cotter, DCM, Denon, Fidelity Research, Grace, Grado, Hafler, Hegeman, Impulse, Janis, JR149, Linn Sondek, Levinson, Marcof, Precedent, Quad, Rappaport, Revox, Rogers, Sequerra, Snell Acoustics, Sony/Pro, Spondor, Symdex, Symmetry, TVA, Tandberg, Tangent, Technics/Pro, Theta, Threshold and Vandersteen. All of these legends at 311 Cherry Street, Philadelphia, Pa. 19106. (215) 923-3035.

CHESTNUT HILL AUDIO LTD.

Pacific Image, Inc. is proud to announce its appointment as the exclusive San Francisco bay area dealer for the astonishing

RENAISSANCE SERIES

Electrostatic loudspeakers, brilliantly engineered and built by Dr. Roger West of SOUND LAB ELECTRONICS.

If you enjoy the means to be able to indulge yourself in what will no doubt become the most sought after esoteric speaker system yet available, arrange for an audition. By appointment only.

PACIFIC IMAGE, INC.

P.O. Box 169
Woodacre, California 94973
415-488-0293

Prepaid shipping within the continental U.S.

AUDIO HORIZONS

P.O. BOX 10973
St. Louis, MO 63135

Issue #3 is now available. It contains reviews of the AUDIO STANDARDS MX-10A pre-pre-amplifier, the DENNESEN Soundtractor, the DENON PCC-1000 phono crosstalk canceller, the JML protractor, and the THETA preamplifier. Issue #3 also features reviews of the BREUER SC, DENON DA-307, DYNAVECTOR DV-505, FIDELITY RESEARCH FR-64s, GRACE G-707MKII, G-704 and G-714, HADCOCK GH-228 Super, INFINITY "Black Widow" GF, JH Audio Labs, LUSTRE GST-1 and GST-801, MAYWARE Formula IV Series IIIIMICRO MA-505X, MISSION 774, SME 3009 Series III, STAX UA-7cf-m, SYRINX PUI, WOODLESS LURNE WLP-1, and ULTRACRAFT AC-3000MC pickup arms, plus reviews of the DENON DL-303, FIDELITY RESEARCH FR-1 MK3F, FULTON RS, GRADO Signature III, KOETSU MC-ONE, LINN ASAK DC-2100K, MISSION 773, ORTOFON MC-30, PRECISION FIDELITY, SUMO II, SUPEX SD-900 Super II and SDX-1000, WIN LABS SDT-10 Type IIC, and YAMAHA MC-1S phono cartridges.

Subscription rates to AUDIO HORIZONS™ for six issues are: U.S. - \$18; Canada and Mexico - \$20; and outside North America - \$26 (AIR MAIL). Please remit in U.S. funds only. Sample copies of all issues of AUDIO HORIZONS are available for \$4.50 each (U.S., Canada, and Mexico), and \$6.00 each (outside North America).

PASSIVE BUT POWERFUL

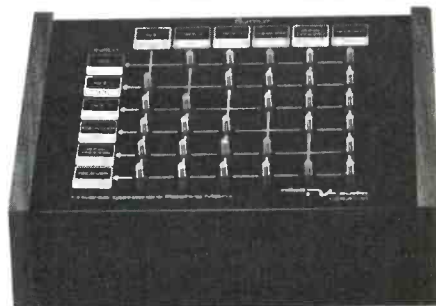

The CPM-31 Universal Component Patching Matrix combines tape decks, equalizers and signal processors in nearly limitless combinations. • It simplifies the tasks of recording, dubbing, equalization, mixing, monitoring and signal processing. • It eliminates the "patch-cord headache." • And the CPM-31 adds no hum, noise or distortion. For more information, write to:

Niles Audio Corporation
P.O. Box 160818
Miami, FL 33116

niles  audio

Dealer inquiries encouraged.

FOR SALE

WORLD AUDIO WESTCHESTER, INC.

Westchester's finest audio sales and service dealer is proud to announce the addition of:

Fried Loudspeakers

to the already fine lines of AR, AKG, ADC, Pro-Accutrac, Quanta, CM Labs, Celestion, Decca, Dir.-to-Disc, Discwasher, J.V.C., J.V.C. Pro., Kos, Lux, L.S.S., Maxell, Panasonic, Pickering, Qysonic Array, Rotel, Scott, Sennheiser, Soundcraftsman, Sound Source, Stanton, Supex, Thoren, Tandberg, TDK. Shipping is free in continental U.S.

WORLD AUDIO WESTCHESTER, INC.

211 North Avenue
New Rochelle, NY 10801
914-576-3230

2.0

YAMAHA CR 2020 Receiver \$550; RG Pro-16B Processor—\$220. Both in exc. cond. D. Altman, 770 Ocean Parkway, Brooklyn, NY 11230. 212-853-1478.

YAMAHA C-2 PREAMP, \$395. (614) 451-1890, (614) 261-2446.

KA/KINETIC AUDIO: Refined speaker systems, ultimate sub-woofers, versatile equipment cabinets, high-tilt speaker stands, audio cable, and more. For information and for dealer nearest you write or call: KA/KINETIC AUDIO, 6624 W. Irving Park Rd., Chicago, IL 60634. (312) 685-6609, 6434.

RECORDS

AUDIOPHILES! Direct-Disc, Digital, Mobil Fidelity-All Labels-Low Prices Fast Service. Write for free catalog. Direct Disc Discounters, 2245 New Hope Church Rd., Raleigh, NC 27604. 9.9

DIRECT TO DISC AND DIGITAL RECORDINGS: All labels at low prices. Telearc, Discwasher, Audio-Technica, Sheffield, Denon PCM, Crystal Clear, Mobile Fidelity Labs. .WE HAVE THEM ALL!! (and more!!) Send for FREE price list and Newsletter or \$2.00 for descriptive catalogue DiSConnection, P.O. Box 10705 Tampa FL 33679.

RECORDS

FREE SOUNDTRACKS & CASTS CATALOG! Personalities! ST/OC Valuebook: \$4. RTSA 711 W. 17th G-1 Costa Mesa, CA 92627. TF

MILWAUKEE! The Audio Emporium: we have over 100 direct discs and other high quality LPs, most labels and constantly new releases. We also have the Keith Monks record cleaning machine. 6900 W. Brown Deer Rd. Open Tues. thru Sat. 10-6, (414) 354-5082. TF

RARE OUT-OF-PRINT LP's. Factory Sealed — 99c to \$3.99 ea. Over 25,000 in stock. List — \$1.00 Record Warehouse, Box 4617, Dept. AO, Rochester, New York 14613.

RECORD HOUND, Box 88A, Eagleville, PA 19408. Fills want list? Doggone right!!! 33% specialist. Fast, friendly service. 10-0

"RECORD JACKETS. Replace old, torn, LP jackets with clean, glossy, pure white or black jackets. Plastic lined inner sleeves, 78 sleeves, opera boxes. Free catalog. CABCO A6, Box 8212, Columbus, Ohio 43201." TF

RECORDSAVERS, POLY-LINED INNER SLEEVES TEN CENTS EACH, POSTPAID, MINIMUM 100. DEO, INC., BOX 452D, GLENVIEW, IL 60025. 6-0

RECORDS, RECORDS, RECORDS

Old, New & Direct Disc too! Send \$1. for Complete Info, S.E.O.J., 519 Wheat, Johnstown, PA 15902. 4.9

SOUSA RECORDS. Free catalog upon request. Stanford. Box 36163, Grosse Pointe, Mich. 48236. 1-0

SWINGING THEATER PIPE ORGAN, Larry Vannucci plays Ain't Misbehavin', 10 others. \$6.95 post paid: Alameda Organ, Box 2174, San Jose, CA 95109.

SPEAKERS

VENEER SPEAKER CABINETS Hardwood Walnut Speaker Cabinets with grill. Routed or unrouted, front baffles, or complete **SPEAKER KITS.** Send self-addressed stamped envelope for complete brochure. **KUSTOMIZED SPEAKER SYSTEMS, 260-A GLENN CIRCLE, POWELL, TN 37849.**

WANTED TO BUY OR TRADE

JBL HARTS-FIELD 1 or Pr. 313-229-7378. 2-9

Manufacturer Seeking Inventions. Advantek, 1100 17th NW, Washington, DC 20036. 10-0

McINTOSH OR MARANTZ any kind of tube amps: Pay top dollar (213) 278-3430, 8633 Airdrome St., LA, Calif. 90035.

McIntosh 3500 US urgently needed. Pay the best price. (514) 482-9372 call collect. 3-0

OPEN REEL pre-recorded tapes. Rock, folk, jazz, classical stereo, quad (8-track quad also). A few of each for sale too. SASE. Ray, 1293 French Ave., Lakewood, Ohio 44107. 11-9

A SINGER'S DREAM!

REMOVES VOCAL FROM MOST STEREO DISCS

The Thompson Vocal Eliminator can actually remove most or virtually all of a solo vocalist from a standard stereo record and yet leave most of the background music untouched! Not an equalizer! We can prove it works over the phone. Write for a brochure and demo record below. COST: \$249.00

YOU SHOULD SEE US

For:

- Delay and Ambience
- Studio Echo/Reverb
- Tape Noise Reduction
- Parametric Equalization
- Electronic Crossovers
- Comp/Limiters
- Mic Preamp/Mixers
- Patch Bays

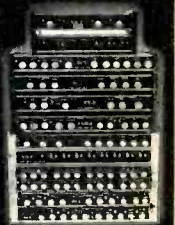

We manufacture a full line of high quality audio and recording equipment. You will probably have to pay twice as much elsewhere to obtain comparable quality. Only Direct Sales make our prices and quality possible. Send \$1 for a 20 page brochure and 20 minute demonstration record.

Write to: **LT Sound, Dept. AU, P.O. Box 729, Decatur, GA 30031. (404) 284-5155**

American Audiophile

recreates the performance in your home through the finest audio components available.

MOVE ONE STEP CLOSER TO THE CONCERT HALL

5 Sunrise Plaza
Valley Stream, NY 11581
516/561-7114

716 Madison Ave.
New York, NY 10021
212/751-9733

- FINEST STATE OF THE ART AUDIO COMPONENTS
- PRIVATE DEMONSTRATIONS
- INTIMATE ATMOSPHERE
- CONSTANT PROOF THAT THERE IS NO REASON TO MORTGAGE YOUR HOME TO GET FINE SONIC PERFORMANCE

WE FEATURE:

AUDIONICS
AUDIO INNOVATIONS
AUDIO STANDARDS
AUDIO TECHNOLOGY
AUDIRE
AXIOM
CIZEK
DAYTON WRIGHT
DCM
DECCA
DENON
GRACE
HADCOCK
HAFLER
H.A.P.I.
IMPULSE
IVIE
JANIS

LEVITATION SYSTEMS

LUSTRE
MARCOF
MICRO SEIKI
NAD
NEXUS
PRECISION FIDELITY
PREMIER
SHURE
SIGNET
SME
SPICA
STAX
STD
SUPEX
THRESHOLD
VANDERSTEEN
VPI
WIN LABORATORIES

REFERENCE AUDIOPHILE RECORDINGS

ALL SHIPMENTS PREPAID AND INSURED
FREE THROUGHOUT CONTINENTAL U.S.

MASTER CHARGE & VISA ACCEPTED

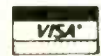

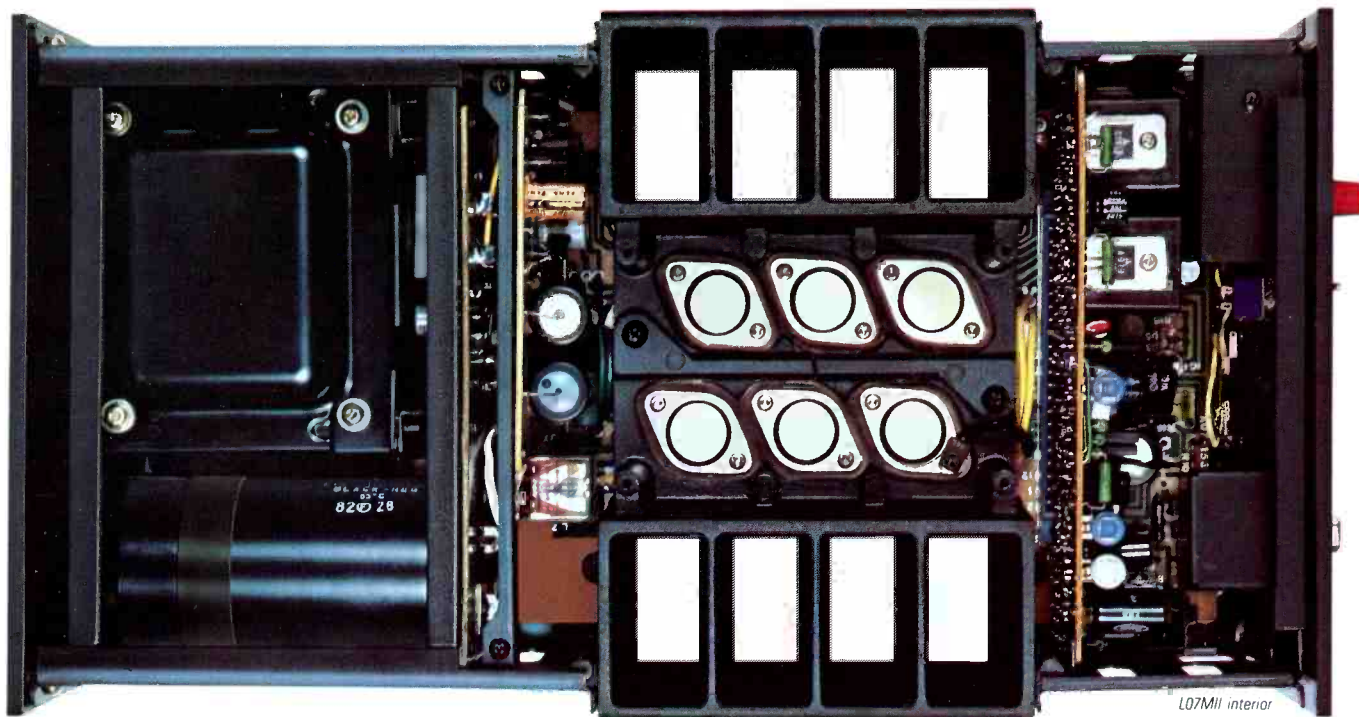

The Ultimate Amp. 0Hz to 600,000Hz (+0-3dB).

For the past several years, a special team of top Kenwood engineers have been re-inventing the amplifier using their most sophisticated innovations in circuit design.

This is the result: The L07MII Hi-Speed™ DC direct-drive amplifier system.

Our research determined that long speaker



L07MII rear

L07MII front

cables seriously degrade sound quality:

Total harmonic distortion doubles, damping reduces by 40%, and there is discernible "ringing." In locating the amplifier close to the speaker by using a special 1-meter cable, THD and damping are not affected and "ringing" is eliminated.



In fact, everything in this amplifier has been engineered to reproduce an input signal audibly free from distortion and coloration. And to achieve a frequency response previously unobtainable. Our DC amplifier improves ultra-low frequency phase shift and transient response. Even the pin plugs of the input cables and locking connectors are gold-plated to insure no signal loss.

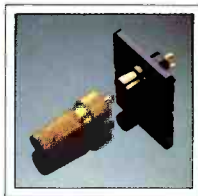

HI-SPEED™

Even more remarkable is the inclusion of Kenwood's exclusive high speed circuitry. By allowing the amplifier to react faster to dynamic changes in the musical input, Hi-Speed produces a more accurate sound. This is especially critical in the mid-to-high frequency transients where conventional amplifiers lose their imaging and detail. The L07MII separates individual singers in a vocal group or individual string players in a symphony orchestra with equal ease.

Of course, to appreciate the many design

innovations requires much more space than is available here. Please write for full technical data at the address below. Or better yet, audition this remarkable amplifier system at a Kenwood Audio Purist Group dealer. If you have the ears to appreciate what the Kenwood engineers have accomplished, the L07MII system will take your breath away.

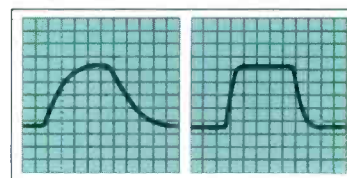

Typical "square" pulse waveform of conventional amplifier.

Pulse waveform of High-Speed amplifier.

Significant specifications: 150 watts one channel minimum power RMS at 8 ohms from 20 Hz to 20,000 Hz with no more than 0.007% total harmonic distortion. SIN 120dB. Rise time 0.55 μSec. Slew rate ± 170 V/μSec.

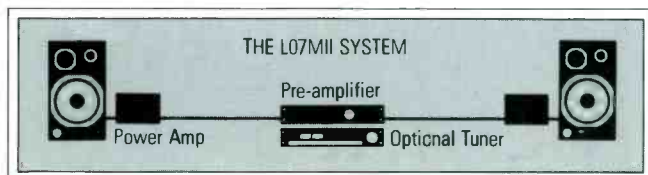

AUDIO PURIST GROUP
KENWOOD®

Not all Kenwood dealers carry these products. For the Audio Purist Group Dealer nearest you, write Kenwood, P.O. Box 6213, Carson, CA 90749. In Canada: Magnasonic Canada, Ltd.

Enter No. 42 on Reader Service Card

Technics RS-M95. When price is no object. But performance is.



There are countless cassette decks to choose from when your object is price. But when your only object is performance, look at the RS-M95 with metal tape capability.

The heart of the RS-M95 lies in its quartz-locked direct-drive capstan motor and its computer-controlled tape tension system. Together, they team up to provide constant tape tension, remarkably low wow and flutter and complete immunity from speed inaccuracy. So when you record an A flat, you'll hear an A flat. No more, no less.

But if more is what you want, you'll get it with metal tape. Because, compared to conventional tape, it gives you a frequency response with more dynamic headroom and more high end extension.

You'll also get the advantage of the RS-M95's three-head configuration: Source/tape comparison. What you don't get is azimuth error, because our HPF record and playback heads are not only precisely gapped, they're also precisely enclosed in a single housing.

To add to the RS-M95's three-head configuration, we added double Dolby*. So you can monitor your tapes with the full effects of Dolby noise reduction.

Another glowing feature of the RS-M95 is its two-colored fluorescent (FL) bar-graph meters. They're fast, thanks to a device attack time of just 5 millionths of a second. And accurate, thanks to a Technics right-slew-factor operational amp for absolute wave and peak detection.

Also included are 4-position tape selectors with bias fine adjustments. A built-in 400 Hz/8 kHz test tone oscillator. A separate, coreless DC motor for reel drive. A microprocessor tape counter with triple memory functions and feather-touch controls.

Technics RS-M95. Its performance is its only reason for being.

FREQUENCY RESPONSE (Metal): 20-20,000 Hz (± 3 dB). WOW AND FLUTTER: 0.03% WRMS. S/N RATIO (Dolby in): 70dB. SPEED DEVIATION: $\pm 0.1\%$.

*Dolby is a trademark of Dolby Laboratories.

Technics

Professional Series

Enter No. 38 on Reader Service Card